

THIRD IMPERIUM

THE WEST'S OWN TRAVELLER MAGAZINE

No. 3 Fall, 1986



MIKE JACKSON '86

NEW!

TRAVELLER STARSHIP COUNTERS

Give your starship battles a realistic touch with new TRAVELLER STARSHIP COUNTERS. This bagged set contains 140 fully illustrated 2cm X 2cm starship counters for Traveller space combat. Printed on four sheets of card, you cut them out yourself.

Each counter shows an illustration of the ship by Mike Jackson and listings of its name and type, tonnage, amount of streamlining, and source book.

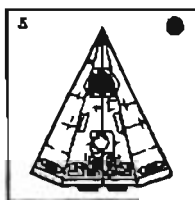

SCOUT/COURIER
100 tons
Basic Traveller
Supplement 7.9
Snapshot

This set contains all the ships from Basic Traveller and Alien Modules 1 to 7. It also contains ships from supplements 7 and 9, The Traveller Adventure, Adventure class ships volumes 1 and 2, Aslan Mercenary Ships, Adventures 1, 4, 6, and 12, Double Adventure 1, the IISS Ship Files, and Third Imperium magazine.

Send \$3.00 Canadian per set to Mike Jackson, No.512, 4676 Yew st. Vancouver B.C. V6L 2J6.

Printed by Third Imperium magazine.

TRAVELLER STARSHIP COUNTERS

Build up your own fleet! Order one or more sets of illustrated Traveller Starship Counters!

Name _____

Address _____

City _____ Province _____

Postal Code _____

Please send me _____ sets of Traveller
Starship Counters.

Total Enclosed _____

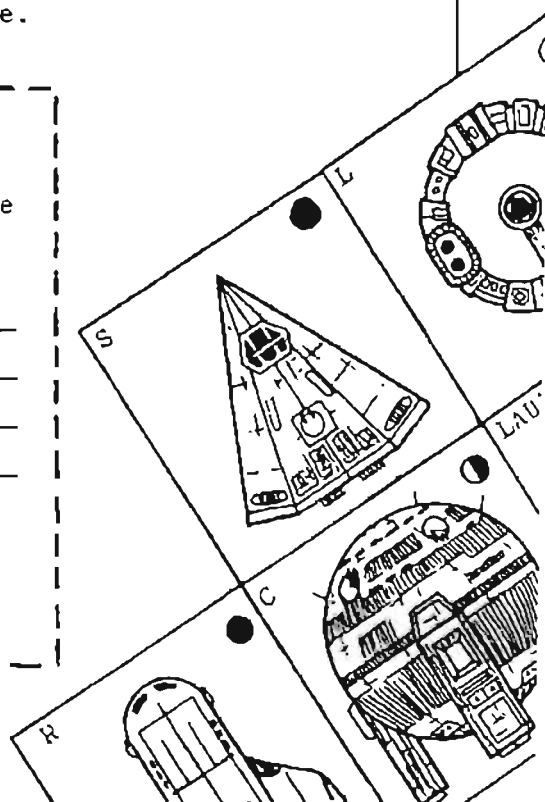

NOTES FROM THE CAPITAL

Welcome to another action-packed issue of Third Imperium! This issue we have a new logo, cleaner titles, and better graphic supplies, so this is at least our best looking issue to date. We have quite a collection of articles as well: we have an exciting new adventure by Aaron van Berg (author of "Out of the Egg, from T.I. no.1), an article on Bounty hunters, a collection of new weapons, and the first installment of Droid Designs. The last is an irregular feature giving various robots built according to Traveller Book 3.

With this issue we also have a new staff member; I would like to welcome David New to Third Imperium.

I would now like to take a bit of space discussing our plans for the

future. Starting next issue we are going to present a series of articles on cyborgs, clones, and androids. Despite their popularity in science fiction, rules for them have never before been published.

We are also considering running several comparison-charts, including illustrations of all the alien races to scale, the symbols of all the major governments, and a complete T1 table including information from all the Traveller books.

Finally, we are soon going to release a special mail-order Traveller supplement; see the ad on the facing page.

-Mike Jackson,
Editor.

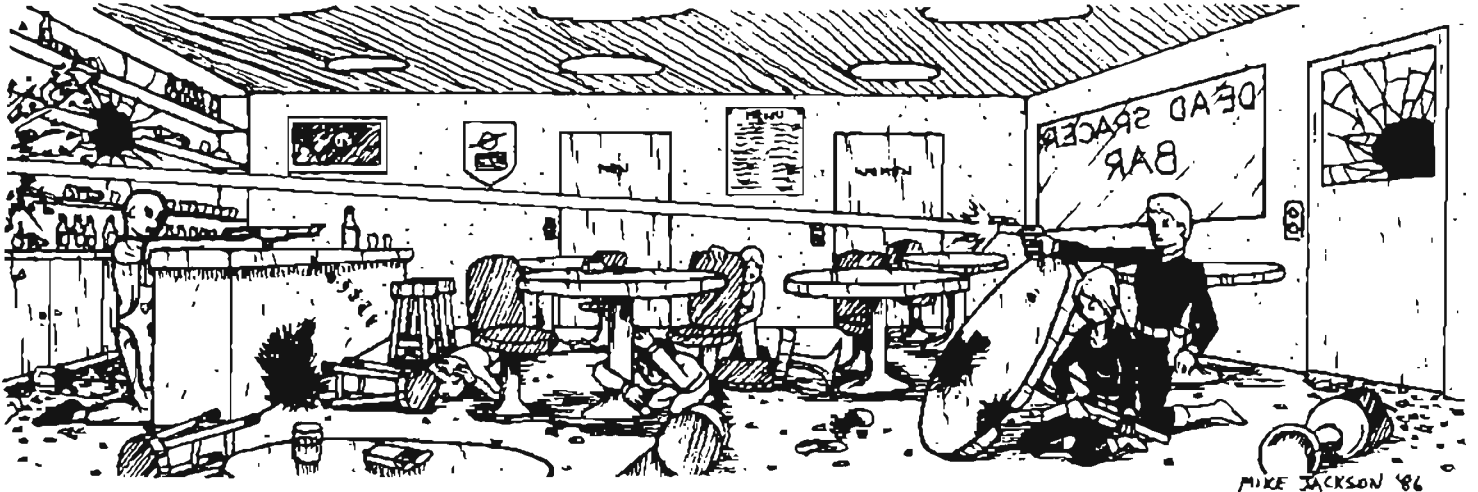

Bounty Hunters.....	4.
Traveller's Hardware.....	5.
Destroyer Escort.....	6.
Gazulin Subsector.....	8.
Feature Adventure.....	10.
Vilani Word Generation.....	14.
New Weapons.....	16.
Droid Designs.....	18.
Traveller's Advice.....	19.
Inside Equipment.....	19.

STAFF: Mike Jackson, Aaron van Berg, Paul Stoneman, David New.
Dedicated to Cameron Carrol, who wanted a more realistic and complex game.

The description of the Destroyer Escort originally appeared in Traveller supplement 9, Fighting Ships, by GDN.

Third Imperium is published quarterly by Mike Jackson. Send submissions, letters, and ads to No.512, 4576 Yew St. Vancouver, B.C. V6L 2J6

BOUNTY HUNTERS

Throughout known space there are always those who commit crimes. However there are not always authorities whose reach extends far enough to catch them. One solution to this problem is the JSB (Imperial Ministry of Justice, Special Branch). The other is Bounty Hunters.

Found almost everywhere, bounty hunters hunt out and kill or capture known criminals. They then return the criminal or his body to the planet that wants him and collect the reward.

Police or government offices will usually have listings of locally wanted criminals. Rewards for their capture vary according to the planet's law level and the seriousness of the crime they committed. Low law-level worlds rarely pay much for any but the most heinous offenders, while high law-level worlds will pay heavily for even the slightest offenders.

Wanted persons usually fall into one of three categories. The first category is light offenders. This includes tax offenders, frauds, and petty thieves. Such persons are usually only wanted in that particular city or state, and fetch rewards between 100 and 2000 credits. They must always be brought in alive.

The second category is serious offenders, including thieves, thugs, arsonists, and kidnapers. They are usually only wanted on that particular world, and fetch rewards between 3000 and 15,000 credits. Only the occasional offender in this category can be brought in dead, and then only on low law-level worlds.

The final category is dangerous offenders, including murderers, hit-men, underworld leaders, and traitors. They are always wanted throughout several worlds, and often throughout an entire sector. Rewards for such criminals are usually from 20,000 to 500,000 credits, half that if they are brought in dead. Dangerous offenders are the type usually listed as "Wanted: Dead or Alive".

Wherever criminals are found you can usually find bounty hunters, so they are most commonly encountered on high population low law-level worlds.

A bounty hunter is anyone who makes a profession of catching criminals. They can come from any service, but unless they are very good with weapons and are skilled at tracking they don't last long. Necessary skills include hunting, street-wise, stealth, and tracking. Thus the best bounty hunters come from the JSB, hunter, or rogue services.

Bounty hunting is frowned upon by most government or police officials, and is actively disliked by the general public. Because of this any dealings with a professed bounty hunter will automatically give a DM-2 on the reaction table.

Bounty hunters must walk a thin line between lawful and lawlessness. They can usually only kill when they have been fired upon themselves, or they will be charged with murder. If they tend to kill more criminals than they capture they may find the JSB coming after them.

Bounty hunters are useful in a Traveller campaign as a deterrent to players close to breaking the law, as a continuing threat to those who have already broken the law, or as a profession for players who don't care about the law. If you are considering running a bounty hunting adventure, remember: the value of the reward is directly proportionate to the dangerousness of the offender. A 100 credit bounty won't attract the players with a fusion gun. Neither will a 500,000 credit bounty sit quietly about while the players grab him.



TRAVELLER'S HARDWARE

NEW DRUGS

Type	price	TL	availability
Pep	600	6	8+
Sleep	20	5	6+
Poison	10/die	2	9+
Poison antidote	50	5	7+
Sober	20	7	4+
Knowledge	40,000	14	12+

PEP DRUG: Pep is a special stimulant available in pill form which holds back all need for food or sleep for 12 hours. The user feels rested and alert, and all of his reactions are as normal. Pep also has the ability to negate the effects of damage- the user will not fall unconscious when a characteristic is reduced to zero; he can continue to fight after his endurance is used up; he will act in all respects as if no damage was taken. Once the Pep wears off all damage effects will return, and the user will take an additional 1D damage.

SLEEP DRUG: A tasteless water-soluble pill, sleep drug puts its user into a deep dreamless sleep that lasts for 12 hours. Nothing will wake the user during that time. Sleep drug takes 10 seconds per point of the user's endurance to take effect (ie: someone with end.7 will take 70 seconds to succumb).

POISON: Available in pills, drinks, injections, and skin absorbed jellies, poison does 1D of damage for every cr10 it costs, up to a maximum of 8D. It takes 1 minute per point of the user's endurance to take effect.

POISON ANTIDOTE: This injection will cancel out the effects of any poison (drug or animal) if it is taken before the poison takes effect.

SOBER DRUG: These pills will immediately cancel out the effects of alcohol or narcotics, making the user sober. It is quite useful in the event of combat after a hard night's drinking. The price indicated is for a box of 10.

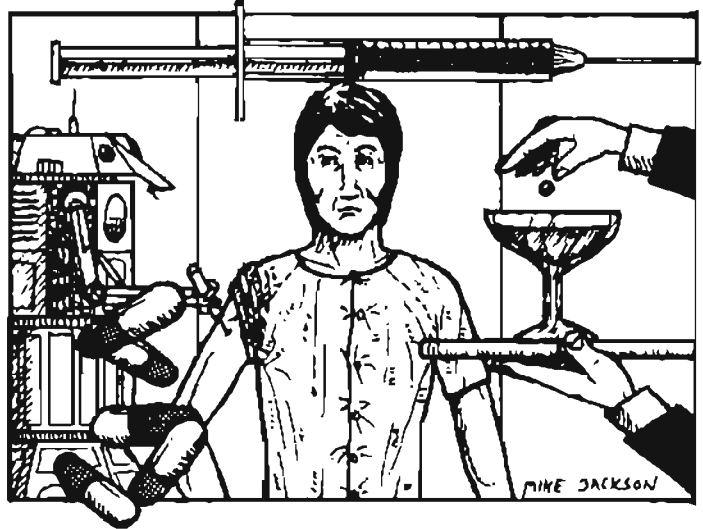

KNOWLEDGE DRUG: Knowledge drug uses RNA to teach the user new skills and knowledge. Each injection can be used to teach one specific skill level, or 3 injections can be used to increase the user's education by one. Education cannot be increased above 15, and the total skill level limit of intelligence plus education still applies.

Knowledge injections must be administered by someone with medical skill to take proper effect. After the drug is taken the user enters a state similar to catatonia, during which time his mind assimilates the data. The player must then roll his intelligence or lower on 2D to leave this state after 2D days. Otherwise he remains catatonic permanently.

RADIATION SUIT

A radiation suit is a large, heavy, lead-lined suit which protects against radioactivity. It consists of a body suit, gloves, boots, and a hood with a transparent visor. It can be worn over most clothes and all armor except vacc-suits, battle dress, and combat armor.

The radiation suit gives +6 protection against radiation effects (see Rad Zone, T.I. No.1). It weighs 71g and is treated as jack armor. cr200. TL 6.

DESTROYER ESCORT

The Chrysanthemum class destroyer escort is a small, fast vessel intended for fleet and squadron escort duties. The design is old but efficient, with examples of the ship serving in the Imperial Navy for over a century. They are ubiquitous ships, being encountered with larger fleet elements as well as alone.

The Chrysanthemum destroyer escort has been pressed into service in a variety of non-escort duties, including orbital patrols, police operations, garrison duties, and even limited strike missions.

SPECIFICATIONS:

Tonnage: 1000 tons standard.
 Crew: 6 officers, 10 ratings.
 Dimensions: 48m L x 27m W x 14m H.
 (Deck B has 5m ceiling)
 Acceleration: 6-G constant.
 Jump: 4.
 Power plant: 9. 90 EP. Agility-6.
 Engineering: 1 Deltic 1201 JK fusion power plant driving 2 LSP Fardrive jump units and 1 Dupree 639 impulse maneuver drive.
 Gravitics: Heavy-duty inertial compensators. 16 floor field.
 Electronics: ISM model/9 fib with fibre-optic back-up.
 Range: Unlimited maneuver.
 One jump (490 tons fuel).
 300 days supply consumption.
 Armament: 2 triple missile turrets in 1 battery. 1 dual fusion turret. 2 particle accelerators in 1 battery.
 5 triple sandcasters.
 Screens: Hull armor factor-1.
 Configuration: Close structure. Partial streamlining.
 Vehicles: 1 50-ton cutter.

DECK PLAN LOCATIONS

1. Avionics.
2. Air lock.
3. Ship's locker.
4. Fibre-optic computer back-up.
5. Ordnance storage. Spare missiles and sand canisters are stored here.
6. Bridge. Positions for pilot, navigator, Computer officer and communications officer.
7. Computer. Access through removable access panels.
8. Gunnery. Remote control panels for the sand-caster turrets. Positions for five gunners.
9. Gunnery. Remote controls for the other turrets. Positions for three gunners.
10. Sick bay. Facilities for medical officer and three patients.
11. Records office. Ship's records and a safe are kept here.
12. Cutter.
13. Fuel scoops.
14. Fuel tanks.
15. Jump drive.
16. Common area. Contains mess and recreation facilities.
17. Galley. Contains food storage and preparation facilities.
18. Officer's stateroom.
19. Officer's stateroom.
20. Officer's stateroom.
21. Officer's stateroom.
22. Officer's stateroom.
23. Officer's stateroom.
24. Power plant.
25. Maneuver drive.
26. Stateroom.
27. Stateroom.
28. Stateroom.
29. Stateroom.
30. Stateroom.
31. Stateroom.
32. Stateroom.
33. Stateroom.
34. Stateroom.
35. Stateroom.

DESTROYER ESCORT	DE-A446932-150000-05024-C	Mar729.11	1000 tons
batteries bearing	5	1 11	TL=15.
batteries	5	1 11	Crew=16.
Passengers=0. Cargo=0. Fuel=490. EP=90. Agility=6. Troops=0. One Cutter.			

CHRYSANTHEMUM CLASS DESTROYER ESCORT

DECK
'A'

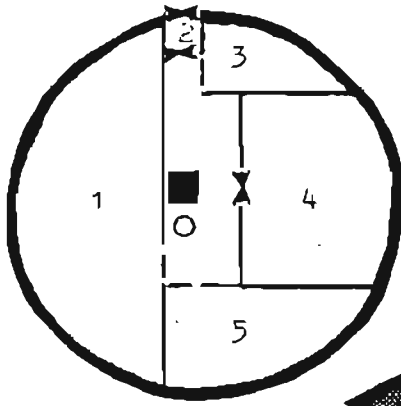

1.5 meter squares
for use with Snapshot
or Azhanti High Lightning



DECK
'B'

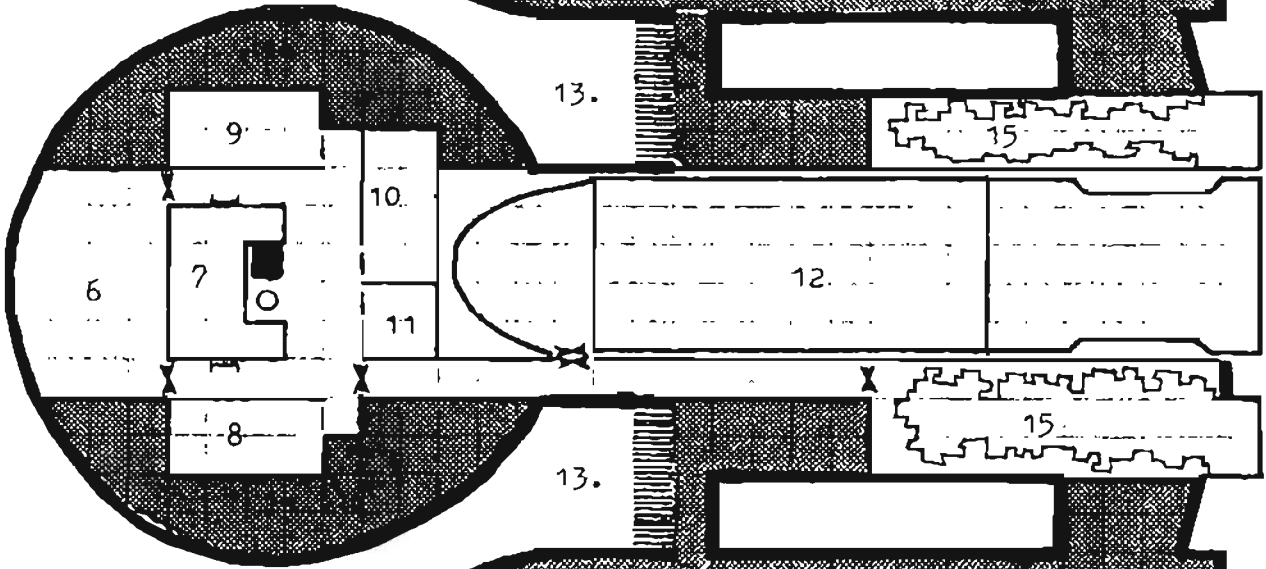

DECK
'C'

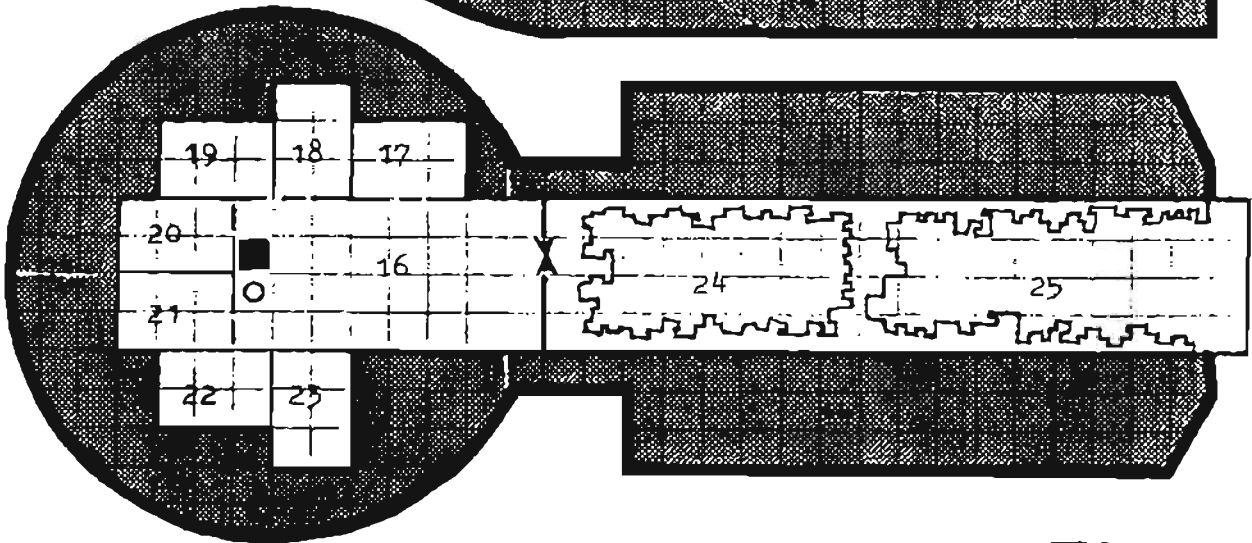

DECK
'D'

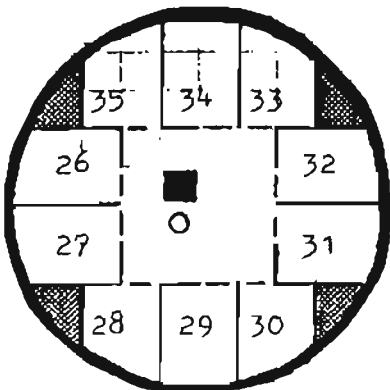

Deck Plan Symbols			
	Interior Wall		
	Sliding Door		
	Lift Shaft		
	Maintenance Hatch		
	IRIS VALVE		MANUAL HATCH
	Iris Valve		Hatch
	Overhead		Overhead
	Floor		Floor
	Both Floor and Overhead		Both Floor and Overhead

GAZULIN SUBSECTOR

Gazulin was the first subsector to be explored and settled in the Trojan Reaches, and as such has a rich cultural heritage. It is regarded as the cultural and artistic center of the sector, with three rich worlds and five worlds with breathable atmospheres. It is the suburb of the Trojan Reaches, attracting thousands of tourists and retired businessmen every year. The subsector is entirely controlled by the Imperium, and has been since its colonization.

Due to certain peculiarities of astrography Gazulin subsector maintains its x-boat link to the Imperium through Tobia subsector rather than through the Spinward Marches. Through this same peculiarity Pax Rulin subsector is completely isolated from the rest of the sector, and is administered from the Spinward Marches.

BELT-9 is one of eleven asteroid belt systems in and around the Imperium owned by Sternmetal Horizons. It is operated almost entirely by robot mining vehicles, with a few humans for supervision and repairs.

OKEEFENOKEE is almost completely covered by thick marshes and swamps. All settlements are raised above the water on stilts sunk deep into the ground. Transport is by hovercraft.

MacDERMONT is named after its first settler. It is currently recovering from a failed revolution, and is ruled from Gazulin.

FINTOR has an amber-zone classification because of the strange religious rites practiced by its populace, including human sacrifice.

627-301 is a restricted Imperial research station. The asteroid belt and gas giant orbit at 154 A.U. around a black hole, and it is being intensively studied.

NAME	STATISTICS	REMARKS	
Labora	0101 B533544-7	Poor. Non-industrial.	G
Belt-9	0202 B000213-E	Asteroid Belt.	G
Corben	0304 B545455-8	N Agricultural. Non-industrial.	G
Gazulin	0305 AA866c7-3	A Rich. Subsector capital.	G
Okeefenokee	0309 D879625-7	S Non-industrial.	G
MacDermont	0401 D200766-8	Vacuum world. Non-agricultural.	G A
Junction	0404 B763773-6	Rich.	G
Peridot	0405 B989894-A	N Rich.	
Fintor	0407 B440344-7	Poor. Non-industrial. Desert.	G A
Bleak	0502 C9C6225-9	S Non-industrial.	
Iscand	0504 B795553-B	N Agricultural. Non-industrial.	G
Kirage	0509 A560876-A	Poor. Non-industrial. Desert.	G
Susanawo	0510 D68A430-5	Non-industrial. Water world.	
627-301	0603 E000120-F	Asteroid belt. Research station.	G R
Neumann	0705 B876AA9-D	N Industrial.	G
Floderash	0707 D303696-8	Non-industrial. Ice-capped.	

The Gazulin subsector contains 16 worlds with a population of 14,906 billion. The highest population is A, at Neumann; the highest tech level is F, at 627-301.

Listings: The base code "N" represents an Imperial Naval base. "S" represents an Imperial Scout base. "A" represents both on the same world.



MAP LEGEND

WORLD CHARACTERISTICS

- Water present
- No water present
- ✱ Asteroid belt

BASES

- ★ Imperial naval base
- ▲ Imperial scout base
- ▼ Scout way station
- ▲ Research station
- ☆ Foreign naval base
- Foreign military base

TRAVEL ZONES

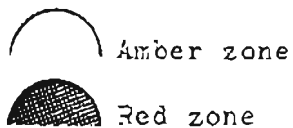

POPULATION

Secundus under one billion
 PRIMUS over one billion

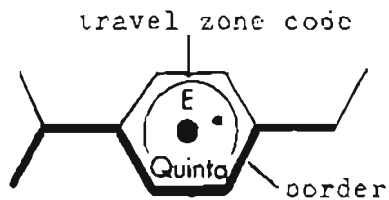
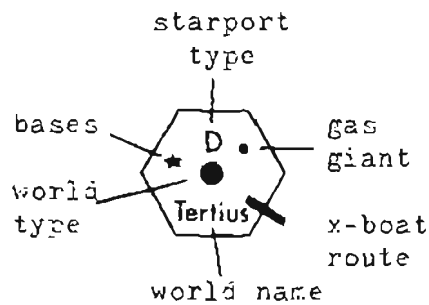

TROJAN REACHES SECTOR

TRIN'S VEIL

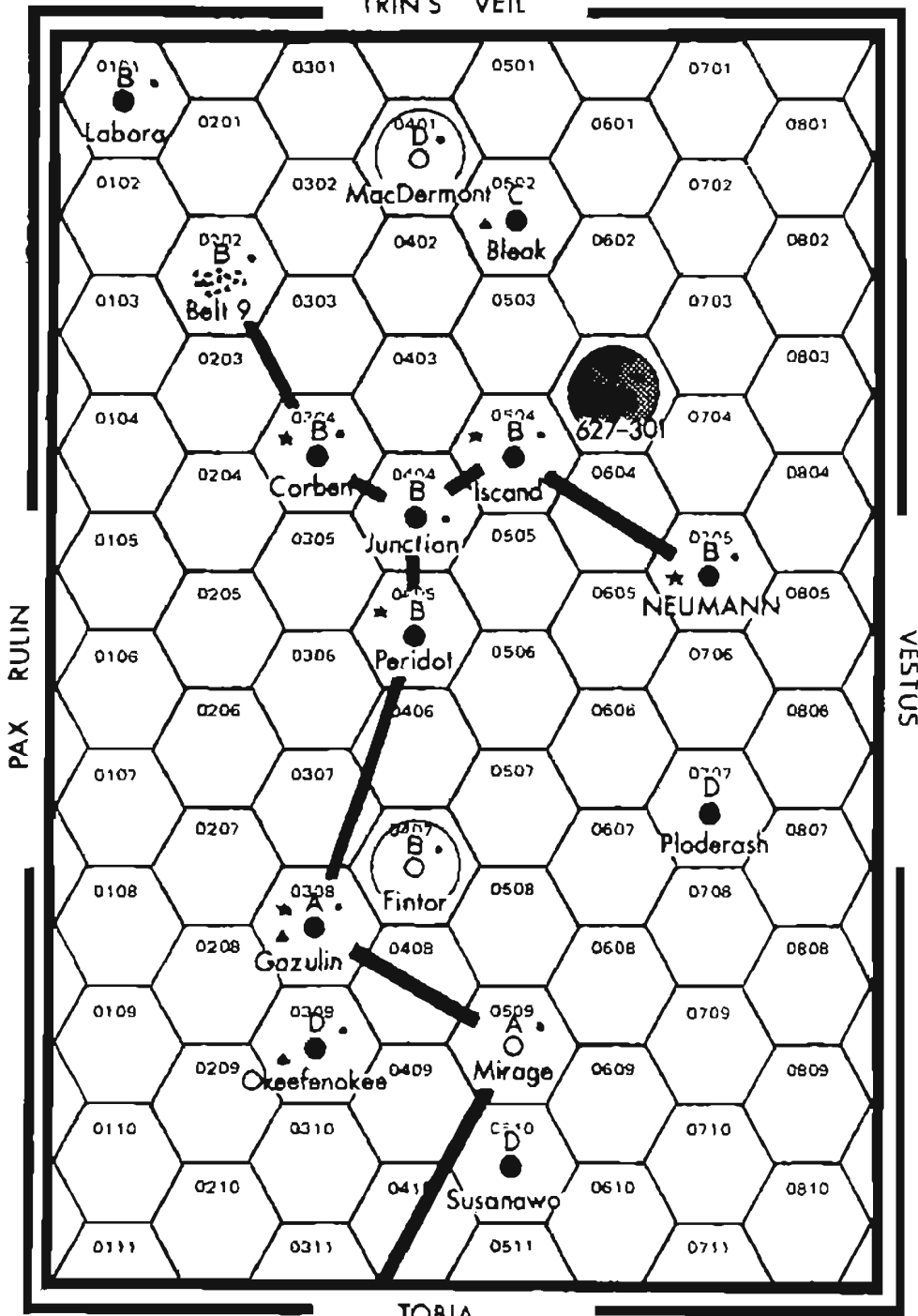

- A: Menorial
- B: Egyrn
- C: Pax Rulin
- D: Gazulin
- E: Yggdrasil
- F: Dpres
- G: Sindal
- H: Tobia

- I: Nora'a
- J: Goertel
- K: Tlaiowaha
- L: The Borderland
- M: Ranib
- N: Silraaihe
- O: Ekea'as
- P: Binary

FEATURE ADVENTURE: THE NARCISSUS CUP

The Narcissus Cup is essentially a murder mystery. As such it is layed out in a format similar to the adventures in Alien Realmstm. Information is presented in separate sections, each dealing with a different aspect of the adventure.

PERIDOT

Peridot (Gazulin 0405 B989894-A) is a large, rich world with a dense, breathable atmosphere and 91% hydrographics. The planet's land area consists entirely of several large archipelagos, most of which are located in the southern hemisphere.

The surface portion of Peridot's starport is located at Perimede, a large city and seat of the planetary government. The orbital portion of the starport is in a geosynchronous orbit directly above the city. Grav vehicles are still rather new, and so transport from city to city is usually by hydrofoil. Peridot's major industry is sea farming, including the export of fish and water plants.

The city of Perimede is built on three large islands and several small surrounding ones. The northern island is dominated by the starport facilities,

with the city's fusion power-plant located 3km off-shore. The western island is mainly residential, but the south end is taken up by sea-farming facilities. Two small islands to the west contain several private estates. The Eastern island contains startown, the government offices, and the downtown business district. More private estates are on the islands to the east, and between the three main islands is Perimede park.

Three underwater tunnels link the main islands, while transport between the other islands is by private boat or grav vehicle. In-city transport is usually by ground car.

A CALL IN THE NIGHT

The players have just completed a long trading mission and so are spending their leave carousing. It is their second free night, 9 PM, and they are just starting their evening at a small startown tavern. Quite unexpectedly, the bartender calls out their names, saying there is a call for them.

The call is from a woman who identifies herself as Gloria Carper, head of

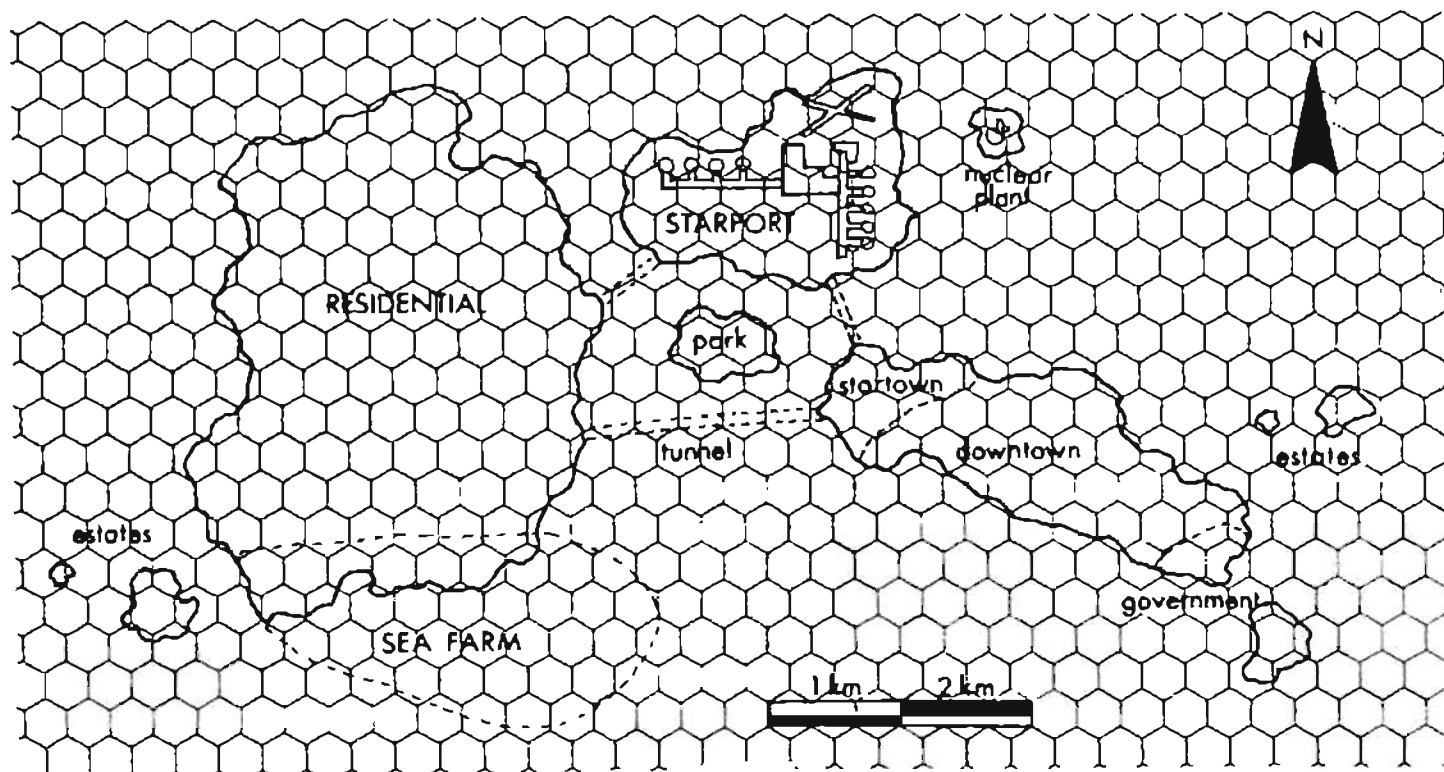

import duty office

valuable imports office

Turpin's office

Carper's office

public imports office

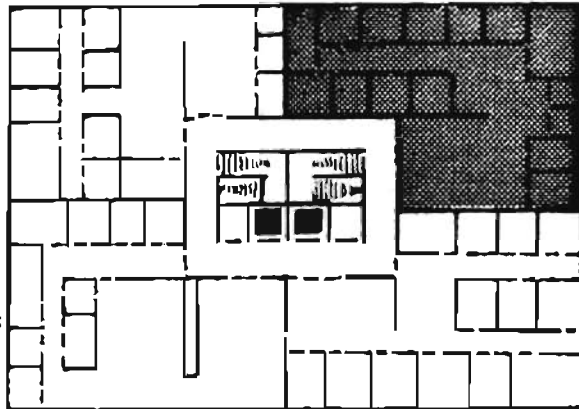

government imports office

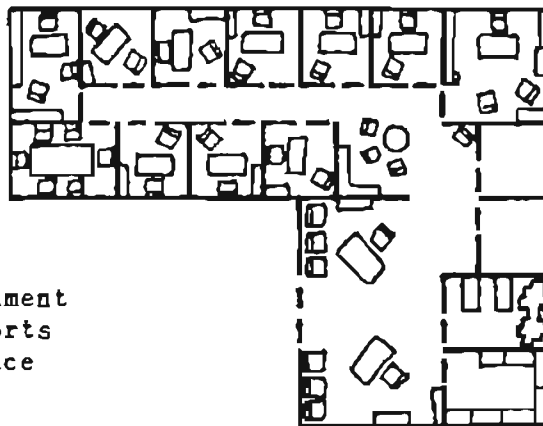

wash-rooms
computer, copies
records



MURDER MOST FOUL

Turpin knocks on Carper's office door but gets no response. After a few seconds he pulls out a key and opens the door. Gloria Carper's dead body is lying in the center of the room. She has been shot twice in the back; her files are rifled and a metal stand on one shelf lies empty. Turpin immediately yelps "She's dead! And the Narcissus-Cup is gone!" He then runs from the room to tell the secretary.

Between the time when Turpin leaves and the police arrive the players have about half an hour to investigate the murder scene. Examining Carper's body will reveal to anyone with medical skill that she has been dead for 13 to 15 hours. Forensic or pistol skill will reveal that she was shot with a body pistol.

Searching the office will reveal several things: first, the window is locked from the inside. No-one came in that way. Several file folders have had their contents removed, including one on Turpin, one on the Narcissus cup, and one on counterfeit objects. Sitting on Carper's desk is a crumpled business card:

the Valuable Imports section of the Peridot Customs Agency. She has learned of the players through a previous employer, and has had them tracked down. She wishes to hire them to "capture and punish a criminal". She will say no more than this, but if the players are interested, she will make an appointment with them for 10AM the next morning.

At the Peridot Trade & Customs building the next day, the players are told that miss Carper hasn't been seen all morning. As they turn to leave, a tall moustached man enters the reception area and asks them to accompany him. He is Allan Turpin (UPP 7AACB8), and he says that the secretary probably just didn't see Gloria come in. He is her assistant, and says he can take them to see her now.

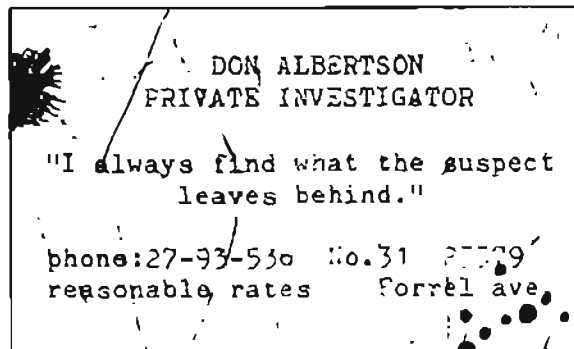

If the players ask around the office they will find that the only people at the office between 9 and 11 were Carper, Turpin, and the cleaning woman. If they try to question Turpin he will say he has an appointment and leave. However, the cleaning woman has alot to say.

CURIOUSER AND CURIOUSER

The cleaning woman (UPF 565545) is about 50 and complains continuously about her back problem. She also mentions that recently had her watch stolen. For this reason she kept a close watch on the office clocks the night before.

She explains that Carper was working late, and at about 8:15 Carper asked her not to bother cleaning her office that night. Soon after she saw Allan Turpin come in, while she was cleaning the reception area. At 9:00 she saw him leave, and he wasn't carrying anything. She is quite sure he didn't take the Narcissus cup as she would have seen it.

According to this evidence Turpin couldn't have killed Carper, since the players spoke to her at 9:00.

If the players ask, the office staff will let them check the computer. If they do so, anyone with computer skill will find a program with the strange title of "My watch has stopped, and so has time". This program sets all the office clocks back 10 minutes, and returns them an hour later.

THE NARCISSUS CUP

The Narcissus Cup is (or rather was) the most valuable import ever handled by Carper's section. Because of its value it was felt it would be safer in her office than in a warehouse until the paperwork was done and it was given over to its owner.

Imported from a family on MacDermont by the Perimede museum of history, the Cup is an artifact surviving from the early days of the First Imperium. It is currently valued at Mcr5.

The Narcissus cup is a sealed transparent plasteel sphere 30 cm in diameter. It is filled with water and contains bacteria, algae, and several small shrimp-like animals. What makes the Cup so special is the fact that it is a closed self-perpetuating ecology. Algae bask in the light and produce oxygen, which is then breathed in by

the animals, who also eat the algae and bacteria. The animals and the bacteria then give off carbon-dioxide for the algae, and the bacteria break down the animal's waste into nutrients for the algae.

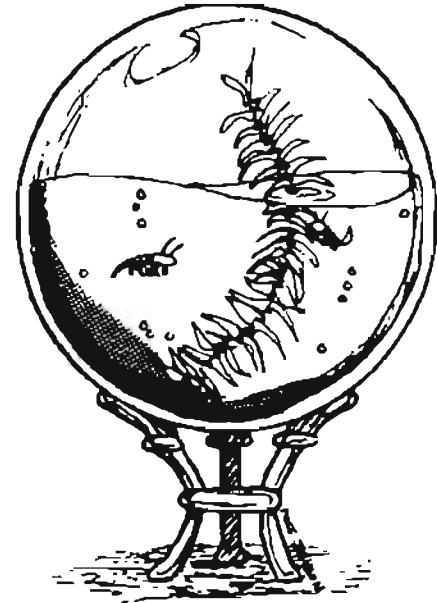

The only thing the ecology needs to continue is 6 hours of light every day. So far the life-cycle inside it has gone on for 4,593 years.

The day after the murder the players are approached by a representative of the Perimede museum of history. He will pay cr150,000 if the players can retrieve the Narcissus Cup and apprehend Carper's murderer.

DON ALBERTSON, PRIVATE EYE

Don Albertson (UPF 999966) has an office in one of the most run-down areas of startown. If the players try to phone they will get no answer. If they go to his office they will find the door locked, but will hear noises coming from inside. If they call out and identify themselves Albertson will reply nervously. He will talk through the door, but he refuses to open it.

Albertson explains that he was hired two weeks ago by Gloria Carper to investigate Allan Turpin, whom she suspected of illegal activities. Albertson found out that Turpin was stealing art and artifacts from the warehouse, copying them, selling the originals, and returning the fakes.

Albertson was going to give Carper the full details today, but someone got to her first. He now fears for his own life, and suggests that the players stop asking around before it's too late.

At this point the players suddenly hear shattering glass and a scream. If they break down the door they will find Albertson dead on the floor, shot through the window by someone with a body pistol. An air-raft can be seen speeding away.

ALLAN TURPIN

The day after Albertson's murder Allan Turpin disappears. No-one answers his phone and he does not come to work. The players may decide to investigate his home.

Turpin has a large comfortable house on the west island. All the doors are locked and the lights are out. If the players break in they will find several things.

First, it looks like he left in a hurry. The bed isn't made, the T.V. has been left on, and a half-eaten sandwich is sitting on the table.

Second, there is an air-raft very similar to the one they saw, parked in the garage. Finally, there is a huge workshop in the basement. It contains computer guided fabricators, imaging



and reproduction systems, and an abundance of raw materials. On the work bench is a partially completed copy of the Narcissus Cup. Nearby is a Grav belt that has been adapted with a net to carry a large round object. In a safe in the corner is the missing file on the Narcissus Cup.

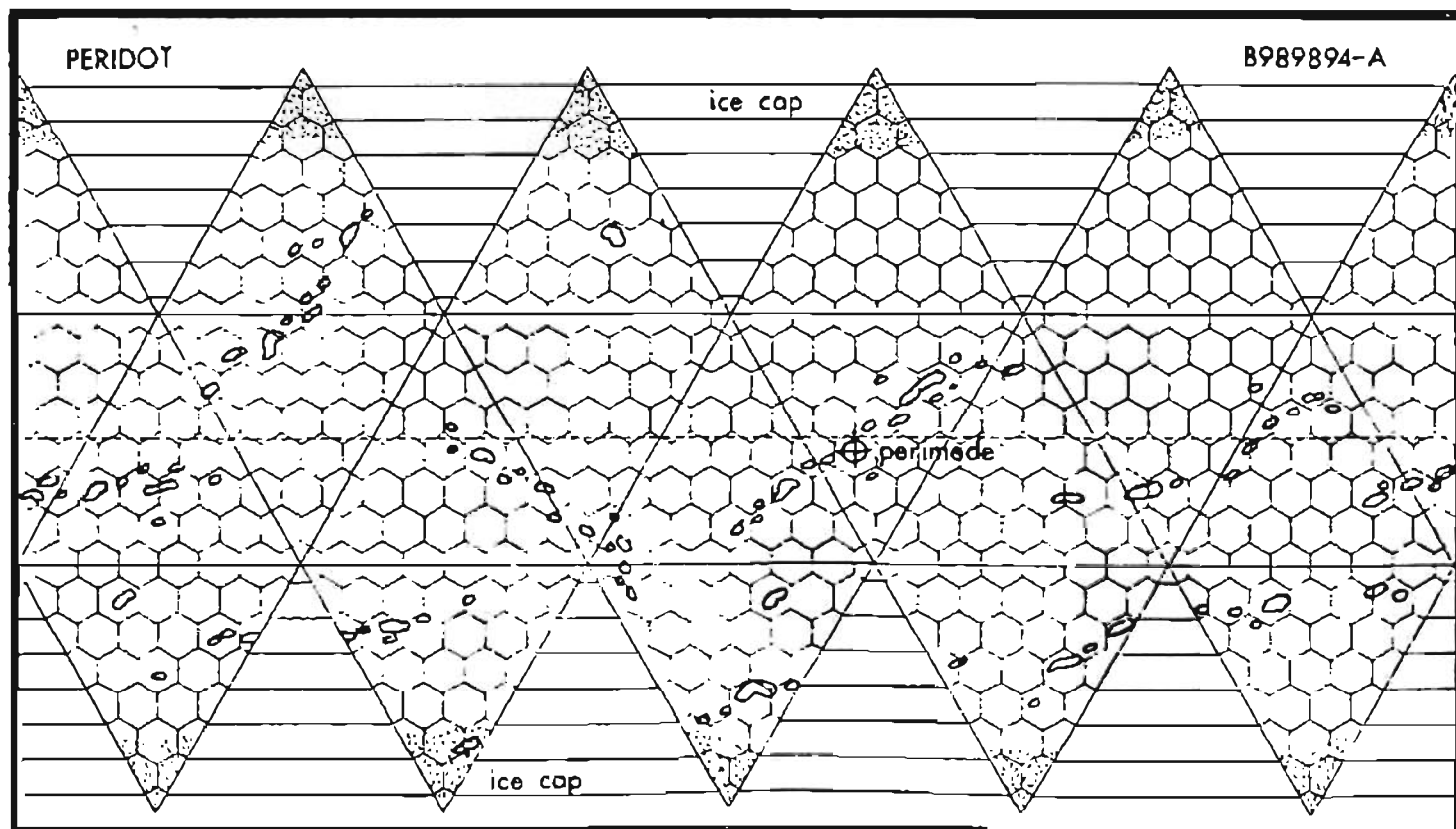

At some point while the players are at Turpin's the doorbell will ring. If the players answer the door a small man waiting there will turn to run. He is easy to catch however, and identifies himself as Ignace Walters (UPF 6773A6). He is a blackmarket dealer, and he has brought Mcr1 in cash with which to buy the original Narcissus Cup. He has no idea where Turpin has gone, but when last he saw him, Ignace noticed that Turpin had a high passage ticket on Tukera Lines.

If the players hurt Walters or take his money they will be later attacked by a group of thugs. They will retrieve the Mcr1 and rough the players up a bit, but will go no further than that.

YOU CAN RUN...

Checking at the starport will reveal that Turpin left on the "STAR OF GAZULIN", a Tukera long-liner bound for the subsector capital. If the players leave immediately on their own ship they may be able to catch him at the Gazulin starport.

At Gazulin the "STAR OF GAZULIN" is held up at customs, and so the players are able to meet Turpin as he steps off the ship. He will try to run, and if he is cornered he will produce a body pistol with a silencer and try to fight.

Once the players capture him they will find he is carrying the other files, 500,000 credits, and the Narcissus cup, stored in a special box with an interior light. If the players haven't already figured out the murder plot he will explain it to them.



PAUCE JACKSON

VILANI WORD GENERATION TABLE

Now that GDW has published all of its Alien Modules on the major races, the chances are rather low that they will ever print a Vilani word generation table. Well, Vilani is an extremely important language, so Third Imperium comes to the rescue!

This table is based on letter and syllable frequency information presented in No.17 of the Journal of the Traveller's Aid Society. This information was itself based on GDW's own computer program, so this table should be completely accurate.

To use this table simply follow the same procedures used for other word generation tables.

THE BEST LAID PLANS...

Turpin planned the murder several days in advance, and so was able to make several preparations. He stole the cleaning woman's watch, wrote a clock-adjusting program, and adapted a grav belt to carry the Narcissus Cup.

The night of the murder Turpin came into the office at 8:20. He then waited for Carper to make any phone call (it just happened to be a call to the players). He then ran his clock program: this gave him an alibi, as he couldn't have killed her when she was on the phone.

Turpin then walked into Carper's office and shot her with his silenced body pistol. Next he took the files and the Narcissus Cup and put them in the altered grav belt. He then floated them out the window and locked it behind them. He then walked out, said good-night to the cleaning woman, and collected the gravbelt with his air-raft.

Afterwards Turpin killed Albertson because he knew too much. When he found out the players were after him he dropped everything and ran.

His plan almost worked...

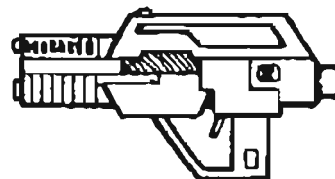

Red Die **Basic** White Die _____

Die	1	2	3	4	5	6
1	V	V	V	V	V	V
2	V	VC	VC	VC	VC	VC
3	VC	VC	VC	VC	VC	VC
4	VC	VC	VC	VC	VC	VC
5	VC	VC	VC	VC	CV	CV
6	CV	CV	CV	CV	CVC	CVC

For initial syllables, or after VC or CVC.

- Determine word length (1D syllables).
- Determine syllable structure. Use the Basic syllable type table if first syllable in word, or if previous syllable ended in a consonant. Otherwise, use the Alternate syllable type table.
- Determine initial consonants from column 1; vowels from column 2; final consonants from column 3.

Red Die **Alternate** White Die _____

Die	1	2	3	4	5	6
1	CV	CV	CV	CV	CV	CV
2	CV	CV	CV	CV	CV	CV
3	CV	CV	CV	CV	CV	CV
4	CV	CV	CV	CV	CV	CVC
5	CVC	CVC	CVC	CVC	CVC	CVC
6	CVC	CVC	CVC	CVC	CVC	CVC

For syllables after V or CV.

1 INITIAL CONSONANT

Red Die _____ White Die _____

Die	1	2	3	4	5	6
1	B	B	B	B	B	D
2	D	D	D	D	D	D
3	D	D	D	D	D	D
4	D	D	D	D	D	D
5	D	D	G	G	G	G
6	G	G	G	G	G	G

VOWEL

Red Die _____ White Die _____

Die	1	2	3	4	5	6
1	A	A	A	A	A	A
2	A	A	A	A	A	A
3	A	A	A	A	A	A
4	A	A	A	A	A	A
5	A	A	A	A	A	A
6	A	A	A	A	A	A

FINAL CONSONANT

Red Die _____ White Die _____

Die	1	2	3	4	5	6
1	D	D	D	D	D	D
2	D	D	D	D	D	D
3	D	G	G	G	G	G
4	G	G	G	G	G	G
5	G	G	K	K	K	K
6	K	K	K	K	K	K

2

Red Die _____ White Die _____

Die	1	2	3	4	5	6
1	G	G	G	G	G	G
2	G	G	G	G	G	G
3	G	G	G	G	G	G
4	G	G	G	G	G	G
5	G	G	K	K	K	K
6	K	K	K	K	K	K

2

Red Die _____ White Die _____

Die	1	2	3	4	5	6
1	A	A	A	A	A	A
2	A	A	A	A	A	A
3	A	A	A	A	A	A
4	A	A	A	A	A	A
5	A	A	A	A	A	AA
6	AA	AA	AA	AA	AA	AA

2

Red Die _____ White Die _____

Die	1	2	3	4	5	6
1	B	K	K	K	K	K
2	L	L	L	L	L	L
3	M	M	M	M	M	L
4	L	L	L	L	L	L
5	L	L	L	L	L	L
6	M	M	M	M	M	M

3

Red Die _____ White Die _____

Die	1	2	3	4	5	6
1	K	K	K	K	K	K
2	K	K	K	K	K	K
3	K	K	K	K	K	K
4	K	K	K	K	K	K
5	K	K	K	K	KH	KH
6	KH	KH	KH	KH	KH	KH

3

Red Die _____ White Die _____

Die	1	2	3	4	5	6
1	AA	AA	E	E	E	E
2	E	E	E	E	E	E
3	E	E	E	E	E	E
4	E	I	I	I	I	I
5	I	I	I	I	I	I
6	I	I	I	I	I	I

3

Red Die _____ White Die _____

Die	1	2	3	4	5	6
1	N	N	N	N	N	N
2	N	N	N	N	N	N
3	N	N	N	N	N	N
4	N	N	N	N	P	P
5	P	P	P	P	P	P
6	R	R	R	R	R	R

4

Red Die _____ White Die _____

Die	1	2	3	4	5	6
1	KA	KA	KA	KA	KA	KA
2	LA	LA	LA	LA	L	L
3	L	L	L	L	L	L
4	L	L	L	L	L	L
5	L	L	L	L	L	L
6	L	L	L	L	L	L

4

Red Die _____ White Die _____

Die	1	2	3	4	5	6
1	I	I	I	I	I	I
2	I	I	I	I	I	I
3	I	I	I	I	I	I
4	I	I	I	I	I	I
5	I	I	I	I	I	I
6	I	I	I	I	I	I

4

Red Die _____ White Die _____

Die	1	2	3	4	5	6
1	R	R	R	R	R	R
2	R	R	R	R	R	R
3	R	R	R	R	R	R
4	R	R	R	R	R	R
5	R	R	R	R	R	R
6	R	R	R	R	R	R

5

Red Die _____ White Die _____

Die	1	2	3	4	5	6
1	K	K	K	K	K	K
2	K	K	K	K	K	K
3	K	K	K	K	K	K
4	K	K	K	K	K	K
5	K	K	P	P	P	P
6	P	P	P	P	P	P

5

Red Die _____ White Die _____

Die	1	2	3	4	5	6
1	I	I	I	I	I	II
2	II	II	II	II	II	II
3	II	II	II	II	II	II
4	II	II	II	U	U	U
5	U	U	U	U	U	U
6	U	U	U	U	U	U

5

Red Die _____ White Die _____

Die	1	2	3	4	5	6
1	R	R	R	R	R	R
2	R	R	R	R	R	R
3	R	R	R	R	R	R
4	R	R	R	R	R	R
5	R	R	R	R	R	R
6	R	R	R	S	S	S

6

Red Die _____ White Die _____

Die	1	2	3	4	5	6
1	S	S	S	S	S	S
2	S	S	S	S	SH	SH
3	SH	SH	SH	SH	SH	SH
4	SH	SH	SH	SH	SH	SH
5	SH	SH	SH	SH	SH	SH
6	SH	Z	Z	Z	Z	Z

6

Red Die _____ White Die _____

Die	1	2	3	4	5	6
1	U	U	U	U	U	U
2	U	U	U	U	U	U
3	U	U	U	U	U	U
4	U	U	U	U	U	U
5	U	U	U	UU	UU	UU
6	UU	UU	UU	UU	UU	UU

6

Red Die _____ White Die _____

Die	1	2	3	4	5	6
1	S	S	S	S	S	S
2	S	S	S	S	SH	SH
3	SH	SH	SH	SH	SH	SH
4	SH	SH	SH	SH	SH	SH
5	SH	SH	SH	SH	SH	SH
6	SH	SH	SH	SH	SH	SH

— NEW WEAPONS —

BATTLE AXE (3000g; cr200; TL1): Similar to a standard wood-chopping axe, the Battle-axe is heavier and double-bladed.

BAGH NAKH (250g each; cr35; TL1): Also called "cat's claws" the Bagh Nakh consists of 3 or 4 small sharp claws affixed to a thong that fits around the hand. Bagh Nakh are also used to assist in climbing.

BLACKJACK (500g; cr10; TL2): A small bag filled with sand, rocks, or ball bearings, used as a cudgel. A standard mugging weapon.

BOOMERANG (300g; cr30; TL1): An L-shaped piece of wood that is thrown at its target. If it misses it will return to the thrower on 8+.

BULLWHIP (350g; cr50; TL2): A long braided leather cord used as a thrasher.

CALTROP (50g; cr2; TL1): A pyramidal arrangement of metal spikes which always lands with one facing up. Often used to damage people's feet or pop tires. The roll to hit is only made if the caltrop is stepped on. Treat tires as jack armor.

CATTLEPROD (500g; cr75; TL5): A 1-meter long pole with a metal tip at one end and a battery pack good for 20 shocks at the other. The damage inflicted is only temporary, healing at 1 point per turn. The cattleprod is usually used to move herd animals. Batteries cost cr6.

CHAINSAW (8000g; cr500; TL6): The same item presented in basic Traveller as a tool can be used as a clumsy weapon. It takes 1D turns to start a chainsaw (as anyone who has tried to start a gas-powered lawn-mower can understand). It can work for 2 hours on 1 litre of gas. Gas is sold for cr20 in 5 litre containers.

DARTGUN (1000g; cr150; TL5): A silent, mechanical, pistol-like weapon which

uses a spring mechanism to fire darts filled with poison or tranq. It is a popular assassin's weapon. The magazine holds 10 darts and fits into the handle. Length:800mm. Loaded magazine weighs 250g and costs cr15.

FLAMETHROWER (3000g gun, 8000g fuel tank; cr500; TL5): Consists of a carbine-like incinerator and a back-pack fuel tank, holding 25 shots worth of fuel. Length:800mm. Tank refill costs cr30. Extra tanks cost cr50.

When anyone is hit by a flamethrower roll 8+ each subsequent turn for the fire to remain burning (Dx-2 if they roll on the ground, -4 if they use a fire extinguisher, -6 if they jump in water). The flame does 2D damage per turn until extinguished.

GAROTTE (200g; cr5; TL1): A small cord used to strangle people. To hit roll the defender's dexterity or higher on 2D, -3 if they have neck protection. The garotte does 1D damage per turn until it is released (either on purpose or by the defender rolling his dexterity or less on 2D).

ELECTRO-GAROTTE (300g; cr25; TL8): A garotte that holds 2 batteries in the handgrips, good for 10 shocks. Replacement batteries cost cr4. Hits as garotte but does 2D damage. After the batteries run out it does 1D.

ULTRA-WIRE GAROTTE (50g; cr350; TL13): A garotte made of a super-strong wire only a few molecules thick. Cuts through most materials with ease. Treat as a 3D damage garotte.

SHURIKEN (50g; cr10; TL2): Throwing star. Two can be thrown per turn. Shuriken are listed as hand-weapons because of their short range.

STUNNER (3000g; cr5000; TL15): A River designed weapon that creates an electromagnetic field in its target's nervous

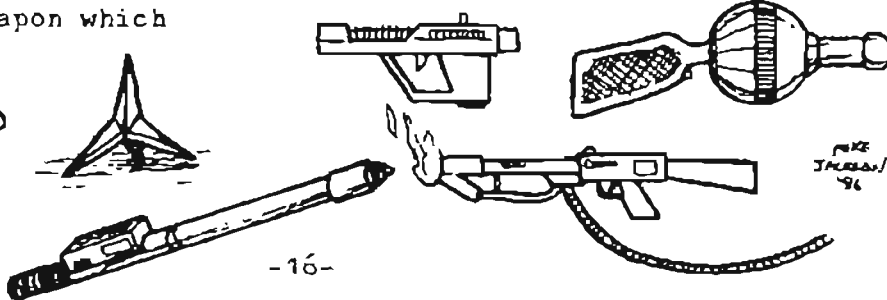
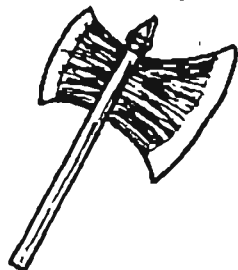

WEAPON AND DAMAGE		None					Jack					Mesh					Cloth				
		C	S	M	L	V	C	S	M	L	V	C	S	M	L	V	C	S	M	L	V
Boomerang	2D	-	-	5	6	-	-	-	6	7	-	-	-	10	11	-	-	-	10	11	-
Dart Gun- tranq	-	10	5	10	-	-	11	6	12	-	-	12	7	14	-	-	13	9	16	-	-
poison	6D	10	5	10	-	-	11	6	12	-	-	12	7	14	-	-	13	9	16	-	-
Flame Thrower	2D	-	5	8	-	-	-	5	8	-	-	-	6	9	-	-	-	5	8	-	-
Stunner	-	0	2	8	10	12	0	2	8	10	12	10	12	18	20	22	0	2	8	10	12
Taser	2D	5	5	10	-	-	6	6	12	-	-	7	7	14	-	-	9	9	16	-	-

WEAPON	Reflec					Ablat					Combat				
	C	S	M	L	V	C	S	M	L	V	C	S	M	L	V
Boomerang	-	-	5	6	-	-	-	11	12	-	-	-	12	13	-
Dart Gun- tranq	10	5	10	-	-	14	10	17	-	-	16	14	18	-	-
poison	10	5	10	-	-	14	10	17	-	-	16	14	18	-	-
Flamethrower	-	8	11	-	-	-	6	9	-	-	-	12	15	-	-
Stunner	8	10	16	18	20	0	2	8	10	12	10	12	18	20	22
Taser	5	5	10	-	-	10	10	18	-	-	15	15	20	-	-

WEAPON AND DAMAGE		None		Jack		Mesh		Cloth		Reflec		Ablat		Combat	
		C	S	C	S	C	S	C	S	C	S	C	S	C	S
Axe	3D+3	8	5	8	5	13	10	13	10	8	5	12	9	16	13
Bagh Nakh	1D	7	9	8	10	11	13	11	13	7	9	9	11	12	14
Blackjack	1D+4	8	8	8	8	10	10	11	11	8	8	10	10	15	15
Bullwhip	2D	-	8	-	8	-	10	-	11	-	8	-	10	-	15
Caltrop	1D-3	-	3	-	5	-	5	-	7	-	4	-	5	-	13
Cattleprod	1D	6	6	6	6	8	8	9	9	6	6	8	8	15	15
Chainsaw	4D	5	7	6	8	7	9	8	10	5	7	7	9	10	12
Shuriken	1D-3	-	6	-	8	-	10	-	12	-	8	-	9	-	14

WEAPON	Required Strength		Advantageous Strength		Required Dexterity		Advantageous Dexterity	
	level	DM	level	DM	level	DM	level	DM
Axe	8	-4	12	+2	-	-	-	-
Bagh Nakh	-	-	9	+1	-	-	-	-
Blackjack	4	-1	8	+2	-	-	-	-
Boomerang	6	-2	11	+1	7	-3	12	+1
Bullwhip	5	-2	10	+1	-	-	-	-
Caltrop	-	-	-	-	-	-	-	-
Cattleprod	-	-	-	-	-	-	-	-
Chainsaw	7	-2	12	+1	-	-	-	-
Dartgun	-	-	-	-	7	-2	10	+2
Flamethrower	-	-	-	-	4	-1	9	+1
Garotte	6	-1	10	+2	-	-	-	-
Shuriken	5	-1	9	+1	8	-3	12	+2
Stunner	-	-	-	-	5	-1	9	+2
Taser	-	-	-	-	7	-3	9	+1

system. This field scrambles all messages from the target's brain, causing something similar to an epileptic fit. The target is rendered helpless for 10 minutes. Length: 700mm. A powerpack good for 10 shots fits into the top. It weighs 500g and costs cr27.

TASER (300g; cr100; TL6): A police device consisting of a handle with a flashlight targeter and a launcher for a single dart on 30m of cable. The dart is fired and gives an electrical shock, and then returns to the launcher. Batteries and shots are the same as for the Cattleprod.

DROID DESIGNS

The following robots were designed using the recently released Traveller book 8. The AN-427 Maximum Security robot originally appeared in Adventure 2, Research Station Gamma, and has been re-designed to conform to the new rules.

MAXIMUM SECURITY ROBOT 7250C-L3-LA104-PA11 cr112,225 332 kg

Fuel=42 Duration=5 days TL=12
40/100 (cloth and reflec)
1 light arm, 2 medium arms
Basic sensor pkg, Active IR, Extra sensitive audio
Acoustical speaker, Radio (5km)
Laser carbine (light arm)
Laser carbine-2
Security-2
Inf ground cbt-1
Close cbt-1

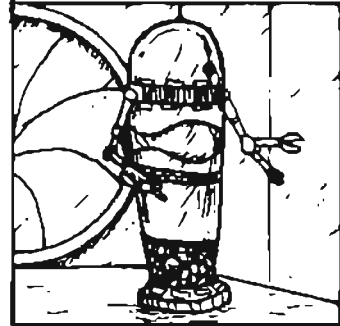

VALET ROBOT 4110A-M2-MK222-4A53 cr646,244 77kg

Fuel=28.8 Duration=8days TL=13
16/40 (mesh)
2 very light arms
1 visual sensor, 1 audio sensor, 1 olfactory sensor, voder
Valet-3
Emotion simulation

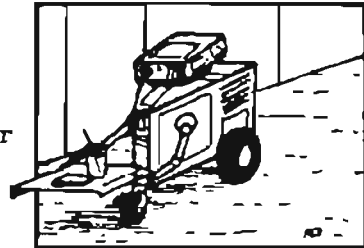

COURIER ROBOT 5310E-00-JM220-5F53 cr190,150 69.9kg

Fuel=10 Duration=2.7 days TL=13
20/50 (mesh)
Basic sensor pkg, Voder
Radio (50kr), Brain interface
16 litres storage space for packages
Robot used to carry information, packages, and documents
from one place to another.

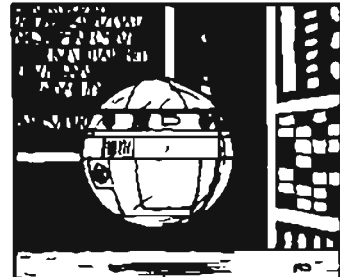

CREWBOT 20000-00-LM211-0063 cr174,750 10.3kg

Fuel=0 Duration=0 TL=15
4/10 (none)
Basic sensor pkg
Power interface, Brain interface
4 spaces in CPU for programs
This type of robot is hooked in directly to a ship's
computer and a command console. It is powered by the
ship's power-plant and communicates through the computer.
It can be programmed as any one of the following (for the
cost of the program): pilot, navigator, Ship's boat pilot,
gunner, or communications.

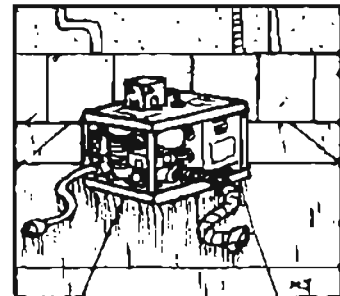

ALL-PURPOSE DROID 6130B-L2-MK320-H963 cr312,900 217.42kg

Fuel=36 Duration=6 days TL=13
30/75 (mesh)
2 light arms
Basic sensor pkg, Voder
Program interface, Radio (50kr)
Laser carbine
Emotion simulation
4 spaces in CPU for programs

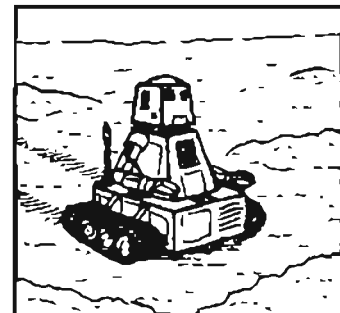

TRAVELLER'S ADVICE

HOW MANY TIMES HAVE YOU TRIED TO BREAK INTO SOME BUILDING OR COMPLEX? THERE ARE BETTER WAYS THAN SHOOTING YOUR WAY IN...

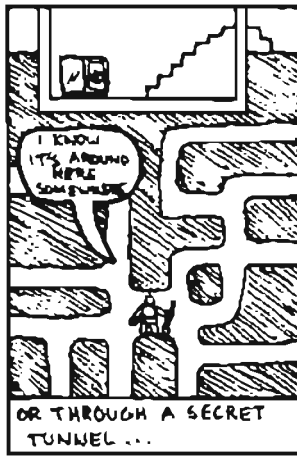

INSIDE EQUIPMENT:

GRAV BELT

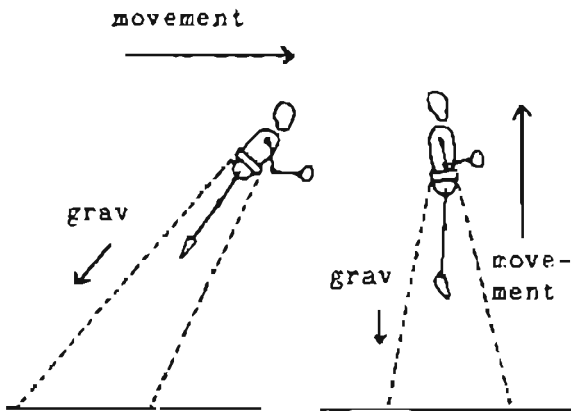

As the angle vs. the ground decreases, forward speed increases and lift decreases.

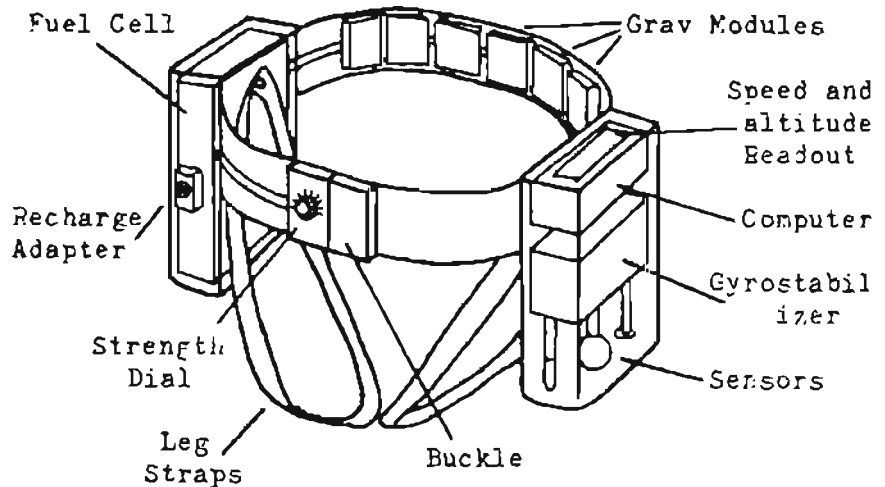

FRONT VIEW:

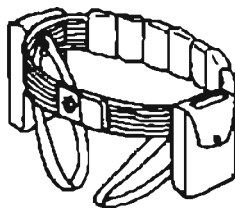

REAR VIEW:

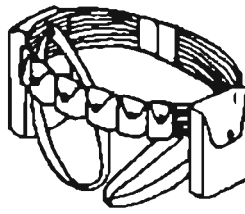

All belt components are held in removable pouches for easy replacement.

Mark XII Grav Belt designed by Ling-standard Products, 1102.

HOW IT WORKS: The LSP Mark XII Grav Belt always pushes against the ground at a 90° angle to the position of the belt. Sensors monitor pelvic tilt and gyration, pointing the grav field at different angles, allowing turns and acceleration. A gyroscopic stabilizer and computer steady the belt and keep it from pointing away from the ground. A single dial changes the strength of the grav field.

NEXT ISSUE :

Feature Adventure- "Delusions of Godhood"
 Hardware- Voice Modulator
 Subsector- The Borderland
 Plus deck plans to a Pirate cruiser, and part 1 of our series of rules on Cybernetics!

On sale in January. Don't miss it!

SENTRY BOX WEST

No. 1 IN TRAVELLER LITERATURE!

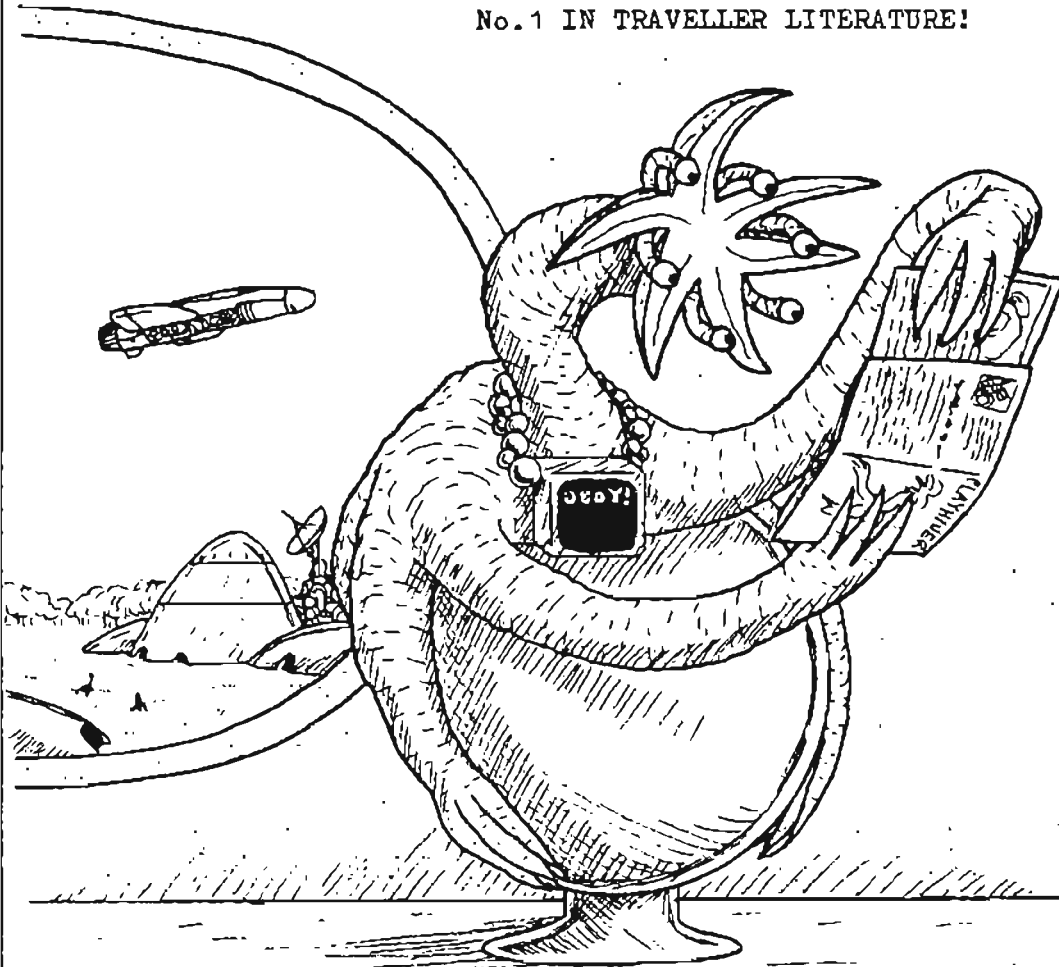

WE STOCK THE
FOLLOWING LINES
OF FIGURES:
Ral Partha
Citadel
RAFM
Minifigs
Martian Metals
Asgard
Grenadier
Frei-korps
Stone Mountain
Heroics and Ros
Skytrex
GHQ
Naismith
Dark Horse
Off the Wall

WE SPECIALIZE IN ROLE PLAYING GAMES,
BOARDGAMES AND LEAD FIGURES...

ESPECIALLY LEAD FIGURES!

We stock all the latest TRAVELLER supplements at reasonable prices!
We also have back issues of Journal and hard to get TRAVELLER figs.
IF YOU NEED SOMETHING JUST ASK!

SENTRY BOX WEST HOBBIES
3309 West 4th Ave.
Vancouver B.C.
Canada
(604) 734-1933

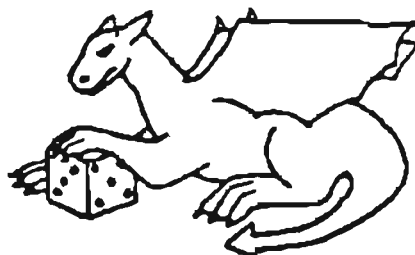

HIVERCARD accepted

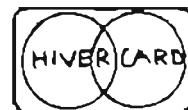

Don't leave your homeworld
without it!

COMING SOON:

FOR TRAVELLER: Challenge 29
Traveller's Digest 9
The Darrians
Regatta

FOR 2300: The Aurora Sourcebook
Pentapods
Ships of the French Arm
Starcruiser