

Approved for Use With MEGATRAVELLER™ and 2300™

U.S. \$4.95

the TRAVELLERS'

Digest

KUSYU!

The Aslan Homeworld
— this issue's
Feature
Adventure

Number 17

Guide to the
Major Races
Beginner's Luck



**MegaTraveller:
Psionic Knights**
An adventure by
William W. Connors

Soundtreks
Adding Music to Your Sessions

2300AD:
The Hogan 500



Digest Group Publications

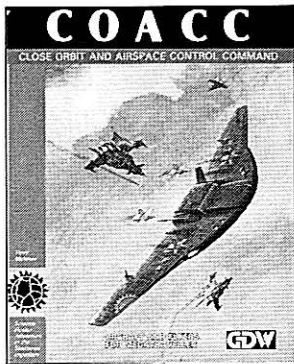

COACC

● Flyers for MegaTraveller.

The army controls the ground! The navy controls space! But the interface between the two belongs to COACC—the flyers. Aircraft of all types—jets, props, helicopters, dirigibles—come under the Close Orbit and Airspace Control Command. **MegaTraveller COACC** provides rules for flyers in the Traveller universe. Coverage includes character generation, COACC organization, aircraft design sequences, example aircraft, and both simplified and detailed versions of air-to-air and air-to-ground combat rules.

GDW: 0216. ISBN 0-943580-72-2. 96 pages.....\$10.

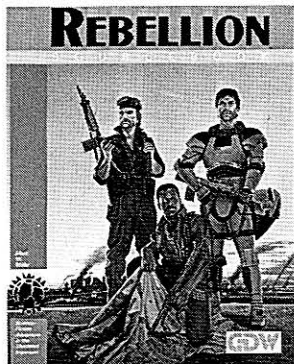

REBELLION SOURCEBOOK

● Join the Rebellion!

The emperor is dead! Who will win the Iridium Throne? Many different factions have squared off in the impending struggle for ultimate power.

Rebellion Sourcebook covers the diverse factions of the Rebellion, their equipment, their goals and strategies, and (most of all) how players can get involved in the grandest adventures the stars have ever seen. Includes the short adventure: "Nail Mission." GDW: 0214. ISBN 0-943580-63-3. 96 pages...\$10.

REFEREE'S COMPANION

● Enhance MegaTraveller.

Expand the universe of **MegaTraveller** with more rules, background, information, and materials for the dedicated referee. Materials that simply wouldn't fit into the grand, three-volume **MegaTraveller** rules set have now been brought together into this useful and detailed compilation.

MegaTraveller Referee's Companion covers all the major alien races in the Traveller universe individually, dealing with each one's homeworld, physical appearance and abilities, mental makeup, and interstellar territories. The **Companion** also covers large-scale combat, timekeeping, communications, research, mapping, in-system operations, mega-corporations, technology, and robots for **MegaTraveller**. GDW: 0215. ISBN 0-943580-71-4. 96 pages.....\$10.

MEGATRAVELLER™

THE VITALITY of the newly founded Imperium was evidenced by its rapid expansion and economic growth. The time was right for a new empire; the human populations of the territory wanted and needed this vast interstellar government. The Third Imperium was an expression of the people who populated it: strong, vital, ambitious.

A THOUSAND years later, the strength and vitality of the human populations were missing; all that remained was the ambition, and that ambition was channeled inward. No longer did the population see expansion as the means to a better future; leaders looked at redistributing the wealth of the Imperium and at carving out petty duchies within the known boundaries of the empire.

AGAINST this background, it was inevitable for some small stimulus to trigger the fall of the Imperium. And once that happened, there was no turning back.

IN THE founding days of the Imperium, great men dreamed great dreams...and achieved them. In the last days of the Imperium, petty men dreamed petty dreams...and achieved them too.

What Happens When A Thousand-Year Empire Is Eleven Hundred Years Old?

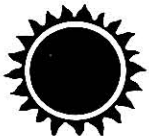

The Imperium began as a small pocket of scientific and technological innovation in a sea of primitive star systems. It reached out to eventually take over more than 10,000 systems. In the course of a thousand years, it fought countless wars and conquered countless races. But after that thousand years, the Imperium is old, tired,

and strained at the borders by dissention and civil unrest.

Now the Imperium is split into many factions. The emperor's assassin—Dulinar—claims the throne is his by an obscure quirk of Imperial law. The emperor's nephew naturally claims differently. Other factions have their own opinions.



MegaTraveller—the complete science-fiction role-playing game.

The **MegaTraveller Players' Manual** contains the basic information any *player* needs to prepare for (and participate in) **Traveller** adventures. A reference for every participant, it includes character generation, skills, task resolution, experience, personal combat, and psionics.

The **MegaTraveller Referee's Manual** is a basic reference for the *referee* which expands on the topic of tasks, and deals in depth with vehicle design and combat (including both surface vehicles and starships), worlds, and commerce.

The **MegaTraveller Imperial Encyclopedia** is the basic reference for every **Traveller** participant. It deals with library data, maps, world data, and equipment. The **Encyclopedia** includes all the raw information necessary to learn about the Shattered Imperium and role play within it.

The boxed **MegaTraveller** set includes all three of these books, plus a poster-size map of the Spinward Marches. GDW: 0210. ISBN 0-943580-49-8. Boxed...\$30. Each book is also available separately.

The **Players' Manual**. GDW: 0211. ISBN 0-943580-38-2. 104 pg.....\$10.

The **Referee's Manual**. GDW: 0212. ISBN 0-943580-47-1. 104 pg.....\$10.

The **Imperial Encyclopedia**. GDW: 0213. ISBN 0-943580-48-X. 96 pg.....\$10.

HERE'S HOW TO ORDER



For sale at your hobby or game store. Or order from GDW. **By Mail.** Write what you want on a piece of paper. Pay by check, money order, or Visa/MasterCard information.

By Phone. Call us at 309-452-3632 between 9 a.m. and 5 p.m. Central Time weekdays. You can pay by Visa or MasterCard.

By FAX. Write out your order (including Visa/MasterCard information) and fax us any time at 309-454-3127.

We are committed to prompt service; we fill orders within two working days. Write for our free 16-page catalog.

FREE! Write for your own copy of the **Imperium Map** showing the borders of the Third Imperium before the present rebellion began. Quantities limited.

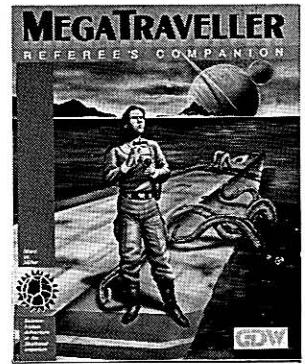

THE SHATTERED IMPERIUM

The time is the distant future. Interstellar travel is not only possible, but commonplace.

The ruling interstellar power is the Imperium, a large, human-dominated empire more than 1000 years old, encompassing 11,000 worlds in a region over 2000 light-years across.

But while the Imperium's thousand-year reign has created an illusion of strength and lasting power, continued expansion and internal pressure have combined to strain the Imperium's ability to govern to the limit. The thread that held the vast Imperium together has always been the emperor, the one individual to whom all Imperial citizens ultimately owe their loyalty.

Now the emperor is dead at the hands of an assassin, with no immediate heirs and no clear successors. The emperor's nephew claims the throne; so does his cousin. Even his assassin claims the throne. No one knows whom to follow; someone is following each of the claimants. Several border regions have lost faith in the Imperium and have declared their independence. A few neighboring interstellar powers, learning of the Imperium's internal chaos, have begun to advance into unprotected frontier provinces.

The Imperium has shattered...

MEGATRAVELLER

Against this background of star-spanning rebellion and splintering empires **Traveller** is set. Its role-playing game rules provide an entire universe to be explored. Players assume any role and any mission in the universe of the future.

Traveller says that mankind has conquered the stars, travel between star systems is commonplace, but the distances involved make interstellar voyages take weeks, months, even years.

The situation is similar to Earth in the 18th century. Communication is limited by the speed of travel, setting the stage for adventure in a grand fashion with all the trappings of classic science fiction: star-spanning empires, huge starfleets, interstellar merchants (and interstellar pirates), complex diplomatic maneuvers, and larger-than-life heroes, heroines, and villains.

Traveller is the name of the overall game. **MegaTraveller** is the name of this rules set, and is used to differentiate it from the 10 years of development and earlier editions that preceded it.

Since 1973



PO Box 1646
Bloomington, IL 61702-1646

The Blade of Koiyekh



"Inquiring minds are not universally welcome."
— Akidda Laagiir, from "Honorable Neighbors" in the *Travellers' Digest*, 1115 .

TABLE OF CONTENTS, Number 17

Editors' Digest	3
The Blade of Koiyekh, Feature Adventure	
The Characters	4
Non-Player Characters	6
Kusyu Dawn.....	6
Exotic Kusyu	7
Referee's Synopsis.....	8
A Damsel in Distress	9
The Doctor's Quest.....	9
Ukhtaitasqistsea	9
Preparing for the Journey	10
Dealing With the Locals	11
The Journey To Haka	11
Noble's Challenge.....	12
We Must Be Getting Close!	12
Brotherhood of Koiyekh	13
Trail of the Koiyekh.....	13
Rescue in the Jungle	14
The Blade of Koiyekh.....	15
On the Trail Of Heroes.....	15
The Unlocked Treasure	15
We've Got Company.....	16
Farewell to Kusyu	16
Aslan Glossary.....	17
MegaTraveller Adventure —Psionic Knights	19
Index to World Builder's Handbook.....	25
Aliens in Megatraveller —Beginner's Luck.....	27
Dark Nebula Sector	
Library Data	30
Trokh: Language of the Warriors	34
Traveller Q&A	38
Soundtreks—The Gaming Digest	40
Losing It—Medical Digest	44
Traveller Arsenal.....	48
The Hogan 500	50

Digest Group Publications products are available through these overseas distributors:

West Germany: Fantastic Shop, Konkordiastraße.61, Postfach:21 01 65, 4000 Düsseldorf 1, Federal Republic of Germany.

United Kingdom: Chris Harvey Games, c/o Matthew Harvey & Co. Ltd., P.O. 38, Bath Street, Walsall, West Midlands, WS1 3BY, UK; Games of Liverpool, 89 Victoria St, Liverpool, L1 6DG, UK; Games Workshop, LTD.,Chewton St., Hilltop, Eastwood, Nottingham, UK.

Australia: Australian Games Distribution, 4 Parkland Avenue, Chirnside Park, Victoria 3116, AUSTRALIA.

Traveller®, **MegaTraveller™**, and **2300AD™** are trademarks of Game Designers' Workshop. The trademarks are used with permission.

The offices of the *Digest* are located on Deneb in Deneb Sector of the Imperium.

The publishing date of this issue is July (September) 1989. The *Travellers' Digest* is published quarterly by Digest Group Publications and is devoted exclusively to **Traveller***, **Mega-Traveller*** and **2300AD***.

Copyright ©1989 by Digest Group Publications. All Rights Reserved. Printed in the United States of America. No part of this magazine may be reproduced in any form or by any means without written permission from the publisher. Portions of this magazine taken from **Traveller** and **2300AD** materials published by Game Designers' Workshop, and are copyright ©1989 by GDW, Inc.

1 2 3 4 5 6 7 8 9 10

Address editorial comments to:
TD Comments
Digest Group Publications
8979 Mandan Ct.
Boise, ID 83709-5850

The *Travellers' Digest* is available quarterly at an individual price of \$4.95. One year subscriptions are \$18.00. Foreign air mail subscriptions (outside the USA or Canada, but not to APO or FPO addresses) are \$26.00 a year. Mail subscriptions (in US funds drawn on a US bank) to:

The Travellers' Digest
Digest Group Publications
8979 Mandan Ct.
Boise, ID 83709-5850 U.S.A.

Editors: Gary L. Thomas, Joe D. Fugate Sr
Associate Editors: Nancy Parker, Robert Parker
Art Director: Rob Caswell
Technical Editor: Deborah Zeigler
Production Manager: Patricia Fugate
Publisher: Digest Group Publications

Artists in this Issue (In Alphabetical Order):

Rob Caswell — pp. 32, 33, 34, 36, 48, 49
 Joe D. Fugate Sr. — p. 3, 44
 Patricia Fugate — pp. 4, 5, 6, 44, 55
 K. Leberz-Gelinas — pp. 30, 31, 50
 Mike Jackson — pp. 19, 23, 24,
 William H. Keith — Cover, pp. 1, 6, 9, 10, 11, 14, 27, 28
 Steven Longpre — p. 41
 Robert Parker — p. 9



Editors' Digest

FROM THE DESKS OF GARY L. THOMAS AND JOE D. FUGATE SR.

Welcome back to reality! Our so-called summer vacations are over and it's time to put out another magazine. If you saw us at ORIGINS in Los Angeles or GEN-

CON in Milwaukee, you know what we're talking about. What starts off as a pleasant trip out of the office always turns into a lot of work that keeps us busy with irregular meals and not enough sleep. It's good to be back at the daily grind, in a way.

At the conventions, we got to see a lot of you, renew old acquaintances, and make new friends: some of you we only see once a year at these cons. We collected more reader feedback, which we fed into our computer for further analysis; we'll give you full details next time, once the results have been tabulated and studied by a human being.

At GENCON, we provided a **MegaTraveller** tournament module, "To Kill an Archduke", written by Philip Athans. If you plan to attend a convention in your area soon, drop us a letter, along with a self-addressed 9x12 manila envelope with six 25-cent stamps, and we'll send you a copy of this tournament for you to run. Be sure to let us know which convention you will be running this at to be eligible for this freebie.

If you attended GENCON, you got to see our new **MegaTraveller** promotional posters, which were handed out at our seminar and at the GDW booth. Your local game store should have one of these big, beautiful posters hanging boldly in its window. If they don't have one, give 'em the word! They can get one directly from GDW at no charge. The artwork for these colorful posters is an enlargement of the cover art by Craig Farley seen on our *World Builder's Handbook*.

Mistake Department: Last issue's playtesters were Craig Sweigart, Nona Sweigart, Ron Abramson, and Mike Hines. Sorry we forgot to mention your names.

Coming soon to a game store near you: **MegaTraveller Aliens Volume 1: Vilani and Vargr, the Coreward Races**. This book, the first in a series of four, completely updates the material on the Vilani and Vargr for your **MegaTraveller** campaign excitement. Look for it this fall. Future volumes will detail the other major races, and include information on minor races and how to "roll your own" aliens.

Also appearing soon will be *The Black Duke*, the first of our campaign sourcebooks. With this book, you can take your PCs to Ilelish, home of Dulinor, assassin of Strepnon and claimant to the Iridium Throne. Can your characters survive in this environment as their loyalties are put to the test? Not just an adventure, *The Black Duke* is packed with background material for Dulinor's domain and the nebulous borders with other regions.

Last but not least, our work with Marc on *Marc Miller's Battles of the Rebellion* series is progressing. Look for it to appear soon... (we can't say just when yet).

One word about this issue: William H. Keith needs no introduction to a multitude of **Traveller** fans, and we are overjoyed that he wrote this issue's feature adventure. It's a winner.

Several issues ago we advertised that we (DGP and GDW) were forming a **MegaTraveller** discussion area on the com-

puter net Delphi. For various reasons, the Delphi computer net did not work out. We have instead gone to the GENie computer net run by General Electric.

The **MegaTraveller** section on GENie has been growing by leaps and bounds, with new members being added weekly. To access GENie, you need a personal computer and a modem. In most areas of the country, you can log on to GENie using a local number (so you don't have to pay long-distance toll charges), and you simply pay for your time on the network (\$6.00 per hour during evenings and weekends).

Joining GENie costs \$29.95, which gives you a user ID and entitles you to two free hours. To join, just do the following:

1. Have your major credit card or checking account number ready.
2. Set your modem for local echo (half duplex) — 300 or 1200 baud.
3. Dial 1-800-638-8369. When connected, enter HHH
4. At the U#= prompt enter **XTX99649,GENie** then RETURN.

Survey Sweepstakes Results from TD16:

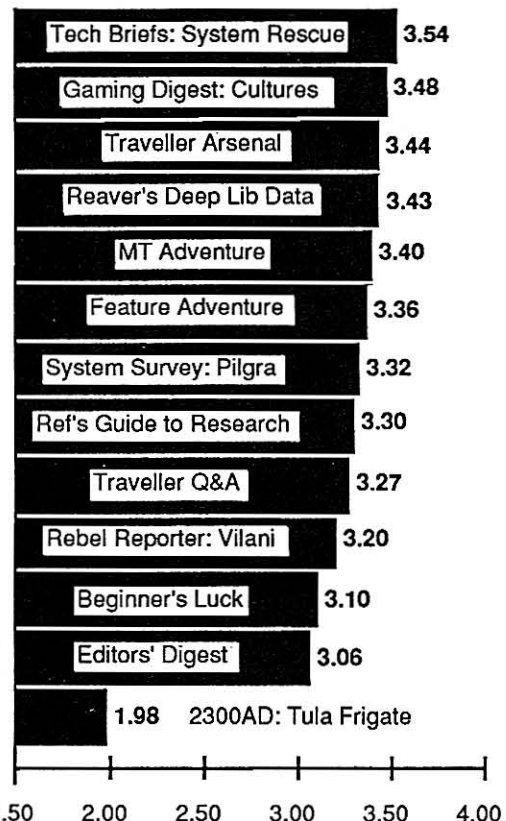

Congratulations to TD15 Sweepstakes Winners of Copies of the World Builder's Handbook:

- Gary Seebo
- Michael Shaffer
- George Maclure •

AKIDDA LAAGIIR, JOURNALIST

STATS:

858AAB age 49 7 terms Cr 21,000
 Interview-5, Streetwise-3, Grav Vehicle-1, Wheeled Vehicle-1, Admin-1, Brawling-1, Computer-0
 Holocrystal Recorder
 Starport A, Large, Dense Atm, Wet, High Pop, Mod Law, High Stellar
 Born: 319-1059

Position: Current recipient of the *Travellers' Digest* Touring Award.

Akidda Laagiir started at age 18 as a copy boy with the *Mora World Review*; his friendly face and ability to gain the trust of others contributed to his steady career progress.

Living on Mora, with its charismatic dictator, the Duchess Delphine the Matriarch, is sometimes a trying experience for any journalist, which may explain his occasionally iconoclastic actions. He is slightly prejudiced against "the system", preferring fresh ideas and fresh ways of doing things. This boldness (especially in interview situations) has also contributed favorably to his career.

His admin skill was learned while moving up the ranks, but it is a skill that he would just as soon not need: he much prefers cutting through to the heart of a situation. While he is sensitive to the needs of others, he has a well developed self-preservation instinct that allows him to quickly adapt to a strange locale or culture — a skill that has saved his neck on more than one occasion.

Like most writers, he is consumed with curiosity, and when the *Travellers' Digest* journalism contest was held again in 1098, he was among the first to apply. His piece was entitled "The Imperial Frontier: The Next Millenium". In it, he discussed the spinward frontier sectors of Deneb, Spinward Marches, Trojan Reach, and Reft as well as their role in shaping the growth of the Imperium in the next 1,000 years. On 258-1099, he received the announcement that he had won the coveted *Travellers' Digest* Touring Award.

Akidda has been travelling and submitting articles of his travels for over nine years.

Roleplaying Notes: Akidda's strong interview skill indicates he has a real nose for a good story: to play him otherwise would be untrue to his character. His natural curiosity makes him likely to pursue "trouble" rather than run from it.

The counterbalance to Akidda's tendency to seek out such trouble is his streetwise skill, which enables him to lessen the harmful results of an otherwise awkward situation. His streetwise skill may enable him to "stumble" onto a valuable source of information the others would overlook.

Keeping this in mind, the referee should use the NPCs encountered by Akidda as those with the most valuable information to the group, as a result of Akidda's abilities. Akidda's phenomenal interview-5 skill gives him tremendous insight when dealing with people.



DUR TELEMOM, EX-SCOUT

STATS:

A7A85B age 41 5 terms Cr10,000
 Auto Pistol-3, Survival-2, Pilot-1, Grav Vehicle-1, Engineer-1, Gambling-1, Brawling-1, Computer-1, Vacc Suit-0 Auto Pistol
 Starport A, Large, Dense Atm, Wet, High Pop, Mod Law, High Stellar
 Born: 038-1068

Position: Ex-Scout (on reserve status).

Dur Telemom was *born* into the Scout Service. His father was in the Scout Service while Dur was growing up, and both of his grandfathers had served in the Scouts in their younger days. Dur enjoyed nothing more as a boy than to sit and listen to their tales of adventure.

The Fourth Frontier War broke out when Dur was a teenager — his father's service in the war was a source of pride for the entire family and deepened Dur's love for the Scouts.

Dur's individualistic nature meshed well with his duties in the Exploration Office of the Scout Service. In his first term, a "routine" mapping expedition on Pannet/Rhylanor suddenly turned into a hostage rescue operation, and it was then that Dur happened to save Dr. Krenstein's life. Neither of them is overly emotional about it, but it was that initial chance encounter that grew into a respect and friendship between the two men over the years.

Dur's second and third terms were spent in District 268 and Five Sisters Subsectors doing various planetary surface and orbital surveys. During these surveys, Dur learned much about staying alive and living off the land in unusual environments. Halfway through his fourth term, he was transferred from his field post in the Exploration Branch to a bureaucratic position in Fleet Support.

Dur has resigned from the Scouts and has been travelling with his uncle, Akidda Laagiir.

Roleplaying Notes: Dur is the brash adventurer of the group and as such he is the least likely to fear physical confrontations or physical discomfort. He is also the most likely of the group to act without giving due consideration to the consequences. He has genuine concern for others and is the most likely to risk his life to save someone.



DR. THEODOR KRENSTEIN, SCIENTIST

STATS:

485FCB age 65 11 terms Cr 300,000
 Robotics-5, Leader-3, Electronics-2, JOT-2, Laser Rifle-1, Grav Vehicle-1, Medical-1, Mechanical-1
 Hand Computer (TL15), Electronic Tool Kit, Robot AB-101
 Starport A, Small, Vacuum Atm, Wet, High Pop, Mod Law, High Stellar
 Born: 173-1043

Position: Graz Redniz Chair of Computational Robotics at Rhylanor Institute of Technology — on sabbatical leave.

Dr. Theodor Krenstein is a gifted, multi-talented scientist, with interests from anthropology and archaeology to xenology and zoology, including most of the "ologies" inbetween.

Born on the planet Rhylanor, he entered the Rhylanor Institute of Technology at the age of eighteen, eventually receiving advanced degrees in computer science and robotics. He went on to serve three terms as Dean of the School of Robotic Science at RIT, after which he was appointed to the Graz Redniz Chair of Computational Robotics, a prestigious and coveted position. He is the author of 12 hologram publications and over 100 articles in technical and scientific journals, in addition to holding more than 250 Imperial military patents for his inventions and robotics work. Despite his academic success, he has become bored with what he has been doing, and realizing his age, took an extended sabbatical from teaching in order to make forays through Deneb Sector.

Among his many pursuits, Dr. Krenstein has aided the Scouts in developing robots for planetary surface surveys. During a test in 1090 on Pannel/Rhylanor, members of a disgruntled anti-technist group kidnaped Dr. Krenstein and threatened to kill him if the Scout Service didn't meet their demands. A young Scout named Dur Telemon was part of the all-volunteer raiding team that finally freed Dr. Krenstein; in fact, Dur was the first to reach the doctor.

After this incident, the doctor constructed his servant, bodyguard and experiment in synaptic learning, "Aybee".

Dr. Krenstein has been travelling with Dur Telemon and Akidda Laagir since their chance meeting eight years ago.

Roleplaying Notes: Dr. Krenstein, the "Mr. Fix-it" of the group, contributes valuable analytical skills. Together with Aybee, the doctor may contribute unusual insights Dur or even Akidda might otherwise overlook.

The doctor is slightly mischievous in the manner in which he conceals Aybee's true robotic nature — a source of much fun if roleplayed completely. The doctor seeks new experiences and knowledge for both his robot and himself, so he will pursue adventure suggestions readily.

Keep the doctor's age in mind — he is the least able of the group physically, although Aybee helps to make up for this.



AYBEE WAN OWEN

APPARENT STATS:

8D9C7B age 19 0 terms Cr 0
 Medical-1, Linguistics-1, Grav Vehicle-1, Laser Welder-1
 Starport A, Small, Vacuum Atm, Wet, High Pop, Mod Law, High Stellar
 Born: 049-1081

Actual Pseudobiological Robot Profile:

Constructed in 1091 by Dr. Theodor Krenstein
 561x2-A2-PM327-FDC7(J) Cr11,970,600 319K
 Fuel=78.1 Duration=21.7 TL=15
 7/17 (Jack)

Head (10%), 2 Lt arms
 2 Eyes (+1 light intens), 2 ears, voder, touch sensors
 Pwr int, brain int, TL 15 holo recorder, Lt laser welder
 Medical-1, Linguistics-1, Grav Vehicle-1, Valet-1, Laser Welder-1, Rescue-1, Emotion Simulation



Position: Personal servant and protégé of Dr. Krenstein.

AB-101, or "Aybee", is a pseudobiological robot designed and constructed by Dr. Krenstein. Aybee's apparent UPP is what Dr. Krenstein wishes Aybee to project to others based upon his programming (he is actually capable of much greater values); his intelligence and education are estimated from his computer hardware and software; and his social class is based upon his position as a knight.

Although Aybee's programming gives him certain basic abilities, he lacks true artificial intelligence and thus can make errors in judgment; in abstract situations, this effectively lowers his true skill level. Aybee's "weapon" is a light laser welder, built into his right arm. Many Imperial worlds specify standards for robot-installed weapons, and Dr. Krenstein has designed Aybee so that his arm (ostensibly used only as a tool) can pass inspection by officials, since laser welders are generally not restricted by local law levels; however, voice override controls allow Dr. Krenstein to use Aybee as a weapon at short range.

Roleplaying Notes: Without a doubt, Aybee is the most unusual of the quartet. He is also the most difficult to roleplay effectively.

Aybee is the most valuable piece of equipment the group has. He can record situations in 3-D hologram form (10 minutes' worth, after which it is relegated to 2-D storage), then play them back for future study at the group's leisure. He will quietly observe a situation and report his findings to the doctor, keeping the doctor's safety as his priority.

Aybee is a good source of logical analysis, although his conclusions are devoid of any creativity or revelations beyond the obvious (although sometimes the obvious can seem like a revelation). Play him as a naive, knowledge-hungry character. He should make errors in judgment when a situation relies heavily on intuition. He is likely to miss subtle innuendos that humans are so prone to use.

Strangers who find out that Aybee is a robot may react negatively (increase the difficulty of any interpersonal task one level). Most will never suspect from casual observation that Aybee is nothing but a machine.

To determine Aybee is a robot at close (1.5m) range:

Difficult, Robotics, Interview, 2 min

Referee: Roll once during the first encounter. Thereafter roll daily if the character constantly spends extended periods of time near Aybee. Otherwise, ignore this task — there is no chance for detection.

Aybee's power plant is a closed hydrogen/open oxygen fuel cell. Aybee carries his own hydrogen supply, but the hydrogen is oxidized by oxygen from the air. Aybee is thus much like a true human in this respect — if he loses his oxygen supply, his power plant will not function. After an accident at the Shudusham Robotics Conference, Krenstein installed a half-hour supply of oxygen for emergencies. Aybee's fuel cell produces a harmless waste by-product which must be eliminated from time to time: pure water.

The Blade of Koiyekh

ADVENTURE NUMBER 17

—by William H. Keith, Jr.



INTRODUCTION

This adventure takes place on fabled Kusyu, homeworld of the Aslan. It throws a Traveller's Digest journalist and his companions into a mystery involving archaeology, Aslan mythology, and political intrigue.

Dates: All dates in this adventure correspond to the Imperial calendar. The starting date for this adventure is 053-1109.

Place: The adventure begins at the Firuahfahr Starport on the south coast of the continent of Tafohti, on the world Kusyu (Dark Nebula 1919).

Playtesters for this adventure: Craig Sweigart, Nona Sweigart, Bill Hezeltine, Jan Thomas.

NON-PLAYER CHARACTERS

Dr. Kal Langtree, Scientist



689AD7 Age 50 8 terms
 General History-5, Computer-4,
 Trokh Linguistics-3, Leader-2,
 Survival-1, Grav Veh-0
 Starport B, Small, Std Atm, Dry,
 Mod Pop, Mod Law, Avg Stellar

Dr. Langtree is a research archaeologist operating on a grant from the prestigious University of Peraspera.

Brad Kiltrik, Scientist



AA9AB6 Age 30 3 terms
 Aslan—Imperial History-4, Admin-1,
 Computer-1, Grav Vehicle-1, Trokh
 Linguistics-1
 Starport A, Medium, Std Atm, Wet, Mod
 Pop, Mod Law, High Stellar

Kiltrik is a research assistant working with Dr. Langtree. His special area of expertise is Aslan—Imperial history. It is he who uncovered the possible significance of the Ukhtaitasoistsea and called it to Langtree's attention.

Judi Pace, Scientist



799AA9 Age 28 3 terms
 Computer-4, Admin-3, Persuasion-1
 Starport A, Medium, Thin Atm, Wet,
 High Pop, Ext Law, Early Stellar
 Pace is Dr. Langtree's personal
 secretary and administrative assistant.
 Her skill with computers makes her
 particularly useful in research and data
 retrieval. She is in love with Brad Kiltrik.

AiaiouweifySitleyuwewu, Outcast

A6A892 Age 24 2 terms
 Artisan-2, History (Aslan)-2, Tolerance-2, Galanglic
 Linguistics-1
 Starport B, Small, Std Atm, Desert, Mod Pop, Mod Law,
 Early Stellar

Known familiarly as Aiai (pronounced Aye-aye), this young Aslan is a landless female of low caste serving as Dr. Langtree's translator and field assistant. Aiaiouwei is invaluable in her knowledge of Trokh and Aslan customs. Helped by Langtree when he arrived on Kusyu, she is completely loyal to him.

Captain Jered Channis, Merchant

989976 Age 38 5 terms
 Pilot-4, Navigation-3, Gunnery-2, Handgun-2, Broker-1,
 Carousing-1, Gambling-1
 Starport A, Small, Std Atm, Dry World, Mod Pop, Mod Law,
 Early Stellar

Channis is a free trader with his own ship, *Freewheelin'*, a 200-ton Free Trader currently grounded on Kusyu. This NPC may be encountered when needed in any Floating Gardens bar. If necessary, he and his 3-man crew can be hired as additional NPCs for the Langtree expedition. Otherwise, he will be glad to help the adventuring party get off-world — for a price.

KUSYU DAWN

(Opening Dialog)

Akidda Laagiir sprang from his bed, eager to rile his nephew by waking him too early. "Everybody up!" he shouted, strolling into the next room while clapping his hands. "If you want an Aslan breakfast, you'll have to —"

He stopped suddenly. Dur Telemo's bed was freshly made, and Dur wasn't in it. Akidda cast his glance about the hotel room: there was Dur's Scout-issue duffel, there was his wardrobe hanging in the closet, there was his auto pistol on the nightstand, but there was no sign of him.

Akidda walked back into his room and sat down by a terminal. He pressed a bright green rectangle on the desktop, and a few seconds later the head of an Aslan appeared floating above it.

"May I help you, sir?" the holographic image asked.

"I hope so," Akidda replied. "Is Dur Telemon in the restaurant?"

The Aslan's face could be seen to turn to one side, and subtle movements of her shoulders revealed that she was keying in the query at her own terminal. "No," she answered, "he isn't."

"Has he left the hotel?" A faintly irritated note crept into Akidda's voice.

"He didn't notify the front desk that he was leaving," the Aslan cooed. "Is anything the matter?"

"No, thank you." Akidda switched off the display and punched in the code for the room of his travelling companions, Theodor Krenstein and Aybee Wan Owen. In a moment, the robot's youthful face appeared.

"Good morning, Aybee," Akidda said. "Can you call Krenstein over? I want to talk to him."

"Certainly, Akidda. Just a moment." The head of the robot disappeared from view, only to be replaced by that of his older, balding creator.

"Krenstein, I'm worried about Dur," Akidda said. "His bed hasn't been slept in, and the front desk doesn't know where he is."

Dr. Krenstein furled his brow and stared back intently. "Perhaps you had better come to our room, Akidda."

"I'll be right there." Akidda switched off the terminal again and walked over to his closet. He reached for a shirt, but decided to save time by risking a short walk down the hall in his pajamas. His companions' room was just next door, after all, and Dur might be in danger: the four friends had picked up a considerable number of enemies along their journey, not the least of which was a Zhodani spymaster they had last seen on Terra.

A few moments later Akidda was knocking on Krenstein's door, and a moment after that the door was opened by Aybee. Akidda hurried inside, about to speak until he noticed Krenstein holding his finger against his lips. The scientist nodded his head in the direction of the window, where Akidda saw Dur sitting quietly, staring outside.

Krenstein leaned over toward Akidda. "Maybe you can talk to Dur — we couldn't do a thing for him," he whispered.

Akidda walked over to his nephew and put a hand on his shoulder. "Dur?" he said quietly. "What's the matter?"

Dur looked up morosely, then turned aimlessly back to the window. "I couldn't sleep last night, I guess. Thought I'd take a walk around, and finally ended up back here."

"So?"

"So it just doesn't seem worth travelling any more. What is there to do?"

Akidda looked back at Krenstein, eyes wide with surprise, then turned again to his nephew. "What is there to do? We're on Kusyu, the homeworld of the Aslan race, that's what there is to do. We've visited the homeworlds now of four major races, and met at least one representative of all of them. What more do you want?"

"That's just the point, Kidd. We've seen everything, we've done everything, and there just isn't that much left. I mustered out of the Scouts because I didn't want to get stuck with a desk job."

Krenstein joined in the conversation. "Dur, what we've been through the last eight years hasn't been my idea of a desk job."

"That's what I'm saying. I've had three lifetimes' worth of excitement, and now we're headed home. The jump-5 route across the rift might be interesting, but I just can't help but feel that everything else is going to be —"

"Anticlimactic?" Akidda said.

"Thanks, Kidd. You can use the word in one of your stories, telling how we limped home across Aslan space, taking our time, seeing the same old stuff, and eventually dying of boredom."

Akidda shook his head. "It won't work, Dur. You talked me out of the same feelings of ennui before we visited Wal-ta-ka. That wasn't anticlimactic, was it?"

"What — being dumped in the middle of some desert and desperately fighting to get out with our lives? Sure, that was fun, but Kusyu is civilized. We won't see any action here."

"C'mon, Dur, you know we're ready for this. Krenstein's been pumping Aybee's circuits full of Aslan words, and we're all up for an adventure. Let's go!"

Dur looked at his uncle for a while, then roused himself out of the chair. "All right, Kidd, you win, but on one condition."

"That we find some excitement soon?"

"No."

"That we do some backcountry exploration while we're here?"

"No."

"What, then, Dur? Anything you'd like, if it would cheer you up, but let's visit Kusyu as long as we're here."

"It would cheer me up if you'd change out of those pajamas before I'm seen with you in public. After all, I am a knight of the Third Imperium, and I have a certain image to uphold."

WELCOME TO EXOTIC KUSYU

(Preliminary Set-up)

Players' Impressions: You arrive at Firuahfahr Starport aboard the freighter which has brought you from Reaver's Deep. The port is a riot of color, as Aslan in brightly-colored garb throng pedestrian ways, load or unload starship cargos, or call to one another in the rich and liquid syllables of Aslanic Trokh. The pungent flavor of *shifaowoi* lies heavy in the air.

The port is in two sections: the ground facilities where starships are serviced, and *L'hahto* — the Floating Gardens. The Gardens is a vast, saucer-shaped building — actually a small city. The Gardens, hovering 2 kilometers above the port's ground terminal, gleams with gold tones, and is richly inscribed with the ornate and flowing letters of Aslan *yoyeaokhtef*.

Referee's Summary: This initial scene is intended as an introduction for the players, and to remind them that this is not a human world. Everything they come in contact with will be subtly different from what they are used to, including the shapes of Aslan starships and buildings (smooth, rounded, and organic-looking), the smells of alien cooking, and the sounds of Aslan speech.

Tasks:

To use a portable translator:

Routine, Aslan Linguistics, Liaison, Instant

Referee: This task supposes that the players have portable translation devices of some sort, which are common and fairly easy to come by. Most models, when programmed for Galanglic-Trokh, will reliably provide two-way consecutive translations. In the absence of a portable translator, consider that Aybee's computer memory has the equivalent skill level of Aslan Linguistics-1.

Rolls should be made for any important exchange of information. Mishaps should be treated as a relatively simple misunderstanding. Trokh is rich in abstract concepts and double meanings, and even the best language program will be confused from time to time. As a simple example, "Where is the key?" could also be translated as "where do we start?" The concepts "key" and "beginning" are both expressed by the same Trokh root: *fahr*.

An exceptional failure may mean that a misunderstanding has caused real trouble, insulting a host instead of thanking him, for example.

Referee's Details: The players should be forcibly reminded that they are on an alien world, one filled with strange sights, sounds, smells, and impressions. *Shifaowoiis* a spice favored by Aslan in their cooking, and can be described as a blend of cinnamon and pepper. Trokh is a sonorous, sing-song language rich in vowels and subtle, whistling sounds. Players might be reminded of the call to prayer sung or chanted by an Arabic muezzin. *Yoyeaokhtef* is an art form blending poetry, drama and calligraphy and employing the Trokh cursive script. The *tao*, or symbol units of *yoyeaokhtef*, are seen everywhere, employed as decoration on Aslan ships, weapons, buildings, and personal ornamentation.

Plant life tends to be broadleafed and darkly pigmented, with a heavy blue-green color (*hto*) which contributes to the jungle feel of the growth. Humans are relatively rare on Kusyu, and everything the players see, hear, and smell seems exotic.

Aslan working at the hotel and throughout most of the Floating Gardens are familiar with human ways (treat as having Liaison skill as applied to intercultural relations) and there is little chance of trouble unless the characters go looking for it. Expeditions farther afield, however, are likely to end in misunderstandings and ruffled feelings at least.

The characters are staying at the *Hyutahiwhteakhtau* at the Floating Gardens, a hotel generally referred to as "the Hyutah" by guests. The name, incidentally, means "gathering of barbarians."

The Floating Gardens is, in fact, a small city, housing certain administrative functions for the starport. It also houses Kusyu's principal human enclave. Here can be found hotels catering to humans and other non-Aslan, as well as bars, shops, restaurants, and the other facilities common to all human starports.

Visitors engage "grav floaters" (transparent-shelled floating eggs) at the port terminal which carry them to the Floating Gardens. All but the cheapest rooms have windows — or even terraces — overlooking the starport and the gleaming blue of the Firuiheatlew Sea to the south.

Meals can be had at any of a variety of restaurants and bars, with prices ranging from Cr4 to Cr32 per person. Attempts to find other accommodations, incidentally, will end in failure. Aslan do not use hotels as such, since Aslan forced to travel stay with clan relatives.

Information about Kusyu and the Aslan will be freely available. Sources include the terminals on board the Aslan freighter the characters came in on, and information centers at the starport.

The higher-priced rooms at the Hyutah have information terminals which display information in a format specifically designed for humans. Access is easy and does not require any special skill. However, the players should specifically request background data on the world or on the Aslan before it is given to them.

Note: Extensive additional background data can be found in the MegaTraveller Referee's Companion and in the old Traveller Alien Module 1, both from GDW.

THE WORLD OF KUSYU

(Players' Background, Library Data)

Star: Binary, Tyeyo and Saietaie

Tyeyo: Type G4V; Luminosity: 0.77; Radius: 0.93; Mass: 0.96

Saietaie: Type DA; Luminosity: 0.0003; Radius: 0.01; Mass: 0.36; Mean distance from primary: 4.2 million km.

Kusyu: Kusyu/Kilrai' (I'aheako 1919 A8769H6-E)

Mean distance from primary: 0.995AU. Period: 320.02 std days. Diameter: 12,980 km. Mass: 1.05. Density: 0.99. Surface gravity: 1.02 G. Rotational period: 36h 2m 23s. Axial tilt: 2°. Orbital eccentricity: 0.01. Average temperature: 9° C. Atmosphere: Standard oxygen-nitrogen, tainted with moderate levels of industrial pollutants. Population: 4.631 billion. Satellites: 2.

Notes: Kusyu, often spelled Kuzu in Galanglic, lies in what humans know as Dark Nebula Sector. It is the homeworld of a major race which calls itself *Fteirle* and which humans know as Aslan.

The world is much like Terra in many respects, with similar mass, density, and gravity. The mean surface temperature is somewhat cooler than on Earth, but the minimal axial tilt and orbital eccentricity result in a stable, year-round climate with a continuous growing season.

The ice caps are slightly larger than Terra's. Equatorial temperatures are quite comfortable for humans. The slightly larger land surface area has resulted in larger desert and tundra regions than on Terra. Despite the extreme territorial nature of Kusyu's natives, large tracts of less hospitable land remain as wilderness.

Of particular geosocial interest is the fact that Kusyu has no capital per se. Each clan has its own *hyufteirleye* — the word refers to a meeting place for the people and could be translated as "city" — but there is no one city or administrative center which speaks for the entire planet. Individual cities are identified with specific clans, and each clan (*ahryi*) large enough to control several such cities generally has one *htahyu*, a "first place", where judgments are made, challenges accepted, and records kept.

The Aslan Council of the 29, the Tlaukhu, meets periodically at agreed-upon sites in rotation.

The principal starport is Firuahfahr, an excellent class-A facility on the south coast of the continent of Tafohti. The site is perhaps the closest thing on Kusyu to an international city, since all of the major clans and many of the minor ones maintain trading and mercantile houses here, convenient to the port. The port itself is directly administered by the Tlaukhu, which maintains a legal presence within the floating administrative complex known as L'Ihahtoi — the Floating Gardens.

Kusyu has two natural satellites, *Aoshi* (Swift Spirit) and *Aoka'ah* (Slow Spirit). Both are planetoids with diameters of only 400 kilometers — they thus appear merely as bright stars from the surface of the planet. They orbit, respectively, at distances of 51,000 kilometers and 96,000 kilometers from the planet. Both satellites support large Aslan colonies.

In addition, there are numerous orbital facilities, including two large colonies in what would be the inner LaGrange positions if the satellites were more massive.

— Excerpted from *Hallowell's Pilot's Manual and Interstellar Ephemeris, Dark Nebula Sector, 1108 edition, Farstar Publishing, Marlheim.*

REFEREE'S SYNOPSIS

The characters join an archaeologist in tracing an Aslan myth, and encounter increasing resistance and hostility from the Aslan. One member of the party is kidnapped by fanatics and must be rescued. In the process, the characters come across clues to the secret the Aslan are guarding so closely: they are not, after all, a major race! Escaping alive becomes the highest priority for the characters.

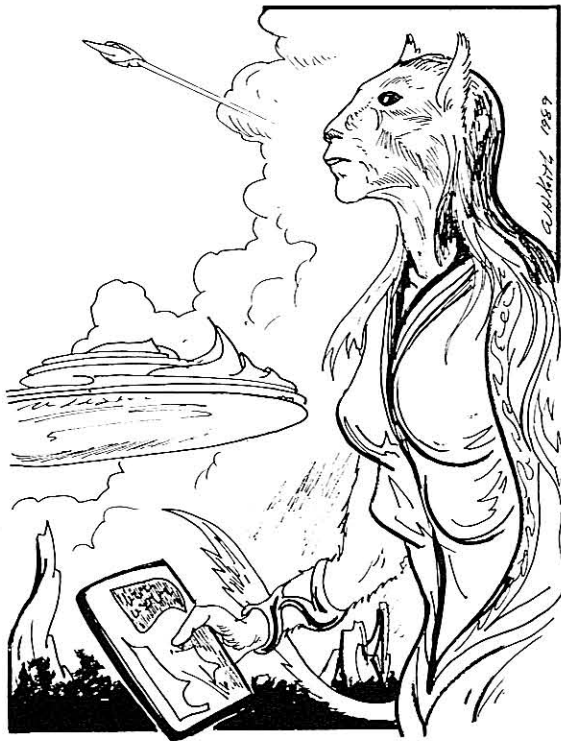

A DAMSEL IN DISTRESS
(Event 1)

Players' Impressions: While walking along an outdoor terrace of the Floating Garden at sunset, you are approached by a female Aslan in obvious distress. "Humans!" she gasps in accented Galanglic. "Humans, you must come! *Sihouwelilyuahry!* Please!"

Referee's Summary: It should be obvious that the Aslan wants the characters to accompany her. Should they refuse, they will see what it is that has upset her so: a band of three Aslan males attacking two humans — a young man and an older, academic-looking man — by the terrace edge.

Tasks:

To notice clues during the fight:
Difficult, Intelligence, Liaison

Referee: Any characters who come in close contact with the attackers should each be given a chance to notice a subtle clue: each is wearing an ornate bracelet inscribed with a curious *tao* resembling the letters "er" in Anglic script. The symbol will be meaningless to them, but players who succeed in this roll should be shown the Koiyekh symbol for future reference.



Referee's Details: Aiai's cry in Trokh means "your pride calls to you", and she considers that any human must respond to the need of other humans in danger. This episode can be handled as a normal combat encounter. The Aslan attackers may each be considered to have a life force of 4/5. The attackers may be killed or driven off. None will be captured alive.

Aiai will recognize the *tao* symbol if she is shown a sketch of it. She will be able to tell the players only that it is the *tao* of the Koiyekh, a secret Aslan brotherhood. If the characters desire to investigate this lead further, the referee should go to the section entitled **Brotherhood of Koiyekh**.

THE DOCTOR'S QUEST

(After the Fight)

Players' Impressions: The rescued scientist, Dr. Kal Langtree, is a middle-aged, professorial-type who introduces himself to you as an archaeologist working on a grant from the prestigious University of Peraspera.

His companions are young, good-looking Brad Kiltrik, his assistant; and a low-caste, unmarried Aslan female called AiaiuweifiySitieyuwewu, or Aiai for short. He is extremely grateful for your timely assistance and insists that you join him in his quarters in the hotel. There you meet the fourth member of his party, Langtree's secretary and administrative assistant, Judi Pace.

Referee's Summary: Dr. Langtree is more concerned than he lets on. After a short conversation with the characters he offers them a job.

Referee's Details: Langtree is on the trail of what he believes will be a significant contribution to the understanding of Aslan science and history. He has come to Kusyu to research the roots of an ancient Aslan myth: the *Ukhtaitasoistsea*. This should be fascinating to Krenstein, who will probably want to join in, money or no money.

Shaken by the attack at the spaceport, Langtree offers to hire the adventurers as bodyguards. He has been plagued by such incidents which, he believes, are aimed at him in hopes of making him abandon his quest.

If the player characters (PCs) refuse the job, they find themselves drawn into Langtree's company anyway as the mysterious assailants assume they must be part of Langtree's party, whether they are or not. If the PCs accept, they find themselves targets of a rapidly escalating campaign to drive all of them off Kusyu.

UKHTAITASOISTSEA

(Player's Background)

The poem which Langtree is studying (he will explain) is a heroic epic called the *Ukhtaitasoistsea*. It describes a war fought between two clans, the Yerlyaruiwo and the Khaukheairl, some 3,000 years ago. According to the epic, the war was interrupted by the appearance of spirits who induced the warring clans to cooperate. It ends with the warring clans agreeing to cooperate to build the Ukhtai, first of Kusyu's starships.

Ukhtaitasoistsea: Epic poem, composed in Trokh by Lyelri'tusye the Elder in approximately 2000 Aslan (-320 Imperial, or about 1,400 years ago). It runs to nearly 3,600 lines, organized into four or five tala (books or scrolls). The name, loosely translated as *Unknown Lands Seized by the Hero*, may hold a deliberate double meaning. Ukhtai (hero) was also the name of the first Aslan starship, which means that the "unknown lands" could here refer to unknown worlds.

The work begins with a brief introduction, the *Tlauftahea* (literally "Thirty Years"), detailing the mutual and traditional hostility between the two senior Aslan clans, the Yerlyaruiwo and the Khaukheairl, in the early years of Aslan space travel. It includes a moving plea equating *ya'uiyekh* (extinction) with *ya'uiya* (dishonor), tied in with a brief description of the third Aslan world war (-18 Aslan, -2098 Imperial).

This leads to the *Tlaukhu'hai*, a somewhat romanticized picture of the formation of the Tlaukhu — the Hierate of the 29 — and the institutionalization of clan warfare and disagreements.

The *Ukhtai* (hero), comprising the longest section of the poem, describes how continuing hostility between the Yerlyaruiwo and the Khaukheairl led the new Hierate into its first crisis, threatening once again to plunge Kusyu into nuclear war — and possibly end all life on the planet (*ya'uiyekh*).

The "hero" of this section is Khisaiyayeruiarl, a young female of the Khaukheairl who averted all-out planetary war by engaging in a long and complex session of *firukhte* (deliberate challenges and insults) with the warrior leaders of the two major clans. This rather novel form of diplomacy challenged both sides, calling the warriors cowards and dishonored if they did not submit to reason and find a way to prove their honor short of destroying the planet. Again, the theme of *ya'uiyekh* versus *ya'uiya* becomes important.

Insulted by her words, a female of clan Yerlyaruwo was sent to challenge Khisaiyayeruiarl to *aisaiakheh* — a duel of honor to the death. Khisaiyayeruiarl won the duel by killing her opponent, but was herself mortally wounded. Rather than accept *khaofiy* (ritual apology) due her for her victory, she gave a final challenge, once more daring the combatants to settle their dispute in a formalized battle (*yerlik*) on the Hkaihelu (Plains of Hkai). Then she died, and her body was burned on a pyre raised between the two armies.

The last major section of the poem, *Hkaiyerlikhelu*, describes the Battle of the Plains of Hkai, which ever after became known as *Ukhtaihelu*, Plains of the Hero.

The battle ended, according to the poem, with an apparition, a "golden spirit, guardian of the unknown lands, cleaving sky and earth in thunder's fury".

The final verses of the saga are disjointed, and most extant copies of the poem leave off at this point. The oldest sources, however, including those in the unabridged *Siyreakhaotoior*, end the poem with a section called *Tlasoistsea*.

The *Tlasoistsea* records the appearance of Khisaiyayeruiarl's *ao* (roughly, her immortal spirit) in the form of a *tai'ao*, one of the air demons of ancient Aslan mythology. The *tai'ao* congratulated the warring clans on their bravery and honor, declaring that they had indeed chosen *Si'khiraokhaor* (roughly, the Warrior's Path of Honor), and granting to the two warring clans *yaeatyao*.

This word-concept cannot be easily translated. *Yae* in modern Trokh means a doorway or entrance, while *tye* refers to the stars (literally a diminutive form of *Tyeyo*, Kusyu's sun), while *ao* is, of course, the immortal spirit.

Modern commentaries render *yaeatyao* as "the gateway to heaven", the place of the star-spirits of Aslan warrior heroes, but this is uncertain. "Heaven" in the poem is given both as the traditional *tyeao* and as *tlasoistsea*, literally "the bounty of unclaimed or unknown lands."

It should be noted that the concept of "heaven" (*tyeao*) for the Aslan is different from that of most human cultures and refers to a state of eternal remembrance rather than a place of literal afterlife. The use of *tlasoistsea* as a kind of reward or literal heaven in this poem is unique to Aslan literature.

The poem ends with the Aslan clans ending the dispute and cooperating together to build the Ukhtai, first of Kusyu's starships, and a literal fulfillment of the promise of

While few extant copies of the *Ukhtaitasoistsea* remain, numerous commentaries and scholarly exegeses have survived which record pieces of the original and which discuss the work and its probable meaning. The lines recording the building of the starship Ukhtai and its first flight are generally believed to be an interpolation added perhaps five centuries after the time of Lyelri'tusye the Elder.

It is extremely unlikely that two clans such as the Yerlyaruwo and the Khaukheairl could have cooperated to the extent necessary to build a starship. The appearance of the "golden spirit" is either an allegorical reference or a natural phenomenon such as a comet or a brilliant meteor, while references to the supernatural *tai'ao* are, of course, mythic elements which Lyelri'tusye used for dramatic effect.



The location of the Battle of Ukhtaihelu was, until recently, unknown, and many scholars suggested that the battle itself was more legend than fact, a compilation of numerous events from across several centuries condensed into a single account. The Plains of Ukhtai are known, however, and the Hkai River nearby may be a memory of the time when the entire region was called Hkai. The nearest city is Htoi helu, some fifty kilometers to the south.

Though most of the events described in the poem are discounted as myth by experts, Langtree believes there is a historical basis to the story. He is trying to mount an expedition to the city of Htoi helu ("green field") in the subcontinent of Haka, some 4,000 kilometers from the starport. Langtree hopes to search this area for indications that the war described in the epic really took place. Unfortunately, he has met with nothing but delays and setbacks since he arrived — and lately he has become convinced that someone is trying to scare him away.

Langtree is stubborn, however, and refuses to give up.

PREPARING FOR THE JOURNEY (A Visit to Aslan Rent-a-Floater)

Players' Impressions: The machine is balky, battered, and corroded, a relic of another age. Still, it is the fastest — and most private — way you have of reaching the area Langtree wishes to explore. The vehicle resembles a large, flattened egg, with smoothly-contoured sides, a transparent bubble, and engraved *yoyeakhtef* invoking the aid of the *Tai'ao*, the Guardians of the Sky.

Referee's Summary: If the characters try to buy passage aboard commercial transport, they find themselves blocked as Langtree and his party have been — delays, bureaucratic confusion, improperly stamped travel permits, and the clear impression that the authorities would rather humans not venture far beyond the spaceport environs. For Cr160 per day, however, they can rent an archaic grav floater and make the journey themselves.

Tasks:

To avoid insulting Aslan through ignorance of customs: Difficult, Liaison, Aslan Linguistics, 30 sec (fateful)

Referee: Roll each time contact with an Aslan is attempted (e.g., when asking for directions or entering a shop).

The task becomes Difficult outside of either the Floating Gardens or the groundside port facilities, and Formidable at distances of over 100 kilometers from the port.

Mishaps result in misunderstandings. An exceptional failure suggests a gross insult has been delivered, and *aisaiaok-heh* — an Aslan duel of honor — will almost certainly be invoked.

Referee's Details: Local authorities have been blocking Langtree's requests for passage to Haka for weeks. The adventurers, new to Kusyu and unknown to the authorities, will be able to hire the old grav floater.

Their preparations for the expedition ultimately invite suspicion, however. Langtree is preparing for a major archaeological dig in the back country, and insists on laying in supplies such as food packs, camping gear, rope, packs, and weapons. They may be followed, or the PCs may begin to encounter the same bureaucratic resistance which has plagued Langtree.

DEALING WITH THE LOCALS (Referee's Information)

These data will be known by any character who has had extensive dealings with the Aslan in the past. In particular, the principal NPCs — Langtree, Pace, Kiltrik, and Aiai — will be excellent sources of information; at least they can tell a PC "you shouldn't have done that."

The referee may allow player characters to know some or all of this material if they have worked with Aslan previously.

The following list can be used by the referee to suggest exactly why that Aslan screamed a challenge and attacked just when the player thought he was getting along so well.

Don't send a boy to do a woman's work: Aslan are sensitive to the importance of sexual roles. Males do male work (hunting, fighting) while females do female work (administration, translating, technical work, almost everything else).

The physical differences between Brad and Judi are less obvious to Aslan eyes than they are to another human. Aslan tend, therefore, to classify human sexes by what the humans do.

Player characters who seem ambiguous about their roles (repairing equipment, then fighting) will confuse Aslan who are not used to humans. Even Aiai will be frustrated by what she perceives as "unnatural" behavior among the humans she is working with.

Considerable difficulty could be encountered by the characters during the adventure when Aslan they are associating with misinterpret their behavior.

Special note: Within Aslan society, males fight only males, while females fight only females. It is a gross breach of propriety for a female to challenge a male, or vice versa, though it is correct for an insulted male (for example) to send a female relative to answer a female's insult.

Do not show your teeth in public: Carnivores are sensitive about this one. A toothy smile will be interpreted as a challenge, unless the Aslan in question has had extensive dealings with humans in the past. An unstifled yawn could have similar results.

Do not offer a male money: This comes under the heading of male/female roles. Aslan mercenaries are paid only through female intermediaries, their "business managers", in effect.

Do not refuse a challenge: Turning down an Aslan challenge-of-honor will result in all Aslan — including even Aiai and others used to human behavior — having nothing more to do with the offending characters. This could be difficult if the party is far off in the outback.

Do not trespass without leave: The Aslan are strongly territorial. Even the vast, seemingly unclaimed back country on Kusyu belongs to *someone*, usually a noble who regards the land (*haso*) as a measure of his status, wealth, and power.

If the characters are found by the land owner or his representatives (if, for example, they are forced to land to repair their floater), they are expected to deliver *ekhtaowetyu*, a formal and ritual obeisance which, in effect, asks the landowner for permission to enter his land. The leader among the characters must drop to one knee and lower his eyes. One or both hands are extended at face level, palms up, with the thumbs (representing dewclaws) held upright.

The petitioner then says *si'yiekhtaowetyu kakhteyatai* ("I formally request the protection granted under the terms demanded by honor and beg your leave to enter your domains") or, more informally, *fiya* ("I am your vassal, sir, and obliged to you").

Although the Aslan lord has the right to deny the request (legally, he could kill the trespassers on the spot), common courtesy generally demands that he reply *ka'tai* ("you have my gracious consent").

Special note: The Aslan lord may extend *si'iaktæ* to persons he now regards as his guests. This is a formal invitation to dinner which must not be refused. If it is refused, the honor of a gracious host has been rebuffed; the lord will turn cold and formal and generally order the characters off his land within a set (and short) period of time.

Accepting *si'iaktæ* binds host and guest in a loose agreement of mutual honor and protection. The dinner may be elaborate or as simple as sharing a cup of water. The lord is expected to protect his guests while they are on his land; his guests are expected to behave themselves, to bring no dishonor upon the lord, and to assist him if he requires it of them.

THE JOURNEY TO HAKA (In Pursuit of a Myth)

Players' Impressions: Your flight begins at the Floating Gardens, high above the ordered urban and agricultural lands near the starport. As you journey northwest, farmland gives way to the Kusyu *khalifakht*, the wilderness back country. Rugged hill country and desert alternates with blue-green jungle growth clinging to winding river valleys. You cross an arm of the sea, endless and unbroken save for isolated Aslan hovercraft or fisheries. After several hours, you draw near to your destination, the city of Htoihele.

Referee's Summary: This section is transitional, a bridge between the starport scenes and the region the characters are going to explore. Depending on the referee's wishes, this passage can be quick and direct, or involve a breakdown in the back country.

Tasks:

To repair a breakdown of an Aslan grav floater: Difficult, Grav Vehicle, Gravitics, 1 hour

Referee: Considering the condition of the flyer, a breakdown is almost inevitable. Roll 2D on the mishap table (but convert any major result to minor damage instead).

Repairing the damage is one level more difficult than usual since the design is unfamiliar, and the instruction manual is written in Trokh. The task becomes Routine if the players think to enlist Aiai's help in translating the manual and reading the symbols inscribed on various engine parts.



Referee's Details: This interlude can be simple or complex, as desired, and details may depend on other aspects of the adventure so far. If the characters have already attracted attention to themselves — by saying the wrong things to the wrong officials, for example — or if they are being followed, the breakdown could be deliberate sabotage, which they will discover when they repair the fault.

The malfunction is in the grav impeller unit. The referee should mention one detail during the proceedings: though Aslan engineering is markedly different from its human counterpart, fortunately the overall design principles are the same. Aslan gravitics (and in fact all high-tech metaconductor systems: gravitics, maneuver drives, and jump drives) follow the same general engineering as human-designed systems.

NOBLE'S CHALLENGE (Encounter at Htoihelu)

Players' Impressions: On the street in Htoihelu, an Aslan male, rich and powerful (judging by the ornate design of his dress and the number of his attendants), stumbles into you [one of the male characters], and accuses you of clumsiness. The confrontation quickly escalates into *aisaiaokheh*, a duel of honor.

"*Fiyiyalrya'uist!*" he bellows, using the deliberately challenging stance of formal *firukhte*. Trokh-speaking bystanders gasp. The challenger has just called you "Imperial scum"; worse — "Imperial scum without honor!" To back down now means accepting shame which could cripple the mission...

Referee's Summary: The Aslan identifies himself as Yuilfewisaofet of clan Yerlyaruiwo. This will cause a stir among any Aslan present, since this is the leading clan of the ruling 29.

Yuilfewisaofet is a powerful and important individual. The challenge is in proper Aslan form and must be answered in single combat, dewclaw to dewclaw. The human will be issued a pair of *ayloi*, curved six-centimeter blades which strap to each palm in imitation of the Aslan *aisai*. The duel will take place in a public place early the next morning.

Referee's Details: The character must face the challenger. If combat is refused — Aiai will explain the consequences in no uncertain terms — all of the characters will be shunned. They will be unable to make purchases, buy flyer passage, or even question the natives. Aiai herself will be honor-bound to depart, and the characters will find themselves completely isolated.

Combat is handled in the usual fashion. The challenger has a life force of 4/6 and a dewclaw skill of 2.

Normally in a formal challenge such as this, combat continues until one of the contestants is wounded. This time, it is clear that the Aslan is trying to kill his human opponent, whether he tries to surrender or not. Once wounded, however, the Aslan immediately offers *khaofiy*, ritual submission, and the battle ends.

Cheating: Attempts by the humans to cheat — using Aybee's hidden laser, for example — will have the same result as refusing the challenge if detected.

The referee must judge the likelihood of success for such attempts, based on their cleverness and subtlety.

Possibilities include dazzling the Aslan with a millisecond, low-power burst from Aybee's laser; having Dr. Krenstein modify the *ayloi* with microelectronic implants (to stun or weaken the opponent); or using Judi's computer skill to access an Aslan medical record net, retrieve the opponent's medical records, and discover he suffered an injury to his left knee several months ago which may still be painful, thus giving the human combatant an advantage in the fight. The referee should not advise the players, however, but allow them to work out a plan for themselves.

It is important for the humans to win this combat in any way they can, since Yuilfewisaofet will do his best to kill his opponent.

If the Aslan submits, he must respond to questions put to him by the victor. Aiai will remind the characters of this if they do not think of it themselves. If questioned about his reasons for initiating the challenge, he will only respond that his kinsman Tlayahei'ifiyYerlyaruiwo commanded it. Tlayahei'ifiy is younger brother of Yerlyaruiwoko — the head of the most powerful of all Aslan clans — and therefore an extraordinarily powerful individual. Yuilfewisaofet will not volunteer this information; it must be demanded of him.

Yuilfewisaofet may not be compelled to answer further questions or otherwise help the adventurers. His "punishment" is the public humiliation of giving *khaofiy*.

"WE MUST BE GETTING CLOSE!" (A Discovery... and Disaster!)

Players' Impressions: Not long after the fight with Yuilfewisaofet, you [Judi Pace, Brad Kiltrik, and any of the player characters who happen to be with them] make an important discovery. At a Htoihelu *lu'uifakte* — an Aslan computer information center — you have accessed topographical surveys of the region Dr. Langtree is interested in and discovered an obscure reference to a minor jungle-shrouded ruin located a

few kilometers from the Plains of Ukhtai (some fifty kilometers north of the city). This news is tremendously exciting for Dr. Langtree, since it may be linked with the Aslan legends he has been studying.

As you leave the information center, you realize that you are being followed.

Referee's Summary: Judi's discovery is what the group has been looking for, evidence of ruins 50 kilometers north of Htoi helu near the site which legend associates with the battle Langtree is researching.

As they leave the center, the group is followed by a band of male Aslan. At a secluded spot, the followers attack.

Tasks:

Use standard combat resolution.

Referee's Details: Specifics of the attack depend on the situation and on the identity of any player characters who have accompanied Kiltrik and Pace. The number of attackers is sufficient to capture Brad Kiltrik and drag him away. Judi fights furiously but is brushed aside. The best efforts of any player characters in the group are not enough to stop Kiltrik's capture.

During the fight, each player character should be given another chance to recognize the *tao* on the attackers' clothing—the "er" symbol they have seen before.

If the players elect to further investigate the Koiyekh, the referee should refer to the next section of this adventure: **Brotherhood Of Koiyekh**. Otherwise, skip to **Trail Of The Koiyekh**.

BROTHERHOOD OF KOIYEKH

(Referee's Background)

Referee's Summary: The Koiyekh is a secret Aslan brotherhood which is behind many of the misfortunes the characters have been encountering. Attempts to research this shadowy organization yield only partial information—and are dangerous.

Tasks:

To learn about the Koiyekh Brotherhood:

Difficult, Aslan Linguistics, Liaison or Interrogation or Computer, 2 hours

Referee: Information about the Koiyekh can be obtained from several sources and using different skills, including interrogating captured members of the Brotherhood, interviewing Aslan officials or other NPCs, and hunting through records in a local *lu'uifakte*.

Mishaps represent some truth. The referee may determine which information should be passed on to the players, and which, if any, should be distorted or suppressed.

Players' Background, Hidden Data: Koiyekh is a secret Aslan warrior's society dedicated to severing all contact with the *tahiwihateakhtau* (barbarians) who threaten to contaminate the purity of Aslan thought, honor, and *akhaoye* (being or reality). It is led by AohkhoUyahuaiaifyWukh, a fanatical devotee of the principle of *khoafteirleao*, which holds that spiritual perfection can be achieved only through a rigorous purging of all things *akyaafteirleao* (roughly: opposed to the spirit of things Aslan.)

The organization is purported to operate all over Kusyu and on numerous Aslan colony worlds. AohkhoUyahuaiaifyWukh is reputed to lead his *ekhoao*—his "spiritual family"—in the area near Ukhtafahr.

The name Koiyekh itself is derived from the Trokh *kho ri'yekh*, meaning, roughly, "submersion of self." The term in this context is comparable to the Old Arabic Islam, meaning submission (to God). The "er" *tao* is the *yoyeaokhtef* meaning *kho ri'yekh*.

Referee's Details: Once the characters learn the meaning of Koiyekh, the pace of the adventure should pick up rapidly. Unknown to the players, whatever they did to uncover information on the Koiyekh has alerted the Brotherhood that *tahiwihateakhtau* are poking their ugly noses where they are not wanted.

Computer records may have been booby-trapped to alert Brotherhood observers; officials may be secret members of the organization themselves or in its pay or power; Aslan NPCs the characters talk to in the street may be interrogated later by Brotherhood agents.

Depending on how far along in the adventure the players are, further attacks—culminating in the capture of Brad Kiltrik (see: "**We Must Be Getting Close!**")—will be made. If the players have not yet left the Floating Gardens, further incidents will be relatively minor in nature: threats and attempts at intimidation.

Aiai is terrified of the Koiyekh, though she knows little about them beyond their name and fearsome reputation. If closely questioned, Aiai or Langtree will eventually admit that Aiai's family was dishonored by what was almost certainly a Koiyekh-implemented campaign; her father served as a mercenary soldier for humans in a campaign which brought him into conflict with the powerful Yerlyaruwo clan.

Her father vanished recently under mysterious circumstances, while under the cloud of official dishonor. As a result, Aiai has been unable to find work, save in the employ of Langtree, and she has responded with a near-fanatical devotion.

Local Aslan authorities will do little to help the characters. Many openly sympathize with the Brotherhood's ideals; others are in the Koiyekh's pay or are secret members. In any case, there is little the authorities can do, short of advising the humans to get off Kusyu as quickly as possible.

TRAIL OF THE KOIYEKH

(Pursuit of Brad's Kidnapers)

Players' Impressions: The trail points to the jungle north of Htoi helu. Brad's captors take few precautions to hide it, openly cramming their prisoner into a grav floater and vanishing toward the northern horizon.

Referee's Summary: This scene is leading the players to their final showdown with the Koiyekh. It is not difficult to find where they have taken Brad, but the characters should realize by now that they are facing a large and powerful organization. Eventually, the characters approach an Aslan encampment in the jungle. As they get close enough, they hear an eerie, wailing chant which Aiai recognizes as *eikhoifiruah*, dusksong for an enemy about to be killed.

Tasks:

To follow Brad and his captors:

Routine, Recon, Hunting or Sensor Ops, 2 hours

Referee: Depending on the situation, the characters may be able to pursue Brad's kidnapers in their grav vehicle, using the craft's sensors to home on the other floater.

Alternatively, the characters may follow on foot, counting on Recon or Hunting skill to locate traces of their quarry, such as smoke from a fire, litter from an encampment, or a long-range glimpse of a flyer landing or taking off.

Mishaps should result in delays (getting lost, or encountering an animal or difficult terrain), but not in failure. Sooner or later, the characters catch up with the Aslan party.

To approach the Koiyekh encampment unseen:

Difficult, Stealth, Recon

Referee: A mishap results in the characters being spotted.

Referee's Details: The pursuit takes several hours and may involve detours or delays as the party gets lost or encounters animal threats or rough terrain. Eventually, they hear a large number of Aslan nearby. A task roll is required to approach the encampment. If the characters are discovered, a battle in the jungle may follow.

Judi, incidentally, is deeply in love with Brad. Any suggestions that he should be left to his fate will be wildly contested by the girl, who will proclaim that she will go rescue Brad by herself if she has to. Aiai will follow (reluctantly) out of devotion to Langtree.

RESCUE IN THE JUNGLE
(At the Koiyekh Encampment)

Players' Impressions: The jungle clearing is filled with Aslan, many in ornate ceremonial clothing. Guest of honor is Brad Kiltrik, bound to a slab of gray metal. An Aslan stands above him, dressed in gleaming ornaments and metalwork, holding a knife to the sky. The watching Aslan continue to chant dusksong, a wavering and hypnotic song in minor keys and alien harmonies.

Referee's Summary: Whether or not the characters have been spotted during their approach, they have little opportunity to watch the scene unfold, for the Aslan — the priest Uyahuiaifiywukhifiyraohkie — is clearly just about to kill Brad. The only advantage the characters have if they elect to attack is surprise. Few of the Aslan are armed, but the human characters are seriously outnumbered.

Tasks:

- To recognize important clues:
- Routine, Liaison, Aslan Linguistics or Int

Referee: Each character who knows anything about Aslan culture should have the opportunity to make this roll.

Referee's Details: This encounter will probably result in a fight. While the Aslan present are armed only with personal hand weapons such as *taleryu* (a double-ended blade with a handle in the middle to fit the Aslan hand), more formidable weapons (laser pistols, rifles) soon appear. Uyahuiaifiy stands and fights any characters who approach Brad. The priest must be killed or incapacitated before Brad can be cut free.

The first roll for recognizing an important clue should lead one or more of the characters to realize that the Koiyekh priest is holding a knife of obviously human design. Anyone familiar with the Aslan should know that the Aslan have never invented any tools or weapons that resemble knives. (Their retractable dewclaws are natural knives which they can use with more skill than an artificial blade.) The closest thing the Aslan have to a knife is the crescent-shaped *taleryu*.

The knife the priest is holding is obviously of considerable ceremonial import to the Koiyekh. If necessary, Aiai can point this out to her human companions. Brad could also say something after he is freed. He has had plenty of opportunity to see the knife first-hand and reflect on its mystery!

If the knife is captured by the players, refer to the section of this adventure entitled **The Blade of Koiyekh**.

The second roll for recognizing a clue will lead one or more of the characters to notice the gray metal slab to which Brad was tied. It is very old and quite corroded. Old Anglic letters, "TRS Pa," can just barely be made out on the surface.



THE BLADE OF KOIYEKH (Referee's Background)

Players' Impressions: The knife is definitely of human design, with a black, carballoy blade and a grip designed for human hands. It is extremely old, the durable metal is etched and pitted, and the blade is covered by a thin patina of corrosion. Ornate Trokh script on the side of the blade reads "*Fahryaatyæao*", literally "Key to the Gateway of Heaven".

Faint words can also be made out along the blade's spine. They are illegible at first, but careful cleaning reveals them to be Old Anglic, reading: TRS *Pathfinder*/Knife, Survival — 8296372490.

Referee's Summary: Once the players have an opportunity to study the knife, its importance becomes chillingly clear. Through any computer with access to human history and ship records, TRS *Pathfinder* can be identified as a starship from the period known as the Rule of Man, a vessel which was lost in space some 3,000 years ago.

Referee's Details: The Old Anglic inscription includes an equipment serial number. The last four digits are the date of issue: 2490 (-2028 Imperial; 63 Aslan). The artifact appears to be a genuine relic of the Rule of Man. Research carried out when the group has access to the appropriate data will identify *Pathfinder* as a Terran research vessel lost during its fifth mission. *Pathfinder* was last heard from in 2505 AD (-2013 Imperial; 80 Aslan).

What is the Koiyekh cult doing with the artifact? Prisoners will only say that the blade is sacred, a relic handed down from the *Tai'ao*, the guardian spirits of long ago. The script on the blade says much the same thing, referring to the blade as the Key to Heaven.

The blade nearly was the key to heaven for Brad, but some thought will suggest that the Aslan concept of heaven is different from that of most human cultures. There is a deeper meaning here, and research, plus discussions with Aiaiouwei will reveal that *Fahryaatyæao* could also mean something like "key to the stars."

If any of the characters spotted the Anglic lettering on the sacrificial slab, he may make the connection: TRS Pa can only be TRS *Pathfinder*. The slab may be a piece of wreckage from the ship or even an exposed portion of the complete vessel.

ON THE TRAIL OF HEROES (The Ruins in the Jungle)

Players' Impressions: After diligent searching you eventually locate the ruins. The entire complex is more than half buried in the soil, with dense jungle overgrowth choking the exposed walls and pillars. The ruins stand only a few kilometers from the place where Brad was rescued.

They appear to be a strange blend of old and new: metal buildings crumbling with corrosion and age, surrounded and supported by stone columns bearing Aslan symbols and script. They exhibit an atmosphere of decay and great age.

After chopping away the dense and tangled overgrowth, you find a tall stone slab covered with Aslan glyphs. One carving in the center is prominent: it seems to represent a human-designed knife. The slab appears to be a lid.

Referee's Summary: If the characters choose to pursue the clues which led them here, they will eventually find the ruins, buried in dirt and jungle overgrowth, several kilometers from the Koiyekh encampment.

Awaiting the characters at this site is a terrible secret, one which could have devastating implications.

Tasks:

To locate the ruins:
Difficult, Recon, Int, 4 hours

Referee's Details: Depending on the outcome of Brad's rescue, the characters may or may not be pursued by a large and thoroughly-aroused band of Aslan cultists. If they were able to escape by air, they will probably have lost their pursuers, at least temporarily. If they escaped on foot, the Aslan will be hard on their heels.

Discovery of the ruins may come through several means: they are pursuing clues uncovered by Judi and Brad; Brad overheard references to "the Sacred Place" while he was a prisoner; or the characters can simply follow a jungle trail and blunder into the place.

The rock slab lid will swing on hidden counterweights if one of the characters touches the carving of the knife.

THE UNLOCKED TREASURE (Inside the Ruins)

Players' Impressions: The stairs lead down . . . down . . . through stone-walled passageways musty with age. At the bottom of the steps is another counterweighted slab with an engraved knife. Inside is a chamber, hewn from bedrock.

Circling the chamber are ten stone platforms, each two meters long and half a meter wide, radiating from the center like the petals of a flower. On each slab is a skeleton, surrounded by age-crumbled bits of plastic and metal. One fact will be immediately apparent to you: *the skeletons are those of humans!*

Referee's Summary: The characters are now close to the secret they have been pursuing. They should be allowed to figure out as much as they can, based on the clues uncovered so far. If the Koiyekh give them the time, they could spend several days studying the ruins. If they are under attack, they may be forced to make some guesses and flee before the entire story is unveiled.

Alternatively, the referee could allow them to find a small recorder. Corroded and decayed, it will be unplayable. Later, aboard ship and with proper electronic tools, they could eventually play the tape and discover a computer diary of one James R. Winston, a planetologist of the Terran Explorer Service, dated 2505 AD. The recording can then provide the characters with all of the answers they seek.

Tasks:

To play the ancient tape:
Difficult, Electronics, Computer, 2 hours

Referee's Details: This information can be revealed bit by bit or through the playing of the ancient tape.

The Terran Research Ship *Pathfinder* misjumped into unknown space on September 12, 2505 AD. While attempting to land on a habitable planet in order to make repairs, the ship suffered a drive failure and crashed. There were ten survivors.

The landing made a great impression on the tech level 7 natives, who apparently were in the midst of a near-nuclear war. Both sides sent delegates to interview the humans, who apparently were thought to be strange heavenly beings. The *Pathfinder* crew made the most of the situation; they needed help to repair their ship, and the natives seemed willing and able.

In order to enlist the natives' help, *Pathfinder's* engineer began explaining the workings of *Pathfinder's* drives. The locals learned rapidly, and their current level of technology was sufficient that they could grasp the principles quickly. Under the direction of the two major clan leaders, a factory was built nearby to begin fabricating the necessary parts.

The remainder of the story is unclear. If the characters are listening to a recording, the narrative breaks off at this point. Possibly, an accident killed the ten shipwrecked survivors

before the repair project was completed. A darker possibility is that they tried to withhold some crucial piece of data and were murdered — or that they ran afoul of Aslan custom and died in honor duels or war. In any case, Aslan technicians learned enough about stardrives that they were able to build *Ukhtai*, the first Aslan starship, within the next few years.

This strongly leads to a startling and dangerous revelation: the Aslan are not, after all, a major race. They did not develop stardrive themselves, but learned about it from humans. Much of the background of the saga Langtree has been studying, long obscured by mythological elements, becomes clear. A battle was indeed interrupted by the arrival of powerful "guardians of the sky," beings who truly did provide the Aslan with the "key to the stars."

WE'VE GOT COMPANY (Continuing Encounters)

Players' Impressions: The Aslan cultists are clearly gathering their forces. You can hear large numbers of them calling to one another in the surrounding jungle, and more than once, one or more approach the ruins. Many are armed now with rifles or light laser weapons. Once, when one of you climbs up to see what is going on, a searing bolt of blue laser light crumbles stone just centimeters above your head. Not long afterward, you hear the faint warbling sound of an approaching grav floater.

Referee's Summary: Once the secret had been discovered, further events can be as simple or as complex as the referee desires and could present the group with an entire campaign in themselves. The characters must escape roving bands of Aslan fanatics and make their way across 4,000 kilometers to the Aslan spaceport. The approaching floater has several passengers on board of interest to the players.

Tasks:

To identify the floater's passengers:

Routine, Recon, Stealth or Int

Referee: This task roll is used only if one or more of the characters elects to go outside the ruins in an attempt to identify it. Exceptional success will give them the identity of two of the passengers. Normal success allows them only to realize that the passengers are important and powerful individuals.

Referee's Details: Further encounters with the Brotherhood are sporadic. Many of the cultists fled when their leader was killed, though bands of 2D-1 Aslan, armed with various weapons, are roaming the jungle, hungry for vengeance and honor.

These bands pose a constant danger to the adventurers until they decide to leave the area. More than one combat resolution may be necessary as the characters fight off repeated disorganized attacks.

The floater lands in a clearing several hundred meters from the ruins. On board are two important Aslan, Yuilfewisaofet and his kinsman Tlayahei'ifiyYerlyaruwo, plus 1D bodyguards. (If Yuilfewisaofet was killed or seriously wounded in the earlier encounter, any other Aslan lord will do as well.)

If the characters get close enough to identify Yuilfewisaofet by sight, they may hear him address Tlay, whom the player characters have not seen before. Alternatively, either Aiai or Dr. Langtree will recognize him.

The floater is met by several cultists, who appear to be explaining things with great animation and agitation. It becomes clear that both Aslan lords are mixed up with the Brotherhood, either as active supporters or for political reasons.

Eventually, the Aslan leave 1D guards with the floater and enter the jungle. If the player characters have misplaced their own floater (either left behind when they followed Brad's captors or because it was later damaged) this encounter gives them a chance of securing a quick lift back to the starport. Other possibilities include using one floater as a diversion or simply capturing it in order to strand the pursuers and buy additional time.

FAREWELL TO KUSYU (Concluding the Adventure; Referee's Information)

Once the characters leave the jungle, they are still not out of the woods. Attempts to reach a spaceport or an Imperial embassy or to board a commercial liner will be blocked by the personal guards of several of the most powerful clans of the 29.

Everywhere, groups of armed mercenary Aslan are searching for the human party, questioning humans, posting guards. It becomes clear that leaders of the Yerlyaruwo clan, at least, know the secret of the Ukhtai site, or enough of it to know that it could be severely detrimental to Aslan foreign relations if reliable proof is advanced that the Aslan are not — by Imperial definition, at least — a major race.

The adventurers can escape Kusyu in one of only two ways.

By Star Liner: Commercial transport is available if the characters can reach the spaceport ahead of Yuilfewisaofet and Tlayahei'ifiyYerlyaruwo and if they can sufficiently disguise themselves or smuggle themselves on board a star liner so that searchers at the port do not see them. No one task will resolve this problem.

The players must use their ingenuity and careful planning; the longer they wait, the tighter the official noose will close around the spaceport, until all passenger ships are grounded pending careful searches by Aslan troops. The time frame for these events is left to the referee; the players should feel as though they are escaping just moments before the authorities close in. Langtree, Pace, Kiltrik, and Aiai may or may not accompany them, depending on how the adventure has unfolded to this point.

By Tramp Freighter: A second way off Kusyu exists in Jered Channis, a free trader with his own ship, who will charge an exorbitant price (say, Cr30,000 each) for smuggling them off-world.

Money may be a problem at this point. The party can sell the Pathfinder knife for up to Cr120,000 to certain powerful Aslan nobles who approach them through shadowy agents at the port. As soon as the exchange is made, however, it becomes clear that the meeting is a set-up. Combat will be necessary to escape the jaws of the trap as they snap shut. Alternatively, the players can attempt to convince Channis that the knife is worth a fortune and promise to cut him in for a share at some future date.

In a final battle with security forces at an Aslan spaceport, *Freewheelin'* blasts clear and runs for it, escaping just ahead of Aslan naval units. Aslan patrols, searching for the fugitives, will cut *Freewheelin'* off from any direct route back toward Solomani space. Instead, they are forced to head toward the dangerous and roundabout J-5 route across the Riftspan Reaches.

If the players prefer, they may leave *Freewheelin'* at another Aslan port and take commercial passage from there.

They will survive only if they can stay ahead of the news of their escape. The 29 itself has ordered their deaths and will stop at nothing to carry out the sentence.

A final problem remains. The adventurers have learned an empire-shattering secret. Now — what are they going to do with it? •

ASLAN GLOSSARY

Ahryl: Clan. Sometimes translated as "pride".

Aisai: An Aslan's dewclaw, a 10 cm, razor-sharp blade which folds like a jackknife into a horny sheath in the base of his palm. From *aisai*, "blade-claw".

Aisalaokkeh: Literally "honor beneath the blade-claw". A duel of honor, usually involving principles so deep and important that the fight must be to the death.

Akhaoye: Being, reality; essence or spirit of things Aslan.

Akyafteirleao: Contrary to the spirit of the Aslan culture. More than "barbarian", it signifies an active anti-Aslan threat.

Ao: Immortal spirit; also that-alone-which-is-real.

Aoka'ah: Slow Spirit. Kusyu's outer moon. Also, a concept—especially an ethical or spiritual idea—which is grasped.

Aohkho: Spirit-to-self. A title of respect similar to "priest" or "spiritual leader".

Aokhaor: Honor. Literally "spirit of strength", the Aslan concept describes a life dedicated to the proper and spiritually correct way of doing things.

Aoshi: Swift Spirit. The inner of Kusyu's moons. Also, a concept too swift to be grasped.

Aylo: Artificial aisai used by humans and any non-Aslan races in order to participate in formal combat and other aspects of Aslan culture. Among Aslan, the word is often extended to mean any knife, since knives are not common weapons to these people who carry their own built-in knives.

Eikholfiruah: "Dusksong". Ritual chant celebrating an enemy's spirit sent heavenward with the honor due it.

Ekhoao: "Spiritual family". Signifies a family bonded by ideals and purpose rather than by blood. Similar to, but deeper than, the meaning in the Anglic word "congregation."

Ekhtaowetyu: Ritual obeisance requesting a landholder for permission to enter his land.

Fahr: Key. The word signifies something done to make an opening or a beginning.

Firuah: Translated "song", it represents a warrior's challenge chanted at a specific time, e.g., immediately before a ritual battle or upon receiving *khaofiy*.

Firukhte: The stylized and sometimes ritual use of insults to provoke or demean another party.

Fiya': Literally, "I am your servant, sir." Spoken as a form of submission to a landowner to beg his permission to enter his land. The meaning encompasses a complex set of mutual obligations and responsibilities.

Flyflyalr: The Imperium. A literal translation would be "vassals of vassals of one", an Aslan-slanted view of the Imperial bureaucracy under the Emperor.

Flyflyalrya'uist: Trokh insult. Roughly translated: Imperial lackey which has soiled itself because it neither understands nor possesses personal honor.

Hakah: A major subcontinent of Tafolti, the larger, northern continent on Kusyu. The land is mostly rugged or barren, more or less equally divided between the Hakaiye Mountains to the north and the Syialah Desert. The Plains of the Hero, watered by the Hkai River, hold special meaning for Aslan as the location of the Battle of Uktaihelu, the Hkaiyerlikhelu of legend.

Hasoi: Land, specifically the landhold of an Aslan lord, reserved for him and his ahryi.

Hkaiyerlikhelu: Battle Plain of Hkai. Book 4 of the *Ukhtaitasoistsea*.

Htahyu: First or pre-eminent place. A clan seat or administrative center for a single family.

Htoihelu: Literally, "Greenfield". Name of Aslan city in Hkai.

Helu: Plains or fields.

Hyuftelrerye: Literally, "Gathering of the People". The word is commonly translated as "city" but could also refer to a market place, a convocation of clan leaders for administering judgment, or even a rioting mob.

Ka'ah: Slow.

Khalifakht: Outback or wilderness terrain on Kusyu. Though apparently unused, it is generally part of a lord's landholds, or *hasoi*.

Khaofly: Literally "submission to the stronger". The ritual apology due the victor of an Aslan duel-of-honor.

Khir: Warrior.

Khoafteirleao: Aslan philosophical concept. Spiritual perfection can only be achieved through a rigorous purging of all non-Aslan influences.

Kolyekh: Secret Aslan brotherhood of warriors. From the Trokh *kho ri'yekh*, meaning, roughly, "submersion of self".

Ka'tal: Literally "it is fitting". Formally: "you have my consent". Affirmative response to a request to enter a landholder's domain.

L'ihaitol: The Floating Gardens, a complex under the control of the Tlaukhu. It is noted for its gardens and parks, lining walkways that overlook the port from an altitude of 2 kilometers.

Lu'uifakte: Terminal-accessed information center. The Aslan equivalent of a public library, consisting of small, private cubicles with a terminal and data display. They can be set to present data in Trokh, Anglic, or any other common language.

Shi: Swift.

Shifaowol: Cooking spice favored by Aslan, frequently described by humans as a blend of cinnamon and pepper.

Sl'laktae: Literally, "under protection of the land holder". Ritual sharing of food symbolizing the landholder's responsibility to his vassals. Usually a symbolic meal with the landholder in his house, it can be as simple as the lord offering a drink of water on his land. Honor demands gracious acceptance.

Sl'khiraokhaor: The Warrior's Path of Honor. That which a warrior must do, based on his responsibilities to his clan.

Sl'yokhtaowetyu kakhtelyatal: Literally, "I formally request the protection granted under the terms demanded by honor and beg your leave to enter your domains." Formal request for permission to enter another's landholding.

Shouwellyluahryl: "Your pride calls to you." Traditional invocation by an Aslan who needs assistance, calling upon blood relatives for help.

Tahiwhtakhtau: Barbarians; those who lack understanding of Aslan culture.

Tal'ao: One of the air demons of ancient Aslan mythology. Sometimes pictured as guardians of heaven.

Tala: Books. The singular is *talat*. The word signifies a scroll which may be one organized section of a longer literary work consisting of several scrolls. The epic poem *Ukhtaitasoistsea* is divided into four (some sources say five) major *tala*.

Taleryu: Aslan personal weapon favored by mercenaries and high-ranking nobles. It consists of a double-ended, crescent-shaped blade with a handle in the concave side designed to fit the Aslan hand. Used with broad, sweeping, slicing or slashing motions, they are sharp enough to sever fingers or hands easily. Occasionally called "meat cleavers" by humans.

Tao: Symbol-units of Trokh yoyeaokhtef. One tao carries the meaning of a discrete word or phrase. Most often used to designate the name of an individual, clan, pride, or brotherhood. An example is the symbol which looks like Anglic cursive "er", referring to the Koiyekh.

Tlasoistsea: "Bounty of new lands". Sometimes used formally to describe a reward of land for valiant effort. The term denotes new lands or worlds for the taking by those upright and correct in spirit and, as such, can denote a kind of Aslan heaven. Book 5 of the Ukhtaitasoistsea.

Tlauftahea: "Thirty Years". In Aslan mythology, the time during which the Tlaukhu was organized. The number is actually 24 in the Aslan base 8 numeric system, and in any case probably does not refer to a literal period of time. Book 1 of the Ukhtaitasoistsea.

Tlaukhu'hai: Gathering of the Twenty-Nine. Book 2 of the Ukhtaitasoistsea.

Tye: Literally "tiny sun"; star or stars, depending on context.

Tyeao: Literally "star-spirits". Aslan heaven.

Ukhtai: Hero. The Aslan meaning pictures one who is perfectly in accord with the Aslan dictates of aokhaor and akhaoye. Book 3 of the Ukhtaitasoistsea.

Ukhtalfahr: Roughly, Hero's Beginning. Place name for ruins north of Htoihelu.

Ukhtaitasoistsea: Literally, "new lands seized by the hero". Name of an epic poem consisting of 4 tala or books: Tlauftahea, Tlaukhu'hai, Ukhtai, and Hkaiyerlikhelu. Some sources include a fifth talat, the Tlasoistsea.

Yae: A doorway or entrance.

Yaeatyao: "The gateway to heaven", where the star-spirits of Aslan warrior heroes and their deeds are remembered.

Ya'ulya: Dishonor. The word has been used to describe a kind of Aslan hell: "death-with-forgetting", i.e., to die and not be remembered by clan or family.

Ya'uiyekh: Literally "emptiness". Extinction.

Yerlik: Battle, especially a formal, referee-monitored contest between two parties.

Yerlikhelu: Literally battle-plains. The arranged place of meeting for a formal, referee-monitored battle.

Yoyeaokhtef: A blend of Aslan artistic concepts—sometimes translated as "PDC", for poem/drama/calligraphy—as a single art form. It employs the complex Trokh cursive script, itself a demanding art form requiring a visual balance of the word shapes to convey meaning, to tell a story—usually mythic or heroic in nature—in dramatic verse. Yoyeaokhtef is one of the most widespread of Aslan art forms, since it is extensively employed as decoration on Aslan ships, weapons, buildings, and personal ornamentation.

Get a New Subscription of the Digest at the Old Subscription Price!

(30% Off the Single Issue Price.)

Offer Good Until January 1, 1990

U.S. & Canada: \$14.00 for 1 Year — 4 issues (Reg. \$18.00)

Foreign: \$22.00 for 1 Year — 4 issues (Reg. \$26.00)

Send your subscription in NOW to:

Digest Group Publications
8979 Mandan Ct., Boise, ID 83709, U.S.A.

Psionic Knights

MEGATRAVELLER ADVENTURE

—by William W. Connors

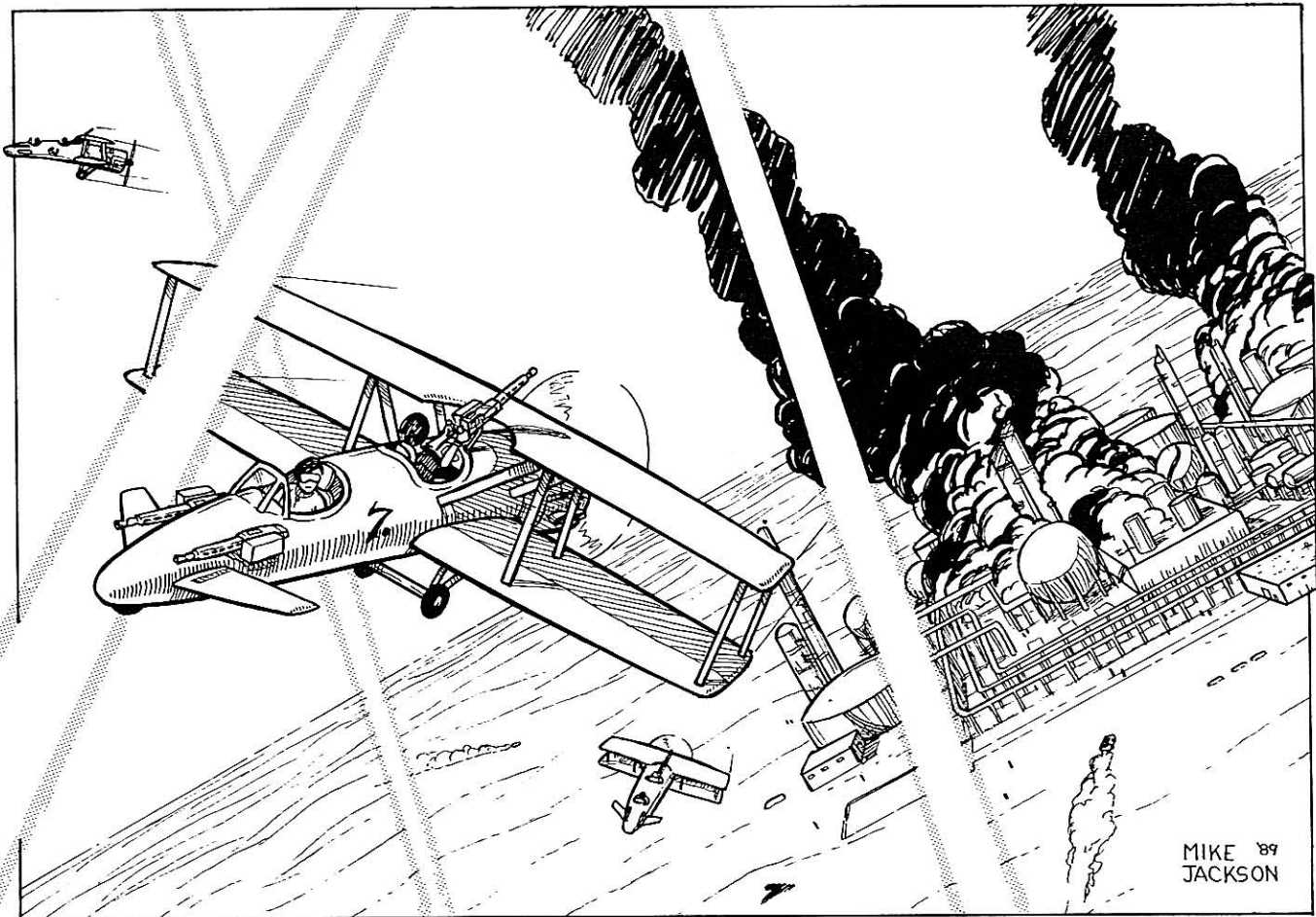

The conclusion of a series of four **MegaTraveller** adventures by William W. Connors.

THE CHARACTERS

Kane Woodlow (Owner)

879857 Age 38 5 terms Cr75,000

Navigation-3, Broker-2, Computer-2, Legal-2, Liaison-2, Pilot-1, Snub Pistol-1, Stealth-1, Psi-0

Starport C, Medium, Dense Atm, Dry, Mod Pop, Low Law, Early Stellar

Kane is a native of the Windsor system who signed on to the crew of a lone tramp freighter when he was a young man. He is a cunning businessman who takes good care of his crew. "After all," he says, "they're my most valuable commodity." His loyalty to the Imperium is strong and he cannot help but feel a duty to aid the Order of the White Star in their covert battle to defend the Empire.

Belinn Woodlow (Pilot)

5B5746 Age 34 5 terms Cr75,000

Pilot-4, Electronics-2, Prospecting-2, Mechanical-1, Snub Pistol-1, Stealth-1, Vacc Suit-1, Psi-0

Starport A, Asteroid, Vacuum, Desert, High Pop, Mod Law, Hi Stellar

Belinn is a former belter from the Glisten system. She is the wife of Kane Woodlow. Although her overly tall and slender physique make her less than a classic beauty, she is an attractive woman with a natural talent for starship operation. Although Belinn sometimes misses her life as a prospector, she is happy in her role as Kane's wife and will do whatever she can to help him in any situation. Like her husband, she respects the Order for its efforts on behalf of the Iridium Throne.

Dell Makkashi (Engineer)

76AA78 Age 30 4 terms Cr20,000

Psi-7, Clairvoyance-7, Engineer-3, Electronic-2, Gravitics-2, Mechanical-2, Brawling-1, Handgun-1

Starport B, Medium, Thin Atm, Wet, Mod Pop, Mod Law, Average Stellar

Dell, a native of the New Rome system, met Kane Woodlow when they both worked aboard the trader *Blue Fox*. Dell is a quiet, gentle man who has always been fascinated with any type of mechanism. Although he is not overly patriotic, Dell's newly revealed psionic ability has sparked a desire to learn more about the Order of the White Star. This, as well as his friendship for Kane and Tynna, is more than enough to convince him to aid in the efforts of the White Star.

Tynna Yovanne (Steward/Gunner)

6958A8 Age 24 1.5 terms Cr16,000

Psi-10, Awareness-10, Telekinesis-10, Telepathy-10, Gunnery-2, Steward-2, Liaison-1

Starport C, Medium, Dense Atm, Dry, Mod Pop, Low Law, Early Stellar

Like Kane, Tynna is originally from the Windsor system. She signed aboard *El-ahrairah* several months before its destruction to "see the universe". Tynna is always willing to embrace new ideas and consider points of view which might be quite alien to her. Her recent experiences and training by the Order of the White Star have made her believe that she can play a much greater role in the struggle for justice than she might have hoped for. Thus, she is eager to become a full-fledged member of the Order of the White Star.

Drakob Ferassis (Medic)

65A9BB Age 46 8 terms Cr50,000

Admin-3, Medical-3, Computer-2, History-2, Biology-1, Liaison-1, Snub Pistol-1, Stealth-1, Psi-0

Starport C, Small, Vacuum, Desert, Low Pop, No Law, Average Stellar

Drakob is from Arba in Lunion Subsector. He has travelled throughout the Spinward Marches, serving as a medical officer aboard numerous vessels. He plans to stay with Kane and his crew for the near future. He finds the recent complications in their lives to be interesting, if not wholly pleasant, and is enjoying himself to some extent.

INTRODUCTION

These adventures began in issue number 14 with the adventure "Ghost Ship", continued in issue 15 with the adventure "Mistaken Identity", and in issue 16 with "The Sword of Arthur".

In the first chapter, the characters found themselves stranded in the Nirton system following a misjump. Here, they discovered a derelict Imperial Navy vessel (the *Sword of Arbellatra*) which, mysteriously, had no entry in *Rah's* computer library.

While they worked to escape from the isolated system by linking the two ships together, Tynna was contacted by what appeared to be the ghost of *Arbellatra's* captain. Through him, she learned that *Arbellatra* had belonged to the Order of the White Star, a company of knights all of whom possessed psionic powers. When the Psionic Suppressions turned the tide of public and governmental sentiment against such groups, the order was betrayed and destroyed by the Imperial military.

As the coupled starships made ready to jump out of the Nirton system, the ghost begged Tynna to see to it that the Order of the White Star was reborn.

Despite the difficulties associated with making the jump out of system in a jury-rigged ship like the one they now flew, the characters made it safely to the Walston system. Shortly after their arrival, however, they were challenged by a patrol cruiser and ordered to stand ready to receive boarders. Much to their surprise, they were dragged aboard the cruiser and thrown in the brig. In horror, they watched as their ship was destroyed by a volley of laser fire.

On Walston, the characters were brought before a judge and accused of being pirates. Here, they learned that Walston had been attacked several times by raiders from an unknown system who flew ships which bore markings very similar to those found on the *Sword of Arbellatra*.

After proving that they had nothing to do with the attacks, the characters found themselves caught in the midst of a pirate attack. In order to help the defenders, Kane and Belinn raced off to join the Vargr fleet in a pair of fighters. En route, however, they spotted a lone pirate ship which had broken away from the fleet and was racing toward the surface of Walston.

They traced the intruder to a point on Walston's surface and destroyed it, discovering a pirate base in the process. A mission to the base later showed that the crew had been undertaking some sort of agricultural processing and that the pirate raids had served as cover for the recovery of their products. The exact nature of their work and the identity of the pirates could not be determined.

Once the investigation had been completed, the characters were asked to join Prince Agzzrgh as he travelled into the Imperium to request additional aid from Archduke Norris. In exchange, the ship they were to travel in was loaded with a cargo of processed agricultural goods which could be sold in the Imperium for a handsome profit, all of which would go to the characters as payment for their services.

On Caladbolg, their first stop, Agzzrgh was gunned down as he stepped from the ship. An official investigation turned up no leads and the characters were at a loss in the matter.

At this time, a mysterious message arrived which bore the seal of the Order of the White Star and the address of a cafe near the starport. When they sought out the restaurant, they met a man named Dabner and a woman named Lillyan who proved to be psionicists, members of the modern day Order of the White Star which had survived the destruction of the *Sword of Arbellatra*.

Explaining that they fought covertly to protect the Imperium from those who would destroy it, Dabner and Lillyan tested the travellers for psionic potential and trained Tynna and Dell in the use of their powers.

With that training now completed, the adventurers have been sent to locate and destroy the Order of the Red Star. Located on Enos in the Sword Worlds, this band of terrorists is out to destroy the Third Imperium and topple the Domain of Deneb.

Although the characters are not enthusiastic about this proposal for various reasons, they cannot help but be aware that they know too much about the Order of the White Star to walk away at this point. Such an act would, no doubt, lead to their deaths; if not at the hands of the Red Star then by the protectors of the White Star itself.

ENOS

(Spinward Marches 1130 E25059B-4G Ni Po De 710Sw M9 V)

Enos is the first world in orbit around the red, main sequence star Kaleshi. Apart from Enos, the system contains a single sparse asteroid belt and a half dozen minor planetoids which have escaped the belt.

Enos is the most rimward member of the Sword Worlds and is only tenuously connected with its off-world government. Many travellers have noted that Enos is treated as a ghetto by the Sword Worlds' rulers, as is evident by its low tech level and lack of cultural funding and support.

Enos is small but unusually dense, being composed largely of heavier metals and similar massive materials. Geological evidence indicates that Enos itself may have been a rogue world which was captured by Kaleshi during a close encounter. The planet's standard atmosphere is also very unusual in light of its probable background.

There is no evidence that life of any sort ever managed to evolve on Enos, probably due to the planet's total lack of surface water. Deep scans of the planet have found huge pockets of gases and fluids. Modern society on Enos depends wholly on these pockets for water.

Perhaps the most unusual aspect of Enos' geology is the Fire Sea. At first glance, this region is nothing more than a sweeping desert of sand broken only rarely by outcroppings of sand-blasted rocks and crags. However, a huge pocket of methane gas rests in the strata beneath the Fire Sea's shifting sands. Because the bedrock in this area is very brittle and has been shattered by seismic activity, the dangerous methane vapors are constantly seeping to the surface. As a result, the Fire Sea is a dangerous place to travel as any unprotected spark in the wrong place may cause a detonation.

In addition, the escaping gas often takes the form of a powerful jet. When this happens, an electrostatic discharge often builds up and causes the stream to ignite. These mighty pillars of flame often trigger long chains of powerful explosions which can decimate areas several kilometers in diameter. These blasts cause the bedrock below to break down even more quickly, releasing more gas and compounding the hazards for travellers.

The 750,000 inhabitants of Enos live in conditions which most off-worlders consider to be barbaric. Their government, originally appointed by the central Sword Worlds government on Gram in 950, has become stagnant and corrupt. Were it not for the planet's distance from the heartlands of the Sword Worlds Confederation, it would probably have been placed under a stricter leadership long ago.

The planetary law level, though officially very high, is nothing more than a paper doctrine. There are few crimes, including murder, which cannot be committed by those with the influence or wealth to escape punishment. In many cases, convicted criminals are freed by powerful local figures in exchange for a period of indentured servitude. Bribery, treason, and deceit are ways of life on Enos. Enos has become home to a number of corsair bands. As long as they restrict themselves to raids on worlds outside of the Sword Worlds Confederation and cut the local authorities in on a share of the plunder, their activities go unchecked.

A Sword Worlds military garrison is maintained on Enos at the request of the local government, serving to keep the corsair bands from setting their sights on planetary domination. Duty in the Enos Garrison is considered a punishment by most members of the Confederacy's military pool because of the unsavory nature of the local society.

The local technology level is very low, being roughly similar to that employed on Terra during its First World War. Although there are numerous examples of higher technology items around the world, these are almost always in the hands of off-world interests.

EL-AHRAIRAH I

In order to allow its agents to move freely throughout the Domain of Deneb, the Order of the White Star has commissioned half a dozen vessels. They are designed so as to pass for typical type-A free traders, though they are actually sophisticated craft intended for the multitude of covert missions which the White Star undertakes.

In keeping with the conventions employed by free traders, these ships are named for mythological characters, specifically those known for stealth, cunning, and

deception. The vessel assigned to the party has been renamed *El-ahrairah*, a name most suited to this type of ship.

El-ahrairah's electromagnetic masking is designed to make the craft look like a typical free trader to outside scans. Only when she is clearly not behaving like a mundane craft (*i.e.*, running for a jump point at 3 gravities) is her true nature apparent. The ship's transponder can be altered to provide false identification of the vessel with little effort.

Craft Id: Espionage Vessel, Type JL, TL 15, MCr117.352
Hull: 180/450, Disp=200, Config=1SL, Armor=50G, Unloaded=2,229 tons, Loaded=2,839 tons
Power: 5/10, Fusion=1,260Mw, Duration=30/90
Loco: 15/29, Maneuver=3, 8/15, Jump=3, NOE=190kph, Cruise=2,138kph, Top=2,850kph, Agility=0
Commo: Radio=System, Maser=System
Sensors: Pass EMS=Interstellar, Act EMS=Far Orbit, EMS Jamming=Far Orbit, EM Masking, Densitometer=HighPen/1km, Neutrino=10kw
 ActObjScan=Routine, ActObjPin=Routine
 PasObjScan=Routine, PasObjPin=Routine
 PasEngScan=Simple, PasEngPin=Routine
Off: Missiles=x02
 Batt 1
 Bear 1
Def: DefDM=+6
Control: Computer=5x3, Panel=Hololinkx115, Special=HU Holo
Accomm: Crew=5 (Bridge=2, Engineer=1, Medic=1, Gunner=1), Staterooms=5, Low berths=10, Env=Basic env, basic ls, ext ls, grav plates, inert comp, 3 airlocks
Other: Cargo=540kliters, Fuel=994kliters, Purification Plant (12 hours), Scoops, ObjSize=Average, EM Level=Faint, Magazine=5 battery rounds
 Variable transponder

MISSION BRIEFING

(The following is a transcript of the mission directives presented to the crew of *El-ahrairah* in a sealed computer file which is accessible only after the jump to Enos has been engaged.)

- *File Begins. Video display only (no audio).*
- *Upon arrival in the Enos system proceed to the planet's landing strip and touch down. Your transponder and all legal documents identify the ship as a merchant based out of Flammarion (Spinward Marches 0930) which operates in the regions beyond the Imperium's Spinward border.*
- *Once on the surface of Enos seek out and contact a former operative by the name of Vandermeer. We have had no active contact with Vandermeer in five years, but he is loyal to the cause and can be counted on for aid.*
- *With Vandermeer's help, obtain demolition charges of local manufacture for use in your mission. It is vital that these devices do not indicate that off-worlders have been involved in the attack on Red Star.*

- *Locate the Red Star's base of operations and infiltrate it. Once inside, plant the demolition charges in a manner which insures the destruction of the facility. Also, obtain access to the base computer and copy all files which pertain to the Red Star's leadership, membership, and objectives.*
- *Once these objectives have been met, depart as soon as practical.*
- *Leave the Enos system by jumping to Caladbolg to report the success of your mission to Sir Dabner.*
- *All hail the Iridium Throne and the memory of Arbellatra.*
- *File Ends. Close and Delete.*

VAGABOND

Once the players have landed on Enos and secured their ship, they will need to begin looking for Vandermeer. He can be located easily (a routine task) after a night in the local taverns with the help of Kane, Tynna, or Drakob's Liaison skill. What they learn, however, is that Vandermeer is a drunken fool. The public belief is that he served in the Fifth Frontier War and was badly injured. Following that, he never fully recovered and became a drifter. When he arrived on Enos is unclear, but he seems to have spent the last few years roaming from gutter to gutter outside the starport.

When the characters seek out Vandermeer they find that the description which they have received is correct. Try as they might, the players can make no satisfying verbal contact with Vandermeer. He responds to neither threats, polite requests, nor even physical abuse. The latter, of course, would draw the attention of the local populace who feel somewhat protective toward the old drifter.

If Tynna attempts to read Vandermeer's mind, however, she finds it tightly shielded. He responds with a probe of his own, all the while keeping up the outward act. Once satisfied of her sincerity, he asks her telepathically to tell the other players to meet him (as below) and not to give away his disguise to anyone else.

If the players give up on their efforts to deal with Vandermeer, he wanders off and is quickly lost in the dark alleys which encompass the starport. Shortly afterwards, however, one of the characters finds a black card in his pocket which bears the seal of the Order of the White Star on it. Printed on the reverse face is an address outside of town and a time: midnight.

MIDNIGHT

When the characters travel to the address on the card, they find a burned-out building.

Looking around inside the ruin, the characters discover that the door to the basement, although blackened and charred, seems to be solid and intact. Even more unusual, in light of the local tech level, is the fact that it seems to have a card-reading lock on it.

Although the characters can pick the lock or break down the door if they try, the easiest way to pass through is to insert the card given them earlier into the reader. As soon as this is done, the device incinerates the card and the door latch unlocks. Behind it is a narrow flight of stairs which leads down into a brightly lighted room.

LAIR OF THE MADMAN

Vandermeer is waiting for them at the base of the stairs. After instructing them to close the door securely, he allows

them to enter the room beneath the destroyed house. Paneled in a somewhat dirty white and well lit by a series of glowing panels in the ceiling, the room looks like a computer center and a security station.

Vandermeer now seems to be as sane as any man. His mind is open to surface telepathic conversation. He explains that his act before was simply his disguise. By carefully leading everyone in the town to believe that he is a harmless derelict, he has managed to keep track of almost all that takes place on Enos.

When he is asked about the Order of the Red Star, Vandermeer smiles and announces that they have been the primary focus of his efforts. Sooner or later, he knew that they would, in his words, "...have to be destroyed before their efforts could cripple the hand of Archduke Norris." Vandermeer is clearly very loyal to the Imperium.

Vandermeer is eager to help the characters in their mission. He already knows of a contact who can provide the team with demolition charges for use against the Red Star.

In addition, Vandermeer announces that he has already pinpointed the location of the Red Star citadel on Enos. The only problem is that it is located in the middle of the Fire Sea.

KILLING TIME

Vandermeer chats with the characters for another few hours, but urges them to leave before dawn. He insists that they return to the wrecked house again the next night ready for an overland journey and a fight. "By the time you return," he says, "I will have the explosives, provisions, and a transport ready to take us across the Fire Sea.

While the characters are free to do what they like over the course of the day, they will be unable to find any information about the Red Star or Vandermeer. This is due to the security precautions taken by both parties and to the fact that the locals do not talk to offworlders.

If the characters spend the day kicking around the starport area, the referee may want to "introduce" them to some of the less friendly residents of the town. Although this will not play a part in the overall structure of the attack on the Red Star, it can surely add a little spice to their lives, especially if the characters try to force information out of any resident of the town or if they seem to be getting a little bit too interested in the goings-on at Enos starport.

INTO THE NIGHT

Vandermeer is as good as his word, and he has managed to get his hands on some state-of-the-art (for Enos) equipment. Parked beside the rubble of the house is a rugged and trusty-looking tracked vehicle. It is similar in design to the Shackleton Explorer (*101 Vehicles*, page 27) but has a number of secondary fuel tanks mounted on roof racks. In essence, this allows the craft to maintain its off-road speed of 30kph for a full 150 hours (roughly 19 standard 8-hour days) of travel. Accommodations will be cramped, but certainly better than walking.

Secured in the back of the ATV are a number of backpacks (one for each character and Vandermeer) which contain high explosive charges. Vandermeer says that he wasn't able to get radio detonators, but he did get his hands on some highly accurate timers.

Tynna, whose knowledge of gunnery gives her some understanding of explosives, will notice that the charges provided do not seem to be enough to destroy anything larger than a small office building or a large house.

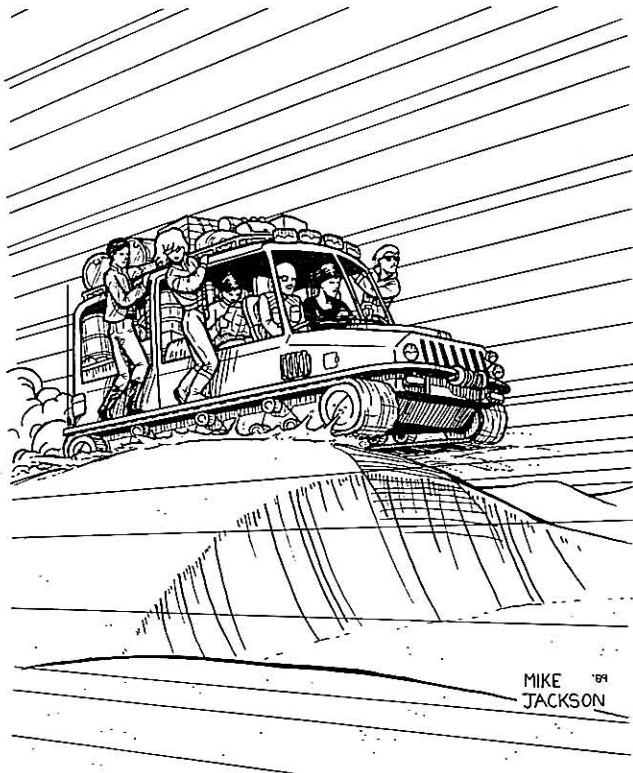

"That is true," Vandermeer responds, "but my information indicates that the citadel has a large chemical processing facility adjacent to it. That, in addition to the fact that it is located in the heart of the Fire Sea, should make for a sizable blast."

ACROSS THE FIRE SEA

The voyage across the barren dunes of the Fire Sea should be quite nerve wracking. Although the craft has been insulated to make travel safer in this dangerous area, it is still a very hazardous trek. Once every eight hours the referee should try the following task:

To avoid an accidental detonation:
Simple, Survival, Int, Instant (fateful, hazardous)

Referee: In the event of a "destroyed" mishap, the adventurers have triggered a terrific explosion which annihilates the vehicle and causes the charges and fuel reserves to go off as well. No matter how bad the damage, however, most of the characters ought to escape severe injury and none should be killed.

If the party is forced to continue on foot, their travel time increases from 70 hours to 200 hours. They can salvage only about 10% of their food and water supplies undamaged. Thus it will be crucial that they trap rainwater and ration their food. Referees are encouraged to generate their own random encounter tables for this portion of the adventure, keeping in mind the fact that Enos has no native life. Possible encounters might include micro-fine sand pits which act like quicksand, a region of toxic vapor from a gas pocket beneath the sands, or a powerful sandstorm.

OUTSIDE THE CITADEL

The party can get a good view of the Red Star citadel from a rise of jagged rock which juts out of the sand some five kilometers from it.

The citadel looks to be a cross between a chemical processing plant, a starport, and a fortress. At first glance, it looks to be a very formidable place to infiltrate, but a close look through the party's binoculars (or Dell's clairvoyance) reveals that the entire facility is protected by equipment which is, at best, tech level 5. Apparently, the station has been designed and built using local materials and technologies. There is nothing visible to the characters that should present them with any problems at all.

The citadel is built atop a flat plain of stone and looks to be fairly safe from the explosion hazards which fill the Fire Sea. Thus, the inhabitants have turned the natural inferno which surrounds them into a powerful barrier to keep out unwanted visitors.

INFILTRATION

No matter what route the characters take to break into the citadel, they should have no problems. There are no video monitors of any type, no electric eyes, no motion sensors, and no neural activity scanners. The only difficulty which presents itself at this point is the guards patrolling the perimeter with animals which fill the same role as guard dogs. Although the referee may want to introduce a minor encounter at this point, the characters should not set off a base-wide alert unless they do something really dumb or obvious. If they do, they deserve what they get.

GETTING WIRED

If the group arrived on foot, they must steal chemical explosives and timers from the processing plant. They could obtain some by Tynna's telekinesis, but that will tire her and it might be wiser to save her strength by sneaking into the plant.

The inside of the base is built with a greater technology than the outside. While moving about in the base, they should find a number of electric eyes and motion sensors, all of about tech level 9. Once again, although the referee will want to present them with a few "near misses", they should not set off any alarms at this time.

The first human guard to be encountered is as follows:

864837 Age 24 1 1/2 terms Cr8,000
Psi-5, Clairvoyance-4, Gun Cbt-1, Tactics-1, Computer-0, Grav Vehicle-0

Subsequent encounters will be with pairs of guards. Their physical stats will be similar, but psi talents, if any, will differ. Implement such encounters on a roll of 7+ on 2D, checked every 15 minutes once inside the base.

Vandermeer can provide directions on where to plant the charges and has set all of the timers to go off in an hour. If everything goes according to plan, they should be well on their way out of the base when the bombs go off.

DATALINK

While the others are setting up the explosives, Vandermeer suggests that Drakob or Kane, both of whom are skilled in the use of computers, try to get the files which they need from the base computer. As soon as they begin to log on to the system, it becomes obvious that the computer is very sophisticated. In fact, both of them can determine that the computer technologies which they are dealing with are state-of-the-art; at the very least, tech 14.

Getting out the files requires a task roll and some undisturbed time at a terminal. The same task roll should be used for each type of information desired (*i.e.*, a list of Red

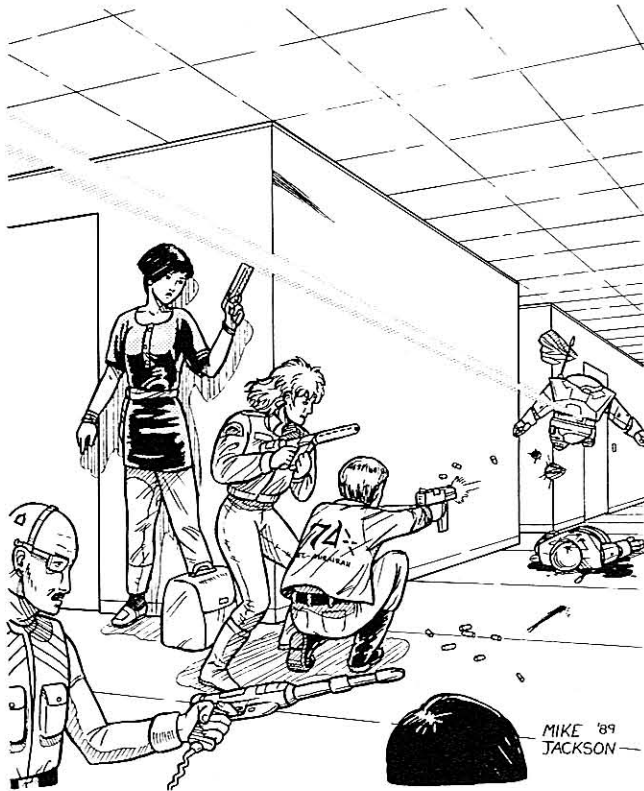

Star members, a schedule of past Red Star activities, intelligence gathered about the order of the White Star, etc.).

To copy a file from the Red Star computer:
Difficult, Computer, Edu, 1 minute (Uncertain)

Referee: After the characters have tried to download a few files (and after the other characters have placed all of their charges), announce that one of them has triggered a security flag. Within seconds, intruder alerts are sent throughout the complex.

A MEANS OF ESCAPE

Once an intruder alert has been sent out, the security team is augmented by the release of a number of Zhodani-built PP04 warbots (as detailed on page 39 of *101 Robots*). In addition, the security troops will now be far more aggressive and numerous in their defensive actions. If the players are resourceful and clever, however, they should be able to escape from the citadel before the blast.

The land vehicle in which the characters came is too slow for the escape, but two possibilities exist at the landing field. There are two corsairs and a half dozen primitive biplanes similar to the Ypres biplane (*COACC*, page 11).

HOTWIRED

The only people near the biplanes are a mechanic or two. The corsairs each have a guard at the entry, one on the bridge, and one in engineering. Any of these can alert the others via intraship communications.

In order to start the planes, the characters must hotwire the engines. This is easily accomplished with the following task:

To hotwire a biplane:
Routine, Electronic, Int, 10 seconds

Those with pilot skill, Kane and Belinn, are assumed to be able to fly the planes with a skill level of zero. Since each craft can hold two persons and Vandermeer can fly a third, the players now have enough transportation to get away from the base.

One of the corsairs is kept flight ready and the other is cold. If the characters have chosen the cold one (referee's discretion), they must capture the other or risk cold-starting the power plant in order to take off.

GREAT BALLS OF FIRE

If the players take the biplanes, one of the corsairs begins to lift off and turns to face them. If they took a corsair, the other corsair must attempt to follow them. (See above and roll for the Red Star engineer's tasks.)

At this moment, even as the guns on the corsairs are making ready to fire, the charges planted in the citadel explode. In a matter of seconds, the deafening roar of the demolition charges is amplified by the sound of the chemical reservoirs going up in flames.

The pursuing corsair is caught in the blast and slammed into the ground, bursting into a fireball.

Because of this truly cinematic chain of explosions, great fissures in the brittle bedrock below the base have opened up. Just as the explosions seem to be about to falter, a torrent of natural gas comes rushing up from below ground and ignites. This final fireball engulfs the entire plain on which the base sat and reduces it to slag and rubble.

There are no survivors.

THE FINAL CHAPTER

The data which the characters have obtained from the Red Star computer files provide information which the Order of the White Star will find most useful.

The unusual plant life found on Walston can be processed into a chemical which produces highly effective psionic drugs (in addition to its use in anagathics manufacture). These drugs are delivered to subversive psionic groups inside the Imperium and provided to the psionic elite of the Red Star when they work against the Iridium Throne. This explains the pirate raids.

The Red Star is far larger than was previously expected and is heavily funded by the Sword Worlds Confederation. One of its most important members is Count Draco Syllas, one of the most important nobles in the Domain of Deneb. In exchange for his help in supplying information to the Red Star, they have agreed to use their power to help him claim the title of archduke when Norris is brought down.

EPILOGUE

The referee is now in a position to continue the campaign against the Order of the Red Star. The characters have proven themselves to their own network and will be allowed to retain and use the new *El-ahrairah* so long as they maintain their ties with the White Star.

Potential future adventures include an attempt to reveal the evil deeds of Count Syllas (a powerful psionic in his own right), or even to assassinate him. The second step is easier, but the first might be more rewarding. A long-term goal might be the clearing of the Order's name and its resurrection by Archduke Norris. •

A

aggressiveness 55, 75
 air/raft 7, 45, 46, 48
 albedo 4
 alien races, see sentient
 survey, analysis 7
 Ancients 9, 15, 16
 archeology 16
 archipelagoes 88
 Aslan 15
 Assiniboia 53
 asteroids, see planetoids
 atmosphere-related details 53, 64-68
 atmospheres
 common gas mixes 54
 composition 53, 64
 corrosive 40, 53, 54
 gaming effects 93
 exotic 54
 exotic irritant 54
 insidious 54
 surface pressure 55, 64
 surface temp 54, 55
 authority, government 78, 79
 axial tilt 52, 55, 63, 66

B

balkinized worlds 78
 base surface temperature 55
 base temperature 65
 belt zones 53
 binary stars 67
 binoculars, image convertor 21
 binoculars, PRIS 22
 biological activity 24
 bioscanner (sniffer) 24
 bridge crew 5
 bureaucracy 3

C

carbonaceous zone (c-zone) 53
 cargo, transport of 25
 character generation note 33
 chemical analysis (sniffer) 7
 cities 55, 89
 large 72
 medium large 73
 moderate-sized 73
 orbital 55, 74
 primary 74
 secondary 74
 small 73
 tertiary 74
 very large 72
 very small 73
 Cleon (emperor) 9, 13
 communications office, emblem 7
 communicator, commdots 30
 communicator, handheld 29
 communicator, remote earpiece 31
 contact and liaison branch 6
 continents 70, 87
 Corridor 0806 (Antiquity) 15
 cultures 2, 6, 7, 16, 95
 customs 16, 75-77

D

data display headset 33
 day, effects 66
 Deneb 2713 (Wal-ta-ka) 12
 densitometer 2, 4, 5, 11
 densitometer, handheld 19
 density 11, 52, 60
 deserts 89
 diagnosis, injury and sickness 23
 diameter 60
 die rolling conventions 1

Donosev 1, 3, 5, 45, 48
 plans 50-51
 dressing habits 75
 Droyne 15
 Dulinor 5

E

eating habits 76
 EMS array 4, 5
 active 10
 passive 10
 energy absorption 65
 English (Anglic) 15
 executive branch 56
 exotic atms 53
 exploration 1
 emblem 7
 forming a party 7
 missions 6
 Scout office 2, 6
 extensiveness 56, 75

F

family practices 76
 fauna 2, 6
 fines (for crimes) 94
 First Imperium 9, 15
 First Grand Survey 48
 floater 25
 flora 2, 6
 forests 89

G

g-carrier 46-48
 g-tube 43, 46
 Galanglic 9, 15
 gamma, definition 11
 gas giants 2, 4, 53, 60
 atmosphere 53
 brown dwarfs 53
 composition 53
 size 53
 government examples 57
 government types 8, 56
 government-related details 56, 78-81
 governments, game effects 92, 95
 grav bike 44, 46
 grav belt 42
 gravity 52, 60
 gravity, artificial 11
 Gvurrdon Sector 15
 gyrocompass 26

H

heat/IR, definition 10
 high-energy source 11
 Hiver 15
 holo pit 5
 holorecorder 7
 hydrosphere 87
 composition 69
 percentage 69, 88
 hydrosphere-related details 69-71

I

icecaps 4
 Imperial citizen, definition 13
 Imperial culture 9, 16
 Imperial grand survey (see survey office)
 Imperial law 94
 Imperial standard time 27
 Imperial, military 3
 insidious atmosphere 40, 53
 interpolation 52
 Interstellar Development Service 5
 iron-nickel zone (n-zone) 53
 islands 88

J

judicial branch 56
 jungle 89
 Jupiter 53

K

K'kree 15

L

ladar 10
 landing parties 2, 3, 6
 collecting samples 4, 7
 contact procedures 7, 8
 decontamination 4, 7
 survival of 7
 language 2
 history of 15
 translating 15
 translator 28
 lasercom relay 32
 law levels 8, 57, 95
 law-related details 57, 82
 law enforcement 94
 standing 94
 uniformity of 57, 82
 lead surveyor 5, 6, 48
 legal profile 82
 legislative branch 56
 liaison 8
 lifeforms 2, 20
 android 13
 clone 13
 contact with 6
 cyborg 13
 intelligent 7, 11
 taking specimens 3, 7
 light, definition 11
 linguistics 8
 Lishun 0621 (Kaiid) 12
 living quarters 76
 Lucan 5

M

m-radar 10
 magnetic field 4, 26
 major bodies 4
 map grid 87
 Margaret 5
 mass 52, 60
 med scanner 23
 memory copies 13
 military bases 92
 mission control station 5
 mixed zone (m-zone) 53
 molecular analysis 24
 Mora 57
 mountains 89
 movement, game effects 93
 multichonometer 27
 multiple star systems 55, 67

N

native life 54, 68
 navigation equipment 26
 navigational charts 2, 6, 7
 navigator 6, 48
 neural activity readings 11
 neural activity sensor 2, 4, 7, 11, 20
 neutrino sensor 2, 4, 5, 11
 night, effects 66, 67
 nobles 9
 Norris 5

O

oceans 70, 87, 88
 orbital distance 62
 orbital eccentricity 52, 55, 63, 65

World Builder's Handbook Index

orbital factor 64
orbital period 52, 62
orbital zones 52

P
Paulo III (emperor) 13
pilot 6, 48
planetary defenses 96
planetographer's checklist 2-4
planetoid belt 4, 52, 61
 belt zones 61
 carbonaceous bodies 52
 cartography 61
 icy bodies 53
 nickel-iron bodies 52
 notation 61
 stony bodies 52
 types of 52
PLSS A 35
PLSS B 36
PLSS C 37
population 8, 92
population-related details 55, 72-77
practicing group 77
probes 2, 49
progressiveness 55, 74
psionic helmet 11, 20
psionics 13, 14
Published Traveller universe 5
punishment for crimes 94

R
radar 10
radiation belts 4
radio 4, 12
 long-wave 10
 microwave 10
 short-wave 10
Regina 57, 87, 88, 91
religion 56
religious profile 56, 78, 79
representative government authority 78
resources 71
 information 71
 manufactured goods 71
 natural 71
 processed 71
ring systems 53
ro'bolla worm (animal) 13
roads 90
robots 13
rotation luminosity factor 66
rotation period 62
rouppa (animal) 13
Rule of Man 15

S
satellites 62
Scouts 3, 6, 7
seasons 55
Second survey 48
seismic quakes 96
seismic stress 52, 63
sensors 1
 active 3, 4, 10
 doing a pinpoint 10
 doing a scan 10
 locating objects 10
 locating sources 10
 masking emissions 10
 object 19
 operation 46
 passive 3, 4, 10
 ranged 10
 readout panel 18
 sources 21, 22
 tasks 17

usage example 17
sentience, determining
 abstraction 13
 adaptation 14
 aesthetics 14
 conceptual thought 13
 control of fire 14
 cooperation 14
 definition 13
 domestication of animals 14
 group compassion 14
 innovation 14
 instinct 14
 language 13
 psionics 14
 social structure 14
 tools 14
sentient races 7, 8
 communicating with 12
 contacting 2, 3
 culture of 12
 first contact 12
 identifying 2
 killing 14
 newly discovered 12
 protection of 14
Shattered Imperium 5
size effects during play 93
size-related details 52, 60-63
skills
 administration 6
 biology 7
 brawling 6
 bribery 6
 chemistry 7
 communication 2
 computer 6
 engineering 6
 forgery 6
 geology 7
 gun combat 6
 gunnery 6
 liaison 6
 mechanical 6
 medical 6
 navigation 6
 pilot 6
 recon 6
 sensor op 7
 streetwise 6
 survey 6
 survival 6
 vehicle 6
society, see culture
Solomani Rim 9
sophontology 16
spaceports, see starports
Spinward Marches 15
Star systems
 ecliptic 2
 habital zone 2
 orbital zones 59
 mapping 2
 when unsurveyed 2
starports 74, 90, 92
stellar luminosity 64
stellar mass 52, 62
surveys
 classes of 2
 kinds of missions 6
 Scout service office 2, 7
 special purpose 3
 studying cultures 8
 use of equipment 1
 use of robots 8
 when doing concealed 8
Sylean Federation 9

Digest Group Publications

T
tech levels 8
 achievement levels 58, 85, 86
 common levels 58, 83
 notes 95
 novelty levels 58, 86
technology 16
 technology profile 58, 83, 95
 technology-related details 58, 83-86
tectonic plates 4, 69, 87
temperature 12
 axial tilt effects 66
 latitude effects 66
 local 93
 worksheet 68
 on the surface 64
Terra 9, 15, 16
terraforming 90
 albedo 55, 68
 atmospheric 55, 68
 greenhouse effect 55, 68
 hydrographic 69
 terrain 69
Third Imperium 16
trinary stars 67
twilight region, definition 67

U
United Nations 15
unusual atmospheres 53
useful mapping formulas 87
utility vest 41
UV, definition 11
UWP 1, 2, 4, 52, 92

V
vacc suits 1, 4, 7
 general purpose 34
 hostile environ 40
 light duty 39
 tailored 38
Vilani 9, 15
volcanoes 4, 70, 89

W
weapons 93
weather 12, 71, 93
 visibility 93
world data, using 92-96
world population 72
worlds
 backward tech 6
 design practicalities 52
 extended surveys 6
 habital zone 12
 interdicted 12
 mapping 1, 2, 4, 87-90
 terrain 4
 tidally locked 55, 67, 90
 totally alien 90
 unexplored 1

X
x-boats 5
x-ray, definition 11

Z
Zhodani 15



Aliens in MegaTraveller: An Introduction

BEGINNER'S LUCK

By Joe D. Fugate, Sr.

One of the more interesting and fun parts of MegaTraveller's rich background is its alien races. Here, for the beginning MegaTraveller player, is an introduction to the six major races, some of which you are sure to encounter in your travels.



Aslan: Descended from carnivore/pouncer stock on the world Kusyu (Dark Nebula 1919), Aslan, like humans, are an upright bipedal race. However, an adult Aslan averages two meters in height and 100 kilograms in weight, thus towering over most humans.

There are two sexes: male and female, of which the most notable difference is the male's increased hair-growth about the head. The Aslan hand has three fingers opposing one centrally-placed thumb, and all digits have retractable claws. The thumb's claw is large and specialized, folding

back into a horny covering at the base of the thumb and palm.

An individual Aslan is usually the member of an *ekho* (family) of from two to 12 individuals under a patriarchal leader. Several *ekho* form an *ahriy* (pride), with one family dominant. A number of *ahriy* together form a *huiha* (clan), with one pride dominant. Certain clans may owe fealty to more powerful clans, especially where blood relationships exist. The 29 pre-eminent clans form the *Tlaukhu*, or Council of 29.

The Aslan sexes play very different roles in their society. Males are concerned mostly with political affairs, the acquisition of territory, and with military operations. The females, however, are more concerned with industry, trade, commerce, and with the accumulation of knowledge and wealth.

Aslan have no racial prejudice, but they look upon non-Aslan as *tahiwihtakhtau* (barbarians) unless they embrace Aslan culture and behave as Aslan. The earliest humans to contact the Aslan (circa -1980 Imperial) felt they resembled Terran lions—and the Aslan felt the Terrans reminded them of the *waufuahyu*, a hairless primate-like rodent native to caves in the tropical regions of Kusyu.



Droyne: Descended from winged omnivore/gatherers, Droyne inhabit scattered worlds throughout charted space. Their original homeworld is unknown. Droyne are differentiated into six castes, determined at adolescence. Size varies with caste: between one and two meters in height and from 50 to 100 kilograms in weight.

Droyne have three sexes: alpha male, beta male, and female. Gender develops only

after casting. Reproduction is complex—pheromones generated by beta males are necessary before a female can be fertilized by an alpha male. Droyne skin is tough and scaled; the

wings are covered with a skin-membrane (vaguely similar to the wings of terran bats).

There are six primary castes in the Droyne socio-biological structure: *aydin* (workers, manual laborers), *aydih* (warriors, enforcers, protectors), *ayssath* (technician, repairer, assembler), *aydirsoth* (drones, traders, administrators), *aykrusk* (leaders, researchers, advisors), and *praysyiv* ("sports", loners, explorers). Each caste exhibits distinct physical and mental behavior.

If Droyne do not caste, they continue their development more slowly. Sexual differences do emerge, but casteless Droyne tend to remain small and only semi-intelligent. Known as Chirpers, Droyne who have lost the ability to caste live as primitives.

Droyne are a bit of a mystery to modern sophontologists. Many believe the Droyne to be descendents of the dead technological superrace known as the Ancients, but this view is far from widespread. Most who disagree with this belief point to the lack of racial drive that is characteristic of Droyne throughout charted space.

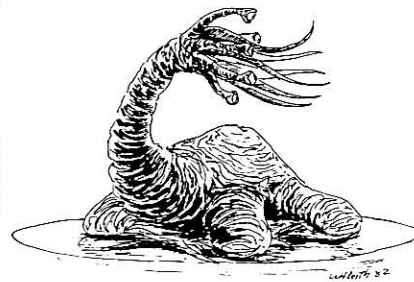

Hiver: Descended from omnivore/gatherer-scavengers which were originally adapted to an underground existence on Guaran (Ricenden 0827), of all the major races, the Hiver look the most alien compared to humans. The Hiver body has a horizontal six-legged radial symmetry, with the brain and most important internal organs contained in the central torso. The adult Hiver stands about 1.5 meters in height (or three meters from limb to limb), and weighs about 150 kilograms.

The six limbs extending from the torso end in manipulative tentacles, with the limbs functioning interchangeably as arms, legs, hands, and feet. One prime limb is typically held in a raised position and includes a sensory cluster with six eye-stalks, six manipulative tentacles, three infrared sensor organs, and three auditory sensors. A Hiver has no sound-producing organ.

Hivers have only one sex. Reproductive cells are exchanged each time two Hivers meet, using the secondary reproductive limb (opposite the prime limb). The process is called *shaking hands* by humans (who tend to avoid it), and is an instinctual Hiver behavior, without any emotional overtones whatsoever. Any time Hiver travel from one location to another, the arrival and departure is always accompanied by parties, discussions, and much hand shaking.

Hivers organize into cooperative groups (called *nests* by humans), usually centered on a common endeavor or interest. A nest may consist of anywhere from five to 500 members, but the average is around 100.

Government is largely the result of many nests cooperating or working in concert. Hiver society is utterly egalitarian—competing for power over others is foreign to the Hiver nature. However, Hivers do possess a strong parental instinct, and as such take great pride in subtle forms of individual predictive

manipulation of others. A successful manipulation (one which is for the common good) earns the manipulator respect and honor among all Hivers.

Humaniti: Upright bipedal race descended from omnivore/gatherers on Terra (Solomani Rim 1827). About -300,000, the now extinct race known as the Ancients visited Terra and took humans back with them, spreading humans among the stars. Eventually, two of these "subraces" of humans achieved interstellar travel using jump drive, but did not call Terra their home. The original Terran humans also became starfaring, making a total of three independent human subraces who have invented interstellar travel on their own.

Modern Imperial culture is a conglomerate of both Solomani and Vilani elements, and as such is neither truly Solomani nor Vilani. The Zhodani, on the other hand, with their psionic-based culture, are dreaded enemies of the Imperium. The average Imperial citizen hates and fears psionics.

Solomani: The original human subrace from Terra. The typical Solomani is about 1.8 meters in height and weighs about 75 kilograms. Solomani blood types include A, B, O, M, N, and Z, but A, B, and O are dominant.

Many modern Solomani believe that pure Solomani — the true original humans — are superior to all other humans, and thus are best fit to rule the Imperial region.

Vilani: The earliest starfaring human subrace. The typical Vilani is about 1.7 meters in height and weighs about 70 kilograms (slightly smaller than Solomani). Purebred Vilani (of which few remain) generally have a medium complexion, with light brown to black hair. Gold eyes are also a common trait. Vilani blood types are C, D, M, N, and O, with types C and N dominant.

Today, the term "Vilani" is much more cultural than racial (unlike "Solomani"). A culturally pure Vilani believes strongly in the team approach to nearly all problems of any significance. To a Vilani, the lone merchant is a fool — personal risk is a thing to be minimized, not relished. And the best way to minimize such risk is to enter into the task as a group.

Zhodani: Starfaring human subrace with a bizarre culture thoroughly permeated by the routine use of psionics. The typical Zhodani is about 1.9 meters in height and weighs about 70 kilograms (taller and thinner than Solomani). Purebred Zhodani are usually dark complected, and often have dark brown or black hair. Zhodani blood types include F, G, P, Q, R, V, Z, with F, Q, V, and Z most prevalent.

By far the most important aspect of Zhodani culture is its utter reliance on psionics — a reliance which Imperial humans detest and fear. Perhaps the most infamous of all aspects of Zhodani culture is the *Tavrchedl'* or the Zhodani thought police.



the head. Weight averages about 550 kilograms.

K'kree have two sexes: male and female. Males average 15 to 20 percent larger than females by mass, while both sexes have dense black hair covering the head, neck, and upper

back. The hand on the front limb — a complex arrangement of bone, ligaments, and cartilage — permits the K'kree fingers to telescope out of the way when the hand is used as a weapon.

Smell is the sharpest of all the K'kree senses, and their works of art concentrate on olfactory rather than visual or auditory elements. A K'kree with experience in dealing with another race (such as humans) can detect certain basic emotions (fear, hunger, anger) from scent alone.

K'kree are extremely gregarious, as befits their descent from herd animals. A lone K'kree is either terminally ill, has been exiled to die, or is dangerously insane. In fact, *traa*, the K'kree word for "my", refers to a possession of the individual's family, not to an individual.

K'kree are strict vegetarians, and they have an instinctual hatred of meat-eating creatures. Even the smell of dead or dying animals causes them considerable distress. When the K'kree encounter a carnivorous race, their first instinct is to convert the race to a vegetarian way of life. Failing that, they exterminate the uncooperative carnivorous race. K'kree interstellar history is filled with wars of extermination where carnivorous intelligent races that refused to change were annihilated.

One of the more spectacular of these wars was fought from -2029 to -2013 with none other than the neighboring major race, the Hivers. The Hivers quickly got the upper hand, and they forced an armistice upon the K'kree that has stood for three millenia.



Vargr: Descended from carnivore/chaser stock native to Terra and transplanted to Lair (Provence 2402) by the Ancients approximately 300,000 years ago. Related to Terran canines, the Vargr were genetically altered by the Ancients into upright intelligent bipeds. The typical Vargr stands about 1.6 meters in height and weighs approximately 60 kilograms. Vargr rear limbs are digitigrade, and their hands are quite similar in size and appearance to human hands,

although they retain sharp, non-retractable fingernails. Vargr can use the same equipment as humans without modification.

Vargr are covered with short fur, generally brown, black, or rust in color. Their tails are fairly long and generally end in a flaring brush. The muzzle is much shorter and less pronounced than in Terran canines, but is still quite evident. Vargr do possess a keen sense of smell, but their olfactory ability is not anywhere near the level of the K'kree. Like their Terran ancestors, Vargr have two sexes: male and female.

The Vargr prefer a pack-oriented culture, obviously a carry-over from their Terran canine background. As a result, Vargr are rather gregarious, and they take great joy in one another's company. Yet at the same time, Vargr within a group are engaged in constant testing of each others' prestige and dominance. The chief driving motivation among Vargr is thus to achieve a higher place in the structure of the current social group, or barring that, to find another group within which a higher position can be achieved.

Vargr therefore move from group to group with great regularity, and seemingly have no loyalty to any specific group or purpose. However, at the local level, Vargr are intensely loyal. In fact, a Vargr may give his loyalty to the local charismatic leader, even if such loyalties lead the Vargr to ignore the dictates of a higher authority. So to a Vargr, loyalties are temporary — but quite strong, just the same. •

LEADER OF THE PACK!

WHITE WOLF Magazine is the hottest new RPG magazine around. A loyal following is still growing. WHITE WOLF contains RPG adventures and articles, as well as special features by the game designers themselves. An example is our 8-page "Segment Jorune" feature in every issue.

WHITE WOLF presents short stories by up-and-coming writers as well as masters such as Robert E. Howard and Isaac Asimov. We cover the world of Play by Mail Gaming and review games and gaming accessories in every issue. We offer all this plus a beautiful full color cover for only \$22.00 for twelve issues.

**WHITE WOLF Magazine
Subscription Office
1298 Winter Place
Anniston, AL 36201
(Please ask about
our overseas rates)**



WHITE WOLF
M A G A Z I N E

Dark Nebula Sector

LIBRARY DATA OF THE SECTOR

—by Nancy Parker

Ealre	Aotrei	Ruih	Akuusir
Kyaenkha	Akhlare	Kilrai'	Danvers
Siei	Yataw	Khtoiakta	Kimson's Stand
Hrorehe	Kou	Yohkui	Staai

Dark Nebula: Subsector Key

Astrography of Dark Nebula Sector: The Aslan homeworld lies at the very edge of Aslan space, rather than in the middle of a sphere of influence as is more common with starfaring major races. (The Vilani spread mostly in one direction because of the limitations of jump-1 drive, but for most others, the stars were more evenly spread.) Most agree that this is because Aslan developed jump drive relatively late, and found that humans had

already claimed most of the worlds to coreward and trailing of Kussyu.

It is noteworthy that in order to expand in the direction left open to them, Aslan had to develop jump-2 almost immediately after inventing jump drive. Many small clusters of Aslan worlds would be isolated with only jump-1 drive available.

Au'alrealko: Ancient Aslan philosopher who formulated the concepts of honor as they are known today among most Aslan. So important was this achievement that her name is written with the "ko" particle usually reserved for clan heads. This remarkable token of respect indicates that all Aslan, in one sense, could be considered her clansmen and descendants, since they follow her teachings.



Eiyosa: Aslan name for a popular herd animal imported to many Aslan worlds from Heline (1005 C665866-2), a non-aligned world in Alakh subsector. (Heline is currently owned by Pannusgario, two parsecs away.)

Eiyosa are warmblooded and thickly furred hexapods. They can reach 400 kg at maturity, at least 60% of which

will be lean meat. If allowed to run wild, they care for themselves quite well, and can fight off most nonsentient predators with ease. Some Aslan prefer to raise them in this manner in order to have the thrill of hunting them. Eiyosa can, however, adapt to domestication. If kept in pasture, their branching horns and leg spurs are usually removed to make fights between the males less damaging.

While the eiyosa do feed their young with milk, they are rarely milked, and the strong-flavored cheese made from their milk is definitely an acquired taste. Their fur can be woven into sturdy textiles.

Fiwai'al: A much sought-after but expensive spice favored both for cooking and for perfuming, fiwai'al is grown only on Hroilr (1536 A5566K8-B), which is controlled by the Keiouwyaouryakh clan. The spice often commands a price equivalent to one Imperial credit per gram. It is rarely sold outside the Hierate, since humans find its smell unattractive and it is toxic when taken internally by humans.

Gerontocracy of Ormine: Small interstellar government primarily found in the Akhlare subsector. The Ormine are a very long-lived minor race with some characteristics resembling Terran reptiles. Their metabolism is slow, with a minimal homeothermic response to keep them from actually freezing.

Ormine are upright, short-legged bipeds with a short, flat tail for balance. The arms are also relatively short and the hands partly webbed. They are covered with jointed plates rather like the armor of a Terran armadillo. Their origin was obviously aquatic and they retain several adaptations that make them at home in the water, including gills which open and activate upon diving.

The lifespan of the Ormine is about 300 standard years, with maturity coming at 30 standard years. The elders of a community are its leaders, and serve for life once chosen. Understandably, Ormine culture is slow-moving and very conservative. On their own, they have never developed past tech level 8.

The Solomani arrival 3,000 years ago was a severe cultural shock. Solomani spacers were impatient with the deliberate movements of the councils that negotiated with them, while the Ormine for the most part thought the Solomani rude, impetuous, and thoughtless.

Human technological superiority, however, was undeniable. This attracted some few younger Ormine minds. With every human visit, some Ormine took passage to new worlds. Colonies grew up on several suitable planets and some unsuitable ones. The technology to conquer the inhospitable worlds was supplied by the Solomani in exchange for work contracts and pledges of loyalty. Thus most of the gerontocracy is deeply in debt to the Solomani and is part of their political sphere.

The Ormine retain their rule by elders, but those elders usually have a human "advisor". Any who express their disapproval of this too strongly may find themselves exiled to one of the less pleasant worlds.

Hlaotiyoiho: Dominant clan of the Ealre subsector, with holdings extending coreward and spinward into Eailyasiyw Sector. Hlaotiyoiho is an offshoot of the Tralyeaeawi clan, founded in 2950 Aslan (502 Imperial) by an ihatei and his followers.

While originally vassal to Hoihwarilta clan, Hlaotiyoiho has worked and fought its way to independence and high status. This clan is a strong contender for a place in the Tlaukhu, should any of the current Twenty-nine fall in prestige. Some recent incidents between Hlyueawi and Hlaotiyoiho clans suggest a possible clan war for this position.

Hteoe(0117 C5947H8-C): Most animal life on Hteoe is subterranean, living in the vast systems of underground caverns hollowed by ground water. The caverns, indeed, are far better supplied with water than the surface is. Because of this ecology, the Aslan of Hteoe have also become cavern-dwellers — an unusual adaptation for Aslan on a world with breathable atmosphere.

Interstellar Governments of the Sector: The Aslan Hierate controls about half of the worlds in Dark Nebula Sector. The other major government is the Solomani Confederacy, controlling the trailing quarter of the Sector. These two trade actively, but sometimes diplomatic relations are strained. Most of the remaining worlds are non-aligned, with every possible attitude toward each other and their larger neighbors. Two small federations, the Ulane Hierate in Earle subsector and the Gerontocracy of Ormine in Akhlare subsector, complete the tally. [See entries elsewhere.]

lystyos: An inexpensive intoxicant popular with Aslan spaceship crews. The grain from which it is brewed is native to Kusyu and has been imported to almost every Aslan world where it could be grown. The brew often causes hallucinations in humans who are unwary enough to try it.

Ktouwaaatritoikh: Captain of the expedition that made the first crossing of the Great Rift in 1185 Aslan (-1044 Imperial). He was born on Steisua (1135 of Dark Nebula Sector) in 1130 Aslan and found land in Ealiyasiyw Sector at the age of 28. This did not satisfy his thirst for roving, however.

Leaving his holdings in the management of his three wives, Ktouwaaatritoikh took exploratory trips to coreward until he encountered the obstacle that had stopped earlier adventurers: jumps too long for his vessel to make. With support from the worlds on the rimward side of the Rift, he set out to create a fuel dump in space to make the longest jump possible. This was accomplished with large fuel pods equipped with beacons, and sufficient extra tankage in the ships to make the return jump. (This fuel dump is still kept stocked and occasionally used by lesser vessels; however, most Rift crossings are now accomplished in jump-5 ships and do not require it.) At the far end of the jump was a thick cluster of worlds suitable for colonization. These lands gave Ktouwaaatritoikh status far beyond that of his holdings in Ealiyasiyw, and he eventually brought his family to his new holdings on the coreward side of the Rift.

Tehleikhoi: Loosely translated as "Soldiers of the Falling Night" or "Knights of the Setting Sun", the Tehleikhoi is a highly regarded Aslan mercenary company based in the Uhtaa subsector of Reaver's Deep. It is owned by Iyhli; an unmarried female belonging to the Iyhlua clan. Its structure is a fairly typical of mercenary companies found within the Hierate. Their sphere of operations extends into both Dark Nebula and Reaver's Deep sectors. The company has been employed by other interstellar governments besides the Aslan, but has often chosen sides in a war by the preferences of Iyhlua diplomats. In this way they extend the clan's influence without direct clan interference.

2601 (X341668-0 Red Zone): Known by no other name than its star-chart designation, this is the Solomani prison world for the sector. No technological development is permitted to the eight million prisoners there. The world is far enough from the Aslan-Solomani border not to occasion diplomatic comment, though the Aslan despise such expedients as prison worlds and are aware that some (or most) of the exiles are political prisoners.

Ulane: A minor race of the Earle subsector, who received a few jump-capable ships from the Aslan about 800 Aslan (-1385 Imperial). They originated as flying quadrupeds, but



their wings are now vestigial, converted to manipulative digits. The Ulane are less than one meter long, hollow-boned and delicate. Their diet consists primarily of fruit, since they require a lot of sugar to sustain their high body temperatures and activity levels. Small animals and insects provide protein. Ulane are adapted to warm climates, but are able to build dwellings that enable them to live anywhere—although they seldom prefer to.

The Ulane social structure is built on clans of related families, so that when the Aslan contacted them, the Ulane decided to emulate their benefactors and model their society along Aslan lines. To the Aslan, this attempt has met with only moderate success. Ulane are not at all combative, and their ideas of honor puzzle the Aslan exceedingly. The hierarchy of clan and family dominance was decided by vote shortly after contact, and can be changed the same way, rather than by competition and combat. Still, the structure is useful to the Ulane.

Ulane prefer to live in very small, scattered towns. Most of their worlds have less than one million population owing to the low birthrate and need for large foraging territories. A larger population on a Ulane world indicates that another race lives there also, usually in a non-competing niche.

With their few ships, the Ulane explored a number of worlds in their own subsector and coreward into Reaver's Deep Sector. However, they found most worlds less hospitable than their homeworld of UI (0603 A682698-6). Since they could neither build nor maintain the ships on their own, Ulane expansion soon stopped and the Aslan expansion flowed on around them.

On some worlds Aslan and Ulane live together cooperatively. The Ulane are known for artistic rather than technological endeavors, and it is these that the Aslan prize when trading with them.

Yehta (0226 C1008HB-A): Yehta is simply the largest of the planetoids in its orbit. Pulled from three directions by their two primaries and a gas giant, these fragments could never coalesce into a larger mass. The planetoids do contain almost every element in the periodic table, however; this area of space has been through three or four cycles of supernova explosions since the formation of the universe; each cycle forms heavier elements and scatters them. Yehta has attracted a sizable belter population from several clans (whose relations are usually rather tense.) •

KILRAI' SUBSECTOR

The Kilrai' subsector (subsector G of Dark Nebula) hosts the homeworld of the Asian race, Kussyu (1919), which hovers at the edge of the Hierate's boundaries. The majority of the subsector is composed of non-aligned worlds providing a buffer between the Hierate and the Solomani Confederation.

Hloa's (1719) population of aquatic sophonts shows no interest in contact with the interstellar community, as they are self-sufficient and feel they have little in common with walkers.

Name	Location	UPP	Bases	Classifications	Zn Data	AI	Stellar
Alaoyaah	1714	B331758-A	Po Na		A 701	Na	G1 V
Khiyyw	1715	C453457-8	Ni Po		223	Na	G1 V
A'awiy	1716	A959678-C	F D5 Ni		103	Na	G2 V
Hlao	1719	X7698CB-5			703	Na	M2 V
Ye	1813	D423547-6	Ni Po		825	Na	M8 V1
Ila'ouh	1911	B542120-A	Ni Po		503	Na	G6 V M8 D
Asati	1912	D729400-9	Ni		A 511	Na	M1 V K0 D
Kakhisil	1915	B6A0444-B	Ni De		225	Na	M3 V M5 D
Horrace	1916	A431658-C	Ni Po Na		A 414	Na	M2 V K6 D
Khoakta	1918	B200211-A	F Ni Va		904	Na	K9 V
Kussyu	1919	A8769H6-E	U Hi In		703	As	M1 V M9 D
Taaehhe	2011	C743301-9	D4 Ni Po		902	Na	M2 IV
Morain	2012	C9A3556-A	Ni		404	Na	M1 V M1 D
Ealari	2014	C97A575-A	Ni Wa		424	Na	G1 V M7 D
Fyeyiar	2017	D100125-5	Ni Va		704	Na	K9 V M2 D
Hleahao	2018	D310221-6	Ni		714	Na	K8 VI M8 D
Oiaous	2020	C6518J9-D	Po		713	As	M3 V M8 D
Ikhaeal	2111	C653131-8	Ni Po		714	Na	M6 V1
Loyse	2113	C445687-6	Ni Ag		224	Na	K0 D
Embrall	2115	A000434-B	F Ni As		914	Na	M0 V
Sharp	2117	E100335-7	Ni Va		203	Na	M6 IV M1 VI
Pritchard	2214	B300367-C	F Ni Va		714	Na	M6 V
Yakolev	2215	A6B6677-C	Ni		700	Na	M2 V
Crain	2216	D525340-7	Ni		210	So	M8 V M5 D
Eholoi	2218	A789213-D	F Ni		802	Na	M9 IV
Van Kemp	2315	B500596-B	J Ni Va		A 904	Na	A1 V
Strin	2316	C1009AD-8	Hi In Va Na		205	Na	M0 V M7 D
Shiro	2317	C433211-8	Ni Po		101	So	G6 V
Nigdye	2413	B242844-8	Po		123	So	M9 V
Ilriyhya	2415	C624733-8			A 804	Na	M0 III M7 D
Stop Gap	2416	C684200-9	Ni		202	So	M2 II

The Kilrai' subsector contains 31 worlds with a total population of 11.829 billion. The highest tech level is E at Kussyu. The data column lists the population multiple, number of planetoid belts, and number of gas giants. Base codes: F=Independent Military & Naval Bases, J=Independent Naval Base, U=Tlakuu & Clan Base.

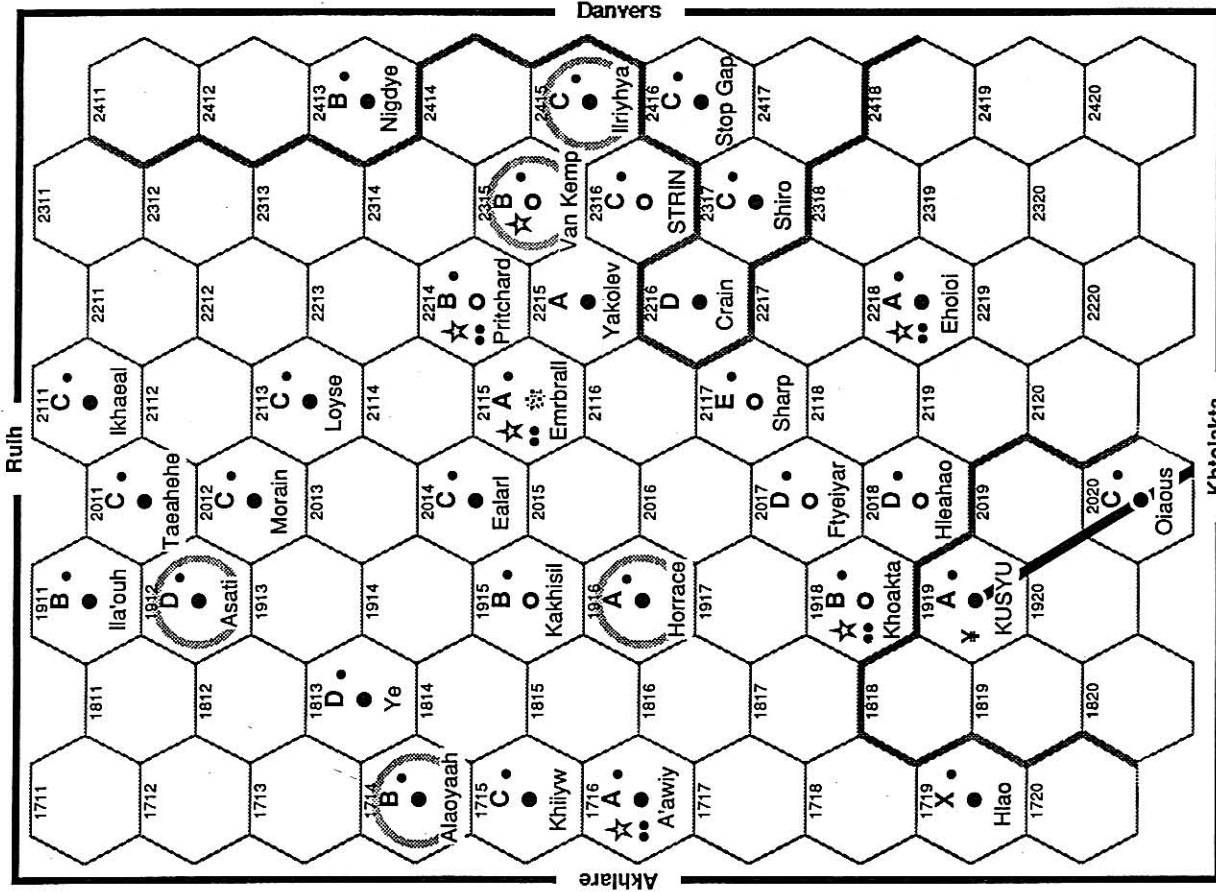

Kilrai' Subsector

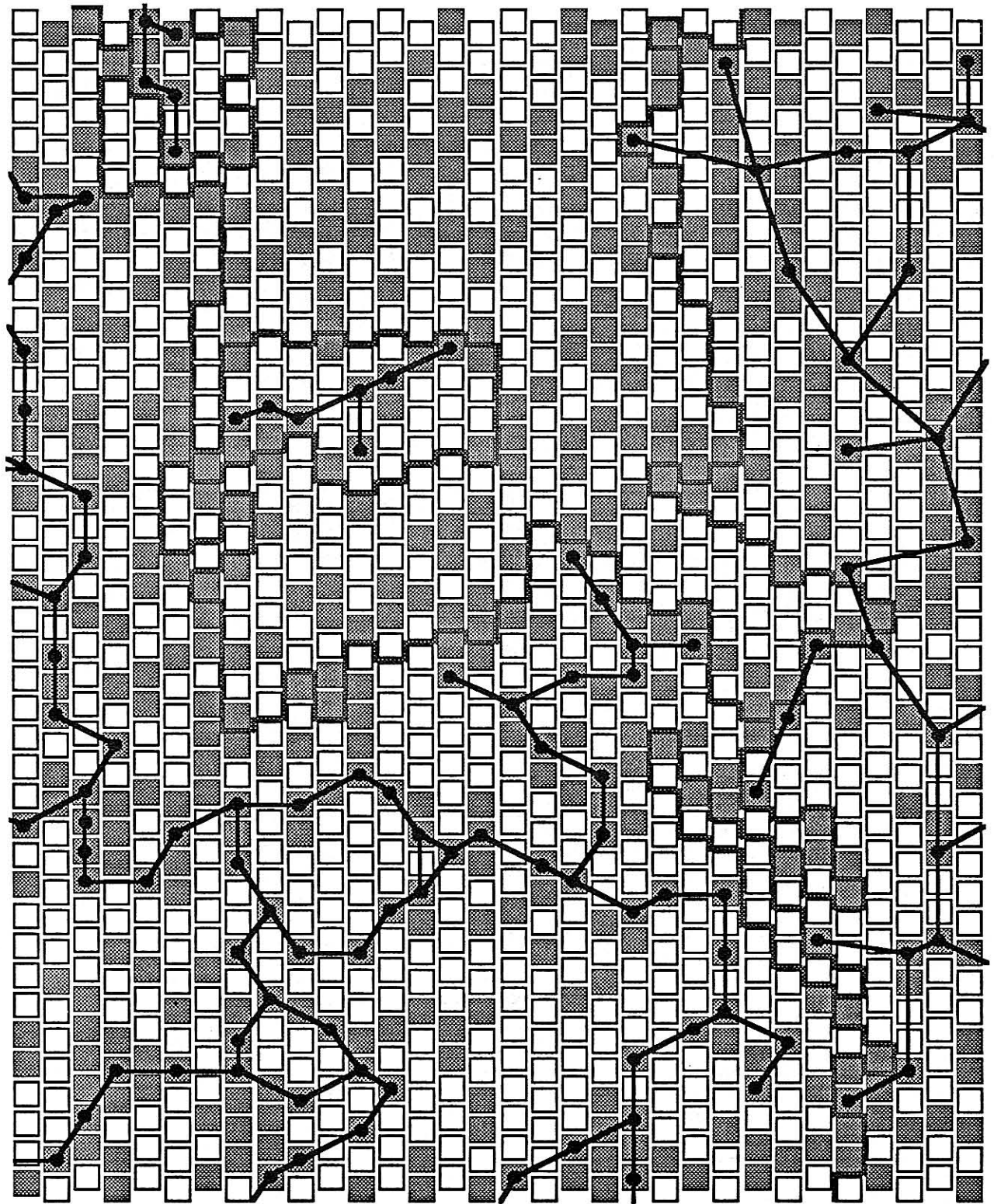

Trade Routes of the Dark Nebula Sector

Trokh: Language of the Warriors

—by Gary L. Thomas

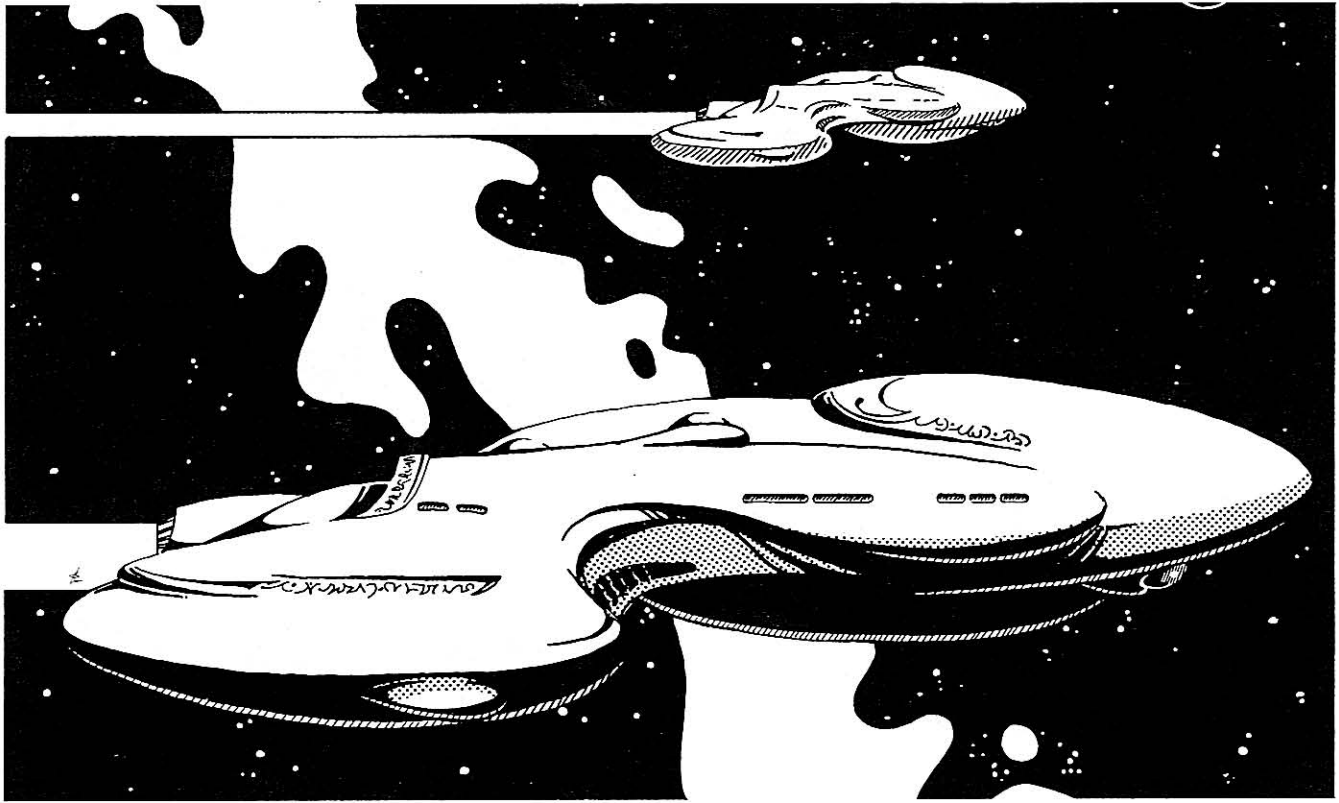

This article is excerpted with permission from The Starfarer's Guide to the Aslan, by Dr. Lawrence Gul-yeh, published last year by TAS Publishing, Terra/Sol.

THE DANGERS OF TROKH

It is both pointless and foolish for the occasional traveller to try to learn Trokh, the language spoken by nearly all Aslan. Not only is the language particularly difficult for the native Galanglic speaker, but besides this, the high honor of the Aslan race affords countless opportunities for the novice to embarrass himself and his listener, provoking a challenge from the offended Aslan.

Despite this, it might be interesting for the visitor to the Aslan Hierate to have some simple understanding of the tongue spoken by these proud warriors. As the Aslan say, "*Astuihyor eayaleal hfoahkeaukhiaoll*": "Closely hearing the words of a stranger reveals him best."

THE ROOTS OF TROKH

The lineage of every Aslan leads inevitably to Kusyu, the Aslan homeland, where the *Tlaukhu* or "Twenty-nine" ruling clans of the Hierate hold their sessions. Trokh, the language of the Aslan, can also be traced to Kusyu, where it reached its present development about 4,000 years ago. In the intervening years, Trokh has changed remarkably little compared to other living languages. If anything, the language has become smaller and more formalized, about which we will have more to say below. It suffices to mention here that among the Aslan, Trokh is essentially one tongue, with only a handful of offshoots or dialects, sprung up only where their speakers were somehow cut off from the rest of Aslan civilization.

PRONUNCIATION

The tongue spoken by the Aslan is both attractive and repellent to the Galanglic ear, combining sonorous and melodic vowel sounds with throaty snarls and near-animal growls, all accompanied by a fair amount of spitting when spoken at any volume.

Like Galanglic, Trokh has very few "pure" vowel sounds, but Trokh exceeds the human speech in the frequency of occurrence of such diphthongs. Proper pronunciation of these sounds is the most difficult aspect of Trokh for a human, as some are pronounced while inhaling rather than exhaling. An Aslan can speak faster than a human, because the Aslan need not pause for breath in the midst of his discourse. Rather, the language itself paces the speaker's breathing, necessitating rapid movement of the diaphragm to change the direction of breath. Indeed, the word *trokh* means "belly", referring to the motion of the Aslan stomach while speaking. To be sure, a human can learn to pronounce Aslan vowels while inhaling, but only after much difficult practice, and even then he is unlikely to enjoy it.

Consonants themselves are implosive or explosive, depending upon the nature of the adjacent vowels; the rules are much too complex to explain here.

Unfortunately for the Galanglic student, most methods of transcribing Trokh words ignore the direction of breath, so that *ao* (with an intake of breath) meaning "spirit" is written the same as *ao* (with an outflow of breath) meaning "iron ore". Naturally, to an Aslan, confusing these words in an utterance might turn an intended polite request into an insult. *Caveat orator*: let the speaker beware!

Finally, it must be mentioned here that the typical books promising to teach Trokh in 20 easy lessons are wholly inadequate in regards to their explanations of the actual sounds made. To say that the transcribed "f" is pronounced "like *whew*" commits an injustice against both the sounds of Trokh and the naive student who believes that that's all there is to it. The only sure way to learn proper pronunciation is from a very patient Aslan tutor, with whom the student can converse in Galanglic.

THE "ONE WAY"

Trokh is both formal and holophrastic, *i.e.*, the language has certain highly proscribed rules of expression, and seemingly small morphemes can be packed with meaning. Let us deal with the formality first.

Whereas the Galanglic speaker can say, "Come and get it!" or "Soup's on!" or "Dinner is served," or "Time to eat!", the typical Aslan need make no such choice, nor is any choice allowed to him in Trokh. The Aslan will always say, "*Ehlowarl eaheawo*," which means any and all of the corresponding Galanglic expressions. If a human student learns the Trokh word for "dinner" and the verbal expression for "is served" and combines them to express this idea, the Aslan is confused. If the dishonorable human meant "*ehlowarl eaheawo*", why didn't he just say so?

Presumably this formality would simplify learning Trokh, but in fact the exact opposite is the case. The beginner does not have the option of putting together words he knows to create a more complex statement; there are so many formalisms in Trokh that the student must simply learn them all by rote if he expects to be understood without being challenged.

Among the languages spoken by major races, Trokh does not have the fewest number of words in its vocabulary, but it is second in that respect, with only 30,000 base words, compared to the more than 400,000 in Galanglic. Surprisingly enough, many of these Trokh words are *holophrastic*. A few brief examples can best explain the meaning of this linguistic term.

Kir means "an unmarried female who has exchanged her control of a company for the control held by another unmarried female of another clan after both intermarried with warriors of the corresponding clan". *Iyoar* means "the shape held by the lips when sniffing the air for a pleasant scent". The tendency of the speaker of Galanglic is to ask how these words are broken up into their constituent parts, but there is no answer to this question. These words, like many others in Trokh, express complex ideas in single terms, and the holophrasis of the language as a whole means additional toil in memorization for the student of the tongue.

GENDER

In Galanglic there is, strictly speaking, no grammatical gender other than the natural gender of words: a man is masculine (he), a woman is feminine (she), and objects are neuter (it), with a few exceptions, such as starships ("her jump drive gave out just after we hit system"). Many precursors of Galanglic had what linguists call *grammatical gender*. For example, in old Terran German, an apple was masculine (he), a sausage was feminine (she), and a ship was neuter (it). Any natural gender certainly influenced the grammatical gender, but a young girl was still considered neuter (it) grammatically. In languages having this feature, the grammatical gender of a noun can affect the form of articles, adjectives, and even verbs used with the noun.

In Trokh, gender is quite a different matter. *Uilyahew* is the masculine word for "dwelling"; *eraoiaikh* is the feminine word for "dwelling". These are not words for different

concepts. They are words used differently *depending upon the gender of the speaker!* A male Aslan says *uilyahew* while a female says *eraoiaikh*. In fact, Trokh is three languages at once: a base language of gender-neutral or shared terms, and two separate languages for males and females, having different emphases of vocabulary. The feminine dialect of Trokh has no word for "shoot"; the masculine dialect has no word for "buy".

Of course, a typical male Aslan will understand many of the words of the feminine dialect, but it would be a grave dishonor for him to utter one. A female careless enough to use a masculine word could expect one of her male relatives to be challenged by any male listeners.

ADJECTIVES

One aspect of the Aslan language related to its formalism is the way that it handles adjectival and adverbial expressions, *i.e.*, words that modify other words. In Galanglic, we use adjectives to modify nouns (a *quick* aircraft) and adverbs to modify other parts of speech (he flew *quickly*). In Trokh, there is no such distinction between modifiers: further, there *are* no special modifiers, strictly speaking. A comparison is here in order.

In Galanglic, we might describe something as emerald green, or sky blue, or sugar sweet. In Trokh, the same semantics are expressed using only the nouns involved. A speaker of Trokh might describe a certain green object as *htoi* or "emerald"; something blue might be called *atiwaw* or "sky"; something sweet might be called *estekta* or "sugar". The listener must decipher the sentence to understand what quality of the noun is being referenced, of course, for *htoi* could also mean "hard", "valuable", "faceted", or any number of other qualities shared by an emerald. The *ayakhyulr* is a carnivore, native to Kusyu, known for both its speed and its ferocity. When an Aslan uses the words (roughly translated) meaning "the *ayakhyulr* warrior", he probably means "the fast warrior" or "the brave warrior", but he might instead mean "the brown-striped warrior" or even "the long-tailed warrior" — context decides which feature is being singled out for comparison.

Fortunately for understanding, the formal nature of Trokh reduces the number of concepts likely in a given utterance. When *tuiweaftokeataeh* (the name of a fruit tree) is used adjectivally, it almost always means "tall"; when *ketri'eaao* (another fruit tree) is used, it usually means "fruitful". By the strictest rules of Trokh literary style, then, a noun can hold only one (or occasionally two) adjectival meanings — but the other meanings are there just the same.

This allows an Aslan speaker to engage in what is called *firukhteahruear* or "masked insult". For example, *aulryuysai* means "desert", and when used adjectivally almost always (thanks to the formal nature of Trokh) means "vast" or "expansive". But using this word to refer to an Aslan male's landholdings implies that his farms are barren and worthless, incapable of supporting even a small *ekho* or family. Ostensibly, no insult is meant — all that was said was that the holdings were large, and presumably valuable — but the use of the word *aulryuysai* to denote this size adds the impolite connotation intended by the speaker. A back and forth conversation in this style gradually escalates both the number and nature of insults, until one of the males stops the *tête à tête* with the phrase *yerlika'* ("I challenge you") or *khaofiya'* ("I submit to your strength").

WRITTEN TROKH

Perhaps the first contact that most humans have with Trokh is with its complex written form, known as *yoyeaokhtef*. The ornamental designs along the edges of an Aslan

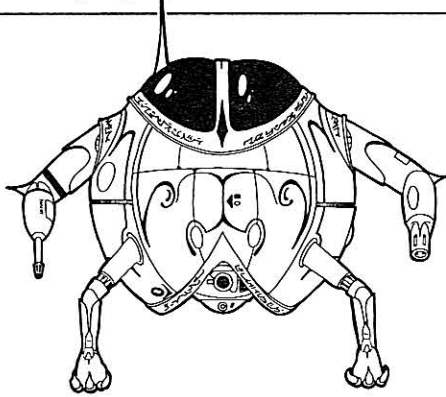

starship, building, or robot are not just random abstracts to the Aslan eye, but are rather a combination of poetry, drama, and calligraphy, exciting the mind as well as the eye and ear. Indeed, one commentator translates *yoyeaokhtef* as "opening the eye that alone can see the immortal spirit in a thing". The Trokh speaker has no good translation for our word "alphabet" — but who would want such a skimpy concept, the Aslan feels, when he has the glory of *yoyeaokhtef*? More than just a way of putting words to paper, *yoyeaokhtef* is an art form unto itself, corresponding to nothing of Vilani or Terran origin.

The process begins with the Trokh ideographs — each word has a single symbol, or *tao*, that represents it. (Compound words are sometimes written by a compounding of the ideographs for their individual elements, but some have their own, apparently unrelated, ideographs.) The shape of a *tao* in *yoyeaokhtef* must then be properly blended with those of other ideographs, harmonizing the graphic elements of the design while simultaneously bringing together the sounds of the words and their meanings to produce a unified whole. The end result is something akin to grand opera in its combination of visual, aural, and dramatic elements. An Aslan would consider it sacrilegious to read *yoyeaokhtef* silently — to him, that would be like looking at the printed notes of a symphony rather than listening to an orchestra perform it.

But what about a textbook? Or a computer reference manual? Or a simple laundry list? *Yoyeaokhtef* is understandably seen as too much trouble for these things — besides, the number of ideographs in Trokh is not conducive to movable type or manual keying of data. To handle these cases, the Aslan use something else entirely, the *tleftuawaoirlouheei*, or "female script". The closest thing we have to this in Galanglic are some of the older forms of shorthand, denoting individual sounds with discrete

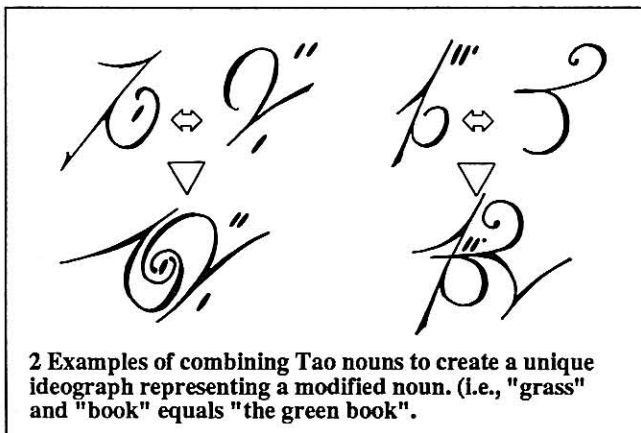

2 Examples of combining Tao nouns to create a unique ideograph representing a modified noun. (i.e., "grass" and "book" equals "the green book".)

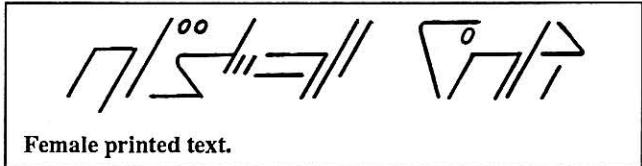

symbols few enough in number to allow mechanical writing to be employed. To be sure, the female script is still flowing in appearance to the human eye used to our individual and separated Galanglic characters.

A typical Aslan battle tank, then, will have its control panel labeled with proud and ornate *yoyeaokhtef*, but the female who wrote the software for the onboard computer will have entered her data with a keyboard configured for *tleftuawaoirlouheei*. A typical male can neither read nor write the female script, but then why should he? If he needs something written down, one of his wives can do it for him.

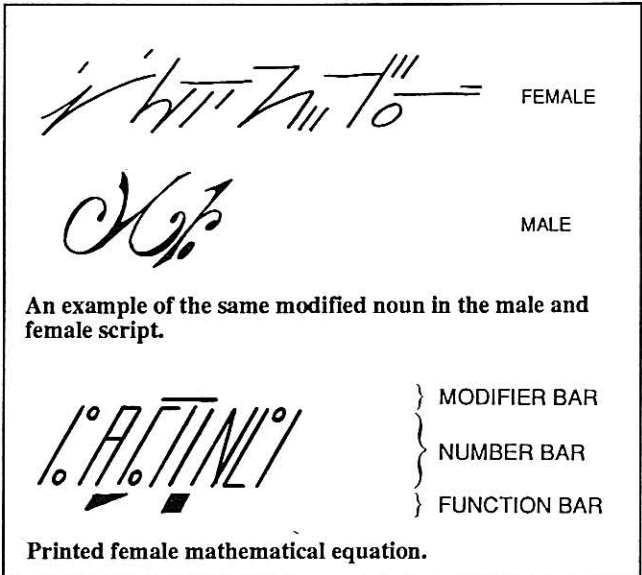

ASLAN PROVERBS

To give a feel for what Trokh sounds like, we end this article with a few common sayings among the Aslan, in both the male and female dialects. Deceptively simple on the surface and highly stylized, these phrases to the Aslan mind carry profound truth, and knowledge of them can ultimately lead to *aokhaor* — a life dedicated to the proper and spiritually correct way of doing things.

Eaeiheas aokhaor alroalyewahwoi'or, khyew kyelaeayaiyses: "Lean honor is better than fat shame." Literally, this sentence — in the Trokh male dialect, of course — means "lean honor is fat, but fat shame is bony". To the Aslan, "life without honor" is a contradiction in terms: life is meaningful only so long as it is strong.

Fou hwyarl iyw: "If you want the tiger's cubs, you must go into the lair." The ideal life of an Aslan is not contemplative, but active. How deeply this idea is ingrained into the Aslan psyche can be clearly seen by the degree of holophrasis in this proverb — three syllables express the whole idea, with all of its ramifications. This saying directly contrasts with our Galanglic maxim, "All good things come to those who wait."

Firuah ftasour wui: "Singing a song with flat sounds." Trokh phonetics divides the sounds of the language into "flat" and "round", depending on whether the lips are used. For example, the vowel diphthong *ea* and the initial

consonant *kh* would be flat; the vowel *u* and the final consonant *w* would be round. The point of this expression is that when all the sounds are *wui'* or flat, the lips can be held back, baring the teeth in a challenging grimace. The formal phrase thus signifies the ritual challenge made by one male to another.

I' ftyohaharl ki i' hwao, ftyohaharl ki i' hwao: "Not aiming is not hunting, and aiming is not hunting." The parallel nature of this proverb lends it to a wide variety of *yoyeaokhtef* representations: it can be found as a slogan adorning the starships of many *ihatei*, or landless sons. The saying means that goals are necessary in any endeavor (not aiming is not hunting), but one also needs the means to achieve one's goals (aiming is not hunting) — it is not enough just to have the goal.

Keisea aokhaor asaia tleftuaw firuah: "So honorable that he challenges females." As can be suspected, this phrase is an insult. Males and females in Aslan society lead quite different lives, and particularly with the difference in language, it is easy for minor misunderstandings between the sexes to arise. In most cases, these are overlooked, but a particularly haughty male does have the option of

challenging a female (the challenge, of course, is answered by one of her close male relatives). Needless to say, such a thin-skinned nature is not highly regarded.

Iyweahataau ko tewiweaheika: "Giving a penny to a clan leader." According to the Aslan code of ethics, a donation of value given to someone is a kind and honorable thing, but of course there are exceptions. The Aslan *iyweahataau*, a tiny coin, has little value in any case, but its minute worth is perverted if given to someone who has no need for it, even if the giver is trying to act as a benefactor. In Galanglic, we might say that someone "should have left well enough alone", and this meaning carries through in this proverb, in the Trokh female dialect. The particle *ko*, translated here as "clan leader", really means "oneself", so the phrase could be translated as "giving a penny to oneself", *i.e.*, keeping it, which is what the giver should have done. A clan leader thus insulted would insist on *yerlik aisaiaokheh*, a duel to the death. •

Two New MegaTraveller Products from Digest Group Publications!

Due Out Winter 1989-90

The MegaTraveller Alien, Vol. I Vilani and Vargr: The Coreward Races

100+ pages, \$12.95
(please, no preorders)

The Vilani. Founders of the oldest human empire in charted space. Their alien cultural view forms the basis for many modern Imperial ideas, such as: "Don't trust technology." "Anyone who likes to read technical manuals is perverted." Or "The lone merchant is a fool."

The Vargr. Humans call them barkers, growlers, or even worse, doggies. Plucked from earth a quarter of a million years ago and manipulated into intelligence by the mysterious Ancients, how could this dog race — a race that knows no long-term loyalties — ever be cohesive enough to become starfaring?

Other MegaTraveller Alien Titles to be Published in the Future:

Aslan and Solomani: The Rimward Races (Vol. II)
Zhodani and Droyne: The Psionic Races (Vol. III)
K'kree and Hiver: The Exotic Races (Vol. IV)
Humans and Nonhumans: The Minor Races (Vol. V)

Campaign Sourcebook 1: THE BLACK DUKE

96 pages, \$12.95
(please, no preorders)

The Federation of Illellsh, ruled by a man named Dulinor, forms the backdrop of DGP's first MegaTraveller Campaign Sourcebook in the spirit of GDW's *The Traveller Adventure*. This product gives you background, sector maps, world data, history, new minor races, new starships, and a comprehensive look at Dulinor's stronghold. Plenty of material for a sweeping campaign set in The Shattered Imperium.

The adventure opens in 1120—The free trader *Lady Jo* limps into Federation space after being attacked by privateers. With their ship grounded until they can afford the repairs, the crew signs on to a passing Tukera freighter journeying deep into the Illellsh sector. Their quest for profits embroils them in schemes much more important than any one had imagined.

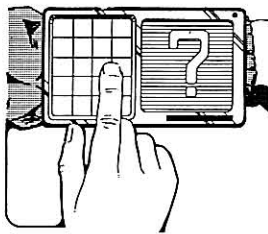

Traveller Q&A

OFFICIAL ANSWERS TO YOUR QUESTIONS

Send us your questions to get an official answer here in this column.

Address your questions to:
Traveller Q&A
Digest Group Publications
8979 Mandan Ct.
Boise, ID 83709-5850

Why isn't technology in the Imperium uniform? With the communication possible, technology could easily be available to everyone. — G. A.

There are good reasons why technology in the Imperium is not uniform, and to understand these reasons, we need look no farther than our own Earth.

If rapid communication and rapid transportation are all it takes to make technology uniform, then our modern Earth ought to be a shining example of totally uniform technology. We have been able, since the middle of this century, to reach any point on the globe with radio. Also, the jet airplane and the helicopter enable us to reach any populated location with ease.

Yet despite all of this rapid communication and transportation, our technology is not uniform across the entire globe. Does the common person living in India have a stereo and own a TV? Is there an Indian ski resort on Mount Everest? Does the general populace living in Borneo own digital watches and carry hand calculators? No, this technology is largely absent from these places. In fact, many places on our tech level 8 globe are still quite backward and primitive, back at tech level 5, if not earlier.

If such technological variations are true here on our Earth, where communicating with any point on the globe can be accomplished within minutes, and travelling to any point on the globe is possible within a day, we can easily expect the technological variations present in a vast interstellar empire to be even more pronounced. After all, in the Imperium, travelling and communicating from border to border can take years, and even the closest points are at least a week apart.

One explanation we might give for why India and Borneo do not have a lot of technology is that the countries are both poor. But then again, saying a population doesn't have technology because they can't afford it is a bit like saying you caught a cold because you kept sneezing. Like sneezing, the lack of money is actually only a symptom of a more fundamental cause.

To ferret out this reason, let's consider another example. When the American Indians were first encountered by European explorers in the 1500s and 1600s, the Indians' technology was simple and backward compared to the Europeans. In fact, it seems the Indians' technology had changed little in thousands of years. Lack of money doesn't seem to make sense in this case — until the American Indians encountered the Europeans, whose technology would they buy?

Perhaps the American Indians just didn't see the need for new technology. "There's just no good reason to change when the way we've been doing it works perfectly fine." In other words, it's all a mindset or an attitude. This "leave things well enough alone" attitude seems foreign to us today; we see change and advancement as a "good" thing.

In *Traveller* history, the humans of Vland advanced to about tech 11, and then stopped there for thousands of years (remember the American Indians?). Eventually, the Terrans entered the interstellar scene at tech level 9 with the invention of jump drive. In a mere two centuries, the Terran technology not only caught up with that of the Vilani, but went on to achieve tech level 12, and even tech level 13.

The Long Night threw the interstellar community into a state of technological decay, and technology of vast regions of systems dropped one, two, even five to ten tech levels. After a thousand years of decline, the Third Imperium was founded, and a new age of advancement dawned. However, many worlds in the Third Imperium still cling to the "Vilani mindset".

"Who needs to advance? What we've got is good enough," they say. "We don't need all that worthless, expensive off-world stuff. Will it help the crops grow? No? Then we don't need it." Since the Imperium does not meddle in local world affairs, this mindset is very much alive.

Just look around. Many models for such attitudes exist right here on our tech level 8 Earth. — *Joe D. Fugate Sr.*

I have a question about the Replacement Body Parts article in TD#13. Why do the Army and Marines have to chose a prosthetic while the Navy and Merchants cannot chose a prosthetic? I don't mind reasonable rationales but I don't like an arbitrary "no, you can't do that". I ask because one of my characters had a prosthetic, but is Navy. If you're going to put limits, please explain the reasoning behind them. — R. T.

When your employer is footing the bill, he can tell you what you can and can't spend his money on. If a merchant character wants to foot the bill himself (since he is in a non-military service), he could easily get whatever he wants — he doesn't have to stick with the "recommended" replacement.

However, a military character will have a difficult time convincing his superiors that he should get something other than the recommended type of part — whether he offers to pay for it himself or not. After all, as anyone who has been in the military knows, they "own" your body for the duration of your term of service.

So why do the Imperial Marines and Army require you to chose a prosthetic? Since they are paying the bill, the answer is simple: prosthetics are cheaper. Never mind that a damaged prosthetic may be rendered totally useless dead weight with one well-placed hit — cheaper is better in their eyes.

The Navy and most large merchant companies take a different view, however. They feel that a prosthetic is too fragile. They prefer a biological replacement, because a biological replacement, even if damaged, will still work somewhat.

Thus while it is not impossible to vary from the recommended type of part, it may require some political battles. Come to think of it, the struggle to get the replacement you want (rather than what you are told you are going to get) might make an interesting premise for an adventure...

— *Joe D. Fugate Sr.*

When rolling up characters, is it possible for an advanced character to attend both flight school and medical school? I have found this confusing, and appreciate any answer you can give. — W. L.

The intent with character generation is that any one of these schools represents a *significant career direction*, and thus they are mutually exclusive. While it is not impossible, most people do not indulge in full-blown, multiple career paths. Put another way — how many people go to medical school, graduate, and then go to law school? The same goes for a character going to both flight school and medical school. It just does not often occur.

If a player insists, I'd make him roll the following task:

To attend both flight school and medical school:

Formidable, End, Int

Referee: The character must have at least a +3 DM (genius IQ or incredible endurance), or this task automatically fails.

That should take care of any thoughts of trying to attempt multiple career paths. —*Joe D. Fugate Sr.*

Suppose an attacker uses a 7mm autorifle. This has a penetration of 3, an attenuation of 2, and a damage of 3. The defender is wearing cloth, with an armor value of 5. The two are at medium range.

The attenuation at medium range causes the penetration of the autorifle to be reduced by half, to 1.5. Is that rounded down to 1? Rounded up to 2? Rounded to the even number, 2? Or left as 1.5?

Let's assume for now it is left at 1.5. Now we compare the penetration of 1.5 to the armor value of 5. The penetration is less than the armor value, so the autorifle inflicts 10% of its damage — i.e., the 3 becomes 0.3. Does that stay as 0.3, or is it rounded down to 0?

Assuming that things are rounded down, doing any damage with most run-of-the-mill weapons against someone wearing cloth is *very* difficult. The only way we can do damage is if the roll to hit achieves "exceptional success", which has a minimum of 1 point of damage, such that the 0.3 becomes 1 point of damage. Well? —*W. H.*

In combat computations, drop fractions. A penetration of 3 reduced in half becomes 1. A damage of 0.3 is 0.

Incidentally, the way you are interpreting attenuation is wrong. An attenuation of 2 means that starting with *short range*, the penetration stays the same for two range bands (short and medium in this case). So the halving occurs at *long range*, not medium range.

You are absolutely right it's hard to damage somebody in cloth armor without exceptional success. You've got to get creative with combat to do real damage with slug throwers against an armored target:

- 1) Use tactical points to get exceptional success;
- 2) Pinpoint hit the guy to get 1/2 armor;
- 3) Use a cautious attempt to get a good, braced, aimed shot. If the attacker doesn't move, and you can stay determined, this is a good way to lower hit difficulty and ensure exceptional success;
- 4) Time for the Assault Rocket Launcher. That'll penetrate cloth armor. . . —*Joe D. Fugate Sr.*

In the tables for basic character generation, there are several default skills that everyone gets, based on homeworld and career. For example, Wheeled Vehicle-0, Computer-0, Gun Combat-0, etc. In advanced character generation, no reference is made to these charts. Thus, Navy characters generated with the basic rules get several basic skills automatically, while Navy characters generated with the advanced rules might never get some of these skills. Is that correct? For instance, one of our players generated a Scout character that never received

Pilot skill, even though she received a Scout ship as a mustering out benefit. If the default skills used in basic character generation are supposed to be applied in advanced character generation, then she gets Pilot-1, otherwise she has to find someone to pilot her ship. What is correct? —W. H.

Sorry, the default career skills are for basic character generation only. The advanced systems are designed to give characters lots of skills. The default career skills help the basic system maintain the same skill levels as the advanced system.

The homeworld defaults, however, apply to *all* characters, basic or advanced. —*Joe D. Fugate Sr.*

Surprise doesn't seem quite right to me. The attacking party, using Leader and Recon skills, attempts to roll 11+ to achieve surprise. I can understand that. However, if a mishap occurs, the defending party achieves surprise instead. As best as I can tell, a mishap in this case means missing the 11+ by 2 or more, which means that *most* of the time, the *defending* party is the one that will achieve surprise. Is that correct? Also, since it does not say "Unskilled OK", does that mean that a party that does not have Leader or Recon skill cannot attempt to achieve surprise? —W. H.

On surprise, read the paragraph following the task. "If the defending party *has no reason to suspect an attack*, the surprise task may become routine."

How can the defending party achieve surprise? If they know an attack is coming, they can prepare a hidden defense. Imagine the Japanese arriving at Pearl Harbor to find no ships to bomb. Then concealed AA guns and planes start striking back. (!) On a tactical level, a party can send flankers around a suspected ambush location to ambush the ambushers.

The surprise task should indeed say "Unskilled OK". Sorry about that oversight; you are sharp to catch it.

In all tasks, do not be a slave to the rulebook. If a task's difficulty level seems inappropriate in this situation, then *change it*. The sample tasks given are not meant to be chiseled in stone, they are mainly a model for you to use for building your own tasks. You can copy them or change them as you see fit. Boggling down a session with rule debates isn't the way to do it. Save the rule debates for after the session.—*Joe D. Fugate Sr.* •

Quad Con '89

October 13 - 15, 1989

At Palmer Auditorium,
Davenport, Iowa

RPG's, Boardgames, Micro Armor,
Miniatures, Tournaments.

**For a copy of the pre-registration
brochure, send a #10 SASE to:**

RiverBend Gamers Association
P.O. Box 8421, Moline, IL 61265

Soundtreks

THE GAMING DIGEST

—by Rob Caswell and Tom Peters



Adding Music to MegaTraveller

Chase music beats out a rapidly increasing rhythm as the two characters sprint out of the main control room with security troops hot on their heels.

Shari: How do we get ourselves into these things?

Dagg: Shut up and keep running!

The characters hear the muffled roar of a plasma gun reverberating in the corridor behind them. Rounding another corner, Shari and Dagg see that the corridor branches both to the left and right just ahead of them. The music proceeds at a frantic pace, mirroring their flight.

Shari: Ack! Quick — down this one.

Dagg: Where's it go?

Shari: Guess we'll find out.

As they sprint down the right-hand side of the fork, the music takes on a menacing tone.

Dagg: I don't think I like this — the job offer didn't say anything about armed guards in combat armor.

About five meters away, the corridor terminates at a sealed pressure door. The guards' footsteps are nearing.

Strains of Dagg's Theme creep into the musical background.

Dagg: Ahhh — OK, you work on the door. I'll go hold them off at the corridor split.

Shari: But we can get through this door in about a minute — the lock looks...

Dagg: Work on it — I'll hold off the guards.

Shari: Dagg!

Dagg takes off down the corridor in the direction of the pursuing guards as his theme music increases again, in rhythm and strength. As Shari crouches down to work on the door, an unfamiliar shape stabs her side. Reaching into her deep jacket pocket, she finds Dagg's extra snub pistol clips, which he had earlier asked her to carry. As the panic of her discovery reaches Shari's face, the music of Dagg's Theme peaks in a sustained violin shriek.

Shari: Dagg! You forgot your...

Heavily armored pressure doors slam into place over the route Dagg had just taken, separating the pair. Dropping to somber bass tones, Dagg's Theme repeats for the last time. The sound of Dagg's snub pistol firing from beyond the pressure doors is followed by an extended volley of plasma gun fire. Abruptly, the music stops.

Shari: Dagg? ...Dagg...

Though this reads somewhat like a script from a movie, Dagg and Shari could just as easily be characters in a MegaTraveller session. Science-fiction roleplaying has taken much inspiration from its cinematic brethren, but there's no reason that the line need be drawn at using a soundtrack. What a musical score does to enhance the excitement of a film, it can do as well for a gaming session.

Even if your music doesn't fit the action, snapshot for snapshot, it still enhances the mood of a selected scene in ways beyond the power of a referee's verbal description.

Just as you can learn to choose and administer a soundtrack, your players can learn to pace their own activities. In many cases, you will find that your players may tailor their own actions to fit your chosen soundtrack better. Such an

action can be undertaken without cramping a player's style and makes it more entertaining for everyone involved.

Many have expressed the sentiment that music played during a game session provides too much distraction. While this can be so, the key to successfully integrating music into the action lies in the careful choice of the music and its selective application. In this way, even the silences between musical tracks can become tools to guide your players and enrich the scenario with atmosphere.

TWO EASY STEPS

Before introducing a soundtrack to your own games, there are two interlinked decisions you must make: what medium will I use and what music, within that medium, do I want to use?

The most common media available are the compact disc (CD), computer software, cassette tape, and records (vinyl). Each has its own advantages and peculiarities, as discussed below.

THE MEDIUM IS THE MESSAGE

A compact disk player (especially a small, portable one) is most valuable for its flexibility. One can jump to the desired track at a second's notice, making the introduction of the music smooth and trouble free.

Though limited a few years back, the amount of music available on CD is now very close to that on vinyl. The only aspect which may prove daunting is the cost. CD prices have been dropping, but they're still the most costly medium.

Second in line for convenience is computer software. Many music programs are available as public domain (check your local BBS or one of the networks). These programs usually present you with a menu of pieces to choose from. To use this during a game, simply leave the menu on screen. When the appropriate scene occurs, just press the number of the desired track.

Another advantage is that many of the programs will repeat their tracks. If the scene takes longer than you'd anticipated, the music plays on till you choose to stop it.

Unfortunately, using a computer, your musical choices are very limited (unless you are a computer musician).

The cassette tape has the advantage of recordability. A referee could select pieces from various albums and compile them all onto one tape for the session. This feature, combined with some decks' ability to scan to desired tracks, makes cassettes fairly versatile.

Unfortunately, in some instances the scan time can be measured in minutes. This could bog down the session, thus destroying the mood that the soundtrack is trying to heighten. The best way to combat this is to try to anticipate a track's use in advance and scan for it between scenes (as players adjust their stats, take inventory, or look about).

Though probably the most common medium and with the widest musical selection, vinyl has the large drawback of not being portable. If you want to use vinyl, you have to locate yourself next to a turntable. And then there's playing with the needle to get the right track. Some turntables do have scanning features that will put on a selected track for you, but it's still a rather "clunky" process.

Lastly, a warning; when using tape or vinyl, the repeated use of a track over a short period of time may reduce the lifetime of the record. CDs suffer no such ill effects.

SOUND JUDGMENTS

Once you've settled on a medium, the next phase is musical selection. First, have a good idea of a number of exciting or important scenes. Then, be prepared to spend a couple of hours with your music collection, looking for pieces with the right pacing and desired feel. Categorization of your selections is important to applying them during play.

Generally, instrumental music is better than vocals. Movie soundtracks are good sources, but often are too heavily associated with their sources. In running a **Mega-Traveller** campaign, it is recommended that music lacking a visual media identity be used. This allows the players to build their own associations to the chosen musical score.

With this in mind, classical music provides a great and varied selection, as do "new age" pieces. Of course, selection is a product of the referee's and players' personal preferences. The most important criterion is that the music fit the tastes of all involved.

Both players and referees can reap the benefits of this approach. The use of an associated theme (say, what the players have come to know as *Lucan's March*) can, by its mere presence, cause the players to react in a manner anticipated by the referee. A useful unifying influence is the choice of a theme piece for the campaign. It provides a way for the players to get into their roles at the game's start and serves to join separate adventures into a campaign.

In this vein, it's also interesting to have individual character themes that play off some aspect of that PC's personality. This way, even if the character is killed, his influence may still be felt by the playing of his theme at a crucial moment of play (as is the case with poor Dagg).

Obviously, themes can be chosen for various major "organizations". If the players work for Tukera, a sense of purpose can be reinstilled by playing the *Tukera Theme*.

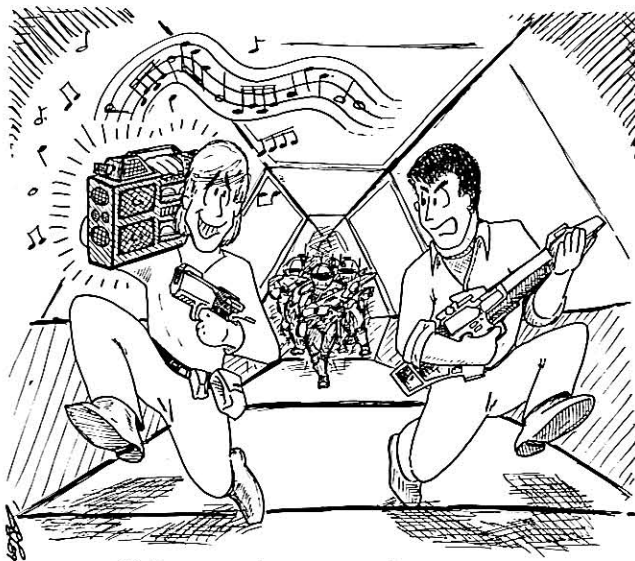

DO YOU ALWAYS HAVE TO
PLAY THAT THING SO LOUD?!

For enhancing the grandiose, space-opera feel of a **Mega-Traveller** game, the use of rich, full orchestral scores tends to be more appropriate than, say, "Conway Twitty's Greatest Hits". The choice, however, is up to you.

If you don't have any specific preferences or are unsure where to start looking for applicable music, the following list of "tried and true" album titles may be a good place to start:

By *In the Nursery*:

Koda
Stormhorse

By *Tangerine Dream*:

Le Parc
Hyperboria
Wavelength

By *Synergy*:

Metropolitan Suite
The Jupiter Menace
Electronic Realizations For Rock Orchestra

By *Mark Isham*:

Film Music
Vapor Drawings

By *Dvorak*:

Symphony No.7 "From The New World"

By *Beethoven*:

Symphony No.7
Symphony No.9

By *Vangelis*:

China
Albedo 0.39
Heaven And Hell

The reviewing process before a game is often a two-way street. In the process of trying to find the right music for a scene, you often can find inspiration for whole new scenes from the images evoked by listening to a certain piece.

RAISE THE CURTAIN!

In reviewing your music, it is recommended that you keep a list of which tracks apply best to which situations in your scenario. Keep this list with you as a quick reference.

Perhaps you would like to choose one track as the "theme music" for your PC's — other cuts may be useful in chase scenes, exploration of mysterious places, or deep space battles. Keeping a record of these "generic use potentials" helps streamline their use during the game.

If using a published adventure in the new "visual nugget" format, making small notes as to what music to use, next to each nugget entry, may also help speed up the process during play. The trickiest aspect of using a gaming soundtrack is anticipating a piece's placement. With a reference list and proper equipment, your scores should slip seamlessly into the scenes, making them live as you and your players never imagined they could.

ON A CLOSING NOTE

Ultimately, music in a role-playing game can instill the sense of wonder and adventure found in movies and TV shows. Alien environments become more than just descriptions — starship battles become more than mere ships' statistics. In addition to providing an enhanced sense of background, music helps players get into their roles.

Music is another way to help the players and referees to immerse themselves in the fictional environment, thus enhancing the roleplaying experience for all. •

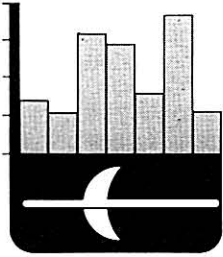

Survey Sweepstakes

TRAVELLERS' DIGEST 17

Let us know what you think! Photocopy the survey below, fill it out for the articles you read, and send it to: TD17 Survey Sweepstakes, 8979 Mandan Ct., Boise, ID 83709. Three names will be chosen at random to win an autographed copy of Alien Vol. I. Deadline for entries is December 15, 1989.

	Didn't Read	Not Useful	Somewhat Useful	Very Useful	
Editor's Digest	<input type="checkbox"/>	<input type="checkbox"/>	<input type="checkbox"/>	<input type="checkbox"/>	<h3 style="text-align: center; margin: 0;">FOR OUR INFORMATION</h3> <p>1. Below are several ideas for supplementary MegaTraveller products. For each product, please mark it if you would buy it.</p> <p>Paper model starships, \$15 to \$30 per starship <input type="checkbox"/> Never Buy <input type="checkbox"/> Might Buy <input type="checkbox"/> Definitely Buy</p> <p>Resin starship or vehicle models, \$20 to \$50 per model <input type="checkbox"/> Never Buy <input type="checkbox"/> Might Buy <input type="checkbox"/> Definitely Buy</p> <p>MegaTraveller miniature figures (ten figures per package) Metal, 25mm, \$20 to \$40 per package <input type="checkbox"/> Never Buy <input type="checkbox"/> Might Buy <input type="checkbox"/> Definitely Buy</p> <p>MegaTraveller uniform patches, \$4 to \$8 per patch <input type="checkbox"/> Never Buy <input type="checkbox"/> Might Buy <input type="checkbox"/> Definitely Buy</p> <p>MegaTraveller costume patterns, \$5 to \$10 each <input type="checkbox"/> Never Buy <input type="checkbox"/> Might Buy <input type="checkbox"/> Definitely Buy</p> <p>MegaTraveller original art portfolios (ten 11 x 17 pieces) B&W, \$10 to \$20 per package of 10 Color, \$25 to \$40 per package of 10 Mixed B&W and Color, \$15 to \$30 per package of 10 <input type="checkbox"/> Never Buy <input type="checkbox"/> Might Buy <input type="checkbox"/> Definitely Buy</p> <p>Strategic level rebellion boardgame, \$25 to \$40 <input type="checkbox"/> Never Buy <input type="checkbox"/> Might Buy <input type="checkbox"/> Definitely Buy</p> <p>MegaTraveller short story anthology, 100 pages, illustrated, \$12.95 <input type="checkbox"/> Never Buy <input type="checkbox"/> Might Buy <input type="checkbox"/> Definitely Buy</p> <p>2. We have been getting mixed signals from our readers on the 2300AD section. We need a definite vote to decide if you would like us to keep the 2300AD section.</p> <p>Lester Smith, the designer (from GDW) of the new edition of 2300AD has consented to become the editor of our 2300AD section. If we keep the 2300AD section, we will concentrate on bringing you exciting new discoveries and adventures in the American Arm — a region of space no other publications are detailing.</p> <p>If we drop the 2300AD section, we pick up 6 - 8 pages for additional MegaTraveller material (more maps, more equipment sheets, more library data). However, the marketing appeal of the magazine becomes less broad. So, which is it? Do we pull the 2300AD section or do we keep it? <input type="checkbox"/> Pull It <input type="checkbox"/> Keep It</p>
Feature Adventure: The Blade of Koiyekh	<input type="checkbox"/>	<input type="checkbox"/>	<input type="checkbox"/>	<input type="checkbox"/>	
Mega Adventure: Psionic Knights	<input type="checkbox"/>	<input type="checkbox"/>	<input type="checkbox"/>	<input type="checkbox"/>	
Beginner's Luck	<input type="checkbox"/>	<input type="checkbox"/>	<input type="checkbox"/>	<input type="checkbox"/>	
Library Data: Dark Nebula	<input type="checkbox"/>	<input type="checkbox"/>	<input type="checkbox"/>	<input type="checkbox"/>	
Trokh: Lang. of the Warriors	<input type="checkbox"/>	<input type="checkbox"/>	<input type="checkbox"/>	<input type="checkbox"/>	
Traveller Q&A	<input type="checkbox"/>	<input type="checkbox"/>	<input type="checkbox"/>	<input type="checkbox"/>	
Gaming Digest: Soundtreks	<input type="checkbox"/>	<input type="checkbox"/>	<input type="checkbox"/>	<input type="checkbox"/>	
Traveller Arsenal	<input type="checkbox"/>	<input type="checkbox"/>	<input type="checkbox"/>	<input type="checkbox"/>	
Medical Digest: Losing It	<input type="checkbox"/>	<input type="checkbox"/>	<input type="checkbox"/>	<input type="checkbox"/>	
2300AD: The Hogan 500	<input type="checkbox"/>	<input type="checkbox"/>	<input type="checkbox"/>	<input type="checkbox"/>	
<p>ART: Interior art this issue <input type="checkbox"/> Excellent <input type="checkbox"/> Good <input type="checkbox"/> So-so Cover art this issue <input type="checkbox"/> Excellent <input type="checkbox"/> Good <input type="checkbox"/> So-so</p> <p>IS THIS ISSUE: <input type="checkbox"/> Better than last <input type="checkbox"/> Same as last <input type="checkbox"/> Not as good as last issue?</p>					
Name and Address:					
Comments:					

OPERATION OVERLORD

The year is 2303. The Kafer invasion has been halted and the alien warships have been pushed back to the frontier. Still, the fighting is far from over. Pockets of Kafer ground troops exist on every single human colony world from Beowulf to Aurore. Kafer guerillas continue to attack the colonial towns and cities. Numerous Kafer warships continue to operate within the French Arm, raiding colonies, attacking unprotected shipping, and ambushing stray warships.

However, these raiders have a weak link — they need to be supplied. Their forward base at Dunkelheim has to be eliminated and Admiral Borodin has put the Americans to the task.

Operation Overlord is the American Marine assault on the Kafer citadel based at Dunkelheim. The adventure follows a group of American Marines from their interface assault landing through a mission which takes them into the heart of the Kafer "Ch*!!"

This book contains information on the colony world of Dunkelheim and the citadel which serves as the Kafer "Safe Place." This book also contains extensive information about the American Marines, their equipment, and their organization.

A modified skills list is even included for characters who enter the career path of the Corps. Finally, a brief update on the Kafer War is provided, describing the disposition of naval forces and of the American Marines following the completion of the adventure.

Operation Overlord serves as more than just an adventure. Its completion leaves plenty of room for further adventures, allowing directors to easily stage a campaign against the Kafers on post-invasion Dunkelheim.

DesignC.W.Hess

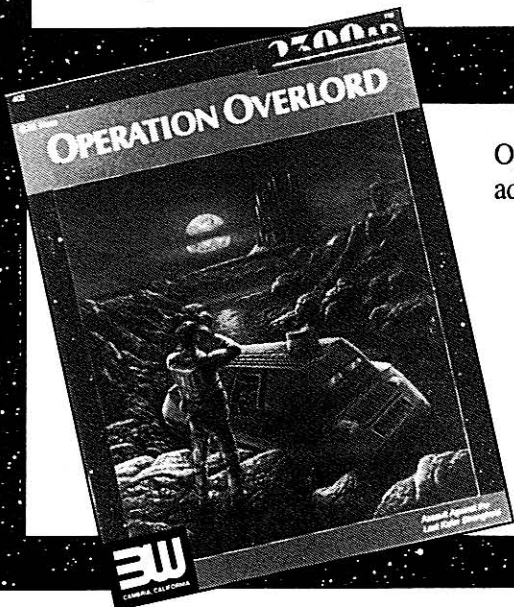
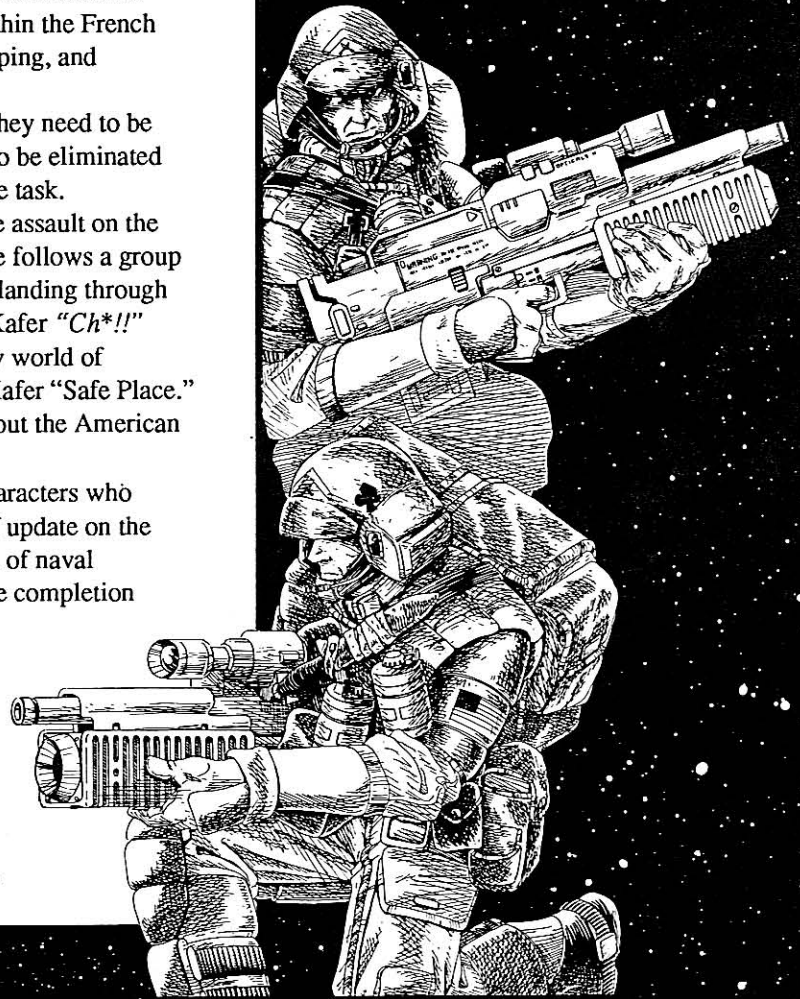

Operation Overlord is a 2300 AD science-fiction role-playing game adventure dealing with the assault on the Kafer "Ch*!!" on Dunkelheim.



Available in Better Hobby Stores Everywhere.
\$8.00 Made in the U.S.A.

To Order Direct:

3W, 4070 West St., Cambria, CA 93428 • 805/927-5439

Visa/MasterCard Accepted. Add 15% Shipping.

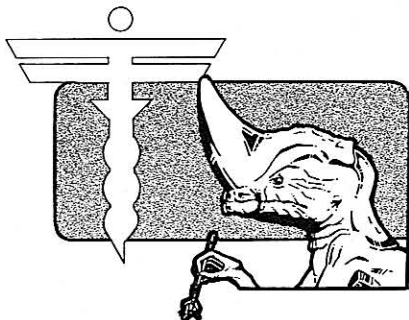

Losing It

MEDICAL DIGEST

— by Terry McInnes

A Look at Mental Health in Traveller

It had been a long, dangerous haul and it was only half over. The *Springbok* was spinward-bound through Corridor Sector heading for Deneb and its relative safety from marauding Vargr corsairs. So far, they were two days into their fourth jump. Each breakout into normal space had been followed by frantic wilderness refueling and a race to exit the gravity well with one or more Vargr corsairs in hot pursuit. The close escort's bulkheads seemed closer together with each jump, with each day. Tempers flashed frequently in the confined spaces.

Jensen was the first to crack. VonPaulus found her sobbing hysterically and frantically pounding on a wrench, trying to turn a frozen fuel refinery pressure relief valve. It took 10 milligrams of tranq and five minutes to pry her loose from the wrench. She wasn't the only one to snap. Half the crew was tranqed or in restraints by the time the *Springbok* crossed the Deneb border...

MENTAL TRAUMA

Not all the wounds suffered in life are physical. Mental trauma may be more common than we care to admit, and it can have a devastating effect on an individual's ability to function. Effects can range from simple lethargy and fatigue, to lethal attacks of homicidal mania, to a total vegetable-like catatonic state. **MegaTraveller** characters and NPCs often undergo major stress during their adventures, and are just as vulnerable as anyone else to going crazy from the pressure of living. In fact, it is said in certain circles that more than one would-be emperor of the Third Imperium suffers from some form of mental illness ranging from infantilism to megalomania — with the current pretender to the Iridium Throne possibly suffering from both.

CAUSES

Stress: Stress is a major cause of mental illness. Stress results from many causes. Constant danger is one; so is confinement in close quarters for a long time. **Mega-Traveller** characters and NPCs can suffer stress from three major causes. They include:

Job-related Stress. This is a common cause. Characters may not be fully qualified for the jobs they hold. This leads to frustration and stress. Their work may be criticized by others. This leads to fear of job loss and stress. Overwork and fatigue can cause stress, undue anxiety, depression, and mental breakdown.

Combat Stress. Individuals in combat situations suffer from fatigue and fear. If both are prolonged, mental breakdowns result.

Frustration. This can result from an inability to accomplish a goal which generates stressful anger. It can also result from the inability to develop relationships with other beings, and the loneliness resulting from this inability.

Civilians in wartime, and victims of crime or natural disasters also suffer severe stress. Stress may be sudden, or it can build over time.



Critical Loss: A critical loss can also tip an individual into a mental breakdown. An example might be the loss of a loved one where grief triggers profound depression. The loss of a job can also cause a breakdown. Many individuals so closely identify their lives with their work that they are shattered and feel totally worthless when their work is taken away, and are unable to adjust to this loss. Many down-and-outers hanging around Star Town bars became derelicts because they couldn't cope with the loss of a ship's crew position or other job loss. The loss of social standing can have a similar effect, if the individual too closely links his self-worth to this characteristic.

Critical losses are generally sudden, and cause sudden breakdowns when the individual cannot cope with the loss. A delayed effect has also been observed (sometimes called "anniversary syndrome") wherein, a specific length of time after a critical loss or major stress, an apparently stable person suddenly suffers physical or mental symptoms of that stress.

Boredom: Boredom is insidious. It builds over time, and is often coupled with frustration in causing a mental breakdown. Starship crews who are denied regular liberty are particularly susceptible to boredom and its problems including daydreaming, lack of attention to the tasks at hand, frustration, and anger.

Self-Sabotaging Thought: Many neuroses begin with a seemingly harmless act: the repression of some knowledge or memory which makes the person uncomfortable. Each such repression turns off a small part of the mind's function, and the sum of such acts can virtually paralyze a patient when he most needs to think clearly. This is why psychotherapy must often delve into a patient's past, sometimes with the aid of hypnosis.

Other attitudes, often learned in childhood, may also lead to neurotic behavior. A secret belief that he is inferior may drive a patient on a lifelong quest to rule others while

refusing even to accept advice, or may cause him to withdraw from society completely or to behave self-destructively. Some psychologists feel that errors in thinking cause at least as much mental illness as organic malfunctions do.

Heredity: Certain forms of mental illness are believed to be biochemical in nature, particularly severe forms of schizophrenia, and may be passed from generation to generation. If, in generating a character, a survival roll is made exactly, with nothing to spare, this indicates a genetic predisposition to mental illness.

Street Drugs: Many illegal drugs can cause psychological disorders ranging from severe depression to violent schizophrenia. These include varieties of cannabis, cocaine, LSD, PCP, and more recently, LCT, a "designer drug" that originated in the illicit sector as a pharmaceutical used to revive livestock travelling in low berths. Most drugs cause mental symptoms during their effect period, and many can gradually cause permanent brain damage.

Psionic Attack: (rare) Attack by a powerful telepath may leave a character with disordered thinking, memory gaps, or a deliberately created psychosis.

TYPES OF MENTAL ILLNESS

There are several types of mental illness which characters may encounter or develop. Three of these are fairly common — anxiety, obsessive-compulsive behavior, and depression (and the variant, manic-depressive disorder) — and are considered to be neuroses in their milder forms. They can often be treated with medication or psychotherapy on an outpatient basis. The others — paranoia, schizophrenia, and catatonia — are relatively rare and considered to be severe psychoses requiring hospitalization, medication, and intense therapy.

Anxiety: Anxiety is defined as the fear of an unreal or imagined danger. Anxiety is often accompanied by tenseness, irritability, and restlessness. Often anxiety is free-floating, a vague unfocused fear that "something bad is going to happen." Headaches, muscle tension, and indigestion or ulcers often occur as physical symptoms of anxiety. A severe anxiety attack is a sudden onset of overpowering fear without external cause, accompanied by rapid heartbeat, sweating, trembling, agitation and possible fainting.

Failure to live up to one's own standards, *whether or not those standards are reasonable*, often results in either depression or anxiety attacks. Phobias are a class of anxiety and can usually be traced to unpleasant experiences in the past. Free-floating anxiety can be brought on by stress, or by illogical beliefs that undercut rational problem-solving.

Post-traumatic Stress Syndrome may be suffered by war veterans, POWs, and victims of crime or natural disaster. It involves symptoms of several neuroses, especially nightmares, compulsions, irrational violent urges, and inability to fit into the former lifestyle. Therapy is indicated.

Obsessive-Compulsive Disorder: A neurosis that sometimes runs in families, OCD causes victims to repeat ritualistic behaviors which may or may not have some value in themselves, but which are useless and harmful when constantly repeated. Handwashing, checking locks, and saving things are a few of the patterns that may get out of hand. This disorder responds well to medication and therapy.

Depression: Depression is a normal feeling when one has lost something or someone, or failed at a task. However, it becomes a neurosis when it persists beyond a few hours or days, or when there is no reason for it to happen. Neurotic depression often results in its victims feeling like failures at

everything, causing them to be less interested in living and enjoying anything. Suicide may result in extreme cases. Headaches, persistent fatigue, loss of appetite, insomnia, and weight loss or gain are common side effects of depression. Many cases are due to unbalanced brain chemistry and respond to supplementation.

Manic Depressive Disorder: Victims alternate between extreme depression and mania, which is a period of hyperactivity, excitement, and elation. The alternation may be sudden, frequent, and unpredictable. While manic, the victim has boundless energy and enthusiasm for thousands of ideas and plans. The victim also has fantastically exaggerated ideas about his power and abilities. While depressed, the victim suffers anxiety and dread, guilt and feelings of worthlessness. This problem often responds to medication.

Paranoia: Paranoia victims suffer delusions of persecution, feeling that other people are "out to get them". Paranoids often react to these imagined threats with violent behavior and may assault others they feel are persecuting them. Paranoids also hallucinate, frequently hearing voices' accusing them of wicked actions or thoughts or telling them to commit crimes. Their thoughts become increasingly irrational and disorganized as the disease progresses.

Schizophrenia: The word "schizophrenia" means "disintegrated personality", not "split personality" as many believe. Schizophrenics function in an irrational and disconnected manner, paying little attention to their own needs or the expectations of others. This problem runs in families.

Hebephrenia : This is an extreme form of schizophrenia. It is characterized by inappropriate silliness and laughter, as well as hallucinations that give the victim a fantasy life. Speech is disconnected and irrational. Anyone reaching this stage is usually a total loss.

Catatonia: This is another "two-phase" disease. The victim may appear to be in a stupor in one phase. However, although he becomes mute and immobile as a statue, the victim is conscious and aware of what is going around him. In the excited phase, catatonics become violently hostile and aggressive, tearing clothing, smashing objects, and attacking people. There appears to be a genetic predisposition to this psychosis.

THE MENTAL HEALTH OF NPCS

Adventurers may meet non-player characters who are not totally sane. Paranoid patrons could hire bodyguards to protect them from non-existent enemies. Manic depressives might hire characters for grand schemes, then suddenly and surprisingly lose interest in everything. Or, patrons could suffer from simple anxiety or depression.

Referees can add flavor to a campaign by creating predetermined encounters with such NPCs. This is another way to introduce surprising twists and turns in a campaign.

Random encounters could also involve psychotic or neurotic individuals. Psychotic individuals are usually easily spotted because of bizarre or withdrawn behavior and irrational speech. (Some criminal psychopaths can appear quite normal, however, as do paranoids at first inspection.) Neurotics often appear normal, and the symptoms of their illness may not become apparent until characters have been in their company for some time.

THE MENTAL HEALTH OF CHARACTERS

A number of stressful situations that commonly involve **MegaTraveller** characters were described earlier in this article. If characters and NPCs are in any of the stressful situations described above, they need to perform the mental illness avoidance task shown below. They must roll this task once a week until their situation returns to normal.

To avoid mental illness:

Routine, Leader, Det, (fateful)

Referee: Failing this task causes the character or NPC to suffer depression or anxiety. An exceptional failure causes the character or NPC to suffer severe mental illness. Roll 1D on the tables in the step charts to determine the exact effect of the failure. The task becomes difficult if characters have a genetic predisposition, get less than six hours of sleep per day for two or more weeks, suffer more than one sudden loss at the same time, are in continuous combat for two or more weeks, or are closely and continuously confined for four or more weeks.

EFFECTS ON CHARACTERS

If a character fails the mental illness throw, he or she suffers the following effects depending on the illness to which the character succumbs.

Depression: Subtract one from Strength, Dexterity, and Endurance to reflect lethargy and fatigue until the character returns to normal. (Many victims recover spontaneously.)

Anxiety: Subtract one from Strength, Dexterity, and Endurance to reflect insomnia-induced fatigue.

Obsessive-Compulsive Disorder: Subtract one from Endurance and increase time on tasks by 25% to reflect time and energy wasted on ritual behaviors.

Paranoia: Subtract two from Intelligence and Education to reflect hallucinations and delusions.

Schizophrenia: Subtract three from Intelligence and Education; subtract two from Endurance to reflect loss of interest in the real world.

Hebephrenia: Reduce both mental stats to one. Patient must be restrained and hospitalized immediately.

Manic Depressive Disorder: Increase Strength and Endurance by one in the manic phase; subtract one from Endurance and Dexterity in the depressed phase. The player should roll 1D to determine whether his character is in the manic or depressed phase. A 1-3 result means the character is manic, 4-6 means the character is depressed. Roll at frequent, random intervals to determine when the phases change.

Catatonia: The player should roll 1D to determine whether his character is violent or is in a catatonic stupor. A 1-2 result means the character is violent, 3-6 means the character is in a stupor. Roll at frequent, random intervals to determine when the phases change.

TREATMENT

Characters and others with neuroses may be treated by a psychiatrist on an outpatient basis with combination of drug therapy and the analysis of the patient's mind. Subliminal suggestion is extensively used for outpatient treatment and can in some cases be obtained "over-the-counter" by those who recognize their own problems. Psychotic characters require hospitalization and intensive psychotherapy supported by chemical or genetic therapy. Certain neuroses and psychoses respond well to supplementation with certain minerals or injections of neurotransmitter chemicals in which the patient is deficient. Some disorders with genetic bases can be treated with genetically engineered "vaccinations" to enable the patient's body to supply missing neurochemicals. Disorders with violent phases can be controlled by microelectronic implants in the brain stem or limbic system. Personality repair is available beginning at TL15 for

the treatment of severe and otherwise incurable psychoses. Catatonia brought on by shock or sensory deprivation may gradually improve under a regimen of pleasant stimuli, to a state where psychotherapy is possible.

Psionic cultures can use telepathy to treat mental illnesses unless they are of organic origin; this requires a psionic strength of 5 or more and at least two weeks in close contact with the patient.

Psychiatrists

Psychiatrists are specially trained physicians specializing in mental health care. To be a psychiatrist, a character must have at least Medical-4 and Liaison-2. Psychiatrists are available on an out-patient basis or on the staff of a mental hospital. Private psychiatrists are available for office visits at CR70 per 50-minute hour. Psychiatrists use the following tasks to cure neurosis and psychosis:

To cure a neurosis:

Difficult, Medical, Liaison, 1 month

Referee: This task assumes one out-patient visit per week.

At TL8, therapy is available that reduces this task to Routine. At TL12, this task is Simple.

To cure a psychosis:

Formidable, Medical, Liaison, 3 months

Referee: At TL8, therapy is available in hospitals that reduces this task to Difficult. At TL12, this task becomes Routine, at TL14 it is Simple and the time increment is one month. Patients in private hospitals have the task reduced by one level of difficulty.

Mental Health Workers

Mental health workers are also available with liaison training (Liaison-2) but without medical skills. They may treat characters as outpatients or in a psychiatric hospital. Their liaison skill may be applied as a positive DM to the task of curing a neurosis, and, if they are part of a team with a psychiatrist, their DM may be added to the psychiatrist's DM in treating a psychosis. Psychiatric nurses (Medical-2, Liaison-2) may add their skills as part of a team effort in a psychiatric hospital. Mental health workers who see outpatients generally charge CR40 per hour.

Psychiatric Hospitals

Characters suffering from a psychosis must be hospitalized in a psychiatric hospital in order to receive the intensive psychotherapy, chemical therapy, or (at high tech levels with severe mental illness) personality repair they need to recover from their illness. Private psychiatric hospitals are available costing CR400 per day. They are generally superior to state-run institutions in quality of care and amount of therapy provided to their patients. If a character is hospitalized in a private facility, the task to cure his psychosis is reduced by one level of difficulty.

Drugs

A number of drugs are available to help manage and cure neurotic and mentally ill individuals. They are available by prescription on high law level worlds and over the counter on worlds with low levels of 5 or less. There are two major groups of psychoactive drugs, as well as mineral supplements and neurochemicals supplied to correct imbalances.

Tranquilizers: Small doses of the milder forms are quite successful in combating neurotic anxieties, enabling the patient to relax, sleep well, and have balanced emotions. Stronger tranquilizers are used to "chemically restrain" violent patients. Carefully regulated doses control the manic phase of manic-depressive psychosis, and the violent phase of catatonia. They help make patients more receptive to psychotherapy. They are administered in pill form or by injection. A month's supply of mild tranquilizer pills costs Cr5. Injectable tranquilizers in prepackaged disposable single dose units for Cr20. These are commonly found in the medical kits of starship sickbays. They should be considered a temporary measure, used until therapy can get to the root of the problem.

Antidepressants: Antidepressants work to elevate the mood of a depressed individual back to normal. They are used to treat the severely depressed, including manic-depressives in the depressed phase, and catatonics in a stupor. Antidepressants become increasingly effective at advanced technology levels as the electrochemical functions of the brain become increasingly understood. By TL12, long-term drug capsules planted under the skin release timed dosages of antidepressants that enable people who would be otherwise severely mentally ill to resume normal lives. Antidepressants are administered in pill form for Cr20 for a month's supply, or at TL12 by subcutaneous capsules costing Cr500 (including the cost of the simple surgical implant) that last for one year. At TL14, capsules appear costing Cr1,000 that last for five years.

Personality Repair

By TL13, psychiatrists and physiologists are able to determine that severe forms of mental illness destroy parts or all of the personality. At TL15, psychiatrists are able to electronically record and analyze a person's memories, emotions, and personality. In cases where there is no hope of cure with other methods, the psychiatrist first records the defective personality. Then, the personality is computer-analyzed to detail the specific damaged and destroyed parts. After the analysis is complete, the damaged parts are repaired and destroyed parts replaced with a computer-generated synthetic personality overlay. This overlay is placed in the patient's mind by a combination of drugs, hypnosis, and sleep tapes. This method leaves the patient's memories intact, and occasionally unresolved conflicts arising from these memories can undo the psychiatrist's work.

To successfully repair a patient's personality:
Difficult, Medical, Computer, 1 week (uncertain)

Out of Print Classic Traveller Products From Digest Group Publications

GDW, FASA, Gamelords, Group One,
Judges Guild

We have a new supply of great Classic Traveller products. Time to fill that gap in your collection of early works. Send a SASE for a complete list.

Mint copies are:

\$5.00 products — Any 5 for \$20.00

\$6.00 products — Any 5 for \$25.00

STEP CHARTS

1. Under Stress?

Determine if character is under stress or has suffered a critical loss, suffers from boredom, or is using street drugs.

2. Avoid Mental Illness.

Roll mental illness avoidance task once a week until the character is relieved from stress or boredom, or stops using street drugs. Roll this task only once if and when a character suffers a critical loss.

3a. Task Failure

If mental illness avoidance task fails, the character becomes neurotic. Determine the character's neurosis by rolling 1D on the table below:

Failure/Neurosis

- 1 Depression
- 2 Depression
- 3 Manic-Depressive Disorder
- 4 Obsessive-Compulsive Disorder
- 5 Anxiety
- 6 Anxiety

3b. Extreme Task Failure

If the mental illness avoidance task is an extreme failure, the character becomes psychotic. Determine the character's psychosis by rolling 1D on the table below.

Extreme Failure/Severe Mental Illness

- 1 Paranoia
- 2 Paranoia
- 3 Schizophrenia
- 4 Schizophrenia
- 5 Uncontrollable Anxiety
- 6 Catatonia

4. Effects

Determine the effects of the illness on the character's behavior from the text. Hebephrenia occurs only as a result of long-term untreated schizophrenia. Uncontrollable anxiety can be treated as chronic extreme anxiety that effectively paralyzes the character, preventing any useful activity.

5. Treatment.

Determine appropriate task for treatment, cost, and length of time elapsed. Exceptional failure on treatment tasks means hospitalization for the character until another treatment attempt succeeds. •

SNUB PISTOL, REVOLVER

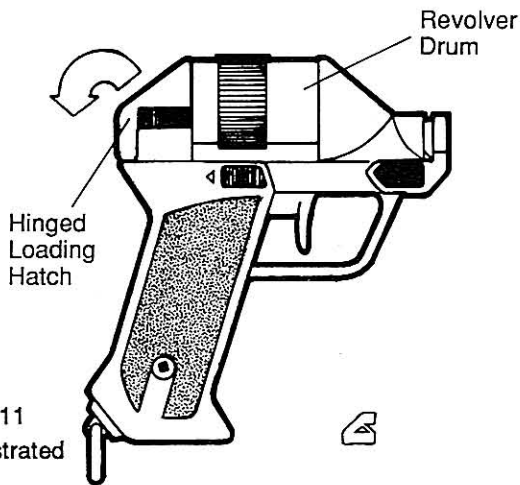

Tech Level 11
version illustrated

NOTES:

EQUIPMENT STATISTICS

TL	Type	Vol	Wt	Price
○ 8	Snub Pistol, Revolver-8	0.2 kl	0.2 kg	Cr150
○ 11	Snub Pistol, Revolver-11	0.14 kl	0.15 kg	Cr200

AMMO STATISTICS

TL	Mag		Sig	Recoil	Danger		
	Size	Round			Space	Weight	Price
○ 8	6 rds	HE	med	low/R	1.5m	0.03 kg	Cr10
	6 rds	HEAP	med	low/R	1.5m	0.04 kg	Cr15
	6 rds	tranq	med	low/R	1.5m	0.10 kg	Cr25
○ 11	6 rds	gas	med	low/R	3.0m	0.20 kg	Cr20
	8 rds	HE	med	low/R	1.5m	0.05 kg	Cr15
	8 rds	HEAP	med	low/R	1.5m	0.06 kg	Cr20
	8 rds	tranq	med	low/R	1.5m	0.15 kg	Cr30
	8 rds	gas	med	low/R	3.0m	0.25 kg	Cr25

med sig=some light/noise generated; easy to spot if fired in darkness;
low recoil=does not cause disorientation if fired in zero-g environment;
/R indicates rapid fire possible.

AMMO USAGE RECORD (OPTIONAL)

Each square represents one round

○ TL8:	<input type="checkbox"/>	<input type="checkbox"/>	<input type="checkbox"/>	<input type="checkbox"/>	<input type="checkbox"/>	<input type="checkbox"/>	<input type="checkbox"/>	<input type="checkbox"/>	<input type="checkbox"/>	<input type="checkbox"/>
○ TL11:	<input type="checkbox"/>	<input type="checkbox"/>	<input type="checkbox"/>	<input type="checkbox"/>	<input type="checkbox"/>	<input type="checkbox"/>	<input type="checkbox"/>	<input type="checkbox"/>	<input type="checkbox"/>	<input type="checkbox"/>

DESCRIPTION

The snub pistol, by virtue of its flexibility and limited range, has made a place for itself in the shipboard environment. Its low recoil also makes it a convenient weapon in zero-G situations.

Four different 10 mm charges are available for the snub pistol: a tranquilizer, a contact-released gas, a high-explosive, and high-explosive armor-piercing (designed to defeat personal armor such as ballistic cloth).

The example shown here uses a barrel which draws its ammunition from the bottom of the revolver drum. The drum is accessed from a hatch at the rear, and the ends of ammo cartridges carry a standard color-coding, for easy identification once loaded.

TASK LIBRARY

Round	Max Range	C*	S*	M*	Hit Dmg
HE	Med (25m)	S/1	R/1	D/1	4
HEAP	Med (25m)	S/6	R/6	D/6	1
tranq†	Med (25m)	S/1	R/1	D/1	1
gas†	Med (25m)	S/-	R/-	D/-	1

*for the range given, hit difficulty/penetration is listed.

†see *Players' Manual*, p.94-5.

To repair a damaged Snub Pistol:
[varies], Mechanical, Dex, [varies]

Referee: Difficulty depends on the damage level of the pistol: use the standard damage and repair guidelines. Time increments for shop repair are as follows:

- superficial damage 2 min
- minor damage 5 min
- major damage 2 hrs
- destroyed..... 4 hrs

For field repair, double the time increment, in addition to other standard increases.

SNUB PISTOL, AUTOMATIC

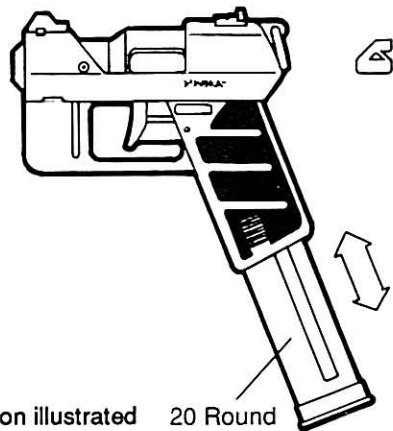

Tech Level 11 version illustrated

20 Round Magazine

NOTES:

EQUIPMENT STATISTICS

TL	Type	Vol	Wt	Price
○ 8	Snub Pistol, Automatic-8	4.0 kl	3.5 kg	Cr600
○ 11	Snub Pistol, Automatic-11	4.0 kl	4.0 kg	Cr900

AMMO STATISTICS

TL	Mag	Size	Round	Sig	Recoil	Danger		
						Space	Weight	Price
○ 8	10 rds	10 rds	HE	med	low/R	1.5m	0.06 kg	Cr20
			HEAP	med	low/R	1.5m	0.08 kg	Cr30
			tranq	med	low/R	1.5m	0.20 kg	Cr50
			gas	med	low/R	3.0m	0.40 kg	Cr40
○ 11	20 rds	20 rds	HE	med	low/R	1.5m	0.10 kg	Cr30
			HEAP	med	low/R	1.5m	0.15 kg	Cr50
			tranq	med	low/R	1.5m	0.35 kg	Cr70
			gas	med	low/R	3.0m	0.75 kg	Cr60

med sig=some light/noise generated; easy to spot if fired in darkness;
 low recoil=does not cause disorientation if fired in zero-g environment;
 /R indicates rapid fire possible.

AMMO USAGE RECORD (OPTIONAL)

Each square represents one round

○ TL8:

○ TL11:

DESCRIPTION

The snub pistol, by virtue of its flexibility and limited range, has made a place for itself in the shipboard environment. Its low recoil also makes it a convenient weapon in zero-G situations.

Four different 10 mm charges are available for the snub pistol: a tranquilizer, a contact-released gas, a high-explosive, and high-explosive armor-piercing (designed to defeat personal armor such as ballistic cloth).

The primary distinction of the automatic version (actually only a semi-automatic) is its use of an extended-round clip inserted into the gun's handle. It loads the same size and variety of ammo as a snub pistol revolver, but is a heavier weapon overall.

Mostly a naval military and paramilitary weapon, the auto snub pistol's increased ammo capacity gives it an advantage.

TASK LIBRARY

Round	Max Range	C*	S*	M*	Hit Dmg
HE	Med (25m)	S/1	R/1	D/1	4
HEAP	Med (25m)	S/6	R/6	D/6	1
tranq†	Med (25m)	S/1	R/1	D/1	1
gas†	Med (25m)	S/-	R/-	D/-	1

*for the range given, hit difficulty/penetration is listed.

†see *Players' Manual*, p.94-5.

To repair a damaged Snub Pistol:
 [varies], Mechanical, Dex, [varies]

Referee: Difficulty depends on the damage level of the pistol: use the standard damage and repair guidelines. Time increments for shop repair are as follows:

- superficial damage 2 min
- minor damage 6 min
- major damage 3 hrs
- destroyed..... 5 hrs

For field repair, double the time increment, in addition to other standard increases.

KINGSLAND

The days on Kingsland are 66 hours long, divided evenly between day and night. The most common herbivore on the planet is the sixgoat, a rugged beast massing about 100 kg. These creatures provide the colonists with meat and skins, but they have the peculiar habit of becoming motionless when they see the color red. Many of the colonists of Kingsland live on ranches, called "stations," to tend these beasts.

There is also some mining on Kingsland, particularly of iron, bauxite, and tantalum.

Hogan, the capital of Kingsland, is also its only major city.

HOGAN

Located in the northern portion of the equatorial belt of Kingsland, Hogan is a city of about 90,000 people. The colony's only spaceport is located nearby, so Hogan serves as a port of entry for anyone arriving on the world. The city also serves as the business and government center of Kingsland. A government mining operation is outside the city, and a steel mill is under construction nearby. The region around the city is otherwise largely agricultural.

QUARRY CORNER

Originally developed as a mining town, Quarry Corner remained in existence after the bauxite mine closed. With a population of 15,000, Quarry Corner serves as a trading center for the many sixgoat stations located in the area. The abandoned mine also serves as a minor tourist attraction, with the most popular nightspot in town being Sheila's Saloon.

The Hogan 500

—by Mark Gelinas



In this adventure, player characters have a chance at excitement in a wild and woolly cross-country race over Kingsland's untamed frontier. Playtesting of this adventure was done by members of the Tidewater Traveller club.

THE RACE ANNOUNCED

The government of Kingsland recently decided to build some interest in the colony and get some creative trailblazing done at the same time. In typical competitive spirit, they decided to sponsor a race, to be run from the town of Hogan to Quarry Corner and back. The distance between the two points is 250 km cross-country, or roughly 500 km by trail. (See the map located later in this adventure.) Using the cross-country distance, the officials decided to call the race the Hogan 500. To enter the race, teams must apply to the Ministry of Transport at Hogan and pay a Lv3,000 entry fee. First prize in the race is Lv100,000. There are also several smaller cash prizes (as the referee sees fit).

RULES OF THE RACE AND OF THE ROAD

Each vehicle entered in the race must have a team of at least two members, a driver and a mechanic. The vehicle must be a stock rock buggy (as detailed in sidebars later in the adventure), and is required to carry a load of one metric ton. The race is to Quarry Corner, where the teams rest overnight, and then back. The team with the shortest total elapsed time wins.

Each team may use any course it chooses, but it is responsible for any property damage done, including damage to crops and herds.

Due to the isolation of communities in the area, there are several rules of the road to be followed. These apply to vehicles in the race as surely as to normal traffic.

First, when vehicles meet along a trail, the group with the fewer vehicles must pull off the road and let the other pass. If a team encounters a disabled vehicle, the team must stop to assist. If a vehicle radios a distress call, any vehicles in the area must go to assist. Any team that violates the rules of the road or makes a false distress call will be disqualified from the race.

GETTING THE PCS INVOLVED

It is possible that, on their own initiative, player characters at Kingsland might want to get involved in the Hogan 500. If not, there are several ways that a referee can get them involved. A company that they work for could ask them to enter the race as its representatives. Or one of the sponsors, particularly one with a vehicle, could hire the PCs as a racing team. If the PCs are troubleshooters, you might convince them to enter the race to monitor the activities of a suspect they are tailing (perhaps the crew of the *Midnight Express*, as will be explained later). Or the race could be presented as an opportunity for the PCs to make money they need to start a project or to get off planet. The referee need only exercise a little imagination, and the PCs should willingly join this race.

REFEREE SYNOPSIS

The primary plot of this adventure is fairly straightforward. The PCs get involved in the race. During the first half of the journey, they travel to Quarry Corner by whatever route they might choose. During the rest period, the team of vehicle #13, the *Midnight Express*, attempts to sabotage the lead vehicles. This will probably include one or more of the player characters' vehicles, given the typical PC advantages. The next day, the return trip becomes more treacherous as sabotaged vehicles begin to break down.

If, however, the sabotage attempts were thwarted, the team of the *Midnight Express* turns to foul play and their Rockwell 12-81 to disable the lead vehicles.

If the referee just runs the adventure as a race, it could end rather soon. It is the events that surround the race which give the adventure its excitement and opportunity for roleplay.

REFEREE STRATEGY

There are several approaches that the referee could use in running this adventure. If there are fewer than four PCs, they should all form the team of a single vehicle. If there are more than four characters, they should form two or more teams. Each team needs at least one driver and one mechanic.

There are two NPCs detailed in this adventure, the crew of the *Midnight Express*. They are the villains of the story. The referee should also add several other NPCs as red herrings. These NPCs could be working for companies that did not sponsor the player characters, or whose sponsorship the PCs did not accept.

If more than one PC team competes in the race, the referee must keep a close tabulation of all contestants' progress in the race, in order to be fair. He should discourage the PCs from playing dirty tricks on one another. He should also give them a fair chance to catch the NPC villains in the act, if they are prepared and alert.

If there is only one team of PCs, the referee can handle the contestants' times in one of two ways. He could simply invent the results, using the progress of NPC teams to push the plot of the adventure. Or he could actually make the task rolls for all of the NPC teams and keep track of the actual time results. In either case, it is to be expected that, given the fact that PCs tend to have higher task modifiers than NPCs, the PCs should win the race, unless they have some sort of catastrophic encounter.

One device that the referee could use to make this scenario more intense is to limit the time that the PCs have to prepare before the race. They must then decide which activities they wish to engage in first: finding sponsors, preparing their vehicles, or participating in pre-race events. The PCs might even have to split into several smaller groups, each pursuing a different goal.

The referee can establish the dates of this first Hogan 500 to fit his own campaign's timeline. In the playtest session, the race's first running took place in the spring of 2301.

TASK LIBRARY

The following tasks are important to this adventure.

Task: To persuade a sponsor to back a team:

Variable. Average of Eloquence and Preparation. 5 minutes.

Referee: For difficulty level, see the list of sponsors. Calculate the Preparation modifier as follows: +1 if one or more team members has Heavy Equipment Operator skill (any level), or Ground Vehicle-2 or higher; +1 if one or more team members has Mechanic skill (any level); +1 if the team paid its own entry fee; +2 if the team expresses its intention to meet the sponsor's conditions, -2 if not; +1 if any team member is from Kingsland; plus any reputation as a driver or mechanic.

Task: To get extra performance from a rock buggy engine (Hazardous):

Difficult. Mechanic. 1 hour.

Referee: If the roll is made exactly, increase performance by 5 percent; if 1 greater, by 10 percent; if 2 greater, by 15 percent. Minor damage will decrease performance by 10 percent; Major by 25 percent; Destroyed makes the engine inoperable.

Task: To drive a rock buggy 100 km:

Variable. Heavy Equipment Operator. Variable.

Referee: Task difficulty is as follows: Simple for Trail or Cultivated; Routine for Hill/Tundra; Routine (but Hazardous) for Wasteland. See the Time Interval Table for base time elapsed. Add 1D10+6 minutes if the team crossed a river or passed through a city, station, or town.

Task: To avoid a mechanical breakdown (Hazardous):

Variable. Mechanic. Instant.

Referee: For Trail or Cultivated terrain, the task difficulty is Simple, Routine for Hill/Tundra or Wasteland.

Driving at maximum speed increases task difficulty by one level.

HEAVY CROSS-COUNTRY TRANSPORT

Specifically designed and built for the colony of Kingsland, the heavy cross-country transport is affectionately known as the "rock buggy", and is capable of crossing the rugged and often rocky terrain of that colony world. Its structure is of steel, to minimize cost and to make field repairs simpler. With its MHD turbine engine tuned to burn alcohol, this vehicle often has an alcohol still in part of its large cargo compartment.

Normal access to the interior of the vehicle is through a floor hatch just behind the driving bubble; a folding ladder fits into the "neck" of the transport. There are also side and back doors built into the body of the vehicle. Most warehouses and the like have loading docks built specifically to the height of these doors.

Each rock buggy holds seats for a driver and three passengers, as well as having two bunks. Additional passengers could ride in the cargo compartment, but they would have a very rough ride. Constant driving over rugged terrain results in frequent breakdowns of the rock buggy in spite of its rugged construction. Consequently, most drivers either have some mechanical training or carry a capable mechanic as part of their crews.

Because a rock buggy represents a considerable investment, communities often form cooperatives to purchase one for their cross-country journeys. Smaller vehicles, usually carried to the community on a rock buggy, serve for local transportation purposes. In this aspect, rock buggies are somewhat like starships, plying routes between far-flung communities as starships ply the lanes between worlds.

ARRIVING AT HOGAN

If the characters come to Kingsland from a different planet, they arrive at Hogan by way of Kingsland's only spaceport. It is also possible that they might already live in Hogan. Or they might be native to some rural region of Kingsland, in which case their journey to Hogan will provide them with some familiarity with the terrain over which the race is to be run.

SEEKING A SPONSOR

If the PCs do not already own a rock buggy, and if they do not have enough funds to purchase one (or they simply do not wish to), they must find a sponsor. This is an excellent opportunity for roleplaying. The referee should not reveal the conditions that a particular sponsor requires until the PCs actually meet with that sponsor's representative. This is especially important if the PCs have a limited amount of time in which to prepare for the race. Time limitations may force them to accept an offer which they might otherwise refuse.

In order to convince a sponsor to sign their characters on as a racing team, the players must roll for the task in the sidebar.

The referee can add to the list of sponsors described later in this adventure as he sees fit. As well, the sponsors' requirements might suggest to the referee some sub-plots, diversions, or special roleplaying opportunities to take advantage of in this adventure. In particular, remember that those who break contracts must suffer the consequences.

PREPARING A VEHICLE

Each rock buggy comes with a standard issue of equipment. The PCs may wish to add more. Also, the PC assigned as the racing team's mechanic might wish to fine tune his vehicle. (Have the player roll for the task in the sidebar.) Obtaining parts for this tune-up can create another subplot for this adventure.

THE SPONSORS

There are a multitude of sponsors available for this first running of the Hogan 500. Those that do not sponsor the PCs will almost certainly find someone else to sponsor. Each of the sponsors is listed with what it desires from a racing team, and what it is willing to offer in exchange. Company slogan and logo are also identified.

Crystal Cola Company: This sponsor is looking for one team only, and it wants its company logo to be displayed on the front of the vehicle's driving bubble. The company is offering Lv1,000 for the privilege. *Slogan:* Clearly Different. *Logo:* Red and white cola can with a large red "C" on a white circle.

Kangaroo Creek Cooperative: The Kangaroo Creek Cooperative will provide a vehicle for its racing team, but it wants that team to drive through Hogan during the race, and to sign a six-month delivery-driving contract. Also, the vehicle remains the property of the cooperative. *Slogan:* Getting there with care! *Logo:* A female kangaroo astride a river. In her pouch is a baby kangaroo holding a package.

Kingsland Metals and Mining: This mining company is offering Lv20,000 for a single racing team. In exchange, it wants the team to place the company logo on both sides of its vehicle, and to carry a corporate official and his prospective client from Hogan to the company mine (about 200 km northwest of Hogan) during the race. *Slogan:* Building blocks of the future. *Logo:* A white circle with blue letters (a "K" over two joined "M"s), the whole superimposed on crossed pickaxes.

Kingsland Rubber Corporation: The Kingsland Rubber Corporation is offering Lv10,000 and a set of tires to up to four teams. In exchange, they want the company's name and slogan on the team's vehicle, and they insist upon the company's tires being used in the race. In addition, if the team takes any place above 4th, they must make three commercials for the company, for which they will receive an additional Lv1,000 per person, per commercial. *Slogan:* Tire us on for size. *Logo:* A smiling king, the base of whose crown is a rubber tire.

Mabuto Imports: This company is looking for one team, to which it is willing to donate Lv15,000. The company's requirements are that its logo be placed on the vehicle's sides and that the team drive through at least two settlements on its way from Hogan to Quarry Corner. (A sixgoat station counts as a settlement.) *Slogan:* Bringing you all the good things of Earth. *Logo:* An illustration of Earth and Kingsland joined by a multicolor banner that bears the company name.

Outback Oil: Outback Oil is willing to give Lv5,000 to any team that will carry the company logo on both sides of the vehicle's cab and use the company's oil during the race. *Slogan:* We're Oil Right. *Logo:* A garish orange oil can with the word "Outback" in a yellowish brown. The company slogan is across the can's bottom.

Red 'Roo Trucking: Red 'Roo is looking for one team, to which it will give Lv30,000. In exchange, the team must carry the company logo on its vehicle's sides, and it must agree either to turn 50 percent of its winnings over to the company or contract to work as company drivers

for six months. *Slogan*: A jump ahead of the competition. *Logo*: A red kangaroo in full jump. He has a bundle on his back.

Royal Tea Corporation: Royal Tea is willing to sponsor any number of racing teams, in the amount of Lv5,000 per team. The corporation's one requirement for giving out this money is that the racing teams must deliver complimentary shipments of Royal Tea to at least three settlements during the race. A station counts as a settlement, for this purpose, but Hogan and Quarry Corner do not. *Slogan*: Taste fit for a king. *Logo*: The company name in decorative gold letters.

Smythe's Sixgoat Station: Smythe is willing to donate Lv10,000 to one team, provided that the team complies with three requirements: (1) The team vehicle must carry the company logo on its sides; (2) During the race, Smythe must be transported from Hogan to his station; and (3) The vehicle must bear the number "23." *Slogan*: Smythe sells the best. *Logo*: Smiling Bill Smythe in full range gear, holding up a steak.

Southern Cross Shipping: This company is seeking a single racing team, to whom it will lend a rock buggy. The company requires that the team pay Lv1,000 to cover insurance for the vehicle and that if the team wins a prize, 10 percent of the winnings go to the company. After the race, the company retains possession of the vehicle. *Slogan*: The star of the shipping industry. *Logo*: A dark blue field with the company's name and the southern cross constellation in white.

Taylor Transport: Mr. Taylor will donate Lv20,000 to a single team, provided that the team's vehicle bears no other logos except his company's. The Taylor Transport logo must be borne on the vehicle's sides. *Slogan*: Taylor made to fit your needs. *Logo*: The name, "Taylor", in large, green letters.

PRE-RACE HOOPLA

Since the Hogan 500 is shaping up to be a big event on Kingsland, a lot of ceremony has begun to develop around it. The local media will want to interview each of the teams involved, asking questions, particularly, about team strategy. Several schools, companies, and civic groups will want teams to appear as special guests at their events. The biggest event before the race, however, is a banquet to be held for all of the teams the night before the race. The referee can use this and other events to pass on to the players information about the region and different route options. He can also use the events to familiarize the PCs with some of their competition.

THE RACE BEGINS

The day of the race will finally arrive, perhaps with some midnight oil being burned to prepare the vehicles. To begin the race, all of the vehicles will be lined up at the starting line, which is at the southern end of Hogan. After the race starts, all of the contestants are on their own. To head due north, or to get on any of the trails, the vehicles must travel through the city. To leave the area any other way will require travelling on paths through cultivated regions. The players should remember that their characters' sponsor(s) may dictate part of the route travelled.

CONDUCTING THE RACE

The actual mechanics of refereeing the race itself involve nothing more than a series of task rolls. However, the referee should not allow the scenario to devolve into a dice-rolling session. The referee needs a means of adjudicating random events, and dice serve that end, but to maintain player interest, he should mingle encounters and descriptions with those rolls.

Each driver should have to conduct a driving task roll for each 100 km travelled in the same type of terrain. If a vehicle does not cross a complete hex, count the distance travelled as 50 km. To determine the time interval for those 50 km, simply divide the time interval for 100 km of that terrain by two. For example, the distance from Hogan to the edge of the next hex just north of it counts as 50 km. (The reduced distance is necessary because the terrain changes from cultivated to wasteland at that point.) With the exception of the fact that the time interval is halved, task rolls for 50km segments of terrain are performed exactly like task rolls for 100km segments.

Because of the rugged nature of the terrain and the fact that racing teams will be pushing their rock buggies for the best possible speeds, there is an ever-present possibility that a rock buggy will break down. To simulate this, each team's mechanic should make his task rolls to avoid a mechanical breakdown at the same intervals as the driver makes his rolls for speed.

Note that teams travelling on the trail move about twice as fast as those travelling cross-country. Therefore, the referee may have task rolls conducted for two separate 100km distances on the trail for every one task roll made by cross-country teams.

Also, every time a team begins a new stretch of terrain, the referee should roll for an encounter. There are two encounter tables included in this adventure, one for teams travelling along the trail, and one for those travelling cross-country. The referee can use these tables, develop his own, or use a combination of both.

Driving a rock buggy usually requires the skill of Heavy Equipment Operator (see *Aurora Sourcebook* for details). A substitute skill is Ground Vehicle Operation, but it works at one level lower when operating a rock buggy. Persons with Ground Vehicle-0 should not attempt to drive a rock buggy. The rock buggy is a very useful vehicle on Kingsland, but it is seldom seen beyond that colony.

Type: Wheeled heavy cross-country vehicle *Crew*: 1 (Driver) *Weight*: 13,700 kg *Armor*: *Suspension*: 0.3 *All Faces*: 0.25 *Signature*: 10 *Evasion*: 0 *Cargo*: 3 passengers and 6,300 kg *Max Speed*: 115 kph *Cruising Speed*: 85 kph *Combat Movement*: 240 m *Off-Road Mobility*: Quartered *Power Plant*: 2.4 Mw MHD turbine, tuned for alcohol *Fuel Capacity*: 5,280 kg *Fuel Consumption*: 220 kg/hr *Endurance*: 24 hrs *Price*: Lv39,623.

STANDARD EQUIPMENT

Rock buggies are sold with the following standard equipment: vehicle maintenance tools, excavation tools, medkit, vehicle communicator, power winch (55 kg, Lv275, 50 m cable, see the *Ground Vehicle Guide* for more details), tire patch kit (5 kg, Lv20, fast-acting RTV rubber in a dispenser), air pump (10 kg, Lv125, air compressor powerable by vehicle electrical system), heavy-duty jack and wheel chocks (20 kg, Lv236)

"DANGEROUS" DAN MUELLER

"Dangerous" Dan Mueller is the driver of the *Midnight Express*. Born in Tanstaaff on Aurore to American parents, Dan remained on that world for a while as a homesteader. He was often a bully as a youngster, and it was during this time that he gained his nickname, "Dangerous Dan." Taking it as a compliment, Dan carried the name with him into adulthood.

When the Kafer war reached Aurore, Dan wanted nothing to do with it. To avoid the war, he moved to the American Arm, where he got involved in smuggling. His partner and closest associate is Mike Jensen (see the next sidebar). Dan is 31 years old, and is an Elite NPC.

NPC Motivation Results:
Diamond Jack: Dan is a coward, but uses a lot of boasting and bravado to hide that fact. *Diamond Ten:* Dan wants to earn more money the quick and easy way. He will cheat and possibly betray friends to gain it.

Attributes: *Size:* 13
Strength: 17 *Dexterity:* 9
Endurance: 11
Determination: 12
Intelligence: 10 *Eloquence:* 5
Education: 8. *Skills:* Heavy Equipment Operator-3, Combat Rifleman-2, Survival-2, Mechanic-2, Sidearm-2, Streetwise-2, Stealth-2, Melee-1, First Aid-1, Forgery-1, and Computer-0. *Equipment:* Rockwell 12-81 Magnum, Traylor Model 57, inertial armor vest, driving helmet (treat as steel helmet).

A NIGHT AT QUARRY CORNER

Eventually, all the racing teams should arrive at Quarry Corner. Those who suffered severe problems that delayed them in the first day should not count themselves out of the race. It is possible that the lead vehicles might have similar problems during the second day. At any rate, the teams will have about a 30-hour layover at Quarry Corner until the next Kingsland day begins. This gives them some time to check over their vehicles, rest, and enjoy some recreation. That favorite pastime of roleplayers, the bar fight, would fit into this layover time nicely. Also, the crew of the *Midnight Express* will try to conduct its nefarious activities during this period of time. See the sidebars for descriptions of the *Midnight Express* crew members.

THE SECOND LEG

About three hours after sunrise on the second day, the race resumes. All vehicles will be started together again, at a line on the southern edge of Quarry Corner. Remember that it is total elapsed time that counts, not merely who crosses the finish line first. The teams are free to return by the same route they took in the first leg or to try a different route. The referee should run this half of the race much the same as the first, adjusting times and events as necessary to heighten interest.

AT THE FINISH LINE

Eventually, all of the teams will find their way back to Hogan. Some may have to ride the trip out in another vehicle, if theirs could not finish. The probability that a PC team will finish first is high. And even if the PCs miss the Lv100,000 first prize, odds are that they will receive second- or third-place prizes.

But winning (or placing, or showing) in the Hogan 500 brings more than just a monetary reward. Winners will also certainly gain renown. Members of the first-place team should certainly get a couple of points, and members of second- and third-place teams should also receive at least one renown point. Many companies, whether or not they sponsored a team in the race, will want the winners to endorse their products. The government will most likely vie for the PCs' services as well.

AFTER THE RACE

Regardless of the outcome of the race, new adventure possibilities will open up for the PCs afterward. Remember that several of the sponsors require follow-up contracts. It is possible that the adventurers might decide to try their hands at taming some of the wilderness themselves. If the PCs were residents of Kingsland, they can return to their jobs with a little more prestige. Of course, there will have been new friends, and new enemies, made during the race. Who knows when they might cross the PCs path again. If the referee follows up on some of these threads of plot, the adventure need not end when the checkered flag falls.

Out of Print, Classic Traveller Boxed Game Set Special!

From Digest Group Publications

One Mint Azhanti Available for \$50.00

OR

Any 3 Boxed Games Listed Below for \$50.00
or Singly for the Prices Listed

(Qty's. avail. shown) 1 - Imperium \$25, 7 - Doublestar \$20,
6 - Belter \$20, 1 - Bloodtree Reb. \$20,
5 - Triplanetary \$15, 10 - Fifth Frontier War \$20,
2 - Invasion Earth \$20

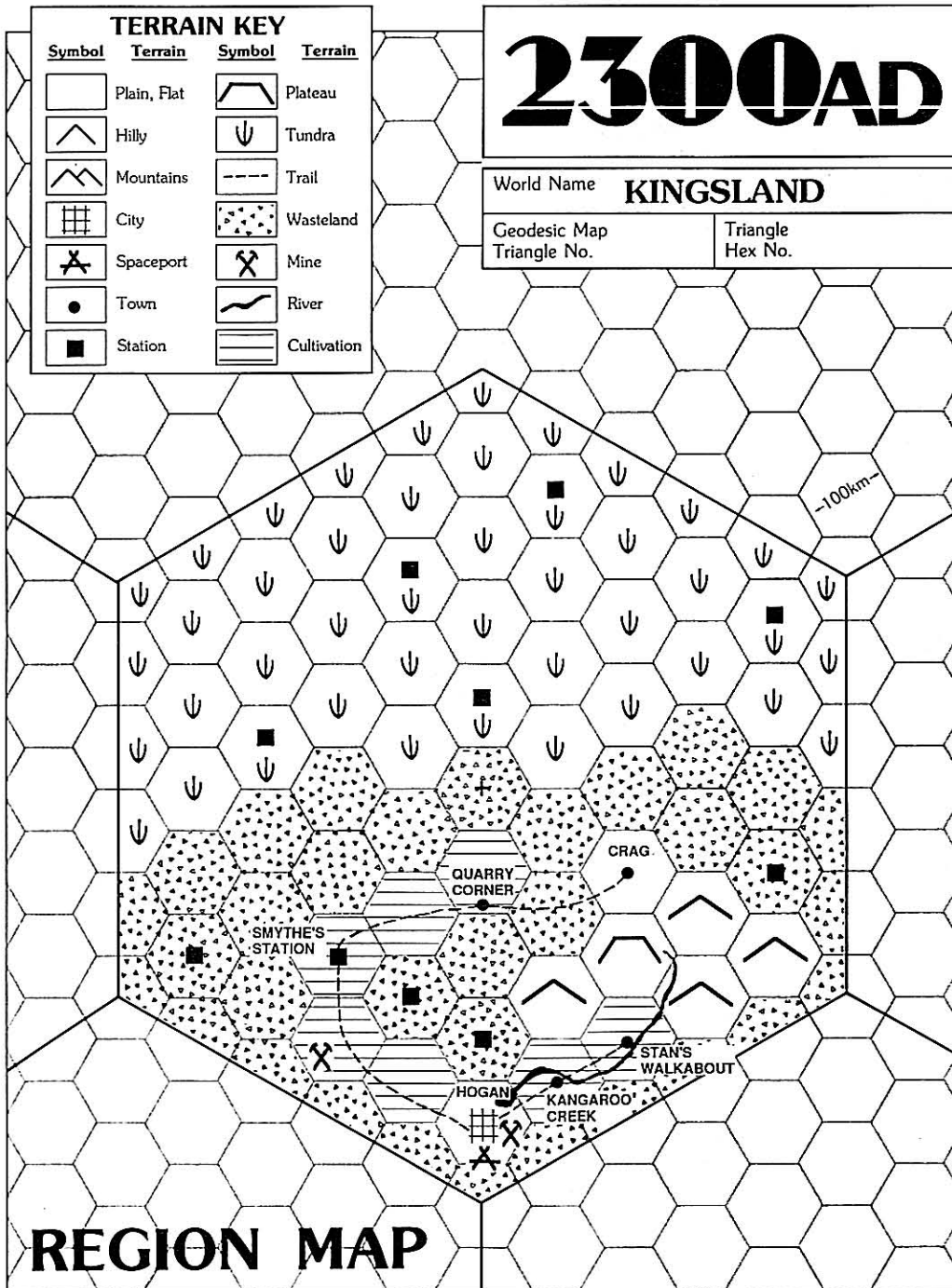

"MARAUDER" MIKE JENSEN

"Marauder" Mike Jensen is the mechanic for the *Midnight Express*. Mike Jensen is the son of a hardworking Australian colonist on Botany Bay. As Mike grew up, he became a restless young man, wanting money, but not making enough as a colonist. After reaching adulthood, he remained on the farm because of loyalty to his parents, but when they died in an accident, he felt no further restraints.

After having a difficult time making money through legitimate work, Mike fell into smuggling. On his first job, he made a mistake that almost cost him his life. Dan Mueller saved Mike because he saw potential in the young man. Mike has remained his partner ever since that time, working with Dan as a smuggler. Mike is 29 years old and is a Veteran NPC.

NPC Motivation Results:
Diamond 7: Mike wants money and will seldom do anything unless there is a fast live to be made at it.
Heart 8: A deep sense of loyalty often serves as motivation for Mike's actions. Loyalty to his parents kept him on Botany Bay. Now loyalty to Dan keeps Mike working with him.

Attributes: *Size:* 8
Strength: 8 *Dexterity:* 12
Endurance: 7 *Determination:* 11 *Intelligence:* 12 *Eloquence:* 6 *Education:* 13.
Skills: Combat Rifleman-2, Sidearm-2, Mechanic-2, Melee-2, Ground Vehicle-2, Stealth-2, Survival-2, First Aid-1, Swimming-1, Tracking-1, Pilot-1, Sea Vehicle-0, P-Suit-0, Forgery-0, and Computer-0. **Equipment:** Knife, Hancock 923 Enforcer, SG-77, full-body inertial armor, driving helmet (treat as steel helmet). Ten concealment grenades in his tool kit.

HOW TO USE THE TABLES

The referee will use the tables on this page quite often in running the Hogan 500. The first table is a base time interval table for each 100 km a team travels. To use this table, simply cross reference the speed of the team's vehicle (listed on the table in terms of percent of normal maximum speed) with the type of terrain being travelled through. The result is the base time for the driving task roll given earlier in the adventure. Actual times to travel 100 km will be approximately 10 times this base, depending, of course, upon the driver's skill level and a 3D6 time roll.

The next two tables are of random encounters for the referee to roll up as the PCs run in the race. Each time the team begins a new 100km stretch of terrain, the referee should roll 2D6 to determine if they have an encounter. The number in parentheses next to each table's title is the chance, on a 2D6 roll, of the group having an encounter. If an encounter is called for, roll 1D6 to determine exactly what that encounter is. Note that encounters 5 and 6 on both tables call for a repair task roll. Use the *Damage and Repair* table on page 43 of the *2300 AD Director's Guide* to determine the task difficulty (remembering to increase the difficulty level by one for field repairs), and using *Mechanic* as the applicable skill. Assume that necessary tools and spare parts are readily available. The time portion of the task statement is 1 minute for Superficial damage, or 2 minutes for Minor.

TIME INTERVAL TABLE
(Base time for task to travel 100 km)

Terrain Type	Speed					
	75%	90%	100%	105%	110%	125%
Trail	29 min	24 min	22 min	21 min	20 min	19 min
Cultivated	36 min	30 min	27 min	26 min	25 min	24 min
Hills/Tundra	44 min	36 min	33 min	31 min	30 min	28 min
Wasteland	52 min	44 min	39 min	37 min	36 min	34 min

Notes:

1. The 75% column represents a vehicle's normal cruising speed, but it may be a vehicle's maximum speed if the team's mechanic botched a task roll to improve performance.
2. The 100% column represents a vehicle's normal maximum speed. Speeds higher than this are possible only by improving engine performance.
3. Regardless of how well a driver does on the time portion of his driving task roll, there are certain minimum times required to cover 100 km of the various terrain types. Those minimums are (in minutes): 190 for Trail, 237 for Cultivated, 285 for Hills/Tundra, and 342 for Wasteland.

TRAIL ENCOUNTERS (7+)

1D6 Encounter	Description
1 Convoy	1D10 vehicles, which take 1D6+3 minutes to pass.
2 Convoy	1D10 vehicles, which take 1D6+3 minutes to pass.
3 Herd Crossing	A herd of sixgoats blocks the road for 1D6+4 minutes.
4 Herd Crossing	A herd of sixgoats blocks the road for 1D6+4 minutes.
5 Disabled Vehicle	A disabled vehicle is on the side of the trail. Roll for a Mishap (see 2300AD rules) to determine the extent of the damage. If Major, the crew will need to go to the next settlement. On any other damage result, the PCs' mechanic can try to conduct field repairs. (See the sidebar for details.)
6 Minor Problem	A minor mechanical problem has occurred on the PCs' vehicle. Roll 1D10-1 on the Mishap table, treating a result of 1 as a 2. The PCs' mechanic can try to conduct field repairs. (See the sidebar for details.)

Note: When sixgoats are encountered, note their peculiarity as explained in the first sidebar, and check the color of any logos displayed on the vehicles involved. Time increments begin only after characters have figured out the problem and hidden any red patches.

CROSS-COUNTRY ENCOUNTERS (8+)

1D6 Encounter	Description
1 Burnt Vehicle	The team comes across a burnt vehicle. If they stop to investigate, two bandits will attack them. After this encounter has happened once, treat further rolls as burnt vehicles without bandits.
2 Sixgoat Herd	The team encounters a sixgoat herd. It will take 1D6+2 minutes for the team to work its way around the beasts.
3 Rock Rat Attack	Several sixgoat herders are fighting off a swarm of rock rats attacking their herd. If the team helps, it will lose 1D6+4 minutes of travel time, but the herders then direct them to a shortcut afterward, saving 3D6 minutes. Treat further rolls of 3 as a 2.
4 Boulder Field	The team encounters a field in which the boulders are unusually large. It will take 1D6+6 minutes for the team to work its way around the field. If the team members decide to travel through the field, have them make an additional driving task roll and mechanic task roll.
5 Disabled Vehicle	A disabled vehicle is on the side of the trail. Roll for a Mishap (see 2300AD rules) to determine the extent of the damage. If Major, the crew will need to go to the next settlement. On any other damage result, the PCs' mechanic can try to conduct field repairs. (See the sidebar for details.) Also, roll 1D6; on a 4+ the vehicle belongs to a competitor.
6 Minor Problem	A minor mechanical problem has occurred on the PCs' vehicle. Roll 1D10-1 on the Mishap table, treating a result of 1 as a 2. The PCs' mechanic can try to conduct field repairs. (See the sidebar for details.)

NEW for MegaTraveller!!!

Detailed Starship Deck Plans In 25mm



#1021 - The 400-ton Laboratory Ship orbits the uncharted world, on a mission cloaked in secrecy. Your assignment to this project was a dream come true; research was proceeding at a rapid pace and several major discoveries had been made. Every goal had been met or exceeded . . . until some exotic specimens aboard the ship disappeared. Now your shipmates are disappearing one by one, victims of the elusive foe. The ships drives are damaged and the life support systems are slowly failing. The dream has become a nightmare as you search for the key to your survival.

\$11.95

SEEKER

P.O. Box 337, Finley, ND, 58230
Available at your local hobby shop or direct from SEEKER.
Please add \$2.50 for shipping. Overseas add \$5 U.S. Order by
Phone (805)-466-3360. Send for your FREE catalog today.



v2

NEW for 2300AD!!!

Detailed Starship Deck Plans In 25mm

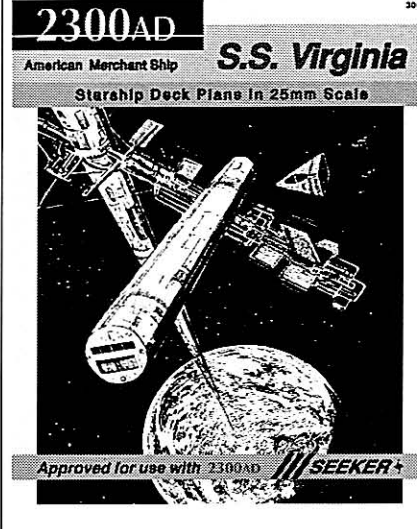

#3001 - The Virginia-class schooner is a small but capable cargo vessel, designed to transport massive cargoes to distant planets. Defense was not a design consideration however, a glaring omission when a formation of Kafer Golf-class fighters is screaming toward your ship. The escorting ships are doing their best, but you may become the next target. The beanstalk is gone, only half of the re-entry cargo containers have been launched, and the people down on the planet desperately need those supplies. Your options are limited, but you never back down from a challenge. You've only a few moments to make your decision. Confront the challenges of the 2300 universe aboard your Virginia-class starship.

\$11.95

SEEKER

P.O. Box 337, Finley, ND, 58230
Available at your local hobby shop or direct from SEEKER.
Please add \$2.50 for shipping. Overseas add \$5 U.S. Order by
Phone (805)-466-3360. Send for your FREE catalog today.



v2

Coming in the Next Issue...

For Traveller—

Clan and Pride — Classic Traveller Adventure

Our adventurers are not the only ones with something to hide...

Dangerous Passage

Megatraveller solo adventure by Nancy Parker

K'Kree Passage

Captain Darius Drake knew they'd be trouble from the moment he saw them...

Fiction by William H. Keith

For 2300 AD—

Newmark's Scouts

Look for issue #18 of the *Travellers' Digest!*

MEGATRAVELLER™

REFEREE'S COMPANION

Referee's Companion expands and enhances the **MegaTraveller** rules for a more in-depth campaign. It contains new rules for large-scale combat (with sample units) for the ground campaigns which are tying up worlds across the frontiers. Also included are rules for in-system starship operations, covering concepts about inter-

face and interplanetary travel. Essays on technology and research for **MegaTraveller** are accompanied by rules to incorporate robots into a campaign situation. The enormous megacorporations, with their tremendous influence and financial resources, are presented for **MegaTraveller** in **Referee's Companion**; their ability to cope

with and influence the Rebellion can easily generate dozens of thrilling adventures. The alien races are also discussed in detail, allowing both referees and players to deal with them in a **MegaTraveller** campaign. **Referee's Companion** is a must for the serious megatraveller. 96 pages. \$10.00. Stock No. 0215. ISBN 0-943580-71-4.

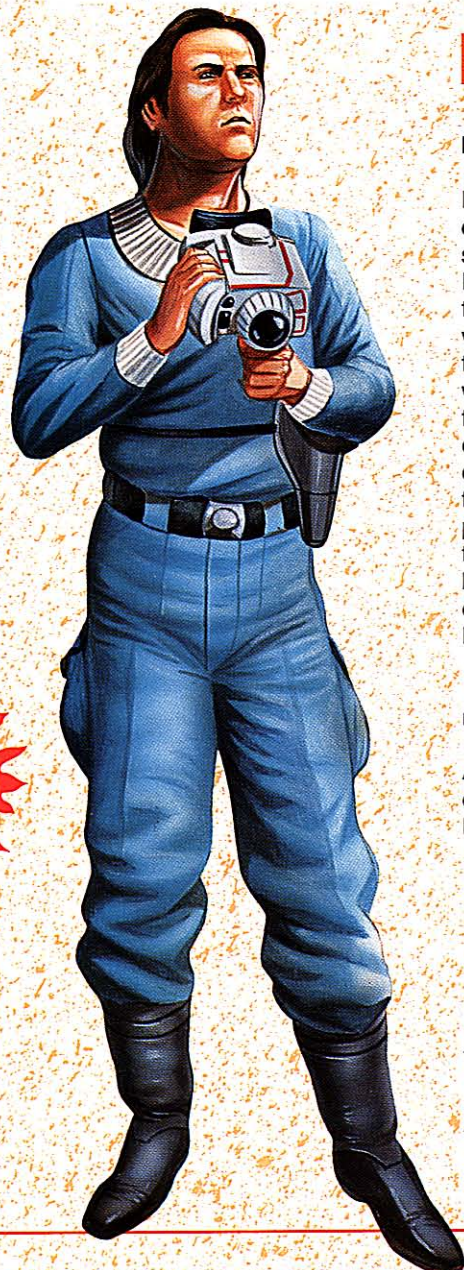

MegaTraveller

With the death of the Emperor, the Imperium has been shattered into dozens of factions and warring states, all vying for the coveted Iridium Throne. **MegaTraveller** is the science-fiction role-playing game which brings you the adventures in this shattered Imperium—become a warrior, renegade, or mercenary fighting for your life and the cause of Lucan, Margaret, Strephon, or a dozen other warring principalities. The realms of starfaring civilized people hang tenuously in the balance as the battles for the Imperium have begun—experience it at your own risk! \$20.00 Stock No. 0210. ISBN 0-943580-49-8.

Also available for **MegaTraveller**:

● **Rebellion Sourcebook.** Choose sides among the factions which seek to rule the Imperium. 96 pages. \$10.00. Stock No. 0214. ISBN 0-943580-63-3.

Available at your local hobby shop or direct from GDW. Add \$1 for handling. For a free copy of our 1988 catalog write to: GDW, PO Box 1646, Bloomington, IL 61702-1646.



The complete line of GDW games is distributed in England by: Games of Liverpool, 89 Victoria Street, Liverpool L1 6DG; Chris Harvey Games, PO Box 38, Bath Street, Walsall, West Midlands, WS1 3BY; and Virgin Games, 41-43 Standard Road, London NW10 6HF. GDW is proud to have these fine distributors presenting its games in the United Kingdom.

Our 15th Year



PO Box 1646, Bloomington, IL 61702-1646