



DIGEST  
GROUP'S

# The MegaTraveller JOURNAL



*Blair Reynolds*



Official MEGATRAVELLER™ Gaming Resource

# NEW GAME!

Coming  
Summer 1992...

# A.I.<sup>TM</sup>

*roleplaying adventure  
in a techno-fantastic age*

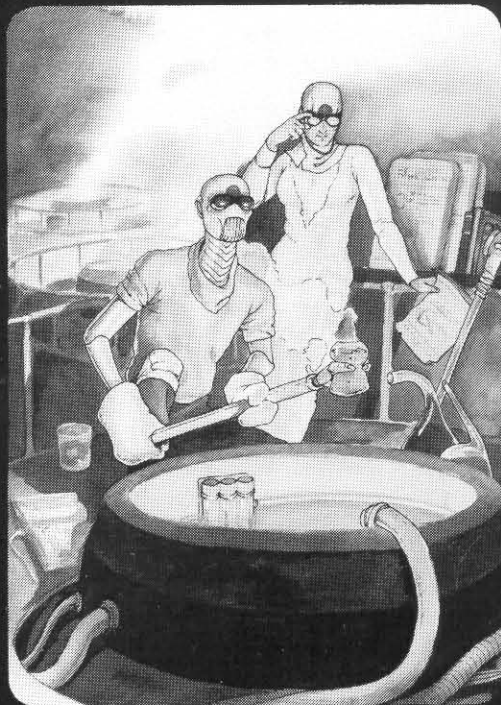

Earth: 1500 years in the future —  
or is it Earth 1500 years in the past?

A massive citadel towers over your village and you tremble at the stories of the strange lifeforms which lurk in the shadowy wilderness that encircles you. For a generous offering, the priest-adept will "resurrect" your tools when they die. The great citadel provides for your basic needs, while you trade for "seeds," seeking to fulfil not only your material needs, but your wants, too. If you can just buy, beg, or borrow the right "nanneez" and the right raw materials, then you can finally grow the devices you'll need to help you on your quest for the ultimate tool: a GENII (Genetically Enhanced Nanotech Intelligent Interface)!

Shaping the decayed future with nanotechnology (molecular-level machinery), machine intelligence, and genetic engineering, A.I. puts you on an alien, future Earth with unlimited adventure possibilities. Remnants of ultra-high technology make the miraculous become reality.

A.I.'s new "fuzzy logic" and object-oriented approach eliminates the mounds of rules and lets you start playing right away.

The basic game includes: 200 pages of background and rules and a fold-out world map of the Alien Earth with area maps of the major citadels. \$25.

A.I. Not technology and magic — but technology AS magic!

 **Digest Group  
Publications**

515 Willow Ave., Woodburn, OR 97071  
Voice or FAX: (503) 981-4752

The publishing date of this issue is **March 1992**. *The MegaTraveller Journal* is published approximately bi-annually by Digest Group Publications, 515 Willow Ave., Woodburn, OR 97071-2109 and is devoted exclusively to **Traveller** and **MegaTraveller**.

Published by Digest Group Publications. All written contents copyright ©1992 Game Designers' Workshop. All Rights Reserved. All art is copyright ©1992 by the individual artists. All rights reserved. Printed in the United States of America. Unless specifically noted otherwise on the page, no part of this magazine may be reproduced in any form or by any means without written permission of the publisher. Portions of this magazine are taken from **Traveller** and **MegaTraveller** materials published by Game Designers' Workshop and are copyright ©1992 by GDW, Inc.

Traveller®, and MegaTraveller™, are trademarks of Game Designers' Workshop. The trademarks are used with permission.

1 2 3 4 5 6 7 8 9 10

Address editorial comments to:

**MTJ Comments**  
**Digest Group Publications**  
515 Willow Ave.  
Woodburn, OR 97071-2109  
U.S.A.

**Editor & Art Director:** Rob Caswell  
**Contributing Editors:** Jay Adan, Joe D. Fugate, Sr., Charles Kalina  
**Technical Editors:** Deb Zeigler, Tom Peters  
**Copy Editors:** Deb Zeigler, Joe D. Fugate, Sr.  
**Production Manager:** Patricia Fugate  
**Text Processing & Production:** Rob Caswell, Patricia Fugate.  
**Playtest Co-ordinator:** Tom Peters

**Publisher:** Joe D. Fugate, Sr.

**Artists inside this issue:**

Blair Reynolds  
Mike Vilardi  
Tom Peters  
Joe D. Fugate, Sr.  
Mike Jackson

**This Issue's Playtesters:**

Carl Burke  
Bob Willis  
Noah Katz  
Charles Kalina  
Fran Braheny

**About the cover:** A group of Scouts, using atmospheric reentry kits, do a practice de-orbit drop into the atmosphere of Atsah. The smaller pod in the background is a slaved unit carrying the genetically modified animal members ("genas") of the party.  
*Painting by Blair Reynolds.*



# The MegaTraveller JOURNAL

## Number Three

<b>Adventure:</b>	Rapid Repo <i>By Greg Videll</i> .....	65
<b>Features:</b>	Worldguide: Vincennes <i>By Charles P. Kalina</i> .....	4
	Megacorporations in the Rebellion Era <i>By Greg Videll and Tom Peters</i> .....	18
	Races of the Domain: The Creduthaar <i>By William H. Keith, Jr.</i> .....	34
	Deneb Dossier: Jeramii Boden <i>By Rob Caswell</i> .....	40
	Sydkai-class Cruiser <i>By George MacLure and Rob Prior</i> .....	44
	Domain of Deneb System Data <i>By Joe D. Fugate, Sr. and Rob Caswell</i> .....	47
	Keith Brothers Interview <i>By Rob Caswell</i> .....	59
	Races of the Domain: The Jonkeereen <i>By James Maliszewski</i> .....	90
<b>Departments:</b>	Helm Report <i>By Rob Caswell</i> .....	2
	Travellers' Cache <i>By Rob Prior and Howard Leidner</i> .....	27
	DIS Newsbriefs <i>By Greg Videll and James Maliszewski</i> .....	97
	MegaTraveller Q&A <i>By Joe D. Fugate, Sr. and Rob Caswell</i> .....	99

Digest Group Publications products are available through these overseas distributors:

**Canada:** Andromeda Publications, 2113 Dundas St. West, Toronto, ON M6R 1X1, Canada; TD Imports, 47 Stradbroke Pl. S.W., Calgary, AB T3H 2A3, Canada; TD Imports East, 20 Parkhill Rd. East, Cambridge, ON N1R 1P2, Canada; Welcan Distributors, 406-12914 Anvil Way, Surrey, BC V3W 8E7, Canada.

**England:** Chris Harvey Games, c/o Matthew Harvey & Co. Ltd., P.O. 38, Bath Street, Walsall, West Midlands, WS1 3BY, England; Esdevium Games, 2, Morley, Surrey GU9 8LY, England; Hobbygames Ltd., Unit S4, Rudford Industrial Estate, Ford Airfield, Nr. Arundel, West Sussex, BN18 0BD, England.

**Australia:** The Jedko Games Co. Pty. Ltd., 134 Cochranes Rd., P.O. Box 164, Moorabin, Victoria 3189, Australia.

**Germany:** Fantastic Shop, Konkordiastraße.61, Postfach: 21 01 65, 4000 Düsseldorf 1, Federal Republic of Germany.

**Spain:** Central de Jocs, C/Provença 85, 08029 Barcelona, Spain; Jocs & Games, C/Muntaner, 193, 08036 Barcelona, Spain.

# HELM REPORT

DGP EDITORIAL NEWS AND INFORMATION: *From the Desk of Rob Caswell*

"Gosh, two pages of Helm Report!? Are you guys just trying to fill space?", you say (you did — I heard you...). Well, to be perfectly honest, "no". It's just that we have two pages worth of things to say (some "soap boxing" and some news).

That said, on with the show. Welcome to our first double-sized (104-page) issue of the *MegaTraveller Journal*! As it's come together, this issue has turned out to be a real exciting potpourri of **MegaTraveller** articles. We are no longer keeping a solid theme orientation (like numbers one and two had), but we have still focussed on the Domain of Deneb region.

## TRAVELLING BEYOND THE REBELLION

This will be my final issue as editor of *The MegaTraveller Journal*. I'm leaving the post to continue to pursue my freelance career, in the gaming industry and elsewhere. However, I'm glad I had the opportunity to do these three issues, and I hope you've enjoyed them, too.

There are several things I tried to do, in this publication. Perhaps one of the most important was to supply meaningful **Traveller** support material. With the Rebellion background, it's all-too-easy to get yourself mired in macro-political examinations of which faction's doing what to whom, etc. There's nothing wrong with that approach, if you enjoy it. You have the freedom to use your game material in whatever way you enjoy most! And for those of you who "play" solo-**Traveller**, this may be your only outlet for the game. But the "macro-political" approach is not really role-playing.

So where does the *Journal* go from here? Well, for starters, Joe Fugate and Deb Zeigler will be taking over the editorial reins. And next issue will be a very special one! Instead of our usual variety of unrelated features, *Journal #4* will be 104-pages of cohesive background and adventure material — really, a campaign sourcebook in its own right.

The adventure is *Lords of Thunder* and is set in the Gateway sector, outside the events of the Rebellion (for more background information, read *The Keith Brothers' Interview*, elsewhere in this issue).

This material will set the stage for gaming in this removed region of space. From details on the scattered, small interstellar states to full sector maps and data, this issue will be rich in new and informative background on a previously undetailed area of the **Traveller** universe.

Besides it's complement of tiny states, the Trailing side of the Gateway sector borders elements of The Two Thousand Worlds: home to the conservative, militant K'kree. As may be expected, they play a significant role in the *Lords of Thunder* adventure.

Millennia ago, the K'kree race (*strict vegetarians*) were at war with a carnivorous race legends call the G'naak. The conflict finally ended with a K'kree victory, as they exterminated the species which so threatened their way of life. Now, in 1122, disturbing reports have been received by the K'kree. The G'naak are back! For the K'kree, this can only mean one thing: the war's not over yet!

I hope you'll be with us next issue for what will easily prove to be our most exciting *Journal* adventure to date!

## SEE SCENIC KUSYU

For those of you who haven't seen it yet, *The MegaTraveller Alien Vol.2: Solomani & Aslan* is now available. Unfortunately, we've completely sold out in our warehouse! However, many stores probably still have copies on their shelves, if you haven't yet picked one up.

It's turned out to be our most beautiful book ever, just loaded with great illustrations by Blair Reynolds and Mike Vilardi! And, in keeping with the *MegaTraveller Alien* series concept, it's full of information, both old and new, which puts you into the heart of the cultures and updates the races to the **MegaTraveller** time period. If you liked *Vilani & Vargr*, you'll love this book.

## PUBLISHING PERILS

Gosh, were that we were perfect... Well, here's the latest in our continuing series of errata. The *Arabella von Ericsson Deneb Dossier* in the previous issue should have included Michael Hebert as the *primary* author. Mike Vilardi (not me) did the illustration accompanying the piece. Sorry, Mike(s).

*Solomani & Aslan* was not (unfortunately) bug-free, either. There were some illustration misplacements. The pictures of the Aslan Courier (page 93) and the Aslan Escort (page 94) were swapped. The illustrations of the Grand Conclave (page 92) and a pair of Aslan storytelling on an interstellar journey (page 64). And lastly, the illustrations of Solomani Chairman Desmond Trinoch (shown on page 33) should trade places with the Solomani investigative journalist (page 12).

Beyond that, let me make some clarifications. The two women on page 9 are Wuans. Page 84 shows an Aslan sitting before a very ornate Shrine of Heroes. Finally, the man shown in the Dark Nebula Library Data (page 99) is Kimson Earle, while the aliens shown on the next page are the Ormine.

Left out of *Solomani & Aslan's* credits was Deb Zeigler, who did some last minute revisions to the Aslan History section.

## TIRED OF THE BUGS?

The 3rd edition of the **MegaTraveller** basic rules set (GDW 0210) is currently available from GDW. This edition corrects many the errors found in the original release. The edition number is not marked anywhere on the box, but it is the one currently being supplied to distributors by GDW. If you'd like to be sure you get this edition, your safest bet is to order it direct from GDW.

## TRAVELLER: THE NEXT GENERATION

GDW has announced their intentions to publish a revised rules set for the game, predicted to be in stores around this November. This incarnation of the rules will carry the title of *Traveller: The New Era*, leaving **MegaTraveller** to be a rules set anchored to the Rebellion period.

So what period *is* the New Era set it, you ask? The New Era will again fast forward the game's clock — this time, about eighty years, to 1200. Due to a catastrophic event, the society

of the Shattered Imperium completely collapsed. Certain areas still retain some semblance of civilization, but on the whole, it seems a new fall of night.

If this all sounds like “just another dark future game”, don’t be alarmed — it’s not. GDW is very sensitive to that. **Traveller** has always carried a lighter, more optimistic feel than, say, something in the cyberpunk genre. GDW has no intention of abandoning that tradition.

*Traveller: The New Era* is a game of rebuilding. Of rediscovering the glory of the Third Imperium. It’s a struggle towards light, rather than a descent into greater darkness. And without the formalization of a great, omnipresent interstellar state, the New Era delivers a more open, frontier feel to the gaming environment. All these elements come together to offer a background which is not only rife with adventure possibilities, but makes adventures easier to generate and run, as well.

The New Era rules will be changed from that of **MegaTraveller**. The game will use GDW’s time-tested house rules set, making it compatible with the **Dark Conspiracy** and **Twilight:2000** role-playing games. Of course, there will necessarily be some differences, due to **Traveller’s** unique setting. Areas like starship design and world generation will be revised, and in many cases, simplified. However, even with the streamlined rules, the final results will yield the same level of useful detail as the **MegaTraveller** rules.

The writing chores for this **Traveller** revision will be spearheaded by GDW designer David Nilsen. A recent addition to GDW’s staff, David is a long-time **Traveller** player. In addition, he’s been a freelance contributor to both GDW and DGP, in support of the **Traveller/MegaTraveller** and **2300 A.D.** lines.

### CHEAP THRILLS

In support of **MegaTraveller** and their other role-playing game lines, GDW has created a new adventure/support product format to deliver more material at an affordable price. Calling them “folios”, these products will be 16-page-long booklets with full-color, trifold covers. They will sell for \$4.50.

Using this format, GDW should be able to make their support releases more frequent, giving you a steady supply of new **Traveller** products to keep an eye out for. But this doesn’t mean they’ll be abandoning their more traditional product format. These smaller books will just help pick up the slack between the regular book releases.

The first **Traveller**-related folio will be *Assignment: Vigilante*. It’s set in the time period of GDW’s recent *Hard Times* product. This book should be available at the same time as this issue — if not a little before.

### FREEDOM OF CHOICE

At conventions, we tend to listen to a lot of gamers complain that they don’t like the **MegaTraveller** rules for “such and such”, and “why don’t you just go back to the rules in old Book X”? Well, as a **Traveller** player, you can use whichever rules set suits you. We’re not looking over your shoulder with threatening glares. Heck, if you want to play GURPS **MegaTraveller**, have a blast! That’s the whole point of RPGs — to have a good time.

Providing support for each and every incarnation of **Traveller’s** rules systems would be too time consuming, space-intensive, and confusing. The rules set we’ve supported is that which we feel currently sits on the cutting edge of game mechanics. It is the

system which we work with and try to evolve to even higher levels of detail, accuracy, and playability. But we also listen to feedback and try to steer things in the directions that you, the players, want the game mechanics to go.

If it makes you feel any better, even the professionals who bring you **MegaTraveller** material differ as to which rules set is best. It all boils down to personal preference and gaming styles. So, the bottom line here is this: don’t ever let yourself feel hampered by the latest rules set while playing. Whatever it takes, whatever rules you need to use - *have fun!* That’s what it’s all about.

### PRIZE CRITICS

The winners of *Journal #2’s* Survey Sweepstakes, are: Clay Bush (Limon, CO), Neil Taylor (Cambridge, England), and Robert Emerson, (Elkton, MD). Each winner will receive a copy of *The MegaTraveller Alien Volume II: Solomani and Aslan*. Congrats!

### USER FRIENDLY PHONES — AT LAST!

Many of you will be glad to hear that we’ve installed a new phone message system at the company offices. Our old answering machine had a less-than-perfect record of operation. Those of you who’ve tried to call in the past may be painfully aware of these bugs. Sorry it took us so long to remedy the situation, but our fix has done more than just make our answering machine effective.

The Digest Group Offices now employ a menu-driven message system. Leaving a plain old vanilla voice message is only one of the options now available to you. Our message system can give you product release updates, information about what we have in stock in the warehouse, and allows you to *effectively* place orders. So, for the latest product info, or to order you favorite DGP product using your credit card, just call: (503) 981-4752.

### A.I. UPDATE

Not unexpectedly, our primary focus for this year is on our new game, **A.I.: Role-Playing in a Technofantastic Future**. Unfortunately, we missed our February release date due to a hard disk crash, in which we lost 50% of all the **A.I.** work done, to date. This has pushed the game’s release date back to early summer of this year.

However, on the positive side, we’ve sent out the first **A.I.** playtest packets and have received some very useful feedback. The response, from those who have seen what we’re doing with the game, has been overwhelmingly positive. Most people are just thrilled that **A.I.** is something really *different* — not just a game jumping on an existing bandwagon.

For those of you who aren’t already aware of the game’s background, it’s set thousands of years in Earth’s future. Society is in the process of rebuilding, after its fall from the Pinnacle. However, the technologies from that earlier golden age continue to shape the world of **A.I.** Areas like artificially intelligent machines and genetic engineering have redefined and reshaped what man thinks of as sentient life. The science of nanotechnology (molecular-level robotics) has redefined the way the people of Earth work, play, and interact with their environment.

All these aspects, and many more, contribute to making **A.I.’s** background one of the freshest available to gamers in years! Besides the basic set, DGP is planning at least one more **A.I.** product release for this year. Look in the next issue of the Journal for more details. •

*ROB*

# VINCENNES

WORLDGUIDE: By Charles P. Kalina

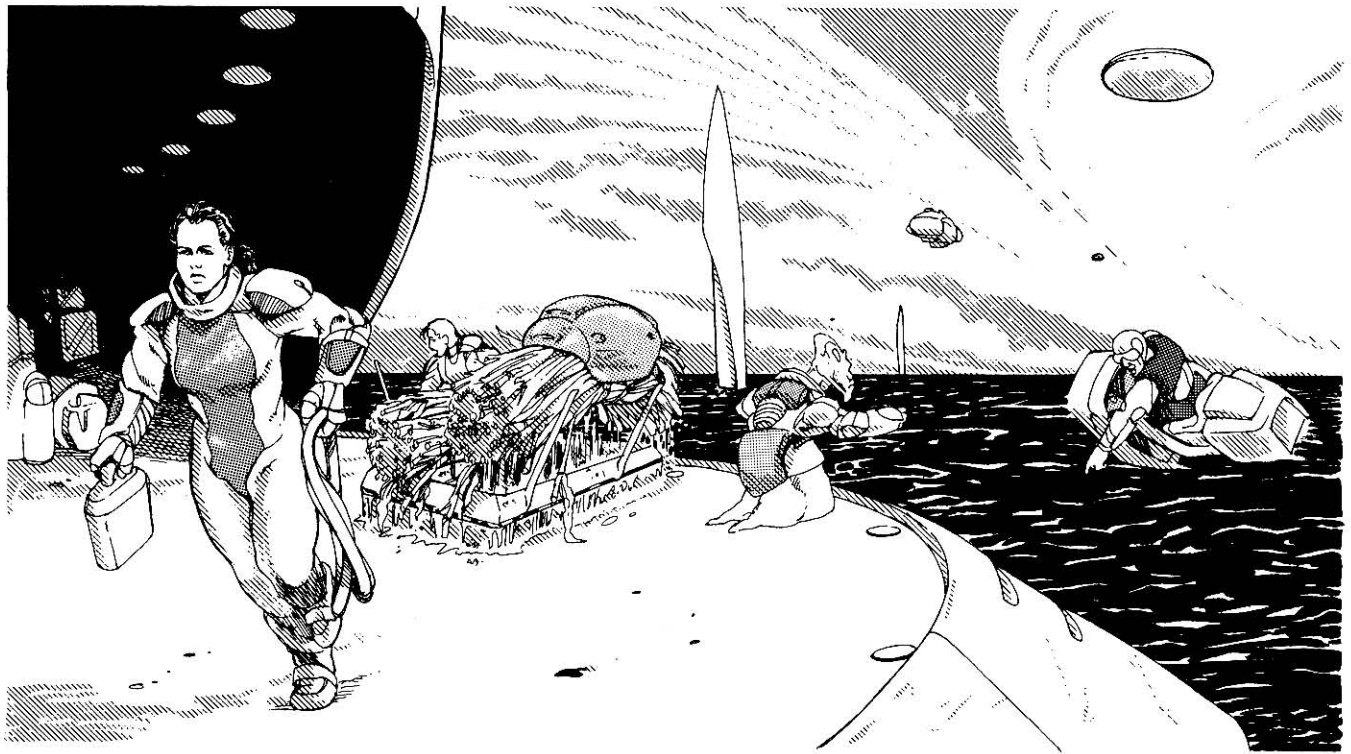

Mike Vilardi

Vincennes is one of the few systems in the Imperium to attain tech-level 16, and one of only two such worlds in the Domain of Deneb. As a result, this water world is a major hub of political and economic activity in the region. Any travellers in the Domain of Deneb with an intellectual, professional, or economic interest in high-technology equipment will almost certainly wish to visit Vincennes.

**Vincennes/Vincennes 1122 A899AA6-G Hi In Cp 113 Dd M7V K1V G1V**

**Primary:** Ember. Spectral Class M7V. Mass=0.3 Std. Diameter=0.3 Std. Luminosity=0.2 Std.

**Planetary System (Ember Sub-System Only):** Two major bodies. One inhabited (Vincennes: Ember II).

## Vincennes

**Physical Planetary Data:** Mean Orbital Radius=59.8 million km (0.4 AU). Orbital Period=199.27 standard days. Orbital Eccentricity=0.015. Diameter=12,755.2 km. Density=1.5. Mass=1.5. Surface Gravity=1.5. Rotation Period=33 hours, 32 min, 15 sec. Axial Inclination=005'32". Energy Absorption=0.620. No Natural Satellites. Hydrographic Percentage=94%. Atmospheric Pressure=1.5 atm. Composition=Oxygen-Nitrogen Mix. Mean Surface Temperature=24.70C. Native Life.

Total Population=10,077,000,000. Primary Cities: *Kehmed* (4.7 billion), *Willis* (1.4 billion), *Nylemsi* (1.2 billion). Government is a

charismatic dictatorship. Tech Level=High Common 16, Low Common 16. Primary Resources=Ores, Radioactives, Parts, Durables, Weapons, Recordings, Software

## HISTORY

The first known contact with Vincennes was circa -2150 (Imperial), and was made by one of the few expeditions the Rule of Man sent beyond the original borders of the First Imperium. The *Vincennes* was the first Solomani ship to enter the system, and gave its name to the system's habitable planet. Although plans were made for settlement of Vincennes, the Rule of Man's increasing internal turmoil made any expansion impossible.

With the onset of the Long Night, a group of Solomani exiles attempted to settle the planet, living in subterranean habitats on Vincennes' single continent. Cut off from outside technology and supplies, however, the colony's population soon fell below levels necessary for perpetuation, and it became one of the countless settlements that died out during the Long Night.

The system was recontacted when the Third Imperium began its Spinward expansion through Corridor, with colonization beginning in the second century. The challenges of the environment on Vincennes spurred a number of technological advances that established Vincennes as the most rapidly developing world in the frontier. Its position as a nexus of regional activity and technological innovation dates from this period.

In recognition of this development, Vincennes was made the subsector capital in 243, when District 192 was integrated into the

Imperium as the Vincennes Subsector. As part of formal integration into the Imperium, the subsector was placed under the dominion of an Imperial noble family, the Humbolts.

A powerful family of Solomani origin, the Humbolts were granted this distant fief following charges of High Treason — charges that were never conclusively proven, thanks to the suspicious deaths of several key witnesses. Dominion of the Vincennes subsector was essentially a polite form of exile.

Vincennes was integral to the development of the Domain of Deneb, as its industries produced high-technology goods for the settlement of the Frontier. With the outbreak of the First Frontier War, Vincennes turned to manufacturing ships and equipment for the Imperial Navy.

The historian Albrecht Heinzmann has hypothesized that the Humbolts encouraged Grand Admiral Olav hault-Plankwell in his bid for the Imperial throne following the First Frontier War, hoping to regain influence in the Imperial Government and return to capital. Unfortunately this period in history is too confused for Heinzmann's hypothesis to be proven.

Still in 628, following the Civil War, the Humbolt family was again charged with extreme violations of Imperial law. Among their offenses was the exploitation of the native sophonts of Perez (Vincennes/Deneb 1221). The Humbolts were forcibly extracting a highly potent hallucinogen from the beings, by a inhumanly cruel process of interest only to the sadist or the most dedicated historian. The breaking of Solomani dominance at the Imperial court meant that their allies in the Moot were no longer able to protect them, and the Humbolts were exiled beyond the Imperium.

Since the Humbolts' exile, the subsector has been under the dominion of a far more reputable family, although conspiracy enthusiasts still ascribe most of the criminal activity in the subsector to the Humbolts' continued presence. The incident ended Vincennes' political status in the Spinward frontier, and political power shifted to the Deneb and Mora systems.

In the modern era, Vincennes has continued to be a world of great technological achievement and, consequently, great wealth and economic importance. The "Vincennes/Dd" production microcode can be found imprinted on goods throughout the Domain.

Vincennes recently sought to reestablish its political standing by submitting a bid to become the new Domain capital. Visitors to the system may note a great deal of local resentment that Mora was chosen over Vincennes ("more politically stable and centrally-located", according to a spokesman for the Archduke Norris). Still, Vincennes remains the most economically powerful system in central Deneb sector, and one crucial to the survival of the Domain in the era of Rebellion.

### PHYSICAL DESCRIPTION

Vincennes is roughly the same size as Earth, but is substantially denser due to its internal composition. This results in a higher planetary mass, local gravity, and atmospheric pressure than unadapted humans find comfortable. All of these are within tolerable limits, and can be easily adapted to in a short period of time.

Over nine-tenths of Vincennes' total surface is covered by ocean, at depths up to nine kilometers. Most of the planet's mining and habitation is concentrated in an underwater region known simply as "The Shoal".

The Shoal is a continent-sized area straddling the equator. Depths in this region are seldom greater than half a kilometer, and

in many areas can be measured in the tens-of-meters. Planetological research indicates that substantial portions of the Shoal were once above sea level, forming a low-lying continent subject to frequent flooding. It is likely that the native life of Vincennes evolved in tidal basins along the shoal, developing into purely aquatic forms when this primeval continent was engulfed by the sea.

Most of the land surface is concentrated along island chains that border the Shoal. The planet's only continent, Kehmed, is probably the remnants of the original continent's "highlands". Terrain on Vincennes is rocky; the torrential summer rains (see below) wash all loose surface material into the ocean, leaving bare bedrock exposed. The sea-floor, especially on the Shoal, is generally covered with layers of sediment washed from the land. Away from the Shoal, ocean depths increase sharply. Typical depths of off-Shoal areas is four to six kilometers, with some trenches as deep as eleven.

### BIOLOGY

The life forms of Vincennes have evolved to a level of complexity similar to that during the Cambrian Era on Earth, and are mostly aquatic colonial organisms. Because of frequent flooding and erosion (see below), no land-based life forms have evolved on or been introduced to Vincennes. Large algal mats are common on the ocean surface; in some areas these cover the water's surface for tens of kilometers, particularly over the Shoal. The most advanced forms resemble terrestrial coelenterates, and usually live along the fringes of the Shoal where temperatures are moderate.

Also common is a kelp-like form known as "Beam". When dried and treated, Beam can be used as a flexible building material similar to terrestrial bamboo. Genetically enhanced forms of

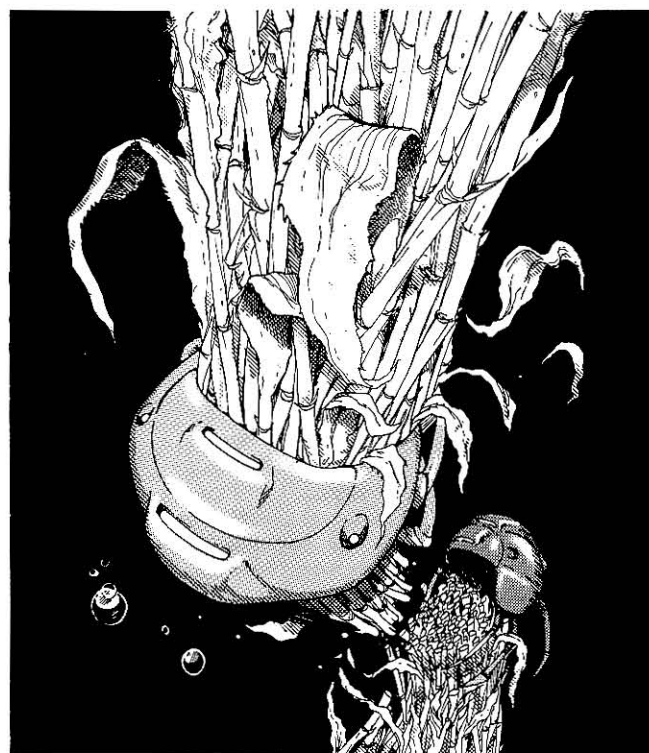

Mike Vifardi



### SHOAL GEOGRAPHY

The Shoal is divided into two regions by the Armegia Rift; the eastern two-thirds are on average somewhat deeper below the ocean surface. The western portion was also the first to be settled; it was nearer the large mass of Kehmed and was much richer in resources than the western third. With resources in the east being depleted, the western portion of the undersea continent has become the planet's new frontier, with newer settlements and a growing importance to the planetary economy.

### MAP AREAS:

- **Vincennes Down Starport:** Extensive class A facility, open year-round, but with many services seasonal. Subterranean transgrav lines extend from the starport to offshore Kehmed city complex.
- **Kehmed Megalopolis:** Kehmed is home to over half the planetary population and over 60% of the industry. Being a megalopolis, it is actually comprised of numerous large cities linked into a single complex. Thirty of Vincennes' forty-three permanent gravitic cities keep station above Kehmed, and are dependent on it for economic survival.
- **Markel Metroplex:** In recent years, the resources surrounding Markel have begun to dry up. Many citizens have migrated to settlements in the western Shoal, leaving a city much larger than its population requires. Housing is very inexpensive. Because of the price breaks, SuSAG moved its largest facility in the sector from Kehmed to Markel and employs almost half the metroplex's population.
- **Willis Metroplex:** Largely a manufacturing city, producing high-quality consumer electronics, computers, robots, and software. The economic slump hitting the Domain has touched

Willis less than Markel or Kehmed.

- **Armegia Rift:** This rift valley divides the Shoal along a north-south axis. Always a focus of planetological research, it been exploited over the last two centuries for its commercial potential. Its resources were initially too hidden to exploit profitably. However, advances in technology have opened up several rich deposits of ores and industrial-grade radioactive elements. The northern portion of the rift has not been exploited significantly, mostly because of hazardous currents.
- **Burke Metroplex:** The smallest and newest of Vincennes' undersea arcologies, Burke grew out of the mining settlements along the southern branch of the rift. It has the largest growth rate of any city on the planet.
- **Hitomi Islands:** One of the largest shallow areas of the Shoal, the Hitomi Bank, surrounds these islands to a radius of 1,200 kilometers. Prospecting here is intense. Although the Armegia Rift mines provide a more stable supply, there have been several instances of prospectors finding lodes of valuable ore on the Bank. However, these lodes have tended to be small and are usually mined out by transients before any permanent settlement can be built around them.



Beam are grown during winter and spring on "plantations" in shallow areas, and are commonly used as a temporary building material, or for disposable containers.

The largest organism on Vincennes is known as "Rockmat". These organisms are similar to terrestrial stromatolites; they form when large algal mats become anchored in shallow, rocky areas. The mats become covered with silt but continue to grow, forming a cemented mass resembling a porous rock. The older the colony, the stronger and larger it becomes. This process can produce colonies several meters across, resembling small islands. Centuries-old extinct colonies have been used as the foundation for landing pads at some of Vincennes' subordinate spaceports, and when hollowed out, they can serve as fairly secure habitats.

As an extension of Vincennes' atmospheric taint (see below), the oceans of Vincennes are more acidic than most terrestrial organisms can tolerate, and transplants onto Vincennes have not been very successful. Native life is not palatable to humans without special treatment and preparation, and even after such treatment tends to have a bitter, caustic taste.

Attempts to genetically engineer edible life forms have been unsuccessful; apparently the foul taste derives from adaptations necessary to an acidic environment. As a result, most food on Vincennes is grown in enclosed hydroponics facilities, chemically

synthesized, or imported. Synthesized food does depend on local flora as a source of raw material, and several algae-harvesting companies are active over the Shoal.

**SEASONS**

Vincennes orbits a red-dwarf star, Ember, that emits insufficient energy for a life-supporting planet. The planet receives most of its energy from the K7V star Undraczech, of which Ember is a companion. As Vincennes orbits Ember, its distance from Undraczech varies from 0.6 to 1.4 AU. As a result of this variation, Vincennes has distinct "seasons", even though it has a negligible axial tilt.

**"Winter":** As Ember and Undraczech come into conjunction, Vincennes is at its furthest separation from its main source of energy. Mean daily temperatures can drop as low as -20°C, and humans cannot safely go outdoors without protective clothing. Areas of still water (around natural or artificial islands, for example) freeze early in the winter season; as temperatures approach their extremes, shallow areas over the Shoal may become covered by large ice floes. The more mobile life forms of the Shoal retreat to deeper areas, where the volume of water moderates local temperatures.

**Vincennes' Seasons** (diagrams not to scale)

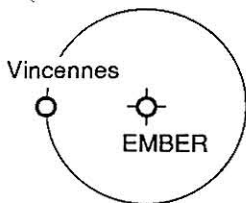

UNDRACZECH



**Winter:** Vincennes is at its furthest separation from Undraczech; received energy is at a minimum. Temperatures drop to below freezing. Local atmospheric taint is moderate, with only a breathing mask required for protection, but protective gear required against the cold.

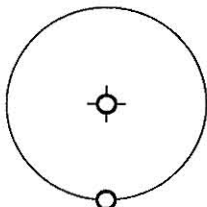

**Spring:** Vincennes begins to revolve closer to Undraczech; weather control maintains moderate but steadily increasing temperatures averaging approximately 24 degrees C. Atmospheric taint is minimal; safe for unprotected humans for periods of several weeks.

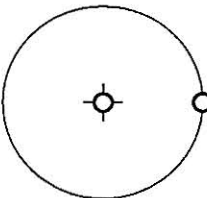

**Summer:** Weather control is unable to compensate for increased energy received from Undraczech, and temperatures soar to an average of 66 degrees celsius. Large volumes of water evaporate into the atmosphere, while heat causes violent convection currents and dramatic lighting storms. Tidal forces cause the release of sulfur compounds into the atmosphere; Vincennes' lower atmosphere is unbreathable during summer.

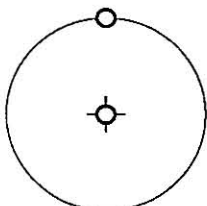

**Autumn:** Vincennes cools as it receives less energy from Undraczech and as the waper vapor in the atmosphere increases its albedo. Autumn is characterized by continuous rain, initially highly acidic. A heavy filter mask is required for outdoor activity during fall, and early-autumn rains will cause an irritating sting to exposed skin.

**“Spring”:** As Vincennes’ orbit moves it closer to Undraczech, the climate begins warming. Weather control takes advantage of the increase in received energy immediately; early in the spring, daily temperature increases dramatically to well above freezing. The temperature then increases at a slower, steadier rate throughout the spring. Ice floes break up and melt, and the ecosystem of the shoal becomes reinvigorated. This is the most hospitable season on Vincennes; not only are the temperatures consistently moderate, but the atmospheric taint is nearly nonexistent.

**“Summer”:** Vincennes’ summer truly begins when local weather control is no longer able to compensate for the increased received energy from Undraczech. As Vincennes approaches Undraczech, temperatures soar to an intolerable mean of 66°C. As a result of the heat, several dramatic upheavals take place in the planet’s environment:

The surface layers of the oceans become virtual incubators for the algal colonies. This is especially true over the Shoal, since there is a smaller volume of water to absorb the increased energy. The xeno-coelenterate forms reproduce during this period, and the algal mats expand greatly. The mats also produce a tremendous quantity of oxygen through photosynthesis. The additional heat also evaporates a tremendous volume of water into the planet’s atmosphere, and induces violent convection currents that cause spectacular lightning storms. These currents also make it hazardous for transports to fly to or from the planet’s surface.

Local summer is also marked by increased levels of seismic activity due to tidal effects. This usually takes the form of sulfuric discharge along volcanic fault lines; undersea rifts are the source of most of this sulfur, but the volcanic islands and near-surface seamounts also put a considerable amount of sulfur and sulfur compounds into the atmosphere. The lightning often causes the sulfur to combust with the increased amount of oxygen, producing infrequent but spectacular sheets of flame, as well as noxious sulfur dioxide.

As Vincennes revolves away from Undraczech, it is receiving less and less energy from Undraczech, in accordance with the inverse square law. In addition, the vapor clouds that enshroud the planet during summer increase its albedo dramatically. As these factors cool the planet, the atmospheric vapor begins to condense, and forms precipitation. The coming of the rains marks the onset of local autumn.

**“Autumn”:** The first rains to come are highly acidic, due to the level of sulfur dioxide in the atmosphere. This “acid rain” carves long erosion gullies in the soft volcanic basalt that comprises most of the islands; one larger island, Mila, is noted for its elaborate network of gullies that have been carved only in the past few decades. These gullies are extremely spectacular, and are major tourist attractions.

As the rains continue, they become less acidic; by winter the sulfur content in the atmosphere has decreased to levels tolerable to a humans in a simple breathing mask. During fall, the daily temperature drops steadily. While local weather control moderates the degree of decline, average temperatures will continue dropping from day to day, leading to winter and a repetition of the cycle.

### LIVING ON VINCENNES

One thing distinguishes Vincennes from all other high-tech, high-population worlds; its tech level. Vincennes is the only system

in the Domain with a common civilian tech level above fifteen (although Depot/Deneb has achieved TL-16, it is a military system and thus not a major economic force). Vincennes’ industries can produce high-stellar products more cheaply than any other system, and many items the system exports are TL-16 goods unavailable anywhere else in the Domain.

This combination has made Vincennes a very wealthy society. Nearly everyone on Vincennes has amassed some measure of personal capital, and most citizens have extensive investments in off-world trade and commerce. Nearly every level of society is dependent on having secure off-world markets that can afford to purchase advanced technology. As a result, the Vincennes system also has a clear interest in supporting the Domain government; in spite of dissatisfaction with many of the Archduke Norris’ specific policies, the system’s commitment to the Domain and its security has never been seriously in question.

### CULTURE

Most of Vincennes’ early settlers were Solomani stock; with the appointment of the Humbolts, Vincennes was viewed as a distinctly Solomani fiefdom. The Humbolts themselves encouraged this perception through preferential treatment for immigrants of Terran descent, and even today Vincennes has a distinctly Solomani character. This affiliation is solely cultural, however; the ideology of Solomani Supremacy has only a small extremist following.

Popular sentiment on Vincennes during the Solomani Rim War did lean toward Solomani independence from the Imperium, but with the Domain’s remoteness from the Rim, this had little impact. One distinctly Solomani element visitors may notice is a lack of respect for titles of nobility. Citizens must acknowledge a degree of noble authority, but few will grant any privileges to nobles beyond that required by Imperial law.

Monogamous families are the norm, although this does not always entail cohabitation. Marriages for legal or financial convenience are not unusual, and persons in such a relationship frequently live apart, maintaining contact by holographic communication. Such marriages are known locally as “casuals”, and typically are contractual arrangements renewed or terminated after two years.

### HABITATS

Because of the violence of Vincennes’ seasons, the population must live in sealed habitats most of the time. The severity of summer makes any form of surface dwelling unsafe, since the seas become too tumultuous for floating cities, and the erosion of the soil makes most surface facilities unstable.

The majority of the population live in undersea settlements along the Shoal, safe from the ravages of the summer. Although the engineering problems are very different from vacuum or other exotic environments, everyday life in an undersea settlement is similar to life in any arcology. The undersea cities typically follow the enclosed-dome style of architecture common to artificial habitats. Some of the more modern undersea structures are capped with “pylon towers”; during most of the year they project above the surface of the water, but during summer, they retract into the depths.

There is as much variety among settlements as there is among cities on any world. Some are remote (often abandoned) mining outposts operating as low as TL-12, while others are TL-16

metropolises extending across thousands of square kilometers and housing hundreds of millions of people. Nearly half the planetary population (4.7 billion) is concentrated in a chain of settlements extending from the eastern shore of Kehmed, along the underground transgrav lines that radiate from the primary starport. This megalopolis is known as the Kehmed Metroplex, even though it is not actually on Kehmed itself. Other large settlements include Willis (1.4 billion), Nylemsi (1.2 billion) and Burke (700 million). Smaller settlements are often semi-permanent mining communities, supplying raw materials to the manufacturing complexes in the metropolises. Most settlements are connected by transgrav lines; smaller communities can be reached by submersible.

Gravitic habitats are the second principal dwellings on Vincennes, and are the most visible expression of its technological advancement. Forty-three gravitic cities hover over the planet's surface, with three having populations over 100 million. Although some manufacturing is done at these cities, they are predominantly residences of the managerial classes and the wealthy. During the more placid seasons, the cities hover very low to the surface; some of the smaller cities actually set down in the oceans, and have receiving bays for submersibles in their lower levels. During the summer, the cities can be safe above the clouds, just as the undersea settlements are safe below the waves. Architectural styles vary; three common configurations are flattened sphere/disk, rounded sphere, or oblong, but there are numerous others. Most cities hover over fixed locations over the Shoal, keeping them close to industrial production sites.

One grav city, Melchen (pop 110 million) is extremely popular among tourists, since the administration of the city strives to maintain conditions close to human norms. Throughout the year, Melchen remains at an altitude where atmospheric pressure is close to one atmosphere, and unlike most cities, public areas and tourist hotels in Melchen are equipped with grav plates, counteracting the slightly high local gravity. Melchen has starport facilities that many consider better than many worlds' primary starports, and the city attracts a great deal of commerce.

In addition to the cities, there are countless smaller "raft towns" that spend much of the year floating on the ocean surface engaged in sea-harvesting or, more commonly, manufacturing. When summer comes, these small settlements lift from the ocean surface into the sky. There are also a large number of private yachts and individual gravitic residences that operate on the same principle. An entire subset of society, the so-called "Grav Set", lifts into the sky during the Vincennes summer.

### HIGH TECH

Vincennes' markets are full of goods — novelties, weapons, equipment — that are useful only because their high technology is a relative advantage. These goods are also expensive to purchase and maintain. The Rebellion is damaging economies throughout the Imperium, and Vincennes is no exception; as fewer worlds are able to buy high-tech products, Vincennes' industries must either reduce prices or scale back production, both of which hurt the local economy. The system has two advantages to help it through this period. Firstly, it has such a substantial amount of reserve capital that can absorb some of the losses incurred. And secondly, at least one industry on Vincennes is booming; sales of personal military equipment have never been better.

Specific areas of technological achievement on Vincennes break down as follows:

- **Transportation:** Gravitic transportation is the most common form of transport on Vincennes. Above the surface, grav freighters shuttle between the starports, grav cities, and orbit routinely. Below the surface, transgrav lines link each undersea metropolis into a transportation grid that crisscrosses the shoal. Gravitic propulsion has been found unsuited to submarines and submersibles, however. Heat transfer in Vincennes' oceans causes very forceful seasonal currents that bat grav subs around like leaves in the wind. Most submersibles use either water jets, or old-fashioned screws for propulsion, although even these are often gravitically-driven to increase output and efficiency. A new submersible design style pioneered on Vincennes has a computer-coordinated articulated, flexible hull, and is propelled by the same body movements used by fishes and eels.

The only "land" transportation on Vincennes are all-terrain rovers that are sometimes used in mining or shallow areas. These vehicles are generally large (10-30 tons displacement), and are only used for short-range travel.

- **Space:** In the early days of the frontier, Vincennes had the largest shipyards in the sector and supplied a vast number of vessels for commercial and military use. Vincennes' shipyards were mostly orbital facilities, with some also located near the System-Defense base at Friend (see "Other Settlements", below). Raw materials were mined in-system, shipped from Vincennes, or imported. Until recent years its shipbuilding industry was in decline, but it has been revitalized as demand for naval vessels has increased with the Rebellion.

Civilian ships produced at Vincennes were of the highest performance and reliability, but their high-technology actually proved a marketing liability. As Vincennes' designs became more and more advanced, fewer and fewer starports were able to service and maintain these vessels. While parts of a lower tech-level could be substituted, these gradually eliminated the advantages of the original (and expensive) high-tech design. Currently, the only TL-16 ships in civilian use are either merchants operating solely in the Vincennes area, or megacorporations for whom the advantages of TL-16 construction outweigh the expense of maintaining such vessels.

With the establishment of Depot/Deneb, the system lost a great many naval contracts. This, combined with the increasingly limited market for high-tech civilian designs, left a great many of Vincennes' shipyards abandoned. As demand for military vessels has increased, however, many of these have been re-opened. Most of the naval contracts being built at Vincennes are recon probes, couriers, and other non-combat vessels. Those that require armament usually have it fitted at Depot. One combat vessel produced entirely at Vincennes is the *Senoma*-class 10,000-ton destroyer, a mixed TL-16/14 craft which has seen considerable action against Vargr raiders in coreward Deneb sector.

- **Energy:** Nearly all of Vincennes' energy needs are met by fusion power, or in some cases by small fuel cells. The only alternate source of energy in common use is sea turbines; these range from ten to two hundred meters in diameter, and are driven by the convection currents caused by seasonal temperature changes. While less efficient and cost-effective than fusion, they enjoyed a certain popularity at one time, and many are still in use at smaller settlements.

# GRAV CITY REPRESENTATIVE ARCHITECTURE

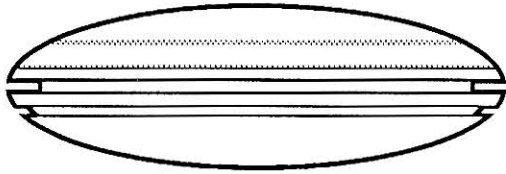

## MELCHEN (Flattened Sphere/Disk):

Melchen is primarily a tourist city, and frequently moves about the skies of Vincennes to maintain standards of temperature and pressure close to human norms. Most cities do not require this degree of mobility, so the flattened sphere/disk configuration is more commonly found in smaller gravitic habitats that spend the winter and spring on or near the planet's surface.

## DUMOROV (Disk/Cone):

Dumorov hovers in a more or less fixed location over the undersea Kehmed megalopolis. While it does not move about the planet, it does change altitude seasonally. During the winter and spring, the city lowers to sea level; the lower extension contains docking bays for submersibles which carry goods directly from undersea factories. During the summer, it returns to higher altitudes; goods stockpiled during the summer can then be sold to orbit at significant profit, since storms make the surface inaccessible.

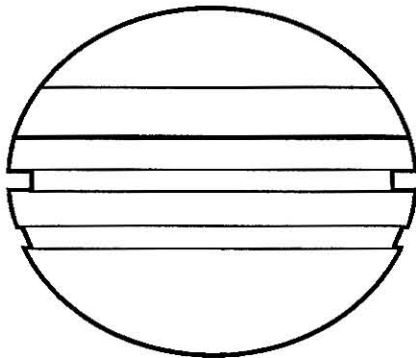
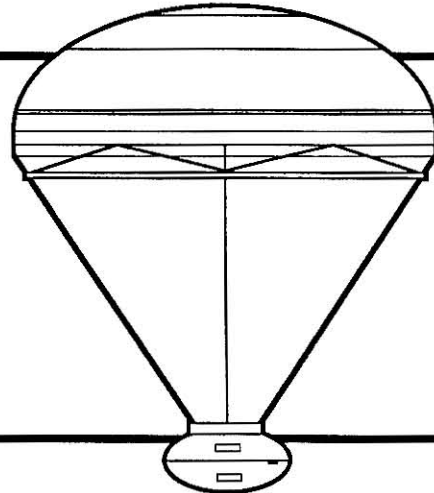

## MALIN TEKCHAR (Sphere):

Malin Tekhar is largely an administrative city; it seldom comes within a kilometer of the surface. Very little actual production takes place there. Its design allows a fair degree of mobility, but Malin Tekhar's movement is usually confined to station-keeping (over Darrow, an island south of Kehmed) and compensation for air currents. The Spherical configuration is common to cities that require some measure of mobility, but do not touch down in the oceans.

## FOXHUNTER (Irregular):

Because they are not at all aerodynamic, irregular structures are usually completely immobile. In addition, they are highly susceptible to strong air currents, such as those that take place during Vincennes' summer. Most irregular structures are smaller, temporary industrial facilities. Foxhunter is unusually large for an irregular structure; begun in 1098, it was to be built as a octahedral Grav City. The construction firm, Bialsh Vincennes LiC, went bankrupt in 1108, and had to sell the existing structure. It has hovered in Vincennes' horse latitudes (where air currents are relatively placid) for eleven years, and there are no plans to complete it. Its economy is based largely on small manufacturing, and it also maintains an inexpensive repair dock for grav freighters and spacecraft.

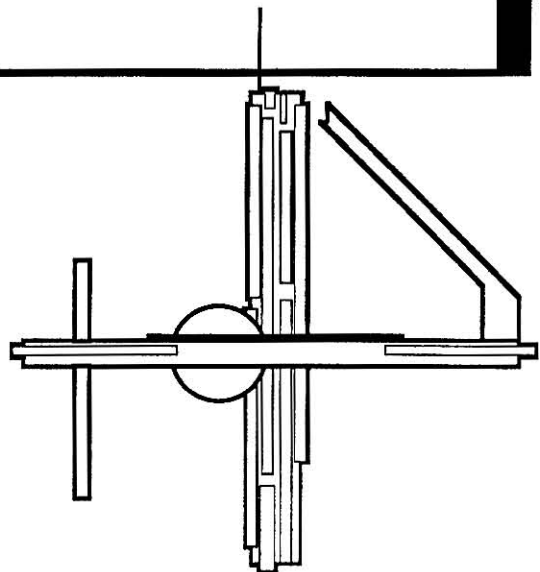

• **Medicine:** Vincennes is a center of medical technology and treatment for the surrounding subsectors; both the Navy and the Scouts send severely injured personnel there for treatment. Cloning and regrowth of injured or damaged organs and limbs is commonplace. Anagathics are readily available; SuSag maintains its largest facility in the Domain at the city of Markel, north of Kehmed.

Neurology is the most unique of Vincennes' medical sciences. Brain transplants, while not routine, are also not uncommon. Patients of such operations typically have an 80-90% survival rate. The procedure is most commonly used when a patient's body is damaged beyond the point where piecemeal cloning can replace destroyed tissue. A completely new body is cloned from surviving tissue, with the brain transplanted from the original body.

• **Military:** Vincennes is a major producer of personal weapons for the military forces of the Domain, both government and private. Plasma rifles and the FGMP-16 are not mass-produced on any other Domain world. One weapon system unique to Vincennes is the gravitic rifle (also produced in pistol and carbine form). This weapon is similar to a Gauss rifle, but uses micro-gravitic modules rather than magnetic fields to accelerate the round. The result is a much higher round velocity, and hence greater accuracy and penetration.

Those who think of TL-16 weapons only in terms of firepower may be surprised to learn that Vincennes is also a major exporter of low-tech weapons such as swords and bows. These weapons are commonly of extruded monofilament construction, giving them astounding penetration. Personal shields made of advanced composite materials are also available. Unlike advanced energy weapons like the plasma rifle, these weapons do not require expensive TL-16 repair parts; they combine the advantages of high-tech construction with the flexibility of low-tech primitive equipment.

Neural weaponry is outlawed on Vincennes, although the technology exists to produce crude forms of neural guns and shields. A limited number of these weapons are produced for police use; the main impediment to their wider use by law enforcement is not technology, but a lack of individuals trained in their use.

Vincennes' heavy military technology is comparatively backward, at approximately TL-14. With the establishment of Depot barely a subsector away, contracts for heavy weapons production drained away and Vincennes' military industry stagnated. Circumstances have improved recently, as even TL-14 systems are advanced compared to most worlds, and the demand for military equipment, has risen sharply; TL-14 is still higher than much of the Domain.

• **Environment:** Vincennes' greatest impact on the surrounding subsector may well be in the area of environmental engineering. Terraforming procedures and equipment developed on Vincennes have improved living conditions on several worlds throughout the region, such as Paven.

Paven is a habitable world orbiting the third star of the Vincennes trinary, Guazhurniim, a G1V star over 300 A.U. distant. Paven was originally uninhabitable, with a runaway greenhouse effect that resulted in searing temperature and pressure. It was the first world that environmental technicians from Vincennes attempted to terraform. The program was begun in 690; within two centuries it was possible to grow crops on Paven, and until a recent blight

(see below), Paven supplied most of Vincennes' foodstuffs. Technology developed during the Paven terraforming project has since been applied to other worlds in the subsector, such as Frisgar (Deneb 1025).

In two areas of technology, Vincennes has developed even farther than the TL-16 that sets it apart from most worlds; Communications/Robotics and Communications. These two fields merit special notice, because the lifestyle predominant on Vincennes is dependant on the widespread availability of advanced robotics and communications equipment.

Both advances were induced by the undersea environment in which most of the population lives. Cumbersome protective equipment is required to work in the high-pressure environment in the planet's deeper mining regions. The hardsuits used by early miners provided personal protection and enhanced strength, similar to modern Battle Dress. These suits became more automated and more elaborate over time; eventually, they were fully automated and no longer required a human operator. Today, not just mining but industrial production and most domestic tasks are performed entirely by human-directed robots.

Communication with these robotic work teams was difficult, because electromagnetic waves do not travel well in a dense medium such as Vincennes' oceans. As a result radios, as well as laser and microwave communications, are not effective beyond fairly short ranges. The need for more effective communications spurred the development of more powerful EM-based communications, and the early invention of meson communicators that ignored the volume of intervening material.

## TECHNOLOGY AND SOCIETY

To many travellers, Vincennes' high technology means simply new technological toys; to a mercenary, Tech Level 16 means advanced energy weapons. To a merchant, that tech level means high-tech goods that can be sold for a profit on virtually any world, even those with high-stellar technology. TL-16 does bring with it a great number of material advancements, as listed above, but there is far more to a TL-16 society than seven-watts-per-liter fusion plants.

The traveller who expects Vincennes to be just another high-stellar world will soon learn that the difference between tech levels on Vincennes is far more than simply "gadgets and gizmos". On Vincennes, the role technology plays in society, and the standard of living that technology has allowed the society to maintain is perhaps best reflected in the old adage, "Yesterday's luxury is tomorrow's necessity." Beyond tech 12 gravitic architecture is an accepted part of life. Making the gravitics an obvious part of the structure is viewed as a sign of backwardness and insecurity — a truly advanced culture accepts this technology without being ostentatious (to beings accustomed to high technology, even the vast hovering sphere of the Imperial palace is impressive in scale, but unsophisticated in concept).

Computer technology is another familiar example. Personal computers generally become available at TL-7, but TL-7 society does not assume its citizens have access to computer technology. By TL-8, computers have become far more common. Society may not assume its members have access to computers, but it is no longer remarkable for an individual to possess one. Computers have become a convenience; a very useful tool, but not vital to daily existence.

# Vincennes

Vincennes/Vincennes 1122 A899AA6-G HI In Cp 113 Dd M7V K1V G1

Primary: Ember, Spectral Class M7V, Mass=0.3, Diameter=0.3, Luminosity=0.2

Planetary System (Ember Sub-System Only): Two major bodies. One inhabited (Vincennes: Ember II).

**Vincennes:** Mean Orbital Radius=59.8 million km (0.4 au). Orbital Period=199.27 standard days. Orbital Eccentricity=0.015. Diameter=12,755.2 km. Density=1.5. Mass=1.5. Surface Gravity=1.5. Rotation Period=33 hours, 32 min, 15 sec. Axial Inclination=00 5' 32". Energy Absorption=0.620. No Natural Satellites. Hydrographic Percentage=94%. Atmospheric Pressure=1.5 atm. Composition=Oxygen-Nitrogen Mix. Mean Surface Temperature=24.7°C. Native Life. Total Population=10,077,000,000. Primary Cities: Kehmed (4.7 billion), Willis (1.4 billion), Nylemsi (1.2 billion). Government is a charismatic dictatorship. Tech Level=High Common 16, Low Common 16. Primary Resources=Ores, Radioactives, Parts, Durables, Weapons, Recordings, Software.

Vincennes is one of the few Tech-Level 16 worlds in the Imperium, one of only two in the Domain of Deneb. It is the capital of Vincennes subsector and is a major economic, political and communications hub of Deneb Sector. Vincennes exports high-tech products throughout the Domain. The majority of Vincennes' population live in undersea settlements along a continent-sized shallow region known simply as "The Great Shoal". These communities are primarily concerned with mining and industrial production. The largest of these communities is the Kehmed Megalopolis, home to over half the planet's population. A smaller percentage of the population, generally the higher social classes, live in massive gravitically-suspended cities that hover far above the planet's surface.

Vincennes has unusually high levels of technology in robotics and communications, and is generally acknowledged to have attained early TL-17 in these fields. Virtually all the actual labor in the undersea mines is performed by robots, with sophonts performing the administrative and decision-making tasks. In the gravitic cities, robots act as stewards, janitors, concierges, and in many other positions. The equally advanced communications technology allows these robots to be directed from the comfort of one's own quarters, leading to an extremely domestic lifestyle. Many Vincennes citizens may not leave home for weeks or months at a time, served by robotic stewards and making decisions implemented by robotic laborers.

Vincennes is part of a double star system (with a third, far companion). Its primary, Ember, is a red dwarf star which would

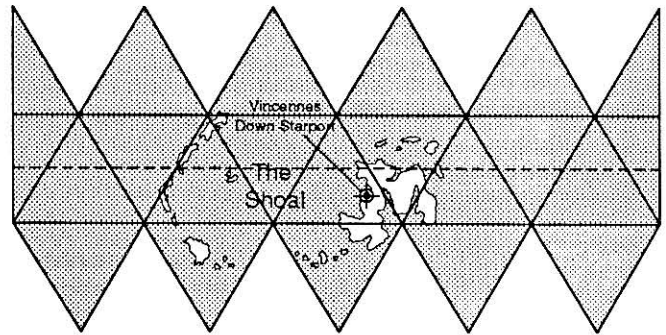

Vincennes World Map

ordinarily be incapable maintaining life-supporting planets. However, Ember orbits in the habitable zone of its near companion star Undraczech (K1V). Vincennes' mean surface temperature is a comfortable 24.7°C. However, Vincennes' orbit around Undraczech (its main source of energy). At maximum distance from Undraczech, the local "winter" sets in, with temperatures dropping as low as -200°C. Conversely, at Vincennes' closest approach, local temperature may soar for a short period to almost 660°C. This extreme "summer" warming produces a cycle of dramatic climactic effects.

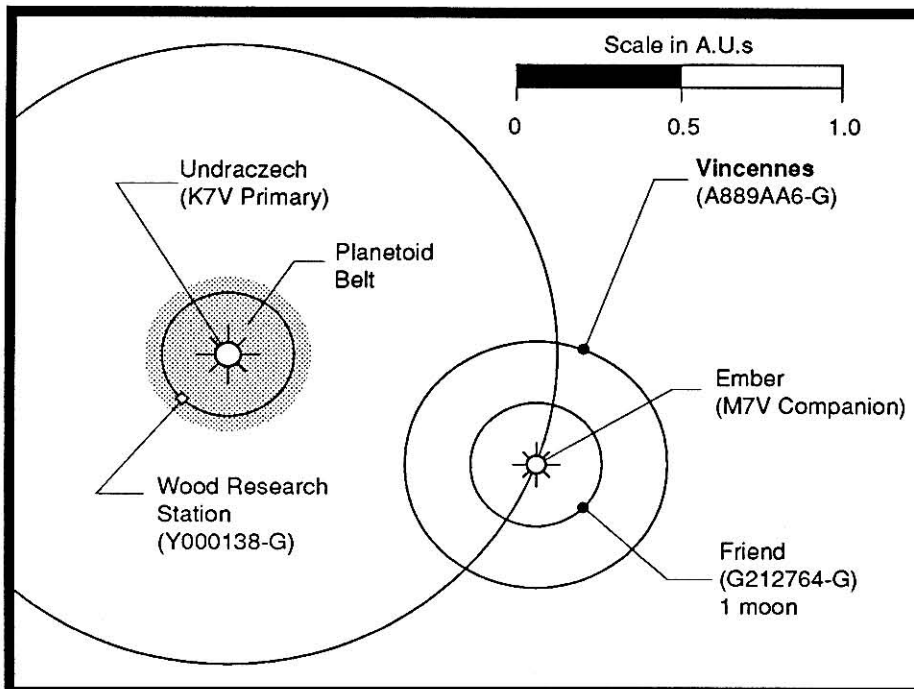

## VINCENNES SYSTEM PROFILE

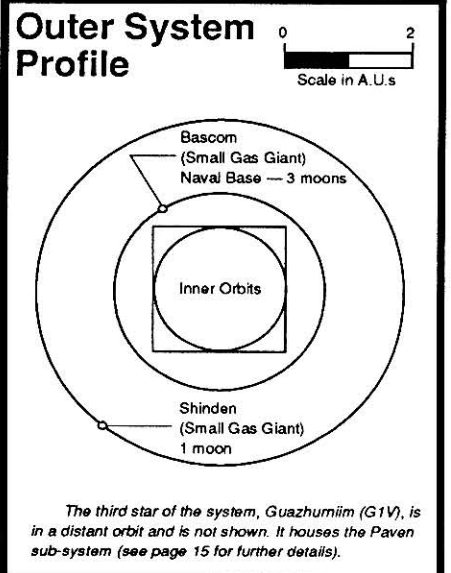

At TL-9 and above, computers have become not only common, but fully integrated into everyday life. As a result, not having a personal computer becomes a handicap, because society assumes its members have access to computer technology. From TL-7 to TL-9, improvements to computer technology do occur. However, the chief difference is not in the machines themselves, but in the role these machines play in society; first a luxury, then a convenience, then a necessity to everyday life (hence the Computer default skill for characters from TL-9+ homeworlds).

### SOCIETY ON VINCENNES

As noted, Vincennes has anomalously high tech levels in two areas; Computers/Robotics and Communications. These advanced tech levels suggest the typical life-style on Vincennes — one in which advancements in Robotics and Communications become an integral and vital part. Antecedents of this life-style first began to appear among the world's professional classes in the 500s, and in the ensuing centuries it has become the predominant way of life on Vincennes.

It should be noted that not all high-tech societies evolve in the same manner, and not everyone on Vincennes follows the life-style outlined here. This life-style is common enough, however, to be considered the "typical" culture on Vincennes.

Visitors to Vincennes will notice almost immediately that most of the people they meet in public will also be visitors. In spite of the planet's high population, concentrated in artificial communities, the streets, shops, and other public places are remarkably vacant. Citizens of Vincennes live in lavish apartments which they rarely leave; because of their advanced communications and robotics equipment, they seldom have to.

Each apartment, hotel room, or other lodging on Vincennes is equipped with concealed holographic projector/recorders in the ceiling, floor and walls. When one person on Vincennes wishes to visit another, these projectors can convincingly give the illusion (to both parties) that the individual is actually present. Only when a strong light source is behind the projection, or if one attempts to touch it, does it become apparent that the individual is not actually present. Those unaccustomed to this method of communication may find the lack of tactile response unnerving, although they can still manipulate their environment using household robots linked to the communications system.

Vincennes' mining and industry, as might be expected, is entirely robotic. The decision-making process is handled by intelligent beings, while the actual execution of those decisions falls to robots. Robots multiply the capacity of the individual worker, since one robot operator has control over dozens of subordinate laborers. The robots can also be remotely directed with great exactness, so that even the most productive of Vincennes residents seldom leave home.

This life-style may seem to some secluded and antisocial; however, the average citizen of Vincennes engages in as much social intercourse as any other intelligent being. The fact that this interaction takes place without leaving home is a suggestion of the communication equipment's sophistication.

In addition, when Vincennes residents do leave home, it is usually for social functions whose lavishness is unprecedented throughout the Imperium. These events attract hundreds or even thousands of people, and are common during the summer, since

most industry slows down or stops when the orbital transports stop flying. The most extravagant affairs occur at the gravitic cities, which offer spectacular views of the turbulent summer cloud formations. Those who find the local life-style secluded have obviously never attended a Vincennes summer party.



Mike Viardi

### LAW AND GOVERNMENT

Vincennes is nominally under the rule of the planet's Imperial legate, the Marquis of Vincennes. Following the Humbolt incidents, the system's noble leadership has been subject to Imperial (or currently, Domain) review once every eight years. If Imperial investigators find popular and upstanding leadership, the Marquis is allowed to continue in power.

In practice, Vincennes is such an important system that the Imperial government has also been known to remove leaders it found disagreeable, in spite of their popularity. During the Solomani Rim War, popular sentiment heavily favored Solomani independence, and the Imperial government found it expedient to install a ruling noble who would keep such sentiment in check.

The current ruler is the Marquis Audine Garhik of Vincennes, also Count of Perez and Eris, nephew of the Archduke Norris. He assumed the position of Imperial Legate in 1108, when the previous legate died without heir, and ensured the local government's loyalty to the Domain. In actuality, the Marquis has very limited powers, and in spite of being technically a dictatorship, the government of Vincennes is not at all invasive. It is primarily responsible for law enforcement, justice, and Imperial liaison, executing judicial and executive functions.

Vincennes law enforcement is fairly unremarkable. With most of the population voluntarily remaining in their homes, public safety is a relatively simple matter, and most disturbances can be handled by local city police. The only planet-wide constabulary are the "Information Police", although since that title sounds distinctly draconian they are also known more simply as the

"Special Branch". They are under the control of the Imperial Legate and thus are the most common manifestation of Imperial authority on Vincennes.

The Special Branch have three main duties. The first is to provide oversight of local police, the second to maintain armed-intervention ("SWAT") teams for special emergencies. The third and most important duty is maintaining the integrity of the communications networks on Vincennes.

With violent crime a rarity, telecommunication and computer fraud are regarded as the most serious threat to civil order. Both are heavily punished; a common sentence is to be confined to quarters without access to outside communications. This is truly isolation, for no-one on Vincennes is likely to take the trouble to visit in person.

Punishments for other crimes are similar to common Imperial practice, but violent crime is usually punished more severely. Because such offenses are so uncommon, Vincennes society is not accustomed to homicide, assault, and so forth, and views it with even more loathing than most.

The most locally important function of government is handled by the Vincennes Trade and Commerce Commission, a body made up of Vincennes' leading industrialists and trading organizations. While the VTCC has no direct on-world power, it is responsible for maintaining and promoting the off-world commerce vital to Vincennes' economy, and has considerable legal authority in matters of off-world trade. This makes it the most powerful body on the planet, although it is still subordinate to the Imperial legate's authority.

Beneath the Commission itself is the VTCC Support Services Bureau. This bureau serves as a "Civil Service", although it is not an official government body but rather a private agency established by the Commission. Decisions of the Commission are binding on members, and since every company involved in exporting is a member of the commission, internal corporate bureaucracy is the usual means by which Commission decisions are implemented. Support Services deals with Free traders, small exporting businesses, and others who are not fully represented on the Commission itself.

Unfortunately the VTCC is more of a hindrance to the local economy than a help; like most such associations, it is rigidly bureaucratic and is organized with power running from the top-down. Any merchant dealing with Vincennes will have to deal with the Support Services Bureau at some point, and may become frustrated at the slow pace at which the extensive documentation required by law is processed. This can be all the more frustrating to those unaccustomed to Vincennes, since all arraignments are, of course, made by telecommunication.

The VTCC is not a stable body. Economic coups d'etat occur frequently, since power derives from commercial preeminence. A corporate takeover, a single bad investment, or any other significant financial event can change the balance of power on the VTCC's ruling committee. While these changes in government are entirely peaceful, the frequent changes in leadership can make matters even more frustrating for merchants waiting for their paperwork to be processed; the form they filled out before a coup might become obsolete after it.

Members of the Traveller's Aid Society may wish to note that TAS and the VTCC are not, institutionally, on the best of terms. TAS's Merchant's Support Division has repeatedly sued the

Commission on behalf of mistreated members, winning substantial settlements in several cases. TAS guides to the subsector carry frequent and vehement warnings about VTCC regulations, and the local TAS Merchant's Support Office publishes continually updated guidelines on how they may be legally circumvented. As a result, TAS offices have been exiled to the remotest building in the Down Starport complex (often inaccessible during the summer without full protective gear), and while the full range of services are available, it is advisable not to advertise one's membership to Starport Authorities unless absolutely necessary.

### ARMED FORCES AND SYSTEM DEFENSE

Ember's inner planet, Friend (see below) is the primary base for System Defense Forces patrolling the inner system. Vincennes has roughly 120,000 tons of shipping committed to system defense and traffic control, ranging from customs launches to corvettes in the thousands of tons. In addition, the Imperial 258th Fleet (assigned to the Vincennes subsector) has its primary repair and refurbishment base in the outer system. The Navy purchased an extensive but disused shipyard orbiting the gas giant Shinden, and retooled it to military specifications. Refueling traffic at Shinden is now restricted to narrow corridors that keep vessels far from the Navy base.

The local military employs roughly five million people, a relatively small portion of the population but still more than most local needs. With the onset of the rebellion, much of the armed forces have been commandeered by the Domain government and shipped to border regions.

### OTHER SETTLEMENTS

The Vincennes system is more than a single world; it has several populated worlds in addition to the vast population on, above, and orbiting Vincennes itself. These settlements include:

**Wood Station (Y000135-G):** Research laboratory in the planetoid belt around Undraczech, named for the Solomani astrophysicist E.A. Wood, who first identified relation of the graviton to the unified field theory. When first established in 920, the station monitored gravitic wave patterns in the belt caused by Ember. In 1092, however, it was placed under Imperial Navy jurisdiction and declared off-limits to unauthorized traffic. Countless rumors abound as to its current function; among the most plausible is that it is the site of crude matter-transfer experiments. Since these experiments involve the conversion of matter to energy, they would have to be performed well beyond populated areas. Various antimatter experiments are also rumored to have taken place in the belt.

**Friend (G212764-G):** World subordinate to Vincennes, supplying raw materials to supplement Vincennes' own resources. Most settlements are on mobile mining platforms (gravitic or tracked) that cross the surface seeking materials. While they can be considerable in size (with some several thousand tons in displacement), these mining platforms carry only a few sophonts, with robot workers prevalent. For unknown reasons, anthropomorphic robots enjoy widespread popularity on Friend. Because it orbits Ember, Friend undergoes similar seasonal climatic changes to Vincennes, but these changes are less pronounced and usually pass unnoticed within the artificial habitats of the mining settlements.



The planet's one satellite, Greenwood, is a captured comet in a highly elliptical orbit; it's cometary tail takes on spectacular and unusual forms as it is buffeted by solar wind from both Ember and Undraczech. It is visible from both Vincennes and Friend at Ember-sunset (so long as Undraczech is not above the horizon).

**Paven** (EB87676-F): Until recently, Paven was Vincennes' main source of food. In 1118 a grain blight swept across the planet and wiped out nearly the entire crop. The source of this blight is unknown, but it was probably inadvertently brought on a merchant ship. While Vincennes can afford to import foodstuffs from other sources, Paven is on the brink of famine; foodstuffs have been channeled through Vincennes starport in a massive relief effort. This blight is considered to constitute an atmospheric taint, although it is not harmful to humans directly (but stepping out into Paven's atmosphere right after eating any grain product can create a distinctly embarrassing situation, as blight microbes make their way into the stomach...). In addition, departure from the planet must be accompanied by a physically unpleasant (and extremely undignified) personal decontamination procedure.

*Merchant's Advisory:* The VTCC has organized a famine relief effort known as the "Paven Foodlift", and it has been managed with the Commission's characteristic bureaucratic inefficiency. The program has lasted three years, and circumstances on Paven have improved only marginally. The Support Services Bureau has been impressing merchant vessels into the relief effort; dealings with the VTCC should be kept to a minimum, to avoid having one's vessel "temporarily" nationalized.

Discontented rumblings among the merchant community hold that the major exporters in the Commission are manipulating the Paven crisis to eliminate competition from Free Traders and smaller shipping companies. Several lawsuits have been filed on behalf of merchant's groups.

**GUAZHURNIIM SYSTEM (The Paven Sub-System)**

The Paven sub-system also contains the Vincennes system's third gas giant. Data for the system is as follows:

<u>Orbit</u>	<u>Name</u>	<u>UWP</u>
Primary	Guazhurniim	G1V
0	Craddick	YS00000-0
1	Lagahar	YS00000-0
2	Anashaldi	Y530000-0
3	Paven	EA77665-FAg Ni
9	Wharton	HS00146-E
4	Shozhul	LGG
2	(Ring)	YR00000-0
7	Plotkin	YS00000-0
10	Stopover	F320134-E Refueling Station

**TRAVELLERS' NOTES**

The traveller to Vincennes should make note of the season he or she arrives, because this will determine what protective gear is necessary. Heavy filter masks are the order of the day during the autumn, while light masks and cold-weather gear are in order during the winter. No protective gear is required during spring; although some particularly sensitive people may react to the trace

quantities of sulfur taint, the atmosphere is safe for prolonged exposure. During the summer, however, the atmosphere is completely unsafe without at least a full hardsuit such as a Scout Walkabout Suit. Even with this protection, high winds and violent storms make the outdoors unsafe without extensive safety equipment; tethers, lightning conductors, etc.

Travellers will also find it difficult to reach the surface and undersea settlements from orbit during summer (landing is a Difficult and Hazardous task), and most traffic is routed through the orbital settlements.

Traffic in the inner system is heavy, but visitors arriving in their own spacecraft have several options. Vincennes' orbital starport is an extensive facility, with numerous ship berths, hotels, and duty-free shops. Orbital berths are also the least expensive. From the highport, shuttles provide regular service to all gravitic cities, and seasonal service to all surface starports and spaceports. During the summer and early fall, flights to the surface are typically by charter only, and few pilots will fly unless there is a break in the weather over the Shoal.



Mike Villardi

The Highport is also home to the corporate headquarters of "G", the largest (virtually the only) marketers of TL-16 products in the domain. "G" imports goods from the surface in bulk; since its executives are all members of the Trade and Commerce Commission, it is able to circumvent most of the VTCC bureaucracy. "G" ships from the highport to its branches throughout the Domain, using both its own transports and hired freighters. Free traders can also buy directly from "G" at the highport.

Landing directly at one of the gravitic cities is also an option. The larger cities have facilities capable of handling vessels under four or five hundred tons, with a level of service equivalent to a Type C port. Unfortunately, berthing expenses are considerable,

and most ships that land at Grav Cities are Grav-Freighters loading supplies to take to orbit.

Vincennes Down Starport is an extensive facility built on high ground on Kehmed, and is the only permanent land settlement on the planet. Kehmed is composed of harder rock that does not erode as easily as the volcanic basalt of the islands, and the foundations of the starport buildings and landing pads pass down to the bedrock. Even so, the rains have worn away the surface around the buildings, and it is possible to tell the age of an individual building or landing pad by how far "ground level" is above the actual surface. A unique feature of Vincennes Down is its use of tractor and repulsor technology to guide incoming and departing spacecraft, especially larger vessels

Numerous smaller ports exist; most are built on platforms or Rockmat colonies in shallow areas, and provide services at widely varying levels of quality. These are generally built near undersea settlements, and mostly serve grav freighters ferrying goods from factory to orbit. If the main orbital and surface starports are full to capacity, these ports often receive business from the overflow.

#### JOB OPPORTUNITIES:

##### VISITING VINCENNES FOR FUN AND PROFIT

Most travellers are by nature adventurous; as the life-style suggests, most Vincennes inhabitants are not. However, Vincennes' wealth allows citizens to hire more intrepid individuals to carry out more unusual tasks for them, tasks for which robots would be either inadequate, or merely a bad investment. Contracts for such tasks are especially common and lucrative during the summer; flights to orbit through the summer storms (or rescuing such a flight that failed), for example.

- **Mercenary:** The appeals to a sense-of-adventure that are the basis of military recruitment everywhere have been understandably ineffective on Vincennes. As a result the Vincennes armed forces, both ground and space, often hire mercenaries to supplement normal recruiting. Pay is adequate, benefits are excellent, and equipment is obviously among the finest in the Imperium.

The Special Branch also hires a great number of off-world mercenaries, especially for the armed-intervention teams. Getting employment with the SB is difficult; some experience with law enforcement is preferred, as well as military or para-military experience. It is more common to be deputized by the SB than to receive full employment.

Recently, the Support Services Bureau has begun hiring independent investigators; supposedly a network of unscrupulous smugglers have been violating the Paven interdiction, selling food at wildly inflated prices and risking the spread of the blight to other worlds. If this network does exist, the Commission wants it disrupted; any information, especially shipping schedules and flight paths, would be handsomely rewarded.

- **Roving Recorder:** One common source of employment is recording adventures for entertainment purposes. This is especially popular on Vincennes, since it allows locals to vicariously enjoy a more "real-life" heroic life-style. Using advanced cybernetics, it is possible to implant a pocket holocommunicator on an individual's body.

There are several entertainment companies that will pay handsomely for data recorded in this manner; anyone with even a minimal reputation for getting into danger will be approached at



Mike Vilardi

some point by one of these companies. Rates are commonly Cr50-100 per day, with additional payments for particularly stunning and exciting recordings. Payment is received at the end of a half-year period; recordings are then edited down to a streamlined, entertaining format.

Some cybernetic recording companies simply provide the holoivid equipment and leave their agents to their own devices. The more affluent companies, however, actually create structured situations into which their agents can be drawn. Often the agents are not aware that the adventures are structured; thus their responses are more genuine.

- **Merchant:** Vincennes, being a major economic power, abounds with opportunities for independent merchants. Assuming one can wade through the VTCC bureaucracy (experience dealing with the Support Services helps), a fortune can be made shipping high-tech goods throughout the region. With numerous merchants being commandeered for the Paven famine relief, those who can avoid having their vessels nationalized will find numerous cargoes "orphaned" by the foodlift. This also gives an unusual advantage to smaller vessels, such as a Type-J Seeker or conceivably even a Type-S Scout-Courier, since their small capacities make them unlikely to be nationalized, and since many smaller manufacturers are increasingly desperate for a means to export their goods.

The Paven foodlift provides some particular opportunities for employment, especially working outside the official foodlift program. With the foodlift only marginally effective, black-market prices for synthetic foodstuffs have skyrocketed. The VTCC has banned independent trade with Paven and interdicted the planet, ostensibly to prevent exploitation of the suffering of the planet's inhabitants by profit-minded free traders. (This is, of course, what the VTCC itself is doing, but the Commission's Public Relations Office has kept this from becoming the popular perception).

For those willing to risk the System-Defense Boats enforcing the interdiction around Paven, there is considerable money to be made smuggling food to the surface. Chemicals and bio-engineered products for soil reclamation are also in demand; Paven is still an agricultural world, although it may take years or even decades to recover from the blight. There is also, understandably, a considerable demand for passenger transport off the planet.

Rumors in the merchant community hold that an underground humanitarian organization has been smuggling food to Paven, and helping to relocate refugees elsewhere in the subsector. Needless to say, the Commission is anxious that such an organization, if it exists, not be allowed to upset the VTCC's monopoly on the relief effort. Keep in mind that the Commission is still subordinate to the Imperial Legate, and that if it can be proven the Commission is exploiting the crisis, Imperial/Domain authorities would certainly step in to help the people of Paven, and the ensuing investigation could disrupt and discredit the Commission itself.

[Referee's Information: This is obviously the smuggler's perspective on the investigatory adventure seed in the Mercenary section. An interesting twist would be for characters to begin as VTCC Investigators, infiltrating the smugglers' network and revealing valuable information to the Support Service Bureau. Over the course of the adventure, however, they could come to see the smugglers as a humanitarian organization, the only group actually helping the people of Paven. They would then have to spend the latter part of the adventure undoing their accomplishments working for the VTCC.]

No world is simply a water world, or a vacuum world, or an agricultural world, and while Vincennes' technology is certainly of interest, it is more than just an unusually high-technology world. Like all worlds, it is home to intelligent beings existing in a society that is both unique, and still distinctly Imperial. It is at least equally important as Mora or Deneb or any other major world itself to the preservation of the Domain in these troubled times. Visiting this system should be a top priority for any Traveller in the Domain of Deneb.

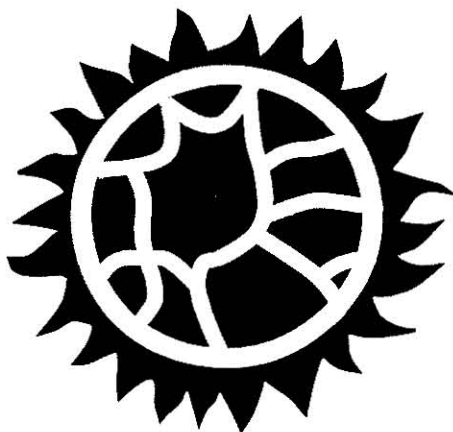

*"For Operations Both Private And Public"*

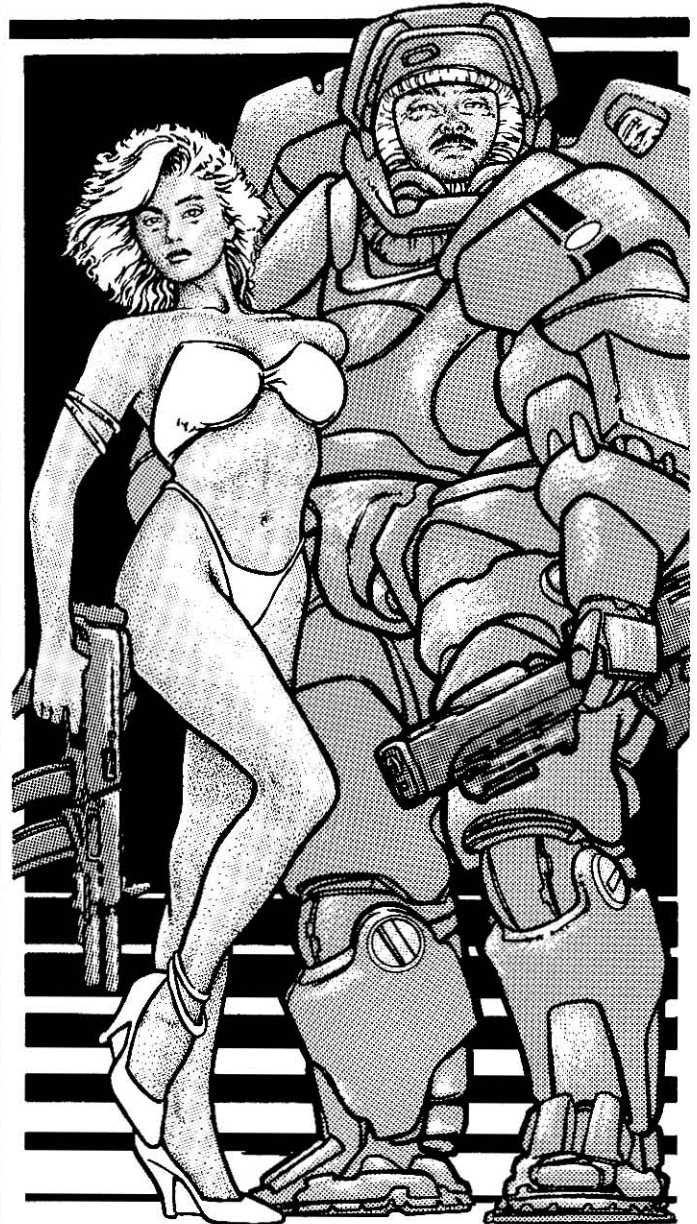

# HOEWAA

TACTICAL SYSTEMS, INC.

LIGHT AND MEDIUM WEAPONRY  
 POWERED PERSONAL DRESS SYSTEMS (PPDS)  
 COMBAT FIELD COMPUTERS  
 TEAM COMM AND ACQUISITION / RECOGNITION MULTI-LINK  
 MAN-PORTABLE HEAVY WEAPONS  
 HOLOGRAPHIC "MESON LIGHTCURVE" RECORDERS  
 FLIGHT HARNESES, PACKS & THRUSTERS  
 SURVIELLANCE  
 VOLATILE ENVIRONMENT LIFE SUPPORT AND TACTICAL SYSTEMS  
 COVERT ENTRY  
 PERSONAL FIELD GEAR & EQUIPMENT

CONTACT CONTROL CODE 48MN\* 733.611 FOR BROCHURE

*Blain Reynolds*

# MEGACORPORATIONS

IN THE REBELLION ERA: *By Greg Videll and Tom Peters*

Of all of the billions of businesses within the Imperium, only thirteen are of such scope and power that they can be called megacorporations. Although there are countless smaller businesses in Imperial space, it is these thirteen which make up the framework upon which the fabric of Imperial economics is draped. Their names are household words, their products common-place, and their logos easily recognized.

These thirteen are so large that no one person, or even group of persons, can know their exact status at any given moment. The number of beings they employ, directly and indirectly, their annual operating budgets, profits and even total shares of common stock defy imagination. In some places they merely lease the grounds their facilities occupy, but in others they own worlds or whole systems. They are so large that different divisions of the same corporation may work in opposition to each other without even knowing it.

## STRUCTURE

The megacorporations or "megacorps", as they are also called, are organized much like any smaller company. There is a board of directors, a chief executive officer, a president or presidents, a host of vice-presidents and so on. The difference comes in the amount of oversight these high level officers have. For the most part, due to distance and travel times, they only make general policy and assign long term goals and objectives. Day to day, and even month to month, operation of the megacorp's divisions falls under a regional general manager (RGM) or other individual with a similar title.

An RGM may control only a fraction of the corporation's total assets, but that fraction may amount to more power than that wielded by local Imperial officials. While a small number of Imperial and local regulatory agencies have power over the megacorps, regional managers can conduct business pretty much as they see fit. One unwritten rule remains inviolate though - direct confrontation with the Imperium is expressly forbidden because of the effect it could have on business. Of course this only means that RGMs are a little more careful where violations of Imperial law are concerned.

All this was true before 1116 - business as usual conducted the same way it had been for hundreds of years. As with so much else in the Imperium and its surrounds, Dulinor's four pistol shots changed everything.

## THE IMPERIUM SHATTERS

At the start of the Rebellion, the megacorps were thrown into a reactive mode, as was nearly everyone else in the Imperium. Initially, the conflict between Dulinor and Lucan caused them to make some changes in the way they did business, but it was felt that the sum total of each corporation could handle the disruption (Much as the Frontier and

Solomani Rim Wars were handled).

As the Rebellion conflict escalated, regional managers in Dagudashaag and Zarushagar found communications with their headquarters in Core increasingly disrupted. This led them to adopt a wait and see attitude while making the adjustments necessary to continue business as usual. Most divisions in Illeish, following the long-standing policy not to antagonize the ruling authority, sided with Dulinor or at least tried remained neutral (raking in big profits as they switched to a war footing).

The megacorporations took advantage of the situation to increase profits, but at the same time, they also suffered from the effects of a fragmented Imperium. It became harder to move resources and finished goods across contested space. Factories, warehouses, offices and other property became the target of factional armies and navies, pirates and commerce raiders. Corporate infighting gave rise to nasty tradewars and terrorist actions. Individual systems nationalized megacorporate property, insurance rates rose dramatically, and financial institutions were less willing to fund new or continuing ventures. Lastly, markets fluctuated as factions came into being and new borders were established.

In time, the cost of doing business began to outstrip revenues from war profiteering. For the first time in their history the megacorporations were operating at a net loss. Events had just moved too fast in too many places for them to adjust quickly enough. In essence, the fragmentation of each megacorporation mirrored the disintegration of the unified Imperium. And when the megacorps fragmented, so did the Imperial economy.

## THE VITAL LINK: TRANSPORTATION

It's no accident that the Third Imperium claimed control of the space between the stars. In order to maintain both an interstellar empire and economy, it was absolutely necessary to make system-to-system transportation safe, efficient and cost effective. By controlling and protecting the starlanes, the Imperium insured its own power and the health of its economy.

The Rebellion struck at this vital link. The result was widespread economic depression. Not all transportation in the Imperium was directly imperiled, but even the *possibility* of disruption had repercussions. Due to their vast nature, the megacorps were intimately tied to this interstellar "ecosystem". Only this time the corporations didn't have unaffected divisions to absorb the shock, unlike the periods during previous regional upheavals and conflicts. As one division declined, so did the others and a vicious circle developed.

Sometime between late 1118 and mid-1119, the megacorporations fell below the point at which they could be considered Imperial in scope - they technically stopped

being megacorporations.

### CONSOLIDATION AND RECOVERY

By 1119, most megacorporations had stabilized their decline on the divisional and factional level as RGMs redefined their goals and operating procedures. Whether it was on the regional or factional level depended on the faction involved. For example, Deneb and Antares developed factional subdivisions of the megacorporations while branches in Lucan's Imperium were either stifled or controlled through forced government subsidy. (This was

evacuated. This also presented plenty of opportunity for small businesses, new and old, to flourish and fill in the gaps left in the market.

The reverse became true within the Restored Ziru Sirka where the Vilani megacorps muscled out the other corporations. The transformation of the megacorporations didn't eliminate the economic impact of the depressions, although it did help reverse, or at least halt, the downward spiral. Times were still tough when a new source of concern raised its head.

In every sector of the Imperium there had been companies,

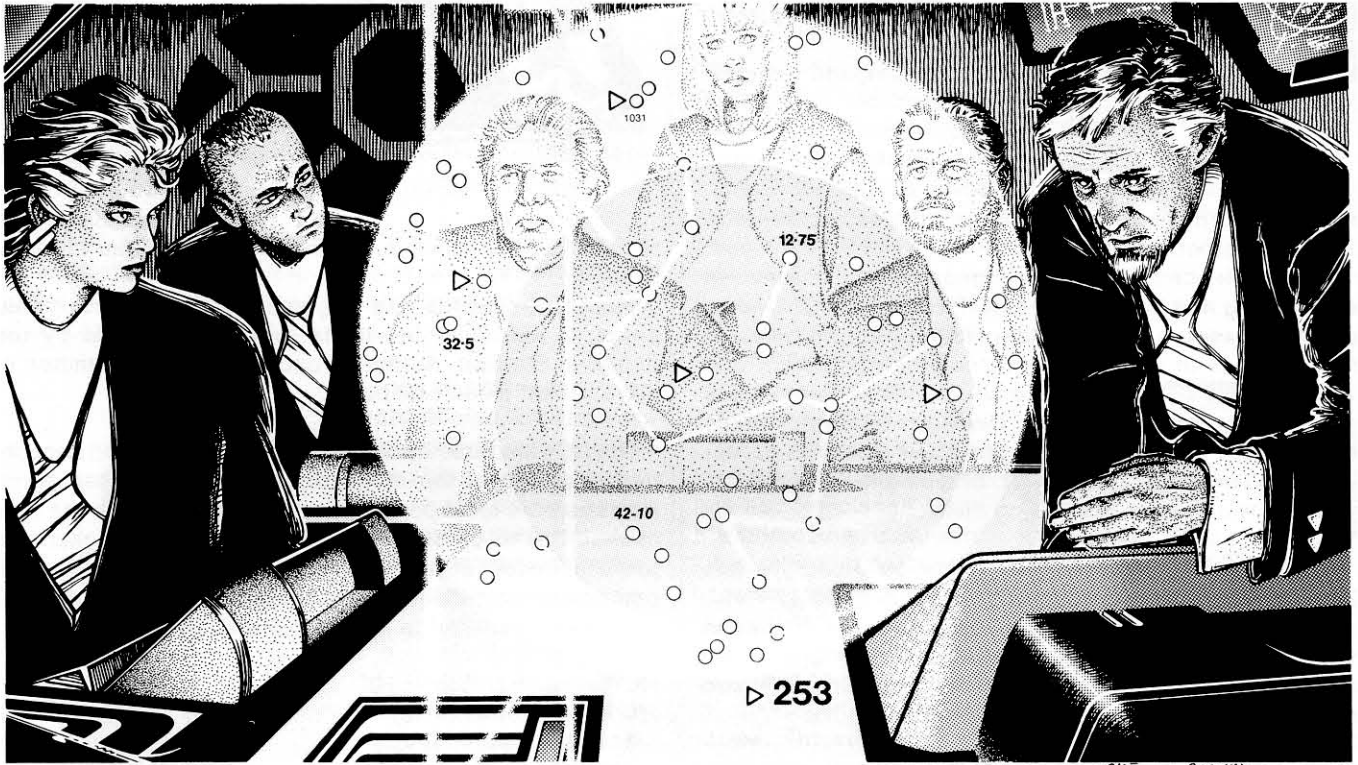

Blair Reynolds

due to Lucan's fear of the megacorps becoming too powerful). In each case, the megacorporation was thus transformed into many smaller, leaner organizations better able to meet the needs of regional consumers. The transition was accomplished in a number of ways.

Hoping to make themselves indispensable, the megacorps solicited the attention of the political powers around them. Contacts in the military, nobility and bureaucracy which had been cultivated years and even decades earlier were exploited, sometimes without them even knowing it.

In the struggle to maintain their plateau of power, the megacorps used a wide array of tactics. These included, but were not limited to, political support, "pork barrelling", kickbacks and even blackmail to achieve their goal. In a few extreme cases, corporations became shadow governments with RGMs quietly calling the shots from behind the scenes.

The timing as to when each corporation was able to bring things under control depended on local events and RGMs. To some extent, the surviving megacorps were assisted by the withdrawal of the Vilani megacorporations. Markets which were previously closed, opened up as the Vilani

before the Rebellion, who lacked the resources to seriously challenge the megacorporations. They were large businesses in their own right and they also suffered the effects of the depression. However, because they were less tied to the rest of the Imperial economy, were better able to survive. These former sector and subsector wide corporations began to make their presence felt as they competed for available consumers. Today several are on the road to fulfilling their dreams of achieving megacorporate status. Fortunately for the megacorporations, a single division often remains the most powerful business in a given area.

In 1120, what was left of the megacorporations continued to rebuild and consolidate their former power. Efforts were being made by RGMs who remain loyal to their employers to reestablish ties between divisions or factional regions. In some circles, there was even talk of returning megacorporations to their former glory.

On the other hand, there were those RGMs who had come to enjoy the vast power they wielded and had no intention of relinquishing it. They saw their position as a

stepping stone to greater things.

**THE MEGACORPORATIONS IN 1121**

The above section deals with the general Rebellion history of the megacorporations. What follows is a more detailed look at how the individual corporations were effected by the Rebellion. Following each entry is a seed idea for an adventure involving that particular corporation.



**Delgado Trading LIC**  
(*Miniaturization, heavy mining and refining, publishing, antiquities trading*)

Delgado was sufficiently diversified before the Rebellion so that individual divisions have survived largely intact,

though they tend to be more isolated from each other than with other corporations.

Two notable points regarding Delgado's operations involve its publishing and trading interests. First most of Delgado's publishing assets are firmly under factional control, in many areas. This is in order to better control information and public opinion. Second, factionalism has increased the value of certain unique goods. There are those resources and products which lie just on the other side of a border which can't be duplicated locally. Shipping them home has created a windfall for the trading divisions.

- A Delgado mining and refining station orbiting a gas giant has fallen out of contact with regional headquarters. Reasons could vary, from an attack by an up-and-coming rival corporation, a find of an anaerobic life form which consumes metals, or an asteroidal collision which crippled the base. The PCs are sent to investigate.

**General Products LIC**  
(*Starships, non-starships, heavy machinery*)

General has long had a reputation for producing products of only adequate quality. The corporation was beginning to make inroads on improving their reputation when the rebellion cut their efforts short. Subsequently, the quality issue was largely overlooked in favor of acquiring badly needed products to support the war.

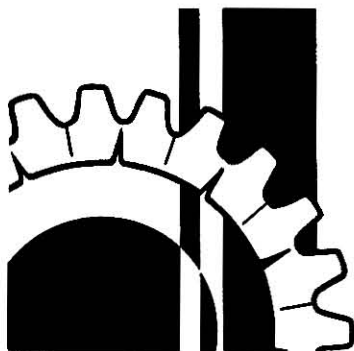

The need to manufacture products quickly further eroded General's quality, leading to a string of embarrassing public failures. As a result, General Products remains in poor shape and is having a difficult time recovering. Some express doubts that its divisions can survive.

- GP seeks to hire a group to locate a downed, experimental GSbAG courier ship which contained vital manufacturing secrets. Unfortunately, the ship went down on a low tech world with a fanatic anti-technology bias.



**GSbAG (Starships)**

GSbAG, being a one product corporation, did amazingly well for itself. It funneled the profits earned from up-gunning commercial merchant ships as well as building and repairing warships. They also capitalized on developing custom ship designs which catered to local needs. Product quality remained consistently excellent. As a

result, GSbAG won many customers over from General Products.

Recently, GSbAG has begun to branch out. In some areas, it has filled the niche formerly occupied by the Imperial Starport Authority and operates a number of starports on a contract basis.

- The PCs are hired by GSbAG to serve as starport security troops at one of the megacorp's newly controlled ports. However, the local population is not pleased with the idea of their link to other worlds remaining in the pocket of a private corporation with vested interests. Through demonstrations and sabotage, the locals try to force GSbAG to relinquish control to local concerns.

**Hortalez et Cie LIC**  
(*Banking, investments*)

The depression resulting from the shattering of the Imperium was not kind to Hortalez. It took extensive rework and consolidation of the surviving divisions to allow them to remain viable. Many are still digging out and rebuilding.

Out of necessity, Hortalez has become conservative in terms of the investments it makes. However, this attitude has softened as the corporation has absorbed the client base abandoned by Zirunkariish, the Vilani banking megacorp. Previously, Zirunkariish had been Hortalez's only major competitor.

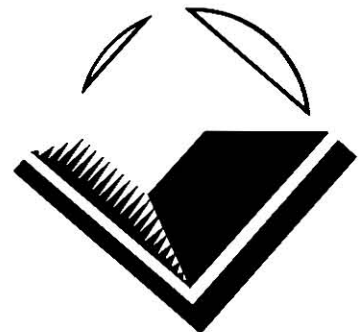

- The characters are part of a team negotiating a transfer of assets between Hortalez and a Vilani megacorporation. Unfortunately, local planetary concerns feel that, with the withdrawal of Zirunkariish, the assets defaulted to local government control.

**Instellarms LIC** (*Military equipment*)

For obvious reasons, Instellarms has done very well by the Rebellion and continues to enjoy the favor of the various factions. However, this doesn't mean that its assets have escaped unscathed. Instellarms remains a primary target for factional and popular forces wishing to cut off the flow of arms to an enemy. Finally, the corporation has been accused many times of supplying both sides of a conflict through back door means, but to date such allegations remain unproven.

- The PCs are hired to discover the reasons behind a sudden proliferation of arms in the area. Clues lead them into the discovery of a covert Instellarms supply operation - which, naturally, wishes to remain covert.

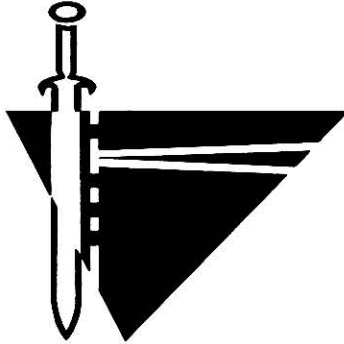

**Ling Standard Products** (*Mining, electronics, ground and air vehicles, starships, ship's armaments and drives, power generation systems, computer systems, software, small arms*)

LSP is perhaps the most diversified of the non-Vilani megacorporations. Its products came to be so integral to the war effort, that although sundered into its component

divisions, it still retains great power. Of late it seems that more and more of this power is being channeled into political pursuits.

LSP has done very well by stepping into the shoes of its former chief competitor, Naasirka. In some regions it has even become the chief supplier of electronics to the military.

- The PCs are recruited to protect an electronics expert from an LSP extraction (ie. kidnapping) attempt or they are hired by a megacorp to pull-off an extraction.

**SuSAG LIC** (*Chemicals, pharmaceuticals, geneering*)

Unfortunately for its corporate image, SuSAG is inevitably linked to the chemical and biological weapons (CBW) it produced for the Imperium before the Rebellion. Although the actual use of CBWs has been limited, their manufacture by SuSAG has made the corporate facilities an inviting target for both factional forces and local populations fearing an industrial accident. As a result, the megacorp's mercenary forces have become well experienced in military style



operations. Often ignored are the efforts of SuSAG's pharmaceutical and geneering divisions to heal the ravages of war. Corporate RGMs are uniformly funding media campaigns to highlight this fact and new products are given wide press. Finally, rumors that SuSAG's extra-Imperial psi drug plants have experienced a boom in business has yet to be confirmed. Despite great difficulties, SuSAG's scattered divisions generally remain in good shape.

- The characters must pass through hostile space in order to acquire and then deliver a critically important SuSAG vaccine to a plague stricken world.

**Sternmetal Horizons LIC** (*Mining, manufacturing, power generation systems, food processors*)

Sternmetal has traditionally had an aggressive business style. This has not diminished since the start of the Rebellion. Of all of the former megacorporations, Sternmetal is perhaps the one which has remained the most cohesive, even though it is no longer Imperial in

scope. The corporation has been attempting to soften its somewhat predatory image by highly publicizing its aid to damaged worlds in the form of power systems and food processors.

- False evidence, planted by an old enemy, implicates the characters in the destruction of Sternmetal property. The PCs need to clear themselves before they are captured by local authorities and quickly convicted in a show trial.

**SPECIAL CASES: The Vilani Megacorps**

**Makhidkaru** (*Communications, entertainment, software, gourmet foods*)

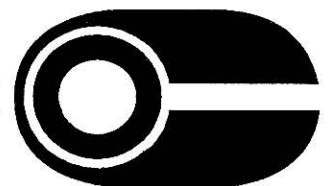
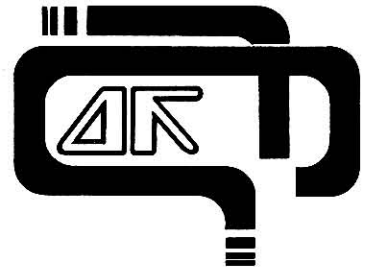

**Naasirka** (*Information storage and processing equipment, software, computers, robots, electronics*)

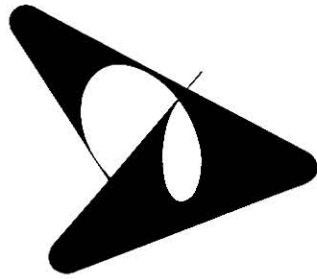

**Sharurshid** (*Trade, speculation, luxury goods*)

**Zirunkarilish** (*Banking, investments, insurance*)

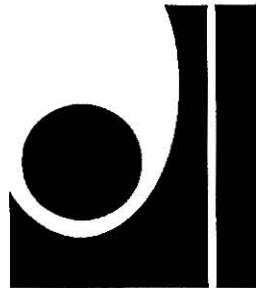

The Vilani megacorporations run the gamut of products and services needed by any interstellar power (With the exception of a major ship builder). This has served the Restored Vilani Empire (RVE) well. It allows the corporations to remain viable businesses while at the same time adapting to the mechanics of governing the region. It also means they've had to cut far fewer employees than if they remained solely commercial ventures in dwindling markets (Which better accommo-dates the Vilani mindset toward lifelong employment).

It is probable that if the Vilani megacorps had not been recalled, Makhidkarun and Sharurshid would have been faced with serious problems, concentrating as they do on luxury and recreational products. Regardless, there's been a sizable drop in profits resulting from smaller available markets.

The other Vilani megacorps, Naasirka and Zirunkari-ish, have been given a virtual monopoly in their respective fields. They've taken the lead in absorbing or reducing the non-Vilani corporations which remain in Vilani space (A brutal process given Vilani business practices). They've also been the most active in establishing links to those factions, Deneb and Antares among them, interested in maintaining megacorporate business ties, .

The recall of the Vilani megacorps to the RVE is one of the more interesting results of the Rebellion. On appearances, the megacorps simply sold their facilities, boarded transports

and headed for the RVE, but the actual situation was much more complex.

Facilities and resource supply contracts were not the only items sold off. Corporate divisions took to bartering away trade secrets and patent rights in an effort to acquire needed or wanted raw materials and capital. Not a few corporations of all sizes lined up to bid on this information and those who proved most successful were the ones who could best bow to Vilani customs. Unfortunately, even taking over a former Vilani operation wholesale was no guarantee of success.

Finally, instead of direct competition, some non-Vilani megacorporate divisions within the RVE took to negotiating an exchange of assets and markets as a means to get out of Vilani space peacefully and profitably. In this way, resources were directed toward business and not tradewar or cut throat competition in a hostile market. Such exchanges continue today on an irregular basis.

A full treatment of the Vilani megacorporations is beyond the scope of this article. For those wishing additional details, *The Mega Traveller Alien Vol. 1: Vilani and Vargr* (DGP 1990) should be consulted.

**Tukera Lines, LIC** (*Transportation*)

At first glance, Tukera should have been the corporation hardest hit by the Rebellion and the ensuing depression but the situation has layers of complexity that elude casual inspection.

The cost of doing business skyrocketed with the need to arm, provide armed escorts for, and increase insurance premiums for the vast fleet of Tukera ships. The corporation compensated by cutting its routes and passing the costs on to its customers in the form of more expensive passages (A violation of Ministry of Transportation regulations, but one overlooked in the chaos of the Rebellion).

Additionally, the heart of Tukera's operations were its routes at the core of the Imperium, where it had a virtual monopoly. These had always been Tukera's fundamental source of income and they were sorely hurt by fighting between the Vengeance and Loyal Fleets.

Despite these factors, many of Tukera's divisions have come through the Rebellion and survive today. Although services were cut, Tukera remains the only shipping line capable of consistently moving passengers and freight in many areas. Continued operations come at a cost, though. Due to the Tukera/Margaret connection, the line has come under scrutiny when operating in other factional regions. Industrial sabotage, false spying accusations, and unfair business practices are only part of what Tukera crews have to deal with.

The current status of each division is very much on a case by case basis. Some are barely functional while others,





especially within Margaret's Stronghold, are thriving. Always Tukera RGMs keep an eye on the smaller shipping lines around them, just in case one should become a serious threat.

### BEYOND THE MEGACORPS

Should the megacorporations not even directly enter into an adventure or campaign, it's still possible to bring the information contained in this article into play. Customers cut off from megacorporate products and services have three choices - do without (not always possible), find another source, or develop their own. Player characters can play an integral part in any one of these choices. Some examples of this include:

- Tukera no longer services an isolated subsector necessitating the hiring of PCs to run the route on an as needed basis (Local consumers can do without most of the time).

- A wealthy patron has been cut off from her SuSAG anagathics and the characters are hired to find a reliable new source.

- An asteroid colony regularly needs critical replacement parts for its LSP life support system. Obviously, they can't do without the parts, but the only nearby LSP plant has been bombed out of existence. It falls to the character group to locate, buy/steal, and bring back the necessary equipment and knowledge to build the parts at the colony.

In this way, megacorporate history has played a part in an adventure without the PCs ever coming face to face with a corporation.

### MEGACORPORATE ADVENTURING

The information presented in this article has a number of uses. It can be used to enhance the background against which adventures are played, making charted space a more interesting place in which to adventure. Single adventures dealing with the megacorporations can be a change of pace for players or help them to better immerse themselves in the Rebellion and its disruptive effects.

Best of all, this article can provide the underpinnings for a megacorporate campaign, perhaps tracing the recent history of a single megacorp or its division. It's up to the individual referee to decide how best to tailor the information to his needs.

A megacorporation, whether poor and struggling or strong and influential, can easily fit the traditional *Traveller* roles of patron, catalyst or villain. Megacorporations serving as patron can provide funding, information, equipment, and motivation as needed. The fact that not even a megacorp can have the right people with the right skills at the right time and place leads to the need to hire travellers for a number of roles.

Long term employment with a megacorp is not without its benefits. Where the Imperium has failed, the corporation insures that "the trains run on time" and that a measure of

stability is maintained. "Why follow a distant and questionable leader", the line of thought goes, "when the corporation takes care of my needs?"

For some characters, loyalty to the empire, a sometimes nebulous concept to begin with, will be replaced by loyalty to the megacorporation. In return for faithful service, the PC receives a permanent job, medical care, training, protection for his family and other benefits. For those dislocated by the Rebellion, a corporation can become a new home after the character's own has been lost, (presumably after a number of harrowing assignments). This in turn may give rise to an interest in advancing up the megacorporate ladder — potentially a fast-paced climb, in some more chaotic regions.

The "trouble-making megacorporation" acts as an impediment to the character's actions, forcing them to expend additional resources and effort to achieve their goals. The megacorp may not even be aware of the PC's existence, yet still be a nuisance. For example, the power regulator a group needs for their damaged ship has already been bought by Tukera Lines or a world owned by LSP denies permission to leave until the proper paperwork is filed.

Megacorps can also serve in the adversarial role for characters who are starting their own business. Especially with the void left by the Vilani-megacorporate pull-out, there are plenty of new market opportunities for small businesses. Of course the remaining megacorps want their piece of the pie as much as do any other company.

A megacorporation in the role of villain is a direct and continuing threat to the characters. The group's actions may be directed against or be in competition with those of a corporation and its agents. Depending on the status of the opposing division, the PCs may be faced by a team of professional mercenaries or a group of NPCs not unlike their own.

The types of activities undertaken by a megacorporation, whether it plays the role of patron, catalyst or villain, are only limited by the imagination of the referee. It's important to remember that the environment in which the megacorporations now operate is vastly different than what they're used to. Instead of a fairly static Imperium, they now do business in a dynamic setting with new political, military and economic considerations. Where once a corporation sought to subtly influence the government, it now *is* the government, with all the benefits and headaches that entails. Without the Imperial Navy to protect the starlanes, corporations now possess powerful starships forbidden them five years ago.

These are just a few of the considerations involved when bringing the megacorporations into an adventure or campaign. What follows are a few specific examples of corporate activities to help get referees started.

- *Tradewar*. The rather well defined, although unwritten, rules governing tradewar before the Rebellion have blurred somewhat over time. Instead of being limited to corporate employees and property, it has now expanded to include acts of terrorism aimed at the general public and military style operations. It is sometimes difficult to determine whether a tradewar or a "real" war is being fought unless the participants are clearly identified.

- *Espionage*. Industrial espionage has always been a tool of the trade for the megacorporations, but with the problems attending the Rebellion, it has been given a new emphasis. Data base raids and theft of prototypes or other hardware have become an important part of maintaining a competitive edge. Similarly, keeping track of the political climate, from the inside, has become crucial to corporate survival.
- *Defection and Kidnapping*. Sometimes the skilled person a corporation needs most works for another corporation. In cases such as this, a megacorp may attempt to entice that person away from their employer through promises of money, prestige, better facilities or a more palatable ideology. Should such inducements prove insufficient or time does not permit such an approach, the megacorps have been known to resort to kidnapping to get who they want. Security forces, both to conduct and guard against kidnapping, have been beefed up as a result.



Blair Reynolds

• *Exploratory Trade*. At one time, exploratory trade would have been taken to mean searching for new markets beyond the borders of the Imperium. While this is still true, and is dealt with below, it has also come to include reestablishing old markets and evaluating new ones in adjacent space. The Rebellion has so changed the face of what was once the Imperium that just expanding into or returning to the next subsector can require a heavy investment of manpower and resources.

The megacorporations have always had extra-Imperial divisions who were tasked to forge links with alien races and governments. In 1121, a greater emphasis has been placed on these divisions to quickly establish ties to markets

and resources not disrupted by the depression. Corporations in the Spinward Marches for example, cut off as they are from the Imperial interior by the Vargr, are particularly concentrating on the human client states of Foreven sector and beyond. Margaret and Vland, most notably, have been doing much the same outside their respective domains.

Exploratory trade, especially inside former Imperial space, remains a high priority for the megacorporations.

• *Diplomacy*. Diplomacy has a dual meaning when considering megacorporate operations. On the one hand, it may mean the efforts of a corporation to gain influence in or over a region. Sometimes in order to gain their objective, the megacorporations prefer to use a soft touch when attempting to acquire power. It allows them to stay out of the limelight, letting others do their fighting for them. On the other hand, diplomacy may mean the maintenance of power already attained, especially with respect to factions or power blocs concerned with competition.

**REFERENCES**

Additional material on the megacorporations can be found in the following sources.

- "SuSAG", Journal of the Travellers' Aid Society (GDW 1983)
- *The Traveller Adventure* (GDW 1984)
- Supplement Number 8, *Library Data A-M*, (GDW 1982)
- *MegaTraveller Referee's Companion* (GDW 1988)

**HEROES OF YESTERDAY AND TOMORROW**

**Fantasy and Science Fiction Character Illustrations**

Players and referees alike will find this collection to be a handy sourcebook. This is the kind of book players can browse through and say, "Oh! Now that's me — that's my character!"

Artists include some of the industry's favorite illustrators: Rob Caswell, Liz Danforth, David R. Deitrick, Rick Harris, Michael Vilardi, and Blair Reynolds, and other skilled artists.

Ask your dealer for this fine book or order direct by sending \$7.95 plus \$1.50 P&H (WA residents include 7.5% sales tax) to:

StarLance Pubns., 50 Basin Drive, Mesa WA 99343

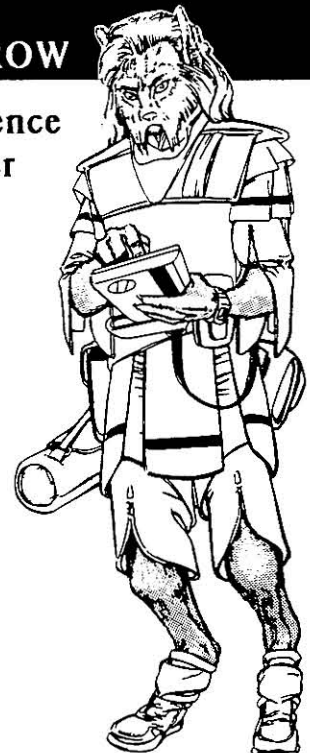

For Use With: **TRAVELLER - MEGATRAVELLER - TRAVELLER New Era**

Starship Deck Plans in 25mm scale

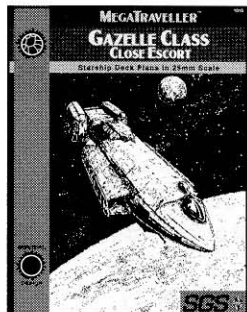

#1015 - \$11.95  
Gazelle-Close Escort

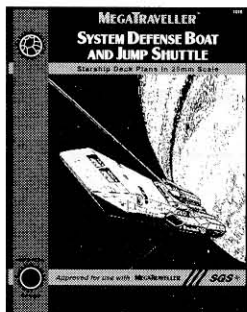

#1016 - \$11.95  
SDB & Jump Shuttle

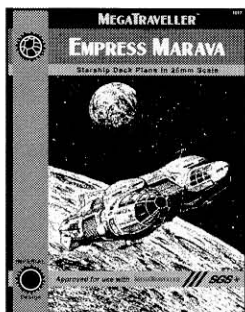

#1017 - \$11.95  
Empress Marava

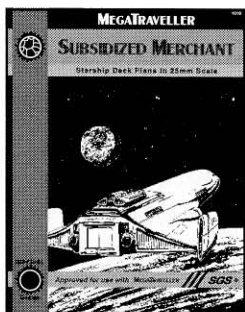

#1019 - \$11.95  
Subsidized Merchant

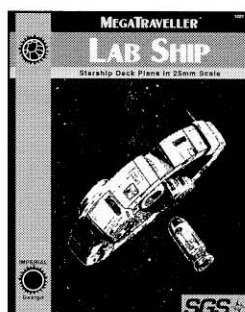

#1021 - \$12.95  
Lab Ship

Starship Deck Plans in 25mm scale

Starship Deck Plans for Available in 25mm Scale

**2300AD**



#3001 - \$11.95  
S.S. Virginia

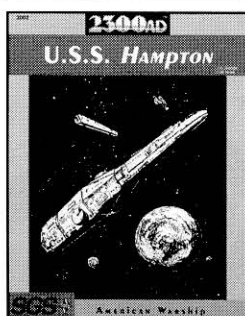

#3002 - \$11.95  
U.S.S. Hampton

For use with: **TRAVELLER - MEGATRAVELLER - TRAVELLER New Era**  
Look for this New Release

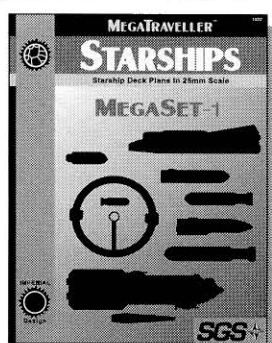

#1022 MegaSet-1, \$19.95

**MegaSet-1**

Take advantage of this limited release of "MegaTraveller Starships: MegaSet-1". Add new dimensions of excitement to the Traveller universe with the *Gazelle*, *Empress Marava*, and *Lab Ship*, plus the *Imperial Small Craft*, a set of five vessels which may be used individually or in conjunction with the other deck plans. So take advantage of the detail and value of "MegaSet-1".

Starship Deck Plans in 25mm scale

Add some Excitement to your Gaming Adventures

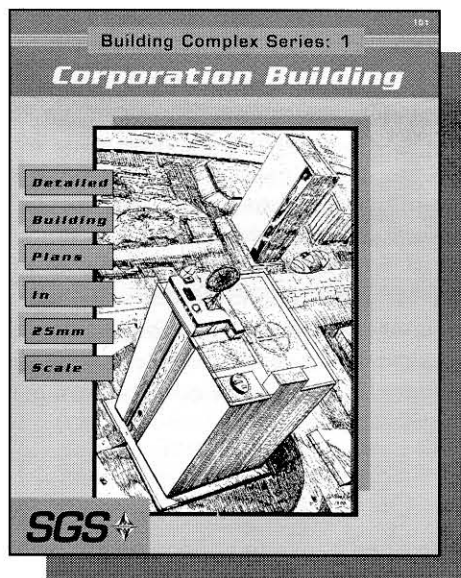

**Building Complex Series:**  
The Building Complex Series presents a fully detailed environment in 25mm scale. The *Corporation Building* and *Research Facility* are designed to be used with role-playing games set in both the near and far future.

The planet's in a turmoil, torn by the storm of rebellion. The corporation has evacuated the world, but you're being sent back. A special project is missing, and your assignment is to find it.

**Corporation Building:**  
#101 - \$12.95

The opposition has occupied a corporate facility and is finishing the work that the company has started. Your mission is to get the vital research back as the corporate confrontation intensifies.

**Research Facility:** #102 - \$12.95

\*Available this Summer\*

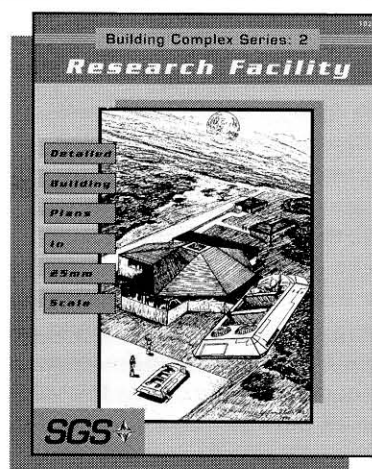

Place your order today!!!  
**1-800-487-7289**

Orders only Please!



**SEEKER GAMING SYSTEMS**  
P.O. Box 1027, Spanaway, WA. 98387  
Voice/FAX Line (206) 535-6513

# ALIEN JOKES

MAKING THE ROUNDS IN STARPORT BARS  
(or SOME THINGS NEVER CHANGE): By Mike Metlay

Q: How many Vilani does it take to change a light bulb?  
A: I'm not sure. What does the manual say?

•—•

Q: How many Solomani does it take to change a light bulb?  
A: Fewer than anybody ELSE, drat it!

•—•

Q: How many Zhodani does it take -  
A: ...to change a light bulb? I knew you were going to ask that.

•—•

Q: How many K'kree does it take to change a light bulb?  
A: As many as can fit in the room.

•—•

Q: How many Aslan does it take to change a light bulb?  
A: Male or female Aslan?

(or, more elaborately...)

Q: How many Aslan does it take to change a light bulb?  
A: Female; only one. Male; at least seven, 'cause I've seen six trying. [if desired, pantomime fierce glowers and head-scratching here]

•—•

Q: How many Vargr does it take to change a light bulb?

Mike Jackson

A: Four. One to get a ladder, one to slug the first one and take the ladder away, one to slap the second one around and force him to hold the ladder while the first one wipes his bloody nose and climbs the ladder, and one to stand by and smirk until the job's done and take credit for it.

(or...)

Q: How many Vargr does it take to change a light bulb?  
A: YES! [insane half-barked, half-howled laughter]

•—•



Q: How many Hivers does it take to change a light bulb?  
A: "Light bulbs"? How primi-tive!

(or...)

Q: How many Hivers does it take to change a light bulb?  
A: None. They get someone else to do it. (and what's worse, they make them think it was his idea all along!)

(or...)

Q: How many Hivers does it take to change a light bulb?  
A: (hold up both hands and rapidly wiggle fingers).

•—•

Q: How many Droyne does it take to change a light bulb?  
A: Six. It always takes six. EVERYTHING always takes six.

(or...)

Q: How many Droyne does it take to change a light bulb?  
A: Six. A worker to split a claw trying to hit nails in the dark, a warrior to rough him up for damaging valuable nails with his carelessness, a drone to cast the coyns and decide if maybe darkness isn't a good idea, a leader to trip over the

hammer and scream for something to be done at once, a technician to immediately implement a feasibility study for future illumination patterns, and a sport to watch the proceedings with resignation, sigh, and go get a light bulb and a ladder.

(or...)

Q: How many Droyne does it take to change a light bulb?  
A: (look around fearfully, then hesitantly peep in a tiny voice:)...One?



# MEGATRAVELLER

## Equipment Detail Sheet

© 1991 Digest Group Publications and Game Designers' Wkshp.  
Permission granted to photocopy for game use.

# CARGO CONTAINER (SEALED)

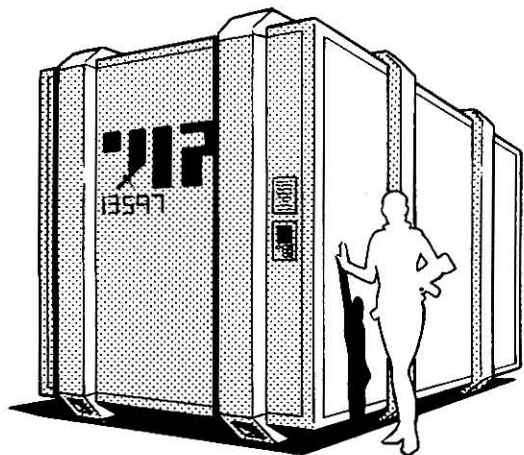

TM 91

Tech level 10 version illustrated

### EQUIPMENT STATISTICS

TL	Type	Vol	Wt	Price
○ 5	Sealed Cargo Container	54kL	10.93tons	Cr8,700
○ 6	Sealed Cargo Container	54kL	8.75tons	Cr8,700
○ 10	Sealed Cargo Container	54kL	2.7tons	Cr9,600
○ 12	Sealed Cargo Container	54kL	2.3tons	Cr8,700

### SUPPLEMENTAL STATISTICS (Optional)

TL	Hits	Armor Value	Construction
○ 5	4/9	10A	Soft Steel
○ 6	4/9	10B	Hard Steel
○ 10	4/9	10E	Crystaliron
○ 12	4/9	10F	Superdense

### USAGE RECORD (Optional)

- With proper care, a cargo container will last for years.

### CUSTOMIZING NOTES :

### DESCRIPTION

Containerization is a major revolution in freight handling. Instead of loading a shipment directly into the hold of a ship, all goods in a particular shipment are placed in one or more standard-size containers.

Cargo handling becomes much easier, as only a few containers of standard sizes must be moved, instead of many with widely varying dimensions. This is particularly important at lower technological levels, when cargo handling robots and equipment are far less versatile.

All-tech level 10+ units come with an integral control plate. This allows merchants to enter the container' manifest, for

easy reference, lock and unlock the unit, activate and monitor the container's security seals, as well as monitor internal conditions. Access to the containers is usually restricted by the use of card readers or key codes.

This version of cargo container is in wide use and can be sealed against vacuum or gases. This not only makes it environmentally flexible, but also ideal for transporting delicate goods. More expensive models come with environmental control systems for regulating temperature and monitoring atmospheric content.

### TASK LIBRARY

To repair a damaged cargo container:  
(varies), Mechanical, Str, (varies)

*Referee:* Difficulty depends on damage level. Use the standard damage and repair guidelines. Time increments for shop repairs are as follows:

- Sperficial damage.....30 sec.
- Minor damage.....2 min.
- Major damage.....40 min.
- Destroyed.....2 hrs.



# MEGATRAVELLER

## Equipment Detail Sheet

© 1991 Digest Group Publications and Game Designers' Wkshp.  
Permission granted to photocopy for game use.

# GRASHFALT

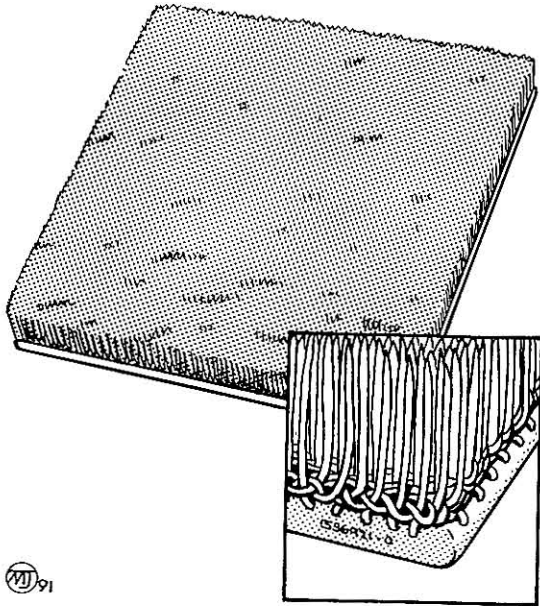

### EQUIPMENT STATISTICS

TL	Type	Vol	Wt	Price
○ 10	Primitive Grassfalt	12L	6kg	Cr8,000
○ 13	Grassfalt	10L	5kg	Cr7,000
○ 14	Improved Grassfalt	9L	5kg	Cr6,000
○ 16	Qwikgro Grassfalt	8L	5kg	Cr5,000

### SUPPLEMENTAL STATISTICS (Optional)

TL	Growth Increment	Temp. Range	Area Covered	Comments
○ 10	2 days	80 C	1,000 sq m	Rqs wly trace compounds
○ 13	1 day	100 C	2,000 sq m	Rqs mnthly trace compounds
○ 14	1 day	120 C	4,000 sq m	Imp. chemical tolerance
○ 16	6 hrs	180 C	4,000 sq m	Faster repair times

### USAGE RECORD (Optional)

- Grassfalt will last until diseased or damaged.

Tech level 13 version illustrated

### CUSTOMIZING NOTES :

### DESCRIPTION

In any urbanized culture, there is a need for durable outdoor ground coverings. Along the Solomani Rim, many worlds use plants geneered for durability. While exact details vary, as a class they are similar. "Grassfalt" is a generic term, believed to be an old brand name from the days of the Terran Confederation.

The plant (root stock, if you will) is a ground-runner similar to Terran chickweed or Esperancian tripwire. It is highly tenacious and can survive extreme environmental conditions such as contaminants, heat, drought, and heavy trampling.

Several limitations have been programmed in to grassfalt's genes to prevent the plant from taking over a local ecology. It

requires periodic fertilization with trace amounts of synthetic compounds, thus a plant that "goes wild" will not survive for long. Proximity of one root system to another is controlled by chemical triggers released by the roots—the plant 'prefers' to root close together, thus a mat of grassfalt tends to stay in a compact clump. Finally, the plant cannot seed itself (which limits the chance of mutation).

The "Temperature Range" displayed in the stats above, indicates the difference between minimum and maximum temperatures. The exact min/max values will depend on the variety of grassfalt being grown.

### TASK LIBRARY

To plant a packet of grassfalt:

Routine, Biology, Edu (varies, see *Growth Increment* above)

*Referee:* Increase the task difficulty when environmental conditions are not suitable for the variety of grassfalt being seeded. The time roll indicates how long it will be until the grassfalt is ready for traffic.

To customize a new variety of grassfalt:

Difficult, Biology, Genetics, 1 week

*Referee:* This task assumes access to a complete geneering lab.

To renew diseased or damaged grassfalt:

(varies), Biology, Edu, (varies)

*Referee:* This task represents regrowing the grassfalt from undamaged portions rather than replanting. Difficulty depends on disease or damage level; use standard damage and repair guidelines. Increments for regrowth are as follows:

Superficial damage.....	1/8 x Growth Increment
Minor damage.....	1 x Growth Increment
Major damage.....	2 x Growth Increment
Destroyed.....	5 x Growth Increment





# MEGATRAVELLER

## Equipment Detail Sheet

© 1991 Digest Group Publications and Game Designers' Wkshp.  
Permission granted to photocopy for game use.



Tech level 10 version illustrated

# ARTIFICIAL GILL

### EQUIPMENT STATISTICS

TL	Type	Vol	Wt	Price
○ 8	Artificial Gill	6L	4kg	Cr4,000
○ 12	Powered Gill	4L	3kg	Cr5,000
○ 13	Miniature Powered Gill	1.5L	0.5kg	Cr7,000
○ 14	Bionic Gill	—	—	Cr35,000

### SUPPLEMENTAL STATISTICS (Optional)

TL	Charge	Operating	Noise	Comments
○ 8	unlimited		bubbling	Only in thin, std, and dense atms.
○ 12	36 hours		bubbling	Bubbles can't be masked
○ 13	1 hour		bubbling	Bubbles can't be masked
○ 14	unlimited		silent	Only in thin, std, and dense atms.

### USAGE RECORD (Optional)

Each square represents 3 hours of usage

- TL8: unlimited usage
- TL12:
- TL13:
- TL14: unlimited usage

### CUSTOMIZING NOTES :

## DESCRIPTION

Artificial gills extract oxygen from water, freeing divers from the need to carry air tanks. The tech level 8 model contains a complex device that extracts oxygen and a small tank containing nitrogen or helium, which is mixed with the extracted oxygen before breathing. Exhaled carbon dioxide is eliminated while the nitrogen or helium is recirculated. For covert dives, a rebreather, containing chemicals that absorb CO<sub>2</sub>, is used to eliminate bubbles.

The powered gill operates on a different principle. A powerpack supplies energy to 'crack' water into hydrogen and oxygen, which are then mixed with the nitrogen or helium. The hydrogen bubbles can not be masked. The miniature version is much lighter, but at the cost of reduced endurance.

Bionic gills are surgically-implanted devices which enable the human body to function freely underwater. Water is 'breathed' through a small intake device tied to the implant during a dive. The lungs are filled with water to equalize pressure. Some people experience difficulties expelling this water after a dive.

The chief dangers when using an artificial gill are anoxia and hypoxia. Anoxia occurs when there is too little dissolved oxygen in the water—this is not a danger when using the powered gill. Victims of anoxia become 'drunk' and lose consciousness. They will die if not given air within five minutes. Hypoxia occurs when insufficient amounts of inert gas are mixed with the oxygen because of a fault

## TASK LIBRARY

To use an artificial gill without mishap:  
Routine, Diving, Int (fateful)  
*Referee:* Roll once for short dives, several times for longer ones.

To repair a damaged holovideo recorder:  
[varies], Mechanical, Edu, [varies]  
*Referee:* Difficulty depends on damage level. Use the standard damage and repair guidelines. Time increments for shop repairs are as follows:

Serficial damage .....2 min.  
Minor damage .....5 min.  
Major damage .....2 hrs.  
Destroyed .....5 hrs.

For filed repair, double the time increment, in addition to the standard increases.



# CRENDUTHAAR

RACES OF THE DOMAIN: *By William H. Keith, Jr.*

Only rarely encountered among the worlds of Man, the Crenduthaar are a fascinating race, a non-human people filled with a seemingly endless wanderlust that has led a few of them down the great trade routes of the Imperium. A minor race native to Ghatsokie (Deneb 0902), the Crenduthaar—an exact translation would be “thinking rulers of Thaar,” but, perhaps because of their love of philosophy, the name is more commonly rendered as “Philosopher Kings of Thaar”—are large, powerful, and impressive. Frightening to many humans when first encountered, they characteristically exhibit traits that many think incongruous in such nightmarish bodies: gentleness, kindness, and a keen and penetrating intelligence.

Of course, there are a few exceptions, especially where the Vargr are concerned.

Though they never developed space travel—indeed, they never developed any industry beyond their basic needs for food and shelter—the worsening political situation on their homeworld has led quite a few individual Crendu to leave Ghatsokie and travel among the worlds of the Imperium. When Travellers encounter Crenduthaar, it is usually at A- or B-class starports or aboard commercial liners, and most often within the Domain of Deneb. A few have taken service as mercenaries or in the private armies of the rich and powerful.

As is always the case with any life form, intelligent or otherwise, the Crenduthaar have been shaped by the world on which they evolved.

## THE WORLD

Ghatsokie is a Vargr world located within the Lamas Subsector, just outside the boundaries of the Domain of Deneb. The innermost planet of a cool, red dwarf, Ghatsokie is tide-locked with its primary, but its dense atmosphere and savage thermal storms serve to distribute heat from the dayside to the frigid wastes of Shgaurrv'vrr'brzgs—the Place Where the Sun Never Shines.

### GHATSOKIE (DENEBO 0902)

BA8669D-8 Ag Ni Ri 304 Va M7 VI

Star: M7 (red dwarf); Luminosity: 0.003 standard;  
Planetary Distance: 0.056 a.u.; Period: 0.033 yr (12.1 day);  
Planetary Rotation: 12.1 day; Orbital Eccentricity: 0.001;  
Diameter: 14,068.8 km.; Density: 6.069 g/cm<sup>3</sup> (1.1 std.); Mass:  
8.8 x 10<sup>27</sup> gm (1.475 std.); Surface Gravity: 1.213 G; Axial  
Tilt: <1°; Atmospheric Pressure: 1500 mm Hg (2 bar);  
Atmospheric Composition: N<sub>2</sub> 88.08%, O<sub>2</sub> 11.01%, Ar. 84%,  
CO<sub>2</sub> 330 ppm; Surface Temperature: Varies with location:  
+40° C. on dayside, -50° or less on nightside . . .

The planet is a large, barren, and rugged world. Dayside temperatures average 40° C. or more in the substellar regions, while temperatures over the dark hemisphere remain well below freezing. The seas are saturated with metallic salts, especially cupric chloride, that give them a purplish tint in the ruby light of

the sun. The world's size and density—both slightly higher than Earth Standard—give Ghatsokie a surface gravity of 1.2Gs. Atmospheric pressure stands at 1500 mm Hg, or nearly twice standard. Though the oxygen content of Ghatsokie's atmosphere is lower than Earth's, the higher pressure generates a partial pressure of oxygen (PPO<sub>2</sub>) breathable by humans. The Crendu can breathe standard atmospheres, though they find them thin and tasteless. Extensive vulcanism on the world releases large quantities of SO<sub>2</sub> and H<sub>2</sub>S into their atmosphere, but levels are low enough that the air can be breathed by humans without special equipment or undue discomfort.

In general, Ghatsokie is a world of broad, rocky plains; shallow seas thick with mineral salts; towering, twilight-band volcanos generated by librational flexing as the planet orbits its sun; and violent storms—called schuvraadah by the natives—that sweep periodically from the dayside to the night with hurricane force.

The planet's UWP code applies to the Vargr colonists, members of an obscure religious sect known as the Ghaa' Auugh, or “the Followers of Auugh.” Three million Vargr live on Ghatsokie, most of them within the relatively temperate twilight belt circling the planet between the light and dark sides, where they have established a religious dictatorship called Auughhrrgra: the Destiny of Auugh.

Vargr religious beliefs, like Vargr society in general, tend to be less than uniform and are often marked by extreme factionalism. Though evidence is scanty, it is thought that the Followers were a persecuted religious sect that fled their world of origin several centuries ago, migrated to Ghatsokie, and established a colony where they could enjoy freedom of worship. The origin of the name Ghatsokie is unknown, but it is definitely Vargric; it may be the name of a founder of the Auugh sect, or it could be a corruption of ghaar'dz'ouudzigh, which means “Follow the Leader” in one of the Vargr tongues of Dzoungdzi.

Reports of Ghaa' Auugh beliefs and practices are fragmentary, but worship appears to center on a creator spirit, Auugh, who formed the Vargr in his image and bestowed on them the gift of intelligence. The Followers claim to enjoy a special relationship with this deity and believe it their destiny to carry knowledge of him to every sapient race in the cosmos.

So far, the Vargr inhabitants of Ghatsokie have been unable to fulfill this destiny, save with a very few of the world's native population. For several hundred years, the Vargr have raided Ghatsokie's Sundside for native prisoners, whom they return to their Twilight Band cities for training and service in Vargr industry and society.

## THE CRENDUTHAAR

Their name for their own world is Thaar, which means, simply, “a wide place” and can refer equally to the world itself or to steppes, plains, or open desert. The Crendu are the nomadic descendants of carnivore/pouncer stock. Massive, powerfully built, with scale-armored hides evolved as protection from their star's frequent flares, and with nightmarish, gape-mouthed heads filled with double sets of razor-edged teeth, they can be terrifying if encountered unexpectedly.

Their image as horrific dragons is undeserved. Once, Thaar was home to extremely large, grazing animals called kotu, and the Crendu evolved to utilize these massive and well-armored creatures as food. Thousands of years ago, the kotu became extinct, forcing the Crendu to adapt by finding alternate sources of food. Fortunately, vegetation on Ghatsokie is quite efficient at absorbing infrared radiation from the nearby sun and converting it to paraglycic sugars the Crendu can metabolize. Despite their fearful appearance and toothy grins, most Crendu are vegetarians, though they frequently supple-

up to 500 kilos. Exothermic, bisexual, and viviparous, they share many of the characteristics of Terran mammals. However, the young drink blood from special glands in both the male and female, and their bodies are protected by scales rather than fur. Their forelegs are modified with a ridge of scales forming a razor-edged blade called a slasher. This was an adaptation evolved by ancient Crendu in the hunt, used to cut the tendons of kotu and other large beasts on the run and cripple them. Though rarely used save in aggressive displays, they are nonetheless still formidable weapons.

Crendu physiology is hexapodal, like that of

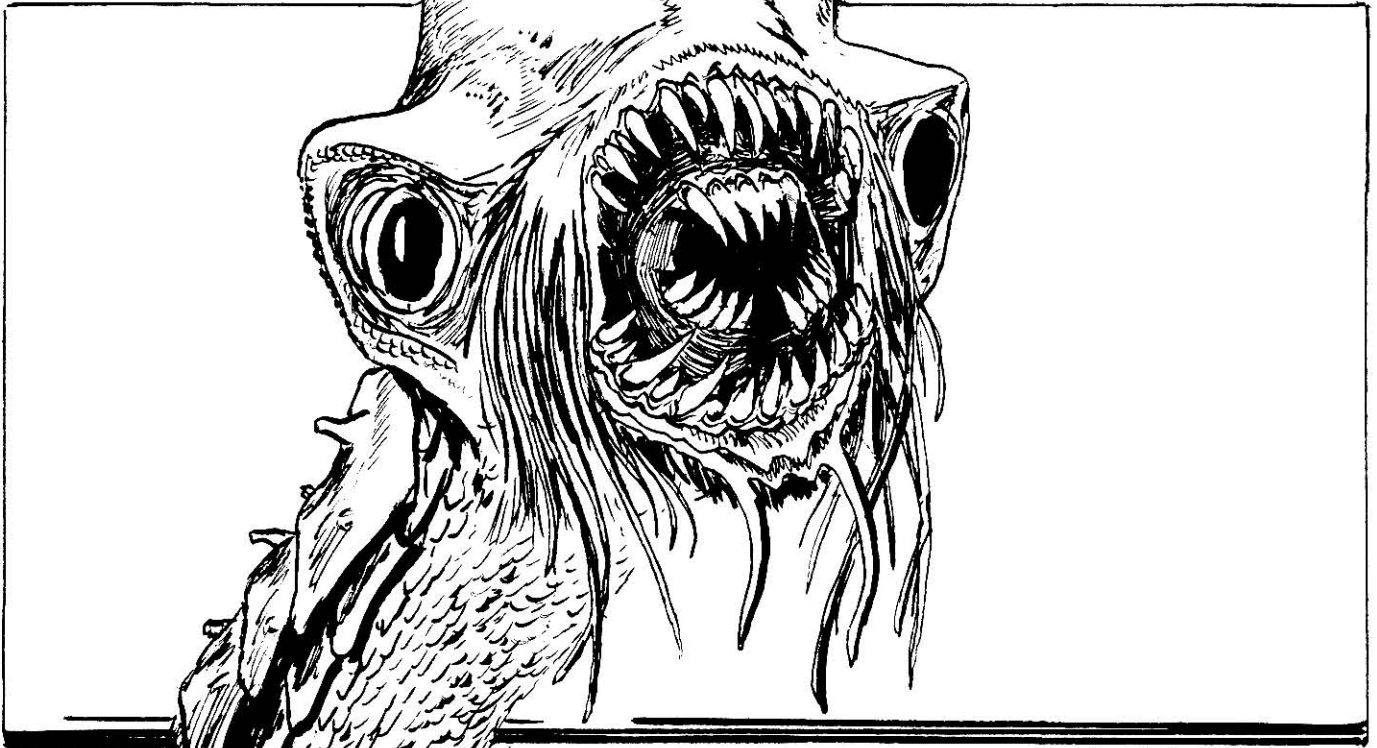

ment their diet with small animals, which they prefer to eat live.

Millenia of social adaptation have evolved in the Crendu elaborate social rituals understood by few outsiders. Conversation between two chance-met Crendu is long, exhaustive, and impossible to comprehend, consisting as it does largely of subtle movements and twitches of the mouth tendrils. They find humans disturbingly hasty, high-strung, and somewhat flighty. In general, Crendu are extremely courteous, gentle, and good natured.

**PHYSICAL DESCRIPTION**

The Crendu number among the larger of the known sapient species, adults measuring some 2.5 meters in length and massing

the K'kree. Unlike the K'kree, however, Crendu are equally comfortable in either a bipedal or quadrupedal stance. Their middle two legs are adapted to either locomotion or grasping and are used for manipulative tasks requiring great strength. Generally, when travelling, eating, or engaged in conversation, Crendu stand on four legs, with their forelegs folded and slashers sheathed. The slashers-folded attitude reminds some humans of hands clasped in prayer, and among Crendu it carries the same meaning as the old, "hands empty, I come in peace" gesture.

Excited or wary Crendu, or individuals engaged in some task requiring four hands instead of two, stand upright. Originally, one Crendu in the hunting group must have stood upright to keep watch across the wide prairie while the others in the clan-group ate; it was also useful while dismembering a slain kotu, which was as large as brachiosaurus, a now-extinct Terran herbivore. Today, this erect posture gives them a tremendous psychological advantage when dealing with humans, who tend to be intimidated by their great height and mass. Unfortunately, it also puts them at a disadvantage inside ships or structures designed for humans. Some Deneban passenger carriers refuse to embark Crendu, for fear of incurring structural damage to entrance ways and overheads.

William H. Keith, Jr.

Crendu are well-armored by tough, leathery scales. These are quite small on arms, legs, and belly but have evolved into massive scutes on head and back. Their evolutionary purpose seems to be to provide protection against their sun's occasional flares, violent events that can sear Ghatsokie's dayside with high levels of radiation, soaring temperatures, and abrasive sandstorms.

The Crendu mouth is the being's most striking feature, at least in the minds of most humans who have encountered them. Where humans have a single mandible articulated from the skull, the front of a Crendu's skull consists of twenty separately articulating bone plates, each ending in several long, razor-edged teeth. Connected by powerful muscles, this "outer mouth" is both strong and flexible. With their outer teeth, Crendu can manipulate objects as dexterously as might a human hand. Behind the outer mouth is a smaller set of extremely powerful jaws, arranged like a three-part valve.

Around the mouth is the Crendu's "beard," so-named by humans because of its resemblance to facial hair. In fact, the Crendu's outer mouth is surrounded by a mass of tentacular manipulators, ranging in thickness from half a centimeter to as slender as a human hair. These possess limited dexterity and strength but probably evolved to help Crendu in the wild pull flesh from the kotu carcass deep within hard-to-reach body cavities.

Crendu senses are quite sharp, at least within the environment to which they are evolutionarily tailored. Their eyes, large and dark-pupiled, are adapted to the red sun of their world. They are blind to the colors green, blue, and violet. Their vision is sharpest in red light, and they can see a considerable distance into the infrared. Their ears are small, protected by bony ridges at the base of their skulls. Crendu hearing is adequate in dense atmospheres; in standard atmospheres they are somewhat hard of hearing. Smell is very keen, though they sense odors through the lining of their mouths rather than through their breathing orifices, which are slits at the base of their necks just above the upper pair of arms. Touch is probably not particularly sharp, except through their facial tendrils. The Crendu themselves claim several senses in addition to the five human senses, including several types of "taste." At least according to the Crendu, they can taste electrical current, low-frequency vibrations, and something they call ushagrid, all experienced through their tendrils.

### CRENDU PSYCHOLOGY

For millennia, the Crendu were masters of their world, with no natural enemies. Their fearsome appearance is an accident of nature, the product of natural selection in the creation of an efficient killing and eating machine. Over the past few thousand years, the Crendu have had to adapt to a change in their diet. More important, they met another predator species, the Vargr.

The Crendu are rational beings. Still as a species they possess several quirks which set their thinking apart from humans.

- They dislike the dark. Not as strong a compulsion, say, as the notorious K'kræe claustrophobia, the Crendu nevertheless live in an environment where the sun literally never sets. For them, the Darkside of their world is a cold and forbidding place, a haunt of demons and vengeful gods, a place where the insane and the infirm go to die.

- They like light. Their red dwarf sun is as bright to them as Sol is to the inhabitants of Earth, and appears to be three times larger. In fact, their infrared vision lets them see quite well in the

dark, but the absence of a large, powerful light in the sky overhead is unnerving. They are more comfortable with lots of light—preferably centered in the red portion of the spectrum.

- They are peaceful. With no natural enemies on their world, this race of predators long ago evolved elaborate forms of etiquette and ritual to sublimate the violent tendencies of pack-hunting carnivores. Typical Crendu seem rather long-winded to humans. Humans, in turn, seem to them to be always in a hurry and unwilling to observe the niceties of properly cultured conversation. While trying at times, these differences in understanding are usually not a source of conflict. Crendu rarely get angry.

- Peaceful they may be, but they do hate the Vargr. "Domesticated" Crendu accept their lot as servants or employees of the Vargr masters; but the species as a whole has suffered at the Vargr's hands, and every Crendu harbors a deep-seated hope that one day their world will be liberated from these invaders. "Wild" Crendu simply eliminate any Vargr they catch, something that they consider an act less of vengeance than of pest control.

### CHAGAS GEMS

To make their way among the human worlds, Crenduthaar have learned that they need a medium of exchange. They have found that medium in chagas gems, a crystallized mineral salt from Ghatsokie's Sunside Thaarlingst Plateau. Ranging in size from kernels of rice to a human fist, chagas gems are blood-red in color, deeply translucent, and appear to contain a pulsing, inner light. Possessing a hardness of 9 (diamonds are 10) they are useful in certain industrial processes, but their greatest value lies in human appreciation of their beauty as gemstones. A small chagas might be worth Cr 1,000, while a very large one might bring Cr 100,000,000 or more. Crendu will offer such gems for perhaps ten percent of their market value. A few merchants and traders have become wealthy hiring their ships in exchange for "chagas bloods" or "star hearts."

Anyone who owns a chagas gem is thought to have his soul linked to the destiny of Thaar. Thus, Crendu think it highly appropriate that traders or smugglers hired to run the Vargr blockade be paid in these stones.

They also tend to be deeply disturbed by characters who take chagas gems for the promised action, then go back on that promise. The Crendu term for such creatures is gnagash.

### TECHNOLOGY AND CULTURE

Technically, "wild" Crendu are considered to be stone-age savages. They live in nomadic communities in a loose organization of clans. They make no weapons, preferring to hunt prey with slashers, hands, and teeth. Their only tools are extremely simple: a pointed stick for planting their few domestic crops, a drag sledge for carrying heavy loads; and they do know how to make fire. Their lack of technology, however, appears to be more a matter of choice than of lack of talent. "Domestic" Crenduthaar learn to use Vargr tools quite readily, yet they have been known to abandon them when they return to live in their home communities, and the nomadic Crendu have been slow to adopt any of the technological wonders of the Vargr community—such as the wheel or the loom.

### PHILOSOPHIES

The Crendu are fascinated by a wide variety of philosophies. Those who have travelled among the stars have acquired a broad range of philosophical views, and they enjoy sharing these with others they may meet. They are thinkers, first and foremost,

despite their lack of sophisticated technology . . . or perhaps because of it. They possess a certain elasticity of thought that leads them to adopt a particular philosophy as casually as a human would don a suit of clothes. Crendu have been known to switch philosophies at times, often with great suddenness, almost as if they've had a religious conversion.

Several philosophies are especially popular with the Crendu. They are not necessarily exclusive, and—with the possible exception of the last two on this list—a Crendu character may blend several widely differing views into a single, complex concept.

- *Wanderlust*: the universe is an amazing, fascinating place, a place of unparalleled wonder, beauty, and meaning. The Crendu character seems driven to explore new worlds, meet strange life forms, and record and discuss his experiences endlessly. A favorite pastime is discussing the places he has seen or heard about with other characters.

- *Liberty and vengeance*. The Crendu's people are slaves of the demons called Vargr. They must be freed, for the greatest good in the universe is liberty—freedom of thought, freedom of expression, freedom to be all that it is possible to be. The Crendu character will seek to raise ships and men to return to Ghatsokie and drive the invaders from the precious soil of Thaar.

- *Nonviolence*. Strangely ill-fitting to so fearsome-looking a race, non-violence is nonetheless a powerful philosophy among many Crendu. Nothing is settled by violence, all beings are brothers, and the greatest evil is that one intelligent being should shed the life essence of another. The character may chide others for their rash thinking and violent actions. Surely it is possible to reason with an enemy, rather than simply blow him away! Crendu who adopt this philosophy often have a great deal of trouble reconciling these beliefs with their feelings about the Vargr.

- *Fatalistic nihilism*. Everything is useless, hopeless, and to no avail, and nothing can be done to change it. There is no purpose to the universe, no matter how many its wonders. The universe is blindly cruel, and the oblivion of death the final reward for life. Crendu who follow this philosophy always seem profoundly depressed and pessimistic. They tend to use phrases like *kyagaa gurrryak* a lot.

- *Joy of life*. The universe is a wonderful place, filled with hope and optimism, and the greatest good of life is to enjoy that wonder to the full. Crendu characters with this mind set are exuberant, even bouncy—often to the detriment of fragile furniture or decorations that might be in the same room.

But they still don't like Vargr.

### REFEREEING THE CRENDUTHAAR

Crenduthaar characters can be introduced to a MegaTraveller game or campaign either as NPCs or as player characters.

Referees running one as an NPC can have fun with the fact that the initial reaction of most humans to a Crendu is fear. They are large, powerful, ugly, and very loud. Their keen intelligence, however, can be of great value to a Traveller group. Human characters may learn from a Crendu character that different is not necessarily bad.

**Characteristics:** When creating a Crendu character, strength, endurance, and intelligence are all determined by rolling 1D6 + 11. Dexterity is rolled as 2D6-2 (less than 2 = 2). Education, determined by rolling 2D6-3 (less than 1 = 1), and should be understood as the Crendu character's understanding of human customs, language, and cultures. Individuals with an education

### SPEECH AND IDIOM

The language of the Crenduthaar is rich, descriptive, and well-adapted to both idiom and picturesque aphorisms. A few of the most common are listed here.

**Abak:** Lightning. Storms on Ghatsokie are serious things. Fatal lightning strikes are common, if random, events. The word is a common exclamation equivalent to "it's up to fate now," or, "it's out of my hands." An equivalent Earth expression is the Arabic *Insallah*—"as God wills," or "it's in God's hands."  
**Bravyerrta:** Literally, "eyes closed." Used in the sense of "you must be blind!" Often an expression of astonishment: "Incredible!" or "I don't believe it!"

**Chagashblet:** "Fire eye." Crendu name for chagas gems, which they believe fell from their star and which hold captive a small part of that star's soul. Corrupted by humans to "chagas blood."

**Dzhanarr:** Crendu word usually translated as "clan." Refers to the extended family or "herd," which is the basic unit of Crendu society. By implication, safety, security, or contentment. A Crenduthaar might refer to the others in a human Traveller group as *dzhanarrik*, "my family."

**Dzhanggeest:** Literally, "I run with you." Used in the sense of "I understand" or "I'm with you."

**Galyagis:** A small, creeping hijacker on Sunside, which ambushes larger predators from the cover of rocks or vegetation and steals their kill. Crendu metaphor for a coward or sneak-thief.

**Gnagash:** Roughly "vermin," a word derived from the Crendu term for soulless creatures lurking in the Darkness. A disgusting creature that does not deserve life, even within the tolerant Crendu view of things.

**Kyagaa gurrryak:** Literally "ice climber." Originally referred to individual Crendu who—because of age, sickness, or insanity—withdrew from the Clan and wandered into the twilight regions to die. The expression has come to refer to someone who is incapable of understanding or who deliberately chooses an empty or foolish path. Used like the Russian *nye kulturnii* (no culture, barbarian) it can be an insult. Spoken sadly, with the Crendu equivalent of a shrug or a shake of the head, it implies a kind of fatalistic acceptance of stupidity: "You're making a bad choice, but there's nothing I can say to make you change your mind."

**Nyadrek:** "Elevated." Also used in the sense of "educated." Common term for those Crendu trained by the Vargr of Ghatsokie and assimilated into their society.

**Shuvaah:** Darkness. Often used as an expression of shock or dismay or as a curse.

**Thaar:** The Crendu word for their home planet. Also "plain," "steppe," or "wide-open space." By implication, any place of freedom, beauty, and wonder.

**Uvriyaashgis:** Literally "way through difficult terrain." Originally a path migrating Crendu could use to reach the open thaar, it now has two meanings: any philosophy (*uvridyi*, "way") that eases a passage; and the secret organization dedicated to smuggling Crendu off Ghatsokie and assimilating them into life within the Domain of Deneb.

**Vadik:** "Unmixed" or "pure." Common term applied to "wild" Crendu still living among the Great Clans of Ghatsokie's Sunside.

**Vrchada:** "In my teeth." Refers to prey caught in the dextrous outer mouth. Used in the sense of "I've got it," or "I understand." A common exclamation similar to the human "ah ha!"

**Zhagshuvaan:** Dweller-in-Darkness. Demon in Crendu mythology, a kind of formless evil that devours souls. Now applied to Vargr and to any insidious, vicious, or cunning foe.

of 6 or less (vadik, or "wild" Crendu) will be puzzled by human expressions and behavior and may frequently exclaim *bravyerta!* Social level is an alien concept to the Crendu, who perceive all rational beings as equal... with the possible exception of *zhagshuvaan* like Vargr.

In gaming terms, Crendu have a speed of 3 on all fours and 2 when walking upright. Their armor is treated as mesh. In a combat round, they may attack, if desired, with teeth +2, or with blade +1. When mapping an encounter using 1.5 meter hexes, a Crendu occupies two adjacent squares when on all fours, one square when standing upright. The referee should keep in mind the height of the ceiling in any room where a Crendu character might decide to stand.

For Crendu characters, treat standard atmospheres as thin, thin atmospheres as very thin, and very dense atmospheres as dense. They can function well in higher atmospheric pressures

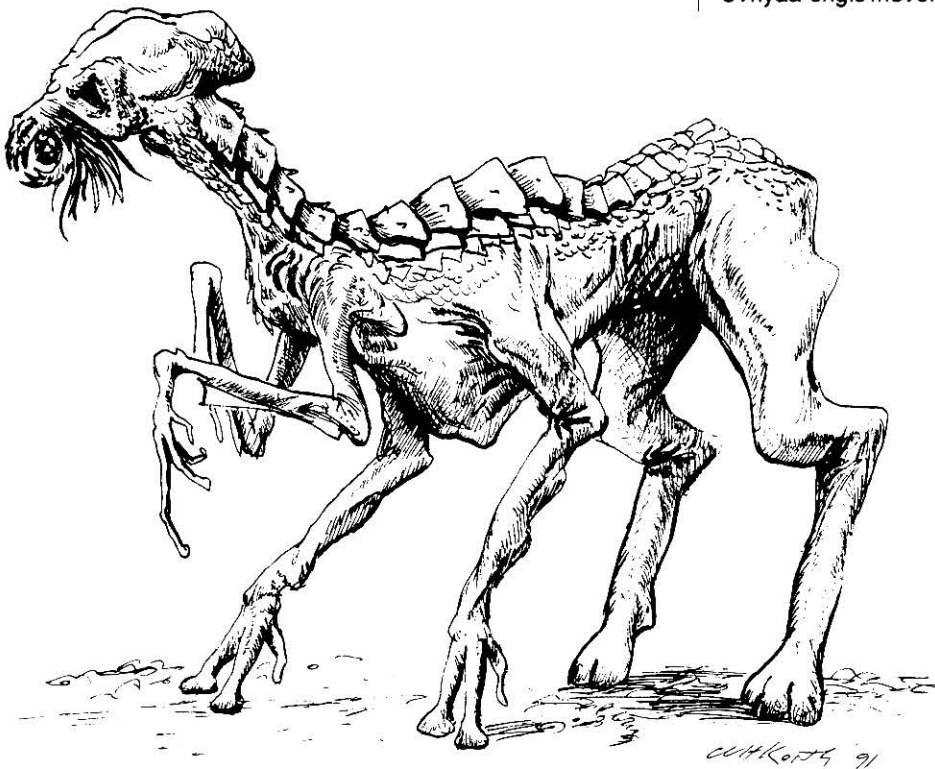

William H. Keith, Jr.

than humans, and are less sensitive to certain contaminants, such as sulfur dioxide, carbon dioxide, and even sulfuric acid.

**Careers:** When using *MegaTraveller* rules, Crendu will be from one of two possible general backgrounds: "wild" or "domestic."

"Wild" Crendu, called *vadik*, are those few who managed to obtain passage off *Ghatsokie* without being assimilated by the Vargr-dominated *nyadrek* culture. The only career type open to them is barbarian. Crendu with an education of 6 or less are *vadik*.

"Domestic" Crendu, or *nyadrek*, are those taken by the Vargr colonists of *Ghatsokie* and trained to work in mines, factories, or as servants. They have an Education of 7 or higher and may choose any of the following careers: Army, Bureaucrat, Diplomat, Hunter, Law Enforcement, Merchant, Pirate, Rogue, Scientist, or Scout.

Bureaucrats will still be in the employ of their Vargr masters and may be encountered in the retinues of important Vargr personages from *Ghatsokie*. Scientists, too, are usually in Vargr

service, but some have escaped to worlds within the Domain of *Deneb* where they live and work in small communities of expatriate Crendu. Diplomats might also be serving with diplomatic Vargr entourages, or they could be individuals representing "free Crendu" who are anxious for help in evicting the Vargr from their world—or at least in winning the right to live in peace. For many years now, a group of Crendu smugglers—using mercenary pilots and hired ships, usually human—have been devoted to sneaking Crendu off *Ghatsokie* and getting them into Imperial space, a kind of underground railway to the stars.

Crendu with Army, Law Enforcement, or Hunter backgrounds probably served their Vargr masters either in the *Ghatsokian* militia or as active participants in *Sunside* raids to capture "wild" Crendu for training and assimilation. They will be despised and distrusted by all *vadik*.

Pirates and Rogues are usually members of the underground *Uvriyaa-shgis* movement. Some began by hiring human or Vargr pirates to help friends and family on *Ghatsokie* and gradually drifted into careers of outright piracy. Their nonviolent natures make them poorly suited to this line of work, however.

A number of free Crendu joined the Imperial Scout service, and have performed with great distinction.

**Philosophy:** To round out the character, the referee (in the case of NPCs) or the player (for Crenduthaar PCs) should choose a particular philosophy or outlook on life. This could be one or several of those listed under Philosophy above, or it could be something of the referee's or player's own devising. Possibly, and if the other players in the group have no objection, the Crendu might even adopt a human or other religion or philosophy, Islam, say, or Confucianism, or even Communism. The Crendu are enthusiastic converts.

**In the game:** The referee is responsible for determining the effect a Crendu has on human characters he interacts with. Humans who have never met Crendu

may be terrified, fearful, wary, disgusted, or hostile, depending on their mood and on the situation. The reaction of human characters and NPCs, obviously, can be an important factor in negotiations, or even in a chance encounter. A Crendu can also be a useful ally in a bar fight, even if he never throws a single punch. Never underestimate the power of intimidation!

Crendu are not good with tools or weapons. The referee should impose an automatic -2 DM on any attempt by a Crendu to manipulate a complex lock, use a weapon, or otherwise use unfamiliar tools. Crendu can train themselves to use the technology of others, however, and can acquire the usual skills in the course of their careers the same as human characters.

Players who choose to run a Crenduthaar character might keep in mind the stereotypical Russian Cossack—big, friendly, passionately enthusiastic, and half-barbarian. The Crendu language does not have articles (the words "the" or "a"), and learning other languages is difficult for them, so their speech often sounds



curt and over-simplified. "I go up steps," a Crendu character might say, describing his actions to others in his group. "See door. Is locked, but I open with mighty blow."

Because the Crenduthaar have difficulty truly thinking in a language other than their own, their speech will be laced with phrases and exclamations in their own tongue. "Shuvaah!" a Crendu character might exclaim with some feeling. "Was waiting for me, like sneaking galyagis, with gun me for to shoot!" Instead of using the ever-popular "I've got a bad feeling about this," a reluctant Crendu might say instead to his companions, kyagaa gurryak.

Perhaps the most distinctive Crendu speech trait is caused by the, to them, thin atmosphere preferred by most humans. Speech at normal levels is a whisper to them, and they tend to compensate by speaking very loudly themselves, especially when they are excited. The Crendu have deep, bass voices and tend to bellow and thunder even in polite conversation.

Finally, Crendu love to discuss philosophy with anyone who will sit and listen. They will passionately argue their case, though they will not become angry if others are not convinced. Human characters might find them irritating, however . . . especially when they want to discuss a plan or argue about its ethical merits when the humans in the group just want to get on with it!

#### ENCOUNTERING THE CRENDUTHAAR

Theoretically, characters might encounter a Crendu anywhere within the former boundaries of the Imperium or within Vargr space. Only a few tens of thousands of individual Crendu have actually left their homeworld, however, so encounters are not common.

Fair-sized communities of expatriate Crendu exist on several worlds, including Pretoria, Inar, Antra, and Deneb—all within the Deneb Sector—and on Regina in the Spinward marches.

#### ADVENTURING WITH THE CRENDUTHAAR

Individual Crenduthaar might join a band of player characters for any of a variety of motives, but their drives will always include wanderlust and justice. Crenduthaar are intensely curious and want to see as much of the universe as they can. Crenduthaar are also always aware of the plight of millions of their fellows still on Ghatsokie. Many are active participants in the network, called the Uvriyaashgis, that has been smuggling Crenduthaar past Vargr gunboats for many years.

Referees might introduce a Crendu character as a patron. He will approach the adventurers seeking to hire them, offering chagas gems in exchange for a ship and crew to run the Vargr blockade at Ghatsokie and liberate some of his fellows. Or, a Crendu might join the party because he needs current employment. His long-term goal, however, will always be to help his fellows on Ghatsokie, and he may try to convince the other characters that they could do great good by helping him in his quest.

Finally, characters who have heard of the half-legendary "chagas bloods" or "star hearts" might organize an expedition to Ghatsokie, where it is rumored the crystals can be found within the searing and desolate wilderness atop the vast, mile-high Thaarlingst Plateau. Any attempt to recover the gems would be opposed both by the Vargr who control the planet and by the "wild" Crendu who dwell on Ghatsokie's Sunside. Characters who aren't killed out of hand for their presumed alliance with the Vargr might find themselves caught up in a scheme to drive the Vargr from the Crendu world.

How the Crenduthaar are played in an adventure is important and is something that can be tailored to the needs of the individual gaming group. They can be played seriously or for laughs: consider a half-ton, dragon-headed monster lecturing the other characters on the evils of violence, for example . . . delivering the sermon in a thunderous, wall-rattling shout.

As with other alien races in the MegaTraveller universe, the key to playing the Crenduthaar is to remember that they are not human. They are the products of a very different environment indeed, and they should be played as such. •



Blair Reynolds

- ▷ **LOOKING FOR A FEW GOOD BLACK & WHITE PRINTS?**
- ▷ **ORDER PRINTS OF MY MEGATRAVELLER INTERIOR ILLUSTRATIONS FROM PRESENT AND FUTURE PUBLICATIONS -- EACH IS NUMBERED AND SIGNED.**
- ▷ **\$10.00 EACH, MONEY ORDER ONLY; SPECIFY PUBLICATION AND PAGE NUMBER.**
- ▷ **CMDR. BLAIR REYNOLDS**  
4627 HARVARD CIRCLE  
FAIRBANKS, ALASKA 99709

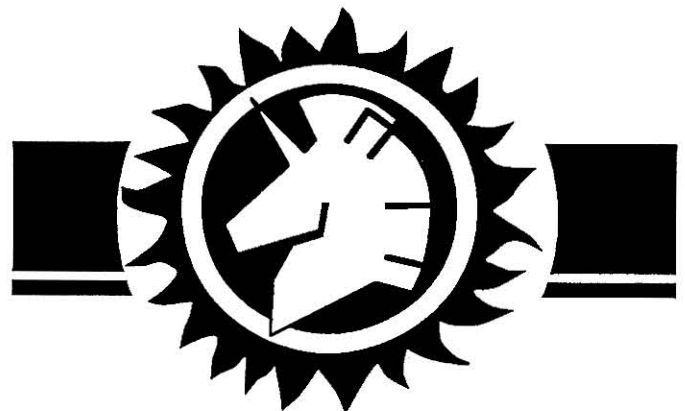

# JERAMII BODEN

DENEBOSSIER: *By Jerri Maggikami-Stythe*



Mike Vilardi

*Through his position as spokesperson for the Traveller's Aid Society (TAS), Jeramii Boden's image has become part and parcel of our interstellar culture. His star-hopping experiences and adventures have captured the imaginations of trillions and earned him a reputation as "the ultimate traveller".*

*Boden is also the author of several best-selling xenolinguistic texts, including The Shanti Perspective, Scaffoldings of Civilization, and his upcoming Echoes of Wonder.*

*The following is an edited transcript from Boden's 1121 holo vid appearance on the Jerri Maggikami-Stythe Show.*

**Jerri Maggikami-Stythe (JMS):** Jeramii, thanks for coming on the show. I've tried to get you here for some time.

**Jeramii Boden (JB):** Yes — sorry it took me this long, Jerri. The way I work, I can't suddenly just up and come halfway across the Domain at a moment's notice. Thanks for persevering.

**JMS:** Well, even before I began hosting this show, I'd dreamt of meeting you. When I was a kid, I used to see your TAS commercials all the time. I even joined the TAS *Junior Explorers Club* — do you remember that? I got the autographed holo and everything.

**JB:** Yes, I remember that. You sure now how to make a guy feel old, don't you? Well, after holding the same job, as TAS spokesman, for — what is it, sixteen years now? — I guess I should come to expect that treatment.

Truth be told, I've really enjoyed my role as spokesperson for the organization, all these years. It's certainly afforded me an interesting and rather unique livelihood.

**JMS:** Yeah, I'd like to talk about that. Can you outline for us just how your life-style works?

**JB:** Well, obviously the core of my life-style is the Travellers' Aid Society. Throughout Imperial space, there are many individuals like myself — "professional adventurers" — who own TAS memberships. They travel from world-to-world using High Passage tickets, which accrue every two months for TAS members. During their two-month or more stay on-planet, members can stay at any TAS or TAS-sponsored hotels at discount rates.

Most of these travellers try to pick up the odd job to subsidize their stay. Sometimes it's acting as a guard for an expedition heading into the world's outback. Other times, it could be something like, oh, making holo-recordings for the city-dwellers on Vincennes. In any event, most of these folks try to scrape out a living while soaking in the charm and wonder of starfaring life.

**JMS:** You must have this stuff memorized. You know, you're not doing an ad right now.

**JB:** No, seriously. This is from the heart. There's nothing like that life-style. I wouldn't trade it for the world. And TAS makes it possible. If you're lucky enough to have a TAS membership, it's like having someone underwrite your adventuring life-style. It's great. And the people I've met — the other "travellers", as it were — they're all quite an interesting bunch. Restless souls who all seem to have an unquenchable thirst to know — to experience. Sure, they don't all pack college degrees or write books, but there's a common something that drives them all. I'd call it "primate curiosity", but that's too humaniti-biased a term to cover

it. I've met many, many travellers who are decidedly un-human. But the curiosity and drive is there in all of them.

And you'd think we'd all get tired of it, huh? That we'd get jaded and start to feel like any new world is just like any other. If all you see is starports, it *can* get that way. But when you get out and see the world, walk its wilderness and meet its inhabitants — it's all startlingly fresh and interesting. As the old saying goes, "Jodo, I don't think we're in New Jersey anymore".

**JMS:** Hey, isn't there some law against quoting yourself to make a point?

**JB:** Sure. But I've got documented permission from myself to use my own material. If I didn't, well then I guess I could sue myself, get rich, and retire. Hey, that's not such a bad idea, y'know...?

**JMS:** If I'm not mistaken, isn't your own life-style a little bit different than what you've described?

**JB:** Well, yeah. I get into trouble by choice, not by necessity. As TAS spokesperson, the organization waives any food and lodging fees while I stay at their establishments. So, if I wanted, I could hit a world, never leave my room for eight weeks, watch holovid shows on the native flora and fauna, then get my ticket and jump to the next world. Some fun that'd be, huh?

I'm into all this as a way for me to see the galaxy. TAS makes it easier for me. I've always got a safety net. But playing it safe was never my strong suit. I'll often take on some local job offer, though maintaining my anonymity is sometimes a problem. I also go on many of the local, TAS-sponsored expeditions. You know about those, right?

**JMS:** Well, I think I've heard of them. I'm not actually a member, you see, and...

**JB:** What?! And you were a *Young Explorer*, too? You should be ashamed of yourself. Well, anyway, the expeditions. Most planetary TAS offices offer expeditions into the wilds of their particular world. These are offered as a service for TAS members, to get more out of their travels. The rates are dirt cheap, but the sights and sounds are always unbeatable.

Some expeditions take members to the ocean bottoms to get first-hand experience with aquatic sophonts. You can see the remnants of an Ancients city, or even just climb into the mountains of a completely alien environment. These are just great opportunities!

I usually get offered to participate on these outings by the local TAS authorities. They think of it as a publicity coup. They haven't yet figured out that I actually *love* these things.

**JMS:** And don't you have some sort of deal worked out with TAS's lecture circuit.

**JB:** Yes. The TAS lecture circuit is... Well, to be polite, it lends my life structure — not that I really wanted any more structure than I already had... Don't take me wrong, here. I enjoy doing the lectures. I do about four planned ones per year, each at a TAS hostel. It's always rewarding to share my thoughts with a receptive audience. While traveling, I sometimes try to get into some juicy linguistics discussions with some of the ships' crews, but — well, their minds are often focussed elsewhere.

So the lectures are the fixed points in my life. I can hit whatever world strikes my whim, as long as I'm where I need to be when I'm scheduled to talk. Oh, and I do let TAS know my destinations, just in case they need me to do a new ad spot. But

even if they know the world I'm on, they oftentimes have trouble tracking me down. I don't stay put for very long and even a single planet is a big place.

**JMS:** So it sounds like you're constantly straining the reins. But you still manage to get in your share of adventure?

**JB:** "Reins". You've got a way with words, kid. TAS is not a master without demands, but there's give and take on both sides. We've been working together for a long time and I think we've learned to make allowances on both sides of the fence.

But as far as the adventure aspect goes, yeah. I certainly *do* get my share. A friend of mine from my merchant days used to say that adventure seems to follow me around. After all these

years, I'm inclined to agree with him. I just seem to have a knack for being in the right — or sometimes, "wrong", depending on your perspective — place at the right time.

**JMS:** Holding that thought, let me ask you "the question". Where were you when the news of the Emperor's assassination hit?

**JB:** Heh. Well, ever heard of a planet called Divad? It's in the Corridor sector. It's the homeworld of a race of looking somewhat like giant spiders, called the Brinn.

**JMS:** Oh yeah, I've heard a little about them.

**JB:** Well, it was definitely the wrong place to be, at the time. These sophonts have always had it in for humaniti, but the strength of the Imperium held them at bay. Not an hour after the news hit, Brinn guerillas were storming the streets, shooting down any humans in sight — no, it was more like any "non-Brinn", now that I recall.

It was a mess. The starport was choked with panicked citizens and the place was on fire from local fighting. Me and a small group managed to escape the city in a cutter, but had a system failure and had to put down in Divad's wilderness. We managed to keep away from Brinn patrols for three weeks, until we stumbled across a covert ISS recon group who finally got us off-world. So it's events like this that have given credence to my friend's statement about my proximity to "interesting" events.

**JMS:** Uh — yeah, I guess! Would you call that one your "most interesting situation", or is there something that eclipses even that.

**JB:** Oh, this was certainly *not* the top of the heap. More par for the course, really. As far as my most exciting and intriguing episode goes, there is one that easily stands out in my mind. Unfortunately, it's not an event I can tell you about. It's been classified by Naval intelligence, you see. I guess that's not a very satisfying answer for you, eh?

Without giving you a monologue to the Boden family home movies, let me just sum it all up by saying that I've done more things in my life than I ever expected I would. That I ever expected *anyone* would! And I'm sure the fates have plenty more in store for me.

**JMS:** If you'll allow me to regress here for bit, just how did you get the job as TAS spokesperson, anyway? It's not the kind of thing they run an ad for.

**JB:** Once again, it was sort of a stroke of luck. I'd just gotten out of the merchants a few years earlier and had decided to travel. I'd say it's in my blood, but there's more to it than that. I'm allergic to anagathics, you see. You must have noticed.

**JMS:** Well, not really. I'd just assumed you were in your nineties, or so.

**"I get into trouble by  
choice, not by  
necessity."**

**JB:** Thanks again, kid. You've just got all kinds of tact on this aging issue, don't you? Well, not having the same extended life span open to me as it is to others, I felt compelled to experience as much as I could. That and being born on the epitome of dull, mainstream-Imperial worlds drove me outward. Once I left Du Dariig Lines, the last place I wanted to go was home. Merchant life had given me a healthy taste of interstellar life and I wasn't about to abandon it.

So I travelled. I'd retired from Du Dariig with a TAS membership, so that set me up. I was on this one world, staying at this hostel placed far up in the mountains. This world was surrounded by a ring of debris from the recent breakup of a small moon. The planet's surface would get regularly pelted by falling debris. Just such a meteorite hit about two kilometers up-slope for this hostel. The whole place got buried in the resulting avalanche.

I forget exactly what I did, but one of the hostel's occupants, at the time, was the TAS regional director. She was so impressed with my efforts that she caught up with me a few months after we got out of that situation and offered me this position. So it was real out of the blue, as far as I was concerned. And I still can't figure out what I did or said to impress her so?

**JMS:** Well, you do seem to have a certain — "charm"?

**JB:** Well, as my friend in the merchants — same friend as I mentioned earlier. I should give him some credit, if I'm going to base this whole interview on his nuggets of wisdom. It's Bob Takahashi. Bob said that I seem to just have a way of saying things. It's not the words I use, it's how I say them. He used to attribute my trading deals to that — and once again, experience has proven that he may have something there. I certainly don't have any special training that other lacked. I could just talk a better deal, without much effort. It helped make a lot of friends, and not a few enemies, too.

I also tended to be, um, resourceful when it came to closing deals. "Unorthodox", was the term my superiors loved to use. They may not have approved of my methods, but they weren't unethical. And Du Dariig's higher-ups didn't seem to mind it when the money from the resulting deals started rolling in.

**JMS:** So, I see you brought your latest pet along.

**JB:** I prefer the term "companion". Padgii goes everywhere with me.

**JMS:** I remember Jodo. He used to appear in most of the ads with you. He was a real hit with the kids — at least for me and my family. Wasn't he a Terran dog?

**JB:** Yes, Jodo was a dog. I've always had a dog, as long as I can remember, but Jodo was really something special. The outpouring of consolation when Jodo died was astounding. I had no idea how deep his connection with Imperial holoivid viewers ran. I got cards and letters from all over the map — for well over a year!

I don't think Padgii will ever fill those shoes, but he's worked in his own pair just fine. Incidentally, Padgii's a first for me. He's not a dog — not really. He's a gena that was derived from dog stock. He's much more intelligent than a dog — a little brighter

than a Ghurdan or a Chimp. He can understand basic words and carry out some fairly complicated instructions. I'm not sure I could go back to just having a dog, after Padg. He and I work as a team, more than I've ever been able to do before. His skills have come in real handy.

**JMS:** I'd think it'd be bad enough parading a dog around in front of the Vargr populations. It almost seems like a genetically engineered dog would be construed as even more of an affront to them. Have you ever had any experiences with that?

**JB:** Surprisingly, no. But I've always been cautious about such things. I have noticed a number of extremely disapproving, sidelong glances from some Vargr, but I've never had a confrontation. I hope that trend continues, but...

**JMS:** I've heard it said that you disdain carrying guns, of any kind. Why's that, and do you rely on your "companions" for help, should a "tight" situation arise?

**JB:** Heh! More likely I'd be protecting Padg, if we got into a bad spot. He's all growl and no fight. Well, you heard right, in that I don't carry a gun. It's not for any deep philosophical reasons. It's simply due to the fact I'm a lousy shot. With gun in hand, I'm far more likely to hurt myself, before anyone else.

I'm not saying I'm not good in a scrap! Hand to hand's my game. And I've polished my arts in everywhere from TAS gymnasiums to startown bars - most of my work in the latter.

**JMS:** So if Jod...sorry, Pad-gii...

**JB:** It's all right. You're not the first to make the slip. As I said, Jodo really worked his way into the hearts of many holoivid viewers. I've come to expect it.

**JMS:** All right. Anyway, if Padgii goes everywhere with you, um, including starships and the like, ah, how does he....y'know...? Without messing up the ship and getting the crew mad enough to space him?

**JB:** You mean...Oh! That. Well, he's trained and I use a pad of K'kree Gray Grass — at least that's the name it was marketed under in the Imperium. It's a small square of geneered plant life. It's actually composed of a couple of different specialized species. Anyway, without going into all the smelly details, it breaks down feces and gives off a pleasant, deodorizing scent. It acts quick, too. So when we have to move, I just pick up the mat, roll it up, and we're off.

It's been an incredibly handy tool. Unfortunately, with all the trade disruption and especially the situation in Corridor, I may not be able to find a replacement when this one wears out. *That* will be a problem.

**JMS:** Gee, you'd make a great salesman. I'm surprised you don't get offers for that kind of work.

**JB:** I *do* get them, but I usually turn them down. I'm not looking for any more connections or obligations. I've got more than I want already — especially with the book deals. I did take on an offer from a luggage company. They're doing a Jeramii Boden line of suitcases and such. The reason I went with the deal was that I didn't have to do anything except say they can use my name

**JERAMII BODEN**  
**Media Personality/Adventurer**  
**(retired Merchant 2nd Officer)**

847AA9 Age 61 5 terms Cr4,000 TAS Member  
 Linguistics-6, Streetwise-2, Brawling-2, Persuasion-2,  
 Carousing-1, Animal Handling (Equestrian)-1, Animal Handling (Guard/Hunting Beast)-1, Jack-o-Trades-1, Grav Vehicle-1, Trader-1, History-1, Vacc Suit-0, Computer-0, Gun Cbt (Pistol)-0.

Starport B, Medium Size, Standard Atmosphere, Wet World, Moderate Population, Moderate Law, High Stellar.  
 Born: 329-1060

Position: TAS Spokesperson/Author/Adventurer

Typical Possessions: Hand Computer  
 Grey Grass Mat

and signature. Beyond that, my only responsibilities have been collecting my royalty checks — when they can catch up with me. The line's been doing pretty well, too.

**JMS:** Well, since you touched on it, I'd like to talk about your books, a little. It seems odd, given your background and life-style, that you'd be writing books on xenolinguistics. What's the story there?

**JB:** Does it seem strange that I'm writing "scholarly" works without a scholarly background? Well, twenty years of exposure to alien cultures and societies as a merchant is worth *at least* six years of sitting in a classroom. I never had any formal schooling in languages, but I got exposed to them out of necessity with Du Dariig. After I'd been forced to learn a couple of tongues, I got bitten by the proverbial language bug. It became a hobby of mine and I earned quite a reputation for xenolinguistics with the company. I'd get pulled in for all kinds of special assignments. In fact, the much talked about Bob Takahashi was a sort of resource manager for Du Dariig. It was his job to find the best crew or man for the job at hand.

Anyway, after I retired from merchant life, I kept up with the linguistic work. I started writing stuff down. My notes, observations, theories, stuff like that. I did that mostly to pass the time on-board ships. I eventually ran into the head of Bunche & Colle publishing during a TAS excursion to Sodatta Canyon. He and I got to talking, he took an interest in my work, and pitched the book idea at me. It flew, but only because of the inherent flexibility in the deal. When I'm done, I'm done. No deadlines, no advances. It's worked so far, for three books. We'll see where it goes in the future. In any case, it's a fun diversion.

**JMS:** You speak, what, seven languages or so?

**JB:** Well, I write and speak six, fluently. I can muddle my way through a half-dozen more, and can recognize some words and phrases from about twenty others. But I really only know six. You may not know some of them, because they're a little too regional. But there are some big ones, like Yaudal — that's the primary tongue spoken by the Suerrat.

These skills come in handy. Sure, translation software is available for nearly every known language, but you can go much further when you deal with a people in their own language. It opens doors which may otherwise remain closed.

**JMS:** You aren't, perchance, related to Martayn Boden, the noted xenologist?

**JB:** You obviously haven't seen any previous interviews with me. *Everyone* asks that question! So, for the one thousand, four hundred and forty-second time, "no".

However, I was lucky enough to meet Ms. Boden at a garden party I attended on Vincennes, about a year ago. And we had fun

swapping tales. It seems her ego took a similar bruising, each time someone would ask her, in the course of an interview, if she were related to Jeramii Boden.

Once we stopped laughing, we had a real productive discussion and she lent some valuable insights for *Echoes of Wonder*. She's done some amazing work on Shi'awei culture.

**JMS:** I'm going to digress a bit, here. I noticed some discussion back stage, before you arrived. Seems like you didn't want to take the studio's transport here?

**JB:** Yeah. No big thing. I got here on time, didn't I? I always do.

I was staying only a few blocks away and wanted to walk it. The chauffeur sent to pick me up didn't like that much, but I wasn't about to let him stuff me in the car. When I'm travelling short distances, say three kilometers or less, I just really can't see driving that. Aside from the fact that all the walking helps keep me in shape, I just don't like to go through life isolated in a metal and plastic bubble. I like to get out there on the streets. To really *see* things, close up. I just I'm just a sensualist.

I guess it's for the same set of reasons that I don't like to travel in liners. If there's a merchant ship or free trader with an available passage space, I'll take that instead. Liners are all façade — they're designed for tourists who don't ever want to feel like they've left their living room. I get so much more traveling with a crew who are professional spacers and will talk about it, who will share their experiences.

I also find I get to meet a pretty unexpectedly interesting selection of fellow passengers, too. I met these three guys and a humanoid robot, years ago, somewhere near Vilani space. We ultimately headed

in opposite directions — me towards the Domain of Deneb and they towards the Imperial Core. It was only years later that I found out who these guys were, in the scheme of things.

**JMS:** That'd be Akidda Laagir and his companions?

**JB:** Yes. I knew his face — I never forget one — but the significance of who he was didn't sink in until much later.

**JMS:** What is it you have yet to do — or what place have you yet to visit, that you'd really like to? It seems like you been just about everywhere!

**JB:** No, not everywhere. I'm currently heading towards Mora, by some meandering route. I really hope to be able to see an Ancients site on the way. I've still yet to visit one. The way they talk about the Ancients in the media, you'd think their ruins were everywhere, but that's not that case at all. Aside from those goals, I'm just open to whatever experiences come my way.

**JMS:** Well, thanks for coming on the show. Perhaps we can have the studio chauffeur walk you home?

**JB:** Thanks. I'd like that. But I hope he can keep up. •

“...translation software is available for nearly every known language, but you can go much further when you deal with a people in their own tongue. It opens doors which may otherwise remain closed.”

# SYDKAI CLASS CRUISER

STARSHIP IN DETAIL: *By George MacLure, Rob Prior, Charles Kalina, and Tom Peters*

The *Sydkai*-class cruiser is a relatively new vessel in the service of the Domain of Deneb. Designed, built and deployed "behind the claw", its mission is long-term detached patrols of the frontier section. With the increasing boldness and potency of Vargr raiders along the Domain's frontier, these anti-piracy patrols have become increasingly important to the survival of the Domain.

## HISTORY

Immediately before the Fifth Frontier War, the Domain experienced a sharp rise in acts of piracy by Vargr corsair bands. Naval assets were adequate to protect developed subsectors, but the thinly settled and technologically underdeveloped systems along the frontier could not afford sufficient local defense forces. While the Navy was tasked to protect such systems, the existing *Kinunir*-class had insufficient endurance, and analysis showed that having to protect a supply ship was a severe tactical handicap. Smaller patrol craft (such as the *Fiery*, *Gazelle*, and *Lurushaar Kilaalum* classes) could not stand up to the increasingly well-armed corsair vessels. There was a need for a vessel tailored to piracy suppression, capable of operating away from base for extended periods, with enough firepower to meet the increasing threat.

In early 1100, the Spinward Marches Fleet Admiralty issued design parameters for the *Sydkai*-class cruiser. The new class was to be capable of defeating two *Ueknou*-class corsairs in ship-to-ship combat, of supporting limited ground actions, and of patrolling for at least two months without refuel or resupply. Several regional and megacorporate shipyards submitted proposals. The review commission selected the GSbAG proposal, largely because it provided considerable support for the ship's marine contingent.

In 1102 the Navy signed a contract for twelve cruisers, to be delivered over a six year period. Construction was interrupted during the Fifth Frontier War, as the yards were needed to repair and replace ships of the line. After the war, construction was indefinitely suspended as the yards were given over to replacing battle losses.

In the aftermath of the war, looters and pirates ravaged the Spinward Marches. Corsairs travelled with impunity throughout the frontier systems, while the Navy remained tied to its bases on high-tech, high-population worlds. Indeed, some systems gave tacit support to some corsair bands, hoping to be left alone or, if possible, to get a share of the profits. To combat this, the *Sydkai* program was revived. Construction on the four partly-completed hulls was resumed, and the INS *Sydkai* was launched in 1114. Since the onset of the Rebellion, all *Sydkai*-class vessels have been placed under Domain command. Due to the isolated nature of the region "behind the claw" and the specific mission objectives of the *Sydkai*, the design has not proliferated to other parts of the Shattered Imperium.

All ships in the class take their names from significant and/or capital cities throughout the Domain.

## SYDKAI SPECIFICATIONS

CraftID: *Sydkai* Cruiser TL 15 MCr: 1,011 in quantity.  
Hull: 1,800/4,500, Disp=2,000, Config=1SL, Armour=40G Unloaded=19,222 tons Loaded=21,040 tons  
Power: A: =Basic Systems (Environment, Controls, Sensors, Commo)  
B: =Maneuver-1 C: =Maneuver-3  
D: =Full Combat Systems (weapons+agility)  
A:12/16 B:21/28 C:42/56 D:39/52  
Fusion=A:1,980Mw+B:3,744Mw+C:7,470Mw+D:7,002Mw=19,836Mw Total  
Duration=[Jump3] A:30/90 B:30/90 C:26/78 D:2/6 [Jump1] A:60/180 B:60/180 C:31/93 D:4/12  
Loco: A:216/288, B:54/72 Maneuver=A:3/B:1  
A:108/144, B:54/72 Jump=A:3/B:1  
NOE=190 kph, Cruise=750kph, Top=1,000kph  
Agility=1  
Commo: RadioCommPlanetary 15x2, RadioCommSystem 15x2  
MaserCommPlanetary 15x8, MaserCommSystem 15x8  
Sensors: EMMask Package x1, EMS-Active-15 Far Orbit x2  
EMS-Passive-15 Interstellar x2, Neutrino(0.01Mw) Sensor-14x2  
Jam EMS-Active-15 Far Orbit x2,  
Densitometer(LowPen)-0.250km-15x2  
Act Obj Scan=Routine Act Obj Pin=Routine  
Pas Obj Scan=Routine Pas Obj Pin=Routine  
Pas Eng Scan=Simple Pas Eng Pin=Routine  
Off : Missiles = x03 BeamLaser = xx4  
Batt 16 Batt 4  
Bear 16 Bear 4  
Def: DefDM = +11  
Control: Computer=9fibx3, Panel=HoloDynamic link x30  
Special=Large HoloDisplay x1, Environ=BasicEnv, Basic LS, Extended LS, Grav Plates, Inertial Comp, AirLock x6  
Accomm: Crew=2x37 (Bridge=2, Engineering=6, Gunner=6, Flight Crew=6, Ships Troop's=46, Command=3, Steward=2, Medical=2, Frozen Watch=14), Staterooms=45, LowBerths=14(Frozen Watch) +2(Medical) SubCraft= 1x50 ton Fast Cutter, 1x50 ton Modular Cutter+ 3 extra Modules, 4x10 ton Grav APC.  
Other: Cargo=648kL, Fuel=10,000kL  
Fuel Purification Plant (total tankage in 24 hrs)  
Fuel Scoops (fills tanks in 2 hours)  
18 Drop Capsule Launch Tubes, 64 Advanced Combat Assault Capsules and 8 Decoy Capsules.  
ObjSize=Moderate, EMLevel=Faint, Battery Round=3 Missiles 4,500 Missiles on board=1,500 Battery Rounds  
Electronic Circuit Protection

**MISSION**

The *Sydkai* is a "detached cruiser"; it is not intended to operate as part of a battle squadron since its acceleration is, by Navy standards, relatively low. It is an extended endurance vessel, intended to operate alone or with minimal support. Its greatest strength is its ability to engage targets at long range; the extensive tech level 15 sensor suite allows the *Sydkai* to detect, pinpoint, and identify targets long before the *Sydkai* comes within enemy sensor range. To best exploit this advantage in detection capability, the *Sydkai*'s primary armament is a number of missile batteries, which are most effective at longer ranges.

The primary weaknesses of the *Sydkai* design are its relatively low maneuver acceleration, plus the complexity of engineering that gives it its prolonged endurance. To allow the extended, on-station capability, a series of double engines and

total of sixty-four advanced combat assault capsules, plus eight decoy capsules. With these facilities, an entire section of drop infantry and decoy capsules can be launched simultaneously.

**DESIGN**

The *Sydkai* is built on a simple oblong frame. The forward section contains crew quarters, which extend along the sides of the hull towards the engine booms. The rear portion of the hull contains the launch and recovery complex for the ship's boats and other sub-craft, which are carried between the engineering booms. The outer layer of the hull is enclosed in fuel tankage, providing an efficient radiation shield for the crew compartments.

The ship's engineering section is divided into two booms extending from the rear of the hull. This division increases tactical maneuverability by allowing for vectored thrust. Maintenance is

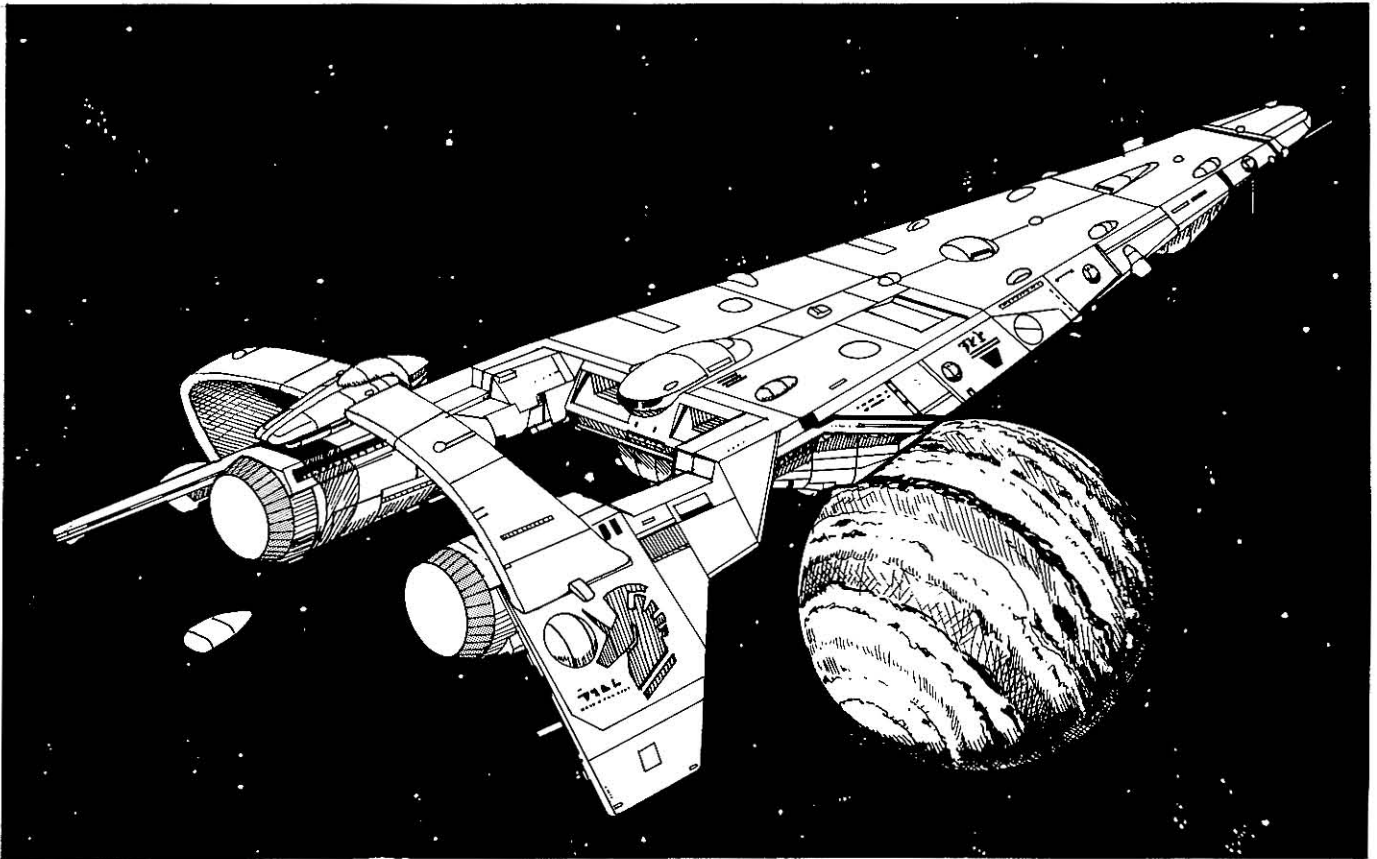

Thomas R. Peters

staged power plants were needed. Even though there is a heavy reliance on self-regulating and self-diagnosing systems (largely of Vilani-influenced design), a larger than normal engineering crew is required to control all systems at maximum output.

The ship carries two subordinate craft, a standard LSP 50-ton *Garrag*-class modular cutter and a *Lushina*-class 50-ton fast cutter. The module handling system for the modular cutter uses a revolving drum, much like the ammunition cylinder of a revolving slug-thrower, except that it is side-loading rather than end-loading. This handling mechanism allows modules to be manipulated even while the cruiser is engaging in high-gee combat maneuvers, a task that would be impossible with the external storage configuration common on ships of the *Sydkai*'s tonnage.

The *Sydkai* is also configured for rapid deployment of drop-troops. It has eighteen drop-capsule launch tubes and carries a

also relatively easy, since EVA repair crews can virtually walk from the hangar bay to the engineering structure.

A characteristic feature of the *Sydkai* is its "flying bridge", mounted on an arch above the engineering booms at the rear of the ship, and connected by gravitic drop-shafts to the crew section. The ship's primary sensor array is mounted in this structure, giving it the maximum sweep. Since strike raids require extensive coordination of sub-craft operations, the bridge was placed on the sensor structure to act as a flight-control tower. In addition, placing the bridge in the same assembly as the sensors meant that the bridge could not be cut off from the sensor array by damage to the connections between them. The obvious drawback to this system, of course, is that the bridge is very vulnerable to battle damage. A single powerful hit to the sensor/bridge assembly not only blinds the ship, but decapitates it. The exposed bridge remains the ship's "Achilles Heel".

All ships in the class take their names from significant and/or capital cities throughout the Domain.

### CREW

Individuals from two separate areas of function — crew and marines contingent — make up the *Sydkai's* total personnel count. The ship carries a standard crew complement of twenty-seven; nine officers, eleven non-commissioned officers, and seven enlisted personnel. In addition, there is a frozen watch complement of fourteen crewmembers.

The marine contingent consists of an undersized company comprised of two platoons. The first is a drop-infantry platoon, divided into two sections of two squads each, plus a command group. Although all marines on a *Sydkai* must be orbital dropped, the first section are trained for zero-gee operations, while the second are trained for ground combat. Both sections are outfitted with state-of-the-art battle dress and appropriate equipment and weapons for their specialties.

The support vehicle platoon consists of four *Astrin*-class Grav APCs and their crews, and is capable of transporting the entire marine contingent along with several kiloliters of equipment. The lead *Astrin* contains enhanced communications gear, and it usually used for Command and Control by the command group. The maintenance crew for the vehicle platoon also act as jump supervisors for the drop infantry platoon. While the composition can be changed for specific missions, the normal patrol ship carries forty-six marines; two officers, twelve non-comms, and thirty-two enlisted personnel.

### OPERATIONAL TACTICS

The Domain relies on a two-tier patrol system; large warships police major trade routes, showing the flag and deterring attack, while smaller vessels such as the *Gazelle* and *Lurushaar Kilaalum* class patrol the backwaters. The *Sydkai*-class, operating alone or in small task forces, roam the border regions on open assignments lasting from two to six months. Naval Command dictates the region to be patrolled, but most other decisions are up to the vessel's captain. Routes are deliberately chosen to be unpredictable; Captain Chahal of the *Astur* is rumored to lay her course based on the gunners' weekly gilku game. Commanders are encouraged to show initiative, following information received from merchants and local starports.

On patrol, the cruiser's primary mission is monitoring and detection. The *Sydkai* emerges from jumpspace with a vector carefully calculated to carry it through the system along an inconspicuous trajectory. All non-essential systems are powered down to reduce the ship's neutrino signature, while the passive sensor suite is continuously monitored for signs of actual piracy or suspicious activity. A distress signal or evidence of combat — meson fire, radiation emissions, and so on — are responded to immediately. Suspicious activity, such as a ship with a false transponder, will be monitored until the commander has enough evidence of wrong doing to satisfy a Domain court, after which the offender is apprehended. The commander is also authorized to inspect vessels before they leave system.

Patrols may also serve a political function: "showing the flag". Upon emerging from jumpspace, the ship broadcasts its identity and heads directly to the main world for a courtesy visit. This not only acts as a deterrent to local corsairs, but also helps forestall local collusion with corsair bands.

Apart from patrols, the *Sydkai*-class are also employed for surgical strikes against known pirate bases. These missions rely

on surprise to be effective. On such missions, the jump emergence point and real space vector are calculated to bring the cruiser, and any escorts, into normal space as close as possible to the target world. After emerging, the *Sydkai* accelerates directly toward the target world, dropping its marine strike force and then providing orbital fire support and cover. The cutters, along with any escorts, assume high guard position against corsair vessels or local system defense boats. This mission relies on surprise and force concentration to capture the nerve center of the pirate base quickly.

### ADVENTURE USES

The *Sydkai* can have several uses in a role-playing context. Perhaps the most obvious is as a service assignment for active-duty Navy and Marine characters. Although military personnel must follow orders, *Sydkai* commanders are given substantial latitude. Within certain constraints, players can wander at will, but still be required to undertake specific missions if the plot dictates. Motivation for involvement is simple; "Orders are orders".

The *Sydkai* can also come to the rescue if a pirate attack that goes badly for the players threatens to prematurely end the campaign (and the characters). Because it may have been quietly scanning for signs of battle for weeks, this is less of a "deus ex machina" than if a battlecruiser simply dropped out of jumpspace at a convenient moment.

A *Sydkai's* commander may shanghai retired Navy characters, or Scout characters with wartime experience, travelling in frontier sectors. It is not uncommon for a *Sydkai* to escort convoys of small merchants. In such a situation, the commander would want each ship to have an acting captain familiar with the Navy's standard operating procedure, and could assign each ex-Navy or Scout character to command a vessel (or group of vessels) in the convoy.

If they do their job well, the commander may wish to retain them as freelance intelligence-gatherers. Since the *Sydkai* travels to many worlds in a given region, the characters will also have earned a valuable contact for inside information (and the referee will have created a fine means of introducing adventures). Of course, not all of this will be true, but much of it should be: a red herring only works if the players believe it. Tips could include advice about war zones, damaged starports or corsair activity, or general information that indirectly suggests good markets or sources of goods.

The local *Sydkai* patrol could also act as a recurring nemesis. Characters will obviously be on the wrong side of the *Sydkai* if they are pursuing some "vaguely" illegal avenue. A more interesting possibility is a *Sydkai* commander "gone bad"; after all, these are officers with little or no oversight, in charge of extremely powerful vessels that operate away from base for months at a time. A Naval officer commanding a *Sydkai* turned smuggler, extortionist or pirate can make an imposing antagonist.

The *Sydkai* can be a powerful tool, a useful ally, or a dangerous enemy, depending on how the referee and players choose to use it. Ideally it should be more than just another set of game statistics or piece of hardware; rather, it should be as an NPC, both in its crew and in and of itself. •



MEGATRAVELLER

# DOMAIN OF DENEK

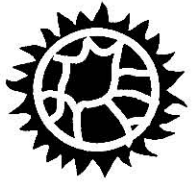

SECTOR DATA

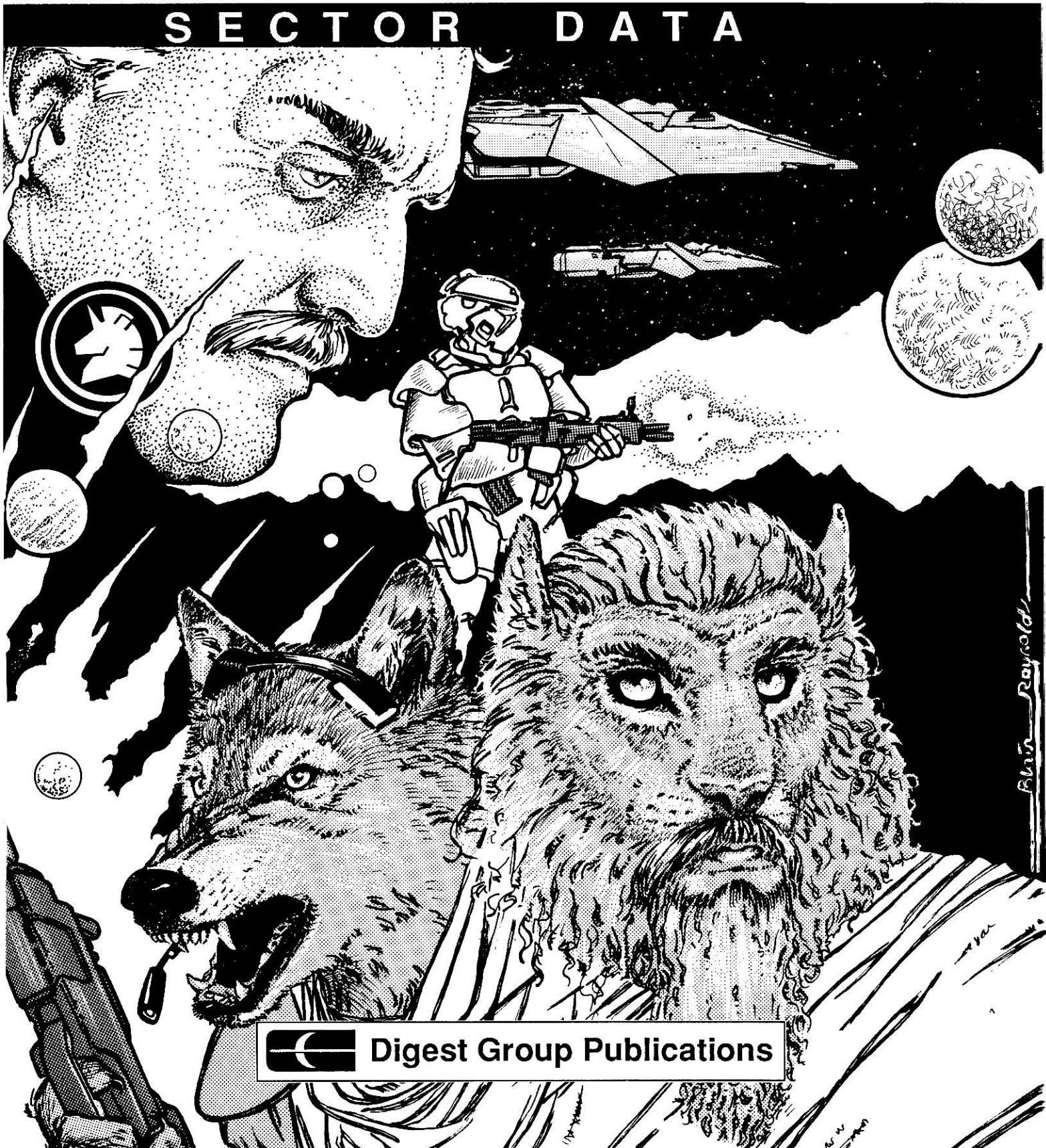

 Digest Group Publications

## Spinward Marches

Zeycude	0101 C330698-9	Na Ni Po De	613 Zh M9 V
Reno	0102 C1207B9-A	Na Po De	603 Zh G8 V M1 D
Errere	0103 B263664-B	Z C0 Ni Ri	910 Zh M1 V M4 D
Cantrel	0104 C366243-9	Lo Ni	520 Zh F1 III
Gyomar	0108 D8B2889-5	Fl	824 Na A8 IV
Atson	0111 B310598-8	Ni	933 Na K8 VI
Yiktor	0114 C6B6431-A	Ni Fl	123 Na G4 V M4 D
Xhosa	0115 EA95124-4	Lo Ni	910 Na M0 III
Junction	0122 D150441-4	Ni Po De	210 Na M3 V M2 D
Uniqua	0129 E62556B-4	Ni	210 Na K9 V M2 D
Garoo	0130 A2008CB-A	Na Va	210 Na M1 V M5 D
Emape	0133 B564500-B	N Ag Ni	A 503 Dd M0 V
Raweh	0139 B130300-B	N Lo Ni Po De	A 920 Dd G3 V M1 D
876-574	0140 E687200-0	Lo Ni	702 Na K7 V
Thengo	0202 C868586-5	Ag Ni	801 Zh G5 V M3 D
Prinx	0212 C436635-6	Ni	720 Na A9 V K8 VI
Rushu	0215 E765664-4	Ag Ni Ri	903 Va A0 IV M6 D
Bael	0218 E200100-8	Lo Ni Va	812 Na K2 V
Stern-Stern	0223 B321588-B	Ni Po	701 Da M0 V M3 D
886-945	0230 D833000-3	Lo Ni Po Ba	504 Na F8 V
Saxe	0231 EAA5543-7	Ni Fl	910 Na A2 V
Andor	0236 C695735-9	Ag	R 603 Dr F3 V
769-422	0240 E754401-8	Ni	924 Na G2 V
Rio	0301 C686648-8	Ag Ni Ri	201 Na M1 V M0 D
Gesentown	0303 B21169B-C	Z Na Ni Ic	801 Zh M9 D M9 D
Chronor	0304 A6369A5-D	Z Hi Cp	304 Zh M8 V
Atsa	0307 B4337CA-A	Z Na Po	810 Zh F7 V M9 D
Mizan-fel	0311 B46258A-8	Ni	323 Na F3 V
Nomym	0321 C233898-A	G Na Po	623 Na G0 V
Laberv	0325 B354443-7	M Ni	834 Da F0 V
Ektron	0326 C332652-9	Na Ni Po	423 Da M5 V
Gothe	0332 E22159B-6	Ni Po	310 Dd F5 IV
Miriam	0333 B9998A6-A	B	A 514 Dd M6 V
Candory	0336 C593634-8	Ni	R 920 Dr F6 V M3 D
Wonderay	0340 E88A46A-4	Ni Wa	210 Na M3 V M1 D
Sansibar	0412 B200310-A	Z D4 Lo Ni Va	701 Zh M3 V M3 D
Attica	0414 C400546-8	Ni Va	810 Na K1 VI M6 D
Retinae	0416 E8C69AA-5	Hi Fl	910 Cs M4 V
Zamine	0421 E897977-A	Hi In	223 Da M4 V
Engrange	0425 C554769-8	Ag	701 Da M1 V M3 D
Ilium	0426 B444831-9	M	401 Da G3 V M8 D
Roget	0427 B566777-9	Ag Ri	420 Da F8 V M9 D
Kardin	0429 E453123-6	Lo Ni Po	410 Na F7 V
Bularia	0430 C774622-5	Ag Ni	310 Cs M5 V M3 D
Jone	0433 B792785-9	N	A 810 Dd M8 V M5 D
Jinx	0440 D100133-7	Lo Ni Va	A 202 Na G3 IV M6 D
Whenge	0503 D648500-8	Ag Ni	610 Na M8 V
Terra Nova	0511 C786342-9	Lo Ni	812 Na M7 D
Asmodeus	0512 E596400-4	Ni	205 Zh K8 V
Faisal	0518 D445436-3	Ni	810 Cs K9 V M7 D
Rorre	0526 D765657-3	Ag Ni Ri	103 Da F4 V M7 D
Mire	0527 A665A95-B	M Hi Cp	110 Da M3 V
Condaria	0528 E54779B-5	Ag	901 Na K3 V M0 D
Dorannia	0530 E42158A-8	Ni Po	510 Na K4 V
Ucella	0532 D574654-7	C0 Ag Ni	A 410 Cs F2 V M6 D
Penelope	0533 C460642-4	Ni Ri De	323 Dd F6 V M7 VI
Karin	0534 A767768-C	A Ag Ri	A 410 Dd M7 V
Wonstar	0538 B455741-7	N Ag	A 910 Dd M0 V M1 D
Froin	0539 C535225-9	Lo Ni	601 Dd M7 V M2 D
Enlas-du	0601 E975776-6	Ag	323 Na F1 V
Algebiaster	0605 C665658-9	Ag Ni Ri	410 Na M0 V M1 D
Rasatt	0607 E883401-7	Ni	910 Na F0 V
Ninjar	0608 A211666-C	Z Ni Na	410 Zh A4 D
Sheyou	0610 B756779-A	Z Ag	111 Zh F4 V M0 D
Lebeau	0613 B869554-C	Ni	901 Zh G8 V M5 D
Querion	0614 B254788-9	Z Ag Cp	804 Zh M6 V

Dekalb	0618 EA8A799-6	Ri Wa	320 Cs M1 V
Winston	0620 E887573-6	Ag Ni	501 Sw K5 V M9 D
Terant 340	0622 D1405A7-9	Ni Po De	523 Da G0 V M5 D
Jacent	0624 A333644-D	Na Ni Po	710 Da M6 V
494-908	0625 X893000-0	Lo Ni Ba	R 710 Da M1 V
Darrian	0627 A463955-G	Hi	225 Da G1 V M1 D
Gohature	0632 C754766-7	S Ag	523 Dd F8 V
Quhaiathat	0637 C31479B-9	Ic	210 Dd M8 V
Lakou	0638 E779454-7	Ni	A 601 Dd M6 D
Indo	0703 E334662-5	Ni	320 Na F6 V
Nerewhon	0704 E738475-7	Ni	820 Na K5 V
Cipango	0705 A886865-C	Z Ri	121 Zh G2 V
Stave	0710 E7667A8-2	Ag	801 Na M9 V M2 D
Rapp's World	0712 C592320-8	Z Lo Ni	402 Zh M5 V M8 VI
Thanber	0717 B243653-C	Ni Po	210 Cs M9 V M1 D
Entrope	0720 E336AAA-C	Hi	720 Sw G6 V M1 D
Torment	0721 X233231-4	Lo Ni Po	R 820 Da G1 V
Trifuge	0723 C446556-9	Ag Ni	210 Da M5 II
Nosea	0724 B2326BB-C	M Na Ni Po	620 Da G0 IV
Spume	0727 C140200-A	M Lo Ni Po De	434 Da M7 V
Ator	0729 D326258-6	Lo Ni	821 Na F7 V M7 D
Ralhe	0731 E224564-8	Ni	801 Na M8 V M3 D
Iderati	0732 A887798-C	N Ag Ri Cp	201 Dd M2 V
Tondoul	0739 E5136A7-4	Na Ni Ic	701 Na M8 V M1 D
Narval	0805 D525688-6	Z Ni	A 603 Na G4 V M6 VI
Plaven	0807 E845300-3	Lo Ni	910 Na G8 V M7 D
Quar	0808 B532720-B	N Na Po	A 401 Dd M2 V
Fron	0810 E9C3300-9	Lo Ni Fl	103 Cs F8 V
Anselhome	0820 C110588-8	Ni	601 Sw M6 VI M0 D
Cunnonic	0822 E65767A-3	Ag Ni	502 Da M0 V
Debarre	0830 B854123-9	Lo Ni	A 822 Cs M2 V
875-496	0834 E888421-7	S Ni	A 510 Cs M8 V M7 D
Ochecate	0837 E747569-7	Ag Ni	210 Na G8 VI M8 D
Mewey	0838 D786799-5	Ag Ri	701 Na M3 V M3 D
975-452	0840 E100316-9	Lo Ni Va	821 Na M0 V
Condyole	0901 E7A1522-8	Ni Fl	923 Na F8 III
Puparkin	0902 C7B3386-9	Lo Ni Fl	502 Na K8 V M4 D
Chwistyoch	0904 B766766-A	Z Ag Ri	A 424 Zh M2 V
Gougeste	0909 C372510-A	Ni	A 420 Na K2 V
Caloran	0911 C796746-5	Ag	510 Na G2 V M4 D
899-076	0912 E201300-8	Lo Ni Va Ic	520 Na F7 V
Quare	0915 B200545-9	Ni Va	204 Cs M3 V
Zeta 2	0919 X6B0000-0	Lo Ni De Ba	R 020 Na M4 V
Hrunting	0921 B463747-9	M Ri	313 Sw M2 V
Tizon	0922 B386887-A	M Ri	323 Sw K2 VI M3 D
Narsil	0927 B574A55-A	M Hi In	224 Sw M0 II M6 D
Flammarion	0930 A623514-B	B Ni Po	710 Dd F8 V
Astelltine	0931 B7A7402-A	Ni Fl	210 Na K7 V M3 D
Inchin	0938 D12035C-A	Lo Ni Po De	823 Na F0 III
Singer	0940 D553774-6	Po	901 Na M2 V M2 D
Esalin	1004 C565673-8	Ag Ni Ri	A 223 Cs F3 V M5 D
Ruby	1005 B400445-B	S Ni Va	201 Dd M1 V M3 D
Emerald	1006 B766555-B	S Ag Ni	534 Dd M1 VI
Zenopit	1010 D130546-7	Ni Po De	622 Na M8 D
Arden	1011 C5549CB-8	Hi	810 Fa M4 V M5 D
Choleosti	1018 C200100-9	Lo Ni Va	101 Dd M9 V M4 D
Margesi	1020 C575677-6	Ag Ni	A 910 Dd M4 V M7 D
Colada	1022 B364685-B	M Ag Ni Ri	A 211 Sw K2 V M8 D
Anduril	1026 B985855-B	M Ri	222 Sw F2 V
567-908	1031 E532000-8	Lo Ni Po Ba	310 Na M9 V M1 D
Avastan	1037 C433520-A	Ni Po	724 Na M8 VI
Kwai Ching	1040 C503758-A	Na Va Ic	320 Na K3 V
Riverland	1102 C566A99-9	Hi	A 214 Zh M7 III
Clan	1103 B672899-A	Z	A 901 Zh M8 V
Jewell	1106 A777999-C	A Hi In Cp	623 Dd G7 V
Zircon	1110 C792668-8	M Ni	624 Fa F0 V
Frenzie	1116 A200436-A	N Ni Va	110 Dd M2 III M3 D

Garda-Vilis	1118 B978868-A	S	912 Dd M3 V	Louzy	1604 D322A88-8	Hi Na In Po	110 Dd M5 V
Vilis	1119 A593943-A	Hi In	820 Dd G5 V M8 D	Grant	1607 X664100-0	Lo Ni	R 222 Dd K6 V
Mjolnir	1121 B530544-A	M Ni Po De	522 Sw A5 V G0 D	Phlume	1611 C887624-8	Ag Ni	710 Dd G5 V M8 D
Joyeuse	1123 B464778-A	M Ag Ri	A 201 Sw M3 V M9 D	Iron	1626 E529000-9	Lo Ni Ba	714 Sw F0 V
Orcrist	1126 B8A6733-A	M FI	401 Sw M7 V M7 D	Bronze	1627 E201000-9	Lo Ni Va Ic Ba	510 Sw M3 V
Enos	1130 E25059B-4	M Ni Po De	710 Sw M9 V	Mithril	1628 E568000-7	Lo Ni Ba	301 Sw F4 D
Faldor	1131 E5936A7-2	Ni	520 Na M7 III	Talchek	1631 C7B1462-5	Ni FI	A 601 Cs K8 V M5 VI
Bowman	1132 D000300-9	S Lo Ni As	811 Cs M0 V	Milagro	1632 E21178A-7	Na Ic	920 Cs M2 V
Squallia	1133 C438679-9	Ni	320 Na F0 V	Pegaton	1634 C769873-4	Ri	913 Na M0 V
Tarsus	1138 B584620-A	Ag Ni	202 Cs K9 V	Binges	1635 A800231-A	Lo Ni Va	720 Na F0 V
Ao-dai	1201 E410644-6	Na Ni	312 Zh K2 V M3 D	Millie Falcs	1637 B9A2469-C	A Ni FI	301 Dd M6 V
Mongo	1204 A368685-A	A Ag Ni Ri	603 Dd M6 III M0 D	Efate	1705 A646930-D	B Hi In	810 Dd K4 V
Utoland	1209 C473464-7	Ni	410 Fa M0 V	Alell	1706 B46789C-A	Ri	410 Dd M7 V M7 D
Pequan	1210 E5656B9-4	Ag Ni	710 Na M5 V	Extolay	1711 B45589A-A	N	110 Dd M2 V M4 D
Digitis	1212 E53668A-5	Ni	920 Na M6 III	Lanth	1719 A879533-B	A Ni Cp	710 Dd F5 IV M9 D
Edinina	1213 E400220-5	Lo Ni Va	A 401 Cs K6 V M0 D	Arba	1721 C200200-C	Lo Ni Va	610 Dd K2 V
728-907	1214 D955000-2	Lo Ni Ba	610 Dd F1 V M4 D	Wardn	1727 B756486-B	S Ni	A 502 Dd M2 V
Stellatio	1216 D5A4420-4	Ni FI	210 Dd M9 III	Olympia	1728 C328342-7	Lo Ni	120 Dd M6 V
Arkadia	1217 E446845-6		402 Dd M1 V	Smoug	1729 C14078A-9	Po De	902 Dd M1 V M7 D
Gungnir	1221 B444779-8	M Ag	432 Sw G3 VI M4 VI	Grout	1731 A400404-B	Ni Va	124 Dd F8 V
Gram	1223 A895957-B	M Hi In Cp	603 Sw F2 D M2 D	Lydia	1733 E110430-6	Ni	902 Dd M4 III M0 VI
Excalibur	1225 B324755-A	M	402 Sw M5 V	Melior	1736 D140466-7	Ni Po De	A 724 Dd G3 V
Walston	1232 C544338-8	S Lo Ni	302 Cs M5 V	Egypt	1737 BAC6567-7	N Ni FI	521 Dd F8 V
Flexos	1233 E5A1422-6	Ni FI	610 Na M8 V M2 D	Aster	1739 C86A410-9	Ni Wa	401 Dd M9 V
Collace	1237 B628943-D	S Hi In	101 Cs F1 V M6 D	Yres	1802 BAC6773-7	FI	335 Dd G5 V
Pavabid	1238 C6678D8-6		A 701 Cs M7 V	Menorb	1803 C652998-7	Hi Po	310 Dd M5 II
Nakege	1305 D591314-2	Lo Ni	A 501 Dd M6 V M0 D	Uakye	1805 B439598-D	Ni	320 Dd M9 V
Lysen	1307 B592655-A	S Ni	623 Dd M9 V	Whanga	1806 E676126-7	Lo Ni	224 Dd A1 V M1 D
Tremous Dex	1311 B511411-C	Ni Ic	201 Na K8 V M5 D	Knorbes	1807 E888787-2	Ag Ri	834 Dd G3 V
Mirriam	1315 E472300-8	N Lo Ni	110 Dd F5 V	Forboldn	1808 E893614-4	Ni	312 Dd G0 V
Saurus	1320 D888588-7	Ag Ni	820 Dd A8 V M1 VI	Ruie	1809 C776977-7	Hi In	A 701 Na M3 V
Tyrfling	1324 B637735-A	M	701 Sw M4 V	Jenghe	1810 C799663-9	S Ni	323 Dd M0 V
Sacnoth	1325 B775956-C	M Hi In	801 Sw F9 V M8 D	Dinon	1811 D100535-A	Ni Va	201 Dd A4 III
Caladbolg	1329 B365776-A	S Ag Ri	710 Dd F7 V M0 D	Ghandi	1815 B211455-A	N Ni Ic	303 Dd F8 V M3 D
			M4 D	Victoria	1817 X697772-2	Ag	R 112 Dd M2 V
Datrillian	1331 E227633-8	Ni	801 Na M7 V	Rabwhar	1822 D5448BA-6	S	313 Dd M5 D
Nirton	1332 X600000-0	Lo Ni Va Ba	R 011 Na K8 V	Adabicci	1824 A57189B-B	N	801 Dd K8 V M8 D
Judice	1337 E9B2000-8	Lo Ni FI Ba	321 Cs M3 III	Zaibon	1825 B000544-B	Ni As	512 Dd G5 III
Trexalon	1339 B361851-C	Ri	923 Na M0 D	Tenalphi	1826 A774102-E	Lo Ni	610 Dd F7 V
Motmos	1340 B68468B-5	N Ag Ni Ri	710 Cs M2 V M2 D	Callia	1836 E150852-6	Po De	810 Dd M7 V
Foelen	1401 B638665-8	Ni	A 910 Zh K0 V	Pixie	1903 A100103-D	N Lo Ni Va	901 Dd M1 V M0 D
Farreach	1402 A200400-B	Z Ni Va	A 415 Zh M3 II M0 V	Boughene	1904 A8B3531-D	S Ni FI	601 Dd M7 V
Rangent	1411 E67A612-7	Ni Wa	503 Na M4 V	Hefry	1909 C200423-7	S Ni Va	320 Dd K6 II M6 D
Denotam	1413 B739573-A	N Ni	324 Dd M2 V	Regina	1910 A788899-C	A Ri Cp	703 Dd F7 V M8 D
Ficant	1417 E567353-5	Lo Ni	910 Dd M0 V M1 D				M6 V
Beater	1424 B685686-A	M Ag Ni Ri	610 Sw M4 V	Dinomn	1912 B674632-9	S Ag Ni	204 Dd M8 VI
Gunn	1429 E344110-8	Lo Ni	A 602 Dd M6 V	Ylaven	1916 X587552-4	Ag Ni	R 922 Dd F9 V
Calibum	1430 E000514-A	Ni As	924 Dd M7 VI	Sonthert	1918 X6266AB-3	Ni	R 314 Dd K6 V M0 D
Noctocol	1433 E7A5747-6	FI	602 Na M5 VI M2 D	D'Ganzio	1920 B120410-D	N Ni Po De	312 Dd M3 V M0 D
Tarkine	1434 C466662-7	S Ag Ni Ri	A 310 Cs M0 V M2 D	lanic	1924 E360697-5	Ni Ri De	924 Dd M6 II M9 D
Dallia	1435 B8B5883-9	FI	610 Cs F2 V	Spirelle	1927 C766846-8	S D1 Ri	715 Dd M4 V
Talos	1436 E333532-9	Ni Po	820 Na F9 V M1 D	Mithras	1932 C8B5546-6	Ni FI	302 Dd M3 V
871-438	1510 E722000-8	Lo Ni Po Ba	801 Na M9 V M8 D	Weiss	1934 A626464-B	Ni	A 703 Dd M0 III M2 D
Tionale	1511 C674321-8	Lo Ni	A 210 Cs M9 V M5 D	Windsor	1935 C783511-9	Ni	210 Dd K9 V M0 D
Calit	1515 C334867-7	C1	501 Dd K9 V M5 D	Overnale	1937 B45467A-9	Ag Ni	423 Dd G3 V
Asgard	1519 X3437C7-2	Po	R 520 Dd F5 II M1 D	New Rome	1938 B837866-B	N	704 Dd F8 V M0 D
Tavonni	1520 E567000-7	Lo Ni Ba	434 Dd G6 II	Craw	1939 C573645-3	Ni	923 Dd G7 V
Dyrnwyn	1522 B958412-A	M Ni	201 Sw M4 V M8 D	Feri	2005 B384879-B	S Ri	620 Dd G4 V M3 D
Durendal	1523 B687334-B	M Lo Ni	714 Sw M1 V	Roup	2007 C77A9A9-7	S Hi In Wa	A 323 Dd F9 V
Hofud	1524 B666553-A	M Ag Ni	501 Sw M4 V M9 D	Wypoc	2011 E9C4547-8	Ni FI	A 922 Dd M3 V
Sting	1525 B645896-A	M	302 Sw M0 V	Derchon	2024 C512799-8	S Na Ic	901 Dd M0 V M7 D
Biter	1526 B354623-A	M Ag Ni	301 Sw M7 V M1 D	Aki	2035 B443987-9	Hi In Po	A 214 Dd G6 V M2 D
Steel	1529 E655000-7	Lo Ni Ba	324 Sw M8 III	Gliten	2036 A000986-F	A Hi Na In As Cp	821 Dd K9 V
Dawnworld	1531 E885000-0	Lo Ni Ba	025 Na F8 D M5 D	Trane	2038 C639422-B	Ni	704 Dd F4 V M3 D
Elixabeth	1532 B426467-8	N Ni	201 Cs M4 V M5 D	Pscias	2106 X355423-1	Ni	R 501 Dd M5 VI
Forine	1533 D3129B8-A	Hi Na In Ic	610 Na M0 V	Yori	2110 C360757-A	Ri De	713 Dd F1 V
Mertactor	1537 B262732-B	S Cp	610 Dd G1 V	Djinni	2111 E459000-9	Lo Ni Ba	R 822 Dd K5 V

Rech	2112 D9957AA-6	Ag	501 Dd M0 V	Pimane	2527 E500343-4	Lo Ni Va	803 Dd K0 V
Lunion	2124 A995984-D	A Hi In Cp	810 Dd M3 D M7 D	Burtson	2534 C462667-8	Ni Ri	402 Dd M4 V
Shirene	2125 B984510-B	S Ag Ni	A 901 Dd G4 V M1 D M1 D	Squanine	2536 A300550-B	Ni Va	303 Dd F4 V M7 D
Penkwar	2128 X978310-1	Lo Ni	R 320 Dd M0 V	Dobham	2537 A450457-A	S Ni Po De	523 Dd G0 V
Harvosette	2129 C330737-9	Na Po De	910 Dd M7 D M5 D	Pyramus	2538 E566335-2	Lo Ni	214 Dd M3 V
Centry	2132 E222447-6	Ni Po	220 Dd K3 V	Thisbe	2539 E4305AD-5	Ni Po De	322 Dd F8 II
Caledonia	2134 C541636-5	Ni Po	910 Dd M4 III M0 D	Aramis	2540 B659772-6		924 Dd M3 V
Sorel	2137 E48569A-2	Ag Ni Ri	921 Dd G3 V M3 D	Corfu	2602 X895674-8	Ag Ni	R 222 Dd M0 V
Horosho	2138 C3378A6-A	S	920 Dd F4 V	Focaline	2607 EA88544-A	Ag Ni	724 Dd F3 V
Romor	2140 B450456-B	A Ni Po De	112 Dd M5 V M3 D	Macene	2612 B000453-E	N Ni As	911 Dd G8 V M8 D
Tentus	2201 C979500-A	S Ni	920 Dd M2 V	Fulacin	2613 A674210-D	Lo Ni	810 Dd G3 V
Kinorb	2202 A663659-8	Ni Ri	622 Dd M7 V	Natoko	2620 C8879AB-9	Hi	204 Dd F4 V
Beck's World	2204 D88349D-4	Ni	701 Dd M0 V M2 D	Fosey	2621 A633656-A	Na Ni Po	620 Dd M3 V
Enope	2205 C411988-6	Hi In Na	600 Dd M4 V M5 D	Mercury	2624 B658663-8	A Ag Ni	304 Dd F7 V
Wochiers	2207 EAC28CC-9	FI	703 Dd F0 V	Tivid	2627 C534477-8	Ni	401 Dd M3 V
K Kirka	2212 CAA5345-8	Lo Ni FI	102 Dd M8 V	Robin	2637 C00059C-C	Ni As	212 Dd M5 V
Quopist	2215 B150679-A	Ni Po De	A 721 Dd M3 V	D'Mara	2638 E75A798-5	Wa	910 Dd F4 VI
Carse	2224 C463325-9	Lo Ni	601 Dd M8 V M6 D	Kelcher	2639 C525567-9	Ni	602 Dd M6 V
Persephone	2228 B775833-A	W	922 Dd M2 V	Lablon	2701 B646589-A	Ag Ni	503 Dd M2 III M4 D
Marastan	2231 D868772-5	Ag Ri	924 Dd M7 V	Heguz	2706 E66A224-C	Lo Ni Wa	510 Dd M5 V M7 D
Crout	2232 E4359CA-7	Hi	314 Dd M7 II M9 VI	Violante	2708 C669452-A	Ni	420 Dd M0 V
Tirem	2233 C7B5975-B	Hi FI	621 Dd K5 V	Risek	2712 A325579-A	N Ni	401 Dd M5 V M3 D
Inthe	2234 C100598-B	Ni Va	924 Dd K3 V	Porozlo	2715 A867A74-B	Hi	2715 Dd M1 V M9 D
Tsarina	2236 D120636-5	Na Ni Po De	A 301 Dd M5 V M2 D	Rhylianor	2716 A434934-F	A Hi Cp	810 Dd M2 VI
Wurzburg	2237 C795300-A	S Lo Ni	A 510 Dd F8 V	Loneseda	2720 C86A215-7	Lo Ni Wa	705 Dd M9 V
Yorbund	2303 C7C6503-7	Ni FI	220 Dd M8 VI	Carey	2726 C579221-9	Lo Ni	910 Dd M7 V M2 D
Shionthy	2306 X000742-8	Na As	R 714 Dd M4 V	Duale	2728 A5437BF-B	Po	401 Dd M2 V M0 7
Algine	2308 X766977-4	Hi	R 723 Dd M9 VI	Tussinian	2731 B678324-7	Lo Ni	520 Dd K0 V
Yurst	2309 E7B4643-5	Ni FI	824 Dd K9 V	Edeneit	2733 A4638BD-B		934 Dd M7 V
Treece	2311 D232866-8	Na Po	610 Dd M1 V	Conway	2735 D894586-7	S Ag Ni	311 Dd F0 V M0 D
Echiste	2313 C53A313-A	Lo Ni Wa	720 Dd G4 V	Doods	2739 C4439DF-7	S Hi In Po	423 Dd M7 V
Pirema	2314 D691142-5	Lo Ni	802 Dd M4 V	Valhalla	2811 E365432-5	Ni	622 Dd G4 IV
Rhise	2317 C100576-A	Ni Va	A 710 Dd M7 V	Zivije	2812 C6B199C-B	Hi FI	A 421 Dd G6 V
Ivendo	2319 B324659-A	A C0 Ni	112 Dd A9 V	Jae Tellona	2814 A560565-8	N Ni De	913 Dd F9 IV
Quiru	2321 B365300-8	Lo Ni	323 Dd M6 V	Gerome	2818 X573000-0	Lo Ni Ba	R 701 Dd K2 V
Gorram	2322 X554220-0	Lo Ni	R 801 Dd M8 V M6 VI	Catz	2824 C22048C-9	Ni Po De	510 Dd G9 V M2 D
Resten	2323 B310100-B	S Lo Ni	501 Dd M5 V M8 D	Meleto	2827 C675100-5	S Lo Ni	724 Dd F9 V
Capon	2324 B747748-A	N Ag	610 Dd M9 D	Hexos	2828 B534420-8	N C3 Ni	123 Dd K1 V M2 D
Sharrip	2325 C575101-A	Lo Ni	503 Dd K5 V	Pedase	2830 C415346-7	S Lo Ni Ic	101 Dd M6 V M7 D
Strouden	2327 A745988-D	N Hi In	920 Dd M0 V M4 D	Leander	2832 E695244-5	Lo Ni	801 Dd M5 V M1 D
Bicornn	2331 E563576-2	Ni	210 Dd M0 V	Pepernium	2833 D567530-3	Ag Ni	503 Dd M1 V
Ffudn	2334 A41489D-C	Ic	904 Dd F3 V M3 VI	Traltha	2834 B790630-6	Ni De	410 Dd F5 V
Bendor	2336 A756656-C	A Ag Ni	820 Dd A5 V	Farquahar	2839 C625563-7	S Ni	201 Dd M5 V
Heya	2402 B687745-5	Ag Ri	734 Dd K6 III M8 D	Pavanne	2905 C669452-A	Ni	425 Dd G2 V
Keng	2405 E2718CA-3		812 Dd G5 III M9 D	Carsten	2906 C427402-B	Ni	804 Dd M8 V
Moughas	2406 CA5A588-B	Ni Wa	801 Dd M9 V M9 D	Zila	2908 E25672C-7	Ag	A 701 Dd M6 V M3 D
Rethe	2408 E230AA8-8	Hi Na Po De	323 Dd G7 V	Henoz	2912 A245543-B	C0 Ag Ni	824 Dd F3 D
Inthe	2410 B575776-9	A Ag	423 Dd F8 V	Celepina	2913 B434456-9	A Ni	201 Dd M2 VI
Keanou	2411 C792348-7	S Lo Ni	213 Dd M3 III M2 D	Gitosy	2918 B000676-9	Na Ni As	620 Dd G6 V M3 D
Tureded	2414 C465540-9	Ag Ni	614 Dd M3 V	Moran	2924 C367300-8	N Lo Ni	A 201 Dd M4 V M7 D
Vreibefger	2415 E481542-3	Ni	901 Dd M9 V	Maitz	2927 A201511-B	Ni Va Ic	122 Dd F1 V
La'Belle	2416 C564112-4	Lo Ni	701 Dd F2 V M3 D	Mainz	2930 C553352-A	S Lo Ni Po	803 Dd K2 V M7 D
Equus	2417 B55A858-B	S Wa	202 Dd F6 V M5 D	Raydrad	2933 E99467A-6	Ag Ni	303 Dd M7 III M9 D
Icelina	2418 B5245A9-7	N Ni	A 301 Dd M9 V M8 D	Zyra	2934 B555448-7	Ni	301 Dd M8 V
Cogri	2419 CA6A643-9	Ni Ri Wa	432 Dd M1 II	Murchison	2935 B544433-6	N Ni	305 Dd M5 III M9 V
Skull	2420 C2237C7-9	N Na Po	601 Dd M1 V M0 VI	Hammermium	2936 A5525AB-B	Ni Po	535 Dd M3 III
Gandr	2425 E000347-8	Lo Ni As	813 Dd M7 V	Thornnastor	2940 D534443-8	S C1 Ni	804 Dd M1 III
Drolraw	2426 EAB6311-5	Lo Ni FI	904 Dd F1 V	Jesedipere	3001 C775300-7	Lo Ni	411 Dd F4 V
Paya	2509 A655241-9	N Lo Ni	603 Dd F3 V	Yebab	3002 C9A489A-7	FI	712 Dd M9 V
Dhian	2510 C9A769D-4	Ni FI	202 Dd M5 V	Nasemin	3003 B98A422-B	S Ni Wa	612 Dd K2 V
Kinorb	2512 C449433-9	Ni	502 Dd A0 V K9 D	Zykoca	3004 X994542-6	Ag Ni	R 320 Dd M9 V
Gileden	2514 C483103-6	Lo Ni	203 Dd M9 V	Aramanx	3005 B657974-6	Hi	210 Dd G0 V
Plannet	2519 E9C5677-7	Ni FI	224 Dd K5 V	Pysadi	3008 C4766D7-4	Ag Ni	201 Dd K9 V M1 D
Garrincki	2520 B632520-7	S Ni Po	410 Dd M0 V M7 D	L'oeul d'Dieu	3010 B98A510-B	N Ni Wa	502 Dd G1 V M9 D
Heroni	2521 B6449B9-8	Hi In	721 Dd F3 V	Belizo	3015 B895646-5	Ag Ni	923 Dd G1 V
Byret	2523 B485697-6	Ag Ni Ri	812 Dd M0 V	Kegena	3016 E869569-3	Ni	A 224 Dd F6 V
				Heroni	3017 E7A0614-3	Ni De	820 Dd G5 V

457-973	3019 X372215-4	Lo Ni	R 534 Dd G9 V	Aziziyah	0229 C86A475-B	Ni Wa	624 Dd M3 V
Somem	3020 C301340-B	Lo Ni Va Ic	201 Dd M6 V M7 VI	Inkekush	0233 A140548-E	N Ni Po De	631 Dd F9 V M2 V
Brodie	3021 C410468-7	Ni	114 Dd M1 III M7 D	Saguenay	0235 B438256-F	N Lo Ni	324 Dd M0 V
Rorise	3022 C994100-A	Lo Ni	502 Dd M7 V	Taman	0237 E874300-4	Lo Ni	810 Dd M7 V M3 VI
Jokotre	3024 B6548D9-7		810 Dd K6 V	Nouakchat	0238 C532114-6	S Lo Ni Po	103 Dd M9 D
Fornice	3025 A354A87-C	Hi	202 Dd M0 V	Kiiga	0303 D530624-8	Na Ni Po De	A 201 Dd M0 V M2 D
Grille	3026 E410335-7	Lo Ni	701 Dd F0 V M5 D	Riacon	0304 B666441-8	N Ni	301 Dd M6 V M8 VI
Pallique	3029 A511965-E	Hi Na In Ic	A 320 Dd M1 V M0 D	Saki	0306 D276641-8	Ag Ni	701 Dd M8 V
Nexine	3030 C97A443-8	S Ni Wa	801 Dd M8 V M6 D	Horizon	0310 E110725-8	Na	324 Dd F2 IV K3 D
Katarulu	3032 B252665-B	B Ni Po	201 Dd M0 V M9 D	Fennec	0311 C556833-8	S	520 Dd M7 V
Prilissa	3035 B985588-6	Ag Ni	510 Dd K9 V	Magash	0316 A400976-F	S Hi Na In Va Cp	824 Dd F8 V K7 III
Tea-Tea-Tea	3038 C110530-9	Ni	902 Dd M2 V	Cabrini	0319 C365510-6	S Ag Ni	123 Dd M9 V
Youghal	3039 AA95365-B	Lo Ni	201 Dd M3 V	Barbary	0327 C5717CF-4	S	813 Dd F5 V K3 D
Tenelphi	3040 D76A579-9	S Ni Wa	901 Dd F4 V MO VI	Dunstan	0328 C649220-8	Lo Ni	523 Dd G4 V
Rugbird	3102 BAC5634-A	Ni FI	A 811 Dd M1 V	Canisus	0330 C4317BA-8	S Na Po	901 Dd M9 V G6 D
Towers	3103 B444448-A	S Ni	A 735 Dd A8 III K6 D				K6 D
Feneteman	3104 C222200-C	Lo Ni Po	910 Dd G4 V M7 D	Aosta	0332 A669236-C	Lo Ni Re	412 Dd M1 V
Lewis	3107 X427402-D	Ni	R 701 Dd F8 V	Furens	0334 C8AA698-A	Ni FI Wa	603 Dd M2 V M9 D
Aramis	3110 A6B0556-B	A Ni De Cp	710 Dd M9 VI	Upuraku	0336 B484554-9	W Ag Ni	301 Dd M2 V
Vinorian	3111 B879610-9	Ni	610 Dd M3 V M4 D	Tuwayk	0339 B672843-A		501 Dd M8 V
Nutema	3112 B864310-8	N Lo Ni	822 Dd M3 V	Gessert	0403 C254315-A	Lo Ni	320 Dd A2 V K2 D
Huderu	3114 X575000-0	Lo Ni Ba	R 920 Dd M0 III	Miwald	0404 C53349B-A	S Ni Po	602 Dd M0 V M5 V
Cipatwe	3118 B35879A-6	Ag	623 Dd M1 V	Pretoria	0406 B656967-9	N Hi Cp	720 Dd G5 IV
Vanejen	3119 C686854-5	C4 Ri	520 Dd K1 V M0 D	L'sis	0409 A764896-8	N Ri	101 Dd M6 V
Nadrin	3123 D120203-6	S Lo Ni Po De	920 Dd M5 V M1 D	Dhapura	0412 E579758-7		512 Dd F4 V
Mora	3124 AA99AC7-F	A Hi In Cx	112 Dd M4 V	Pharos	0415 B593477-8	Ni	612 Dd M2 V
Zephyr	3138 X89556A-3	Ag Ni	R 404 Dd M5 V	Sui'tang	0417 B552864-A	Po	415 Dd G4 V M3 D
Chamois	3139 B544642-5	S Ag Ni	723 Dd F9 IV	Ara Pacis	0419 A337678-B	Ni	601 Dd M3 V
Junidy	3202 B434ABD-9	W Hi	310 Dd F7 V M9 D	Rouenet	0422 C362201-B	Lo Ni	705 Dd K0 V
Patinir	3207 C000632-9	Na Ni As	223 Dd F3 V	Zyed!	0431 E551443-5	Ni Po	501 Dd K3 IV
Natoko	3209 B582211-8	N Lo Ni	A 801 Dd M2 VI M6 D	Endup	0436 D6939EG-9	Hi In	104 Dd M6 V G5 D
Reacher	3210 C9A8542-8	Ni FI	A 233 Dd G4 D	Beaxon	0439 D88AA99-C	Hi Wa	A 923 Dd F1 D
Margesi	3212 A576257-C	A Lo Ni	920 Dd F0 V	Noghon	0440 D79798B-9	Hi In	521 Dd F5 V M6 D
Bevy	3216 D4209CC-A	S Hi Na In Po De	224 Dd F4 V	El D'Nah	0502 C549456-B	Ni	502 Dd M6 V
Tacaxeb	3218 C230411-B	Ni Po De	801 Dd M6 V M2 D	Spectre	0503 B100654-A	Na Ni Va	A 802 Dd M8 V
Powaza	3220 C787566-5	Ag Ni	332 Dd A5 V K4 D	Ash	0504 A540887-8	S Po De	201 Dd M9 V M1 D
Dojodo	3223 C512311-7	S C0 Lo Ni Ic	710 Dd M5 V	Caladib	0508 B697222-9	N Lo Ni	301 Dd M2 V
Fen's Gren	3228 C647346-9	Lo Ni	A 423 Dd K7 V	Redi	0509 E575565-4	C4 Ag Ni An	712 Dd F3 V M3 D
Ramiva	3233 B1107A7-8	Na	913 Dd M9 V	Gra-Bie	0510 C23027B-9	Lo Ni Po De	120 Dd G7 V
Trin	3235 A894A96-F	A Hi In Cp	101 Dd M0 V	Marnie's World	0514 AA9A324-B	N Lo Ni Wa	510 Dd F3 D
Hazel	3236 C645747-5	Ag	A 110 Dd A1 V M6 D	Endimyon	0516 X555434-1	Ni	R 523 Dd F3 III M5 D
				Seleen	0517 A310467-E	Ni	704 Dd M6 V
				Thingen	0518 B467998-D	N Hi	305 Dd M9 V
				Isurkun	0524 A441334-A	Lo Ni Po	721 Dd G4 IV
				Sejmal	0525 C210643-A	C0 Na Ni	534 Dd K4 V
				Moltke	0529 C646110-8	S Lo Ni	204 Dd M6 V K9 D
				Briaxis	0531 C120445-D	Ni Po De	901 Dd M1 VI M9 V
				Maricutin	0534 B764000-A	N Lo Ni Ba	213 Dd F9 V K5 VI
				Kirkland	0602 A668443-A	N Ni	423 Dd F4 V
				Carmel	0604 B346441-9	Ni	302 Dd F0 V M0 VI
				Urnas	0609 D120974-C	S Hi Na In Po De	A 210 Dd K7 V
				Anomaly Five	0615 X100000-5	Lo Ni Va Ba	R 623 Dd M9 V
				Sevas Topol	0619 D9C3256-7	Lo Ni FI	923 Dd M2 V
				Mushinag	0622 D575556-8	S Ag Ni	520 Dd F6 V
				Araa	0623 C566254-A	S Lo Ni	522 Dd F7 V M4 D
				Helmuth	0624 C846203-8	S Lo Ni	922 Dd M9 III
				Kernal	0626 B566786-7	Ag Ri	323 Dd F3 V
				Askigaak	0629 E549AA8-C	Hi In	901 Dd M1 V
				Preslin	0633 B130679-E	N Na Ni Po De	310 Dd M2 II
				Brufort	0638 C669642-6	Ni Ri	420 Dd M5 V F5 III
				Taa	0701 A650643-9	Po Ni De	330 Na G7 VI
				Dilex	0702 D626888-7		902 Va M1 V
				Hylaxis	0709 B7B2354-A	Lo Ni FI	522 Dd K7 V
				Naali	0710 D61657A-8	S Ni Ic	324 Dd M4 V
				Amirante	0713 D210899-4	S Na	602 Dd K5 VI
				Bahadur	0715 A326230-E	N Lo Ni	102 Dd M5 V
				Rhinom	0717 B7768AB-8	N	601 Dd M9 V
<b>Deneb</b>							
New Ramma	0108 D465540-6	S Ag Ni	703 Dd M6 V M6 V G6 V				
Saarinen	0113 B566212-8	Lo Ni RsE	513 Dd M6 V K5 D				
Rena	0123 D596211-7	S Lo Ni	403 Dd M4 V				
Gulistan	0124 CAB2358-7	S Lo Ni FI	820 Dd K6 II				
Chaosheo	0130 E87A788-1	Wa	A 625 Dd K8 V				
Iruku	0138 B21048A-9	Ni	501 Dd F1 V M2 VI				
Marz	0201 A584985-A	S Hi	101 Dd M4 V M7 D				
Carthage	0202 B2107B9-C	C0 Na	724 Dd M2 V				
Enaaka	0203 B777786-6	Ag	922 Dd F5 V				
Rubrak	0207 C554511-7	S Ag Ni	701 Dd K3 V M8 D				
Teh	0208 D263136-5	S Lo Ni	802 Dd M2 V				
Kretikaa	0209 B20056B-C	Ni Va	623 Dd K2 IV				
Suvfoto	0211 D95488A-7	S	304 Dd K6 V				
Musayid	0214 E5448AE-5		514 Dd K5 V				
Umikam	0217 DAA6300-5	Lo Ni FI	401 Dd M1 V G7 D				
Vanzeti	0218 C52A531-C	S Ni Wa	401 Dd M3 V M7 V				
Mater Nova	0221 B575744-9	Ag	314 Dd M8 V K0 D				
Breslow	0222 X440510-1	Ni Po De	R 902 Dd K8 VI M1 D				
Daumier	0223 B88A452-E	Ni Wa	510 Dd K7 V M9 V				
Adapam	0224 E796442-8	Ni	822 Dd K8 V				
Wroclaw	0226 C4667BF-7	Ag	823 Dd M8 V K2 VI				
Rimkuku	0228 D9A8872-7	S FI	324 Dd M3 V G1 V				

Shen-Yang	0727 C665520-5	Ag Ni	502 Dd F7 V K1 V	Keirei	1133 C110330-C	S Lo Ni	734 Dd M7 V
Norg	0729 A000114-D	N Lo Ni As	710 Dd M7 V	Lilad	1135 C447AAE-E	Hi In	824 Dd M6 V
Sultana	0730 B649414-9	Ni	521 Dd M5 III	Third Mu	1137 BA7A210-C	Lo Ni Wa	225 Dd K3 V
Qevar	0731 A2326AE-F	A Na Ni Po Cp	403 Dd M6 V	Ushashin	1138 EA9A210-7	Lo Ni Wa	734 Dd M7 V
Raguseppe	0734 B410555-B	Ni	710 Dd M0 V K5 D	Oriyu	1140 B536534-9	Ni	901 Dd M4 V M3 VI
Kiangya	0735 C7C0200-C	S Lo Ni De	714 Dd M3 V	Lengighdzuertz	1202 A300520-B	Ni Va	923 Va G6 V
Taormina	0737 D3216AE-7	Na Ni Po	834 Dd G8 V	Naimar Station	1203 B000347-A	N Lo Ni As	912 Cs M5 V F6 D
Mtensc	0740 D351454-A	Ni Po	123 Dd M0 VI	Haniwa	1208 XA9A643-4	Ni Wa	R 210 Dd F4 II
Retion	0803 C558445-4	Ni	601 Va K7 V M4 D	Prigojin	1212 E100440-8	Ni Va	903 Dd K4 D
Jode	0805 A9A6220-B	Lo Ni FI	410 Dd F3 IV	Inar	1213 A310736-E	N Na Cp	903 Dd M7 V
Therm	0809 D9B0489-5	S Ni De	313 Dd M9 V	Morninglori	1216 B544585-7	Ag Ni	113 Dd M2 V
Cicus	0812 E310330-5	Lo Ni	621 Dd M4 VI G0 V K0 V	Clarissa	1217 C536422-A	S Ni	514 Dd M4 V
Makeni	0813 E100542-8	Ni Va	302 Dd M1 V	Gaagir	1218 C86A358-A	S Lo Ni Wa	601 Dd K6 V K9 V
Amritsar	0814 C897535-8	Ag Ni An	413 Dd F3 V	Minde's Star	1220 D235452-B	S Ni	303 Dd M7 V
Pangumo	0815 C352598-B	Ni Po	301 Dd K0 V M8 V	Perez	1221 C536224-6	Lo Ni	801 Dd M6 VI K8 D
Coshecawat	0816 X100641-1	Na Ni Va	R 313 Dd M6 V F6 D	Montane	1223 C683104-7	Lo Ni	122 Dd G8 V
Jehun	0819 E66766A-7	Ag Ni Ri	901 Dd K2 V M4 V	Achemadon	1224 A3477BB-A	Ag	701 Dd M7 V M3 VI
Tlaza	0824 C303100-A	Lo Ni Va Ic	913 Dd M6 V	Bishop	1226 B201553-F	S Ni Va Ic	524 Dd M6 II
Imone	0826 A9C1555-F	N Ni FI Cp	613 Dd M0 V	Taburi Nen	1227 A44658A-B	Ag Ni	121 Dd M7 V
Kopyeh	0827 B500534-C	Ni Va	902 Dd F9 V M9 D	Djar	1229 C3008CE-7	S Na Va	102 Dd F0 V M4 D
Burnham	0828 B664379-8	N Lo Ni	501 Dd K3 VI	Point Ay	1231 C460524-B	S Ni De	902 Dd M1 V
Bukit Seng	0830 C442334-8	Lo Ni Po	404 Dd M4 III	Veltd	1235 C467754-8	S Ag Ri	514 Dd F6 V
Mephit	0833 C9B8436-7	S Ni FI	302 Dd G6 V K4 VI	Muntgumree	1238 B253666-8	A Ni Po	303 Dd K1 V
Ghatsoke	0902 BA8669D-8	Ag Ni Ri	304 Va M7 VI	Latros	1301 B688227-B	Lo Ni	501 Na K3 V M0 D
Matsa	0903 A234453-F	Ni	102 Cs F3 IV M5 VI	Kantra	1302 C301698-9	Na Ni Va Ic	622 Na M7 V
Aksofouta	0905 D55677A-4	Ag	612 Va M6 V	Qi'iri	1303 E454323-7	C Lo Ni	410 Va M0 V
Waalikii	0906 B525586-B	N Ni	834 Dd F8 V	Lome	1306 E32487B-9		101 Dd M0 V M7 D M7 D
Malkei	0907 B659866-8		610 Dd M1 III	Lamas	1309 B7AA585-C	N Ni FI Wa Cp	701 Dd M5 V
Gyrfal	0910 C8B6545-7	Ni FI	103 Dd M8 V	Quannah	1311 C467474-6	Ni	123 Dd M4 VI
Kayu	0912 E9B75A8-8	Ni FI	412 Dd M2 V	Rayel	1313 B693632-8	Ni	410 Dd G3 V
Amarkimi	0913 B446410-A	W Ni	902 Dd K8 V	Modika	1314 B450413-8	S Ni Po De	503 Dd F5 V M5 D
Otomisl	0914 B5A5577-C	S Ni FI	403 Dd M9 V G6 V	Ciprien	1318 C553310-7	Lo Ni Po	821 Dd F5 V
Skold	0915 B764323-A	C2 Lo Ni	124 Dd K0 V	Thane	1319 D585430-8	S Ni	421 Dd M3 V
Kubishush	0917 B8B69AA-D	Hi FI	901 Dd M8 V M3 VI	Al-Uqayr	1323 E567259-5	Lo Ni	513 Dd F2 V
Norhammon	0921 B764667-A	A Ag Ni Ri	620 Dd M5 VI	Jonkeer	1324 C4908C9-9	S De	401 Dd M1 V
Teyobald	0922 B8B3545-D	Ni FI	822 Dd M4 VI F0 D	Medard	1327 B321425-C	Ni Po	701 Dd K9 V G0 D M0 D
Ibix Donora	0925 C332245-9	Lo Ni Po	901 Dd K1 V M3 V	Giffert	1332 B7A9557-E	Ni FI	220 Dd F5 V K1 D
Sipedon	0929 E3536AB-8	Ni Po	902 Dd M4 V K0 D	Shiiku	1333 D6507BF-6	S De	522 Dd M0 V
Arnyi	0930 B683697-8	A Ni Ri	723 Dd G2 D	Giranima	1334 D7979C8-9	S Hi In	313 Dd K9 V M1 V
Echura	0933 C6837AB-8		603 Dd M1 V	Dawn	1336 AA9A531-C	N Ni Wa	403 Dd M9 V
Inquar	0935 B8B5754-B	S FI	723 Dd M6 III	Unxava	1337 B677627-7	Ag Ni	723 Dd G3 IV
Tullyhome	0936 D66977A-5	Ri	401 Dd F2 V M1 V	Sorel	1338 B539113-C	N Lo Ni	601 Dd K6 V K8 D
Sestos	0939 D5A6878-7	FI	803 Dd K6 V M6 V	Zeng	1339 A226446-C	N Ni Cp	411 Dd M3 V
Kfathvaedal	1001 B000661-C	Na Ni As	224 Va G5 VI	Agdarmi	1340 B266799-A	Ag Ri	724 Dd M8 III
Sisi	1004 B8D0610-8	Ni De	624 Va M4 V	Qi'ire	1403 A657377-A	Lo Ni	402 Na M8 V
Kamisaraki	1006 C354467-A	S Ni	703 Dd G1 V M3 D	Anatre	1405 D5788A7-6		401 Dd M3 V
Jessok	1011 C623510-B	Ni Po	920 Dd G8 V G0 V	Borlund	1406 E454AAA-9	Hi	701 Dd M8 VI M9 VI
Mowebe	1014 C748551-B	Ag Ni	601 Dd M2 V K9 V	Krisna	1409 C84A651-A	Ni Wa	812 Dd M8 V
Liiri	1016 B542998-D	Hi In Po	401 Dd M4 V K8 D	Taillon	1415 C78A668-9	S Ni Ri Wa	701 Dd M6 V M9 D
Hessel	1018 B658100-D	N Lo Ni	801 Dd M4 V M2 D	Starn	1417 B000996-F	S Hi Na In As RsB	722 Dd K0 V
Irumunu	1023 B7B3620-C	W Ni FI	101 Dd M6 VI M6 VI	Montcolm	1419 D675212-8	Lo Ni	122 Dd K4 V
Frisgar	1025 E424752-9		401 Dd M1 V K7 V K7 V	Quebraco	1420 E78A568-4	Ni Wa	824 Dd M1 III F3 V
Burtrum	1026 C5387A9-8		501 Dd M3 V M0 VI	Sarden	1424 E552652-7	Ni Po	501 Dd M6 V
Prege	1030 B79A678-9	Ni Wa	702 Dd M2 V	Kew	1426 C512103-B	Lo Ni Ic	313 Dd M3 V
Quinthept	1032 C521575-B	Ni Po	521 Dd F0 V	Condamine	1428 C665578-7	Ag Ni	921 Dd F9 V M0 V
Storm	1035 CAD6223-B	Lo Ni FI	614 Dd M0 V	Ishiri	1429 E36598A-7	Hi	521 Dd F7 V M0 VI K0 VI
Timmer	1038 C362652-8	S Ni Ri	214 Dd M6 V K3 VI	Eretaro	1430 C9C4100-B	Lo Ni FI	901 Dd M3 V K9 D
Zeen	1111 D653643-6	S D5 Ni Po	301 Dd K6 VI	Pashus	1432 A232455-G	S Ni Po RsZ	812 Dd A9 V
Pecena	1115 B347014-A	A Lo Ni	722 Dd M4 III	Atab	1433 C140899-A	S Po De	303 Dd G7 V M7 VI
Abydos	1116 D335666-8	S Ni	410 Dd M5 V	Quirinal	1435 C651754-9	Po	101 Dd M9 V M9 V G2 D
Karabeth	1118 E663468-7	Ni	102 Dd K9 III M3 V	Isidor	1436 C371565-8	Ni	623 Dd M0 II
Vincennes	1122 A899AA6-G	Hi In Cp	113 Dd M7 V K1 V G1 V	Breit-Tuue	1439 C325574-B	Ni	811 Dd M1 V
Erisis	1123 D679443-7	Ni	913 Dd F1 V	Fessenden	1440 C4357CC-6		401 Dd M1 VI
Dekha	1128 C100A9A-F	S Hi Na In Va	210 Dd M6 V F3 V				

Mur	1502 C100733-A	Na Va	120 V6 F1 V M8 D	Liran	1923 B0008B8-A	Na As	811 Dd M5 VI G5 D M5 D
Gila	1504 E663674-6	Ni Ri	201 Na K5 V K5 D	Deneb	1925 B537ADD-C	N Hi In Cx	610 Dd A2 Ia
Lagut	1505 C312555-B	Ni Ic	932 Dd F9 V	Amshal	1926 B687365-9	N Lo Ni	622 Dd M0 VI
Pek'e	1508 C441325-7	S Lo Ni Po	412 Dd F3 V	Thussor Ozoam	1927 X245101-6	Lo Ni	R 615 Dd M1 V G3 III
Prolam	1509 B769436-A	N Ni	223 Dd A7 V	Exile	1928 X799212-4	Lo Ni Pr	R 810 Dd M8 V
Trevith	1518 E673347-4	Lo Ni	422 Dd G0 V M0 D	Turkoman	1930 B9C67CB-7	FI	220 Dd A4 V
Kauai	1520 BA89537-B	A Ni	924 Dd F8 V K3 D	Filangger	2001 A76A654-C	Ni Ri Wa	823 V6 A0 IV G6 VI
Bumushe	1522 C68A657-6	S C6 Ni Ri Wa	324 Dd F9 V	Orenberg	2011 B130678-E	Na Ni Po De	201 Dd M5 V G4 D
Verd	1524 E150433-6	Ni Po De	102 Dd F2 V M7 V	Twinian	2013 C40447B-7	S Ni Va Ic	702 Dd M5 V
Rajian	1532 C87A112-B	Lo Ni Wa	821 Dd M2 V F3 D	Zinuun	2014 E2367BA-5		911 Dd M8 V
Gzigorlloe	1601 A311677-A	Na Ni Ic	A 801 V6 M1 V	Ugrik	2016 E300000-7	Lo Ni Va Ba	321 Dd F7 V
Gzonksoeg	1603 D567200-7	C Lo Ni	401 Va M9 V	Ruwendzori	2017 E749024-7	Lo Ni	303 Dd M8 V
Yef	1606 E243342-4	Lo Ni Po	202 Dd M2 V	Namidshur	2019 B2106A9-D	S Na Ni	215 Dd G9 V
Gaashushnu Li	1608 X744255-4	Lo Ni	R 404 Dd F4 D	Bruyere	2023 C524367-B	S Cw Lo Ni	422 Dd F0 D
Ansirk	1609 B100100-F	N Lo Ni Va	122 Dd F2 V	Minocoy	2024 B422505-D	N Ni Po	620 Dd G4 V K5 V
Depot	1613 A100644-G	D Na Ni Va	220 Dd F9 II	Avernus	2027 E8865A6-4	Ag Ni	602 Dd M3 V M9 VI
Spingarn	1614 E564320-5	D6 Lo Ni	510 Dd M9 V M6 D	Niyasal	2028 B300653-D	N Na Ni Va	324 Dd M2 V F0 V
Gaza	1615 B430656-B	W Na Ni Po De	723 Dd G1 V K5 V	Torrens	2105 C100238-D	Lo Ni Va	104 Dd M4 D
Ashasi	1618 E9D5AA8-C	Hi FI	621 Dd M3 V	Bangwe	2109 D78A302-A	Lo Ni Wa	112 Dd M5 V
Neopidan	1619 BA9A547-8	N Ni Wa	724 Dd K3 V	Diiski	2111 C66A200-8	Lo Ni Wa	812 Dd K7 V
Surisha	1620 D682232-3	Lo Ni	201 Dd M1 V K9 D	Kadidun	2114 D5A2003-9	S Lo Ni FI	220 Dd K1 IV K0 V
HRD	1623 A401654-F	N Na Ni Va Ic	810 Dd M5 III	Piram	2116 E311777-4	Na Ic	611 Dd G2 V
Risir	1626 C230225-9	Lo Ni Po De	310 Dd K1 V M6 D	Cunha	2117 C62677C-7		324 Dd M7 V
Alaungpaya	1628 C140794-8	S Po De	601 Dd M6 V	Teatro	2120 C8A78CA-7	FI	903 Dd F8 V M7 V
Brontitor	1630 B9C4210-8	Lo Ni FI	904 Dd K0 IV	Arcanum	2126 X334868-3	RsA	R 810 Dd M6 V
Pikha	1633 B738A86-C	Hi	612 Dd K7 V	Nusukha	2127 E310100-7	Lo Ni	215 Dd G7 V G7 V
Ibsen	1635 D4346AC-6	Ni	110 Dd M8 III A2 D	Javan	2131 C77A135-A	S Lo Ni Wa	510 Dd M0 III
Balzac	1636 A452879-D	N Po	513 Dd G1 IV K5 D	Gounuerz	2202 B235330-A	C Lo Ni	510 Va G9 V
Uushadiiru	1639 A351445-A	N Ni Po	521 Dd G0 V	Dofil	2204 E59368B-5	C Ni	710 Va M1 V F3 V
Jecife	1640 A439667-F	N Ni	123 Dd F6 II	Mazirbe	2210 D5537A6-4	Po	124 Dd K7 III F0 D
Graek	1704 D7879C7-4	Hi	A 101 Cs M4 D	Imlaar	2212 D677551-6	S Ag Ni	423 Dd M5 II K5 VI
Dunant	1706 B311320-E	S Lo Ni Ic	A 523 Dd G2 V M4 V	Torm	2220 C456445-9	S Ni	134 Dd K5 V
Remsen	1708 B788676-9	S C7 Ag Ni Ri	524 Dd F9 V M7 D	Byblos	2223 C6738BD-7	S	601 Dd M1 V
Uakari	1710 C5348AA-6		912 Dd K6 VI	Revoc	2224 C9AA577-A	S Ni FI Wa	502 Dd F7 V M2 D
Petrarch	1712 B554853-8	A	210 Dd M6 V	Usani	2225 A452699-C	N Ni Po Cp	202 Dd M0 D
Stoyben	1713 D21356A-8	S Ni Ic	211 Dd M3 V	Catacomb	2234 A8A7551-B	Ni FI	201 Cs K1 V K4 D
Andalia	1714 C87A447-6	Ni Wa	A 903 Dd M7 V G8 D	Malory	2309 C320774-6	S Na Po De	223 Dd K8 V K8 D
Reims	1716 C624779-6		601 Dd M9 V M0 V	Gaiikusu	2316 E647ABC-B	Hi In	105 Dd M8 V
Kennebec	1717 E978552-6	Ag Ni	523 Dd F7 V	Lan-chou	2317 D855788-7	S Ag	120 Dd M5 V K8 VI
Polizzi	1719 B402532-E	Ni Va Ic	823 Dd K9 V	Sage	2322 D463310-A	Lo Ni	120 Dd A5 III M1 V
Redemption	1722 X140634-1	Ni Po De	A 033 Dd G0 V	Azed Bek	2323 C766300-B	S Lo Ni	610 Dd M5 V
Wooros	1726 X747678-1	Ag Ni	R 014 Dd K4 V	Tchien	2403 B696266-A	N Lo Ni	610 Cs M5 V
Monogan	1728 E10056A-8	Ni Va	902 Dd K2 D M0 D	Gagaridir	2405 B220310-A	N Lo Ni Po De	201 Dd M1 V K2 V
Gatooma	1730 E100566-7	Ni Va	424 Dd M8 II	Insi Kar	2406 B211454-B	Ni Ic	624 Dd K4 V
Rif	1732 C687200-6	Lo Ni	702 Dd F4 V G4 IV	Syrenaica	2407 C669464-9	Ni	503 Dd A4 V M6 V
Imazura	1733 C555555-9	S Ag Ni	203 Dd M8 V	Haggard	2409 C777224-6	S Lo Ni	613 Dd F1 V M9 V
Dzoungdzi	1802 A457353-E	Lo Ni	624 V6 K7 V	Nibel	2411 E688303-4	Lo Ni	701 Dd M1 V K5 VI
Cilnodan	1805 B342221-9	Lo Ni Po	632 Dd M9 V F8 D	Pagamin	2412 C371114-8	Lo Ni	502 Dd M7 V
Antra	1808 A53789C-E	Cp	501 Dd M0 D K5 D	Dunmag	2413 A427138-C	N Lo Ni Cp	201 Dd M3 V M1 D M1 D
Syr Darya	1810 E55769C-5	Ag Ni	922 Dd M4 V G3 V	Jurburk	2414 B454033-B	N Lo Ni	802 Dd M6 V G9 V K9 V
Karst	1814 B87679B-6	C2 Ag	133 Dd F8 III	Ayers	2424 C230668-A	S Na Ni Po De	323 Dd F8 V
Rolvaag	1821 E380345-7	Lo Ni De	804 Dd F6 V K1 D	Hysyl	2425 C2407A9-7	S Po De	702 Dd M8 D
Tetzel	1823 B643232-B	N Lo Ni Po An	A 301 Dd F3 V M6 D	Tubb	2502 C89A799-9	Wa	701 Na M7 V M0 D
Farraco	1824 E200478-A	Ni Va	112 Dd K7 V	Moskene	2506 E200101-B	Lo Ni Va	603 Dd G7 V F5 V
Eshamli	1826 A334343-B	S Lo Ni	323 Dd F2 IV	Niven	2512 E9C3237-6	Lo Ni FI	A 534 Dd F3 II M3 V
Prefecture	1827 E1307B6-9	Na Po De	724 Dd G1 D	Kasmar	2515 E631754-9	Na Po	101 Dd M3 V M5 D
Bisistra	1829 B357579-D	N Ag Ni	802 Dd M0 V	Erita	2519 E99A575-8	Ni Wa	113 Dd G8 V K9 V
Ronsard	1830 DA89654-8	S Ni Ri	225 Dd G5 V M5 D	Kiirindor	2520 B446666-B	A Ag Ni	310 Dd A0 V K9 D
Takahira	1831 B9C5223-8	A Lo Ni FI	722 Dd M7 D	Genishir	2521 A110123-D	N Lo Ni Cp	302 Dd K8 D
Kamlar	1832 B387462-C	N Ni	810 Dd M2 V	Maelstrom	2522 B79A855-D	C5 Wa RsG	702 Dd M0 V M3 VI G3 V
Noscius	1902 C222201-7	Lo Ni Po	A 511 V6 G3 V M8 V	Exotrope	2523 D300674-4	S Na Ni Va	401 Dd M6 V M6 V
Fursuelgigz	1903 B200787-8	Na Va	901 V6 M1 V	Unekh	2603 C20088B-7	Na Va	502 Vu M1 V
Marnig	1904 E241101-5	Lo Ni Po	301 V6 K7 III M8 V	Berora	2615 B100672-D	Na Ni Va	822 Na M8 V G7 V
Ostov	1905 C768532-6	Ag Ni	422 Dd F7 V G7 D				
Uramid	1910 B345568-A	A Ag Ni	621 Dd M2 V				
Donu-na	1917 C460850-B	Ri De	525 Dd F2 V M8 D				
Shinorasus	1918 A410200-E	Lo Ni	203 Dd F8 V M9 D				





Thor	0813 D669577-5	Ni	702 Na F6 V M0 D
Yggdrasil	0815 B3507CD-8	Po De	310 Cs F5 VI
Sif	0820 A765867-7	Ri	112 As K4 D M4 D
Eahaw	0823 B523000-0	Ba Lo Ni Po	R 013 As M7 V
Yaeawaokh	0824 B1307LB-E	T De Na Po	400 A9 F6 V M8 D
Alirar	0825 A3555HA-C	R Ag Ni	913 As K4 D M4 D
Ehaeair	0829 B6365HB-9	Ni	210 As M5 V M8 D
Stohyus	0835 A5678N6-E	R Ri C4	902 As F6 D M2 D
Hkakh	0837 A3245J6-E	R Ni	704 As K6 V
Ohtae	0839 B6651M8-9	Lo Ni	903 As F8 V M6 D
Ultasoayaw	0840 B5796J7-9	R Ni	103 As F3 D M2 D
Walei	0902 E7B4776-5	FI	811 Na K3 V M5 D
Pa'an	0909 E649333-4	Ni Lo C1	513 Na F3 V M0 D
Solaria	0914 B665734-8	Ag	614 Na F8 VI
Dpres	0915 B631689-A	N Na Ni Po	122 Cs G5 V
Alr	0929 A7795K8-B	Ni	102 As F5 D
Ehrafou	0930 B0007K4-E	R As Na	904 As M4 V M4 D
Eoiw	0931 B3306K4-E	R De Na Ni Ag Po	803 As M0 D M3 D
Earlyu	0933 B9898L9-D	T Ri	801 A2 F3 D M6 D
			M9 D
Hkuikhekh	0934 B5323G6-E	Lo Ni Po	804 As G0 II
Ewyeyal	0936 B4845HA-E	U Ag Ni	100 As K8 V
Aisaoawi	0938 BAC5000-0	Ba FI Lo Ni	R 023 As M0 V
Gorgon	1005 E690264-6	De Lo Ni Ex	504 Bs K3 V
Connaught	1015 D431153-9	Po Ni Lo	910 As M8 V M8 D
291-540	1016 CABA000-0	Ba FI Lo Ni Wa	R 404 As K2 II M2 V
Ftulrois	1022 B4686LA-9	Ag Ni Ri	200 A4 K8 V
Oatre	1023 B5323N6-C	R Lo Ni Po	312 As K6 II M2 D
Hea'a	1025 E8402LA-5	Lo Ni De Po	603 A7 F5 V
Eiaihy	1026 B5001G2-A	R Lo Ni Va	923 As M4 V
Syoakh	1027 A6968MC-C	Cp	500 As F5 VI M5 D
Htourlao	1028 B3119H8-E	R Ic Na In Hi	512 As K7 V
Keawoaw	1030 B4304J3-9	De Po Ni	413 As M9 V M0 D
Eiyehwehakhea	1034 B79A5HB-B	R Wa Ni	103 As F9 V
Haealrolea	1036 B5544M7-9	R Ni	730 As F1 D
Wuuki	1038 A1105K5-C	R Ni	413 As M0 V
Belgard	1106 D371321-9	M Ni Lo	902 Bs K8 D M0 D
Velscur	1110 X374479-3	Ni	302 Na F9 VI
Gabriel	1114 C210100-B	Ni Lo	703 As G8 V M8 D
Dostoevsky	1118 B678673-A	Ag Ni Rs An	220 As F4 D
Asyuh	1121 B8C32N5-9	R Lo FI Ni	912 As M9 V M4 D
Yero'ilra	1124 D5008N7-B	Va Na	103 As F8 V M1 D
			M7 D
Oihu	1126 B3004M4-9	R Va Ni	702 As M4 V
Eikhaaw	1128 C8897NC-9	Ri	903 As F1 V
Kaldamar	1201 E745326-7	Ni Lo	403 Na F4 D
Nabeth	1202 D326579-8	S Ni	823 Cs M4 V
985-373	1209 X775000-0	Ba Lo Ni	020 Na K6 V M3 D
Janus	1216 C375321-7	Ni Lo	902 As M9 D
Peroi	1219 E360256-4	De Ni Lo	631 As F0 V
Delta Theta	1220 B701610-9	Ic Na Ni Va	732 As K6 V M3 D
Colony Six	1221 A68A541-D	Wa Ni	303 As F4 D M4 D
Goertel	1222 B6688DC-6		122 As F7 D
Hteakya	1223 B2234J6-E	Ni Po	413 As K6 V M3 D
Khau	1226 C6875N8-C	Ag Ni	222 As F8 D M5 D
Erasaso	1230 B68A1G6-C	T Lo Ni Wa	113 As F2 D M3 D
Aoiyras	1235 B3406KC-9	De Ni Po	813 As F0 V
Irlaiw	1236 C336AH5-D	Hi	813 As M6 VI M4 D
Gollere	1305 D574756-7	Ag	720 Na F5 V
Ganulph	1307 X200000-0	Ba Lo Ni Va	R 011 Cs M3 VI
Eleson	1308 E441100-8	Ni Po Lo	323 Bs F8 V M2 D
Caldos	1317 B630879-6	Na Ni Po De	824 As F2 V
Lacidaeus	1319 D100786-5	Na Ni Va	502 As M9 V
Hrahraiu	1322 B4206LC-D	T De Na Po Ni	800 A9 M6 V
Hliyh	1323 B200AK7-E	R Va Na Hi In	102 As F8 D
Eilaeah	1324 B6632G7-C	Lo Ni	414 As G6 D
Rileakh	1333 C2378N5-A		702 As F7 D M6 D

			M6 D
Eateaw	1334 B223000-0	Ba Lo Ni Po	R 004 As M7 V M6 D
Yu'eal	1335 B2326L6-E	T Na Ni Po	524 A4 M6 V M7 D
Aiuiktiyr	1338 E7974M9-A	Ni	204 As M9 V
Htoiuhui	1339 A3688H3-E	R Ri	105 As G0 V M4 D
			M1 D
Selshor	1402 X330576-0	De Ni Po	R 913 Na F6 V M0 D
Goria	1410 E222475-6	Ni Po	200 As M1 V
Sagan	1417 C796453-8	Ag Ni	204 As F1 D
Yestahwye	1426 BAA06M6-C	De Ni	602 As M4 D
Fiyleakh	1429 B4138MA-D	R Ic Na	604 As F6 D M0 D
Huahohr	1436 B4204NC-9	R De Ni Po	823 As G2 IV
Teiseirle	1438 BA9A3H7-8	Lo Wa Ni	703 As F9 D
Carben	1502 X3555A9-1	Ag Ni	R 114 Na K6 V M9 D
Tlazolteotl	1514 D5409CD-7	In Po De Hi	412 As M6 V M2 D
Tyr	1518 A551557-B	Ni Po	804 As F0 V M5 D
Hecarda	1519 B560332-9	De Ni Lo	503 As F5 V
Tryaoke	1524 D5569H8-5	Hi	801 As K8 V
A'eouya	1530 B950000-0	Ba De Lo Ni Po	R 012 As F2 V
Ouiyloi	1533 C5747L9-C	Ag	601 A8 F2 V M1 D
Stehasu	1534 A7206H7-C	R De Na Ni Po	800 As M7 D M2 D
Sosuasach	1535 B1008N8-B	R Va Na	203 As G7 D
Kheiyyo	1537 C5257J7-9		803 As K6 VI
Ashley's Rock	1601 D100120-5	Ni Lo Va	614 Na K0 IV
T'yanana	1602 E568752-8	Ag Ri	200 Na G4 VI M2 D
Vior	1605 X500401-1	Va Ni	301 As M4 V
Braudel	1608 X543200-3	Lo Ni Po	R 903 As K4 D
Thalassa	1613 B88A889-8	Wa Ri	505 As F8 D M9 D
Tktk	1618 D142640-7	Po Ni	502 As F5 VI M3 D
Acis	1619 B885796-A	Ag Ri	603 As F7 D M2 D
Akhwohkyal	1621 BA956J8-9	Ag Ni An	113 As G7 D
Ftiys	1626 C76A3K5-7	R Lo Wa Ni	714 As F2 V M1 D
Eauhti	1630 B5404H9-D	R De Ni Po	432 As F3 V M1 D
Yai'ilrao	1631 B8583GB-E	Lo Ni	604 As F7 D M2 D
Aiuite	1634 B6457J7-E	R Ag	223 As F5 VI M3 D
Awaweaw	1637 E8558N9-9		121 As F8 D M9 D
Homestead	1715 D560250-6	Ni De Lo	524 As F9 D
Ace	1719 E7A08B9-5	De	700 As M0 VI M7 D
			M5 D
Oiwoieaw	1723 B7878M7-D	Ri	711 As F0 V M7 D
Asoieteal	1728 B6976J8-A	R Ag Ni	604 As F2 D
Wesiyeah	1731 D6412K9-9	Lo Ni Po	823 As K4 D
Aiwewakh	1733 BA961G3-D	Lo Ni	404 As G4 VI M2 D
Ohraihah	1734 E8B67J7-7	FI	124 As F4 D
Ayayo	1735 B0006H4-D	Ni As Na An	820 As M0 V
Feaheaha	1736 E3012G8-9	Ic Lo Ni Va	200 As F0 V M7 D
Candia	1801 D4006A9-4	Na Ni Va	703 Na M7 V M2 D
Kydde	1810 B644779-5	Ag	804 As F2 D
Salif	1816 A6236A6-A	Po Na Ni	301 As F9 III M0 D
Number One	1818 C9C6778-7	FI	602 As M8 V
Camoran	1823 A55167A-B	Ni Po	514 As F9 D
Keaih	1830 CAA18J7-9	FI	202 As K1 D M3 D
Afeakter	1835 A69A6NA-B	U Wa Ni	514 As F2 D
Bantral	1906 C886589-9	S Ag Ni D0	503 Cs F5 V
Thebus	1919 B534320-6	Po Ni Lo	823 Na M8 V
Ohauair	1927 B4223G8-9	T Po Ni Lo	214 As M9 V
Tlaiowaha	1928 B1209L4-E	T De Hi In Na Po	411 A1 F4 D
Ralaiw	1931 B4205M4-D	Ni Po De	422 As F4 V
Ereah	1933 B67A3G9-E	Wa Lo Ni	531 As K8 V
Kryslion	2002 D483AA9-9	Hi	520 Dd F6 V M6 D
Orsach	2008 E241364-7	Ni Po Lo	223 As F1 V
Noricum	2018 D8867BB-1	Ag	804 As G2 D M9 D
			M6 D
Oghma	2020 B214754-9	Ic	404 As F5 D M4 D
			M5 D
Khusai	2023 A5766M5-C	R Ag Ni	724 As F7 D
Staha	2029 B7554K6-E	R Ni	313 As F3 V M8 D

Cyan	2102 C4689B9-B	W Hi	510 Dd F6 D M7 D	Acrid	2722 AAC1388-D	Fl Lo Ni	103 As M7 III
Berengaria	2105 B56644-7	A Ag Ni Ri	304 Dd F7 VI	Inurin	2724 E668776-5	Ag Ri	404 As F7 D M9 D M4 D
Senlis	2108 B671633-A	Ni	510 As F6 V	Falcon	2725 A158448-D	Ni	405 As F6 V
Dolberg	2113 BAC889D-B	Fl	300 As F7 D	MacDermont	2801 D200768-8	Va Na	A 204 Dd F1 V
Vume	2115 B100477-C	Ni Va An	123 As K7 II	Junction	2804 B763773-6	Ri	905 Dd M9 D M8 D
Theev	2116 A434500-F	Na Ni	A 934 As G0 V	Peridot	2805 B989894-A	N Ri	700 Dd F3 D M8 D
Marduk	2120 C377436-3	Ni	503 As F7 D	Fintor	2807 B440344-7	Po Ni De Lo	703 Dd F9 VI
Asim	2123 B867564-6	Ag Ni	205 As F2 D	Saurus	2813 A350543-B	De Ni Po	512 As F0 D
Kteiroa	2125 C4601K4-8	De Lo Ni	710 As F5 VI	971-852	2814 E78A000-0	Ba Lo Ni Wa	A 004 As F6 V M3 D
Hewekho	2133 E1007KA-7	Va Na	923 As G6 II M9 D	Ardasii	2815 B650684-9	Ni De Po	110 As F7 D
Airliweiw	2134 D3676HB-A	Ag Ni Ri C6	513 As F5 V	Wildeman	2819 B201674-C	Ic Na Ni Va	402 As F7 V
Tisilli	2137 B78A945-A	Wa Hi	604 Na F0 V M5 D	Pandora	2820 B878313-B	Ni Lo	401 As F0 D
Doradon	2202 A400369-B	S Ni Va Lo	100 Dd F3 V	Cordan	2821 A895347-9	Ni Lo	203 As F4 D
Perrior	2203 A633966-B	N Na Po Hi	330 Dd G2 D	Exe	2823 B300101-A	Ni Va Lo	601 As K6 D
Pax Rulin	2204 A402231-E	N Ic Lo Ni Po Va	p 413 Dd M8 III	Sperle	2824 BA8A76A-7	Ri Wa	920 As F3 V
Albe	2211 A540A98-E	De Hi In Po	213 As F4 V M2 D	Bleak	2902 C9C6225-9	S Ni Lo Fl An	304 Dd M2 V
Realgar	2213 B750444-A	De Ni Po	303 As G4 V M7 D	Is cand	2904 B795553-B	N Ag Ni C4	101 Dd K6 D
Palindrome	2216 B433334-B	Po Ni Lo	502 As F9 V M1 D	Mirage	2909 A560676-A	De Ni Ri	603 Dd F0 V
Borite	2219 E655796-4	Ag	703 As G4 V M8 D	Susanawo	2910 D68A430-5	Ni Wa	111 As F0 D
Torpol	2221 B55477A-8	Wa	624 As F4 D	Darchona	2912 B49A742-A	Wa	533 As F9 VI
Drinax	2223 A33645C-F	Ni	714 As M1 V	Sabruse	2915 EAC8343-8	Fl Lo Ni Rs	220 As F3 V M5 D
Tyokh	2226 B466AH7-E	Hi	204 As F4 D M7 D	Imisaa	2916 B520867-6	Na Po De	113 As F8 D M5 D
Iroioah	2227 B6301G3-E	De Po Ni Lo	823 As M3 V M4 D	Fist	2918 B789430-C	Ni	313 As F1 V
Hleakhayes	2229 E4434KB-A	Po Ni	812 As F2 D M0 D	Umemii	2921 C521877-6	Na Po	304 As F5 D
Akoaft	2230 E898000-0	Ba Lo Ni	R 231 As F3 D	Argona	2923 B612586-9	Ic Ni	403 As K2 V M3 D
Khtyrlro	2232 DA887KA-B	R Ag Ri	222 As M6 V M2 D	Sarage	2938 B440523-C	N De Ni Po Rs	902 Cs F1 D
Eachfose	2233 B6736L7-B	T Ni	105 A5 K6 V M9 D	627-301	3003 E000120-A	As Lo Ni Rs	R 911 Dd F3 D
Gikarlum	2234 B110587-9	Ni	714 Na F0 IV	Dimorus	3011 D300755-4	Na Va	600 As G0 V M7 D
Rhysk	2304 E413730-3	Ic Na Po	R 613 Dd M1 V M4 V	Our Planet	3012 B687100-A	Ni Lo	314 As F1 D
Caraz	2306 E111959-A	N De Hi Ic In Na	A 222 Dd F7 V M5 D	Ayldem	3013 A7407X4-D	Po De	A 804 Dr M6 VI
Magen	2309 C543550-9	Ni Po	902 As F9 V	Pichot	3015 E546330-3	Ni Lo	123 As F1 V M8 D
Chalchiutlicu	2314 B76A787-7	Ri Wa	423 As G9 D M3 D	New	3016 D66668A-5	Ri Ni Ag	503 As F9 V
Clarke	2322 B899753-8	C5	820 As F1 V M9 D	Villane	3029 B100634-8	Na Ni Va	413 Na F1 IV
Pourne	2324 A9B2887-A	Fl	902 As F3 D	Browne	3030 B750A96-9	De Hi In Po	303 Na G4 D M2 D
The World	2327 E100551-6	In Ni Va	223 As M5 V	Neumann	3105 B876AA9-D	N In Hi	123 Dd G3 D
Vorito	2329 E595ABB-A	In Hi	105 As F4 D M6 D	Ploderash	3107 D303696-8	Ic Na Ni Va	520 Dd F1 V M9 D
Burgess	2332 B796633-6	Ni Ag	703 As F6 D M0 D	Khaliki	3111 D11156B-9	Ic Ni Pr	215 As F5 V
Islent	2402 BAC0789-6	De	A 103 Dd A4 V	Simok	3113 DAA08CC-5	De	701 As F0 D
Alexin	2405 B000420-C	Ni As	230 Dd F5 V	Attee	3116 C7529AE-4	Po Hi	404 As F9 VI
Cordillon	2411 C431210-C	Po Ni Lo	922 As K1 V	Eshadi	3117 B431358-E	Ni Po Lo	311 As M7 V
Blue	2421 B443487-C	Po Ni	702 As F9 V	New Moscow	3119 B76779A-7	Ag Ri	513 As F8 VI
Hilfer	2424 BA5077A-6	De Po	600 As M6 V	Aitawry	3140 A5668XA-F	P Ri An	R 514 Dr G6 VI
Paal	2425 B564679-6	Ag Ni Ri	603 As F3 V	Berg	3212 A675542-B	Ag Ni	805 As F5 V
Sink	2426 D665220-5	Ni Lo	813 As F5 VI	Kedus	3213 D867400-3	Ni	913 As F8 D
Fantasy	2428 E788400-2	Ni	331 As G2 D	Tobia	3215 A444A55-F	In Hi	203 As F7 D
Labora	2501 B533544-7	Po Ni	103 Dd M1 V M1 D	Batav	3219 B5A8764-A	Fl An	110 As M6 III
Pryme	2513 B48668B-9	Ag Ni Ri	305 As F0 V	<b>Reft</b>			
Nekrino	2515 A788400-C	Ni	914 As M4 D	Cauldron	0102 D9B8222-4	Fl Lo Ni	403 Dd M0 V
Bouider	2517 D100758-9	Va Na	330 As K2 V M4 D	Iselen	0105 A243678-9	Ni Po	403 Dd G0 V
Exocet	2520 A574126-8	Ni Lo	203 As F6 D	Reudden	0106 B3536BG-7	Ni Po	400 Dd G4 V
Byrni	2527 B955699-6	Ag Ni	404 As F3 D	Kukaa	0108 C544100-B	Lo Ni	503 Dd G1 D
Belt-9	2602 B000213-E	As Lo Ni	523 Dd M1 V M5 D	Amoirve	0109 B565476-C	N Ni	704 Dd G8 D
Intelia	2612 C474653-6	Ag Ni	704 As F4 V	Grudovo	0111 B260453-E	Ni De	914 Dd K0 IV M9 D
Gor	2614 C868677-3	Ag Ni Ri	403 As M5 V	Banskonna	0112 A482444-C	D6 Ni	204 As G0 V
Scaladon	2616 AAD98DK-A	Fl A	600 As F6 VI	Bastion	0118 B737332-B	R Lo Ni	701 As A9 V K4 D
Arunisir	2621 B776530-6	Ag Ni	103 As F8 D M5 D	Solbatn	0203 B87A443-A	Ni Wa	603 Dd K3 D
Tech-World	2624 A455154-F	Ni Lo	310 As F8 D	Peshtorno	0208 B7B3841-8	N Fl	622 Dd G1 V
Ergo	2625 X767500-0	Ag Ni	R 412 As F8 VI	Petre	0210 B696478-A	Ni	210 Dd F4 D
Corben	2704 B545455-8	N Ag Ni	814 Dd F5 D M9 D M7 D	Aldaya	0212 B885620-6	R Ag Ni	423 As K4 V
Gazulin	2708 AA86887-B	A Ri Cp An	213 Dd F3 D	Neon	0216 D9B227A-A	Lo Ni Fl	923 As M4 V M8 D
O'Keefe	2709 D879625-7	Ni	604 As F4 D	Cerebin	0217 B323662-C	Na Ni Po	534 As G1 III
Empire	2711 B679334-C	Ni Lo	503 As G2 V M4 D	Dimple	0305 D200201-8	S Lo Ni Va	500 Dd G1 V M1 D
Hradus	2714 B54699B-7	In Hi	223 As F1 V M6 D	Helifil	0313 D110724-8	Na Rs	403 As K1 V
Hexx	2715 B78A577-D	Ni Wa	314 As F6 V	Benidorm	0402 E446400-A	Ni	120 Dd G2 V
Iligan	2719 C467787-8	Ag Ri	812 As G7 V				
Tanith	2721 A589342-B	Ni Lo	105 As M3 D M5 D				

Carian	0408 B300459-B	N Ni Va	924 Dd M0 V M7 D	Halibun	2540 B565777-7	Ag Ri	514 Fi K9 D
Ambossa	0410 B684459-9	Ni	700 Dd G2 V	Gordon	2609 B310776-A	Na	203 Na M4 V M3 D
Tonnurad	0416 B463695-7	Ni Ri	803 Na G3 VI M5 D M5 D	Stock Point 3	2636 A336010-F	Lo Ni	500 Fi M3 V
Garden	0435 B755578-A	Ag Ni	404 Na K4 VI M4 D	Grecon	2638 B7A858C-D	Ni Fi	700 Fi K3 V
Corp Town	0502 B474211-B	Lo Ni	100 Dd F6 V M1 D	Filentred	2731 B548534-8	S Ag Ni	504 Na F5 VI M7 D
Lintl	0503 B739AEE-F	Hi Cp	404 Dd K2 VI	G'haenbaz	2733 C557558-A	Ag Ni	100 Fi F4 V
Fraaga	0511 B691420-D	Ni Fi	702 Dd K2 V M9 D M1 D	Bouvrier	2737 E230668-8	Na Ni Po De	210 Fi K1 V
Whisp	0602 C251110-6	Lo Ni Po	204 Dd F7 D M0 D	Cyril	2738 A7A69B9-F	N Hi Fi Cx	522 Fi G4 VI
Gaspar	0604 B336337-D	Lo Ni	801 Dd M5 V	Chateau	2739 E450200-5	Lo Ni Po De	714 Fi K4 D M1 D
Igualada	0605 B140567-9	N Ni Po De	701 Dd G2 D	Dead End	2740 C576010-5	Lo Ni	902 Fi K4 D
Mukiud	0701 B333210-E	Lo Ni Po	823 Dd M6 V	Debica	2832 D645688-7	Ag Ni Rs	600 Fi K7 VI M4 D
Checker	0702 C300225-9	Lo Ni Va	615 Dd M4 V M7 D	Gundamoor	2833 B311637-D	Na Ni Ic	324 Fi K1 IV M5 VI
Colony Five	0707 B4759A5-E	Hi In	420 Dd G9 IV M1 D	Bokilbom	2834 B573552-D	Ni	804 Fi F0 V M8 D
Zaguki	0710 B260212-9	Lo Ni De	804 As F2 D M6 D	Angsturm	2837 A545788-B	Ag	314 Fi K4 V
Elixir	0801 B768321-9	Lo Ni	423 Dd F4 D	Vlad	2838 A554844-D	N	804 Fi F1 V
Evet's World	0903 B201656-C	N Na Ni Va Ic	A 503 Dd M6 V	Schuuni	2904 BAAA599-D	Ni Fi Wa	100 Na G0 V
Zuflucht	0921 C445720-8	J Ag	800 Na F6 D	Cyclone	2930 B599347-9	Lo Ni	204 Li G9 V M1 D
Wellington	0925 C8B0263-A	De Lo Ni	800 Es M6 II	Vlecek	2931 C762475-6	Ni	404 Li G2 D
Esperanza	0926 A674ABC-B	J Hi In	303 Es F9 V M2 D	Pamraeltan	2932 A537651-E	N Ni	703 Fi A2 V M5 D
St. Hilaire	0930 B579763-A	J	500 Es K2 V	P'hakar	2934 C220456-B	S Ni Po De	923 Fi M4 V
Ulnert	1002 B53769D-7	Ni	803 Dd K4 VI M8 D	Harmony	2935 E6538AF-4	Po	633 Fi F0 V
Nebelwelt	1030 C879425-5	Ni	612 Na F2 D	Numeron	2939 B432769-9	Li Po	313 Fi M3 V
Earl Center	1102 A998011-9	Lo Ni	604 Dd K9 D	Eskandor	3028 C251499-9	Ni Po	804 Li G3 V
Yvette	1103 A79A633-D	Ni Wa	133 Dd G2 V	Sakaliin	3029 B857222-B	Lo Ni	413 Li F0 D M9 D
Gloire	1123 C764567-9	Ag Ni	924 Sb M0 III M0 D	Rampart	3030 A334200-F	N Lo Ni	812 Li M8 V K4 D
Oleiros	1204 B000457-D	Ni As	300 Na M1 V	Mynez	3035 E627989-A	Hi In	904 Fi K1 VI
Sestao	1301 A120675-C	N Na Ni Po De	611 Dd M0 VI	Seville	3036 B657445-7	Ni	404 Fi F1 V
Gorod	1302 D6689CG-9	Hi	111 Dd K4 V M1 D	Dagu	3037 B100362-C	Lo Ni Va	504 Fi K8 V M1 D
R'bak	1314 B387777-3	Ag Ri	R 721 Na G3 V	Transit	3038 B987030-8	Lo Ni	520 Fi G7 V
Serendip Belt	1323 A000959-C	J As Hi In Na	502 Sb G1 VI M4 D	Elphintrax	3040 C374476-7	C4 Ni	A 413 Fi F2 V M1 D
New Colchis	1327 A8959AA-C	J Hi In	103 Nc F8 VI	Jokelyn	3128 B201469-B	Ni Va Ic	915 Li M3 V
Herzenslust	1426 E995765-6	Ag	920 Nc F0 V M6 D	Alexander	3132 B32369A-B	Li Ni Po	404 Li G4 V
Orphee	1429 X885600-0	Ag Ni	R 100 Na M9 III	Breezy	3133 B100544-C	Ni Va	704 Li M4 V M7 V
Topas	1522 D120899-5	De Na Po	904 Na K8 D	Dlaekan	3134 A383657-D	Ni Ri	202 Fi G4 V M6 D
Elysee	1525 B502532-9	J Ic Ni Va	200 Na M1 V	Good Home	3135 B745789-9	N Ag	303 Fi F0 V M6 D
Besancon	1526 C201341-9	J Ic Lo Ni Va	502 Na M2 V	Alverik	3136 A150698-A	Ni Po De	A 800 Fi K0 D
Berlichingen	1621 D600437-7	Ni Va	700 Na F5 D	Unseren	3140 B452549-9	S Ni Po	803 Fi G5 VI
Joyeuse	1628 A7899B9-C	J Hi	404 Jo K2 D M3 D	Hoihnapuli	3229 B76565A-8	Ag Ni Ri	335 St F1 V
Sturgeon's Law	1724 DAC1451-6	Fi Ni	815 Na M1 V	Bonn	3230 A8C578C-B	Fi	913 Fi M1 V M2 D
Quichotte	1729 E576667-6	J Ag Ni	413 Jo F6 D	Roger	3231 B424200-B	Lo Ni	300 Fi M8 V
Undrelyn	1812 B551433-6	C2 Ni Po	A 514 Na F4 V M7 D	Jeandrent	3237 BA7A666-8	N Ni Wa	613 Fi G0 V M4 D
Neubayern	1822 A7889C9-C	J Hi	610 Nb M3 V				
Lemente	1907 B897563-B	Ag Ni	824 Na K4 VI				
Schlesien Belt	1923 C000367-B	J As Lo Ni	110 Na K4 V				
New Home	1925 A565857-D	J Ri	704 Nh G0 V				
Colchis	2026 B676898-9	J	911 Na F7 V M5 D				
Zamorán	2108 B674675-A	Q Ag Ni	904 Dr F5 V				
St. Genevieve	2123 C460100-A	J De Lo Ni	404 Na M4 V				
Arraste	2139 B59368B-6	Ni	604 Fi M7 VI M5 D				
Acadie	2225 C868563-9	Ag Ni	400 AmK6 VI M9 D				
Jacob	2239 B100400-E	Ni Va	302 Fi M4 V				
Fresnelse	2240 B728512-A	Ni	622 Fi M4 V M6 D				
Sansterre	2322 A87A943-C	J Hi Wa	222 Sa M0 V M9 D				
Achille	2324 E101335-9	Ic Lo Ni Va	100 Na M0 V M4 D				
Amondiaage	2325 A5629A9-C	J Hi	102 AmF1 V				
Pit Stop	2337 B593326-A	S Lo Ni	311 Fi G1 V				
St. Denis	2423 D735764-7	J	803 Sa K1 V M7 D				
Uxors	2435 BAA7377-9	Cw Lo Ni Fi An	804 Fi M7 V				
Mieniept	2436 B794454-B	Ni	800 Fi G0 V				
Arnorac	2509 B381468-A	N Ni	302 Cs K8 VI				
Quiver	2534 B310405-D	Ni	404 Fi M1 V M3 D				
Argus	2536 C755A96-8	S Hi	403 Fi G4 D				
Boneyard	2537 B220310-A	N Lo Ni Po De	914 Fi G2 V M8 D				
Delinski	2538 B45367A-8	Ni Po	914 Fi K4 D M6 D				
Valentorn	2539 D56512-4	Ag Ni	900 Fi F0 V				

Design: Joe D. Fugate, Sr.  
Graphic Design: Rob Caswell  
Front Cover Illustration: Blair Reynolds  
Back Cover Illustration: Thomas R. Peters



With the outbreak of the Rebellion, the remote sectors comprising the Domain of Deneb found themselves cut off from the Imperial Core. Fierce Vargr marauders swarmed through the narrow bridge of stars in the Corridors sector, looting and occupying any worthwhile nugget of civilization. Its umbilical severed, the Domain of Deneb — called by its inhabitants, the region “behind the claw” — was on its own.

Recognizing their plight, the reigns of power for the region were grabbed by Archduke Norris, a charismatic leader and hero of the Fifth Frontier War. Uniting the peoples of the Domain under his banner, he pulled the region together with a force of direction and hope. But matters only got worse...

Soon, vast fleets of Aslan colonists started nibbling at the worlds on the Domain's Rimward flank. In search of new lands, these “invaders” did not necessarily leave a path of destruction, but would claim any apparently vacant piece of property which fell under their feet. Like European colonists settling the North American continent of old Terra, their encroachment was slow but pervasive.

The Domain's external threats were not all overt. To Spinward lay the mighty Zhodani Consulate. Long time enemies of the Imperium, they *surprisingly* did not swarm across the borders to take advantage of the region's weakened state. Trying to ascertain the answer “why” became almost as taxing an issue as the Domain's more “dynamic” problems.

Add to this an endless number of internal conflicts and you have a complete picture of The Domain of Deneb. This special supplement for *MegaTraveller* collects the complete sector data on this troubled region, making campaigns easy to run. This booklet is most effective when used with the Domain of Deneb map, featured in *The MegaTraveller Journal #1*.

---

## **MEGATRAVELLER** Special Supplement

---

 **Digest Group  
Publications**

515 Willow Avenue  
Woodburn, OR 97071  
(503) 981-4752 [voice or FAX]

# KEITH BROTHERS

INTERVIEW: *Transcribed by Rob Caswell*

It is possible (though unlikely) that you could be a *Traveller* player and *not* know who the Keith brothers are. For those few, an introduction is in order. Brothers J. Andrew and William H. Keith, Jr. were two of the primary creative forces behind *Traveller* in its *Golden Age* (circa '79-'84). Their writings, both in collaboration and working separately, copiously peppered the game's released material. Additionally, Bill's artwork (another common sight of the times) provided a "viewscreen" to let us peek on the *Traveller* universe. Along with Marc Miller and John Harshman, the Keith brothers were instrumental in defining the look and feel of what we've all come to take for granted as "the Imperium background".

Their work didn't stop with GDW. Many other companies which chose to produce *Traveller* support products used the Keiths to lend an air of "validity" to their lines. Both FASA and Gamelords used Bill and Andrew's work as the cores of their *Traveller* lines.

I spent an hour or so on the phone with both brothers Keith, trying to entice them to set the *way-back machine* for the early eighties — the era of *Classic Traveller*. So go grab up a handful of those small books, hunker down into a cozy chair, and enjoy a look back at the early days of the game.

**Rob Caswell (RC):** Well, I guess the best place to start this is to ask how you both got professionally involved with the game and what were you doing before you made a career out of gaming?

**J. Andrew Keith (JAK):** It was about 1978, or so — shortly after *Traveller* came out. I was a clerk in a grocery store and I'd been involved with wargaming a long time. Bill introduced me to that back in the sixties, when I was younger than the age of "twelve and up" which they always printed on the Avalon Hill games.

So I saw this ad for *Traveller*, one fine day. I didn't have the faintest idea what it was. I just thought it was some SF wargame. When I got it, I couldn't figure out what the hell it was all about, since I'd never seen a role-playing game before. But it looked very interesting! A short time after that, I saw the first ads for the *Journal* [GDW's *Journal of the Traveller's Aid Society*] and thought, "well, maybe this will explain what it is I'm supposed to do with this game?" So I ordered it.

Somewhere early on, they [GDW] ran some ads that said they wanted writers. I'd gotten myself into a very expensive hobby and here was a way I might off-set the costs. So I submitted a few articles. Loren [Wiseman] liked them and we started corresponding regularly. It was about that time that I dragged Bill into it. I said, "Hey, this is a great way to make some money. You're an artist, do some art for them. They need it."

**William H. Keith, Jr. (WHK):** I think it was about 1979. I had just quit my nine-to-five job in Chicago in disgust and was working as a commercial artist. I took a look at some of the artwork in the game material Andrew had picked up and said, "Hmm. I think I can do better than this."

I sent a package off to GDW and a couple of weeks later I got a very nice letter back from Loren Wiseman saying, "We'll buy all of it. Send us more." So I started doing regular *Traveller* artwork. I'd done lots of work for other people, but very rapidly, GDW was buying enough work for both the *Journal* and for various games that they were my number one client.

**RC:** It seems like your work really dominated the game's published material, back then. Was it simply due to your being so prolific or had GDW fit you in as planned development team for the game?

**JAK:** Well, it's mostly that we wanted to do things and there we were.

**WHK:** My theory is that we were the only people who were doing artwork and writing professionally for gaming. Most other contributors, at that time, were students or hobbyists. Since we prided ourselves on making deadlines and did very fast, professional work, it got to the point where Loren could always come to one of us and say, "Look, I had so-and-so doing this job and he wasn't able to make the deadline. Can you have this by next Wednesday?". We could always make deadlines, so we became indispensable.

**JAK:** It took us quite a while before we were actually "dominating the industry", or anything. It took us a long time to get GDW to let us do an adventure, as opposed to just doing a lot of work for the *Journal*.

**WHK:** Somewhere in there, it might have been 1980 or '81, Marc Miller took us over and introduced us to Jordan Wiseman of FASA at a local hobby convention. Jordan, at that point, was coming out with a line of *Traveller* support products — starship deckplans. FASA, in those days, was a *verys* shoestring operation — basically, Ross Babcock and Jordan Wiseman working out of Jordan's basement.

So this was a big boost for both of us. Jordan needed artwork. He just had very simple line drawings on the covers of his products. And he needed someone who could string words together for descriptions of ship interiors and adventures to go with them. FASA was voracious for new material for their product line.

**JAK:** At that time, it helped considerably that Jordan was trying to keep the GDW connection solid and there were very few people that could write *Traveller* material that John Harshman would approve. John was in charge of what

directions the universe was taking on. That's what made us indispensable: we were one of the only ones who understood where the universe was going and could actually get John to agree with us by saying, "But this will work!"

**WHK:** I guess if Andrew and I have a talent, it's being able to take somebody else's universe or ideas and extrapolate from those basics while still staying consistent with the overall facts and flavor of the universe.

Many people have the tendency of saying, "Oh, I've got a good idea!". But what they produce is something totally "other" — something that doesn't really fit well. Andrew and I could work something out that would usually go very nicely with the overall flavor of the universe. And we were pretty good at translating GDW's needs and passing those on to Jordan. We were kind of go-betweens, since we were providing material for both publishers. I think that's how our work became so integral to the look and feel of *Traveller*.

**RC:** Well I don't think "dominated" is too strong a word to describe your impact on the game in that period. You'd be hard pressed to find a product that didn't feature either Keith art or writing.

**JAK:** I had to adopt a number pseudonyms for the *Journal*, just so it wouldn't look like I was writing the whole thing!

**WHK:** There was one funny time when we were down in Normal and Marc told Andrew that he'd gotten a letter from somebody who had been applying higher biblical criticism to the articles that were appearing in the *Journal*. There was John Marshal, there was Keith Douglass, there was J. Andrew Keith — were there any that I'm missing?

**JAK:** That was about it, I think, but I never really knew for sure *who* I was, on any given day.

**WHK:** Anyway, this writer had gone through counting the frequency of words and came to the conclusion that John Marshal, Keith Douglass, and John Andrew Keith were all the same person.

**RC:** Where the two companies looking for different things? Say, were there types of adventures that FASA would like more than GDW, and vice versa? It seems like the two had a slightly different flavor.

**JAK:** I think FASA was always open to more free-wheeling, action-oriented adventures. Things like *Uraqyad'n of the Seven Pillars* and the *Sky Raiders* trilogy. Y'know, slam-bang, action adventure stuff. GDW liked the more cerebral adventures. Things like my *Murder on Arcturus Station*. Material that would

widen their universe in an unusual way without being "just another *Traveller* adventure."

**WHK:** Jordan would take more of our adventures. There just wasn't that big a market for them with GDW because they only came out with so many and a certain percentage of those were done by in-house staff. So we didn't get that many shots at big adventures for GDW.

**JAK:** The first one we did for GDW was the double adventure, *Chamax Plague/Horde*. I don't think we did another one until *Nomads of the World Ocean*? We did do part of another double, *Night of Conquest/ Divine Intervention*. That adventure was an outgrowth of our short-lived *Traveller* licensee company, Marischal Adventures. That originally began as one of our folio adventures, but GDW wouldn't approve it. Then John said, "Well, why don't you expand on this and we'll use it as a double."

**RC:** So why is it you chose to start up your own *Traveller*-producing company while you were still doing freelance work for the others?

**WHK:** To create more of a market for our work. While GDW and FASA were our primary clients, at that time, they only had so many products they could put out. We were already doing a tremendous percentage of the work for both companies.

**RC:** So you were doing more work than they could publish?

**WHK:** We could have been doing a lot more, but there was only so much that they could buy. Andrew and I could have probably done eight to twelve adventures a year, but they couldn't publish that many. And probably the players would have gotten tired of Keith adventures pretty fast. So Marischal Adventures was our attempt to produce our own *Traveller* products, as a licensee.

**JAK:** Specifically to we tried to fill a niche that we thought had been overlooked, with small adventures which you pick up and run on the spur of the moment.

**WHK:** I think it's still a fantastic idea that nobody's really capitalized on. Rather than these monstrous, twenty-dollar mega-adventures that go on for years and years, something that players and a referee can get together and play in an evening or two. Everyone's happy, the characters get their diamonds the size of a fist, and they can go on to something else. We came out with four of these folios which sold for \$1.50 each.

**JAK:** We made money on the first three. The fourth one didn't go as well, largely because we had to change printers

"I guess if Andrew and I have a talent, it's being able to take somebody else's universe or ideas and extrapolate from those basics while still staying consistent with the overall facts and flavor of the universe."

and the new one wanted a lot more money. So we ended up losing money on that one and decided, "Okay, that's enough."

Stafford Greene of Seeker Game Systems wanted to revive the folio idea. As a matter of fact, I did one for him (*Escape*). But he kept wanting to put more material into the format than would really easily fit. We eventually had to break off that project due to budgetary restrictions.

**RC:** Wasn't the Reavers' Deep sector partitioned-off to be sort of the "Keith playground"?

**JAK:** We got that back in the early days, during the era of *Great Land Grants*. We were lucky we didn't get stuck out in the middle of nowhere, like FASA did when they were given the Far Frontiers sector. Once we got the land grant, I could tell other publishers, "Look, I can write stuff for you set in this region and it's a pretty neat place."

I never understood how they originally arrived at these land grants, though I've always rather suspected it had something to do with a dart board...

**RC:** So what areas of the *Traveller* universe did you have the most input into developing? Are there any aspects that stand out?

**WHK:** We had some input in working on some of the alien races. At some point rather early on, I wound up writing quite an involved background, history, physiology, and psychology on the K'kree. As a matter of fact, at that point, they were just centaurs. I invented the name "K'kree" and came up with most of the other details about them.

**JAK:** If I remember properly, John Harshman was always impressed by Bill's biological knowledge. Bill was a hospital corpsman in the Navy, many years ago, and has always had an interest in that sort of thing.

They would get talking, either at conventions or during our trips down to Normal. John would start tossing ideas out about biology, and then Bill would get involved in it. Next thing you know, they'd be off in another world and I'd have to talk to Marc about something of interest to me.

**WHK:** Our first involvement with the aliens began when there was an art assignment for me for defining the "Centaurus". All they knew about them was that they'd be grazing herd animals with an unusual type of foot. They wanted me to draw that foot. Well, I did, but in order to justify some of the things they were saying and some of the aspects of my drawing, I wound up writing this long background discussing how their anatomy would have developed. That must have appealed to John because he just took it all, and that's how the K'kree came to be.

Then, John got to talking to Andrew and I, at this Chicago convention, about the Aslan. There wasn't a whole lot known about them. On the train trip back, we worked out most of the culture, based distantly on the Samurai.

We also had a fair amount of input on the Hivers. All they knew about the Hivers was that they reproduced by shaking hands. They wanted me to do a painting of cover of one of the *Journals*. They were looking for some-thing pretty much "un-human". Of course, all the major races offer some good role-playing werefun! They don't look or think like us at all. I did the painting of this vaguely starfish-looking thing and, wrote up an involved background explaining we never got how they think and work. Unfortunately, to write some adventures showing how you'd use the Hivers during play. It'd be pretty hard to role-play them, but they'd make great patrons. But those adventures just never came to be.

**JAK:** Well I think what happened is, after the initial material saw print, they got interested in doing the alien modules. But they never followed through the way I thought they would, by doing related adventures. There had been a vague start to it with the *Alien Realms* book, but it didn't seem to go any further.

**RC:** Well, the two major races I've always found the most interesting were the K'kree and Hiver. Maybe because were more steeped in the tradition of literary SF.

**JAK:** They were much less the wild, space opera style "humans in alien suits". They were real, genuine, well-thought-out aliens. On the other hand, very few players that I met could actually run them. There's room for all kinds.

**RC:** Well, what's often fun to read might not always be playable.

**JAK:** Of course — that was one charge that was always leveled against us. People liked to *read* our stuff. It's not a matter of wanting to play it, they just wanted to read it.

**WHK:** The highest complement we ever received was when we were at a convention in Chicago. Someone came up to us and said they had bought *Ordeal by Eshaar* and had stayed up all night just reading it, as they would a novel. I was delighted!

Role-playing, in my opinion, is very closely related to the original form of story-telling: sitting around the campfire talking about how Ugg suckered that mammoth into the pit and now we've got food for a month.

**JAK:** As a matter of fact, you can hear echoes of that whenever two gamers get together!

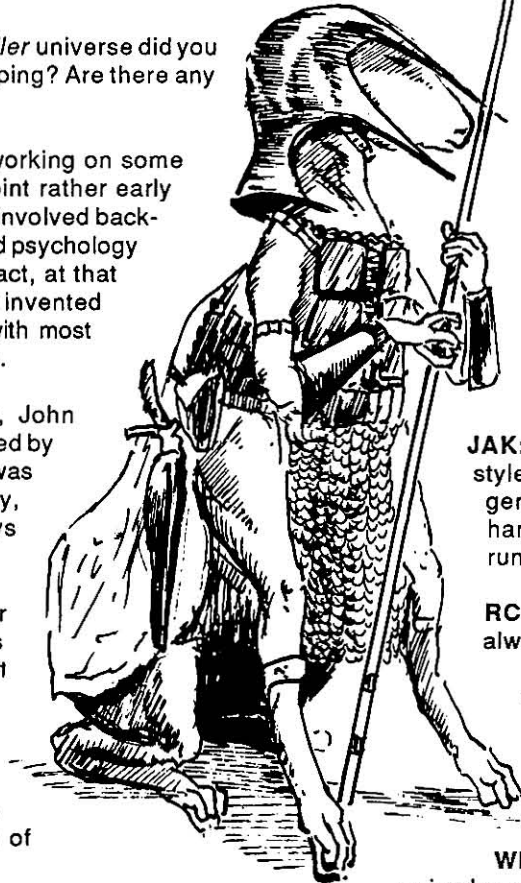

**WHK:** (laughs) Well there's something very primal about all of that. It's story-telling. It ought to *be* a good story. I think Andrew and I both chaffed at the adventure formula that went: when you come to the door, roll two D6 to see if you can open it. We wanted something that was more like a good, fast-paced SF novel and we tried to write our products that way.

**RC:** Yeah, I think that's one of the appeals of the older *Traveller* material. Just that flavor you can get from reading them.

**JAK:** The only thing I had against Digest Group's nugget format was that it really disjoint-ed the story-telling angle. As a gaming aid, the nugget format is marvelous. It was a real step forward. But I always regretted the loss of the unfolding story that Bill and I specialized in.

**RC:** At the risk of sounding like I'm posing the tired question "Where do you get your ideas", what would you say were your primary influences, in the work you did for *Traveller*?

**WHK:** In general, I love SF. I'm a passionate devotee and I'm a professional SF writer today. You can't be a SF writer without being influenced by certain writers. My favorite writers would have to be Arthur C. Clarke, Robert Heinlein, and Poul Anderson. There are others, but those are my main three.

All three write what I think of as "real SF", which is fiction with a solid scientific foundation. As little "magic" as possible. Anderson would always calculate every planetary detail — the rotation, its distance from the sun, the luminosity, and everything. And I do that myself. I like to build a planet that works, I like to build life-forms that work and are biologically feasible. I like to come up with aliens which are not just people in a rubber costume. So that's why I like races like the K'kree, who really do think differently than we do. And I think I can trace that back to Anderson.

**JAK:** Yeah, Anderson was most certainly an influence for me as well. Others were H. Beam Piper — and Marc Miller. Those are my primary ones. Though I was never the hard scientist that Bill is, I always liked interesting planets. Anderson, of course, is the original master of planet-building. Piper's attention to history and society happened to coincide with some of my main interests, so that fit in as well.

**RC:** Are there any specific aspects of these writers, aside from their hard science bend, that you used as an ideal in your *Traveller* works?

**WHK:** Well hard science and another key phrase would be "sense of wonder". All three of my favorites do it. I love Anderson's use of language in conveying the sheer, grand, awe-inspiring glory of stars, nebulas, galaxies, and the great gulfs beyond. "Sense of wonder" is something that characterized all science fiction during its Golden Age in the '30s. When John Campbell was grooming new authors, he'd always stress it.

Oftentimes the sense of wonder is lost in recent writing because it all comes down to number crunching. But space is so vast and there are so many things out there we can't even *begin* to imagine. J.B.S. Haldane, the British astrophysicist, said, "Space is not only stranger than we imagine, it's stranger than we *can* imagine."

Anderson puts this into all of his work — what I think of as "glory and thunder". I try to bring that to my game writing; I try to bring it to my novels.

**RC:** Was there any product that was your personal favorite? One that strikes you as more creatively successful than any other?

**WHK:** Hmm? It's hard to say. I was totally in love with each one as I was doing it, but generally hated them afterwards (laughter). And I really haven't looked at any of them since.

I very much liked *Uraq-yad'n of the Seven Pillars*. I was going for this very deliberate retelling of *Laurence of Arabia*, with guerilla warfare out in the desert.

That was certainly one of my favorites.

**JAK:** I think *Ordeal by Eshaar* stands out in my mind as one of the times we really hit exactly what we were aiming for. Although we had to give up about a third of what we'd originally written.

**WHK:** We were on our way towards a SF novel, there. You always have to watch out for that.

**JAK:** I probably was happiest overall, as far as individual effort, with the first book of the *Sky Raiders* trilogy. You've got to understand, I wrote *Sky Raiders* the same summer as *Raiders of the Lost Ark* came out. However, I had never seen *Raiders of the Lost Ark*, as I'm not a big movie-goer. So when I first sat down and started running that adventure





for my playtest group, this one guy kept doing all these strange things. He was constantly checking for traps or pressure plates that would trigger an elaborate disaster. With them getting into the mood of running through a *Raiders of the Lost Ark*-style adventure, it really made it fun to run that playtest.

So it always struck me as a real success for evoking that kind of atmosphere — especially since I had no idea what I was evoking!

**RC:** What stands out in your mind as the building-blocks for a good *Traveller* adventure?

**WHK:** My ideal for a good *Traveller* adventure, and I know this goes for both of us, is the “scientific mystery” format, where you were presented with a scientific puzzle to solve. We always tried to stay away from the “thump the alien” adventures. In general, we’d try to work a trap into our adventures, so those who tried to solve the problem by thumping the alien would get into a lot more trouble than they started off in. So I think, for that reason, our adventures were a little more cerebral and required a little more thought.

That kind of ties in with the Anderson and Heinlein approach where there are going to be a lot of mysteries and puzzling things out and your knowledge of how a planet works is going to have a bearing on whether or not you survive when you’re exploring it. This is all stuff we tried to incorporate into *Traveller*.

**RC:** Is there anything you’ve wanted to do for *Traveller* that you’ve just never had the opportunity to do?

**WHK:** Actually, the only thing I wanted to do, I *did* do, but I’m not sure it’s ever going to see the light of day. Seeker games had commissioned me to do a campaign module, *Lords of Thunder*, and they just gave me an entire sector to play with. It’s the Gateway sector and it’s out between the Imperium and K’kree space.

It’s far enough from the Imperium that I was able to set up seven or eight different mini empires, each one with maybe twenty or thirty stars. K’kree space is right next door, in the next sector over. One off-shoot of the Two Thousand Worlds has kind of broken off from the parent group and formed their own Empire. They’ve started to leak across, into this sector. They’ve just now absorbed a human-dominated subsector. Also mixed in with this are rumors that the G’naak, the thought to be extinct ancient enemy of the K’kree, are about, somewhere, and they have agents out looking for them.

I wrote this entire campaign, where the adventurers come in and they can be hired by any number of different patrons. One way or another, they’ll find themselves going out and getting involved in any of the following. There’s an archeological party that’s tracking down this mysterious, presumably extinct civilization. There are pirates that are

organizing raids against ships, there’s a war brewing between all of these human empires, the K’kree are coming through, and there are refugees fleeing the K’kree — you can really get caught up in the politics of this sector.

But this project really does represent one of my main goals. That was, to take a whole sector and work it up with enough detail in the planets and in the conflicting cultures and the history so that you could just draw dozens of adventures from it.

**RC:** Andrew, how about you? Are there any avenues you’ve wanted to explore for the game?

**JAK:** Well, back when I was working for Gamelords, I’d come up with what I thought were a pretty nifty series of modules. Each one was an expansion on one of the “Other” career options. The first one was going to be called *Letter of Marque* and was going to be all about privateering. Putting together privateering expeditions, how to judge the value of a captured ship, expanded generation on pirate characters, and that kind of thing.

The second module I had planned was going to be on confidence games. How to run a scam and some character interaction rules (which they didn’t have at the time). I had others

planned in that series, as well, and I would have really liked to have seen them make it to print. But Gamelords collapsed right about then and I could never get anyone else interested in them.

**RC:** What you’re both doing now, since *Traveller* is no longer the core of your work?

**JAK:** Talk about the one-armed paper hanger with the itch — I don’t know if I want to list all the things I’m *supposed* to be doing right now.

**WHK:** We are writing... and writing and writing.

**JAK:** Both of us have broken into the regular, mass market fiction, writing novels.

**RC:** How many of these projects are coming out under your own names? And are you allowed to reveal your previously published pseudonyms?

**WHK:** I don’t really see why not. My first six novels were all published by FASA and they were all under my name. Then came six for Berkely, which Andrew and I collaborated on under the name Keith William Andrews.

**JAK:** That’s the *Freedom’s Rangers* series — a very strange hodge-podge of action adventure, commie bashing, and time travel. But you won’t find it in the science fiction section of a bookstore. It’s usually filed in with the “men’s adventure” novels. Then there’s the five book *Carrier* series. The first

“My ideal for a good *Traveller* adventure, and I know this goes for both of us, is the “scientific mystery” format, where you were presented with a scientific puzzle to solve.”

three we collaborated, the second two, Bill did one, I did the other. We resurrected Keith Douglass for the occasion.

**WHK:** Since that time, I've done another six-book series called *Cybernarc*, under the name Robert Cain. That's for Harper.

**JAK:** I'm doing a sort of "foreign legion in space" series called *The Fifth Foreign Legion*. It's due out in January '92, if I recall. The first two of those are official collaborations between Bill and I, although when we collaborate, usually one of us does most of the work and the other provides input.

As in the first three *Carrier* books, where Bill did most of the writing and I did a lot of fussy, looking over the shoulder saying, "Why don't you do it this way?" The first two *Fifth Foreign Legion* books were collaborative efforts, but the second two, which I'm still working on, are entirely by me. The first one is entitled *March or Die*. It's under our names. It's the first non-gaming series where we got our real names on the cover.

I'm also working on a very large novel for Bantam. The tentative title is *Deep Dive*. It's a near-future, technothriller involving undersea habitats and a new class of super sub, all based in a post holocaust world. It's about half done. This will also be under my name.

And I'm doing another of the FASA *Battletech* books, which pretty much picks up where Bill left off with his series. Bill, you have a couple of things you're working on...?

**WHK:** I have just finished a *Buck Rogers* novel for TSR. They've come out with several different series set in their *Buck Rogers* universe. They're now planning a nine-book series — this is the second book in that series. That was a lot of fun.

And next on my board are two books for Avon. The series will be called *War Strider* and will be under my name. A favorite theme of mine is "men at war". I think just about every book I've ever done has touched on that in some fashion. But this book further explores the union between man and machine — human intelligence and machine intelligence. It's all against the backdrop of a high-tech war against a very, very alien enemy. I think it's going to be a lot of fun.

It'll be going into direct mind links with machines, where machines become extensions of your body.

**RC:** It sounds vaguely like some of the aspects of some of the cyberpunk genre?

**WHK:** I *hope* not. I'll be dealing with some of the concepts common in some of the cyberpunk stories, but I wouldn't characterize this as cyberpunk.

**JAK:** Both of us have avoided being linked into the cyberpunk stuff, although in the *Fifth Foreign Legion* series, we have some elements also common to cyberpunk. Any time you start exploring the future, you start exploring the directions of computer technology and you end up with some of the classically cyberpunk trappings, whether you like it or not.

**RC:** Well, we've just about run out of time. Any parting comments?



**WHK:** Yes. You know, I really, honestly do love *Traveller* — especially the older rules, where you just have six numbers for your stats and left almost everything else up to the imagination. I think it's one of the finest role-playing games that's ever been created. Not to criticize what came later, but the earlier *Traveller* just had such a marvelous simplicity. If you've got a referee who's got some imagination, you can just do anything with it.

I've always admired that. The system was simple, the universe was large, and the possibilities were wide-open. It was such a wonderful concept.

**RC:** Well, thanks for talking, guys. It was fun, and good to get a glimpse behind the scenes of both the old *Traveller* days and your current projects.

*Editor's Postscript: After hearing Bill's gushing enthusiasm for Lords of Thunder, during this interview, we decided to open communications with Seeker Gaming Systems about obtaining the rights to print that product ourselves. Things happened pretty quickly, and before we knew it, we had Lords of Thunder scheduled as an integral part of MegaTraveller #4. You can find the ad for it elsewhere in this issue. Unfortunately, that means that Bill has to find a different answer to the question of, "What product have you always wanted to do for Traveller, but never had the chance to get it into print?"*

# RAPID REPO

A MEGATRAVELLER ADVENTURE: By Greg Videll

## INTRODUCTION

Rapid Repo propels a team of Domain Scout commandos into the Vargr-occupied Imperial Navy depot in Corridor sector. Their mission: to retrieve an experimental "deep radar" system, thought destroyed years ago. Failing this, the PCs are to insure that the radar has been destroyed, thus denying it to the Vaenggvae, the corsair band which currently controls much of Corridor.

The adventure begins in late 1121 in the Atsah/Atsah (2913 Deneb) system. Given the current situation in and around the Domain of Deneb, Archduke Norris needs all the forces at his disposal to provide security for his realm and its people. A vital part of this effort involves the Domain Scout Service (DSS). More than just explorers, scientists, or postal carriers, the Scouts also possess a highly efficient intelligence organization and security/commando force. Though this aspect of their operations was under-utilized during the calmer, pre-Rebellion days, it now plays a significant role in the Domain's restructured Scouts. This adventure focuses on this aspect of the Scouts' mission.

## RUNNING THE ADVENTURE (Referee's Information)

The characters used in *Rapid Repo* must be either active duty or reactivated Scout commandos assigned to the Scout's Security Branch, Special Services Section (often referred to as "S-3" by the Scouts). Special Services is an elite organization composed of dedicated, highly trained and motivated individuals. Because of differences in training, doctrine, equipment, and so on, the mission is limited to experienced Scout personnel and will not include either Army or Marine commandos.

Certain critical skills are required for this adventure. If those skills are not already present, the referee should work with the players to "round out" their PCs, perhaps granting level-0 skills for the duration of the adventure. Alternatively, NPCs with the proper skills can be inserted by the referee. It's best if the characters have been generated using the expanded Scout system in GDW's *MegaTraveller Player's Handbook*. The referee also has the option of telling the players that their characters attended Army or Marine commando school as part of an exchange program.

Critical skills include weapons proficiencies, vacc suit, computer, stealth, intrusion, animal handling/guard beasts, grav belt and recon. Additional helpful skills are demolition, pilot, and navigation. Certain positions on the team will be determined by the skills possessed by the PCs.

- The character with the highest skill level in computer will be designated the computer specialist for the mission.
- The PC most skilled in animal handling will likewise be designated the handler for the team's genetically enhanced animals (*genas*).
- The individual with the most skill in either communications and/or sensor ops will be responsible for coordinating the data feeds generated by the *genas* and is called the *gena* coordinator. (More on this later).

Other positions in the team will be determined by what skills and experience the PCs possess. The total team should number

between six and eight individuals with any empty slots filled by NPCs.

## REFERENCES

Useful and inspirational material for use with this adventure can be found in DGP's *MegaTraveller Alien Volume 1: Vilani and Vargr*, *Travellers' Digest Numbers 18 and 19*, and *MegaTraveller Journal Numbers 1 and 2*. Copies of DGP's *Starship Operator's Manual* and *WorldBuilder's Handbook* are also helpful, but not required.

## THE NPCs

### Nemo Stark, Scout Senior Administrator

996987 Age 39 5 terms  
Intrusion-2, Leader-2, Pilot-2, Rifleman-2, Streetwise-2, Vacc Suit-2, Computer-1, Liaison-1, Navigation-1, Survival-1

Stark's career in the Scouts took off with the outbreak of the Fifth Frontier War in which he commanded a Scout squadron. Decorated many times, he came to the attention of Norris as a man who could get the job done. Stark repeatedly proved his worth over the years that followed and eventually became the top operative in the Marches' Scout

Security Branch. Today, he's the Scout Norris calls upon when something needs to be done efficiently, quickly, and above all, quietly.

Of average height but powerful build, Nemo Stark's dedication and professionalism inspires loyalty and confidence in those around him. It's often been remarked that he'd be excellent recruiting poster material if it weren't for the jagged purple scar across his bald head (a present from the Zhodani). Additional wounds received during the recapture of an X-boat tender from the Vargr a year ago have permanently grounded him and left Stark with a slight limp. While he misses field work, Stark hasn't lost his dedication to duty.

### Rosseneau Khagii, Scout

697C89 Age 34 4 terms  
Pilot-3, Engineering-2, Ship Tactics-2, SMG-2, Admin-1, Bribery-1, Computer-1, Liaison-1, Navigation-1, Sensor Ops-1, Streetwise-1, Vacc Suit-1

Khagii got her start flying transport and re-survey missions in Trojan Reach sector. The Fifth Frontier War gave her a taste of life on the edge and she hasn't backed away since. Today, she specializes in special operations missions for the Scout Security Branch. Possessed of the nonchalance and irreverence which marks a Field Scout, Khagii is nonetheless a highly skilled professional. In fact, the

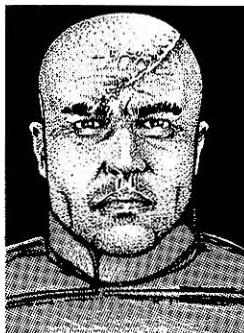

Blair Reynolds



Blair Reynolds

captain has displayed such grace under fire that her crew refers to her as "The Empress of the Ice".

Rosseneau Khagii is of average height and build. Her long, barely-regulation, jet black hair highlights her almost Nordic complexion and fine features.

**Uekdhuegh, Corsair Leader**

67788A Age 38 5 terms  
 Infighting-2, Small Blade-2, Pilot-2,  
 Vacc Suit-2, Grav Vehicle-1, Handgun-  
 1, Interrogation-1, Intrusion-1, Leader-  
 1, SMG-1, Ship's Boat-1, Ship Tactics-  
 1, Computer-0

Uekdhuegh is the head of the Aek Aeg, the Vaenggvae's counterintelligence organization. He discovered fragmentary evidence of the Old Imperium's deep radar project after Depot was seized. Uekdhuegh wants it

for himself to support a bid for a top leadership position in the corsair organization.

Ruthless and efficient, the Vargr has surrounded himself with corsairs who are intensely loyal to him. They hope to ride their leader's coat tails to fame and fortune. Uekdhuegh speaks Anglic with a guttural accent, a skill he learned while running a protection racket involving Tukera Lines shipping in the Provence sector.

**Raul Nellis, Ex-Enforcer Lieutenant**

AA67A7 Age 34 4 terms  
 Brawling-2, Forensics-2, JOT-2, Liai-  
 son-2, Legal-2, Combat Rifleman-1,  
 Computer-1, Grav Vehicle-1, Handgun-  
 1, Small Blade-1, Streetwise-1, Vacc  
 Suit-1

Nellis was originally a special investigator for the Imperial Ministry of Justice's Special Branch before transferring to the Scouts in 1117. Since then, he has served as an Scout liaison to various human resistance organizations in Corridor sector.

Raul Nellis is physically powerful although he appears to be much softer due to his rounded facial features, which are partially hidden by a beard and mustache.

**REFEREE'S SYNOPSIS OF SCENARIOS**

Like chapters in a novel, this adventure is divided into scenarios, each of which is subdivided into a number of nuggets. This section tells you what each scenario of this adventure covers.

**Scenario I - Mounting Up:** The characters are ordered to report to Atsah Scout Base in the Deneb sector in preparation for a commando mission. Once there they learn the details of the mission, proceed through equipment outfitting and are introduced to their genetically engineered teammates as well as the ship they'll travel aboard. Activities at Atsah conclude with each PC executing an individual reentry from orbit.

**Scenario II - Infiltration:** Arriving in the Depot system, the characters must crack the extensive early warning net surrounding the planet in an attempt to gain the surface. Along the way they visit a secret supply dump in order to refuel their ship and obtain a set of rare TAC missiles in the process. Once down on the

surface, the PCs are ready to infiltrate the Depot and carry out their assignment.

**Scenario III - Depot:** The characters are faced by known and unknown dangers as they penetrate the occupied Navy base and its research and development complex. Matters are further complicated when they encounter a corsair leader bent on stealing what the PCs have been sent to recover. Finally, in the midst of an all-out alert, the team must find a way through the Vargr forces arrayed against them and get off Depot alive.

**SCENARIO I: MOUNTING UP**

**Summary of Nuggets**

1. **Final Approach (key):** This nugget introduces the PCs into the adventure.
2. **Nemo (key):** The characters meet a famous Scout.
3. **Mission Briefing (key):** The PCs learn the details of the mission they are to undertake.
4. **Q Division (key):** Outfitting and the introduction of special equipment occurs in this nugget.
5. **Genas (key):** Two genetically enhanced animals are introduced to the characters.
6. **Thundering Muse (key):** The starship *Thundering Muse*, the ship the team will take to Depot, is detailed.
7. **Free-fall (key):** The PCs train in orbital assaults using reentry kits.

Blair Reynolds



Blair Reynolds

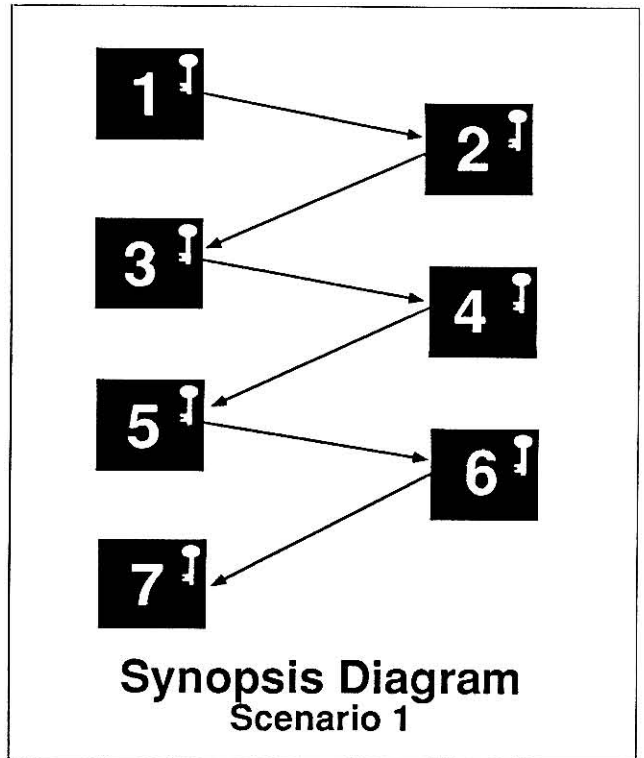

**1. FINAL APPROACH**

The characters arrive at Atsah aboard a Scout starship. Location is Atsah (2913 Deneb)

**Scene:** You guide the ship through the last wisps of hazy cloud cover high above Havril, Atsah's capital. Far below, native tanstone architecture is surrounded by the precise interlocking grids of the agro zones. Then, farther out, span the scrubby range lands of the local baathi ranchers. Sliding "down the pipe" defined

by the glowing lines of the holo heads up, the ship is on a picture perfect descent into Atsah Scout Base.

**Action:** Tasks in this nugget are of the usual starship operational variety as found in GDW's *Imperial Encyclopedia* and DGP's *Starship Operator's Manual*.

This nugget is used to introduce the PCs to one another. Since they're all travelling aboard the same transport, the players can exchange a little background history for their characters; where they're from, what they've been doing lately, past shared experiences, whatever seems appropriate. As far as the current assignment goes, the characters all received priority orders to report to Atsah but no details beyond that.

Once the characters land at the base, they'll go through routine in-processing and be assigned visitor's quarters. A mission briefing is scheduled for the next day.

The world of Atsah is a client state of the Imperium, in name, and the Domain of Deneb, in fact. Due to its proximity to Vargr space, the system is an excellent forward base for intelligence operations in Corridor sector.

## 2. NEMO

**The PCs meet the "legendary" Nemo Stark.**

**Location is a secure briefing facility at Atsah Scout Base.**

**Scene:** The auditorium goes suddenly quiet. Following the eyes of a number of others in the room will lead you to the image of a silhouetted figure in the doorway. Displaying a slight limp as he strides briskly to the podium, the man who's just entered is immediately familiar to you. You doubt that there's a Scout in all of the Domain who's not heard of Nemo Stark. Hero of first the Fifth Frontier War and now the Second Civil War, reputed to be Norris' top DSS troubleshooter, he's a larger-than-life legend.

Stark takes up a position behind the podium and in front of the vivid floor to ceiling holo of the DSS insignia. His steely gaze takes in the room. Stark's ramrod posture and commanding presence reminds you of the posters that hang in the front windows of the service recruiting stations.

**Action:** This nugget provides a chance for the PCs to meet an important figure in the Domain. Nemo Stark is a highly motivated, energetic and dedicated Scout; the type of person most characters would willingly follow into battle. He is highly personable and will take the time to get to know the characters and they him.

Stark, as the mission organizer, will personally oversee the characters' preparations for the mission and will be a constant fixture during this scenario. He acts as a conduit through which the referee can supply information or make needed suggestions.

## 3. MISSION BRIEFING

**The characters learn the details of the mission they're to undertake.**

**Location is a secure briefing facility on Atsah (2913 Deneb).**

**Scene:** "I'd like to welcome all of you to the commencement of Operation Rapid Repo.", begins Stark. "I know you're anxious to learn what the next few weeks hold, so I'll cut to the chase. It's my intent to send a highly qualified team of special operatives — that's you — to the occupied Depot in Corridor. There you'll recover a vital piece of Imperial technology; an experimental deep radar system.

"I have it on very good authority that His Grace Archduke Norris has a personal interest in this operation and I don't intend to disappoint him. And I know you don't either.

"Now to the details..."

**Action:** For those players not familiar with the concept of deep radar, the referee, as Nemo Stark, can relate the following information.

Using a combination of cutting edge meson, neutrino, as well as several other exotic technologies, deep radar can selectively "see" through all but the most dense concentrations of matter and energy. For example, a planet can be ignored in order to detect a ship hiding behind it. This eliminates many of the problems inherent with conventional or laser radars which can be jammed by electronic countermeasures (ECM) or blocked by planetary bodies, "sand" from sandcasters, and the like. The military potential for such a sensor is obvious and a number of Imperial research facilities, including the Naval R&D lab on Depot/Corridor, were working on the project before the Rebellion broke out.

Naval personnel who evacuated Depot in 1118 reported that Admiral Xavier, Depot's commander, had the deep radar project lab destroyed to prevent its capture by the Vargr Destiny Alliance. Recently, new evidence has been brought to light indicating this might not be the case.

The discovery was made by a young Naval lieutenant who arrived in Deneb just two months ago, after an arduous two and a half year trek through Corridor. Part of the team assigned to evacuate critical personnel and technology from the base, she heard a garbled message over an open comm net stating that the lab's self destruct system had failed to detonate. With Vargr closing in on her position, she was unable to confirm the message before being forced to flee the system.

Determined to get to Deneb and report the possible survival of the deep radar lab, she was later forced down on Ikhur/Ian (0611 Corridor) by corsairs. The only survivor of the small, all-Navy crew, she was literally compelled to hike to the other side of the planet to get to the starport and thence to Deneb sector.

Archduke Norris heard this revelation while attending a conference on Deneb several weeks ago. He tasked the Scout Service to send a team to either recover the deep radar's key components or insure their destruction. Norris, long familiar with his reputation, personally chose Stark to organize the mission.

### Deep Radar: Key Components

There are three critical components of the deep radar system that the characters must recover. All are featureless gray boxes studded with optical ribbon connectors. They are otherwise unmarked and obviously handtooled. Each is approximately 5 liters in size and weighs between five and seven kilograms. The PC team will be given holos of what each component looks like from several angles.

These three boxes are the heart of the deep radar system. The remainder consists of a huge bank of ultrafast, supercooled computers, a heavy duty multispectral transceiver and a very powerful fusion generator.

It's expected that with the components, the test radar can be reconstructed by the researchers who made it to Deneb in just a few years. Without them it could take as much as a decade to complete the work.

Nemo Stark outlines the following details and requirements:

- The team's cover identity is that of an exploratory trade mission out of Deneb.
- The team should be reminded that time is of the essence. Should the deep radar project remain intact, it mustn't be found

by the Vargr, otherwise Deneb could find itself up against a dangerous new threat. Deep radar capability in the wrong hands could prove fatal to the Domain.

- The mission is to be conducted under the utmost secrecy. With the Domain's forces already spread so thin, the last thing Norris wants is to stir up a hornet's nest. For this reason, and because a significant captive human population remains on planet, large scale damage to the facility should be kept to a minimum (in other words, don't nuke the site from orbit).

- Finally, should the PCs find themselves in trouble, they can call upon the Service's agents or allied human resistance groups on several different worlds. They're given a list of contacts and identification codes for these locations.

Stark concludes the mission brief by informing the characters that they have one week in which to prepare for departure. The referee is reminded that as loyal agents of Norris, the PCs will want to recover the radar components for the "home team". Destruction of the components is only to be considered as a last resort.

There's another, untold reason behind Norris' desire to see the mission performed quickly and quietly. For some time, he's been working behind the scenes to encourage a stable Vargr presence in Corridor. The existence of the Vargr has helped keep Deneb from being dragged into the chaos of the Rebellion, but it has also brought problems all its own (after all, they are corsairs bent on pillage).

Possession of even an experimental deep radar system by the Vaenggvæ could upset the delicate balance of power currently being built, yet Norris can't overtly act for fear of being seen as duplicitous. His solution is a covert mission to deny the technology to the Vargr, either through its recovery or destruction.

#### 4. Q DIVISION

The PCs review what equipment they'll take on the mission.

**Scene:** The hand lettered sign at the entrance to the technical section reads "Q Division" although the meaning of the



reference escapes you. Inside is a large work area occupied by broad tables, tools and test equipment. Behind this jumble are rows of storage racks stretching toward the distant back wall. Four or five techs are occupied at lab tables, moving storage cases on grav floaters or searching the storage bins.

**Action:** The Scout Service will supply whatever equipment the characters request, within reason and in keeping with the overall mission. This includes weapons appropriate for the skills possessed by the PCs. The DSS has already assembled such basic necessities as combat armor, grav belts, communications gear, medical supplies and the like. In addition, a complete set of maps and technical data for Depot is provided. It should be noted that the data is current as of 1117 or just before the major Vargr

#### SPECIAL EQUIPMENT:

##### Black Boxes

Black box is a generic term used by commandos, including the Scouts' Security Branch operatives, to describe a wide variety of custom built electronic intrusion devices. The ones used in *Rapid Repo* are small, purpose built units which are powered by an internal battery good for 8 hours of continuous operation. Each black box weighs 0.1 kg. and has a volume of 0.1 liters. Approximate per unit cost for either model is 50KCr.

Two different types of black box will be provided to the PCs. The first, called a "Fixer", negates remote security sensors by means of a low power jamming signal. The second type of black box, not surprisingly named "Lockpick", allows direct manipulation of an electronic lock. A Lockpick must be physically interfaced into a lock to operate. Four Fixers and two Lockpicks are available for the mission.

##### The Ichiban Model 117

The Ichiban Model 117 portable computer is a heavily modified, militarized version of a commercially available hand computer. In addition to the standard wireline, radio and optical interfaces, high capacity memory, advanced processing power and small size, the Imperium has added a host of computer intrusion, code breaking, and virus programs. The Model 117 weighs 2 kg. and is 3 liters in volume. It's available only to authorized Imperial personnel and is not otherwise available at any price (black market versions go for 375KCr but are inferior in performance and lack many of the capabilities of a true model).

The characters will be issued one Model 117. The computer can only be used by a skilled operator with a minimum of Computer-1. Without such a computer, or the proper passwords, operating instructions and biometric IDs, a character would stand little or no chance of penetrating a computer system. The Model 117 can also function as a Lockpick black box.

invasions. All of the equipment and weapons have been "sanitized"; any clues which can be traced back to the Domain have been erased or altered.

This nugget also affords the opportunity to introduce several items of special equipment required for this adventure; two types of "black box" and the Ichiban Model 117 portable computer (see sidebar).

The players, using the maps provided, can also make whatever preliminary plans they feel are required for the job at hand.

The referee can of course include her own special equipment or take suggestions from the players. The technicians at Atsah will be able to fabricate whatever is requested as long as it's not too exotic (referee's call). Possible suggestions include sonic grenades audible only to Vargr, monomolecular garottes, or tripwires and the like.

## 5. GENAS

**The characters meet their new teammates, a pair of genetically engineered animals.**

**Location is a Technical Office lab at Atsah Scout Base.**

**Scene:** The rich aroma of animal life hits you hard as you round the corner leading into the Technical Office's Animal Support Section. Along the way you sidestep a base security guard reprimanding her bloodvark partner for causing some unspecified "mess". Your guide seems not to notice the two as he motions you into Work Area No. 3.

The two occupants of the room are an interesting contrast in almost every respect. Sitting on a work table is a pure white, beaked monkey. Larger than any beaker you've seen before, it's methodically field stripping an SMG.

On the floor in front of the beaker is something you can't readily identify, but you're relieved it looks asleep. Sporting nasty looking claws and dental work, a silky mane surrounding its head, the creature's fur is a shade of green so dark it almost looks black. You definitely get the impression you don't want this thing mad at you.

**Action:** The Imperium has been using genetically enhanced animal species, or "genas" for short, for over three centuries. Geneered for increased intelligence, more efficient use of natural attributes, tool using abilities and rudimentary problem solving skills, genas have proved themselves able assistants to sophonts. They provide a low cost, (relatively speaking), low maintenance, self reproducing alternative to robots in both military and civil applications.

The beaked monkey, also known as a beaker, is a common pet throughout the Imperium, especially among ship crews. This is due to their friendly nature, endearing appearance and reputation for cleanliness. It stands to reason that the characters, if not the players, have run into at least one in the past. The enhanced beaker has been engineered for its mechanical and technical aptitude. Its small size makes it ideal for working in confined spaces denied to larger sophonts (also making it a good choice in scouting applications). The beaker can remember fairly complex commands and technical procedures.

Enhanced beakers average 84 to 105 cm in length and weigh anywhere from 2.8 to 4.2 kg. They are not too dissimilar to Terran monkeys with the notable exception of the hard, parrot-like beak.

The sleeping beast is a nanshu, a carnivorous chaser native to Shirene/Lunion (2125 Spinward Marches). It's been engineered for a purely combat/recon role although it's about equal in intelligence to the beaker. Also able to retain and execute complex commands, the creature can move swiftly and silently. Between its natural weaponry and imposing bulk, the nanshu has an obvious shock value in combat.

Nanshus in general combine both canine and leonine features — both characteristics being most pronounced in the area around the head, which is surrounded by a mane of fine hair. Coloring is a very deep shade of green, an adaptation to the

creature's native environment. Another environmental adaptation is an ability to sense electrical fields in a twenty meter radius. Not only does this sense make the nanshu a better hunter, it gives enhanced nanshus the ability to detect opposing forces and electronic equipment.

Enhanced nanshus stand approximately 110 cm at the shoulder and weigh 280 kg. Each of the four paws features a set of retractable claws averaging 10 cm in length.

## Genas Statistics

Animal Type	Wt	Hits	Armor	Wounds & Weapons	Speed
Enhanced Beaker	3.5 kg	2/1	—	1 Teeth	2
Enhanced Nanshu	280 kg	8/4	Jack	7 Claws and teeth	3



Blair Reynolds

Both animals have been conditioned to life in confined spaces, such as a starship, and have had subdermal radios implanted in their skulls for communication with their handler. The radios are low power, frequency-agile, two way communicators with a range of about a hundred meters. In addition, taps into the genas' optic nerves, and processed by a special hand computer carried by the gena coordinator, allow him to see what the animals are seeing through a display headset. A secondary tap into the nanshu's electrical sense can be overlaid on its visual feed thus providing a computer generated display of electrical fields near the gena.

The referee is encouraged to personalize both animals by giving them names of her own choosing or by soliciting appropriate, or humorous, ones from the players. Both the beaker and the nanshu should also be given little personality quirks or distinctive habits that set them off as unique NPCs, albeit animals.

Specific animal handling tasks must be developed by the referee as the situation warrants. When conducting a task, the PC animal handler must explain to the referee what he wants to accomplish. The referee then creates an appropriate task and the players roll.

## 6. THUNDERING MUSE

The characters take a look at *Thundering Muse* and meet its skipper, Captain Rosseneau Khagii.

Location is a hangar at Atsah Scout Base.

**Scene:** The hangar is empty save for the two craft before you; a wedge-shaped merchant vessel and a gig. Under the glare of the ceiling floods, there's little to mark the ship as unusual. The boat is another matter. Clearly visible is a servo mounted plasma gun, extended from a fitted compartment, hanging beneath the bow.

**Action:** The characters will travel aboard the improved *Alexandria*-class merchant, *Thundering Muse*. The improved *Alexandria* is an upgraded version of the basic *Alexandria*-class used throughout Imperial space in areas of high stellar density (such as the Spinward Main in the Marches). The upgrade sacrifices cargo space for greater jump, maneuver and fuel storage capability allowing the ship to travel farther in a shorter period of time. The Scouts have long used both models for everything from survey to transport to scientific research missions. In the Domain of Deneb in particular, many of the Scouts' improved *Alexandrias* have been further upgraded and assigned to the Security Branch for use in special missions. The Universal Craft Profile for *Muse* and her gig can be found in the sidebar.

One notable feature of *Thundering Muse* which does not appear in the sidebar profile is the existence of a number of secret compartments designed around structural members, power conduits, and machinery. The compartments stand a fair chance of avoiding detection by an inspection team, even one armed with advanced sensors. Items of equipment which clearly identify the PCs as commandos will go into these spaces.

*Muse* will carry a selection of goods of special interest to Vargr. Items such as precious metals, meats, wines, dustspice, and even a few things from the "beads and trinkets" category have been placed aboard. Not only will this cargo help the team maintain its cover identity but it can also be used to bargain with Vargr corsairs or officials.

Finally, use this nugget to briefly introduce Capt. Khagii and the crew of the ship. Individual crew members can be tailored using the quick NPC rules in GDW's *Referee's Manual*.

The crew is experienced in this kind of work and takes the burden of getting to Depot off the commandos, allowing them to concentrate on their portion of the mission. For the most part, operation of *Muse* will be transparent to the characters although don't ignore the roleplaying possibilities. Confined aboard the same ship for an extended period of time, the team and the crew will naturally get to know each other.

## 7. FREE-FALL

The characters conduct an orbital assault using individual reentry kits.

Location is in orbit above Atsah.

**Scene:** You're riding a shooting star into the upper atmosphere of Atsah. Space above has been all but blotted out by the fire trail left in your wake. Somewhere around you, the other members of the team are riding their reentry shields toward the planet below. The thought occurs to you again that this is one heck of a refresher course.

**Action:** Training in the use of a reentry kit is standard for all S-3 commandos, but unless an individual regularly "jumps", refresher courses are mandatory. (The genas ride down in a special drop capsule under sedation. Specifics on the pod appear in the next column.)

### THUNDERING MUSE and her Gig

**Craft ID:** Fast Merchant, Type AF, TL 15, MCr 69.25  
**Hull:** 180/450, Disp=200, Config=1SL, Armor=40G, Unloaded=1642, Loaded=1673  
**Power:** 1/2, Fusion=1642 Mw, Duration=20/60  
**Loco:** 14/28, Maneuver=3, 7/14, Jump=3, Cruise=750, Top=1000, Agility=2  
**Commo:** Radio=System x2, Laser=System  
**Sensors:** PassiveEMS=Interstellar, ActiveEMS=Far Orbit, Densitometer=HiPen/1km, Neutrino=10kw, ActObjScan=Simple, ActObjPin=Simple, PassObjScan=Rou, PassObjPin=Rou, PassEngScan=Simple, PassEngPin=Rou  
**Off:** Missiles=x03  
 Batt 1  
 Bear 1  
 Missile Storage=40 rnds with more in the cargo hold.  
**Def:** DefDM=+6, EMMask, EMSJammer  
 Sandcaster=x03  
 Batt 2  
 Bear 2  
**Control:** Computer=3Fib x3, Panel=DynamicLink x60, Special=HoloHUD x4, Large Hologdisplay, Environ=Full Environmental  
**Accom:** Crew 5x1, (Bridge=2, Engineer=1, Gunner=1, Command=1), Staterooms=7, SmStateroom=1, Subcraft=Gig  
**Other:** Cargo=46 tons, Fuel=73 tons, ObjSize=Avg, EMLevel=Faint, Fuel scoops, On-board fuel refining, plant requires 12 hours to process a full load.  
**Craft ID:** Gig Raider, Type GR, TL 15, MCr 39.22  
**Hull:** 18/45, Disp=20, Config=1SL, Armor=40G, Unloaded=480, Loaded=485.7  
**Power:** 1/2, Fusion=342 Mw, Duration=20/60  
**Loco:** 2/4, Maneuver=5 Cruise=750, Top=1000, Agility=1  
**Commo:** Radio=System x2, Laser=System  
**Sensors:** PassiveEMS=Interstellar, ActiveEMS=Far Orbit, Densitometer=HiPen/1km, Neutrino=10 kw, ActObjScan=Simple, ActObjPin=Simple, PassObjScan=Rou, PassObjPin=Rou, PassEngScan=Simple, PassEngPin=Rou  
**Off:** Missiles=x01  
 Batt 1  
 Bear 1  
 Missile Storage=20 rounds  
 Rapid Fire Plasma Gun (RPB-15) in fitted compartment under bow. Directed by gunner's helmet mounted sight. See GDW's *Referee's Manual* for details.  
**Def:** DefDM=+4, EMMask, EMSJammer  
 Sandcaster=x02  
 Batt 1  
 Bear 1  
**Control:** Computer=2Fib x3, Panel=DynamicLink x10, Special=HoloHUD x2, Environ=Full Environmental  
**Accom:** Crew 2x1, (Bridge=1, Gunner=1)  
 Seating=Roomyx10,  
**Other:** Cargo=4 tons, Fuel=6 tons, ObjSize=Avg, EMLevel=None  
**Notes:** The gig is a wedge shaped lifting body with a limited glide capability (an unpowered descent is often used during infiltration missions).



Originally developed as a means to "bail out" of an orbiting spacecraft in trouble, reentry kits were later adopted by hobbyists and the military alike. They are favored by commandos for covert landings in situations where a ship, boat or other vehicle might be too easily detected by opposing forces (which may be the case once the PCs reach Depot). The kits used in this adventure are high-grade military models commonly used by Domain forces.

For a description of the individual reentry kit and how it's used, see the sidebar "Reentry Kits".

The drop pod used by the genas incorporates reaction thrusters, integral heat shields, life support good for 48 hours, and a set of parachutes used to achieve a soft landing. One character, probably the animal handler, will have the genas' pod slaved to his actions. His reentry roll, without modification, also covers the pod's reentry.

At the end of this nugget, the PCs depart for Depot.

Given the limited space available here, the trip to Depot will not be covered in detail. Feel free to intersperse whatever encounters you wish as the characters make their way across Corridor. Inspiration for these encounters can come from the sources listed in the *References* section of the introduction.

The quickest way to make the journey is to simply follow a "jump-refuel-jump" routine. Following standard procedure, *Muse* will run without its transponder on, the EM mask up at all times, and keep all power usage to a minimum in order to avoid detection by neutrino sensors. The on-board EMS Jammer can also be used to ward off detection.

### Reentry Kits

There are three phases to an individual atmospheric reentry: preparation, de-orbit, and landing. Each is described below along with the relevant parts of the reentry kit used during that phase (see also the cover of this issue for what an individual reentry looks like during use).

• **PREPARATION PHASE:** The character is already dressed in a vacc suit or other pressurized garb before strapping on the reentry shield inflation mold. He then gathers up the remainder of the kit and makes a final equipment check prior to leaving the vehicle. Once outside, the shield foam canister is attached to the mold (if it hasn't been already. Most military models come with the canister pre-attached to save time and trouble). Triggering the canister allows ablative foam to fill the mold, inflating it to its full size. After about 15 minutes, the mold has completely filled and the foam has hardened to the desired consistency.

While this is going on, the character deploys a chemical fuel attitude/braking thruster. A hard-wired computer with optical sight is attached to the thruster and is used to control it. If the planet the character wishes to land on has an orbital

navigational positioning system, the computer can be tied via radio link into its broadcasts. This allows for a more precise, safer de-orbit burn and an increased chance of landing in a desired location.

This phase complete, the character then moves on to perhaps the most difficult part of an individual reentry; the de-orbit phase.

To successfully complete the preparation phase:  
Routine, Vacc Suit, Dex, 2 mins.

• **DE-ORBIT PHASE:** Using the thruster control computer, the character adjusts his attitude for the proper de-orbit, or reentry, burn. The orientation of the shield and its occupant is checked and, if correct, the burn is initiated. The thruster then pushes the PC into a transfer orbit which will take the shield to the top of the planetary atmosphere. If the burn was properly accomplished, atmospheric braking begins at this point.

A failed burn can lead to the shield burning up if the approach angle was too steep, or bouncing off the atmosphere if the approach angle was too shallow. In the latter case, it's sometimes possible to swing around the planet for a second try.

The character spends approximately 10 to 15 minutes in the ablative portion of reentry, the time during which the shield is protecting him from the heat generated by atmospheric friction. It's during this phase that the PC is slowed sufficiently to permit a safe landing. At the end of this period, the PC and what's left of the shield is in free-fall.

To successfully complete the de-orbit phase:  
Difficult, DM, Edu, [See Below] (hazardous, fateful)

*Referee:* The special DM is based on the following factors:

• Per level of Vacc Suit, Computer, Pilot or Navigation skill: +1

• If the thruster control computer is tied into an orbital navigational system: +2

• If a precise drop from a vehicle is made, no de-orbit burn is required as all the necessary vector matchings will already have been made. The task is an automatic success.

• If atmosphere is type B: -1

• If atmosphere is type C: -2

The total time required to de-orbit is computed as follows:  $M=6(S \times 2D)$  where M is minutes and S the planet's UWP size code.

On a fumble, the character burns up on reentry or is bounced into deep space. In the case of a failure, the character is allowed one additional de-orbit attempt. Task difficulty is not increased but a second failure is either equivalent to a fumble or the landing task is automatically fumbled.

• **LANDING PHASE:** At approximately 35 kilometers altitude, a drogue parachute is released, slowing the user such that the main parachute can later be safely deployed. The main chute opens at about 5 kilometers altitude, giving the character plenty of time to find a safe landing zone. Parawings, grav chutes and grav belts are sometimes used in place of parachutes. All incorporate safety features which activate the landing device at a minimum altitude if the PC wishes.

Commandos deploy the main 'chute at an altitude specified by their operational scenario. The standard minimum altitude specified in Domain doctrine is 300 meters, although drops to 100 meters have been successfully accomplished.

Once on the surface, the remaining portion of the shield will float and is proof against some small arms fire. It has an armor value of three for game purposes.

(continued on page 73)

# MEGATRAVELLER

## Equipment Detail Sheet

© 1991 Digest Group Publications and Game Designers' Wkshp.  
Permission granted to photocopy for game use.

# PERSONAL REENTRY KIT

### EQUIPMENT STATISTICS

TL	Type	Vol	Wt	Price
○ 8	Personal Reentry Kit	20L	14.5kg	Cr15,000
○ 10	Personal Reentry Kit	16L	11kg	Cr12,000
○ 13	Personal Reentry Kit	12L	8kg	Cr10,000

### SUPPLEMENTAL STATISTICS (Optional)

TL	Weight	Capacity	Comments
○ 8	400 kg		Parawing
○ 10	400 kg		Grav Chute
○ 13	600 kg		Grav Belt

### USAGE RECORD

All forms of the device are usable for only one reentry. However, the support hardware, such as grav belts or parawings, are reusable.

### CUSTOMIZING NOTES :

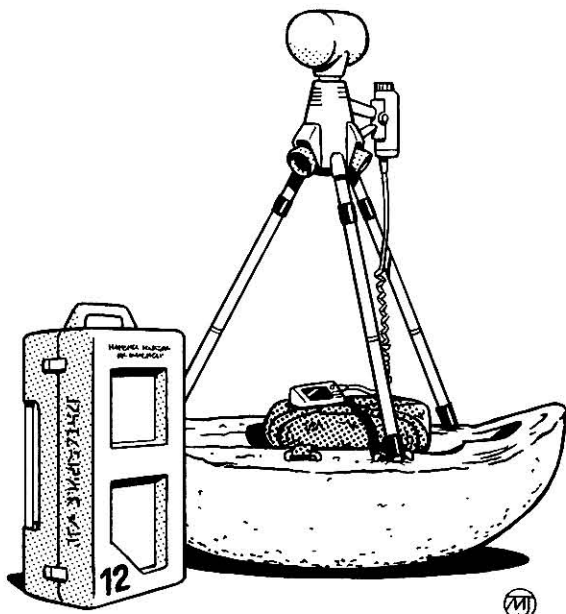

Tech level 10 version illustrated

### DESCRIPTION

Originally developed as a means to "bail out" of an orbiting spacecraft in trouble, reentry kits were later adopted by the military and hobbyists alike. A reentry kit consists of an inflatable, ablative shield mold, a canister of ablative foam, a chemically fuelled attitude/reentry thruster with hardwired control computer, and a soft-landing system.

Alternative landing systems include parawings, grav chutes, and grav belts. Parawings are equivalent to parachutes in weight and

volume, but are more maneuverable, allowing greater steerability to a drop target.

Grav chutes are a hybrid of early gravitics technology and parachutes. A grav belt-like harness helps negate some of the user's weight. Add 5 kg. and 3 L to the equipment statistics above. Grav belts function as described in GDW's *Imperial Encyclopedia*.

When using a reentry kit for a sports drop, special foams can be used that result in flaming reentry trails of specific colors.

### TASK LIBRARY

To complete a reentry preparation phase:  
Routine, Vacc Suit, Dex, 2 mins.

To complete the de-orbit (reentry) phase:  
Difficult, DM, Edu, [see below] (hazardous, fateful)  
Referee: The DM is based on the following:

- Per level of Vacc Suit, Computer, Pilot, or Navigation skill: +1.
- If the thruster control computer is tied into an orbital navigation system: +2.
- If a precise drop from a vehicle is made, no de-orbit burn is required as all the necessary vector matchings will already have been made. The task is an automatic success.
- If atmosphere is type B: +1.
- If atmosphere is type C: -2.

The total time required for reentry is computed as follows:  
 $M=6(S \times 2D6)$  where M is minutes for reentry and S is the planet's

UWP size code. On a fumble, the character burns up on reentry or is bounced back into space. In the case of a failure, the character is allowed one more deorbit attempt. Task difficulty is not increased, but a second failure is either equivalent to a fumble or the landing task is automatically fumbled.

To successfully complete the landing phase:  
Routine, Vacc Suit, Edu, [see below] (hazardous, fateful)  
Referee: A fumbled task roll results in a critical injury, but do not lower more than two stats to zero. A failure causes the character to miss the desired landing zone by 2D6 kilometers.

- Individual reentry is not possible on a world with UWP atm. codes 1-3.
- The gravity field surrounding size 0 worlds is weak enough that the thruster can be used for landing. Omit the landing phase, in this case.

(continued from page 71)

To successfully complete the landing phase:  
 Routine, Vacc Suit, Edu, [See Below] (hazardous, fateful)  
 Referee: Total time from end of the de-orbit phase to touchdown is computed as follows:

$M=30 \times A$  where M is minutes and A is the atmospheric modifier from the table below.

A=0.5 if the atmosphere is thin.

A=1.0 if the atmosphere is standard.

A=2.0 if the atmosphere is dense.

Note: Reference DGP's WorldBuilder's Handbook for atmospheric density of UWP codes A+.

A fumbled task roll results in a critical injury, but do not lower more than two stats to zero. A failure causes the character to miss the desired landing zone by 2D6 kilometers.

Finally it should be noted that an individual reentry is not possible on a world with UWP atmosphere codes 1-3 as there is insufficient atmosphere for the ablative shield to brake with. Also, the gravity field surrounding size 0 worlds is weak enough that the thruster can be used for landing. Omit the landing phase in this case.

**SCENARIO II: INFILTRATION**

**Summary of Nuggets**

1. **Distant Eye (key):** After evaluating the situation around Depot, the PCs formulate their plan of attack.
2. **Cache (key):** In need of fuel for the expected return journey, the characters visit a secret supply dump.
3. **End Run:** The PC team attempts to land on Depot either in or from *Muse's* gig.
4. **Going Ballistic:** The PC team attempts to land on Depot by ballistic infiltration.
5. **Touchdown (key):** The characters get their first detailed look at Depot and deal with the aftermath of their landing.
6. **First Contact:** The PCs encounter an aerial Vargr patrol.
7. **Arrival (key):** Having arrived at their destination, the closing nugget of the scenario leaves the characters with some interesting questions.

**1. DISTANT EYE**

The characters examine the security around Depot.

Location is in deep space in the Depot system (1511 Corridor).

Scene: With the return to realspace in the Depot system, *Thundering Muse* is at action stations. Cloaked by its electronic defenses, weapons at the ready, the converted transport is whispering in-system on a curving, low energy arc high out of the system ecliptic.

Clustered around the holo tank, you all watch as Depot is peeled back like an onion by passive sensors. Alphanumerics appear and disappear next to tiny blips denoting ships. Vast false color walls define the sight lines of the big active sensors. Capt. Khagii stands off to one side, intent on the images floating before you. Her brow furrows as she reaches for a control console.

"Just what I thought. The computer has ID'd an *Aek Naz* and two *Foghoks* in near orbit. This'll be a lot tougher than I thought."

Action: From its vantage point above the plane of the system, *Muse* can build a detailed picture of the Vargr presence around Depot. The picture is not a good one. Three large ships as well as a host of other ships, *Ueknou*-class corsairs and small craft circle the planet as does a massive orbital shipyard. (See GDW's *Rebellion Sourcebook* for details on the *Aek Naz* and

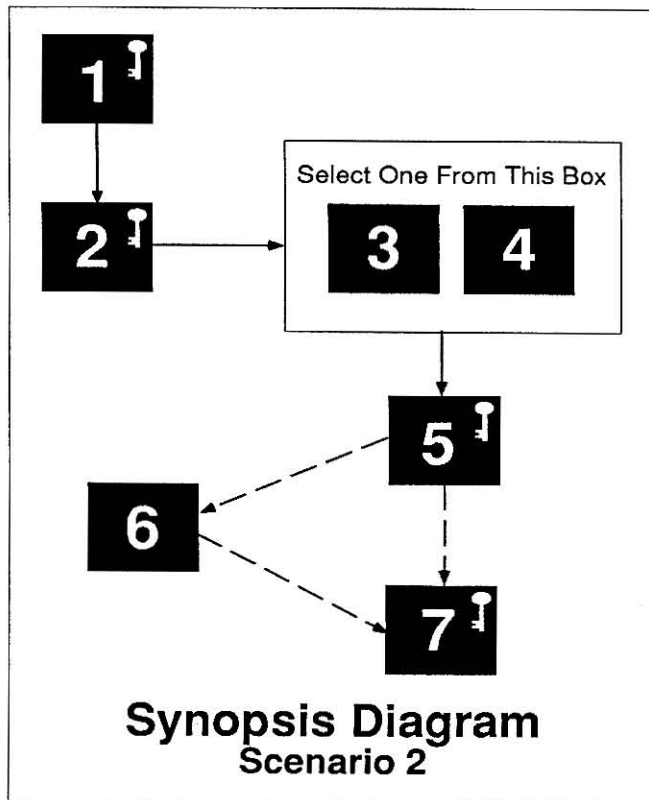

*Foghoks* cruisers and *MegaTraveller Journal Number Two* for the *Ueknou* class corsair). While some of the craft are in for maintenance or refit, several are assigned to picket duty and are constantly running active scans (which are inherently more accurate than passive scanning).

Active ground-based sensors are continuously scanning the heavens as well. This includes meson gun search sensors which can be readily identified as such. (A few of Depot's emplacements remain operational) although there are some gaps in coverage which could possibly be exploited, the point to emphasize here is that Depot's spaceborne early warning net is tight. Even use of the EM mask and jammer is no guarantee of running this gauntlet.

Taking into account the monolithic security around Depot, the characters should formulate whatever detailed plans they feel are necessary to complete the mission. The nuggets below deal with landing via the gig, individual reentry kit, and ballistic infiltration.

Recognizing that players can be perversely innovative, managing alternative approaches to landing on Depot and the subsequent retrieval are up to the referee.

To scan Depot with passive sensors:

Routine, Sensor Ops, Edu, 10 mins.

Referee: This task is used if a character assists in the evaluation. Success allows the character to either spot a previously undiscovered security feature or better define a known one.

To find an exploitable gap in sensor coverage:

Difficult, Ship's Tactics or Sensor Ops, Int, 2 hr.

Referee: Under no circumstances will a gap sufficient to pass *Muse* be found.

# Depot

**Depot/Strand** 1511 **A686354-F D Lo Ni 123 Vg M4V**

**Primary:** Enders, spectral class M4V. Mass 0.462 Stellar Diameter 0.45. Luminosity 0.37.

**Depot:** Mean orbital radius 32.25 million km (0.215 AU). Period 56.78 days. Diameter 9,920 km. Density 1.0 (molten core). Mass 0.421. Mean surface gravity 0.75. Rotation period 26h 39m 14s. Axial inclination 2 degrees 4' 16". Energy absorption 0.74. Two satellites. Surface atmosphere pressure 1.2. Composition std oxygen-nitrogen mix. Hydrographic percentage: 62% (Water). Mean surface temperature 1.79 degrees C. Native life. Total world population 1281. Primary settlements- Depot Navy Base, 1049; Other scattered locations (all military installations), 232. World government feudal technocracy. Tech level-high common 15, low common 15. Primary resources- agriculture, compounds, agroproducts, nonmetals and durables.

The initial surveys of what would become the Depot system were performed by the maverick interstellar explorer H. A. Enders in the first century of the Third Imperium. (The system's primary is named after her). Possessing resources of only limited value, the world was passed over in favor of richer, more accessible planets closer to the then major routes leading to the rapidly expanding frontier.

It was the exploration and settlement to spinward which lead the young Imperium to place a Navy base in the system to protect the growing flow of merchant traffic transiting the sector. Over the centuries, the base was repeatedly expanded, as was its mission, until Naval High Command decided to make the installation the sector Depot for Corridor. Although primarily intended to support counter Vargr operations, Depot also played a strategic role in the maintenance of the Imperial-Zhodani border. (Mainly as a fleet marshalling and transshipment point).

Depot has been occupied by the Vargr since 1118.

The planet is largely underdeveloped with the exception of the areas around the Naval facilities. Possessed of a relatively mild climate, Depot's minimal axial inclination results

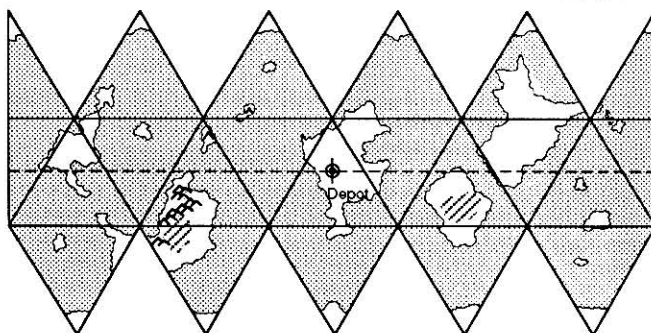

**Depot World Map**

in little variation in temperature from one season to the next. Largely automated farms and ranches take advantage of this fact to continuously supply foodstuffs to the base and its resident fleets.

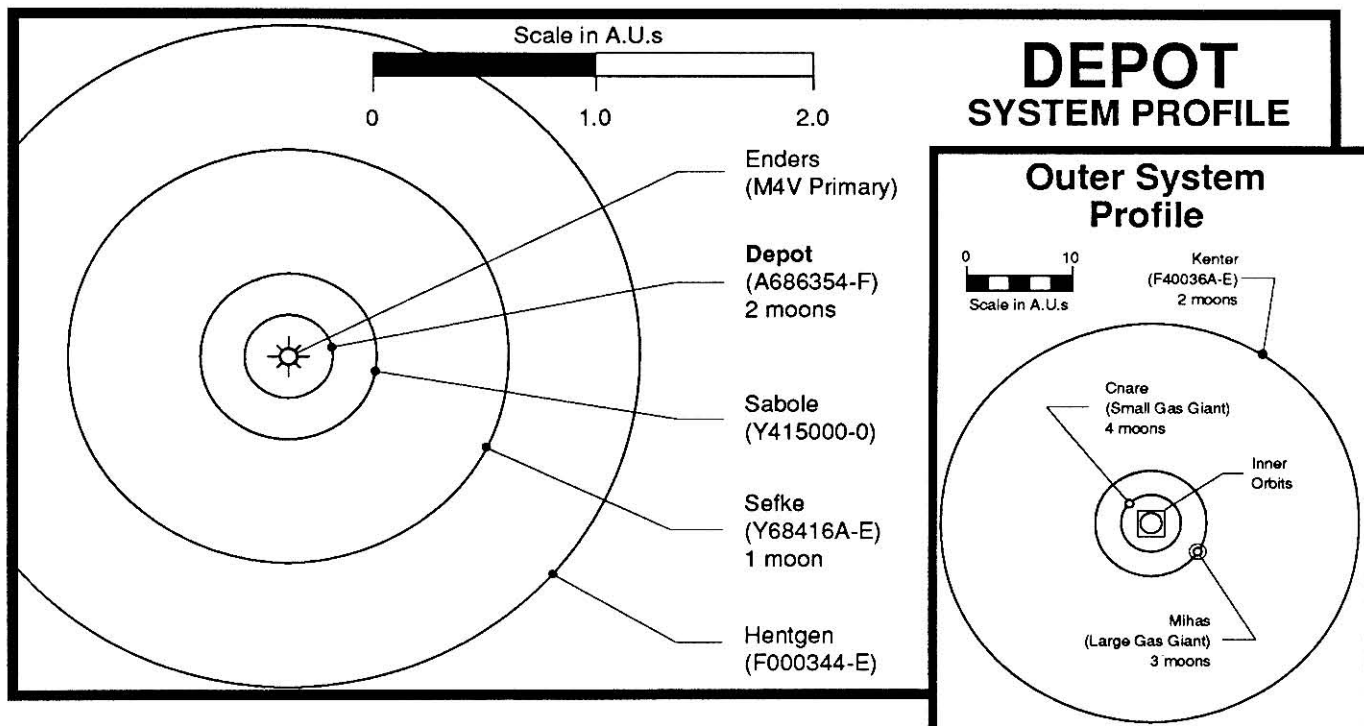

## 2. CACHE

The PCs visit a covert fuel and equipment cache on the way to Depot.

Location is in deep space in the Depot system.

**Scene:** *Muse* hangs behind you while ahead is the asteroid which is your destination. Microbursts from your maneuvering pack carry you closer to the airlock door. [Concealed in a furrow in the asteroid, the door would never be seen if you didn't know it was there.] Even to your experienced eye, this rock appears to be little more than space flotsam — and that of course is the idea.

**Action:** *Muse* needs to refuel before she can leave the system. As this is best done before the PCs make their landing, in case a quick escape is needed later, the next step is to locate a covert supply cache. Every Imperial Naval depot had a number of secret deep space caches containing fuel, food, and equipment for use in emergencies. The Scout Intelligence Branch knows that the Vargr patrol the system's gas giants, so it supplied the team with orbital data for several such caches.

The caches are hidden in hollowed-out asteroids spread throughout the system. The characters must exercise caution, though, as they have no idea whether or not the supply dump they visit has been "compromised". An EVA is required to inspect and then open the secret supply dump.

To inspect the asteroid for signs of compromise:

Routine, Vacc Suit, Int, 30 mins (uncertain)

**Referee:** Anything other than a Total Truth result means the inspection was inconclusive. Don't increase the difficulty on subsequent rolls. In the case of the first cache inspected, fudge the results if necessary to show that no compromise has occurred.

Once the inspection is complete, the PCs must transmit the proper code, supplied at Atsah, to deactivate the cache's physical security system. After that they may attempt to enter.

To enter the cache:

Routine, Vacc Suit, Int, Instant

**Referee:** A failure result means the asteroid's airlock has malfunctioned. A referee-created repair task is required to repair and then activate the portal.

The first cache visited by the PCs has been utterly cleaned out by the Vargr counter intelligence chief Uekdhuegh, whose professional talents allowed him to leave no external trace of his having been there (see the sidebar "Uekdhuegh's Search"). He found the asteroid during a sweep of the system for any remaining Imperial forces in 1118. Realizing that the cache might be visited by Imperial-allied commandos or advanced scouts in the future, Uekdhuegh left behind a tight beam burst transmitter to alert him if the asteroid was opened. Having since learned of the deep radar project, he will correctly guess that the planet's R&D complex is the target of a commando raid and prepare to execute his long-standing bid for power.

*Muse* will register the tight beam pulse and quickly inform the characters. The best course of action is to get away as quickly as possible and locate another cache. Curiously, from the PCs' perspective, pursuit by the Vargr is not forthcoming. Repeat the tasks above with respect to the second asteroid cache located.

The second cache has not been entered since a routine inspection in 1117. The characters may want to look over the



Blair Reynolds

equipment stored there to see if they can find anything of potential value during the mission. Most of the items contained within are of a fairly mundane nature or have already been supplied at Atsah. The most notable exception are the TAC missiles described in the sidebar, "The Buzzbomb".

Finally, having gained entrance to the cache, the PCs can now refuel *Muse*.

To transfer fuel to *Thundering Muse*:

Routine, Vacc Suit, Dex, 1 hr.

**Referee:** Interior controls will open armored, camouflaged panels on the asteroid's surface revealing several hose reels with standard Imperial fittings. Task failure results in an accident. Further events are up to the referee.

### UEKDHUEGH'S SEARCH

Uekdhuegh found fragmentary records regarding the deep radar project in a burned-out admin office on the other side of the base. They described in broad terms the project's goals and that it was located in the R&D building, but nothing else.

Uekdhuegh, like any Vargr, saw an immediate chance to bolster his charisma and dug deeper into the mysterious radar project. He even made a foray into the R&D complex but, without knowing specifically where to go or what to look for, came up empty. Unable to pursue the matter any further, the Aek Aeg chief put the issue aside and kept the details to himself. The sealing-off of the R&D complex for safety reasons insured that the project's existence on Depot remained buried.

Uekdhuegh always hoped that one day, Imperials would show up to lead him to the radar. Now, having received the burst transmission from the asteroid supply cache, Uekdhuegh believes that day has come.

### The Buzzbomb

The Imperial MT-112A TAC Missile was the most sophisticated battlefield TAC missile in the Imperial inventory at the start of the Rebellion. Called "the Buzzbomb", because of the distinctive sound made by its gravitic propulsion system, the MT-112A is a multi-purpose weapon for use in surface-to-surface or surface-to-air combat. For additional details see the equipment sheet elsewhere in this issue.

*Referee:* The MT-112A is currently so rare as to be almost impossible to find. There are a total of four missiles and two sight/computers in the supply dump (although these totals can be changed to suit the referee's needs). Used judiciously, the TAC missiles can be great equalizers should things get sticky.

### 3. END RUN

The PCs attempt to land on Depot in *Muse's* gig. Location is deep space in the Depot system.

**Scene:** The dim crescent that is Depot continues to grow in the forward viewport. Everyone seems to be in an introspective mood as the gig nears the planet. There's been little conversation. Packed into the small craft along with all the basic necessities and reentry gear, in case you have to jump for it, there's little room left over to move around in, especially with a nanshu sitting in the aisle. You find yourself wondering if nanshus in the wild also snore.

**Action:** This nugget is used if the characters decide to land by means of the gig.

The gig crew consists of a pilot (not Khagii) and a gunner/sensor operator. The pilot will fly through one of the coverage gaps and glide in toward the planet over a relatively uninhabited region. From there he'll hedgehop to a landing zone not far from Depot itself, discharge his passengers and then move off to a nearby hide site. How well this actually comes off is up to the referee.

If the referee so chooses, the PCs can be forced by circumstance, for example, a pair of SDBs, to individually reenter if the gig appears threatened (leaving the NPC crew to work their way back out). In any case, it's a good idea if the team brings along all the necessary reentry equipment as a contingency measure. If a drop is planned or becomes necessary, implement the following tasks:

To prepare the genas for drop:

Routine, Animal Handling, Edu, 2 mins

*Referee:* The genas need to be sedated before being placed in their drop pod. The team animal handler will have been trained in the proper procedure. Failure means the procedure was botched and must be rerolled (do not increase task difficulty beyond Difficult). This task is rolled once for each animal.

Finally, roll the individual reentry tasks from Scenario I to determine each character's performance during the drop. Characters can take advantage of the fact that Depot's navigational positioning system remains in place thus conferring the +2 DM on the task roll.

### 4. GOING BALLISTIC

The PCs undertake the ballistic infiltration of Depot. Location is at standoff range from Depot.

**Scene:** Hurling through space in your pressurized combat

armor, your portion of the mission gear strapped about you, you're falling alongside *Muse's* port beam. The rest of the team has also moved into position as well, small figures against infinity.

**Action:** One option open to the PCs for getting to Depot is ballistic infiltration (see sidebar). If the characters choose to go this route, they'll need to perform a few tasks before they can "go ballistic":

To compute the proper ballistic trajectory:

Routine, Navigation, Int, 10 mins

*Referee:* Failure will put the team 1D6 x 10 km off the planned landing zone.

To prepare the genas for drop:

*Referee:* See the nugget above.

To assume the proper position outside the ship:

Routine, Vacc Suit, Dex, 1 min

*Referee:* A failed roll requires a mid-course correction later on. Ignore subsequent results but let the player sweat it out.

To avoid a mishap while coasting to Depot:

Routine, Vacc Suit, Dex (hazardous)

*Referee:* Once during the coast phase and before reentry, have each player roll this task. Potential mishaps include micrometeor strikes, vacc suit malfunctions, and so on.

### Going Ballistic

There are a number of ways to secretly land commandos, or, for that matter, intelligence agents, on a planet's surface without detection. Examples include small craft, exotic stealthships (which are becoming increasingly rare as the Rebellion drags on), deadfall gliders or lifting bodies, drop capsules, and individual reentry kits. The exact choice is a function of how well defended or just plain busy the system is.

Perhaps the most extreme method of covert landing is the ballistic infiltration, generally referred to as "going ballistic". It's used when sensor and ship coverage around a planet is so extensive that landing or even a close approach carries a high risk of interception.

In a ballistic infiltration, the dropping ship assumes a trajectory and velocity which will intersect the planet's atmosphere at a point at which an individual reentry kit can be used to de-orbit. The commandos EVA and assume a position such that they are "falling" alongside the ship. The ship then completes a braking program and moves off to a holding position to await retrieval. During the entire drop, the ship has stayed far enough out of sensor range that the probability of detection is nil.

The commandos retain the same vector they had upon leaving the ship. Each infiltrator is equipped with an individual reentry kit, a long duration portable life support system (PLSS) with integral maneuvering jets, and any gear needed for the mission. Ballistic infiltrations typically last anywhere from 12 to 24 hours before reentry is attempted.

Most sensor networks are programmed to ignore objects below a certain size, otherwise they'd set off alarms for every piece of "space garbage" that drifted by. As a result, a single vacc-suited individual can almost always pass through such a net unnoticed.



Roll the individual reentry task from Scenario I to determine each character's performance during the drop. Characters can take advantage of the fact that Depot's navigational positioning system remains in place thus conferring the +2DM on the task roll.

## 5. TOUCHDOWN

**After landing on Depot, the characters make their way cross country.**

**Location is near the main Navy base on Depot.**

**Scene:** Skimming just meters above the surface of Depot in your grav belt, you have a vantage point unavailable on the ground. This is because of the dense clumps of foliage, called groundscreepers in the briefing files, which otherwise block sight. Here and there against this verdant backdrop, tall, attenuated trees reach upward. All of the vegetation is weirdly colored to make the most of the light coming from the system's blood-red primary.

Banking gently, you make for the spot where the genas' pod came down. Already two of your compatriots are reeling in its parachutes. As they steadily disappear, it looks as if the plantlife is slowly eating them like something out of a bad holo on the late night boob-cube.

**Action:** In general, the vegetation in equatorial Depot stands about waist to head high and includes extensive networks of ground running vines connecting large broadleaf plants. The foliage is so closely spaced that little grows below this canopy. The surface itself is of a moist, spongy composition. At regular intervals, the groundscreepers, as the broadleaves are called, give way to open areas dominated by tall grasses and even taller trees. Although they average 30 meters in height, the trees are no more than 5 meters across at the base.

Movement through the groundscreepers is both tiring and tedious. It also carries the risk of inadvertently stumbling over, or actually into, the hidden burrows of a shy local herbivore. (This

part of Depot is home to a diverse number of lifeforms, none of which are particularly hazardous in any case).

Temperatures around the base reach a high around 22 degrees C (72 degrees F) during the day before falling to a nighttime low of approximately 10 degrees C (50 degrees F).

If the characters landed in the gig, use the first paragraph in this nugget to describe what the PCs see as they make their way toward Depot. Then proceed to the next nugget.

If the team came down using landing kits, read both paragraphs and conduct the following tasks. Some scattering will result from the drop even though the team is equipped with grav belts. Since the drop pod containing the genas soft lands by means of parachute, its landing site will serve as the initial team assembly point.

To fly to the gena drop pod:

Routine, Grav Belt, Dex, 6 mins (safe)

**Referee:** This task is rolled by each individual. Use of navigation aids or radios reduces the difficulty to Simple (too much radio traffic may draw unwanted attention — see the next nugget). Failure indicates a minor injury such as colliding with the ground cover or brushing a tree.

To revive the genas:

Simple, Animal Handling, Edu, 30 secs.

**Referee:** One roll is made for each animal. A critical success cuts the time increment in half. A critical failure makes time increment 10 minutes versus 30 seconds.

Once up and about, the beaker can travel with one of the PCs. The nanshu has its own grav belt, which is slaved to one of the characters. Quick release fittings make it possible to take the belt off, or drop the gena to the ground, quite rapidly.

## 6. FIRST CONTACT

**The characters encounter an airborne Vargr patrol.**

**Location is on the surface of Depot.**

**Scene:** Huddling in the underbrush, the team holds its collective breath. The high pitched whine of the approaching air/raft grows in volume. Sneaking a peek, you see the mock tiger striped vehicle hurtle past, hugging the deck. Four armored figures are safely ensconced behind bolt-on ceramic plate. One in particular keeps a casual grip on a pintle mounted plasma gun.

**Action:** If the PCs have drawn attention to themselves or if the referee just wants to keep the players on their toes, this optional nugget can be used.

The Vargr patrol consists of one raider NCO and three troopers (Vargr raiders fulfill much the same function as the Domain Marines; they act as shipborne troops and guard ground installations). Each wears combat armor and is armed with a gauss or laser weapon. The air/raft is a standard open-topped model, (use the one listed in GDW's *Imperial Encyclopedia* as an example), and sports bolt-on armor, (add 2 to the vehicle's armor value), and a PGMP-12. The plasma gun is powered by a standard power pack bolted to the deck.

As long as the characters don't do anything rash, they'll go unnoticed. Otherwise, the Vargr will engage the PC(s) who have acted against them and call for reinforcements. Two additional air/rafts, outfitted as above, will arrive in 1D6x5 minutes.



Blair Reynolds



Statistics for the Vargr are as follows:

- **NCO:** UPP: 9A5768, Important Skills: Combat Rifleman-2, Infighting-1, Tactics-1.
- **Troopers:** UPP: 786555, Important Skills: Combat Rifleman-1. In addition, one trooper has Air/Raft-1 and one has Heavy Weapons-1.

Additional skill assignments can be made by the referee.

## 7. ARRIVAL

**The PCs arrive at the outskirts of the Depot complex.**

**Location is outside the main naval base on Depot.**

**Scene:** After a journey of countless weeks, your objective is in sight. From just behind the top of a slight rise in the terrain, the dirtside Depot complex stretches to the horizon. Grav vehicles can be seen flitting about and every once in a while a boat or small ship can be seen rising heavenward or falling to earth.

The age and character of the base shows in its architecture. There's the ponderous, centurie- old style common to all Imperial space governmental structures in the headquarters complex. The base housing stacks are of the dull chrome kind made popular in the last century. There are weathered temporary structures that have been in place for decades and heavily fortified buildings from the classic bunker school of design. You know from your briefings that the underground facilities are even more extensive.

You pick out the central R&D complex by referencing the map board sitting on your knee. Something strikes you as odd about the scene. Scanning carefully at high magnification reveals a partially fire-blackened and collapsed structure where the R&D building should be.

**Action:** The region around the base is protected out to the local horizon, 5 km., by a TAC fire point defense system. TAC fire creates a defensive umbrella stretching from ground level to a height of 100 kilometers above Depot, where other defensive systems take over. It uses energy weapons, missiles and hunter/killer warbots to defeat precision guided munitions, grav troops and grav vehicles.

Although theoretically the TAC fire defense is effective even at ground level, "ground clutter" and the lush, local vegetation renders the system ineffective below three meters. To make up for this lack, remote sensors have been emplaced in a clear zone surrounding the base (these must be dealt with by the PCs in the next scenario). The best course of action is for the team to land just over the horizon and approach the base on foot. Failure to do so will result in an investigation by an airborne patrol outfitted as per Nugget 6, but with two air/rafts.

This nugget closes out Scenario II and leaves the PCs with a few unanswered questions. What's happened to the R&D building and how will it affect the mission? Has the entire effort been a waste of time? There's only one way to find out and that's to break into Depot itself.

## Status of Depot

Depot/Corridor, built to support fifteen numbered fleets, was the old Imperium's single largest naval base. It housed literally thousands of military and civilian personnel and dependents. When the Corridor Fleet left, so did the bulk of the planet's population. Depot is currently home to approximately a thousand permanent human residents and an equal number of support staff left behind by the fleet. A comparable number of Vargr are also on-planet.

Out of this total there are perhaps two hundred ground troops although several hundred more could also be armed and pressed into service in an emergency. The remaining eight hundred Vargr support general corsair operations as repair techs, logistics personnel, and so on.

Because of the sheer size of the base, the Vargr can't effectively patrol the entire installation. Instead they rely heavily on the early warning network, the ships in orbit, and elite forces on the ground.

Other installations across the globe were used by the Imperium for planetary defense, secondary and tertiary command, control and communications, COACC and other purposes. Some are still used by the occupying corsairs, but the majority have had their functions automated by the Vargr or been closed down all together.

## SCENARIO III: DEPOT

### Summary of Nuggets

1. **Taking The Point (key):** The infiltration of Depot begins with the team's beaker scouting ahead.
2. **Out In the Open (key):** The team must pass through a sensor field where an unexpected surprise awaits.
3. **Back Alleys (key):** Possible encounters on the way to the lab building are discussed.
4. **Forward Observers:** Reconnaissance involving the genas is explored.
5. **Break In (key):** The PCs enter the R&D complex housing the deep radar lab.
6. **Patchwork (key):** In this random nugget, the PC computer specialist can examine Depot's computer network.
7. **On Shaky Ground (key):** Collapses and pitfalls at the R&D complex are dealt with in this nugget.
8. **The Lab (key):** The characters reach their objective: the deep radar lab.
9. **Uekdhuegh (key):** The PCs get a surprise visit from the Vargr counterintelligence chief.
10. **Breakout (key):** The characters fight their way toward the pick-up point.
11. **Remote Mayhem:** The commandos have an unusual encounter.
12. **Nellis (key):** The characters make inadvertent contact with DSS field agent Raul Nellis.
13. **Dropping The Net (key):** The team computer specialist must disable Depot's remaining defenses before retrieval can be accomplished.
14. **Dust Off (key):** Details involved with the team's departure from Depot are discussed.
15. **To The Wall (key):** With the Vargr in hot pursuit, the PCs attempt to escape the Depot system.

**1. TAKING THE POINT**

The beaker makes an initial reconnaissance of the outskirts of the Navy base.

Location is the outskirts of Depot on Depot.

**Scene:** It takes some concentration to both monitor the beaker's progress and remain aware of what's going on around you. The bobbing, weaving, knee-level image in the heads-up shows the cleared zone surrounding Depot as seen through eyes of the gena. It takes some practice to accurately interpret the

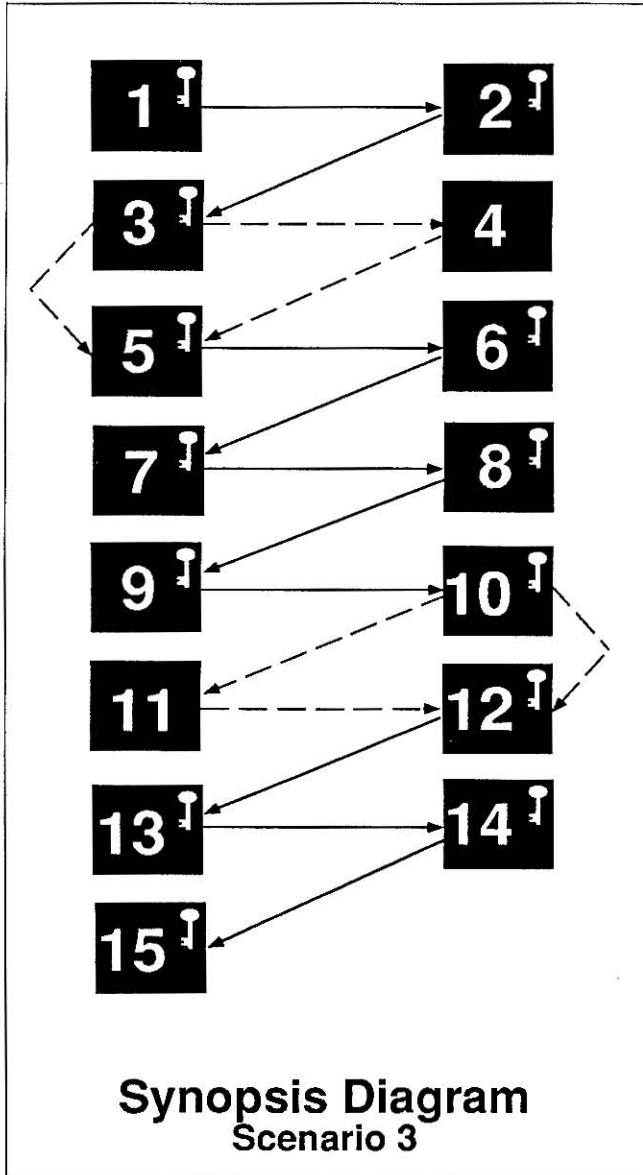

computer-generated monochrome picture, but you're able to take note of those points which help or hinder the team's progress when it's your turn to infiltrate.

**Action:** Surrounding the Depot is a 60 meter clear zone laced with remote ground sensors. The ground sensors are designed to make up for the TAC fire's inability to monitor activity closer to the ground. As the majority of them are noted in the technical readout the characters received on Atsah, the team should be able to chart a path through the zone with minimal difficulty. Fixer black boxes can negate those sensors which

can't be avoided.

The characters face a dilemma at this point. Having to cross sixty meters of open space while stopping to spoof the sensors obviously puts the team at risk of discovery. Two solutions, both involving the beaker, present themselves. The gena handler will be responsible for monitoring the creature's progress throughout the nugget.

The beaker is small enough not to trip an alert because the sensors are programmed to ignore any threat, mainly local lifeforms, below a certain size. The beaker can slip through the zone and insure the way is clear by scouting the general area for opposing forces. It can also be ordered to create a diversion or otherwise lead any Vargr it spots away from the infiltration point. Use Nugget 3 for suggestions as to specific encounters.

Alternately, the beaker can be tasked to go in and disable the sensors, thus clearing a path for the team. There are several drawbacks to this approach. If the gena is caught in the act, the Vargr may mistakenly think it's just some dumb local creature playing around and then again they might not. This is up to the referee to determine based on her interpretation of events and the demands of dramatic effect. Such an effort won't be helped by the fact that the beaker will have to carry a few tools and a Fixer to accomplish the task. Also, disabling the sensors instead of temporarily jamming them won't go unnoticed for too long before someone arrives to check out the system.

The following tasks are to be used to determine the beaker's success. They also apply to the PCs either in this nugget and/or the next.

To properly emplace and activate a Fixer:

Routine, Recon, Dex, 10 secs. (hazardous)

**Referee:** The black box can be left behind or removed once the sensor has been passed (roll the task again). Failure brings an airborne guard patrol, use the one from Scenario Two as an example, in 3D6 minutes.

If this task is being performed by the gena, it becomes a "To instruct" task. Replace the Recon skill above with an average of Recon and Animal Handling. Likewise, Dexterity is replaced by the Education of the animal handler PC. The character with the Recon skill must work with the animal handler in describing the procedure to the beaker. A critical task failure causes the sensor to sound an alert.

To instruct the beaker on how to disable a sensor:

Difficult, Avg(Animal Handling+Electronics), Edu, 30 secs. (hazardous)

**Referee:** Success means the gena will successfully clear a path for the characters. Failure indicates that the beaker has failed to understand the procedure and the task must be repeated. A critical failure means a sensor is tripped while the gena is in the process of disabling it. An airborne patrol will arrive as per the task above.

Unbeknownst to the commandos, Depot's new owners have sown a minefield in the cleared zone (in order to back up the ground sensors). Unless the beaker has been instructed to look for threats other than the sensors, this additional hazard will only be discovered by chance (roll the task below as desired). As with the sensors, the gena is too small to trip a mine.

To detect the presence of land mines via the gena link:

Difficult, Sensor Ops, Int, Instant (hazardous)

# IMPERIAL NAVAL DEPOT

Base Clear Zone  
(Remote Sensors and Mine Fields)

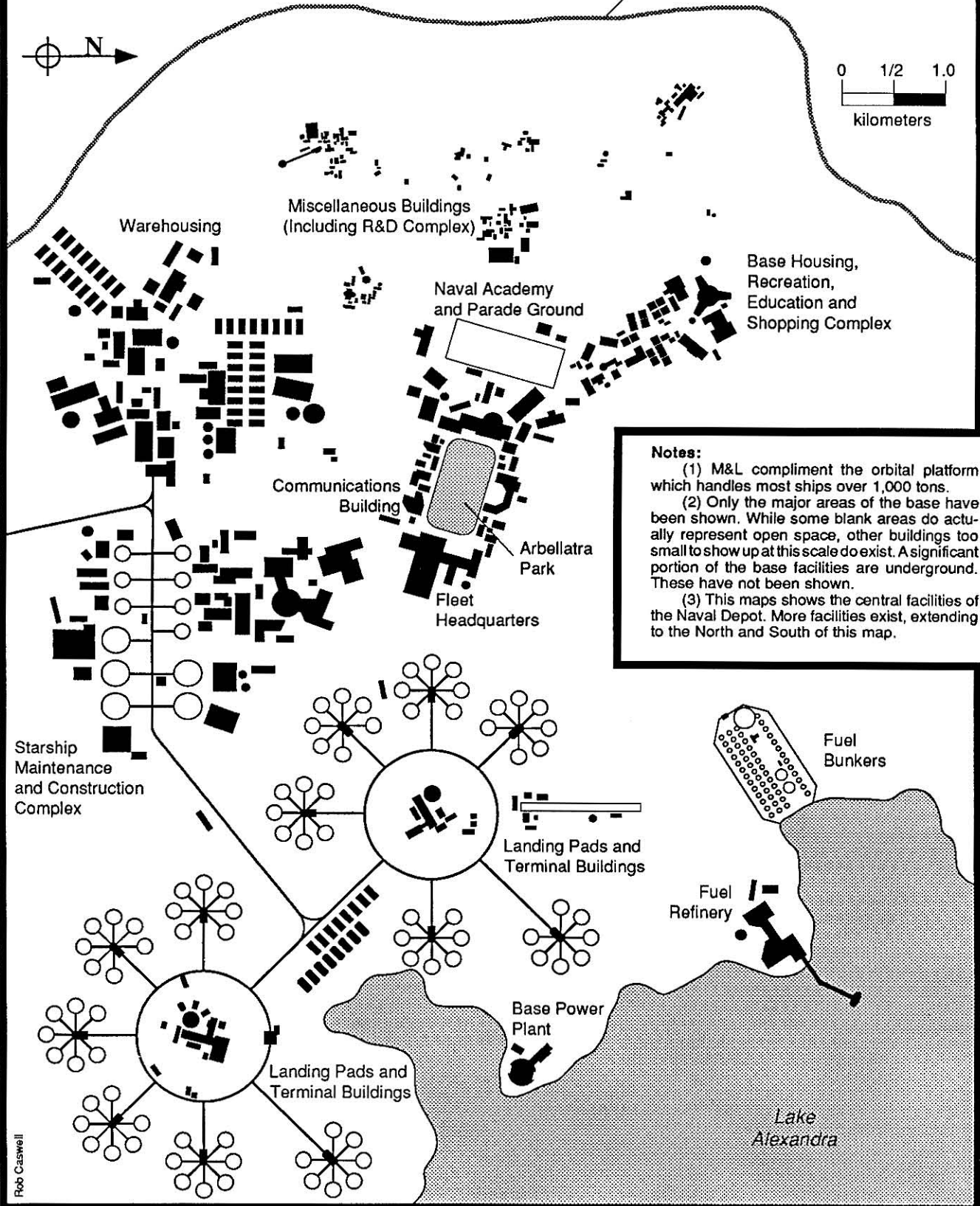
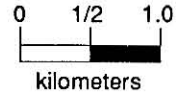

**Notes:**

(1) M&L compliment the orbital platform which handles most ships over 1,000 tons.

(2) Only the major areas of the base have been shown. While some blank areas do actually represent open space, other buildings too small to show up at this scale do exist. A significant portion of the base facilities are underground. These have not been shown.

(3) This maps shows the central facilities of the Naval Depot. More facilities exist, extending to the North and South of this map.

*Referee:* This task is rolled blind by the gena coordinator. Emplaced mines are markedly different from ground sensors in appearance, but remain difficult to detect via the visual feed from the beaker. On a failed roll, consult the damage chart in the next nugget.

## 2. OUT IN THE OPEN

**The PCs pass through the cleared zone at the edge of Depot. Location is the outskirts of Depot on Depot.**

**Scene:** The cleared zone has seemingly taken on the proportions of the Great Rift as the team proceeds in trail. It's slow going looking out for sensor pods that'll call down the Vargr on you. Suddenly, you freeze in your tracks. There's a small rise in the ground that doesn't look much like a ground sensor. It looks like something a lot more deadly.

**Action:** Use the sensor negation task from the nugget above as the characters infiltrate this part of the base. Once the characters are in the clear zone, they have a chance to detect the minefield, if it hasn't already been spotted.

To detect the presence of land mines:

Routine, Recon, Int, Instant (hazardous)

*Referee:* Emplaced mines are markedly different from ground sensors in appearance. On a failed roll, use 2D6 and consult the following chart.

- 1-9: The mine, which is equivalent to a TL13 hand grenade, explodes. See GDW's *Mega Traveller Player's Handbook* for grenade stats.
- 10-12: The mine is a dud. It's a poor copy of a Zhodani device not designed for Depot's specific environment.

Should a mine explode, a Vargr patrol will arrive in 4D6 minutes to check out the situation.

To avoid tripping a mine:

Routine, Recon or Stealth, Dex, Instant (hazardous)

*Referee:* Once the detection task above has been rolled, or a mine set off, the PCs will know what to look for. Use the chart from the mine detection task above in the event of a failed roll. A Fixer will not work against a land mine.

Impose several sensor avoidance tasks and a lesser number of mine avoidance tasks during the crossing. Don't forget that working one's way across sixty meters of open ground in hostile territory is nerve-wracking work (even if the beaker is performing a recon in advance). Be sure to transmit this feeling to the players.

## 3. BACK ALLEYS

**The team negotiates the outskirts of the Depot.**

**Location is near the R&D complex on Depot.**

**Scene:** Things are a little easier now that you've got some cover to work with. The team advances in standard formation: too far apart for a single grenade to take out everyone at once and close enough to provide mutual fire support. So far so good.

It occurs to you that the planet's new owners have not been keeping the place up. At least on this portion of the base, the imported, geneered greenswards are thick with weeds. An assortment of litter floats in the fitful breeze. Definitely not up to the noble standards of the Navy.

**Action:** The distance from the cleared zone to the R&D complex depends on where the PCs entered the base. Refer to

the map of Depot while tracing the characters' route to the R&D complex. Roll the following task as needed:

To avoid an encounter:

Routine, Recon or Stealth, Dex, Instant (hazardous)

*Referee:* Encounters can potentially jeopardize the mission or be no more than a nuisance. Suggestions include:

- Vargr corsair support personnel.
- Human technicians or laborers under Vargr supervision (use a rough three humans to one Vargr ratio).
- Robots. This includes guard, surveillance, or laborer models (see DGP's *101 Robots* for specific details on individual models or just ad lib).
- Vargr ground or airborne forces.

The motivations of those encountered will vary. Vargr noncombatants will run for help if unarmed. Humans, scared of Vargr retribution may sound an alarm, want to join the group thinking that the liberation of Depot is at hand or assist the PCs in any way they can. Robots will do whatever is most applicable to their function. Any unavowed encounter with armed forces results in the following task having to be rolled:

To break contact with Vargr patrols:

Routine, Stealth, Int, 30 secs.

*Referee:* Vargr ground forces have placed a great deal of confidence in the early warning net in space, hence the difficulty level of this task. If the task is failed, the patrol will attempt to pin down the PC group while calling in reinforcements. Further events are up to the referee to mediate.

Uekdhuegh's forces have been positioned near the lab building. If the characters are unable to avoid contact with one of his patrols, the Vargr will seemingly pursue the PCs before "losing" them. Their orders are to allow the commandos access to the R&D complex.

## 4. FORWARD OBSERVERS

**Further reconnaissance is performed by the genas.**

**Location is Depot.**

**Scene:** A monochrome landscape again fills your vision as you check in with the genas. The beaker has used a downspout to climb to the roof of a three story structure: staff offices for a long departed strike CruRon. Following your instructions, it's making a slow sweep of the horizon. The majority of the visible activity appears to be concentrated near the port, headquarters and the housing stacks.

A low, throaty growl causes you to switch channels to the feed from the nanshu. From a place of concealment, the gena has a G-carrier under surveillance. Six Vargr, including two hidden from view but detectable by their bioelectrical fields, are clustered around the vehicle which has one of its maintenance hatches open. Their heated debate reaches you through the nanshu's bone conduction mike. This is something to keep an eye on.

**Action:** This nugget should be used in conjunction with Nugget 3 above and highlights the role of the genas in the mission. As a note, the nanshu's electrical sense doesn't supply the gena with the visual images seen by the gena coordinator. These are created by the computer processor interpreting the signals from the animal. To the nanshu, the electrical sensing capability is no different than the senses of smell or hearing in the way they "feel".

**5. BREAK IN**

**The characters enter the R&D complex.**

**Location is the R&D complex on Depot.**

**Scene:** There's a large sign on the door of the R&D building before you that reads:

"WARNING: THIS BUILDING STRUCTURALLY UNSAFE. AUTHORIZED PERSONNEL ONLY. NO ADMITTANCE EXCEPT ON ORDERS OF THE BASE COMMANDER."

The strange characters below must be some sort of Vargr script, but you're not surprised you don't recognize it (after all, who knows how many alphabets the *doggies* use). Still it gives you little idea what happened here to cause the damage you saw earlier.

**Action:** During the Vargr invasion, an errant anti-ship missile plunged out of the sky and struck the R&D building. The resulting fire and blast collapsed part and weakened the rest of the complex. The Vargr have since declared the building a safety hazard and only officially-sanctioned technical/scrounger teams are permitted entrance (and then only on the first floor). This is one of the reasons the deep radar lab has never been examined by the Vargr save the counterintelligence chief, Uekdhuegh. It's also the reason the lab's self-destruct system failed to detonate.

The complex is a two story above-ground, one level below-ground, windowless structure housing the bulk of Depot's research and development activities. Doors to the facility are not unlike airlocks in order to maintain a more comfortable, standard atmospheric pressure inside.

The PCs will probably use a door to enter the building (entrance through the blast zone on the roof is also possible but highly dangerous). All of the doors to the building are alarmed as much for safety as for security reasons. They are also locked electronically.

To check an external door for alarms:

Routine, Intrusion, Int, Instant (hazardous)

**Referee:** Uekdhuegh has seen to it that the alarms have been rerouted to his personal command center only.

To negate the alarm and open a door:

Difficult, Intrusion or Electronics, Dex, 30 secs.

**Referee:** A Lockpick black box or the Ichiban Model 117 is required in this task.

To enter through the roof:

Formidable, Dex, Int, 10 mins. (hazardous)

**Referee:** Because of the damage done to the roof, further collapse is highly likely. A failure causes the PC to fall to the next floor, taking 2D damage in the process.

Most of the damage from the missile is located toward the center of the building although there's also a certain amount of collateral damage. Initially the team's progress should be unimpeded by obstacles. Such amenities as power and lighting will vary in different parts of the building according to the mood and environment the referee wants to create. Internal building damage can be treated the same way.

If the PCs insist on exploring along the way to the lab, use modified versions of the tasks presented above for the external doors. Internal doors are locked on a roll of 8+ and lock and

alarmed on a roll of 10+ (the alarms don't work, but the wiring remains in place). Other than possibly finding a serviceable computer port to interface with, there's little of interest to be found.

**6. PATCHWORK**

**The team computer specialist examines the local computer net structure.**

**Location is the R&D complex on Depot.**

**Scene:** The Ichiban rests next to a dead workstation. Its lid/display has been flipped up and multicolored characters fill the screen. Your computer expert is tapping away at the keys preparing programs. A length of optic cable reels away toward an open panel in the wall. Somewhere down the maintenance trunk, the beaker is at work splicing new fiber into the local computer services grid.

**Action:** The events in this nugget can be run at any time up to and including Nugget 8, "The Lab".

In all probability, the player running the PC computer specialist will be itching to get a crack at Depot's computer network. It should be a simple matter to locate a data port in an office or at a lab workstation. The radar lab also has several.

To tie into a local data port:

Difficulty, Electronics, Dex, 1 min.

**Referee:** The task is as simple as plugging into an operative port or as difficult as having to find the right fiber optic line to splice into. (The proper tools to do this have already been included as

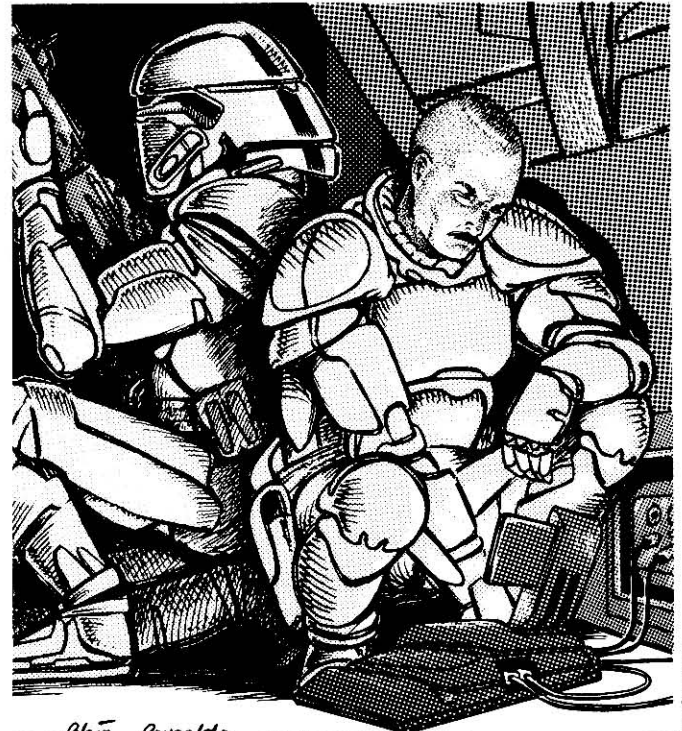

Blair Reynolds

part of the team's equipment). Use the above scene as an example of the latter. This can also serve to get the beaker and animal handler PC involved. (In which case turn the task into a cooperative venture between team members).





To avoid network security:

Difficult, Computer, Int, 1 min. (hazardous)

# RAND D

## COMPLEX FLOORPLAN

### Symbol Key

-  Sliding Door
-  Elevator
-  Stairwell
-  Missile Impact Point
-  Self Destruct Floor Panel

### Ground/Second Floor

Note: Ground floor and second floor have identical layouts. Refer to keys below for specific component differences.

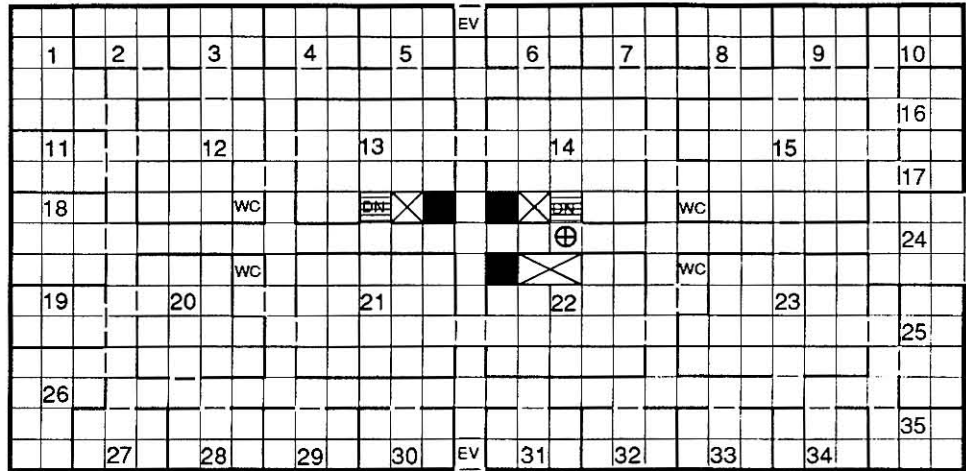

Scale: One square is three meters on a side.

### Special Abbreviations

EV: Environmental Airlock  
WC: Water Closet

Special Projects Lab



### Basement

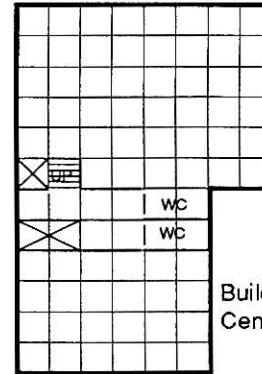

Missile damage to the building is as follows:

- Second Floor: Building collapsed within 20 meters of point of impact. This floor is structurally unsafe/unstable for an additional 20 meters beyond that.
- Ground Floor: Building collapsed within 10 meters of point of impact. Structurally unsafe/unstable 5 meters beyond that.

### Ground Floor

1. Technical Library
- 2-5. Various Offices
6. Lunch Room/Vending Area
7. Calibration Lab
- 8-10. Various Offices
11. Mail Room
12. General Lab Space
13. Electronic Fabrication Facility
14. Mechanical Fabrication Facility
15. Prototype Test Facility (2 floors)
16. Supply Storage
17. Supply Office
18. Robotic Repair Station
19. Robot Storage
20. Equipment Repair Shop
21. Physics Lab
22. AnalysisLab
23. EM Studies Lab
24. Loading Dock (with air lock)
25. Message Center
26. Security Monitoring Room
- 27-31. Various Offices
32. Storage
- 33-34. Various Offices
35. Medical Station

### Second Floor

1. Mid Level Administration Office
- 2-5. Various Offices
6. Lunch Room/Vending Area
7. Computer Support/Memory for #15
- 8-10. Various Offices
11. Mail Room
12. Office Space
13. CAD Center
14. Holo Demonstration/Simulation Facility
15. Prototype Test Facility (2 floors)
16. Office
17. Office
18. Robotic Operations Office
19. Robot Storage
20. Procurement Office
21. Conference Room
22. (renovation)
23. Meson Comm. Modeling Facility
24. Office (without airlock)
25. Security Monitoring Room
26. High Level Administration Offices
- 27-31. Various Offices
32. Storage
- 33-34. Various Offices
35. Office

**Referee:** Task failure means the character has alerted an access watchdog program at the main computer complex several kilometers away. A patrol will be dispatched to the R&D building on a roll of 9+ to investigate. Otherwise the notification will be treated as a glitch in the system and ignored.

To discover an item of useful information:

Routine, Computer, Int, 2 min.

**Referee:** A critical success is required to find a particularly useful file or program. See below for examples.

Like any installation built by a high tech civilization, computers play a vital role in every day life on Depot. (This is why commando teams include computer specialists). When Depot was invaded, many parts of the planetwide computer net were either damaged or destroyed. To make up for lost computing power, various computers are now being used by the Vargr for purposes they were never intended. As a result, network security has badly degraded and all sorts of useful files and programs can be found if one is willing to spend some time looking. Two examples of what the characters might be able to access are listed below.

- Local space traffic control files. The files contain the combined outputs of every ground and spaced based sensor watching local space. By editing these files, ships can be made to seemingly appear or disappear. Target selection for the planet's meson batteries is based on the contents of this file.

- Communications data net. Access is available to Depot's electronic mail system which can be used to send text only messages. Fortunately for the PCs, it's also used as a back up comm system by the Vargr. By inserting bogus messages, the team can try to send the Vargr on a wild goose chase.

The implications of these two examples should be obvious and can provide the characters with a means to disrupt Depot sufficiently in order to escape later in the scenario. In addition, by using the special virus programs contained in the Ichiban, the PCs can disrupt selected portions of the net by editing, altering or erasing files and programs.

To "tune" a virus program:

Routine, Computer, Edu, 1 min.

**Referee:** This task is required to adapt a generic virus program to a specific purpose and system. The PC is required to explain to the referee what the virus is targeted at and what the desired result is. The ref then interprets that explanation and implements the results. Task failure results in the virus doing something wholly unexpected or nothing at all.

There are limits to the Vargr's reliance on the computer. For example, items such as fire control for the meson batteries, the central and back up fusion plants and so on each have their own control computers and are not tied into the net. The idea here is to provide the PCs with a diversion, not utterly overwhelm the Vargr.

Keep the players focused on the PCs attaining the lab, if they haven't made it there yet, and do not let them get too bogged down with the computer net at this point.

## 7. ON SHAKY GROUND

**The PCs must traverse the damaged sections of the R&D complex.**

**Location is the R&D complex on Depot.**

**Scene:** An "I" beam half your height plunges through the

ceiling and into what's left of the floor. Ragged cabling and sheared off conduit dangle over the abyss. You've got about half a meter of ledge to use to get around the three meter hole.

**Action:** As the characters get deeper into the complex, they'll encounter more damage from the missile explosion. Early incidents should be no more than creaky floors and falling bits of masonry. Later on it becomes missing or collapsed floors and ceilings. Have the players roll the following tasks as desired.

To spot an unstable area:

Routine, Int, Instant

**Referee:** The task should be rolled blind unless the PC is actively searching. Roll 1D6: 1-3 indicates an unstable floor, 4-6 an unstable ceiling.

To avoid an unstable area:

Routine, Dex, 1 min. (hazardous)

**Referee:** Failure results in a 1D injury from falling or crushing damage. Determine whether it's the floor or ceiling from the spotting task. A rescue operation may need to be undertaken to recover the unlucky character.

In addition, the character who failed the task may cause additional damage which blocks the passage (8+ to occur). This requires the PCs to bypass the new obstruction.

## 8. THE LAB

**The PCs reach the deep radar lab.**

**Location is the deep radar lab on Depot.**

**Scene:** The stairwell opens onto a small vestibule outside the lab. There's not much to see in the dim blue-green glow of the still functioning emergency lights. A pair of sealed, unmarked three meter high armored alloy doors face you. The fine layer of dust that coats the floor as well as the cracks in the walls stand in silent testimony to whatever force hit the building.

**Action:** Access to the deep radar lab is accomplished via a single stairwell. Next to it is a no longer functional lift shaft. (It's blocked about halfway down). The stairs themselves are intact and wholly useable. The vestibule is as described in the scene above. If the characters wish to take a look in the lift shaft, have them roll the "to force the door" task listed below but at a Routine difficulty. The only thing they'll find is the lift car.

The doors to the lab remain functional although slight warping of the door frame will mean additional work to get them open. The doors are listed as being alarmed in the technical readout on Depot, but a quick check will reveal that it's no longer working. (This is due to missile damage and not Vargr intervention).

To open the door:

Difficult, Intrusion or Electronics, Dex, 30 secs.

**Referee:** This task requires the use of a Lockpick or the Ichiban computer. At most the door will open a quarter meter before the motor burns out with a loud electrical buzz.

To force the lab doors open:

Difficult, Str, Instant

**Referee:** The total strength applied to the door divided by 8, rounding down, is the task DM. A maximum of four PCs may participate in any one attempt.

At this juncture refer to the lab map and let the characters have at it. Items of interest in the lab include:

- Computer Workstations. Radar operation, calibration and

testing were done at these stations. Many of the lab's computers are functional but the memory banks have been partially wiped clean. (Insufficient data remains to rebuild the radar although it does provide some valuable insights). Several computer ports are located at the workstations and remain active on a roll of 8+.

- **Main Equipment Racks.** This room contains the three key as well as other vital, components. All of the components look virtually identical. Each is bolted into a rack and still connected into the overall radar system. The door to the room will move freely but jam solid after sliding a quarter of a meter. If the PCs think of it, the beaker can get in, unhook the components and pull them out. The door has an armor rating of 25.

- **Self Destruct System.** The shock of the missile strike caused the primary timer on the self destruct system to fail. A back up chemical decay timer is still functional. Once the prominent safety handle is pulled, demolitions charges capable of bringing down the building are activated. They will go off in fifteen minutes and once started, can't be stopped. Explicit instructions and warnings regarding the system are printed on the inside of the floor access hatch.

- **Structural Damage.** Although certain parts of the ceilings and walls have crumbled, the lab is basically stable.

If the characters plan on using the computer net as a means to escape Depot, it's best if they act now before the next nugget. Refer to the relevant tasks in Nugget 6 as required.

### 9. UEKDHUEGH

The Vargr counterintelligence chief Uekdhuegh confronts the characters.

**Location is the R&D complex on Depot.**

**Scene:** Even though you've secured your objective, it's no time to relax. Hopefully things will stay quiet on the way out. As you proceed through the darkened, damaged corridors of the building, an indicator begins to flash in your heads-up display. The visual feed from the nanshu scouting ahead overlays the hall before you. The way before the gena appears clear. That is except for the artificially generated, softly glowing forms hoping to conceal themselves in the rooms around you.

The stillness of the hallway is shattered by a guttural, heavily accented voice speaking Anglic. The accent is that of a Vargr tongue. "I am Uekdhuegh of the Aek Aeg," says the voice with no small amount of pride. "Turn over the deep radar to me and I might just spare your lives". Less than a beat later the Vargr snarls again. "Then again, I might not".

So much for a quiet exit.

**Action:** Accompanying Uekdhuegh to the complex are several teams of his best raiders; individuals who've been loyal

to him since his days as a corsair leader in Provence. The exact number of raiders in any one team should be about equal to or a little smaller than the character group. Each has been issued cloth armor and carries either a gauss or laser weapon. At least half have a few grenades. Uekdhuegh is dressed the same as his troops, but carries an SMG and auto pistol instead of a rifle. All are equipped with radios. Only one team is currently with their leader, the rest are spread throughout the building.

Uekdhuegh will demand the deep radar components thinking that they comprise the entire system. He of course has no intention of letting the characters walk out alive no matter what he might say. Where the ambush occurs is up to the referee to decide but should be somewhere near the stairwell leading to the lab. It will be sprung once the main body of the party is surrounded, an event which will not come to pass due to the nanshu's special sense.

The Vargr chief has never seen a nanshu before and is not aware of its capabilities, although he can draw some obvious conclusions by looking at it. This should tip the balance in favor of the commandos. The creature's electrical sense will largely nullify the element of surprise for the opposing force and permit the PCs to form a counter strategy. In a similar vein, the beaker can either go unnoticed or be discounted as a serious threat. Its potential for creating diversions should not be discounted.

In the end, the characters should gain the upper hand. Ultimately, Uekdhuegh and what's left of his group decide on a "tactical withdrawal". The characters are free to pursue or simply quit the building and get back to *Muse*.

One factor might change their minds about the latter course of action. The Vargr leader can be heard shouting into his radio for reinforcements, but he's apparently getting no response. (The building is shielding his signal). Stopping him before he gets a response is probably a good idea.

**10. BREAKOUT**  
The PCs fight their way out of the lab and toward the designated retrieval point.  
**Location is Depot.**

### 10. BREAKOUT

The PCs fight their way out of the lab and toward the designated retrieval point.

**Location is Depot.**

**Scene:** The dark hallway is lit with brilliant tracer fire. Running it back, you take out the Vargr who pulled the trigger with a few carefully placed bursts. Sudden screams to your right mark new victims of the nanshu's slashing claws, while to the rear there's the soft thump of a grenade going off. It's followed by a cacophony of tumbling ferrocrete as more of the complex gives way.

**Action:** Starting with this nugget and continuing through the end of the scenario, events should move quickly. Set a fast pace

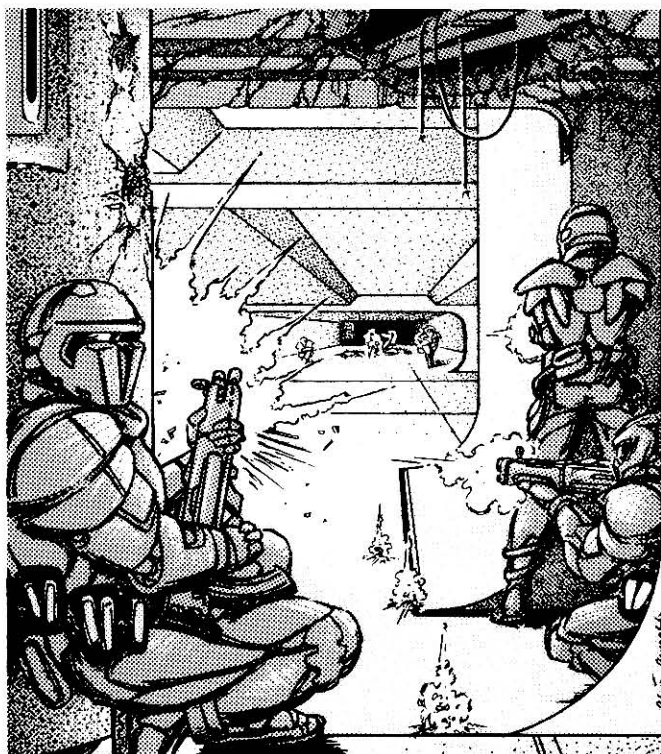

Blair Reynolds



and stick to it, possibly foregoing some dice rolls in the process for the sake of expediency.

Initial opposition will be small groups of Uekdhuegh's troops in the R&D building itself. Each squad should number no more than the character group and is outfitted as per the nugget above. Use the damaged condition of the building to help or hinder the PCs as appropriate.

Uekdhuegh will attempt to again ambush the characters and seize the radar components in a place of his choosing. Failing this, he'll retreat further and possibly try again. This is combat on a very personal level; a kind of grudge match. Uekdhuegh is very used to getting what he wants and will be enraged that the PCs have foiled his plans and put his charisma at risk. He'll even go so far as to yell threats or taunt the characters. Also consider that eliminating the Aek Aeg chief can make for a very satisfying facet of this scenario.

Outside the building opposition becomes more intense as other ground forces join Uekdhuegh's surviving troops. (They are outfitted as per the airborne patrol in Scenario II). Their increased numbers are mitigated by the fact that Depot is in chaos. Due to the PCs tampering with the computer net, or whatever other havoc they have wrought, Vargr command and control is in disarray but quickly sorting itself out. This will end the first time a Buzzbomb is used, after which the Vargr will go into panic mode assuming a major invasion is underway. (The PCs must remember that they're under orders to keep major damage to a minimum).

Don't overwhelm the characters but don't let them waltz right out either. The PCs best hope for survival is to keep moving and get to the rendezvous point in time to make retrieval.

Finally, the characters will also be assisted indirectly by some of the humans who remain on-planet. They've decided to take advantage of the chaos to strike at the occupation forces. While this is only a minor problem for the Vargr to deal with, it will draw some forces away from pursuit of the commandos.

## 11. REMOTE MAYHEM

**The characters have an unusual encounter.**

**Location is Depot.**

**Scene:** It's one of those rare moments when no one's in direct pursuit of you. Pausing to get your bearings, you flatten at the sound of gunfire. Eyes and weapon moving in unison, you turn knowing your back is covered. You're brought up short by the gun metal grey sphere floating two meters off the ground several hundred meters away. It lets off a string of staccato reports and then flashes away.

**Action:** The one meter metal sphere is an Domain Marine robot called a "Noisemaker". The grav propelled device employs radio jammers, smoke charges and a sound effects generator firing blank cartridges to deceive and unnerve an enemy on the battlefield.

To identify the Noisemaker:

Routine, Exp, Instant

**Referee:** The robot was never adopted by the IISS or DSS, so it may not be readily identifiable to the PCs.

To analyze the robots actions:

Routine, Tactics, Edu, Instant

**Referee:** On a successful task roll, the PC realizes that the Noisemaker isn't directed against the team, but rather the Vargr. The question then becomes, who loosed the Noisemaker against the Vargr?

This nugget can either be presented as a mystery with no apparent answer or as a lead in to the introduction of Raul Nellis in the next nugget.

## 12. NELLIS

**The PCs encounter IISS field agent Raul Nellis.**

**Location is Depot.**

**Scene:** You spot the three Vargr as they jump out of concealment and level their rifles in your direction. A distant part of your mind realizes that no one's in a position to take them out before they savage the team.

Then there's the sound of concentrated gunfire, but it's not coming from your team nor the Vargr, who are now sprawled on the ground. A figure replete with flak jacket and combat shotgun appears and waves you toward an open storage building.

"You'll never know how glad I am to see you", says the man as he guides you inside. Suddenly you realize there are three more individuals, all wearing well-worn Marine issue, bringing up the rear.

**Action:** The mysterious newcomers are Scout field agent Raul Nellis and three Domain Marines. Speaking quickly, Nellis relates the following story.

After the Vargr invaded Depot, a small group of humans, including a few Marines, fled the base for an emergency bunker in the countryside. They hoped to wait until the Imperium arrived to reclaim the base, but of course this never happened. Over time, with the Marines acting as instructors, they forged themselves into a small but determined resistance organization. Taking care never to become too much of a threat, lest they be exterminated, they've long been an annoyance to the Vargr.

A few months ago, one of the Marines managed to signal an DSS reconnaissance ship using a secure military burst transmitter. Nellis was aboard at the time and decided to try and make contact with the group. His individual reentry was flawless and he quickly located the resistance. Unfortunately, the field agent underestimated the Vargr defenses. His ship was unable to make pick up and he's been stranded on Depot for the last couple of months.

The resistance has gathered a great deal of valuable information regarding Vargr operations on Depot. Nellis was participating in one of their recon missions when the shooting started. By chance he happened onto the characters and now has his ticket home; he asks to be extracted along with the characters' team. Before he leaves, Nellis will arrange for the Marines to burst transmit all the data they've accumulated over the years to the gig or *Muse*.

Raul Nellis is familiar with the area and can act as an interface to the resistance. (For example, he could request that the resistance provide a diversion or loan the team the Noisemaker seen in the nugget above). He can also help locate an interface to the computer net if the team had insufficient time earlier to do so. Like Nemo Stark in Scenario I, Nellis can be a source of information and assistance where necessary.

If individual resistance members are needed, use the Quick NPC table in the *Referee's Manual* to generate them.

### The Human Resistance

Throughout Corridor there are bands of humans opposing the Vargr occupation. Some are militant guerrilla organizations like that of the "late" former sector Duke Rehman. Some are slowing picking away at the Vargr or simply biding their time while stockpiling the materiel needed to one day rise up against the occupation. Others have allied themselves with Deneb or Vland in hopes that they'll come to the aid of the resistance in the future. By the look of things, they may all be in for a long wait.

### 13. DROPPING THE NET

**The team computer specialist must clear the way for the landing of the gig.**

**Location is Depot.**

**Scene:** The gunfire has seemingly faded in the distance as all your attention focuses on your work to the exclusion of all else. The rest of the team is keeping the barkers at bay while you type furiously on the Ichiban's keyboard. In just a few moments, you'll release a virus which will make the ones used earlier look like a slight case of the sniffles.

**Action:** To insure the safe approach of the gig, the PC computer specialist needs to get into what remains of Depot's computer network and "finish things off" by taking out any remaining defensive systems. (If not the whole net).

To locate a computer port:

Routine, Det, 1 min.

**Referee:** This task requires that the characters search inside one or more buildings.

Refer to the nugget "Patchwork" for the "To overcome network security" and "To tune a virus program" tasks which must next be implemented. As the characters' escape from Depot hinges on this nugget, it should be executed in an appropriately dramatic manner.

### 14. DUST OFF

**The characters are retrieved from Depot.**

**Location is Depot.**

**Scene:** The ground heaves under you from the sustained impact of heavy weapons fire. A grav fighter flying nap of the earth is swinging round for another pass. Just as it's about to unleash its guns yet again, a streak of light reaches out and touches the garishly painted dart. There's a sharp crack and the fighter is pinwheeling through the sky in flames. With a horrendous roar, gig drops to the ground in front of you, executing a brutal six gee braking maneuver in the process. The tail ramp drops to the ground as the chin mounted plasma gun lays down a withering field of suppressive fire.

**Action:** Just as with Nugget 10 above, keep this part of the adventure fast and furious. If the characters don't look like they'll make it to the pick up point, have the gig come to meet them. Once the characters and Nellis are aboard, further events are largely out of their hands. (Unless the gig is hit and a PC has to crew in a pinch).

Initially the gig can rely on its EM mask and EMSJammerto evade pursuit, but this won't last forever. Eventually, the Vargr will spot the boat visually and try for an intercept from there. Run whatever ship combat seems appropriate to heighten the adventure.

The nugget ends with the gig being taken aboard *Muse* while on the fly.

### 15. TO THE WALL

**Thundering Muse leaves the Depot system while under fire.**

**Location is the Depot system.**

**Scene:** You can feel the muted roar of the engines they drive *Muse* at over three gees. Standing next to the holo tank, you listen in on the bridge crew at work.

"Three ships still in pursuit Captain," reports the sensor operator. "Remaining ships have either fallen behind or jumped". In the holotank, a Vargr scout glows brightly for a second before slipping into jumpspace. "There goes another one".

"They're trying to get out ahead of us," replies Khagii. "We can expect a hot reception wherever we go".

"Missile launch detection, a spread from the corsairs trailing us. Estimated impact: 120 seconds".

There's no noticeable change in Khagii as she speaks. She pauses a moment before continuing on in a voice one might use to describe the weather. "Eighty seconds to jump. Which leaves us a whole forty seconds to play with. All right folks get ready, I'm about to stand this baby on her tail".

**Action:** Once aboard *Muse*, the characters, if physically able, will be assigned to damage control duty. Those with starship skills might instead be ordered to assist the regular crew.

At this point *Muse* has been identified and the Vargr aren't far behind. Finesse goes out the window in favor of just getting out of the system as quickly as possible. There are a few obstacles to overcome first though.

As *Thundering Muse* races for jump point, it will first come under attack from the *Aek Naz* and *Foghok*-class cruisers in orbit. They don't have nearly enough speed to pursue the Scout ship, but they'll fire off everything they've got in hopes of scoring a lucky hit. After that comes several *Ueknou*-class corsairs. The 400-ton ships will be able to keep up with *Muse*, turning the flight outsystem into a running gun battle.

Ship to ship combat can be played out or dealt with abstractly at the referee's discretion. Realistically *Muse* can expect to take some hits; a good source of emergency repair tasks for the PCs in their role as damage control coordinators.

As *Muse* finally nears the 100 diameter limit, Vargr ships will be spotted jumping outsystem. The Vaenggvae leadership on Depot is sending out an "all points bulletin" to the surrounding systems to intercept *Muse*. The commando raid has been an embarrassment to the Vaenggvae's leaders and with their charisma on the line, they want the PCs bad.

This nugget ends the adventure. Upon the team's return to Atsah, they'll be given a warm welcome by both Nemo Stark and Archduke Norris, who has been anxiously awaiting the outcome of the mission. The characters can expect to receive hefty performance bonuses and extended leaves. The last is awarded if the individual PC isn't returning to "retirement" (and have you ever known a traveller to really retire?). Stark will probably keep the characters in mind for future operations as well. Of course the details of the mission are classified since it never officially happened.

Finally, special note will also be taken of the information brought back from Depot, that data gathered by the resistance, as well as the existence of that organization. DSS Intelligence will no doubt find both items quite interesting.

The Vaenggvae will spend the next few months realigning their organization as individual leaders fall from grace and new "top dogs" are installed. During this time, DSS Intelligence will find its job somewhat easier. (Especially if Uekdhuegh was killed during the adventure). Refer to the DIS News column elsewhere for additional ramifications of Operation Rapid Repo.

Finally, the Domain of Deneb is in possession of what remains of the deep radar project. In a few years it will have a working prototype but there's no telling when a practical model will ever be completed. Still, the characters can take pride in a job well done.

If the players are interested, this nugget can also signal the beginning of a campaign centered around the team's return to Deneb. Consider that the characters are on a possibly damaged

ship soon to be wanted by every Vargr within several parsecs. They may need to find a safe port to put into for repairs. This might mean a visit to the nearest covert DSS Intelligence base or, alternatively, Raul Nellis can be particularly helpful in contacting a human resistance organization for assistance. His experience as a Scout liaison to such groups will prove invaluable in this case.

If a plausible means exists, you may want to bring Uekdhuegh back to further bedevil the characters; elevating him to the ranks of a classic villain as he chases the PCs all the way back to the Domain in his quest for revenge. The rest is up to you. •

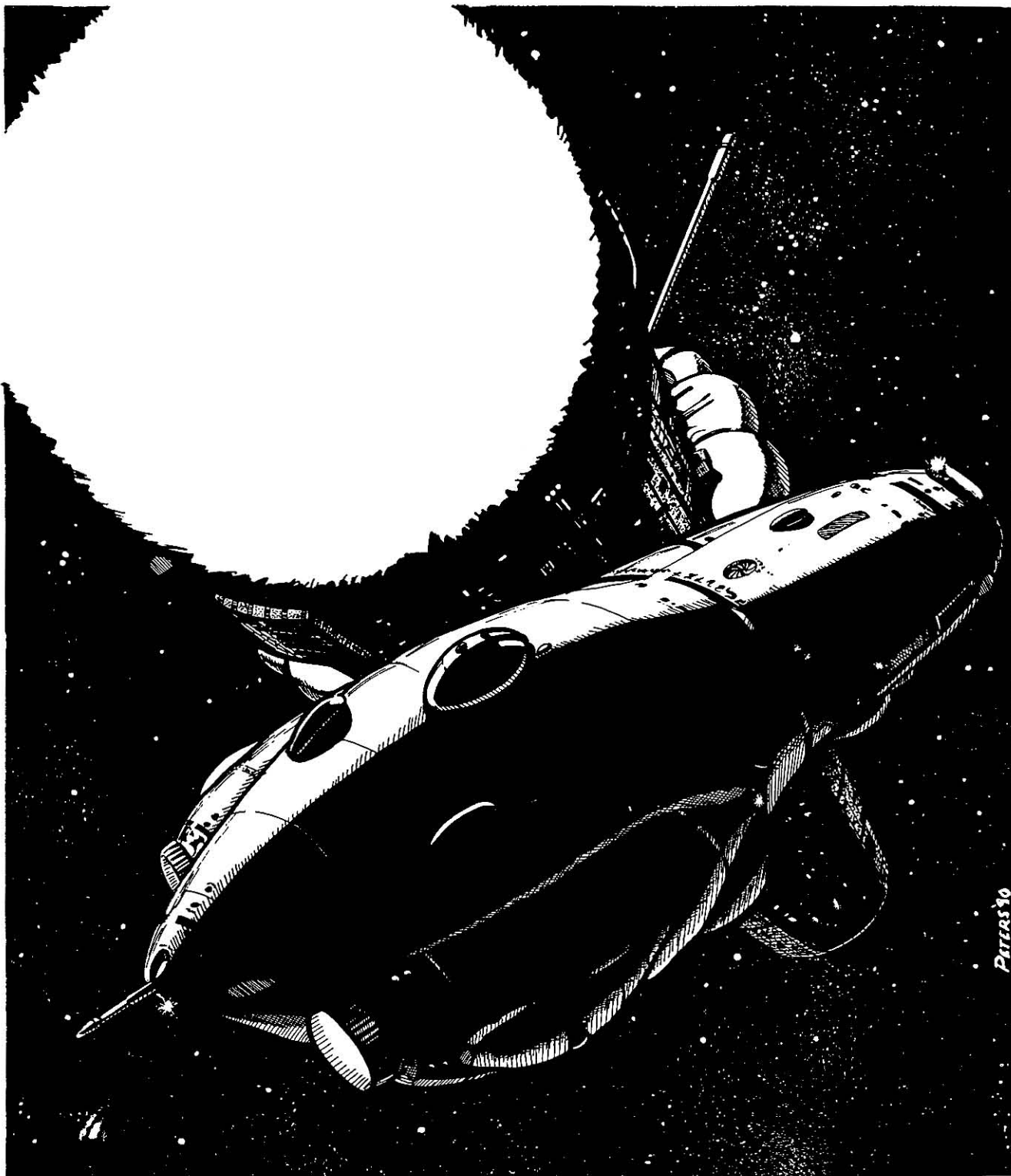

# JONKEEREEN

**RACES OF THE DOMAIN:** By James Maliszewski, Deb Zeigler, and Jay Adan

"One does not *think* of being Jonkeereen, one simply is."  
- Statement by the Jonkeerin taji, Didaree, to researchers at the Jonkeer IISS base (1105)

Human geneering (genetic engineering) techniques have a long ancestry. The first substantive efforts at genetically altering human beings occurred during the Solomani-Vilani Interstellar Wars, millennia ago. Those early experiments were not entirely successful and few examples of those altered species survive today. During the Long Night, human geneering projects were all but abandoned.

Centuries later, the Third Imperium began to delve into geneering. Though Imperial attitudes were very wary of altering the human genome, several different projects were begun under the Imperial Ministry of Colonization. Their goal was to produce human colonists suited for environments which would otherwise seem inhospitable. One of the most successful of these projects was the Jonkeereen.

The Jonkeereen are perfectly suited for survival in a desert environment. Over 400 million Jonkeereen inhabit Jonkeer (Deneb 1324 C4908C9-9) alone and millions more live on desert worlds throughout the Domain of Deneb and beyond. The following information relates mainly to the nomadic Jonkeereen dwelling on Jonkeer as they make up the largest — if least seen — portion of this race.

## THE ORIGINS OF THE JONKEEREEN

The original design plan for the Jonkeereen called for the geneering of a race of humans optimized for survival in a harsh, desert environment. This new race was to be seeded on a desert planet in order to colonize it and eventually become another loyal, well-populated world of the Imperium. The target world for this plan, however, was not Jonkeer, but another desert planet, Hillalladi (Gushemege 2438).

Back in the early 500s, Hillalladi was virtually untouched by any sentient species — and deservedly so. With surface temperatures ranging up to 45 °C in summer, no surface water to be found in any significant quantities, and desert extending from horizon to horizon, Hillalladi was a hellish world that no one was interested in, even though it was technically "habitable" by human standards (just not comfortably so). The Suerrat, however, in looking for new worlds to expand onto, discovered Hillalladi possessed some particularly rich mineral deposits as well as some botanicals with unusual medicinal properties. With so very few worlds still available to Suerrat colonization, Hillalladi seemed one of the last opportunities for the Suerrat to settle a new, habitable world. Thus, they began an extensive colonization effort on that world. Things progressed slowly, however, mostly due to the fact that the Suerrat, having evolved in a cool, arboreal environment, were even less fit, than most human varieties, for such an extremely arid environment.

At this time, the Imperium was trying to limit Suerrat expansion. There had been repeated trouble in the past with the Suerrat, but the Imperium didn't want to risk outright military conflict to keep the Suerrat under control. Strategically-speak-

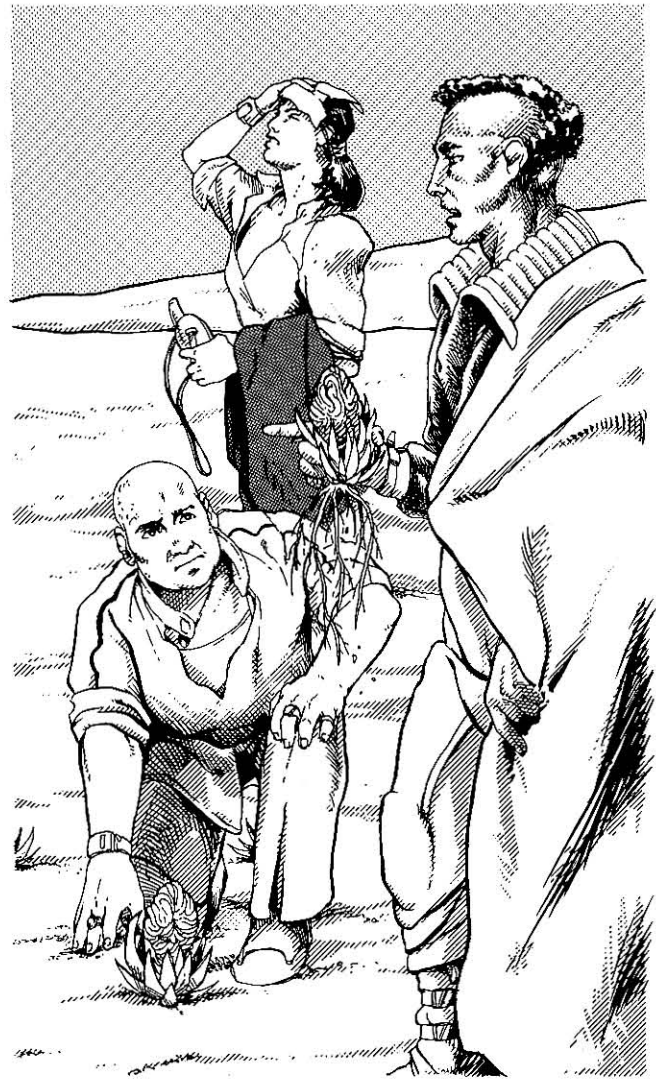

ing, Hillalladi was nothing to the Imperium. However, as an opportunity to squelch Suerrat expansion and to diminish their racial pride, Hillalladi offered an interesting opportunity.

A plan was hatched by General Emil Shusalani, a close associate of the Emperor's, to out-colonize the Suerrat on Hillalladi. With human geneering experiments a hot research topic in the Imperium at that time, the plan was to create a human race optimized for life on Hillalladi, seed them on that planet, and let them breed and expand the population as fast as they could. The Suerrat, overwhelmed by the better-adapted competition, would be driven off Hillalladi in the process, losing both their newly-claimed world and a good amount of their pride.

This geneering and colonization plan had quite a number of

Imperial supporters for a variety of reasons. The military saw this newly-geneered race as a perfect chance to get desert-optimized troops. SuSAG thought members of this new race might be ideal for them to hire as security personnel at SuSAG's desert world research installations. The leaders at the Ministry of Colonization loved the idea since it would open up previously inhospitable worlds to loyal Imperial colonization efforts. The scientific community saw it as a wonderful scientific and technical challenge. All in all, when proposed, the whole plan was quite popular with Imperial leaders, and was given quick approval and funding.

Duke Simon von Leung of Deneb, anxious to see the financing for this plan spent in his region, used his extensive influence to have the base of operations for the project located in his sector. Jonkeereen, with its similarities to Hillalladi, was thus selected as the initial "test-bed" for the newly-designed race. If they could survive and flourish on Jonkeereen, building up a sizeable population quickly enough, this desert race would then be sent on to Hillalladi to colonize that world, and crowd the Suerrat off it.

The geneering work progressed surprisingly well, and by the mid-500s, the first members of the new desert race were approaching maturity. By 600, the first groups of Jonkeereen settled in at the test-sites on Jonkeer and proved themselves up to the challenge of living and thriving there. Shortly after the first Jonkeereen settlements proved viable, however, the Suerrat, who, over the years, had been struggling with great difficulties in their own efforts on Hillalladi, finally abandoned the idea of permanent settlements there.

The main reason behind the Jonkeereen race's design had now disappeared. Many of those in the Imperial government who were behind the whole project had gone by now. Human geneering was no longer the hot research topic it once was. In the meantime, the military had developed new technological means to the problems of extended operations on desert worlds. The Ministry of Colonization had new, more exciting settlement projects it was involved in. The Jonkeereen, just as they were proving themselves successful as a desert-optimized human race, suddenly found themselves an orphan project — out of the limelight and with no substantial funding forthcoming in the future. Effectively, they were now on their own — to survive or not, based on their own abilities in the harsh environment of Jonkeer.

Since then, relations between the Jonkeereen and the Imperium have been an on-again off-again series of events. Basically, whenever the Imperium thought they had a use for the Jonkeereen, they would meddle in Jonkeereen affairs, otherwise the Imperium mostly ignored the fact that the Jonkeereen were ever created. As a defense against this situation, the Jonkeereen have developed an aloof, mistrustful attitude towards outsiders, while at the same time strengthening their racial identity. With the break-up of the Imperium, the Jonkeereen have once again been left mostly to themselves. Currently, the Jonkeereen and the Domain of Deneb maintain cordial, yet reserved, diplomatic relations.

### JONKEERIN PHYSIOLOGY

In some respects, the Jonkeereen differ greatly from other strains of humaniti. These differences include both the obvious, external changes, along with those that run deep beneath the skin.

The average Jonkeerin is taller than most humans. Males average 2.1 meters tall, while females stand about 2 meters. Both sexes mass approximately 60 to 65 kilograms. These two

traits were built into the race to better allow them to survive in the desert. The greater height gives more surface area and aids in cooling down their body temperature. The lower body mass helps in much the same fashion.

Like desert dwellers throughout Charted Space, the Jonkeereen possess dark, dry skin. They tend to have less hair on their bodies than most other varieties of humaniti. Facial hair is unknown among the Jonkeereen. Although they do possess dark hair crowning their heads, it usually grows in a pattern reminiscent of an exaggerated "widow's peak" combined with a receding hairline. Though their great height gives them an imposing appearance, their lesser body weight gives them a lithe form.

Jonkeereen eyes are slightly larger than those of other humans and they are set farther apart. They are dark-hued and covered by a protective membrane that gives them a somewhat glassy look. This membrane protects the eyes from windblown particles. Likewise, their ears sit flat against the sides of their heads and also possess a protective membrane.

Jonkeereen senses are about the equivalent of those of other humans. A Jonkeerin's eyes are slightly better able to withstand higher intensities of light due to their protective membrane. Their hearing is slightly less acute due to the protective membranes. When in a humid environment, the Jonkeereen sense of smell tends to be more sensitive than the human average, although in its arid home environment, it is usually only average. The other senses, taste, and touch, tend to fall within the baselines of human norms.

Below the skin, the Jonkeereen exhibit several other physiological differences. The Jonkeereen metabolism gains greater nutrition from smaller amounts of food. Also, their perspiration system deals more efficiently with Jonkeer's 50°C mean temperature. All this is achieved with a smaller water loss than that experienced by "normal" humans under similar conditions. Jonkeereen body tissues are also able to store more water for longer periods of time than the average human, allowing them to store up extra water, which is then used at a slower rate, thereby letting the Jonkeerin go even longer between water refills.

Like most humans, the Jonkeereen thrive on an omnivorous diet. However, they are uniquely designed to survive on those plants and animals that can manage to survive in an extremely arid environment. Many food sources which other varieties of humaniti would find of little nutritional value are put to good use by the digestive tract of the Jonkeereen. In particular, the Jonkeereen are fond of the various species of kahaerchee found on Jonkeer. These protein-rich insectoid creatures are a staple of the Jonkeereen diet. The dried, preserved bodies of the smaller varieties of kahaerchee are often strung on a cord worn around the neck. They are then plucked off during the day and eaten as snacks. Kahaerchee are reputed to have a salty-spicy flavor with an enjoyable crunch — however most non-Jonkeereen humans are reluctant to try this tasty treat due to its resemblance to Terran insects.

### REPRODUCTION AND LIFESPAN

Jonkeereen females give birth after a ten month gestation period. Multiple births almost never happen as a designed result of their geneered parameters. As with many geneered varieties, the Jonkeereen are not cross-fertile with the rest of humaniti.

The 60 to 65 year natural lifespan, is short when compared with that of many humans. This is a side effect of the geneering project, though it is uncertain whether this was an intentional

**JONKEEREEN HISTORY**

The Jonkeereen are a relatively new culture. Thus, their history, speaking in purely chronological terms, is a short one.

- 488:** SuSAG exploratory vessel *Louis Pasteur* sends an exploratory party down to the world of Jonkeer
- 521:** Ministry of Colonization approaches SuSAG about a potential contract to geneer humans for survival in a hazardous environment. The Ministry is interested for scientific reasons as well as the possibility of opening new worlds for habitation. After an initial reluctance, SuSAG accepts the Ministry's contract.
- 528:** First Jonkeerin experimentation begins at Research Station Zeta at Pashus (Deneb 1432).
- 533-50:** Viability testing of first Jonkeereen children. Publicly these are said to be a resounding success. Geneering detractors doubt this is the whole truth. These children never actually see Jonkeer but are used as the models for the first creche.
- 600:** Permanent placement of first three generations of Jonkeereen on Jonkeer. Jonkeereen immediately take to the world and require very little aid from their benefactors. In fact, once established, the Jonkeereen seem to desire independence, rather than assistance.
- 637:** Suerrat abandon their "permanent" settlements on Hillalladi. Imperial government regards Jonkeereen development as a dead-end project and drops funding and support to nearly non-existent levels. Jonkeereen people feel abandoned by the Imperium, and realize they are now truly on their own.
- 665:** Self-reliance trend flourishes among the Jonkeereen. They protest any Imperial interference in their affairs.
- 667:** SuSAG representatives, interested again in using the Jonkeereen as security troops at their sabotage-plagued desert-world facilities, gain the ear of emperor Zhakirov. The Jonkeereen Project is revived and given new funding. Some further "fine-tuning" geneering is done on selected Jonkeereen populations. A Scout base is established on Jonkeer to monitor the Jonkeereen and render aid, if needed. Most Jonkeereen feel that the Scouts are watchdogs and spies, but some settle near the base and create the first true Jonkeereen city.
- 700:** Ministry of Colonization shows renewed interest in the Jonkeereen race. Due to transplanting programs, Jonkeereen can now be found on desert worlds throughout the region "behind the claw."
- 1080:** Jonkeereen population at 400 million.
- 1083-84:** First uprising of the Jonkeereen. Protesting forced transplantation by the Ministry of Colonization, Imperial interference in their affairs, and the possibility of their world's starport being upgraded, a union of tribes under chief Tabali seize control of the Scout base and demand a hearing on their complaints. SuSAG representatives visit Tabali and assure him of the Imperium's commitment to helping them achieve their chosen goals. The uprising ends, although scattered skirmishes continue for months.
- 1101:** Second uprising of the Jonkeereen. A plan to introduce a reproduction-inhibiting retrovirus into the population of Jonkeer is uncovered by Tabali and his advisors. The Ministry of Colonization is considered at fault by the Jonkeereen. Again, SuSAG steps in, but not before Imperial Marines restore order and kill Tabali. The uprising ended but discontent and mistrust continued for years. No one but SuSAG employees are favorably received by the Jonkeereen for some time.
- 1106:** A group of tribal leaders take the case of Tabali's murder by Imperial troops to the highest levels of sector government. Their charges, that the action was in violation of the Imperial charter, stick, after the affair is given detailed media coverage. The result is a set of safeguards to prevent further Imperial interference.
- 1120:** Duke Norris sends an envoy to Jonkeer to ensure that good relations continue between the Jonkeereen and the Domain of Deneb after the break-up of the Third Imperium. Although the Jonkeereen receive the envoy with their usual caution, pledges of goodwill are exchanged by both sides.

design feature. Most of the common anagathic drugs, do not seem to work well for the Jonkeereen. However, the zaerkee plant, which is one of the staples of the Jonkeereen diet, has anagathic properties, but only it seems for the Jonkeereen — other human races appear to gain no benefit by ingesting the plant. Zaerkee grows only on Jonkeer, so those Jonkeereen who live off-world and wish to enjoy a longer lifespan must have the plant shipped to them. Scientists have not been successful in growing the plant off-world — some essential environmental element seems to be missing. They have also attempted to recreate the essential compounds in the zaerkee plant synthetically, but for unknown reasons, the synthetic versions just aren't effective.

**JONKEEREEN PSYCHOLOGY**

While their origin stock is human, the Jonkeereen have mentally diverged from their "parent species". These desert dwellers' thought patterns substantially differ from other humans — even those living in similar environments.

Austerity is a prime Jonkeerin trait. Life is very serious to a Jonkeerin. The environment of their adoptive homeworld is such that, even with their genetic adaptations, life is still very dangerous. Since survival alone requires such a degree of care and concentration, anything deemed frivolous or unnecessary is tossed aside. Decorations on clothing and weaponry which may seem overly ornamented to outsiders actually denote status within the tribe or family, therefore serving an important purpose. So, although Jonkeereen life is very serious and spartan in general, it is not entirely without the ornaments and decorations common among many cultures.

Conservatism and traditionalism are very important in Jonkeereen thought. They feel that adherence to their traditional ways and thought patterns is what truly constitutes their race. This seems to be a part of their built-in survival instinct. Innovation, when you have something that already does the job well enough, does not fit into their outlook. They are particularly conservative in regards to things or ideas that come from non-Jonkeereen sources

Cooperation is also a Jonkeereen characteristic. The various tribes of Jonkeer are extremely faithful to their members. If a tribe member is in trouble, the rest of the tribe will do whatever is necessary to help. However, this cooperative nature does not mean that a Jonkeereen tribe will foolishly waste time and energy trying to save a fellow they deem to be *beyond* help. Actions of this sort go beyond the bounds of reasonable practicality. Given the dangerous nature of their homeworld, such impracticality of action cannot be justified. The survival of the group (the family, tribe, or even the Jonkeereen race) is of paramount importance — the individual's fate matters little if he or she is a hopeless case or of no value to the group.

The Jonkeereen are independent and wary of outside interference. At times, their independent nature seems to go to extremes. Many outsiders have mistaken this for xenophobia. More than anything, the Jonkeereen fear that their traditional ways of doing things will be undermined by outside influence. To gain the favor of these people, one must respect their traditional ways.

The Jonkeereen are a somewhat stoic people, preferring to keep their emotions to themselves. However, when a Jonkeerin *does* express his or her feelings, one should be prepared for a level and intensity rarely matched among the members of humaniti.

With Jonkeer's local day being slightly more than 27 standard hours, the Jonkeereen have divided their day into three, nine-hour periods of sleep, work, and rest. As is the case with many desert dwellers, a rest period falls at that point when the sun is at its highest in the midday sky. Work is much more easily done in the waning period of sunlight.

Because the Jonkeereen have become accustomed to the wide-open expanses of their desert environment, the average Jonkeerin has a much larger concept of "personal space" than do most other sophonts. A Jonkeerin is most comfortable speaking with someone who is at least a meter away from them, perhaps two. Standing any closer to a Jonkeerin is perceived as a challenge and may result in hostile attitudes or reactions.

Not too surprising, the Jonkeereen — especially Jonkeer's nomads — have a tendency towards mild claustrophobia. They prefer the vast expanses of their desert homes and are uncomfortable indoors. For most Jonkeereen, this claustrophobia is not extreme, but it is strong enough to make them wary of entering enclosed areas (like starships). In the city located around the Scout base the buildings are tall and broad with many windows and skylights. Most are only one or two levels high.

In Jonkeer's one major permanent settlement, the architecture clearly illustrates the race's need for space. Buildings are built outwards rather than upwards and have many large windows. Individual dwellings cover much more surface area than the homes of almost any other species. Most buildings have only one floor. Having more would mean that the lower floors would be denied the open sky. Those with multiple levels have tall ceilings and as much of the outer wall as possible is windowed.

The Jonkeereen have grown used to yelling, or at least speaking loudly to one another, since they are often several meters away during conversations. Shouting has become a common means of long-distance communication and some Jonkeereen tribes have even instituted what can only be called "shouting matches" as a kind of entertainment. The cacophony of their deep voices ringing across the desert expanses can be rather unnerving to off-worlders.

### JONKEEREEN SOCIETY AND CULTURE

In some ways, Jonkeereen culture mirrors that of many desert-dwelling human societies. This is not really surprising, considering that the original Jonkeereen were taught desert surviving through human examples and experience.

The basic Jonkeereen governmental unit is best described as a tribe. The tribe is an extended family group headed by a *tajj* (dominant elder) or council of *tajjin*. The *tajj* may be either male or female since the Jonkeereen do not seem to have any sexual biases. As the dominant elder of the tribe, the *tajj* is assumed to always know what is best for the tribe as a whole, through the benefit of extensive life experience.

The *tajj* is an absolute ruler whose word is law. In the Jonkeereen mind, this is the way things must be. Any kind of dissent or deviance from the rules set up by the *tajj* is perceived as dangerous and must be stopped. Thus, the traditional Jonkeereen government is classified by Imperial standards as a *charismatic dictatorship* or *charismatic oligarchy*.

Jonkeereen society is a harsh one. Crippled members of the tribe often voluntarily enter the desert without food or water so as not to burden the tribe as a whole. Capital offenses are dealt with harshly and there are many crimes which are punishable by death. The misuse of water is one such capital offense among the Jonkeereen. No amount of water is allowed to go wasted, and

those who waste water are considered among the vilest of criminals. Crime does not benefit the group, but only the individual — those who commit crimes are going against one of the fundamental tenets of Jonkeereen culture. Fortunately, crime is a rare thing on Jonkeereen.

Warfare among the tribes is uncommon. Many of the tribes are related by marriage and other such familial arrangements. In fact, it is contrary to Jonkeereen custom and law to marry within one's own tribe. This is done for cultural as well as genetic reasons. Tribes related to one another are less likely to be at odds and, therefore, wasting precious resources fighting amongst themselves.

Jonkeereen society is also very homogenous. The concept of *individuality*, in the sense of purposefully choosing to "stand out in the crowd", is unknown. It is rare to encounter a Jonkeerin who will publicly admit to disagreeing with the ways of his or her people. This is not merely a show, however. Most Jonkeereen believe strongly in their ways and feel that they are truly the best ways of doing things. This strong streak of egotism and ethnocentrism can make dealing with a Jonkeerin very difficult for many humans.

### OFF-WORLD AND CITY-DWELLING JONKEEREEN

The majority of the information in this text deals with the nomadic, desert-dwelling Jonkeereen. It is interesting to note that the nomads themselves are rarely seen by off-worlders even though they make up the largest portion of the population. Anybody who claims to have seen or met a Jonkeerin has more than likely met one on a world other than Jonkeer. If they have actually visited the planet itself then chances are that they have seen one of the handful of natives who have settled around the scout base. You may argue that locale makes little difference when speaking of an entire race, but the nomadic Jonkeereen would disagree.

Many of the Jonkeereen's societal and cultural traits are the direct results of the survival abilities generated into them by the Imperial Ministry of Colonization. Jonkeereen inhabiting worlds other than Jonkeer tend to exhibit very similar cultural patterns. However, this is not to suggest that *no* deviation has been known to occur among the widely-separated colonies of Jonkeereen throughout interstellar space.

Two factors are of prime importance to the amount of deviation likely to be found among the different Jonkeereen nations. First is the extensiveness of the desert terrain on the world which they inhabit. Second is the level of technological achievement on that world.

Without a ready supply of water and with only hectare-upon-hectare of desert sands to gaze upon, the Jonkeereen of Jonkeer have become a harsh and austere people. On other Jonkeereen-inhabited worlds, with less harsh environments, these hardened traits are less apparent. The Jonkeereen on these other worlds still are obviously biological Jonkeereen, but they have begun to develop their own unique societies in response to the conditions of their new homes.

Technological level also affects Jonkeereen societies. Jonkeer's tech level of nine is somewhat misleading. That tech level really only applies to the settlement near the Scout base. The tech level of the nomadic peoples is probably closer to 2 or 3 although the nomads are sophisticated enough to use technology obtained through trade with Schunamann und Sohn, LIC (SuSAG).

However, the nomadic Jonkeereen of Jonkeer consider themselves to be the paradigm of their people. These other



Mike Viardi

Jonkeereen communities, for their part, look on their homeworld's inhabitants as needlessly officious and conservative even by Jonkeereen standards. These new groups consider themselves to have adapted admirably to their new surroundings while still retaining those things which are the essence of the Jonkeereen ways.

### PLACE IN THE DOMAIN

Members of mainstream Domain society view the Jonkeereen with a combination of curiosity and respect. Many Domain citizens cannot help but be fascinated by these hardy beings who are able to survive in the open desert.

In spite of this, many Domain citizens have become increasingly wary of the growing — what they perceive to be — xenophobic trend among the Jonkeereen, particularly those on Jonkeer. These citizens cannot understand why the Jonkeereen are becoming withdrawn within their own enclaves. Those Jonkeereen who do not exhibit this tendency (usually those on the higher-tech worlds of the Domain of Deneb) have received a great deal of attention in the news services and some have even gained the status of minor celebrities.

Many of the personnel at the Jonkeer Scout base are engaged in the long-term observation of the Jonkeereen and their deviation from human norms. These Scouts are working this venture in cooperation with the Ministry of Colonization, as well as with SuSAG. Having the only major settlement developing around them helps a great deal.

At first, the various tribes of Jonkeer dealt regularly with the Scouts and proved quite helpful to them in their tasks. Later, many of the tribes became distrustful as some of the Jonkeereen people became accustomed to the readily available technology of the Scouts and started the first permanent settlement on Jonkeer. The nomads are now rarely seen inside that settlement, which has no official name and is usually just referred to as "the

city". They come to drop off zaerkee shipments, but will usually only interact with the city's other Jonkeereen inhabitants. Traveling deep into the city, beyond the zaerkee warehouses, is rare for a nomad.

Offworlders, namely SuSAG, are a common enough occurrence on the world. But direct off-world trade with the Jonkeereen nomads is sporadic, at best. The nomads desire as little interference as possible in their tribal affairs and prefer to be left to themselves.

SuSAG is the main advocate of the Jonkeereen to the Scouts and the Domain government. It has been mainly through their efforts that Jonkeer has remained as isolated as it is.

### JONKEEREEN LANGUAGE

Being a product of Imperial society, the original Jonkeereen were taught Galanglic. Though that is technically their tongue today, it is spoken with a noticeable dialectic accent and holds many significant deviations from the mother tongue.

Many of these divergences in the language can be traced to their "alien" outlook and the linguistic demands of their environment. Shouting over long distances has prompted the evolution of a verbal "shorthand" version on Galanglic. Since messages are relayed much more quickly using this dialect, it is popular and commonly heard on Jonkeer.

### JONKEERIN CHARACTER GENERATION

Generally, a Jonkeerin is generated no differently than standard human characters. The few changes are described here.

A Jonkeerin possess the same basic characteristics and the same range of values. All abilities are generated with 2D. Endurance is given a DM of +1, although a value of 15 is still the maximum. Dexterity is given a DM of -1 and scores of 1 are possible.

No initially generated Jonkeerin character, no matter how high his or her Social Standing, will possess a patent of Imperial nobility. Characters whose Social Standing is 11+ either initially or through career generation are not, in fact, considered nobles by the Imperial society. They merely possess high levels of power and respect within Jonkeereen communities. No Jonkeerin at this time has been ennobled.

To reflect the abilities Jonkeereen have in desert environments, all initially generated Jonkeereen characters automatically receive the skill of Survival-1.

A Jonkeerin possesses three names: a given name and two surnames. The given name occurs first and the surnames last. The first surname, actually the middle name, is the Jonkeerin's family name. The second surname represents the tribe to which the Jonkeerin belongs. Jonkeereen possess a wide variety of naming traditions, particularly for the given name. Some are of Galanglic or Vilani derivation while others are completely unique to the Jonkeereen.

A Jonkeerin can pursue almost any human career. Many, however, serve in the military, particularly the Army. Jonkeereen sailors, however, are very rare. Similarly, any space-faring career would be considered unsuitable by most Jonkeereen due to their racial claustrophobia. This is not to suggest that exceptions do not exist. A few Jonkeereen have served in the Imperial Navy.

Those Jonkeereen who live on more technologically-primitive worlds or who shun contact with offworlders are, naturally, eligible for the Barbarian career. This is the usual case when



generating a Jonkeer nomad.

Very few Jonkeereen become diplomats because of the strong allegiance to their own people. Jonkeereen diplomats tend to have difficulty understanding the validity of other cultures' ways. Those who do become diplomats are usually from the more technologically-advanced Jonkeereen communities, which are not as rigid in the Jonkeereen traditions as those groups on Jonkeer.

#### ROLE-PLAYING NOTES

The Jonkeereen are, first and foremost, a proud and conservative people. They are proud of their own achievements and are somewhat haughty and elitist in their sensibilities. They firmly believe in the superiority of their own people and their ways of doing things.

Jonkeereen are also rather stoic in their attitudes and do not easily let their feelings be known by outsiders. Only their closest friends and family members are privy to such information. The Jonkeereen are, nonetheless, a passionate people. When they do show their feelings, there can be no doubt as to what those feelings are.

The Jonkeereen are very loyal. A Jonkeerin friend, once made, is for life. Jonkeereen are not prejudiced with regards to gender or race. They judge only according to abilities and results. Even so, they have very high standards by which they judge themselves and others. Because of this, very few individuals live up to those standards and the Jonkeereen have been known to simply dismiss those who they do not see as unworthy of their attention.

The Jonkeereen do not like standing close to one another. They are accustomed to the wide-open spaces of the desert and can be somewhat claustrophobic indoors. Likewise, Jonkeereen will usually stand a few meters apart when talking to one another. Shouting is a favorite form of long-distance communication and some Jonkeereen consider it a kind of entertainment. A Jonkeerin can be very boisterous and loud when he or she wants to be.

Finally, the Jonkeereen often seem very distant to "normal" humans. They have a far-off look in their eyes and appear very caught up in their own little worlds. Their view of "personal space" also contributes to this view. Since they view themselves as no longer part of the human race as such, they feel separated from other humans and prefer their own company. Some Jonkeereen appear lonely and introspective to outsiders. Nonetheless, the Jonkeereen are a pleasant and happy race with as wide a range of feeling as any other.

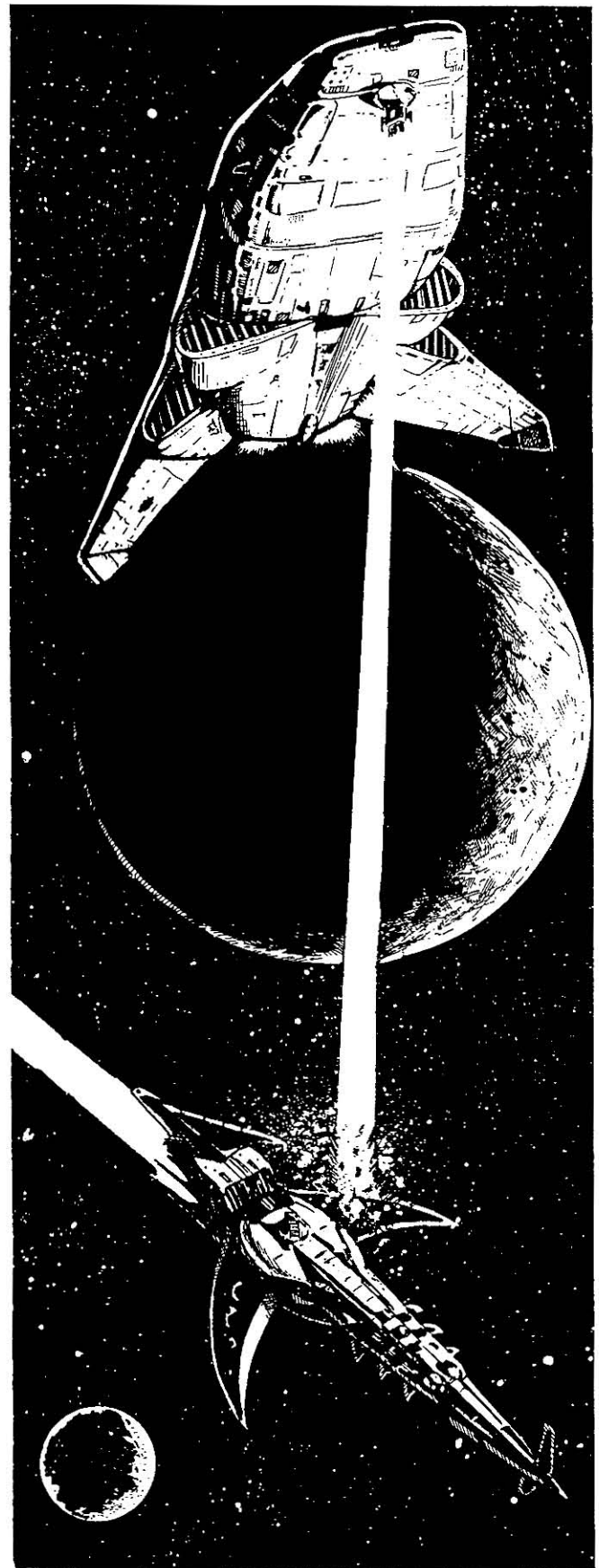
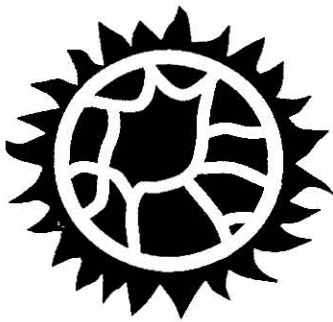



# Sword Worlds Incursion Claimed by Darrians

[122-1122] The Darrian Confederation has lodged a formal protest with the Sword Worlds government regarding a recent incident along the Darrian Confederation/Sword Worlds border in the Nosea (0724 Spinward Marches) system.

A pair of Confederation Navy frigates intercepted a bulk freighter believed to make its home port in the Tizon (0922 Spinward Marches) system. It was not transmitting a transponder ID signal at the time of intercept. A Navy spokesman asserted that the merchant was ga-

thering electronic intelligence from the local Navy base. The freighter jumped out of the system before the frigates could conduct a customs/security inspection. The government of Tizon has not commented on the charges. Representatives of the Sword Worlds Confederation declined to comment as well.

Relations between the Confederation and the Sword Worlds have remained tense since the Darrians retook the Entropic Worlds during the last war with the Zhodani and their allies. •

## Darrians Annex Nonym

[354-1121] Protocol procedures finalizing the annexation of the world of Nonym (Spinward Marches 0321) by the Darrian Confederation were recently announced. Nonym, a world which had been settled by Darrian colonists previous to the *Maghiz* of -925, has been a nominal member of the Confederation since late 1120.

According to the Confederation's spokesperson, Countess Ros Labhiladh, "Nonym is culturally and societally part of the Darrian sphere of influence. Due to the chaos of recent events, it is only natural that Nonym would become a full member of the Confederation." With ratification of the final agreements, Nonym at last became a full member of the Darrian Confederation.

While this news was greeted with approval by the Domain's government, the nearby Sword Worlds were not so pleased. Siegfried Vanderthal, a spokesman for the Sword Worlds Ministry of State, stated that "my government does not look kindly on the blatant imperialism of the Darrian Confederation. Nonym must be the first and only world the Darrians annex. Any attempt at further expansion will be looked upon most unfavorably."

Both Darrian and the Domain governments dismiss Vanderthal's statements as mere posturing. However, several Naval vessels in the region have been put on alert in case violence should erupt. •

## War Erupts on Lome

[311-1121] A full-scale war between the large nation of Liitheel and Mahad broke out on the world of Lome (Deneb 1306). Located near the Domain's border with the Vargr Extents, Lome has always been a contentious planet, with its six nations. Until recently, though, the states of Liitheel and Mahad, old rivals for centuries, have never fought one another directly, but only through covert operations. Now, large troop movements and heavy weapon usage have been reported.

As far as can be ascertained, the ostensible cause of the warfare is a disagreement over Liitheel's efforts to upgrade its starport facilities and encourage trade on Lome.

Domain officials are taking a wait-and-see attitude. Minister of the interior, Francisco Javier Maagaashin, said that "while the government is concerned about the recent unpleasantness on Lome, there are more pressing matters which fall under the Domain's jurisdiction."

At the same time, Maagaashin also stated that his ministry, in cooperation with the Ministry of Industry, was looking into what he called "the possibility of inordinate megacorporate interest" behind the conflict. When pressed, he would not explain the statement further. •

## Unrest Continues On Dinom

[032-1122]- Reports coming in from Dinom (1811 Spinward Marches) indicate a growing dissatisfaction with the planetary government, the Revolutionary Council of Workers (RCW). Continued economic mismanagement has been cited as the reason for the growing unrest.

The RCW seized power from the Dinom Corporation in 1106, but has been unable to return zuchai crystal production to pre-1106 levels. Dinom did experience a boom in orders during the Fifth Frontier War, but in the aftermath of the conflict, the world slumped into a deep recession. Incidents of anti-government violence have been on the increase and it's reported that mercenaries, some rumored to be in the employ of the former board of directors of the Dinom Corporation, are responsible.

Domain officials have privately expressed concern over the situation but deny that the deployment of the assault cruiser *al-Khafji* to the region, carrying a Marine expeditionary force, is related to the matter. Clearly, given the forces threatening Deneb, continued zuchai production on Dinom is vital to the Domain's interests. •

## Artifact Stolen on Deneb

[329-1121] A bronzed amulet with a star symbol, an artifact of the Church of the Stellar Divinity, was stolen from a Church-run museum in Sydkai, on Deneb. The amulet, the so-called *Star of Jyestha*, is reputed to have been the personal possession of Jyestha Yerubid, who founded the Church in -3883, during the Ziru Sirka.

Traditionally, the star has been the property of the Antarean branch of the Church, but every twenty-five years, as a gesture of ecumenism, the Star is put on tour throughout the Imperium. The Star reached Deneb in 1117 and, with closure of safe, routine

traffic in Corridor, has remained there ever since.

Both the High Priest of Deneb's Church, Emri Bragashaan, and the Duke of Deneb, Aleksandr Lagaa-shinga, expressed concern and dismay at the daring theft. Valued in the millions of credits, the Star of Jyestha also has profound spiritual value to the Church's faithful.

A search for the artifact and its thief is underway. Because of the hard times of the Rebellion, no statement has been received from Antarean Church officials. At this time, there are no leads or suspects in the investigation. •

## TAS Issues Special Advisory

[011-1122] The Travellers' Aid Society (TAS) today issued a special advisory from its Deneb facility regarding travel near or in Corridor sector. Spokesman Logan Miirsten, citing a recent upsurge in corsair activity in Corridor, stated that the advisory was in addition to the blanket Amber zone rating already given the sector by the Society.

Miirsten explained that Society members who had recently been in or near Corridor reported large scale ship movements, some involving cruisers in the 10 to 30,000 ton range. Experts agree that nothing on this scale has been seen since the Vargr invaded in 1118.

Although it can't be confirmed, Society members also said it appears that the Vargr are especially interested in merchant vessels in the 200 displacement ton range. No reason for this peculiar behavior has been forthcoming.

Miirsten was quick to reiterate that, while the Society has no reason to doubt the word of its members, there's been no independent confirmation of these reports. He had no comment as to whether or not the Traveller News Service would attempt to obtain such confirmation.

Latest word from the Society's facilities in the systems of the Kirzow Pact indicate that the treaty organization's combined forces are on a heightened state of alert. There have been no border incidents to date. Miirsten concluded the announcement by saying that the advisory is in effect until further notice, but that "it shouldn't be more than a few months".

Later the same day, the Imperial Navy issued a statement calling the Vargr activity "no more than war games... a simple exercise" and the Society's advisory "prudent".

## Oberlindes Responds to Akerut

[124-1122]- Sergei hault- Oberlindes, son of the merchant line's owner and president Marc hault-Oberlindes, released a statement today refuting charges by Akerut that Oberlindes is suffering from a shortage of trained personnel. He said that operations in the Regina and Aramis subsectors, as well as across the frontier, continue apace and that the company has not defaulted on its commitments as its rival has asserted. Oberlindes concluded by saying that the line is always looking for qualified ship crews and staff.

At the same news conference, Oberlindes was asked if this hiring policy included Vargr. He responded by saying "We continue to take all qualified applicants". The line has been under fire from some quarters for its hiring of Vargr from both sides of the Imperial border.

## Aslan Delegation Arrives at Bantral

[058-1122] Representatives of the Aslan Ikhtealyo clan arrived on the client world of Bantral (Trojan Reach 1906) to begin a series of talks concerning improving relations between the Domain and the Aorlakht.

The Ikhtealyo clan has been involved, for some time, in trade with the worlds of the Domain and sees the current chaotic situation in the Trojan Reach as an impediment to free trade. Domain officials agree and hope that something substantial will result from these talks. A number of Darrian-born Aslan are to be present at the talks, in an effort to foster goodwill between races.

Security will be very tight at these talks, since there have already been threats made against the Aslan by a racist terrorist organization calling themselves "The Brothers of Humanity". The Brothers seek to eliminate the Aslan presence in Trojan reach through violence, if necessary.

In addition, Domain Naval Intelligence suspects that Aslan of the rival Eakhtiyho clan may attempt to sabotage the talks. The Eakhtiyho are hostile to both the Domain and the Ikhtealyo clan. For this reason, further reports of the talks and their level of success will be tightly controlled by the Ministry of State until such a time as it is deemed proper.

## Missing Ship Sighted

[364-1121]- Representatives of Baraccal Technum (BT) reported to Domain Navy authorities on Pax Rulin (2204 Trojan Reach) today the sighting of the Imperial missile frigate *Hajuk* in the Gollere (1305 Trojan Reach) system several weeks ago. *Hajuk* disappeared during the opening days of the Fifth Frontier War in the Emerald (1006 Spinward Marches) system while conducting a rear guard action for other fleet elements during the initial Zhodani incursion. The ship has been carried as missing in action since that time and is believed to have been missed.

The frigate was reportedly spotted by the BT *Leviathan*-class merchant cruiser *Roman de la Rose* while it was maneuvering to recover one of its boats. Contact was made at extreme range and subsequent attempts to intercept the missile frigate were unsuccessful. Sensor and flight data recordings turned over to Domain authorities are said to support the identification of the ship, but no explanation is forthcoming why an intercept was not accomplished.

An unnamed source is quoted as saying "Apparently *Hajuk* maneuvered away from *Rose*, how or why I can't say. After all, she's been missing for almost 15 years. If the crew were still alive, why didn't they report in? If the ship was captured by the Zho, what's it doing in the Reach? Your guess is as good as mine."

Local Navy representatives stated that due to present commitments regarding the Aslan in the region, they may not be able to dispatch a ship to investigate. Some talk of contracting out a search and rescue mission has been circulating around PaxPort. It should be noted that some skepticism exists as to the veracity of the sighting by merchants knowledgeable about the area. Several contacted by this reporter said that rumors of ghost ships are part and parcel of the Reach and should be taken with a grain of dustspice. Both Baraccal Technum and the Navy stand by their reports.

## Still No Word On Whisper

[131-1122]- After nearly two months of effort by the combined forces of the Ministry of Justice's (MoJ's) Special Branch and corporate security for SuSAG, there are no new leads in the apparent kidnapping of the Virushi nanobiologist known as Whisper. Whisper disappeared without trace from the joint Imperial/SuSAG operated Special Projects Lab (SPL) at Research Station Alpha on Duale (2728 Spinward Marches). The purpose of the research undertaken at the SPL, one of several labs located at Alpha, is classified although obviously related to the biosciences.

Katreem Vlar, spokesperson for SuSAG, has stated in the past that Whisper was satisfied with its work at the SPL, invalidating the theory that the Virushi left of its own volition. (There's been some friction between MoJ and SuSAG because of the Ministry's refusal to rule out Whisper's willing defection to another corporation). Both organizations are said to be concentrating on the possibility that the nano-biologist was the unwilling victim of a corporate extraction.

Officials have yet to name any suspects, corporate or private, and no ransom or others demands have been received. SuSAG is offering a reward of 100kCr to anyone with information which leads to the recovery of Whisper and the capture of those responsible for its abduction.

## Boloball Set To Expand?

[098-1122]- Barrett "Grunt" Gurnd, Domain vice president of the Federated Boloball League (FBL), held a press conference today to announce that the FBL was considering expanding the league by three teams sometime in the next three years. Gurnd cited the "runaway popularity" of the sport as well as the potential for earning millions of credits as the reason for the action.

Investors on Collace, Perrior and Deneb (1237 Spinward Marches, 2203 Trojan Reach and 1925 Deneb respectively) have already been soliciting funds to purchase a franchise. (Tentative names for the teams are the *Collapsars*, the *Predators*, and the *Demolishers* respective-

## Nomad Fleet Arrives at Raweh

[119-1122]- Ships of Tentrassi Nomad Fleet No. 8 continued to arrive in the Raweh (0137 Spinward Marches) system today, including the 1.2 megaton factory/homeship *Albiasi*. The approach of the fleet was first learned five days ago when an advanced scout craft arrived in-system and contacted Raweh System Control and the Navy base to establish traffic handling procedures.

Thus far, some eight ships have broken out of jump and assumed a convoy formation outside the normal trade lanes. Another eight to twelve craft are expected shortly. Local and Domain officials, as well as a Scout Service contact and liaison team just back from the Foreven sector, are planning a formal welcoming ceremony for the fleet sometime next week.

The Tentrassi nomad fleets are an outgrowth of the fact that the location of the race's actual homeworld remains a mystery. This has spurred not a few of the minor alien race to go to space in hopes of finding their place of origin. The fleets conduct merchant operations while plying the spacelanes and a fair percentage of what is sold or bartered is manufactured aboard the giant factory/homeships which are the heart of any fleet. Eventually, most fleets tire of the search but continue their merchantile wanderings.

Nomad Fleet No. 8 last visited Raweh before departing for points spinward over twenty years ago and is rumored to have travelled as far away as Theata Borealis sector, some 100 parsecs distant.

ly although this may change). A committee established by the FBL will be tasked with evaluating each world in terms of fan support and earning power.

The Church of the Stellar Divinity on Deneb will reportedly block any attempt at granting a second franchise to that world because of the violent nature of the sport. Deneb is the only system in the once Imperium spanning league to potentially have two boloball teams.

Domain vice president Gurnd is a former boloball player who holds the league record for the most seasons played (three), the most points scored in a career (57), and the most acquittals for premeditated mayhem (four).

**I have a question that deals with starship design and the special control panel add-ons on page 81 of the *Referee's Manual*. What do I do with the CP number, like the 200 CP on the TL 13 Heads-up Hologisplay? — R.B.**

The CP number is a measure of the amount of "control" that is needed by all the parts of the starship. If the computers, control panels, and all their related add-ons don't provide enough control points to cover all the ship's needs in control points (CP), then the ship you design will never get out of its space moorings, since it will immediately be out of control.

Let me illustrate. Let's say you design a tech level 12 starship and add up all of its control point needs, getting a total of 5,000 CP. You will need to install enough control panels, control panel add-ons, and pipe it all through a computer so that the CP output of this control system equals or exceeds 5,000 CP needed by the ship. Control panels and control panel add-ons feed into the computer, which then multiplies this input by its CP multiplier. The more powerful the computer, the larger the CP multiplier, and the more CP output provided for a given CP input.

Let's look at how we might satisfy the control needs of our tech 12 starship. Looking at the computer table on page 83 of the *Referee's Manual*, I see a tech 12 starship could install a model 6 computer, which has a CP multiplier of 45 that applies to any control panel units attached to it. Dividing the 5,000 CP by 45 tells me how much CP input the control panels will need to provide to the computer — or 111.11 CPs, which we will round up to 112.

Looking over the control panel list, I see that I could install dynamic linked control panel units, and they each provide a CP of 1.0 — meaning I would need 112 units to be fed into my model 6 computer to control my ship. But, rather than have some many control panel units, I opt instead to replace 100 control panel units with two heads-up displays, each providing 50 CPs. These two heads-up displays and 12 dynamic linked control panel units, all tied into my model 6 computer, provide what I need to control my ship.

So the control panel add-ons can be used in place of regular control panel units. In effect, the control panel units and the control panel add-ons are all in the same table. You pick and choose some combination that provides enough input into the computer to offset the CP needs of your ship.

I hope that clears up for you how CPs work. — *Joe D. Fugate Sr.*

**For the new Traveller referee who started with MegaTraveller, what are some of the most vital pre-MegaTraveller titles to have if that referee wants to run a campaign in the Imperium? — B.A.**

Most pre-MegaTraveller products did not deal with the details of the Imperium. So the answer to your question is simple: *not much*.

But if I can take the liberty of changing your question to be, simply: "What are some of the most vital MegaTraveller titles to have?" then I can give you specific titles. I am also assuming the reason you ask the question is because you have limited re-

sources and you want limit yourself to the best of the classic Traveller titles. If you were a real die-hard Traveller fan (like me) then the answer would again be simple: *all of them*. But that isn't the answer I think you want either.

So I need to give you a list of *the best* titles that make up the body of classic Traveller works. This list, of course, is my own opinion. Others would pick different titles.

Number one, I would recommend the *Sky Raiders* trilogy by the Keith Brothers and published by FASA. I have refereed these adventures several times and have enjoyed them immensely each time. Next, get a copy of the *Traveller Adventure*, written by Marc Miller and published by GDW. The sheer volume of adventure material in this book makes it an amazing work, although it is not the wide-eyed adventuring romp that the *Sky Raiders* series is.

Any other adventure you can find written by the Keiths is a good bet. Many of them were printed by FASA and Gamelords. Study the elements the Keiths put into their adventures and you will learn a lot about what makes adventures fun.

And of course, the early issues of our own magazine, the *Travellers' Digest*, will give you lots of useful information about the Traveller background. Issues 12 and earlier are what I call the "pre-MegaTraveller" issues.

None of these titles are still in print, but don't despair. Elsewhere in this issue is a list of many of these out-of-print classic Traveller items and they're for sale. — *Joe D. Fugate Sr.*

**In looking at *Vilani & Vargr* on page 11, I noticed a problem in the Meshan sector. The old Traveller adventure *Disappearance on Aramat* plotted subsector C of Meshan, and looking at the star system locations plotted in *Vilani & Vargr*, I see a difference. Does this new data supersede the previously published data? — B.S.**

To quote from page 1 of *Vilani & Vargr*, "If the material in this book conflicts with any prior information presented in Traveller or MegaTraveller works ... this book supersedes that prior material."

As a guideline, you can pretty much assume *any time you find a conflict, the later work rules*. The volume of Traveller work has become so vast that trying to stay consistent with every word of every official publication is just no longer practical. Try as we might, it is inevitable that we'll make mistakes. This example is a case in point. I know for a fact the writer who submitted the Meshan data to us has never looked at *Disappearance on Aramat*, and it never crossed my mind that he should do so. This product is produced by a licensee, and a rather obscure one at that — to my knowledge they only produced this one product.

The more practical approach to consistency is to simply assume if the newer material conflicts with older material, that the older material is obsolete. As long as we stay consistent with the obvious sources, we should be basically okay. And that's what we do, so that's the one we'll say is the official one.

While we are on this subject, I'll make one more observation. Since this is your game session, you can pick the version you like.

In some cases you almost have to do that — let me illustrate with an example. The editors of GDW's *Challenge* don't always know what we (DGP) are working on before they print something, and we don't always know what they're going to print. They could have something in the works at the same time we also have something in the works, and our two publications could hit the streets with conflicting views. This has happened more often than either one of us cares to think about. It's not ideal, but then that's what you have to expect in a mature game like Traveller with its massive quantity of background.

The criteria I use to resolve a conflict for my own game sessions isn't always what I think is more official — bet that surprises you, doesn't it? I pick the one I think is the most fun! After all, fun is the reason we play Traveller, isn't it? You should do the same. — *Joe D. Fugate Sr.*

**How would your average non-starfaring (read: out of shape) person use a floor- or ceiling-mounted iris hatch? From the deck plans that have been published, those things seem to be the only way to go from one deck to another, but there seems no way to get through them. Am I missing something? — T.M.**

Yes, you are missing something. It's really quite simple: ladders. Ladders don't show up very well in overhead deck plans, though. The ladders are often located parallel to a nearby wall, so they don't block the flow of traffic. Floor mounted iris valves are typically mounted so their vanes forms part of the floor, and they are solid enough that you can easily walk on them. A sensor arrangement prevents the valve from opening if anyone is standing on the valve.

If anyone is standing near a valve and approaching it, and someone down below is ordering the valve to open, a light and sound alarm goes off to tell the approaching traffic the floor valve is about to open. Of course, with the proper clearance code, the iris can be ordered to open even if there is someone standing on it!

The diagram to the right illustrates these points.

— *Joe D. Fugate Sr.*

**I was flipping through my copy of *Starship Operator's Manual* and noted something in the Old-Timer's box in the "Hull and Environment" section where he notes that he served aboard the Allamu during the False War. If I am correct in assuming that this is the Kinunir-class battlecruiser that was lost in 1084 (GDW's *Adventure 1*, page 11), I remembered there was a rumor regarding the Allamu. Rumor E on page 8 is a reference to a veteran who didn't serve on that last flight, the Battle of Two Suns. Is this man the Old-Timer? — J.F.**

Your hunch is correct. Gary Thomas wrote all the Old Timer sidebars. When we were writing that product, I remember Gary pouring over all the material he could find about starships and the Frontier Wars. Gary is a stickler for detail, and it pays off, as you can see in this instance.

The Old Timer sidebars are my favorite part of the *Starship Operator's Manual*. The original idea for the sidebars actually came from our regular contributing artist and technical editor, Tom Peters. Gary, as one of the key writers on the SOPM project (as we called it) took Tom's suggestion and ran with it. He did a marvelous job — I still get a good chuckle when I read those sidebars today. Thanks for noticing and appreciating Gary's

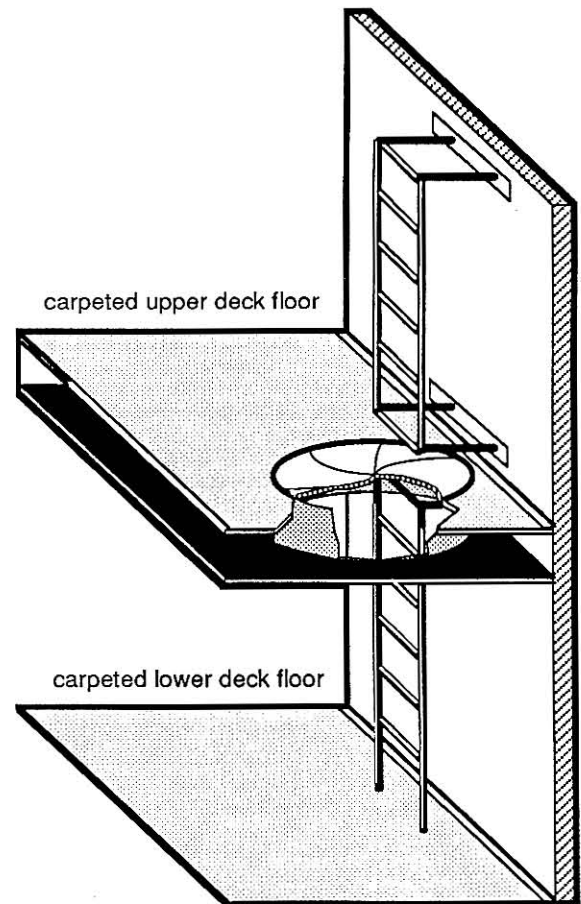

drawing not to scale

work and for pointing out the attention to detail he put in on the Old Timer. — *Joe D. Fugate Sr.*

**Does battle dress affect the value of the wearer's life force or hit number? — D.W.**

Since battle dress enhances your physical attributes, you might think battle dress could enhance your life force — but it is not so. Battle Dress does not make you bleed slower, nor does it boost the functions of your internal body systems. Its protection/enhancement is — in this sense — superficial.

Since you asked this question, I'm going to take this opportunity to explain some of the philosophy behind Traveller armor protection, penetration, and damage. But even before I do that, I'm going to tell you why we go beyond just answering the specific questions we receive. We feel that if we also educate you about what we were thinking when we wrote these rules, you can then answer far more rules questions than we could ever cover in a hundred Q&As — all on your own. And that's worth it — for all of us.

So, what about Traveller armor, penetration, and damage? At a quick glance, you might think armor should make you easier to hurt, so that means you should get more hit points. Or, that

armor ought to make you harder to hit, so the "to hit" task ought to be more difficult if you are wearing armor.

Neither of these is true. Armor makes it harder for the weapon to penetrate to where you are — it keeps the hits away from your "precious hide" as we might say!

Once that hit manages to get through the armor, then and only then will it will do some damage. Damage is assumed to be damage to bodily systems: punctures, cuts, bruises, fractures, and so on. In basic MegaTraveller, we don't dwell on specifics since all we care about during combat is not that you hit him 4 cm below the third rib — we want to know, is he still in the fight? This is especially true in role-playing situations where the referee often has to single-handedly run an entire army of NPCs.

So to summarize, armor does not in itself make you harder to hit, and it does not increase the amount of *damage* you can take. It will increase the number of *hits* you can take, assuming the armor prevents some of those hits from penetrating. That's how it all works.

See the relationship between armor, penetration, and damage? Once you understand this relationship, you can easily answer questions like the one you posed. — *Joe D. Fugate Sr.*

**I'm trying to collect all the sector maps of the Imperium I can find. What magazines did you publish sector maps in? — P.G.**

The most recent, of course, was issue number 1 of the *MegaTraveller Journal*. In that issue we published all four sectors of the Domain of Deneb (Spinward Marches, Deneb, Trojan Reach, and Reft — and in this issue, we give you all the UWPs for these four sectors).

As far as back issues of the *Travellers' Digest* is concerned, here is a list of sectors we published:

TD20	Trojan Reach, Reft
TD19	Riftspan Reaches, Deneb
TD18	Corridor, Ealiyasiyw

We've also published sectors in some of our recent products:

Vilani & Vargr	Vland Sector
Flaming Eye	Lishun Sector
Solomani & Aslan	Dark Nebula Sector

Of these products listed, we still have copies of issues 19 and 20 of the *Travellers' Digest*. *But that's it*. All the others are sold out. (Although if you are desperate, check out the special sale elsewhere in this issue. But the quantities in this special sale are limited so don't wait around). — *Joe D. Fugate Sr.*

**Considering that robots are in existence now, doesn't tech level 12 seem a bit late for them to finally be used on an Imperium-wide basis? — D.W.**

I like questions like this! GDW and Marc Miller have done their homework when it comes to the technology of Traveller. While I won't go so far as to say that the game's tech level rationale is flawless, I will say it makes very good sense — especially in regard to robots.

First, some quotes from the classic *Traveller* book we wrote for GDW, Book 8 *Robots*.

"The technological challenge is to build a cheap, reliable robot able to completely replace a being with intelligence. Relatively mindless robotic machines and appliances appear at tech level 8, and reliable speech recognition occurs at tech level 10. The reliability of primitive (non-creative) artificial intelligence often follows at tech level 11, making the way for widespread

introduction of intelligent robots at tech 12."

Also consider this quote from the book *Mind Children: The Future of Robot and Human Intelligence* (1988). "... the best of today's machines have minds more like those of insects than humans. Robot servants, ubiquitous in science fiction, [are] unlikely in the [near] future ... safe and effective operation in the often chaotic home environment is a lot more difficult than in controllable factory settings. Existing robots offer mostly blind, repetitive, potentially lethal motions at a price comparable to that of an entire residence."

An item is not listed in the tech level charts when it first becomes possible, but when it leaves the laboratory and becomes a consumer item — something your character can buy in the stores. *This one misconception is perhaps the greatest mistake we see Traveller gamers make about the meaning of tech level.*

Just because a technology is doable doesn't mean it is affordable. The driving force behind all technology becoming common place is when it becomes *affordable*.

Another aspect of this question deals with our assumption that we humans (or any life form for that matter) are simple to duplicate. As biologists learn more about us, they are continually amazed at just how complex and intricate we really are, and the thought of man truly duplicating humans in machine form very soon is starting to look foolishly optimistic. Here's another quote to illustrate from Michael Denton, an Australian microbiologist. This quote is from Denton's book *Evolution: a Theory in Crisis* (86).

"Human intelligence is yet another achievement in life which has not been equalled in our technology, despite tremendous effort and significant advances which have been made in the past two decades towards the goal of artificial intelligence — a goal which may be further away than is often assumed. The most telling criticism of current work in artificial intelligence is that it has not been successful in modelling what is called common sense. It could turn out that ... intelligence cannot be achieved in terms of a non-biological plastics' and metals' technology ... the goal may never be reached, for an object of [the complexity of the human brain] would require an eternity for its assembly in terms of our current engineering capabilities."

In light of this statement, maybe tech level 12 is *too soon* for intelligent robots? — *Joe D. Fugate Sr.*

**Concerning the passenger table on page 50 of the Referee's manual, shouldn't 1D-1D actually read 1D-1? — D.W.**

I can see how you might think 1D-1D is nonsense at first glance, and must be wrong. But stop and think for a minute. This roll is the number of passengers for the destination in question. It could be there are rarely any passengers for this given destination, but once in a great while there might be lots of them.

Maybe it is clearer if you realize negative numbers mean *zero* passengers. With a 1D-1D roll, the result will be negative about half the time (1-6, 2-5, 3-4, etc.). But when the first roll is bigger than the second roll, you'll have at least one passenger! A result of 6-1 will give you the most passengers: 5. But, this result will only happen about one out of 36 times (or roughly 3% of the time).

No the 1D-1D is not a mistake. Just roll the dice like is shows. Roll 1 die, then roll another and subtract the result of the second die from the first. If the result is negative, you don't have any passengers. — *Joe D. Fugate Sr.*

**In Referee's Companion, there's a formula for travel in system. Where does the number 32.4 come from? — B.L.**

This formula was derived algebraically from the original formula in the original Traveller set. (You remember algebra, don't you? That's the class most of us slept through in high school.)

Here is the original formula:

$$T = 2\sqrt{D/A}$$

Where:

T=Travel time in seconds

D=Distance travelled in meters

A=Acceleration in meters per second<sup>2</sup>

The obvious problem with this formula is the units. Travel time should be in hours, distance in kilometers, and acceleration in gees. These are units that are useful to us starship travellers. The units in the original formula are only useful to physics students.

So here, for those of you who didn't sleep through algebra class, is the algebraic derivation of the new formula.

First we need to convert time into hours, so we divide by 3600:

$$T = \frac{2\sqrt{D/A}}{3600}$$

or, more simply:

$$T = \frac{\sqrt{D/A}}{1800}$$

Next, we need to convert meters per second to gees, and meters of distance to kilometers:

$$T = \frac{\sqrt{D \cdot 1,000/A \cdot 0.1}}{1800}$$

or, more simply:

$$T = \frac{\sqrt{D \cdot 10,000/A}}{1800}$$

And lastly, we have to get the division by 1800 under the square root so we square it:

$$T = \frac{\sqrt{D \cdot 10,000/A}}{1800^2}$$

or, more simply:

$$T = \frac{\sqrt{D \cdot 10,000/A}}{3,240,000}$$

and finally, we simplify to:

$$T = \frac{\sqrt{D/A}}{32.4} \quad \textit{There! A much handier formula.}$$

— Joe D. Fugate Sr.

**I am interested in more data about the star system maps you show in the two alien books, *Vilani & Vargr* and *Solomani & Aslan*. Can I get UWPs for the all the worlds shown on these star maps? I would like to stay official. — M.P.**

The Traveller universe is getting quite big and laden with data these days. We are finding it more and more difficult to know all the references we must check to make sure things stay consistent (refer to the previous question on *Vilani & Vargr*). Add to this the fact we must leave *somewhere* for a referee to fill in with their own data. We need not detail every nook and cranny of the Traveller universe!

Our stand on the Alien star maps is that we provide them as an inspiration to you. Use that information as a starting point for your own detailing of these areas. We never intend to detail these sectors in the official gaming press — so have at it. You are free to detail them however you like. This also means we are *not* interested in any submissions detailing these regions or in any adventures set in these areas. Our official playground is "Imperial Space" — essentially the 35 or so sectors of the the Imperial region. And of course, the MegaTraveller Journal's focus is even more concise than that: the Domain of Deneb.

We get letters and phone calls from time to time from gamers wanting the "official" locations for the worlds on those maps, since they can't quite tell what parsec some of the worlds are in. Again let me repeat our stand: we have no intention of detailing the worlds outside the Imperial region — in fact we are so intent on following through with this stand that we have *deleted* the world position detail used to generate those maps. We have no intention of ever doing anything more with these regions, so we didn't even save the data!

This makes the answer to your question simple: there is not nor will there ever be any official data about the worlds shown on these maps (other than an occasional world UWP that has *already been printed* in the Alien books, which you have). You are on your own and free to do what ever you like. We have no plans to ever contradict it. — Joe D. Fugate Sr.



# FORMS AND CHARTS

## MEGATRAVELLER BLANK I.D. CARDS

In the tradition of GDW's Supplement 12: Forms and Charts, we present these identification badges for your use. These can be xeroxed onto color stock and, if you're feeling ambitious, laminated. They can then be given out to your players, as "props" for enhancing the atmosphere of the game. Included are a sampling of cards from various prominent organizations and industries about the Domain.



**Mutech**  
Microgenetic Design and Modification

Name:

Dept:  Branch:

Domain of Deneb

**JUMPSPACE**  
INSTITUTE



Name:

Dept./Clearance No.:

The identified individual has been cleared for access to all encoded departments and experimental sites. Verification documents on file: 002-65-9110.

Signature

PERSONNEL AUTHORIZATION PASS

**MORA**  
WORLD REVIEW

Name

Position/Rank

DPU Authorization Number

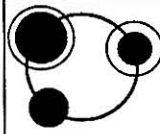

This card verifies that the sophont identified below is a representative of the:

*Domain of Deneb*  
**Ministry of Science**

Name/Title

Field

Home Institution Code

**AL MORA**  
Interstellar Transport Services  
*Serving the Spinward Marches for Over a Millenium*



Photo

Employee Name

Deneb Information Systems

**dis**

Position:

Name:

**PRESS**

1992 Game Designer's Workshop and Digest Group Publications. Permission granted to photocopy for game use.

# SURVEY SWEEPSTAKES

MEGATRAVELLER JOURNAL NUMBER 3

Let us know what you think! Photocopy the survey below, fill it out for the articles you read, and send it to: MTJ3 Survey Sweepstakes, 515 Willow, Woodburn, OR 97071. Three names will be chosen at random to receive a free copy of our new roleplaying game, AI™. Deadline for entries is August 15, 1992.

	Didn't Read	Not Useful	Somewhat Useful	Very Useful	FOR OUR INFORMATION	
Adventure: Rapid Repo	<input type="checkbox"/>	<input type="checkbox"/>	<input type="checkbox"/>	<input type="checkbox"/>	<p>1. If you had to pick one thing you would change about Traveller/MegaTraveller, what would the first thing be (mark with a 1)? What is the <i>last</i> thing you would ever change (in other words: don't change this, it is just fine like it is — mark this item with a 9)?</p> <p>___ need more rules</p> <p>___ need more examples</p> <p>___ need more adventures</p> <p>___ need more new products</p> <p>___ need more background</p> <p>___ simplify the rules</p> <p>___ change the background</p> <p>___ change the rules to match other GDW games</p> <p>___ get rid of the task system</p> <p>___ put in more illustrations</p> <p>___ make more worldsheets and equipment sheets</p> <p>___ simplify the craft design system</p> <p>___ end the rebellion</p> <p>1. If you were in charge of the MegaTraveller rules revision, what one thing would you do that you think is the most likely to foster new interest and growth in the game's sales?</p> <p>___ new rules</p> <p>___ new background</p> <p>___ rules that match other GDW games</p> <p>___ advertising blitz for the current game</p> <p>___ revise products with new illustrations</p> <p>___ do a new miniatures system</p> <p>___ do a video game</p> <p>___ do a series of Traveller novels</p>	
Worldguide: Vincennes	<input type="checkbox"/>	<input type="checkbox"/>	<input type="checkbox"/>	<input type="checkbox"/>		
Megacorporations in the Rebellion Era	<input type="checkbox"/>	<input type="checkbox"/>	<input type="checkbox"/>	<input type="checkbox"/>		
Deneb Dossier: Jeramii Boden	<input type="checkbox"/>	<input type="checkbox"/>	<input type="checkbox"/>	<input type="checkbox"/>		
Races of the Domain: The Jonkeereen	<input type="checkbox"/>	<input type="checkbox"/>	<input type="checkbox"/>	<input type="checkbox"/>		
Domain of Deneb System UWP Data	<input type="checkbox"/>	<input type="checkbox"/>	<input type="checkbox"/>	<input type="checkbox"/>		
Races of the Domain: The Creduthaar	<input type="checkbox"/>	<input type="checkbox"/>	<input type="checkbox"/>	<input type="checkbox"/>		
Sydkai-class Cruiser	<input type="checkbox"/>	<input type="checkbox"/>	<input type="checkbox"/>	<input type="checkbox"/>		
Keith Brothers Interview	<input type="checkbox"/>	<input type="checkbox"/>	<input type="checkbox"/>	<input type="checkbox"/>		
Helm Report	<input type="checkbox"/>	<input type="checkbox"/>	<input type="checkbox"/>	<input type="checkbox"/>		
Travellers' Cache	<input type="checkbox"/>	<input type="checkbox"/>	<input type="checkbox"/>	<input type="checkbox"/>		
MegaTraveller Q&A	<input type="checkbox"/>	<input type="checkbox"/>	<input type="checkbox"/>	<input type="checkbox"/>		
DIS Newsbriefs	<input type="checkbox"/>	<input type="checkbox"/>	<input type="checkbox"/>	<input type="checkbox"/>		
1. Quality of Cover Art: <input type="checkbox"/> Excellent <input type="checkbox"/> Good <input type="checkbox"/> So-so						
2. Quality of Interior Art: <input type="checkbox"/> Excellent <input type="checkbox"/> Good <input type="checkbox"/> So-so						
Name and Address					Comments	



# The MegaTraveller JOURNAL

**NEXT  
ISSUE**

**CONSISTENT WITH OUR NEW RESOURCE BOOK PHILOSOPHY...**

Digest Group is producing a very special fourth issue of the *MegaTraveller Journal*! Our new 104-page format enables us to devote over half the pages to a *spectacular* adventure by William H. Keith — one that unfolds a new revelation about the Traveller universe!

**So don't miss the next issue as we journey to K'kree space in —**

## ***LORDS OF THUNDER !***

**Lots of neat illustrations, diagrams, worksheets, equipment sheets,  
and much, much MORE!**

**Expected release: Fall '92**

## **Rare and Out of Print SALE!**

*The supply on these products is very limited (often only one copy).  
They will be sold on a first-come, first-served basis.*

### **From Digest Group ...**

- Travellers' Digest #1, 3, 4, 5, 6, 7, 8  
— \$3 each.
- Travellers' Digest #9, 10, 11, 12, 13,  
14, 15 — \$4 each.
- Travellers' Digest #16, 18 — \$5 each.
- Grand Survey — \$8
- World Builder's Handbook — \$12
- MegaTraveller Referee's Gaming Kit  
— \$9
- Flaming Eye — \$12
- Vilani & Vagr — \$12

### **From GDW...**

- Alien Realms — \$10
- Book 6, Scouts — \$6
- Book 8, Robots — \$6

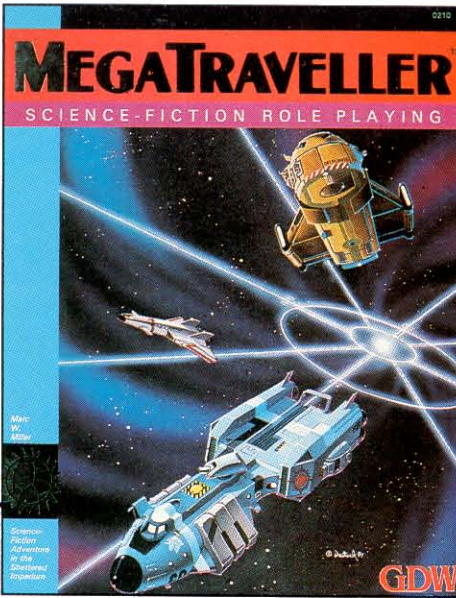

# MEGATRAVELLER

For a thousand years, the Imperium ruled the stars. Now, its tranquility is shattered by civil war. The once-solid Imperium has disintegrated into many petty empires, each fighting for its piece of the galaxy. It's a dangerous place, and your goal is to survive and just maybe turn the tide.

- The leading science-fiction role-playing game.
- Background coverage of history, personalities, equipment.
- Rules coverage for ship design, ship combat, tasks, animal encounters, character generation, and more.

### MegaTraveller.

Boxed set. *Players' Manual. Referee's Manual. Imperial Encyclopedia.* Plus a detailed star map of a complete Imperial sector. GDW: 0210. \$30.00.

## MEGATRAVELLER

At better hobby stores everywhere. Order by mail (add 10% for shipping) or phone (Visa/MasterCard).

309-452-3632



P.O. Box 1646  
Bloomington, IL 61702-1646

## FIGHTING SHIPS

### of the Shattered Imperium

The ships of the Imperial Navy are in the hands of every Rebellion faction. Here are 58 ships of the Imperial Navy—from battleships to battle riders, from dreadnoughts to escorts, many with full-page illustrations.

#### Fighting Ships of the Shattered Imperium.

96-page book. GDW: 0218. \$10.00.

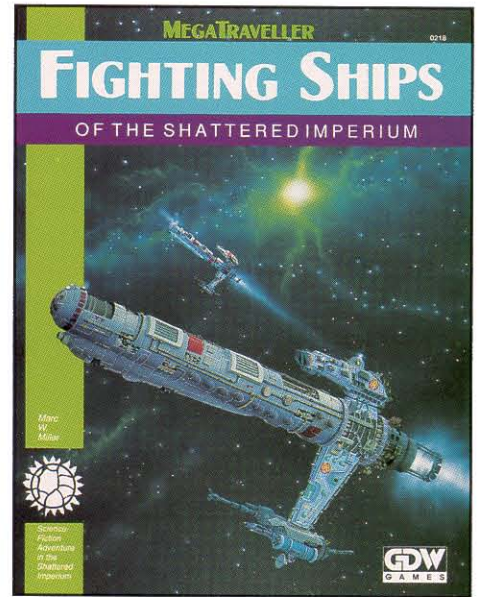

### COACC

COACC controls aircraft in the Imperium. Here is aircraft pilot character generation, aircraft design and combat, plus a campaign to win the Rebellion on one world.

96-page book. GDW: 0216. \$10.00.

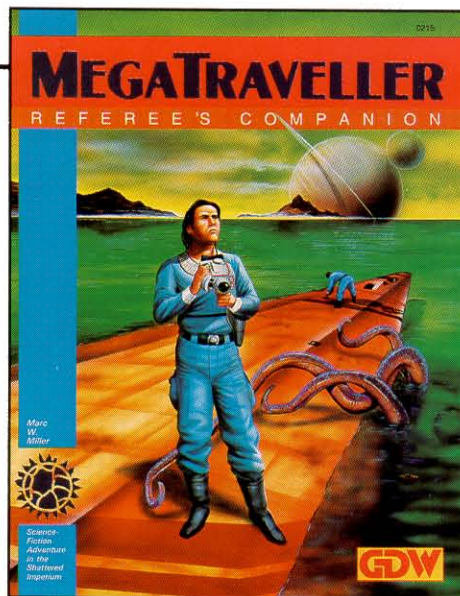

### REFEREE'S COMPANION

Rules expansions for the **MegaTraveller** referee: includes large-scale combat, timekeeping, communications, research, mapping, technology, and aliens.

96-page book. GDW: 0215. \$10.00.

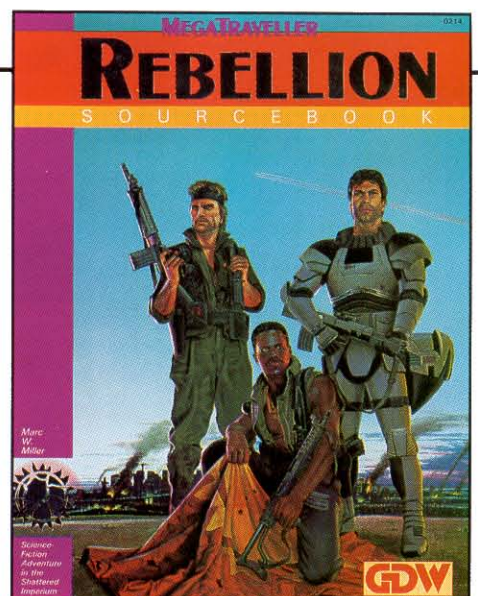

### REBELLION SOURCEBOOK

A fierce Rebellion shakes the Imperium—each faction fights for a piece of the rich star-spanning empire. Here are the Rebellion's sides, leaders, territories, and equipment.

96-page book. GDW: 0214. \$10.00.