

GENERAL

★ AVALON HILL

Volume 28, Number 3

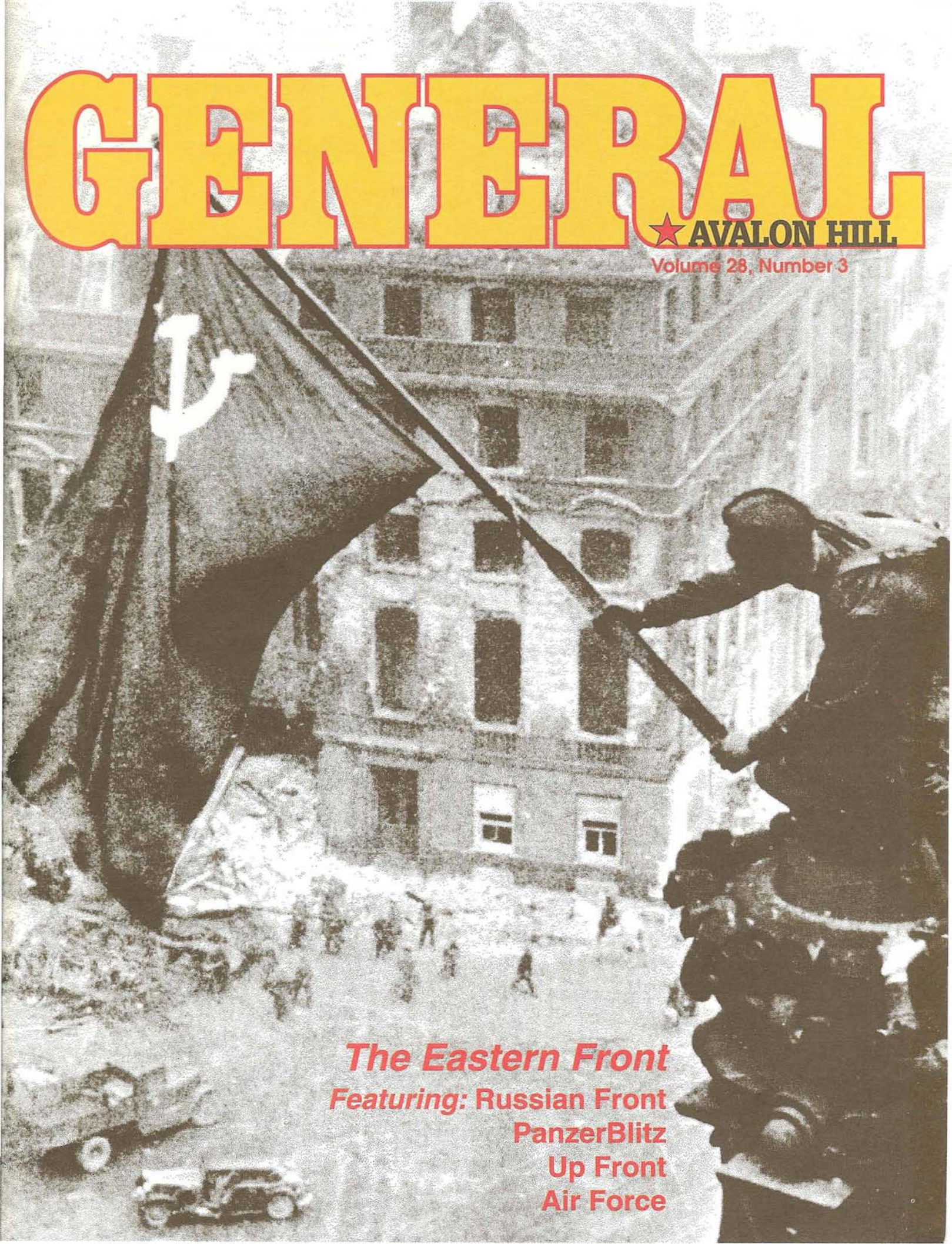

The Eastern Front
Featuring: Russian Front
PanzerBlitz
Up Front
Air Force

★ ★ The AVALON HILL
GENERAL

The Avalon Hill Game Company's *GENERAL* is dedicated to the presentation of authoritative articles on the strategy, tactics and variation of our games of skill. Historical articles are included only inasmuch as they provide useful background information on current AH titles. The *GENERAL* is published by The Avalon Hill Game Company solely for the cultural edification of the serious game aficionado, in the hopes of improving the game owner's proficiency of play and providing services not otherwise available to the game buff. The Avalon Hill Game Company is a division of Monarch-Avalon Industries, Inc. The shares of Monarch-Avalon, Inc. are publicly traded on the NASDAQ System under the symbol MAHI. For information about the Company, write Frank Fontanazza at the executive offices (4517 Harford Road, Baltimore, MD 21214).

Publication is bi-monthly with mailings made close to the end of February, April, June, August, October and December. All editorial and general mail should be sent to The Avalon Hill Game Company, 4517 Harford Road, Baltimore, MD 21214. One-year subscriptions are \$15.00. Two-year subscriptions are \$24.00. All domestic subscriptions sent via bulk permit. Domestic First Class Delivery and all subscriptions to Canada and Mexico must pay an additional \$15.00 per year postage charge. All overseas subscribers must add an additional \$25.00 per year postage charge. Send checks or money orders only. The Avalon Hill Game Company is not responsible for cash lost in transit. Those with a current American Express, VISA or MasterCard may call 800-999-3222 toll free to renew subscriptions or order merchandise. Absolutely no complaints or questions will be handled on this extension. Any business other than a credit card purchase must be handled by mail. Address changes must be submitted at least six weeks in advance to guarantee delivery. Paid advertising is not accepted, but news of importance to the gaming community is solicited. Convention announcements must be received at least six months in advance and contain information pertaining to The Avalon Hill Game Company's games in use.

Articles from subscribers are considered for publication at the discretion of our editorial staff. Articles should be typewritten, double-spaced, and embrace the tenets of standard English usage. (For submission of material in electronic format, please contact the Managing Editor beforehand.) There is no limit to word length. Accompanying diagrams should be neatly done, with appropriate captions. Photographs must have caption and credit line attached. Rejected materials will be returned whenever possible, provided return postage has been enclosed. Potential authors should be advised that all outside submissions become the sole property of Avalon Hill upon publication.

EXECUTIVE EDITOR: Donald J. Greenwood

MANAGING EDITOR: Don Hawthorne

GRAPHICS: Jean Baer, Charles Kibler and Matt Pumphrey

COVER ART: Yevgeni Khaldei and Charles Kibler

GENERAL Subscriptions: Kathleen Grazer

Purchase of Games, Kits and Parts: Theresa Naimaster

FOREIGN DISTRIBUTORS: Readers are urged to make subscription arrangements with their appropriate agent (address shown where phone number not available) -

AUSTRALIA: Jedko Games Ltd. (Victoria) 555-1022; BELGIUM: SPRL Prolude (32 Ave. de Teruuren, Box 32, 1040 Bruxelles); CANADA: Andromeda (Toronto) 682-8381, E&K Kroeger (Scarborough) 752-4382, L'Avenir (Montreal) 341-1561, TD Imports East (Cambridge) 623-5282, TD Imports West (Calgary) 252-2006; FINLAND: Fantasiapeli Tudeer Oy (Vantaa) 872-5950; FRANCE: Jeux Actuels (Caillouet) 3226-2257, Jeux Descartes (Paris) 4648-4820; GERMANY: Das Spiel (Hamburg) 044-8687, Games In (Munich) 523-4666, Welt der Spiel (Frankfurt) 380-8088; GREAT BRITAIN: T.M. Games (Littlehampton) 377-3170; GREECE: P. Marmalis Ludo (Athens) 293-2203; HONG KONG: Wargames & Computers (Hong Kong) 417-1587; ITALY: Fernando Ferrari (Verona) 580-00319, Stratelibri (Milano) 295-10317; JAPAN: Post Hobby Company (Tokyo) 3351-0471; NETHERLANDS: 999 Games (Amsterdam) 644-5794, Capful Books (Amsterdam) 625-5537; NEW ZEALAND: Blackwood Gayle Ltd. (P.O. Box 28358, Auckland); NORWAY: AEH Hobby (Pilestredet 7, 0180 Oslo 1); PORTUGAL: Frente Cri (PC Duque de Saldanha 20, R/C 1000, Lisboa); SINGAPORE: Wong International (Singapore) 545-3995 SOUTH AFRICA: Gamma Games Ltd. (P.O. Box 2904, Capetown 8000), Wizards Warehouse (Capetown) 461-9719; SPAIN: Joc Internacional (Barcelona) 345-8565, Naige Juegos (Madrid) 544-4319; SWEDEN: Target Games AB (Stockholm) 611-9585.

Questions: R&D; **Note:** All questions should be diagrammed. No questions can be answered which are unaccompanied by a self-addressed and stamped envelope. Questions must be based on the current edition of the rules of play (not historical or design matters). Questions on more than one title must be listed on separate pages and accompanied by a separate SASE for each game. Please, no phone calls regarding either rules questions or AREA ratings; such information will not be given without a written request.

IF YOU CHANGE YOUR ADDRESS: Inform us immediately! The Post Office destroys undeliverable magazines even if you leave a forwarding address. The Avalon Hill Game Company assumes no responsibility for issues lost due to an invalid address. Please state both your new and old address.

Copyright 1993

ISSN 0888-1081

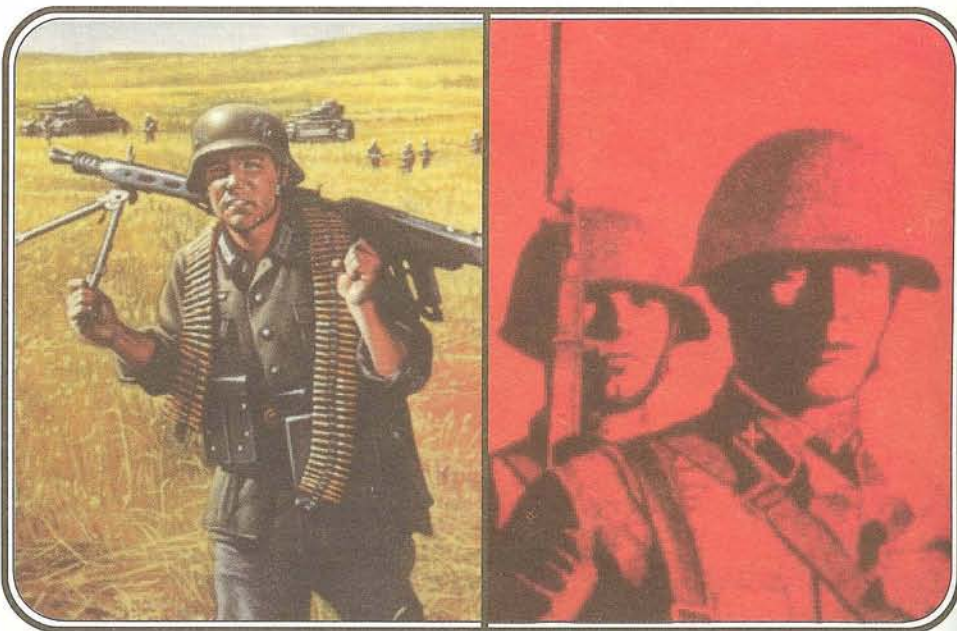

FEATURES

A STEPPE IN THE RIGHT DIRECTION The German First Turn in <i>RUSSIAN FRONT</i>	5 By Richard L. Miller
PANZER HUNTERS Tactical Air Support for the <i>PANZERBLITZ</i> Series	15 By Carl Schwamberger
NEW EXPRESSIONS FOR A FAMILIAR FACE Six New Scenarios for <i>PANZERBLITZ</i>	21 By Alan Arvold
THE NUMBERS GAME Rating the Scenarios of the <i>ASL</i> Family of Games	29 By Russ Gifford
THE BLACK SEA WALTZ Naval Movement Options in <i>RUSSIAN CAMPAIGN</i>	33 By James Lutz
A DECADE OF SHUFFLING ALONG <i>UP FRONT</i> Celebrates its 10th Anniversary	37 By Don Hawthorne
GOVERNMENT INTERVENTION IN <i>RAIL BARON</i> A Variant for AH's Game of Empire-Building	40 By Taylor, Brown & Marian
GONE BUT NOT FORGOTTEN... The World's Oldest Wargame	42 By Patrick Carroll
A FOND FRIENDSHIP RENEWED Re-Acquainting Oneself with <i>THE RUSSIAN CAMPAIGN</i>	46 By Art Kritzer
EASTERN SKIES An <i>AIR FORCE</i> Variant	57 By Andrew Visegrady

COLUMNS

AH Philosophy	4
Coming Attractions	25
Contest #162	I-3
Sports Special	35
Opponents Wanted	43
Letters to the Editor	44
Computer Corner	45
Readers Buyer's Guide	58
The Question Box (<i>TURNING POINT: STALINGRAD, UP FRONT</i>)	58
The Infiltrator's Report	59

AVALONCON

THE NATIONAL BOARDGAMING CHAMPIONSHIPS

**August 5th–8th, 1993
& August 4th–7th, 1994
BALTIMORE, MD**



Marriott Hunt Valley Inn, Hunt Valley, Maryland

In only two short years, AVALONCON has become THE place to be for boardgamers interested in pursuing their hobby to the highest level. Avalon Hill's "back to basics" approach has proven immensely popular with gamers who revel in four solid days of competition free from the commercial distractions of more conventional game conventions. Engaging in rated play with legitimate seeding systems and proper recognition for winners has given the boardgaming hobby a new sense of direction and esprit de corps which is truly infectious. Come see why 98% of all AVALONCON attendees swear they'll return to this Baltimore suburb next year for more of the same.

Be a part of the great reawakening of the boardgaming hobby.

Your \$30 pre-registration fee entitles you to all of the following features of AVALONCON:

- ★ Unlimited participation in as many events as you choose with no individual event fees or "sold-out" events.
- ★ FREE admission for spectators and those under 14.
- ★ FREE Juniors-only events for those 14 and under.
- ★ FREE AVALONCON souvenir T-shirt or hat.
- ★ A \$5 credit towards the purchase of any Avalon Hill or Victory Game.
- ★ FREE A.R.E.A. Rating System membership for any non-member.
- ★ Rated play of all games.
- ★ Championship plaques and merchandise credit prizes for all events.
- ★ FREE Team Tournament competition for groups of four.
- ★ FREE Convention program mailed to you by first class mail before the action begins.
- ★ Dedicated volunteer Gamesmasters in charge of only one event.
- ★ National and International-level competition (40% of our attendees live over 800 miles away).
- ★ Beginner-level events for the inexperienced where the game will be taught prior to play.
- ★ Pre-convention instruction kits provided by the GMs for certain events.
- ★ Perpetual plaques to record your victory throughout the history of AVALONCON.
- ★ Major coverage of all events in the GENERAL, plus ongoing updates in every issue.
- ★ Marriott's Hunt Valley Inn—a ★★★★★ luxury hotel with 25,000 sq. ft. of meeting space.
- ★ Light Rail access (\$2.50 roundtrip) to Baltimore's fabulous Inner Harbor attractions.
- ★ FREE parking in a pleasant suburban setting only steps from Hunt Valley Mall.

For more information on AVALONCON, send a SASE to:

The Avalon Hill Game Company

4517 Harford Road, Baltimore, MD 21214.

Pre-registration information will not be available until after March 31st, 1993.



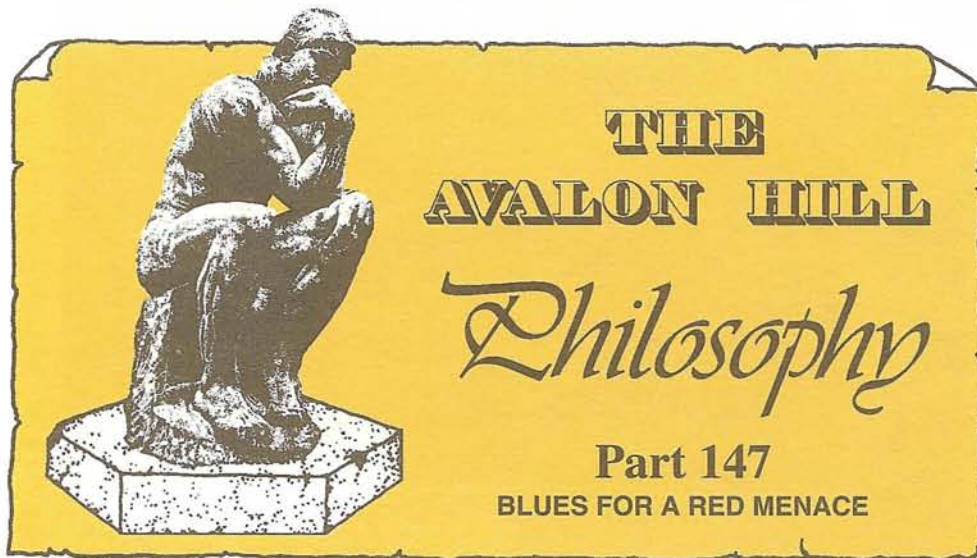

Once upon a time, there was an evil empire.

By the standards of its species, it was comparatively short-lived, having come into being near the start of the 20th century, and giving up its ghost less than a decade before the 21st.

Yet in that short span of time, it made itself master of the single largest national land mass on earth. It turned a collection of third-world nations into a superpower. It consistently staged confrontations with the planet's only real superpower and frequently come out ahead in such contests, at least temporarily.

While dragging its own population, kicking and screaming, out of the 18th century and into the 20th, it also brought the rest of humanity into the Space Age. And, perhaps most importantly, while accumulating a record of human rights violations possibly unsurpassed in modern history, it enjoyed the singular irony of having made the world safe for democracy.

It did not do so alone, of course, and in fact it could not even claim to have done so intentionally, for certainly democracy was the last thing its wartime leader was interested in. But it shouldered much more than its share of the burden for that victory, and in fact it is not unreasonable to state that a great portion of the free world owes its prosperity, and perhaps its existence, to the Union of Soviet Socialist Republics. For it was the USSR's war of extermination against National Socialist Germany which in the end allowed the global conflict to be won.

The character of the Soviet Union or its Communist leaders is almost of secondary importance when balanced against the threat of Nazi Germany, for no one familiar with Russian history could ever regard the USSR as a serious economic threat, and the history of world domination is invariably the history of commercial domination.

The same is certainly not true of Germany, which, whether provincial, Imperial, Nazi or democratic, has always been such an economic dynamo that many of the abuses heaped upon it at the end of the First World War were engineered by a Western Europe desperate to cripple the commercial giant in its midst. But while the Communists (and certainly Stalin, who morally shared far more in common with Hitler than with any member of his own Politburo except possibly Beria) can be justly vilified for having fought the Great Patriotic War as much with the blood of their citizens as with bullets, it must be recognized

that they were locked in literally mortal combat with an opponent against whom nothing less terrible would have served.

The citizens of the Soviet Union and Nazi Germany both enjoyed a very clear understanding of the reasons for their conflict. Some are far less credible today than they must have seemed in the face of burgeoning Socialism or Nazi aggression, but the fact remains that their sacrifices were made in good faith at the time, and in the context of the times in which they lived.

What each nation lost on the Eastern Front was also clear at the time: Germany her national sovereignty; Russia almost 25 million of her people. What they gained in the years following seemed equally obvious: Germany an economy re-built by the West and unfettered by the military or expansionist requirements which had undermined it for decades; Russia the status of superpower.

Yet now, less than half a century since the end of the Second World War, the victorious nation of that theatre of the conflict has only recently ceased to exist, in name if not in spirit. The aggressor nation, divided to prevent any future attempts at conquest, has been re-unified, and as Germany begins to court the former constituent republics of the now-defunct USSR, she stands poised to gain by commerce what eluded her in conquest.

But, the point must be granted; this Germany is not that Germany, just as this Russia is not that Russia. The world moves on, and the political entities which dominate the 21st century will very likely bear little resemblance to those of the 20th.

From the perspective of history then, of a world where many more people living in it were born after the war than during or before it, what was it for? What was really gained? The Western Allies and the Soviet Union proceeded to embark on a fifty-year armed truce of escalating hatred and distrust, finally ending only when the economically impaired USSR bankrupted itself maintaining the arms race. It seemed that all we gained was a replay of the war within a generation. But that was not the real victory.

Until recently, there has been in the west only grudging acknowledgement at best of the role played by the Soviet Union in the Second World War. That Stalin used his nation's part in the conflict to steal as much territory as possible at every opportunity certainly did nothing to help the USSR's image. It is not even uncommon to hear

gamers voice the opinion: "The Eastern Front; what a great war! Whichever one loses, you don't care!" But to hold such an opinion is to take a very limited view of history.

What the Soviet Union (whatever its faults) gained for the West (Germany included) and itself, was time.

The Allies fighting in the Western and Mediterranean theatres never faced more than 30% of Germany's available ground forces; the balance were engaged in the East. Had the Soviet Union fallen, vast amounts of garrison troops would certainly have been required to hold it, but much of these would have come from internal puppet-regimes the Nazis intended to create.

If we assume only half of those Wehrmacht forces engaged in the East had been freed to face the Western Allies in France, Italy and Germany, the prospect for a protracted, bloody conflict becomes horrendous. In the end, America would have been faced with three choices: Abandon the occupied territories to Germany; continue a bloody war of attrition from the air and on the ground; or use the new atomic bomb in Europe. With the American people's characteristic hatred of dictators, the first option was unlikely; their historic distaste for needless bloodshed and graphic memories of the First World War made the second option even more so. And here, one should remember that the deciding factor in Truman's choice to use atomic weapons against Japan was the projected casualties among American troops and Japanese civilians.

It can be argued then, that with the ignorance of the sort of damage nuclear weapons were capable of—remember, *nobody* knew what they could do in 1945, and even many who saw their effect found the scope of the destructiveness impossible to grasp, and their long-term effects were unsuspected—it is frighteningly likely that the third option would have been chosen. And whatever of Europe survived such a conflagration would likely not have been worth saving.

In the end, however, the United States was spared such a decision. The sacrifices of the Allied nations, together, brought the German armed forces to their knees. After the war, the laws of those Allied forces, applied with justified moral superiority, proclaimed to the world that such abuses in the name of nationalism would no longer be tolerated by civilized peoples. Those laws helped to bring about and maintain an era of peace on a scale unknown to the three generations of humanity that had lived before them.

Was such an extended period of peace likely in a world where Nazi Germany had *not* been defeated? There were abuses by and among the victors, to be sure, and many episodes where the fragile peace was nearly broken. But nothing like the sort of posturing which could have been expected from the successors of Hitler.

As the great nations which emerged from the Second World War struggled to co-exist in the world they had created, they used that time of relative peace to come to terms with the concept of Superpowers, nuclear weapons and the death of Empires. They learned, with at least some success, to recognize dictators as they ascend to power and perhaps limit the amount of damage they can do. Most importantly, they have attempted to learn to come to terms with one another, so that the next century need be as little like the last as possible.

(Continued on Page 57)

✚ A STEPPE IN THE RIGHT DIRECTION ★

The German First Turn in RUSSIAN FRONT

By Richard Lanson Miller

When studying Operation *Barbarossa*, the German campaign for the invasion of Soviet Russia, one is struck by the fact that no clear operational objective seems to have been envisioned; three army groups of approximately equal strength attacked wholly divergent objectives. This inability (or unwillingness) to concentrate Germany's limited offensive power at one decisive point led to a prolonged war of attrition and Germany's ultimate defeat in 1945.

This lack of strategic direction was a result of the opposing opinions between Hitler and his OKW staff (the High Command of the Armed Forces) and those of Halder and the OKH staff (the Army High Command). Hitler wanted to make drives to the extreme north and south of Soviet Russia for economic reasons. In the north was Leningrad, named for the father of the Bolshevik Revolution, with its munitions plants, shipyards and tank assembly lines. Leningrad was also a fortress in the Gulf of Finland and home of the Soviet Baltic Fleet. Quite clearly, the city was an objective of immense political, economic, and military value. To the south was the grain of the Ukraine and the oil fields of the Caucasus. Hitler reasoned that if these two areas could be captured, Germany's economic position would be vastly improved, while the military-economic strength of the Soviet Union would wither away. Hitler's most pressing concern was to capture the Crimea to "eliminate this dangerous aircraft carrier[sic] operating against the Rumanian oilfields."

In contrast, Halder advocated a single thrust towards Moscow. The fall of the Soviet capital, he reasoned, would decide the outcome of the entire campaign, for Moscow was a principal producer of armaments, an important political center, and the primary hub of the rail transportation system of all European Russia. Moscow's

capture would have an enormous psychological impact not only on the Russian people, but on the rest of the world as well. Halder's argument was in complete accord with Clausewitz' dictum: "First, the enemy's armies in the field must be smashed, then his capital must be occupied." *RUSSIAN FRONT* presents you, as the German player, with the same strategic considerations as your historic counterparts — without the "benefit" of Hitler's intuition. This article presents a hypothetical playing out of the game's opening moves to more clearly illustrate the principles presented herein. Average die rolls have been assumed, but the most important aspect of this undertaking is planning out the integration of all the elements in the Wehrmacht's arsenal. This is an undertaking of great risk requiring absolute precision and consummate skill. It is up to you to take the first steppe . . .

GERMAN STRATEGY

The strategic key to victory lies to the south, on the steppes, for the overriding concern of German offensive strategy is to capture the maximum number of objectives in the least amount of time with minimum casualties. Key cities can be captured by following the path of least resistance to avoid the entanglement with massive Soviet reinforcements inevitable in any protraction of the conflict. There are at least four turns of fair weather in 1941, and fair weather is possible in October and November in the Central and South Weather Zones. The German player must be ready to exploit any opportunities such good weather might offer.

Table I shows the list of objectives that are attainable in 1941. The objectives are assigned to five army groups, and a City/Objective Ratio is given for each army group. The ratio is used to assign forces proportionate to the task at hand.

The rule of thumb here is to "spend" the best German assets on tasks which have the greatest potential return on such investments. Of the five ratios given, the figure for Army Group South is

**TABLE I
AXIS OBJECTIVES
FOR 1941**

Force and Target Cities	Objective Count	City/Objective Ratio
Finnish Army		
1. Hango [UU-11]	(1)	
2. Petrozavodsk [UU-24]	(1)	2/2
Army Group North		
1. Tallinn [SS-12]	(1)*(ARC)	
2. Riga [NN-9]	(1)*(ARC)	
3. Pskov [MM-15]	(1)	
4. Novgorod [NN-17]	(1)	4/4
Army Group Center		
1. Brest-Litovsk [BB-4]	(1)	
2. Vilna [GG-9]	(1)*(ARC)	
3. Minsk [DD-11]	(3)	
4. Vitebsk [FF-15]	(1)	
5. Gomel [Y-14]	(1)	
6. Smolensk [DD-17]	(2)	
7. Bryansk [Z-18]	(1)	7/10
Army Group South		
1. Lwow [V-3]	(1)	
2. Vinnitsa [R-8]	(1)	
3. Kiev [U-12]	(3)*(ARC)	
4. Dnepropetrovsk [M-18]	(2)*(ARC)	
5. Stalino [K-21]	(1)	
6. Kharkov [Q-20]	(4)	
7. Kursk [U-21]	(1)	
8. Orel [X-21]	(1)	8/14
Rumanian Army		
1. Odessa [J-10]	(1)	1/1

* (ARC): Axis Replacement City

TABLE II
RUSSIAN REINFORCEMENTS
IN 1941

	JUL	AUG	SEP	OCT	NOV	DEC	TOTAL
LENINGRAD	1	3	2	-	-	-	6
MOSCOW	3	4	9	-	3	5	24
KIEV	1	-	-	-	-	-	1
KHARKOV	-	4	-	-	-	-	4
DNEPROPETROVSK	2	-	-	-	-	-	2
ROSTOV	-	-	-	3	-	-	3
SEVASTOPOL	-	1	-	-	-	-	1
STALINGRAD	-	-	-	-	-	1	1
ANY	-	-	-	1	4	4	9
TOTALS:	7	12	11	4	7	10	51

indicative: The capture of eight cities will yield fourteen objectives, a very favorable ratio. Army Group Center has the next best ratio, yielding ten objectives for seven cities. The remaining three army groups all have ratios in the "one-to-one" category, giving one objective per city captured. Forces commensurate for such objectives can be assigned accordingly.

A look at Table II shows the total of newly arriving Russian forces for 1941. Twenty-four units are scheduled to appear at Moscow alone, virtually half of all reinforcements for the year. A total of eight Russian units will arrive in Army Group South's sector during the first four turns, and of these, two are infantry units scheduled to appear at Dnepropetrovsk in July, with four more appearing at Kharkov in August.

If the German player can advance his forces quickly enough, he can impose reinforcement arrival restrictions through clever positioning of his own units. Such restrictions will delay the Soviet units' arrival and may force the Russian player to place them in less advantageous locations. (Note that the "Standard Reinforcement Schedule" would not apply if the Optional Limited Intelligence Rules are in effect).

Our main drive, therefore, will be made through the Kiev Military District. Here, there are few obstacles to an armored advance, as the multitude of clear terrain provides excellent tank country; and while the rail network is inconvenient, we can offset this in a unique manner.

Historically, the planners of Operation *Barbarossa* chose this "classic" invasion route to Moscow — with the bulk of the invading forces, Army Groups North and Center, pushing eastward to the north of the Pripyet Marshes — because of the quality of the transportation network in the area, as that network was ideal for supplying mobile operations. The terrain itself, however, was *not* ideal for such mobile conflict as the transportation network was expected to support. The solution therefore is to supply the panzerkorps in the south with the superior rail net in the north. The primary rail line in the north will run from Brest-Litovsk (BB-4) to Minsk (HH-12). If stiff Russian opposition is encoun-

tered near Minsk, the rail line leading from JJ-5 to Riga (NN-9) to Vitebsk (FF-15) will become the primary line instead. The rail from Minsk (DD-11) or Vitebsk will be converted to Smolensk (DD-17) and Bryansk (Z-18) or Gomel (Y-14) and Kursk (U-21), as required.

In July, the southern panzer drive will be supplied by air from Lublin (AA-2) or Brest-Litovsk (BB-4) for the Ground Movement Step, and by newly-converted rail lines leading from Brest-Litovsk for the Exploitation Phase. The panzerkorps will drive towards Kursk and Orel (X-21). In August, they will be supplied by air from Minsk or Vitebsk for the Ground Movement

Step. The three panzerkorps from the northern drive will then join with those advancing on Kursk and Orel.

A total of 22 Russian cities yielding 31 Axis objectives, combined with the ten cities in Axis control at the start of the game, gives a grand total of 41 Axis objectives; a Marginal Victory for the German player at the first Victory Level Phase. If the Germans can capture Tula (AA-24) and Voronezh (T-24) and prevent the Siberians from re-capturing any cities, they will have a Decisive Victory in November, 1941.

Any strategy must ultimately be translated into individual unit assignments, and these assignments will be discussed as delineated by sector. (A note on terminology is perhaps in order: When discussing specific units involved in a given operation, it is easy to become confused over which is German or Russian. Therefore, German units will be referred to as panzers, panzerkorps, fliegerkorps, kriegsmarine, mountain, or infanterie; Russian units will be referred to as armor, air force, navy, or infantry; Finnish and Rumanian units will be identified by nationality and type.) The weather is Fair in all Weather Zones in June, 1941. All Advanced and Optional Rules are in effect, except Option 19.5. Consult Table 3 for Battle Locations.

FINNISH SECTOR

The low Finnish replacement rate dictates a rather conservative offense. Strong air and



ground forces will assault Hango, with additional air coverage provided by Army Group North. The Finnish Navy attempts a minelaying at PP-8, while blocking Russian naval interference with the Kriegsmarine at NN-5. Preliminary preparations are made for a drive on the Svir River and Petrozavodsk (UU-24).

Battle Locations: UU-11, PP-8.

Combats: The 1st Fliegerkorps, flying out of Memel, protects the Finnish forces from Soviet air power based in Leningrad. The 4th Finnish Infantry, supported by the Finnish Air Force, eliminates the Hango garrison with a loss of one infantry hit. The Finnish Navy is eliminated in a naval combat with the Soviet Navy (3-3-7) from Riga. The 2nd Finnish Infantry converts the rail in XX-19.

BALTIC SECTOR

The Baltic line will be breached and encircled by exploiting panzers and interdicting German air. Retreat routes are blocked to guarantee elimination of some Russian units, and a gap will be created for the Reserve units to move through.

Battle Locations: JJ-6, JJ-7, II-8, NN-5, MM-6, LL-6, KK-6, II-7.

Combats: The 41st and 56th panzerkorps Blitz the 16th Infantry at JJ-6, eliminating the 16th in two rounds of combat.

The 41st and 56th use Blitz movement to reach KK-7 and LL-7, converting the rail line in each hex. The 2nd and 8th Fliegerkorps interdict JJ-7 and II-8, surrounding a portion of the Baltic line, in conjunction with the two blitzing panzers. The 13th Infanterie is in JJ-6 to block retreating Russian units.

TABLE III
BATTLE LOCATION HEX COORDINATES

Combat	Hex	Axis Units	Russian Units	CRT Column
1.	JJ-7	1 Air	Interdiction	—
2.	II-8	2 Air	Interdiction	—
3.	G-11	R Air, R Nav	Minelaying	—
4.	PP-8	F Nav	3-3-7 Nav	-2
5.	J-10	BS Nav	4-4-7 Nav	0
6.	JJ-6	41 Pz, 56 Pz, 13 Inf	16 Inf	+5
7.	EE-6	57 Pz, 20 Inf	21 Inf	+4
8.	Y-4	4 Air, 3 Pz, 14 Pz, 24 Pz, 39 Pz, 46 Pz, 47 Pz, 48 Pz	15 Arm	+7
9.	UU-11	F Air, 4F Inf	Hango Inf	+4
10.	NN-5	10 Inf, B Nav	10 Inf	+7
11.	MM-6	2 Inf	12 Arm	+4
12.	LL-6	53 Inf	11 Inf	+3
13.	KK-6	5 Inf	3 Arm	+4
14.	II-7	7 Inf, 9 Inf	29 Inf	+2
15.	FF-6	43 Inf	11 Arm	+3
16.	EE-4	12 Inf	13 Arm	+3
17.	BB-4	8 Air, 49 Mtn	28 Inf	+4
18.	AA-4	44 Inf	16 Arm	+3
19.	Z-4	17 Inf	4 Arm	+1
20.	X-3	4 Inf	6 Inf	+4
21.	Q-4	5 Air, 30 Inf	22 Arm	+7
22.	L-6	1R Mtn	35 Inf	+1
23.	L-8	4R Inf	2 Arm	+1

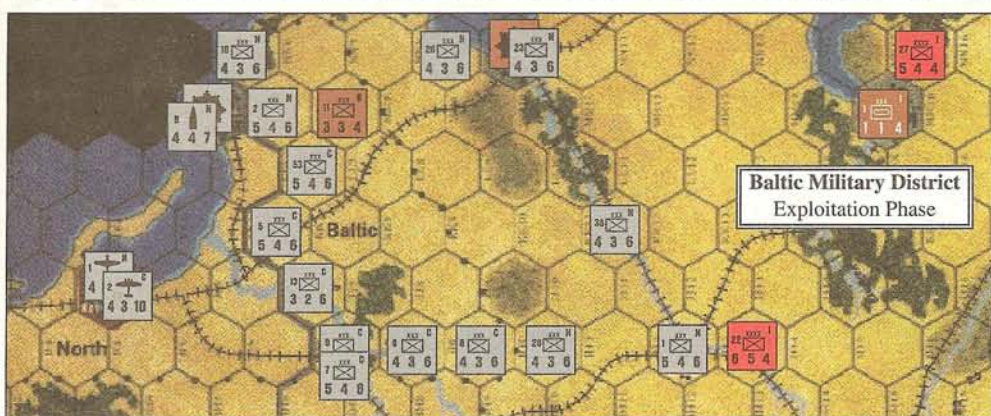

Five Soviet units are engaged by elements of Army Groups North and Center: The 10th Infanterie and the Kriegsmarine (4-4-7) eliminate the 10th Infantry in NN-5; the 2nd Infanterie eliminates the 12th Armor in MM-6; the 53rd Infanterie suffers one hit attacking the 11th Infantry in LL-6, forcing the 11th to retreat to MM-7 with two hits; the 5th Infanterie converts the rail in KK-6 and takes one hit to eliminate the 3rd Armor there; the 7th Infanterie (backed up by the 9th Infanterie) takes two hits to eliminate the 29th Infantry in II-7, converting the rail in the process. A substantial gap has now been created in the Baltic line.

Exploitation Phase: The 41st Panzerkorps moves to GG-11 and the 56th goes to HH-10. Reserve infanterie exploit the gap in the line. They will combine Strategic Movement on the newly converted rail hexes in JJ-5, KK-6, and KK-7 with ground movement to maximize use of their movement factors. Three units form a supply corridor to the Army Group North Panzers: the 28th moves to II-10, the 6th moves to II-9, and the 8th moves to II-8. The 1st Infanterie, absorbing one hit for Extra Movement, occupies Dvinsk (II-12), preventing the Russian 22nd Infantry from using Strategic Movement. The 38th Infanterie moves to KK-11. The 23rd Infanterie takes one hit for Extra Movement to



take Riga. And the 26th Infanterie blocks coastal supply in NN-8 from retreating Russians. Vilna is isolated and the Russian player is denied the use of the airbases in Dvinsk and Riga. The Reserve infanterie is positioned to convert the rail line running from KK-6 to Riga to Vitebsk in July on Turn Two.

WESTERN SECTOR

The Grodno salient will be cleared and a panzerkorps will move through the gap to seal the Vilna pocket in conjunction with elements of Army Group North.

Battle Locations: EE-6, EE-4, FF-6.

Combats: The 57th Panzerkorps takes one hit as it blitzes the 21st Infantry at EE-6, eliminating it in two rounds of combat. The 57th stops at EE-7.

The 20th Infanterie converts the rail in EE-6 and blocks retreat into this hex by adjacent Russians. The 42nd Infanterie converts the rail in EE-5 and protects the rail line from any retreat by the 13th Armor in EE-4. The 12th Infanterie

converts the rail line in EE-3 and EE-4 and eliminates the 13th Armor in EE-4. The 43rd Infanterie converts the rail line and eliminates the 11th Armor in FF-6.

Exploitation Phase: The 57th Panzer now proceeds to DD-10 and cuts the Russian supply line running from Minsk. The Vilna salient is now completely isolated.

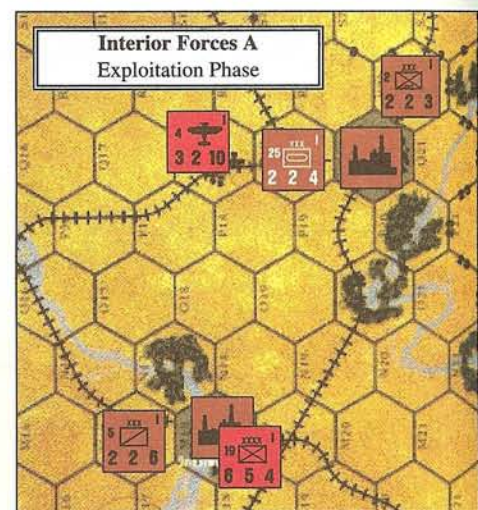
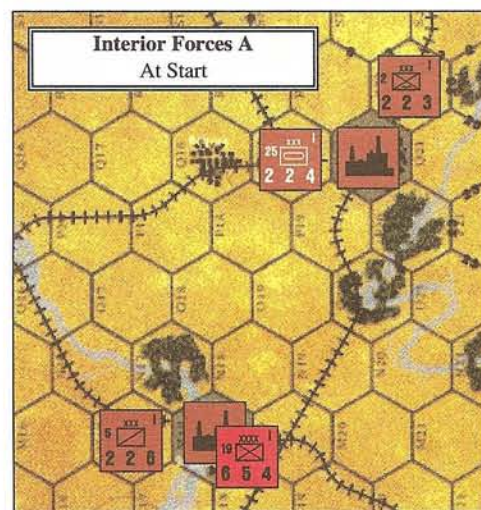

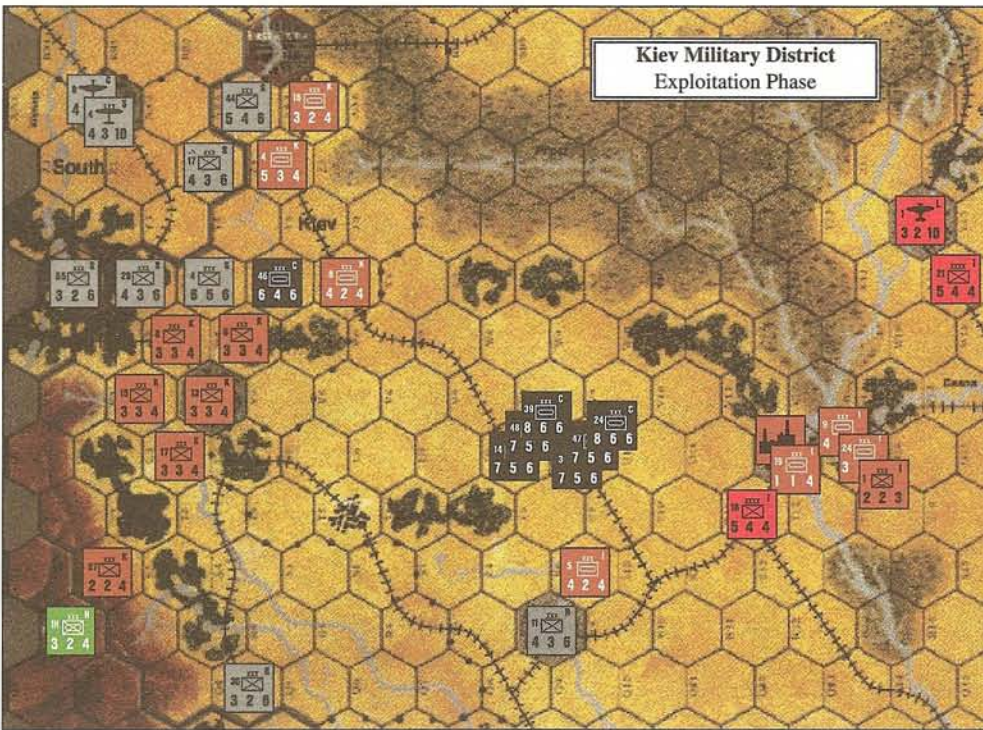

KIEV SECTOR

Panzerkorps from Army Groups Center and South make a concentrated blow at one hex, penetrate the line, and cut the rail line at U-9 and U-8, leaving several Russian units out of supply.

Battle Locations: Y-4, BB-4, AA-4, Z-4, X-3.

Combats: The 5th Fliegerkorps supports seven panzerkorps (3rd, 14th, 24th, 39th, 46th, 47th & 48th) in the blitz on the 15th Armor in Y-4. The 15th Armor is eliminated in one round and six panzerkorps proceed to W-5. The 46th Panzerkorps stops at X-4. The six remaining panzerkorps proceed to W-5 using Extra Movement. The six panzerkorps incurred one hit

each to move to W-5. This movement is necessary to allow the panzerkorps to move freely in the Exploitation Phase. (If two rounds of combat were required to eliminate the 15th Armor, the six panzerkorps would have had to suffer two hits apiece for Extra Movement.) If the 8th Armor executes a Response Movement, one panzerkorps will combat it while the others move on.

The 4th Fliegerkorps supports the 49th Mountain in the assault on the 28th Infantry in Brest-Litovsk. The 49th absorbs one hit, converts the rail, and eliminates the 28th in two rounds of combat. The 44th Infantry takes a hit and

forces the 16th Armor to retreat from AA-4 with one hit. The 17th Infantry retreats to Z-3 with two hits in an attack on the 4th Armor in Z-4 (which suffers one hit). The 4th Infantry attacks the 6th Infantry in X-3 and the 6th retreats to W-4 with two hits.

The 29th Infantry converts the rail in X-2. A supply corridor to the spearhead at W-5 is opened through the 46th Panzerkorps at X-4, the 4th Infantry at X-3, the 29th Infantry at X-2, and the 55th Infantry at X-1. The 52nd Infantry converts the rail in CC-4 and maintains supply to the new German airbase at Brest-Litovsk.

Exploitation Phase: The 3rd, 24th, and 47th Panzerkorps proceed to the rail hex U-9. The 14th, 39th, and 48th Panzerkorps moves to the rail hex at U-8. The Russian player may successfully recapture one of these rail hexes, but not both. This insures that the rail line will stay cut. These two hexes are an excellent location to hold, as the panzerkorps are difficult to surround and the area is in range of defensive air support from Lublin. Exposure to hostile air attack is minimized because enemy airbases are themselves either out of range (as at Odessa (J-10) and Poltava (Q-18)), in danger of being overrun (Minsk (DD-11), Kiev (U-12), and Vinnitsa (R-8)) or are neutralized in the initial attack (Lwow (V-3) and Tarnopol (T-5)). Gomel (Y-14) is the only airbase in range. At most, only two Russian air units can possibly menace the panzer spearhead. The 46th Panzerkorps remains in X-4.

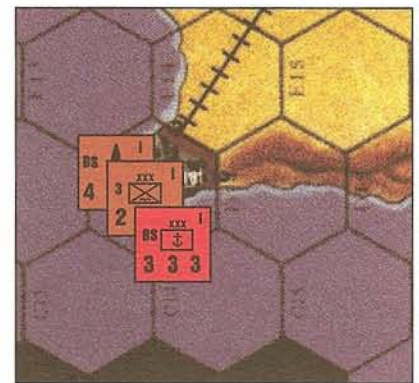

Interior Forces B At Start

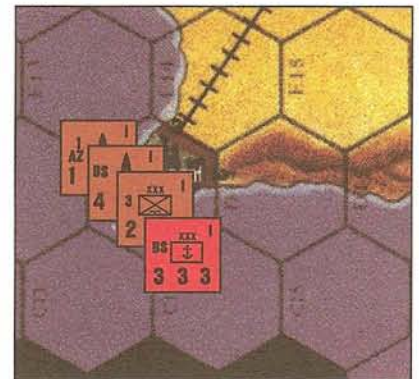

Interior Forces B Exploitation Phase

ODESSA SECTOR

Axis forces must cut the rail lines to the Odessa and Kiev Military Districts and protect Bukharest, Ploesti, and Constanta. The Rumanian Air Force will be employed in a Strategic Bombing mission. The Kriegsmarine will tie up the Russian Navy in a minesweeping attempt on Odessa while the Rumanian Flotilla conducts minelaying operations.

Battle Locations: D-13, J-10, I-8, L-6, L-8.

Combats: The Rumanian Air Force bombs Sevastopol (D-13) in a Railroad Attack, reducing the Russian rail movement to zero. The Kriegsmarine (3-3-7) attempts to minesweep Odessa (J-10), engaging the Russian Navy (4-4-7) on the "0" column of the Combat Results Table. If the German player is lucky and rolls a series of "fives" or "sixes", he can inflict serious casualties and may successfully sweep the minefield. If he is not so lucky he can break off the attack, confident at least in the knowledge that the Russian Navy has been tied up long enough for the Rumanian Navy to lay a mine at I-8. (In actual combat, the Kriegsmarine absorbs one hit and retreats.)

The Rumanian 4th Infanterie and 1st Mountain attack the Russian 2nd Armor and 35th Infantry respectively. This neutralizes enemy zones of control and allows the 54th Infanterie to move to K-10, cutting the rail line. (The Rumanian 4th Infantry is itself eliminated while eliminating the 2nd Armor.) The Rumanian 1st Mountain takes a hit in forcing the 35th Infantry (also taking one hit) to retreat to L-7. The 11th Infanterie cuts the rail line in Tarnopol. In July, an attempt will be made to convert the rail line from P-3 in Romania to Tarnopol, bypassing any resistance in Lwow. This will give the German player an airbase in range of Odessa and Kiev.



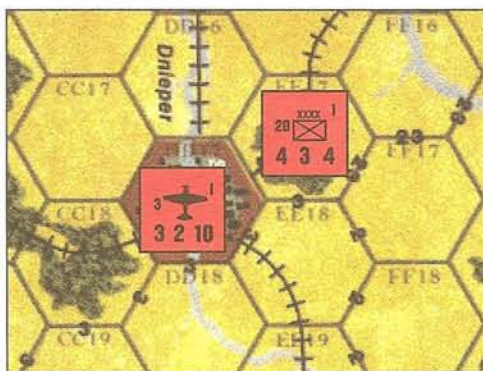

RETURNS — TRANSFERS

AXIS AIR: The Finnish Air Force bases at Turku with the 1st Fliegerkorps to make it difficult for the Russian Air Force to make an airbase attack. The remaining fliegerkorps are situated at two bases: The 2nd and 8th in Königsburg, and the 4th and 5th in Lublin. These are purposely placed out of range of Russian airbases, yet still able to provide defensive air support to friendly ground formations. If they were deployed at forward airbases, the Russian player could tie up two fliegerkorps at one base with a single Russian air unit. This would deprive the German ground units of defensive air support and render them vulnerable to counterattack. The Rumanian Air Force returns to Constanta.

AXIS NAVY: In the Baltic Sea, the Finnish Navy is eliminated and the Kriegsmarine (4-4-7) returns to Memel. In the Black Sea, the Kriegsmarine (3-3-7) and Rumanian Navy return to Constanta.

RUSSIAN AIR: The 1st Air Force stays in Leningrad, the 3rd Air Force transfers to Gomel and the 4th Air Force transfers to Odessa.

RUSSIAN NAVY: The Onego Navy remains in Petrozavodsk. The Ladoga Navy transfers to Schlüsselburg. In the Baltic Sea, the 5-5-7 Navy transfers to Leningrad and the 3-3-7 Navy goes to Tallinn. In the Black Sea, the 4-4-7 Navy stays in Odessa and the 2-2-7 Navy remains in Sevastopol. The 1-1-7 Navy transfers to Sevastopol.

CASUALTIES

Table IV lists the Axis and Russian casualties for the Axis Phase of Turn One.

The Axis forces suffered 24 hits, 16 of which occurred in combat and eight by Extra Movement. 12 Russian units were eliminated and seven hits were absorbed by surviving units.

**TABLE V
AXIS RAIL CONVERSIONS**

BOARD A	BOARD B
XX-19	KK-6
	KK-7
BOARD C	LL-7
R-8	II-7
Q-4	FF-6
	EE-6
BOARD D	EE-5
None	EE-4
	EE-3
	CC-4
	BB-4
	X-2

RAIL CONVERSIONS

Table V lists the 13 Russian rail hexes converted by the German player on Turn One.

**TABLE IV
AXIS/RUSSIAN CASUALTIES**

Axis	Unit	Location	Retreat	Hits	Cause	Russian	Unit	Location	Retreat	Hits	Cause
1. Finnish	4F Inf	UU-11	—	1	Combat	1. Russian	HN Inf	UU-11	—	1 (Elim)	Combat
2. "	F Nav	PP-8	—	1 (Elim)	Combat	2. "	3 Arm	KK-6	—	2 (Elim)	Combat
3. German	1 Inf	II-12	—	1	Extra Movement	3. "	12 Arm	MM-6	—	2 (Elim)	Combat
4. "	5 Inf	KK-6	—	1	Combat	4. "	10 Inf	NN-5	—	2 (Elim)	Combat
5. "	7 Inf	II-7	—	2	Combat	5. "	29 Inf	II-7	—	2 (Elim)	Combat
6. "	12 Inf	EE-4	—	1	Combat	6. "	16 Inf	JJ-6	—	3 (Elim)	Combat
7. "	17 Inf	Z-4	Z-3	2	Combat	7. "	11 Arm	FF-6	—	2 (Elim)	Combat
8. "	23 Inf	NN-9	—	1	Extra Movement	8. "	13 Arm	EE-4	—	2 (Elim)	Combat
9. "	44 Inf	AA-4	—	1	Combat	9. "	21 Inf	EE-6	—	3 (Elim)	Combat
10. "	49 Mtn	BB-4	—	1	Combat	10. "	28 Inf	BB-4	—	3 (Elim)	Combat
11. "	53 Inf	LL-6	—	1	Combat	11. "	22 Arm	Q-4	—	2 (Elim)	Combat
12. "	3 Pz	W-5	—	1	Extra Movement	12. "	15 Arm	Y-4	—	3 (Elim)	Combat
13. "	14 Pz	W-5	—	1	Extra Movement	13. "	2 Arm	L-8	—	2 (Elim)	Combat
14. "	24 Pz	W-5	—	1	Extra Movement	14. "	11 Inf	LL-6	MM-7	2	Combat
15. "	39 Pz	W-5	—	1	Extra Movement	15. "	16 Arm	AA-4	AA-5	1	Combat
16. "	47 Pz	W-5	—	1	Extra Movement	16. "	4 Arm	Z-4	—	1	Combat
17. "	48 Pz	W-5	—	1	Extra Movement	17. "	6 Inf	X-3	W-4	1	Combat
18. "	57 Pz	EE-6	—	1	Combat	18. "	35 Inf	L-6	L-7	1	Combat
19. "	BS Nav	J-10	I-10	1	Combat						
20. Rumanian	1R Mtn	L-6	—	1	Combat						
21. "	4R Inf	L-8	—	2 (Elim)	Combat						

BATTLE SUMMARY (AXIS)

REPLACEMENT COSTS

1 Finnish Infantry hit	1
1 Finnish Navy hit	2
11 German Infantry hits	11
7 German Panzer hits	14
1 German Naval hit	2
3 Rumanian Infantry hits	4 (Includes Rebuild cost)

TOTAL: 34 Replacement Factors

BATTLE SUMMARY (RUSSIAN)

REPLACEMENT COSTS

13 units Eliminated	Non-replaceable
2 Armor hits	4
5 Infantry hits	5

TOTAL: 9 Replacement Factors

SUMMARY

The first step in any strategic plan is to define the objectives to be taken. The objectives chosen should reflect an understanding of the fact that the Russian Bear cannot be defeated in a long, drawn out struggle, but must be slain quickly and decisively, in a single lightning blow. Any deviation from this fundamental truth will almost certainly result in a repeat of history. Therefore, it is essential to concentrate the (essentially limited) offensive power of the panzerkorps in one massive blow at one decisive point.

The armored units, together with their supporting air units, are the heart of the Axis armies, and so must be deployed for maximum effectiveness. They operate superbly on the open steppes, but are far less effective in cities, marshes, mountains, and forests. They are very expensive to repair, even when the refit capability is used. Whenever possible, they must attack at high odds to minimize casualties. In addition, care must be taken to insure that all friendly units receive adequate defensive air support. This is especially true for the panzerkorps, which can easily outrun their protective aerial umbrella and may thus become vulnerable to crushing counterattacks. By the same token, friendly airbases must be sited out of range of enemy airbases to avoid airbase attacks on themselves.

There are several useful tactics that can confer numerous incremental advantages: The 2nd and 5th Fliegerkorps are Withdrawal units. Be mindful of how you use them, because when each is withdrawn, a number of replacement factors equal to the unit's defense factor *minus any hits on the withdrawn unit* may be recorded as excess replacement factors for later use.

Use every opportunity to eliminate non-replaceable Russian armor and cavalry units. The Russian player can use such armor which survives for replacement points later, and the cavalry can be used to substitute for Guards cavalry.

German replacements should be channeled to those units that need them the most, not the rear echelon. The 6-5-6 Infanterie and the 5-5-6 Mountain units are your heavy-hitters. Give these units top priority for replacements, as they are an excellent reserve to keep available on the rail lines for contingencies. The infanterie should convert only the most essential rail hexes in the initial drive and make full use of Strategic Movement to support the fast moving troops. Do not waste a single movement point.

SPECIAL THANKS

I was inspired to write this article after reading "The Steppes: Key To Victory" by Mr. Paul E. Morrison in Volume 24, number 1 of The *GENERAL*. I would like to thank Mr. Morrison for the strategic guidance his article provided me while writing "A Steppe In The Right Direction". Although I cannot guarantee a German victory with the principles I have described herein, I can promise you an exciting opening turn of *RUSSIAN FRONT!*



THE GENERAL BACK ISSUES

Only the following back issues of The *GENERAL* remain in stock; price is \$4.00 per issue (plus the usual shipping and handling charges). Due to the low quantities of some back issues, if ordering, please specify alternative selections. Below is a listing of each in-stock back issue by subject matter; game abbreviations are italicized and standard (a partial listing may be found on the "Opponent's Wanted" form on the insert of any issue). Type of article is indicated by the following abbreviations: A - Analytical, DN - Designer's Notes, H - Historical, Q - Questions, P - PBM (postal), S - Strategy, Sc - Scenarios, SR - Series Replay, V - Variant. The featured game for each issue is always the first one listed.

- 14-3: *AIW*-S, H, DN, A, Q; *TRC*-S, 3R-S, *STAL*-SR; *WAS*-V; *PBLITZ*-Sc
 14-5: *SL*-DN, A, Q; *WS&IM*-A, V; *TRC*-A; *MD*-S; *SST*-A; 3R-A; *Games Guide*
- 16-1: *AZ*-S, Sc, V, DN; 3R-S; *NP*-S; *PB*-SR; 1776-S, A; *DIP*-S, *SL*/*COI*-Q
 16-4: *MR*-DN, A, S, V, Q; *SL*/*COI*-A; 3R-S, A; *TRC*-SR
- 17-4: *FE*-S, P, DN, V; *MD*-V, Q; *COI*-SR; *VITP*-S; 1776-Sc; *WQ*-A; *SST*-V; *NAP*-S
 17-5: *CM*-S, V, Q; *RW*-V; *SL*-V; *STAL*-V; *PL*-S; 3R-S, SR; *CAE*-V; *KM*-S; *MR*-S
 17-6: *STAL*-S; *WS&IM*-V, Sc; *WAS*-V; 3R-SR; *SL*-S; *CL*-S; *VITP*-S; *TRC*-S
- 18-1: *FITW*-A, Q; *BIS*-S; *SL*-S; *DUNE*-V; *DIP*-S; *AK*-A; *PB*-SR; *AL*-S; *W&P*-S
 18-2: *AF*-A, Sc, Q; *AK*-V; 3R-DN; *TB*-V; *SL*-S; *AIW*-V; *VITP*-S; *DIP*-S; *DD*-S
 18-3: *GOA*-S, DN, V, Q; *AOC*-V, Sc; *AK*-S; *VITP*-V; *SL*-S; *WS&IM*-SR, P; *DIP*-S
 18-4: *GL*-H, V, A, Q; *SL*-A; *LW*-V; *W&P*-SR; *AOC*-S, P; *FE*-V; *WAS*-S; *AK*-S
 18-5: 3R-S, A, V, DN, Q; *SL*-S, A; *TRC*-V; *TB*-V; *RW*-V; *CL*-A; *DUNE*-V
 18-6: *FT*-A, Sc; V, DN; *VITP*-V, Q; *MD*-S, Q; *SOTN*-A; Q; *SUB*-Sc; *BL*-V
- 19-1: *SOA*-A, V, DN, SR, Q; *TLD*-A, Q; 3R-S, Q; *DWTK*-DN; *TB*-A
 19-2: *BB'81*-H, Sc, S, DN; *TLD*-A, Q; *SL*-V; 3R-S; *SOA*-SR
 19-3: *GSL*-A, Sc, V, SR, Q; *DIP*-A; *RW*-Sc; *GE*-V; 1776-Sc; *LRT*-V, Q; *SL*-A
 19-5: *SON*-A, S, H, Q; *W&P*-S, Q; *DIP*-A; *WAT*-V; *WS&IM*-Sc; *SL*-A
 19-6: *VITP*-P, SR; 3R-V, Q; *DIP*-A; *FT*-V; *BIS*-V; *NAV*-A; *SL*-A, Sc; *SUB*-V, Sc
- 20-1: *GI*-S, A, DN, V, Q; *VITP*-SR
 20-2: *TT*-A, DN, S, Q; *MR*-V; *LRH*-A; *SL*-Sc; *W&P*-V; *GOA*-S, Q; *DIP*-A; *PL*-V
 20-3: *FRED*-S, V, Sc, Q; *PB*-A; 1776-Sc; *DWTK*-S, V, Q; *DIP*-A; *CONQ*-V, S
 20-5: *BR*-SR, S, H, Q; *LRT*-S; *DIP*-A; *GSL*-Sc; *GE*-A; *WS&IM*-Sc
 20-6: *B-17*-A, V, SR, Q; *AF*-V; *LW*-S; *DL*-S; *FE*-S; *DIP*-A; *MD*-S; *BR*-SR; *GOA*-Sc; *SL*-A; *PL*-Q
- 21-1: *UF*-S, A, SR, DN, Q; *SOA*-S; *GI*-H, S; *TRC*-S; *DD*-S
 21-2: *NAB*-S, DN; *W&P*-S, A, Q; *NAP*-S, Q; *DIP*-A; *FR*-S; *FE*-S; 3R-S; *BFI*-S; 1776-S; *SL*-A
 21-4: *PGG*-S; SR; *PB*-A; 3R-S; *TRC*-S, V, Q; *DIP*-A; *STAL*-V, S; *SL*-Sc
 21-5: *HW*-S, V, A; *MR*-S, Q; *OR*-A; *DIP*-A; 3R-A; *RB*-S; *CONQ*-V; *CIV*-S; *SL*-A
 21-6: *FP*-H, V, SR; *AIW*-S, Sc; *BL*-V; *TAC*-V, Q; *SL*-A
- 22-1: *PAA*-A, S, Q; *TB*-A, V; *DWTK*-DN; *TR*-V; *GSL*-P; *DIP*-A; *AOC*-S; *WAS*-S, Q; *AK*-V; *CIV*-S; 3R-S, Q
 22-2: *BANZ*-A, SR, Q; *FT*-A, S; *SUB*-Sc; *VITP*-S, Q
 22-3: *PB*-SR; *PL*-Sc, V, Q; *SOA*-S; 3R-V; *DIP*-A; *CIV*-A; *UF*-Sc, Q; *AIW*-S; *GOA*-A, Q; *TLD*-A
 22-4: *RF*-A, V, S; *TRC*-V; *PK*-S, Q; *DIP*-A; 3R-V; *SUB*-V; *PGG*-S
 22-5: *DEV*-S, A, Q; *GSL*-Sc; *BR*-S; *DIP*-P, A; *SC*-V; *FITG*-A; *ASL*-Sc, Q
- 23-1: *FL*-A, V; *DL*-V, *B-17*-V, DN; *HW*-S, Q; *VITP*-V; 3R-S; *TT*-V; *LW*-V; *SST*-V; *RW*-V
 23-2: *ASL*-A, S, Sc, Q; *BV*-SR; *UF*-S; *DIP*-A; *PL*-A
 23-3: *SUB*-V, Sc; *ASL*-S; *BV*-SR; *HW*-V; *BL*-V, Q; *BB'81*-A
 23-4: *EIA*-S, DN; *W&P*-V, S; *WS&IM*-Sc; *SC*-V; *NAP*-S; *YS*-S; 3R-S, Q
 23-5: *KOTA*-DN, Sc, Q; *WAT*-V, *B-17*-V, Q; 3R-S; *RW*-V; *ASL*-S; *VITP*-S
 23-6: 1830-DN, S, V, Q; *FP*-Sc; *RB*-S; *DEV*-P; *CIV*-S; *MR*-S
- 25-3: *PAT*-S, H, V, Sc; *TPS*-DN; *AK*-V; 3R-Sc, Q; *ASL*-S; *PGG*-P; *PB*-A; *UF*-V; *SOA*-V; *PL*-S; *BB'81*-S
 25-4: *EIS*-S, H, V, Sc; *WS&IM*-V, P, Sc; *EIA*-V, Q; *VITP*-S; *NB*-DN; 1776-V
 25-5: *GE'88*-SR, V, H, Q; 1776-S; *ASL*-H; *FP*-Sc; *RB*-V; *OS*-V; *DEV*-S; *GOA*-DN, Q; *W&P*-S, Q; *BR*-DN
 25-6: *ASL*-H, S, V, A, Sc, Q; *PAA*-S; *RSN*-V; *UF*-S; *FP*-Sc
- 26-1: *MOV*-S, DN, V, SR, Q; *DE*-V; *DUNE*-V; *DLW*-S; *KM*-S; *SC*-S; *ASL*-A, Q; *KR*-V, Q; *ROR*-DN; *CIV*-V
 26-2: *TPS*-S, DN, SR, Q; *PB*-Sc; *ASL*-H, A; 3R-S, Q; *HW*-S, Q; *UF*-V; *RF*-S
 26-3: *MBT*-H, S, SR, Q; *FL*-V, Sc; *FP*-Sc; *ACQ*-S; *TA*-S
 26-4: *SOJ*-H, DN, S, Sc, Q; *KM*-V; *TT*-V; *CIV*-S; *DIP*-S; *MR*-A; *ASL*-A
 26-5: *UF*-S, V, SR; *AF*-V; *FT*-Sc; *B-17*-V; *FP*-V; *ASL*-H, Q
 26-6: *NB*-DN, S, H, Sc, Q; *EIA*-Sc, V; 1830-S; *WS&IM*-Sc; *DEV*-S; *W&P*-Sc
- 27-1: *TRC*-S, H, V; *ASL*-H, Q; *KR*-V, Q; *RF*-S; *TPS*-S
 27-2: 3F-V, Sc, A; 6F-S; 2F-V; *EIA*-S, Q; *ASL*-S, D, Q; *WS&IM*-V; *FT*-V; *VITP*-S
 27-3: 3R-S, DN; *TLD*-S, V; *ASL*-S, DN, Q; *FE*-S
 27-4: *ROR*-A, SR, DN, Q; *CIV*-DN; *KR*-V; *EIA*-S; *DIP*-P
 27-5: *BB'91*-A, S, V; *BB'81*-DN; *ASL*-H; *DIP*-P; *TA*-A; *ROR*-SR, Q; *DD*-S
 27-6: *BKBD*-SR, S, DN, A, *SPD*-V; *GSTR*-S; *MOV*-V; *ASUB*-A; *W&P*-V, *NW*-V; *WRAS*-S; *S&B*-S; *CARR*-Sc; *WS&IM*-V
- 28-1: *PELOP*-SR, S, DN, H, Q; *ASL*-Sc; *FP*-G-DN; *PACW*-V, Sc; *CIV*-V, S; *Game Rating System*
 28-2: *ASL*-A, Sc, *GUNG HO!*-H, A, DN; *ROR*-A; *FP*-G-A, Sc; *B17*-Sc, -Q; *ACIV*-V, Q; *SPF*-V; *AvalonCon II*

The Games of Summer...

881
**Turning Point:
Stalingrad**
\$25 Retail

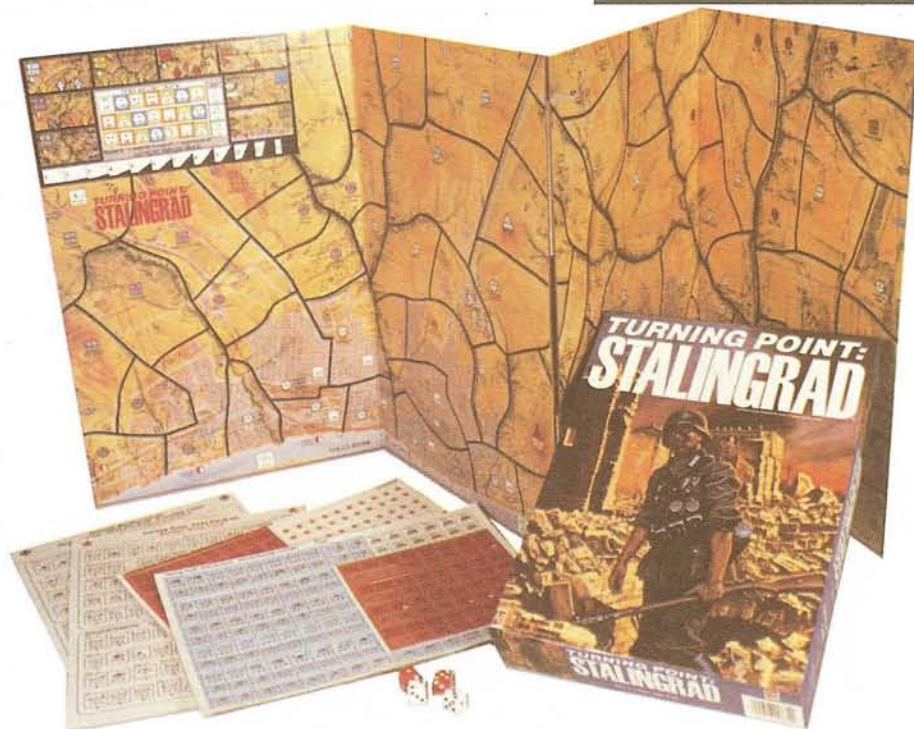

Uses an award-winning game system that re-creates the dazzling German initial breakthroughs which almost won the city for the German 6th Army in the whirlwind opening days of battle, only to be turned back by the valiant resistance of the Russian 62nd Army. Game features a highly-detailed map stretching from

the southern outskirts of Kuporosnoye to Spartakovka and Rynok to the north. In between lie the bitterest battle sights of WWII. Rated 4 on the 1-10 complexity level, **Turning Point** takes from 2 to 30 hours to play—and is highly suitable for solitaire gaming.



882
MBT
(Main Battle Tank)
\$31 Retail

A detailed look at the organization, equipment and capabilities of some of today's most powerful and advanced military forces. Included are the latest American, West German, and Soviet vehicles, their accompanying infantry and attached weapons, and supporting artillery, air and helicopter elements that compose modern "combined

arms" forces. Game includes 4 separate mapboards that can be placed in numerous configurations as terrain varies from scenario to scenario. Complete Data Cards for 28 modern vehicles highlight this game for two or more (team play) players—rated 6 on the 1-10 complexity scale.



The Avalon Hill Game Company

DIVISION OF MONARCH AVALON, INC.

4517 Harford Road • Baltimore, MD 21214

For Quick Credit Card Purchasing
call **TOLL FREE 1 (800) 999-3222**

Capture the Famous Ordnance Factory and, Maybe, Change History in

RED BARRICADES

The 8th in the expanding series of *Advanced Squad Leader* modules, places one in command of Germans or Russians inside the city of Stalingrad.



The First Historical ASL Module

Fight for control of Stalingrad's famous "Red Barricades" ordnance factory and surrounding environs. The historically accurate 2-piece map features new 1" wide hexes for ease of play in the scenarios that require high troop counter density. The factory complex alone, exactly adapted to ASL scale from aerial reconnaissance photographs, spans an area approximately 31 x 16 hexes. Two countersheets provide (for the first time) markers for Fortified Building Locations, A-T Ditches, Cellars, Guttled Factories and Hand-to-Hand Melee. Included as well are Perimeter, Location Control and Burnt-Out-Wreck markers for the Campaign Game, plus extra Russian and German infantry and SW. Two new weapons also make their debut: the Russian "Molotov Projector" and the German StuIG 33B assault gun. Seven action-packed standard scenarios (in addition to those for the Campaign Game) are offered, most of which utilize only a small portion of the map.

Also included is Chapter O, which contains the rules for several new terrain types (debris, railway embankments, interior factory walls, storage tanks, single-hex two-story buildings and culverts), all colorfully detailed in the standard ASL fashion. **Red Barricades** features three separate Campaign Games which are designed for play exclusively on the new map, enabling the ASL gamer to create an ongoing series of interrelated scenarios.

Rated the highest on the complexity scale, **Red Barricades** boasts a "medium" rating for solitaire play. However, **Red Barricades** is not a complete game — ownership of ASL, *Beyond Valor*, and *Yanks* is required for play.

No.	Title	Number of Players	Ages	Complexity	Suggested Retail
8231	RED BARRICADES	2	12 & Up	Very High	\$25.00

(Wholesalers note: comes in 6-game master pack weighing approx. 10 lbs.)



The Avalon Hill Game Company

DIVISION OF MONARCH AVALON, INC.

4517 Harford Road ★ Baltimore, MD 21214 ★ 301-254-9200

Call TOLL FREE 1-800-999-3222 to order.

PANZER HUNTERS

Tactical Air Support Rules for *PANZERBLITZ* and *PANZER LEADER*

By
Carl Schwamberger

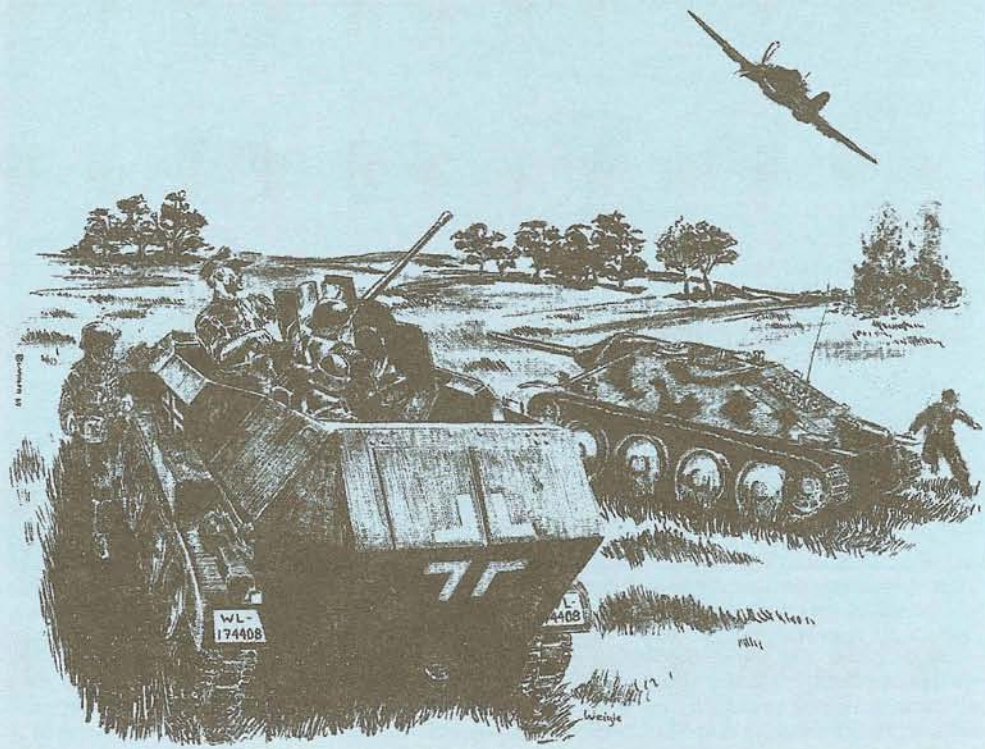

Tactical air support was of major concern to the battlefield commander of World War II, and quickly became a critical part of the modern war of combined arms. Although tied to relatively fixed bases, the speed of aircraft gave them a tactical mobility exceeding any other weapon in existence. The weight of ammunition which could be placed on target within a few days (or even hours) of request rivaled that of the artillery arm. Ostensibly games of armored warfare, *PANZERBLITZ*, and its companion *PANZER LEADER* are readily adaptable to the simulation of most aspects of combined arms warfare, including tactical air support. Of course *PANZER LEADER* already includes air units and their use. These are quite useful for illustrating the general effects of tactical air support. But, there are no comparable rules for *PANZERBLITZ*. Neither do the *PANZER LEADER* rules simulate the use and control of air support as completely as they might. To fill this gap I'll first briefly review the development of tactical air power through 1945, then suggest some rules for its inclusion in these two games.

PRELUDE

The earliest use of tactical bombers was by the Italian army during its conquest of Libya in 1911-12. This consisted of little more than dropping oversized grenades from altitudes of a few hundred feet. Whatever effect this might have had on the Africans is obscure, but its effect on military aviators everywhere was dynamic. Even so, further development of the concept was hampered by the engineering problems; at this stage of aviation, it was difficult enough designing machines which could carry more than just the pilot. There was also the matter of convincing the entrenched military authorities that these

powered kites could have any real effect on the battlefield. The value of air reconnaissance was grudgingly recognized, but it was not completely appreciated and was in fact still often misused at the start of the Great War. The collapse of traditional military concepts during 1914-1918 forced the development of air power as far as the crude technology of the time would then allow.

The use of airplanes for observing long range artillery fire against targets deep in enemy territory did prove successful. This use of aircraft was highly specialized, but still no more than an extension of normal reconnaissance procedures. More important however were the efforts to arm the aircraft for the ground attack role. Entrenchments made the front lines a poor target for the light machine guns and 25 Kg bombs of the era, but the lines of communications were a different matter entirely. Moving combat and supply units were particularly vulnerable to the new weapons. By 1918 effective tactical air operations against maneuvering enemy forces were being sustained by the Allied armies on all fronts. Of particular significance were the campaigns along the Mediterranean. There, relatively small air forces greatly accelerated the collapse of the enemy armies. In Palestine the British, with barely a dozen operational aircraft, learned to effectively disrupt every attempt of the Ottomans to move any formation of significant size. In Macedonia, the Bulgarian army was mercilessly machine-gunned and bombed in the restricted mountain passes when attempting to retreat, turning an orderly troop movement into a rout. The Italians gave the Austrians the same treatment as they retreated into the southern Alps, with similar results. Franco/British operations of this sort on the Western Front were effective, but rendered less noticeable by the size

of the armies, the lack of such choke points in the terrain, and the better discipline of the German armed forces. They were also overshadowed by the British air operations against German supply depots and rail communications.

The result of these successes was an attitude on the part of the air commanders that they could accomplish great things while operating independently of the ground forces. The Italian Marshal Douhet and others theorized that future wars could be decisively and quickly won by massive precision air attacks on the enemy military. Participation by the traditional armed forces — the infantry, artillery, and cavalry — would be limited to mopping-up operations of the paralyzed enemy. Airmen argued that, like the Naval arm, the new Air Corps should become separate services, their operations complementing those of the Army's only at the strategic level. Unfortunately their analysis was simplistic and flawed. While air activities in WW I had been closely coordinated at the senior levels, there was little interaction with the infantry in contact with the enemy. The airmen depended largely on their own reconnaissance for acquiring targets. The information gained by air recon also tended to go to the army HQ first, then be disseminated downwards. Finally, the selection of targets, while supporting the battle at large, seldom directly affected the infantry engaged. Since there was little interaction with the infantry who were actually fighting, little thought was given to incorporating such a combination into the new air doctrines.

The colonial wars across the globe during the 1920's gave practical schooling in a different concept. There small groups of half a dozen (or fewer) planes coordinated with the local commander, who was often no more than a lonely

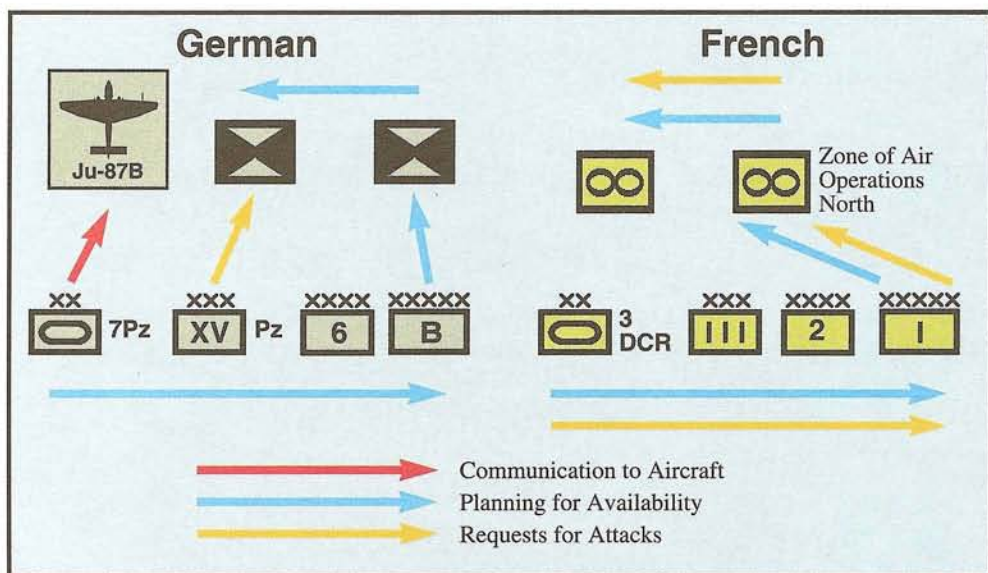

Figure 1. Illustrated are simplified depictions of the German and French systems for planning and coordination of air support. The ability of the German liaison officer at the lowest level to request air attacks directly from the supporting air HQ meant attacks could be provided in well under 24 hours. The senior HQ monitored requests made to the air HQ, and would intervene to resolve conflicting requests, alter priorities, and so forth. The French processed all requests for air support through each HQ in the chain of command. In this sense, it did not differentiate between the planning phase and immediate requirements arising during the execution of the plan.

battalion or company commander fighting a gang of bandits. With little in the way of strategic or operational targets, the airmen turned to attacking in direct support of their comrades on the ground. Communication was crude; messages could be dropped from the plane, sometimes they could be returned by a skilled pilot using a hook suspended from the aircraft to snatch a message container suspended on cord strung between two poles. Using colored cloth panels to indicate to the airmen the direction and range of a desired target proved very successful, but it was often most effective to simply land for a conference with the colonel or captain of a cavalry patrol. Many pilots were formerly of the infantry or cavalry, and this familiarity with operational considerations was of great help to their understanding of what was happening on the ground below.

The experience gained from these campaigns on the North West Frontier of India, in North Africa, and in Nicaragua would become a counter balance to the theory of the "Strategic Air Force". Unfortunately, a hide-bound mindset was rarely a hindrance to a career in the interwar years, and many of the bright young airmen of 1918 became themselves rigid traditionalists by the 1930's. In ill-considered attempts to retain control, authority and status, many commanding officers presented tremendous resistance to anything that might prevent the growth of their fledgling air services into separate military entities; true "air forces". The younger lieutenants and captains who were then doing the flying were left to ponder their combat experience in obscurity.

THE GERMAN EXPERIENCE

The Luftwaffe started the war little different from other air forces. The majority of its leaders

were convinced of the validity of the Douhet philosophy, so the precision dive bombing tactics of which the Germans were particularly enamored would make the Luftwaffe more effective than its counterparts, but fundamentally no different. Like the French and Soviets, the intent was to attack the enemy ground combat units while they were on the move, or in camp, or re-supplying; in short, to maintain pressure at all times. Nevertheless, the Luftwaffe was detailed to provide more direct support of the ground battles in Poland, against the Allies in the West and later in the Soviet Union. This took the form of bombers attacking enemy ground troops a few kilometers ahead of the advancing German ground forces, and was highly effective against poorly defended positions and ill-disciplined soldiers.

Guderian's crossing at Sedan is an excellent example. There, some 1,500 aircraft comprising the VII & II Fliegerkorps attacked the two French "B" divisions over a seven hour period, an attack foreshadowing the American carpet bombing tactics practiced four years later.

It was soon realized that to improve the effectiveness of tactical air support, direct coordination at levels lower than Army HQ would be necessary. Thus in the Polish campaign the leading elements of the Wehrmacht, the Panzers, had air liaison officers attached to the HQ's down to the corps and division level. Equipped with radios, the purpose of these liaison teams was to send support requests and coordinating instructions directly to the HQ of the supporting air unit, rather than up one side of the chain of command to the top echelon and then back down the other side to the requesting field unit.

As the war progressed, the number of these liaison teams increased; one such team per panzer

er division was common by 1941, with the team including spotters in light reconnaissance aircraft. With radio links to both the attacking aircraft and the ground liaison teams, these reconnaissance units would fly at low altitudes, hunting for targets in front and to the flanks of the ground advance, and guiding combat aircraft to the battle area. Liaison officers on the ground also took their coordinating efforts closer to the targets, and by using their radios to contact the combat aircraft entering the battle area, could guide those aircraft to targets in visual range of the ground liaison officer.

The potential effectiveness of this technique of close air support cannot be overstated. Although in practice difficult to master, the ability to guide bombers directly to a target is extremely advantageous. While air attacks a few kilometers ahead of the ground advance are useful, there are several problems: Important targets often are not seen by the air crew, due to camouflage, terrain or the vagaries of weather. Moving at high speed, pilots have difficulty identifying the critical targets out of the aggregate. All too often, airmen mistake their own comrades for the enemy, or are fired on by their own side. But perhaps most important, the enemy usually has time to recover part or all of his combat power

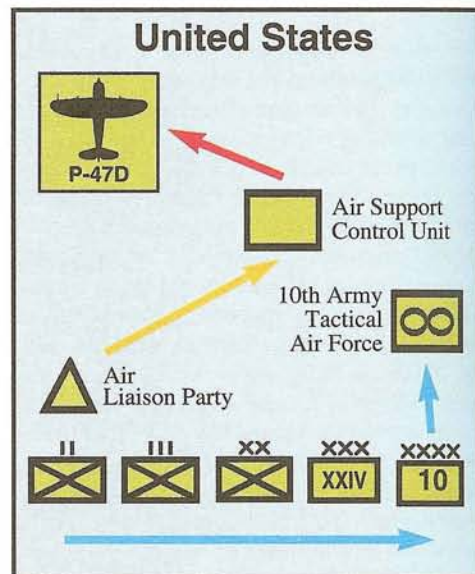

Fig 2. Late-war close air support in the Pacific differed from Europe in that trained Air Liaison Parties (ALP's) were commonly available to the front line battalions. The US Army in Europe generally provided ALP's for forward air control to the critical attack in a division. Unlike the system used in the Philippine campaign, ALP's in the Tenth Army at Okinawa were required to route coordinating instructions for the attack through the Air Support Control Unit, rather than directly to the flight leader. It was believed the crowded conditions on Okinawa (three-to-four divisions on a ten mile front) would lead to mass confusion on the radio net. Despite this, close air support on Okinawa could claim an average of merely 55 minutes between air support request and first bomb on target.

before the ground attack can follow up the air strike. By 1944, for example, US soldiers in Europe discovered that one hour was usually sufficient time for the German survivors of air or artillery attacks to recover combat effectiveness. A ground commander who could have an air attack guided to the targets he needed hit at the appropriate time thus gained a tremendous advantage.

The result of the lessons learned at the beginning of World War II was that by the summer of 1942 the German air liaison teams had their own communications vehicles, capable of keeping up with the leading panzer and panzergrenadier formations. The ability to deliver air attacks synchronized with the ground battle was no small part of the success of the Wehrmacht that summer. But these efforts could not be sustained. Germany's shortsighted production policies began to hamper her military efforts by the Fall of 1942. New units could not be added to exploit the new tactics which had been developing for them, nor could the existing Luftwaffe formations be maintained in strength sufficient for the commitment to close air support required to sustain large scale offensive actions. Shortages also meant liaison teams were only provided to a few of the panzer divisions and other elite units. Many of the air commanders felt that bombing a few dispersed vehicles or strong points in contact with the ground force was not as productive as bombing a larger concentration of targets along the lines of communications, or in assembly areas. Consequently true close air support was generally not available to the German ground commander.

The most common types of aircraft used in the close air support role were the single engine bombers. Although most bombers appeared on tactical missions near the ground battle, several types can nevertheless be modelled in *PANZERBLITZ*. The Ju-87 proved too slow and unmaneuverable to survive against either competent fighter opposition or the antiaircraft cannon encountered after 1941. Indeed, the Luftwaffe intended to begin replacing the Stuka in the Fall of 1940, but for the failure of intended replacements such as the Me 210. Fighters were therefore equipped as bombers, and eventually the FW-190 became successful as both a tactical bomber and an interceptor. Like the Ju-87's, the FW-190's of 1943-45 were often armed with armor piercing cannon. Other aircraft types which served in the ground attack role included the Hs-129, a sort of prehistoric A-10. Armed with a 30mm cannon and heavily armored, it performed ground attacks from 1942 to '44. The Germans also frequently made use of medium bombers for tactical air support. The bomb loads of such aircraft compensated for lack of strafing weapons, and of these the Do 17 series is a typical example.

FRANCE

The French had no chance to develop anything beyond what existed in May of 1940. Their existing system for coordinating tactical air sup-

port was poor compared to those of the British, German, and even the Soviets. The entire reason for this is too complex to reiterate completely here, but some points should be touched upon.

First, liaison between the air and ground units barely functioned below the army HQ level. Attack requests and target information were passed along in a methodical manner up the chain of command, then across to the operational air HQ for Northwest France, and then down to the air unit to make the attack, virtually guaranteeing the obsolescence of the information by the time the attack could be made. This lack of efficient coordination also meant that requests for air attacks and their execution by the ground and air commands were often ill-conceived. Interdiction of roads and bridges were the bulk of the missions performed by the French Armée de l'Air, as well as by the RAF of that period. These attacks, while in themselves not entirely ineffective, yet lagged a day or two behind the rapidly moving events of May 1940. Thus, in operational terms, they were of marginal value at best.

A variety of tactical bombers were available to the French in 1940. Unfortunately there were not very many and most of them were not very good. The Po-633 was the most common type, with about 300 units available. The Po-633's light bomb load was partially compensated by the twin 20mm cannon (The French were a little ahead of other nations, equipping ground attack planes with cannon as early as 1939.).

The LeO-451 was an excellent machine. Actually a medium bomber, it possessed a bomb load of 4,000 lbs. and a maximum speed of 300 mph. Less than one hundred were used in combat, and low level tactics against the German panzer columns generally resulted in their immolation by anti-aircraft fire.

The 167A-3 Martin Maryland Bomber (MM 167) was originally designed for the US Army Air Corps as a "Strike" bomber. Though rejected by the Americans, it was ordered by the French. Even so, the 75 which arrived at the end of May 1940 served to good effect in the last weeks of the Battle of France.

SOVIET STURMOVIKS

The usual propaganda and misinformation endemic to Russian historical records applies as well to the chronicles of their use of air power. It is apparent the use of tactical air support developed along the same general lines as in other nations, with the same problems, and with some unique Soviet hindrances. The shortage of skilled officers created by the purges after 1937 was as damaging to the abilities of the Red Air Force as to those of the ground forces. And lack of good communications equipment made the liaison between the air and ground formations even more cumbersome than in comparable services of other nations. As with other Soviet operations, effective air support depended on careful, detailed planning before the engagement. Adequate response to unexpected changes in the battle was always a problem. Like the French, liaison and planning for air support usually went

no lower than the army HQ, with the exception of the elite mechanized and armored formations, following the German model. Much like the Luftwaffe and other air forces of the early 1940's, Soviet tactical air support usually operated a few kilometers ahead of the advancing ground forces, but there were exceptions. Innovative leaders would scrape together the communication equipment necessary and create an *ad hoc* system for getting bombs on targets of immediate interest. By 1944, the Soviet armored and mechanized corps usually did have liaison teams, although these did not always take up the forward air control role.

The Sturmovik air regiments deserve special mention. Clearly these were the most effective Soviet air units, acquiring a healthy reputation as tactical bombers. They were mixed formations of interceptors and tactical bombers. The Il-2 bombers of the Sturmovik regiments were piloted by more determined men than were usually found in other Soviet air units, and were heavily armored against light antiaircraft weapons; advantages offset by the aircraft's moderate bomb load.

Virtually all Soviet aircraft were used as tactical bombers as well as in their designed role. Most air units were less aggressive than the Sturmoviks, and were less likely to be controlled by a ground liaison party. Some of these other aircraft types included the Su-2, a pre-war design produced in quantity, but which had faded away by 1942.

The Pe-3 was originally a high altitude interceptor. A dive bomber version and good bomb load led to its common use as a tactical bomber.

The Yak-1 armament was typical of the variety of cannon, bomb, and rocket-armed fighters that provided tactical air support to ground forces.

ANGLO-AMERICAN SUCCESS

Like their German counterparts of 1940, British liaison teams seldom existed below the corps level, and were organized and equipped for planning rather than direct control. Tactical bombers, as with the French, were sent against the German lines of communication, with no better results. The battle against the Afrika Korps provided a field laboratory for testing a different application of air power. By the end of 1942, the concept of direct liaison between the ground divisions and the tactical bombers was accepted. And, as with the Germans, this led to the liaison teams (which the British colorfully named Tentacles) moving closer to the actual fighting in order to give more effective direction to the tactical bombers. This lesson stayed with the Eighth Army through the remainder of the war. The leaders who accompanied Montgomery to Britain attempted to obtain the same sort of support for the campaign in France, but found their counterparts in the RAF were less than cooperative. Whereas in Italy in 1944 liaison teams for forward air control could be provided to brigade HQ's whenever and wherever needed, in Normandy only one was available for an entire division.

Although the United States ostensibly possessed no independent air force, the US Army Air Corps acquired an independent attitude as aloof as any other nation's air service.

Consequently, close air support techniques were no better developed in the American armed forces than elsewhere in 1939. The US Army in the European theatre did not gain any real combat experience until early 1943. But as Rommel observed, no one learns faster than the Americans. By the middle of 1944 they had equalled British methods for controlling direct air support of their combat troops, despite the fact that, like other air force commanders, the US Army Air Force leaders very often did not *want* to risk their units to provide close air support. By the end of the Sicilian campaign, close air support was regularly available from the Army Air Corps, although such support was hampered by the forward air control officers not having been regularly provided with radios. This forced them to use cloth panels, smoke grenades, and other archaic signaling systems.

But unlike the British in Normandy, General Omar Bradley was aided by an airman who did not balk at the fine points of doctrine or supply protocol. General Quesada, commanding the 9th Tactical Air Command, proved energetic and enthusiastic in providing the support the ground leaders requested. When he realized the visual signals were inadequate, General Quesada obtained radios compatible with those of his aircraft and distributed them to the US combat units in the line, in time for the critical Cobra operation of the Normandy campaign. Although the US efforts in Europe never included sufficient training, by the last year of the war they had equalled (and in many cases exceeded) the air/ground liaison abilities of both the Germans and British.

In 1940, Britain fielded two tactical bombers. The Fairey Battle acquired a poor reputation, probably due to the low numbers of them which returned from bombing missions.

The Bristol Blenheim was very popular throughout its three years of war service; perhaps due to its great speed, since in 1940, it had proven as vulnerable to anti-aircraft weapons as any other plane at low altitudes.

The Typhoon and Thunderbolt aircraft depicted in *PANZER LEADER* are typical of the high-speed fighters which provided air support in 1943, '44 and '45. Like the FW-190, their speed and superior handling abilities enabled them to survive anti-aircraft fire better than the tactical bombers of the early war.

In late 1944, the A-26 Invader began a thirty-year career, unloading its three tons of bombs and rockets on the Ardennes battlefield. The Invader's service life continued into the Viet Nam era, where A-26's were operated in CoIn (Counter-Insurgency) configurations.

WHAT MIGHT HAVE BEEN

No nation in the European theatre developed the technique of close air support as far as they might have done. As with the Germans, competing demands for other types of missions consti-

tuted a drain on available assets. And in fact, there were very good reasons for assigning ground-attack capable aircraft to interdiction of transport, attacking supply depots and airfields, naval bases and ships at sea, ground units in reserve, and mounting strategic operations against enemy industry and population centers. Only in the last eighteen months of the war did the Anglo-American Allies possess sufficient aircraft to allocate significant numbers to all types of air missions.

Another major obstacle to the full application of air support to ground operations was the lack of sufficient liaison teams. An excellent example of this can be found during Operation *Goodwood* in Normandy. Close air support for the Eleventh Armored Division failed when the forward air control team's only communications asset, the halftrack carrying the radios, was destroyed as the attack began. The waiting Typhoons eventually dropped their bombs and rockets on targets of opportunity in the German rear, rather than on the Tigers and anti-tank guns that were savaging the British forces. There was also strong resistance by many pilots to the entire concept of close air support. Not only did close support run counter to the idea of the airmen single-handedly raining stunning blows on the enemy, but neither was it much fun making circles in the sky waiting for an air controller's call designating a target. More important was the perception among airmen that attacking concentrations of targets — such as march columns, supply dumps, repair depots and so forth — was more productive than attention to those dispersed and difficult-to-hit enemy targets which were in contact with the friendly ground forces.

Strictly in terms of attrition of enemy resources, this outlook was valid. But unsupported friendly tanks and infantry take greater losses than when aided by air strikes. Further, when ground forces with close air support can break loose from or overrun the enemy, then the rear targets become equally vulnerable to them as they are to the air forces.

In fairness to the airmen, ground commanders themselves did not help their case. They did not always use their air support effectively, and thus provided the airmen with their evidence that close air support wasn't practical. Finally, there were the usual teething troubles to deal with as everyone involved experimented to learn the best techniques and procedures for actually controlling air attacks from the ground. It had taken since the turn of the century for the field artillery to bring the methods of control and coordination up to the sophisticated level permitted by the technology of the 1940's. It was perhaps asking too much for tactical air support to achieve the same level of efficiency in far less time.

Still, far more might have been accomplished. It is interesting to compare developments in the Asian and Pacific theaters with those of Europe. An early example occurred during 1942 on Guadalcanal. The US First Marine Division defended a relatively static position, with a large

airfield located literally within its lines. The primary mission of the Marine, Navy and Army pilots based there was to attack the Japanese combat and transport ships as part of the battle of attrition focused on the island of Guadalcanal. They were also called upon to act as flying artillery in defense of their own airfield.

When given close air support missions, the pilots often traveled the three or four miles to the front line to have the targets shown to them, review the ground commander's plan, exchange radio frequencies, and otherwise coordinate with the Marine infantry. From this intimate way of fighting developed an idea of carrying liaison down to the battalion level. As the Pacific campaigns developed this grew into a sophisticated system. The Air Liaison Parties (ALP) were expected to be placed where they could see the targets and direct the bombers precisely. The use of smoke grenades and mortar shells, flares, and tracer ammunition to provide reference points for the pilots was also developed far beyond the common practice in Europe. That the liaison officers were often pilots, and that a large portion of the Marine pilots had training or experience as infantry leaders, could only help matters. In 1944, the provision of Marine Air Group 24 and its jeep mounted ALP's to the US Army 37th Infantry and 1st Cavalry divisions in the Philippines campaign proved an enormous success — much to the embarrassment of the staff of the US Fifth Air Force who, during planning for the Philippines campaign, had rejected the whole idea of close air support as impractical. Subsequently, on Okinawa the Tenth Army had a full-blown liaison system, with ALP's available for all the infantry battalions in the front lines.

In Burma the British army similarly developed close air support to a fine art, which served them well in the battles around Imphal. As did the Americans, they created as many liaison teams as possible so that every battalion engaged in combat might have close air support. The British used transport aircraft to insert infantry battalions and light artillery, along with their logistical support, to the flanks and rear of the Japanese positions — anticipating the future concept of "vertical envelopment" which would eventually develop as a part of helicopter tactics. The fact that heavy infantry and artillery units *with vehicles* were landed and sustained solely by air made this a more effective airborne force than the light paratroop formations used elsewhere in the Pacific and Europe. It also carried the meaning of "close air support" far beyond just tactical bombing.

CLOSE AIR SUPPORT RULES

The existing rules in *PANZER LEADER* provide a solid foundation for simulating close air support, and anyone not familiar with the *PANZER LEADER* air rules should review them at this time. For those who do not possess this game, a copy of these rules are included in the sidebar, allowing these rules to be grafted onto the *PANZER BLITZ* game by using the modified turn sequence which follows.

The rules for the observation plane are concerned specifically with observation for the spotting of artillery fire. The remainder of these original rules are sufficient for simulating tactical air support when direct communication is not available between the aircraft and the ground units.

The additional rules proposed here are intended to improve the general simulation of close air support in the *PANZERBLITZ* and *PANZER LEADER* game systems. They are certainly not as detailed or realistic as they might be, but to do so would make them hopelessly complex and incompatible with those systems.

Remember that the attachment of an air liaison team to a ground division or brigade was not common practice. Such teams were placed with armored or infantry units leading the critical attacks. The liaison teams attached to the Corps or Army HQ were intended for planning; they often did not have the equipment, time, or training to act as forward air controllers (FAC), so your use of this capability should be minimal. No more than one FAC per scenario should be allowed, nor should this capability be available for any side but the Germans before 1943. If using weather rules, their effect must also be considered. Visibility conditions that would hardly be noticed by the ground troops could prevent pilots from seeing the signals of the FAC and identifying their target; and sufficiently bad visibility would certainly make the pilot of any aircraft somewhat reluctant to get too close to the ground.

The aircraft described here are samples of the most common types used for tactical air support. The Hs-129, while not actually very common, was included for the unusual weapons different models carried. The French were incapable of close air support tactics in 1940, but are included because attacks, albeit uncoordinated, were conducted near their ground troops. The A-26 squadrons did perform some close support missions; their inclusion gives the players some indication of what close support aircraft would be capable of in the second half of the twentieth century, when accurate delivery of even larger bomb loads became common. (Also, frankly, I wanted an air unit counter that would be capable of squashing a King Tiger in one pass.)

The *PANZER LEADER* sighting rules for aircraft are a bit too optimistic. Admittedly, the observation plane crew does have the advantage of low speed and binoculars; even so, only medium and large caliber cannon would be visible firing from any distance. In addition, those rules do not allow spotting of vehicles on roads that pass through wooded or urban terrain. Attack aircraft move considerably faster, and their crews were far less experienced at spotting things. Pilots typically had difficulty picking out weapons firing from concealed positions. Again, the effect of weather is significant and should affect spotting.

**PANZERBLITZ AND PANZER LEADER
AIRCRAFT COMBAT VALUES**

AIRCRAFT TYPE	ARMAMENT	COMBAT VALUE	AVAILABILITY
GERMANY			
Ju-87B	MG's: 2 x 7.9mm	1 (I)	
	Bombs: 1,100 lb	10 (H)	
Ju-87G	Cannon: 2 x 37mm	6 (A)	Available from 1943
FW-190 A8	MG's: 2 x 13mm	} 4 (A)	Available from 1943
	Cannon: 2 x 20mm		
	2 x 30mm		
	Bombs: 1,100 lb	10 (H)	
Do-17Z	Bombs: 2,200 lb	30 (H)	
Hs-129 (R1)	MG's: 2 x 7.9	} 2 (A)	Available from 1941
	Cannon: 2 x 20mm		
	Bombs: 48 (fragmentation)	30 (I)	
Hs-129 (R2)	MG: 1 x 30mm	3 (A)	Available from 1942
	MG's: 2 x 37mm	6 (A)	Available from 1943
	Cannon: 1 x 75mm	8 (A)	Available from 1944
FRANCE			
Po-633	MG: 1 x 7.5mm	1 (I)	
	Bombs: 1,328 lb	12 (H)	
MM-167	MG: 4 x 7.5mm	2 (I)	
	Bombs: 1,200 lb	10 (H)	
LeO-451	Bombs: 4,400 lb	40 (H)	
SOVIET UNION			
Il-2	MG's: 2 x 7.62mm	} 2 (A)	
	Cannon: 2 x 20mm		
	Bombs: 4 x 220 lb	8 (H)	
	Rockets: 8 x 82mm	20 (A)	
Il-10	MG's: 2 x 23mm	3 (A)	Improved IL-2, available from 1944
	Bombs: 2,200 lb	30 (H)	
Su-2	MG's: 4 x 7.62mm	2 (I)	Rare after 1941
	Bombs: 880 lbs	8 (H)	
	Rockets: 10 x 82mm	20 (A)	
Pe-2	MG's: 2 x 7.62mm	1 (I)	
	Bombs: 2,200 lbs	30 (H)	
Yak-1	MG's: 2 x 12.7mm	} 2 (A)	
	Cannon: 1 x 20mm		
	Bombs: 440 lbs	5 (H)	
	Rockets: 6 x 82mm	10 (A)	
GREAT BRITAIN			
Battle II	MG: 1 x 7.7mm	1 (I)	Withdrawn from service, 1941
	Bombs: 1,000 lbs	10 (H)	
Blenheim	MG's: 2 x 7.7mm	1 (H)	Withdrawn from service, 1943
	Bombs: 1,000 lbs	10 (H)	
Typhoon*	MG's: 2 x 20mm	2 (A)	
	Bombs: 2 x 1,000 lbs	30 (H)	
	Rockets: 8 x 4.5"	20 (A)	
UNITED STATES			
A26	MG's: 6 x .50 calibre	3 (I)	Available from November 1944. May carry both bombs and rockets.
	Bombs: 4,000 lbs +	64 (H)	
	Rockets: 10 x 4.5"	20 (A)	
P-47D*	MG's: 6 - 8 x .50 calibre	3 (I)	
	Bombs: 2 x 1,000 lbs	30 (H)	
	Rockets: 10 x 4.5"	20 (A)	

*Statistics for these aircraft have been duplicated from Rule XII. AIRPOWER, on page 13 of the *PANZER LEADER* rulebook.

PANZERBLITZ AND PANZER LEADER SUPPLEMENTARY AIRPOWER RULES

XII B 2. Change to read: Observation aircraft may sight enemy units in clear terrain to a range of twenty (20) hexes. Enemy units in woods and town hexes may be sighted if the observation aircraft is within six (6) hexes of the unit(s) to be spotted, if those units fire, or if they used road movement to enter the hex they occupy.

XII C 4 e. Change to read: FB units may sight targets in the same manner as observation aircraft, except that they may not sight targets which fire from woods or town hexes. They may not spot targets for ground units, but if one FB unit sights a target it is spotted for all FB units on the board.

E. FORWARD AIR CONTROLLER

1. The air liaison team in the Forward Air Control (FAC) role is represented by a command post marker. This unit may only spot for aircraft.
2. Any enemy unit which is spotted by the FAC marker under the applicable *PANZERBLITZ* or *PANZER LEADER* rules may be designated as a target for air attack.
3. The designation of the target, the spotting unit, and the attacking unit is made at the same time as the artillery indirect fire attacks in the *PANZER LEADER* game. A modified *PANZER BLITZ* Sequence of Play is provided below. The designating player secretly notes the targets and reveals them when the attack is performed.
4. The air attacks designated by the FAC are executed during the regular air phase of the turn following the designation of the attack.
5. If the unit counter representing the FAC is dispersed or destroyed, any air attacks designated and not yet executed are canceled.
6. Liaison officers in the FAC role usually had vehicle-mounted radios. The FAC may therefore spot while being carried on any (C) class vehicle.

F. FIGHTER BOMBER ADDITIONS

1. Aircraft are not all of uniform performance. Some extra rules following show the special capabilities of certain types.
2. Sturmovik formations were less likely to break off an attack because of anti-aircraft fire. Add one to the die roll of any anti-aircraft attack against an Il-2 which results in a 'D'. X results are unaffected. Similarly, certain German formations (such as Rudel's Stukas and the Hs-129 squadrons) and some Anglo-American squadrons were known to press home their attacks despite intimidating return fire from the ground. If you are designing a highly historical scenario where such elite pilots appeared, then extending the same rule to the German or Allied aircraft would be appropriate. Conversely, if your research indicates extraordinarily non-aggressive airmen were present, then increase the likelihood of the D result.
3. Some pilots made multiple passes on a target, dropping only part of the bomb load at a time. Divide the attack factor by the number of attacks to be made and use that value in each attack. No more than four attacks may be made by a single aircraft counter.
4. The A-26 could carry a full load of bombs and rockets. Both may be included as its payload. It may not use both in the same attack.

G. AA DEFENSE ADDITIONS

1. The anti-aircraft weapons represented in *PANZER BLITZ* and *PANZER LEADER*, ranging from 12.7mm to 40mm calibers, are the heaviest that can be easily simulated in these games. The anti-aircraft machine guns common among the motorized and mechanized units were of some small use, so simulation of them is worthwhile.
2. The vehicles which have an "I" class attack factor may use this attack factor out to a range of two (2) hexes against aircraft.
3. Tanks, assault guns, and self propelled guns did not always carry anti-aircraft machine-guns. Should the players agree that specific vehicles do, then give the representative unit counter an "I" class attack factor of two (2), with a range of two hexes, as above.
4. Units which make an anti-aircraft attack are considered to have made a direct fire attack, and are subject to all applicable rules for that situation.

H. AIR RECONNAISSANCE

1. Although a large portion of the light reconnaissance planes were controlled by the artillery units solely for their use, tactical air reconnaissance was used by infantry and armored commanders from the start of the war. When playing refereed *PANZER LEADER* games with "blind" rules, the addition of a reconnaissance plane is recommended.
2. A CP unit must be present to represent the communication link between the reconnaissance plane and the ground commander. This is the CP unit's only function.
3. If the CP unit is dispersed, no enemy units may be spotted by the reconnaissance plane. If it is destroyed, the aircraft counter is permanently removed from the game.
4. The reconnaissance plane may spot enemy units only for friendly units adjacent to or stacked with the linking CP unit. The reconnaissance plane may spot for artillery fire, or spot for ground units, but it may not do both simultaneously.

MODIFIED PANZERBLITZ SEQUENCE OF PLAY

MODIFIED STEPS

Step 2 — German player announces which of his units are attacking which Soviet units, and what attack techniques are being used; identifies targets for air attacks for the following turn; declares the spotting unit and the attacking unit.

Step 4 — German player moves as many face-up VEHICULAR and AIRCRAFT units as he desires, executing any Overrun attacks as he does so. Soviet player may execute anti-aircraft attacks against any aircraft that move into range of his anti-aircraft weapons, as the aircraft are moved. Anti-aircraft weapons are inverted after attacking, but are not considered "dispersed". mark them with a blank counter or an "Opportunity Fire" marker from *PANZER LEADER* to avoid any confusion.

Step 5 — German player moves any face-up NON-VEHICULAR units, then executes air attacks identified the previous turn, and makes Close Assaults after doing so.



ARMOR IN ACTION

Long-time subscribers will recognize the header art for "Panzer Hunters" as having first appeared on the cover of Volume 12, Number 5 of *The GENERAL*, way back in the summer of 1976.

This print, entitled "Air Attack", is by artist Bruce Weigle, and comes from his *Eastern Campaign Portfolio*, part of the "Armor in Action" series of limited edition prints published by Lamo-Lem Battle Prints of La Jolla, California.

"Air Attack" depicts a strafing Sturmovik, having narrowly missed its prey (a Panther in the background), closing with a mobile flak crew operating a 20mm rapid-fire weapon mounted on the ubiquitous Sd. Kfz halftrack. Meanwhile, the crew of a Hetzer caught in the middle demonstrates the better part of valour.

The five portfolios in the "Armor in Action" series are:

Portfolio I — "France '40": The blitzkrieg of France, shown through the PzKw I, II and II, the Char B, and the British 'Matilda'.

Portfolio II — "The Desert Campaign": Desert armor in the North African battlefield, including British tanks 'Crusader' II and Vickers Mk VI, Rommel's PzKw IV, and 88mm gun and tractor.

Portfolio III — "The Eastern Campaign": From the Russian steppes to Berlin... contains Soviet T-26, BT-5, T-34 and JS-II, with Germany's Sd. Kfz. 251 AA APC and Jagd Panzer 38(t)—the latter vehicles are those in the print pictured at the beginning of "Panzer Hunters".

Portfolio IV — "The Peninsular Campaign": Mud, Waffen SS and stalemate, shown through four prints of U.S. and German equipment: M2 'Grant' and M3 halftrack APC; Stg. III and 'Tiger' II.

Portfolio V — "France '44": Normandy through the Ardennes offensive. Vehicles covered are the German PzKw V 'Panther' and Stg. IV, the U.S. M4A3 E8, and the British 'Churchill' VII.

All are published by Lamo-Lem Battle Prints of La Jolla, California, and all make a splendid addition to the walls of a gaming room or office.

For more information, write to:

Lamo-Lem Battle Prints
P.O. Box 2382
La Jolla, CA 92014

NEW EXPRESSIONS FOR A FAMILIAR FACE

More Scenarios and Units for *PANZERBLITZ*

By Alan R. Arvold

In this wargaming era where games of tactical level armored warfare have been published, remained popular for a time, and then disappeared forever from the hobby store shelves, few titles have stood the test of time so well as *PANZERBLITZ*, now celebrating its twenty-third year in print. The secret of *PANZERBLITZ*'s longevity is simple: While lacking the complexity of more recent tactical games like the *MBT/IDF* or *ADVANCED SQUAD LEADER* series, *PANZERBLITZ* boasts a playability which those games lack. With *PANZERBLITZ*, one can expect to begin and finish a game within a few hours. (By way of contrast, a single *game-turn* in *ADVANCED SQUAD LEADER* may take an hour to complete, given a medium size scenario.) Now I am not trying to put down *ASL* or any other complex tactical game. But as a wargamer with twenty-three years in the hobby, I no longer have the time to play a long game as I once did. Like many other gamers my age, I have come to prefer simpler games with which to contest my opponents' skill, and *PANZERBLITZ* fits this need quite nicely.

This article provides six new scenarios for *PANZERBLITZ*. There is no central theme behind these scenarios, occurring as they do in different periods of the war, and thus they serve simply as an adjunct to the original scenarios presented in the game. Besides the original *PANZERBLITZ* counters, these scenarios make use of counters from Ramiro Cruz' articles "PanzerBlitz 1941" (found in Vol. 13 No. 3 of *THE GENERAL*) and "Panzer Leader 1940" (a *PANZER LEADER* variant published in Vol. 15, No. 2 of *THE GENERAL*), as well as counters represented in the *PANZERBLITZ* Campaign Analysis Booklet. There are also three new counters described in the following section. Finally, there is a short historical background for each scenario presented here. Although most are historical scenarios, they are not exact re-creations of actual battles, but approximate representations of them. Some have undergone numerous revisions over the years of their existence to bring them more in line with the historical set up, but all are designed simply for fun. I do not claim that these scenarios are balanced, because history shows that very few battles were ever actually "balanced". In each of these scenarios, all Optional Rules and the Experimental Indirect Fire rule from the *PANZERBLITZ* game are used. [Alternately, players who own *PANZER LEADER* may wish to apply the rules of that game here, where applicable, especially the rules for "Opportunity Fire". Ed.] At this time, I should like to mention that Situations 2, 5 and 6 were originally created by Al Muelling.

NEW COUNTERS

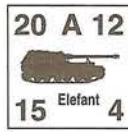

Jagdpanzer Tiger: Also known as the *Ferdinand* or *Elefant*, this was a very heavy tank destroyer mounting the 88mm Pak on the Tiger tank chassis. Used in the Kursk offensive as an assault gun — a role where it suffered heavy losses due to its lack of a mounted machine gun, which allowed Russian infantry to close-assault the vehicle and knock it out. Surviving *Elefants* were later used in the German withdrawing actions in the Ukraine during autumn 1943 before being recalled to Germany for rebuilding later that year.

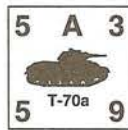

T-70a Light Tank: Russian light tank used from 1942 to 1945. Withdrawn from front line service in early 1944, it was still used by some recon units at the end of the war. It should be noted that on various occasions during 1942 and '43, the Russians would use light tanks to temporarily make up losses suffered by their tank brigades during extended armored combat. Situation 28-3/5 is an example of what could happen as a result of this policy.



BA-32a Armored Car: The main Russian reconnaissance vehicle for the first half of the war. Due to poor cross-country performance, the BA-32a was withdrawn from service by the end of 1943, when the Russians began using halftracks as their recon vehicles.

HISTORICAL BACKGROUND FOR THE SCENARIOS

Situation 1: By the first week of December 1941, the last German offensive of the year petered out just short of Moscow. Front line German units, many of them now mere shadows of their strength of six months earlier, would try to hold a line stretching from Leningrad to the Black Sea. One such unit was the 17th Panzer Division stationed just south of the city of Tula. Though its strength was down to that of a regimental *kampfgruppe*, this unit was expected to defend a frontage that would normally require a full strength division. Widely dispersed into battalion- and company-sized formations, the 17th Panzer prepared to meet the Russian offensive. On 3 December 1941, elements of the Russian 50th Army and a supporting cavalry corps struck all along the frontage of the weakened division. The Germans at first tried holding them back by shifting mobile elements to stop each Russian spearhead, but the spearheads were too numerous and the available defending mobile elements too few. Soon the Germans were forced to with-

draw to conserve what little strength they had left. (It should be noted that most of the German vehicular losses during this time period were due to mechanical breakdowns brought on by the extreme cold of the Russian winter.)

Situation 2: In the late spring of 1942 the Russians launched an offensive in the south with the objective of taking back the city of Kharkov, to be followed up by the clearing of the Ukraine. This offensive was launched on 12 May 1942 and caught the Germans completely by surprise. The Russian 28th Army formed the northern portion of the attacking force and initially met with tough resistance from the defending German units. But after four days of constant Russian attacks, the German defense finally collapsed and the Russians committed their mobile units to a deep penetration operation behind German lines. This penetration ran straight into the assembly area of the German 3rd Panzer Division (which was preparing for the Germans' own spring offensive), and the resulting German counterattack created a huge meeting engagement, with the Russians being thrown back with heavy losses. The Germans then launched their spring offensive, but the inexorable drain on their forces had begun again, and these losses would be sorely missed later in the year.

Situation 3: After blunting the Russian spring offensive, it was the Germans' turn. The Russians counterattacked furiously but were consistently beaten back. Although the Russian mobile forces were severely depleted after two months of savage fighting, the Russians did not pull them out of the front lines to rebuild them. Instead they were used to form small delaying forces to slow down the advancing German armored units. Situation 3 is not itself an actual re-creation of a specific battle; instead, it is a hypothetical representation of those delaying actions the Russians used against the Germans that summer. It should be noted that even though the Germans occasionally caught up to and destroyed some of these Russian delaying units, they succeeded in preventing the Germans from surrounding and isolating large concentrations of Russian forces. The Germans' delaying actions of the later years of the war were adapted from their own experience against such tactics during the summer of 1942.

Situation 4: At 1500 hours on 5 July 1943, the battle at Kursk began. In the northern pincer, units of the German 258th Infantry Division assaulted the forward defense line of the Russian 15th Infantry Division. Facing a determined Russian defense, this attack bogged down almost immediately. Armored units of the German 20th Panzer Division were hurriedly brought in to salvage the situation, and the attack resumed soon

PanzerBlitz

Situation #28-3/3

RUSSIAN DELAYING ACTION (Hypothetical); SOUTHERN RUSSIA (1942). During the German Summer Offensive, the Russians made extensive use of delaying tactics to slow the German mobile units and gain time to allow major Russian forces to safely withdraw.

Map Configuration



RUSSIAN FORCES



Set up first anywhere on the No. 1 and No. 2 Boards.

5 A 3 1 264 5	2 A 3 1 60 6	12 A 6 KV1 10	5 A 3 B4-32a 12	5 I 4 RIFLE 16	8 I 1 SMG 1	3 I 1 RECON 4	2 M 12 82 mm 3
x4	x2	x2	x2	x3	x4	x1	x2

24 M 20 120 mm 2	7 A 3 45 mm 3	6 I 6 127 mm 2	12 A 5 76.2 mm 2	0 C 0 TRUCK 1
x1	x3	x1	x1	x6

VICTORY CONDITIONS:

The Russian player gets one point for each enemy unit destroyed. The side with the highest point total at game's end is the winner.



GERMAN FORCES



Enter on the west edge of the No. 2 Board.

8 A 6 PzKpf III 7	8 A 3 PzKpf III 50/L42 6	5 H 8 PzKpf IV 75/L24 7	5 H 8 SG-III 12	10 H 12 GW 38(t) 5	3 I 6 RIFLE 8	3 I 4 M 10	3 M 12 81 mm 3
x8	x2	x4	x2	x1	x9	x1	x1

4 H 10 20 mm 1	14 H 10 20(4) mm 1	40 (H) 12 105 mm 2	2 C(I) 4 HAUFTRK 4	0 C 0 TRUCK 1
x2	x2	x2	x11	x6

VICTORY CONDITIONS:

The German player receives one point for each enemy unit destroyed and one point for each German unit that exits off the east edge of the No. 3 Board by game's end. The side with the highest point total at game's end is the winner.

German moves first TURN	1	2	3	4	5	6	7	8	9	10	11	END	12
-------------------------	---	---	---	---	---	---	---	---	---	----	----	-----	----

PanzerBlitz

Situation #28-3/4

GERMAN ATTACK ON ORGANIZED RUSSIAN DEFENSE; KURSK CAMPAIGN (5/7/43). As the spearhead of the German northern pincer commences its attack on the forward line of Russian defenses, infantry units of the German 258th Infantry Division, supported by elements of the 20th Panzer Division, assault units of the Russian 15th Rifle Division, itself supported by an independent tank brigade and a heavy tank regiment.

Map Configuration

3 7 1



RUSSIAN FORCES



Group A: Set up first anywhere on the No. 2 Board.

5 I 4 RIFLE 16	8 I 1 SMG 1	3 I 2 M 8	3 I 1 RECON 1	0 - CP 1	3 M 12 82 mm 2	24 M 20 120 mm 2	7 A 3 45 mm 3	9 A 4 57 mm 3
x18	x2	x2	x4	x2	x6	x2	x4	x2

12 A 5 76.2 mm 2	3 H 10 76.2 mm 2	40 H 20 122 mm 1	6 I 6 127 mm 2	0 C 0 WAGON 3	0 C 0 TRUCK 1	40 40	X	MANG 2-1
x6	x2	x2	x2	x8	x4	x8	x14	x11

Group B: Set up second anywhere on the No. 1 Board.

12 A 6 T-34 C 9	12 A 6 KV1 11	40 H 24 M-13 2	2 M 12 82 mm 2	8 I 1 SMG 12	3 I 1 RECON 4	8 H 12 37 mm 1	0 C 0 TRUCK 1
x6	x2	x1	x1	x4	x1	x1	x7

VICTORY CONDITIONS:

The Russian player receives one point for each enemy unit destroyed. The side with the highest point total at game's end is the winner.



GERMAN FORCES



Set up last on the No. 3 Board, at least four hexes from the nearest Russian units.

15 A 12 TIGER I 12	16 A 12 PANTHER 12	14 A 8 PzKpf IV 8	5 H 8 SG-III 12	12 A 8 MAARDER 7	20 A 12 EMERSON 15	10 H 12 GW 100M 4	40 H 32 WESPE 5
x4	x8	x6	x4	x2	x1	x1	x2

60 H 24 HUMMER 6	3 I 6 RIFLE 8	6 I 3 SMG 6	3 I 4 M 10	3 M 12 81 mm 3	15 M 20 120 mm 2	13 A 6 75 mm 2	14 H 10 20(4) mm 1
x1	x18	x6	x3	x2	x2	x3	x2

Group C: Set up last on the No. 1 Board.

4 H 10 20 mm 1	6 H 12 37 mm 1	0 C 0 TRUCK 1	2 C(I) 4 HAUFTRK 4
x2	x1	x16	x11

VICTORY CONDITIONS:

The German player receives one point for each enemy unit destroyed, one point for each friendly unit on the No. 1 Board at game's end and two points for each friendly unit that exits off the south edge of the No. 1 Board by game's end. The side with the highest point total at game's end is the winner.

German moves first TURN	1	2	3	4	5	6	7	8	9	10	11	END	12
-------------------------	---	---	---	---	---	---	---	---	---	----	----	-----	----

afterward. By the end of the day the Germans had driven the Russian 15th Infantry Division from its first line of defense, suffering heavy casualties in the process. The badly-mauled 15th Division settled into its second defense line and was reinforced during the night. By morning, it was again ready to meet the German onslaught.

Situation 5: In August 1943, after the debacle at Kursk, German forces were slowly being pushed back through the Ukraine. Led by the 5th Guards Tank Army, a Russian spearhead was trying to reach the city of Kharkov from the south. A German *kampfgruppe* consisting of remnants of the 3rd Panzer Division and the 503rd Tiger Battalion moved to a small village a few miles southeast of Kharkov to block the Russians. On the morning of 19 August 1943, the Russian 5th Guards Tank Army engaged the blocking force. The Russians attacked with the 18th Tank Corps late in the morning. The Germans repulsed this attack, inflicting heavy losses on the Russian force. That afternoon the Russians launched a second tank corps at the Germans, but it too was driven back. In a moonlight battle that evening, the 5th Guards committed its last tank corps. After losing over half their armored vehicles, the Germans managed to defeat the night attack, but were forced to retreat from the area the next day to escape encirclement by other Russian forces. They left behind over 200 knocked-out Russian tanks in and around the small village.

Situation 6: In March of 1945 the Russian 5th Shock Army was on the banks of the Oder River, waiting to march into Germany itself as other Russian forces secured its flanks. The 5th Shock Army had established a small bridgehead over the river at the town of Kustrin; on 23 March, 1945 they attacked out of it with a Guards Tank Corps, attempting to enlarge the bridgehead for the major Soviet offensive scheduled for April. All that stood in their way was a patchwork Panzer Division, possessing neither name nor number, hastily thrown together and consisting of a large battalion of Tiger and Panther tanks with an infantry battalion acting as forward screen for the AFVs. The Russians attacked with two tank brigades and a motorized rifle brigade reinforced with heavy tanks and assault guns, with a third tank brigade held in reserve. The two tank brigades quickly broke through the German infantry screen and drove deep into the rear to engage the enemy armor, but the reinforced rifle brigade became entangled with the German infantry screen and spent the rest of the battle clearing it out. The two Soviet tank brigades were successively ambushed by the German armor and ultimately sent reeling back to the bridgehead with over 60 tanks lost. Though the Germans lost few tanks, their infantry screen was destroyed, forcing them to pull back to a more defensible position. Rather than risk such a costly advance again, the Russians simply consolidated their existing bridgehead and waited for their upcoming offensive.



Coming Attractions

AULD LANG SYNE

Writing this column on New Year's Eve naturally led me to view the past year in retrospect. For me, that means games which you won't see until 1993. I know not how the new year will treat my recent projects, but I can honestly say that I cannot remember a year's development chores that I have enjoyed more during my two decades on the Hill. The subjects were about as diverse as one could imagine and consequently I suspect there are very few readers who will share my enthusiasm for all of them. But if at least one of them doesn't turn you on, we certainly don't share the same taste in games. As for me, my biggest problem will be finding the time to play them at future *AVALONCONs*. These are games I will continue to play—and that's not something I can always say after a year of intensive play in development.

ROADKILL

ROADKILL was my first project in 1992, and the hardest. The game went through numerous levels of evolution and the end product holds scant resemblance to the original submission. The game was described in detail in this column last issue, so there is no need to do so again here. Suffice it to say that it is an attempt to branch out into new subject areas while attracting a younger audience. That is not to say that this is a children's game, nor that the concepts of a solid strategy game were sacrificed. Far from it. *UP FRONT* fans will recognize many of the same gut-wrenching decisions which makes that card game such a favorite. Unlike *UP FRONT* however, players should have an easy time with a much slimmer rulebook. Besides its obvious graphic appeal, the card game format remains my favorite method for presenting complex concepts with a minimum of rules resistance, because the components themselves provide the bulk of the memory prompts.

ROADKILL was born out of a desire to fill a sales niche rather than a love of the subject (although I'll admit to owning the Mad Max video trilogy). Yet, like *WRASSLIN'*, by the time we were through I had overcome my disdain of the subject and found it every bit as absorbing and entertaining as my favorite games. I recommend it highly to anyone who enjoys our brand of sophisticated card games and can gather a group of four or more.

STATIS-PRO BASKETBALL

From futuristic cross-country demolition races to NBA basketball is a broad leap but that's

where my next project took me. Statistical sports games played to replay past season performances rather than as a competitive medium between two opponents are a far cry from what I term games of skill. They are usually played solitaire with the emphasis on reliving past sports matchups of real life players. "Watching" stars repeat their athletic prowess is the real attraction here. Competitive play between the coaches is a rarity and usually viewed as secondary to the game's statistical accuracy. The exception is when coaches get together to draft their own "dream teams" for league play. Even then, the skill lies more in the draft than in the play of the game. It is an appeal I had personally forsaken long ago in favor of head-to-head competitive play à la *FOOTBALL STRATEGY*.

Nevertheless, I was not without background in this area, having been enamored with such products as BLM and APBA in my youth when opponents were hard to come by. Many a summer was spent replaying entire American League baseball seasons as I tried to relive Mickey Mantle's exploits in cardboard. Nor was basketball ignored. The truth of the matter is that an NBA season replay probably did more harm to my college roommate's GPA than his participation on the freshman basketball team.

So when it came time to give *STATIS PRO BASKETBALL* a facelift I was the obvious choice. *STATIS PRO* has a lot going for it. Its Fast Action Card system (which replaces the seemingly endless convoluted charts of other stat games) is both faster and much easier to use than conventional methods. However, the game had suffered from neglect over the years and failed to keep pace with the changes in basketball. Enter yours truly to stir the pot.

The first thing I did was to change the game from base-8 to base-10 percentages. This made the game easier to play because addition/subtraction in base-8 is cumbersome for most people. It also made the game more accurate because it changed a range of 64 possible outcomes to 100. The player ratings are thus automatically more detailed as well as being easier to recognize.

The next change dealt with stamina—the system whereby coaches are forced to rest players rather than play their starting five an entire 48 minutes. This issue has been a major problem in all stat games and *STATIS PRO* is no exception. Every new edition of the rules seemed to pose a different version of the rule. All of them were based on variations of limiting a player's time on

the court to a cumulative total of his statistics. Whether the stamina rule in vogue that season limited a player's shots, rebounds, steals, fouls, or any variation thereof, the result was always the same: A tedious, continuous tally of every player's stats which allowed him to perform to his monotonous average every game—but never allowed him a truly great night. Jordan could be counted on to score 30 every game, but he magically “tired” after every 28th shot and had to be removed. Hogwash!

Previously, the game allowed the coach to decide who would take each shot—as long as someone shot within three passes. This resulted in coaches always holding the ball until their best shooter got it, or worse, rationing shots among their players so as not to exceed their “stamina” ratings and be forced to leave play. I viewed this as giving the coach an unrealistic control over his team far in excess of that enjoyed by even the most rigid disciplinarian. It was also artificial in the extreme. Competitive coaches invented all kinds of schemes to circumvent the “stamina” rules and keep their best players on the court, playing minutes far in excess of their season stats.

My solution was simple, yet profound. Every pass was now numbered. If that pass was \leq the ballhandler's Shot rating, he had to shoot (except in the final 2:00). If it wasn't, he had to pass unless the 24-Second Clock was expiring—in which case he had to take a forced shot. This one change instantly cured most of the game's ills. Now effective Point Guard play is as important as it is in the NBA. The role of the assist, previously all but ignored in the game, is emphasized. Now Jordan can have an occasional 60 point night instead of routinely scoring 30, game after game, before he “tires”. More importantly, stamina restrictions are now handled automatically by the game system rather than requiring constant statistical updates. If a coach elects to play a little-used substitute exclusively, he is penalized automatically by more forced shots, because the substitute lacks the shot attempts to get many open shots.

The third major change was to alter the timing system to reflect more accurate use of mechanisms that stop the clock and make that last minute of an NBA game such a drawn-out affair. Previously, the game had no mechanism for distinguishing between plays that stopped the clock and those that didn't. A quarter was 180 cards regardless of what happened. In fact, contrary to logic, it was actually beneficial for the leading team to foul because it used more cards. The expanded FAC deck establishes a reservoir of “dead ball” cards to use in such situations. The addition of time-outs to the game creates opportunities for coaches to practice strategy in a realistic manner while also implementing an easy automatic-timing mechanism for resting players.

Of course, there were many smaller changes too detailed to relate here. However, I believe that it is now the best stat game on the market. It's not often you can claim to have made a

game easier to play, shorter, and more realistic and enjoyable at the same time. I believe that is now the case with the '93 version of *STATIS PRO BASKETBALL*.

The replay enthusiast in me enjoyed reliving Larry Bird's last exploits in the final season of my last sports idol. The only negative aspect of the new version is that the new base-10 stats are not compatible with prior seasons. We will publish conversion formulas so that play between teams of different seasons will remain possible, albeit inconvenient.

HISTORY OF THE WORLD

If *ROADKILL* was my hardest project in 1992, *HISTORY OF THE WORLD* was the easiest. This game was published in England as a private label effort with a very limited print run. Despite modest physical components, it debuted to very flattering reviews and we were equally impressed. The game is a cross between *RISK* and *BRITANNIA*, combining the best features of both into a splendid multi-player game of world conquest. Others might liken it to a simple *CIVILIZATION*, playable in an afternoon.

Players command a different empire in each of the game's seven turns. Each, in turn, rises to prominence in its corner of the world as centuries pass at a rapid pace. With 5,000 years passing rapidly before your eyes between the ancient Sumerians and the advent of the First World War, the trick is to maximize the performance of each empire during its moment in the limelight while preserving the remnants of its power as the passing years and new world powers take their toll. The result is a panoramic playback of the game's namesake painted in bold, swift strokes.

HOTW's best feature is its simplicity. Any casual gamer can be taught the game in a matter of minutes. I have yet to see anyone who didn't enjoy their first game of *HOTW*. Aside from upgrading the components, our version concentrated on improving the skill level to encourage repeated play. The game's biggest flaw was that it was perceived as too luck-dependent. Our development has focused on that problem and tried to increase the player's sense of being in control of his own destiny.

The crucial mechanism in *HOTW* is the process for determining which empire a given player will get each turn. Each player draws an empire card and decides—based on its strength, whereabouts, and order of appearance—whether he'll keep it or pass it to another player. The order of the draw is all-important, and players must weigh how badly they want (for example) those 25 legions of the Roman Empire against the likelihood of drawing last for the remainder of the game. In the original version, players drew in reverse order of their score—an obvious play balance mechanism which actually punished good play. The simple expedient of changing the draw order in favor of those who have received the least cumulative Empire strength greatly improved the game by rewarding good play throughout without harming play balance.

Most of the other changes were cosmetic and involved upgrading the game components. For example, the event markers have been changed to cards so that each is self-explanatory. In addition, instead of drawing one per turn for use in that turn, players are now dealt a set of nine at the start of play. This allows players to plan their strategy while reducing the luck element by ensuring that all players receive an equitable share of the chance elements.

We halted the development of *HOTW* ahead of schedule because we simply couldn't find anything wrong with it. I am confident that it will be a hit among the relatively wide audience of casual gamers for whom *RISK* has previously epitomized the ultimate game. In my opinion, *HOTW* is simpler, more colorful, quicker, and more fascinating than the enduring Parker Brothers classic. That is high praise from someone who has lost Kamchatka more times than he cares to admit.

BREAKTHROUGH: NORMANDY

The veteran wargamer may complain that none of these projects are true wargames. He would be right if his definition of a “real” wargame must include a hex grid and voluminous rules. But my “real” wargame project for the year didn't include a hex grid, and the rules are hardly *ASL*-esque.

BREAKTHROUGH: NORMANDY is the fourth in the series of area, semi-simultaneous movement games following in the steps of *STORM OVER ARNHEM*, *THUNDER AT CASSINO*, and *TURNING POINT: STALINGRAD (TP:S)*. From a marketing viewpoint, I should never have considered publishing this game. Coming on the heels of the Smithsonian series *D-DAY* remake, and with *FORTRESS EUROPA* and Victory's *FRANCE 1944* barely cold in the grave, one would have to question my sanity for choosing to release yet another *D-DAY* game at this time.

The scale of the Smithsonian game made it “D-Day” in name only, and both of the earlier failures were strategic level games covering the entire campaign in France; we had never done *D-DAY* at this scale and using this system.

Ah, the system. I freely admit to being nuts over the impulse-movement games, and this one takes the system to new heights. I like to think that each game in the series has been an improvement on its predecessor, and this one is no exception. As much as I like *TP:S*, this game may put it on the shelf.

BREAKTHROUGH: NORMANDY is a regimental-level portrayal of the D-Day landings and the battles that ensued in the following three weeks. As in the preceding game, the action is divided into weekly sessions. At the end of each week, Victory Points are totaled to see who has won. In the event of a tie, play can continue for another week. The map includes all of the Contentin peninsula in the west, ranging to Cabourg on the East and Thury-Harcourt in the South, at a scale of 2.7 miles per inch. Fans of the system will note three major changes:

First, impulses now come in two varieties: Assault and Bombardment. Gone are the Ranged Attacks of *TP:S*. Instead, Divisional and Corps artillery can be used either to support assaults or bombard areas. If a bombardment impulse is chosen, a target area is selected and all fresh artillery in or adjacent to that area can join in the attack. The defenders absorb barrage damage to varying degrees depending on unit type, but cannot lose more than one level per unit per impulse. During an assault impulse, the attacker not only suffers losses for losing an attack, but must retreat if his attack was obligatory due to entering an uncontested enemy area. On the other hand, if an area is already contested it can be entered without requiring an attack.

Second, Fresh and Spent units no longer comprise different "groups". Instead, they form one homogeneous defense of an area. Both can be affected by a single attack. Furthermore, additional Fresh units in an area contribute to its defense in ways other than an increased ability to absorb losses before yielding control of an area. Losses are now taken in terms of levels or "hits" which can be repaired one per day given adequate supply during the Refit Phase—rather than automatically put of action for a given length of time. These changes eliminate several of the abstracted concepts of the *TP:S* combat system and are perceived as more realistic than the former game's "bloodless attack".

Third, besides Terrain Effects Modifiers, areas now are rated for *Bocage* and being within Naval Gunfire range. In addition, area boundaries are of three types: Open Ground, Rivers, or Flooded. The boundary type affects movement costs and adds a whole new dimension to the game in the form of control and/or destruction of bridges.

The uncertainty of each day's length—first introduced in *TP:S*—remains, but is expanded by the fickleness of weather which can change during any impulse. The result is, again, a delightful game to solitaire because of the unknown factors beyond either player's control. But the delicious tension of the two-player game is simply greater than I've experienced in any other game.

The "You go/I go" pressure of the impulse system against the backdrop of a ticking time bomb that is the unpredictable sunset has been enhanced by the addition of changing weather and the need to safeguard or blow bridges. Both players constantly face pressing needs all over the board, but can scratch only one itch at a time. The move not taken this impulse may not still be available in the next. The need to constantly prioritize the many needs along the constantly changing front keeps both players on the edge of their seats. Should the Germans risk moving Panzer Lehr now despite savage Allied air interdiction, or wait for cloud cover that may never come in time? Should the British take that bridge now and risk casualties if repulsed, or soften the far side of the river with a preparatory barrage? The cautious route may be punished by the sight of a bridge being destroyed before the Allies can

cross it. These are just two of a never-ending series of tough decisions faced by both players.

If I sound rhapsodic over this game, it's because I am. The improvements to an already tension-filled game system are obvious, but the biggest plus may be the situation itself. This is the first game in the series which escapes a siege mentality. For once, both sides have very real attack possibilities—and often at the same time. In fact, often the only thing preventing an attack by either player is the need to solidify his defense elsewhere. Each player hopes for a momentary lapse in the enemy initiative to launch his own offensive. Areas once taken can be retaken and only overwhelming Allied air, naval, and artillery superiority allow the Allies to remain generally on the offensive—a condition which changing weather can soon remedy.

BREAKTHROUGH: NORMANDY is currently undergoing extensive blind playtesting. This test is a revolutionary one for me because it marks the first time where I will actually be playing a dozen different field testers instead of just reading their reports. By using the electronic mail of GENIE I will be able to actually see the tactics of the various field groups first hand. It should be an enjoyable and rewarding experience which I expect to pay big dividends to fans of this system.

1993 looks like a very good year.

Don Greenwood



✈ AIR TRANSPORT ✈

USAir has been designated as the official carrier for the attendees of AVALONCON. Together, USAir, USAir Express and USAir Shuttle offer more than 5,082 flights daily to more than 211 cities. For our convention in Baltimore, USAir and USAir Express offer 194 flights daily. Of course, USAir Frequent Traveler members will earn a minimum of 750 Frequent Traveler miles when flying on USAir to the convention.

To obtain current flight and fare information, call the USAir Meeting and Convention Reservation Office at (800) 334-8644, 8 AM to 9 PM, EST. Once your reservations are confirmed, USAir can suggest several convenient methods of purchase. If you normally use the services of a travel agent or corporate travel department, please have them place the call for you. **Refer to Gold File Number 46510055.** Travel for AVALONCON is valid on USAir between August 3-10, 1993.

The BWI Shuttle Express—Route C to Hunt Valley provides Round Trip transportation to the Hunt Valley Inn for \$21 (\$14 one-way) every two hours between 5:45 AM and 11:45 PM. Round-trip tickets are on sale *only* at BWI. Reserve space by calling (410) 859-0800 at least two hours in advance on the day of service.

CONVENTION CALENDAR

The *GENERAL* will list any gaming convention in this column free of charge on a space-available basis, provided that we are notified at least six months in advance of the event date. Each listing must include the name, date, site and contact address for the convention. Additional information of interest to our readership, such as tournaments utilizing Avalon Hill games, is solicited and will be printed if space permits. The Avalon Hill Game Company does not necessarily attend nor endorse these gatherings, nor do we guarantee that events using our titles will be held. Readers are urged to contact the listed source for further information before making plans to attend.

MARCH 6 — APRIL 18, 1993

1st ANNUAL CHICAGO BOARDGAME CHAMPIONSHIPS. The "Windy City Wargamers" is sponsoring this six-week event with tournaments in Titan, VITP, Diplomacy, Adv. CIV, ASL, and Blackbeard. Contact Louie Torkaz, 5724 West 106 Street, Chicago, IL 60415, (708) 857-7060, or Robert Banozic, 2256 North Cleveland, #107, Chicago, IL 60614, (312) 528-1095.

APRIL 23 - 25, 1993

POINTCON XVI, United States Military Academy, West Point, New York. For more information, write to: USMA Wargames Committee; ATTN: POINTCON XVI; P.O. Box 62; West Point, NY 10997.

MAY 14 - 16, 1993

HEXACON VII, Braubach, Germany. Germany's biggest board wargaming convention, held at the Marksburg Castle near Koblenz. Among other events, a tournament in the most popular wargame in Germany, *UP FRONT*. For more information, contact: Ulrich Blennemann, Rosental 76, D-4320 Hattingen, GERMANY.

MAY 15 & 16, 1993

MADISON GAMES CON (formerly Madison Games Day) '93, Madison, WI. For further information, please send a SASE to Pegasus Games, 6640 Odana Road, Madison, WI 53719, (609) 833-4263. For hotel information, call the Quality Inn South at (608) 222-5501.

MAY 21 - 23, 1993

ADVENTURE GAME FEST '93, Portland, OR. Board games, Miniatures, Role-Playing games, all genres. Contact: Adventure Games Northwest, Inc., 6517 NE Alberta, Portland, OR 97218. Tel.: (503) 282-6856, or call (206) 574-GAME.

MAY 21 - 23, 1993

CONWEST V, Albuquerque, NM. Scheduled events include *UP FRONT*, *ASL* and *DIPLOMACY*. Contact: The Weregamers' Guild, SHC, Box 45, SUB UNM, 87131, or call (505) 883-9553.

New from Avalon Hill... for SPRING '93!

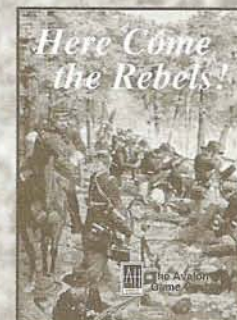
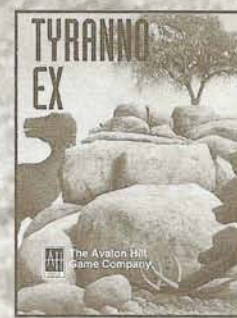
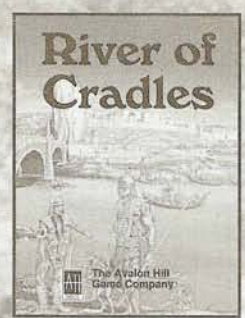
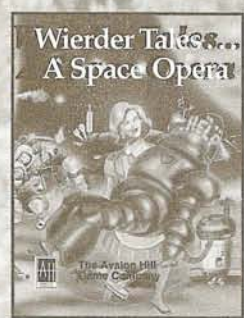
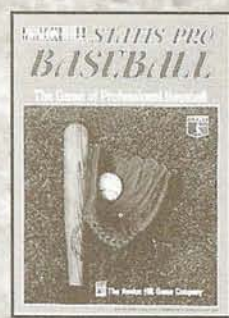
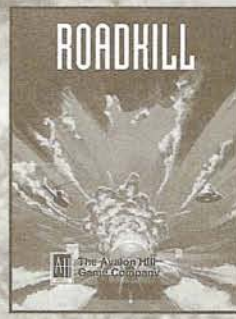
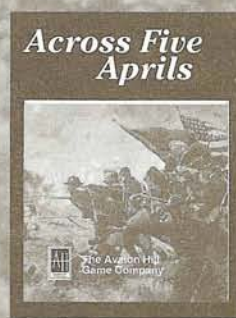
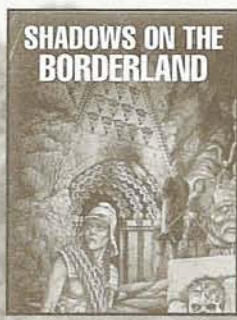
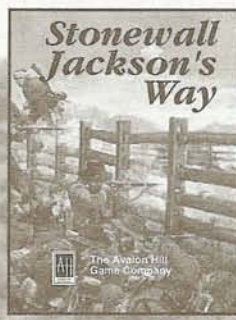
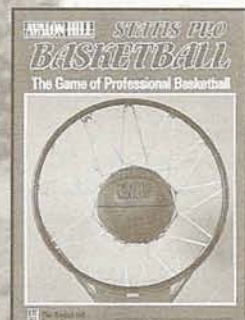

The Avalon Hill Game Company
DIVISION OF MONARCH AVALON, INC.
4517 Harford Road • Baltimore, Maryland 21214

Farm photo courtesy of Dept. of Economic & Employment Development, State of Maryland

For Quick Credit Card Purchasing call **TOLL FREE 1-800-999-3222**

THE NUMBERS GAME

A Look at the 1992 ASL Competition

By Russ Gifford

As an ASL player myself, and as a tournament director at AvalonCon this past summer, it's my goal (some might say "duty") to see players competing in scenarios which both sides have an equal chance of winning. Winning a scenario with a side that can't lose isn't my idea of fun; and I'm certain that playing the other side in such is no one's idea of a good time, either—at least, not in a tournament! I believe that is why Mark Nixon's article, "The Numbers of October" (in the '91 ASL Annual), has resonated throughout the ASL fraternity around the world. I've seen gamers from Minneapolis to Dallas, from Baltimore to San Francisco, consulting "Nixon's Numbers" before they decide to play a particular scenario in competition. And it's no different at major conventions anywhere; I've found "the numbers" jotted directly on the scenario cards, and the entire chart taped inside the cover of ASL rulebooks.

I'm not at all certain that this is what Mark intended when he penned the piece (or Rex when he published it), but like his "anti-IIFT" article, it has changed the way people play ASL. Even the very best players do not seem immune to the influence of the inferences and conclusions drawn about the scenarios from these records, despite reservations and warnings from Nixon and others. Now ASLers are hungry for all the win-loss stats for the scenarios that they can get their hands on; so consider this piece "The Numbers, Part 2" and let me share with you how the scenarios I selected for the competition fared at the 2nd AvalonCon ASL Championship. (Please refer to the accompanying chart.)

Comparing these stats to Mark's numbers, you'll quickly notice that the AvalonCon tournament gave many of these scenarios as much play in one year as they have had in five [now six] of Conner's "ASL Oktoberfest" (often abbreviated as "ASLOk"). In short, the play at AvalonCon could be considered the "acid test" of the numbers game. Readers should remember that the format of the tournament was designed to bring players of equal ability together in each round in a select few scenarios, as opposed to the somewhat random nature of pairings and scenarios at ASLOk. (Since the AREA ratings were new to about half the field this year, there were some regrettable "overmatches" in the first two rounds; next year, as the AREA system becomes prevalent, the skill levels should be much closer to parity in every round.)

What sort of conclusions can be drawn from these results of the competition? In most cases, they simply serve to prove that five year's worth of ASLOk play was no fluke. For example, "Silence that Gun" received 19 playings this year and the Germans finished with a record of ten wins and nine losses. Some 18 playings at the

ASLOk (as of 1991) give the Germans an 8-10 rating. Add the two together, and you'll have a 18-19 record for the Germans in this scenario, indicating that it is fairly balanced when played by experienced gamers in a tournament setting. Other scenarios show a similar tendency. Putting all this together, we can consider the most-played scenarios (with a minimum of 20 matches at the two tournaments combined) among those used at AvalonCon:

Scenario	AvCon	ASLOk	Total	Balance
ASL #14	10-9	8-10	18-19	49-51
ASL #27	14-13	9-11	23-24	49-51
ASL #48	2-4	9-8	11-12	48-52
ASL #16	7-7	6-4	13-11	54-46
GEN T1	5-5	11-14	16-19	46-54
GEN A	4-3	16-14	20-17	54-46
GEN G6	8-12	9-9	17-21	45-55
GEN T4	7-7	10-17	17-24	41-59
RB6	3-7	6-6	9-13	41-59
DASL #1	5-10	17-5	22-15	59-41
ASL #1	11-20	8-8	19-28	40-60
RB3	10-13	4-8	14-21	40-60

(All figures list German victories first)

As you can see, most of these scenarios are tested, tried and true. Avalon Hill has striven to produce well-balanced challenges (despite early impressions) for fans of the system and seem to have succeeded. The data from two large tournaments certainly confirms this impression, as not a one of these quite popular scenarios reads as unbalanced. But all this leaves us with some intriguing questions.

Take, for example, ASL #16 ("No Better Spot to Die"). Some top players have labeled it as grossly unbalanced, yet the results of 14 playings at AvalonCon see an equal number of wins by both sides. And the combined total shows only a 54% tilt to the German player, hardly a significant amount; and this is with only 24 playings. This only serves to underline the problems of playing the "numbers game". ASL #16 might well be unbalanced (as some hold), but its record in high-level tournament play isn't bad.

By the same token, ASLOk scores DASL #1 ("Guryev's Headquarters") as one of the least balanced scenarios of all. Yet the Germans, favored by the ASLOk trials, lost two out of three playings at AvalonCon. Then there's "Fighting Withdrawal". I've always felt this scenario favors the Russians when they play tough, but the ASLOk numbers say it's a toss-up for either side! Humorously (now, not then), the only grief I got as tournament director in Camp Hill was from an entrant who felt DASL #1 didn't belong among the choices offered as the statistics "clearly show" it is a walk for the Germans. He also felt that I should have included more scenarios like

"Fighting Withdrawal", since they are "proven" to be balanced! The truth is, I would have eliminated "Fighting Withdrawal" before dropping "Guryev's Headquarters" from the list. Why? Because my personal experience leads me to believe that I'd take either side in DASL #1 against *any* player before I'd take the Finns in ASL #1. Is that a fair assessment? Statistically, at AvalonCon II, the balance of these two scenarios ended within a percentage point of one another. In the "numbers game", that's a breakthrough for DASL #1 and a breakdown for ASL #1.

There are many possible reasons for any of the results from both these tournaments. Which side got the balance provisions? How were the dice? Did the player who got tromped use all his possible resources (such as Smoke, Fire Lanes, Sewer Movement, Roof Tops)? Did both players play without rules errors? Many players, especially in the high-pressure environment of a tournament, overlook all the aces that are dealt them by the scenario designers, and some scenarios absolutely require a player to make use of all the tactical tricks to win. For instance, T8 almost demands that the player try for SMOKE on that first shot with the 155mm. In ASL #16, if the American doesn't realize that his chances of victory are pinned to the forced truce TC, he might structure his defense along the wrong line. Conversely, perhaps our German players lost because they overlooked the use of armored assault when crossing all that open ground and so suffered too many failed MCs. Such unanswered questions are why you can't simply point to any of these numbers as proof of a scenario's worth.

Four old favorites of mine had interesting results in the tournament:

"Rockets Red Glare" had 20 playings, and ended with a respectable 8-12 balance. However, in 18 matches at the ASLOk, it is adjudged perfectly balanced. Still, added together, that's only a 5% tilt from a perfectly even match-up in a short and enjoyable scenario. Perfect for an evening's entertainment.

With a 10-13 result at AvalonCon, "Bread Factory #2" is one of those scenarios where the Russian player makes it tough for the German only by utilizing every trick in his arsenal (Did the Russians use the cellars, or the Stealth advantage?). At the ASLOk, the scenario had a 4-8 record through last year—until the 1992 competition, when it was 5-5. Thus, as of right now, the results of the AvalonCon tournament closely mirror the six-year record at Mr. Conner's *Oktoberfest*. The fact that RB3 was selected in the last round for the championship game by the two finalists only attests to its perceived balance by the "best of the best."

In fact, only two other scenarios had more playings at AvalonCon II. One favorite from my

list proved to be "Liberation of Tulle", with 27 matches. At ASLOk, it enjoyed another 20. With some 47 games recorded, I'd say we have a fairly accurate look now at the balance of ASL #27. And it's pretty darn close. But the most-played AvalonCon scenario? Well . . .

The "loser" (as though there were any) at AvalonCon had to be everybody's favorite, "Fighting Withdrawal". Rated "even" in five years of the ASLOk, this chestnut hit bottom with an 11-20 record; almost a 2:1 spread! Why? I suspect that the Russians were easier to play than the ASLOk numbers would lead us to believe. Too, given the common perception of this scenario, I suspect that the majority of players grabbed the side *they* believed to have the advantage; some got a rude shock in the rough-and-tumble first round. (The vast majority of the top seeded contestants played DASL #1, by the way.) The other possibility (which I can't prove), is concern over the balance provisions. Worried that they might give the Finnish player the balance (an extra turn), both players may have chosen to play the Finns, and so surrendered the balance provision to the Russians. (On that point, I see no reason why a "null" choice for sides can't be used in competitive play [*i.e.*, *hold out an empty fist*]; though this guarantees that your opponent will get his choice, it certainly prevents some of the more drastic balance provisions from coming into play. And if both players do this, low die roll gets choice of side with no balance provisions in play for either.)

The "winner" among scenarios in the "numbers game" at AvalonCon II? In my mind, it has to be DASL #1. "What?" I hear you screaming, "It's sitting at 5-10, which is a 2:1 spread!" Quite true. But in the opposite direction of the ASLOk numbers, which I've always contended were highly suspect. My theory on the imbalance supposedly shown at the ASLOk is that many of the players there prefer being the attacker in a scenario, so in the somewhat friendly competition took the German side and prevailed. But at AvalonCon, I think they "voted with their feet" and took the side they perceived to actually have the edge (the Russians), and thus consistently won. It's also interesting to note that the results of the '92 ASLOk were 3-3 for DASL #1; hopefully, all these numbers will redeem this gem.

One scenario was a surprise to everyone, myself included. While "Rachi Ridge" is just 3-2 in ASLOk play, it certainly wasn't a safe choice in the ASL tournament at AvalonCon. Of course, my first question must be, "Did every stick really land on target? Everybody involved figured out the drift correctly?" I couldn't say. Certainly in my playings, the scenario didn't seem that unbalanced. Has someone figured out a sure-fire trick for the Germans? If so, please share it with this poor *fallschirmjäger*.

My personal surprise, however, occurred on a different line of hills. I have argued that "Cibik's Ridge" was unbalanced since it was in playtest for *GUNG HO!* But I honestly thought it was unbalanced in favor of the Japanese. After

THE NUMBERS OF AUGUST AVALONCON 1992:

Module/Scenario	Axis Win-Loss	Round
BEYOND VALOR:		
#1 Fighting Withdrawal	11-20(Finn-Russian)	Rd #1
#2 Mila 18	4-2	Rd #1
#4 Commissar's House	3-0	Rd #6a
#10 The Citadel	0-1	Rd #7
PARATROOPER:		
#11 Defiance on Hill 30	2-1	Rd #6
#14 Silence that Gun!	10-9	Rd #2
#16 No Better Spot to Die	7-7	Rd #2
PARTISAN!:		
#27 Liberation of Tulle	14-13	Rd #3
#31 The Old Town	1-1	Rd #3
WEST OF ALAMEIN:		
#35 Blazin' Chariots	1-3	Rd #4
#36 Rachi Ridge	9-0	Rd #4
THE LAST HURRAH:		
#43 Into the Fray	3-3	Rd #5
#46 Birds of Prey	4-3	Rd #5
#48 Toujours L'Audace	2-4	Rd #5
HOLLOW LEGIONS:		
#51 Taking of Takrouna	7-4	Rd #4
CODE OF BUSHIDO:		
#63 Eastern Gate	3-2	Rd #6
#65 Red Star, Red Sun	0-2	Rd #6
GUNG HO!:		
#67 Cibik's Ridge	6-12	Rd #6
The GENERAL:		
A Guards Counterattack	4-3	Rd #4a
L Hitdorf on the Rhine	5-8	Rd #4a
G6 Rocket's Red Glare	8-12	Rd #2
T1 Gavin Take	5-5	Rd #5a
T4 Shklov's Labors Lost	7-7	Rd #6a
T8 Aachen's Pall	3-5	Rd #5a
ASL ANNUAL:		
A32 Zon with the Wind	7-4	Rd #4a
A42 Commando Hunt	4-4	Rd #7
A44 Blocking Action at Lipki	2-0	Rd #7
A46 Rattle of Sabres	0-2	Rd #7
RED BARRICADES:		
RB3 Bread Factory #2	10-13	Rd #3
RB6 Turned Away	3-7	Rd #6
DELUXE ASL:		
#1 Guryev's Headquarters	5-10	Rd #1
A To the Last Man	0-1	Rd #7

AvalonCon in August, I doubt that very many players feel that way any longer.

I'll leave the rest of such analysis and number crunching to you, with this caveat. Don't forget to look at trends. Mark's original ASLOk chart lists the results by year. Check to see which scenarios showed an imbalance in the first year of playings, but then showed a balanced result in later years. Like ASL #16, a scenario may start out favoring one side until players master how best to play the opposing side. *Don't just assume a scenario is balanced because you read it here.* Nothing can take the place of your own experiences.

So, what good are these ASL win-loss statistics? For one thing, Mr. Nixon's initial article has been a boon to tournament directors (at least to *this* tournament director); a report in black-and-white of how a scenario has performed in competitive play is far better than personal opinion. Although I may disagree with some of the results, it is still a very useful guide if you heed Mark's caution to keep an eye on the transitory reality of numbers. Anything that helps tournament directors create a level playing field is a good thing in my book, and Mark Nixon deserves a lot of thanks for his work on the continuing ASLOk scenario summation.

I do have one last word for the readers. You must realize that there is one huge factor in all these numbers that is not immediately obvious. I'm sure that all of you are now silently mouthing: "The dice". *Wrong!* In my opinion, the key factor in the results of all these hundreds of matches is *the person playing the winning side*. If the dice, or "unbalanced" scenarios, or any other single design feature or random factor really makes all the difference, why do we see so many of the same names at the top of the list each year at these tournaments? The key to such success can only be their skill in playing ASL. Sure, bad luck might imbalance a single game, but these "top guns" know that while the dice may win any match, it's the player that loses it. Bad strategy and bad moves have killed more hopes than bad luck ever has. Winning in ASL requires more skill than luck, and good planning and solid play *will* pay off. As a grizzled vet of SL days once told me: "Good dice come and go; it's the guy who does the majority of things right that wins the game."

The years have proven to me that he was quite right. Good play will win more games than good dice, as the results of both the Oktoberfest and the AvalonCon Championship show. Remember that the next time you begin adding up "the numbers".



The
Latest News
In
Competitive
Gaming

Area News

For Today...
and Tomorrow

BY RUSS GIFFORD

Over the last year, the AREA rating system has seen some startling growth. It's easy to track the reasons for this: Specific Ratings. For many months now, 75% of the AREA slips processed involve at least one "Specific Rating" player. Many of these players are long time AREA members, but more than half are new to the AREA system, thanks to the excitement game-specific ratings offer. One new accomplishment is the growth of AREA-rated tournaments, though I'm not certain whether AREA-Specifics are the cause or the effect of these tourneys!

As I've stressed in past columns, the rating system does two things very well: First, it allows tournament directors to make pairings as fair as possible, making the resulting contests very exciting—an experience players are anxious to repeat. Second AREA's rating system provides players with an ongoing form of feedback about their progress and their achievements. This can also be seen by the continued usage of AREA among players following such a tournament. AREA also allows them to find players of equal skill, and with the Specific Ratings, it allows them to find opponents in their particular game. (Yes, I've said this before, but the growth in AREA usage makes it worth repeating.)

This increased activity has occurred at a time when many predict a downturn in gaming, not an increase. This increase has come about because, through AREA, you can be part of an organized hobby making efforts toward a standardized system of national rankings, tournament guidelines, and with a rating system that offers advancement and recognition within and beyond that hobby.

These are all things AREA was created to foster, so why is this news now? As I said above, recognition is the key. When AREA was formed, the wargaming world was different. If you played one of the classics, chances are your skill in another AH game was at least good enough to keep you in

contention for a win. AREA's Specific Game ratings were introduced because games (and gamers) have become more specialized. When players who have earned a high rating in their favorite game become reluctant to "risk" that rating on a different system, it undermines what AREA is all about: Competition.

As an example, ASL has proven everything that the AREA Game-Specific Ratings were meant to achieve. Renewed competition, with a national theme; face-to-face tournaments with ratings points changing hands; players joining AREA just to be in on the hunt for the #1 spot on the list; tourney directors signing on to host AREA-sanctioned events. All this brings not only more competition, but entirely new players to ASL, and to wargaming in general. These are people who like the idea of being part of a national organization, people who like to compete and strive for recognition. Most know they will likely never be "#1," yet still enjoy the feedback a rating system can provide. The same can one day be true of every Avalon Hill wargame. But that feedback needs to be more timely.

The appearance of the "Top 20" listings for specific game ratings showcases the skills of those players willing to pursue excellence in their specific games. The listings generate interest and excitement, and have brought new life to AREA from a group of players that normally wouldn't have looked twice at the system. Now, with its availability as a resource for tournament organizers, AREA is gaining recognition as a competitive body of wargamers.

With recognition comes more possibilities for increased wargaming activity. Officials from GenCon recently called to offer space and promotional help for an AREA-rated tournament at GenCon '93. GAMA officials have likewise inquired about the possibility of AREA-sanctioned tournaments at Origins.

AREA is making great strides, and even non-wargamers are taking note. Various

hobby shops have begun sponsoring local and regional AREA tournaments. Players from across the country have taken the plunge and joined AREA, all because Game-Specific AREA listings have generated excitement. These listings show these players that there are other people out there, playing these games—new titles as well as old. But most importantly, with Specific Ratings there is now no longer any excuse for ducking a rated game—a common practice that in the past has given AREA members a bad reputation.

A flurry of activity generally follows the placement of an AREA Top 20 listing for a particular game. But once every 18 months is not going to cut it. As promised in the beginning of the AREA Specific Ratings, the Top 20 listings need to become a regular feature for the action to continue to spread. The Specific Game Ratings, by their very nature, will have more movement than the AREA Top 50 has shown. This movement is what players are looking for and expect with a specific rating. Since it is the Specifics that are drawing the attention in AREA, beginning in this issue, readers will notice a change in the Top 20 listing in *The GENERAL*. In the future, expect to see the Specific Games Listings on a permanent basis, and the Top 50 as the occasional listing.

This only makes sense. Change among the Specific Listings is often tied to face-to-face play, and those positions change far faster than the typically PBM-oriented Top 50. The real point however, is that with the addition of Game Specific Ratings, an AREA card for your favorite game should be the actual starting point for players today to reap the benefits of AREA. The Specific listings have generated more activity in one year than AREA generics have generated in many years preceding, and will continue to increase in importance, since the Game Specific listings provide new tourney directors with an increasingly reliable database for potential players. If you don't have an AREA Specific Rating, you're not on that data list.

If you're a long time AREA player, don't view this as a negative. AREA will still provide you with everything it has in the past: A method of checking to see if your prospective opponent is reliable, and a way to gauge his skill. But as AREA approaches its 20th birthday, these changes are a way AREA can continue to connect players of similar games, and meet some of the long term promise of AREA: National competition among players.

While an AREA Specific Rating costs a bit more, it does more, too. Players interested in hosting an AREA tournament can apply for a set of Guidelines for various tourney formats. For a small fee, they can also get a listing of the holders of Specific Ratings prior to their tourney, which will allow them both to market their tournament and seed it correctly. Local tourneys by local GMs, can generate more excitement and interest in wargames than any other event. Avalon Hill's focus on grass-roots gaming organizations can have a great effect on gaming in your region. Make use of AREA's Specific Ratings, and join the fun.

If you are interested in hosting an AREA-rated tournament, Guidelines are available from Avalon Hill. Just send a stamped, self-addressed legal-sized envelope, include your own AREA Number (of course), and a potential date and location for the tournament you are planning.

Now, on to the news...

There has been a great increase in AREA activity during the last quarter of 1992. For the past few months, players across the country and around the world have been inundating the AREA Technician with victory slips of hard-fought games. Even more interesting is the growth in AREA slips on Multi-Player games—it could be that some people are already jockeying for position at the upcoming *AVALONCON* National Championships! Great going, folks!

Looking into the Specifics: October must have been a rough month for Tom (Mister *ANZIO*) Oleson: He lost games to J. Rowley, Bill Scott and even (gasp!) Don Greenwood. Don't worry, though; Tom has bounced back with a win over H. Tucker. Tucker, Rowley and Oleson represent the international arm of our hobby, with the first two from England, while Tom now hails from Sweden. Other battles for the Italian boot saw James Lutz win a pair of games from Paul Miller.

On another front, there's been a clash of titans over *WATERLOO*: Joe Beard has posted a win over Kevin McCarthy, while Pat McNevin has won three games, including a pair from John Ellsworth. Action in *AFRIKA KORPS* saw Andy Maly moving past Chuck Stapp, and Scott Goehring edge Mark Gutfreund; although Scott lost to Rodney Robinson and Lynn Barlow in another classic, *BULGE '65*. On the newer boards, *BULGE '91* is seeing a lot of action, including Randy Heller over Glenn Sauer and, once more, Andy Maly over Joe Brooks.

There is also news from the Ladders: After a sluggish start (due mostly to my

ineptitude) the *VICTORY IN THE PACIFIC* ladder is truly underway, with guidance from the able hand of skipper Glenn Petroski. I know there is a great deal of interest in this ladder, and I encourage everyone anxious to join this one to connect with Glenn. I have forwarded all my info to him, but if you wrote me about the ladder, Glenn asks that you confirm your status with him. His address is 210 W. Hunt, Twin Lakes, WI 53181-9786, and his phone number is (414) 877-4178.

Most of you probably recognize Glenn's name; since the first *AVALONCON*, it has been synonymous with *VITP*, and players at both *AVALONCONs* have consistently voted high marks for his Tournament Director skills. The *VITP* ladder promises to be "where the action is" in 1993, so jump aboard now! Also, Glenn says he is more than happy to supply information and answer questions about the ladder, or *VITP* for FTF or PBM, so feel free to get in touch.

More Ladder News: *THE RUSSIAN CAMPAIGN* leader Jim Bjorum (BJ) reports the end of round one and the beginning of round 2 in the great *TRC* ladder! In the first round, Pat Flory defeated Tom Oleson to retain his ranking as *TRC* Champion, while Jim Eliason defeated Paul Siragusa to earn the right to challenge Pat in round two. This is some organization, folks! There are 15 matchups—30 players in a smooth and enjoyable PBM tourney. Run by the "chess clock" method, the second round in this PBM tourney began October 15th, and will end June 15th. Pat and Jim's game promises to be a great match—but so do the other 14 games! More on this series as it progresses.

As reported in an earlier issue of the AREA News here in the pages of *The GENERAL*, there is some interest in ladders for *WOODEN SHIPS & IRON MEN* and *ANZIO*. If there's enough interest, there are two fellows who have offered to run them, and they are both champing at the bit to get started... any response?

That's it for this column. I'd like to take this moment to thank everyone for the honor of voting me the first recipient of the *AVALONCON* Gamemaster award. Just to have been among the finalists with great GM's like Glenn Petroski, Randy Heller, Jim Burnett, Randy Cox and all the other unsung heroes of *AVALONCON* is an honor. Every GM knows the hours are long and the pay is lousy, but it's nice to know people notice the effort. Thank you all once again, and hope to see you at *AVALONCON '93!*



THE BLACK SEA WALTZ

Naval Movement Options in *RUSSIAN CAMPAIGN*

By James Lutz



The focus of *THE RUSSIAN CAMPAIGN* game system is clearly on the ground forces involved (along with a temporary emphasis placed on the powerful *Luftwaffe* early in the game). But sea movement capabilities, while relatively limited, are available and important—and at times, may even be critical. Invasion, transport and evacuation can play a strategic and/or tactical role for both sides. When sea movement does occur, it is often dangerous: In the Black Sea there is a chance that the force moving over water will be lost unless all three Black Sea ports are in friendly hands. German sea movement in the Baltic (there is no possibility of Russian sea movement there) is never automatic either, although control of Leningrad will reduce the chance of failure. Partially offsetting the risk involved in some cases is the fact that sea movement never automatically fails; therefore, the opposing player needs to be aware that it is always an option, and what may result from such an operation.

INVASIONS

Seaborne landings on the coast of the Black Sea are the most dramatic form of naval movement. The German player will normally use his two invasions early in the game. (If he needs them later, the Axis are probably in dire straits.) German invasions are always a threat against unoccupied Russian ports. So long as the German player has an invasion left, Russian units must garrison the ports. Any port left unoccupied at the beginning of the July/August 1941 turn simply invites an invasion by the expendable Hungarian panzergrenadier. The fall of Rostov to an invasion will complicate Russian movement and divert scarce resources to what is, for the moment, a rear area. For the Russian

player, Rostov is ultimately more important to defend (if only one unit is available) than Sevastopol, since the latter will fall to the Germans relatively early in most games. Rostov is also important as part of a river defense line once the Germans are across the Dneiper and threatening Stalino.

German invasions can be equally effective in other circumstances. A landing on the east side of the Straits of Kerch can pre-empt any Russian defense of this terrain... or at least force the commitment of more extensive forces since a solitary 2-7 cavalry can no longer defend the straits. A landing further south (at NN18 or OO17) can penetrate to Krasnodar on second impulse, thereby cutting Russian communications and providing the Axis invader with a supply source if the Russians do not or cannot react. Such an invasion will threaten the capture of the oil well at PP13 as well. A German invasion can also be used to gain a limited tactical advantage: For example, to un-double the Russian defense behind the Dneiper or the Don, or to surround Russian units. Other options include attacks against unprotected worker units in cities such as Rostov, Stalino, Sevastopol or Krasnodar.

By example, if both Sevastopol and Rostov are garrisoned in July/August 1941, the heroic (read: "expendable") Hungarian 1st Corps could attempt to land at HH16, HH17 or HH18, and if successful, attack Stalino on second impulse at 1-to-1 odds. A daring German player might instead substitute the equally heroic (though far less expendable) 40th Panzer Corps for the Hungarian unit to achieve 2-to-1 odds for that second-impulse attack on Stalino instead. A successful foray into this area would cause tremendous problems for the Russian player. Of course, on the negative side, the invading unit could be sunk at sea, be eliminated on the attack (perhaps

even without the benefit of an Exchange), or be eliminated by being forced to retreat on its invading turn. However, should it survive to the second impulse before being forced to retreat, it could block the rail line between Sevastopol and the Ukraine, making reinforcement of the Crimea more difficult and the Axis capture of Sevastopol quicker and less costly. The invading unit would probably be eliminated by Soviet units in the Russian phase, although the diversion of the necessary forces to deal with a German panzer corps (or even the Hungarians) in their rear would handicap the defense of the Ukraine or the approaches to Moscow and Leningrad. Perhaps the major disadvantage of an unsuccessful attempt to eliminate the Worker unit at Stalino would be that one of the two German invasion possibilities would now be gone forever. The threat of German invasion, which can have as great an impact on play as its actual implementation, would be correspondingly lessened.

Just as the German player will likely use his invasions early in the game, the Russian player is likely to need his later (barring an attempt in 1941 to knock Rumania out of the game by a surprise landing on the Rumanian coast, as pointed out by Richard Jarvinen ("*Barbarossa Repulsed: Expanding on the Viipuri Defense*" in Vol. 14, No. 3 of *The GENERAL*). Generally, Russian invasions will support planned offensives, and the Russian offensive capabilities are limited in the beginning turns of *TRC*. The threat of Russian invasions will, however, keep Axis garrisons in Odessa, Sevastopol, and Rostov once they are captured. A Russian landing at an ungarrisoned Rostov could cut German rail lines to the southern portion of the board, and even put Axis forces in this area out of supply.

If the war is going well in 1944, Russian invasions can be used to un-double German river

defenses along the Don, Dneiper, Dnestr or Prut (the Bug should be safe against such tactics since it can be anchored by a unit in Odessa). Again, the mere *threat* of such an invasion can be effective, since some Axis units must be diverted from the front line to guard against this possibility. For the Russian player at this stage of the game, it is quite possible that the best invasion is the second invasion *that is never used*. Once no further Soviet landings are possible, all available Axis units can move right to the front.

If the war is going poorly for the Russians in the endgame (as is often the case when I take them), an invasion might be undertaken in conjunction with a desperate counterattack somewhere along the coast. If such an invasion is successful in reaching its designated target, a poor 1-to-1 attack against an important German stack could become a much better 1-to-1 "Surrounded" attack by such an invasion.

TRANSPORT

Moving troops by sea is one way that a player can quickly get units to forward areas or reinforce pockets of resistance. Both the Russian and German commanders can deploy troops to Sevastopol by sea if it is cut off from reinforcement by rail. Sea transport can also be used by the Germans to reinforce hexes in the Baltic or the Black Sea regions which are not accessible by rail due to Russian Partisan activity. Such sea

transport can be dangerous if all the Black Sea ports are not controlled. (And there is always a degree of danger in the Baltic, especially if Leningrad has not been captured.) One reason to garrison Odessa against a potential Russian invasion is to permit other Axis troops to use sea transport with greater safety. Sea transport is also often an effective means of reinforcing a unit which made a successful invasion on the previous turn. If Axis troops in Finland are threatened, sea transport may be the *only* means of reinforcement. Sea transport is also an effective means of getting German HQ units which appear as replacements in the Spring of 1942 or '43 close to the front while the Germans can still use their Stuka capability. By the time an HQ moves overland to Leningrad, there may be no clear weather left in a given year. Sea movement to Sevastopol or Rostov will also place many hexes within Stuka range much more quickly than overland movement of the HQ unit(s).

EVACUATIONS

Even isolated units can at least attempt to evacuate by sea. If a unit is out-of-supply, or pinned to the coast where it will be forced to attack at unfavorable odds, an evacuation attempt is in order; if the unit will be lost anyway, there is no harm in taking the chance on sea movement. But judge the moment carefully; if enemy forces are closing in on a unit which is

simply out of touch with friendly forces, an evacuation may not be warranted if supply can still be maintained. Units drawing enemy forces away from the front still serve a useful purpose, even if eventually lost. However, units that are out-of-supply or face odds where there is no chance even to exact the revenge of an Exchange should take their chances at sea.

TIMING OF SEA MOVEMENT

The timing of any type of sea movement can be crucial in a game turn. If friendly units are going to move through an unoccupied Black Sea port that was previously controlled by the other side, wait until after the movement of these units before attempting an invasion, transport or an evacuation. For example, German forces may be able to make an Automatic Victory attack against a Russian unit defending in a port, thereby enhancing the chances of successful sea movement by other German units. Such sequencing of movement can be important in other circumstances as well.

Let us assume, for example, that the Russians are defending behind the Don near Rostov, and the Germans already control both Odessa and Sevastopol, and have at least one invasion opportunity left in our hypothetical scenario. German units move into Rostov to attack the Russians behind the river. Then, *and only then*, a German unit invades at JJ15 or JJ16 to undouble some of the enemy units behind the river, with no fear of being lost at sea (since all three Black Sea ports are controlled at the time of the invasion). Even if the German player has no invasions remaining, moving into Rostov would permit the sea transport of an additional unit (the about-to-arrive 1st or 2nd SS Panzer Corps, for example) to the front—one that could participate in the attack and change the final odds. Under these circumstances, a major unit can safely be sent via sea movement, since there is no danger of the convoy being sunk. (A logical corollary to all this capturing of ports to facilitate sea movement is, obviously, that the defending player should recognize that protecting ports warrants high priority, even if not necessarily the highest.)

ONE EXAMPLE

Lest the above comments seem too theoretical in nature, an example from actual game experience will demonstrate some of the above points. In July/August 1941, the Hungarian panzer-grenadiers invaded the Black Sea coast, after other Axis units had occupied Odessa. The Hungarians survived the sea movement, and on the second impulse drove on Stalino to attack the unguarded worker unit in that city. The combat result in this second impulse attack was a "Contact". In the Russian move, enough troops were diverted to achieve 2-to-1 odds, resulting in a "DR". There was no Russian second-impulse combat, as none of the Russian units involved had second-impulse movement capabilities.

(Continued on Page 57)

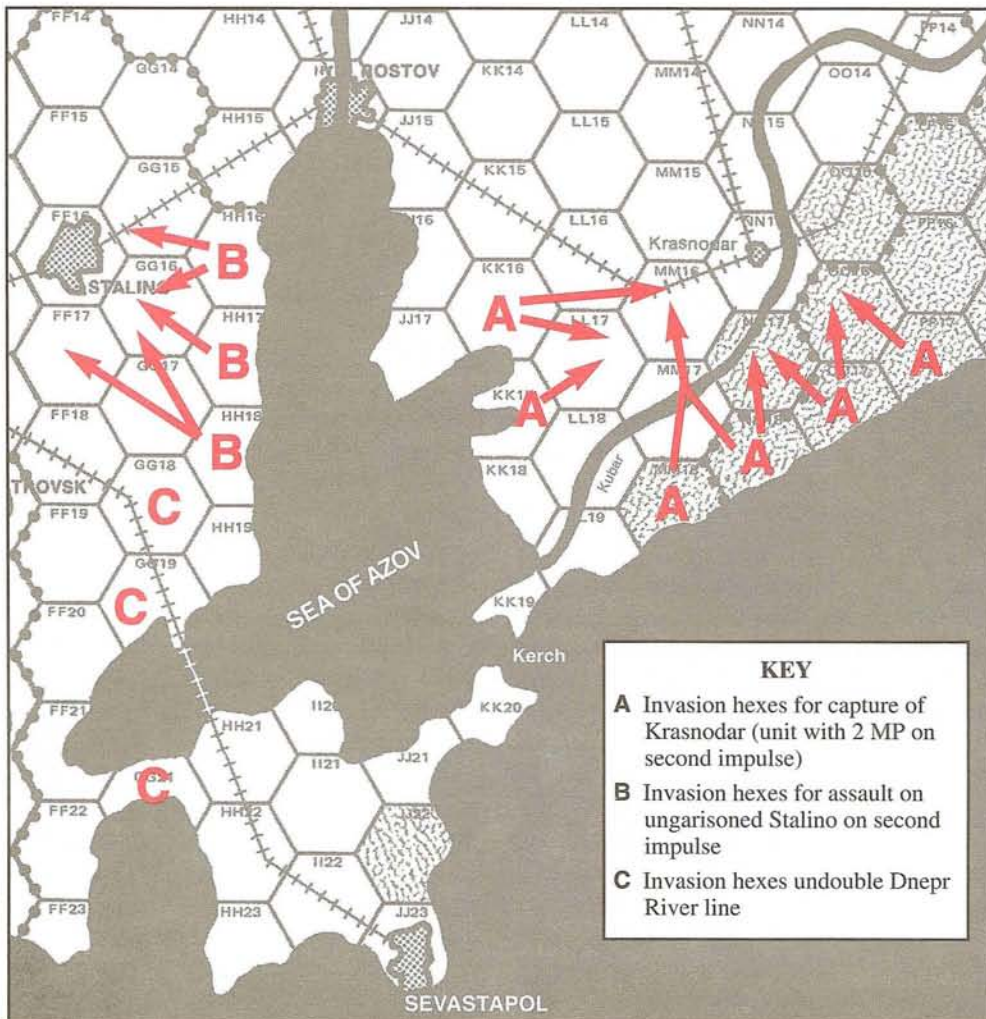

Sports Special



STATIS-PRO FOOTBALL BECOMES A FAD

By James C. Gordon

The 109 Fast Action Cards in *STATIS-PRO FOOTBALL* (hereafter *SPFB*) produce Run and Pass numbers, blocking and tackling modifiers, pass rushes, solitaire defensive strategies, injuries, penalties and fumbles. The FAC deck is the engine which drives the action and constant fine tuning keeps the system in peak condition. Translation: Shuffle the deck frequently to maintain the randomness and unpredictability in the play results. The principle is identical to shuffling a Blackjack deck in order to thwart the card counters.

Players who find it tedious to halt play and shuffle the deck after every series can replace the FACs with a pair of Fast Action Dice (FADs) to generate play resolution. The FAD system uses one six-sided die and one 8-sided die for the first and second digits, respectively, on the accompanying tables.

The Offense has five Running plays. The *Sweep Left* and *Right*, and *Inside Left* and *Right* use blocking and/or tackling modifiers to alter the play result. *End-Around Runs* use a different resolution. The first step in resolving a running play (see Table I) is to determine the modifiers that affect the resolution.

Table I: Running Play (Dice Roll = Modifier)

<u>Sweep Left</u>	<u>Inside Left</u>	<u>Inside Right</u>	<u>Sweep Right</u>
11-12 = BREAK	11-12 = BREAK	11-12 = BREAK	11-12 = BREAK
13-14 = LG	12-15 = CN	11-12 = CN	13-14 = RG
15-18 = LG+LT	16-22 = LG	16-2 = RG	15-18 = RG+RT
21-23 = LT	23-24 = LT	23-24 = RT	21-23 = RT
24-25 = LG+LE	25-26 = CN+LG	25-26 = CN+RG	24-25 = RG+RE
26-27 = LE	27 = BACK	27 = BACK	26-27 = RE
28 = BACK	28 = BACKvG	28 = BACKvI	28 = BACK
31 = BACKvG	31 = BACKvH	31 = BACKvH	31 = BACKvG
32 = BACKvF	32 = BACKvI	32 = BACKvJ	32 = BACKvJ
33-34 = LGvF	33-36 = CNvC	33-36 = CNvC	33-34 = RGvJ
35-36 = LTvB	37-38 = CNvH	37-38 = CNvH	35-36 = RTvD
37-42 = LTvA	41-45 = LGvB	41-45 = RGvD	37-42 = RTvE
43 = LTvG	46-47 = LGvG	46-47 = RGvI	43 = RTvI
44-47 = LEvF	48 = LTvG	48 = RTvI	44-47 = REvJ
48 = LEvH	51-54 = B	51-54 = D	48 = REvH
51-54 = A	55-58 = B+G	55-58 = D+I	51-54 = E
55-58 = A+F	61-64 = C	61-64 = C	55-58 = E+J
61-64 = B	65-68 = C+H	65-68 = C+H	61-64 = D
65-68 = B+G			65-68 = D+I

After determining the modifier, the Offensive Player rolls for the Run Number (Table II) and refers to the ball carrier's card, applying the modifier to resolve the play.

Table II: Run Number

(Die Roll = Run #)

11-14 = 1	26-33 = 5	51-54 = 9
15-17 = 2	34-38 = 6	55-58 = 10
18-22 = 3	41-45 = 7	61-64 = 11
23-25 = 4	46-48 = 8	65-68 = 12

End-Around Runs begin with a roll to determine the re-roll or the standard running play resolution; 11-38 = re-roll 6-sided die; 41-68 = OK. If the result is a re-roll of the 6-sided die, the result on that die (1 to 6) equals the yardage lost. With an "Okay" result, the Offense rolls for a *Run Number* and resolves the play, without modification, from the ball-carrier's card.

The Offense has four Pass plays: *Quick*, *Short*, *Long* and *Screen*. On Pass plays, the Offense designates the type of pass and the intended receiver. Play resolution determines the actual receiver (Table III) or a Pass Rush result.

Table III: Pass Receiver
(Pass x Dice Roll = Receiver)

Quick	Short	Long	Receiver
11-32	11-32	11-32	= Original
33-38	33-38	33-37	= Left End
41-46	41-45	38-44	= Right End
47-57	46-53	45-51	= Flanker
58-63	54-57	52-55	= Back 1
64-67	58-63	56-61	= Back 2
68	64-68	62-68	= Pass Rush

After determining the Pass receiver or Pass Rush result, the Offensive Player rolls for a Pass Number (Table IV) and refers to the Quarterback's card.

Table IV: Pass Number

(Dice Roll = Pass #)

11 = 11	25 = 25	41 = 41	55 = 29
12 = 12	26 = 26	42 = 42	56 = 30
13 = 13	27 = 27	43 = 43	57 = 39
14 = 14	28 = 28	44 = 44	58 = 40
15 = 15	31 = 31	45 = 45	61 = 1
16 = 16	32 = 32	46 = 46	62 = 2
17 = 17	33 = 33	47 = 47	63 = 3
18 = 18	34 = 34	48 = 48	64 = 4
21 = 21	35 = 35	51 = 9	65 = 5
22 = 22	36 = 36	52 = 10	66 = 6
23 = 23	37 = 37	53 = 19	67 = 7
24 = 24	38 = 38	54 = 20	68 = 8

Screen passes are resolved using the Running N Column on the Pass Receiver's card. In the event of a completion (COM on Table V), the yardage gained can be multiplied by 1.5, 2 or 3.

Table V: Screen Pass

(Dice Roll = Result)

11-12 = COM x 3	48-54 = COM x 1.5
13-17 = COM x 2	55-67 = Incomplete
18-47 = COM	68 = Interception

Kickoffs and Returns, Punts and Returns, Fake Punts and Field Goals and Interceptions are resolved by rolling for Run numbers. When resolving Interceptions, separate dice rolls determine the player who intercepts the Pass and the length of the Return. Placekicks are resolved by rolling for the Pass Number.

Included in the 109 FACs are 13 of the dreaded "Z" cards which produce injuries, penalties and fumbles. At the start of *each quarter of play*, roll the 8-sided die once to determine the Z result number. The Z number can change every quarter and when the digit appears on the 8-sided die within the first three rolls of a given play, it produces a Z situation. The type of Z result is determined by another dice roll: 11-36 = Injury; 37-62 = Penalty; 63-65 = Fumble(s); 66-68 = Fumble. Further dice rolls determine the injured player (Table VI) and the severity of the Injury (roll for Pass #), or the Team (offense, Defense, Kicking, Return) guilty of the Penalty (Table VII)

Fumble(s) results are ignored by the home team; other wise, Fumble recovery uses a Pass number, modified by the Defensive team.



Table VI: Injury Dice Roll
(Die Roll = Injured Player)

11 = QB	37-38 = LE	55 = H
12-22 = BC	41-42 = A	56 = I
23-24 = RE	43-44 = B	57 = J
25-26 = RT	45-46 = C	58 = K
27-28 = RG	47-48 = D	61 = L
31-32 = CN	51-52 = E	62 = M
33-34 = LG	53 = F	63 = N
35-36 = LT	54 = G	64 = O
		65-68 = Reroll

Table VII: Penalties
(Situation: Dice Roll = Team-Penalty)

Situation 1:

11-22 = OFF1	44-46 = OFF3	57 = OFF6	67-68 = OFF14
23-33 = DEF1	47-48 = OFF4	58-62 = OFF7	
34-37 = OFF2	51-52 = OFF5	63-65 = DEF7	
38-43 = DEF2	54-56 = DEF5	66 = DEF9	

Situation 2:

11-18 = OFF1	36-37 = OFF3	45-54 = OFF7	66 = DEF9
21-27 = DEF1	38 = OFF4	55-57 = DEF7	67 = OFF10
28-32 = OFF2	41-42 = OFF5	58-61 = OFF8	68 = OFF18
33-35 = DEF2	43-44 = DEF5	62-65 = DEF8	

Situation 3:

11-17 = KICK1	32-34 = RET5	42-61 = RET11	63-67 = RET13
18-26 = RET1	35-41 = KICK9	62 = RET12	68 = KICK14
27-31 = KICK5			

Situation 4:

11-13 = KICK1	16-18 = KICK5	24-31 = KICK9	63-65 = RET12
14-15 = RET1	21-23 = RET5	32-62 = RET11	66-68 = KICK15

Table VIII: Solitaire Defense
(Situation x Dice Roll = Defense)

Situation					Defense
1	2	3	4	5	
11-22	11-18	11-21	11-17	11-12	= P
23-26	21-24	22-24	18-22	13	= Px2
27-34	25-33	25-31	23	14-25	= R(BC)
35-61	34-62	32-52	24-25	26-67	= R(NK)
62-66	63-66	53-61	26-46	68	= PR
67	67	62-65	47-56	NONE	= PRx2
68	68	66-68	57-68	NONE	= BLITZ

The solitaire system replaces the active response by the Defense (Table VIII). Depending on the down and distance situation, the solitaire results indicate a Run Defense, with or without a key on the ball carrier, Pass or Pass Prevent, with possible double coverage on the eventual Receiver, and the Blitz.

Converting the Fast Action Card results to Fast Action Dice requires some minor modifications in the exact rate of occurrence of some results, but the *STATIS-PRO* system does not suffer in the translation. If you like using dice, you may find this FAD to your liking.

AREA SPECIFIC RATINGS

ADVANCED SQUAD LEADER (GENERAL 28-3)

Rank	Name	Times On List	Rating	Previous Rank
1.	R. Berger	—	2065GJG	—
2.	P. Cocke	—	2065HI*	—
3.	M. McGrath	—	2062GH*	—
4.	B. Conner	—	2051FE*	—
5.	G. Fortenberry	—	2012GJD	—
6.	M. Hanna	—	1892DGH	—
7.	B. Rinehart	—	1851FF*	—
8.	P. Petry	—	1823CC*	—
9.	R. Barnette	—	1785CF*	—
10.	C. Goetz	—	1780DF*	—
11.	T. McCorry	—	1778GIJ	—
12.	E. Baker	—	1768CG*	—
13.	R. Gifford	—	1748JLH	—
14.	J. Paull	—	1720BEF	—
15.	S. Gfesser	—	1705ABA	—
16.	D. Connell	—	1685BDF	—
17.	W. Boardman	—	1680AB*	—
18.	R. Woloszyn	—	1675GKB	—
19.	B. Sielski	—	1670BDE	—
20.	S. Flicker	—	1655BD*	—
21.	L. Mehr	—	1648IJN	—
22.	J. Davis	—	1645ACE	—
23.	T. Hively	—	1629DHC	—
24.	B. Geryk	—	1625ACE	—
25.	L. Tokarz	—	1620BD*	—
26.	R. Wolkey	—	1615DFF	—
27.	A. Robin	—	1610AC*	—
28.	F. Timm	—	1601DFG	—
29.	B. Hegdahl	—	1596JGC	—
30.	B. Youse	—	1596IIC	—
31.	S. Semenza	—	1585BD*	—
32.	R. Yeates	—	1581CFD	—
33.	C. Schilling	—	1548EFH	—
34.	P. Dowd	—	1545BD*	—
35.	S. Romanowski	—	1540AAA	—
36.	G. Linneberg	—	1520ABB	—
37.	G. Engelstein	—	1505BDE	—
38.	J. Allen	—	1500***	—
39.	T. Baker	—	1500BB*	—
40.	P. Cook	—	1500***	—

As per Mr. Gifford's notice in this issue's *AREA News* (see page 31), this marks the first of our new listings of AREA ratings by competition in specific games. *ADVANCED SQUAD LEADER* was chosen to launch this new format, mainly because of its immense popularity and the commensurately scrupulous attention of its adherents to their standings within their gaming community (and thus, by extension, to filing their AREA chits).

Some slight differences appear from the old "Top Fifty" format, which should be explained.

First, in the "Rating" column, several of the names have their numerical AREA rating followed by letters and/or asterisks(*). Don't panic; there's no qualifier you need to look for at the bottom of the page. An asterisk in place of a letter simply means that no games were listed (on the most recent printout) as having been played in that format. The next AREA Specifics listing for the game will update these where applicable.

Likewise, in the "Times On List" and "Previous Rank" columns, all numbers have been replaced by a dash(—). While many of the above names appeared on the last AREA Specific listing for *ASL* (The *GENERAL*, Volume 27, Number 2), it was decided to make this a fresh start; again, when the next AREA Specific listing is made for *ASL*, these columns, too, will be updated.





UP FRONT

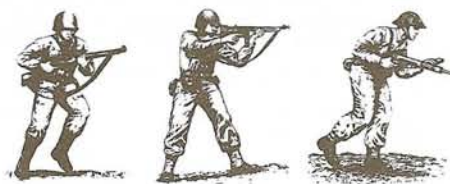

A DECADE OF SHUFFLING ALONG

By Don Hawthorne

This summer marks the tenth anniversary of an event dear to my heart. Way back when, at Origins '83, to be exact, Avalon Hill unveiled a game which was new and different in every sense of the words. That game was *UP FRONT*, and while it failed to set the gaming world aflame, the staunch support of its developer, Don Greenwood, and vocal enthusiasm of its fans around the world have helped to keep the game and its expansions in print.

I say around the world, because *UP FRONT* has managed to carve out several niches for itself in the worldwide gaming community. Ulrich Blennemann, editor and publisher of Germany's *Der Musketier*, has conducted a survey which reveals *UP FRONT* to be the single most popular wargame in Germany (where, by the way, it must be sold literally under the counter, to customers specifically requesting it, and in generic packaging, in order to comply with German laws regarding depictions of Nazi regalia; the SS runes on the soldier's collar, to be exact). Emanuele Oriano, one of the officers of the Overlord Gaming Club in Italy, declares *UP FRONT* to be the consistent favorite of his associates and even his family. Stateside, Pat Cook conducts a regular convention for the California *UP FRONT* State Championships, and the officers of southern California's *Strategicon*, producer of no less than three major conventions a year, offer an *UP FRONT* tournament at each one, and to my knowledge have always had to make room for additional players. At *AVALONCON '92*, fifty-three gamers devoted their Saturday to a fight for the *UP FRONT* tournament plaque. This is a game with a devoted following, and it deserves to be supported. Hence, in answer to many requests (and my own avowed prejudice for what coincidentally happens to be my favorite game), and in honor of its tenth anniversary, this new column in *The GENERAL*.

UP FRONT deserves credit for a lot of "firsts". First true wargame without a board; first tactical wargame system to provide gamers with the Japanese forces of World War Two; and first wargame to truly and accurately model the problems and even in many ways the experience of small unit command and control in combat (more about this later).

Before *UP FRONT*, card-driven game systems were rare and simplistic in the extreme. But the last ten years have seen systems very closely related to *UP FRONT* gain prominence both as "engines" for game systems and as integral parts of existing games.

Even so, among many gamers, *UP FRONT* is regarded as sort of the "problem child" of the Avalon Hill family. No mapboard—shudder! No perfect situational intelligence—horrors! Troops who won't march blithely to their deaths at their commanding player's whim (not even the Brits)—preposterous! And thirty-six pages of rules? For a *card game*? Well, twenty-four, actually, the rest being optional rules, TO&Es, scenarios and Designer's Notes (...you *do* all read the Designer's Notes, I trust? If you haven't, do so now. I'll wait...)

Despite these admitted drawbacks, however, the game is finally beginning to achieve the popularity it so richly deserves. In spite of its woes, the "problem child" is being revealed instead to be simply a "late bloomer". Let's take a look at some of the reasons why.

First, as stated above, *UP FRONT* is the first—and in many ways, still the only—accurate portrayal of small-unit command and control. The game's lack of a mapboard actually enhances its simulation of reality, if you remember while playing that *your point of view is that of the men in your squad*.

Terrain does not "magically appear" when your opponent discards it upon one of your moving groups; rather, for that phase of play, your opponent has become part of the game system, his discard not simply a "random factor" beyond your control, but in fact representing his (temporarily, at least) superior knowledge of the surrounding terrain; your men "blundered" into it, while his did not.

An example from personal experience: I've been good friends with Jim Murphy, the person who taught me to play *UP FRONT*, for many years; one of our adventures together was playing paint-gun games when they first started to get popular. Our first time out, we decided to head for some prominent high ground (let's call it a Hill card, shall we?) to get a look at the field. Crashing through high grass (a Brush card), we broke out of the thicket to see before us, blocking our path to the hilltop, a wide gully with a wet ditch along its bottom (a Stream card). Grinning, we turned to each other and declared simultaneously: "It's just like *UP FRONT*!"

Nor did the similarities end there. Getting us and our teammates into firing range (playing Movement and Fire cards) necessitated their exposure to the opposing team's paintballs (no Concealed cards). Guess what they were reluctant to do? And these people were only playing a game; they risked, not the life and limb of real combatants, but only the time they would lose

sitting out the game until the next one could start. And once people stopped moving and were pinned down in one place (a lack of Rally cards), it was only a matter of time before they were picked off, while whoever was leading them at the moment could only shout uselessly at the slackers and depend wholly on those unpredictable few (Hero cards) who might or might not advance when called upon to do so.

Now I have never been in actual combat; I frankly have no desire to do so if it can at all be avoided. The paint-gun games are as close as I ever need to come. But I do have friends who have "seen the elephant", most of whom are wargamers, some of whom play *UP FRONT*, and all of whom vouch for its accuracy.

The point is, despite the prejudices of many who prefer complete control over all aspects of their gaming, in a true model of tactical combat, such control is, by definition, impossible. There is simply *no way* to tell what you will find in your path when heading for your objective. Likewise, it is impossible to tell which men will behave like lions and which like lambs. Tactical combat is random and unsure, and most participants stumble into victory more through sheer tenacity than anything like skill. In *UP FRONT*, this is frequently modelled by simply holding your squad together until the other player makes a critical error.

Thus the game has the appearance of being utterly random or, if you prefer, "luck-oriented". As a gamer who believes wholeheartedly in luck, I have no problem with that, but possibly the greatest prejudice against *UP FRONT* stems from this perception. In fact, the game is no more random than combat at this level really is, a point which Courtney Allen and Don Greenwood make abundantly clear in their Designer's Notes (which you just read).

As a player, therefore, you are thrown into an essentially chaotic environment and expected to impose some level of control over the situation (any former Marine who is reading this has heard these words before). And that is exactly what command and control in combat is. Gamers who claim stacks of dumbly obedient counters and volumes of rules are a better model of reality *at this level* are deluding themselves.

Of course, a lot of us play wargames just for that Grand Illusion of Control. Many gamers actively dislike the stress imposed by the chaos of tactical combat reality, particularly in a tournament environment (and like a high-stakes game of *Poker*, a hard-fought engagement in *UP*

28-3/A3. THE END IN SIGHT — Battle at the Reichschancellery

Set Up
 1st



Set Up
 2nd

Guards: 1, 19, 28, 3-9, 11-15,
One Demolition Charge & One
Radio (Fire Strength 7)



No cards are removed from the Action Deck.

Set Up
 3rd

Guards: 26, 20-25 & 39



SPECIAL RULES:

A3.1 The German player receives three -3 Buildings cards prior to play for use on any of his groups. In addition, he also receives the Pillbox, which is treated as a -4 Building and may hold any number of men. The rest of the Buildings cards are removed from the Action Deck and placed in a separate Draw Pile, from which the German player may randomly select them as terrain for any of his groups when such placement of a Terrain Card could normally be performed on those groups. The Russian player may make use of this draw pile for any of his groups which have reached Range Chit 3 or greater.

A3.2 All Woods and Brush cards are considered to be Rubbled Buildings. Their TEMs remain unchanged, but they are otherwise treated in all respects as Buildings Cards. Vehicles which overrun units occupying Rubbled Buildings make Bog Checks normally. Stream, Gully and Marsh Cards represent large craters and extensive street damage; their use is unchanged from the basic game. Minefields are Cover cards.

A3.3 The German squad has an extra "Sniper" capability; in effect, he must suffer two "Sniper Lost" results before he loses his ability to play Sniper cards. Also, the *UP FRONT* countermix contains only two Panzerfaust counters; use the German ATR chit to represent the third Panzerfaust.

A3.4 Each Russian player may use Sniper cards normally until the German player has made two separate Sniper Checks which have inflicted two "Sniper Lost" results. These Sniper Checks and "Sniper Lost" results may be against the same or different Russian players.

A3.5 The German squad represents the remnants of a French SS unit, little motivated to do anything but survive another hour. Basically an *ad hoc* unit, they do not receive the Elite status capabilities of regular SS units, but having no delusions as to their fate at the hands of the Soviets should they be captured, they will break only after having suffered over 75% casualties (i.e., 12 out of their original 15 men). They do have the advantage of being led by a Senior Sergeant, entitling them to a six-card hand so long as he remains in the game and unpinched.

A3.6 Both Soviet Groups are Polish Guards units, extremely well-motivated and determined to capture the Reichschancellery. For game purposes, they are considered to be Russians, and are entitled to all Elite status capabilities for their nationality. Although controlled by two players, the Russian force is considered to be a single squad for purposes of breaking from casualties. Thus, both Russian players may continue the game (assuming either has any personality and/or vehicle cards remaining) until total Russian casualties exceed 51% of their starting forces, or 12 out of 23 personality cards (including the vehicle). To fill out the Soviet OB (and add spice to the battle), they have been given the support of a JS-II for this assault.

A3.7 The Russian players may communicate and compare hands only after establishing Radio Contact (*UP FRONT* rule 41.7). For game purposes, the Russian Players are entitled to maintain such contact so long as their Radio Chit is operating and Russian Player Two's AFV is functional and CE. Should the AFV Button Up or the Radio Chit malfunction, Radio Contact is lost until re-established as per 41.7. If the AFV suffers a "Commander Killed" result, Radio Contact is lost permanently. In addition, see **SSR A3.8**, below.

A3.8 THREE-PLAYER GAME SET-UP: German player sets up first, using Group ID chits A through D, inclusive, and must have at least four starting groups. Russian Player One then sets up. He must set up using Group ID chits Z, A and B, and have at least three groups. Russian Player Two then sets up, using Group ID chits C, D and E, and having at least three groups. Both Russian players must take their turns in numerical order (i.e., Russian Player One must complete all of his groups' actions before Russian Player Two begins his turn) before the German player takes his turn. If the Russian Players have established Radio Contact as per **SSR A3.7** above, they may conduct their groups' actions in any order desired.

A3.9 VICTORY CONDITIONS: The Russian side wins by having an infantry group of any size infiltrate and capture the "Pillbox" without being itself infiltrated by any German soldiers. The German player wins by avoiding the Russian players' victory conditions. The German player automatically loses if at any time he voluntarily vacates the Pillbox (in effect forfeiting the game).

A3.10 OPTIONAL RULES: Environmental Conditions: *Fair Visibility*. All Fire Attacks have their Fire strength reduced by one (1); all Ordnance Attacks have their To-Hit number reduced by one (1), and may only acquire their targets if their To-Hit number drawn for an attack was also Black. Infiltration attempts receive a one-column shift to the left, in addition to any other modifiers for Terrain or Concealment cards.

FRONT can have you sweating bullets). Some go so far as to declare that *UP FRONT* is too close to the real thing to be entertaining. I really wouldn't know. I *do* know that I've tried just about every game there is at one time or another, but there are only a precious few that I keep coming back to. And on that very short list, *UP FRONT* is number one.

So, in the interests of getting more people out there to play and enjoy *UP FRONT*, this column enjoins those of you who know the game to teach it to those who don't. As I believe those twenty-four pages of rules are better taught than learned on one's own, the following scenarios are provided as, among other things, a means for two players familiar with the system to introduce it to a third who is not.

Therefore, if you are a fan of *UP FRONT* (and the amount of letters we receive indicate that many of you are), here's your mission: Get your usual *UP FRONT* opponent and invite a third person who doesn't know the game to sit in. Give the new person one of the two team squads and help them along to learn the game. Go easy on them the first few times and be patient; there's a lot of stuff in these variant scenarios that isn't part of the Basic Game.

Remember that the mechanics of *UP FRONT* are inherently logical; most of what you think you *should* be able to do in reality, you *can* do in the game, given the necessary cards and a proper grasp of the rules. Make sure your pupil is aware of that. When you're done, wind down with a game of *A Meeting of Patrols* between the new person and an experienced player, with the extra person providing help and commentary. Of course, if you have someone eager to learn the game who is completely intimidated by these scenarios, by all means, skip to step two.

Why do I suggest throwing the neophyte directly into such complicated scenarios at all? Because most wargamers disdain *UP FRONT* as simplistic; show the new player that every aspect of tactical combat is available in *UP FRONT*: Artillery support, assault weapons, armor. Support their ideas and let them try any tactics they like, and allow them to learn from the consequences. Once they see *UP FRONT* as a *system*, they will be able to assimilate the simpler *Patrol* scenario much more easily.

You may find it tougher to teach "old hands" than those who've never seen a wargame before. To the latter, *UP FRONT*'s concepts can seem positively friendly when compared to hexes, lines-of-sight and half-inch counters with teeny-tiny type; to the former *UP FRONT* flies in the face of a lot of gaming conventions we've gotten (too) used to over the years. But don't lose patience, and don't lose heart.

Nobody ever learned to play *THIRD REICH*, *EMPIRES IN ARMS*, *ADVANCED SQUAD LEADER* or any of the *FLEET* Series games the first time through, but neither did anybody ever walk away from those games once they'd discovered what great fun they can be.

DOING AWAY WITH SCENARIO J

Alternative 3-Player Scenarios for UP FRONT

My good friend Scott Steinmann once told me: "Many's the time there were three of us sitting around the game table, trying to decide what to play, wishing one of us would leave so the other two could play *UP FRONT*." Having myself played a couple of sessions of Scenario J, *Free for All*, I understood why Scott and his group were not inclined to avail themselves of that particular solution. To me, the sole value of Scenario J is that it makes *three* people available to figure out the Night Rules at one sitting, thus increasing the likelihood that somebody will know what's going on by the end of the game.

In the end, though, *Free for All* inevitably degenerates into a bully-fest bloodbath as two players blast a third into chutney before turning their guns on one another. Not a lot of fun. So as an alternative, I designed some three-player scenarios based more or less on historical incidents. They took a bit of tuning, but there was no lack of enthusiastic *UP FRONT* fans to play them and offer suggestions (it seemed Scott and his group were not alone). We now had some three-player *UP FRONT* scenarios which would allow a sort of "Team Play" without requiring an extra copy of the game (the fact that each of us already owned at least one copy of *UP FRONT*, *BANZAI* and later, *DESERT WAR* was beside the point). These scenarios were especially helpful in teaching others the *UP FRONT* system.

The first of these scenarios appeared in the short-lived *UP FRONT Newsletter*, where it generated overall favorable responses from those gamers who saw it. This brought more suggestions which resulted in more improvements. I am indebted to Scott and all those other *UP FRONT* players who suffered through these scenarios in their early incarnations to bring them to a level where I felt I could inflict them on the gaming public at large.

Most of the unusual rules are the result of my desire to make the scenarios better-balanced and more fun for all three players.

In the meantime, however, here are two of those three-player scenarios. Both require only one copy of *UP FRONT* to play. Future columns will include three-player (and other) scenarios for *BANZAI* and *DESERT WAR*, variants and discussion of various aspects of play.

Readers' comments on these scenarios and rules are welcome, and of course, any players out there with new and different *UP FRONT* scenarios of their own are heartily encouraged to request a set of our *Guidelines* so that they may submit them to The *GENERAL* to be considered for publication.



28-3/B3. A LITTLE CORNER OF HELL

Assault on Bastogne

Set Up
 1st

SS: 1, 2, 6, 10, 12, 15,
17, 19, 26, 2 and One Radio
(See SSR)



No cards are removed from the Action Deck.

Set Up
 2nd

SS: 3, 4, 5, 8, 9, 23, 24, 35

Set Up
 3rd

Paratroopers: 3, 4, 5, 7, 9,
11, 14, 15, 17, 18(SSGT),
20, 21, 23, 25, 30 and One
Radio (See SSR)



SPECIAL RULES:

B3.1 The American player receives three -3 Buildings cards prior to play for use on any of his groups. In addition, he also receives the Pillbox, which is treated as a -4 Building and may hold any number of men. The rest of the Buildings cards are considered to be Scenario-Defined Cower Cards, and are unusable by any player. The German players may only occupy Buildings cards which they have captured from the Americans by Infiltration and Close Combat.

B3.12 After Set-Up and Prepare for Play, mark all Buildings cards (and the Pillbox, if used) with unused RR "0" Chits. Each time an Ordnance attack with an Un-Boxed Fire Strength of 4 or greater hits a Building, replace the chit with one of the next highest value. When a Building has suffered *four* such hits, it is considered *Rubbed*; mark it with a Blank counter. Thereafter, the Building is treated in all respects as a Wall card. It no longer counts as a Building for Victory Conditions, but remains in play until vacated.

B3.2 Buildings cards (including the Pillbox) which are vacated by the American are returned to the Action Deck, and thereafter are treated as Scenario-Defined Cower Cards. Minefields are Cower cards. Sniper and Wire cards are Cower Cards for the Germans only; they may be used normally by the American.

B3.4 RADIOS: The German Radio may call in artillery attacks of Fire Strength 7 during the first deck, Fire Strength 6 during the second, and Fire Strength 5 during the third. It has no value from the beginning of Deck Four until the end of the game. The American radio has no value during the first deck of the game; it may call in artillery strikes of Fire Strength 5 during the second deck, Fire Strength 6 during the third deck, and Fire Strength 7 during the fourth deck.

B3.5 Both German Player's squads are SS units, and entitled to Elite status capabilities for their nationality. Although controlled by two players, the German force is considered to be a single squad for purposes of breaking from casualties. Thus, both German players may continue the game (assuming either has any personality and/or vehicle cards remaining) until total German casualties exceed 51% of their starting forces, or 10 out of 18 personality cards (including the vehicle).

B3.6 The American forces are US paratroopers, an element of the 82nd Airborne. They are considered to be Elite (of course), and are entitled to the Elite status capabilities of their nationality. In addition, the American SL is considered to be a Senior Sergeant, entitling the American Player to a seven-card hand so long as he remains in the game and unpinned.

B3.7 The German players may communicate and compare hands only after establishing Radio Contact (*UP FRONT* rule 41.7). For game purposes, the German Players are entitled to maintain such contact so long as their Radio Chit is operating and German Player Two's AFV is functional and CE. Should the AFV Button Up or the Radio Chit malfunction, Radio Contact is lost until re-established as per 41.7. If the AFV suffers a "Commander Killed" result, Radio Contact is lost permanently. In addition, see **SSR A3.8**, below.

B3.8 THREE-PLAYER GAME SET-UP: German Player One sets up first. He must set up using Group ID chits Z, A and B, and have at least three groups. German Player Two then sets up, using Group ID chits C, D and E, and also have at least three groups. The American player then sets up, using Group ID chits A through D, inclusive, and must have at least four starting groups. Both German players must take their turns in numerical order (i.e., German Player One must complete all of his groups' actions before German Player Two begins his turn) before the American player takes his turn. If the German Players have established Radio Contact as per **SSR A3.7** above, they may conduct their groups' actions in any order desired.

B3.9 VICTORY CONDITIONS: The German side wins by capturing, through Infiltration and Close Combat, a greater number of intact Buildings cards than are occupied by the American forces. A Building may have been severely "damaged" by Ordnance, but so long as it is not "Rubbed", it counts as a Building for Victory Conditions. In addition, if the German AFV has reached Range Chit 8, the German side can win by occupying a number of intact Buildings *equal to* or greater than those held by the Americans. The American player wins by avoiding the German victory conditions while occupying at least one intact Buildings card or the Pillbox at the end of the game. Thus, the American player automatically loses if at any time he voluntarily vacates all Buildings cards (including the Pillbox), in effect forfeiting the game. Any result other than those above, including breaking the enemy squad, counts as a draw.

B3.10 OPTIONAL RULE: Heavy Snow; Fair Visibility: Stream and Marsh are Scenario-defined Cower cards for Infantry *only*; they may be discarded normally on a moving AFV, which must still refuse Marsh (tanks would break through where men would not). A sideways movement card must be placed before any movement card may be played to change range. AFVs must check for "Bog" for each Terrain card placed on them. Infantry guns may not be moved. Entrenchment attempts are successful on a RNC draw of "0" or "1". Subtract "1" from the strength of all Fire Attacks and the Fire Strength of Un-Boxed Ordnance.

GOVERNMENT INTERVENTION IN RAIL BARON

A Variant for Avalon Hill's Game of Empire-Building

By Stephen Taylor, Jim Brown and Alan Marian

Like most multi-player games, *RAIL BARON* is most enjoyable with five or six players. However, our gaming sessions are generally limited to two or three players, and we sought a way to increase the competition and interaction. Specifically, we have simulated the effect of railroads being purchased by a full complement of players. This simulation of other players is what we term "the Government" in this variant.

Though not strictly an historical variant, there is a basis in fact for the US Government getting into and then out of the railroad business. Consolidated Rail Corporation (Conrail) was created by Federal Law in 1976 from several failing rail line companies. By 1987, it was turned back into a for-profit private corporation with stock offered to the public.

Using this variant, *RAIL BARON* will be more competitive and exciting, particularly when there are fewer players in the game. In fact, you can play this variant with only two players. During the course of the game, the Government will take over railroads (more railroads will be taken over when there are fewer players). Even if there are just two or three players, a player will probably acquire only six to eight railroads by game's end. Money management and careful selection of which railroads to buy will determine who will win the game. This is because the price of a railroad may vary from 50% to 150% of the cost stated on the card. To guarantee the purchase of a particular railroad you will have to pay a premium. To get a railroad at half cost, you must take your chances on a random draw and auction.

Use all the standard rules except as noted below (In order to better represent the logic behind these variant rules, we have followed each with a brief summation, in bold type, of the rationale behind them):

1. The Home City has no effect on the game except to determine where the Player starts the game. **In this variant there is no "rover play" (see step 8).**

2. When a player reaches a destination, he may buy an express train for \$4,000 or a Superchief for \$25,000. There is no change in the Bonus rules. **This makes the Superchief a viable option by lowering the cost.**

3. When a player reaches a destination, and after he has decided whether or not to purchase an express or Superchief, he must select one and only one of the following options:

a. He can buy any one of the bank's railroads at 1.2 times the price listed on the card. Round off numbers to the next highest \$500.

b. He can buy any one railroad owned by the Government at 1.5 times the listed price.

c. Select a bank's railroad at random, and conduct an auction starting at 50% of the price listed on the card. The active player starts the bidding. If nobody bids on the railroad, the railroad is taken over by the Government. **By having an auction, all players are involved. Selecting a railroad at random adds to the excitement because the players do not know which railroads will come up for bid. Thus, if a player wants a particular railroad, he can take the chance that the railroad will come up for auction and possibly obtain it at half cost; or, if he**

the last player performs this step, the fewer players there are, the more times this step will be performed. Because the railroads are selected at random, each game will be different, depending on which railroads go to the Government. It also adds to the tension level when a desired railroad may be taken over by the Government in the random draw.

5. You do not pay any user's fee to travel on your own railroad. **It simplifies the game by not having to pay \$1,000 when using your own railroad, and it now becomes advantageous to use your railroad rather than the bank's railroad.**

6. If a player uses a railroad owned by the Government, he must pay a user's fee of \$6,000. The fee increases to \$12,000 when the bank runs out of railroads. When using a railroad owned by another player, the fee increases to \$10,000 when the bank runs out of railroads. There is no need to keep track of money paid to the Government (the Government cannot win the game). **The player will have to make a tough choice: Use an expensive Government railroad, or use a cheaper railroad owned by an opponent. It may pay to use the Government railroad and not give an opponent the additional income.**

7. If a player cannot pay a user fee, he must sell one or more of his railroads to the Government, *not* the bank, at 50% of the price listed on the card. **The game is more competitive because it is expensive to take advantage of another player's misfortune. Sold-off railroads must now be purchased from the Government at 1.5 times the cost.**

8. The game ends when a player has \$200,000, and the last player has been given the chance to complete his turn. The winner is the player with the most money. **This simplifies the victory conditions by eliminating the "rover play" at the end of the game, and now all players will have the same number of turns at game's end.**

Between everyone in our group, we've played almost every game in the Avalon Hill catalogue. *RAIL BARON* is an excellent change of pace and theme, especially with the additional interplay and money-management decisions created by this variant and its simulation of additional players. Now you will have the joy of seeing a crucial railroad transferred to the Government and then having to make the decision of whether or not to buy it back at 150% of its cost (if you don't, it may come back owned by another player). This can become a huge factor in winning or losing this fast-paced game.



is willing to pay the premium, he can assure the purchase of any railroad not owned by a player. Players will not be able to pay the premium very often. By allowing the players to purchase a railroad owned by the Government, no railroad is taken out of the game. Each railroad can be purchased by a player; possibly at a steep price, but often a key railroad is worth 1.5 times its original cost.

4. Whenever the last player reaches a destination, and after step 3 of this variant is conducted, a railroad owned by the bank is selected at random and given to the Government. For example, if there are three players, this step will be conducted only by the third player. **By giving railroads to the Government, you get more quickly to the point where user fees go up (this is when the game gets really exciting). Since only**

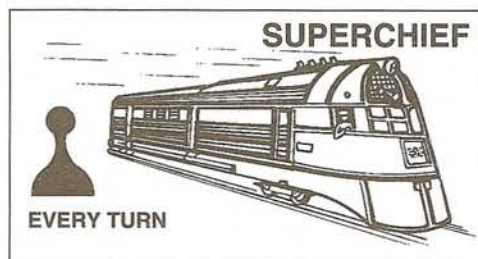

RAIL BARON Railroad Prices

Company		Par Value	120%	150%
ACL	(Atlantic Coast Line)	\$12,000	\$14,500	\$18,000
AT&SF	(Atchison, Topeka & Santa Fe)	40,000	48,000	60,000
B&M	(Boston & Maine)	4,000	5,000	6,000
B&O	(Baltimore & Ohio)	24,000	29,000	36,000
CB&Q	(Chicago, Burlington & Quincy)	20,000	24,000	30,000
CMSTP&P	(Chicago, Milwaukee, St. Paul, & Pacific)	18,000	22,000	27,000
C&NW	(Chicago & Northwestern)	14,000	17,000	21,000
C&O	(Chesapeake & Ohio)	20,000	24,000	30,000
CRI&P	(Chicago, Rock Island & Pacific)	29,000	35,000	43,500
D&RGW	(Denver & Rio Grande Western)	6,000	7,500	9,000
GM&O	(Gulf, Mobile & Ohio)	12,000	14,000	18,000
GN	(Great Northern)	17,000	20,500	25,500
IC	(Illinois Central)	14,000	17,000	21,000
MP	(Missouri Pacific)	21,000	25,500	31,500
L&N	(Louisville & Nashville)	18,000	22,000	27,000
NP	(Northern Pacific)	14,000	17,000	21,000
N&W	(Norfolk & Western)	12,000	14,000	18,000
NYC	(New York Central)	28,000	34,000	42,000
NYNH&H	(New York, New Haven & Hartford)	4,000	5,000	6,000
PA	(Pennsylvania)	30,000	36,000	45,000
RF&P	(Richmond, Fredericksburg & Potomac)	4,000	5,000	6,000
SAL	(Seaboard Air Line)	14,000	17,000	21,000
SOU	(Southern)	20,000	24,000	30,000
SP	(Southern Pacific)	42,000	50,500	63,000
SLSF	(St. Louis-San Francisco)	19,000	23,000	28,500
T&P	(Texas & Pacific)	10,000	12,000	15,000
UP	(Union Pacific)	40,000	48,000	60,000
WP	(Western Pacific)	8,000	10,000	12,000

----- (These charts are presented as Player Aids for RAIL BARON. Permission is hereby granted to photocopy them for personal use only.) -----

RAIL BARON

Trip Log

Player's Name: _____ Token Color: _____

	Region	City	Payoff
Start	_____	_____	_____
1st Destination	_____	_____	_____
2nd Destination	_____	_____	_____
3rd Destination	_____	_____	_____
4th Destination	_____	_____	_____
5th Destination	_____	_____	_____
6th Destination	_____	_____	_____
7th Destination	_____	_____	_____
8th Destination	_____	_____	_____
9th Destination	_____	_____	_____
10th Destination	_____	_____	_____
11th Destination	_____	_____	_____
12th Destination	_____	_____	_____
13th Destination	_____	_____	_____
14th Destination	_____	_____	_____
15th Destination	_____	_____	_____
16th Destination	_____	_____	_____
17th Destination	_____	_____	_____
18th Destination	_____	_____	_____
19th Destination	_____	_____	_____
20th Destination	_____	_____	_____
21th Destination	_____	_____	_____
22th Destination	_____	_____	_____
23th Destination	_____	_____	_____
24th Destination	_____	_____	_____

GONE, BUT NOT FORGOTTEN...

THE WORLD'S OLDEST WARGAME

By Patrick Carroll

Among Avalon Hill's "Leisure Time" Series of games is a real sleeper of a boardgame—maybe the ultimate sleeper of all time. That game is *GO*, and it is the oldest boardgame in the world, having survived virtually unchanged for some three or four millenia. (Games conceivably older than *GO* have been dug up in Egypt and Mesopotamia; unfortunately the archaeologists didn't dig up any rulebooks to go with them.) *GO* has enjoyed a consistent popularity since its origination in China, where some references date it as early as 2356 BC.

Today, *GO* is enjoying a tremendous surge in popularity worldwide. *GO* clubs have arisen in most major cities in the U.S. and Canada, and on every continent (with the possible exception of Antarctica—but who knows? The Japanese have a research station there, too...)

So what does this have to do with wargaming? Well, *GO* may just be the ultimate wargame, depending on your point of view.

For those unfamiliar with it, *GO* is an elegantly simple two-player game. The board consists of a 19-by-19 line grid, and the playing pieces ("stones") are all alike except that one player's stones are black and the other's white. Play consists of taking turns placing stones on the points where grid-lines intersect. And the object of the game is to fence off more territory (i.e., vacant grid-line points) than your opponent.

Extremely simple—yet also exceedingly complex. In Japan and elsewhere in the far East, *GO* is regarded as a sort of intellectual martial art—the karate or kung fu of boardgames. Children learn the game at an early age, and those who show promise begin training under the guidance of a professional. There are academies devoted to teaching play of the game as a profession; and a lucrative profession it can be, as the income of a *GO* master in the Far East is easily comparable to that of his western counterpart in *Chess*.

But the training is arduous in the extreme, and only a few have the aptitude and maintain the years of discipline it takes to eventually master the ancient game.

But those are the professionals; when played by us ordinary folk, *GO* is immensely enjoyable as an abstract wargame. Legend has it that the samurai carried *GO* sets everywhere and played between battles to keep their strategic wits finely honed. Over the centuries, ancient courtesies and conventions have been adopted into the play of the game, rituals which are now as integrated

into the play of *GO* as the placing of the stones themselves, making it as much a social heritage of the samurai as their martial spirit and giri, or devotion to duty.

But you need not be Samurai to enjoy this true classic. If you're a wargamer, the basics of *GO* are well within your ability to grasp.

Like most strategy-level wargames, *GO* involves the acquisition of territory. And as in many wargames, the playing pieces—which in fact abstractly represent military units—must maintain lines of supply in order to survive. Those groups cut off from supply are captured.

Unlike most wargames, however, the territories of the *GO* board do not represent any particular field of battle, nor do the "armies" ever actually move. There are no head-to-head clashes in *GO*, all "battles" being comprised instead of efforts to engulf enemy armies and thus capture the territory they occupy. Still, if *Chess* can be thought of as the ultimate abstract tactical wargame, then *GO* is certainly the ultimate abstract strategic wargame.

GO relies explicitly on what many strategic wargames deal with implicitly; the *pattern* of a conflict. As the game progresses, that pattern emerges and becomes more clear, as it is guided in different directions by the opposing players, to their own advantage and (hopefully) eventual victory. *GO* requires (and rewards) patience and planning, which is true of any good strategic simulation.

So, if you're not hopelessly hooked on tanks and infantry, detailed mapboards and realistic combat simulation; if your interest in military science and strategy gaming is broader than that, then by all means, give *GO* a try. It is truly a fascinating game, one that can provide a lifetime of challenge and gaming fascination.

But... a word of caution: *GO* is not what it at first appears to be. The rules are perfectly simple (there are, in fact, only *three*), and take only a minute to learn—but then come the practice games. If you're used to playing one or two practice games to catch on to a new wargame, plan to spend at least ten to twenty practice games getting the hang of *GO*. Once you've "cracked the code", however, you'll be richly rewarded. More, you will have access to what many people, for many centuries, have justifiably regarded as the best strategy boardgame in the world.



1993 DIPLOMACY HOBBY AWARDS

Dave McCrumb, Hobby Awards Chairman, is requesting nominations for the 1993 *DIPLOMACY* Hobby Awards. These Awards recognize those individuals who have contributed to the *DIPLOMACY* hobby during the past year. This is an excellent opportunity to show your appreciation for someone who has helped to increase your enjoyment of this hobby. All it takes is a few minutes of your time, but the recognition received by the nominee will be greatly appreciated.

Nominations are being requested for the following awards (Please list the reason you have submitted your nomination. For the *Walker Award*, a copy of the related article will be appreciated):

Don Miller Memorial Award for hobby service. This is normally considered the most prestigious award. Past recipients have included some of the hobby's most distinguished members. The recipient should be someone who has made a major contribution to the hobby in the past year. (Ineligible: John Caruso, David Hood)

Rod Walker Award for literary excellence. Presented for the best article written and published within the past year, this award may be given for an individual or collaborative work. (Ineligible: Garrett Schenck, Mark Berch)

John Koning Memorial Award for outstanding play of *DIPLOMACY*. This may be for PBM, PBEM, FTF or tournament play during the past year. (Ineligible: Gary Behnen)

Melinda Holley Award for general participation in the hobby. Designed to recognize those people who make this hobby so enjoyable and functional year in and year out. (Ineligible: Kathy Caruso, Melinda Holley)

Nominations in each category will be screened by a committee to reduce the list to five finalists in each category. These finalists will then be presented to the *DIPLOMACY* hobby, with votes being solicited from each hobby member in each category. The recipient of each award will be announced at the 1993 *DipCon* in California during September.

Hobby members may make as many nominations as they wish. The only restrictions are that the winner of each award is ineligible to win that particular award for the next two years, and the chairman of this committee is ineligible for all awards. While members of the Selection Committee may not nominate each other for any awards, other members may do so. In this event, that member of the committee will not be permitted to vote in that category.

For further information and filing nominations, please contact: Dave McCrumb, 3636 Oldtown Road, Shawsville, VA 24162, USA. Telephone No.: (703) 268-9745 (No calls after 10:00 PM Eastern Standard Time, please.)

DIP PBM. AREA. Experienced game master has several player openings. Send country-preferences in order with SASE for more info. Perry Young, 3724 E. Columbine, Phoenix, AZ 85032.

30's graduate seeks PBM opponents for WS&M. All letters answered. Would like to correspond with opponents from other countries. Edward Mansfield, 322 Avenue A, San Manuel, AZ 85631. (602) 385-4383.

Adult gamer seeks FTF opponents for PL, PB. Not rated, but competitive. Phil Propper, Burbank, CA 91502. (818) 483-7982.

Looking for opponents in the Las Vegas/Nellis AFB area. Especially FTF ASL, but willing to try most anything. Forrest E. Metz, 24 Strunk Pkwy, Las Vegas, CA 89115. (702) 643-2662.

Opponent Wanted, PBM WAT. John Phillips, 2780 Creston Drive, Los Angeles, CA 90068. (213) 463-8188.

Adult gamers wanted for CIV, DUNE, and most other games. I just relocated here and want to meet new opponents. Glenn MacArthur, 134 East Kelly Drive, Novato, CA 94949. (415) 382-7708.

31-year-old novice seeks FTF or PBM opponent for AFRICA KORPS. Carlo Bertocini, 545 Wellington Drive, San Carlos, CA 94070. FAX: (415) 592-0440.

PBM opponents wanted for BB '65, BB '81, AK, Chess, PB, ANZIO. Also GM games of KM, 6th Flt; also PBM STAL. Marcel Carboneau, 240 Iron Drive, Apt. 17, Vista, CA 92083. (619) 941-8510.

Experienced gamer new to Denver willing to play all AH wargames, especially DIP, CIV, KM, HW, UF and many others. Nathan Wagner, 90720 E. Girard Ave, #10, Denver, CO 80231. 755-5745.

PBM TACTICS II? Will be using '61 version of Advanced Game with all options except nukes. Am non-AREA-rated. Peace! Kenneth W. Burke, 6 Meadowbrook Road, West Hartford, CT 06107.

FTF NB, ASL, ROR, many others. Any gamers in the Space Coast area? Les Doggrell, 410 Apache Trail, Merritt Island, FL 32953. (407) 453-7853.

Wanted: Mature PBM opponent, rated or unrated. Have PBM systems for BB '91, TRC, RF, TP:S, & new PBM PW scenarios. Dave McFarland, 2247 Quail Ridge S., Palm Beach Gardens, FL 33418. (407) 622-3035.

PBM rated game of BR, CAE and SOJ. CAE is easy to PBM. SOJ may require phone for melee resolution. Hank Burkhalter, P.O. Box 12074, Panama City, FL 32401. (904) 763-8744.

Join the PBM DIP hobby! *Pontivedria* lists 'zines with openings for DIP, its variants, and other games. Send SASE to: Phil Reynolds, USF #4286, 4202 Fowler Ave., Tampa, FL 33620.

Wanted: Face-to-face opponents for SL, ASL, GE '88 and W&P. Any clubs in southern Idaho? Craig Brown, 370 N. 9th St. E., Mountain Home, ID 83647. (208) 587-8672.

Wanted: Adult opponent rated 1500+ PBM RF campaign game, optional rules, 17.2 Limited one mission per turn, modified naval base rule. You pick side. Michael G. Mitchell, 260 Lakemont Drive, Roswell, GA 30075. (404) 998-2152.

Would like opponents for FTF games of AK, TRC and VITP. Interested in learning and enjoyment. Bill Deneen, 12408 Maple Ave., Blue Island, IL 60406. (708) 385-0203.

ASL, A3R, TT, ACIV, Players and more. Join the WCW of Chicago. 80+ members get our roster and newsletter. Louie Tokarz, 5724 West 106th Street, Chicago Ridge, IL 60415. (708) 857-7060

OPponents WANTED

25-year-old diplomat seeks FTF DIP players in SW Chicago suburbs. Jim O'Kelley, 27 North Brainard, Apt. B2, LaGrange, IL 60525. (708) 352-2768.

Adult gamer wants mature gamers of any age on North Shore for FTF ASL, ROR, ATR, PW, MID and others. Michael C. Neubauer, 302 North Western Avenue, Lake Forest, IL 60045. (708) 735-1805.

Looking for experienced FTF players for TP:S, CASS and TRC. My place or yours. Tom Johnston, 7509 W. 159th St., #303-C, Tinley Park, IL 60477. (708) 614-0188.

Serious STATIS PRO FOOTBALL player seeks opponents in Chicagoland area. Will play anytime, and willing to teach others. Michael DelGardo, 7611 Hohman Avenue, Munster, IN 46321. (219) 836-5614.

SOS! I have ASL but no opponent! Please help! I play for fun. If I'm not home, please leave a message. Ernst Bartis, 71 Longwood Dr., Portland, ME 04102. (207) 772-1462.

Opponents Wanted: Will drive within the DC and Baltimore area. Will play any game: Desperate! I own PW, FT, TT, SC, several others. Randy Gutt, 4007 Emerald Lane, Apt. D, Bowie, MD 20716. (301) 464-5804.

Postal DIPLOMACY games for Mensans. Annual dues of \$5.00 gets you six issues of the DIPLOMAG newsletter and entry into all-Mensa games. For information contact Fred C. Davis, Jr., 3210-K Wheaton Way, Ellicott City, MD 21043.

ASL, FP, UF, TP:S opponents wanted. Beginners through pros. Let's actually play these silly games we've invested so heavily in. Jeb Nagel, 133 Round Bay Road, Severna Park, MD 21146. (410) 544-9886.

Looking for FTF play for MBT. Dan Reed, 701 NE 8th Street, Buffalo, MN 55313. (612) 682-2990.

Experienced adult player seeks PBM rated games of WAT, D-DAY, AK. Looking for timely responses. Pat McNevin, 12985 Raven Street NW, Coon Rapids, MN 55448. (612) 754-3917.

Competitive yet good-humored gamer craves AREA FTF games of UF, BB '81, TRC and more. Also AREA PBM games of TRC, BB '81. Any gamers/clubs in Twin Cities area? Mike Kosloski, 1900 Roosevelt Dr., #2, Northfield, MN 55057. (507) 645-5517.

Looking for B-17 group to join PBM. If you have info let me know. Thanks. David Brady, 5255 Manhattan Road, P-2, Jackson, MS 39206. (601) 362-1437.

Looking for FTF ASL, any clubs in area. George Sedlak, 117-14 Union Turnpike, Queens, NY 11415. (718) 263-2554.

Veteran gamer seeks victims for AREA rated PBM GE and RF. Have good systems. 1500+ preferred, all letters answered. Jim Eliason, 3804 Greystone Avenue, #F2, Riverdale, NY 10463. (718) 548-6168.

Need a TP:S teacher/opponent for FTF match, likewise for DEV. Opponent also wanted for PBM GE '88, AK. Rated or non-rated okay. Willie Voll, 2810 Moreland St., Yorktown Hts., NY 10598. (914) 245-4636.

Adult gamer looking for anyone in Charlotte interested in playing classics such as VITP, TRC, MD or DD. Bill Deaton, 5200 Pine Dr., Charlotte, NC 28269. (704) 597-7956.

Wanted: Any opponents for any games. Multi-player games okay too. Am AREA-rated with over 25 years in hobby. John Welage, 591 Four Mile, Cincinnati, OH 45230. (513) 232-3305.

Beginning adult gamer in the north central Ohio area and willing to take his lumps seeks FTF opponents for BB, SOA, CASS, STAL. John Simatacolas, 25 Cedargate Court, Galion, OH 44833. (419) 462-5883.

Looking for gamers in NE Columbus. Especially interested in SJW, BR, BRIT, BB, CIV, TP:S and TRC, and in learning ASL. Steve Likevich, 11713 Duncan Plains Rd., Johnstown, OH 43031. (614) 967-9875.

Experienced (12 years) gamer seeking FTF opponents and PBM systems for: EIA, FT, TRC, RF, 3R, VITP, W&P, WAS, Will GM FT. Beginners Welcome. Paul D. Carlson, 12085 SW 135th Avenue, Apt. #1, Tigard, OR 97223. (503) 524-6037.

PBM or FTF for SOJ, PB, PL, TRC, WSIM, SAM or SJW. I prefer an honor system for PBM. Dean Hallley, 2485 SE Alder, Hillsboro, OR 97123. (503) 640-2106.

Experience the fog of war as I umpire your MBT game. Send address and side preference to: Matt Lees, 35 Norwood House Rd., Downingtown, PA 19335.

Any wargamers in the Lehigh area? Looking for FTF opponents in Bethlehem and Allentown areas. Have large collection of Avalon Hill boardgames. Contact Tom Addison, 2009-L Hoover Avenue, Allentown, PA 18103.

New to Memphis area! Have large game room for CIV, ASL, 3R, SOJ, TLD, SUB, WS&M and many, many more! Jim Miller, 3541 Neyland Drive, Collierville, TN 38017. (901) 853-6566.

FTF opponents wanted in Knoxville and Morristown area. Rated and non-rated play for ASL system. Adults 19+ only. Tim Deane, 2110 Carolyn Drive, Jefferson City, TN 37760. 475-9286.

Wanted: Conroe area FTF wargamers. Play 3R, FT, CW, WSIM and willing to learn others. Call Matt Streger at (409) 756-0067. 1728 Tims Lane, Conroe, TX 77301.

Looking for opponents? AHKS has been providing quality PBM opponents for over 27 years. For more info contact: J.K. Atkins, 5014 Encino, Friendswood, TX 77546. (713) 482-3604.

Novice PBM-er wants opponents for AZ, BL, BB '91, GE '88, TRC, WSIM. Bryan Register, 907 Forest Lake Drive, Seabrook, TX 77586. (713) 474-4674.

Will play any war games; familiar with EIA, RF, 3R, W&P and willing to learn others. Gary Sattman, 26 South Union, Burlington, VT 05401. (802) 658-5376.

The Washington Gamers meet twice monthly. Join and get our newsletter of articles, notices and ads. Dues are \$6.00 per year. For more information, contact Wendell Albright, 4403 North 4th #2, Arlington, VA 22203. (703) 528-5123.

PBM PB, PL. All letters answered. Would like to try W&P or SL but need help. Clyde Longest, 3 Jules Circle, Newport News, VA 23601. (804) 596-0121.

Searching for gamers in Tacoma area. Ten years experience. Seeking to join and/or begin an ASL club; also AK, BB, TRC and others. Contact Don Lazon, 10622 11th Avenue Court South, Tacoma, WA 98444. (206) 537-8167.

AREA 1500 wants PBM opponents for rated matches in GE'88, CW, MD'92, LW, VITP, WAS, RW, PB, SJW and PL. Michael Zeimentz, 216 South 5th Street., Delavan, WI 53115. (414) 728-1979.

The Fox Valley Gamers meet on alternate Saturdays. New members welcome! We play CIV, BRIT, KM, 3R, PAA, DIP, 1830. Contact: William Jacobsen, 1309 Liberty Court, Neenah, WI 54956. (414) 722-6187.

ASL, SOA, DD. Tim Wilson, 353 Cascade Street, Lander, WY 82520. (307) 332-6973.

GAMING VIA E-MAIL

America On-Line Wargaming Club. Meets 3rd Wednesday each month in the Conference Room of the PBM & Strategy Forum at 9:30 EST. E-Mail Address: AWC.

CANADA, EUROPE & ELSEWHERE

Any Torontonians out there? Novice interested in FTF ASL, 3R, AZ, FT. Will try PBM but need system. AREA 1500 (prov). Jean Tessier, 250 Queen's Quay W #1001, Toronto, Ontario M5J 2N2, CANADA. (416) 260-6165.

Need players for Game-Mastered FLAT TOP, modified Coral Sea Scenario. Please state command/side preference. Hans R. Frey, c/o Altherr, Martiusstr. 6, D-8000, München 40, GERMANY.

Avon calling! Dependable player needs opponents for FTF ASL. Own all modules and Annuals. Willing to travel within Avon County. Adrian Catchpole, 120 Somerset Road, Knowle, Bristol BS4 2JB, GREAT BRITAIN. Tel.: 0272-713396.

Experienced gamer new to ASL seeks adult opponent in North or West Yorkshire. Contact with other GB ASL players welcomed. Please contact Bob Groves, 56 Hall Orchards Avenue, Wetherby, West Yorkshire, LS22 6SN, GREAT BRITAIN. Tel.: 0937-588271.

AREA (1500 provisional) PBM for ASL, AK, AF, AZ, PB, PL, PK, TRC, SL, 1776, SOJ, 3R and more. Friendly, fair play. Also AHKS. Contact Angelo Tropicano, Via Urbanati, 15, Palazzolo(SR), 36010, ITALY. Tel.: 0039-931-882 909.

Adult gamer posted to remote, isolated island seeks PBM TRC. Also would like to hear from a MACHIAVELLI or CIV group for PBM. Gregory Straw, Am. Cons. Ponta Delgada, PSC 76, Box 3000, APO AE 09720-0002.

Novice adult gamer wants AREA/Non-AREA opponents. In order of preference, FTF: AF, CIV, others. PBM: HW, TP:S. Need PBM systems. Adolfo Coelho, Rua Capitães de Abril, N°-54-8°-Esquerdo, Colina-do-Sol, 2700-Amadora, PORTUGAL. Tel.: (351) 1-475-01-94

Adult gamer seeks fellow gamers for FTF play. All games including ASL, TLD, SOA, 3R. Speak French and German. Alex McCusker, Ave. de Morges 46, Lausanne, SWITZERLAND 1004. Tel.: (21) 24.79.63.

Swiss gamer is looking for FTF or PBM AK, DD, CIV, ROR. Willing to learn others. AREA member. Jesper Mlisa, Kirchstrasse 4A, St. Gallen, SWITZERLAND 9010. Tel.: +22/7866008.

ASL, AK, TPS, UF, TRC, RF, SL, CASS. Martin Bacon, 41 Davenport Road, Banbury, Oxon, UK. Tel.: 0295-258023.

Individuals and clubs are encouraged to make use of this column to further the growth of our hobby. "Opponents Wanted" forms and conditions for listings can be found on the Insert Pages of every issue of The Avalon Hill GENERAL.

NOTE: Ads pertaining solely to AVALONCON travel, room-mates, or teammates are placed free of charge to any subscriber.

Letters to the Editor . . .

Dear Sir:

As an experienced *AVALONCON* gamemaster and advocate of the "Swiss System" for game tournaments, I would like to make a few comments on Russ Gifford's "AREA News" column in Volume 28, No. 1 of *The GENERAL*. Generally, Russ presented an excellent overview of the different formats, particularly his discussion of seeding. While Russ makes a good case for the Swiss System, I believe it is even better than he suggests if organized properly.

First, as we know, many people do not wish to continue playing in an event once they cannot win. One of the features that makes a Swiss format ideal for a wargame tournament is that players are *not* required to play additional rounds if they don't want to. The GM must simply avoid making pairings prior to the start of a round. At the start of a round, rank all players by won-lost record (or whatever scoring method you're using) and take a roll call, pairing off available players from the top. If you have a no-show, just skip over that player and continue pairing. As long as you have a fill-in to guarantee an even number of players, the tournament will not be seriously disrupted by departures. As Russ notes, late-round byes need not be awarded to contenders, so they won't affect the standings even if needed.

Another advantage of the Swiss format is that players may still have a chance to win the tournament even after having lost a game. Accordingly, an ideal Swiss tournament should have more than enough rounds to reduce the field to one undefeated player. Otherwise, a Swiss becomes virtually the same as Single Elimination, because a single loss means one cannot win the event. If there are so many players that the field cannot be reduced to a single undefeated player in the available rounds, no system will work perfectly, but a Swiss is by far the best.

The only real difficulty with a Swiss, regardless of the number of rounds, is that a system must be devised to break a tie between two players who have the same record. Certain games, which are scored by points or levels of victory, lend themselves to a convenient tie-break mechanism—one can simply require a certain point level before a player gets a "Full Win". A delicate balance must be kept here, however; if it is too easy to get the maximum game score, few games will have "Partial Victory" results and ties probably won't be broken, but if it is too hard to get a full win, some players will get an unfair benefit from weak or discouraged opponents who don't put up enough resistance and yield the maximum score easily.

Alan Applebaum
Brookline, MA

★★★★★

Dear Editor:

After reading Patrick Pressler's letter in 27-6 (a response to my letter in 27-3) I re-read my letter praising Avalon Hill's "back to the basics" approach. Well, okay, so I sounded a little like an Avalon

Hill press release, but the feeling was sincere. It's nice to enjoy a challenging game with friends who normally wouldn't care about wargames, and still have time for other minor distractions, like your family. But I think it's worth a few paragraphs to pick Mr. Pressler's letter apart, because he's been out of civilian life too long. He just doesn't get it. The world of gaming is changing.

First of all, his comment: "keep your hands off *my* hobby" (italics mine). Begging your pardon, Lord Pressler, but I thought it was my hobby, too. I was pushing the ships in *JUTLAND* around on my kitchen floor while you were still sucking your thumb. And the hobby nearly died in the late '70's because of the attitudes of people like you, who stubbornly thought it was "their" hobby and proceeded to design games that only their elitist circle could appreciate. The vast majority of us, who enjoyed the challenge of playing a good game as opposed to deciphering rulebooks of biblical proportions and moving pagoda-like stacks of counters, got bored. Many quit playing altogether. And, for a while, it looked as if it really was going to be your hobby—because the selfish interests of you and a few like you had killed it for everyone else.

Next, Mr. Pressler's comment: "if you don't like the way things are, jump ship!" I've been on this ship for a lot longer than you, Mr. Pressler, and I have no intention of jumping. The game systems are becoming better and better, because designers are rediscovering the virtues of simplicity—that a game can be elegantly simple in design and still hold up well under repeated playings. I don't know how many times I've enjoyed storming Cemetery Ridge in *GETTYSBURG '88*, but it numbers in the dozens. The fact that I can enjoy it with people who normally wouldn't play wargames as well as the die-hards doesn't diminish the game's play value, the high level of challenge or, most of all, the sheer fun of it. And if you want to sneer at the "kiddie games" like the Smithsonian Series, then you're only thinking of challenge in terms of rulebook thickness, which is a very different kind of challenge from the ones I enjoy—and one fewer and fewer people have time for.

I was surprised to read Mr. Pressler's letter, because I thought dinosaurs of his particular species were finally nearing extinction. But I suppose we should think of Mr. Pressler's pitiful cry of rage as a beast in its death throes. Look at the Top 25 Avalon Hill sellers, Mr. Pressler, and figure out which way the hobby is going. People are voting with their pocket books, and games you can actually play are winning by a landslide. To Mr. Pressler and the rest of the self-centered, misguided handful who nearly ruined our hobby a little more than a decade ago, I can only say: Go lock yourselves in a closet and play week-long sessions of Monster-Games if you want to. The rest of us are trying to have fun.

Ed Brickell
Dallas, TX

★★★★★

Dear Mr. Hawthorne:

I have a rather unusual request that may be of particular interest to players of Avalon Hill's *SQUAD LEADER* and *ADVANCED SQUAD LEADER*...

The 10-2 "Cpt. Heyman" German leader counter was named after an actual person, Harry Heyman. Mr. Heyman was involved in the Board Game Hobby for many, many years as both a player and teacher. Harry and his close friend (and brother-in-law) Jerry Thomas, were both directly involved in the hobby, including the pre-release playtesting of *SQUAD LEADER* and the establishment of the *Pacificon* game convention in northern California.

After retiring for the evening on October 29, Mr. Heyman suddenly passed away. He simply did not wake up on the morning of October 30. Harry was 44 years old.

I invite all members of our Board Game Hobby to remember Harry as we continue to enjoy *SQUAD LEADER*, *ADVANCED SQUAD LEADER*, and almost any other board game. Thank you very much.

Richard Renner
San Jose, CA

★★★★★

Dear Mr. Martin:

I was saddened to read of your departure from *The GENERAL*, but having recently made a transition myself (from the military to civilian life), I understand that there comes a time to move on to other things.

But the reason I am writing is that I wanted to thank you for your contributions to the hobby, and for bringing a "little life" back into a pastime which, it seemed, had grown a little stale.

I started playing Avalon Hill games as a 10 year old with *RICHTOFEN'S WAR*. Since then I have purchased many games from your company (and several others); but with the increasing pressures of school, and then my work in the service, I no longer had the time to play the games as I once did. It was also about this time that the games took on more complexity, and it seemed we spent more time fighting the rules than we did enjoying the games.

Then I read your article, "That Sinking Feeling; Scuttling Ol' Dad" in *The GENERAL* Vol. 25, No. 4. Here was a replay article that was actually a joy to read and not buried in statistics. The description of your games was so entertaining that I went out and bought the featured game [*ENEMY IN SIGHT*] for myself, and have enjoyed it since.

Then in Vol. 27, Nos. 4 and 5, you succeeded once again with your article on PBM *DIPLOMACY*, "Leviathan; A GM's View of Game 1988HW (with G. Behen)". I had played *DIPLOMACY* only once before, in college, and had forgotten how much fun it could be. The article was funny, informative and just fun to read. Though still under some

time limitations, I bought the game and wrote to one of the GM's in *Diplomacy World*; I'm now waiting for his reply as to whether or not there is a game opening soon which I can join.

In closing, I hope that you continue to write for *The GENERAL*, and I would like to thank you once again for bringing new life to a hobby that, for me, has provided much enjoyment.

Ed Ouelette
Norman, OK

★★★★★

Dear Mr. Martin:

I thought your "Philosophy" column about bringing younger ones into the hobby was excellent. My nine-year-old son Ryan has been playing AH games with me every weekend for the last four months. We have played *STALINGRAD*, *BATTLE OF THE BULGE '91*, *D-DAY '91*, *STARSHIP TROOPERS*, *AMOEBIA WARS*, and *MIDWAY* (his favorite). Of course I have to help him calculate odds sometimes but we still have great fun! My ex-wife says that he has been driving her crazy talking about the *Hornet*, *Enterprise* and the *Yamato* and all his strategies for beating dad. When I read "letters to the editor", I can't believe all the complainers. The *GENERAL* is bigger and better than ever and the new Smithsonian-AH games are exactly what this ten-year veteran wargamer has been looking for. I have nothing but praise for AH and the direction it is taking the hobby. Thanks.

Michael N. Powell, D.C.
New Bedford, Massachusetts

★★★★★

Dear Mr. Hawthorne,

I had been considering allowing my subscription to *The GENERAL* to lapse—especially in light of rumours that ASL coverage was to be restricted, due amongst other reasons to a twice-yearly(?) *ASL Annual*.

Nevertheless, I was persuaded (partly by your "expiring subscriptions" letter) to renew—with a two-year subscription. At least I would continue to receive the *ASL* scenarios on the insert...

I am writing to thank you for justifying my faith! Your promise of a semi-regular (hopefully more than less) Scenario Briefing is all I could have asked for.

Not that the rest of *The GENERAL* is not of interest; there is simply *so much* to read and catch up with nowadays.

Please do not bother to respond to this letter—take it as a "welcome aboard" from a reader since Vol. 11, Number 4!

Ian Daglish
Cragshire, UK

Thanks for the kind words; I want to apologize to the readership for the lateness of this issue; I hope it was worth the wait. I'd also like to assure the fraternity of ASL players that, so long as Rex (who will indeed be keeping busy around here) and Bob keep me supplied with ASL material, I will do my best to have something in each issue, even if it is only the Insert scenarios. For the most part, though, look for the more exhaustive ASL coverage in the Annual, whereas The GENERAL will carry articles more helpful to new ASL players.



MY TOP TEN

By John Huff

This is a list and brief description of my ten favorite Microcomputer products. Some are older products, some are current. I participated in the development of many of them, while some of them came into existence without my help. My choices are based purely on personal taste.

I didn't rank them because I spent just about the same amount of time playing all of them, and extracted considerable pleasure from each.

Combots

Commodore 64

I designed this game and worked closely with the programmer. It's a tactical combat game pitting human-controlled armored vehicles against an army of invading alien robots. It includes programs for designing your own scenarios, building your own machines, and even designing your own devices (power plants, weapons, sensors...).

We avoided hokey animation to give as much content to the game as possible. The end product is a game that gets a lot out of the old C-64.

Computer Acquire

IBM

One of our recent products. It's quick, challenging and easy to play. It's even fun. One of those fiddling kinda games that just occupies time and leaves you entertained. Runs on IBM compatibles and supports most graphic modes.

There are 20 different profiles for computer players; each is selected randomly and assigned a name. That computer player will play consistently throughout the game, and the right combination of computer players can be devastating.

Computer Third Reich

Commodore Amiga and Atari ST

Not being a fan of the paper version, I inherited this project with some trepidation. However, I was wrong to worry, and in spite of some technical flaws, I find the game a delight to play. It moves at a quick pace, and you have a good sense of dynamic flow as the turns progress.

As I've admitted in earlier articles, the Computer Player leaves something to be desired. Still, the relatively small population of dissatisfied gamers are mostly bothered by discrepancies between the paper game and the electronic. I didn't find that a major problem, and the ease of play more than compensates.

Dark Horn

Apple II and Commodore 64

A fantasy wargame that pits up to four opponents against each other. The neat thing about the game is that it's played in real time. Things get kind of frantic, but each player tries to increase the size of their armies, build fortifications and take territory.

The real-time aspect makes the simple game mechanics shine. If you've still got one of these machines, you won't regret buying a copy.

Diplomacy

Commodore Amiga/C-64, Atari ST and IBM

A classic in computer games. The original release for the IBM is an excellent game, and the newer versions for the 68K and C-64 are great. Surprisingly enough, I have a marked preference for the C-64 version. It has a more flexible interface with the computer players.

The 68K versions have outstanding graphics and are well executed. The actual writing of the program was done by Virgin Games in the UK, and they have done one of their best jobs yet.

Dreadnoughts

Apple II and Commodore 64

Computer conversion of *BISMARCK*. One of the first of our games that I played, it remains one of my favorites. Published in 1984, the graphics are now dated, but the game content is still strong and gives a good account of itself.

Incunabula

IBM

Our first *CIVILIZATION* conversion. Plays easily, graphics (CGA) are above average for the time period. I particularly like the overall feel of the game. Replaying it has my mouth watering for our upcoming *COMPUTER CIVILIZATION*.

Legends of the Lost Realm

Apple Macintosh

I've played most of the computer-adventure games out there (ours and theirs). This is the best one I've ever played. Tailored for the Mac environment, *LOTLR* is a breath of fresh air in the Computer Adventure World.

Parties consist of up to six adventurers. The first scenario has hundreds of places to explore, several small puzzles, and an overall puzzle that supports the theme of the game. Combat is a combination of styles with a good tactical feel,

but abstracted enough to avoid the tedium so common to most other games of this design.

There are many different routes you can take to solve the game, so the constricted, linear style of most computer-adventure games is avoided.

Spitfire 40

Commodore C-64, Atari 8-bit, and Atari ST

Our first and only foray into the world of Flight Simulators. It was the most advanced at the time (several computer flying clubs adopted it as their standard). Gives all of the feel of flying a Spitfire Mk II. I personally flew a lot more missions than were required for play-testing.

The Atari ST version is dynamite, but with the general failure of the ST in the U.S. marketplace, it (sadly) never really got off the ground. I would still recommend it to anybody who owns one of the appropriate machines.

Under Fire

Apple II and IBM

The initial version was developed by Ralph (TAC) Bosson. Excellent computer version of squad level combat. The Apple release eventually included additional units (including Japanese and British) and a campaign game which tied all the games together into a cohesive whole.

The IBM further improved on the initial game. It has CGA/HERC standard graphics and an older type of interface, but as a tactical wargame will still hold its own with the best. Again, I still play the IBM version for my own entertainment and there are not many other games that I do.

Wooden Ships and Iron Men

Commodore C-64

This game is one of the reasons I still have my Commodore 64. True to the original paper game with the added ability to build your own fleets, build your own ships, design your own playing fields and knock out your own scenarios. Graphics are as close to the paper game as the old C-64 could manage. If you still have one of the C-64's (64c, 128 or 128D) and are a tactical wargame fan, you need this game.

The computer opponent is relatively good, adapting well to changing situations. We had no room to teach the computer player how to negotiate coastlines, so solo scenarios have to be built without land masses. Oh well! Still a great game!

There are lots of other games which I have enjoyed both playing and working on (*Tsushima*, *Fortress of the Witch King*, and *Legionnaire* to name a few) but these are the ten games which I regard (for my own reasons) as classics.

We are on the verge of releasing a number of new computer games that hold the same promise. I hope you will enjoy them as much as we do.

The Keyboard Passes On

Beginning with our next issue this column will be handed over to Jim Rose, our operations director. He is a long-time gamer, a computer professional and has run his own wargame-dedicated BBS. I am sure you will find his views both new and exciting. I know he is excited about sharing with you the benefits of his knowledge and opinions.



A FOND FRIENDSHIP RENEWED

Re-Acquainting Oneself with *THE RUSSIAN CAMPAIGN*

By Art Kritzer

There are very few games that combine simplicity with challenging play, time after time. Fewer still become classics, and remain so years after their initial release. Rediscovering one of these gems is akin to meeting an old chum. For those who have played *THE RUSSIAN CAMPAIGN*, I need go no further. Despite endless playings, this game continues to be one of my all time favorites, and I continue to enjoy it immensely. Recently, I had the “pleasure” (more about those quotation marks later) of playing this classic with an old gaming buddy of mine named Paul. We wanted something quick to play, and *TRC*’s six-page rule book fit the bill nicely.

With more than a little re-kindled interest, my old and rather tattered copy of *TRC* was dusted off and set up for play. Old strategies and tactics began coming back to me to be tried once more. What was most surprising was how much we actually *enjoyed playing the game*—there is no lack of eastern front games out there, but *TRC* had lost none of its appeal for me over the years I had been away from it. Everything was there: The Panzers, the Stukas, the Russian Guards, the Cavalry and the good old pesky Russian Partisans. Great gaming was at hand! My friend took a break and I glanced through the rule booklet (remember when all rules came in “booklets” rather than full-fledged “books”?). Since we had only one extended evening to play, the full campaign game was out. That left us with one or two scenarios—but which scenarios?

First pick was obviously the good old 1941 Barbarossa Campaign. As I recalled, the Germans always had great fun with this one. Three Stuka counters, endless encirclements, sweeping Panzer advances and countless beautiful Russian cities waiting to be taken. The only question remaining was where to strike Panzer-terror into the Russian hordes? As for the Russians, the only factor in their game plan was delay, delay, and more delay. Sacrificial units were an essential part of their game plan. More importantly, the Russians had Generals Mud and Winter, crafty Partisans and potent Siberian forces waiting in the wings to save the day. Yep, this scenario has it all. Still, the others warranted our consideration, as well.

All the 1942 scenarios featured a much stronger Russian opponent. The May/June scenario, for example, offers plenty of German offensive possibilities, but the German player would not be able to attack all along the front (every Russophile’s heart bleeds at that, I’m sure). In fact, by virtue of their set-up, the Russians could pretty much determine where the Germans would strike. But despite lacking the Teutonic flair of the Barbarossa scenario, this one did allow both players the chance to fight for Moscow.

By now, our game-clock was running, and a decision had to be made. We decided to play more than one scenario for the evening, and somehow managed to agree on a seldom-played one: 1944, with Berlin as the focus. We rolled off for sides, but as usual, I was the Russians and Paul would be the Germans.

Now, a quick glance at the scenario force mix will show that the Russian enjoys tremendous advantages in this scenario, so in my best diplomatic fashion, I let it be known that the determination of a “winner” for the evening’s gaming would be based on the best of two matches, with the Russian level of victory to be the determinant for the overall winner. In complete modesty, my opponent declared that he would “make a good show of an otherwise bad situation.”

For myself, I just loved the prospect of steam-rolling over the Germans; Paul had always seemed to get the better of me in past contests. I was not about to let that happen this time. Wistful fantasies of *Operation Bagration* danced through my mind—I thought nothing of the evil gleam in Paul’s eye at the time.

Never mind that I could barely recall those aforementioned tactics and strategies for *TRC*. Nevertheless, I felt sufficiently confident to place the bulk of my armor near Smolensk and the mountain area just east/southeast of Lwow. Heck, I even threw a few armies into the swamps just south of Minsk. To deceive my opponent, a sizeable force of three Guards Infantry and two Armor went into hexes W23, X24 and Y23 (just east of the Dnestr River). The plan was to strike for Minsk, Brest and Lwow before moving on to Warsaw and Berlin; everything else was to be bypassed or ignored completely.

Reviewing my dispositions, I could see that a German rout was inevitable. My only concern was to maintain my concentration and not get sloppy. I anticipated no difficulties for Comrade Stalin’s forces.

Well, I was in trouble right off the bat. Rather than fight, Paul withdrew the bulk of his forces to the Neuman River line. In the south, he anchored his front on the Dnestr/Bug River lines. The effect of all this was that it took me two turns to reposition my forces sufficiently to mount anything worthy of the term “assault”. Even more depressing was the fact that it took *another* turn before the bulk of my sloth-like army reached the front line.

Still, I was confident that I could recover. After a turn of massive assaults, the Neuman was crossed. Winter was fast approaching, and I looked forward to my vast replacements capacity to offset the consequences of multiple 2-to-1 and 1-to-1 attacks. As well, I anticipated a glorious Soviet paratroop drop to help break the new German line forming near the Vistula. But, as with any wargame which eventually earns the name of classic, *TRC* had its own surprises in store.

On the January/February Turn, I was ready. The slow but steady German losses were about to increase dramatically; Paul was simply running out of troops. In the south, he opted to leave most of his area open, tempting me to advance. But I had other plans, and quickly releasing the German Balkan Garrison was not among them.

Filled with confidence, I continued. After losing four armies (two of them Guards), Königsberg fell. Soon I would be assaulting Warsaw, and in the works was an all-out assault on every German unit from the Baltic Sea to the Hungarian border. Painstaking planning was called for. All attacks were calculated and re-calculated down to the last factor. Special emphasis was placed on crossing the Vistula River north and south of Warsaw. Hexes J27, K26, M26, N26 and O27 were about to change hands. Cocky, you say? Overweening ambition? Nay, for my ace-in-the-hole was to be my *Desantniki*, the glorious Soviet paratrooper corps! Their landings behind the German lines would eliminate any hope of escape for the Fascist hordes. I rubbed my hands in villainous glee; all was in order.

You know, you really shouldn’t go such a long time without playing these games; *TRC* in particular. Things which are comically obvious when you play once a week (or even once a month) attain a sort of rosy, nostalgic hue with the distance of years. In a way, it’s sort of like learning the game all over again, with the added humiliation of knowing you would never have made the same mistakes if you’d only kept your hand in over the years.

For there, sitting in Moscow and directing the glorious advance of the Red Army—as it had been since the beginning of the game—was my STAVKA unit. You know; the unit from which the paratroopers must trace their range when executing an airdrop (said range being a mere eight hexes). The same unit that moves only once, in the second impulse of a turn, and which cannot use Rail Movement. The unit which would, therefore, be at least three turns getting into position to activate the paratroops, by which time it would be summer and the war (or at least, the game) would be over.

Now, I know none of you have *ever* done this in a game of *TRC*. And true, some gamers would just say: “Oh, sure, go ahead, put that STAVKA unit up where it belongs, old buddy. I know you meant to do that.” But I had too much pride to ask for a break, and anyway, Paul just smiled.

Still, all was not lost! My big attacks could still pull it off. The two most important die-rolls centered on Warsaw’s adjacent hexes. And in all probability, the Germans would be pushed back and suffer casualties all along the front. But since Paul had retreated his forces so far back

(Continued on Page 57)

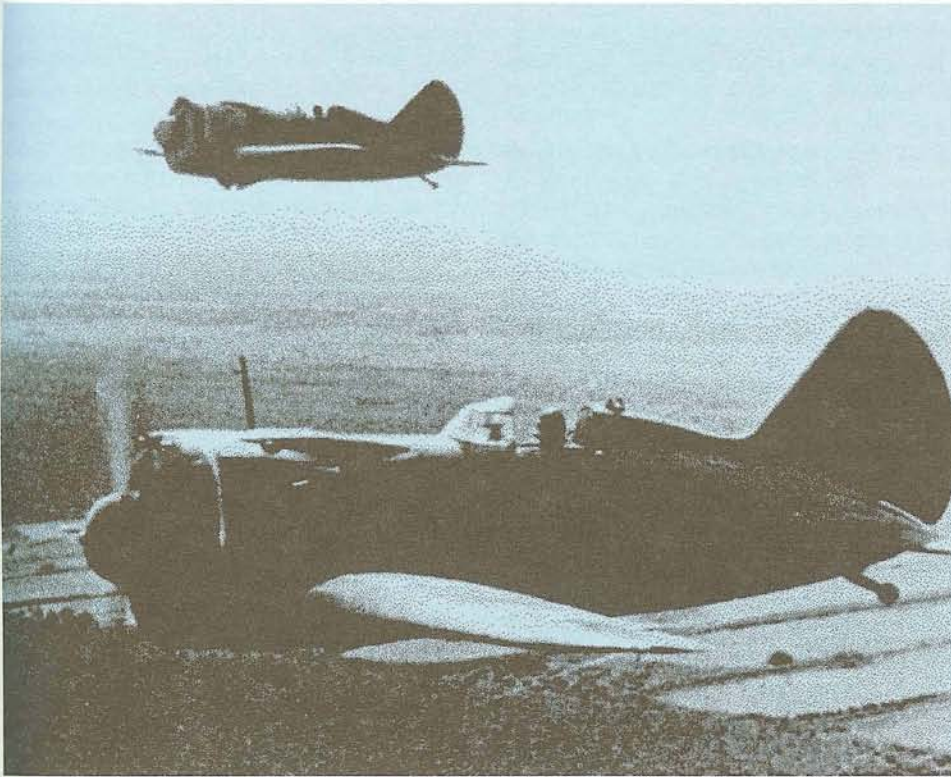

EASTERN SKIES

An AIR FORCE Variant

By Andrew Visegrady

This variant is intended to provide *AIR FORCE* with some "Eastern Front Flavor" by presenting rules for some of the most commonly-used Hungarian aircraft of the second World War. Hungary entered the war on the Axis side in June of 1941, and ended her participation in 1945 as Germany's very last ally.

The Hungarian Royal Honvéd Air Force (*Magyar Királyi Honvéd Légierő*; *Honvéd* has been the name of the Hungarian national defense forces since 1848) — hereafter HRAF — like other service branches of the Hungarian Royal Army, shows a very close organizational relationship to the German and Italian armies of the period. Most of the HRAF's equipment was ordered from German and Italian firms such as Junkers, Heinkel, Fiat and Caproni. But Hungarian governmental resolutions resulted in numerous aeronautical developments by Hungarian scientists and engineers.

The modernization and improvement of the HRAF began in 1938 as part of the "Huba I" Army Organization Development Program. The air force was divided into fighter, bomber and reconnaissance regiments (*ezred*), each of which consisted of two groups (*osztály*). Each group was composed of two squadrons (*század*), having 9 - 12 planes each. (For further information, see the accompanying TO&E of the HRAF at the time of Hungary's entry into the war.)

The role of the HRAF, like that of the Luftwaffe, evolved over the years of the war. From 1941 through 1943, the HRAF's operations were concerned with the Axis' overall offensive momentum, while from 1943 to the end of the war, the HRAF had joined its German counterpart in shifting to a defensive posture. This latter period would probably not be of special interest to players of *AIR FORCE*, since by this point in the war the HRAF was usually equipped with

German Me 109 and Me 210 aircraft serving as fighters or fighter-bombers, and HRAF units equipped with these aircraft participated in combats defending Hungarian central cities against raids by the United States' 15th Air Force.

However, during the offensive period of the war, and especially while taking part in the invasion of the Soviet Union, the HRAF made extensive use of its early war bombers, fighters and reconnaissance aircraft: The Cr-42, Re-2000 *Héja* ("Héja" is the Hungarian name for the goshawk), Ju-86, Ca-135 and He-46, and it is the actions of these aircraft which this variant helps to simulate.

At the beginning of the war (1941 to 1942), part of the HRAF was attached to the Hungarian Mobile Corps (*Gyorshadtest*). In the following year the First Hungarian Air Brigade (consisting of one bomber squadron, one fighter squadron and two reconnaissance squadrons) was attached to the Hungarian 2nd Army. Those aircraft which participated in air combats over Russia were:

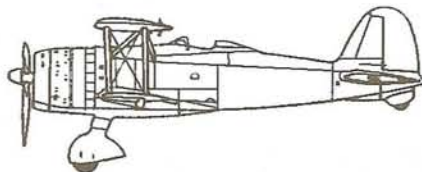

Cr-42. An improved version of the Italian Cr-32, often called the "advanced Cr-32". The Cr-42 was ordered from Fiat in 1938-39, with 18 planes arriving in Hungary in 1938 and a further 50 units arriving in 1939. Compared to the Russian fighters, they were underpowered and slow, so Cr-42's could only face the enemy by forcing the engagement into a turning fight. The two Breda 12.7 mm MG's of these planes were not efficient weapons, and with a low ammunition supply only the best-trained pilots could put them to

effective use. Nevertheless, they were the standard Hungarian Army fighter of the early war years. They were used by the airpower support arm of the Mobile Corps with the 2/III Squadron.

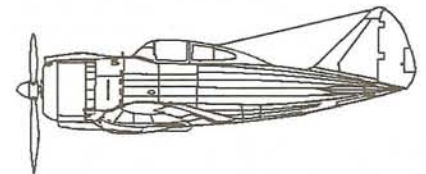

Re-2000 "Héja." The Héja was delivered to the troops in 1941. Only the most experienced pilots were allowed the opportunity to try out the new aircraft, which became the most widely-used fighter of the HRAF. About 60 of these aircraft were used with various other types to bring the total number of first-line fighters to 96. In 1941-43, one squadron (the 1st Squadron of 1st Group) of Héjas entered the war as the fighter arm of the 1st Air Force. (As an historical side note, this is the type of plane which the Hungarian regent's son was flying on 20 August, 1942. While on his final flight before traveling home to Hungary from the Eastern Front, he made a tight turn without applying sufficient acceleration; the plane went into a spin and crashed, claiming his life.) After 1943 Héja's were gradually phased out as Me 109's began taking their place for the air defense of Hungary.



Ju-86. This type arrived in Hungary by the first half of 1938, with 61 planes reserved for military purposes and three for bomber training. They were equipped with the Weiss Manfred-Gnome

Rhone K-14 Kirs engine. In their pre-war prime, these aircraft were the equal of the Do-17, He-111B or the Handley-Page Harrow, but by the time of Operation *Barbarossa* they were outclassed by Soviet fighters. As a result, Ju-86's were escorted by large numbers of fighters. The Ju-86 had almost the same bomb-carrying capacity as the Ca-135, but its speed, dive and climbing abilities were markedly inferior to those of the Caproni. After the battles of the Mobile Corps in western Russia, they were withdrawn from combat and used for transport missions.



Ca-135bis. This type was ordered from the Caproni factory in 1940. A total of 108 planes were ordered in three shipments. Because of events in Italy in 1943, the final shipment due that year never arrived. The HRAF units equipped with the Ca-135bis first used them in raids against Russian towns near the Hungarian border. After that, the Mobile Corps operated a mixed bomber squadron composed of the Ju-86's of the 4/I Squadron and Ca-135's of the 3/II Squadron for ground support missions. The Ca-135's were the most widely used bombers of the HRAF. Their Piaggio XI RC 40 engine required a great deal of care and maintenance, and while the bombers were used in small numbers, their crews were superbly trained. One example of such training can be found in the events of 12 July, 1942, when minor repair and maintenance for all 5 Caproni 135's of the bomber squadron was performed in time to make the squadron available to provide air support for the 7th Light Infantry Division the same day. By the second half of 1943, the Ca-135's were replaced by Ju-88's.

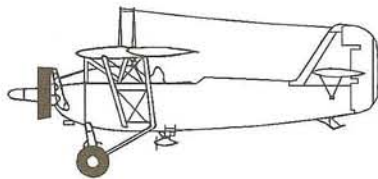

He-46. For ground operations, this was one of the most important plane types in the HRAF, and also performed well in both a short- and long-range reconnaissance role. The He-46 could be used for artillery spotting, reconnaissance and bombing missions. He-46's were also used with the reconnaissance aircraft WM 21 "Sólyom", a Hungarian design manufactured in Budapest by Weiss Manfréd Works. The He-46 was used in Squadrons I through X. Even within the air group of the Mobile Corps, He-46's shot down more enemy planes than the fighters! The He-46 was slow and vulnerable, but as was the case with the Cr-42's, they could beat the enemy when skilled use of their tighter turning radius allowed the pilot a good firing position. Still, after 1943 these aircraft too were withdrawn from front-line duty.

Some other important aircraft types used by the HRAF were the Cr-32, He-111P, Ju-88A, Ju-87B, Me-109G, Me-110, Me-210 Ca, WM-21 and He-70K.

Eastern Front scenarios require Soviet aircraft for opponents. Provided with this article are specifications for the Polikarpov I-16 "Rata". The Rata was developed in the early 1930's and saw duty with the Republican forces during the Spanish Civil War (where it earned its nickname; literally, "Rat", a term of wary respect bestowed by enemy pilots frequently surprised by its performance). Despite its infamous ungainly appearance, this aircraft was quite effective against the He 51, but with the appearance of the Me-109 it was totally outclassed and almost literally wiped from the skies.

In the early period of the air war in the East, Ratas were committed to battle in great numbers in attempts to hold back the Axis air forces, but inasmuch as they were flown by inexperienced pilots, the Russian losses were correspondingly very great.

The Rata had much heavier weaponry (typically, two 7.62mm machine guns and two 20mm cannons) and a higher speed than its Hungarian

counterparts, but the HRAF planes' advantage lay in their greater maneuverability and superior turning abilities, coupled with a higher training level of pilots and a commensurate ability to exploit these advantages. In addition, the Rata's cockpit was not well protected, and once a favorable firing position could be achieved against it, the pilot was extremely vulnerable.

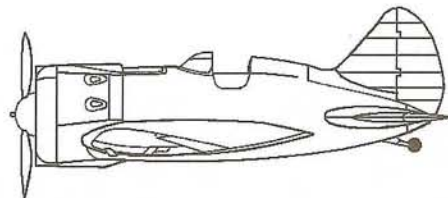

After the 1942-43 period, the Red Air Force' Ratas were replaced by more modern types of aircraft, such as the MiG-3, LaGG-3 and La-5.

On the following pages, the reader will find scenarios for this variant as well as Data Cards for the planes presented herein. For ease of use, these are presented in formats identical to those found in the *AIR FORCE/DAUNTLESS* games.

HUNGARIAN ROYAL HONVÉD AIR FORCE IN 1940

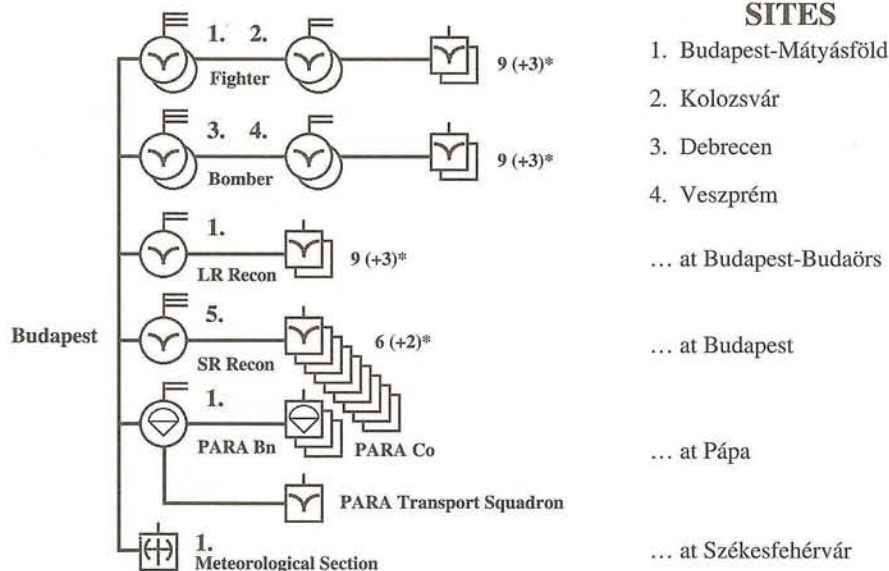

* The first figure indicates the number of aircraft in a squadron; the second figure in parentheses indicates the number of additional aircraft after mobilization.

LEGEND (AND CONVENTIONAL SYMBOLS IN 1940)

Air force HQ/Army Légierő pks.†	Flight Repülőraj	Airfield Warden Repülőtér gondnokság	Lorried Radio Co
Air Division HQ Repülőhadosztály pks.†	Meteorological Section	Air Photographic and Analysis Group	Air Transport Group
Air Brigade HQ Repülődandár-pks.†	Airplane Services Javitóműhely	Air Shed	Sapper Co
Air Regiment HQ Repülőezred pks.†	Air Signal Co. Híradó század	Air Fuel Depot	Heavy MG Co
Group HQ Repülőosztály pks.†	Parachute Co. Ejtőernyős század	Lorried Signal Bn HQ	Airfield Construction Co
Squadron Repülőszázad	Parachute Bn HQ Ejtőernyős zászlóalj pks.†	Lorried Signal Co	† pks = parancsnokság

EASTERN FRONT SCENARIOS FOR AIR FORCE

SCENARIO NR. EF-1: RECONNAISSANCE MISSION OVER KOROTAIK

On 17 August, 1942 Lt. Török József and Sgt. Szoó Lajos aboard an He-46 were on a reconnaissance mission when they and their escort ran into trouble over the Korotaiak bridgehead. After one Rata was shot down, the second broke off and escaped. Nevertheless, Lt. Török could register another kill.

1. Set-Up and Entry

Hungarian Forces: One He-46 at 10,000 feet, Speed 4, Level Bank. Two Re-2000 "Héja" at 12,000 feet, Speed 5, Level Bank. Hungarian forces enter on Turn 1 from board edge 1/2.

Soviet Forces: Two I-16 "Rata" at 9,000 feet, Speed 6, Level Bank. Soviet forces enter on Turn 1 from board edge 5/6.

2. Special Rules

Three target hexes on board(s) 1/2 and/or 3/4, at least 8 hexes apart from each other and four hexes from any board edge must be designated "target hexes". These hexes contain the targets for the Hungarian player to reconnoiter with the He-46. The aircraft pilots have the following characteristics: Héja #1: TE (Aver); #2 TR EV (Aver); Rata #1: None (Novice); #2 None (Aver).

3. Victory Conditions

The Hungarian player must reconnoiter two of his targets with the He-46 and exit from the same board edge which it entered. To reconnoiter a given target hex, the He-46 must pass over that hex in a Level Bank. The Soviet player wins by shooting down the He-46 or if the He-46 cannot fulfill its own victory conditions as stipulated above.

SCENARIO NR. EF-2: HOMEWARD BOUND

On 11 August, 1941, while returning from a bombing mission over the Bug River, a lone Ca-135 was attacked by Soviet fighters. After losing two aircraft, the remaining fighters achieved a good firing position against the bomber, but at the last moment Sgt. Szónyi arrived and drove away the Russian fighters.

1. Set-Up and Entry

Hungarian Forces: One Ca-135 enters board edge 1/2 at 6,000 feet, Speed 5, Level Bank with 1 F and 1 W hits damage; One Cr-42 enters board edge 5/6 on the 3rd Turn at 6,000 feet, Speed 5, Level Bank.

Soviet Forces: Three I-16 "Rata" enter board edge 1/2 on the 2nd Turn at 8,000 feet, Speed 6, Level Bank.

2. Special Rules:

Two of the Rata have the following pilot characteristics: None (Novice); the third Rata has: None (Average). The Cr-42's pilot characteristics are: ETR, +1 on BHT (Ace).

3. Victory Conditions

The Hungarian player wins by exiting the bomber off board edge 5/6,

or by shooting down two Rata. The Russian player wins by shooting down the bomber without losing more than one of his planes.

SCENARIO NR. EF-3: FLYING IN THE LATORICA VALLEY

On 29 June, 1941, a mixed force of Ca-135's and Ju-86's began their bombing run against Russian positions in the town of Stri. The Capronis were capable of reaching the target more rapidly, but maintained formation with the slower Ju-86's. The entire bomber force was thus caught by alerted Russian defensive fighters, and had to fight their way in to the objective.

1. Set-Up

Hungarian forces: Six Ju-86 (Loaded) enter board edge 1/2 on Turn 1 at 9,000 feet, Speed 4, Level Bank; three Cr-42 enter board edge 1/2 at 12,000 feet, Speed 5, Level Bank. Russian forces: Four I-16 Rata begin anywhere on board 5/6 at 15,000 feet, Speed 6, Level Bank.

2. Special Rules

The Hungarian Cr-42 pilots have the following characteristics: #1: T (Average); #2: TRE (Average); #3: TREW, +1 on BHT (Ace). All Ju-86 pilots are T (Average). The Russian pilot characteristics are as follows: Rata's #1 and #2: None (Novice); #3: None (Average); #4: ER (Average).

3. Victory Conditions

The Hungarian player wins by exiting board edge 5/6 with at least four loaded bombers, or by shooting down three Ratas. The Russian player wins by preventing the Hungarian victory conditions.

SCENARIO NR. EF-4: DOGFIGHT OVER NIKOLAIEV

On 11 August, 1941, planes of the 1/3 fighter squadron met nine I-16 Rata's over Nikolaiev. In a short and bloody engagement, the Cr-42's shot down five of the Ratas without losing any of their own aircraft.

1. Set-Up

Hungarian forces: Six Cr-42's enter board edge 1/2 on Turn 1 between 6,000 and 10,000 feet at Speed 5, Level Bank.

Russian forces: Nine I-16's start anywhere on board 5/6 at 8,000 feet, Speed 6, Level Bank.

2. Special Rules

The Hungarian pilot characteristics are as follows: #1: None (Average); #2 and #3: T (Average); #4: TE (Average); #5: TEW (Average); #6: TER, +1 on BHT (Ace). The Russian pilot characteristics are as follows: Ratas 1, 2 and 3: None (Novice); Ratas 4 and 5: None (Aver); Ratas 6 and 7: E (Aver); Rata 8: EV (Aver); Rata 9: ERW, +1 BHT (Ace).

3. Game Length and Victory Conditions

The game lasts 30 Turns. At the end of that time (or when all of one side's planes have been eliminated), the player with the most victory points wins.

AFTERWORD

One of Hungary's top Aces was Sgt. Szónyi Márton, mentioned in Scenario EF-2. Sgt. Szónyi was a pilot with the 1/3 Fighter Squadron during 1941. This unit was sent into action no less than 447 times, logging over 800 flight hours, and achieved a total of 17 kills.

Another prominent name is that of Lt. Török, assigned to the reconnaissance squadron of the 2nd Hungarian Army. This unit was withdrawn in October 1942 after shooting down 3 Russian aircraft (Lt. Török was credited with two of these, both kills achieved during a turning fight); the unit lost only one He-46.

After the war, the strength of the Hungarian army was limited by the Allied Controlling Committee. The number of aircraft and active duty personnel was limited to 70 and 5,000, respectively. In 1947, the new OB was heavily influenced by Soviet doctrine, and the equipment became exclusively Russian in manufacture. Many wartime aircraft saw new life in the Hungarian air forces, including such planes as the Yak 9P, IL-10 and Po-2. In due course, these aircraft were succeeded by the MiG-15, IL-18, MiG-19, MiG-21 and MiG-23. In the last few years, the Hungarian air force (smallest in the Warsaw Pact) began changing its performance profile by varying its arsenal.

But that subject is best represented in another Avalon Hill title, *FLIGHT LEADER*.



SO THAT'S WHAT YOU'VE BEEN PLAYING

(Volume 28, Number 3)

Titles Listed: 114

Total Responses: 348

Rank & Title	Pub	Rank Times		
		Last On List	Time	Freq. Ratio
1. Advanced SL	AH	1	35	5.3
2. Up Front	AH	2	22	4.3
3. Russian Campaign	AH	13	8	2.3
4. Diplomacy	AH	6	36	2.7
5. Stonewall Jackson's Way	AH	—	1	2.6
6. Adv. Third Reich	AH	15	2	2.4
7. Blackbeard	AH	3	2	2.3
8. Panzer Leader	AH	19	2	2.3
9. Gettysburg '88	AH	—	1	2.1
10. Legends of Robin Hood	AH	—	1	2.0
11. Republic of Rome	AH	—	1	2.0
12. Peloponnesian War	VG	12	2	2.0
13. Third Reich	AH	5	15	1.9
14. Turning Point: Stalingrad	AH	—	1	1.7
15. Bulge '91*	AH	—	1	1.7
16. Napoleon's Battles	AH	—	1	1.6
17. Acquire	AH	—	1	1.4
18. Civilization	AH	18	8	1.3
19. Attack Sub	AH	—	1	1.1
20. Midway '92	AH	—	1	1.0

Another good mix of new titles (*STONEWALL JACKSON'S WAY*, *MIDWAY '92*) and old favorites (*PL*, *DIP* and so forth), as well as both *THIRD REICHS*. Ancients games are also well represented (*ROR* and *PELOP. WAR*), reflecting the current popularity of the subject matter. *ASL* and *UP FRONT* both look to be pretty much entrenched for the duration. Since 28-1's upset, the amount of ballots pouring in for both titles even suggests a voting rivalry of sorts developing between devotees of each game. We'll see...

*Sorry! Last issue's listing of *BULGE '91* should have been for *BULGE '81*; the current listing is correct, however.

Extend Your Enjoyment of AIR FORCE

Play DAUNTLESS

the AIR FORCE
Expansion Module
\$25 Retail



DAUNTLESS is a gamette which adds ships, 30 new aircraft types, dive bombing, and carrier takeoffs and landings to the existing **AIR FORCE** game system. All the **AIR FORCE** components are interchangeable, and in fact necessary for play of **DAUNTLESS**.

DAUNTLESS allows you to re-create representative historical air battles from any period of the Pacific War. New Mission types include anti-torpedo plane patrol, various reconnaissance missions, carrier strikes, island attacks, and anti-sub missions.

Aircraft Represented:

Lockheed P-38L "Lightning" Fighter
 Lockheed P-38G "Lightning" Fighter
 Douglas TBD "Devastator" Carrier Torpedo Bomber
 Mitsubishi G4M2a-22a "Betty" Medium Day Bomber
 Kawanishi H8K2-12 "Emily" Heavy Flying Boat
 Nakajima Ki. 44-IIb "Tojo" Fighter
 Martin B-26B (Short Wing) "Marauder IA" Medium Day Bomber
 Grumman TBF-1C "Avenger" Carrier Torpedo Bomber
 Grumman F4F-4 "Wildcat" Carrier Fighter
 Nakajima Ki-84-Ia "Frank" Fighter
 Northrop P-61A and B "Black Widow" night Fighter
 Douglas SBD-5 "Dauntless" Carrier Dive Bomber
 Chance Vought F4U-1A "Corsair" Carrier Fighter
 Brewster F2A-3 "Buffalo" Carrier Fighter
 Aichi D3A-1-11 "Val" Carrier Dive Bomber

Even more than the European conflict, the Pacific War was a contest of Industrial power—Boeing against Kawasaki, Lockheed versus Mitsubishi, and Grumman against Nakajima—clashing over cheap raw materials, labor and markets, of the so-called South-east Asia Co-Prosperity Sphere. And more than any other factor, industrial technology decided the outcome.

DAUNTLESS reveals the industrial nature of the war, as it is virtually a contest of machinery—the best that either system was capable of producing. And there are undoubtedly some first-class machines among them . . .

Nakajima Ki.43-Ic "Oscar" Fighter
 North American B-25C-1 "Mitchell" Medium Day Bomber
 Grumman F6F-3 "Hellcat" Carrier Fighter
 Mitsubishi A6M2-21 "Zero" Carrier Fighter
 Curtiss P-40N "Warhawk" Fighter
 Curtiss SB2C-1c "Helldiver" Carrier Dive Bomber
 Douglas A-20G "Havoc" Light Day Bomber
 Nakajima B5N2-23 "Kate" Carrier Torpedo Bomber
 Boeing B-29A-BN "Superfortress" Very Heavy Day Bomber
 Kawanishi NIKI-Jb-11b "George" Day Fighter
 Bell P-39D "Airacobra I" Fighter
 Kawasaki Ki.61-Ib "Tony" Fighter
 Curtiss P-40C "Tomahawk" Fighter
 Mitsubishi A6M5b-52b "Zero" Carrier Fighter
 Kawasaki Ki.45-KA1a "Nick" Day/Night Fighter Bomber

This gamette includes:

Four-color Data Cards

for 30 different aircraft types

365 Playing Pieces

representing aircraft and targets

Pad of "Log" Sheets

for plotting all maneuvers

20-page Rules Folder

with Scenarios and Historical Notes

Complexity Rating: 7 on a scale of 1 (easy) to 10 (hard)

Does not include all components necessary for play; **DAUNTLESS** is a gamette expanding on the new **AIR FORCE** game system.

Ownership of AIR FORCE is necessary to play this game.

Available NOW at your favorite game store. If not available locally, you may order direct from us. Enclose a check or money order for \$25 plus postage (USA add 10%, Canada, Mexico add 20%, foreign add 30%). We also accept American Express, VISA and MasterCard.



The Avalon Hill Game Company

DIVISION OF MONARCH AVALON, INC.

4517 Harford Road ★ Baltimore, MD 21214

For Quick Credit Card Purchasing
call **TOLL FREE 1-800-999-3222**

CR-42

Fiat CR-42 Day Fighter (Double Winged)
 PV: 13 Engine Type: R Producer: Italy
 First used: 1939
 Loaded: could carry one bomb

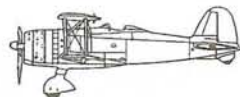

Stall Speed	Dark Purple
Maneuver Sp	Light Purple
Level Speed	Yellow
Dive speed	Red
Loaded (Opt.)	-1

Speed Change

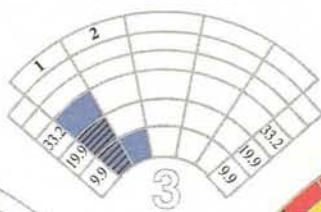

Power Brakes	Diagonal Hatching
Brake Factors	Blue

Half Loop	White
Slip	Diagonal Hatching
Turn	Blue
Bank	Blue

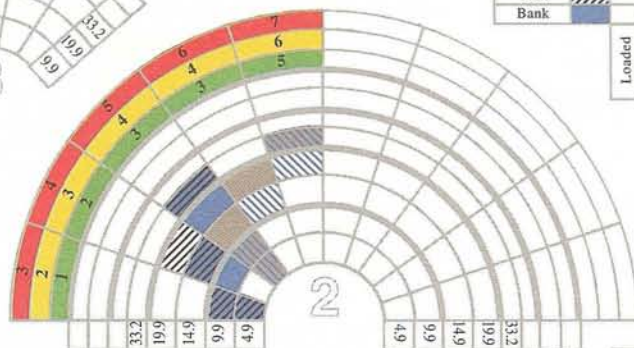

Speed Increments

Altitude Change

Maneuverability Requirements

Blind Spot Modifiers

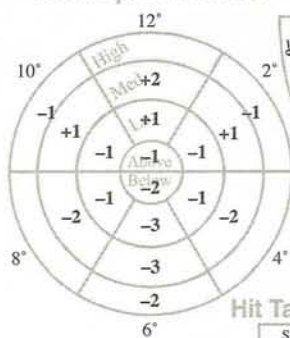

Hit Table Modifiers

Silhouette	+8
Fire	+2

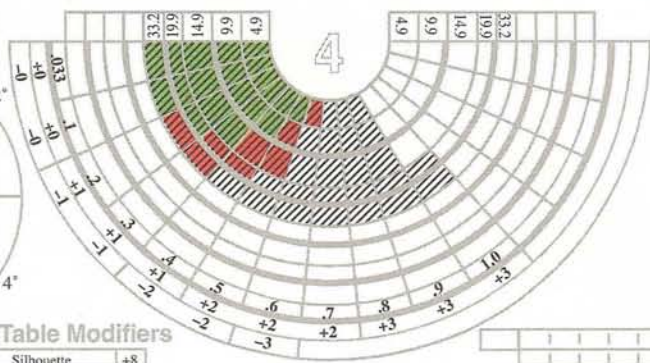

Dive Accel.	+1
Climb Deceler.	-1
Max Dive	-1
Dive Sp. Climb	Red
Max Climb	Green

Target Characteristics

W	5	Cn	-	Mg	5
F	4	L	2		
C	2	C	-		
E	3	E	-	E	-
G	2M			2M	
	(S)			(B)	
	FF			FF	

Variants

Héja

Reggiane Re-2000 Falco 1. "Héja" Day Fighter
 PV: 14 Engine Type: R Producer: Italy/Hungary
 First used: 1941
 Loaded: could carry one bomb



Stall Speed	Dark Purple
Maneuver Sp	Light Purple
Level Speed	Yellow
Dive speed	Red
Loaded (Opt.)	-1

Speed Change

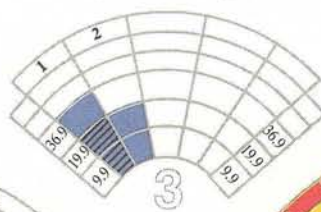

Power Brakes	Diagonal Hatching
Brake Factors	Blue

Half Loop	P
Half Roll	P
Turn or Slip	+2
Bank	+1

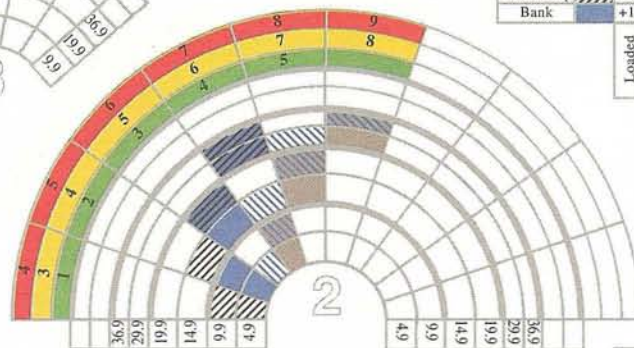

Speed Increments

Altitude Change

Maneuverability Requirements

Blind Spot Modifiers

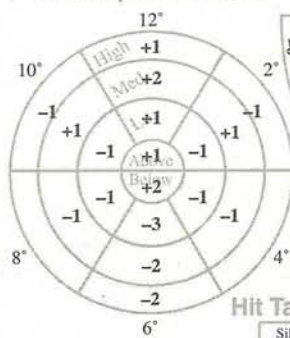

Hit Table Modifiers

Silhouette	+1
Fire	+1

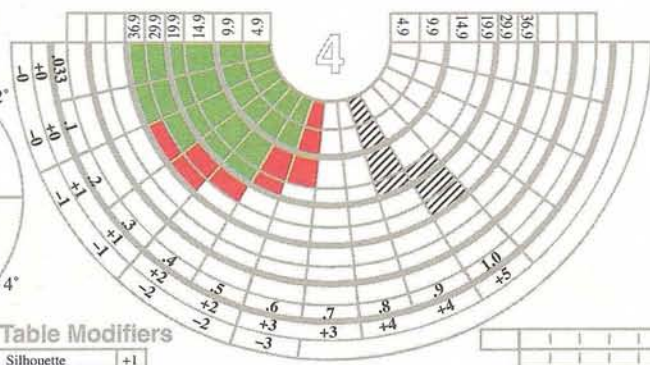

Dive Accel.	+1
Climb Deceler.	-1
Max Dive	-2
Dive Sp. Climb	-1
Max Climb	-1

Target Characteristics

W	5	Cn	-	Mg	5
F	4	L	2		
C	3	C	-		
E	3	E	-	E	-
G	2M			2M	
	(S)			(S)	
	FF			FF	

Variants

Fall 1862: The Confederates Invade...

Here Come the Rebels!

When it is over, 23,000 Americans will lie dead and wounded in the Maryland countryside near a town called Sharpsburg.

- Volume II in AH's new series!
- Interactive system of play
- Extensive historical overview
- Portrays the entire campaign

Eight rich scenarios include South Mountain, the Baltimore Raid, Harpers Ferry and the Battle for Washington, each of which transport the players back in time to 1862 on the Maryland-Virginia line. The two beautifully painted maps represent the campaign area in accurate detail, exactly as it was 130 years ago. **HERE COME THE REBELS!** is sure to appeal to all those with an interest in this dynamic period in American History. The first volume in this series, **STONEWALL JACKSON'S WAY**, simulates the Second Bull Run campaign and can be joined with **HERE COME THE REBELS!** to re-create the entire Confederate Eastern Offensive of 1862!

No.	Title	Players	Ages	Suggested Retail
892	Here Come the Rebels	1,2 or Teams	10 & Up	\$30.00



The Avalon Hill Game Company

DIVISION OF MONARCH AVALON, INC.

4517 Harford Road • Baltimore, MD 21214 • 410-254-9200 • FAX 410-254-0991

To order, call TOLL FREE 1-800-999-3222



Ju-86

Junkers Ju-86K-2 Medium Day Bomber
 PV: 17 Engine Type: R Producer: Third Reich
 First used: 1936
 Loaded: can carry 2000 lbs of bombs
 (4 bombs at low level) Has sights for use as a level bomber

Stall Speed	Green
Maneuver Sp	Yellow
Level Speed	Red
Dive speed	Blue
Loaded (Opt.)	-1

Speed Change



Power Brakes	Blue
Brake Factors	Diagonal lines

Slip	Diagonal lines	+2
Turn	Blue	+1
Bank	Blue	+2
Loaded		

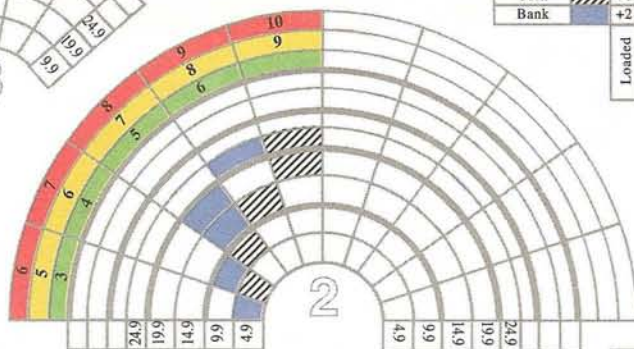
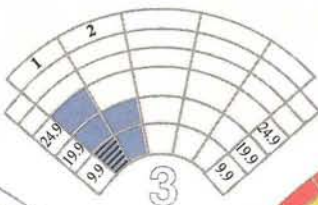

Speed Increments

Altitude Change

Maneuverability Requirements

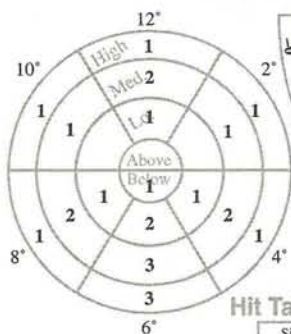

Hit Table Modifiers

Silhouette	+5
Fire	0

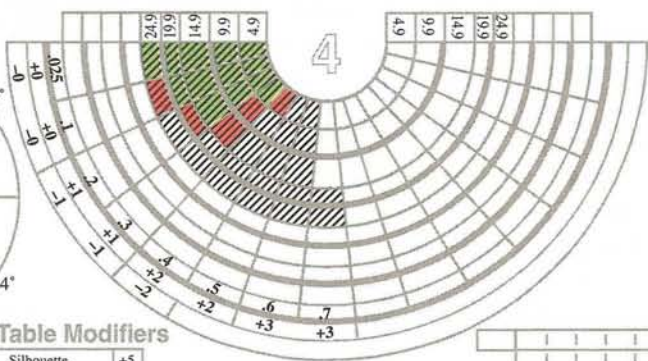

Target Characteristics

W	7	5	Cn	-	Mg
F	7	5	L	3	
C	2		C	2	
E	3	E	-	E	3
G					
			(5)		
			F		

Variants

Ca-135

Caproni Ca-135bis Medium Day Bomber
 PV: 19 Engine Type: I Producer: Italy
 First used: 1941
 Loaded: can carry 2500 pounds of bombs
 (4 bombs at low level) Has sights for use as a level bomber

Stall Speed	Green
Maneuver Sp	Yellow
Level Speed	Red
Dive speed	Blue
Loaded (Opt.)	-1

Speed Change



Power Brakes	Blue
Brake Factors	Diagonal lines

Slip	Diagonal lines	+1
Turn	Blue	+2
Bank	Blue	+1
Loaded		

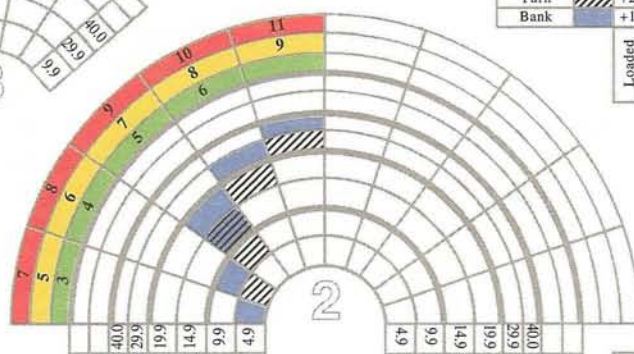
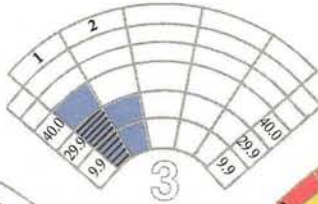

Speed Increments

Altitude Change

Maneuverability Requirements

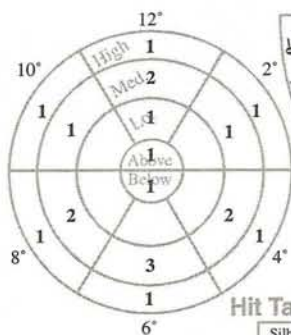

Hit Table Modifiers

Silhouette	+5
Fire	0

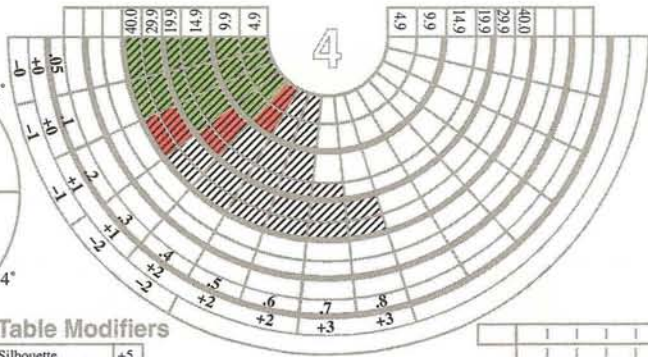

Target Characteristics

W	8	5	Cn	-	Mg
F	7	5	L	3	
C	2		C	2	
E	3	E	-	E	3
G					
			(5)		
			F		

Variants

The French and ASL!

Croix de Guerre

ASL
MODULE 10

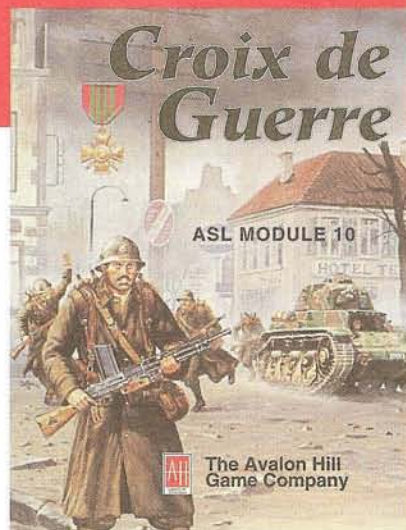

French Extension to the Advanced Squad Leader Game System

May 13th, 1940...In the chill of the Arctic spring, a French Foreign Legion battalion prepares a hasty assault on a supply depot north of Narvik. Currently in German hands, the depot holds small arms desperately needed by the Norwegians fighting in the mountains. In the face of Wehrmacht machine guns, audacity—and two Hotchkiss tanks—will be key to the legionnaires' success.

May 18th, 1940...The French 9th Army is disintegrating rapidly. Its headquarters, just setting up in the village of Le Catelet, is not sure how far the enemy has advanced. Suddenly the alarm is raised—Germans approaching from the north! Armored cars quickly take up positions to fight a holding action, while the small HQ staff and local garrison hurriedly make what defensive preparations they can. Their day promises to be desperate.

June 20th, 1941...Elements of the Free French Division must take the rugged, boulder-strewn stronghold of Hill 740, the last Vichy position covering the road to Damascus. Tanks, guns and men stand ready amidst the wadis and broken ground, but no one is enthusiastic about having to fight his erstwhile brothers-in-arms. Regardless of which side prevails, it is bound to be another sad day for France.

November 8th, 1942...The Americans have landed in Morocco, but in their ranks confusion reigns. Some mistakenly advance in the wrong direction, and in a small village find themselves subjected to a steadily escalating attack made by Vichy infantry with tank and artillery support. The green GIs know they're in the "big leagues" now—and, whether they like it or not, it's time to play ball.

Here, at last, is the long-awaited French addition to the ASL system. *CROIX DE GUERRE* offers greatly expanded coverage of the French, in terms of both counter types and historical research. Containing not only the entire ASL order of battle (all personnel, weapon and vehicle counters) for the French in 1939-40, but also that of the subsequent Vichy regime's overseas colonies, plus many extra counters for equipment used by the Free French but never included in *YANKS* or *WEST OF ALAMEIN*. Enclosed as well are two new mapboards (#s 40 and 41), one new sheet of building, stream and open-ground overlays, eight revised rulebook pages for Chapters A, B and F, eight new scenarios, and the usual detailed Chapter H historical and Design-Your-Own information (including many facts never before published in the English language). Last but not least you'll find the Chapter N divider, which contains both an updated Sequence of Play (incorporating Chapters E, F, G and O) and a standardized "check list" of pre-game functions for printed and DYO scenarios.



THE GAME OF WWII TACTICAL COMBAT

CROIX DE GUERRE (#8234) is not a complete game. Ownership of ASL, BEYOND VALOR, YANKS and WEST OF ALAMEIN is required.

CONTENTS:

- 2 8" x 22" mounted Mapboards
- 350 1/2" Counters laminated on both sides
- 288 5/8" Counters laminated on both sides
- 8 ASL Scenarios
- 8 Revised rulebook pages
- 1 Chapter N Divider
- 1 Sheet of terrain overlays

TIME SCALE: Two minutes per Game Turn

MAP SCALE: 40 meters per hex

PLAYERS: Two (also suitable for solitaire and team play)

UNIT SCALE: Five to ten men with individual leaders, guns and vehicles

PLAYING TIME: Variable based on scenario played; four-hour average



Suggested retail is \$35.00 at better hobby, game, book and comic shops everywhere. If not available locally, feel free to contact Avalon Hill direct at 1-800-999-9200 for ordering information.



The Avalon Hill Game Company

DIVISION OF MONARCH AVALON, INC.
4517 Harford Road, Baltimore, MD21214

He-46

Heinkel He-46E Reconnaissance/Light Day Bomber
 PV: 15 Engine Type: R Producer: Third Reich
 First used: 1941
 Loaded: can carry 500 pounds of bombs
 (2 bombs at low level)
 Has sights for use as a level bomber

Stall Speed	■
Maneuver Sp	■
Level Speed	■
Dive speed	■
Loaded (Opt.) -1	■

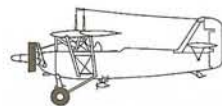

Power Brakes	■
Brake Factors	■

Slip	■	+2
Turn	■	+1
Bank	■	+2
Loaded	■	

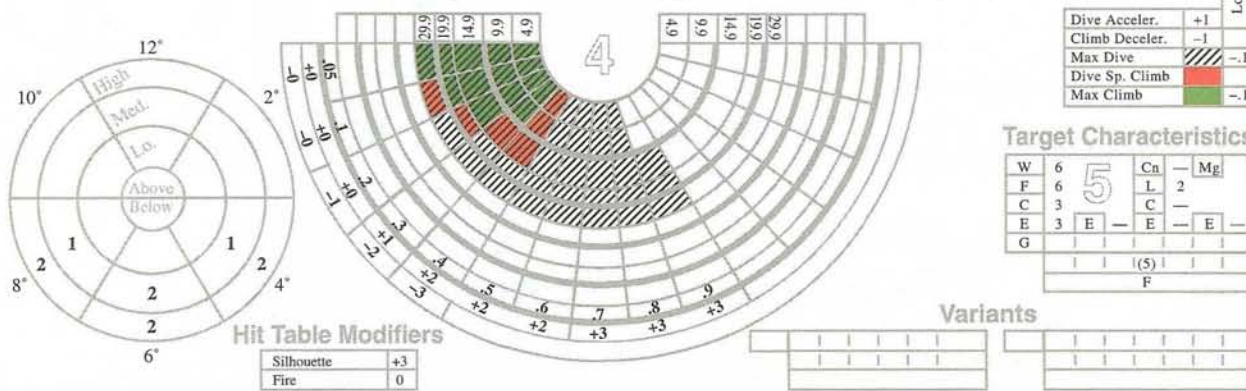
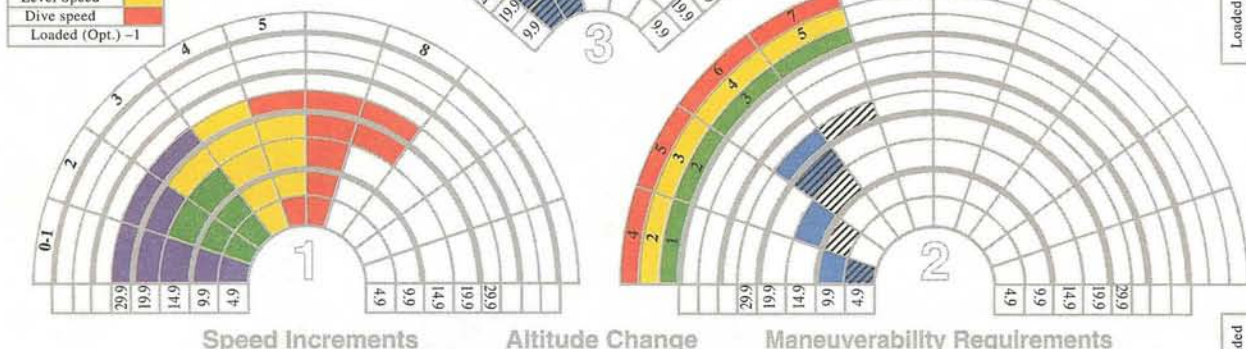

I-16

Polikarpov I-16 "Rata" Day Fighter
 PV: 14 Engine Type: 1 Producer: Soviet Union
 First used: 1936 6,555 of all types built
 Loaded: Could carry one bomb

Stall Speed	■
Maneuver Sp	■
Level Speed	■
Dive speed	■
Loaded (Opt.) -1	■

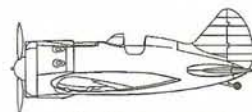

Power Brakes	■
Brake Factors	■

Slip	■	
Turn	■	
Bank	■	
Loaded	■	

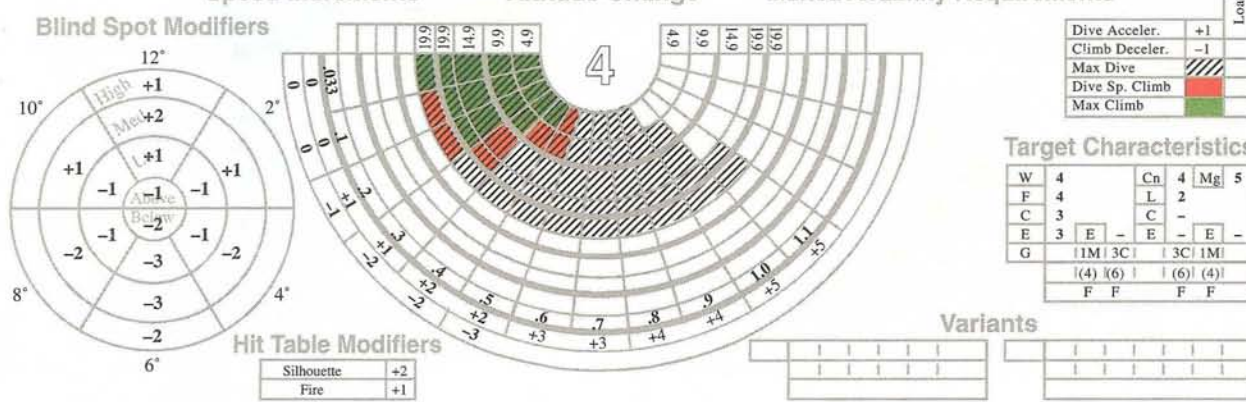
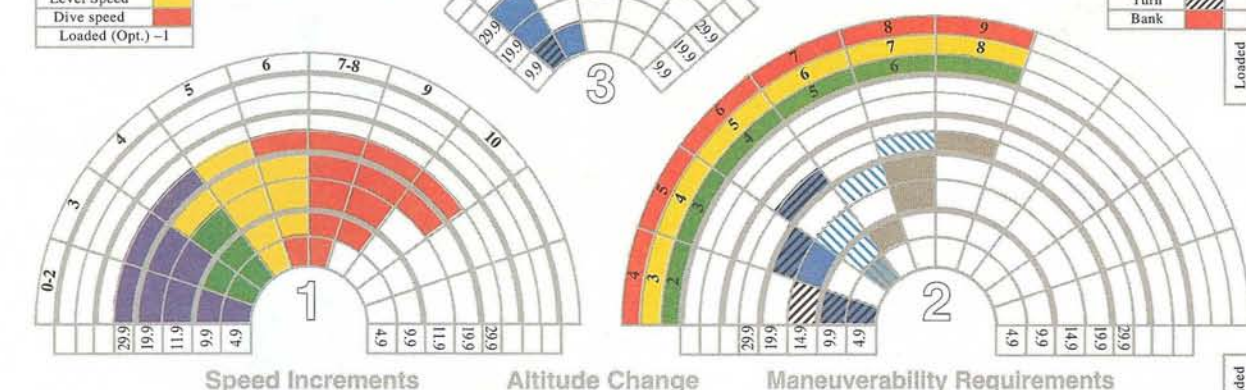

Armored Warfare on the Nation's Highways

It's a wild game of cross-country demolition racing!

ROAD KILL

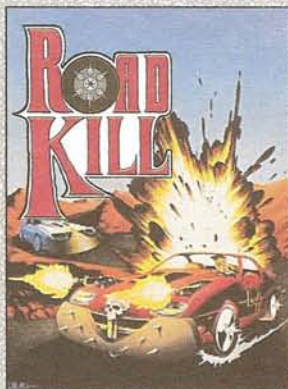

In a table-top recreation of the cult film, *Deathrace 2000*, Roadkill offers 2 to 6 players the opportunity to do what they've always fantasized doing to road hogs.

Each player maneuvers an armored car. To win, players must exercise violent tactics, such as machine gun attacks, laying of smoke screens, using grenade launchers, sideswiping with razor-sharp scythe hubcaps, all the dirty tricks familiar to those who drive the Los Angeles Freeway. Terrain and weather conditions conspire to return a breakaway leader to the pack so that nearly every race is a photo-finish.

The game includes rules variations that allow players to custom build their own cars with such non-standard features as 20mm cannon and nuclear powered engines.

CONTENTS:

One set of Control Panels
Set of 128 Action Cards
One set of die-cut Autos
One Rules Folder

ROADKILL #6440

PLAYERS: Two to six
(Ages ten and up)

COMPLEXITY: Easy/Medium

SUGGESTED RETAIL: \$24.95

(wholesalers note: comes in 6-game master pack weighing 2 lbs.)



The Avalon Hill Game Company

DIVISION OF MONARCH AVALON, INC.

4517 Harford Road ★ Baltimore, MD 21214

410-254-9200 ★ Fax: 410-254-0991

To order call toll free 1-800-999-3222

A FOND FRIENDSHIP RENEWED;*(Continued from Page 46)*

early in the game, his stacks were formidable. In addition, the release of the Warsaw garrison gave the Germans defending stacks with a twelve-combat-point average. Nevertheless, I clenched my jaw and rolled the die.

By the end of the first impulse, the law of averages had turned against me. The die gave me nothing but ones and twos, and I got nowhere fast. Worse still, the Russian spearheads were forced to attack Warsaw at poor odds in the second impulse, and suffered mightily for it. At the end of the turn, Warsaw had not been liberated and German casualties amounted to a single 4-4 infantry unit. For the Russians, Berlin seemed very far away.

Paul took mercy on me and offered to end it right there, but I of course had too much pride, remember? And so, refusing to quit, I fought on for another turn-and-a-half despite continuing humiliation. Besides, Paul had earned the right to see his defense through to victory. I was so desperate I even made 1-to-2 and 1-to-3 attacks into the Hungarian mountains; predictably, this forlorn tactic led to disaster, and at the end of the March/April turn, I resigned. Paul, ever the diplomat, graciously pointed out my errors and strategic blunders and offered his suggestions as to how they might be rectified. Like I could really use the help now, right?

Anyway—mercifully—we didn't play the rematch, but played something else for the remainder of the evening, as I chafed at the memory of such a rout—and at the hands of an inferior opponent! Even though I managed to win a few bouts of an ancients wargame later in the evening, my mind remained with *TRC*. I had to find a way to do better.

And so, for the past few weeks, *THE RUSSIAN CAMPAIGN* has occupied a lot of my free time. Forgotten strategies have been reawakened, overlooked tactics have been tested, and buried rules have been reviewed. While writing this account of my reintroduction to this classic, I have often stopped to move Panzers and Guards about the mapboard. It is November/December 1943, and a vast armor duel has just ended in stalemate to the east of Rostov. And as I continue to play, my thoughts center on a re-match with my buddy Paul. After all the time apart, this fast-moving, easily-learned, always entertaining game of the eastern front has gotten me hooked just as surely as it did the first time I played it.

Welcome back, old friend.

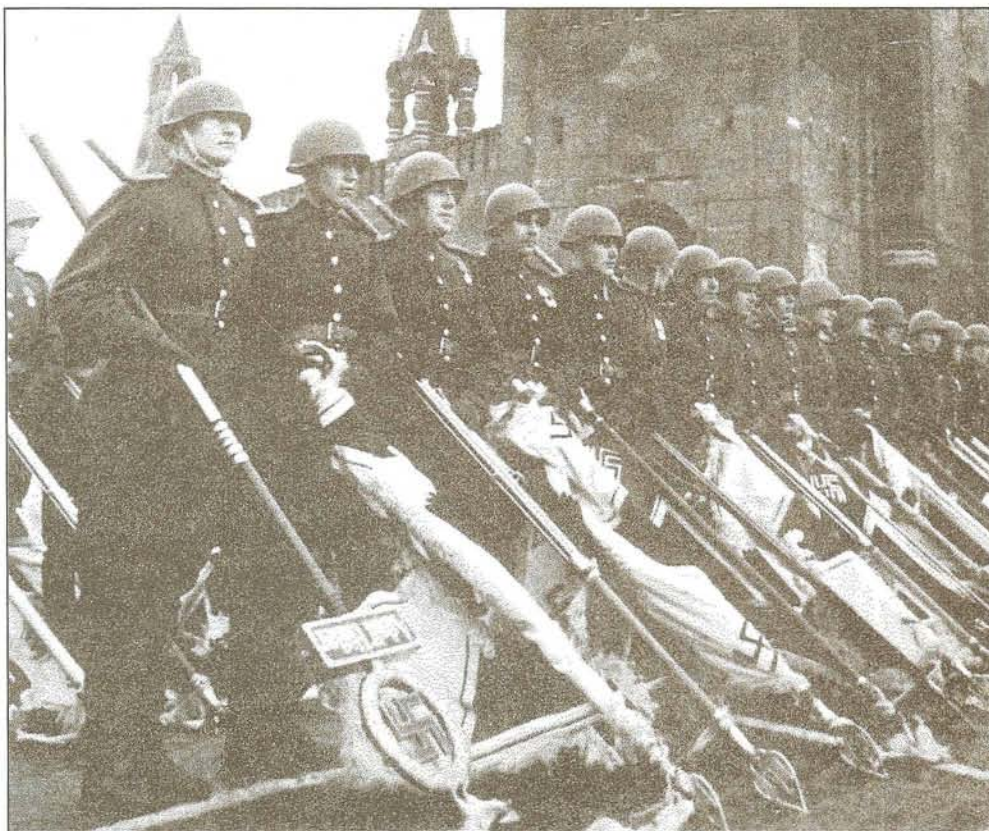
**THE BLACK SEA WALTZ***(Continued from Page 34)*

The eventual Russian costs were heavy, however, because of this invasion... even though the worker at Stalino was not eliminated, and no Russian units were lost in the counterattack.

Since the rail line to Sevastopol was blocked, the Russian had to use sea movement to attempt to get a 6-3 unit to that vital port, but it was sunk *en route*. Axis forces then easily captured Sevastopol, overwhelming the single armored corps defending it during the ensuing September/October turn. The Hungarians proceeded to garrison Dnepropetrovsk, preventing the Russians from creating a secure defensive position in the south, and Stalino itself fell to the Axis in November/December 1941 (with help from the weather). The successful invasion had led to the direct loss of at least one valuable enemy unit and indirect losses of several others, and to a relatively speedy Axis advance in the Ukraine. Though in fact, their loss would not have been critical, in this particular case, the Hungarians even survived to the spring! Thus, careful utilization of sea movement capabilities in this situation probably gave the Axis player at least one extra turn in the game to attempt to win the war outright.

It certainly gives a wise *RUSSIAN CAMPAIGN* player something to think about. Hopefully, this short investigation will have helped to make the reader that wise player.

**THE AVALON HILL PHILOSOPHY***(Continued from Page 4)*

This issue of *The GENERAL*, featuring some of the games in Avalon Hill's line which deal with that struggle, is dedicated to the more than 20 million Soviet citizens and soldiers who fought and died on the Eastern Front for four bloody years, half a century ago.

We should take a moment when we read of that conflict in history books, or the rules to *RUSSIAN FRONT* or *ADVANCED THIRD REICH*, to note that Soviet armed forces locked in battle on the Eastern Front, and what they achieved there, did more than contribute to the creation of the "World Order" of the mid-20th century. In helping to create that order, short-lived and filled with strife though it was, those armed forces bought the time for the lessons which their successors managed to learn pretty well. Well enough that the time gained even saw the nation which purchased it "wither away", its place in history to be inherited by generations who would hopefully never know the sort of sacrifice made by their forebears to win it for them.

The Romans knew that "In the face of arms, the law is silent"; and so knew that the law must go armed as well in order to have voice, if civilized societies are to survive.

The laws of civilized society were given voice by the Allied armies of the Second World War, and it is not unfair to say that, while as a conductor Stalin may have been no better than Hitler, the loudest voices in that chorus belonged to the Red Army.



THE QUESTION BOX

TURNING POINT: STALINGRAD

8.28: Change the third sentence to read: "Russian reinforcements may attempt infiltration after crossing the Volga provided the Area they infiltrate is the landing area or adjacent to it."

14.6E: Can Russian artillery add its attack factor to the defensive value of rubble, even if the area attacked does not contain a Russian unit?
A. Yes.

15.2: May other units move during an impulse when the German uses his artillery provided the moving unit does not enter an enemy-occupied area?
A. Yes.

18.3: Insert as the fourth sentence: "Other units already in the landing area may move, attack, or regroup normally as part of the same impulse."

18.5: Delete "not" in the fourth sentence.

UP FRONT

10.45: Can two Hero cards be played on the same man on the same man simultaneously to triple his firepower if he wasn't already entitled to doubled firepower?
A. No.

37.1/43.5: May Partisans ever be considered "Elite"?
A. No.

43.7: Is the purchase cost of Secondary Weapons 15% more for "Elite" troops and 15% less for "Second-Line" troops?
A. Yes.

SCENARIOS:

Scenario W (BANZAI): Are any Buildings cards allowed other than those the defender sets up in?
A. No! All Buildings cards are discarded as they appear, as per the normal rules (see 16.1 and EXAMPLE), as are those the defender sets up in, once he leaves them.

43.0 May Partisans ever receives armor support?
A. No!

Q. The Morale values of Japanese troops and many nationalities' armor units conflict with the conditions of Rule 39.7. How can this be resolved for DYO purposes?
A. DYO pushes many game systems to their design limits, and UP FRONT is no exception. Where armor is concerned, comply with the DYO point cost modifications, and ignore the Morale value contradictions—vehicles retain their printed Morale values (this is in keeping with the designer's stated rationale behind the performance of armor crews in the Designer's Notes).

As for troops, when using "Second Line" forces, limit your SL and ASL purchases to the lowest Morale representatives available for that nationality which will comply with the DYO restrictions. Likewise, "Elites" should also be limited to the highest-Morale leaders for that nationality, while complying with DYO restrictions.

Thus, the Japanese may only use Sgt. Kodu (#21) for "Second Line" DYO forces; the Italians must use Sgt. Capone (#21) for "Elites". Use of either nation's available Corporals for ASLs is unaffected.

THE PELOPONNESIAN WAR

\$35.00

Victory Games' Solitaire-to-Multi-Player Simulation of the Great War of Antiquity

It is frankly difficult to believe the ratings for *THE PELOPONNESIAN WAR*; virtually every letter regarding this title has praised its treatment of the subject. At worst, commentary has been neutral because a given gamer has not been thrilled by the subject matter. Yet the majority of those who responded to the Survey gave *PLPW* such poor ratings that it places in the bottom third of the RBG.

Though hard to accept, that would still be credible were it not for the ho-hum rating of 2.89 for Play Balance. This one figure undermines the survey overall since, when played Solitaire, *PLPW*'s Game System can force a switch in sides; surely Play Balance can't get much better!

Maybe I'm missing something. But having worn out a set of counters for this game already, I can attest that there are more than a few folks who are missing a lot of enjoyment.

In any case, the complete ratings breakdown for *THE PELOPONNESIAN WAR* is as follows:

Overall Value: 3.26

Components: 3.00

Map: 3.10

Counters: 3.31

Rulebook: 3.84

Complexity: 4.78

Completeness of Rules: 2.94

Playability: 3.21

Excitement Level: 3.52

Play Balance: 2.89

Authenticity: 2.94

Game Length (average): 19.80

Shortest: 1 hr., 30 mins.

Longest: 4 hrs., 5 mins.

Year: 1991

Type: SO

Sample Base: 76

READERS BUYER'S GUIDE

The following games are ranked by their reader-generated Overall Value. Further aspects of reader response to our titles are indicated by the ratings in other categories. By breaking down a game's ratings into these individual categories, the gamer is able to discern for himself where each title's strengths and weaknesses lie in the qualities he values highly. Readers are reminded that ratings take the form of a numerical value ranging from 1 to 9 (with "1" equalling "excellent" and "9" equalling "terrible"). However, the Game Length category is measured in multiples of ten minutes (thus, a rating of "18" equates to three hours). A "+" following the Year of release indicates that the game is continued or complemented by additional modules in successive years (for instance, the ratings for SL reflect the entire system—original game plus add-on modules). Game Type is broken down into three broad categories: SO = Solitaire; MP = Multi-Player; 2P = Two Player. Finally, it should be noted that a minimum requirement of 50 responses (see the Sample Base) was judged necessary for a valid representation; additional titles that garner such will be added to the RBG in the future.

Title	Overall Value	Components	Complexity	Completeness	Playability	Authenticity	Game Length	Year	Type	Sample Base
ADVANCED SL	1.80	1.77	9.25	2.11	3.44	2.04	33.02	'85+	2P	172
1830	1.85	2.00	3.88	2.72	2.04	3.20	24.52	'86	MP	50
CIVILIZATION	1.97	2.60	3.20	2.03	1.72	4.09	32.08	'82	MP	152
FLATTOP	2.00	2.47	3.61	3.12	3.56	1.76	43.96	'81	2P	95
EIA	2.08	2.45	8.08	2.94	3.84	2.11	156.86	'86	MP	71
TP STALINGRAD	2.10	2.14	3.42	3.56	2.23	2.94	30.00	'89	2P	61
UP FRONT	2.11	2.24	4.36	2.83	2.38	3.56	10.16	'83+	2P	126
RUSSIAN FRONT	2.12	2.33	5.32	2.88	2.67	2.40	40.16	'85	2P	113
KREMLIN	2.28	2.51	3.64	3.33	1.81	5.24	11.94	'88	MP	63
BRITANNIA	2.31	3.08	2.93	2.89	2.07	3.52	23.72	'87	MP	77
TAG AIR	2.38	2.39	5.02	2.91	2.77	2.72	33.65	'88	2P	88
GETTYSBURG	2.42	2.61	1.79	3.32	1.64	4.43	9.11	'88	2P	66
MOV	2.50	2.42	3.38	2.46	2.24	3.53	15.42	'88	MP	79
VITP	2.55	3.12	2.56	3.32	1.91	5.56	21.09	'77	2P	183
TRC	2.60	3.35	3.85	3.10	2.28	4.22	35.44	'76	2P	220
ENEMY IN SIGHT	2.61	2.88	2.30	2.63	1.87	5.76	7.73	'88	MP	68
7th Fleet	2.62	2.77	6.47	2.96	3.04	3.16	38.01	'87	2P	50
CASSINO	2.68	2.71	4.43	2.75	2.32	2.63	23.67	'88	2P	52
DIPLOMACY	2.71	3.36	3.00	2.69	2.92	5.16	33.26	'76	MP	169
ST. NAZAIRE	2.72	2.56	4.01	3.12	2.80	2.52	18.92	'87	SO	98
FIREPOWER	2.76	3.03	6.42	3.63	3.76	2.88	15.48	'85	2P	94
FLIGHT LEADER	2.79	2.20	4.62	3.00	2.77	3.20	10.18	'86	2P	76
MBT	2.80	2.68	5.37	3.16	3.36	2.57	15.08	'89	2P	51
DEVIL'S DEN	2.81	2.85	5.04	2.99	3.52	2.61	24.58	'85	2P	60
B-17	2.83	2.87	2.93	2.83	2.00	3.33	8.82	'83	SO	192
SQUAD LEADER	2.84	2.11	8.05	3.68	4.27	3.00	21.37	'77+	2P	231
2nd Fleet	2.89	3.35	5.27	3.44	3.28	3.55	32.23	'86	2P	55
WS&M	2.92	3.24	5.64	3.00	3.04	2.60	20.07	'75	2P	172
THIRD REICH	2.95	3.56	8.83	3.70	4.00	3.51	45.83	'81	MP	227
PANZER LEADER	3.12	2.79	5.63	3.72	3.32	3.82	19.47	'74	2P	210
WAR & PEACE	3.13	3.44	4.55	3.68	2.95	3.15	36.80	'80	2P	138
BLACKBEARD	3.14	2.67	4.32	3.53	2.96	3.35	13.60	'91	MP	56
TITAN	3.16	2.68	3.48	2.66	2.47	4.48	29.08	'82	MP	65
Civil War	3.20	3.69	6.95	3.92	4.17	3.58	46.96	'83	2P	112
Pelop. War	3.26	3.00	4.78	2.94	3.21	2.94	19.80	'91	SO	76
MAGIC REALM	3.29	2.44	8.41	4.08	4.20	3.79	20.76	'79	MP	75
NAVAL WAR	3.35	4.20	1.12	3.40	1.60	6.72	6.00	'83	MP	81
KINGMAKER	3.39	3.21	5.65	4.48	3.49	4.63	27.98	'76	MP	141
PG GUDERIAN	3.40	3.24	5.44	3.20	3.28	3.32	22.87	'84	2P	90
PATTON'S BEST	3.43	3.22	4.16	4.23	3.25	3.87	14.13	'87	SO	109
GLADIATOR	3.44	3.36	3.89	3.32	2.56	3.20	8.69	'81	2P	56
CM	3.47	3.60	3.28	3.39	2.64	3.36	11.70	'80	MP	91
6th Fleet	3.48	3.04	5.64	3.73	3.88	3.64	47.67	'85	2P	59
AIR FORCE	3.48	4.27	5.36	3.64	3.61	3.12	12.90	'80+	2P	76
PANZERBLITZ	3.56	3.55	4.92	4.16	3.26	4.50	18.25	'70	2P	215
Pacific War	3.64	3.57	7.98	4.32	5.28	3.19	120.63	'86	2P	66
Pax Britannica	3.64	3.60	4.85	3.91	4.25	4.61	52.14	'85	MP	50
MIDWAY	3.65	4.48	2.80	3.16	2.43	4.52	21.10	'64	2P	130
Ambush	3.68	4.08	4.94	4.40	3.91	4.61	19.69	'83+	SO	121
AFRIKA KORPS	3.77	4.43	2.20	2.84	1.88	5.40	21.44	'64	2P	167
HITLER'S WAR	3.80	3.89	4.20	4.25	3.44	4.68	34.79	'84	2P	78
WIZARD'S QUEST	3.82	3.07	2.11	2.94	2.15	4.92	20.92	'79	MP	85
WAR AT SEA	4.04	3.94	1.40	3.40	1.87	6.72	12.80	'76	2P	155
BLITZKRIEG	4.19	4.36	5.84	3.87	3.60	5.57	33.76	'65	2P	136
1776	4.25	3.64	5.28	3.88	3.24	4.40	26.30	'74	2P	154
D-DAY	4.32	4.73	3.56	3.45	2.91	5.08	27.16	'77	2P	125
RICHTHOFEN'S	4.33	3.78	3.99	3.60	3.24	4.87	8.23	'83	2P	53
WATERLOO	4.44	4.48	2.24	3.08	2.21	5.55	17.99	'62	2P	104
LUFTWAFFE	4.80	4.27	4.16	4.08	3.91	5.33	20.08	'71	2P	170

Our PELOPONNESIAN WAR feature issue opened The GENERAL's 28th Volume year with an overall passable rating of 3.53. Most of the letters included favorable comments regarding the issue's featured game. Curiously, while many letters vilified Frank Hamrick's "Searching For the Perfect Game", most grudgingly admitted his system to be of some use after all, and the article placed fourth on the list. Whatever... Anyway, based on a random sampling of 200 responses (with three points for a first-place listing, two for a second and one for a third), the responding readership ranked the articles of 28-1 as follows:

ATHENS IN VIET NAM	197
PELOPONNESIAN WAR SERIES REPLAY	195
MORE OLD CHESTNUTS II	192
SEARCHING FOR THE PERFECT GAME	140
FROM ALASKA TO CHINA	119
DEUS EX MACHINA	117
FORGETTING HISTORY	77
FLASHPOINT: GOLAN DESIGN ANALYSIS	60
SLAVERY IN CIVILIZATION	47
AREA NEWS	22
AH PHILOSOPHY	21
CONTEST #160	6
SPORTS SPECIAL	5
INFILTRATOR'S REPORT	2

The Dean's List is a newsletter-style roster of the favorite games of reviewer Dean R. Martelle. To qualify, a game must be in print or currently available, and be owned and played regularly by Mr. Martelle and his associates. You'll permit us a bit of strutting in that out of 69 boardgame titles on the 1992 Dean's List, 25 (36%) are Avalon Hill/Victory Games titles (including my personal favorite, UP FRONT). Still, the best part about reading The Dean's List isn't seeing your favorite title on it, but enjoying Mr. Martelle's unbridled enthusiasm. There is no elitist tunnel-vision here. The Dean's List touches on games by every publisher, and of every period, type, level of complexity and field of interest, and he has something good (and different) to say about every one of them. Kudos to Dean Martelle; attitudes like his make the hobby more enjoyable for everyone.

Le Marshalate (pronounced, so we're told: "Lay Marshal-lay") game club of southern New Hampshire focuses on historical boardgaming, and publishes a monthly newsletter entitled Lines

The Infiltrator's Report



of Communication. Le Marshalate is in its fifteenth year of welcoming serious wargamers to the hobby. Annual membership dues are \$25.00. For further information, contact either Mark Hinkle, President, at (603) 881-7416 or Franklin Haskell, VP of Recruiting, at (603) 424-7681.

SCENARIOS for Wargamers is a new quarterly 'zine "written, edited, and published by professional military historians who are also wargamers... dedicated to in-depth coverage based upon the best source material available"—and it looks it, too. Issue No. 1 includes (among others) articles on the Seven Years' War, the Spanish Civil War, and the featured article: "Groveton, 28 August 1862: The Iron Brigade's Baptism of Fire". SFW warrants consideration by any historical gamer, and especially miniaturists. A 4-issue subscription is \$24.00. For further info, write to: SCENARIOS for Wargamers, P.O. Box 15172, Chevy Chase, MD 20825-5172.

To that list of undignified wargaming anagrams which includes "BuRPs", "MiMiCs" and "NiPiC", now comes one of our favorite 'zines: "BROG". Occasionally outrageous, frequently hilarious, unfailingly informative and always entertaining,

the Berg's Review of Games keeps both gamers and publishers informed of what's right and what's wrong with the hobby, whether those gamers and publishers want to hear it or not. There are slicker amateur 'zines out there, but darn few with BROG's level of irreverent independence. A six-issue subscription is \$19.00, payable to Richard Berg, P.O. Box 567, White Plains, NY 10602.

Following the deluge of answers received for Contests 159 and 160, Contest #161 generated, if anything, even more correct entries. Sigh. So much for ciphers providing a challenge when there are so many home computers out there. Solving Contest #161 requires that you first note that most of the numbers in the cipher are primes. The alphabet has been translated into numerical values equal to the first 26 prime numbers. But the order of those prime numbers is alphabetical. Thus, the first prime number (and thus the equivalent of "A") is not "1" (beginning with an "O") but "83" (beginning with an "E"). This establishes the letter/number equivalents as follows:

A = 83 B = 11 C = 59 D = 53 E = 5 F = 41
 G = 47 H = 43 I = 19 J = 97 K = 1 L = 101
 M = 7 N = 17 O = 79 P = 71 Q = 73 R = 61
 S = 67 T = 13 U = 31 V = 37 W = 3 X = 29
 Y = 23 Z = 2

In addition, each successive occurrence of the same letter in the cipher has its numerical value increased by the number of such occurrence of that letter. Thus, the first "A" = 83 (the base value), the second "A" = 85 (the base value of 83 plus 2 for the second occurrence of the letter "A"), the third "A" = 86 (83 plus 3 for the third occurrence), and so on. Once deciphered, the letter groupings can be divided into the proper word breaks to reveal the message: "OLD SOLDIERS NEVER DIE THEY JUST FADE AWAY". Winners will be listed in Vol. 28, No. 4 of The GENERAL.

Contest #160 required another random draw to pick ten winners. After disqualifying the dozen or so entrants who didn't rate the issue as a whole and/or list their three favorite articles (you've got to read the rules, folks), that still left over 150 from which to glean the following ten lucky entrants: John Cadwallader, Worthington, OH; James Collins, Gulfport, MS; Chris Eastman, Omaha, NE; Chad & Jeanne Jensen, Rohnert Park, CA; Marvin & Jill Levine, Appleton, WI; Steve List, Levittown, PA; Jeff Paull, Cary, NC; Petteri Raatikainen, FINLAND; Robert Young, Rockford, IL; and Michael Zeimentz, Delavan, WI.

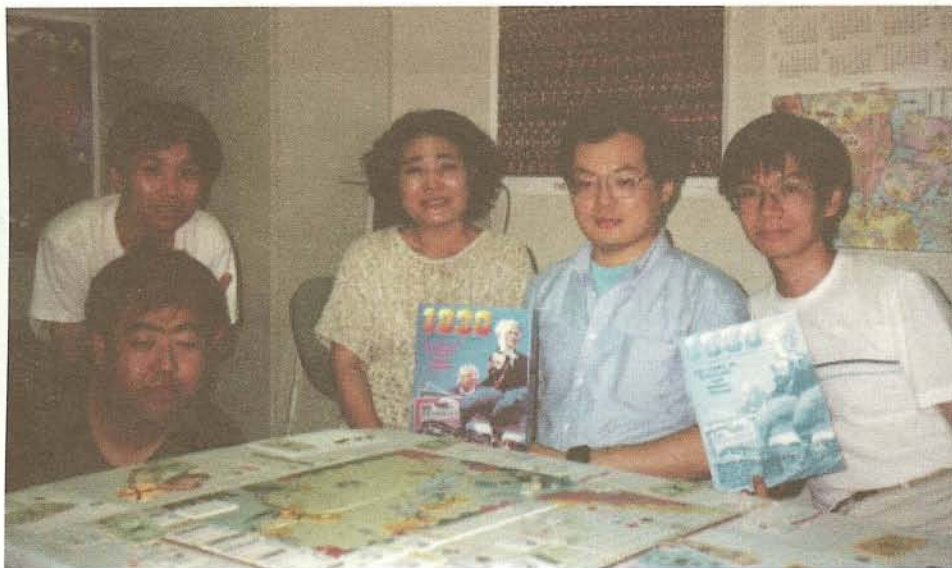

The lady at the center of this gang of ruthless railroad tycoons is Ms. Koko Kunieda, President of Japan Game Association, a very active Japanese gaming club. JGA sent us a packet of photographs depicting their first "mini-convention", wherein competition was held in (among others) MERCHANT OF VENUS and, of course, 1830.

Next Time:

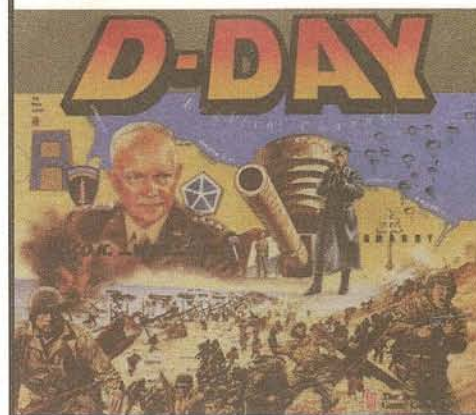

The Western Front

Sizzling Aerial Dogfights!

MUSTANGS

Authorized by The Smithsonian Institution for the American History Series!

Designed to introduce a new generation to the fascinating world of historical military strategy games, *MUSTANGS* is a recreation of World War II aerial combat. Players can recreate aerial dogfights in this highly competitive game of chess-like strategy. Easy to learn rules allow players to maneuver colorful playing pieces, representing individual planes, into fast and furious fun!

★ Introductory and Advanced Game.

★ Dive out of the sun in the dreaded Japanese "ZERO" !

★ Climb into the cockpit of Germany's infamous secret weapon, the ME-262.

★ Maneuver your P-51 into position and unleash a hail of deadly gunfire!

ABOUT THE AMERICAN HISTORY SERIES

As a producer of realistic military strategy games since 1958, Avalon Hill is always in the forefront of introducing new enthusiasts to the hobby. As design partner with The Smithsonian Institution, Avalon Hill has developed the American History Series of games... games which are easy to learn, simple, yet challenging to play. All such games, including *Mustangs*, have been endorsed by the Smithsonian Institution for their authenticity and informative values.



NO.	TITLE	NO. OF PLAYERS	AGES	COMPLEXITY	SUGG. RET.
736	MUSTANGS	2-4	12 & Up	Easy	\$25.00



The Avalon Hill Game Company

DIVISION OF MONARCH AVALON, INC.

4517 Harford Road • Baltimore, MD 21214 • 410-254-9200 • FAX 410-254-0991

To order, call TOLL FREE 1-800-999-3222



INTRODUCING:

TALES FROM THE FLOATING VAGABOND

Ludicrous Adventure

In A Universe

"...this rip-roaring read of a book is guaranteed to bring a smile to the face of even a traffic warden...the book is well laid out, well indexed...we have no qualms about recommending this to experienced RPG'ers and beginners alike, it's fabulous."

Gamesman Magazine

Whose Natural Laws

Are Out to Lunch!

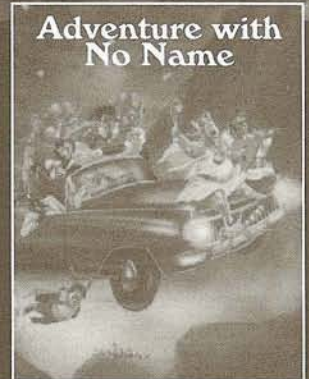
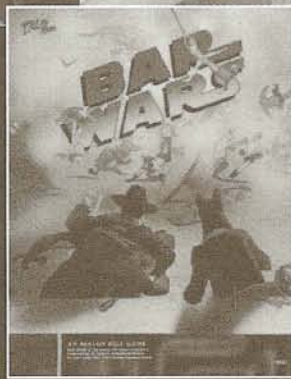
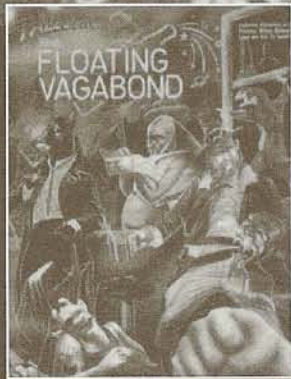

Tales From The Floating Vagabond is more than a game; it's a key to knowledge. What other game fulfills your educational needs by teaching you: the secret of the pyramids; the simplest means of achieving perpetual motion; the locations of all-you-can-eat-for-free fast-food restaurants? For instance, did you know the city of Winchester, Virginia, was occupied 70 different times by Union and Confederate troops during the American Civil War? Did you know "target vomiting" is a rite of passage for 14-year-old boys of the Looky Looky Indian tribe of South America? Did you know the role of Nurse Chapel on TV's *Star Trek* was actually played by special-effects whiz-kid Immanuel Lewis? **Tales From The Floating Vagabond** knew. And it passes that knowledge on to you, the discriminating gamer—the gamer who knows the difference between laughing hard and hardly laughing. Once the dice start rolling, there's no stopping the laughs. And there's no stopping the products either. Every month or so, you'll see another new adventure or another new supplement. Add to that the products already on the shelves, and you've got an ongoing campaign guaranteed to keep your players in sutures. So what are you waiting for?



The Avalon Hill Game Company

DIVISION OF MONARCH AVALON, INC.

4517 Harford Road, Baltimore, MD 21214 ★ 410-254-9200 ★ Fax: 410-254-0991

GANGSTERS \$25.00

Multi-Player Game of Gangland Warfare in 1920's Chicago

INSTRUCTIONS:

Rate each category by placing a number ranging from 1 through 9 in the appropriate space to the right ("1" equating to excellent; "5", average; "9", terrible). EXCEPTION: Rate items 7a and 7b in terms of minutes necessary to play the game, in ten-minute increments. (Example: If you've found it takes two and one-half hours to play the basic scenario of HITLER'S WAR, enter "15" for category 7a.) For an explanation of the categories, refer to the AH Philosophy of Vol. 24, No. 5. Enter ratings only for those categories relevant to the game in question. Note that AH's ratings for Complexity, Year of Publication and Type (2P=two player; MP=multi-player; SO=solitaire) have been provided for your information.

- | | |
|----------------------------|--------------|
| 1. Overall Value | _____ |
| 2. Components | _____ |
| 2a. Mapboard | _____ |
| 2b. Counters | _____ |
| 2c. Rulebook | _____ |
| 3. Complexity | _____ |
| 3a. Avalon Hill Complexity | <u> 3 </u> |
| 4. Completeness | _____ |
| 5. Playability | _____ |
| 5a. Excitement Level | _____ |
| 5b. Play Balance | _____ |
| 6. Authenticity | _____ |
| 7. Game Length | _____ |
| 7a. Shortest | _____ |
| 7b. Longest | _____ |
| 8. Year of Publication | <u>1992</u> |
| 9. Type | <u>MP</u> |

Good for Postage Charges Only on Complete Game Purchases

This coupon is valid only for mail order purchases of complete games direct from The Avalon Hill Game Company. Each postage coupon entitles the sender to deduct up to \$1.00 from the postage charges of any order for a complete game, provided the amount deducted does not exceed the total postage for that order. Coupons are not valid for parts, magazines, or PBM kit orders.

Shipping charges are computed according to instructions found on the current Parts List and pre-paid order forms. Any past GENERAL postage coupons previously offering different values may be used as the equal of this coupon.

Example: Customer A lives in the USA and orders a \$15 game. His postage charge is \$4, which he may pay by sending four postage coupons and \$15, or two postage coupons and \$17. Customer B lives in Canada and orders the same game. He must pay \$15 in US funds plus \$ postage coupons or \$15 plus \$1 (US) for each postage coupon less than 8 which he sends.

\$1.00
Volume 28, Number 3
\$1.00

WHAT HAVE YOU BEEN PLAYING?

Top ten lists are always in vogue—be the subject books, television shows, movies or even games. The public seems never to tire of seeing how its favorite way of spending leisure time stacks up against the competition. So, to cater further to your whims (and to satisfy our own curiosity), this is The GENERAL's version of the Gamer's Top Ten. From the responses to this form, your editor produces the regular column "So That's What You've Been Playing" found elsewhere in this issue.

We aren't asking you to subjectively rate any game. That sort of thing is already done in these pages and elsewhere. Instead, we ask that you merely list the three (or fewer) games which you've spent the most time playing since you received your last issue of The GENERAL. With the collation of these responses, we can generate a consensus list of what's being played by our readership. This list can serve both as a guide for us (for coverage in these pages) and others (convention organizers spring instantly to mind). The degree of correlation between this listing, the Best Sellers List, and the RBG should prove extremely interesting.

Feel free to list any game of any sort regardless of the manufacturer. There will be, of course, a built-in bias to the survey since the readers all play Avalon Hill games to some extent; but it should be no more prevalent than similar projects undertaken by other periodicals with special-interest based circulation. The amount to which this bias affects the final outcome will be left to the individual's own discretion.

1. _____
2. _____
3. _____

Opponent Wanted

50¢

1. Want-ads will be accepted only when printed on this form or a facsimile and must be accompanied by a 50¢ token fee. No refunds. Payment may be made in uncancelled U.S. postage stamps.
2. For Sale, Trade, or Wanted To Buy ads will not be accepted. No refunds.
3. Insert copy on lines provided (25 words maximum) and print name, address, and (if desired) phone number on the appropriate lines. Ads pertaining solely to AVALONCON needs are free.
4. PLEASE PRINT CLEARLY AND LEGIBLY. If your ad is illegible, it will not be printed.
5. So that as many ads as possible can be printed in our limited space, we request that you use official state and game abbreviations. Don't list your entire collection; list only those games which you are most interested in locating opponents for.

Advanced Squad Leader—ASL/SL, Afrika Korps—AK, Air Force—AF, Arab-Israeli Wars—AIW, Attack Sub—ASUB, Battle of the Bulge—BB(Year), Blackbeard—BKBD, Blitzkrieg—BL, Britannia—BRIT, Circus Maximus—CM, Advanced Civilization—ACIV/CIV, D-Day—DD(Year), Devil's Den—DEV, Diplomacy—DIP, DUNE, 1830, Empires in Arms—EIA, Firepower—FP, Flat Top—FT, Flight Leader—FL, Fortress Europa—FE, Gangsters—GANG, Gettysburg—GE(Year), Gladiator—GL, Guadalcanal—GUAD(Year), Gunslinger—GSL, Guns Of August—GOA, Hitler's War—HW, Kremlin—KREM, Kingmaker—KM, Knights Of The Air—KOTA, Luftwaffe—LW, Magic Realm—MR, MBT, Merchant of Venus—MOV, Midway—MD(Year), Napoleon's Battles—NB, PanzerArmée Afrika—PAA, PanzerBlitz—PB, Panzergruppe Guderian—PGG, Panzer Leader—PL, Rail Baron—RB, Republic of Rome—ROR, Richtofen's War—RW, The Russian Campaign—TRC, Russian Front—RF, Samurai—SAM, 1776, Siege of Jerusalem—SOJ, Starship Troopers—SST, Stellar Conquest—SC, Storm Over Arnhem—SOA, Submarine—SUB, Tac Air—TA, Advanced Third Reich—A3R/3R, Thunder At Cassino—CASS, Titan—TT, Trireme—TRI, Turning Point: Stalingrad—TPS, Up Front—UF, Victory In The Pacific—VITP, War and Peace—W&P, Wooden Ships & Iron Men—WSIM, Wrasslin'—WRAS.

Name _____ Tel. _____
Address _____
City _____ State _____ ZIP _____

CONTEST #162

A change of pace this time around, for those of you who (like me) are tired of ciphers and puzzles and all things computable. Quite simply, this is a trivia test to see how much our readership knows about World War Two. Well, not all of World War Two; just the last days of the Third Reich. On the cover of this issue, we have reproduced a portion of one of the most famous photographs of the war, depicting a Soviet soldier hoisting the banner of the USSR over the Reichstag in Berlin. Contest #162 asks our readers to answer this question:

This is one of two Soviet soldiers who raised the flag over the Reichstag; what are the names of these two soldiers?

ANSWER: _____

Bonus Question (Tie-breaker): What unit are these soldiers from?

ANSWER: _____

SOURCE: _____

Note: Your answer must be accompanied by a written source printed in the English-language! You needn't send the whole book, of course; just title, author, publisher and year of publication.

To be valid, each entry must include your numerical rating for this issue as a whole ("1" being "excellent" and "10" being "terrible") and your rating of the three best articles, in your opinion, in order of your preference. The solution to Contest #162 will appear next issue, and the list of the ten winners (who will receive merchandise credit vouchers from Avalon Hill) in the following issue.

Issue as a whole _____ (Rate from 1 to 10, with "1" equating to excellent and "10" terrible). To be valid for consideration, your contest entry must also include your choice for the three best articles, as listed below:

1. _____
 2. _____
 3. _____
- NAME _____
ADDRESS _____
CITY _____ STATE _____ ZIP _____



I am not yet an AREA member. As a paid registrant to AVALONCON, I will receive my free Generic AREA membership which will allow me to play rated games in any tournament. I understand I'll receive AREA membership materials in the mail before the Convention program.

I am already an AREA member. My AREA Membership Number is: _____

I've lost my AREA number. I believe my Zip Code at the time I entered the AREA system was: _____

I am already an AREA member and already have a Specific Game membership rating in the _____ game which I would like printed on my badge for use in that tournament.

I enclose \$10.00 to purchase a Specific AREA membership for use at (or before) AVALONCON for the _____ game.

OFFICIAL AH USE ONLY:

Membership Number: _____ Current AREA rating: _____ Specific rating: _____

TEAM TOURNAMENT: I wish to register my four-person team in the Team Tournament at no additional charge. I realize that all the members of my team must be pre-registered and that we must each play a different title for which we have pre-registered. Substitutions of team participants or game selections can be made by mail or phone call to: (410) 254-9200, ext. 320 prior to August 2nd. Our team members and the game each will play are listed below:

**Official AH
Use Only:**

1. _____ 2. _____ 3. _____ 4. _____

Game to be played by this team member:

1. _____ 2. _____ 3. _____ 4. _____

HATS & T-SHIRTS: Reserve my free AVALONCON souvenir and \$5.00 game credit because I've pre-registered before July 1st. ✓ one only:

T-Shirts: Small Medium Large Xtra Large
 AVALONCON cap None of the above

XXL XXXL XXXXL

There is a \$4 surcharge for these sizes.

Please reserve _____ additional hats for which I enclose \$8 each.

Please reserve _____ additional t-shirts in sizes _____ for which I enclose \$8.00 each (or \$12.00 each for size XXL or larger).

I enclose \$30 in check or money order made payable to The Avalon Hill Game Company to register for AVALONCON.

Charge my: VISA MASTERCARD AMERICAN EXPRESS Expiration Date _____

Account Number _____

Signature _____

Name _____

Address _____

City _____ State _____ ZIP _____ Total Enclosed: _____

HURRY! Registrations postmarked after July 1st, 1993 will not receive a free AVALONCON souvenir or \$5.00 game credit. Make your check or money order payable to: The Avalon Hill Game Company and mail to 4517 Harford Road., Baltimore, MD 21214 or to FAX it, ☎ (410) 254-0991.

◆ Be sure to register for your main event(s) on the reverse side. ◆

☞ **SMOKING POLICY:** There is a No Smoking policy in effect in all public areas of AVALONCON which will be strictly enforced.



EVENT PRE-REGISTRATION Chronological Listing

Time	Event	Duration	Time	Event	Duration
We 18	<input type="checkbox"/> UCV Demo		Fr 14	<input type="checkbox"/> RBN [4-6]	
	<input type="checkbox"/> WRJ Demo		Fr 15	<input type="checkbox"/> MMS 1 [5, 0]	
	<input type="checkbox"/> BRI Demo			<input type="checkbox"/> SCT 2 [5, 0]	
	<input type="checkbox"/> Playtest Session			<input type="checkbox"/> SJW [5-7]	
We 19	<input type="checkbox"/> HWD Demo			<input type="checkbox"/> BBP 1 [5, 0]	
We 20	<input type="checkbox"/> VIP Demo			<input type="checkbox"/> PPW Demo	
Th 10	<input type="checkbox"/> AFK [1-5]		Fr 16	<input type="checkbox"/> FPR [5-6]	
	<input type="checkbox"/> CDT [1]		Fr 17	<input type="checkbox"/> DIP 1 [5-8, 0]	
	<input type="checkbox"/> RKL Demo			<input type="checkbox"/> 183 3 [5-9]	
	<input type="checkbox"/> SQL [1-5]		Fr 18	<input type="checkbox"/> ACQ [5-6]	
	<input type="checkbox"/> SOA [1-3]			<input type="checkbox"/> CMJ [5-6]	
	<input type="checkbox"/> SSB [1-2]			<input type="checkbox"/> ROR [5-7]	
	<input type="checkbox"/> 3R4 [1-0]			<input type="checkbox"/> TAC [5-8]	
	<input type="checkbox"/> TTN [X, 7-8]			<input type="checkbox"/> WRS [5-6]	
	<input type="checkbox"/> TXJ [1]		Fr 19	<input type="checkbox"/> CMS 1 [6, 0]	
	<input type="checkbox"/> TTT [1-2]			<input type="checkbox"/> PGG [6-9]	
	<input type="checkbox"/> WAS [1-2]		Fr 20	<input type="checkbox"/> GBG [6-9]	
	<input type="checkbox"/> BRI 1 [1, Y, 0]			<input type="checkbox"/> MMS 2 [6, 0]	
Th 11	<input type="checkbox"/> ASL [1-0]			<input type="checkbox"/> BRI 4 [6Y0]	
	<input type="checkbox"/> B17 [1-3]			<input type="checkbox"/> BBP 2 [6, 0]	
	<input type="checkbox"/> 183 Demo [1]		Fr 21	<input type="checkbox"/> TBT [6]	
	<input type="checkbox"/> 3RT [1-0]		Fr 22	<input type="checkbox"/> GR\$ 2	
Th 12	<input type="checkbox"/> ASA [1-5]		Fr 24	<input type="checkbox"/> GR\$ 3	
	<input type="checkbox"/> NVW [1-2]		Sa 9	<input type="checkbox"/> SPB [7-0]	
	<input type="checkbox"/> RKL [1-2]			<input type="checkbox"/> UPF [7-9]	
	<input type="checkbox"/> WRJ [1-2]			<input type="checkbox"/> AVJ [7]	
Th 13	<input type="checkbox"/> SCT 1 [1-2, 0]			<input type="checkbox"/> ACV [7-0]	
Th 17	<input type="checkbox"/> ANZ [2-5]			<input type="checkbox"/> B81 [7-9]	
	<input type="checkbox"/> 183 1 [2-3, 7-9]			<input type="checkbox"/> HWD [7-8]	
Th 18	<input type="checkbox"/> A3R [2-9]			<input type="checkbox"/> MBT [7-9]	
	<input type="checkbox"/> EIA [2-0]			<input type="checkbox"/> MOV [7]	
	<input type="checkbox"/> FSE [2-4]			<input type="checkbox"/> NAP [7-9]	
	<input type="checkbox"/> MUS [2-3]			<input type="checkbox"/> PZB [7-9]	
	<input type="checkbox"/> WAT [2-5, 7]			<input type="checkbox"/> 7FT [7-0]	
	<input type="checkbox"/> MVJ [2-4]			<input type="checkbox"/> 176 [7-0]	
Th 19	<input type="checkbox"/> FBS [2-4]		Sa 10	<input type="checkbox"/> DLW [7-8]	
	<input type="checkbox"/> HCR Demo [2]			<input type="checkbox"/> BRI 3 [7Y0]	
Th 20	<input type="checkbox"/> VIP [3-0]			<input type="checkbox"/> DIP 2 [7-8, 0]	
	<input type="checkbox"/> BRI 2 [3, Y, 0]		Sa 12	<input type="checkbox"/> CMS 2 [7, 0]	
Th 21	<input type="checkbox"/> DUN [3]		Sa 13	<input type="checkbox"/> SCT 3 [7-8, 0]	
	<input type="checkbox"/> RBN Demo [3]			<input type="checkbox"/> ESJ [7]	
Th 24	<input type="checkbox"/> GR\$		Sa 15	<input type="checkbox"/> MMS 3 [8, 0]	
Fr 9	<input type="checkbox"/> B91 [4-8]			<input type="checkbox"/> WTT [8]	
	<input type="checkbox"/> SFT [4-7]			<input type="checkbox"/> BBP 3 [8, 0]	
	<input type="checkbox"/> KRM 1 [4-6]		Sa 16	<input type="checkbox"/> WPS [8-9]	
	<input type="checkbox"/> RFT [4-9]		Sa 17	<input type="checkbox"/> CMS 3 [8, 0]	
	<input type="checkbox"/> TRC [4-0]			<input type="checkbox"/> WQJ [8-9]	
	<input type="checkbox"/> TYX [4-7]		Sa 18	<input type="checkbox"/> GR\$	
	<input type="checkbox"/> WSM [4-5]			<input type="checkbox"/> KGM [8-9]	
	<input type="checkbox"/> TPS Demo [4]		Sa 19	<input type="checkbox"/> ADV [8-0]	
Fr 10	<input type="checkbox"/> CVW [4-7]			<input type="checkbox"/> GSR [8-0]	
	<input type="checkbox"/> 183 2 [4, 7-9]			<input type="checkbox"/> TVW [8-9]	
	<input type="checkbox"/> PXB Demo [4-5]		Sa 20	<input type="checkbox"/> BBP4 [9-0]	
	<input type="checkbox"/> SCJ [4]			<input type="checkbox"/> MMS4 [9-0]	
	<input type="checkbox"/> BRI 3 [4, Y, 0]			<input type="checkbox"/> BRI 6 [9Y0]	
Fr 11	<input type="checkbox"/> TVJ [4-5]		Sa 21	<input type="checkbox"/> AUC [9]	
Fr 12	<input type="checkbox"/> TPS [4-0]		Sa 22	<input type="checkbox"/> FIS [9]	
	<input type="checkbox"/> KRM 2 [4-6]		Su 9	<input type="checkbox"/> LRH [0]	
Fr 13	<input type="checkbox"/> HCR Demo [4]		Su 10	<input type="checkbox"/> ATS [0]	
	<input type="checkbox"/> W&P [4-6]			<input type="checkbox"/> EIS [0]	
	<input type="checkbox"/> PCW [4-7]			<input type="checkbox"/> SST [0]	
Fr 14	<input type="checkbox"/> BKB [4-6]		Su 11	<input type="checkbox"/> WBR [0]	

REGISTRATION INFORMATION: All children under 14 and spectators are admitted free and may participate in Open Gaming, space permitting. They will not receive a badge, program, or free souvenir items. Children may participate in free specially designated "Juniors-only" tournaments or pay the \$30 fee and participate fully in any event. All other participation is limited to paid registrants wearing their own badges. Registrants may participate in any number of events at no additional charge, but can only play in one at a time. Most events will not be "sold out", but to guarantee an opportunity to play you must bring a copy of the game (to ensure sufficient copies on hand) and be present at the announced starting time. Those registering after July 1st will not receive a free AVALONCON souvenir or \$5 credit towards purchases. There are no one-day admissions. Early arrivals may register and partake of Open Gaming and introductory demonstrations as early as 4 PM Wednesday.

WHAT YOU'LL GET: Pre-registrants of record on July 1st will be entitled to their pre-selected choice of a free AVALONCON souvenir hat or T-shirt upon arrival. *Those who are not already members of the AREA Player Rating System will receive a free membership and explanatory materials by return mail.* Any game played at AVALONCON is subject to rating in the AREA system if any participant requests it at the start of play. Refusal to submit to rated play in any AVALONCON event is not allowed. All who are pre-registered by July 1st will have the Convention program mailed to them on July 6th or shortly thereafter. This is the only confirmation you will receive. Those registering after July 1st must pick up their convention program at the site.

TEAM TOURNAMENT: You may pre-register any four players as a team if each plays a different title for which they have pre-registered. Team entry and substitutions of players or game choices are allowed ONLY by pre-registration. You may make such changes by mail or phone only if they are received by August 2nd. Call (410) 254-9200, ext. 320 to make last-minute changes. Players in the Team Tournament play individually for themselves, but also score in the event they have entered as a Team Tournament entry for their team's total score. The winning team will receive two free rooms at the 1994 AVALONCON.

EVENT DESCRIPTIONS: Events are listed in chronological order at left, and in alphabetical order hereafter using the following format:

Name, Class, Format, Style, Duration, GM, Starting Time, [Pre-Registration Limits].

Name: Lists abbreviated name for the event used on the Chronological Chart & badges.

Class: A: Rules will not be explained; for experienced players only. B: Beginners welcome. Rules will be briefly explained. **If you need to be taught how to play, be present one hour before the scheduled playing time for instruction. Rules will NOT be taught during play except on an individual basis as time allows.**

Format: *Swiss Elim:* All entrants play an equal number of preliminary rounds to determine a number of finalists who will then play in Single Elimination format. *Swiss:* All entrants play same number of rounds, being paired against opponents with similar records. *SE:* Single Elimination; entrants play until they lose a game. *DE:* Double Elimination; entrants play until they lose two games. *DEMO:* No prizes. *OTHER:* System to be explained by the GM.

Style: *CONTINUOUS:* Play continues round after round until completed with no more than one-hour breaks. Rounds will not start after midnight and will resume at 9 AM. *The GM may require that rounds*

begun by midnight be played to conclusion that night. Players must adhere to the GM's schedule or forfeit. *SCHEDULED:* Play has designated, timed rounds with predetermined meal/rest breaks of two hours or more. *SPLIT:* Two or more qualifying rounds at different times, players may participate in only one qualifying round. *HEAT:* Two or more qualifying rounds at different times, players may participate in as many qualifying rounds as they wish. *In all formats, the GM may adjudicate games which do not adhere to schedule.*

Duration: The expected number of rounds and length of each. *NOTE: Some formats will require more or less rounds than planned depending on number of entrants.* Players should schedule their time accordingly and refrain from entering those events their time constraints will not allow them to finish should they advance. Final rounds may be rescheduled to accommodate finalists at the discretion of the GM.

GM: The Game Master who is in charge of the event. If an address is printed, the GM will provide additional photo-copied information in advance to all who send him a SASE.

Times: Starting times of the initial round are abbreviated as follows: Th: Thursday, Fr: Friday, Sa: Saturday, Su: Sunday. Hours are given in military time (12 = noon, 13 = 1 PM). The expected duration for all events is shown on the Chronological listing. We suggest copying this page before registering.

[Pre-Registration Limits:] AVALONCON has been divided into ten time blocks of five hours each as follows: 1 = Th 10-14, 2 = Th 15-19, 3 = Th 20-24, 4 = Fr 9-14, 5 = Fr 15-19, 6 = Fr 20-24, 7 = Sa 9-14, 8 = Sa 15-19, 9 = Sa 20-24, 0 = Su 9-14. Each event's most likely duration is summarized by these time blocks. However, those advancing to the Final round or participating in larger-than-expected events may still experience overlapping schedule conflicts. You may Pre-Register for as many events as you like, provided they do not have overlapping time blocks.

Prizes: All winners will receive a championship plaque. The winner and other finalists will receive Merchandise Credits good for the purchase of our merchandise/plaques according to a standard schedule based on the number of entrants. For example, there will be 32 prize-winners in a 128-player tournament.

THE EVENTS: Those designated "jr" are only for children under the age of 14. Parents are urged to sit in to help supervise and should attempt to familiarize their children with the game beforehand.

Across Five Aprils (ASA), B, Swiss Elim, Continuous, 3 4-hr prelim rds of Bull Run, Pea Ridge, & Bentonville. 4 advance to SE Shiloh & Gettysburg. A. Lewis, 8503 E. Woodcove Dr. #133, Anaheim Hills, CA 92808. Th 12 [1-5]

Acquire (ACQ), A, Swiss Elim, Continuous, 3 prelim 1-hr rds with hidden stock holdings, 4 advance to final game. B. Cleary. Fr 18. [5-6]

Adel Verpflichtet (ADV), B, Swiss Elim, Continuous, 4 prelim 1-hr rds, 10 advance to 2-game Semis, 5 advance to SE Final. R. Pfeiffer. Sa 19. [8-0]

Adel Verpflichtet Jr (AVJ), B, Swiss-Elim, Continuous, 3 prelim 1-hr rds, 5 advance to Final. S. Davis. Sa 9 [7]

Advanced Civilization (ACV), A, SE, Continuous. Final will start Sa night and finish Su using Western Map Extension for an 8-player game. C. Hickok. Sa 9 [7-0]

Advanced Squad Leader (ASL), A, Swiss, Scheduled, 7 6-hr rounds. R. Gifford, 320 East 27th, South Sioux City, NE. Th 11. [1-0]

Advanced Third Reich (A3R), A, Other, Scheduled, 2 rds. 3-hr 1940 scenario to rank players, followed by 2-day Campaign Game with winner decided on points. J. Brophy, 16 Beachfront Ln, New Rochelle, NY 10805. Th 18. [2-9]

AFTER ACTION MEETING: Beat your chest or sing our praises. Your chance to critique AVALONCON 93 and influence next year's championships. Sunday 8.

Afrika Korps (AFK), B, SE, Continuous, 5-hr rds. J. Beard. Th 10. [1-5]

Anzio (ANZ), A, SE, Continuous, 3 5-hr. rds of the 15-turn Basic Game. No options other than 1st Para optional deployment. M. Sincavage. Th 17. [2-5]

Attack Sub (ATS), B, Swiss Elim, Continuous, 4 1-hr prelim rds of Scenario E playing each side twice. 4 advance to SE best-2-of-3 choosing scenario or side. Scenario H tie-breaker. M. Fitzgerald. Su10. [0]

Auction aka The Collector (AUC), B, Swiss Elim, Continuous, 2 1-hr prelim rds. 4 advance to SE. J. Scarborough. Sa 21. [9]

B-17 (B17), A, Other, Continuous, 3 3-hr. rds. A multi-round bombing raid of the 8th Air Force in 1942. Players will fly in squadron formation and be given a "second life" if shot down. D. Terry, 7501 Norris Ave, Sykesville, MD 21784. Th 11. [1-3]

Battle of Bulge '81 (B81), A, SE, Continuous, 4-hr rds using Race to Bastogne scenario revised for balance. B. Eshleman, 1720 Round Hill Circle, Kernersville, NC 27284. Sa 9. [7-9]

Battle of Bulge '91 (B91), A, SE, Scheduled, 3-hr rds. Scenario #1 with all Basic Game and most Optional rules with modified VC. R. Eeastep, 14715 Soft Wind Dr, N. Potomac, MD 20878. Fr 9. [4-8]

Blackbeard (BKB), A, SE, Continuous 2-pirate games with 4 players/game using only the best 8 pirate cards. If no winner after 4 hrs, the survivor with the most loot will advance. R. Knowles. Fr 14. [4-6]

Britannia (BRI), B, Swiss-Mod, HEAT, 6 5-hr qualifying Heats. Must play in at least 2 of 6 Heats to qualify for Finals. Rank determined by number of wins and average of 2 highest scores. T. Strong, 1027 E. 7th St #5, Long Beach, CA 90813. Th 10, Th 20, Fr 20, Sa 10, Sa20, Su 10. [X, Y, 0]

Bowl Bound/Paydirt (BBP), B, League, 4 Heats, play 2 games each Heat (one Bowlbound; one Paydirt). Winners advance to final Su 10 using Paydirt Advanced Rule 1. D. Baumgardner, 3621 Wayland, Fort Worth, TX 76133. Fr 15, Fr 20, Sa 15, Sa 20. [X, 0]

Candidate (CDT), B, SE, Continuous, 2-hr rds. All states remaining unresolved after 2 hrs will be Undecided entering the convention. K. Gutermuth. Th 10. [1]

➤ **Circus Maximus Jr (CMJ)**, B, SE, one race of 3 laps or 3 hrs (whichever comes first). R. Cox. F18. [5-6]

Circus Maximus (CMS), B, SE, 3 prelim 3-hr Heats with final on Su 9. W. Coates. Fr 19, Sa 12, Sa 17. [X, 0]

Civil War (CVW), A, SE, Continuous, 4-hr rds. D. Johnson, 11635 Crystal Creek Ln, Manassas, VA 22111. Bid for sides. Fr 10. [4-7]

➤ **Dinosaurs of Lost World JR (DLW)**, B, SE, Continuous, 3 2-hr rounds. R. Stakenas. Sa 10. [7-8]

Diplomacy (DIP), A, Swiss, Scheduled, 3 6-hr rds. Traditional prizes augment merchandise credit. Best 2-out-of-3 rd scoring system. J. Yerkey, 4 Dutton Ave, Catonsville, MD 21228. Fr 17, Sa 10, Su 9. [5-8, 0]

Dune (DUN), A, SE, Continuous, 2 2-hr rds with 6 finalists (selected by points) advancing with no alliances allowed. R. Cox, 57 Coastline Dr, Inman, SC 29349 Th 21. [3]

1830 (183), A, SE, Heats, three 5-hr qualifying 1st-rd heats to qualify for subsequent play Sa 9 & Sa 17. A demo game will run Th 11. Th 17, F10, F17. K. Whitesell, 107 Nursery Rd, N. Linthicum, MD 21090. [X, 7-9]

Empires In Arms (EIA), A, Other, Continuous play with winner based on % of VP. Bid for 1805 or 1792 scenarios. W. Jaffe. Th 18. [2-0]

Enemy In Sight (EIS), B, SE, Continuous, 2 2-hr rds by designer Neal Schaffer. Su 10. [0]

➤ **Enemy In Sight Jr (ESJ)**, B, SE, Continuous, 2-hr rds. C. Villeneuve. Sa 13. [7]

Facts In Five (FIS), B, SE, Continuous, 1-hr rds. R. Cox. Sa 22. [9]

Fifth Fleet (SFT), A, Swiss, Continuous 5 4-hr rds using scenarios 2, 3, 5, 6, and 8. Bid pts for sides. D. Davis, 35 Brigham Ln Pk Lot #19, Lake Katrine, NY 12449. Fr 9. [4-7]

Firepower (FPR), A, Swiss, Continuous 4 2-hr rds. Single-squad scenario. Advanced rules with option 16.8-.9. Not used: Terrain Destruction, Buildings, Crewed Weapons, Vehicles, Acquire/Discard weapons, & Advanced Tree Cover. Victory by accumulated scenario points. J. Krauss, Box 165, Bunola, PA 15020. Fr 16. [5-6]

Football Strategy (FBS), B, SE, Continuous, 5 2-hr rds. J. Powell. Th 19. [2-4]

Fortress Europa (FSE), A, SE, Continuous, 4 3-hr rds of the 33.3 Invasion scenario. Mulberry damage (29.5) occurs only on a dr of '6'. R. Heller, 138 Osprey Dr, Groton, CT 06340. Th 18. [2-4]

Gangsters (GSR), B, SE, Continuous 3-hr rds of 4-player games. Bring stopwatch or watch with second hand if available. J. Vroom. Sa 19 [8-0]

Gettysburg '88 (GBG), A, SE, Continuous, 5 4-hr rds of Scenario 5 using all Options except 10D. K. McCarthy. Fr 20. [6-9]

\$Greed (\$GR), B, Swiss, 4 1-hr Heats. Play in subsequent Heats by losing points accrued in previous Heat. Each player plays 3 consecutive rd/Heat. No final rd - just a decision whether to risk what you have for a better score. R. Cox, P.O. Box 1144, Clemson, SC 29633. Th 24, Fr 22, Fr 24, Sa 18. [No restrictions]

Here Come the Rebels (HCR), Demonstration by designer Joe Balkowski showing how the new game links with Stonewall Jackson's Way. Th 19, Fr 13

History of the World (HWD), B, Continuous 4-hr rds. P. Weintraub. Sa 9. [7-8] Teaching Demo Game We 19.

Kingmaker (KGM), A, SE, Continuous, 4-hr rds. Variant cards will be used; Advanced Combat won't. H. Thoen, 6220 Sherbrooke St. W, #510, Montreal, QUE H4B 1M3 Canada. Sa 18. [8-9]

Kremlin (KRM), B, Swiss-Elim, Continuous Heats, 2 3-hr Prelim rds. Any double winners automatically advance to 8 PM Final. Single winners plus others (determined by points) advance to 4 PM Semi-Final. S. Cousins, 96 Cedar St #4, Bangor, ME 04401. Fr 9, Fr 12. [4-6]

➤ **Legends of Robin Hood Jr (LRH)**, B, SE, Continuous, 2-hr rds. J. Scarborough. Su 9. [0]

March Madness (MMS), B, SE, Scheduled Heats, 4 4-hr Advanced Game Prelim of 16-team Regionals which will each advance 1 team to Final Four on Sunday. Players draft up to 2 teams/Region which play till they lose. Players participating in more than 1 Region draft last. J. Ellman. Fr 15, Fr 20, Sa 15, Sa 20. [X, 0]

MBT (MBT), A, Swiss Elim, Continuous, 3 2-hr prelim rds, top 4 advance to 4-hr SE. Simple scenarios; no Helo/Air used. M. Walker, 105 Alwyn Blvd, Ladson, SC 29456. Sa 9. [7-9]

Merchant of Venus (MOV), B, SE, Continuous 2-hr rds. Winner based on % of game's money. G. Mayer, 5190 Winter Haven Ct, Imperial, MO 62052. Sa 9. [7]

➤ **Merchant of Venus JR (MVJ)**, B, SE, Scheduled 2 4-hr rds. C. Hickok. Th 18. [2-4]

Mustangs (MUS), B, SE, Continuous 1-hr rds of scenario 1 with no options. A. Maly. Th 18. [2-3]

Napoleon (NAP), B, SE, Continuous 4-hr rds. Players will play both sides in each rd. If both win, victor is based on time of win, most units left, and most CV left in that order. B. Smith, 9E Squire Vlg, Walden, NY 12586. Sa 9. [7-9]

Naval War (NVW), B, SE, Continuous 2-hr rds of 6-players to 75 pts. J. Sharp. Th 12. [1-2]

Pacific War (PCW), B, Swiss Elim, Continuous, 4-hr rds, 2 prelim battle scenarios with the VC converted into VPs and players bidding VPs for sides. Two highest scores advance to SE Final. M. Herman. Fr 13. [4-7]

Panzerblitz (PZB), A, DE, Continuous 3-hr rds. C. Harris. Sa 9. [7-9]

Panzergruppe Guderian (PGG), A, DE, Continuous 5-hr rds. Bid VPs for sides. Can't anyone beat two-time champ P. Rennert, 7135 Kurth Ln, Seabrook, MD 20706? Fr 19. [6-9]

Pax Britannica (PXB), B, DEMO, 1 7-hr rd. Duplicate Tournament with improved rules. All random events rolled. R. Sacks, 4861 Broadway 5V, NY, NY 10034-3139. Fr 10. [4-5]

Peloponnesian War (PPW), B, DEMO, Swiss Elim, Continuous, 4-hr rds, 2 prelim mini-scenarios with players bidding VPs for sides. 2 highest scores advance to SE Final using the Campaign scenario. M. Herman. Fr 15. [5-7]

Rail Baron (RBN), A, SE, Continuous, 5-hr, 5-player rds, 6-player final. Teaching Demo Th 21. C. Foster, 6809 McCart Suite 104, Ft. Worth, TX 76133. Fr 14. [4-6]

Republic of Rome (ROR), A, SE, Continuous, 6-hr rds. The Middle Republic scenario will be used for the 1st rd, Early Republic for the second, and Late Republic for the third. If game wins, no players advance. Sudden-Death VC

MARRIOTT'S HUNT VALLEY INN By Car

Take Exit 20A on Shawan Road off I-83.

Marriott's has an indoor/outdoor swimming pool, whirlpool, tennis, exercise room and sauna, ice cream parlor and deli, and the Fifties-style Wurlitzer's night club. It is within walking distance of Hunt Valley Mall and convenient to light rail travel to Baltimore's fabulous Inner Harbor. For baseball fans, the Orioles are at home in their new ballpark on Wednesday vs the Brewers and Sunday vs the Indians, but sellouts are common so order your tickets now by calling (410) 685-9800. Your special AVALONCON rates at the Marriott apply Wednesday through Monday...but only if you make your reservation by July 16th.

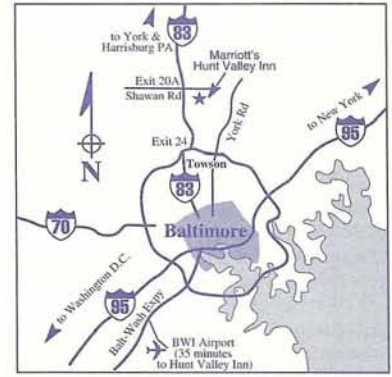

PUBLIC TRANSPORT

AMTRAK: Leave Penn Station walking SW to the Mount Royal Station of the Light Rail. Board the Light Rail North to the Park & Ride last stop at Deereco and Timonium Roads. Take Bus #9 North up York Road to Hunt Valley Mall. There is a bus every 15 minutes.

GREYHOUND: Walk west on Fayette St. to Howard St. and then North to Lexington Market Light Rail Stop. Take Light Rail North to the last stop in Timonium. Take Bus #9 North to Hunt Valley Mall.

Tickets must be purchased before you board the train. Transfers allow you to transfer between MTA buses, the Metro, or Light Rail to continue a one-way trip. Pay for your transfer before you board the light rail. Total one-way fare is \$1.25 plus a .10 transfer.

AIR TRANSPORT

USAir has been designated as the official carrier for the attendees of AVALONCON. Together, USAir, USAir Express and USAir Shuttle offer more than 5,082 flights daily to more than 211 cities. For our convention in Baltimore, USAir and USAir Express offer 194 flights daily. Of course, USAir Frequent Traveler members will earn a minimum of 750 Frequent Traveller miles when flying on USAir to the convention.

To obtain the most current flight and fare information, call the USAir Meeting and Convention Reservation Office at (800) 334-8644, 8 AM to 9 PM, EST. Once your reservations are confirmed, USAir can mail the tickets to you or suggest several other convenient methods of purchase. If you normally use the services of a travel agent or corporate travel dept, please have them place the call for you. Refer to Gold File Number 46510055. Travel for AVALONCON is valid on USAir between August 3-10, 1993.

The BWI Shuttle Express - Route C to Hunt Valley provides Round Trip transportation to the Hunt Valley Inn for \$21 (\$14 one way) every two hours between 5:45 AM and 11:45 PM. Roundtrip tickets are on sale only at BWI. Reserve space by calling (410) 859-0800 at least two hours in advance on day of service.

from Vol. 27, #5 of GENERAL apply. J. Gottesman, 4264 Mary Ridge Dr, Randallstown, MD 21133. Fr 18. [5-7]

Roadkill (RKL), B, Swiss Elim, Continuous, 3 2-hr prelim rds with progressively longer races culminating in an 8-Section Final. Earn car upgrades in the prelims as per Campaign Circuit rules with top point cars advancing to the Finals. Demo teaching race Th 10. J. George. Th 12. [1-2]

Russian Front (RFT), A, SE, Continuous, 7-hr rounds. Advanced Game with no options. June '41 scenario. June Weather is Clear. Bid VPs for sides. J. Falling, 7129 Sandringham Dr, Raleigh, NC 27613. Fr 9. [4-9]

Seventh Fleet (7FT), A, DE, Continuous, 4 4-hr rds using Battle of South China Sea, Civil War in Philippines, Invasion of Hokkaido, Blockading Japan. K. Boylan. Sa 9. [7-0]

1776 (176), A, Swiss Elim, Scheduled, 3-hr scenario rds to pick 2 finalists for Su Campaign Game. N. Moran. Sa 9. [7-0]

Slapshot (SST), B, SE, Continuous, 2-hr rds with expanded player deck, transaction limits, and most options. J. Gottesman. Su 10. [0]

➤ **Speed Circuit Jr (SCJ)**, B, SE, 4-hr race using enlarged track and 1:55 scale miniatures. R. Cunningham. Fr 10 [4]

Speed Circuit (SCT), A, Other, Scheduled 3 4-hr prelim Heats. Best 2 results determine winner as in Formula 1. Detroit, Hockenheim, Paul Ricard circuits for qualifiers. Suzuka for Su 9 Final. Start Speed, 2d6 Chance Tables, and Forced Passing changes. 1:55 scale miniatures. R. Cunningham, 216 Charing Ct, Sterling, VA 20164. Th 13, Fr 15, Sa 13. [X, 0]

Squad Leader (SQL), A, Swiss Elim, Continuous, 3 4-hr rds to pick 8 finalists for SE. Original 12 SL scenarios. J. Miller. Th 10. [1-5]

Statis Pro Baseball (SPB), A, Other, Continuous, Draft your own team one player at a time, play short regular season, followed by best 2 of 3 playoffs. Write for list of players and rules. B. Patrick, 10323 Gratiot, Richmond, MI 48063. Sa 9. [7-0]

Storm Over Arnhem (SOA), A, SE, Continuous, 3-hr rds with optional hidden AT Gun placement and chit randomizers. J. Fuqua. Th 10. [1-3]

Stonewall Jackson's Way (SJW), A, Swiss Elim, Scheduled, 2 2-hr rds of Cedar Mountain to pick 4 finalists for SE Sa 10. J. Balkowski. Fr 15. [5, 7]

Superstar Baseball (SSB), B, DE, Continuous, 1-hr rds using randomly assigned teams of baseball greats. R. Cox, 57 Coastline Dr, Inman, SC 29349-9655. Th 10. [1-2]

The Russian Campaign (TRC), A, League, Continuous. A swiss format using 5-turn games with historic weather to determine SE seeding. Players will bid VPs for Germans. P. Flory. Fr 9. [4-0]

Third Reich, 4th Edition (3R4), A, SE, Continuous 10-hr rds using '39 scenario or mutual choice. GM provides variant substitutions. D. Bowman. Th 10. [1-0]

Third Reich Teams (4th Edition) (3RT), A, SE, Continuous, Teams of 3-6 players in 2 rds of Campaign Game play. If a third rd is necessary, a scenario will be used in the first rd. Each team simultaneously plays a game as both the Axis and Allies. Enter your own team or write to be assigned to one. B. Sutton, 9225 Fairlane Place, Laurel, MD 20708. Th 11. [1-0]

Thunder At Cassino (TAC), A, Swiss Elim, 3 1-hr prelim rds using scenarios to select 4 finalists for SE Campaign Game. R. Robinson. Fr 18. [5-8]

Titan (TTN), A, Swiss-Elim, Heats, Continuous 4-player qualifying Heats will run Th-Fr. Any winner may advance to 2-rd SE format Sa 9. B. Scott, 2317 Barracks Rd, Charlottesville, VA 22901. Th 10. [X, 7-8]

➤ **Titan JR (TJ)**, B, SE, Continuous, 3-hr rds, L. Lingle. Th 10. [1-2]

Title Bout (TBT), B, SE, Continuous, 1-hr, 8-rd fights leading to a 15-rd finale. B. Reiff, 2207 Smokey View Blvd, Powell, OH 43065. Fr 21. [6]

Turning Point: Stalingrad (TPS), A, SE, Continuous, 6-hr rds. One week games with tie-breakers. Bid VPs for sides. 3rd edition rule changes including Ranged Attacks x3, Russian CB and Landing Activation play balance rules. Special "Dice Tower from Hell" prize for the runner-up. Teaching Demo of Kuibyshev Sawmill Fr 9. R. Fedin, 112 Glengarry Dr., Coraopolis, PA 15108. Fr 12. [4-0]

TV Wars (TVW), B, SE, Continuous, 2-hr rds. R. Stakenas II. Sa 19. [9]

➤ **TV Wars Jr (TVJ)**, B, SE, Continuous, 3-hr rds. Fr 11 S. Buck. [4-5]

Tyranno Ex (TYX), A, Swiss Elim, Continuous, 4-hr rds. 3 prelim rds to pick 4 finalists using place finished as criteria with total VPs as tie breaker. C. Good. Fr 9. [4-7]

➤ **Tyranno Ex Jr (TXJ)**, B, SE, Continuous, 3-hr rds. K. Stroh. Th 10. [1]

Unlimited Civilization (UCV), a Civilization variant for early arrivals featuring marketplace auctioning of Trade Cards, randomly assigned calamities, 50 Civ cards, metropolises, pirate pursuit, iron/bronze weaponry, domestic stability points. J. Scarborough, RR1 Box 160, Payson, IL 62360-9743. We 18.

Up Front (UPF), A, League, SE, Continuous, 8 hrs of round robin divisional play of any scenario except O and W. Divisional winners advance to SE round of scenario A or B. M. Hawthorne, 8814 Cromwell Dr., Springfield, VA 22151. Sa 9. [7-9]

Victory In the Pacific (VIP), A, Swiss, Continuous, 7 5-hr rds. Teaching session & Strategy discussion Wed 20. G. Petroski, 210 W. Hunt, Twin Lakes, WI 53181. Th 20. [3-0]

War At Sea (WAS), A, Swiss-Elim, Continuous, 5 2-hr prelim rds, 4 finalists advance to SE. Bid for sides. A. Applebaum, 12 Gibbs St #3, Brookline, MA 02146. Th 10. [1-2]

War & Peace (W&P), A, SE, Continuous 2-hr rds of the 1813 scenario. B. Jackson, P.O. Box 631, Glenham, NY 12527. Fr 13. [4-6]

Waterloo (WAT), A, SE, Scheduled, 5-hr rounds. A 7 PM turn will be added to each day and the game will end after four days. R. Beyma, 109 Brentwood Circle, Pocomoke, MD 21851. Th 18. [2-5, 7]

Win, Place & Show (WPS), B, SE, Continuous, 4-hr rds. J. Burnett. Sa 16. [8-9]

➤ **Wizard's Quest Jr (WQJ)**, B, SE, Continuous, 2-hr rds. B. Navolis. Sa 17. [8-9]

Wooden Ships & Iron Men (WSM), A, Swiss-Elim, Continuous. Three 90-min prelim rds. Top 4 advance to SE finals. Advanced rules. J. McAden, RR#2, Box 43, Millbrook, NY 12545. Fr 9. [4-5]

Wrasslin' (WRS), A, SE, Continuous. Elimination bout. Each player receives a stable of three wrestlers. C. Kibler. Fr 18. [5-6]

➤ **Wrasslin' Jr (WRJ)**, B, SE, Continuous. Elimination bout. GM picks wrestlers. S. Duncan, Th 12. [1-2] Teaching Demonstration Wed 18.

Wrasslin' Battle Royal (WBR), A, SE, Continuous. GM selects wrestlers. C. Kibler. Su 11. [0]

Wrasslin' Tag Team (WTT), A, SE, Continuous. Best 2 of 3 falls per match. Form your own teams. GM selects wrestlers. C. Kibler. Sa. 15. [8]

WEDNESDAY NIGHT PLAYTEST SESSION

Checking in early to beat the Thursday morning rush? There will be unofficial events at AVALONCON to keep you amused. Our entire R&D staff will be on hand conducting demonstrations of new products or playtesting the next generation of Avalon Hill games. It all begins at 6 PM Wednesday.

Talk Diplomacy with Rex Martin while he leads a session of *ASSASSIN*—a new card game of international intrigue. If you haven't yet had a chance to humiliate Don Greenwood at *TPS*, let him show you his next offering in the area—movement, alternating impulse system with a game of *BREAKOUT: NORMANDY*. *ASL* players can bombard Bob McNamara with questions on the system while he demonstrates *KAMPFGROUPPE PEIPER*. Civil War enthusiasts can talk the blue and the gray while Craig Taylor demonstrates *HORSE SOLDIERS*. *TITAN* fans can try out the planned expansion module *THE MIGHTY & THE MAGI* with Mick Uhl. *GENERAL* subscribers can quiz editor Don Hawthorne about his plans for the magazine while getting in a practice game of *ROADKILL* with the *UP FRONT* guru.

And there will be other demonstrations and teaching sessions by our GMs plus plenty of Open Gaming space for those who want to warm up their dice before the competition starts in earnest.



ROOM RESERVATIONS

August 4th – 9th, 1993

Complete this form or a facsimile and return it with the required deposit to: Marriott's Hunt Valley Inn, 245 Shawan Rd, Hunt Valley, MD 21031-1099 Or call 1 (800) 228-9290. *Make your reservations promptly, as after July 16th rooms will be subject to availability and may be charged normal rates up to 50% higher than the specially-negotiated AVALONCON rate.* To guarantee your reservation for late arrival (after 6 PM) Marriott requires that you either enclose a check or money order covering the first night's stay, or send them the entire number of your major credit card. Don't forget the expiration date and your signature.

Name: _____

Address: _____

City: _____

State: _____ Zip: _____

Phone: () _____

Arrival Date: _____

Departure Date: _____

Check-in time is 4:00 PM. ♦ Check-out time is noon. Unguaranteed reservations will only be held until 6 PM.

Credit Card _____

Number: _____

Expiration Date: _____

Signature: _____

RATE: The Room rate is \$60.00 per day (if reserved by July 16th) plus 13% tax for one-to-four guests per room. Maximum of four people per room. A \$67.80 deposit is required to guarantee each room reservation.

I will share this room with:

Name: _____

Name: _____

Name: _____

Deposit Enclosed: _____

Registration and Open Gaming will begin Wednesday, August 4th at 4 PM. Official tournaments will not start before 10 AM Thursday. Reservations requested after July 16th are subject to availability. Rooms may still be available but not necessarily at this rate.

TIGER, TIGER



ASL SCENARIO G14



CHERNICHEVO, RUSSIA, 11 February 1943: Encouraged by the success near Schlüsselburg, the Soviet command decided to employ another pincer attack on the northern front. The objective of this even more audacious plan was to encircle the commanding Sinyavino heights and the road junction at Mga. If the operation went as hoped, a large part of the German 18th Army would be caught in the trap. The western pincer would launch its assault in the direction of Krasny Bor, and eventually move on to Mishkino. Just before dawn on the 10th of February, the Russians began their operation with a tremendous barrage, which fell squarely upon the Spanish 250th *Azul* ("Blue") Division. Resistance was short-lived, and the Russians surged through the gap. By afternoon the Soviets had taken Krasny Bor. The 4th SS-Polizei Division, to the right of the hapless Spanish, managed to withstand the attack and blocked the highway for the time being. Nevertheless, a large number of Russian tanks bypassed the SS, and had advanced as far as the village of Chernichevo by nightfall. In the evening, three Tigers and three smaller Panzers were sent from the reserve to the 4th SS-Polizei's commander. Lt. Meyer, in command of the little *kampfgruppe*, was promptly ordered by that general to take up position at Chernichevo and end the threat the Russian AFVs posed. Moving through the cold night, he briefed his tank commanders on the situation as they positioned themselves 300 meters west of the village.

VICTORY CONDITIONS: The Russians win at the end of any Game Turn if they have ≥ 8 Mobile AFV on board 11. For every German PzKpfw IIIN eliminated, deduct one from the total required for a Russian victory; for every PzKpfw VIE eliminated, deduct two.

BOARD CONFIGURATION:

11			
		18	33
			17



BALANCE:

- ✚ Add a 9-1 Armor Leader to the German OB.
- ★ Add an 8-1 Armor Leader to the Russian OB.

TURN RECORD CHART

SIMULTANEOUS Set Up (See SSR 2)	1	2	3	4	5	6	7	END
★ RUSSIAN Moves First								

Elements of the 46th Tank Brigade set up, in Motion, on board 17 road hexes on/between hexrows K and V: {SAN: 0}

 10 11 11 76L 2/4 ⁸²	 11 11 8 76L 2/4 ⁸²	 14 8 6 76L 2/4 ⁸²
6	6	6

Elements of schwere Panzer Abteilung 502 set up on Level 1 hill hexes on board 18: {SAN: 0}

 12 11 8 1 88L 3/5	 13 6 3 1 75* 3/5
3	3

Set up on board 11:

 AA M 4 2 88L AS/4/3 ⁴	 2-2-8
---	-----------

SPECIAL RULES:

1. Weather is Ground Snow (E3.72), with no wind at start.
2. Setup is simultaneous. Stand an extra board across the playing area so neither player can see the other's placement of units. When both sides have finished setting up, remove the extra board and begin play. Note that German HD DR (D4.221) must be made *after* the extra board is removed immediately prior to the first Game Turn.
3. All buildings are wooden. Level-2 hill hexes do not exist (i.e.; treat such on board 11 as Level-1 hill hexes).
4. The German 88L AA Gun may be Bore Sighted.
5. All Russian AFV have Winter Camouflage (E3.712).

AFTERMATH: In the first light of the new day, the Germans could observe the Russian crews as they casually ate breakfast and climbed aboard their tanks. Some 40 KVs of various models prepared to resume the advance towards Mishkino. When the first shells from the Tigers struck home, several of the Soviet tanks burst into flame. Quickly the fight became a long-range armor duel. Despite losses, more and more Russian tanks rolled out of the cover of the houses and into the snow-covered fields. By sheer weight of numbers, eight to ten reached the positions occupied by the lighter German panzers, which were massed on a slight rise. As the first topped the slope, a concealed "88" opened fire, knocking out three in rapid succession. Then the gun itself was destroyed by a direct hit. Nonetheless, the combined fire of the Tigers with this AA gun had turned the tide and stopped the Russian attack. Only a few KVs succeeded in escaping back to the village. According to German records, for the loss of one Tiger and two other AFVs, 36 enemy tanks had been destroyed. Meyer would be awarded the Iron Cross (First and Second Class) and a promotion by the commanding general himself. The Russian threat was far from over, however; for the next month the Panzers of Abt. 502 would act as a "fire brigade" along the entire front, clearing up enemy penetrations in a dozen spots.

BURZEVO



ASL SCENARIO R



VICTORY CONDITIONS: The Russians win if at game end they have amassed ≥ 8 Casualty VP (Personnel only), provided the 88L gun is eliminated/unmanned and all German AFV are eliminated/immobilized.

BURZEVO, RUSSIA, 2 December 1941: By the end of November, Operation "Typhoon" had blown itself out; resolute Soviet resistance, German exhaustion, and sub-zero temperatures had frozen the German advance into virtual immobility. Along the Minsk-Moscow highway, the most direct route to the Russian capital, von Kluge's Fourth Army made a last, desperate effort to dislodge the defending Russians by an encircling attack from the south. But the only real progress was made by the 258th Infantry Division, whose spearheads managed to capture the village of Burzevo on the afternoon of the 2nd. The 3rd Battalion of its 478th Infantry Regiment was ordered to hold there. The men of the regiment were anticipating a blessed respite from the -30° F night. But at 0200 hours, the Russians counterattacked.

BOARD CONFIGURATION:

BALANCE:

✚ Majority Squad Type for the German is Normal.

★ The identity of the OT-34 is unknown to the German (it is represented onboard by a T34 M41, ID letter recorded secretly) until its FT is first used, at which point the OT-34 counter is immediately substituted for the recorded T34.



TURN RECORD CHART

✚ GERMAN Sets Up First	★	1	2	3	4	5	END
★ RUSSIAN Moves First							

Reinforced Elements of Bataillon III, Infanterie Regiment 478 [ELR: 3] set up on/between hexrows L and Z (see SSR 4): {SAN: 2}

	 4 ¹ -6-7	 2-2-8	 9-2	 8-1	 8-0	 5-12	 3-8	 1-12	 30-1
	8	2				2	2	2	

	 14 6 3 75*	 16 1 1 15PP AAMG -/-/3	 AA M(4)
	3		

Elements of the 20th Tank Brigade enter on Turn 1 along the east or west edge: {SAN: 0}

	 17 6 76L 2/4	 17 6 76 2/4	 17 6 76L -/-/4
	2	5	

SPECIAL RULES:

1. Weather is Extreme Winter (E3.74) with Ground Snow, Wet EC and with no wind at start.
2. Night Rules are in effect. The initial Base NVR is four hexes, with Overcast cloud cover. The German is the Scenario Defender (E1.2); the Russian is the Scenario Attacker. The Majority Squad Type for the German is Lax.
3. All buildings are wooden. All hills are non-existent, but buildings/woods thereon exist normally at Level 0.
4. All German non-crew MMC must set up in buildings, with a maximum of one per Location. No StuG may be set up in a woods or building hex. The

AFTERMATH: Amid blazing buildings and tanks, the German infantry tackled the T34s that had overrun the outposts with demo charges, ATRs and anything else at hand. By dawn the Soviet attack had been defeated, but with heavy losses to the 3rd Battalion. Later that same day, von Kluge suspended the offensive and ordered all units to withdraw back across the River Nara. The trials of the men of the 478th were far from over, however; the Russian winter offensive was only days away.