

# GENERAL

\$3.00

★ AVALON HILL

Volume 21, Number 5

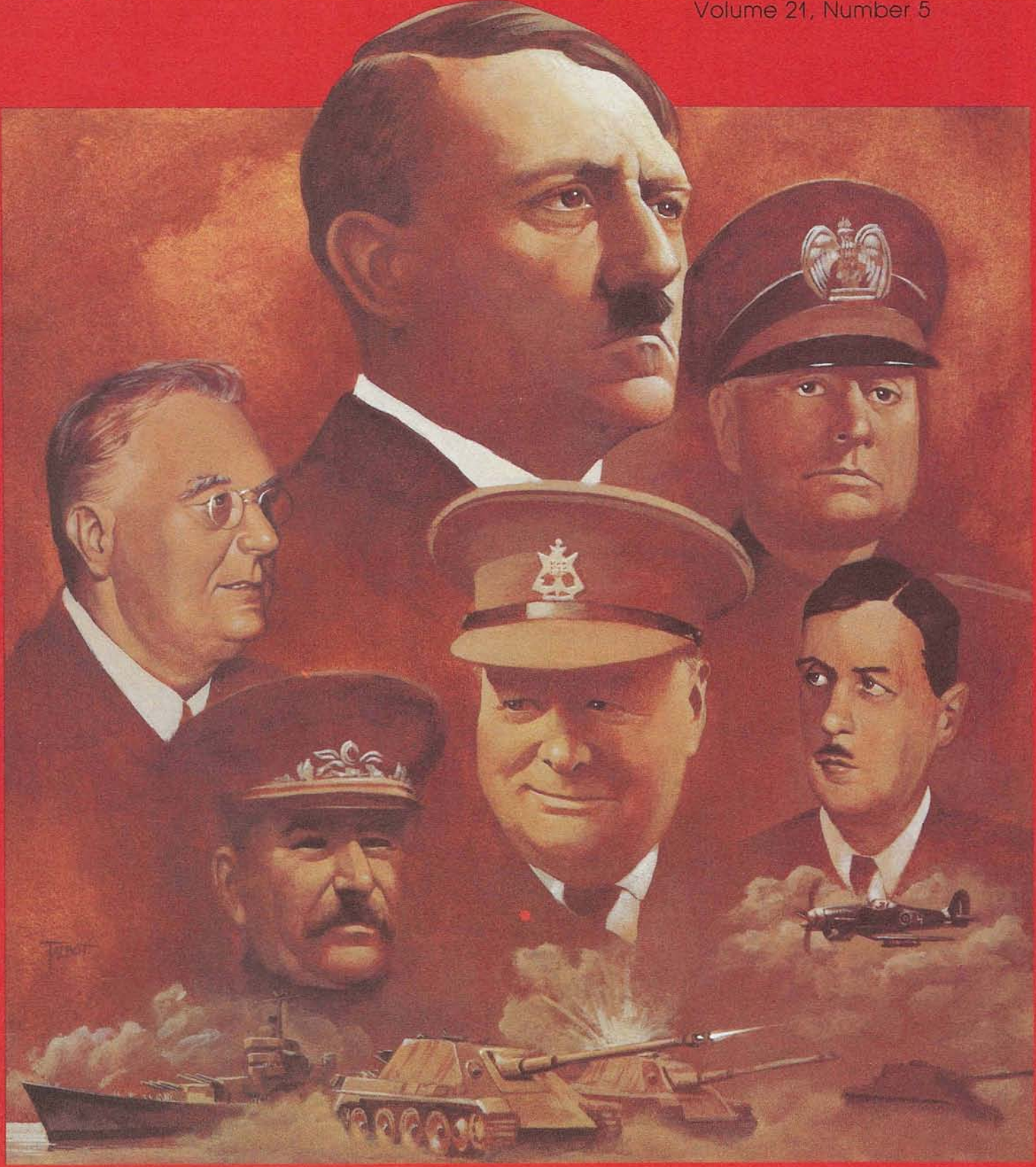

# ★ ★ The AVALON HILL GENERAL

## The Game Players Magazine

The Avalon Hill Game Company's *GENERAL* is dedicated to the presentation of authoritative articles on the strategy, tactics, and variation of our games of strategy. Historical articles are included only inasmuch as they provide useful background information on current AH titles. The *GENERAL* is published by The Avalon Hill Game Company solely for the cultural edification of the serious game aficionado, in the hopes of improving the game owner's proficiency of play and providing services not otherwise available to the game buff. The Avalon Hill Game Company is a division of Monarch Avalon Industries, Inc. The shares of Monarch Avalon, Inc. are publicly traded on the NASDAQ System under the symbol MAHI. For information about the company write to Martha Burman at the executive offices at the company, 4517 Harford Rd., Baltimore, MD 21214.

Publication is bi-monthly with mailings made close to the end of February, April, June, August, October and December. All editorial and general mail should be sent to The Avalon Hill Game Company, 4517 Harford Road, Baltimore, MD 21214. One year subscriptions are \$12.00. Two year subscriptions are \$18.00. All domestic subscriptions sent via bulk permit. Domestic First Class Delivery and all subscriptions to Canada and Mexico must pay an additional \$9.00 per year postage charge. All overseas subscriptions must add an additional \$12.00 per year postage charge. Send checks or money orders only. The Avalon Hill Game Company is not responsible for cash lost in transit. Those with a current American Express, VISA, MasterCard or Choice may call 800-638-9292 toll free to renew subscriptions or order merchandise. Absolutely no complaints or questions will be handled on this number. Any business other than a credit card purchase must be handled by mail. Address changes must be submitted at least 6 weeks in advance to guarantee delivery. Paid advertising is not accepted, but news of importance to the gaming community is solicited. Convention announcements must be received at least 3 months in advance and contain information pertaining to The Avalon Hill Game Company's games in use.

Articles from subscribers are considered for publication at the discretion of our editorial staff. Articles should be typewritten, double-spaced, and embrace the tenets of good English usage. There is no limit to word length. Accompanying examples and diagrams should be neatly done in black or red ink. Photographs should have caption and credit line written on back. Rejected articles will be returned whenever possible. Potential authors should be advised that all outside submissions become the sole property of The Avalon Hill Game Company.

**EXECUTIVE EDITOR:** Donald J. Greenwood

**MANAGING EDITOR:** Rex A. Martin

**GRAPHICS:** Jean Baer, Dale Sheaffer, Charles Kibler and Mike Creager

**COVER ART:** Jim Talbot

**MASTHEAD DESIGN:** Stephanie Czech

**AREA Technician:** Brenda Parrish

**GENERAL Subscriptions:** Gertrude Zombro

**Purchase of Games, PBM kits and parts:** Brenda Brauer

**FOREIGN DISTRIBUTORS:** Overseas readers are urged to make subscription arrangements with the appropriate agent,

AUSTRALIA: Jedko Games, 18 Foncaca St., Mordialloc, 3195, Victoria; BELGIUM: Codaco S.P.R.L., 1072 Chausse de Ninove, 1080 Bruxelles; DENMARK: Jorn Erksen, Sondertoften 209, DK 2630 Taastrup; FINLAND: Kulttuurikanava, Lorkeavourenkatu 13, 00130 Helsinki 13;

GREAT BRITAIN: Avalon Hill (UK) LTD, 650 High Rd., North Finchley, London N. 12, ONL; HONG KONG: Arnold Enterprise, 130C Lu Shan Mansion, Taikoo Shing, Hong Kong;

ITALY: Selegioch s.r.l., Via Fumagalli 6, 20143 Milano;

JAPAN: Post Hobby, Yoyogi, Cityhomas Bldg. 26-5, 5-chome Sendagaya, Shibuya-ku, Tokyo 151; NORWAY: Morn-Eversen & Noddellund A/S, Jacob Aallsgt. 49, Postboks 5122 Majorstua, Oslo 3; SINGAPORE: Wong International Entr., 6 Jalan Sinar Bulan, Singapore 1750; SPAIN: Joc-Play S.A., Aribua 272-274, Barcelona 6; SOUTH AFRICA: Gamma Games Ltd., P.O. Box 2904, Capetown 8000; SWEDEN: Hobbyhuset, Box 2003, S-750 02 Uppsala.

**Rules Questions:** R&D. NOTE: all questions should be diagrammed. No questions can be answered which are unaccompanied by a self-addressed envelope. Questions must be based on rules of play (not historical or design matters) and be based on the current rules edition. Questions on more than one game must be listed on separate pages and accompanied by a separate SASE for each game.

**IF YOU CHANGE YOUR ADDRESS:** Inform us immediately. The Post Office destroys magazines even if you leave a forwarding address. The Avalon Hill Game Company assumes no responsibility for issues lost due to an invalid address. Please state both your new and old address.

## AH Philosophy Part 107

One of many letters framed above a desk at The Avalon Hill Game Company's Research and Design Center in Baltimore, Maryland . . .

Dear Mr. Greenwood,

I just had to write to tell you what a terrific game you have in *SQUAD LEADER*. In fact, the entire series is beyond compare. It is without a doubt the best game I've ever played. I anxiously await the *ADVANCED SQUAD LEADER* combined rulebook. When can I send my money?

Joe Beckworth  
Kansas City, MO

And one of several letters lining the bottom of a waste basket at the same address . . .

Dear Mr. Greenwood,

The purpose of this letter is to both praise and admonish the efforts of you and TAHGC. I wish to praise The *GENERAL* for its varied contents. I support the decision to have a wide range of games covered in its pages. As a result of articles therein, I have become interested in some of your other products, although remaining primarily a *SQUAD LEADER* player. It is when *SQUAD LEADER* comes to mind that negative feelings take over.

While understanding your Company's legal obligation to defend its copyrights, I feel you have a duty to your loyal *SQUAD LEADER* customers.

Continued on Page 12, Column 1

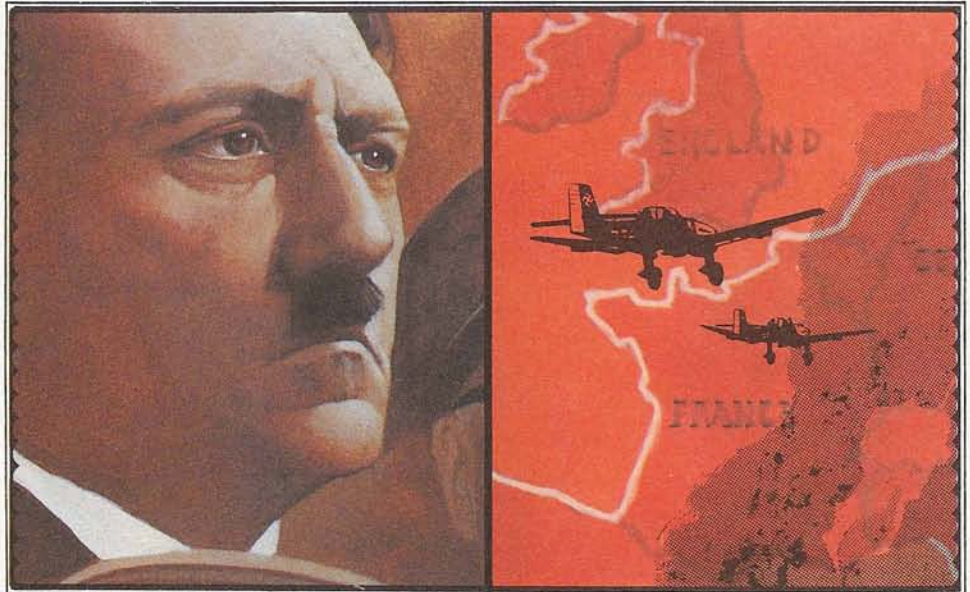

### A WESTERNER'S VIEW

German Strategy for *HITLER'S WAR*

5  
By Michael Palmer

### HITLER'S ALTERNATIVES

Variants for *HITLER'S WAR*

9  
By James E. Meldrum

### DESIGN ANALYSIS

Errata for *HITLER'S WAR*

11  
By Mick Uhl

### WHICH WAY THE WITCH KING

A *MAGIC REALM* Seminar

14  
By Paul R. Bolduc

### TOURNAMENT ORIGINS

A Truly Diplomatic System

20  
By Dave Slick

### THE COMPLEAT DIPLOMAT

Give Till It Hurts!

22  
By Rod Walker

### THE LUCK OF THE DRAW

*THIRD REICH* Variants

23  
By James C. Gordon

### MOVIN' ON

Strategies & Tactics for *RAIL BARON*

28  
By Bertrand Bauer

### FUR TRADERS AND BUCCANEERS

Historical Variant for *CONQUISTADOR*

34  
By Glenn Rahman

### QUO VADIS?

Choosing A Nation in *CIVILIZATION*

41  
By Daniel Ferens

### SQUAD LEADER CLINIC

View From the Trench

44  
By Jon Mishcon

# FIREPOWER®

**FIREPOWER** is a detailed look at the organization, weapons and equipment and tactics of many of the world's nations since 1965. During the long "peace" since the end of World War II, there have been innumerable wars and threats of wars. New weapons have entered inventories in the more advanced nations, then been replaced in turn by still newer weapons, while the older equipment filtered down to the armies of the "third world". Unit organizations have been shuffled and new tactics devised and tested in attempts to integrate the new weapons for maximum flexibility and effect. **FIREPOWER** gives players the opportunity to command squad units in recent or current wars, and to experiment with their own squad organizations. The destructive capabilities are massive, and the problems of command and control in devising effective tactics are a real challenge for any gamer.

**\*Endless Scenario Variations:** Use any of the given scenarios or devise your own.

**\*Hundreds of Differentiated Weapons and Vehicles:** We won't say that it is all here, but just about every important piece of equipment from the M1911A1 pistol to the M1 "Abrams" tank is covered.

**\*Flexible Mapboards:** The mapboard panels may be arranged in numerous configurations and their terrain varied for situations varying from deserts to jungles to city blocks.

**\*Organizational Data:** Squad organizations from over 50 different nations.

**\*Solitaire Playability:** Can't find an opponent? The solitaire scenarios provide a real challenge.

**\*Basic, Advanced, and Optional Rules:** Choose the levels of complexity and detail that YOU enjoy.

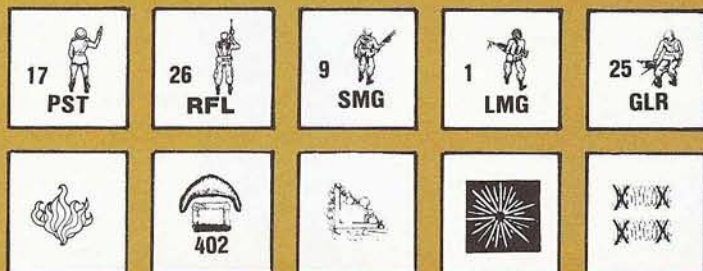

**FIREPOWER** is now available for \$22.00 from The Avalon Hill Game Company, 4517 Harford Road, Baltimore, MD 21214. Please add 10% shipping and handling to all orders (Canadian orders, add 20%; overseas, 30%). Maryland residents please add 5% state sales tax.

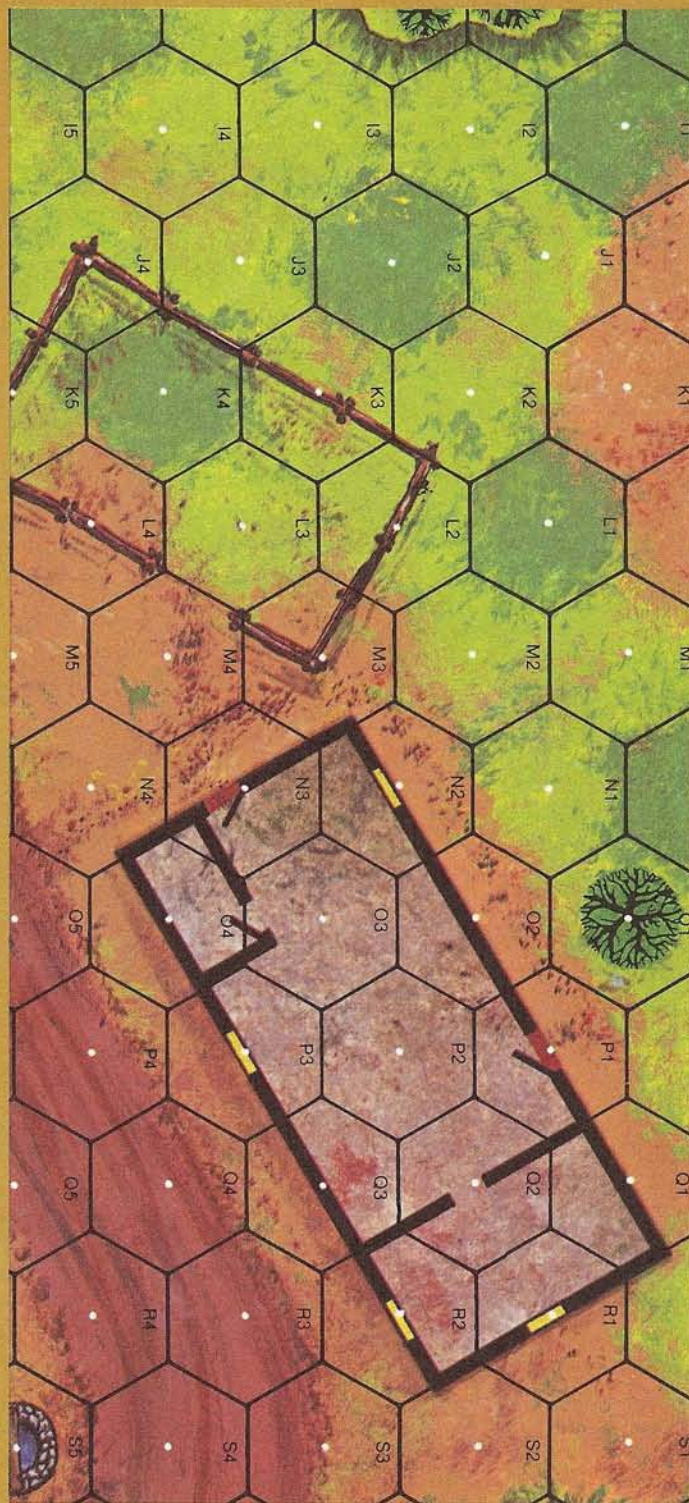

# Stellar Conquest

**THE HEAVENS**—A home to the ancient gods, an infallible guide to the traveller, inspiration to the poet, the ultimate enigma to the scientist, a wonderful and beautiful mystery to us all—now becomes the battlefield of the future.

STELLAR CONQUEST presents the heavens to explore and develop. In the beginning the galaxy is completely unknown to you and your rivals. Each of you command a space fleet consisting primarily of colony transports protected by a small number of warships. In advance are the scout ships to lead the way. They must quickly search and locate planets suitable for habitation. It is important to settle your people as soon as possible since they will form the basis of your industrial power. Once established, you can begin producing weapons and researching new technologies to support further exploration and migration. Inevitably, you will collide with other civilizations intent upon their own expansion and then, you must be prepared to fight. In STELLAR CONQUEST, strength begets strength, and only by a careful policy of production and expansion can you hope to gain enough planets to ensure the survival of your civilization.

Here are just a few of the many decisions you must be prepared to make:

You must decide very early on whether to concentrate on developing the planets you already have discovered or to continue exploring the galaxy for better homesteads. There are some valuable planets to be found and it is always preferable for you to be the one to find them. However, too much effort in exploration could put you behind the pack in the productions race.

Certain planets support high numbers of people but little resource. While others are mineral-rich but virtually uninhabitable. Occupying the former will ensure slow but steady growth. Colonizing the latter can yield quick dividends but at the expense of growth. Which is better? It will be up to you to decide.

Heavy investment into research once achieved can lead to many advantages but leave you vulnerable during the process. Yet if you can survive until their fruition, double salvos, faster speed, wider ranging and more powerful warships can turn the tide to your favor.

If you are able to amass a large empire early, a defensive posture might be the best strategy. Research and construct missile bases and planet shields to protect your holdings. However, if you have fallen behind, you can always build war fleets to win by force the industrial planets you were unable to develop yourself.

STELLAR CONQUEST is now available for \$24.00 from The Avalon Hill Game Company, 4517 Harford Road, Baltimore, MD 21214. Please add 10% shipping and handling to all orders (Canadian orders, add 20%; overseas, 30%). Maryland residents please add 5% state sales tax.



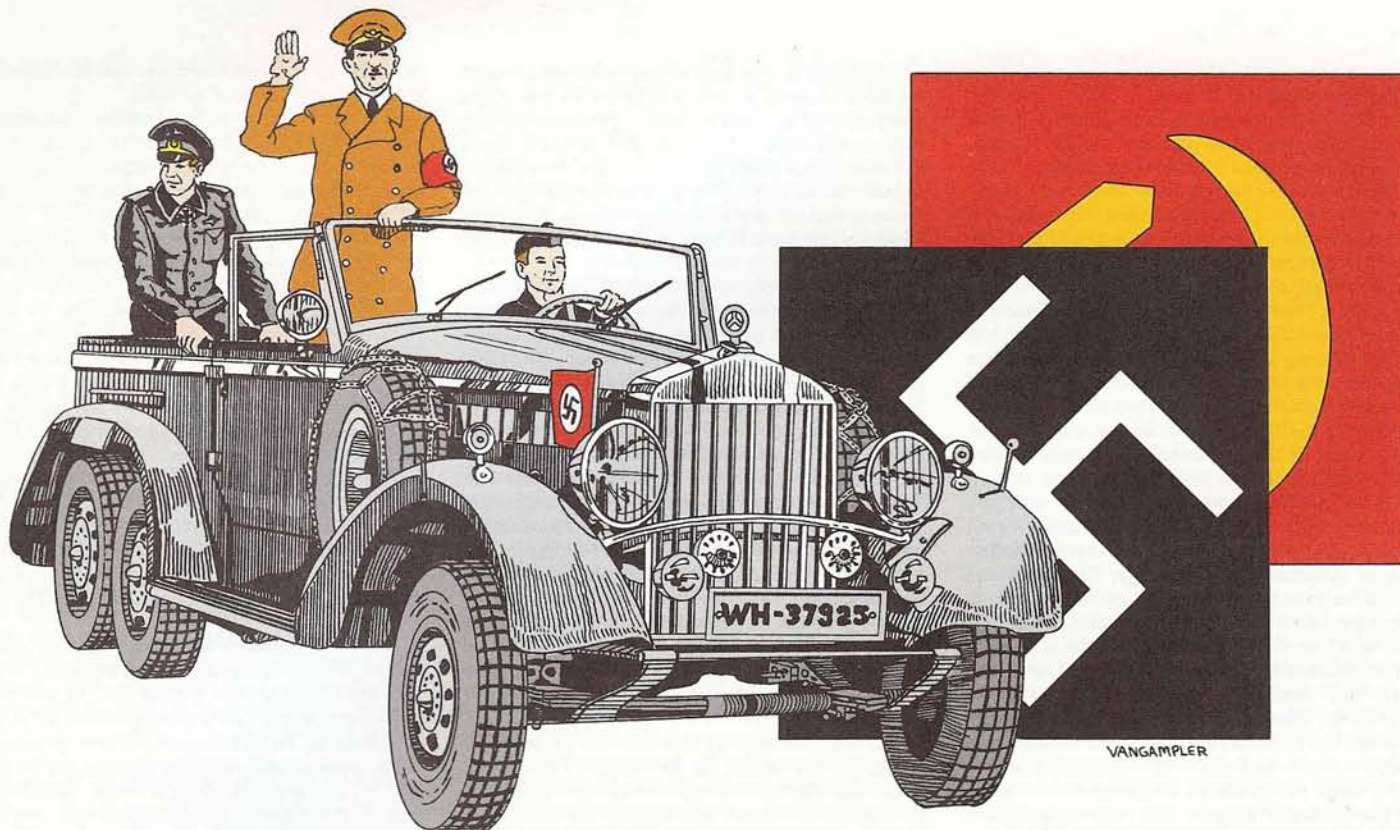

## A WESTERNER'S VIEW

### German Strategy for HITLER'S WAR

By Michael Palmer

Have you grown tired of the complexities of *THIRD REICH* with its endless questions? Have trouble devoting a day to its play, or lining up five fairly competent folk to play it? Maybe the colorless map and oodles of counters put you off. Now comes liberation from this demon that demands so much of our bodies and souls. *HITLER'S WAR* spells relief.

The latest edition of *HITLER'S WAR* is a revision of a game of the same name first published by the now-defunct Metagaming in 1981. This new version contains superior components, a mounted map, and a much cleaned-up design. The sequence of play has been changed (with strategic warfare now following, rather than proceeding movement and combat). Rules for strategic submarine warfare have been drastically altered (about which more in due course). Naval warfare has been refined and greatly expanded. The player aid charts are significantly improved, as are the research and development rules. The physical improvements alone make The Avalon Hill Game Company's edition worth the price.

#### The Game

*HITLER'S WAR* is a grand strategic simulation of the Second World War, European Theater of Operations. The board is small, 16"×22", and the actual playing area only about 13"×16". The very colorful map covers Europe and the Middle East from the Atlantic Ocean to the Ural Mountains, from northern Scandinavia to North Africa. Each hex represents an area about 80 miles across. Do not be put off by the scale; it is only four hexes from Normandy to Berlin, and seven from Moscow to Berlin, but the system makes each of these hexes critical and the battles raging over them exciting. Also on the mapboard are the *Production Points*,

the total of which held by each player gives him his base of construction (in much the same manner as the BRPs of *THIRD REICH*, but with more realism). And all important sea routes to the rest of the world (the important parts of which depicted by colored boxes) are shown. On the map, a nice touch from some recent games, are all the tables you'll need in the play.

Land counters represent Army and Army Group headquarters to which the players—Axis, Allied, and Soviet—can assign infantry, mechanized, tactical air, paratroop, and amphibious points. Under the optional rules, these headquarters may be assigned leaders as well. Individual charts (one each for the Western Allies, Axis and Soviet players) track the actual strength of the Armies/Army Groups. Obviously, some of the counters on the board will be built up, others only "paper tigers". An element of "fog of war" enters play. There are also naval and strategic warfare markers representing capital ships and carriers, submarines, anti-submarine warfare units, strategic bombers, escorts, interceptors, and surface-to-surface missiles. All players have the potential to build an atomic bomb. The possibilities and options are endless. Each turn represents four months. A complete campaign game consists of eighteen turns.

The combat systems are unique. Armies may move only within controlled areas. Once at the "front", they may be launched into enemy territory. All initial attacks are declared, the units may either simply assault—killing enemy combat points in on-board Army/Army Group counters—or advance entailing no casualties but capturing territory and making it "friendly". Each unit may assault only once per turn, but may advance as long as it continues to roll the die well. Unfortunately, a consequence of the advance devastates any produc-

tion points in that hex. (But these can be repaired; it just costs a bit.) Special rules handle mountain, invasion, winter and "Off-Map" (those important other areas of the world mentioned above) combat. There are many subtle methods and strategies to all this, which I'm certain will be explored in detail in later articles. Suffice to say, that the combat system is intriguing enough to warrant extended study and is much superior to the traditional system found in *THIRD REICH*.

As but a single example of this study, consider the following. In an advance, the mechanized points of the Army/Army Group are compared to all the combat points in the opposing army (or the inherent garrison if unoccupied). The difference between the two is the range of die rolls needed to succeed. If the number rolled is within the range, the attacking Army/Army Group advances into the enemy hex and the defending Army/Army Group is forced to retreat into an adjacent friendly hex. (It is possible for a force containing no mechanized points to attempt an advance, but only against either unoccupied or ungarrisoned enemy hexes.) A successful advancing Army may continue its drive by attempting an advance against the next enemy hex, but its chance of doing so is reduced. The attacker must add one to its die roll for each hex it has already advanced that turn.

It would seem that one wants to maintain large purely-mechanized armies, right? Wrong! Any Army with armor will certainly drive far, but will let the enemy player in his following turn *assault* (a much bloodier proposition for the defender) and simply wear away the armored force. Since mechanized points are considerably more expensive than infantry, the morale is obvious. And, if the mechanized behemoth has advanced too far unsupported, the enemy may simply cut its supply line

to send it scampering back to hide under the skirts of the foot-sloggers. If there is one lesson that *HITLER'S WAR* teaches, it is to obtain a proper balance of combat point types for the job at hand. A purely mechanized force is a sitting target when on the defense (i.e., during the other player's turn). Infantry is still the "queen of the battlefield". Of course, for those specialized tasks you'll need the air, paratroop and amphibious combat points. These too have their tricks and techniques.

Finally, I must mention the economic aspects of all this, for *HITLER'S WAR* is much more than merely shoving pieces around. Like any excellent strategic game these days, it demands a great deal of forethought from the players controlling the destinies of the three powers. During each Production Phase, the players expend their accumulated budget (the production points of the areas he controls) on building new combat points—with the "quality" stuff more expensive of course—or on repairing devastated territory to increase its production, or research and technology. The latter can reduce the expense of building combat unit types, or bring on some new "super weapons". Here we have such "goodies" as carriers, bombers, missiles and the dreaded atomic bomb. As is usual, once one player has launched himself on such a path, the others must follow simply to maintain the balance of terror. Very careful planning to create the balance of forces mentioned above is the keynote here.

The range of options in the game is very wide, and the mechanics elegant. The systems really are some of the cleverest on the market, and The Avalon Hill Game Company's handling has put the icing on the cake. It is a fine piece of design, and of development. The scale is admittedly large, but in all honesty it is a worthy successor (or stablemate if you prefer) to *THIRD REICH*. Certainly if you've one, you should have the other. And you can play *HITLER'S WAR* to completion in an evening.

## The Problem

The rest of this article will deal specifically with the Campaign Game II ("The War for Europe") with the use of all rules, including those optional. In this advanced format, each player is locked with the enemy in three distinct, but interrelated, struggles. First, he must decide which types of units he wishes to possess, and he must channel production points into their research and development. Secondly, he must carry out strategic warfare against his enemies and defend his own industrial base against their efforts. Third, he must fight the ground war and occupy key centers with his armies. If a player is to make any coherent effort to win the game, he must decide upon a strategy for the prosecution of the war as early as possible. The game system punishes those who try to reshape their plans in mid-game. As does war.

The Axis player, holding the initiative early in the game, of necessity will be the first to decide upon his strategic approach for the war. His decisions, in turn, will determine the options available to his Allied and Soviet opponents.

To shape an effective strategy, the Axis player (and all the players) must keep their eyes firmly on the victory conditions. In the two-player version, the Axis wins if at game's end (Summer 1945) Berlin is still German. In the three-player game, victory is determined by control of Berlin (for the Axis player) and possession of production points on the board. There are 110 production points on the map, though all may not be in play. Given the scenario victory conditions for winning, if the Axis player can hold onto more than thirty points, he will probably win at least a Marginal Victory. Possession of the central core of Europe—Denmark (one production point), the Low Countries (two), Germany (sixteen), Italy (seven), Yugoslavia (two), Greece (one), Poland (two) and Rumania (one)—will yield 32 points.

To win, then, the Axis player need not conquer the Soviet Union nor overrun Great Britain. Germany must simply retain its early position and fight to stave off defeat. To accomplish this end, there are two basic options available. The Axis player should choose one before play even begins. If the German finds himself debating strategy in the late 1940s, as did Adolf Hitler, he has missed his chance for victory.

The first strategy can be termed the traditional or "Eastern Approach". It is a straightforward strategy aimed at annihilating the major land threat to the Axis position—the Soviet Union. The German player should essentially follow the historic course of events. He must clear his rear, conquering Denmark, the Low Countries and France. He should send some forces to North Africa to keep the British occupied there. He should probably take Yugoslavia if he has the time. I doubt the ultimate wisdom in game terms of bothering to attack either Norway or Greece, but the production points are worthwhile. A massive assault should then be launched against the Soviet Union in an attempt to force that country's surrender by the occupation of Leningrad and Moscow. The attack must be launched in the Spring of 1941. Two turns of good weather will be necessary if the German attack is to succeed.

The shortcomings of this Eastern strategy are many. If the attack is to succeed, maximum economic effort must be given to the production of infantry, mechanized, and tactical air units. The Germans can never have too many mechanized factors when they invade Russia. In the meantime, research and development, and the strategic war against Great Britain, will suffer. Should the Soviets parry the German thrust and survive, the Axis is doomed. And even if *Operation Barbarossa* succeeds, the German player, by falling behind in the strategic war and the research and development race, runs the risk of defeat.

## The Western Approach

The second option open to the Axis player is a Western strategy. It is by nature a strategy of exhaustion and defense. The Germans must make the best of their early initiative and superiority by striking hard and fast in the West. Rather than assaulting Poland on the first turn, the Germans should conquer the Low Countries, setting up a two-hex attack for the next turn on the French army in hex O8 and a subsequent drive on Paris. More often than not, this move will succeed. (If it does not, Italian entry on Turn 2 will guarantee a French collapse the following turn.) On Turn 3, Germany troops should invade Spain and push through to Gibraltar, which should fall some time between the third turn and the fifth. Subsidiary forces must be taking Denmark, Yugoslavia and Greece during this period. A force of paratroopers should be built and, supported by some tactical air points, used to conquer Malta. This will allow transport of three Axis points per turn to North Africa. With Gibraltar now under Axis control, the Allies will only be able to move a single factor around the Cape to Egypt. Hex D15 (Suez) will fall, costing the Allies its one production point and the two for India.

There is little the British can do to frustrate this line of attack. Little production will be available. Early Allied production, after the fall of France, will total only 16 (13 after Suez falls). Axis production should be in the thirties and the German edge can be channelled into research and the building of bombers, escorts, air defense, infantry, and mechanized. Investing in a few German bombers for use against Britain will have a dramatic effect. To counter the bombers, the Allied player will be forced to construct air defense units which, early in the game, will cost between 6 and 8 production points. With only 13 to 16 points available, little will remain to fight the Germans, pursue research,

or build up an Allied strategic warfare capability to cripple the German economy.

A word is in order here concerning strategic warfare in *HITLER'S WAR*. In the initial edition, both U-boats and bombers that attacked successfully on the firepower table devastated production points in the enemy country. U-boats were terribly effective—in fact too effective. In reality, submarines sank ships and did not literally destroy production centers as did massed bombers. In The Avalon Hill Game Company's edition, the losses caused by U-boats are subtracted from the production points available that turn. This is certainly a much more realistic approach. But these rules have instead made the U-boats wholly ineffective.

The Germans begin the game with two U-boat factors. If they add four more, for a total of six early in the game, the effort will consume about 20 production points. Six U-boats will, on average, cost the Allies one and a half production points per turn. It will therefore take 12 or 13 turns (four years) for the German investment in submarines to pay off, assuming none of the U-boats are lost! Why build U-boats?

Bombers, on the other hand, are more cost effective. Every hit scored actually costs an opponent four production points—the one lost in knocking out the center, and the three that will have to be spent to rebuild it. To construct six bomber points early in the game costs about 40 production points. While this is twice the cost of six U-boats, the effectiveness of the bombers can be considered four times that of the submarines.

Bombers are therefore extremely powerful. A force of twenty bombers, scoring on average six hits per turn, will cost an enemy 24 production points per turn. Such a force can all but neutralize the Soviet Union (which has a maximum production capability of 28 with the Baltic States). Against Britain before American entry, four hits per turn would inflict more damage that could be repaired and will shortly lead to the collapse of the British economy.

Morale is another consideration. These rules were poorly received in the game's first edition (and widely ignored by my friends). I was surprised to see the morale rules survive in The Avalon Hill Game Company's version. Their inclusion, however, makes a Western strategy by the Axis very inviting. The Germans cannot allow the British to gain the upper hand in strategic warfare early in the game and German production is insufficient both to match Britain's effort and invade the Soviet Union. There is nothing worse than being the German player and, having knocked out the Soviet Union in a classic blitzkrieg, watching helplessly as Bomber Command scores terror point after terror point against Berlin, lowering German morale to zero and forcing a surrender. But by concentrating on a western strategy, the Axis player prevents the Allies from gaining this upper hand, and in fact may well gain it himself.

The German will then have several options. He can force an early British surrender and then turn on the Soviet Union. Alternately, he can leave British morale near zero, switch his bombers to attacks on the Soviet economy, and wait for an American buildup after their entry. Under the rules, when Britain surrenders, all Allied forces in British territory on the map (other than in off-map boxes) are lost. This makes an Allied buildup in England near suicide. But with the Axis victorious in Africa, and with the Mediterranean sealed off, there are few options available.

Now, what options are open to the Soviet player in the early stages of the game if the Germans concentrate on Britain? In short, there are few. Under the rules, Soviet production is limited to eight points (nine if the Baltic States are conquered) until the Germans attack Russia or until Turn 8, Summer 1942. This means that until Turn 8, at which time the United States enters the war too, total anti-Axis

production is only 22 (nine Soviet plus thirteen British). German production should be over 30 points. By not attacking the Soviet Union, the Axis player assures himself of economic superiority for the first half of the game. By not attacking the Russians in the Spring of 1941, the Axis player costs the Soviets 60 production points, a major victory by any measure. If the Soviets do attack anything besides the Baltic States prior to the Summer 1942 turn, the nine production point limit then remains in force until the Summer of 1944! By attacking, the Soviet player will be relegating his country to the role of a minor power until the last year of the war.

Gaining the strategic upper hand early in the game and building a force of 20 bombers as soon as possible is the key to Axis victory in *HITLER'S WAR*. Possession of such a strategic force allows the Axis to knock out Britain, via the morale rules, and after 1943, devastate the Soviet economy. Scoring six hits per turn against the Russians will consume 24 of their 28 available production points. It is not unusual for the Axis to possess a net production advantage in the latter stages of the game. By net production, I mean the number of points remaining after the Allies and Soviets pay the cost to un-devastate their production centers. On several occasions, the Germans ended the game on the offensive in the east, and in one actually conquered Russia in Spring 1945.

An Axis Western strategy does not necessarily insure victory, but in my opinion it is a preferable approach to an Eastern attack. The game will frequently be decided by the morale rules, with strategic bomber forces bringing about either a British or German surrender. Once players realize the potential of strategic bombing under the morale rules, the game will tend to deteriorate into a terror contest that will provide little enjoyment to either victor or vanquished. This tendency for the game after repeated plays to degenerate along ahistorical lines, I believe necessitates further revisions of the rules.

### Optional Rules

I do not think that the morale rules should be scrapped completely. Eliminating the negative morale effect for conventional bombing hits is sufficient to prevent play from becoming a "mad bomber" exercise. An atomic bomb hit should certainly have an impact on morale, as should events such as American entry into the war, the loss of Suez or Gibraltar, or the gain or loss of massive amounts of territory. I do not believe, nor does the historical evidence suggest, that either Britain or Germany could have been forced to surrender by terror bombing alone.

As for strategic warfare in general, I think that bombing remains too effective while U-boat warfare has been reduced to near total ineffectiveness. I would suggest that the cost to repair devastated production points be reduced from three to two. As for U-boats, I would add an additional rule:

*For the purpose of U-boat attacks during the strategic warfare phase (not for attacks on transatlantic shipping), if the Axis player controls hex O6, the number of submarine points is doubled for the attack.*

I believe that these revisions in the rules will lead to better play along more historical lines. Even with these changes, I have found that the Western Approach for the Germans remains more effective than any Eastern-oriented strategy. Instead of building bombers, however, the Axis must now strive to create a large force of submarines that can reduce Allied economic strength, and prevent the transfer of forces to Europe from North America in the key middle period of the game. But, try it yourself and see. At the very least, you'll have enjoyed one of the most intriguing games of grand strategy on the market.

## The Case for The Allies

By Mick Uhl

I must say that I am somewhat surprised by at least one of the assumptions made by this author in his zeal to spread the air bombing gospel to all Axis players. I never attempt to repair destroyed production areas within range of a healthy enemy bomber fleet. I accept their loss for the moment and direct my remaining strength into more fruitful channels. Since an already devastated production point cannot be re-destroyed, his planes become useless after a few turns for want of targets.

Anyway, if I were the Allied player, I would never permit the Axis to build such a bomber fleet in the first place without some attempt to respond. I would try to match his research and production expenses toward bombers with payments of my own towards air defense. By the time the Axis player is ready to fly, I should have an air defense equal in strength to receive him. He would cause some destruction to my production centers, certainly, but I should cause an equivalent number of casualties to his bomber force unless tagged with some extremely bad luck. Now, here's the rub (to the Axis player, that is). It costs the Allies four points to repair one production point, as the author has so clearly stated. It will cost the Axis player seven points, on average, to repair one bomber point. I'll fight this kind of a war of attrition anytime.

As another defensive strategy, the Allied player could consider building a similar bomber fleet of

his own. He begins the game at a one step advantage in bomber technology over the Axis and has available a greater number of production sites to destroy. From the continent, Axis bombers can reach eight production points in Great Britain. Allied bombers, meanwhile, can reach up to twenty-four production points on the continent. If the Allies can average just two points of production damage per turn, it will cost the Axis player eight per turn simply to keep them in repair. This is the same loss the Allies are forced to accept if they don't bother to repair their production. If the Axis player chooses not to repair, the Allies can eventually destroy all enemy production points. The potential for air bombing is just much greater for the Allied player than for the Axis player.

In the case of terror bombing, assuming the very worst, the Allied player isn't completely crippled by the loss of Britain. He makes sure that there are no forces in the islands at the time of her surrender, and he is no more hurt than if all her production had been lost to conventional bombing. He just re-invades immediately afterwards and he can continue the fight as before. The Axis player is helpless to stop the invasion since he doesn't have enough naval strength to contest it.

In reference to the author's comments on the inefficiency of U-boats, I would tend to agree with him—so far as his argument goes. I only wish that

The Western Approach

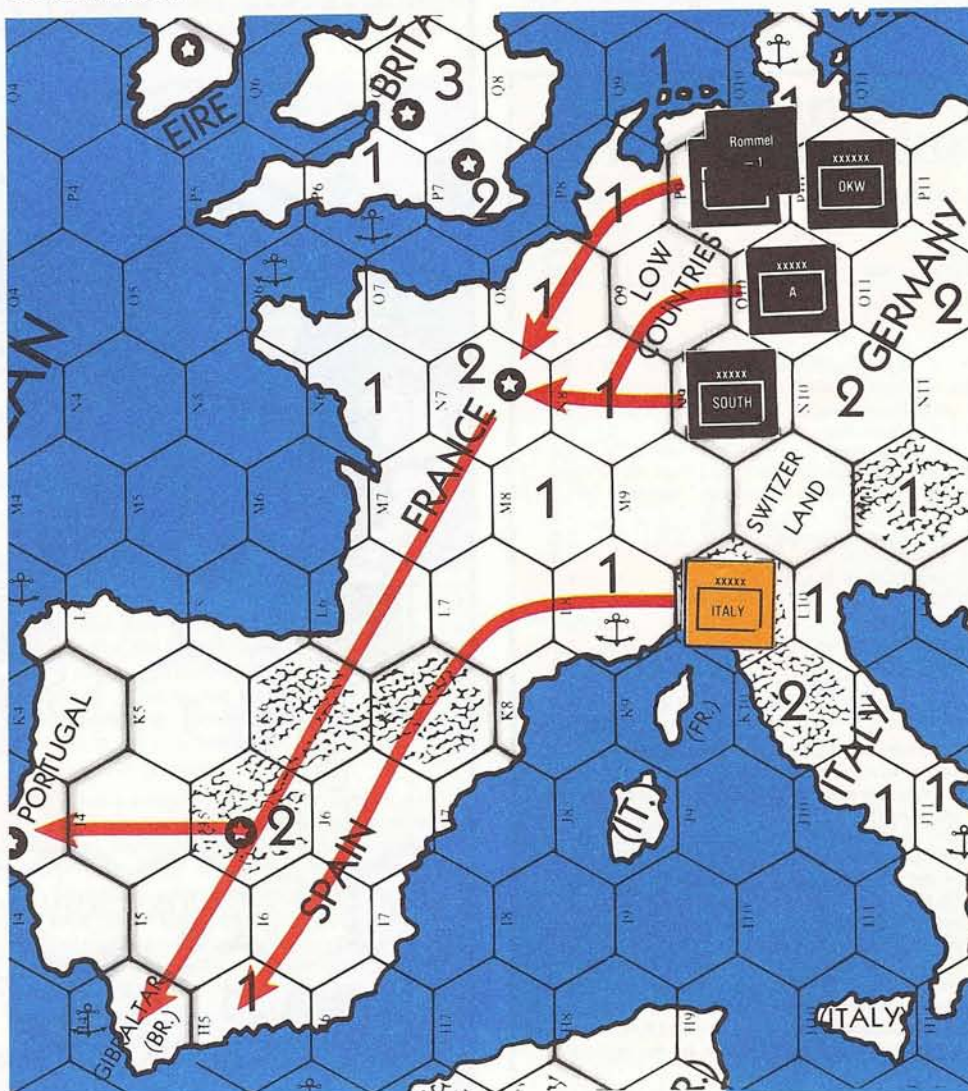

he had considered a little more carefully the impact of research on cost reduction in his calculations. Granted, if the price of a U-boat remains at six points or drops only to four points, then the expense may not justify the purchase. However, a concentrated and successful effort to reduce the price of U-boats even one more step makes their use a good strategy—one threatening to the Allies. In our play-test games the Axis players always, as a matter of course, attempted to reduce the cost of his U-boats as quickly as possible; when successful, he would then, with all speed, build up his U-boat strength to a fleet of twenty or more. At this stage, they would paralyze a good portion of the Allied economy. And U-boats cut into American production as well, whereas Axis bombers can't. The obvious strategy, then, would be to hold back from buying U-boats in any quantity until their price can be lowered to under four points.

I haven't intended my comments to be a criticism of the author's strategies. In fairness, only a rigorous testing at the gaming table can decide the issues. My intention is simply to point out several alternatives as possible defenses to the Western strategy as propounded by the author. At the very least, I hope it stimulates some thought and discussion. Isn't this just what the more interesting games tend to do?



## SO THAT'S WHAT YOU'VE BEEN PLAYING

Titles Listed: 98

Total Responses: 423

Rank	Title	Pub	Rank Times		
			Last	On	Freq.
			Time	List	Ratio
1.	B-17	AH	4	7	3.4
2.	Third Reich	AH	3	24	3.2
3.	G.I.	AH	15	14	3.1
4.	Up Front	AH	1	6	2.8
5.	Squad Leader	AH	2	24	2.5
6.	Civilization	AH	14	5	2.3
7.	Naval War	AH	16	2	2.2
8.	Diplomacy	AH	—	1	2.0
9.	Civil War	VG	—	1	1.8
10.	VITP	AH	—	1	1.7
11.	Bulge '81	AH	5	4	1.6
12.	Russian Campaign	AH	6	24	1.5
13.	Ambush	VG	9	3	1.4
14.	Guns of August	AH	—	1	1.3
15.	Midway	AH	—	1	1.2
16.	PGG	AH	—	1	1.2
17.	War & Peace	AH	10	2	1.1
18.	COD	AH	17	3	1.0
19.	Hitler's War	AH	19	2	1.0
20.	WS&IM	AH	8	9	1.0

With the usual shake-up, some six titles fall off this issue's listing and six reappear. The most interesting development over the past year seems to be the strong following that the solitaire titles—*B-17* and *Ambush*—have engendered. Obviously, this is a concept whose time has come. Expect to see a flood of such games on the wargaming market. On the other hand, *UP FRONT*, the penultimate fast-playing two-player game, and *DIPLOMACY*, the classic multi-player game, both also continue to show strongly. *HITLER'S WAR*, heading this issue's multi-player game theme, seems to be exciting quite a few readers also. And *PG GUDERIAN* return to the line-up, certainly due to its being featured in our last issue. As always, *THE GENERAL* has a great impact on what is being played by our readership.

## Contest #123

This test of the readership's savvy with regard to *HITLER'S WAR* presents a hypothetical situation using only the Barbarossa Scenario rules. You are the Soviet Player getting ready to take your Summer turn. The Axis forces (depicted below) are obviously arranged to launch a massive invasion of the Soviet homeland in their next turn. Your assignment is to protect your three capitals from capture. Position your available forces (indicating any attacks you may wish to make) and decide your production builds in such a way that you have the best chance of keeping your capitals friendly. Assume that it is more important to guard Moscow (hex Q17) than Leningrad (T15), and more important to guard Leningrad than Stalingrad (M19). The Soviet forces available at the start of the turn are 10 mechanized and 25 infantry combat points. The Soviet Union also has 23 Production Points to use.

The Axis forces shown on the map below contain the following:

Army Group	Hex	Infantry	Mechanized
North	Q13	—	7
A	P13	—	10
Center	O14	—	10
C	N14	—	10
South	M15	3	5
Rumania	L15	6	—
(and a "1" devastated marker)			
Italy	N13	—	2
OKW	P10	1	1

Readers should take into account that the Axis player can rearrange the Axis forces as he likes in his own turn before combat on an Army-by-Army basis.

To enter Contest #123, simply list each Army/Army Group, its hex of placement, its composition. In addition, list any attacks or advances (and the target hexes) for each Soviet unit on the following line. Finally, indicate any Soviet builds and the Army assigned to. Your answer must be entered on the official entry form (or a facsimile) found on the insert of this issue. Ten winning entries will receive merchandise credits from The Avalon Hill Game Company. To be valid, an entry must be received prior to the mailing of the next issue and include a numerical rating for this issue as a whole, as well as listing the three best articles. The solution to Contest 123 will appear in Vol. 21, No. 6 and the list of winners in Vol. 22, No. 1 of *THE GENERAL*.





# HITLER'S ALTERNATIVES

## Variants for HITLER'S WAR

By James E. Meldrum

Finally there is a playable simulation of World War II in Europe which can be completed in just an afternoon or evening. *HITLER'S WAR* is The Avalon Hill Game Company's newest simulation of the European Theater of the Second World War. It is, among other things, a game of almost unlimited possibilities. The game allows the player to use it as an experimental vehicle to readily answer many "what-if" questions dealing with the Second World War in Europe, together with many other chances for exploring historical alternatives in World War II. The variant situations presented in this article may be used either with the individual scenarios or with the Campaign Game to simulate the effects of hypothetical events that may have altered the outcome of the war that was, truly, Hitler's war.

While *HITLER'S WAR* provides for a number of historical alternatives, there are so many more chances for alternative situations to happen that the potential for exploring these has barely been exploited. As mentioned earlier, all variant rules may be used with any scenario in this game; the specific variant to be used should be selected by the mutual consent of both players and at the most each player should use only one variant rule. In any instance where a conflict between the variant rules and the original game rules develops, the original game rules take priority in resolving the dispute.

Most of the variant situations may be simulated quite easily using the existing game mechanics and equipment. However, it may be necessary for players to make extra unit counters. This may be done by using any of the unprinted units in the boxed game; unit symbols may be drawn on the backs of these counters using felt-tipped pens following the format of other units included in the game. The extra units are added to the game as called for by the variant rules. To inject an element of the unknown into play, players could select one or more variants randomly, either by chit draw or die roll.

### THE VARIANTS: (Allied)

#### 1) The Low Countries become Allies:

On Game Turn 1 the Low Countries are considered Allied powers, may be entered by the British and French armies, and have their infantry and production strengths added to those of the Allies. Use this in the Campaign Game.

#### 2) Spain Joins the Allies:

As soon as Germany invades France, Spain ceases to be non-aligned and joins the Allied Powers. Use in the Campaign Game.

#### 3) United States Enters the War Earlier:

Because of German submarine activity, the US enters the war. The US becomes one of the Allied powers at the start of the Summer 1940 game turn. Use in the Campaign and Barbarossa games.

#### 4) Strategic Bombing Concentrates on Crucial German War Industries:

Starting in 1943, all Allied strategic bombing die rolls are reduced by one. Use in the Campaign Game.

#### 5) Assassination of Hitler:

Hitler is considered to be assassinated at the start of the Summer 1944 game turn. During this game turn only, no German production points may be expended. Use in the Campaign and Fall of Germany games.

#### 6) US Concentrates its Fleet in the Atlantic:

The US Navy is assumed to have concentrated its fleet in the Atlantic. When playing the Campaign

II Game, change the allied fleet in port strength to 12 points.

#### 7) Russian Deploy in Depth:

The Russians are assumed to deploy their armies in depth rather than manning their borders. With the exception of the armies placed in hexes R13, T15, Q17 and Siberia, all other Russian armies may be placed *anywhere* in Russian territory. Use in the Campaign and Barbarossa games.

#### 8) More Shipping in the Atlantic:

The Allies send more merchant shipping into the Atlantic and may now transport up to six strength points between the US, Canada, Europe, and North Africa. Use in the Fall of Germany and Campaign games.

#### 9) Increased Commitments from the Colonies and Dominions:

This variant assumes that the British Dominions and French colonies increase their commitments to the defense of their home countries. Double the portion values of all British and French overseas possessions. Applicable to the Barbarossa and Campaign games.

#### 10) France Extends the Maginot Line:

In this variant France is assumed to have extended the Maginot Line fortifications to the English Channel. In the Campaign games deploy one extra French fortification in hex O8.

#### 11) France does not build the Maginot Line:

This variant assumes that France elects to build extra armored strength points for its army rather than construct the Maginot Line fortifications. In the Campaign Game, no French fortifications are deployed and France receives 10 extra mechanized strength points.

#### 12) Italian Hesitation:

When this variant is used, the Italians are assumed to be pro-Axis but don't actually join the fighting because of the vacillating foreign policy. Starting on Game Turn 2 the Axis player rolls one die: if the die roll is 5 or 6 Italy joins the Axis; if not, then continue to roll a die once per game turn until Italy joins the game.

#### 13) Fortified Russian Frontier:

Prior to the start of the war Stavka orders the Russians to fortify their frontier. At the start of both the Barbarossa and Campaign games one fort each is deployed in hexes T15, Q14, P14, O15, N14, M15, and L15 free of cost.

#### 14) Stalin Removed from Power:

If the Stalinist Purges of the late 1930's had never taken place, historians assume that the Red Army would have been lead much more competently. When using the optional leader rules, allow the Soviets to use two leaders. Use in the Barbarossa or Campaign games.

#### 15) French Evacuation to North Africa:

When this variant is used, it assumes that the French Army evacuates to North Africa in the event of a French defeat. Should France surrender, place the French 1st Army Grp. in hex G6. Roll one die for each *type* of strength point contained by this unit except mechanized; this corresponds to the *number* of each type of strength point that successfully completes the evacuation to North Africa.

The French fleet may also evacuate to North Africa, England, or any French overseas possession. Roll one die for the French fleet; on a roll of 5 or 6 the fleet goes over to the Allies; on 2-4 the fleet is destroyed, scuttled, or interned and is re-

moved from play; on 1 the French naval strength points are transferred to the German fleet.

### THE VARIANTS (Axis):

#### 1) The Z-Plan:

The Z-Plan was a naval construction plan that provided for the reconstruction of the German surface fleet after the seizure and scuttling of the German High Seas Fleet at the end of World War I. This variant assumes that the Z-Plan was fully implemented by the German Kriegsmarine. In the Campaign Game, the German fleet in port is composed of six strength points and may contain up to two aircraft carriers.

#### 2) Separate Russian Peace:

Beginning with the Summer 1944 game turn, the Germans may conclude a separate peace with the Soviets because of a refusal by the Western Allies to make political concessions to the Soviets. As soon as Russia has occupied all of Poland and captured hex Q13 (East Prussia), all Russian units are frozen in place and may neither move nor attack. The German player must keep at least one German army in place on the Eastern Front but all others may move as the German player desires. With the exception of the occupation of Q13, no Russian army may be inside German borders. Use in the Campaign games.

#### 3) No Lend-Lease:

For political reasons the US and Great Britain do not send Lend-Lease supplies to Russia. As a result, the Lend-Lease rules are not used in the Barbarossa or Campaign games.

#### 4) Poland Backs Down:

Poland is assumed to have backed down from war and yields the Polish Corridor. Consequently hex Q12 is considered to be part of Germany on Game Turn 1, and may be used in all scenarios.

#### 5) Spain joins the Axis:

As soon as Germany attacks Russia in any scenario, Spain becomes an Axis Ally. This variant may not take effect before Summer 1941.

#### 6) Turkey joins Axis:

As soon as Germany captures Stalingrad in any scenario, Turkey becomes a German Ally.

#### 7) Vichy France joins Axis:

If the Allies enter overseas French possession before the start of 1943, the Axis player rolls one die; on a roll of 1 or 2, Vichy France becomes a German Ally.

#### 8) Japan attacks Russia:

On the Winter 1941 game turn Russia is attacked by Japan. Russia does *not* receive the Siberian Army and Siberian production is frozen at 8 points for the remainder of the game. For use in Barbarossa and Campaign scenarios.

#### 9) The Balkans join the Axis sooner:

In the Barbarossa and Campaign games Hungary, Rumania and Bulgaria join the Axis at the start of the Winter 1940 game turn.

#### 10) Earlier German switch to a War Economy:

This variant assumes that the German economy was shifted to the war economy sooner. At the start of the Spring 1941 game turn, *all* German production hexes with a value of 1 become 2. Use with any scenario.

#### 11) No Axis Coup in Yugoslavia:

Yugoslavia becomes a German Ally on the Spring 1941 game turn.

## 12) Bavarian Redoubt:

At the end of World War II there was a rumor to the effect that the Germans had secret fortifications in southern Germany where they would make a last stand. In the Barbarossa and Campaign scenarios a fortification marker is placed in hex M11. This fort may contain a missile unit. Germany is not considered to surrender unless both Berlin and the fort are captured and *eliminated*, respectively.

## 13) Improved German Winter Operations:

Starting in the Winter 1941 game turn, the German player does not have to modify his die roll, thus reflecting improved German preparedness for winter warfare. Use in the Barbarossa and Campaign games.

## 14) More effective German Submarines:

Commencing with the Summer 1942 game turn, subtract one from all die rolls for German submarine attacks. Use with any scenario.

## 15) German Gas Warfare:

In 1944 the German Army had stocks of nerve gas that could have been used in combat. The Allies also had stocks of poison gas that could have been used in retaliation. Beginning with the Summer 1944 game turn the Axis may make one nerve gas attack per game turn at a cost of three production points per attack. *All* adjacent Allied units must be attacked; all Soviet units under attack must also retreat one hex. May be used in any scenarios.

## 16) Stronger Italian War Industry:

This variant assumes that hexes L10 and J11 assume production point values of 2, and hex K10 assumes a production point value of 3 on the game turn immediately after Italy becomes a German Ally.

## 17) Pro-Axis Coup in Iraq:

This variant assumes that the pro-Axis coup in Iraq succeeded in the Spring 1941 game turn. When this variant is used, Iraq is considered to be an Axis Ally having an army composed of two infantry strength points. Russia may not receive Lend-Lease

production points in hex M20 until Iraq is re-conquered by the Western Allies. Use in the Barbarossa or Campaign games.

## 18) Finnish Neutrality:

Assume that the Finns remain neutral in all scenarios unless invaded by Russia, in which case they become a German ally.

## 19) Rumanian Neutrality:

Assume that the Hungarians remain neutral in all scenarios unless invaded by Russia, in which case they become a German ally.

## 20) Bulgarian Neutrality:

Assume that the Bulgarians remain neutral in all scenarios unless invaded by Russia, in which case they become a German ally.

## 21) A Completely Mechanized German Army:

When using this variant, assume that the Germans make a greater use of captured trucks and increase their domestic truck and military vehicle production. As a result, treat *all* infantry units as though they were mechanized units for advance purposes.

## THE REPRIEVE OF GERMANY— SET-UP AND SPECIAL RULES

## INTRODUCTION

This variant represents more than a simple variation of the Barbarossa Game. The situation is based on the assumption that Germany has managed to win the Battle of the Bulge, which results in a cease fire with the Western Allies. Hitler is then free to turn to forces previously occupied in the West against the Soviets in an attempt to fight Stalin for Germany's existence in the post-war era.

AXIS FORCES IN PLAY			SOVIET FORCES IN PLAY				
Army		Infantry	Mechanized	Army		Infantry	Mechanized
Place in any Axis armies in any Axis friendly hexes		25	12	Place in any Soviet armies in any Soviet friendly hexes		40	16
Fort	Location	Fort Strength		Fort	Location	Fort Strength	
No. 1	N9	2		No. 1	T15	2	
No. 2	O10	2					
No. 3	K10	2					
No. 4	P8	1					
No. 5	Q9	2					
No. 6	Q10	3					

### AXIS-FRIENDLY AREAS AT START

Germany (except hex Q12)  
Italy (hexes L9, L10, K10, K11)  
Norway  
Denmark  
Hungary  
Low Countries  
France (hex O8)  
Yugoslavia (hexes L11 and L12)

Devastated production hexes: L11 and L12 only.  
All production hexes in Germany are at full strength.

### AXIS PRODUCTION AT START

25 points

### FIRST TURN—FINAL TURN

Winter 1944—Summer 1946  
Axis moves first, the Soviets

### SOVIET FRIENDLY AREAS AT START

Soviet Union  
Germany (hex Q13)  
Baltic States  
Poland  
Rumania  
Bulgaria  
Albania  
Yugoslavia (hexes K12 and K13)

Devastated production hexes: O13 and N13 only.  
All production hexes in Soviet Union are at full strength.

### SOVIET PRODUCTION AT START

29 points

### VICTORY CONDITIONS

1. The game ends immediately upon Soviet capture of Berlin (hex P10); or, if Axis forces capture Moscow (hex Q17). Should these fail to occur, the game ends at the conclusion of the Summer 1946 turn.
2. The Axis player wins if, at the end of the game, Berlin is still friendly.

### SPECIAL RULES FOR THE REPRIEVE OF GERMANY

1. The following countries are neutral and may not be attacked nor entered by either player: Finland, Sweden, Greece, Turkey, Iraq, Iran, all French and British territories (except hex O8), Spain, Portugal, Eire, all Italian territories (except Albania and hexes L9, L10, K10 and K11).
2. All capitals other than Berlin (hex P10) and Moscow (hex Q17) are ignored.
3. An out-of-supply hex becomes friendly to the opposing player.



# AREA TOP 50 LIST

Rank	Name	Times On List	Rating	Previous Rank
1.	K. Combs	42	2598YOV	1
2.	B. Dobson	17	2368RJR	2
3.	D. Burdick	41	2188GGN	3
4.	P. Siragusa	36	2157EHJ	4
5.	B. Sinigaglio	27	2150GHI	5
6.	J. Beard	31	2103HIQ	7
7.	F. Preissle	39	2089LNX	8
8.	W. Scott	39	2082KIM	6
9.	D. Garbutt	40	2055GIN	10
10.	E. Mineman	12	2045CEE	11
11.	J. Kreuz	36	2041GGL	12
12.	D. Barker	7	2014GHN	13
13.	P. Landry	16	2012HHM	14
14.	M. Sincavage	31	1993EEJ	17
15.	H. Newby	7	1992NHI	9
16.	B. Remsburg	25	1964GIP	16
17.	F. Freeman	16	1964EFG	19
18.	D. Munsell	37	1958HHM	20
19.	J. Cormier	1	1957CEF	—
20.	S. Sutton	9	1952EGL	15
21.	G. Charbonneau	5	1937HJG	22
22.	P. Gartman	7	1907HJG	18
23.	R. Leach	43	1906ILS	23
24.	P. Flory	18	1897DGJ	21
25.	F. Reese	22	1896HDF	24
26.	L. Kelly	35	1889WWL	25
27.	M. Simonitch	12	1874DEH	26
28.	R. Beyma	17	1871CDF	27
29.	B. Schoose	7	1856GHP	28
30.	M. Rogers	2	1855CEH	29
31.	C. Wannall	18	1852HLP	30
32.	F. Ornstein	25	1843FHN	31
33.	T. Oleson	51	1839XYZ	33
34.	N. Cromartie	27	1838GHO	32
35.	R. Berger	3	1833CDE	34
36.	J. Sunde	17	1830KKS	35
37.	B. Downing	31	1830FHL	36
38.	J. Baker	14	1829CEI	37
39.	P. DeVolpi	8	1828DED	38
40.	D. Greenwood	42	1821GFJ	39
41.	B. Salvatore	10	1816GKO	48
42.	R. Shurdut	8	1815DEJ	46
43.	W. Ownbey	11	1812CEI	40
44.	J. Anderson	18	1809DDF	41
45.	R. Phelps	23	1806HJQ	42
46.	B. Sutton	10	1806DFE	43
47.	D. Kopp	1	1801GIN	—
48.	P. Ford	7	1797GCP	44
49.	M. Miller	28	1795GHO	45
50.	M. Frisk	2	1783CDH	47

## MEET THE 50 . . .

Mr. Peter Gartman is 35, married and father of two, holds a BS in chemical engineering and MBA in finance, and is employed by Emerson Electric in St. Louis, Missouri.

**Favorite Game:** THIRD REICH  
**AREA Rated Games:** 3R, TRC, CEA  
**AREA W-L Record:** 16-8-9  
**Gaming Time/Week:** 7 hrs.  
**Hobbies:** Racketball, Weight Lifting, Running  
**Pet Peeve:** Opponents who take an inordinate amount of time to make their move.  
**% Time PBM:** 80%  
**Play Preference:** PBM

Mr. Gartman writes of his pleasure in gaming:

"I find wargaming a stimulating diversion from the business world. The challenge of making a good move and eagerly opening the *Wall Street Journal* to discover the result is an excellent way to start the day for me. Through Avalon Hill and AREA I have found a steady stream of good opponents. The only improvement to my situation would be the opportunity to play against more of the Top 50 themselves—the best in the hobby."

# DESIGN ANALYSIS

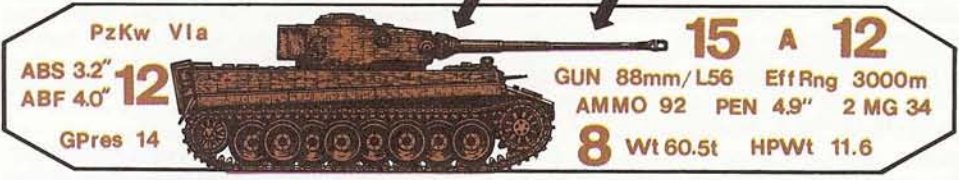

## Errata for HITLER'S WAR

By Mick Uhl

The following are the changes, correcting oversights and errors, that should be made in the published version of *HITLER'S WAR*. Owners of this first edition should note these in their rulebooks.

**Components** (page 2). An important clarification needs to be made to correct a great misunderstanding. The number of counter sheets included in the game is *two*, not four. To be exact, each copy of *HITLER'S WAR* should include 520 counters and markers on two counter sheets.

**Unsupplied Hexes** (page 6, rule 3). The wording was found to be confusing to some gamers who correctly pointed out that supply considerations are made only during an army's turn of attack and not while on defense. Expand the final sentence in rule 3 as shown—"It may defensively assault *even though currently cut off from supply due to the opponent's advance.*"

**Repairing Devastated Production** (page 7, rule 4). Delete rule 4. The situation described therein cannot possibly occur. A hex out of supply by the time of the Production Phase would already have reverted to another's control at the end of the previous Combat Phase (see Unsupplied Hexes, rule 2).

**Barbarossa Scenario Set-Up and Special Rules** (page 7). Add the *Baltic States* to Soviet-Friendly Areas At Start.

**Supply Route** (page 8, rule 1). the sea supply rules need to be clarified to reflect the impact of the future scenarios upon it:

1. A hex or army tracing a supply route may include sea routes through any number of friendly seas to its production point. A sea is friendly to a player if he can transport at least one strength point through it. Note that the transport status of seas can change from scenario to scenario. Always be guided by the sea transport rules presented in the scenario being played.

**Effects of Forts on Combat** (page 9, rule 5). Add a new rule to cover the fate of forts when out of supply. "A player's forts are eliminated along with his armies if found to be unsupplied at the end of his Combat Phase."

**Lend-Lease** (page 9, rule 1). This rule needs to be rewritten in order to specify when Lend-Lease may begin. "As soon as an Axis army enters a Soviet-friendly hex, the Allied player may begin lend-lease to the Soviets. The Allied player may choose to give up to four production points from his budget each turn to the Soviet player. This can be done only in the Allied Production Phase."

**The Fall of Germany Victory Conditions** (page 10). One more game turn (Winter 1945) was accidentally left off the Time Record. It does exist and it is the final turn for this, and only this, scenario.

**The Fall of Germany Set-Up and Special Rules** (page 10). A new rule must be added here. The reason for such will be self-evident upon reading. Add: "5. The Axis player sets up first, followed by the Soviet player, and finished with the Allied player."

**Violation of Neutrality** (page 10, rule 6). Add this rule; its intent should be obvious: "A player must declare war on Spain to attack Gibraltar from Portugal."

**Surrender—Great Britain** (page 11, rule 3). Substitute *Allied Strength Points* for "British Strength Points". This corrects an outright contradiction to the concept of Allied armies only as set forth in Rule 8 for Movement (on page 4).

**Production Limitations** (page 12, rule 3). A minor correction to the date needs to be made here to correct an obviously nonsensical situation. The limit to Soviet peacetime production must be changed from Spring 1941 to *Spring 1944*.

**Siberian Industry** (page 12, rule 1). Another problem with dates. Change the Winter 1943 reference to read *Winter 1942*.

**Firepower Table** (page 13). A slight modification must be made here to allow firepower attacks that combine air and land strength to be made in excess of ten points. The rule should read, "It is now possible for firepower attacks *from sea or involving air strength to be made* in excess of ten points."

**Partisan Attacks** (page 13, rule 1). A very important omission has unfortunately been made to partisan attacks which unnecessarily complicates a system which was intended to be fairly straightforward. Change it to read, "1. The Allied player and the Soviet player (even after surrender) may attempt to gain control of *unoccupied* Axis-friendly hexes by partisan attacks."

**Naval Fire** (page 14, rule 5). Add the following new rule: "While an Axis fleet is at sea, the Axis player may transport one strength point for every fleet strength point through the Atlantic."

**Tac Air Abilities** (page 14, rule 4). In the original version of *HITLER'S WAR*, tactical air, because of its unlimited stacking ability, could be virtually un-dislodgable on defense. This was due to the fact that the defender was allowed to deduct assault losses from his air strength as well as from his land strength points. Our playtests showed that when his was applied by the Soviet Player, he could delay the total conquest of Russia almost indefinitely by placing an army of at least ten strength points in one capital and then feeding in enough tac air to absorb the Axis assault losses. As long as the ground strength stayed at ten, the army could not be forced out by the enemy. Our solution was to divorce tac air from the assault losses, thereby letting the attacker get directly at the ground forces. We tried, instead, to give tactical air a different but still important role on the battlefield by devising the system of *air attack*. On reflection, we believe that in our zeal to enervate tac air in assault, we have perhaps made this important arm military arm ineffectual. The following change to rule 4 will redress the imbalance:

4. The normal assault is now resolved. Tactical air strength points not used in the air attack can be added into the assault resolution. Losses from the assault cannot be taken from tactical air strength

points unless they are the only points remaining. The addition of tactical air strength points now allows an assault to be made in excess of ten strength points.

*Air Attacks* (page 14, rule 11). Add this to the rules for clarification: "Armies composed solely of tactical air strength points defend against advance using the '0' column of the Advance Table."

*Leaders* (page 16, rule 5). A minor clarification: "The Leader marker is kept face down until the army is ready to make an attack into a non-friendly hex, at which time it is turned over and revealed."

*Units Capability Table*. The air strength point needs to be further defined to eliminate any possible confusion as to its identity. Just change "Air" to *Tac Air*.

*Advance Table*. Change the die roll heading to read *Strength Points*. Of course, die rolls are unnecessary to use this table—it is read by comparing the attacker's advancing strength to defensive strength.



### AH Philosophy . . . Cont'd from Page 2

What steps have been taken to fill the need for high quality accessories? Players obviously want more scenarios and TAHGC has not been forthcoming in sufficient volume to satiate our appetites. Has TAHGC ever considered some type of *SQUAD LEADER* newsletter apart from *The GENERAL*?

Secondly, after having invested some \$200.00 undervalued Canadian dollars into *SQUAD LEADER* and its gamettes, I discover, as of *ORIGINS 85*, I may as well throw it away. This decision, on your part, gets no support from me. Why do such a thing to this great game? These changes only serve the cause of those who consider *SQUAD LEADER* a giant rip-off with all its changes to date. Until now, I have only ignored such opinions. Lately, however, I must agree. If we don't "go with the flow", so to speak, we will be ignored in the pages of *The GENERAL*.

All the game system needs is revised Russian/German counters and a North African gamette. Instead, TAHGC appears poised to perpetrate a pseudo-fraud on its loyal game customers. Tragically, this may be the straw that breaks this customer's back. It seems like the only answer may be cancelling my *GENERAL* subscription and buying games only from those few suppliers left not controlled by TAHGC megalith.

Glenn P. Christie  
Mississauga, ONT

Those two letters are representative of the extremes prevailing in our mailbox these days. The combination of concern, anticipation, anger and delight over the impending release of *ADVANCED SQUAD LEADER (ASL)* has pretty much monopolized our correspondence for the past several years and is growing increasingly prevalent as the release date draws near. Of course, neither writer is completely correct; the truth lies somewhere between the two widely contrasting opinions shown above. *ASL* cannot be all things to all people and, like all games, the degree to which it satisfies or enrages one will be a matter of personal taste. In truth, it will be neither a panacea or a rip-off, but opinions on that are sure to run the full spectrum. What I am attempting to accomplish here is to put some of Mr. Christie's complaints into perspective while hopefully providing some background information to other players who may be contemplating whether they should take the plunge into *ASL*.

First the easy questions: WHERE and WHEN.

Barring a major catastrophe, *ASL* will make its debut in Baltimore at *ORIGINS XI* on June 27-30, and will be made available for mail order and wholesale shipments shortly thereafter. Please do not place orders for it until you've been informed of its definite availability, because as of yet a fifth question—HOW MUCH—has not been answered.

WHY? If, like Mr. Christie, you're predisposed to think the worst, this may take a while. Before launching into my sales pitch, let's try to answer Mr. Christie's points one at a time.

I agree we have an obligation to our "loyal *SQUAD LEADER* customers". However, I am of the opinion that we are fulfilling that duty to our utmost by publishing *ASL* rather than sweeping the game under the rug. Never before in its 26+ years has TAHGC committed so many resources to a single game system. Accessories? At present there are 24 mapboards for use with this system, plus a deluxe version with enlarged hexes about to make its debut. By way of comparison, *PANZERBLITZ*—a not dissimilar game system which was once every bit as widely acclaimed—has three. Besides the 40+ scenarios found in the various gamettes, we have published an additional 40 for separate sale as well as dozens more as free inserts in *The GENERAL*. I submit to you that if you have played each of those 100+ scenarios that you are: 1) in the minority and 2) a recipient of more hours of pure unabashed fun per dollar spent than the average game purchaser in our hobby.

As regards to a newsletter just for *SL* players, please keep in mind that *SL* is just one of nearly 200 games published by TAHGC—each of which has some following, no matter how small, that would like to see their favorite given equal time. Surely, you've observed the letters from other *GENERAL* readers who do not share your interest in *SL* and who complain of its dominance in these pages. You've no doubt observed our problems with publishing *The GENERAL* in a timely fashion and witnessed the demise of *ALL STAR REPLAY* due to a lack of adequate circulation, despite being the vehicle for a dozen games, not just one. Given these factors and the economic restraints under which all companies which hope to stay in business must operate, I believe most readers would side with me when I say that such a newsletter must come from the playing public as a labor of love—some of which already exist.

I maintain that dollar for dollar and hour for hour, you've probably derived more entertainment value for your *SL* buck than most other war-games you've purchased (especially if, as you say, you've gone through over 100 scenarios). In any case, "throw[ing] it away" seems a bit drastic. After all, it's still the same game that you loved enough to motivate you to write in the first place. No one is saying you have to buy *ASL* and throw your old game away—unless it's you. Although, I do agree you may have trouble finding people who want to play the old game once *ASL* becomes widespread. And if you do bite the bullet and become enamored by *ASL*, you'll find much of what you've already got can be put to use in one form or another. The old scenarios, with some minor tinkering, can be used with *ASL* and vice versa. The boards remain the same and while many of the counters will become obsolete, most will remain useful in a backup capacity for large DYO efforts or SSR of your own design.

No doubt much of Mr. Christie's pique is directed at Rex's recent announcement that he was no longer interested in *SL* submissions for *The GENERAL*. While I neither recommended nor endorsed that decision, I can certainly understand the necessity of it. Speaking as one who slaved over this magazine for ten years in Rex's current

capacity, I can well appreciate his dilemma. As editor, he assumes ultimate responsibility for what graces these pages; it is his duty to separate the wheat from the chaff. This means that he must possess enough expertise on each of our approximately 200 games to decide who is expounding intelligently on game theory and who is just wasting good ink. Whenever he doesn't catch an illegal or nonsensical statement in a published article he is left with egg on his face, loss of credibility for the magazine, and the ire of the folks who have to answer the inevitable mail the mistake creates. Is it any wonder that he wants to limit articles on a game to the latest edition? Just how much sense would it make for us to still print articles on the 1961 edition of *D-DAY* or the first edition of *THIRD REICH*? Isn't it likely that the bulk of the readership would prefer material based on the most current edition of any game? Wouldn't he be equally condemned by those wanting only *ASL* material as opposed to articles on outdated editions? Pleasing everyone is impossible; pleasing the greatest number must always be the goal. It is difficult for me to logically conclude how he could have arrived at any other course of action.

"All the game system needs is revised Russian/German counters and a North African gamette." Well thanks, Glenn . . . I'm glad you like it, but I beg to differ. As the poor clown who must answer all the mail this game system generates, I hope you'll take my word for it that this rascal hasn't quite arrived yet. The truth of the matter is that I've grown to hate *SL* because even I can't answer all the questions it creates in its many different editions. Especially when the writer precedes his queries with the *conditions* for the answers. "Please answer as if using the optional semi-simultaneous movement rules per 3rd edition *SL*, 2nd edition *COI*, and 1st edition *GI*—but exclude all *COD* rules as we don't play with them." And then there's the guys who ask a few dozen questions and want separate answers for each edition of the rules and/or subsequent gamette in the series. Counting the original play-test, I've been answering *SL* questions for a living for nine years now. Fellas, if I can't keep them straight, I think it's a fair assumption that the casual player has some problems too. Frankly, I've been answering the *SL* mail for the past six months according to *ASL* rules and I've never had it so easy. So, at long last, WHY? Because, it is badly needed!

The *SL* game system, for all its acclaim (and even our competition grudgingly concedes it is the biggest game system in the wargame field), was based on a flawed foundation. The subsequent gamettes, in building on that start, only complicated matters by attempting to patch that foundation rather than replace it altogether. *ASL* suffers no such handicap; the entire game system has been redesigned from scratch. I like to think it retains all the playability of the original while having more realism than *GI*. In fact, I think *ASL* is so superior to the *SL* series in all areas that there is really no comparison between their relative merits. I am, of course, biased in the extreme.

I also believe there is a lot more at stake here than just a rewritten set of rules—or a redesigned game for that matter. Veteran observers of the wargaming scene are aware of the general malaise which has gripped our hobby since its recent "Golden Age", with many companies disappearing from the scene altogether. The economy, video games, computers and even role playing have all been cited as the cause by one source or another. My pet theory, however, remains *over-saturation* of what never was a large market. Although there are probably more gamers today than ever before, we are all separated by

the "forest-for-the-trees" syndrome. There are so many games available now, that relatively few of us share the same gaming experiences or interests—let alone familiarization with the same set of rules. Without the shared experiences of having assaulted the same hill or defended the same town, our conversations lack the common thread of comparison that I found so entertaining in the "good old days" when the gamers still outnumbered the games they competed in. I think this is one of the reasons for the popularity of "game systems" over "games" today. Although game systems tend to be much more comprehensive than games, they allow playing of endless scenarios (or adventures) with basically the same set of rules—generally attracting and holding a larger audience. Wargame systems have never matched the popularity of D&D (nor have any of the other FRP imitators which followed), but the *SQUAD LEADER* series is undoubtedly the closest any wargame has ever come. By enhancing the popularity and charisma of the game system with a complete redesign and unprecedented quality production, we hope to emulate (on an admittedly smaller scale) the success others have achieved with deluxe treatment of their best sellers and finally elevate a wargame to a leading position in the marketplace. It is, in short, not only an attempt to improve a game system, but to elevate the hobby itself to a higher plane. Don't we owe it to ourselves to strive for the "cadillac" of our industry, to put out the very best product we are capable of to see if we can enlarge wargaming's scope? Or should we settle, as Mr. Christie seems to suggest, for smaller and smaller print runs for a continually shrinking audience? Unfortunately, if *ASL* fails, we will probably not see another wargame with such lavish trappings pass this way again for a long time as most companies will relegate the wargame category to smaller print runs and correspondingly modest budgets.

There is a tendency among many wargamers, apparently including Mr. Christie, to think of TAHGC as the corporate giant profiting from the financial difficulties of the little guy—snuffing out the competition by buying them out like the proverbial Scrooge foreclosing on another mortgage. In reality, the situation is quite different. The present financial climate for wargame companies is so dismal that most fail within a few years even though they are run as part-time operations. The vast majority of wargames produced by all but a select few companies inevitably cross my desk quite uninvited within a few years of their initial release, sent unsolicited by designers all too anxious to sell them to TAHGC. Believe me, the games we turn down far outnumber those we accept, and I personally wish the percentage turned down was higher still. Contrary to popular opinion, the R&D people here have come to dread such submissions like the plague because they intrude on the resources we can muster for our own games. In recent years, I can recall our initiating an eventual acquisition only in the case of *KINGMAKER*, *CIVILIZATION*, and *EMPIRES IN ARMS*. No one likes to be handed the thankless job of cleaning up someone else's mistakes, especially when we have to read in the hobby press about the dearth of new offerings from TAHGC. Doubtless, elements of that same hobby press will dismiss *ASL* as just another rehash of *SQUAD LEADER* and I find that unfortunate. If our hobby had less "here today, gone tomorrow" titles and more games that had benefited from nine years of development, I think we'd all be better off. And that, faithful reader, completes my long-winded explanation of WHY.

WHAT you can expect from *ASL* on June 27th is three separate products. The first is *ASL* itself,

a quality three-ring binder packaged in a bookcase sleeve. The binder will eventually contain all the rules for the entire *ASL* system—including many accessory chapters which will be added later. Initially, there will be only five chapters included: Infantry & Basic rules, Terrain, Ordnance, and Vehicles, plus one on Deluxe *ASL*. This will provide you with the rules for most of what the *SQUAD LEADER* series encompassed in the past. The rare stuff such as boats, paratroops, weather and air support will follow in miscellaneous chapters to be provided free of charge along with any errata/changes at a later date via a special coupon included in every set. The rules themselves will be richly supported with full-color illustrations and index-stock, die-cut divider sheets. More importantly, *ASL* will never become outdated. If changes are made, new pages will be provided with the changes highlighted to replace outdated pages in a manner similar to the posting of regulations in an Army Field Manual. Gone forever are the days of searching for rules spread throughout four different rulebooks.

The second item, *BEYOND VALOR*, is the first *ASL* boxed module and will give you something to play *ASL* with. *BEYOND VALOR* contains four geomorphic mapboards (20-23), the complete counter mix for the German, Russian, Finnish, and Minor Allied TO&E, all the informational markers needed for *ASL*, and ten scenarios based on street fighting on the Eastern Front ranging from the first attacks on Warsaw in 1939 to the rubble of Berlin in 1945. Perhaps just as significant is what is not included—any rules. Those not enthused by the Eastern Front will be able to purchase the various counter sheets they do want (which will be fully inventoried in *ASL*) separately by mail.

The third item, *STREETS OF DESPAIR*, is the first Deluxe *ASL* boxed module and contains four of the large scale 26.5" by 11" geomorphic mapboards and ten scenarios also depicting street fighting on the Eastern Front. Deluxe *ASL* is simply *ASL* played on beautifully crafted 2.2" hexes. This enables *ASL* to be played with miniatures and/or without stacking of any type, save that necessary to show possession. This simple mechanism makes *ASL* among the most playable of games and has been largely responsible for making *SQUAD LEADER*, once again, my favorite game after years of growing discontent with its increasing complexity. The panorama this version provides matches or exceeds all but the most elaborate of miniatures games. To that end, I am pleased to announce that we have entered into a co-operative licensing arrangement with GHQ—long the leader in casting military vehicles—for use of their 1/285th scale figures with Deluxe *ASL*. No such figures will actually be contained in our boxed modules; but to those wanting to experience the ultimate in tactical wargaming with both the panorama of miniatures and the ease of play of *ASL*, special *ASL* packs will be offered by GHQ containing a copy of the scenario and enough figures to represent it in miniature. Details on this conversion process are contained in the Deluxe *ASL* chapter. In addition, GHQ will be offering a new product line of three-dimensional hexes for wargaming in miniature which has exciting combination possibilities for the creation of real LOS mapboards when used in conjunction with our Deluxe *ASL* scale.

So much for the good news. WHAT you won't see yet is the TO&E for the British, French, Italian, Japanese and U.S. and their accompanying point values (although we suspect you'll begin seeing them within a year). WHAT you will probably see is a large price tag for all these new products; products that Mr. Christie feels represent "pseudo-fraud"—a scheme to sell you the same

game all over again. Well, we all have to make up our own minds on that one, but here's how I rationalize it. A few years ago, not long after video cassette recorders made their appearance, I was so enamored by them that I just had to have one. Two years later they were selling models for half the price with twice the features which mine had. Sometimes I regret buying that VCR so soon, but then I recall all the fun I had with it when it was new and eventually concluded that my money was well spent after all. It basically amounts to realizing you "can't have your cake and eat it too". There never was a product of any type which wasn't improved the next time around. I believe that is called progress, or evolution, or whatever it is that keeps human beings forever striving for something better. The question seems to be whether wargames are worth perfecting; or should we simply be content with more and more initial models?

For me the answer lies in striving for perfection. Maybe some of you will find your answer in the ongoing demonstrations of Deluxe *ASL* at ORIGINS this June. For others, such as Mr. Christie, I hope the answer will be provided by word of mouth from fellow gamers who have given *ASL* a try and found it a good buy. I do not believe *ASL* is for every gamer—not even for every WW2 wargamer. Despite great strides in playability, it remains a comprehensive game system—which means that it is very involved and not really a wise undertaking for the casual player. *SL* players tend to play it to the exclusion of most other games because they have so much time invested in learning the system. If, like Mr. Christie, you've gone the gamette route all the way through *GI*, I feel confident you'll eventually embrace *ASL* because it is a quality product and the culmination of everything you've experienced up to this point. Oh, it may play slower until you've forgotten the old rules and the new ones become second-nature, and you may gripe about a favorite rule or two which has been exorcised, but eventually you'll concede that the game is more realistic and playable and—most important—more fun than it ever was. If you're one of those who enjoyed *SQUAD LEADER* but dropped out somewhere along the way because the game was becoming too convoluted—well, *ASL* was designed with you in mind. On the other hand, if you've tried *SQUAD LEADER* and never really cared for it in the first place, you probably won't like *ASL* any better because the flavor remains much the same. It's still primarily the same game system—just much more finely polished. And if you're that rare gamer who has never given the original *SQUAD LEADER* a try—well, maybe you should before you purchase *ASL* because the one thing the latter doesn't have, which basic *SQUAD LEADER* does, is Programmed Instruction. Learning *ASL* without benefit of playing *SQUAD LEADER* itself, while not impossible, may still be difficult for those who wrestle with simulation rulebooks.

Don Greenwood

*Few game systems in the brief history of this hobby have been so extensively, or lovingly, re-worked. It is a unique event, and one which is looked on with both eager anticipation and some trepidation by many long-time SL fans. Now that you've read Don's views, it is only fair that we give the readers the view from another vantage point to ponder. Find, on page 44 of this issue, Jon Mishcon's comments on the impending release of ASL in its latest installment of the SL Clinic—"View from the Trench".*



# WHICH WAY THE WITCH KING?

## A MAGIC REALM Seminar

By Paul R. Bolduc



The Witch King is undoubtedly the most interesting and challenging of all the characters that travel the *MAGIC REALM*. His powers are mighty yet ephemeral. He must survive on magic alone for he has neither MOVE or FIGHT counters. The Heavies (Dwarf, Berserker, and White King) can afford to put all their victory points into Fame and Notoriety, then go out looking for trouble and expect to survive, prosper, and even win within a week. Not so the Witch King, who may not even be able to leave the Inn if his choice of starting spells is poor. How then, is one to go about playing this character whose command of the awesome Type IV, V and VI spells ought to demand the respect of every opposing player? It is the purpose of this article to acquaint the reader with some of the less arcane approaches to this question.

### GAME MECHANICS

For those of you unfamiliar with the game who might have missed Richard Hamblen's fine article "The Magical Mystery Tour" (The *GENERAL*, Vol. 16, No. 4), here's a capsule summary of how the game is played. Be warned; I'll be talking in generalities. Just about every major rule has an exception somewhere involving spells, treasures, or special advantages. I'll also be using the rules as amended and clarified in that issue.

To begin play, the 20 tiles that comprise the board are dealt out to all the players who then assemble the board tile by tile. Warning, Sound, and Treasure Location counters are secretly and randomly distributed. At this point the players choose their characters.

For each character he controls, the player will choose victory conditions, dividing four victory points (VPs) between five categories: Great Treasures (1/VP), Usable Spells (2/VP), Fame (10/VP), Notoriety (20/VP), and Gold (30/VP). Thus a magic-user could take one point in each of the first four categories and would win when he has, as a minimum, possession of one Great Treasure, learned 2 spells, and attained 10 Fame and 20 Notoriety points.

Those characters who begin the game with recorded spells choose them now. *MAGIC* counters may freely be converted into color counters. The Campaign/Mission/Visitor counters are placed. Finally, the Warning counters in the valley tiles are revealed, the Dwellings and Ghosts set up, the character counters placed at the Inn, and the game properly begins.

*MAGIC REALM* is played in turns called "days". Each day is divided into a "Movement Portion" and a "Combat Portion". The Movement Portion is subdivided into "phases"; characters get four phases a day, plus bonus phases for individual special advantages or treasures, plus or minus a phase for weather effects. Characters in, or moving into, cave clearings only get two phases per day plus bonuses regardless of weather. A character can perform only one activity per phase. Activities include such fantastical pursuits as Hide, Move, Spell, Search, Alert, Rest, Trade, Hire, and Fly. A special activity, Follow, allows a character to follow another character or hired leader, doing whatever the followee does. Each character's moves are recorded secretly prior to the *Monster Roll*.

Blocking is also a special activity, and an important one. In the first two encounters, it leads to many a draw. Unlike any of the others, Blocking doesn't need to be written. A character may voluntarily block another character, monster or native group (the target) merely by being in the same clearing as the target provided that it isn't hidden (unless the character has found "Hidden Enemies" that day), and either of them has expended at least one phase already that day. Now the bad news, when blocking (or being blocked) the character forfeits the rest of his written move. Monsters block characters whenever possible.

A character's weight and twelve combat counters define his vulnerabilities and abilities. A character is killed when struck by damage equalling or exceeding his weight. Each of the combat counters is inscribed with an action, a weight (except *MAGIC* counters), a time, and zero, one or two fatigue asterisks. The action is either MOVE, FIGHT, (do

*MAGIC*, DUCK, or (go) BERSERK. The weight describes how much force is involved with the blow (FIGHT) or how much one can carry (MOVE). The time number describes how fast the action is, lower numbers being quicker. The fatigue asterisks are a measure of the effort involved in performing that action at that speed and weight.

Once all the characters have committed themselves in writing, the die is cast to determine which monsters and natives are active that day. The character to move first is randomly determined and his written move is read and executed. The Warning and Sound/Treasure counters in the tile he ends in are revealed, and any active monsters or natives cited on the Set-up Card are placed or moved. The next character to move is determined, and so forth until all characters have either fully executed their moves, blocked, or been blocked by a character, monster, or native group.

Activities can be grouped into two classes: those that require dice rolls (Hide, Hire, Trade, Search) and those that don't. In most cases, two dice are rolled and the higher of the two is taken as the resultant roll. This generates the set of probabilities shown in Table 1.

Normally, movement is along roadways, passing from clearing to clearing. There are three kinds of clearings (woods, mountain, and cave) and four kinds of roadways (open, tunnel, hidden paths, and secret passages); except for the Wizard, characters must search for and find the latter two before they can be used. Best odds are 25% for paths and 16.6% for passages. When flying, one travels from tile to adjoining tile with the landing clearing determined by a die roll.

To deal with natives, a character must be in the same clearing with them. After stating his intention (to hire or trade), the player rolls on the "Meeting Table". While it is possible to get an item for free, one will usually spend two to four times its base price (the price listed on the individual treasure card or on the Price List). Treasures can be bought from or sold to native leaders, visitors, or other characters; they can also be looted from one of the eight

treasure locations after the character has "found" the location counter by rolling on the search tables.

Hiding, if successful, allows a character to sneak by marauding monsters unmolested and to avoid other characters unless they have "Found Hidden Enemies" that day and elect to block him.

After all movement for the day is completed, the "Combat Portion" of the day occurs. This is divided into rounds consisting of three steps: Encounter, Melee, and Fatigue. In the Encounter step, monsters and unfriendly natives are apportioned to any characters in that particular clearing. Characters may then try to prevent other characters from running away or try to run away themselves. Spells are cast at this time. In the Melee step, attacks are made and resolved. In the Fatigue step, combat counters are wounded or fatigued as necessary. Combat continues in a clearing until only one character remains, or no one/thing was killed, or combat counter wounded or fatigued for two rounds.

Spells come in eight "ritual types" and are "fed" by five colors. Most spells will only activate in the presence of one particular color. Permanent spells are lasting but not necessarily always in effect. Color is available in three manners: 1) MAGIC counters can be converted into color counters by means of expending two Spell phases; 2) a tile can be enchanted by using two Spell phases and matched MAGIC and color counter or three Spell phases and two matched MAGIC counter; 3) certain treasures, days, and places always have color available.

Days are grouped into weeks of seven days for weather purposes and months of 28 days. At the start of a new month all monsters and unhired natives return to their starting locations, the Campaign/Visitor/Mission counters are flipped and penalties for unsuccessful campaigns and missions exacted.

### THE WITCH KING HIMSELF

Let's now examine the Witch King's assets. He has neither armor nor weapons. He does start with four spells—more than any other character—and he needs them. As mentioned before, he has no MOVE or FIGHT counters. What he does have is MAGIC, in spades. He has four counters each of Types IV, V, and VI, so he can make Purple and Black at will. Times are 3,3,4 and 4 for the IV spells; 2,3,3 and 4 for the Vs; and 2,3,3 and 4 for the VIs. All carry a single fatigue asterisk. Now, in order to cast a spell, a character must use a MAGIC counter whose time number is less than or equal to the move times of all monsters, natives and character combat counters on his sheet (i.e., attacking him). The usual worst case (see "First Day Jitters" below) is a time of two (easily supplied by the Elf, Swordsman, Druid, Woodsgirl, Rogue 4, or Tremendous Octopus), which means any defense spell must either have a time of two or have been prepared (an Alert phase expended that turn). Type IV spells are suspect since the fastest time is three; there's no guarantee that the Witch King will be able to alert the spell in time to use it.

Another problem the Witch King alone has to face is that to do practically anything, he must cast spells which will fatigue MAGIC and/or color counters. This inevitably means resting them—often at inopportune times. Keep in mind that a fatigued color counter takes a minimum of three (Rest, Spell, Spell) phases to recover; that's two whole days in a cave clearing if you hide.

The Witch King's two special advantages are his "Aura of Power" and the "Disembodied" state. The former gives him (and the Sorcerer, who shares this advantage) an extra Spell phase every day, thus offsetting the Spell phase lost to Rule 48.3. Since the Witch King will need to make a lot of color and will likely enchant several tiles in the course of the game, it is a significant advantage. Being "Disembodied" is a bit harder to gauge. Consider Table

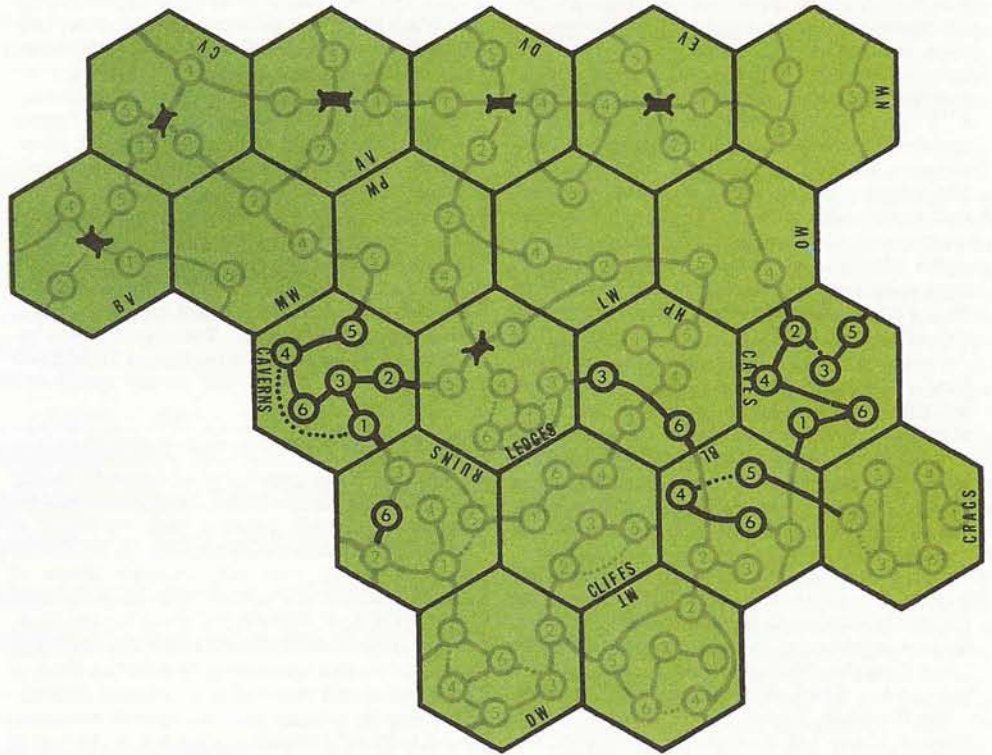

Figure 1 Before Enchantments

In the illustration above, note that although the valley tiles are all adjacent, only Curst (CV) and Awful (AV) valleys have their potential dwelling sites within a day's journey. Bad Valley (BV) and Evil Valley (EV) are three days apart, and Dark Valley (DV) is all by its lonesome. Indeed, it takes no less than 15 days to travel by foot from Bad Valley 5 to Curst Valley 5 (eschewing the hidden paths

and secret passages) even though the tiles are adjacent. Notice also how Cavern 2 leads into Ledges 5 and Border Land 5 into Crag 2. Anyone but the Amazon or the Elf will have to forego his Hide roll to climb from these cave clearings to these mountain clearings. Pity the Dwarf if the Inn should appear in Bad Valley! Now, consider Figure 2 below . . .

Figure 2 After Enchantments

What a difference enchanting the five "W" tiles makes! The valleys are now completely cut off from the rest of the mapboard. If there are no magic-users left behind, those characters stuck "behind the lines" (as it were) will have to try to win without access to the treasure locations and their high value monsters—perhaps a mixed

blessing for the Light characters. This, in effect, dooms them to seek out their victory conditions by dealing with or killing wolves, vipers, natives, each other, and an occasional Heavy Flying Dragon (via Dragon Essence). Notice that if the Inn were to be in either Awful or Curst valleys, simply enchanting the Maple Woods (MW) would be sufficient to lock in the non-magic types for the duration.

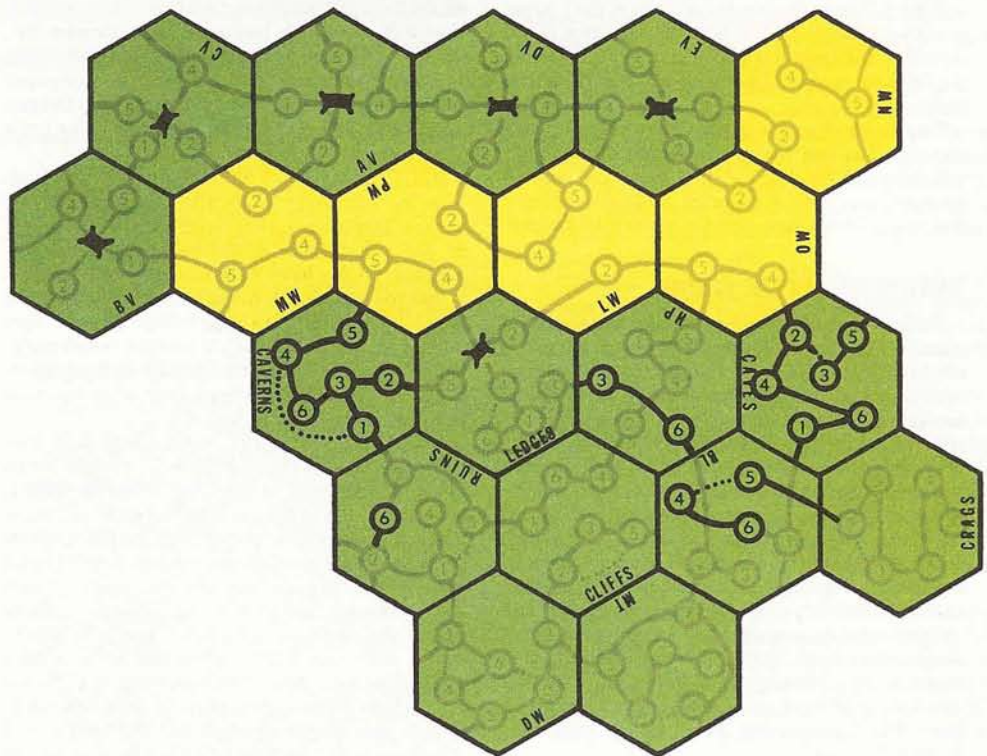

2. It is definitely advantageous with regard to finding counters and to reading spells (no chance of a curse and you only get spells you can use); it is definitely inferior for finding hidden paths, secret passages, and usually hidden enemies. One needs a "3" or a "1" die roll to loot a treasure card, as opposed to one through six (depending on how many treasures are left) for the Loot Table—but with Magic Sight you always draw the top treasure card, making it the table of choice when three or less treasures remain. Also remember, the treasures on top of the piles are large treasures and are generally more valuable than those four or five down. Trouble is a lot of them are too heavy to use Broomstick (see Movement below).

To conclude this section, we consider the Witch King's relationships with each native group. First, he's allied with the Bashkars, a rambunctious bunch of riding raiders who appear at the Campfires. The six of them range from L2\* to M5\* attacks. They have a base price of 12 gold. More importantly, they have six ponies for sale at a base price of 14 gold—and a pony is as good as MOVE counters outside of caves.

He is friendly with the Company, whose specialty is heavy destruction. Their attack values range from L3\* to T4\*, including a H6/H1 Crossbowman. They have some armor and arrive at either the Inn or the Large Campfire. You can expect the Black Knight to try to hire the seven of them for free, however.

The Woodfolk, Rogues, Patrols, Soldiers, Guard, Shaman, Crone and Warlock are all neutral. The Rogues are at the Inn, can be hired individually, and own six slow horses. More on them later. The Woodfolk appear at the House or the Small Campfire; they control all the bows. The Patrol appears at any of the fixed dwellings and owns some armor. The Soldiers dwell at the House and the Guard at the Guard House. Between them they control the Light and Medium weapons respectively and some armor. The Shaman has a Type II and a Type III spell to sell and possibly some expended potions. The Crone and Warlock have Type V and VIII and Type IV and VI spells respectively for sale for a base price of ten gold; an excess of gold can theoretically be turned into "Usable Spells" by seeking out these Visitors and dealing with them. In practice, it's very tough.

The Witch King is unfriendly with the Lancers and the Scholar. The former arrived at the Chapel or either Campfire. The Scholar has three small treasures. If he acquires a spell book, you have only a 2.78% chance per Trade phase to buy it for 200 Gold.

Finally, the Knights of the Order are his sworn enemies. The four Knights are armored, mounted, and deadly. They dwell at the Chapel and own all the heavy weapons, war horses, and suits of armor available. Avoid them like the proverbial plague.

## BEGINNING THE GAME

Before you get to choose your character, the board must be constructed and the first player without a tile to play then chooses a character. During construction, you should strive to make the board as favorable to your intended abilities as possible. If you intend to fly, try to put the Valleys on the periphery of the board and to isolate them as much as possible via hidden paths, secret passages, mountain and cave clearings and, perhaps best of all, "W" tiles (Woods, excluding Deep Woods) where enchanting the tile would cut off whole sections of the board. (Figures 1 & 2 show perhaps an ideal case.) Your ability to fly (or ignore roadways) will circumvent these obstacles and leave the rest of the characters behind. Don't be surprised if you find those intending to play the Witch, Druid, Dwarf, Amazon, or Wizard also setting up such obstacles. See "The Disappearing Road Trick" below for further discussion.

All right, the board is set and you've now become the Witch King. You get to choose your victory conditions and your spells. Since the next few sections deal with these topics exhaustively, nothing more will be said about them here except to emphasize that your choices of victory conditions and spells are interrelated, one must complement the other. The two of them will dictate your strategy of play.

One further consideration before play begins. Try to get the Warlock and Crone counters on the Shrine or the Bashkars where you're likely to spend some time. You may be able to buy an extra spell. Don't count on this too highly as the flip side of the Warlock is the beer truck (Food and Ale) and this often is placed fairly early. Then again, if you anticipate a long game, it'll be available as the Warlock next month.

## MOVEMENT

The first major question to be answered during spell selection is movement. It is so important a question that we'll examine each possibility at length. Remember, the Witch King has no MOVE counters, so he must rely on other means of locomotion.

**HURRICANE WINDS (IV, Purple) Individual, Move:** allows the individual to FLY T1 in the next round of combat (presuming he survives the first one), but is only effective in a mountain clearing. This may be a handy spell for later in the game, but it is initially worthless since it can't be cast at the Inn. It can be used later as a get-away spell if you're hidden and don't care to hang around and risk another Hide roll on the morrow.

**ABSORB ESSENCE (V, Black) Monster, Permanent:** caster becomes the target monster and must fly if winged when moving. Although a spiffy attack spell that could be used to augment movement later in the game, this spell is not really suitable as an initial movement spell since no monsters appear at the Inn except when Dragon Essence happens to be one of the treasures held by a native group there. The chances of that range from 4.44% for only the Rogues to 20.00% for the unlikely combination of the Rogues, Patrol, Company, and Scholar. But then you'd draw a pair of Heavy Flying Dragons (provided someone didn't activate them elsewhere); should you absorb one, you'll end up brawling with the other and there is a 43.78% chance of your fatally losing this fight. Despite that, this is an excellent spell for one-on-one encounters with tremendous monsters. I especially recommend using it on a Troll or, better yet, the Flying Dragon when heads and clubs are in play. See "The Let's Get Physical Ploy" later.

**BROOMSTICK (V, Black) Individual, Move:** allows the individual to Fly L1 once, whenever he wishes. This is an excellent spell for quick get-aways or just to get ahead of the pack. Highly recommended. It does have drawbacks though. The first is that you don't know for sure exactly where you'll land, so don't forget to Hide before take-off. Second, it ties up a MAGIC V counter indefinitely. Third, you can't use it to transport Medium or heavier objects. But one fast escape when you need it will make a believer out of you.

**MELT INTO MIST (VI, Purple) Individual, Permanent:** individual has a MOVE T4 counter which is the only counter he may play when the spell is activated. It allows the use of hidden paths and secret passages without discovering them but precludes attacks on or by the individual and any activity other than Move. This is a very powerful spell for self-use. It allows you to stroll to your objective unhampered; and since it is a Type VI, you'll be able to cast it with your V12\* counter and avoid trouble on the first turn. See "The Vanishing Act" below for perhaps its most-used ploy—a great defense as long as your Purple counters last! The spell's chief drawback is that another character may be able to

deny you your objective merely by enchanting the tile if it contains Purple magic, thus activating the spell and preventing you from searching, brawling, resting, or even casting magic until you leave the tile and return to normal. One way around this difficulty would be to take a Dissolve Spell and to remove Melt upon reaching the place you want to loiter. *Beware of the Pilgrim with Exorcise!* He can burst your immunity bubble and place you at the mercy of whatever is in your clearing. All in all, teamed with Broomstick, perhaps the best movement spell combination. It also has amusing offensive potential. Consider when the Hoard is in a tile with Purple magic. Enchanting the tile and then casting Melt on the Flying Dragon renders it totally impotent for the rest of the game.

**TRANSFORM (VI, Purple) Individual, Permanent:** individual becomes the creature indicated by rolling on the Transform Table, moving and fighting with the creature's given values, and treating himself as a hired native leader. You will either be able to fly or to ignore roadways and you have a 25% chance of improving your carrying capacity and fighting strength. The drawbacks include the worst features of Broomstick and Melt into Mist. That is, if flying you have no control over where in a tile you'll land, and someone can activate the spell against your will. It also has a few of its own. While it would be great to be a Flying Dragon, the odds say a squirrel or frog is more likely—and a frog can be caught by someone/thing with a move time of two. The "ignore roadways" feature is particularly tempting in light of the lousy chance to find hidden paths and secret passages that the Magic Sight Table provides. But a hired leader cannot search, record Fame and Notoriety, glimpse counters, etc. under these conditions (i.e., owner not present) unless the Hired Captain optional rule is in effect. It remains a decent attack spell and should you take Unleash Power, acquire a Gloves card somewhere along the way, or hire some natives, you can indulge in the "Transform Trick" (see below).

**UNLEASH POWER (VI, Purple) Magic Chits, Day:** converts MAGIC counters into MOVE/FIGHT counters which can be used for either movement or attacking with the time number of the counter determining both time and strength. This is best used for moving short distances, ideal for movement from where Broomstick landed you to where you really want to go. Your two and three time counters become Light and the fours become Medium, so you still won't be able to haul Heavy or Tremendous treasures. Warning: the spell expires before the Combat portion of the day begins, so you won't be able to use it to run away or fight until it's recast; meaning, if not hidden, you can only maneuver during the first round of combat.

**SLOW HORSE:** Well, you might try to buy a horse from the Rogues, but your chances are dismal—one in 11,664 or less than 0.01%. This translates, at four phases a day with no Hides, into once in 2,916 days (or eight game years). And if the Cloven Hoof shows up (same chances as Dragon Essence cited before), forget it—that +1 DRM makes it impossible. Notice that if someone kills the Rogue leader, his treasures and horses will be abandoned in the clearing; but since there is no provision in the Magic Sight Table to loot a horse, you're still out of luck unless another character will loot one and then sell/give it to you. Don't hold your breath. Also, horses die in caves, thus possibly cutting you off from large portions of the board.

**BOOTS:** There is a 21.12% chance that one of the five Boots cards will be held by the Rogues. Unfortunately, three of the five offer the same chance of purchases as did a slow horse. The other two, the Elvin Slippers and the Seven League Boots, offer a slim 0.33% chance to purchase. The Patrol, should they arrive, offer similar prospects, but the Company offers odds 36 times better since they're



**TABLE 1**  
Basic Odds in MAGIC REALM

Number Rolled	One Die		Two Die	
	equal	less than	equal	less than
1	16.67%	16.67%	2.78%	2.78%
2	16.67%	33.33%	8.33%	11.11%
3	16.67%	50.00%	13.89%	25.00%
4	16.67%	66.67%	19.44%	44.44%
5	16.67%	83.33%	25.00%	69.44%
6	16.67%	100.00%	30.56%	100.00%

**TABLE 2**  
Comparison of Magic Sight to Other Search Tables

Action	Search	Peer	Locate	Loot	Read	Magic Sight
Hidden Enemies	27.78%	33.33%	11.11%	—	—	varies*
Hidden Paths	22.22%	—	25.00%	—	—	2.78%
Secret Passages	16.67%	—	11.11%	—	—	2.78%
Glimpse Counters	11.11%	33.33%	11.11%	—	—	—
Find Counters	2.78%	2.78%	11.11%**	—	—	25.00%
Loot (treasure)	—	—	—	varies***	—	16.67%
Learn Spell	—	—	—	—	25.00%	19.44%
Free Spell	—	—	—	—	44.44%	19.44%*
Curse	—	—	—	—	25.00%	—

\* Dependent upon what the "Hidden Enemy" is carrying; ranges from 2.78% to 44.44%.

\*\* If "Glimpsed Counters" previously in turn, the odds are 55.56%.

\*\*\* Depending on the number of treasures remaining; ranges from 2.78% to 100%.

**TABLE 3**  
Fiery Blast and Lightning Bolt  
against Monsters, Natives, Horses, and Unarmored Characters

Spell	L	M	M*	H	H*	T	T*
Fiery Blast	100%	69.44%	44.44%	44.44%	25.00%	25.00%	11.11%
Lightning Bolt	100%	100%	69.44%	69.44%	44.44%	44.44%	25.00%

**TABLE 4**  
Meeting Table Odds

	Free	×1	×2	×3	×4	No Deal	C/I	B/B
Allied	2.78	8.33	13.89	19.44	55.56	—	—	—
Friendly	0.08	0.23	22.61	19.89	26.54	30.56	—	—
Neutral	0.002	0.01	0.63	8.89	15.47	52.08	13.58	9.34
Unfriendly	—	—	—	—	2.78	22.22	44.44	30.56
Enemy	—	—	—	—	—	—	8.33	91.67

"C/I" = Challenge or Insult

"B/B" = Block/Battle

friendly, 0.31 and 11.81% respectively. While a Boots card is the optimum solution to the movement problem and there's up to a 52.88% chance of one being there, this option is not really reliable enough to risk your whole game upon. But don't pass up the chance if it presents itself.

**OTHER MEANS:** Later in the game, a pony can be purchased from the Bashkars or, if you've picked up the Quest counter, a warhorse from the Order. Perhaps you can discover the Flying Carpet (a large treasure and thus never in with the Natives' treasures) or one of the Boots cards at a treasure site.

As an insight into the movement problem (and how the designer probably intended the Witch King to be played) consider the Witch King at his first level of development, as a Wraith. Here he has only three combat counters: MAGIC IV4\*, MAGIC V4\*, and MAGIC VI4\*. Due to color considerations, only a Type VI spell makes any sense since the Type IV counter can't simultaneously be itself and the Purple counter is needed to cast the spell. Likewise the Type V and Black. Thus only Melt into Mist, Transform, and Unleash Power are viable choices. Choosing a permanent spell over Unleash saves one Rest Phase per spell activation; and Melt

is preferable to Transform due to its assured carrying capacity and better defensive aspects.

To sum up this section then, the Witch King should take Broomstick and either Melt into Mist, Unleash Power, or Transform as his movement spells. Don't expect to get a Boots card for initial movement—but if the opportunity arises, grab it.

## OTHER SPELLS

Remember, at this point the board has been assembled but the whereabouts of the Inn is still unknown. You've chosen a set of movement spells that best compliment the structure of the board. The time has come to choose your other spells. It is now that the truly tough planning decisions must be made, for these remaining spells will largely dictate how you can play the game until such time that different spells can be learned (if ever). There are a total of twenty spells in Types IV, V and VI. We've already discussed six of them. Now the others.

**BLAZING LIGHT (IV, Purple)** clearing, *Day:* extra phase in cave clearing for all that begin the turn therein. A good spell if you plan to spend a

lot of time in enchanted caves with some friends. But remember, the phases you gain will have to be repaid later in Rest Phases, which means that if you stay in the caves no net gain in phases (for you). But ah, for your comrades! This one is best used for a spell book or artifact in an enchanted Purple tile.

**ELEMENTAL SPIRIT (IV, Purple)** MAGIC chits, *Day:* changes Type IV counters to Type VIII and Type VI to Type V for a day. This spell was probably designed for the Sorcerer. If the Witch King should take it, he can only gain the Type VIII spells. The temptation is to increase the "Usable Spells" victory criterion and to go to the Statue for the Type VIII spell there. This would surely be falling into a small trap. In order to claim the Type VIIIs for victory purposes, you couldn't claim any of the Type IVs or VIs that you might also have learned and vice versa. Not recommended.

**FIERY BLAST (VI, Purple)** multiple, *Attack:* a L\*\*\* (=T) missile attack rolled separately for each target. A dandy spell; highly recommended. A guaranteed kill on unarmored Light characters, and a 69.44% chance versus unarmored Medium monsters, natives, and characters. Table 3 provides the gory details. Armored characters are another story, with only a 11.11% chance of killing them (2.78% with the Armored Bonus rule in effect). This is an excellent anti-goblin weapon (especially considering your limited mobility) if they are on someone else's sheet since there's only an 11.22% chance of wiping out a whole six-pack of them. The "Goblin Gambit" has proven to be a profitable, although gutsy, trick. See below.

**LIGHTNING BOLT (IV, Purple)** individual, *Attack:* one M\*\*\* (=T\*) missile attack rolled against a single target—but only in a mountain clearing. This spell is stronger than Fiery Blast, but is much more limited—only one target and then only in the 19 mountain clearings. It's a guaranteed kill on an unarmored Light or Medium target—but since when do Medium monsters travel alone? Still it offers a 44.44% chance of bagging a solitary, unarmored Tremendous monster. See Table 3 for odds breakdown.

**ROOF COLLAPSES (IV, Purple)** clearing, *Attack:* Smash H4 attack against every character in the cave clearing (including you). This one is blatantly anti-Dwarf. 'Nuff said.

**VIOLENT STORM (IV, Purple)** hex, *Day:* causes up to five phases to be lost in all Woods and Mountain clearings in the tile (caves are excluded). This one is also just harassment.

**ASK DEMON (V, Black)** demon, *Instant:* caster gets to ask a secret yes/no/number question of another player, who *must* answer truthfully. Before using this one, you probably ought to cast Pentangle (see below) to ensure that the demon doesn't kill you in subsequent rounds of combat. Then again, it's hard to anticipate what questions might be worth squandering a spell on.

**CURSE (V, Grey)** character, *Instant:* roll on the Curse Table and apply result to the target. Another harassment spell and one wonders why it's not a Type VIII as noted on the Imp's counter. Don't even consider it.

**PENTANGLE (V, Black)** individual, *Combat:* demons and imp cannot be committed against the individual; effects of spells and curses against him personally are ignored. If you anticipate doing magical battle with any character (Sorcerer and Witch mainly) and intend extended visits to the Shrine and/or Statue, this one's a must. Otherwise . . . This pairs well with Ask Demon; but this spell is no defense against Exorcise.

**POWER OF THE PIT (V, Black)** individual, *Instant:* Power of the Pit attack is rolled against the target. This one is great if you're a Demon, but not if you're a Light character!! A gutsy attack as the odds are all against you in fact, there is a 16.67% chance (rolls of 1 and 3) that the spell itself will

kill you and even better odds that your target will kill you. For instance, if used against the Berserker without a movement counter of some sort, he need merely play his FIGHT H5 counter; there is then only an 8.33% chance you will survive. If you like those kinds of odds, Las Vegas was built for people like you. Take my advice and pass it up. Please. Probably easier to just absorb a demon.

**DISSOLVE SPELL** (VI, *Purple*) spell, *Instant*: causes target spell to be broken, can't be used against curses. Useful for breaking permanent spells that you have on yourself or others if you're so inclined. It pairs well with Transform and Melt into Mist. Consider it carefully.

**ENCHANT ARTIFACT** (VI, *Purple*) artifact, *Permanent*: enables character to "attach" one of his recorded spells onto an artifact. This results in a readily prepared spell just awaiting color to be cast. If lent/given/sold, it allows other characters to cast one of your spells when the proper color is present. A fascinating spell with only one drawback—it can be used but once, and then only on the eight artifact cards. Great with Blazing Light or Fiery Blast.

**PHANTASM** (VI, *Purple*): character, *Day*: character has an invisible double which can Move, Peer and Spell on the next turn, and which can neither block nor be blocked. This one is a recc unit for cautious players. The Phantasm will be fatiguing your MAGIC and color counters when he Spells, but will be able to move even though you might not. Can be used with Melt into Mist or Transform to unenchant *Purple* tiles from a distance so you can later move there and Search.

**WORLD FADES** (VI, *Black*) character, *Permanent*: allows the character, if unhidden at the end of a Round of Combat, to make a normal Hide roll, hiding if successful. May only use Magic Sight Table when searching. Probably designed for the Magician. The free Hide aspect is a bit shaky; one can only take the Hide roll if no monsters, natives, or characters are on your sheet just when you'd need it most. A poor choice.

To summarize, Fiery Blast should probably be chosen as a desperation defense against masses of medium monsters, unarmored characters, unarmored heavy monsters, and noxious natives. That leaves a choice of Absorb Essence or Transform for one-shot defenses against solitary Tremendous monsters. Consider Enchant Artifact, Pentangle, or Phantasm if you don't take Broomstick.

## STRATEGIES

We'll next consider several distinct strategies and the spells to be taken when employing them. I call them the "Lone Wolf", the "Lone Ranger", the "Good Ole Boy" and the "Hit Man". These four are actually opposite corners of the spectrum of possible strategies. None are guaranteed winners, although some have better chances than others. We'll also look at a compound strategy I'll call the "Leader of the Pack".

The "Lone Wolf" strategy entails going off alone, avoiding other characters and doing your own thing. It calls for alert self-reliance and for a brand of cunning deviousness usually found among mere mortals only in *DIPLOMACY* players. Flying ahead to pull the Disappearing Road Trick is standard procedure. Broomstick and Melt into Mist are all but essential. Seek out the Shrine and the Bashkars. Consider Absorb Essence and then go trolling for a Tremendous Troll or Flying Dragon to absorb; it'll tend to discourage disturbances.

The "Lone Ranger" strategy requires that you find a Tonto. If you're playing two characters simultaneously, there's no problem. Otherwise, take your chances and hire a Rogue; there's only a 9.34% chance of Block/Battle on any given roll. You won't be able to fly and take "Tonto" along, so take Unleash Power and plan to do a lot of walking. Beware of hidden paths and secret passages. You only

	1	2	3	4	5	6	7	8	9	10
1) F.Dragon1	0	0	66.7	66.7	66.7	4.4	66.7	44.4	0	0
2) F.Dragon	100	44.4	100	100	100	100	100	100	69.4	23.2
3) Dragon	33.3	0	0	33.3	33.3	33.3	0	11.1	7.7	23.2
4) Giant	33.3	0	66.7	44.4	0	11.1	0	0	7.7	0
5) Serpent	33.3	44.4	66.7	66.7	44.4	100	44.4	44.4	23.2	0
6) Spider	100	44.4	66.7	88.9	44.4	44.4	44.4	44.4	44.4	0
7) Troll	33.3	44.4	100	100	100	100	44.4	100	7.7	23.2
8) Octopus	100	44.4	88.9	88.9	81.5	100	44.4	44.4	83.0	44.4
9) F.Demon	97.2	27.8	89.5	89.5	74.1	59.9	89.5	59.9	55.2	0
10) Demon	97.2	27.8	74.1	89.5	89.5	97.2	74.1	59.9	97.2	19.3

The monsters above are numbered; each corresponds to the column as well as the row (thus, column 7 and row 7 both relate to the Troll). To use this table, find the row of the absorbed monster; then read across to the column of the monster faced. Thus a Troll has a 23.2% chance of survival against a Demon (column 10). Dragon 1 is the Hoard monster, while Dragon 2 is the one derived from the Transform Table. On Table 6, results assume that the absorbed monster will always play its club/head side up.

	1	2	3	4	5	6	7	8	9	10
1) F.Dragon1	66.7	100	100	100	100	100	100	77.8	46.4	69.4
2) F.Dragon	43.9	44.4	89.9	89.9	100	100	100	100	69.4	23.2
3) Dragon	46.2	66.7	69.4	69.4	100	77.8	33.3	66.7	46.3	54.0
4) Giant	44.1	66.7	69.4	69.4	100	72.2	33.3	55.6	50.2	46.3
5) Serpent	10.0	44.4	19.2	19.2	44.4	100	44.4	44.4	23.2	0
6) Spider	26.7	44.4	28.6	54.1	44.4	44.4	44.4	44.4	44.4	0
7) Troll	23.2	44.4	89.9	89.9	100	100	44.4	100	7.8	23.2
8) Octopus	42.4	44.4	59.2	59.2	81.4	100	44.4	44.4	83.0	44.4
9) F.Demon	72.4	27.8	68.9	64.2	74.1	59.9	89.5	59.9	55.2	0
10) Demon	48.6	27.8	47.7	68.9	89.5	97.2	74.1	59.9	97.2	19.3

have a 2.78% chance of finding them using Magic Sight, and unless your Rogue is the leader he won't be able to search for you either. Phantasm won't help much since the Peer Table has no provision to find paths and passages. Melt into Mist won't let you be followed. An interesting ploy is to transform the Rogue! When the spell is active, he functions as a hired leader; he can then search, peer, and loot as long as you travel together. Don't let his term of hire expire without dissolving the spell or killing him though.

Now, this strategy should be used only if all the valleys have open (or potentially open via enchantment) access to the board. Tonto's main purpose in life if he's not a character or leader is to serve as baggage handler and human sacrifice to any monster that jumps you, enabling you to recast Unleash Power and run away.

The "Good Ole Boy" strategy entails being a social animal and running with a bunch of characters, each aiding the others. This is potentially the most powerful manner of playing the game, but is rife with difficulties (chiefly mistrust and greed). Unlike the "Lone Ranger" or "Hit Man" strategies, here all are equal partners. You will need Unleash Power in order to walk around with the gang. Fiery Blast and Blazing Light are highly recommended and Transform, Lightning Bolt, and Enchant Artifact are only slightly less so. An early test of the group's loyalty will be in acquiring any boots card that the Rogues and others may have for your use. You in turn, will be expected to read runes via Magic Sight, provide extra phases in caves, and Fiery Blast away gaggles of goblins, wolves, ogres, bats and what-not. Victory conditions should include Fame, Notoriety and perhaps Spells . . . or a Great Treasure. Beware of a double-cross.

The "Hit Man" strategy reverses the roles of the Lone Ranger strategy; here you're Tonto. Your mission, should you choose to accept it, is to harass and ultimately destroy every other character except yourself and your liege. Standard tactics include the

Disappearing Road Trick, casting Violent Storm, attacking Light and Medium unarmored characters with a prepared Fiery Blast, and perhaps going Dwarf-hunting with Roof Collapses. The strategy calls for the ruthless cunning of a gangster and the sacrifice and dedication to duty of a kamikazi—you may occasionally win with this one, but don't count on it. Use it to avenge the death of your first character when using the Revival or Exchanging Characters optional rules, or to make straight the path of your other characters of playing the Multiple Character option, or even to set your wife up for a win. [What!] Your victory conditions should include Gold and be heavy on Notoriety (gathered from your vanquished opponents). Good luck.

The "Leader of the Pack" strategy combines the "Lone Wolf" and the "Lone Ranger" strategies. First the Witch King takes off in typical lone wolf fashion and mucks around until he has sufficient gold to both purchase a pony and hire the Bashkars. He and his gang then sweep down on unsuspecting characters and monsters, wreaking havoc. The problem with this strategy is that it takes too long to accomplish; if you're playing the standard four VP game one of those Heavies often wins it in a couple of weeks. Just the process of getting the requisite gold or treasures to purchase the pony can take you that long. Still this is a quite viable strategy for longer games. Consider taking Broomstick and Melt into Mist for movement and Fiery Blast and Transform for attack. Melt will serve as a defense spell also. Of course all this presumes that cave clearings can be totally avoided.

Your best chances, if new to the game, probably lie with the "Lone Wolf" strategy. Your power is likely to be feared by the other characters, who probably wouldn't feel a chance to slay you pass by. The "Good Ole Boy" strategy is likely to tempt them over much. The "Lone Ranger" gambit will slow you down more than it will help. The "Hit Man" strategy is just short of suicidal; but then if you can't take chances in a game, where can you take them?

## VICTORY CONDITIONS

Let's examine each of the victory conditions and discuss the relative ease of achieving them for the Witch King. Keep in mind that whatever victory conditions you might select will largely determine the strategy you'll need to employ.

**GREAT TREASURES:** Seventeen of the 74 treasure cards (22.97%) are Great Treasures. This breaks down to seven of 45 small treasures (15.56%), ten of 23 large treasures (43.48%), and none of the six Treasures within Treasures (0% but four of these contain large treasures). Thus the chances that the Rogues, or any other native group for that matter, have exactly none, one or two Great Treasures are 71.01%, 26.87% and 2.12% respectively; thus, better than two in seven that at least one starts the game at the Inn. But of these only Dragon Essence allows a reasonable chance of purchase (9.53%) with the ten Gold you start with (see discussion under "Absorb Essence" for likelihood of appearance). Dealing with the Company or the Bashkars increase these odds to 42.90% and 44.44% respectively. Clearly one shouldn't expect to immediately acquire a Great Treasure in this way, especially with the other characters also in the bidding. Table 4 shows the actual odds break down from the Meeting Table.

Slaying another character for his gold and treasures is a possibility of course. Unfortunately, while you cast your attack spell in the encounter step, there's nothing to prevent the intended victim from running away. A hired native would solve that problem, or attacking him when transformed or as an absorbed monster. Given that you'll want to Loot, the question becomes where. A close inspection of the Treasure Troves and the odds discussed so far shows that the Hoard, the Vault, and the Altar are the sites of choice.

The Hoard (or the Pool for that matter) has a 50% chance of being in a cave. The Flying Dragon is the defender, and if the "Clubs/Heads" optional rule is in play, it should be your first choice to absorb; most characters and monsters haven't a chance to "whup 'im" (see Tables 5 & 6). There's also a 50.06% chance of at least one Great Treasure amongst the four small treasures there. The Pool suffers the disadvantage of causing you to fatigue a counter for each Loot Phase and isn't recommended unless you have some hired leader to do the looting since he can't fatigue.

Unless you have the Lost Keys, the Vault has to be broken into to be looted, but Melt into Mist or a lucky Fiery Blast (25%) can handle that; Unleash Power can't. Lightning Bolt can (44.44%) when the Vault is in Mountain or Crag (20% of the time). The resident monster is a Troll—just the kind of guy you'd like to absorb. On the average, it should take four Search Phases to find the counter, and seven more for each treasure. With one Hide phase a day, that's 39 days in a cave or 13 days in the open. Start early.

The Altar with four large treasures has odds of 16.33%, 40.91%, 32.38%, 9.52%, and 0.89% of exactly zero through four Great Treasures being there. The two spells there are worthless to you.

The Shrine has only two large and two small treasures. Odds are 57.82% that there is at least one Great Treasure among the large and 28.99% for at least one among the small. Overall that's 29.95%, 44.57%, 21.39%, 3.95% and 0.23% for there being from zero to four Great Treasures respectively. Not the most favorable; but since there is a Type V spell there, you can save some time and search for both simultaneously.

To sum up, if Great Treasures are among your victory conditions, expect to spend a lot of time searching at a treasure location. The Vault and the Hoard offer the best chances for large treasures and also a good, strong defending monster to absorb. The Phantom Glass would be a useful acquisition since combined with the superior "Find Counter"

chances offered on the Magic Sight Table, it would make looting truly efficient. You must also be able to transport your booty, so don't expect to FLY L1 via Broomstick afterwards. Indeed, even Unleash Power is suspect, so Melt into Mist is almost a must.

**USABLE SPELLS:** There is always a temptation to take several VPs in this category. After all, you have three or possibly four (if Elemental Spirit was taken or learned) types to draw from. Resist the temptation.

First of all, even if all the treasure location counters have been revealed, you would only know with certainty where one spell would be—the Type V spell at the Shrine (double that with Elemental Spirit and include the Type VIII at the Statue). All the others must be looted or traded for. The Warlock and Crone may not be active this month or may never appear if they are. These visitors are prohibitively expensive anyhow, at least in the early stages of the game. The bulk of the Type IV and VI spells are in the two spell books—somewhere out there (forget them if the Scholar has them). They are worth killing for. Thus all the available Type IV through VI spells are restricted to the Shrine, three spellbooks, three artifacts, and two visitors. Adding the Type VIII spells increases it to only two sites, three books, four artifacts, and the same two visitors. Thus out of the 74 treasures only six (or seven, 8.11% or 9.46%) are what you seek.

At most, take one point unless a really long game is contemplated. You may be able to work a deal with another character to Magic Sight an artifact; you record the spell and he gets a useful artifact.

**FAME:** Fame is gained only by killing monsters, returning lost treasures to their proper owners, and by possessing certain treasures, but most treasures carry negative Fame (if any). This is especially true of those you covet most. Avoid this category unless you're contemplating the "Goblin Gambit", the "Transform Trick", or the "Let's Get Physical Ploy".

**NOTORIETY:** Gained like Fame, but also from killing natives and other characters. The treasures you seek have positive Notoriety so at least one point and probably two should be taken here. Remember that Notoriety gained from killing a character is his recorded Notoriety at the time of his demise.

**GOLD:** There are only four ways to augment that ten Gold you start with: sell treasures or items, conduct certain missions, loot certain treasures within treasures, or kill characters for what they have (or natives if the "Pocket Change" optional rule is in effect). In practice only the first two options are practical, as most players seem to use any gold they have for new armor or weapons or to hire natives. That leaves looting and missions. Looting, as we've seen, can take a long time and presumes a carrying capacity to haul the loot back to a dwelling to sell. A mission merely requires being where the counter is likely to turn up and waiting for the "Monster Roll" of six, then picking it up and getting it to its destination. Your ability to fly can make this an extremely easy way of making a fast buck. Unfortunately, the Warlock is the flipperside of the beer truck, so you can't have it both ways.

No one set of victory conditions can or should succeed everytime. Nor would we really want them to. Someone planning to aggressively pursue the "Goblin Gambit" may split the VPs between Fame and Notoriety, while another might emphasize Treasures, and yet a third may prefer a more balanced approach. Just remember that you'll be stuck with these goals for the rest of the game. Try to make them attainable.

## TRICKS OF THE TRADE

**COLOR MANAGEMENT:** Obviously, you want to keep your fastest MAGIC counters available for casting spells rather than tying them up as *color*, but also be wary of casting permanent spells with

them. Prior to the first turn, convert only the mid-ranged counter to *color*. Then, if there's no rush, use the slowest counters for the permanent spells or the morrow's movement spell. If you're using Unleash Power, you then have some Medium counters to use if necessary. Never willingly get too low on *color*!

**THE DISAPPEARING ROAD TRICK:** Enchanting the various woods tiles drastically alters the roadway patterns. When the board is set up favorably, it can stop the non-magical characters cold. (See Figures 1 and 2.) The Ruins tile is also sometimes effective in this way. These enchantments do increase the powers of the Elf, Wizard, and Magician so some care should be taken. Enchanting tiles with *Purple* present should be avoided if you are using Melt into Mist and there is a treasure location of interest there. The nuisance value of this trick (provided you did well on the board-building phase) is often well worth the few phases it cost you.

**FIRST DAY JITTERS:** You are at your weakest today. The other characters may want to get you now while they can. The Wizard, Swordsman, Sorcerer, and Pilgrim are suspect here. The Swordsman can elect to go first, then block you at the first opportunity. If he does, the best thing to do is to block everyone else you can. Sure, that won't win you many friends, but you don't want one of those spell-slingers to alert a spell and do you in either. You won't be able to move since you've not yet cast any spells—any battle is apt to be short and decisive. The Wizard and Sorcerer can alert a Fiery Blast, block you, and then fry you easily. The Pilgrim's Exorcise will leave you helpless for the second round. Stones Fly could also be fatal (Druid, Wizard, and Witch). So typically you'll need to cast a spell with a time of two to avoid trouble. This precludes the type IVs. Melt into Mist is the only real choice. With Broomstick, you'd only be able to maneuver that round—not fly away. But the third round you'd be out of luck (and out of Type V and *Black* counters). Unleash Power would allow you to maneuver and to attack next round with the optional dagger but you probably won't survive that long. Only Melt offers immunity—barring Exorcise—from the stings and arrows of outraged opponents. It can be a jungle out there!

**THE GOBLIN GAMBIT:** Going into a caves tile and feel a bit gutsy? Have you recorded Fiery Blast? Do you have a Broomstick Fly L1 counter ready to go? Then you're ready for some quick relief for your Fame and Notoriety totals! Merely lure a six-pack of goblins to your clearing, stack them together, and cast a prepared Fiery Blast, then use your Broomstick to maneuver. While there is an 11.22% chance of killing all of them immediately, any survivors (and there's likely to be two or three of them) have only one chance in three of matching your direction and killing you (the spear goblins would also have to change tactics, 10.19% chance overall). Let's say you nailed four of them for 10 points. You may now either perform a Vanishing Act or hit them with another Fiery Blast and hope for the best since you won't be able to maneuver. In the latter case, you have a 40.76% overall chance to survive against wolves or axe or sword goblins (59.54% against the spear goblins) while garnering 21 points. Not recommended when using the "Deadly" rules. The astute reader will have noticed that attacking a stack consisting of two or more six-packs and sundry other monsters increases the payoff for a single Blast while the risk remains the same. If using the "Magical Attacks" optional rule, be sure to alert the Type IV counter!

**THE LET'S GET PHYSICAL PLOY:** Tired of skulking around in a cloud of mist? Are you tired of running away from every tin-plated, clattering vagabond on the board? Well take Absorb Essence and grow hair on your palms as a Troll or sprout

*Continued on Page 33, Column 3*

# TOURNAMENT ORIGINS

## A Truly Diplomatic System

By Dave Slick

In comparison with an opportunity to play either *DIPLOMACY* or *KINGMAKER*, the prospect of tournament competition in *ORIGINS OR WORLD WAR II* may not seem very appealing to the average wargamer. Certainly both of these giants of political gaming are more frequently played by the general gaming public, and have a much broader following in all respects. Furthermore, *ORIGINS* is not the kind of game which makes a lasting first impression. I have found that most gamers are not overwhelmed with enthusiasm after an introductory session of *ORIGINS*, especially if they were saddled with the United States or France.

For those few of you who are totally unfamiliar with *ORIGINS*, allow me to point out that The Avalon Hill Game Company's game of pre-WW2 power politics is a terribly imbalanced five-player struggle contested over a small and relatively unimpressive mapboard of Europe. Each player (US, France, Britain, Russia, Germany) attempts to win by achieving his own diplomatic objectives in various regions of the continent. The company's entirely accurate complexity rating of 1 results from a game system which can be fully absorbed in less than 30 minutes. As such, most people soon realize that the game will neither challenge their mental facilities nor provide an equitable chance for victory. For these reasons, I would venture to guess that the game is largely ignored today.

Among those familiar with political wargames, at least some must be wondering how any rational comparison between lowly *ORIGINS* and either *DIPLOMACY* or *KINGMAKER* could be made. After all, using just the Reader Buyer's Guide (RBG) as a comparative index, *ORIGINS* (5.26 Overall Value) ranks considerably below both *KINGMAKER* (3.03) and *DIPLOMACY* (2.30). Surely both of these timetested favorites are a cut above The Avalon Hill Game Company's 1971 creation.

It is my contention, however, that given certain assumptions about tournament competition, a workable tournament format and slight modifications in the mechanics of play, *ORIGINS* can be an exciting and balanced multi-player confrontation which, in some respects, is distinctly superior to both *DIPLOMACY* and *KINGMAKER*. With that "one-fell-swoop" alienation of all hardcore *DIP* and *KM* fans, I will now attempt to craft a case for *ORIGINS*. My effort begins with a review of tournament competition standards.

### Tournament Competition

This term has not been repeatedly used by accident. In my opinion, tournament play of any game represents the highest form of competitive gaming effort. It is important to differentiate tournament competition from non-tournament games in this discussion because I would not argue that *DIPLOMACY* and *KINGMAKER* do not make for better "social" events.

So what do I mean by "tournament competition"? Basically I'm talking about a one- or two-day event for which one is required to pay some sort of entry fee and can expect some sort of reward if won or finished well. Most such competitions imply full days of gaming and are necessarily characterized by time-limited moves. Most tournament gamers play for the sake of the competition. As such, they are generally not concerned with the simulation value, realism or historical accuracy of the game at hand. Play-balance and a well-defined rules structure are two pre-eminent concerns of the experienced competitor, since in the absence of these qualities even the most skilled player can be frustrated.

### Game Length

Playing time is one great inherent advantage of *ORIGINS* over both *DIPLOMACY* and *KINGMAKER*, and it is the one which makes the tournament format proposed by this article eminently possible (even for non-monied "social" games).

The current RBG chart shows that the majority feel *ORIGINS* is, roughly, a 90 minute game in comparison with three approximately 3.25 hours for *KINGMAKER* and 4.10 hours for *DIPLOMACY*. I interpret these figures to be average estimates of the time required to reach the game's stated victory condition without restrictions on individual playing time. Although the chart gives you a rough idea of comparable game length, such estimates are irrelevant when the three games are compared from the perspective of a one-two day tournament. This results from the fact that most such *DIPLOMACY* and *KINGMAKER* tourneys are played in time-limited rounds, which are designed to ensure the play of more than one game in a day. Such events also utilize improvised victory conditions, such as most economic centers controlled, most royal pieces held, or most "points scored" at the end of the time frame. These conditions are rarely representative of a decisive result. Consequently, most such *DIPLOMACY* and *KINGMAKER* events have been won without the game's stated victory condition having ever been reached. Herein lies the beauty of *ORIGINS* for the competitive gamer. Not only is a decisive result achieved quickly, it is achieved every time.

### Play Balance

This essential tournament quality is achieved by implementing an expanded version of the concept which originally presented in the sole *ORIGINS* Series Replay (Vol. 11, No. 4 of *THE GENERAL*) to see print. Simply stated, every participant is required to play each country once. Tournament standings are determined on the basis of total points, with half of the points earned by virtue of "game" performance and the other half earned by way of "country" performance. Admittedly, this system does not attempt to balance the play of any one particular game/scenario. It does, however, provide an equal-opportunity forum for tournament play.

My tournament experience with *KINGMAKER* has been that players who receive poor initial draws in a time-limited game usually lose. Furthermore, players who receive poor initial draws in more than one round on the same day have no chance. The nature of *KINGMAKER* is such that no player can be guaranteed that he will have no poor initial draws. Thus, in my opinion, Tournament *ORIGINS* gives competitors a more equal chance to win the tournament.

Although a *DIPLOMACY* competition can certainly be structured in the same manner as that which is proposed here, the game's length would prohibit completion of such a tournament within the same time frame as an *ORIGINS* one. And while *DIPLOMACY* has better individual game play balance, a random-draw tournament format still leaves one with the possibility of participating as a non-optimum entity in every game.

### Point System

The game performance/country performance method of scoring an *ORIGINS* tournament lends

a certain amount of natural intrigue to the competition. Experience shows that the country performance will remain somewhat undecided until the final game of the tournament is finished. It is therefore difficult to tell exactly where you stand at any one point in time, making for exciting and tense play throughout by all the players.

Our club utilizes 5-4-3-2-1 scoring for 1st through 5th place in both game and country performance, which makes 50 points the maximum possible value that could be reached. Country performance scores are extended to zero when more than five players are in a group (see Tournament Organization below) and ties in either category divide points evenly (e.g., two players tied for first would receive 4½ points each).

### Tournament Organization

Some readers may be wondering what happens if more than five people show up for the tournament. Some basic ideas on formatting such an event are presented below:

1. You must have a minimum of five players. Otherwise, you don't have the tournament.
2. If there are more than nine players, you should stage a two-day event, with an elimination round on the first day, and the championship round on the second. Although you could compare the total points of players in different groups and declare a champion in one day, such action would tend to degrade tournament play balance.
3. For the ten- (or more) player tournament, divide the players by chance into a number of groups in accordance with the Tournament Organization Schedule. Each group plays out its own elimination round independently with winners advancing to the championship round. The schedule is based, in part, on the idea that the optimum number of players in a group is six (explained later).
4. All games are five-player games. When the number of players in a group is not evenly divisible by five, then the players in that group will be rotated such that each player has each country once and there are five players in each game. An example schedule which accomplishes this for a six-member group is presented. Players A-F are determined by chance at the start of the competition.
5. Beyond 36 players, one or more of the following unattractive options must be adopted (I'm certain that the nature of each particular event would dictate which methods could be used):

- a) go to a three-day event.
- b) increase the size of each first round group.
- c) reduce the number of championship round qualifiers on the basis of points scored.

### Time Limits

In order to ensure a timely completion of the tournament, time limits on individual play are absolutely necessary. Normally we allow ten minutes for first turn Diplomacy, and four minutes thereafter. Placement of factors can be time-consuming; we limit all players to 20 seconds for the first turn, 30-60 seconds thereafter (depending on nationality and game turn). Allotted time for the placement of political factors should be modified with respect to the scenario that is being played. A standard 20 seconds per player suffices for placement of Controls and Understandings by experienced players.

### Tournament Organization Schedule

Entries	No. of Groups	Players Advanced to Final Round
10-12	2	top 3 from each group
15-18	3	top 2 from each group
19-24	5	top from each group; next two best from all groups
25-30	6	top from each group; best from all groups
31-36	7	top from each group

### Schedule of Games for Six-Player Group

Player	Game:	1	2	3	4	5	6
A		US	FR	BR	RU	GE	—
B		FR	BR	RU	GE	—	US
C		BR	RU	GE	—	US	FR
D		RU	GE	—	US	FR	BR
E		GE	—	US	FR	BR	RU
F		—	US	FR	BR	RU	GE

Our experience has shown that the time limits presented here are adequate and do not bring distorted play of the game.

If all of the time allowed above is used, then approximately 63 minutes will be consumed by one game. However, all players will not utilize the full time allotments. Thus, our experience has shown that when all of the untimed phases of the game are added in, each game takes about 60-70 minutes to complete. The "tournament-day" length will thus depend upon the number of people in each group (one reason why smaller group sizes are preferable).

When time limits are used, tournament administrators should also incorporate time limit penalties. While the exact scheme might vary with the nature of the event, a suggested set of rules is as follows:

1. Diplomacy beyond allotted time: All political factors (PFs) of all involved parties must be placed in their home countries in that turn. If the home country is controlled, the PFs are lost.
2. Failure to place PFs in allotted time: Unplaced PFs go to the home country. If controlled, they are eliminated instead.
3. Failure to place Controls/Understandings in allotted time: Counters cannot be placed until the next turn. All 6th turn controls/understandings occur automatically.

In addition to the outright time limit penalties, any "diplomacy" or "kibbitzing" outside of the diplomacy and review phases of each turn should be absolutely forbidden. This enhances speed of play, limits shouting matches and forces more individual decision-making.

### Rules Modifications

By now I'm sure that many *DIPLOMACY* and *KINGMAKER* fans must figure that they have me in the bag, because all of the play balance/tournament formatting techniques in the world do not make *ORIGINS* a better game. Quite so. However, what does make *ORIGINS* a better game are some modifications in the mechanics of play which are so simple, that it is difficult to believe that these concepts have not appeared in this magazine at least once during the decade since the game's release. Proposed rules modifications for *ORIGINS* are as follows:

1. Unless otherwise stated, all rules are in accordance with The Avalon Hill Game Company's game of *ORIGINS OF WORLD WAR II*, including face down placement of PFs and utilization of decoy counters.
2. Contrary to the AH rules, all counters will remain face down at the end of each turn. Exact PF counters will be revealed only as necessary to resolve political conflict. (All of the following rules are necessitated by this simple concept.)
3. Once placed, blank counters cannot be voluntarily moved from any area of the board except your home country. Blank counters regain mobility when exposed due to combat. Each nation can have no more than four blanks in play at any one time.
4. The Revised Political Conflict Table will be used. Note that the table only adds new odds columns and does not otherwise change the existing table.

a) For odds of 1-4 or worse, or 5-1 or better, the defender/attacker need only show sufficient PFs to prove the odds.

b) Blank counters cannot be used to make attacks by themselves. Attacks against "blanks only" are automatic victories with no loss to the attacking player.

c) Defenders/attackers may deliberately show blanks as part of the defense/attack in order to promote the mobility of their decoys.

5. A player may look at the hidden PFs of another player only with permission from the owning player and only during the diplomacy phase of the turn. The penalty for an infraction of this rule is that the guilty party cannot place any factors on board during the turn in which the infraction occurs. Such PFs would be permanently lost.

6. Each player is responsible for placing his PFs in the spaces provided for his nation's counters on the board. A player will not be penalized for looking at other PFs that were incorrectly placed in his space on the board.

7. Control of the placement of PFs is handled in one of the following ways:

a) If somebody is available to referee, then all players must show their PF counters to the referee prior to placement each turn. (This is the primary reason for an optimum group size of six.) The referee is responsible for ensuring correct counters.

b) If nobody is available to referee, then all players must first place counters on the edge of the table face up. After ensuring correct counters, counters are inverted and placed on board.

Because these rules do not change the original nature of the game, and are applicable to any scenario, I do not feel that these modifications constitute a "variant" game form. In my opinion, these concepts defend a "better" game form for *ORIGINS*.

### Credit Where Credit is Due

Quite frankly, I deserve none of the credit for the ideas described above. All of the tournament organization and game rules concepts that have been presented were developed by one Jim Reilly of Santa Ana, California. To the best of my knowledge, Jim first introduced these concepts in 1975. Although I am not responsible for the creation of this system of play, I can offer five years worth of experience with it.

Having tried all of the game's originally provided scenarios under tournament conditions, some brief comments about the relative value of these game situations are perhaps inevitable. We found that the Historical and Aggressive British/US Alliance scenarios make for interesting tournament competitions which are likely to go down to the last battle. The Anti-Bolshevik Crusade is much more stimulating than it might appear to be on paper, and is also recommended. But those who are former Legionnaires and/or foam at the mouth when given the deceptive PF allocation chart for the Aggressive French Policy may be terribly disappointed. There were no French winners in our 1978 tournament primarily because the French are in no position to prevent understandings in Paris before it is

too late. But where the Aggressive French Policy may make for a playable tournament, the Aggressive French-British Policy does not. As it turns out, this scenario almost always boils down to a three to two wargame because there is so little flexibility for creative backstabbing. Consequently, this scenario is not recommended.

### Strategy in Tournament ORIGINS

There are a number of strategic considerations which are unique to Tournament Origins. Since these factors add new dimensions to the game and may not be obvious from the preceding discussion, some comments on these are apt.

Even when a particular contest falls along "classic lines", the nature of this game is somewhat different than the "box" version. Knowledge of an opponent's PFs in an area, plus the number that he can add to that area in any one turn, are often fundamental challenges in this game. Economy of force has never been more clearly demonstrated than when a German player finds himself attacking Poland at 20-11 rather than 20-10, or 20-0 rather than 5-0. Stockpiling counters in one's home country now takes on a refreshingly mysterious quality which can be the cause for a considerable amount of embarrassment in the latter stages of a game. And scouting becomes a viable tactic whereby players will deliberately sacrifice PFs at low odds in order to find out what other players have in certain area on the board.

"Protection" is a tangible quality of the tournament version of *ORIGINS*. Protection occurs when a player intentionally throws away his chances with one country in order to "protect" a score he previously made with another. For example, let's say you are France in the fourth game of the tournament in the Historical Scenario. Previous French players have established relatively high 18, 17, and 16 point scores. You have the high US score thus far (11 points). In this situation, many players decide that they have no reasonable shot at a high French score, and therefore torpedo the current US player without regard for their own French performance.

The original tournament organization can have a very real bearing on strategy. In groups larger than five, probably the best player to undermine is the one who is Germany when you're not in the running. By the same token, however, if you are scheduled to play in the tournament's last game, it may be important to recognize who plays Germany then. If you have befriended this individual in an earlier situation, and he obviously has no shot at the tournament title, your PFs may hold a remarkably large amount of his attention in the last game.

Although this last quality is certainly not unique to this version of the game, for those who really get off on backstabbing, Tournament *ORIGINS* opens up a whole new world. Since a number of external influences often force the game out of the standard Axis versus Allies mode, new horizons for sabotage are opened up in almost every scenario. For the "finesse" backstabber (who attempts to drive the knife all the way home before any sensation of pain is felt), the "slam dunk" backstabber (who delights in dropping a skyscraper stack of PFs in the same region as a lone understanding counter), and the "used-car" backstabber (who would sell out his grandmother if she were entered in the

competition), *ORIGINS* offers a forum for every devious talent. Unlike *KINGMAKER*, where a contrived plot can be fouled by a number of uncontrollable factors, and *DIPLOMACY*, where the complete demise of a backstabbed player can take several turns, backstabs in *ORIGINS* are almost always devastating and instantaneously decisive, one way or other.

### Summary

Play balance and excitement level are the two individual game quality categories in which readers of *The GENERAL* have ranked *ORIGINS OF WORLD WAR II* much lower than both *DIPLOMACY* and *KINGMAKER*. This article has attempted to describe methods which yield a considerable improvement in both qualities of the game. In my humble opinion, *ORIGINS OF WORLD WAR II* is superior to both *DIPLOMACY* and *KINGMAKER*, but only when:

The comparison is made from the standpoint of tournament competition;

You are limited to a total time frame which cannot exceed one or two days;

The number of participants is manageable;

You insist upon competitive tournament equality; and

You prefer a game/tournament system which yields a decisive result.

Except for the obvious rebuttals which will be directed at the editor, I am certain that this article will not impact on dedicated *DIPLOMACY* and *KINGMAKER* players. However, I do hope that the more open-minded gamers will reconsider the value of *ORIGINS*, an undiscovered gem in The Avalon Hill Game Company's mine.



### FULL SERVICE BOOTH

Attendees at this year's *ORIGINS* will have the opportunity to purchase virtually anything in The Avalon Hill Game Company inventory from our Parts Booth, down to and including the smallest item. For the first time ever, we will have a booth on hand to accept orders for individual game parts, magazine subscriptions, in-stock back issues, or the relatively obscure games that we don't normally bring to a convention. Merely place a "mail order", minus the postage costs and the mailman. Get a *Replacement Parts List* from our booth on Thursday or Friday, write down your selections, pay the sales clerk, and get a receipt for your order. Your order will be waiting for you on Saturday and Sunday in the same booth for you to claim. So take inventory now. See which of your games have worn or missing pieces that need to be replaced. Make a list. Check your *GENERAL* collection for any missing issues still available in the current listing of back issues on the back cover. Check that catalogue for the unmounted mapsheets, magnetic strips, game trays, variants, pbm kits, scenarios, magazine binders, and other accessories that you've always wanted but never got around to ordering by mail. Bring your shopping list to *ORIGINS '85* and get it filled on the spot with no postage charges or mail delays. ONLY on Thursday and Friday at *ORIGINS '85*.

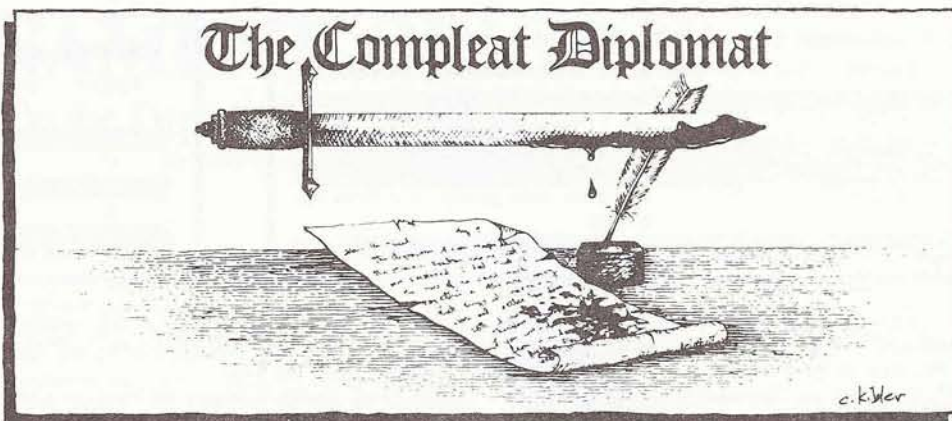

## Give Till It Hurts!

By Rod Walker

Someone who gives you something is not always your friend. When Lucy Borgia (long ago named patron saint of the *DIPLOMACY* hobby) offered a glass of wine . . . well, it wasn't "some enchanted evening" by any means. By the same token, when somebody takes something that's not his, are you sure it's not by pre-arrangement? "Things are seldom what they seem/Skim milk masquerades as cream", said Sir Gilbert in *H.M.S. Pinafore* nearly a century ago; when it comes to *DIPLOMACY*, how right he was! In this column we are going to discuss some ploys, in which a center (home or otherwise) is given or "taken" . . . for some very sneaky reasons.

*The Brussels Boomerang.* You are playing England, and the French player offers you an alliance. He also offers to support an army of yours into Belgium so that the two of you can go after Germany. Of course (ahem), he will want to build two fleets in Fall 1901 so that he can also seize control of the Mediterranean. Well, Belgium—and a big share of Germany—is prime, so you accept. Sometimes it even works out, sometimes.

But, sometimes the French unaccountably wind up 1901 with a fleet in Portugal, an army in Spain, and of course the army in Picardy which supported you into Belgium. His Spring '02 orders turn out to be A Spa-Gas, F Por-Mid, F Bre-Eng, F Mar-Spa; and by this time Germany has armies in Holland and the Rhur, plus two fleets pressing in. Your wonderful gift of Belgium has left you a sitting duck. The army in Belgium is about to be annihilated and your fleets are out of position for the major Franco-German invasion that will take place in 1903.

*The Bavarian Backdoor.* You are playing Italy, and it looks as if France may be getting ready to attack you. Suddenly, however, a French army in Burgundy lurches into Munich and Germany's outraged howls are heard from one end of Europe to the other. *Molto bene*, right?

Maybe. What you may see the next season however, is a French order of A Mun-Tri, accompanied by movement toward or into Piedmont and the Mediterranean. Munich and Tyrolia are, in fact, France's back door into Venice, given a lot of German trust. This arrangement, when it works, can be extremely demoralizing for Italy. Furthermore, it can put Italy badly off-guard since he would expect the French navy to move toward Scandinavia and the Low Countries to strike at Germany . . . and therefore possibly neglect his own defenses. Once France moves, an Italy that has mistakenly thrown everything into a war with Turkey is a dead Italy.

*The Dardanelles Dodge.* It's now Spring '02 and the Russians, who are in the Black Sea, make a grab

for Constantinople, and actually get it! Austria heaves a sigh of relief . . . the Ice Queen and the Wicked Witch of the East are at war. Now certainly he can take his pick of allies and help one carve up the other. Listen to the Turk yell.

Imagine Austria's consternation, then, when in Fall that same Russian fleet moves to the Ionian Sea as the Ice Queen and the Wicked Witch prepare to claw their way into the Balkans. This procedure, in which Turkey must be very trusting, can yield big dividends for both Russia and Turkey. The Russian fleet passes into the west (and Russia has promised not to build another one) to become an outrider for the Turkish navy. Austria, usually thrown off-balance by what appears to be a Russo-Turkish war, may become a much easier target. For both parties, it is easier to keep their alliance without the constant irritation of Russia's southern fleet present.

There is an interesting variant of this concept in which in Fall '01, a Turkish army takes Sevastopol while the Russian fleet takes Constantinople. This creates a spit on which Austria roasts quite nicely. It's called the "Sev-Con Shuffle", and there is a detailed discussion of it in #33 of *Diplomacy World*.

It's ploys like these which help make the game so fascinating. It is not just the tactics involved, but the diplomacy and the real and feigned reactions of the players. These give such tactical moves their impact. This is one subject on which, in particular, I'd like to hear from the readership. Have you done, or witnessed, a ploy in which a center is given or taken in a very misleading manner (tactically or diplomatically or both)? What happened and how did it work? I'd like to hear of some of your experiences along this line, really.

Rod Walker is the editor of *DIPLOMACY WORLD* and the author of *THE GAMER'S GUIDE TO DIPLOMACY*. He is past recipient of every major award in the *DIPLOMACY* hobby, member of the *DIPLOMACY* Hall of Fame, and namesake of The Avalon Hill Game Company's funded annual Award for Literary Excellence. *DIPLOMACY WORLD* is a quarterly publication featuring articles on the game, hobby news, ratings, a demonstration game and numerous other tidbits. It has been the central *DIPLOMACY* hobby publication since its founding in 1974. Further information may be obtained by contacting Mr. Walker, 1273 Crest Drive, Encinitas, CA 92024. Rod also edits a monthly publication, *PONTEVEDRIA*, which lists postal GameMasters who have openings for play-by-mail *DIPLOMACY*. To obtain a copy at any time, merely dispatch a request to Mr. Walker along with a self-addressed and stamped envelope.



# THE LUCK OF THE DRAW

## THIRD REICH Variants

By James C. Gordon

The 1981 *THIRD REICH* update included several changes to the variant counter section of the rules, including alterations to several variants and three completely new sections adding variables to the game. An additional article in *The GENERAL* (Vol. 18, No. 5) expanded the list of variants to twenty for both the Allied and Axis players. Many of the early *THIRD REICH* articles mentioned one or more variants in conjunction with a specific plan or scenario, and recent articles have treated the variants almost as a necessity (perhaps rightfully). Every variant offers an advantage of some kind and comparing the possible uses of each (for the best effect) allows one to compile an "order of importance" list to gauge how the luck of the draw has fared with the players. This article will illustrate the reasoning behind the placement of each variant on such a list by weighing the specifics of the variant—additions, pre-requisites, time limits—the importance of the variant being withheld from the opposition, and the primary strategic options made more attractive by drawing each variant.

Before exploring the factors involved in setting any order of importance, a few explanations will assist those readers who have yet to buy the update kit (if there are any such). The three new sections added to the variant counter rules are the *Intelligence Table*, *Foreign Aid*, and *Turkey as a British Minor Ally*. By spending five BRPs once per turn, one country per alliance can roll two dice, consult the Intelligence Table and possibly uncover the opponent's secrets. The opposition can spend five BRPs for counter-intelligence, lowering the die roll by one; otherwise the roll is raised by one. Foreign Aid consists of Major Powers transferring BRPs, via strategic redeployment, to Minor Countries potentially becoming Axis Minor Allies. These BRP transfers modify the die roll now required for Minor Ally activation if Foreign Aid has been given by either side, or both. The last of these three new situations applies only if the Allies achieve a very advantageous position in the Mediterranean Front, holding the lead in ground and naval factors, and owning at least seven objective hexes. The British must pay 35 BRPs for Turkish entry and receives the Turkish BRPs immediately.

The twenty new variants will be mentioned in the order which I have placed them, from *least to most useful*. One numbering change should be noted: Allied #4, raising the British Growth Rate, becomes #18 while the new #4 proposes a Loyalist victory in the Spanish Civil War with Spain potentially becoming a Minor Ally of France and/or Britain. The numbering change prevents both sides from drawing Spain as a Minor Ally.

### ALLIED VARIANTS

A. Variant #18, raising the British Growth Rate to 50%, offers the least advantage to the Allied player because its chief benefit derives from conservative strategies to save BRPs. The BRP level will improve slightly, but equally important, this variant prevents the Axis player from placing more emphasis on bombers in his air force, with potentially effective results during the Battle of Britain. Lacking a solid advantage, this variant is a good example of when the Allied player should concentrate on Intelligence and Foreign Aid, to keep constant surveillance and harass the Axis player's activities. If the Intelligence efforts uncover the Axis variant and find a situation involving a Minor Ally, Foreign Aid should be sent to that Minor country,

thus delaying activation. Without an obvious priority, the Allied player could spend heavily on Foreign aid to Finland, intending to secure the Russian's northern flank for a few extra turns, or to Rumania, possibly stalling the entry of Germany's strongest Minor Ally.

B. The few extra French units available at start with Variant #1 offers little more than Variant #4, essentially saving the French ten BRPs for not having to build the four 2-3 infantry and two 1-0 replacement units (the other two 1-0s now deploy at start). Offensively, the French could risk advancing their position to the German border by attacking Belgium and Luxembourg in Fall 1939. In Winter, the French back up to allow the British to occupy those two countries and also conquer the Netherlands during that turn, thereby gaining 30 BRPs for the 1940 YSS. Beyond that minor offensive, the Allies should use Intelligence and Foreign Aid, as outlined above, and sit largely on the defense. A new rule disallows the old strategy of France "buying" Persia for the British because it would become closed again once France fell to the Axis.

C. The ten free ASW factors from Variant #5 have been changed to a "full commitment" by the U.S. Navy, reducing the effectiveness of submarine factors surviving Strategic Warfare resolution. Starting in 1941, U-boats subtract only two BRPs instead of three, continuing throughout the rest of the contest. This variant must be played in the 1941 YSS, ending any suspense over which variant was drawn but also warning the German player to build more U-boats. If the Allied player constructs a couple of SAC factors early, forcing the German to respond with Interceptors, then the effectiveness of submarines will be reduced even further.

D. Variant #8 raises two possibilities by increasing the U.S. Initial Deployment limit to seven. Defensively, one additional fleet can assist in transferring BRP grants to Russia (or Britain) without disrupting the normal build-up of forces in Britain. More offensively, the faster build-up might be used to support an early invasion of northwest France. Excluding BRP grants, the U.S. entry could follow the sequence below:

Month	Builds (BRPs)	I.D.
Spring 1942	3 fleets (81)	7 fleets
Summer	4 air units (60)	5 air, 1 armor 1 airborne
Fall	4 armor (40)	4 armor, 3 infantry

The Winter 1942 turn finds the U.S. with 39 BRPs and seven fleets ready to carry up to three 5-6 armor and two 3-4 infantry units, backed by one airborne and five air units. The combined strength for the assault would be at least 11 (one armor + one infantry + airdrop) plus 25 air factors (minus counter-air needs), with two armored units for exploitation, if practical. British involvement in the invasion would increase the odds in the Allies' favor, but might not be necessary depending on the Axis deployment. Using U.S. forces exclusively on the Western Front allows the British to concentrate on the Mediterranean, releasing both countries from paying for offensive options on both fronts.

E. The Allies can neutralize Italy for one year with Variant #12, by paying Italy 35 BRPs and evacuating Corsica, Tunisia and Malta. After playing this variant in Winter 1939, the Allies can concentrate their efforts against Germany in the hopes

of extending the inevitable campaign in France and might even preempt the German attack by a move into the Low Countries during that Winter turn. However, German superiority in armor and near parity in air factors (assuming the Allies strip their Mediterranean defenses) should force a French collapse around the time that Italy can become active, leaving the British without an ally and without Malta to help defend the Mediterranean (unless they declare war and recapture it). In an alliance game, Italy has the biggest advantage here, because it can spend its "neutral" year conquering Yugoslavia and/or Greece; it may get a shot at capturing Malta; and it has the option to turn on Germany (shades of 1915).

F. The Free Soviet Winter Offensive from Variant #10 can be used in 1942 to blunt the German advance, or in 1943 to spark the Russian counter-offensive. Winter 1941 usually finds the Russians too short of quality units for an effective counter-attack and by 1944 they may have swept a majority of German units out of Russia, limiting the choice of targets. By soliciting Western Allied help in gaining the initiative during the Winter turn, the Russians can avoid making their attack in the wake of a massive Axis offensive on that turn. They need many armor and 3-3 infantry units available to be most effective and should try for a few breakthroughs followed by exploitation to surround the maximum number of Axis units.

G. Variant #7 doubles the effectiveness of SAC factors, eliminating four BRPs each, starting in 1944, and accompanies a revision in the standard rules governing the ASW to U-boat rate-of-exchange. During 1940-1942, one ASW is exchanged for one U-boat; in 1943 this ratio becomes 1:1 and 1/2; in 1944-45, it's 1:2. This variant offers the chance to damage the Germans heavily late in the war, and encourages aggressive SW builds early to gain an advantage in SAC factors over Interceptors. Equally important, this variant deprives the German of Turkey as a Minor Ally, opening the possibility of the British activating Turkey about the time that the SAC factors are proving significant.

H. The Allies gain a great advantage when Hitler is assassinated in Variant #15, but only for *one* turn. German air, naval and 100 BRPs are frozen for one turn and ground units can only end up in Germany if moving by SR. This variant rates no higher because it only lasts for one turn and does not involve any wholesale desertion or rebellion by German units, which may or may not have happened (at least before 1945). Essentially, it gives the Allies two turns in a row at any time of their choosing (in 1942 or later), without BRP restrictions. It could protect an Allied bridgehead on the continent immediately after the D-Day invasion, or stymie a German attempt at a *coup de grace* during 1942 in Egypt, in Russia or against Britain.

I. Variant #13 offers a qualitative improvement in the Russian infantry with 35 combat factors instead of the 22 available at start (plus 25 in allowable builds, instead of 28), but that increase is still spread among the same number of units—17. The purging of Stalin by Tukhachevsky alters the situation more drastically in the 1942 scenario, with 22 units setting up with 56 combat factors instead of 29; but again this advantage is handicapped by the numerical status quo. Improving the infantry does not expand the defense-in-depth possibilities, but it can present the Germans with a tougher nut to crack. The advantage here, becomes more notice-

able if the Russians attack Turkey with as many as ten 3-3 units available by Winter 1939 (building six in Fall), backed by ten 2-3 units plus armor and air. Turkish defenses might fall a turn earlier and the Attrition Option would have more affect, if used. Hopefully, the Russians could then redeploy their units earlier to meet the expected Axis attack. The corollary to this is worth noting, namely that removing those cheap 1-3s makes Axis attrition against the Red Army much more expensive for the Soviet player.

J. Spain can become a minor French or British ally in Variant #4 (bringing Portugal also, for the British) if France survives until the 1941 YSS or if the Allies control Africa and Rome. Loyalist Spain might also join the Russians, requiring some diplomacy for the Western Allies to reap the benefits in an alliance game. The strategic position Spain offers is worth the maximum effort required to sustain France through 1940, but even stripping the colonies to commit all of the British armor and air units will rarely stop a determined Axis attack. (A follow-up attack might give them Spain as well before they turn east.) Saving the counter until the Allies achieve victory in North Africa and attack Italy can give them the best advantage of the two possibilities. This usually requires a strong and early offensive in Italy after the invasion, tying down many quality air, armor and airborne units to take Rome as rapidly as possible. But once taken the Allies are relieved of the necessity to mass their fleets for an invasion of France. Hopefully, the Allies can activate Spain at a point where they are getting two turns in a row, to afford a maximum build-up and the start of an advance before the Axis reacts.

K. Variant #3, passing control of all French colonies to the British, now requires French survival until Winter 1940 or later to become usable. This change restricts the old tactic of stockpiling the better French units in the colonies before Paris falls, even before the Germans attack. A strong defense calls for massive British aid (as above) and the Allies might consider an advance into the Low Countries to improve their position and hide their secret intent. Southern France *must* be protected as the escape route when, or if, the opportunity presents itself. The fleet should avoid engagements to remain ready for transferring units to Africa, and it goes over to the British automatically (if the variant applies). Executing attacks against Libya or Iraq might conceal the reason for locating units in the colonies, but spending BRPs for these attacks absorbs the rebuilding capabilities and draws off the units which will be needed for France to survive into Winter.

L. The Russians gain a slightly better advantage with Variant #19, presupposing that no Winter War took place and essentially neutralizing Finland. Relieved of this threat to their right flank, the Russians will have some extra units available to resist the Axis advance from Eastern Europe, though not many more. By drawing this variant, the Russians should adequately eliminate the chance of Leningrad and Vologda being surrounded or controlled, cutting off the Murmansk Convoy route. The Axis player loses the quality Finnish units from their attack and the convenience of up to ten combat factors when taking the Attrition Option; one or two Finnish units can also be lost to attrition without bringing a disaster, when they are available. Combining this variant with massive Foreign Aid to another Axis Minor Ally (e.g. Rumania) to delay its activation could put the Russians in a *much* better position than merely improving the quality of their infantry units.

M. Variant #14, lifting the restrictions on Anglo/French Cooperation, adjusts a major hindrance to Allied planning and operations during the early years. British and French units can combine in attacks and exploitations, lend Ground Support

to each other and British units can take a more definite role in defending France. Attacking Brussels and achieving an armored breakthrough would allow the Allies to exploit into the Netherlands, enabling them to capture all three Low Countries in one turn, or into Germany itself if the border is not properly guarded. A similar combined exploitation attack could be used against Italy, landing on coast hex W24 or AA23 and threatening Rome, or taking hex EE21 in Sicily and exploiting onto the "toe" of the Italian "boot". In either strategy, the drawback remains a lack of quality units in sufficient number to adequately exploit the early gains—or even hold onto them. France should survive for a little longer on the average, but this variant seems unlikely to ensure its survival indefinitely.

N. The enlarged U.S. Navy in Variant #6 adds two fleets to the U.S. force pool, but more importantly it allows three fleets to be shifted from allowable builds to available at start. Because those three fleets need not be built initially, this variant adds the equivalent of 81 BRPs to the U.S. total. The BRPs "saved" this way can help defer the cost of sending BRP grants to the other Allies, for which two extra fleets are available to escort. Building the two extra fleets does cost 54 of the "saved" BRPs, but they need not be built immediately, allowing the American player to transfer BRPs early without inhibiting the rapid growth of the navy—it's already built when they enter the war. The larger U.S. fleet is very important when the Allies choose to divide the American and British theater responsibilities, Western and Mediterranean, respectively. The extra fleets are available for stronger invasion forces, intercepting Axis naval forays or effecting better SR of rebuilt units back to the area.

O. The addition of 40 French BRPs in Variant #2 can be used conservatively for Intelligence, Foreign Aid, making counterattacks and rebuilding units (during the inevitable Battle of France). Alternatively, the French could take the initiative and use their extra BRPs to capture Belgium and Luxembourg in Fall 1939. Both countries could then be turned over to the British in Winter, giving them the BRP additions in 1940 and the option to also invade the Netherlands. Iraq presents another possibility for a French attack, offering no BRPs but containing an objective hex which could be turned over to the British after the one or two turns needed to capture it. Either operation will absorb the extra French BRPs, leaving them with a normal amount in Spring 1940, but occupying Iraq offers the extra objective hex and the Low Countries improve the defenses against Germany. The major drawback here is that there is no improvement of the units themselves and the Allies must attack in order to make any substantial gain.

P. Variant #11 is similar to #2 with its emphasis on moving the main defense line forward to the Rhine. In this instance, the forward movement can be made without force, as Belgium and Luxembourg are cooperating with the Allies for mutual defense. Once again, the British should supply the forces to occupy those countries since they have the stonger units, and a Fall conquest of Holland followed by the Allies gaining the initiative in Winter (for two consecutive turns) might catch part of the German border unprotected. The early Allied gains become a buffer zone between Paris and the Germans, though it won't last for long. Britain must still make a sizeable commitment in air and armor units if France is to survive until late 1940, by which time they are normally overwhelmed. The potential delays to the German attack through Allied-occupied Low Countries might leave the Axis without enough time to seriously threaten an isolated Britain, whether in the Home Islands, Malta, Egypt or elsewhere, before turning against Russia.

Q. In Variant #20, the American entry into the war can come as early as Winter 1940, although the die-roll requirement makes the exact turn of ac-

tivation uncertain. The advantages of this preemptory deployment include the addition of BRPs to the Allied pool when determining initiative, more fleets available to escort BRP when determining initiative, more fleets available to escort BRP grants to Russia or moving troops to the Mediterranean, plus the earlier threat to invade France. Fewer units are available at start, but the time needed to deploy units into Britain helps dilute this drawback. If a determined Allied defense can prevent a French collapse through 1940, the Americans might enter soon enough to join the battle at its critical point—shades of the Great War—but French survival is unlikely. The Americans gain a 50% chance of entering the war in Summer 1941 and by building and redeploying in a schedule similar to the one outlined in item D above they can be ready to attack in Summer 1942 (with seven fleets, five air, five armor, an airborne, and six infantry units, plus about 100 BRPs). Assigning all British forces to the Mediterranean allows the U.S. to invade France sooner, possibly by late 1942 allowing for time spent helping the other Allies, when the Axis forces are heavily involved in Russia.

R. The French have a choice in Variant #16, where they can add three armor units or one armor and one air unit to their allowable builds, offering a sizable boost to their rather dismal army. However, the Maginot Line hexes do not function as fortress defenses, partially negating this variant's advantages because they must now expect an attack at any point along the frontier. A frontline defense of infantry, possibly moved forward to the Rhine, can be backed by stacks of armor to inhibit exploitation and make counterattacks. Alternatively, with a maximum commitment of air units the Allies can gain a 7-6 advantage over the Germans, though this would mean stripping the British colonies (which may be an open invitation to the Italians), and forfeits two additional armor units. A very aggressive Allied player might coincide the loss of the Maginot Line as an incentive to attack Germany first: the British capture Belgium and Luxembourg in Fall 1939 while the French build their armor units; in Winter, either or both countries could attack Germany while the British also conquer Holland (or simply attack and move through to exploit across the Rhine). If the British continue moving north, they could capture a port city for landing reinforcements to carry on the battle, and also providing the eventual escape route.

S. The most obvious advantage in Variant #17 is defensive, extending the Maginot fortress hexes along the Franco-Belgian border to the sea. Germany will face quadrupled defensive factors all along the front, usually two infantry units in each stack with air and armor behind. Because British units cannot garrison the Maginot Line, they can either protect southern France against the Italians, provide a second line of defense behind the Maginot, or invade the Low Countries to add the buffer zone as previously mentioned. By leaving France to the French entirely, the British become free to deal Italy a crippling blow; air factors from Malta could cover an invasion of Sicily with an armored exploitation crossing to the "toe". The two Allied fleets can more than equal the Italian navy and both Allied countries can attack Libya by land, possibly knocking Italy out of North Africa. French air units can cover an invasion of Sardinia, the Italian coast or an overland advance toward Milan and Genoa, with all three armor units making a breakthrough and exploitation. If both Allies attack Italy in strength the forces holding the extended Maginot Line will be reduced, but any early success against the Italians may force Germany to lend assistance, delaying their invasion of France until they bail out the Italians. The "free" entry being given to Italy is balanced by the potential losses that can be inflicted on the Axis position, particularly the Italian fleet and their North African base, and the possible



lengthening of France's survival.

T. The list presented here places Variant #9 in the most important spot, adding 50 BRPs to the Russian total at the start of any turn. Considering the generally poor condition of the Russian BRP level at times, this 50 point addition can swing the contest slightly in their favor. Applied early, the Russians could attack Turkey, before or after the Baltic States, and gain the Turkish BRPs no later than the 1941 YSS. This conquest opens a threat to the entire Balkans should the Axis be slow to move East, and prevents the Germans from gaining Turkey as an ally later on. The offensive against Turkey does not require the extra BRPs and might still be attempted even if the variant is held back for future needs, and to keep the secret longer. Once the Axis invasion of Russia begins, the additional BRPs will help alleviate the need for grants from the Western Allies, freeing the fleets normally absorbed by the Murmansk runs and possibly stimulating a Second Front earlier. When the bulk of their better units arrive in the Forces Available pool, in the Spring 1942, the Russians can build almost to the maximum with Variant #9 and carry out an immediate counterattack.

Many of the Allied variants provide subtle advantages, assisting the defensive position more than promoting a specific offensive action, though the ten newer variants reverse this trend to a degree. Note however, some of the offensive actions outlined within the list are done for defensive purposes, such as the invasion of the Low Countries. The division of theaters between the Americans (West) and the British (Mediterranean) is a fairly common strategy and usually leads to an earlier invasion of France by the Americans. One primary alternative in the Mediterranean is to shift the offensive emphasis to the Balkans once Italy has been invaded (and the Italians surrender via the new rules which do not require that Rome be captured) and the attack there has bogged down on the narrow peninsula. The British may be able to bring Turkey into the war as a Minor Ally to support a Balkans campaign. At the very least it will give them more units in adjacent positions when selecting the Attrition Option. The Allies have fourteen variants that raise BRP levels, improve unit availability or add extra allies while at least ten should directly inhibit the Axis forces in pursuing their own strategies. Nine variants seem to promote some definite offensive action to take advantage of the new situation; thirteen improve the overall strategic positioning of the Allies, giving them more physical assets and more choices of how and where to pursue their planned attacks. The ten new variants appear to be more interesting than the old ten, making better unit improvements and offering more direct suggestions for an optimum strategy. Dividing the entire list into three levels of relative importance, I place the bottom six (A-F) in the "Minimal Significance" category, nine (G-O) in the middle as "Reasonably Significant", and five (P-T) at the top as "Most Significant".

## AXIS VARIANTS

A. The bottom rung of the Axis list is occupied by Variant #14, wherein the threat of a Bavarian Redoubt comes true once the Allies enter Germany (but not before 1943), with Berchtesgaden becoming an active supply source and fortress. This mountain objective is a formidable target for the Allies to capture and in the 1944 scenario this variant might enable the Germans to survive long enough to achieve some level of victory. However, in the Campaign Game, it's really too little and too late by the time it activates. In order for the Allies to penetrate the border, the Germans must be in a fairly weakened condition and will have trouble holding a sufficient number of objectives. The implication here is for the Germans to play a defensive strategy

late in the contest, with the option to defend one or both supply sources, forcing the Allies to fight all the way by not wasting units on counterattacks that may incur irreplaceable losses. This is one instance when the Axis player might spend heavily for Intelligence and Foreign Aid.

B. Variant #13 assists the Axis slightly in their offensive against Russia with a propaganda campaign inhibiting Western Allied assistance to the Russians (limited to 20 British, and no U.S., BRPs per turn). The Russians invariably run short of BRPs, but there is no certainty that the Allies would have sent them more than are actually transferred anyway. The Americans can give the British BRPs to compensate for those passed to the Russians, but the British fleets might be tied up longer since they can't transfer as many at one time. This variant implies an increased effort against the Russians, kicking them while they're down, but the Axis player will usually do that anyway. The usefulness of this variant depends largely on what the Allies *might* have given to the Russians rather than anything more concrete.

C. The submarine campaign gains a slight advantage in Variant #8; if the Germans gain a 3:2 advantage over the Allied ASW factors then the U.S. Initial Deployment is reduced to five units per turn, starting anytime after 1941. Building the maximum number of U-boats possible in the early years is a standard German tactic to inflict losses on the British BRP level before the Americans join them and reduce any such losses to a minimal importance. This extra incentive cannot raise the limits on BRP expenditures for Strategic Warfare builds to obtain the 3:2 advantage, but the Germans should forego any planned Interceptor builds until the odds are too heavily weighted against them (once the Americans start building ASW factors *en masse*). Naval and/or air units might be placed in the Murmansk box once Russia is invaded, to replace the U-boats that would normally oppose the Lend-Lease convoys, but some Intelligence efforts should be tried before tying up these important air and naval factors for anti-convoys duty. Reducing the Initial Deployment to five will not inhibit the Americans that much in the long run.

D. Variant #16 offers a Wafdist uprising in Egypt anytime that the Axis player has one supplied armor or infantry unit in Egypt. The two 1-3 partisan units allowed can be used to help surround the Allied units holding the forward positions, possibly isolating them at a critical time. Alternatively, the partisans could try to occupy an objective port/city. The Axis player must be aggressive to make this variant useful, first to activate the partisans, and then to keep the Allies busy so that the partisans can remain in the game. Partisan units cannot by themselves force the closing of the Suez Canal, nor do they cost the British any BRPs, but they can be an effective harassing force as long as the Axis player is pursuing an aggressive strategy in the Eastern Mediterranean to support them.

E. Adequate preparation by the Axis for the Russian Winter in Variant #15 negates the usual restrictions for the Axis player during the Winter turns, offering the advantage of the normal doubling of factors on defense and allowing them to conduct offensives. The Germans should abandon any plans to invade Britain after France falls and concentrate on Russia earlier, probably pre-empting their North African campaign as well. Pressing their attack throughout 1941, the Axis may catch the Russians at their weakest in Winter, bringing them one turn closer to a successful conclusion by continuing the offensive through the end of the year. The continual attacks may well lead to the capture of Moscow or Leningrad. Any BRP grants from the Western Allies should be countered by the Germans, using U-boat and naval units preferably. They might also try to Intelligence work to determine the possible Allied intentions while they occupy themselves with their Eastern campaign.

F. Variant #2 appears to offer only a minor advantage, requiring the diversion of ten British ground or air factors to quell an Irish rebellion by garrisoning Ulster for one year. Playing this variant early prevents some British activity in France or the Mediterranean while the Germans make their Western advance. After France falls, the Irish rebellion can detract from the necessary defense of the Home Islands, as well as the Mediterranean involvement. Played later, this variant can help protect the Axis conquests in the West while the major offensive is directed against the Russians. Use of this variant can be negated by the British if they have given the Irish six BRPs in foreign aid more than the Germans have, but it is otherwise available to the German player at any time. Once the British have deployed a large portion of their units to the Mediterranean, the Germans could spring this variant as a surprise, forcing the British to strip their Home defenses in response and waste time transferring units back from the Mediterranean.

G. In Variant #11, the Axis player gains a situation similar to Variant #2, with Arab unrest encouraging the French to send occupation troops to garrison Morocco-Algeria-Tunisia, if played before France falls, or lose 15 BRPs per turn. After the French are out of the contest, the Axis can gain either six partisan units (as in Variant #16) or six minor allied units, depending on whether the colonies are Free French or Vichy. As partisans, the Arab units encourage the Allies to waste units for garrison duty by threatening to occupy the few towns in one or more colonies, including the ports. As armor allies, they can be used for Attrition losses and again, the Axis can base units (air and airborne) to threaten Gibraltar. This variant can be played almost anytime, and gives the option to deprive the French of their much-needed units early, before the battle for France, or cause problems for the British later, once they are isolated and alone.

H. Iraq's activation in Variant #1 provides an objective hex for the Axis and changes the strategic positioning in the Mediterranean, and possibly in Russia as well. The threat posed by Iraq's weak army forces the Allies either to keep a garrison in their Eastern Mediterranean colonies or spend the time and BRPs to conquer Iraq. This variant can be an unnerving surprise for the Allies if played right after the fall of France, and it must be used before 1943. However, there is the possibility that the Allied player will choose to invade Iraq early, as was outlined in the Allied variant list more than once. Assuming they do not, and if Lebanon-Syria remains under Vichy control, Axis forces could move there via strategic redeployment (using the Italian navy) and reinforce the Iraqi units, posing a major threat to Egypt from the rear. Even if Lebanon-Syria goes Free French, the Italian navy would be available for an invasion to assist Iraq, though this is more risky. Once established, the Axis pose a threat not only to Egypt, but Persia, Turkey and Russia as well with a couple of fast armored thrusts.

I. Variant #3, adding Vichy France to the list of German Minor Allies offers a slight advantage over the last variant, starting with the less precarious position Vichy is in. The units are better, and may include some armor or air if the Germans are lucky, and usually some naval factors. This variant also rules out the chance of the French colonies going over to the Allies automatically. The Germans desire an early defeat of France because this variant cannot be played until three turns after France falls. Any Italian drive into southern France might prevent some units from escaping through Marseilles. The French fleet is the real prize, allowing the Italians to equal, if not outnumber, the normal British deployment on the front, enhancing the idea of a seaborne invasion of the Levant.

J. A temporary postponement of hostilities comes with Variant #12 when Poland concedes the Danzig

corridor (three hexes) to the Germans, but Germany loses the free Offensive option on the first turn, and must keep 20 combat factors on the Eastern front. The British or French can declare war without cost and the Russians can still enter the Baltic States. If the Germans don't attack Poland and the Allies jump in immediately, then the German player is worse off than usual. However, the Allied player may see his weak armies as excuse enough to stay out of the fray for the moment and build his strength; this would give the German time to build his own army while perhaps capturing Poland, Denmark, Yugoslavia or the Low Countries as well. Poland cannot launch an attack and it provides a kind of buffer zone between the Germans and Russians in case the Axis player decides to pursue the extreme options on the Western and Mediterranean fronts (SeaLion, Malta, Gibraltar, Spain). A winter 1939 attack should still take Warsaw, if desired, giving the Germans the Polish BRPs for the 1940 YSS.

**K.** The strategic situation receives an important addition in Variant #10 with improved interceptor factors; this variant allows two interceptors to eliminate three SAC factors and adds a +1 DRM for the German air units, starting in 1943. The German player should be able to build U-boat units longer, given the improved interceptors, to harass the Allied effort. By using only naval or U-boat factors in the Murmansk convoy box the Germans will have all of their improved air factors available as well. This variant is a good example of one which arrives too late to be critical: the Battle of Britain is over, the tide would have turned in North Africa and probably Russia, and the American air units will tip the number of factors in the Allies' favor anyway. The tenth is a very good *defensive* variant, but it will rarely lead to a solid Axis victory.

**L.** Variant #20 offers an uncertain result because a die roll is used to determine the effects of Japan bypassing the Pearl Harbor attack, thus keeping America out of the Pacific War, at least temporarily. The Americans can usually start rolling for activation in Summer 1942, but they may be delayed for several turns by the necessary die roll. On an initial roll of two, the Japanese attack only Russia, depriving them of five 3-3 units and the Free Builds to face the Germans, but the Americans naval DRM becomes +2 (a more than even trade for the Axis player, I would say). With the expectation that the American activation will be delayed for a couple of turns I would send the Axis forces in a maximum effort against the Russians, even forsaking the normal defenses in the Western theater for a couple of turns to put extra pressure on the Russians. One daring option is to bypass the campaign in the West entirely and attack Russia immediately. Success normally requires a substantial Italian effort (with some German assistance) to keep the Allies occupied during the first critical turns. However, should the Allies undertake to attack Italy first, then they make the German plan all the more feasible. Russian might be defeated before the Americans can arrive in force.

**M.** One variant with uncertain potential is #18, featuring an expanded German bomber force which becomes active on the first turn after France falls. The number of German air factors within four hexes of London—minus the number of British air factors covering London within the same distance—eliminate that many BRPs from the British pool. This calls for a rapid conquest of France (possibly initiated in 1939 as mentioned above) and the massing of all six German air units against the British. Italian units do not count toward the bomber total, but Italy should carry the offensive to the British at this critical time as an aid to the German effort. Lent Italian air units could be used to counterair the British factors guarding London, freeing more German factors from strategic bombing. Or perhaps a major Italian effort could be made against Malta or Egypt to draw off some of the British units. Ideally,

France will fall by Summer 1940, leaving the British isolated with half their air factors in the Mediterranean. The Italian threat requires Britain to maintain a sizable force in Egypt and gives Germany a 3-1 advantage for the Fall air attacks. Britain loses 20 BRPs in Fall and Winter, slowing the building up of their army and navy. By Spring 1941, Germany invades Britain; London falls by Summer. Any delays to this schedule risks giving the Russians the chance to attack first, but the potential rewards of knocking Britain out of the war entirely are enticing enough to run the risk.

**O.** Another conditional variant is Axis #17, though it is potentially very rewarding as well. If the Fsjr Airborne unit is never lost in battle and if the 2 Fsjr unit has not been created as standard infantry before 1942, then the latter can be built with airborne capability. An early loss of the 1 Fsjr unit can negate this variant even before it can be played (in which case the German should keep his draw a secret); airdrops which isolate the unit, such as Norway, Britain or Malta, should be avoided. And the 2 Fsjr should never be built as infantry under any circumstances. Once both units are activated in Spring 1942, they might be used in a belated SeaLion attempt (six airborne factors + 18 air factors plus a seaborne follow-up carrying three armor units can be impressive). Or maybe they should be used against Malta, Egypt or Gibraltar (if French North Africa has gone Vichy), all with Italian naval and ground assistance. The airborne units can help extend an exploitation deep into Russia, or take part in a massive attack on Leningrad. This variant may offer the Germans their best advantage with the smallest actual gain (one unit).

**P.** The addition of Spain as an Italian Minor Ally in Variant #4 offers one great advantage: an overland route for attacking Gibraltar. Spanish activation costs 35 BRPs and requires the Italians to possess five objective hexes prior to the Spring 1941 turn. The Italians need one objective beyond what they hold at start, which can be gained by invading southern France in conjunction with the German attack or by conquering a minor neutral, say Yugoslavia or Greece. By attacking a minor country, Italy can remain neutral while they gain their fifth objective hex: Belgrade seems the better choice because Yugoslavia offers 20 BRPs and only one coast hex to defend. Spain does have several beach hexes which are vulnerable but if Gibraltar can be taken, with German assistance of course, then the situation in the Mediterranean will improve dramatically. A reduced British presence on that front relieves some of the threat of invasion into Spain to establish a foothold on the continent. The drawback here is the time restriction, Spain will only activate in Spring 1941 and only if Italy has enough objective hexes. German assistance might be necessary to insure that Italy meets the requirement, and a strong British defense might still hold onto Gibraltar indefinitely.

**Q.** Variant #19, activating Yugoslavia as a German Minor Ally ranks slightly ahead of #4 above because the addition occurs automatically at the same time that Hungary becomes belligerent, in Summer 1941. The Yugoslav army is not bad for a minor country and the Germans gain 20 BRPs without having to fight for them (the campaign to subdue the Yugoslavs can often cost more than they receive from the conquest). As mentioned above, there is only one coast hex to defend, and the additional units can always be put to use on the Russian front. Russia is allowed to build two partisan units in Yugoslavia (Tito's troops), but a single unit garrisoning Belgrade will effectively stall any successes. Gaining this ally also helps to solidify the potentially weak Balkan peninsula in case the Allies plan any offensive activities in that area to disrupt the German movement east. With the BRPs obtained for free in this variant, I might bypass the usual attack against Greece; few BRPs can be gained and

it adds several coast hexes to defend (including Crete).

**R.** The weak Italian position receives its best adjustment with Variant #9, adding 25 BRPs and four units to the allowable builds anytime prior to 1942. The BRPs equal half of the cost to declare war and take an offensive option while the four units include two armored pieces. A major decision is when to play this variant, flexibility being one of its assets. Played early, it can assist the Italians in conquering Yugoslavia (or Greece) while still neutral, or allow them to build a better army sooner, improving their position versus that of the Allies. If the variant is held back and the Allies attack first, these benefits will have an extra attraction by being a "free" surprise—the BRPs won't be spent on a Declaration of War. With the large Italian army available, the Germans might be relieved of some requirements to aid the Italians. Alternatively, the Italians could lend up to four armor units to the Germans for use in Russia, possibly to take part in a massive breakthrough and exploitation effort.

**S.** The 50 German BRPs available in Variant #6 come at a critical time (1942 YSS); the question is whether they are too late to be decisive. These BRPs allow an increase in SW builds but the U.S. will enter at the same time with its vast resources to tip the balance drastically in their own favor. Ground and air units can be built and rebuilt rapidly, adding their numbers to the climactic Russian campaign but the Russian army will also be receiving their best units. A persistent attack with some extra armor units and continual offensive options throughout 1942 offers the best chance at beating the Russians—perhaps before the Allied counteroffensive can gain any momentum. If made available earlier, these BRPs might make a bigger difference with simultaneous and continual attacks in Russian and North Africa, and allow a little breathing space for the German to recoup their losses after a bad decision. However, the Axis player must be content with what he is offered and these extra resources can still help him hold onto his early gains, aiming at a victory on points (objective hexes).

**T.** The addition of Turkey as a Minor Ally ranks highest for the Axis because Variant #7 alters the strategic situation on both the Eastern and Mediterranean fronts. Turkey enters anytime prior to 1943 if Germany is at war with Russia and the Axis forces outnumber the Russian combat factors, calling for a maximum effort against Russia as soon as France falls and the gains to date have consolidated. I often consider attacking Russia even before the Minor Allies activate if the British seem timid enough to avoid any immediate counterattacks. Italy can supply some additional forces and the Germans might even risk removing their garrison from Rumania in hopes that Russia will attack (with German intervention this brings Rumania in early). Hopefully, the Germans will be able to play this variant in 1941, before the Russians gain their better units and start receiving substantial BRP grants from the West. Turkish units should guard the beach hexes while German armor moves north into the Caucasus region and south toward Egypt. Coordinated attacks from Turkey and the Ukraine can envelop the defenses in southern Russia and a rapid advance to the Caspian Sea can eliminate the Soviet redoubt in those mountains. Equally important, activating Turkey opens the entire Levant to Axis offensives without using the Italian navy. The Allies are usually unprepared for a major attack heading south toward Egypt, scooping up Mosul and Suez, coordinated with an advance from Libya. The threat to British control in the Mediterranean can rarely be equalled. By the time the Americans arrive in force, the British may only possess Gibraltar and Malta.

The Axis variants usually offer more direct and aggressive adjustments than those for the Allies: 14 variants add extra units (for Major or Minor countries), improve the existing units (e.g., 2 Fsjr) or

bring some of them into the battle early. There are also 14 variants which promote, or at least assist, one of the various offensive options open to the Axis. Nine variants, including the partisans in Egypt and French North Africa, work to inhibit the Allied cause while the strategic position of the Axis powers are improved by ten variant situations. Dividing this set among the three levels of importance, I group seven (A-G) as "Minimal", eight (H-O) as "Reasonably", and five (P-T) as "Most Significant". It appears that the two lists are about equal, with the Allied group slightly ahead. However, two of the Axis variants (F-G) could easily be placed in the middle group and as many as three (M-O) might be shifted from "Reasonably" to "Most Significant". The Axis variants seem to be more conditional, with requirements to meet beforehand and time limits for availability making some variants slightly less attractive than they might be. The Axis player is the early aggressor and the burden is on him to set the pace. France will fall, Britain will shudder and Russia will reel, but it may not happen on schedule.

The indecisiveness of each individual placement persists throughout both lists because any variant can reasonably be moved at least one place, occasionally two, in either direction without causing an appreciable change in the logic. The exceptions might be the very best and the very worst; but again, the choice for each of those is strictly subjective. Most

of the strategies outlined can be pursued without the assistance of a variant, though the alterations might make them more attractive. The luck of the draw can also create some interesting situations when both sides draw a number which leads them to consider the same area as the best place to promote activity. Both sides might want to make a pre-emptive move into the Low Countries or Turkey; Italy might move against Yugoslavia while still neutral only to be attacked by France and Britain on the next turn. *THIRD REICH* is a limitless game in itself and these variant situations only add to its fascinating dimensions (if that's possible). My intention here was to offer some new angles for looking at the game and a variety of means for enjoying them.

## SUMMARY

### The Gordon Rating of Allied Variants

- A. British Growth Rate (#18)
- B. French Units at Start (#1)
- C. Reduce Sub Effectiveness (#5)
- D. Raise U.S. Deployment (#8)
- E. Neutral Italy (#12)
- F. Russian Winter Offensive (#10)
- G. Increase SAC Effectiveness (#7)
- H. Hitler Assassinated (#15)
- I. Stalin Purged (#13)
- J. Spain Activates (#4)
- K. Free French Colonies (#3)

#25—Germany reorganizes European transportation systems with new rail and autoban constructions. Increase German SRs to 12 per turn. Play at the start of any Scenario.

#26—Himmler expands the SS Foreign Legions. Add two 3-3s (*Spanish SS* and *Turkish SS*) and three 1-3s (*1st French SS*, *2nd French SS* and *Croat SS*) to German 1943 Force Pool additions. Units can only be constructed if an overland SR route can be traced from the recruited country's capital (i.e., Madrid, Ankara, Paris and Belgrade) to Berlin. That is the *only* restriction on these units. Play during the 1943 YSS or add to the 1944 Scenario allowable builds during set-up.

#27—Axis intelligence suspects compromises and changes their military codes. Germany may make one cost-free intelligence or counter-intelligence usage per turn. In lieu of free cost, Germany may pay BRPs for an additional die modifier as the once-per-turn use of this variant. This variant is void if the Axis are currently under the effects of an intelligence die roll of "2" or "3". Play when first used.

### Allied Variants

#21—Increased and blatant Nazi atrocities arouse greater resentment from conquered peoples. The Allies may increase by two the number of partisans allowed in England, France and Poland; and increase by one the number allowed in Greece, Yugoslavia, Russia and Spain. Play anytime after US entry.

#22—Increased Soviet motorization and improvement in mobile warfare tactics. All Soviet infantry movement allowances now become four and armor movement allowances become six. Play during the 1942 YSS or at the beginning of the 1942 or 1944 Scenarios, *before* set-up.

#23—Greater British preparedness for war. Allow the British player to add 30 BRPs worth of his allowable builds to his initial onboard forces. Play during the opening set-up of the 1939 and Campaign Scenarios only.

- L. No Winter War (#19)
- M. Anglo-French Cooperation (#14)
- N. Two Extra U.S. Fleets (#6)
- O. 40 French BRPs (#2)
- P. Belgium-Luxembourg Cooperation (#11)
- Q. Early U.S. Entry (#20)
- R. French Armor/Air (#16)
- S. Extend Maginot Line (#17)
- T. 50 Russian BRPs (#9)

### The Gordon Rating of Axis Variants

- A. Bavarian Redoubt (#14)
- B. Propaganda Campaign (#13)
- C. Reduce U.S. Deployment (#8)
- D. Egyptian Partisans (#16)
- E. Winter Preparation (#15)
- F. Irish Rebellion (#2)
- G. French West African Partisans (#11)
- H. Iraq Activates (#1)
- I. Vichy Activates (#3)
- J. Poland Concedes Corridor (#12)
- K. Increase Interceptor Effect (#10)
- L. No Pearl Harbor Attack (#20)
- M. Early Minor Ally Activation (#5)
- N. Expanded Bomber Force (#18)
- O. Second Airborne Unit (#17)
- P. Spain Activates (#4)
- Q. Yugoslavia Activates (#19)
- R. Italian BRPs/Units (#9)
- S. 50 German BRPs (#6)
- T. Turkey Activates (#7)

## ADDITIONAL THIRD REICH VARIANTS

By Alan Emrich

*These variants are a compilation of the ideas and the author wishes to greatly thank Larry Bucher and T. Wall Hannaford for their contributions. It is especially important, I feel, to increase the number of non-"foreign affairs" variants in the game after so many were made obsolete by the new and excellent Diplomacy Point additions in The GENERAL (Vol. 19, No. 6). Good luck to all, and may these fresh variants add more enjoyment to your game and keep it forever new!*

### Axis Variants

#21—Hitler continues to support the Kriegsmarine Z Plan. Germany adds one full strength fleet counter per year to her Force Pool beginning in 1942. Note that this variant also improves Germany's Surface Raiders as explained in my article "Total War" (Vol. 21, No. 3). Play during the 1942 YSS, or add one full strength fleet to the allowable builds in the 1942 Scenario or two full strength fleets to the initial forces and one to the allowable builds of the 1944 Scenario.

#22—Revitalization of the Italian armed forces. National air and naval DRMs are now +0. Replace two 1-3 infantry units with 3-3 units, and add one 2-5 armor and one 5-4 air unit to the 1942 Force Pool additions. Playable during the Italian set-up of any scenario.

#23—Improved Italian industrial preparations for war. Italy starts with a 100 BRP base and a 30% growth rate. Playable only during the Italian set-up of the 1939 and Campaign Scenarios only.

#24—German XXI type U-boats mass-produced earlier. One ASW exchanges for one submarine throughout the game. Play during the 1943 YSS or at start of the 1944 Scenario.

## NEW SQUAD LEADER BOARDS AVAILABLE

Eight new geomorphic mapboards, destined for inclusion in the first two *ADVANCED SQUAD LEADER* modules scheduled for June 1985 release, are now available for separate mail order purchase. *Board 16* depicts a few farmhouses surrounded by large cultivated fields. *Board 17* shows a small village with large wooded areas, orchards, fields and even a pond or two about. Gently rolling level-1 hills interspersed by gullies appear on *Board 18*, while *Board 19* has a large open plain dominated by dense woods along one edge. *Board 20* is one of the densest city boards with both large industrial complexes and plenty of rowhouses, with a gully to keep things interesting. *Board 21* is a city section dominated by a large cathedral and central cemetery. *Board 22* has a typical section of the outskirts split by a stream. And on *Board 23* the edge of the city is marked by a canal running lengthwise along the board able to mate with river Boards 7 and 8.

It is stressed again that these boards will be available in future modules for the *ADVANCED SQUAD LEADER* system. However, for those impatient few, they may be ordered direct from The Avalon Hill Game Company (4517 Harford Road, Baltimore, MD 21214) for \$4.00 each. Please add 10% shipping and handling (Canadian orders 20%; overseas orders 30%). Maryland residents please also add 5% state sales tax.



# MOVIN' ON

## Strategies and Tactics for Rail Baron Players

By Bertrand N. Bauer



*A private railroad car is not an acquired taste. One takes to it immediately.*—Mrs. August Belmont, *Fabric of Memory*

Flights of fantasy about private railroad cars, and about the luxury, wealth, and power of a rail tycoon, are all part of the fascination of the *RAIL BARON* game. The game itself is as frustrating and as fascinating to its many players, with careful efforts to build one's own railroad empire while ruthlessly keeping competitors from one's territory unless they pay dearly for the privilege of traveling through it. At least, *RAIL BARON* can be played carefully and ruthlessly, and the purpose of this article is to show how to do it.

Playing well increases one's chances of winning the game, of course. Also—and this is even more important—playing well changes the character of the game by making it more a contest of skill and less a matter of luck with the dice. Many who have played several games of *RAIL BARON* look back on them with mixed feelings when analyzing the winning strategy: partly, it's a matter of wisdom (or stupidity) of the player's decisions during a game, and it's partly a matter of the outcomes of the dice throws. Players who have had this reaction are ready for an analysis of the game.

The first section of this article recommends some changes to the rules. The next part starts the analysis of the game by presenting two basic strategies. Next I present the solution to the problem of intelligently coping with the throws of the dice (namely, an appropriate set of probability tables). The fourth section presents a detailed discussion of tactics. Last part summarizes a typical game when *RAIL BARON* is played in the way this article recommends.

### Changing the Rules, or the "Bauer Amendments"

To play *RAIL BARON* in a way that maximizes skill, the otherwise excellent rules of the developer need to be changed in a few respects. Players should feel free to change the rules in any way they think improves the game presumably by unanimous consent of those playing.

First, the minimum number of players should be two, not three. I have played many two-person games, and I can guarantee that such games are fascinating. The game is played with great intensity when two players are evenly matched and both play ruthlessly. Reducing the minimum number of players from three to two does not require changing any of the other rules.

Second, any bonus roll of the red die should be made as soon as it is apparent that the player is entitled to a bonus roll, before any movement, and

the sole effect of the bonus roll should be that of increasing the amount of movement toward the player's current destination. If a player has a Superchief, he always rolls all three dice at the same time to get his total movement. If a player reaches his destination from the white dice alone, the red die is ignored; the player does not find a new destination, he would know before moving whether he can get all the way on this turn, instead of having to take a chance on whether the red die will be enough to finish the trip. This can determine whether the player pays his opponent once or twice to get to his destination, so it is an important matter. As yet another beneficial effect, no player would ever be able to buy two railroads on the same turn, which reduces the ability to buy a desirable combination of lines solely by spectacular luck with the dice.

Third, players should be allowed to count dots and compare alternate routes after throwing the dice for movement. Currently, the rules require speedy movement after throwing the dice, and that encourages stupid mistakes. Worse yet, the current rules (as I understand them) permit a player to take all the time he wants before throwing for movement, so a careful player will choose his best routes for all possible throws. This obviously takes more time than choosing the best route for the one throw that actually occurs. In any event, careful routing is one of the enjoyments—or maddening frustrations—of the game and putting any speed requirement on this decision eliminates one of the skills we wish to encourage. Players should throw for movement as soon as it is their turn, then decide carefully how to move.

Fourth, each player's cash should always be displayed for every opponent to see; and, if the cash is hard to count, any player should have the right to ask any opponent, at any time, how much cash he has. Under the existing rules, a player will always know each opponent's cash position, anyway, if he notes every receipt and every expenditure on a piece of paper. Such notes should not become a part of the game, though, because they too are time-consuming and penalize silly mistakes in arithmetic. The rules already recognize some need for information on cash positions by requiring players to announce when they have accumulated \$150,000. There are, however, other critical situations besides the threat of declaring when an opponent's cash position is vitally important. Since "keeping books" is allowed if one wishes to do it, it is better for the game to abandon any attempt to allow cash to be secret and instead require it to be publicly displayed.

Fifth, any player may ask at any time what the revenue is between any pair of cities. No existing rule prohibits this, but cash forecasts are so important that it is well to make clear that this informa-

tion is always available to any player at any time.

Sixth, the use of certain terms and announcements adds to the game. It helps to call a "pawn" a *train*, as the rules suggest. It adds some railroad flavor to call a "chip" a *marker*, even though the railroad meaning of "marker" is not related to origins and destinations. It helps to call a "payoff" a *revenue*. It is exact to call a "penalty" a *wheelage* (a short form of "wheelage fee", or charge for letting wheels use a transportation route). Railroaders sometimes say "wheelage", but they never say "penalty". Then the \$1000 payment to the bank becomes a *bank wheelage* and the \$5000 or \$10000 payment to an opponent becomes a *foreign wheelage*. (In railroad parlance, "foreign" means a railroad other than one's own, without regard to international boundaries). Finally, it helps if players publicly announce their proposal routes, to see if any foreign wheelages must be paid. The following rule works well for public route announcements: no player need ever make such an announcement; if he does, it will be presumed that his announced route is the one actually taken when moving his train unless the actual movement is clearly different from the announced route; a player is never bound by his announcement route and may change it at any time, with or without advance public announcement; and a player is bound by his actual route, just as in the original rules, no matter what his announced route was.

Seventh, the revenue table should be changed in the following respects to correct obvious errors in inconsistencies: Albany-St. Paul from 12 to 12.5; Atlanta-Casper from 25.5 to 15.5; Butte-Charlotte from 17.5 to 23.5; Butte-Chattanooga from 14 to 20; Casper-Tampa from 15 to 20; Chattanooga-Tampa from 2 to 6.5; El Paso-San Antonio from 16 to 6; Fargo-Rapid City from 4 to 7; Las Vegas-Spokane from 17 to 14; and Oklahoma City-Shreveport from 10.5 to 4. Most of these corrections have a realistic basis in the "Long and Short Haul" clause, paragraph 4 of the Interstate Commerce Act. Some of the apparent inconsistencies in the revenue table should not be changed; in particular, rates between San Diego and points to the east are still based on the San Diego & Arizona Eastern Railway's mileage even though that railway has since been abandoned.

Eighth, the "merger options" should not be played. Assembling a railroad empire is more interesting when the individual lines are smaller. However, this is more a matter of personal preference than of any obvious effect on the game.

Ninth, a player reaching his destination should be regarded as receiving his revenue and then paying his wheelage (or wheelages), rather than the other way around, for the purpose of determining

whether he must sell a railroad.

Tenth, speed should not be part of a purchasing decision. A player should not be rushed when deciding what to buy. However, a purchase is final when a player has paid for it, received his change, and received the deed.

Eleventh, the rule binding a player to the actual movement of his train should never be relaxed except for beginners who do not yet understand the rules. Some players think this is far too rigid, but it does add to the skill required for the game. There is a basis in reality, too, since routing mistakes are expensive and someone must bear their cost; there is, after all, no way in real life of taking back a move that has already occurred.

**The Two Basic Strategies**

There are two basic, and contradictory, strategies that every player must consider at all times. One is the "offensive" strategy, which consists of "owning" cities so that opponents must pay high foreign wheelages when the destination table forces them to go there. The other is the "defensive" strategy, which consists of "buying access" to cities to avoid paying high foreign wheelages when forced to go there.

For example, in the early part of a game, the first railroad to be purchased in the Southeast would ordinarily be the SAL. It "owns" Miami, which gives it great offensive power. It also "buys access" to seven additional cities, which gives it defensive power. Buying the ACL first, instead of the SAL, is a serious mistake because the ACL doesn't "own" any cities, which gives it no offensive power, and it "buys access" to only six cities (all of which are also served by the SAL), bringing the ACL less defensive power than the SAL. Once the SAL has been purchased, the next road to be bought in the Southeast should ordinarily be the ACL. For the SAL's owner, adding the ACL is very desirable for offensive reasons (i.e., owning Tampa, Jacksonville, and Charleston in addition to Miami). For any opponent of the SAL's owner, buying the ACL is very desirable for defensive reasons (i.e., buying access to Tampa, Jacksonville, and Charleston). The purpose of this example is not specific advice on when to purchase each road, but how to approach to decision to buy a road. Think defensively—look for places where opponents

threaten to buy additional cities—and make a tentative purchase decision. Then think offensively—look for cities to buy—and make a final purchase decision after having considered both the defensive and offensive aspects of the purchase. This advice is very general. To make it detailed and specific, probabilities must be considered. These are presented next.

**Probability Tables**

Four probability tables are helpful to any RAIL BARON player. Table A below shows probabilities for fair dice. For two dice, all of the exact probabilities have the denominator 36, this being the lowest common denominator. For three dice, the lowest common denominator is 216. The probabilities are calculated according to the ordinary rules of elementary rules of elementary probability theory. One of the uses of Table A is in judging the wisdom of declaring. Suppose a player has a Superchief and is fifteen dots from his home city at a time when he could declare, but an opponent is almost certain to catch him in a rover play if the player does not reach his home city in one throw. Table A shows that the probability of getting 15 or more on three dice is 20/216, or about 9.26%. Unless other considerations are powerful, the player should not declare because he has such a poor chance of getting to his home city.

Table B shows the probabilities that the dice, alone, will select each of the various regions. All of these probabilities have the denominator 72, this being the lowest common. The probabilities are calculated according to the ordinary rules of elementary probability theory, and they are based on the two-dice probabilities of Table A. For example,

**P(S.E. region)**  
 = P(white "3" and red "odd", or  
 white "4" and red "odd", or  
 white "5" and red "odd")  
 = (2/36) (1/2) + (3/36) (1/2) + (4/36) (1/2)  
 = (2 + 3 + 4)/72 = 9/72

One use of Table B is in deciding on regional specialization. Is it better, for example, to try to buy many railroads in the Northeast or in the Southwest? Table B shows that the Northeast is nearly twice as probable as the Southwest, so buying North-

eastern roads is ordinarily much more desirable than buying Southwestern roads.

Table C shows the probabilities that the dice will select each of the various cities, given that the region has already been selected. All of these probabilities have the denominator 72, this being the lowest common denominator. The probabilities are calculated according to the ordinary rules of elementary probability theory, and they are based on the two-dice probabilities of Table A. For example,

**P(Chattanooga, given the S.E. region)**  
 = P(white "4" and red "odd")  
 = (3/36) (1/2)  
 = 3/72  
 From the RAIL BARON Destination Table  
 White dice probability from Table A  
 As shown in Table C

Table C is very useful to a player who can pick his region because the dice selected the region he's already in. Suppose a player is in New York and wants a high-revenue run, but an opponent already owns the UP. Is it better to risk Las Vegas in the Southwest or Pocatello in the Northwest? Las Vegas's probability is 6 (meaning 6/72, given that the Southwest region has been selected) while Pocatello's probability is 4 (meaning 4/72, given that the Northwest region has been selected). Unless other considerations are important, such as routing difficulties due to other roads that his opponents already own, the player should pick the Northwest region because it is less risky for him than the Southwest region.

Table D shows the probabilities that the dice, alone, will select each of the various cities, before a region has been selected. All of these probabilities have the denominator 5,184, this being the lowest common denominator. (722 = 5,184). Again the probabilities are calculated according to the ordinary rules of elementary probability theory, and they are based on Tables B and C. For example,

**P(Chattanooga)** = P(S.E. region and then Chattanooga)  
 = P(S.E. region) × P(Chattanooga, given the S.E. region) Using the theorem  
 P(A and B) = P(A) × P(B, given A)  
 = (9.72)(3/72) From Tables B and C  
 = 27/ 5,184 As shown in Table D

Table D permits easy calculations of offensive power. For example, considering offensive power, is SAL or the C&NW the better buy? They each

**Table A: Probabilities When Throwing Fair Dice (fractions are exactly correct; percentages have been rounded to the nearest 0.01%)**

Sum	Two Dice Probability of:		Sum	Three Dice Probability of:	
	Exactly This Sum	This Sum or More		Exactly This Sum	This Sum or More
2	1/36 = 2.78%	36/36 = 100.00%	3	1/216 = 0.46%	216/216 = 100.00%
3	2/36 = 5.56%	35/36 = 97.22%	4	3/216 = 1.39%	215/216 = 99.54%
4	3/36 = 8.33%	33/36 = 91.67%	5	6/216 = 2.78%	212/216 = 98.15%
5	4/36 = 11.11%	30/36 = 83.33%	6	10/216 = 4.63%	206/216 = 95.37%
6	5/36 = 13.89%	26/36 = 72.22%	7	15/216 = 6.94%	196/216 = 90.74%
7	6/36 = 16.67%	21/36 = 58.33%	8	21/216 = 9.72%	181/216 = 83.80%
8	5/36 = 13.89%	15/36 = 41.67%	9	25/216 = 11.57%	160/216 = 74.07%
9	4/36 = 11.11%	10/36 = 27.78%	10	27/216 = 12.50%	135/216 = 62.50%
10	3/36 = 8.33%	6/36 = 16.67%	11	27/216 = 12.50%	108/216 = 50.00%
11	2/36 = 5.56%	3/36 = 8.33%	12	25/216 = 11.57%	81/216 = 37.50%
12	1/36 = 2.78%	1/36 = 2.78%	13	21/216 = 9.72%	56/216 = 25.93%
			14	15/216 = 6.94%	35/216 = 16.20%
			15	10/216 = 4.63%	20/216 = 9.26%
			16	6/216 = 2.78%	10/216 = 4.63%
			17	3/216 = 1.39%	4/216 = 1.85%
			18	1/216 = 0.46%	1/216 = 0.46%

Long-run average sum when throwing two dice: 7

Long-run average sum when throwing three dice: 10½

When throwing for movement, the long-run average sum is the follow: no Express or Superchief, 7½, or approximately 7.0972; Express, 7¾, or approximately 7.5833; Superchief, 10½, or 10.5000.

cost \$14000, and they each own a city. Miami's probability, though, is 90 (meaning 90/5,184) while Rapid City's probability is only 40 (meaning 40/5,184). Unless other considerations are important, the SAL is the better buy. As another example, above we said that adding ACL to the SAL is an excellent idea because of offensive power. Table D measures the offensive power: Tampa's probability is 63, Jacksonville's probability is 54, and Charleston's probability is 36, adding to 153. The ACL costs only \$12000, and that's cheap for this much offensive power.

## Tactics

**Offensive Power.** A prime candidate for purchase, for offensive reasons, is any railroad that solely serves a city. Every RAIL BARON player should know the following eight roads that fall into this category.

B&M—owns Portland, Maine (probability: 60; cost: \$4000)  
 N&W—owns Norfolk (probability: 63; cost: \$12000)  
 SAL—owns Miami (probability: 90; cost: \$14000)  
 L&N—owns Nashville (probability: 63; cost: \$18000)  
 CRI&P—owns Des Moines (probability: 40; cost: \$29000)  
 C&NW—owns Rapid City (probability: 40; cost: \$14000)  
 UP—owns Las Vegas and Pocatello (probability: 72+32=104; cost: \$40000)  
 AT&SF—owns San Diego (probability: 84; cost: \$40000)

The information in parentheses permits comparing Table D's city probability with the cost of the railroad. Obviously, some roads are much better buys than others, when only these factors are considered. For example, in this list the B&M has the highest "cost effectiveness" if the city probability is divided by cost.

A prime candidate for purchase, for offensive reasons, is any pair of railroads that, together, own a city served only by those two roads. There are twenty such pairs of railroads. All of them are listed below, in approximately geographical order, together with all the cities they own, these cities' total probability and the roads' total cost. One of the entries may be a surprise: Portland is owned by NYNH&H-NYC even though neither road gets to Portland.

B&M-NYNH&H—Boston, Portland (210; \$8000)  
 B&M-NYC—Albany, Portland (120; \$32000)  
 NYNH&H-NYC—Albany, Boston, Portland (270; \$32000)  
 NYC-PA—Albany, Boston, Cleveland, Indianapolis, New York, Portland (645; \$58000)  
 NYC-C&O—Detroit (121; \$48000)  
 PA-B&O—Fargo (24; \$31000)  
 PA-B&O—Baltimore, Philadelphia, Pittsburgh (390; \$54000)  
 SAL-ACL—Charleston, Jacksonville, Miami, Tampa (243; \$26000)  
 SAL-SOU—Charlotte, Miami (117; \$30000)  
 SOU-L&N—Chattanooga, Knoxville, Nashville (144; \$38000)  
 L&N-GM&Q—Mobile, Nashville (117; \$30000)  
 GN-NP—Fargo (24; \$31000)  
 NP-CB&Q—Billings (40; 34000)  
 CMStP&P-C&NW—Milwaukee, Rapid City (128; \$32000)  
 C&NW-CB&Q—Casper, Rapid City (72; \$34000)

CRI&P-MP—Des Moines, Little Rock (76; \$50000)  
 CRI&P-SP—De Moines, Tucumcari (76; \$71000)  
 MP-SP—San Antonio (54; \$63000)  
 SLSF-T&P—Dallas (72; \$29000)  
 WP-SP—Reno, Sacramento (96; \$50000)  
 SP-AT&SF—Phoenix, San Diego (180; \$82000)

The probabilities in this list range from 645 (for the NYC-PA) down to 24 (for the GN-NP), from very powerful to insignificant. The prices are no guide to the probabilities because some of the expensive combinations have low probabilities and some of the cheap combinations have relatively high probabilities, so Table D is essential in determining how much offensive power a particular combination will deliver. There is no need to memorize these 20 railroad pairs. It is enough to be on the alert during the game for pairs that would help a player if he owned them, or hurt him if an opponent owned them.

There are triplets of railroads having substantial offensive power. An example is CMStP&P-GN-NP, which owns Seattle as well as Fargo and Spokane (probability: 208; cost: \$51000). Another example is the AT&SF-SP-WP combine, which owns San Francisco/Oakland in addition to Phoenix, Reno, Sacramento, and San Diego (probability: 504; cost: \$90000). It isn't necessary to list all the triplets of railroads (or the quadruplets, quintuplets, etc.). It is enough to know that Table D is essential when measuring offensive power, and that alertness during the game is essential to assembling desirable combinations of roads and to keep opponents from assembling desirable combinations of roads.

Table D is not the full measure of offensive power. Another aspect is the length of approach to a city. If the approach is long enough over one player's roads, an opponent is likely to have to pay him twice to get into the city, and twice more to get out. Therefore, adding the ACL to the SAL is even better than Table D indicates, because it makes an opponent's approach to Miami so long. By contrast, buying Dallas by adding the SLSF to the T&P has no "approach bonus" because it's fairly easy for an opponent to get to Fort Worth, from which Dallas is only one dot away. One dot, then, has no approach bonus. Four dots have some bonus, and eight dots have a substantial approach bonus.

Offensive power is, I think, vital to winning the game. A player must acquire some offensive power—not necessarily a great amount—to have a reasonable chance of winning. One reason for this is the availability of cash for buying additional railroads. If, early in the game, an opponent must pay a player owning the N&W \$5000 to get into Norfolk, plus \$5000 more to get back out of Norfolk, the player's cash goes up by \$10000 and the opponent's cash goes down by \$10000, for a total swing of \$20000. This could easily mean the player's getting, say, the CB&Q instead of the opponent's getting it. Later in the game, when each foreign wheelage is \$10000 instead of \$5000, an opponent who must pay a player to get into and out of Norfolk will cause a total cash swing of \$40000 in favor of the player who owns Norfolk. In the race to accumulate \$200000 to win the game, each \$40000 cash swing is very important. A player should, by all means, give himself a good chance of collecting some foreign wheelage and enjoying the cash swings in his favor.

Finally, there is a bit of nastiness that is worth mentioning—"buying ahead" of an opponent. For

example, very early in the game, suppose a player has just completed a trip from Chicago to Boston and an opponent still has a long way to go on his trip from Phoenix to Norfolk. The player should seriously consider buying the N&W because it will really cost him only \$2000. It is also likely to upset the opponent!

**Defensive Power.** In the Northeast, the Pennsy has strong defensive power. Especially when coupled with the New Haven, a player can get to almost any northeastern city without having to pay a foreign wheelage. Notice that the New Haven is important to either an offensive or a defensive strategy in the Northeast. Sometimes, buying the Pennsy will force opponents into defensive purchases. If a player buys the Pennsy while the NYC and B&O are still in the bank, his opponents must buy these two roads as quickly as possible—passing up other opportunities if necessary to accumulate cash—to keep the player from getting the NYC-PA combination or the PA-B&O combination. Naturally, while the player is forcing his opponents into defensive purchases, he is free to do what he likes elsewhere on the board.

In the Southeast, the SAL is strong defensively. Adding the L&N to the SAL is very strong defensively, reaching every southeastern city but Norfolk. Since these two roads also have offensive power, they are a desirable combination. Other combinations with strong defensive power in the Southeast are the SAL-SOU, the ACL-L&N, and the ACL-SOU. Taking the four biggest southeastern roads one at a time, I consider the SAL to be the strongest defensively, followed in order by the ACL, L&N, and then the SOU. Notice that the SOU is rather weak defensively and has no offensive power at all; it is a relatively poor buy.

If a player's only major southeastern road is the SAL, then adding the GM&O is good sense defensively. It prevents him from "dead-ending" on the SAL, and it gives access to Mobile. The GM&O also connects St. Louis, Chicago, and Kansas City, and it does all this cheaply. The same comments apply to adding the GM&O to the ACL. In my experience, the GM&O is often bought rather early in the game because of these advantages. By contrast, the IC is almost worthless and is frequently the last road to be purchased.

The North Central region is so richly served by railroads that defensive power in this region is ordinarily not a problem. It is worth noting that, if the opponents already own the NYC and the PA, then the C&O is sometimes a more attractive purchase than the B&O.

Elsewhere on the board, roads with strong defensive power are the T&P, CB&Q, either the NP or the GN, and the WP. The WP is particularly interesting. It is cheap, and it combines well with either the UP or the SP. A fine triplet is the WP-D&RGW-UP, having both good defensive power and strong offensive power. In my experience, the WP is often purchased rather early in the game.

Sometimes the defensive power a player needs is a road connecting other roads he already owns, rather than access to cities. Suppose, for example, the only roads a player owns east of the Mississippi River are the SAL, GM&O, and B&O. Then the RF&P becomes attractive because it very cheaply connects the B&O with the SAL, preventing long circuitous routes on such trips as Philadelphia to Jacksonville. Sometimes the SLSF's line to Birmingham becomes very attractive as a way of connecting the SAL or ACL to the South Central region and the Plains region. Sometime the WP-GN "inside passage" route becomes very popular, connecting San Francisco, Sacramento, and Reno with Portland, Spokane, and Seattle. Many other examples exist, depending on which roads a player owns and which roads the opponents own.

Often, a player has to choose between buying a railroad for offensive reasons or buying a different

**Table B: Regional Probabilities (in 1/72's)**

Northeast	15	Plains	8
Southeast	9	Northwest	8
North Central	11	Southwest	12
South Central	9	Total	72

railroad for defensive reasons, where the two railroads are about equally attractive to him. In this situation, I believe he should ordinarily buy defensively. No city in Table D has a high probability because the denominator of every entry in the table is 5184. So his choice, in this situation, is a small addition to the probability that he will collect a foreign wheelage as against an ironclad guarantee of access to more cities (or convenient connections between his other roads). The defensive purchase should be always favored unless the offensive purchase is clearly much more attractive.

**Safe Regions.** Several times in each game, the dice will select the region your train is already in. On these occasions, the player benefits by having access on his own roads to every city in a region, so he can choose to go to it without any risk of having to pay a foreign wheelage. It's worth some effort to have this benefit, and it's worth some effort to deny it to opponents. Therefore, some railroad purchases may be wise ones for these reasons, even though they may be foolish from ordinary considerations of offensive and defensive power.

**Cash Reserves.** When deciding which railroad (if any) to purchase, a player must keep in mind that he doesn't know yet how expensive his wheelages will be to his next destination. In my experience, a cash reserve of \$5000 is adequate to cover the unknown future wheelages unless special circumstances require a larger cash reserve. One of these special circumstances is being at an extreme location (i.e., at or near either the Atlantic coast or the Pacific coast). Then \$7000 is ordinarily adequate. Another special circumstance is the existence near a player's train of a city owned by an opponent (or by a combination of his opponents). Suppose the player has just arrived at Casper over the C&NW, which he owns, and now suppose the opponents own all the roads into Denver. If the player has to go to Denver as his next destination, the revenue from Casper will be too small to pay the foreign wheelages into and back out of Denver (the Casper-Denver revenue is only \$3500). Therefore, his cash reserve at Casper should be about \$12000, which will pay a \$5000 wheelage into Denver and a \$5000 wheelage out of Denver, leaving \$2000 to be added to the \$3500 Denver payoff to cover bank wheelages after leaving Denver. Depending on circumstances, the cash reserve at Casper may need to be substantially higher. If foreign wheelages are \$10000 instead of \$5000, then the reserve at Casper should be \$22000. If other cities near Denver, such as Salt Lake City and Tucumcari, are also owned by the opponents, the reserve at Casper may need to be about \$32000. There is no need to worry about foreign wheelages to cities that are far away (because the revenue will be enough to pay them), unless their approaches are so long that one is likely to have to pay twice just to reach them.

While it is foolish to let one's cash reserve fall too low by failure to calculate how much to reserve should be, it is wise under certain circumstances to let the reserves go as low as zero. I remember losing a game by failing to buy the SP because of a cash reserve problem. The SP was the last railroad left in the bank, and my holding of western roads was very poor. Had I bought the SP, I would almost certainly have had to sell some other railroad in order to pay my wheelages to my next destination. So I didn't buy the SP and an opponent got it, with the result that I had no access to Los Angeles or San Francisco, nor to many other less important western cities. Since I desperately needed the SP, I should have bought it even though that would make my cash reserve dangerously low. It wasn't long before I was paying high foreign wheelages to get to the cities served by the SP, so I lost a railroad or two anyway—and the game!

**Selling a Railroad.** When selling a railroad, a player must make two choices: how to sell the railroad, and which railroad (or railroads) to sell. In a two-

**Table C: Conditional City Probabilities, Given a Region (in 1/72's)**

Given Northeast		Given Southeast		Given N. Central		Given S. Central	
Albany	4	Atlanta	15	Chicago	16	Birmingham	6
Baltimore	9	Charleston	4	Cincinnati	8	Dallas	8
Boston	10	Charlotte	3	Cleveland	10	Ft. Worth	6
Buffalo	6	Chattanooga	3	Columbus	5	Houston	9
New York	14	Jacksonville	6	Detroit	11	Little Rock	4
Philadelphia	10	Knoxville	6	Indianapolis	5	Louisville	7
Pittsburgh	7	Miami	10	Milwaukee	8	Memphis	7
Portland	4	Mobile	6	St. Louis	9	Nashville	7
Washington	8	Norfolk	7	Total	72	New Orleans	9
Total	72	Richmond	5			San Antonio	6
		Tampa	7			Shreveport	3
		Total	72			Total	72

Given Plains		Given Northwest		Given Southwest	
Denver	12	Billings	5	El Paso	4
Des Moines	5	Butte	5	Las Vegas	6
Fargo	3	Casper	4	Los Angeles	17
Kansas City	18	Pocatello	4	Oakland/	19
Minneapolis/	14	Portland	17	San Francisco	
St. Paul		Rapid City	5	Phoenix	8
Oklahoma City	8	Salt Lake City	9	Reno	3
Omaha	7	Seattle	18	Sacramento	5
Pueblo	5	Spokane	5	San Diego	7
Total	72	Total	72	Tucumcari	3
				Total	72

**Table D: Unconditional City Probabilities, Before a Region is Determined (in 1/5,184's)**

Albany	60	Knoxville	54	Reno	36
Atlanta	135	Las Vegas	72	Richmond	45
Baltimore	135	Little Rock	36	Sacramento	60
Billings	40	Los Angeles	204	St. Louis	99
Birmingham	54	Louisville	63	Salt Lake City	72
Boston	150	Memphis	63	San Antonio	54
Buffalo	90	*Miami	90	*San Diego	84
Butte	40	Milwaukee	88	Seattle	144
Casper	32	Minneapolis/	112	Shreveport	27
Charleston	36	St. Paul		Spokane	40
Charlotte	27	Mobile	54	Tampa	63
Chattanooga	27	*Nashville	63	Tucumcari	36
Chicago	176	New Orleans	81	Washington	120
Cincinnati	88	New York	210	Total	5,184
Cleveland	110	*Norfolk	63		
Columbus	55	Oakland/	228		
Dallas	72	San Francisco			
Denver	96	Oklahoma City	64		
*Des Moines	40	Omaha	56		
Detroit	121	Philadelphia	150		
El Paso	48	Phoenix	96		
Fargo	24	Pittsburgh	105		
Ft. Worth	54	*Pocatello	32		
Houston	81	*Portland, ME	60		
Indianapolis	55	Portland, OK	136		
Jacksonville	54	Pueblo	40		
Kansas City	144	*Rapid City	40		

\*Served by only one railroad.

person game, the selling method should always be to the bank, not at auction, to give the selling player a chance of getting the railroad back. In a multi-person game, an auction might be preferable if the other players are likely to bid quite high for the railroad. The first step in deciding which railroad (or railroads) to sell is estimating how much cash must be raised to get the player to his destination. Then the player should decide which railroad he can most easily afford to lose; often, some cheap lines are very important while some more expensive lines are less important. No player should automatically sell his cheapest lines when he has to raise some cash.

**Timing One's Purchases.** A general rule is to take the opponents' cash portions into account when deciding which railroad to purchase. For example,

very early in the game, such roads as the New Haven, B&M, SAL, and ACL are very attractive. At this time, there is no point in saving up to buy the NYC or the Pennsy because then the cheaper roads will all go to the opponents, to a player's considerable disadvantage, and the opponents don't have enough cash to buy the NYC or the Pennsy anyway. However, once an opponent has accumulated some cash, and perhaps is also starting a high-revenue run, a player must lay plans to buy one or more of the expensive roads lest the opponents get them.

Some purchases are best delayed until a player's cash position is fairly poor (but not extremely poor, since then he should pass his purchase opportunities until his cash position improves). For example,

it is best to delay buying an Express until a player has, say, only \$10000 in cash and needs a \$5000 cash reserve. As another example, the WP is very desirable later in the game, but it's a mistake to pass up a crucial Eastern or Midwestern road to get the WP. If a player can't afford any of the desirable Eastern or Midwestern roads, but he can afford \$8000 for the WP, then he should buy the WP.

In my experience, it is much better to buy something at every purchase opportunity instead of passing to accumulate cash, except when one's cash reserve is too low and except when it is clear that cash must be accumulated to buy an expensive road before an opponent buys it.

**Routing Flexibility.** When going to a destination owned by opponents, be sure to look at circuitous routes; blindly taking the quickest route can be an expensive mistake. As a simple example, suppose a player is enroute from Philadelphia to Miami and has arrived in Jacksonville. He owns the ACL but an opponent owns the SAL. He throws a "3" for movement. He should take the ACL to Tampa, hoping to throw at least a "5" next time. The move to Tampa gives him a good chance of paying his opponent only once to get into Miami. If, by contrast, he takes the quickest route from Jacksonville to Miami, he must pay his opponent twice to get into Miami.

As a more complicated example, suppose a player is in Nashville, enroute to Tampa. He owns the L&N and SOU but an opponent owns the SAL and ACL. He throws a "7" for movement. He should take the L&N to Chattanooga and Atlanta, then the SOU to Birmingham, then the L&N one dot southeastward, ending at Montgomery (although the dot for Montgomery is not named on the *RAIL BARON* board). If he throws at least a "6" next time, he'll have to pay his opponent only once to get into Tampa. Also, if he throws less than a "6" next time, he can continue moving south and east on the L&N, giving him a second chance to get into Tampa with only one payment to his opponent. And this is what "routing flexibility" really means—giving oneself a second chance to get into an opponent's city with only one payment to the opponent. By contrast, moving directly south from Nashville, via Birmingham and Montgomery, and then a little east to Pensacola (the unnamed dot on the Gulf of Mexico), is a poor move. Next time, if the player throws a "3", "4", or "5", he must pay his opponent twice to get into Tampa, having left himself no routing flexibility.

The concept of routing flexibility is an example of using circuitous routing to minimize wheelage payments. This basic idea can sometimes be used when leaving a city owned by the opponents. Suppose, continuing the previous example, that a player has arrived in Tampa as his next destination and an opponent owns the ACL and SAL? Notice that the assumption here is that the same opponent owns both the ACL and SAL. His best move is four dots northwestward on the ACL from Tampa toward Montgomery, followed by one dot south and west on the SAL to its junction with the L&N at Chatahochee, Florida. He will pay one foreign wheelage but no bank wheelage. His quickest move involving only one foreign wheelage would put him one dot west of Chatahochee on the L&N, but that one dot would cost him an additional \$1000 bank wheelage. It is usually worth a one-dot penalty in board position to save \$1000 in wheelage. This concept works only when one can find a route over an opponent's lines that puts him exactly at a junction with his own roads or the bank's roads.

Sometimes circuitous routing will entirely avoid a bank wheelage when going from a city owned by an opponent to one's next destination. In this situation, he must pay a foreign wheelage as he starts moving, so it is worthwhile to see how far he can get without having to pay any additional wheelages. Sometimes he can make it circuitously in one move

to his next destination without any additional wheelages.

**Letting an Opponent Go Broke.** Sometimes circuitous routing should be used to force an opponent to sell a railroad or to prevent his purchase of a railroad, by delaying foreign wheelage payments to him. As an example of the former, suppose it is early in the game and a player has to go from Chicago to Norfolk and, unfortunately, an opponent owns the N&W. This opponent has let his cash reserve go down to \$3000 and now must travel from New York to San Francisco. The player should consider moving circuitously, avoiding the N&W until his opponent must sell a railroad to pay his wheelages. Once a player starts using the N&W, his \$5000 payments will finance the opponent's wheelages, so it might be worthwhile to postpone the inevitable. However, in my experience, this tactic can easily backfire. The player will be moving for a while without getting any revenue or purchase opportunity. The opponent may make it to San Francisco without selling a railroad. (It's 38 dots via NYC to Chicago, C&NW to Omaha, and UP-SP to San Francisco, and with \$3000 in cash, the opponent will not have to sell a railroad if he throws well enough to move 38 dots in four moves.) Even if he does have to sell a railroad, it might be a line whose loss wouldn't hurt him much and whose gain wouldn't help the player much. It is satisfyingly nasty to force an opponent to go broke, but it is also irrational unless one clearly stands to gain from the act.

**Becoming Established.** Sometimes circuitous routes should be used to become established on a railroad. For example, suppose only Northeastern and Southeastern roads have been brought, and a player is in St. Louis enroute to Rapid City. He throws a "3". If an opponent will have the opportunity of buying the C&NW before the player throws again, he should take the GM&O to Chicago even though that's a circuitous route. Once in Chicago, he is established on the C&NW and will avoid the \$5000 rate for foreign wheelages.

**Uses of an Express.** It might appear that an Express is a foolish investment. It costs only \$4000, suggesting that it isn't worth much because it doesn't cost much. Not so. Moreover, as the bottom of Table A shows, the average movement throw is 7 7/72 dots without an express (allowing for the red die when 12 is thrown on the white dice), while the average movement throw is 7 42/72 dots with an Express, for an increase of only 35/72 dots per movement throw. Nevertheless, I strongly advise buying an Express as soon as one has a purchase opportunity but not enough cash to buy a desirable railroad. For one reason, an Express will pay for itself immediately if it avoids paying a foreign wheelage twice to get into an opponent's city, or twice to get back out, or if it avoids a foreign wheelage entirely by getting one established on a road before an opponent can buy it. For still another reason, the Express will speed up collecting one's revenues from reaching one's destinations. Consider, for example, the New York to San Francisco run. The quickest route is 38 dots, as is mentioned earlier. The revenue is \$31500. Without an Express, repeatedly taking this run will require an average of  $38 / (7 \frac{7}{72}) = 5.354$  movement throws. The revenue per movement throw will then average  $\$31500 / 5.354 = \$5883$ . By contrast, repeatedly taking this run while having an Express will require an average of  $38 / (7 \frac{42}{72}) = 5.011$  movement throws. The revenue per movement throw will then average  $\$31500 / 5.011 = \$6286$ . This is an increase of \$403 in revenue per throw, so an Express would pay for itself in ten throws. Granted, other runs will probably show that more than ten throws are needed for an Express to pay for itself, but it is clear that the speeded up payoffs, alone, will quite quickly let an Express pay for itself. Another reason can be very important. Often there are races to see which player can buy a desir-

able railroad. An Express will occasionally get a player into his destination just ahead of an opponent's reaching his, which lets the player win the race for the desirable railroad.

A Superchief has two of the same kinds of advantages that an express has a chance of avoiding two foreign wheelages to get into or out of an opponent's city, and an improvement in the speed with which revenues are collected. It seems best to delay buying a Superchief, however, until all the railroads have been bought. An argument can be made for buying a Superchief much earlier in the game, but I have yet to see in a game where this has happened.

**Choosing a Region.** When the dice select the region a player is in, he needn't automatically choose a safe region or the lowest-risk region. If he has to have a lot of cash quickly, either to buy a railroad he needs very much or to have a reasonable chance of winning the game, he must choose a region giving him a long run despite some risks.

**Rover Play.** The rover play is definitely the most difficult tactic in the game, either to execute successfully (if a player is trying to catch an opponent who has declared) or to ward off successfully (if a player has declared). The rover play can lead to amazingly complicated routing decisions. It is a fascinating highlight in those games in which it occurs.

Some unusual things happen. So much is at stake that both rover and declarer often voluntarily pay \$10000 foreign wheelages just to get temporarily better board positions. The "no backtracking" rule is very, very important. (That's my phrase for the rule prohibiting the use of any rail section more than once during a trip from origin to destination.) This rule can make routes so complex that they should be written down during the play, to keep accurate track of which player has used which rail sections. Sometimes the declarer gets a favorable alternate destination (i.e., a city from which it would be easy to declare and to win the game). Then, if he is threatened by a rover play, he may do best by paying \$10000 wheelages as quickly as possible to reduce his cash to just under \$200000, thus becoming undeclared and no longer subject to the \$50000 rover penalty. Sometimes the declarer can take advantage of the rule permitting him to move to or through an opponent's train without penalty. Sometimes a player and an opponent have both declared at the same time. Then each, of course, can be caught by the other's rover play. Neither can risk approaching the other very closely, but both must risk some closeness in order to have any chance of catching the other. In this situation, it may be worth the risk to force the opponent to become undeclared even though he is virtually certain on his turn to force the player to become undeclared.

It is vital to think several moves ahead—move, counter-move, second move, second counter-move, etc.—whether one is the declarer or a rover. For example, if an opponent is one dot from his current destination and will then have enough cash to declare but the player won't have enough cash to declare even if he reaches his current destination quickly, he must threaten the opponent with a rover play in order to have any chance of winning. But it isn't enough to move close to the opponent's current destination now, because his next move will be the one dot into his destination. Then the player will have to move again; at the end of this move, he must have a good chance of catching the opponent if the opponent declares. And if the player uses several railroads near the opponent's destination before the opponent declares, the opponent has a good chance of moving into the player's "shadow" (i.e., of moving to a dot the rover cannot reach because of the "no backtracking" rule). And the player must pay a little attention, at least, to the possibility that his threat of a rover play will be successful and the opponent will not declare. In that case, the player needs a reasonable route to his own current desti-



nation. Also, if a rover is in an area where he owns only one or a couple of railroads, he must try to leave himself a route not owned by opponents, or his \$10000 wheelages will be very expensive. Similarly, a declarer escaping from a rover must look ahead or his \$10000 wheelages become very expensive.

When the rover play becomes complicated, which happens in about one game in five, the routing decisions approach the complexity of chess. When played with such skill, *RAIL BARON* games often have fascinating endings!

*Finishing a Game at a Later Time.* It is easy to stop a game and then resume it at any later time. When the game is stopped, record who will throw the dice next, and the order in which the players take their turns. Also record the following information about each player: home city, current origin, current destination, current train location, ownership of an Express or Superchief, amount of cash, and railroads owned.

Each game has three major phases. These are buying railroads, accumulating \$200000 in cash, and declaring. Any of the phases can lead to a severe case of the "grumps" by a player who feels he is losing. But the game can turn around dramatically, even at the very end because of the rover play.

In my experience, during the railroad-buying phase the first race is always for the New Haven. The New Haven's buyer then tries to add the B&M, NYC and/or Pennsy. The other player or players try to prevent these combinations, of course. The first player not having a desirable northeastern railroad to purchase buys the SAL. Then he tries to add the ACL, and the other players try to prevent this. About this time, players often buy Expresses when their cash positions are poor but not hopelessly so.

The battle for roads usually concentrates for quite a while in the Northwest and Southeast. Once the majority of roads are bought, the battle explodes into all the other regions. West of the Mississippi River, the first roads to be bought are the WP, D&RGW, C&NW, and CB&Q. These don't cost much, and they combine well with other roads. Except for the IC and RF&P, the expensive western roads are usually the last to be purchased, because the cheaper roads are so attractive.

During the second phase, accumulating \$200000, players usually buy Superchiefs as soon as they can after all the railroads have been purchased. The second phase tends to be quieter and more routine than the others, although minimizing the foreign wheelages that must be paid sometimes requires interesting circuitous routes when striving for routing flexibility, and choosing a region sometimes requires taking a risk of landing in an opponent's city.

The third phase can be anything from clean and quick to tortuously complicated, depending on how the rover plays (and threats of rover plays) develop. One of the many surprises of *RAIL BARON* is the frequency of even games, where each of two players accumulates \$200000 at about the same time, even when one player seemed to be behind earlier in the game. And, of course, if a player is behind and successfully executes a rover play, he greatly increases his chances of winning the game.

Personally, the feeling that the quality of decisions is vital, rather than simply the fall of the dice, colors the whole game and adds interest to it. Yet, even when Bauer's Amendments are used, *RAIL BARON* is still very much a dicey game, so unlikely things do happen. I remember a two-person game where I was \$100000 behind in the race to accumulate enough cash to declare. Then my opponent had to go to five of my cities in quick succession, completely turning the game around and letting me win it. I prefer to forget some of the other unlikely things that have happened! But that's the joy of playing any game.



## CONVENTION CALENDAR

The *GENERAL* will list any gaming convention in this space free of charge on a space available basis provided that we are notified at least four months in advance of the convention date. Each listing must include the name, date, site, and contact address of the convention. Additional information of interest to our readership such as tournaments or events utilizing The Avalon Hill Game Company's games is solicited and will be printed if made available.

The Avalon Hill Game Company does not necessarily attend or endorse these gatherings, nor do we guarantee that events using The Avalon Hill Game Company's games will be held. Readers are urged to contact the listed sources for further information before making plans to attend.

### MARCH 22-24

**SIMCON VII**, Rochester, New York  
Contact: SimCon VII, P.O. Box 29142, River Station, Rochester, NY 14627.

### MARCH 29-30

**CON-TEST II**, Tulsa, Oklahoma  
Contact: Tactical Simulation Society, P.O. Box 4726, Tulsa, OK 74159.

### MARCH 30

**TIPPY-CON V**, Lafayette, Indiana  
Contact: Randall Black, Tippy-Con V, P.O. Box 5596, Lafayette, IN 47904.  
Note: Tournaments in *SL* are on the broad-interest schedule.

### MARCH 30

**GAMES PLUS DAY**, Mount Prospect, Illinois  
Contact: Joseph Orlowski, Games Plus, 20 West Busse Avenue, Mt. Prospect, IL 60056.

### APRIL 12-14

**NORTHEASTER 3**, New Brunswick, New Jersey  
Contact: Edward Sullivan, Rutgers University Gamers, 320 New York Avenue, Apt. 8, Elizabeth, NJ 07201.  
Note: Tournaments in *SL*, *DIP*, *NW*, *CM* and *GL* among many others.

### APRIL 27-28

**GOLD CON III**, Pompano Beach, Florida  
Contact: John Dunn, Omni Box Office, BCC North, 1000 Coconut Blvd., Pompano Beach, FL 33066. (305) 973-2249.

### JUNE 1-2

**4th ANNUAL SQUAD LEADER OPEN**, Charlotte, North Carolina  
Contact: D.R. Munsell, 6101 McBride Street, Charlotte, NC 28215. (704) 535-7401.  
Note: Five rounds of *SL* and its gamettes.

### JUNE 27-30

**ORIGINS '85**, Towson, Maryland  
Contact: ORIGINS '85, P.O. Box 139, Middletown, NJ 07748. (301) 298-3135.  
Note: The National Adventure Gaming Convention will have numerous events, including competitions in most of our titles.

### SEPTEMBER 7

**AUTUMN CAMPAIGNS '85**, Lexington, Kentucky  
Contact: Tim Wisner, The Rusty Scabbard, 513 East Maxwell Street, Lexington, KY 40502.

## SHOW SPECIAL

### OUT WITH THE OLD; IN WITH THE NEW

While updating *SQUAD LEADER* into the long-awaited *ASL*, we decided we would go all out and improve the boards too; so we've re-issued boards 9, 10, and 11—the so-called "Rogue" boards—with new artwork by ace *SQUAD LEADER* artist Charlie Kibler. Hard as it is to believe, these boards contain only minor changes in actual terrain and can still be used to play the Rogue scenarios which derived their name from the original boards. Now among the most beautiful mapboards in the series and bearing the *ASL* logo and new terrain types, these boards sell for \$4.00 each or \$15.00 for a set of four (including the new "valley" board 24). These may be ordered directly from The Avalon Hill Game Company (4517 Harford Road, Baltimore, MD 21214), of course.

So what's the Show Special? Well, we're hung with . . . err, we have a few of the original boards 9, 10, and 11 which we would like to bestow upon you FREE with any *ASL* purchase.

Buy *ASL* and get a set of the old Rogue boards (9, 10, & 11) FREE!

Buy *BEYOND VALOR* and get another set of Rogues FREE!!

Buy Deluxe *ASL STREETS OF DESPAIR* and get yet another set of Rogues FREE!!!

Buy the four new mapboards and get another set of Rogues FREE!!!!

Buy the Rogue scenarios and get still another set of Rogues FREE!!!!!!

**Offer good only at ORIGINS 85  
while supplies last.**

Witch King . . . *Cont'd from Page 19*

wings and claws to be a Flying Dragon. The benefits are legion. Your carrying capacity becomes tremendous and your fighting ability is fearsome (see Tables 5 and 6 for chances for surviving vs other monsters) Watch the points roll in (as well as a few heads rolling off) as your alter ego rips into the lesser monsters and characters.

**THE TRANSFORM TRICK:** This is a favorite trick of the Sorcerer and the Magician. First transform a Monster into a squirrel or frog, and then kill it with your optional dagger or stomp on it with hired thugs. Of course, a low dice roll can transform it into something quite nasty, but there is a 75% chance of transforming it into something totally innocuous. Be sure to slay the beastie, or you won't be able to cast the spell again.

**THE VANISHING ACT:** Cast Melt into Mist on yourself. Keep a few Purple counters on hand. Whenever you're confronted with something too big (or numerous) to handle, just "pop a Purple"; that is, play a Purple counter to activate the spell during that encounter step. Nothing except Exorcise can then affect you—even other alerted spells. On the morrow, you have the choice of hiding or re-activating the spell and leaving.

## CONCLUSION

Finally, I want to emphasize that this article does not put forth a fool-proof set of guidelines. *MAGIC REALM* is too full of unpredictable quirks for anyone to claim that. That's its charm. But I hope that some of the ideas I've set forth here will help you to grasp some of the subtleties of this marvelous game. Enjoy!





# FUR TRADERS AND BUCCANEERS

## Historical Variant for CONQUISTADOR

By Glenn Rahman

The Avalon Hill Game Company's *CONQUISTADOR* is the most popular and technically successful game dealing with conflict and seafaring in the sixteenth century. It depicts, with authentic feeling, the limitations, hazards, opportunities and rewards of the first great European colonial race, 1495 through 1600. Yet, despite all its virtues, *CONQUISTADOR*'s designers make an unhistorical assumption which takes it out of the realm of ordinary simulation and into that of fantasy or alternate history: the French and English are permitted under the standard rules to join into the colonial scramble at the same time and with resources nearly equal to those of the New World's true pioneers, the Spanish and Portuguese.

Historically speaking, the colonization effort was almost entirely a two-horse race. Despite their early explorations, the French and English attempts at starting settlements were half-hearted failures. Before either of these nations managed to establish a single permanent colony in the Western Hemisphere, the seventeenth century had dawned. Nonetheless, this second wave of colonial expansion makes fascinating reading. The vitality of Spain and Portugal was played out by that time, but other states had matured enough to take their role in Western Exploration—not only France and England, but Holland, Denmark and Sweden as well. This was the fascinating era of West Indian buccaneering, the opening of the fur trade and the African slave trade. Every colonizing power produced energetic individuals whose worth and fortitude rivaled that of the brave and ruthless conquistadors who had gone before.

This variant will provide additions and changes to the *CONQUISTADOR* game system to make the strategic options of the years 1595-1700 possible. The number codes beginning the variant paragraphs below correspond, where possible, to the appropriate section of the standard rules.

### 2. MAPBOARD

2.1 The black hexes in the Caribbean area should be considered green hexes and are open to colonization. While it is true that the Spanish did not bother with the Bahamas and the Lesser Antilles, those islands were among the most coveted prizes

in the colonial competition of the seventeenth and eighteenth centuries.

2.3 Add a new island (Barbados) in hex 2511. This island, the historical seat of early English sugar production, cannot in fairness be omitted.

2.4 Before play, the settlements of the Spanish and Portuguese non-players must be set up. By the end of the sixteenth century, the states of Spain and Portugal were united. In the seventeenth century Portugal attained political independence, but for game purposes (unless otherwise stated) the Spanish and Portuguese may be considered as one group.

Deploy green Colonist counters in the hexes given below. They shall stand for major Spanish/Portuguese towns established in the sixteenth and early seventeenth centuries:

Hex	Town Name	Date Founded	Number of Units
4410	Asuncion	1536	1
3904	Bahia/Itabuna	1549/1537	2
3017	Bogota	1538	2
4811	Buenos Aires	1580	1
2714	Caracas	1567	2
2817	Cartagena	1533	5
4612	Cordoba	1573	1
1928	Durango	1563	1
2524	Guatemala	1527	1
2220	Havana	1515	2
2418	Jamaica	1509	1
4013	La Paz	1548	2
3719	Lima	1535	5
2816	Maracaibo	1571	1
2127	Mexico City	1521	5
3601	Natal/Parahyba	1597/1583	2
2619	Panama	1519	5
4003	Porto Seguro	1537	1
4213	Potosi	1544	2
3319	Quito	1537	1
1920	St Augustine	1565	1
3520	San Miguel	1532	1
1328	Santa Fe	1601	1
4716	Santiago/Valparaiso	1541/1544	2
2316	Santo Domingo	1496	1
4406	Santos	1532	2
4414	Tucuman	1565	1
2126	Veracruz	1519	5
4204	Victoria	1537	1

### 3. COUNTERS

3.2 The yellow counters are Dutch. Green counters are the Spanish/Portuguese non-player.

### 5. SEQUENCE OF PLAY

B. Initial Naval Phase—If the Slave Trade option is used (see 29.), the players not moving units to "Guinea", fighting combat or purchasing slaves there, must *Pass* during the "Guinea Phase".

### 6. ROYAL COUNCIL OPERATIONS

6.3.2 Colonists. To represent the lack of French and Dutch colonists historically, reduce the number of Colonists due the French and Dutch player each turn (after Random Event modifications) by

"1". The number may not be less than zero however.

**6.4.9** The English player begins the game with a "South Cape Rutter". If unable to attain one normally by the end of Turn 4, all the other players acquire Rutters automatically at that time.

**6.4.10** Ignore this event. At the beginning of the game the Pitosi Silver Mines (hex 4231) will produce 50 ducats per game turn for any controlling player.

**6.4.15 and 6.4.16** Ignore these events. The dream of the treasure cities died with Sir Walter Raleigh.

## 7. NAVAL MOVEMENT

**7.1.3** Galleon Fleets may be purchased beginning with the first turn of the game. By the seventeenth century, they were no longer invulnerable. Galleon Fleets in this variant have a defense factor of 50. They may never attack. If attacked, they are not sunk nor captured, but any loss as a defender in naval combat is interpreted to mean a loss of gold to the attacking fleet. A loss of D1 forfeits 25% of the gold on the Galleon Fleet; a loss of D2 forfeits 50%. A loss of D3 and DE forfeits 75% and 100% of the indicated treasure respectively. Round to the nearest 5 Ducats.

## 12. LAND ATTRITION

As pointed out in a past issue of *The GENERAL*, the first edition Land Attrition Table has to be corrected. It should read:

Adjusted Area Attrition Level

Die Roll	1	2	3	4	5
1	—	—	—	—	—
2	—	—	—	—	C*
3	—	—	—	C*	S
4	—	—	C	S	CS
5	—	C	S	CS	2CS
6	C	S	CS	2CS	All

**12.3** In this variant the presence of a Pathfinder adjusts the Attrition Level of a hex. Subtract one (-1) from the die roll when checking for Attrition results.

## 13. MAINTENANCE

**13.3** No Spanish missionaries are in play. However, this rule holds if the words "French Players" are substituted for "Spanish Player".

## 14. GOLD & TREASURE

No gold may be mined in the Caribbean Area. All mainland Gold hexes except Santa Fe (1328) occupied by a Spanish settlement are mines already in operation (should a player capture them). All other gold hexes, including 1328, are undiscovered at the game's start.

**14.3** All three Treasure Cities begin the game looted.

## 16. SPECIAL UNITS

**16.1** The players receive the following Explorers:

### England

Richard Hawkins, enter turn 1, exit turn 1  
Bartholomew Gosnold, enter turn 2, exit turn 2  
John Smith, enter turn 3, exit turn 4  
Henry Hudson, enter turn 4, exit turn 4

### France

Marquis de La Roche, enter turn 1, exit turn 1  
Francois Grave du Pont, enter turn 2, exit turn 4  
Sieur De Monts, enter turn 2, exit turn 4

### Holland

Jacob Mahu, enter turn 1, exit turn 1  
Henry Hudson, enter turn 2, exit turn 3  
Jacques Lemaire, enter turn 4, exit turn 4

**16.2** *Charters*. By the seventeenth century the great age of American coastal exploration was ending.

Explorers aplenty there continued to be, but the greatest fame went to those in Pacific waters. For every Smith or Hudson whom we remember today, American shores saw many De Montses and Gosnolds, men whose names are almost unknown even amongst experts, despite the worthiness of their accomplishments. For the rest of the seventeenth century fame would fall upon the inland explorers. The coasts would belong to influxes of settlers, led by men of a different stamp.

Once the coasts were known, settlement depended on government interest and support. The expression of this support was the granting of a charter.

**16.2.1** At the beginning of each Planning Phase starting with turn 5, a player wishing to found a colony or land Soldiers and such, may roll on the Charter Granting Table. The die may be modified:

**A.** If in the last turn the player's Treasury held a greater number of Ducats at its end than at its beginning, the player's colonial efforts have shown a profit. This profit encourages further settlement. Add one (+1) to the Charter die roll.

**B.** If the government actively invests in New World development, more Charters may be made available. The player may spend five Ducats from his Treasury and add one (+1) to the die roll on the charter Granting Table.

**16.2.2** The player receives the number of Charter counters indicated by his die roll. The presence of a Charter in an expedition allows the Colonists and other units of an expedition to disembark in a non-Port coastal hex after Trans Oceanic Movement. Landing units will cause the Charter counter to be removed from the map. A single Charter permits the landing at only one non-Port hex, but an expedition may carry more than one Charter.

**16.2.3** If a ship carrying a Charter is captured or sunk, the Charter is removed from the map. This represents the loss of a vital leader, or the discouragement of the colonists.

**16.4** *Missionaries*. The seventeenth century saw a concerted effort by French religious orders, especially the Jesuits, to bring Catholicism to the Canadian Indians. For their efforts and travels, men like Hennepin, Marquette and Biard are well remembered.

**16.4, 16.4.1, 16.4.3:** In these rules substitute "France" for "Spain" and "French Player" for "Spanish Player" throughout.

**16.4.4** The Conversion rating of a French Missionary is never used to affect combat. The French, and still less the missionaries, were never interested in the military subjugation of the Indians.

**16.4.7** The French player needs no Missionary to land Pathfinders, Buccaneer Leaders or Buccaneer Soldiers in areas with a Native Level.

**16.4.8** The French Missionary pool is equal to the Spanish (two +3, two +2, three +1, two 0, three -1, two -2, two -3). If all Missionaries are on the map and the French player wishes to send still more to the New World, he may create a new 0-rated Missionary counter in the planning phase. He may make only one new counter per turn.

**16.4.8** The Conversion Rating of the French Missionaries affect the Alliance of Indians. See 23.3 below.

**16.4.9** Ignore Missionaries when Native Level reductions under Random Event #12 are called for.

**16.5** *Pathfinders*. The French were blessed by a small number of remarkable frontiersmen. They traded with Indians, lived among them, learned their ways and languages, and sometimes led them in battle. While English colonials still hugged the coasts, French explorers were mapping the vast North American interiors, often accompanied only by the Indians themselves. By the efforts of such men, and an enlightened colonial policy, France be-

came not the competitor, but the friend and ally of the Indians living within its domain.

**16.5.1** The French player receives Pathfinders, in Europe, according to this schedule:

Samuel de Chaplain, enter turn 2, exit turn 5  
Etienne Brule, enter turn 5, exit turn 8  
Jean Nicolet, enter turn 6, exit turn 10  
Sieur de Groseilliers, enter turn 12, exit turn 15  
Pierre Radisson, enter turn 12, exit turn 15  
Daumont de Saint-Lussion, enter turn 15, exit turn 15  
Nicolas Perrot, enter turn 15, exit turn 19  
Louis Joliet, enter turn 16, exit turn 20  
Sieur de La Salle, enter turn 16, exit turn 19  
Sieur Duluth, enter turn 17, exit turn 20

**16.5.2** Historically, some of the Pathfinders defected to English employ. In turn 8, Etienne Brule becomes an English Pathfinder (to exit at the end of the turn). Radisson and Groseilliers both become English for the game turn 15. Should these Pathfinders fail to survive until their defection date, no defection occurs. The defection (or, alternatively, rent) of Pathfinders is crucial to the English. Historically it took the defection of Radisson and Groseilliers to enable the English to establish the long-lived Hudson Bay Fur Company. No Englishman was able to carry the task.

**16.5.3** A player may rent a Pathfinder from another player at whatever cost and for whatever length of time they agree upon (within the restrictions of the Pathfinder's arrival and departure dates). This financial arrangement must be encoded in a treaty.

**16.5.4** Pathfinders are intrinsically worth one Alliance Point each for attempts to ally the Native Level of an area. See 23. below.

**16.5.5** The presence of a Pathfinder in a hex allows one (-1) to be subtracted from the Attrition die roll (using the table in 12. above). Only one Pathfinder may perform this function per hex. Pathfinders may perform this function only in areas north of the Aztec Empire.

**16.5.6** The presence of a Pathfinder (or a Missionary, or a Trading Post) is necessary for the operation of the Fur Trade in an area.

**16.5.7** A Pathfinder may not discover gold.

**16.5.8** A Pathfinder may make land discoveries.

**16.5.9** A Pathfinder may end a turn alone in a hex. If attacked, a Pathfinder may retreat with any surviving units. If alone in a hex, the entry of enemy Colonist or Soldier units captures the Pathfinder, unless it escapes (see 23.12).

**16.5.10** A captured Pathfinder is not killed, but must move with its captors. It may be ransomed back to its owner. If Attrition or Combat calls for the death of a *Conquistador*, one friendly (non-captive) Pathfinder in the effected stack is eliminated.

**16.5.11** If capturing units are forced to retreat in battle, the Pathfinder does not retreat (but is freed or captured by the victor).

**16.6** *Buccaneers*. The seventeenth century saw the phenomenon of the West Indian Buccaneers. These were originally outlaws and wanderers who settled on uninhabited islands in the Spanish Caribbean to hunt the wild cattle. Conflict with the Spaniards soon turned these tough pioneers into ferocious and effective amphibious fighters and raiders. At first they recognized no authority but their own brotherhood; but gradually European governors insinuated themselves into their strongholds and used them for a kind of irregular marine force. Eventually the buccaneer forces grew so large and so powerful that their former patrons turned against them and outlawed buccaneering in the closing years of the century. During their brief heyday, the men who led the Brethern of the Coast were made legends for their luck and daring.

**16.6.1** Players receive Buccaneer Leaders according to this schedule. They arrive directly inside Caribbean ports. If no Port exists when the Leader is due to appear, its arrival is delayed until the Planning Segment in which such a friendly Port does exist.

#### England

Flood, enter turn 10, exit turn 11  
Mansfield, enter turn 12, exit turn 14  
Morgan, enter turn 15, exit turn 17  
Peake, enter turn 16, exit turn 17  
Davis, enter turn 18, exit turn 20

#### France

Le Vasseur, enter turn 10, exit turn 12  
L'Ollonois, enter turn 13, exit turn 15  
De La Mothe, enter turn 16, exit turn 17  
Grammont, enter turn 17, exit turn 18  
Du Casse, enter turn 19, exit turn 21

#### Holland

Brouwer, enter turn 10, exit turn 11  
Roc, enter turn 12, exit turn 14  
Van Noort, enter turn 15, exit turn 16  
Van Horn, enter turn 17, exit turn 18  
De Graff, enter turn 17, exit turn 21

**16.6.1** Brouwer and Van Noort are fictional names. Dutch buccaneers swarmed in the Caribbean in these years, but very few of them are noted by name in the meager chronicles of the time. They are included here to give the Dutch player the same chance at successful Buccaneering that his historical counterpart enjoyed.

**16.6.2** A player may rent a Buccaneer Leader from another player at whatever cost and for whatever length of time they agree upon (within the restrictions of the leader's arrival and departure dates). This financial arrangement must be encoded in a treaty.

**16.6.3** Buccaneer Leaders may sail anywhere without attrition to Buccaneer Ships and Soldiers, unless the purchased bounds are exceeded, in which case the Buccaneer units are attritioned on the 9+ column of the Naval Attrition Table. Non-Buccaneer units in the same expedition as the Buccaneer Leader do not benefit from its presence. Take normal Attrition losses from these units.

**16.6.4** A Buccaneer Leader, leading Buccaneers, reduces the Naval Combat/Invasion die roll, when attack, by one (-1). When attacking non-player units, the Leader likewise reduces the die roll by one. If it defends against Spanish Land or Naval Attacks, add one to the die.

**16.6.5** A Buccaneer Leader, leading Buccaneers, increases the die rolls when determining Spanish City Loot and Spanish Galleon Treasure (see 27.10, 27.11).

**16.6.6** If a Buccaneer Leader is stacked with Buccaneer units in defense against a Spanish Land Attack or a Spanish Naval Attack, one (-1) is subtracted from the die roll.

**16.6.7** A Buccaneer Leader may retreat from combat with friendly surviving units. A Buccaneer leader may end a turn alone in a hex. If enemy Soldiers or Colonists enter a hex containing a lone Buccaneer Leader, it is captured. A captured leader may be killed immediately or held for ransoming later.

**16.6.8** If capturing units are forced to retreat by combat, the captive Buccaneer does not retreat, but is freed (or captured) by the victorious player.

**16.6.9** Only a Buccaneer ship may carry a Buccaneer Leader.

**16.6.10** If a solely Buccaneer Fleet under a Buccaneer Leader is victorious in Naval Combat or gains Treasure by the Spanish Galleon Treasure Table, all ships lost by the enemy become Buccaneer prizes.

**16.6.11** If Attrition or Combat calls for the death of a *Conquistador* or *Explorer*, a friendly (non-captive) Buccaneer Leader in the affected hex is eliminated.

## 18. NATIVES

**18.3** In the Native Combat Segment of the Land Phase, each player may attempt to lower the Native Level of a given Area by attacking the Natives—if and only if that player has suffered a Native Uprising in that particular area in the previous turn. If the player chooses not to attack the Natives in the turn following an Uprising, he may not do so later unless provoked by another Uprising.

The seventeenth century colonial powers rarely sought confrontation with the Indians. The English ignored them unless an uprising needed to be punished. The Dutch and especially the French coveted the Indians trade goods more than their territory, so cultivated friendly relations.

**18.3.1** If the Random Event #11 or #13 occurs, the proper time for attacking the Natives is the Native Combat Segment of the *same* turn.

**18.4.6** The Native Level for the Caribbean Indians is a special case. Under the standard rules it is normal for the Caribbean Indians to be attacked in the first turn or so and permanently eliminated. This is not historically accurate. There were many unsettled islands which the Caribs held onto. They remained a powerful foe well into the middle of the seventeenth century. Therefore we offer the following rules:

A. The Native Level on the islands of Cuba, Jamaica, and Hispanola (the three islands with Spanish settlements) is zero. The Bahamas (2118 and adjacent hexes), the Lesser Antillies (2512 and adjacent hexes), and Puerto Rico (hex 2314) shall each be considered a separate sub-area with a Native Level of "3" each. The reduction of Natives in one sub-area has no effect on Natives in another. Likewise, the alliance of Natives in a sub-area is limited to their sub-area.

B. Despite alliance, event #13 will be carried out normally. Caribs which go on a rampage, cease to be allies of the player they have rampaged against. It is possible to ally them again later.

## 19. DISCOVERIES

At the beginning of the game, the following discoveries have yet to be made: Hudson's Bay, Mississippi Land Expedition, and the Great Lakes. In addition, any player except England who successfully passes an Explorer through the South Cape receives 15 Victory Points (once). For its exploration in the previous century, England begins with 15 Victory Points and France receives 15 Victory Points for Cartier's discovery of the St. Lawrence River.

## 20. AREA POLITICAL CONTROL

6) A Spanish Empire area is not controlled by a player unless all other conditions are met, *plus* the capture of all non-player settlements in the area.

## 22. SCENARIOS

This variant covers the second century of the Age of Exploration, from 1595 to 1700. It may be played by two, three or four players.

The resource multiplier is unchanged on the game track; the English, French and Dutch were settling untamed land which did not benefit from the work of the Iberians in the tropics. Beginning with turn 8, up to one ship per turn may be built in a New World Port.

**22.1** *Two Player Scenario* Treasuries: English Player, 290 Ducats; French Player, 240 Ducats. Monarchs: English Player, Elizabeth I (rated for advanced years) C; French Player: Henry IV, B.

Victory Points: English Player 15; French Player 15.

**22.2** *Three Player Scenario* Treasuries: As above; with Dutch Player, 190 Ducats.

Monarchs: As above; with the Dutch Player: Maurice, B.

**22.3** *Four Player Scenario* Treasuries: As above; with Danish Player, 200 Ducats.

Monarch: As above; with Danish Player, Christian IV, A.

**22.3.1** Denmark actually played a small, but interesting role in the New World exploration. It explored Greenland, traded slaves to the New World and in 1625 chartered the Danish West Indian Company. Its colony in the Virgin Islands remained Danish until the 20th Century. King Christian IV was an able ruler of a prosperous state. Had warfare not diverted Denmark's energies to the continent, its presence in the West might have been much more felt.

**22.3.2** Counters to represent the Danish Explorers, Colonists and Soldiers may be found of the insert of this issue.

**22.3.3** The Danish player receives Explorers according to this historical schedule, slightly adjusted for game purposes.

John Knight, enter turn 1, exit turn 1

Godske Lindenow, enter turn 3, exit turn 3

William Gordon, enter turn 4, exit turn 4

**22.3.4** Danish colonists are reduced in number in the same way as French and Dutch Colonists (see 6.3.2).

**22.3.5** There seem to have been no historical Danish buccaneers. The Danish Player shall be permitted to create Buccaneer ships and Soldier detachments normally. They may rent Buccaneer Leaders from other players or, optionally, accept this hypothetical schedule:

Fliind, enter turn 10, exit turn 12

Carlsen, enter turn 13, exit turn 15

Krogh, enter turn 16, exit turn 18

Christensen, enter turn 19, exit turn 20

## 23. ALLIANCE OF NATIVES

**23.1** A player possessing a French Missionary or a Pathfinder, may elect to make allies of Natives in an area during the Native Combat Segment. If attempting to make an alliance with Natives in an area, one may not attack the Natives that turn.

**23.2** All enemy Soldier detachments must be removed from an area before an alliance attempt may be made with its Natives.

**23.3** Natives are allied by means of a die roll on the Native Alliance Table. The die roll is cross-indexed with the "Alliance Points" available in the area. The *negative* rating of a Missionary converts directly into Alliance Points. Each Pathfinder counter is equal to one Alliance Point. Each *two* friendly Soldier detachments equal one Alliance Point. It is not possible to have more than six effective Alliance Points in an area.

Soldier detachments by themselves have no value; they must share the area with a Missionary or Pathfinder to be counted.

**23.4** The available Alliance Points in an area are reduced by a number equal to the *positive* rating of a Missionary and by one for each Colonist in the area.

**23.5** The result yielded by the Native Alliance Table equals the number of Native Level points made friendly to one player (or more), yet another player may attempt to use Native Alliance upon them. Non-alliance Natives in an area must be allied first; afterwards the player may select friendly Native Level points from any player(s) of his choice. There is no special limit to the number of times the

same Native Level points may change alliance.

**23.7** When checking for Uprisings, Natives friendly to a player are never counted. Natives friendly to other players *are* counted. A side record of which Natives in what areas are friendly to whom must be kept.

**23.8** A player may never attack Natives friendly to him. However, in case of Random Event #12, he must first choose to eliminate friendly Native Level points, since they would be in closest contact with him. Afterward, Native Level points friendly to other European powers are reduced. Non-allied points are reduced last of all. Pathfinders, Buccaneer Leaders, Missionaries and Trading Posts do not by themselves put Random Event #12 into effect.

**23.9** A player who successfully attacks Natives, may eliminate enemy Natives and/or non-allied Natives in any order he pleases.

**23.10** Random Events #10, #11 and #13 will cause the affected Natives to become non-allied (as well as having their normal effect).

**23.11** Friendly Native Level points are added into the combat strength of any friendly European units in that area. Losses are always taken solely from European units. The friendly Native Level points are not added into the defense or attack on a port via Naval Invasion.

**23.13** Friendly Native Level points are essential for the operation of the Fur Trade. See 24. below.

## 24. THE FUR TRADE

One can hardly exaggerate the importance of the fur trade in the seventeenth century. The English and Dutch lusted for it; it was the decisive factor in France's otherwise illogical colonial policy which preserved the wild at the expense of settlement.

**24.1** These areas produced Fur Resources as follows:

Area	Ducats produced per turn (base value)
California	Two
East Coast	Two
Great Lakes	Four
Maritime	Three
Northumbega	Three
Northwest	Four
Rocky Mountains	Three
Saguenay	Four

**24.2** A player able to draw Fur Resources from an area adds the appropriate number of Ducats directly into his Treasury in the Resource Segment; no ships are necessary.

**24.3** A player may draw Fur Resources from an area if the following conditions are met:

A. The area must contain a Native Level greater than zero and at least one Native Level point must be allied to the player.

B. The area must contain a Missionary, a Pathfinder or a Trading Post friendly to the player.

C. The player must have an Atlantic Port during the Resource Segment. It must be in a Fur Trade area or adjacent to a Fur Trade area (see D. below). If in an area with effective Natives, at least one Native Level point must be friendly.

D. The Fur Resources may "flow" to port through any number of other Fur Trade areas which contain at least one friendly Native Level point, or which have no Natives whatsoever.

**24.4** Elimination of Native points reduces the base value of the area proportionally. Alliances with Natives which divide the loyalties of an area, divide the Fur Resources. (Round to the nearest Ducat to the benefit of the player with greater Initiative).

**24.5** If two (or more) players have friendly Natives

in the same areas and meet all the other Fur Trade conditions, the Ducats from Fur Trade are divided so: the player with Initiative takes one Ducat, then the second player, and so on up to the maximum of the area's Fur Resource production that turn. When calculating available resources, keep in mind rules 24.4 and 24.6.

**24.6** The basic Fur Resource production (24.1) is multiplied by the current Resource Level number on the turn track to determine the total Ducat value each turn.

**24.7** For a Fur Trade area to produce, it must contain a friendly Missionary, Pathfinder or Trading Post. Any number of Trading Post counters may be made. No more than one may be placed in each Fur Trade area by a player. A Trading Post is placed in the planning segment, in an area containing a friendly Native Level point. It costs nothing, but must be maintained at the expense of one Ducat per turn. Once placed, it may not move. It may be voluntarily removed in the Planning Segment.

**24.8** In the event of Uprising, treat the Trading Post as a Colonist when determining losses. If stacked alone with enemy Colonists or Soldiers, the Trading Post may be ignored or removed from the map.

**24.9** Reduce the base value (24.1) of a Fur Trade area by one (-1) for each non-Spanish Colonist not mining Gold in that area. Colonists mining Gold do not affect the production of Fur Resources. The base value of the area may be restored if the non-mining Colonists exit the area. (In effect, the land returns to its wild state and the fur-bearing wildlife returns.)

**25.10** At the end of the game, if a Fur Trade area meets the conditions for producing Fur Resources and the Natives are *all* friendly to a single player, that player, if no other player meets the conditions of control, has Political Control of the area for 150 V.P.

## 25. THE NEWFOUNDLAND FISHERIES

The earliest New World treasure discovered by Europeans was the fabulous fishing banks off Newfoundland. For a long time all nations shared the banks, but by the seventeenth century conditions were ripe for one nation to try to seize total control.

**25.1** The island of Newfoundland (0812 and adjacent hexes) is to be considered a sub-area of Maritime. The Native Level on Newfoundland is zero. Soldiers and Colonists on Newfoundland never suffer Native Uprisings nor contribute to their making. They are ignored for Random Event #12, and for 24.9 (Fur Trade).

**25.2** A Port on Newfoundland may not service the Fur Trade, but at the end of the game it does count toward the political control of Maritime.

**25.3** If no Colonist or Soldier exists upon Newfoundland, each player receives one Ducat in the Resource Segment of the game turn (times the current Resource Level multiplier). This represents the income from the shared use of the banks.

**25.4** If a Colonist or Soldier exists upon Newfoundland, the owning player may (but doesn't have to) declare in an Resource Segment that he is closing (or opening) the fisheries to *all* competing nations. If the fisheries are closed, the player draws a base of three Ducats per turn (times the current Resource Level multiplier).

**25.5** If Colonists or Soldiers of more than one nation are upon Newfoundland, the fisheries are automatically open.

## 26. BUCCANEERS

**26.1** Buccaneer Soldier detachments are created in the Planning Segment by exchanging Colonist units

in the Caribbean Area for Soldier units. A 1-4 Colonist unit becomes a 4-8 Soldier unit. To be able to recognize Buccaneer Soldier units for what they are, the player may make additional and slightly different Soldier units, or mark ordinary counters with a "B".

**26.2** Any ship unit built in a Caribbean Port may be considered a Buccaneer ship. To be able to recognize Buccaneer ship units for what they are, players may make additional and slightly different ship units, or mark ordinary counters with "B".

**26.3** Any enemy ship taken as a prize by a naval force consisting solely of Buccaneer Soldiers and ships, becomes, if the player wishes, a Buccaneer ship.

**26.4** Spanish ships captured by solely-Buccaneer attacks on the Spanish Treasure Fleet may become Buccaneer ships.

**26.5** The building of Buccaneer ships is limited by Rule 7.1.4. Depending on the number of Colonists in the Caribbean, any number of Buccaneer Soldier detachments may be created each turn. Buccaneer ships may not be converted into ordinary ships, except as the consequence of outlawing Buccaneering (see 26.7). Buccaneer Soldiers may not be converted into ordinary Soldiers, nor back into Colonists, except as a consequence of outlawing Buccaneering.

**26.6** Buccaneer Soldiers and ships must be maintained by the national Treasury. Soldiers and ships may not be maintained in Europe.

**26.7** A player may begin creating Buccaneer units as of turn 8. He may outlaw Buccaneering (for his own units) at the end of any Resource Segment. If outlawed, all Buccaneer Leaders are removed, Buccaneer ships become ordinary ships in place. All Buccaneer Soldiers in the Caribbean become Colonists in place (4-8s become 1-4s). Soldiers outside the Caribbean are eliminated. Buccaneering is automatically outlawed in the Resource Segment of turn 21.

**26.8** Within a Planning Segment, ships are built before Buccaneer Soldiers are created. Hence Colonists may build a ship, then turn into Buccaneer Soldiers to sail in it!

**26.9** Unlike Privateer ships (rule 16.2.4), Buccaneer ships do not need to carry Soldiers.

**26.10** Buccaneers may travel at sea only upon Buccaneer ships. Buccaneer ships may not carry ordinary Soldiers nor Colonists, Pathfinders nor Missionaries. If ordinary ships are available in the starting port, mixed-unit expeditions are possible.

**26.11** Gold captured by Buccaneers may not be carried to Europe in Buccaneer ships. It must be transferred to ordinary ships in a friendly Port. Buccaneer ships may not pick up gold in a Port, unless it is gold taken from the Spaniards/Portuguese or from a different player.

## 27. THE SPANISH/Portuguese NON-PLAYER

With some exceptions, any area of the map containing a Spanish/Portuguese unit is considered part of the Spanish (or Portuguese) Empires. These areas will be handled by a series of abstract rules. By 1600 the Spanish Empire virtually ceased to grow and became stagnant. Its New World holdings were populous and often highly civilized. The mines and rich cities of the Spanish tropics became a magnet for Privateers, and later Buccaneers and invasions by foreign powers. Throughout the century a gradually weakening Spain fought to defend its sea lanes and its far-flung coasts from growing hordes of predators. Its fight was generally successful and no important territory was lost permanently to its rivals.

**27.1** The Native Level of any area containing Spanish/Portuguese settlements (other than the

Caribbean—see 18.4.6) is zero, with these exceptions: Rockies, Sonora, Deep South and Aracua. The Native Level in these areas is normal. Non-player settlements are never a factor in Native Up-risings, nor in Random Event #12.

27.2 Non-player settlements are never removed from the map for any reason not even by combat, except in the case of Jamaica (Rule 27.6).

27.3 *Combat and Settlement Capture*

27.3.1 Non-player settlements may be attacked by players. To attack the settlement, land units or an amphibious force enters the hex as per the standard rules (see 8.7 and 11).

27.3.2 Before initiating combat, the player rolls a die and consults the Spanish Garrison Table. Increase the die result by +1 if the hex contains an active gold mine, or if the settlement is Veracruz, Panama, Lima, Cartagena. The result is the number of Spanish Soldier Detachments which will fight to defend the settlement.

27.3.3 Once he has determined the garrison of the settlement, the player must either carry out his attack at once, or retreat his units from the hex.

27.3.4 An attack on a non-player settlement is carried out normally, except that non-player Colonists never retreat and are not eliminated. If non-player Soldiers are forced to retreat, they are removed from the map.

27.3.5 If a successful attack leaves a force occupying a hex of a non-player settlement, the settlement is considered captured. The settlement remains captured as long as the capturing player maintains Colonist or Soldier strength points in the settlement in excess of the printed strength of the non-player Colonists.

27.3.6 Should the capturing player need to defend a captured settlement against other players or a Spanish Land Attack, the Iberian units in the hex lend nothing to the defense.

27.3.7 While captured, the non-player Colonists are ignored for Resource-collecting purposes. If the settlement is a Port, it functions as a friendly Port.

27.3.8 Should the player abandon the captured settlement, it reverts at the end of the turn to an ordinary non-player settlement, with a potential Spanish soldier garrison (see 27.3.2). Should Soldier and/or Colonist strength in the settlement become equal or less than the printed strength of the non-player Colonists, the occupying units must immediately retreat from the hex or be eliminated.

27.3.9 If the attacking player should be forced to retreat from a non-player settlement either by combat or voluntarily (see 27.3.3), he may not attack the settlement again that game turn. Any Spanish Soldiers remaining in the vacated settlement are removed from the map. If another player attacks the settlement that turn, a new garrison is determined as per 27.3.2.

27.3.10 Resources (excluding Fur Resources) may not be taken from an area containing any uncaptured Spanish/Portuguese settlement.

27.4 A player must consider himself at war with Spain under the following conditions:

A. If a "Costly European War" Random Event comes up. Should this occur, the player involved rolls a die; if the result is 1-3, the war is against Spain. If the result is 4-6, the war is not against Spain (but the cost is still paid by the player).

B. If he has declared war against Spain in the Planning Segment and has paid the 50 Ducats demanded by the expense of such an enterprise.

27.4.1 No non-Buccaneer ship or Soldier detachment may ever attack a Spanish/Portuguese settlement or the Spanish Treasure Fleet unless a "Costly European War" has inadvertently begun against Spain or the player has chosen to declare war on

16.2a

CHARTER GRANTING TABLE

Die Roll:	1	2	3	4	5	6	7	8
Number Charters rec'd:	0	0	1	1	1	2	2	3

23.5a

NATIVE ALLIANCE TABLE

Alliance pts.:	1	2	3	4	5	6+		
	2	3	3	4	4	5	1	
Number of Natives	1	2	2	3	3	4	2	Die Roll
Allied:	0	1	1	2	2	3	3	
	0	0	1	1	1	2	4	
	0	0	0	1	1	1	5	
	K	K	K	0	0	1	6	

K: Eliminate one Soldier, Missionary or Pathfinder.

27.3.2a

SPANISH GARRISON TABLE

Number Colonists in non-player settlement:		1	2	5
	1	0	1	1
	2	0	1	1
Die Roll	3	1	1	2
	4	2	2	2
	5	2	2	3
	6	3	3	3
	7	3	4	4

27.5.1a

SPANISH RETALIATION TABLE

Die Roll:	1	2	3	4	5	6	7	8	9+
Number Targets:	0	1	1	2	2	3	4	5	6

27.5.5a

SPANISH LAND ATTACK

Die Roll:	1	2	3	4	5	6	7 or more
CRT Column:	5-1	4-1	3-1	2-1	1-1	1-2	1-3

27.10.1a SPANISH CITY LOOT TABLE (Results in Ducats)

Number Colonists in Settlement:		1	2	5
	1	0	5	10
	2	5	10	15
Die Roll	3	10	15	20
	4	15	20	25
	5	20	25	30
	6	25	30	35
	7+	30	35	40

27.11.4a SPANISH GALLEON TREASURE (Results in Ducats)

Expedition strength, ships only:		2	8-16	24-32	40-48	56+
	1	0	0	0	0	0
	2	0	0	5*	10*	15*
*Spanish Naval Attack	3	0	0	10	15	20
	4	0	5*	15*	20*	25*
	5	5	15	20	25	30
	6	10*	15*	25*	30*	35*
	7+	15	25	35	40	50

28.3a

SMUGGLING INCOME TABLE

Die roll:	-1 or less	0	1	2	3	4	5	6	7	8	
Ducats gained:		0	0	5	10	15	20	25	30	35	40

29.4a

SLAVE AVAILABILITY TABLE

Die roll:	-1	0	1	2	3	4	5	6	7
Number Slave units:		0	1	2	3	4	5	6	7

29.12.1a

SLAVE SALE TABLE (Results in Ducats)

Die roll:	1	2	3	4	5	6
Price:	N	1	2	3	4	5

N: Spanish Naval Attack

Spain/Portugal in his Planning Segment and has paid the 50 Ducats to cover the cost of the war in Europe.

**27.4.2** From turn 10 on, Brazil ceases to be Spanish (though its Portuguese garrisons are generated still by table 27.3.2a). Any attack on Brazil by non-Buccaneers requires a separate declaration of war against Portugal itself (50 Ducats).

**27.5** Engaging in war with the non-player Spaniard will often trigger "Spanish attacks" against the player's own New World holdings.

**27.5.1** Should war with Spain exist, the involved player must roll on the Spanish Retaliation Table in the Native Combat Segment of the game turn.

**27.5.2** Add one (+1) to the die roll for each Spanish Empire area containing the player's own Colonists or Soldiers when rolling on the Spanish Retaliation Table to derive the number of Spanish attacks.

**27.5.3** The player must pick out those friendly stacks which shall be the object of Spanish Retaliation by the following criteria:

A. Friendly Colonists/Soldiers occupying a non-player settlement. If possible, choose enough targets to equal the Spanish Retaliation number. Choose targets with the largest number of Colonists.

B. Enough stacks of Colonists/Soldiers in occupation of any non-settlement hex of the Spanish Empire to make their sum and that of the targets in section A equal the Spanish Retaliation number. Select targets on the priority of where the most Colonists are.

C. Any friendly settlements in closest proximity to areas of the Spanish Empire, should the number of targets in categories A and B above not equal the number derived from the Spanish Retaliation Table. Proximity is counted by the number of hexes from the border of a Spanish Empire area, treating land and sea hexes alike. In the Caribbean, count from the (uncaptured) towns of Havana and Santo Domingo. If two or more settlements are equidistant and not all may serve as targets, choose the largest in terms of Colonists.

**27.5.4** After selecting the targets of Spanish Retaliation, the "Spanish attacks" are immediately carried out.

**27.5.5** If the target is a Port containing friendly ships, a naval battle is fought before the attack on the settlement. Roll on the Spanish Naval Attack Table to determine the odds of the combat. This done, roll on an appropriate column of the Naval CRT. Remove friendly ships as Defender losses; ignore Attacker losses. If any friendly ship survives the naval attack, the Spanish attack has been beaten off the settlement is spared. If all friendly ships are eliminated by the Spanish Naval Attack, the settlement immediately suffers a Spanish Land Attack.

**27.5.6** To carry out a Spanish Land Attack on a target, roll on the Spanish Land Attack Table to determine the odds of the attack. Next go to the Land CRT and roll on the appropriate column. Remove friendly units as Defender losses; ignore Attacker losses.

**27.6** Jamaica is a special case. Historically the Spanish culture there was entirely supplanted by that of its conquerors. Therefore, should the Port of Jamaica be captured, all Spanish units on the island are eliminated. Jamaica henceforth is no longer regarded as part of the Spanish Empire.

**27.7** Hispanola contains a normal Spanish Port-Settlement. However, it is this Port alone which is considered a part of the Spanish Empire.

**27.9** Beginning with turn 10, Brazil is no longer part of the Spanish Empire and forces within Brazil are no longer subject to Spanish Retaliation. They may be subject instead to Portuguese Uprising. Historically, the Dutch conquered Brazil, but a

patriotic guerrilla war eventually exhausted the Dutch occupiers and forced their withdrawal.

**27.9.1** In any Native Uprising Segment beginning with turn 10, any player with Colonist or soldier units in Brazil must check for Portuguese Uprising. A result of 1-6 will cause a Portuguese Uprising, but the die is modified by minus one (-1) for each friendly Soldier unit in the area. Despite Soldiers, a natural roll of "6" will always cause an uprising.

**27.9.2** Resolve the Portuguese Uprising on the Native Uprising Table.

**27.9.3** At the end of any Native Uprising Segment in which there are no friendly Soldier detachments in Brazil, all Colonists of that nationality are eliminated within Brazil.

**27.10** Spanish/Portuguese settlements that are captured may be Looted.

**27.10.1** In the Resource Segment of the game turn, any Spanish/Portuguese settlement which has been captured in the current in the current turn may be Lotted. To determine the amount of Loot, go to the Spanish Loot Table and roll a die. Add one (+1) to the die if the settlement contains an active gold mine, or if the settlement is Veracruz, Cartagena, Lima, or Panama. Deploy the Gold-Loot immediately.

**27.10.2** If the party or expedition which Looted the settlement contains at least one non-Buccaneer Soldier detachment, the amount of loot taken from the Looted settlement is doubled. This represents the gold taken directly by government representatives and kept out of the wasteful hands of Buccaneers. For this to be possible, formal war must exist between the non-player country (Spain or Portugal) and the player's nation.

**27.10.3** A single player may Loot the same settlement in the same game turn.

**27.10.4** Two players may not Loot the same settlement in the same game turn.

**27.10.5** Loot may be loaded aboard available ships in a captured Port in the same Segment that the capture occurred.

**27.10.6** A non-player settlement captured from another, occupying, players, may *not* be Looted.

**27.11** Through out the seventeenth century, the ever more exposed Spanish treasure fleet continued to be the prey of warships and pirates. It was never more vulnerable than in the headwinds of the narrow Florida channel.

**27.11.1** An expedition may attack the Spanish Galleon Fleet by expending an additional 3 movement points in hex 2120 and rolling a die on the Spanish Galleon Treasure.

**27.11.2** Deploy the number of Gold-Ducats indicated on the Spanish Galleon Treasure Table along with just enough ship units to hold the captured Treasure. These ship units may be Carracks and/or Caravels—not Galleon Fleets. Treat them as prize ships.

**27.11.3** If there is an asterisk next to the Ducats indicated by the die roll, the Spanish escort offers a fight. If the Spanish offer fight, the player may retreat by not drawing any Treasure and continuing on his journey, leaving the hex. If the player's expedition elects to fight, a Spanish Naval Attack is immediately made against the expedition.

**27.11.4** To fight naval combat with the Spaniards, roll on the Spanish Naval Attack Table to get an odds factor. Go to the Naval CRT and roll on the indicated odds-column. Remove friendly ships as Defender losses; ignore Attacker losses.

**27.11.5** For each friendly ship lost, reduce the *base* amount of Treasure indicated by 25% (D1: -25%, D2: -50%, D3: -75%, D4: -100%), rounded to the nearest increment of 5 Ducats.

**27.11.6** If at war with Spain and one or more ships in the expedition are non-Buccaneer, double the indicated amount of Treasure. Take also enough prize ships to carry the Treasure.

## 28. MERCHANT FLEET SUPERIORITY

The seventeenth century witnessed the first great struggle of European nations to dominate the trade lanes of the world. The Dutch took an early lead, becoming the common carriers for much of the colonial world. The English soon challenged their hegemony and a series of Dutch wars, fought with shifting alliances, eventually brought English seapower to the forefront.

**28.1** The players shall establish an off-the-map area to represent the "Command of the Seas" combat, fleet-storage area whenever the Dutch nation is played.

**28.2** Combat may be fought in the Command of the Seas area, observing the rules in Rules Section 8.

**28.3** The player with the most ships in the Command of the Seas area gains these benefits:

A. Any other player with one or more Colonists on an island of the Caribbean must transfer a sum equal to two (2) ducats times the current Resource multiplier (on the record track) directly into the Treasury of the player dominant in the Command of the Seas area (after Resource collection, but before Maintenance).

B. To represent trade and smuggling to the non-player settlements, the player dominant in the Command of the Seas area may roll a die on the Smuggling Income Table. Since the volume of trade grew gradually in the early years of the century, the die is modified. Subtract six from the die in turn 1, five from the die in turn 2, and so forth until turn 7, when 0 is subtracted. The player receives the designated number of ducats directly into his Treasury in the Resource Segment.

**28.4** The Dutch begin with three Carracks in the Command of the Seas area, free of charge. Furthermore, for every Carrack they build and place (directly) into the Command of the Seas area, they receive a free matching Carrack, up to a maximum of seven free matching builds.

**28.5** All nations may build ships directly inside the Command of the Seas area. All nations may also move ships in European ports to the Command of the Seas area free of charge in the Planning Segment. *However*, ships may not be moved out of the Command of the Seas area once there.

**28.6** Ships in the Command of the Seas area require no Maintenance.

**28.7** A player with more (offensive) ship strength in the Command of the Seas area than the combined strength of his two richest rivals (in terms of Ducats in the Treasury at the beginning of the Resource Segment), add +1 to his Smuggling die roll that turn. If a player has more naval strength in the Command of the Seas area than all his rivals in a four-player game, he may add +2 to his Smuggling die roll that turn.

## 29. AFRICAN SLAVE TRADE

The Spanish and Portuguese began trickling African slaves into the New World in the sixteen century. The first slave labor force, the Indians, were in rapid decline in the face of European diseases and the rigors of the Iberians' colonial policies. But it was not until other European powers entered the Caribbean and discovered the value of the sugar crop that the trickle of African captives turned into a flood. All the colonial powers, including the Swedes and Danes, eventually set up permanent trading bases on the West African coast to facilitate the transfer from Africa to tropical

America, where white labor was in short supply.

**29.1** If no Colonist units are available from an unused national color, the players may make a supply of Colonist units to represent slave laborers. All players may draw from the same force pool.

**29.2** A "Guinea" subsegment begins the Trans Oceanic Phase. Expeditions may sail to an "off map" area which is to be considered to be two (2) Bounds distant from the European Ports.

**29.3** After players have either moved units to the Guinea area or passed, Naval units (ignore Soldiers) may fight combat in the Guinea area, initiating combat in the order of Initiative.

**29.4** After combat (if any), the players in order of Initiative may roll a die on the Slave Availability Table to determine the *maximum* number of Slave units which may be bought that turn. To buy a Slave unit, sufficient ship space must be available to carry the purchased units and all the regular units of the expedition. Slaves may not be maintained off map. The price of a Slave unit is one (1) Ducat each.

**29.4.1** The price of a purchase of Slaves is increased by competition. For each rival who declares his intention to purchase Slave units during the current turn, one Ducat is added to the price of the *total* purchase (e.g., three Slaves would cost four Ducats if one other player wishes to buy).

**29.5** The number of Slave units available in a turn is modified in two ways:

A. For each rival who has bid, or states his intention to bid for Slaves in the current turn, reduce the die roll for Slave Availability by one (-1).

B. If the player has built a "Trading-Fort" in Guinea (see 29.11), one (+1) may be added to the Slave Availability Die Roll. The permanent organization of markets along the coasts allowed traders to be more methodical in seeking and buying captives.

**29.7.1** Expeditions which begin in Europe and travel to Guinea must add 2 Bounds to the total (map-derived) distance traveled.

**29.7.2** Expeditions beginning in "Guinea" and traveling to any hex between rows 2100 must add one (+1) Bound to the printed map distance.

**29.7.3** Expeditions beginning in "Guinea" and traveling to any hex south of hex rows 2100 and 2800 (inclusive) on the Atlantic coast are assumed to have traveled the printed distance.

**29.7.3** Expeditions beginning in "Guinea" and traveling to any hex south of hex row 2800 may reduce the distance printed on the map by one (-1) Bound.

**29.8** Slave units act as Colonists with these exceptions:

A. Slaves may draw resources only from green-colored hexes between hex rows 1500 and 4700 (inclusive). Elsewhere Slaves produce no income.

B. Slaves have zero value in Combat. They do not retreat with friendly units.

C. Slaves have shifting allegiance. They become friendly to *any* player who occupies their hex with his own Colonists or Soldiers after the voluntary or forced removal of all other Soldiers and Colonists from the hex.

D. Slaves may be traded or sold between players, at any mutually agreed price. They may embark/debark in enemy Ports for this purpose.

E. Slaves must begin the Resource Segment stacked with a Soldier or Colonist, or be eliminated. (Assume they have run away.)

F. Slave units do not count as Colonists for forming Ports.

G. Slave units never become Buccaneers.

**29.9** Slave units may be eliminated when Land Attrition requires the removal of Colonists. Slave units are counted when determining the five-Colonist

limit for a hex's Resource output. Slave units are counted when calculating the chance for Native Uprising.

**29.10** Slavery had a depressing effect on free labor. Therefore, in each hex containing both Slave and Colonist units, *one* Colonist unit draws no Resources from the hex. This unproductive Colonist does not count toward the limit of five producing units which the hex can accommodate.

**29.11** Each player may build one Trading-Fort in "Guinea". He does so by sending at least one ship to the Guinea area and expending 10 Ducats, announcing the fact that he is establishing a permanent African base.

**29.11.1** Each player who builds an African fort in Guinea creates a permanent African Port for himself. Ships and other units (except Colonists) may begin and end the turn in Guinea. All ships and others in the Guinea area in the Maintenance Segment must be Maintained.

**29.11.2** A fort in Guinea may not be attacked nor destroyed. The Fort itself has no maintenance cost.

**29.12** Instead of being kept for his own use, a player may sell Slave units, both to other players and the non-player nations.

**29.12.1** To sell Slaves to the non-players, Slave units must be physically carried either from an area of the map or from Guinea, to a Spanish/Portuguese Port in the area described in 29.8A. Roll a die on the Slave Sale Table for the price offered per Slave in Ducats. If the roll derives a too-low amount to suit the player, the expedition can move on to another non-player Port and try again. One expedition may offer to sell Slaves to a maximum of three non-player Ports in one turn. Ducats received are added directly into the player's Treasury.

**29.12.2** If the Slave Sale Table comes up a "1-N", no price is offered. Instead the Spanish/Portuguese navy attacks the trading expedition (since trade with their European rivals was forbidden by the Iberian princes). The expedition is immediately subject to a "Spanish Naval Attack" (see 27.11.4).

**29.12.3** To sell Slave units to another player, the units are carried (or marched) to a settlement belonging by the buyer. The agreed upon price is paid directly from one Treasury to the other immediately upon transfer of control. Units moved by one player, may not be moved again by another player in the same turn.

**29.12.4** Player may combine delivery of Slaves to friendly ports with slaves to non-players and to other players in the same expedition.

**29.13** Slaves captured on prize ships become the property of the capturing player.

**POSTSCRIPT:** By 1700 (where our simulation ends), most of the colonizing powers had fallen into poverty from wars and mismanagement. England and France retained their energy, but wasted it in endless conflict with each other around the world. Already one of the four French and Indian Wars had been fought. The next seventy-five years would see the French expulsion from the American continent and the American Revolution—an event which would write a formal ending to the First Age of Western Colonialism.

*Those interested in Mr. Rahman's variant for CONQUISTADOR will find appropriate counters for the new characters, as well as the Danish and Slave unit markers, upon the insert. Please note that French, Dutch and British counters follow the same color pattern as in the original game. The counters for charters and trading posts are shaded a neutral brown, while those for the Slave units are black on white.*



## The GENERAL INDEX 1964-1984

Updating the previous effort at listing every item in our pages, the new 16-page Index to The *GENERAL* brings twenty years of continuous publication into sharp focus. From the AH Philosophy to the contests, from our Series Replays to Buyer's Guide evaluations, every facet of wargaming's oldest continuing magazine is divided for ready reference by those interested in specific games. The major portion of the Index is devoted to a game-by-game listing of every article that has appeared in these pages since the early enthusiasm of wargaming washed over those fascinated by military history. Other major sections of the Index, covering Volumes 1 through 20, concentrate indexing the authors and the many letters printed in The *GENERAL*. Whether for the aficionado of a particular AH game seeking every word printed on it by the experts, or for the game collector looking to insure that his AH collection is complete, or simply for the reader wanting a new (though old) idea for winning, The *GENERAL* Index is a must.

The *GENERAL* Index is available from The Avalon Hill Game Company, 4517 Harford Road, Baltimore, MD 21214. Price is \$4.50 (plus the usual 10% shipping and handling fee—20% for Canadian orders and 30% for overseas). Maryland residents please add 5% state sales tax.

## FAME & FORTUNE

Well, maybe not *much* fortune . . . but certainly a little fame. We want you to write for The *GENERAL*. If you can string words together, and are knowledgeable about our games, there's a good chance you're just the person we're looking for. You can supplement our literary staff with articles on strategy and tactics, game analyses, Series Replays, historical commentaries, new scenarios or variants for any of our extensive list of titles. If you've ever had the urge to see your name in print, and feel competent to write on your favorite game, consider submitting your efforts for the consideration of our editors. The *GENERAL* was founded on the efforts of the gamers themselves, and for over twenty years has relied on their good works. We encourage all such free-lance submissions.

All articles should be typed, double-spaced and accompanied by a self-addressed envelope bearing first-class postage. Otherwise, rejected articles will not be returned. Articles should be supplemented with all necessary illustrations and/or charts. Direct all free-lance submissions to the attention of Rex A. Martin, Managing Editor.

The *GENERAL* will pay \$6.00 per running ten-inch column of edited text upon publication. Letters to the editor are not subject to remuneration. Alternatively, authors may elect to take their remuneration in the form of our products, paid at the rate of 150% of the cash remuneration. Note that illustrations and decorative type faces are not subject to remuneration except by prior agreement with the editor. At the end of each volume year, an EDITOR'S CHOICE article is selected. The author of this best article of the year will receive a \$100.00 bonus and a lifetime subscription to The *GENERAL*.



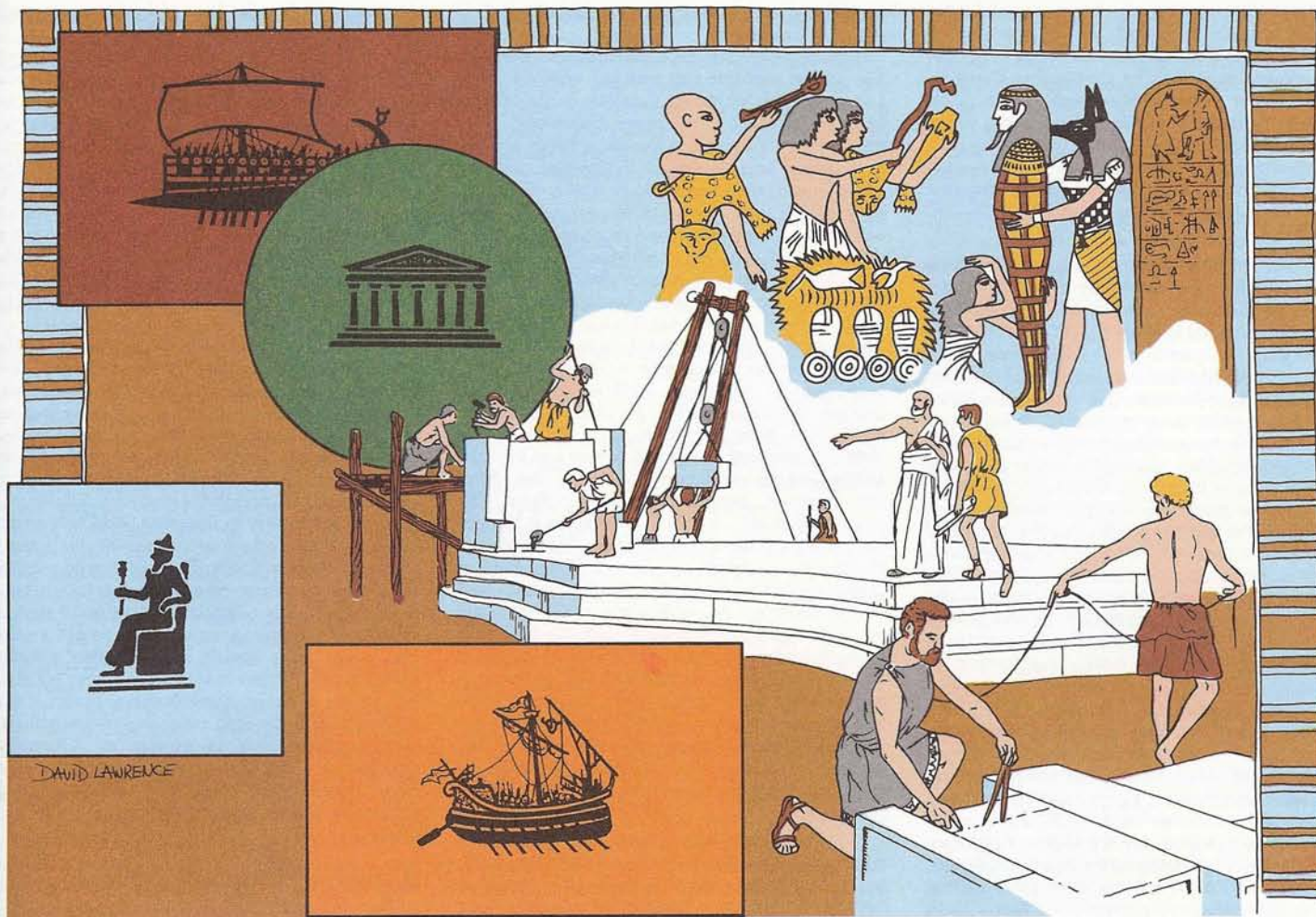

# QUO VADIS?

## Choosing a Nation in CIVILIZATION

By Daniel V. Ferens

*CIVILIZATION* is one of those rare games which are interesting and challenging in many aspects, even to jaded wargamers as is evidenced by its consistently high rankings in the "So That's What You've Been Playing" list in *The GENERAL*. This article is written to help the novice player in two crucial areas of the game: choosing a nation and acquiring Civilization Cards. These two aspects seem to best fit a logical analysis. Other areas, such as Trade, depend much on the player and there is no single method that will always work. Balancing stock and treasury is still another element that contains so many variables it often times appears to be more of an art than a science. Stephen Hall's article in Volume 19, Number 4 of *The GENERAL* provides some useful guidelines, and no more need be added here. The decisions of *Quo Vadis* ("Which Way To Go") in this game will be analyzed solely in the areas of choosing a nation and acquiring cards for it.

### Choosing A Nation

Players will select a nation because of family heritage, personal preference, or even the color of the pieces. Some readers may feel that all nations are equally good choices. While it is true that all nations have advantages and disadvantages, and that the game designers undoubtedly tried to balance these factors as much as possible, it does appear that certain nations are better choices than others.

Two overriding factors which determine which nations may be the best choices are ease of expansion and the Archeological Succession Table (AST) order and requirements.

Ease of expansion relates to the potential of a nation for city sites and population support. Ideally, any nation could obtain nine city sites and adequate population support without having to enter conflict with other nations. Ease of expansion is important during the early stages of the game as Calamity Cards such as Civil War and Iconoclasm/Heresy will foil the best expansion plans later in the game. The nation which expands early in play has a firm base for trade and, consequently, advancement on the AST.

An important assumption in discussing ease of expansion is that players will avoid extensive conflict during the early stages of the game if at all possible. If two nations fight early in the game, they will surely exhaust their own resources and hinder their own expansion while their unaffected opponents proceed uninterrupted with their plans. Even if one nation "wins" an early conflict, other players may remember this when it comes time to trade an Iconoclasm/Heresy Card, or choose an unwilling Civil War designee. Therefore, unprovoked conflict should be avoided early in the game. As a result, having first move may be an advantage early in the game because an opponent will probably avoid contesting the areas you occupy, especially if you are vocal about your determination to fight for it.

The other factor affecting choice of a nation is the AST. All nations will strive to progress one space on the AST each turn, and less stringent requirements can facilitate this. Some nations have notably less severe requirements than others, as will be noted in the discussions below. Another crucial AST aspect is order. Nations nearer to the top have, with equal city distribution, first choice of Trade cards and first move, but have the disadvantage of having last choice in acquiring Civilization Cards. The latter aspect may indeed be more significant, as number of cities will affect who has first crack at Trade cards, while the Civilization Card order is always the same.

These two factors are primary in this determination of the order of desirability presented below. It is nominally assumed that we speak of a six- or seven-player game and that any player's immediate neighbor could be in play. Exceptions are discussed when appropriate. Here, then, are the preferences in descending order of preference:

1. *ASIA*. Asia appears to have the best combination of expansion and AST factors. The Asian player's path of expansion will normally be southward and westward down the Turkish peninsula and into the northeastern Mediterranean region. He should be able to pick up six or seven city sites with no problems, even if another nation, such as Thrace or Crete, occupies the city sites on the western end of the Turkish peninsula. The player should also

have no trouble insuring population support for the cities, although support areas are not overly abundant. His sixth place position on the AST should allow him to acquire most Civilization Cards he wants (except possibly Mysticism). Asia is an especially good choice in a four-player game, where he will be able to expand into the Western areas of Turkey unopposed. Of course, a hostile Assyrian player could cause trouble but, for reasons discussed above, it's unlikely until the Asian Empire is well established.

2. **EGYPT.** Mr. Hall's article indicated that Egypt has many advantages, especially in ease of expansion. Egypt has six city sites readily available with plenty of population support. Egypt may be able to acquire even more territory by initially expanding across the Sinai into the southeastern Mediterranean area, taking three city sites, and then moving backwards into the Nile basin. Africa could cause some trouble, but the African player will probably be trying to settle his own areas early in the game and won't move east until later. Of course, in a four- or five-player game, Egypt doesn't have to worry about Africa at all! Egypt also has first choice of Civilization Cards, which can be a strong asset. However, Egypt does have some disadvantages unmentioned by Mr. Hall. The Nile's flood plain can cause serious problems (although having an Engineering card can help). The most serious challenge for the Egyptian player, however, is in the AST requirements. To keep pace, the player must build two cities after acquiring only 16 tokens. This leaves him with only four tokens at the beginning of the Bronze Age. As a result, his ability to expand quickly and build additional cities will be severely impeded. Consequently, Egypt's ability to acquire Trade cards, which he needs badly early in the game, will be restricted. For this reason, Egypt may not be the best choice despite the many advantages.

3. **ASSYRIA.** Assyria has a fairly good starting position and a relatively good position (seventh) on the AST. He can acquire most Civilization Cards he wants (again, except Mysticism). Except for the 1400 point requirement, his AST progression requirements are the least severe for the four Eastern nations (Asia, Assyria, Babylon, Egypt). Assyria's main disadvantages lie in his ease of expansion. The natural route is southward to take the two "3" city sites, then westward where the Assyrian player can take an additional three or four in the eastern Mediterranean area. Once he accomplishes this, however, he will probably find himself "strung out" along this route and flanked by Asia and Babylon. Having two cities in the two rich areas may also hinder movement of tokens between his northern and southern territories. He may even feel some pressure from Egypt on his southwestern fringe later in the game. Still, Assyria is a relatively good choice, as the Assyrian player can probably hold onto four or five city sites and retain adequate population areas for quite a while.

4. **ITALY.** The five Western nations generally have less severe AST progression requirements than those of the Eastern nations, but generally suffer from more difficult expansion. Also, their numerically lower AST order can inhibit their ability to acquire the Civilization Cards they want. Therefore, all things being equal, they are usually less desirable choices than the Eastern nations. Among the western nations, Italy is probably the best choice. It has very relaxed AST progression requirements, although the second position gives the Italian player nearly last choice in Civilization Cards. Italian expansion is relatively easy at first. It can easily take the three city sites along the "boot" and the site on the island of Sardinia to the west. Should he also be able to grab Western Sicily without too much trouble. From this initial territory, Italy may be able to later expand into Africa, the Yugoslav territories or even the Greek peninsula, depending on what other nations are in play. Italy is a perfect choice

in a two- or three-player game because of this flexibility in expansion.

Italy does have several disadvantages, however. Two of the probable city sites are near volcanos, and an eruption of Mount Vesuvius on the boot or Mount Etna on Sicily may prove devastating. Also, the Po River Valley in the north, a major population support area, is subject to flooding. Because of the limited population in the Po Valley, Engineering is of little help. Typical of Western nations, Italy will have to struggle to expand their population base.

5. **AFRICA.** Any player who chooses this nation because of the beautiful scenery described in Toto's hit song "Africa" may be disappointed. The Africa of this game is all in the Sahara desert (the modern day countries of Libya and Tunisia). The Sahara can't support much population, so the African player will have the game-long challenge of trying to acquire adequate support for his cities. The African player does have an advantage of starting in an isolated area where no one will oppose him for quite awhile, and can easily acquire four city sites. After that, however, expansion becomes difficult. The player may be able to get a few territories in western Egypt, but will have to fight for any Nile territory. He may try to expand upward into Sicily, but can expect opposition from Italy. The Agriculture card is most valuable to this African player, and he should try hard to get it. This may be difficult, however, because Africa's number one AST position gives the player last choice of cards each turn. Astronomy may also help the African, as he can then try to settle into other coastal areas around the Mediterranean. Expansion for the African player is not easy, but his isolated position and relatively mild AST requirements give him many advantages, if not many challenges.

6. **BABYLON.** It may be a surprise to some that Babylon is rated this low in order of preference, but the rating does seem to be justified. Babylon initially suffers from the same stringent AST progression requirements as Egypt and yet does not have Egypt's ease of expansion. The Babylonian can probably acquire four or five city sites with adequate population support fairly early, but Assyria and possibly Egypt will hinder any further expansion without warfare. Also, three of his city sites are in the Euphrates flood plain, along with most of his population support areas. He must acquire an Engineering card as soon as practical. Unless something dramatic happens to Assyria, Babylon may be relegated to the Eastern end of the board with but four or five city sites and the constant threat of a flood for quite some time. Of course, he need never worry about Piracy; but other limitations of his location, combined with the stringent AST progression requirements, can make the Babylonian player's life difficult.

7. **ILLYRIA.** Illyria has an ideal starting location with one of the few "5" areas in his immediate possession. Also, except for the 1400 point final requirement, Illyria has relatively mild AST progression requirements. However, Illyria's expansion is anything but easy. With Italy to his west, Thrace to the east, and Crete in the south, the Illyrian player must expand through sparsely populated areas to obtain three or four city sites in the area of northern Greece. Expansion southward from here will be opposed by Crete and expansion eastward may be opposed by Thrace. In reality, it is likely that either Crete or Thrace will not be in play, which will facilitate Illyria's expansion somewhat. However, the barrenness of the areas north of Greece and the Danube flood plain will still provide obstacles. It is perfectly feasible that, in the end, Illyria could lapse into barbarism.

8. **THRACE.** Thrace's mild progression requirements on the AST may tempt a new player to choose this nation. However, Thrace probably has the most difficulty of any nation in developing an expansion plan. It only has one city site solely to itself, and

this lies in the Danube flood plain. Illyria may well expand eastward to take this "4" site; too, a Thracian city on this location will hinder north-south movement of his tokens. A possible expansion route lies in obtaining a ship or two and settling in the westernmost territories of the Turkish peninsula. However, the Thracian player will soon face opposition from Asia and perhaps from Crete. The Danube flood plain, the lack of a ready path of expansion, and likely opposition from other nations will probably make the Thracian player's entire game an uphill struggle. Thrace, however, would be a good choice in a two-player game if the first player does not choose Illyria. If nothing else, he will have first choice of Civilization Cards.

9. **CRETE.** At first, Crete seems to be in an ideal location—initially isolated from everyone. His middle position on the AST gives the Cretan certain advantages and his AST progression requirements are not too severe. However, Crete is the last choice for most, primarily because of the expansion problems. Although he has plenty of city sites, all are on islands and the player must acquire and maintain ships early in the game. This will hinder his acquisition of tokens and/or building his treasury to buy Civilization Cards. The city sites do not have much population support available, so he will have to struggle in this respect. His "natural" path of expansion is northward into Greece, so nations like Illyria will soon oppose him. Another possible sphere for the Cretan is western Turkey, but Asia and Thrace will soon stop him there. In fact, Crete seems to lie in the long-range expansion paths of several nations: An Agriculture or Astronomy Civilization Card may help the Cretan player's cause, but his "Island Kingdom" will be anything but easy to sustain. Leave Crete for the experienced players.

### Acquiring Civilization Cards

The value of Civilization Cards to any player depends on at least four factors: AST Requirements, card values, contribution toward buying other cards, and benefits of holding specialized cards. Table 1 lists the sixteen Civilization Cards in order discussed below with relevant information. As is evident, all cards have value. How, then, should a player select his cards? The AST requirements are the prime factor; a player must have cards in three different categories to enter the Late Bronze Age, seven cards to enter the Early Iron Age, 1000 points worth of Civilization Cards to enter the Late Iron Age, and a certain number of total points later. [For the purposes of this article, the requirements of Asia and Illyria are assumed; namely 1,200 points then 1,400 points during the Late Iron Age. The other nations' requirements will be addressed in the narrative.]

Tables 2A and 2B present what can be considered "optimal" strategies with and without Mysticism. Since the rules limit the number of Mysticism cards available, one or more players must use an alternate strategy such as the presented in Table 2B. In games with six or seven players, some of the other cards may not be available to all either (except Law). Therefore, the cards not in the Table 2 plans are discussed also.

The selected plans are based on the AST requirements and lowest overall cost to the player. Order is important if a player is to maximize advantage of the "credits" listed in Table 1. When two cards are of equal point and contribution values, the most useful is selected (for example, Pottery is generally considered more useful than Clothmaking). Here, then, is a tested order for acquiring cards.

1. **MYSTICISM.** As stated in Mr. Hall's article, Mysticism is a "deceptively cheap" card which can cause problems later because of the eleven-card per player limit. However, the acquisition plan in Table 2A can overcome this difficulty. This card can propel a player into the Late Bronze Age with minimal cost—an important consideration for Egypt

and Babylon who must enter this age very early when they have few cities built. Expect these two nations to make favorable trades so both can acquire Mysticism before others get the chance. Another advantage is that it will give 120 points in credit toward buying the other cards listed in Table 2A. Note the overall cost in Table 2B is significantly higher than that of Table 2A. Therefore, this card should be obtained if possible.

2. **POTTERY.** This card, combined with Mysticism, will meet a player's Late Bronze Age requirements with only 75 points. Pottery also is invaluable in case of a famine (even if the optional rule in Vol. 19, No. 4 in *THE GENERAL* of turning in grain cards is used). Third, it contributes 30 points toward later cards in Table 2A.

3. **COINAGE.** The benefits of having Mysticism now start to take effect; a player only needs 90 points to get this 110-point card. Since this card is very valuable to a player in helping him maintain a balance between stock and treasury, it is listed third. However, it should be noted that the third through seventh cards on Table 2A (and 2B) can be acquired in any order without altering the overall acquisition cost or AST position. A player's need for a particular card and his credits available to buy cards in any turn may dictate variations to the order presented. The only restriction is that a player should not buy two cards in the same category during the same turn, as this will prevent him from best using his credits.

4. **AGRICULTURE.** This card is also useful to most nations (especially so to Africa and Crete) who may consider acquiring this card third instead of Coinage. Curiously, there are times when holding this card may be disadvantageous. A player may want to deliberately overpopulate some of his areas to increase his stock or, in rare cases, to reduce the number of cities he has. The Agriculture card makes this harder to do! However, most players will agree that the advantages of this card generally outweigh the slight disadvantage. Also, Agriculture and Coinage can be acquired in the same turn with no credit penalties. If accomplished, this is quite a coup.

5. **ENGINEERING.** If Table 2A has been followed, this 140-point card can now be bought for only 80 points. Because it is a two-category card, it also gives useful credits in acquiring a number of other cards later. The 140 points are a notable help toward meeting the 1000 points requirement for the Late Iron Age. This card is especially valuable to Egypt, Babylon, and possibly to Thrace, in reducing the effects of a flood. These nations may consider acquiring this card as early as third in order and wait until the next turn to find Coinage and Agriculture.

6. **ASTRONOMY.** If nothing else, this card is "cheap" at this point. The player's 60 Science credits make this 80-point card a bargain at 20 points. A cheap card may be helpful after buying the previous three cards and struggling to obtain seven cards for the Early Iron Age while also keeping long-range requirements in mind. If a player has unlimited resources, Medicine would be best to obtain now, but resources are usually a little scarce at this point. This card also provides the advantages of being able to "leap great oceans in a single turn," which could be very useful to Africa and Crete in their expansion plans. Even Babylon may find this card useful if he acquires western territories as a result of a Civil War or some other calamity.

7. **LITERACY.** This card, which may be obtained in the same turn as Astronomy with no credit penalties, has no intrinsic value except the 110 points. However, it is almost essential because of its credit toward Law, Democracy and Philosophy later on in the game. Acquisition of this card will complete the seven-card requirement for entry into the Early Iron Age. The Architecture card is a possible alternative if a player is short on funds and has to acquire several cards during the current turn,

but in the end Architecture gives 30 fewer points at the same overall cost.

8. **LAW.** Some players will regard this card as a "necessary evil" because it is required for Democracy and Philosophy. It is also expensive: even with Literacy and Mysticism, it will still cost 140 points. However, the card does provide some minor benefits in reducing the severity of Civil Disorder and Iconoclasm/Heresy calamities. Its 170 points also moves one significantly toward the 1000 point requirement for the Late Iron Age.

9. **PHILOSOPHY.** Acquisition of this card should give a player 1035 points on Table 2A. It would, of course, be more cost-effective if a player obtained Medicine before this card for the 20 point credit, but this would not satisfy the 1000 point requirement, as Democracy would not (by 5 points!) either. Of course, if a player obtained Medicine as his sixth choice (instead of Astronomy), he could now obtain Democracy, then Astronomy, then Philosophy for a maximum amount of cost effectiveness. However, it is usually difficult to obtain Medicine at that point because of its additional expense. The benefits of having Philosophy to combat an Iconoclasm/Heresy calamity may be valuable at this point in the game. (Note that on Table 2B, Democracy can be obtained at this point because it will satisfy the 1000 point requirement.)

10. **MEDICINE.** After acquiring the expensive Law and Philosophy (or Democracy) cards, a relatively cheap card will probably be necessary. Medicine costs only 60 points at this point, and its 140 point value will result in a total just 25 points short of 1200. If a player can muster 25 points in tokens and trade cards, his entry into this last square is certain. Medicine is also useful in combating the effects of an Epidemic calamity card, which can be devastating at this point—and frequent.

11. **DEMOCRACY.** This card will give a player a total of 1375 points. The Democracy card is useful in reducing the effects of the Civil War and Civil Disorder calamities. Any player should easily be able to collect an additional 25 points from tokens or trade cards, so entry into the last square is virtually assured unless a player loses all his cities. It should be noted that Africa and Crete do not even need this card and can have 1200 points with the first ten cards or buy a cheaper alternate card (see below) for "insurance". The 1300 point nations (Egypt, Italy, and Thrace) may elect to select a card such as Metal Working instead of Democracy or a less expensive card instead of Medicine to fulfill

their requirements. A player cannot always obtain the cards he wants because there are not enough for everyone. Therefore, some of the merits of the other cards that can be taken as alternatives are discussed below.

12. **ARCHITECTURE.** This card is almost a "must" if Mysticism is unavailable to help a player meet his Late Bronze Age requirements. Table 2B details an acquisition plan based on this card. It is also a possible alternative to Literacy if it is unaffordable at the time it is needed (see the seventh choice above). The card pays for itself later in its credits toward Law, Democracy and Philosophy.

13. **METAL WORKING.** This is probably the "best of the rest." It has the largest point value (80) of the remaining cards. It also conveys an advantage in combat which may be invaluable in the later stages of the game. Of course, if the opponent also has this card, the advantage is negated.

14. **CLOTHMAKING.** This card is probably best described as "an alternate to Pottery". If a player finds that all the Pottery cards have been used, he is almost forced to take this to meet his Late Stone Age requirements. This card does not convey the advantages of Pottery in combatting calamities or otherwise making a player's road easier, but still can be an advantage to seafaring nations such as Africa or Crete. That extra sea area can sometimes be very helpful. However, for most players, this card is still only "an alternate to Pottery".

15. **DRAMA AND POETRY.** In discussing the merits of this card, it will be assumed that the optional rule in Vol. 19, No. 4 of *THE GENERAL* is in effect which gives this card a 20 points credit toward Democracy (instead of 10). This gives it 40 points of special credits, and it also contributes 5 points toward acquiring the Law card because of its category. Still, this card will not be that useful to most players. It does nothing for the player except to bring him credit towards other cards, and its relatively low (60) point value may hinder a player from meeting AST requirements later in the game. Unless no other cards are available, it is probably best to bypass this card and concentrate on the ones listed in Table 2A or 2B.

16. **MUSIC.** The same comments apply as for Drama and Poetry—more so since this card gives only 30 credits instead of 40. The high number of credits toward Philosophy may sometimes be useful, but this card should still be avoided if other cards are available.



TABLE 1 CERTAIN CRITICAL CIVILIZATION CARDS

Card	Categories	Point Value	Credit
Mysticism	A/S	30	5A/20S
Pottery	C	45	10C
Coinage	S	110	20S
Agriculture	C	110	10C
Engineering	C/S	140	10C/20S
Astronomy	S	80	20S

TABLE 2 ACQUIRING CARDS

With Mysticism:			Without Mysticism:		
Card	Value	Cost	Card	Value	Cost
Mysticism	30	30	Pottery	45	45
Pottery	45	45	Architecture	80	80
Coinage	110	90	Coinage	110	110
Agriculture	110	100	Agriculture	110	100
Engineering	140	80	Engineering	140	100
Astronomy	80	20	Astronomy	80	40
Literacy	110	105	Literacy	110	95
Law	170	140	Law	170	130
Philosophy	240	135	Democracy	200	130
Medicine	140	60	Medicine	140	80
Democracy	200	145	Philosophy	240	120
Totals:	1375	950	Totals:	1425	1030

# Squad Leader Clinic

## VIEW FROM THE TRENCH

By Jon Mishcon

*Now that you've heard a biased viewpoint on the impending release of ASL (namely, Don's in this issue's AH Philosophy), here's one that isn't. Few people have played more SQUAD LEADER—in all its forms—than Jon Mishcon, who has been active in the "blind playtesting" of the game system since its inception. And he's proved, in these pages, to be a living "Gamer's Guide" to the system. This is what he thinks.*

Don has asked that I write down my feelings about *ADVANCED SQUAD LEADER* as "something of an outsider". I say "something" because Joe Suchar and I have been involved with the *ASL* development pretty much since its first word was set to paper BUT (and this is big "but") we are not employees of The Avalon Hill Game Company. We're gamers. Just that and only that. We read the rules, plunk down those pieces of cardboard, and roll the dice just like you do. The only reason we are on the playtest team is to give Don grief over scenarios and rules we won't enjoy playing. I write this on the last day of January 1985 after having reviewed the latest—and hopefully last—complete rewrite. So allow me to anticipate your *ASL* questions:

*Is it perfect? No, but it's good.*

*After all these years, why isn't it perfect?* Every *SL* player has his own idea of perfection. Playability versus realism issues. "Little" rules that reflect this or that nuance. The task of resolving the conflicting views of a bunch of strong-minded playtesters would have given even Job ulcers. One player's favorite rule is another's curse. The present mix must be considered a reasonable compromise for players of all persuasions.

*OK, let's have the bad news.* First, it is a new

game. Closely akin to *SL* but NOT the same. All your old reflexes will need to be reviewed and re-evaluated; some of those old patterns will earn you a whole new crop of KIAs. Second, we feel that even after you get comfortable with the system, most scenarios will take between 10% and 50% longer to play (depending on the infantry/armor mix). Third, this version still has a greater "realism" flavor than playability. Make no mistake, the playability has been increased (see below) but there are still a number of those "little rules" that seem to have impact only in very special situations. (Of course, you have to understand that we speak as very strong advocates of playability over realism.) Fourth, the scenarios are nothing to write home about; they seem designed to allow "introduction" to the system rather than demonstrate its strengths.

*Strengths? Sounds like I'm better off with GI?* Listen, its loaded with strong features. A strong systems approach to rules has been made in *ASL*. Learn a concept and it applies, with varying DRM, in all similar situations. This makes the game easier to learn and play. The rules make more sense. Most of the old "funny" rules that allowed "cute" tricks have been deleted. Mostly, I guess, its a distillation of the best of *SL*.

*What is it like to play?* Set-up has to be done for both players before game onset. No sniper or scout pieces (although searching and sniper fire are still present). Prep Fire is pretty close to that of *GI* with the notable exceptions that artillery fire isn't called until the Fire Phase and that most weapons now have a rate of fire (Roll less than or equal to that ROF and you get another shot; e.g., HMG—ROF 3). Movement is very close to the system of *GI* but you'll have to spend one MF to start or stop an AFV. The biggest change is that ALL defensive fire is

handled in one manner, very similar to the way you've always fired upon vehicles. A good compromise has been reached to prevent flooding an infantry position while still allowing you to "draw" fire. MGs still have lanes of fire but now they can, if you're lucky, sweep back and forth. The Advancing Fire Phase is also integrated into movement with vehicles (only) allowed to move, stop, shoot, restart, and move again. The Rout Phase's biggest changes are the "Low Crawl" (allowing a one-hex rout away in the open) and the prohibition of routing adjacent to enemy units. More huge changes to the Advance Phase are evident. Close Combat now prevents the use of LMGs or leadership DRMs when the leader is alone in a hex, but each SMC always has a CC strength of one.

In short, there's a lot less crapping around in the rules. Most importantly, the vast majority of the rules really will tend to benefit the player who thinks as did his historical counterpart. (Sigh, an end to our torching most of the mapboard.) Otherwise, it is pretty close to *GI*.

*But I like what I'm doing now. Why should I change?* Most important is that Don has ruled THIS IS IT! There will be errata and updates, but in large part no further changes to the game system. That means that everybody can play all the scenarios. I plan to use the "SQUAD LEADER Clinic" to release updates on old scenarios that will be balanced for *ASL*. The scenario production business will surely be getting busy again.

*Summary?* I'd say . . . buy the rules. My guess is that 90% of you will be like us: initially repelled and then hooked. Some 10% will be content with the old, and more power to them. But, this is the future. I plan to be at ORIGINS '85 for my copy.

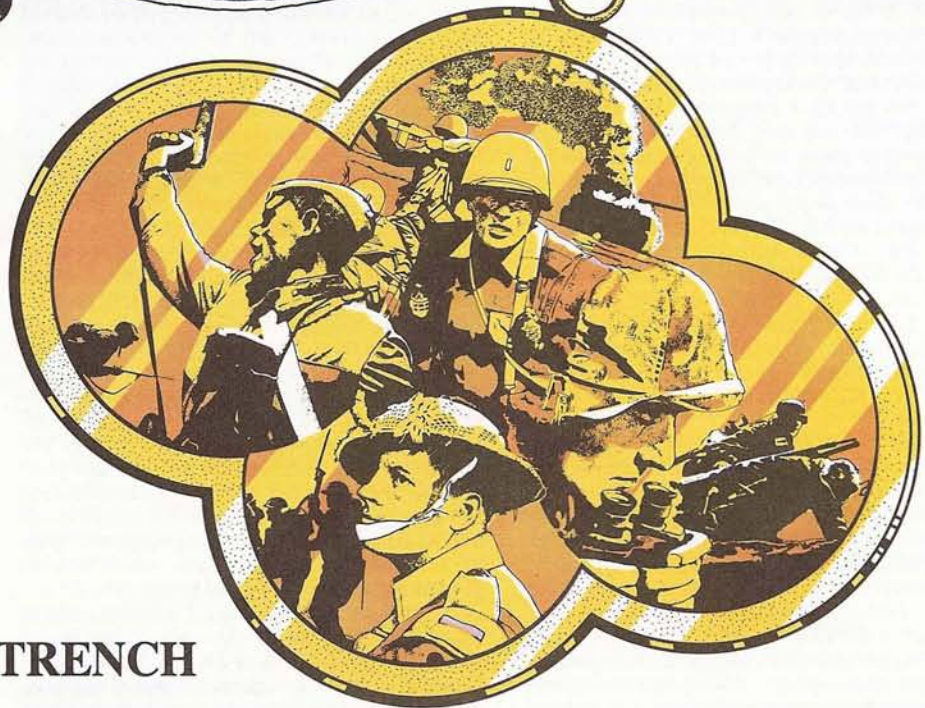

Dear Sir:

No. 121 is my kind of contest. Short, sweet, not many pages of rules in the game and it doesn't take me very long to lose.

At the moment of play described in the contest, North has 99 points, South (you) 100, West 103 and East 100—with the latter two scheduled to lose ten points each for having been eliminated. The only real competition South has is the North player, and there should be no way South can lose.

With three cards left to draw, and with the game ending after the last card is drawn, you will get to play two cards to North's one. The sequence of play should be this. Play the 14-inch "1 Salvo" card from *Mississippi* to sink *Scharnhorst*, giving you 105 points to his 100. This allows you to get that 14" shot off in case North decides to sink the *Mississippi*. If North, during his turn, sinks any of your ships, even the *Missouri*, the maximum points he will end with is 106. Then, on your turn, you counter with the 16-inch "2 Salvo" card to sink *Giulio Cesare*, giving you 109 points to his (at best) 106. Since there will be no more cards to be drawn or played, you win.

The only card which North could play to cause you problems would be a Destroyer Squadron card, with its potential to sink all your ships. If North plays the DD card, you still get to draw and play one more card. [Technically, according to the rules, the game ends when the last card is drawn with only the drawer having the option to play one more card. Theoretically, this line of reasoning could allow you to escape the consequences of a DD card played by North. However, the North player may not be susceptible to your cool, unbiased logic, and you could lose a game opponent for life. (If North is bigger than you are, you could lose more than that.)] But no matter. If North does play a DD card, you counter with your Smoke card and chortle, having won the game. (Again, if North is bigger than you, you may have to content yourself with a silent smirk.)

I believe the above sequence of play can counter any attack North has to offer. If you should play some other cards, you could run into trouble. For instance, if you play your Smoke card first, North could counter with a Smoke card of his own and would win. Or he could play an Additional Damage card and win. If you should use your Repair card first, North could play a Salvo card to put the game out of reach. Play your cards in the order I have described and you win. Again, many thanks for a different and intriguing contest.

Ken Nied  
Spring Hill, Kansas

★★★★★

To the Editor:

I read with interest the TLD article in Vol. 21, No. 3. While I agree with many of the points presented, others need a bit of comment. I will not attempt to discuss the strategies and tactics outlined, since I have found that what works for one player may turn to disaster for another. There are a few points on rules and procedures which need mentioning, however.

1) There are a few decisions to make on the Air Drops actually. These specifically include when to drop HQs and the location of drops for a number of the British units.

2) Some points raised in the discussion of the Air/Naval Phase would lead the reader to believe that placement and resolution are sequential rather than simultaneous. Common sense if not the specific letter of the rules require that all air and naval units be assigned to their tasks before any resolution is attempted. This is true for all types of air, rocket and naval missions.

3) Remember that the DD Calamity Table may also influence many of the landing attacks and probabilities.

I agree that the 6 June turn is the most crucial of the game. The only way for the Allies to lose TLD, short of improbably bad weather or incompetence, is an unfavorable D-Day. It is most unfortunate that so much is riding on this initial turn. We are at present in preparation of the second edition rules for TLD. Among the changes planned at this time are major revisions to the structure of the first turn such that the probabilities of a historical outcome will be more likely. This will unfortunately cancel a bit of the analysis in this article but should solve other game balance problems. The victory conditions will be altered to rebalance the overall game.

Jim Burnett  
Clinton, Tennessee

## Letters to the Editor ...

Dear Mr. Martin,

The "exchange" of letters between Mr. Salvatore and Mr. Harmon concerning Stuka attacks in TRC was an interesting exercise, but it left nothing resolved or clarified except that they still disagree. This is especially distressing in light of the fact that the matter was clarified nearly eight years ago by Richard Hamblen, co-developer of *RUSSIAN CAMPAIGN* and long-time resident expert on the game. In the "Design Analysis" column in Vol. 14, No. 1 of *THE GENERAL*, Mr. Hamblen wrote directly on the matter of what constitutes a single attack and he spoke decidedly in favor of Mr. Salvatore's interpretation.

In the course of a long article in which he discussed and clarified most of the rules in the booklet, Mr. Hamblen posed the question of whether a Stuka could be used to increase the odds in an attack "against defenders in different hexes". His answer was "Yes", with the stipulation that all defending units must be within range of the HQ supporting the Stuka. Then he added, "Notice that each attacking unit must be adjacent to each defending unit for this kind of attack to be made, however." [Italics added.] Thus, Mr. Harmon's "mass attack against four defending hexes" is clearly ruled out; in a single attack against four defending hexes, the only way for each attacking unit to be adjacent to each defending unit would be for all the attacking units to be in a single hex, surrounded by defending units in four hexes adjacent to that single hex. This situation can only occur due to a "Contact" combat result in the previous player turn. With only three defending hexes, it is possible to precipitate the attack yourself during your attack phase (by moving into the center of a half-circle of defenders)—but again, all the attacking units must be in a single hex.

It has been a long time since I ran into the "mass attack" interpretation of the rules, but I'm not really surprised since it hasn't been mentioned in print for nearly eight years.

Jim Davis  
Northport, Alabama

Having finally pinned Mr. Hamblen down (now that he is no longer employed here, he leads a well-deserved life of unplanned leisure) and gotten his ruling on the question, I find that Mr. Davis is definitely correct in his exposition on the rules. In essence, to the question of whether any length of hexes can be attacked in a single battle, Richard answered that "every attacker in a battle must be adjacent to every unit being attacked in that battle. Harmon is wrong." And that should settle the dust. Of course, it may arise again in eight more years, so note and preserve this issue for future reference.

★★★★★

Dear Mr. Martin:

I was very glad to find your 3R variant article "Total War: Club Rules for THIRD REICH" in Vol. 21, No. 3. Several references in the article, however, are obscure to me and perhaps you would clarify them for me. I've looked over my extensive collection of back issues and cannot find that they've been mentioned in print in *THE GENERAL* before.

Specifically, Mr. Emrich mentions Axis Variant #22 (revitalization of Italian Armed Forces) under "RDM Unit Criteria"; what is this variant? And he later makes mention of the effects of the "Z Plan" in his rules for Surface Raiders. What is that? The article was most interesting, and I certainly hope to read more by Mr. Emrich on 3R variants, extensions and strategies.

Robert Norsis  
San Anselmo, California

Concerning the "mystery" variants for 3R mentioned in Mr. Emrich's article, indeed this was another case of putting the "cart before the horse". It is due, no doubt, to the fact that I'm playtesting so many variants and games that I've a tendency to lose track. Actually, it was a combination of lack of space, time pressures, and forgetfulness that I'd not yet had them typeset (they were to be a boxed sidebar to the article). In any event, these and several others, will be found at the end of Mr. Gordon's article in this issue. I expect that you'll enjoy them; we do.

Dear Editor,

Thank you for publishing my letter. However, I wish to set the record straight in relation to the Mercer Adventure Gamers. I did not start that club nor am I a member of it. The fact is that I cannot even reach it for a visit (it being in Hightstown NJ, not Trenton)! I did get to visit the R. U. G. (Rutgers University Gamers) a bunch of times and found both opponents and enjoyable surroundings. Both of these clubs are (alas) Saturdays-only affairs and far in distance to travel.

I think in response to your query of what you can do to help FTF gamers would be to list clubs specifically by state (those devoted to FTF as opposed to postal organizations). FTF gamers should be encouraged to be more militant than they have been in demanding recognition from the hobby as a distinct group. All I've heard is a dull murmur so far. If reading this causes others to deny my charges, fine. But I rather suspect both a policy of subliminal discouragement in the pages of *THE GENERAL* and passiveness and apathy among the readership is responsible for the problem. I am not saying that the policy is conscious or willful, merely that it exists.

The fact is that most wargamers have other things to do and that "gaming" is only a sideline, a hobby. We cannot go opponent-hunting without outside help. And how do you start a club? It would be nice to read an article in *THE GENERAL* that addresses ways of finding opponents and starting clubs for face-to-face encounters.

Dwight McMahon  
Trenton, New Jersey

Heavens, "subliminal discouragement"? In any case, a listing of local wargaming clubs with regular meetings for face-to-face play would be useful. So... I'll here ask the secretaries of such organizations to send me a brief note with their club name and address (along with phone if possible), regular meeting dates, and list of our games they play with some regularity. I'll print these in, say, six months. This should give a boost to that "flagging" interest in FTF play among our readership.

★★★★★

Dear Mr. Martin:

Now that so many people have worked so hard thrashing out the historical "flavor" of *BB'81*, may I finally solicit ideas for how to make it a game? *BB'81* is, in this veteran gamer's mind, a truly fine piece of work. The research, time, creativity, energy and (I suspect) spit that went into it are obviously extensive. It has rapidly become one of my personal favorites. It has also, however, become apparent how low the odds of a German victory are. (Excluding the scenarios *Outbreak*, *Martin* and *Herbstnebel*; I haven't played these enough to judge.) The historical reproduction appears to have been accurate enough to also replicate the historical odds of a German victory—about 10%.

It sometimes seems that if any more restrictions are put on the German's ability to attack, we may just as well glue the counters to the board east of the Our. Your latest suggestion, the Corps Area Congestion rule found in Vol. 21, No. 3, brought the matter to a head. Below are what seem to me to be severe (unnecessary?) limitations:

Gen 21-3, Corps Area Congestion  
25.4, SS Pz Commitment Restriction  
38.0, Armor Attack Restrictions  
43.0, German Corps Integrity  
41.2, the relocation of Pz150 to hex XX12  
42.3, the increased ability to generate Cmo  
Recognition Checks  
from Q/As, NW road movement rate of one-third and one-half  
no victory points for launching of 15th Army Offensive  
no serious penalty to Allies for abandonment of St. Vith or Bastogne  
The following, on the other hand, appear to me to be more even in allowing the German player his chance, barring fantastic die rolls or Allied error:  
allowing SS Pz 16AM commitment  
NW road movement of one-quarter regardless of ZOC  
No panzer woods attack restrictions

no Corps Integrity  
No Corps Congestion  
adjustment of victory conditions/points

This is, of course, only one man's views. I seek now is the opinion of other gamers; I seek the "playtest" of experience. Each gamer of each game usually reaches the point of asking the question, "Have I reached the present limits of my insights... or the final limits of the game?" I am at that point for *BB'81*.

This is not a complaint, merely a frustrated question. The optional rules and nearly obsessive simulations on the market are fascinating and enjoyable to try out. However, I still find myself returning to the question of balance. These are still games, are they not? Regardless of the answers, I shall enjoy *BB'81* for a long time to come I am sure, even if the German counters are glued to the board.

David Cashell  
Collingdale, Pennsylvania

★★★★★

Dear General:

I enjoyed the Vol. 21, No. 3 *BULGE* articles, but I think your focus is still too German-oriented. Your variants, analyses, *Series Replay* and all involve a "let's see how far the panzers can get" slant. Unfortunately, in play the game often breaks down half-way through. If the German player can't get where he wants to go, he often simply quits, leaving the Allies no chance to enjoy the counterattack.

What I'd like to see are some articles and variants with an Allied focus. Try starting the game at the German high water mark, with Bastogne still surrounded. Give the German set-up, have the Allies move first, and let the Allies attack to try pushing the Germans back into Germany (or pinch off the "Bulge" at the base and win by destroying units). That way, players could have a choice in playing a shorter "half game" with the Allied attack as the starting point, in addition to the many variations already published that begin with the initial German offensive.

Mike Boyce  
Tuckahoe, New York

★★★★★

Dear Mr. Martin:

Having just been soundly and enjoyably defeated in a heated battle of *UP FRONT*, I am compelled to write you this note. Never in a conventional wargame have I been so satisfied with a loss. Losing in *UP FRONT* is akin to losing your virginity; you can't help but feel the satisfaction of learning something real. Most good wargames are a thought-provoking experience. Unfortunately, many demand a certain drab patience on the part of the participants and eventually end up in some conveniently inaccessible corner of the attic, victims of their inherent complex "realism". The point here is that realism is not necessarily a 60-page manuscript filled with cases, subcases, and endless exceptions. Rather, realism is the successful application of all those dead facts within a simulated framework. At risk of offending hard-core data and detail gamers, this is where all realistic monster games fail. The realism of combat is not logistics or politics or bookkeeping. It is based on fear, or the lack of it—an ultimately personal condition.

My hardy congratulations go to Mr. Allen. He seems to have designed the perfect balance between realism and playability. The game flows as quickly as the adrenaline it activates. The rules are the closest thing to instinct ever written; the only thing complicated about the system is the multitude of tactical decisions one is faced with (as it should be). Play balance relies totally on those decisions. There is no luck involved—rather a justifiable element of fate. One has no basis in feeling cheated by the system when a seemingly overwhelming and intricate assault fails. One has only to accept human nature. The flexibility of the system is perfectly elegant because the premise can be applied to any tactical period with a little further development. Survival was the primary instinct of cavemen and cowboys too.

Lastly, the physical components are outstanding, a thing I have come to take for granted with The Avalon Hill Game Company. All told, *UP FRONT* is further proof that The Avalon Hill Game Company is the leader in the industry.

Steve Hooper  
Mobile, Alabama

## THE QUESTION BOX

### MAGIC REALM

**Q.** Does an attack doing Maximum damage that hits a shield also destroy any other armor behind it as it kills the character?

**A.** No.

**Q.** May the Pilgrim use the "T" attack gained when he "wishes for strength" to open the vault?

**A.** Yes.

**Q.** May the Witch King use Magic Sight to loot the Chest without use of the Lost Key? To loot the Vault?

**A.** No. No.

**Q.** Must the Witch King fatigue when drawing treasures from the Cairns when using Magic Sight? From the Pool?

**A.** Yes. Yes.

**Q.** Do the Woodfolk and Rogue 4 attack when light-side-up?

**A.** No.

**Q.** Do unbought horses die if the native HQ passes through a cave clearing?

**A.** No, they must be abandoned before entering the cave.

**Q.** Does a character have to roll on the Meeting Table for his own (enemy, unfriendly, neutral) hired natives if ending a turn in the same clearing?

**A.** Only for hired leaders; see 4.5.2

**Q.** The Balck Knight has just hired Rogues 6 and 7. At the start of combat at the Inn, he rolls "Trouble" and then "Block/Battle". What is the status of his hired Rogues? Do they aid him against the rest of the Brotherhood, join the Brotherhood against him, or remain strictly neutral, aiding neither side?

**A.** They aid him.

**Q.** Is a MAGIC counter fatigued if a character attempts to cast a spell with it but is undercut by an opponent's spell? Does it count toward his two asterisk limit?

**A.** Yes. Yes.

**Q.** Are controlled bats treated as hired leaders (as per the definition of "controlled") or as hired non-leaders (as per the explanation of the spell)?

**A.** Non-leaders, the spell explanation overrules the rule.

**Q.** Does a "Block/Battle" result when trading with a Visitor block a character? Must a character roll on the Meeting Table at the end of the day for the Visitor? How may a character kill a Visitor?

**A.** Yes. No. Visitors cannot be attacked.

**Q.** Does a character who becomes a T. Giant or either type of T. Dragon because of Absorb Essence use the head/club, the body, or both for any attack he may make? Is the red-side of the club/head the "ready" side or may either side be played?

**A.** Both. Either side may be played.

**Q.** Do fatigued MAGIC counters count as combat counters for purposes of the Flowers of Rest?

**A.** Yes.

**Q.** Does Make Whole and Health (from Small Blessing) rest either the MAGIC counter or the color counter that were used to cast them?

**A.** Yes.

**Q.** Is a die roll necessary to enter a tile with Lost activated on it? If cast on Borderland (enchanted), would it apply to all the clearings, or just to 2 and 3?

**A.** No. All the clearings.

**Q.** Does the Phantasm fatigue its owner's MAGIC and color counters when it executes Spell phases, or does it "fatigue" its own duplicates of them? May the Witch King's Phantasm move, although he may not be able to himself?

**A.** Its owner's. Yes.

**Q.** May one use the Hide from World Fades if a T. Monster is red-side-up on your sheet?

**A.** No! One cannot hide if anyone is on your sheet, attacking.

**Q.** Adjusted dice rolls can be as low as "-1" or as high as "9". Are rolls of "0" and "-1" treated as "1" and rolls of "7" to "9" treated as "6"?

**A.** Yes.

**Q.** May Medium and Heavy characters with Elvin Slippers still use one die for Hide rolls?

**A.** No.

**Q.** Do the players make a Monster Roll on a day lost by showers? Do characters that have run away remain where they are (even if airborne)?

**A.** Yes. Yes.

**Q.** Does "Choice" on the Magic Sight Table include the rest of the Magic Sight Table? Free Spell?

**A.** Yes. Yes.

**Q.** Does a roll of "4" on the Magic Sight Table allow the Witch King to learn a spell at the Shrine? Must he take his chances and draw the top spell or may he directly record the Type V spell there?

**A.** Yes. He may directly record the Type V spell.

## AH RBG RATING CHARTS

The following games are ranked by their reader-generated overall Value rating. Further aspects of reader response to our titles are indicated by the ratings in other categories. By breaking down a game's ratings into these individual categories, the gamer is able to discern for himself where the title's strengths and weaknesses lie in the qualities he values highly. Readers are reminded that the Game Length categories are measured in multiples of ten minutes (thus, a rating of "18" equates to three hours).

### WARGAME RBG

Title	Overall Value	Components	Complexity	Completeness of Rules	Playability	Authenticity	Game Length		Year	Sample Base
							Shortest	Longest		
1. GI	2.02	1.93	10	3.01	3.38	1.88	12.84	35.33	1982	264
2. COI	2.06	1.95	9	3.29	3.13	1.99	11.61	29.27	1978	532
3. 3R	2.21	2.67	10	3.81	3.40	2.73	25.94	69.24	1981	273
4. COD	2.23	1.97	10	3.12	3.08	1.85	12.15	30.20	1980	224
5. TRC	2.29	2.53	4	2.52	2.12	3.11	17.44	37.74	1976	540
6. SL	2.31	2.09	8	3.48	2.87	2.45	10.17	27.90	1977	680
7. UF	2.42	2.26	4	2.57	1.31	2.84	4.84	13.05	1983	58
8. B-17	2.51	2.62	3	2.52	1.86	2.21	3.30	11.50	1983	87
9. WS&IM	2.53	3.04	6	2.93	2.67	2.39	7.01	34.90	1975	464
10. W&P	2.61	2.76	5	3.46	2.93	3.04	13.04	57.19	1980	374
11. BB'81	2.67	2.46	4	2.53	2.94	2.91	19.62	35.09	1981	277
12. TLD	2.68	1.95	8	3.72	3.54	2.04	24.44	170.68	1980	119
13. VITP	2.72	2.86	2	2.89	2.22	4.52	16.96	22.36	1977	420
14. CAE	2.85	3.01	4	2.32	2.89	2.52	25.14	32.57	1976	252
15. SON	2.92	3.03	10	3.72	4.09	1.92	29.50	81.78	1981	123
16. SOA	2.97	2.79	3	2.73	2.41	3.88	18.22	22.57	1981	232
17. FE	3.00	2.72	7	3.21	3.21	3.00	21.17	49.05	1980	345
18. FRED	3.00	3.41	4	2.93	2.58	2.75	12.25	24.67	1983	58
19. SUB	3.08	2.64	8	3.13	3.08	2.74	9.41	26.15	1978	281
20. MD	3.13	3.51	3	2.80	2.21	3.44	14.75	20.74	1964	395
21. AZ	3.17	2.72	7	3.18	3.86	2.68	18.63	63.40	1978	292
22. PL	3.19	2.94	7	3.31	3.13	3.50	9.49	25.80	1974	479
23. 1776	3.21	2.97	7	3.09	3.03	3.10	10.16	45.09	1974	373
24. FT	3.23	3.12	10	3.22	3.67	3.16	24.51	57.39	1981	196
25. PB	3.35	3.08	6	3.73	2.90	3.94	10.35	23.07	1970	448
26. BIS	3.45	2.96	6	3.43	3.25	3.06	12.41	26.35	1979	248
27. AAOC	3.52	2.95	5	3.02	3.26	3.07	15.52	26.53	1978	239
28. FITW	3.53	3.14	4	3.17	2.94	3.72	16.14	30.01	1981	100
29. CL	3.54	3.35	5	3.15	3.33	3.79	12.53	25.53	1975	136
30. DL	3.61	4.02	7	3.85	3.22	3.29	6.66	19.94	1981	120
31. GOA	3.66	3.37	5	3.67	3.79	2.98	18.68	60.06	1981	297
32. WAS	3.71	3.67	1	2.48	2.37	5.98	9.09	12.71	1976	396
33. GE	3.72	3.12	6	4.64	4.41	2.84	13.25	57.13	1977	248
34. AF	3.74	4.16	7	3.98	3.34	3.35	5.61	16.02	1980	192
35. AIW	3.74	3.05	8	2.92	3.52	3.06	8.69	25.36	1977	308
36. LRT	3.75	3.60	4	3.53	3.39	2.96	13.04	17.00	1982	56
37. TR	3.80	3.76	3	3.33	3.60	3.70	9.51	25.79	1980	72
38. WAT	3.83	4.17	2	2.95	2.64	5.00	17.08	23.13	1962	296
39. NP	3.87	3.29	3	3.27	2.56	4.89	9.69	14.40	1978	159
40. AK	3.92	4.38	2	3.30	2.48	5.09	14.49	19.13	1964	492
41. AL	4.03	4.05	5	3.69	3.18	3.57	12.34	17.93	1974	217
42. TB	4.06	3.53	7	3.48	4.47	2.50	11.28	32.50	1975	304
43. RW	4.14	3.14	5	3.32	2.91	3.98	4.22	21.15	1973	311
44. JU	4.17	3.20	6	3.61	3.83	3.22	16.01	36.66	1974	193
45. PAA	4.17	4.24	5	3.79	3.99	3.70	15.51	25.24	1981	144
46. DD	4.22	4.07	2	3.04	2.88	4.64	17.54	26.25	1977	367
47. CH	4.39	3.80	4	3.35	3.52	4.67	14.76	24.96	1961	140
48. STAL	4.39	4.29	2	2.88	2.75	5.83	20.57	28.85	1963	320
49. LW	4.45	3.75	5	3.77	3.79	4.79	13.36	34.14	1971	372
50. FR	4.79	3.49	4	3.47	3.75	4.06	16.27	26.95	1972	244
51. BL	4.73	4.16	7	3.65	3.77	5.27	20.43	41.44	1965	336
52. TAC	5.62	5.25	1	2.79	3.23	6.34	11.70	19.29	1961	285

### HITLER'S WAR

The Strategic War in Europe, 1939-45

\$16.00

Once again our attempt to rate a recent release from The Avalon Hill Game Company "comes a cropper" as not enough responses are received from the readership to place *HITLER'S WAR* on the ongoing RBG listing. Several of the newest titles, those most of interest to our regular readership when they are looking to purchase a game, have not made their way onto the list. However, our recent experience with *NAVAL WAR* indicates that a re-rating would bring most of these to the RBG. I suspect that, when dealing with the newest titles, many of the readers cannot rate the game in question simply because they are not familiar with it, having not yet decided to take the plunge and buy it. Certainly, most seem to wait for coverage of a game in *The GENERAL* before rushing out with their money in hand. In the past, it has been the policy to present the RBG results of a game in the issue in which it was featured; this meant that the rating actually took place some four months before the readership "met" the game. However, recent attempts to rate *PANZERGRUPPE GUDERIAN* and *HITLER'S WAR* have forced me to re-evaluate this policy. Instead, henceforth the RBG survey entry will be found in the issue featuring the game and the results of the ratings in an issue two later. It is hoped that,

with this small change, the RBG can continue to grow and serve as a guide to the readers when looking for a new thriller to master. To commence this practice, the readers will find on the insert the RBG survey entry for *HITLER'S WAR* again, and the results will be reported in this space in Vol. 22, No. 1.

**Overall Value:** 2.66  
**Components:** 2.59  
**Map:** 2.88  
**Counters:** 3.20  
**Player's Aids:** 3.11  
**Complexity:** 4.25  
**Completeness of Rules:** 2.78  
**Playability:** 2.33  
**Excitement Level:** 2.42  
**Play Balance:** 4.00  
**Authenticity:** 3.55  
**Game Length**  
**Shortest:** 2 hrs., 3 mins.  
**Longest:** 6 hrs., 54 mins.  
**Year:** 1984  
**Sample Base:** 27

COMING UP  
NEXT  
TIME

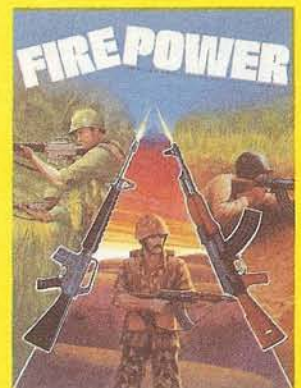

Our issue in celebration of the 40th anniversary of the Battle of the Bulge scored a 3.37 overall—certainly satisfactory in light of the fact that Vol. 21, No. 3 served as a "catch-all" for a broad selection of articles planned for previous "theme" issues which were deleted from them due to confines of space. To judge by the spread of the voting on individual articles in the issue, there was considerable interest in them all. The ratings for our *ad hoc* mix of articles, based as usual on a random sampling of 200 responses, are as follows:

BULGE '81 SERIES REPLAY . . . . .	203
FORTY YEARS LATER . . . . .	173
WHO WAS THAT 10-3? . . . . .	164
THE GRAND ART . . . . .	131
DIEPPE: CANADIANS UNDER FIRE . . . . .	96
TOTAL WAR . . . . .	87
SKORCH THE SKINNIES . . . . .	77
SQUAD LEADER CLINIC . . . . .	63
SOURCES OF STRENGTH . . . . .	61
GETTING ASHORE & STAYING SHORE . . . . .	50
CONVOY . . . . .	32
PERSPECTIVE ON SOLITAIRE METHODOLGY . . . . .	30
THE COMPLETE DIPLOMAT . . . . .	23
AH PHILOSOPHY . . . . .	10

Perceptive readers will notice a change in the format of the mailing label commencing with the last issue. In pace with the times, we now use a computer-generated label to get The *GENERAL* to you. This represents a considerable savings in time and expense, and hopefully will speed the entire process. The label, in addition to your name and address, also gives some important subscriber information on the first line. By way of illustration, the following is an example of the new label:

2 GEN013486-104  
General Subscriber  
Apartment A-3  
123 Main Street  
Townsville, NY 12345

The first number on the left of the top line indicates the number of copies you will receive of each issue, if you receive more than one. If your subscription is indeed for one copy only, as most are, no number will be printed here. In this case, the subscriber would be receiving two copies by mail.

Next comes your personal subscription number in the format of an alpha-numeric code (here **GEN013486**). The "GEN" indicates that the subscription is for The *GENERAL*. The six-digit number immediately following is the individual listing on our computer for your current subscription. Please, when contacting us concerning your subscription to The *GENERAL*, include this letter-number code (or better yet a copy of your most recent label).

Following the dash comes the subscription type code, indicating the general classification of your subscription. The four letter codes are: **I**, Initial subscription; **R**, Renewal subscription; **C**, Complimentary subscription; **L**, Life subscription. Since we have not, as yet, kept track of renewal subscriptions, at the moment all labels will carry the designators **I**, **C** or **L**.

Finally, the number of issues remaining in your subscription are indicated by the final two digits in the top line. This shows how many issues, including the current one, are due you before your subscription expires. The number will decrease with each issue mailed; it should increase to

## Infiltrator's Report

reflect a renewal if submitted prior to your receiving the last issue. In the case above, the subscriber has only four more issues to receive.

Should the reader have any further questions, comments or corrections concerning his subscription, they should be sent to Ms. Gertrude Zombro, Subscription Manager, The *GENERAL*, 4517 Harford Road, Baltimore, MD 21214.

The Avalon Hill Game Company is currently revitalizing the Elite Club, a scheme whereby mail order customers can obtain a 10% discount once they have made a first-time order totaling \$90.00 or more. In the past, membership in the Elite Club allowed only a \$1.00 savings on each order for games. Now, according to Tom Shaw, the Elite Club will offer a 10% savings on anything ordered—games, parts, magazines, and all—from The Avalon Hill Game Company, Microcomputer Games and/or Victory Games. This may be applied to any *one* direct mail order from the company each year. Now in operation, the scheme will demand that the member simply attach his yearly Elite Club coupon to his order and deduct 10% from the total remittance made. Obviously, under the Elite Club it pays to make multi-product purchases to obtain maximum benefit from the program.

To become a member of the Elite Club, all one need do is make an initial purchase that totals \$90.00. That purchase can be made at any time, but must be made direct from The Avalon Hill Game Company—even at our booth at Origins '85 this summer. Current members of the old Elite Club may obtain the same advantages by contacting Ms. Brenda Brauer (care of The Avalon Hill Game Company) and exchanging the unused portion of their coupon for the one now in use; there is no fee for this exchange, and it does represent a considerably better deal. For all members of the plan, once the 1989 coupon has been used, an additional five-year ticket will be sent free of charge (with another option to renew in 1994). Note however, that the responsibility for the safe-keeping of the ticket lies with the member; if it is lost for any reason, he must requalify again.

The new Elite Club coupons have already been printed, and enrollment into the savings has already commenced. If your hobby interests look to be expanding, and if you're not adverse to significant savings, the Elite Club warrants investigation—and investment.

Recently in another hobby periodical appeared a rather muddled accounting of a request by this company regarding the usage of the term "Avalon Hill" and the common abbreviation of that term. I'm not certain how that editor interpreted the letter that he and all other hobby publishers received from our attorneys, for it was but a straightforward request to respect our legal obligations regarding an agreement with Avalon Industries by showing good faith in informing the hobby press that we are trying to meet the terms of the agreement (i.e., not to spread confusion in the marketplace). I certainly see no threat of "legal action" against magazines which fail to honor this request by our attorneys in that letter—although this does not rule out such action by the other interested party to the agreement. It was simply our effort to request voluntary compliance from the hobby press to the terms of our

settlement with Avalon Industries. What a shame that the sniping continues.

Quite a few (about 50%) of our entrants saw through the many options they faced to select the correct solution to Contest #121. From those who chose to use the 14" "1 Salvo" card from their hand, ten were drawn at random. Mr. Ken Nied of Spring Hill, Kansas, sent in one of the best analytical explanations of a contest solution that it has been our pleasure to receive in some time; his letter may be found among the "Letters to the Editor" on page 45 of this issue. Besides Mr. Nied, each of the following winners will receive a merchandise credit voucher: Neil Bonner, Freehold, NJ; Roger Cox, Spartanburg, SC; Robert Gorak, APO, Miami; Michael Kessler, Biloxi, MS; Fred Lum, Weiser, ID; Kirk Raymond, Lapeer, MI; Paul Sivacek, Battle Creek, MI; Klaas Tadema, Dickerson, TX; and Harry Walker, San Diego, CA.

The solution to Contest #122 lies in the fall of Vyazma during the German Player's *Combat Phase*, and requires *three* die rolls of "2". This can be accomplished in two different ways, but one is less costly for the German side. Both solutions break the Russian perimeter at hex 3912 with overruns, and then capture Vyazma in the Combat Phase.

For the best solution, split the 20th Motorized Infantry, moving one unit to hex 4116 and the other to 4013. These units will help put the enemy units in Vyazma and hex 3912 out of supply. Now move the 12th Panzer to 3811 and attempt to overrun the two Russian units in 1912. As stated in the contest description, the Russian strengths are exactly average (thus, four each—see page 11 of the rules). The Russians defend against the overrun with a strength of eight (eight halved, then doubled), and the German attacks with a strength of eight (halved, then doubled). The 1-1 overrun, die roll of "2", results in "D1/A1". The Russian player has the option of retreating both units to hex 4011, or of killing one and leaving the other in 3912. In either case, the survivors are disrupted, thus losing their ZOC. However, any retreat would leave open a clear path to Vyazma for the 10th Motorized Infantry and 17th Panzer and simplify the German attack, so instead one Russian unit must be killed. The Russian player really has no other option. The 12th Panzer is retreated into hex 3711 and 3810.

Now, the 17th Panzer moves to 3811 and overruns the survivor in 3912 at odds of 2-1 (8-4), resulting in "D1". The Russians must either destroy their lone unit or retreat it to 4011 (still disrupted). In either case, the 17th Panzer occupies 3912 and continues moving to hex 3915. Finish the German Movement Phase by shifting the 10th to hex 4014.

During the Combat Phase, the 17th Panzer, 10th and element of the 20th Motorized Infantry attack Vyazma at 3-1 odds, taking the city on a die roll of "2".

The alternative solution requires moving the entire 20th to 4116. Then the 12th Panzer overruns 3912 at 1-2 odds resulting in a "Eng", killing one Russian and losing one German step in the process. The 17th Panzer then overruns 3912 at 1-1 odds resulting in a "D1/A1". The last Russian in 3912 is either destroyed or retreated one hex and disrupted. In either case, the 10th Motorized Infantry then can move to 3915, surrounding Vyazma. The attack on Vyazma by the 10th and 20th is made at 3-1, also taking the city. The first solution, however, is superior because it requires no German step loss. Given enough correct solutions, entries with the alternative solution will be discounted.

OPPONENTS WANTED

Attention: Squad Leader Gamers! Find out about "On All Fronts" the newsletter for the SL/CI Series of games. Write to: On All Fronts, P.O. Box 265, Marshall, AR 72650.

Old Guard Wargamer returns to Bay Area. Looking for mature adult to fit PGG, WF, and other WWII orientated games. No beginners please. Randy Heller, 4442 Paradise Knoll, Castro Valley, CA 94546, 535-0230.

Wanted pbm opponents area rated 1150 or less for AK, CHESS and TB. Also WSIM to join KMC multi-player game. Marcel Carbonneau, 1824 S. Broadway, OceanSIDE, CA 92054.

Adult returning to gaming seeks pbm or hf for: FRED, 1776. Willing to try other interesting primarily in "historical" games. Henry Lowood, 160 Acacia Avenue, San Bruno, CA 94066, (415) 871-9721.

San Diego Area Gamers: Join the Game Towne Club (5537) Open gaming Sundays, facilities available 7-days/wk. Paddy league, pbm DIP, AH classics, plus more. Game Towne, 3954 Harney St. (in Old Town), San Diego, CA 92110, (619) 291-1666.

Looking for hf players in Bay Area—any games except role-playing. Trying to find enough players for group games. Philip Covevey, 801 Fillmore St., #15, San Francisco, CA 94117, (415) 346-3835.

Seeking pbm opponents for non-rated friendly competition in BR, FRED (need system), WSIM, AZ (old O.O.B. only), Honor system only. Ken Thurston, 12356 East Ohio Blvd., Aurora, CO 80012, (303) 363-0761.

Need player for DD, BB, MD, BR, 1776, TRC, MD (Area 900) rated or not welcome. Victor Scolora, 190 Wellville Ave., New Milford, CT 06776, 355-0653.

27-yr. old in second year of gaming seeks hf for FT, MD, VTP, BIS. Any clubs in Tex Area? Joe Sarsant, 7055 San Jose Blvd., Jacksonville, FL 32217, (904) 737-0216.

Experienced gamer new to the Area. Have 20 plus AH games. Desire hf—GI, COD, COI, SL, VTP, LW, TRC, MD, WAT and others. James Weufall, 225 38th Ave., S.E., St. Petersburg, FL 33705, (813) 821-6089.

Wanted hf in Atlanta area for CIA, PGG, PK Classics. Club meets monthly, Classics tournament July 5-7, 1985. Contact: Henry C. Roubine, 3172 Lake Monroe Rd., Douglasville, GA 30135, 942-7416.

Ft GI, TRC. Anything in the Savannah Area? John Kudla, 1201 King George Blvd., #90, Savannah, GA 31419, 927-7926.

Fif semi-regular gaming sessions. No D&D experienced gamers. Preferred multiple games available. Contact: Jayson Grulic, 38127 North Shore, Waukegan, IL 60087, (312) 336-4284.

I'm looking for pbm opponents for BL, TAC, TAC II and Kriegspiel. I need pbm systems. Scott McAninch, 1160 Barksdale, G.A.F.B., IN 46971.

Pbm opponents for CIV, DIP, FT, KM, RB, TRC, SST, 3R, TT, VTP, W&P, and WSIM. HELP! No players in Leavenworth! Bob Sweney, 614 Cass St., Leavenworth, KS 66207, (913) 651-4864.

Computer moderated blind games FT or SL series. \$3 per turn to pay computer time and mailing costs. Sam Belcher, 2304 Duane, Topeka, KS 66606, (913) 234-4141.

Waiting for daylight! Novice needs opponents for classics, TRC, SL, JR, etc. Ftf or pbm. Learn together or teach me how to beat you. Ken Berlin, 217 Leavasser Ave., Apt. 2, Covington, KY 41014, (606) 431-2744.

The Baltimore Conflict Gamers Club is now open for membership. Contact: Larry Bertel, Jr., 768-2159 or John Brivleville, 944-9166.

Police: journal of the Washington Area Regiment of (TACTI) Highly Organized Gamemasters, presents announcements of ftf gaming opportunities in Balto.-Wash. including DIP, TT, CIV, RB, Ken Peel, 8708 First Ave., #T-2, Silver Spring, MD 20910, (301) 495-2799.

1478CDH seeks Area pbm in STAL, PB and COC a must. All letters from verified 1300+ players answered. Peter Halfman, 75 Outlook Drive, Lexington, MA 02173, (617) 861-0036.

E.M.V. gamer hoping to meet other E.M.V. gamers and wage war with our cardboard armies. Bob Hahn, 596 Brookside Place, Cranford, NJ 07016, (201) 278-3553.

Adult novice wants pbm opponents for DD-77 and TRC. Stephen Smith, Rt. 1, Box 244, Buffalo, MN 55313, (612) 682-1878.

Adult Twin Cities Gamers are invited to attend club meetings Friday evenings, Mount Sinai Hospital, Details Don Frick, 4230 Monroe St., N.E., Col. Hts., MN 55421, 789-6762.

Would welcome a command in multi-player DIP, BR. Also interested in hf ftf VTP, PGG and HW. Tom Scarborough, 3823 Langley Ave., St. Louis, MO 63123, (314) 352-7843.

Jersey Wargamers meet first and third Fridays, first and third Sundays each month. For info: Days Bob Wielgos (717) 992-5135—Evenings, Bob Hahn, 596 Brookside Place, Cranford, NJ 07016, (201) 278-3553.

Pbm PB, BL—Honor system. Ftf most AH games, prefer SL—Series thru GI, JR, TRC, PL. Will learn terms. Richard Wengheim, 12 Adams Drive, Laurel Springs, NJ 08021, (609) 227-9512.

Adult gamer (24) seeks hf opponents for AK, CH, MD, NP, STAL, FRED. Large game room available, mature players only. J.P. Kelly, 196 Baltic St., Apt. 3, Brooklyn, NY 11201, (212) 855-8921.

Need COI, GI, PL opponent rated only for pbm adults only or within 100 mile radius of Elmira. Anyone only? Kevin Raffozoff, 712 W. Water, Elmira, NY 14905, (607) 734-0949.

In Westchester, NY Area (White Plains—New Rochelle) is there anyone who would like to play ftf. I have PL, SL, 1776. I am also very interested in the Civil War 1861-1864. If interested write K.F.M., 17 Harmony Drive, Larchmont, NY 10538.

Staten Island gamer 27-yr. old non-rated wants ftf opponents for WWII and Napoleon Era. AH games especially SL and WSIM. John Bobort, 91 Ludwig Lane, Staten Island, NY 10303, 494-6118.

Want pbm area or non-area rated: AIW, FE, LW, TRC. Ft SL thru GI, most other Avalon Hill games. Carl Palmaster, B/519 Mt BN, Ft. Bragg, NC 28307, (919) 396-9827.

Ft MD, LRT, JR. Will try any of The Avalon Hill Game Company's games and clubs in the Western Carolina Area. David Blaylock, Rt. 1, Box 630, Canton, NC 28716.

Adult seeking pbm PB, SSN opponents. Also have pbm system for miniatures, opponents needed. Any ftf opponents in Durham? Bert Watkins, 1707 Forest Rd., Durham, NC 27705, (919) 286-0730.

Small group of gamers looking for ftf SL thru GI.1. Also pbm TRC. Dale Miles, 600 3rd St. N.W., Minot, ND 58701, (701) 852-1910.

15-yr. old gamer seeks opponents for 3R. Do not have pbm system. Willing to learn. All letters answered. Jason Kinkelberger, 139 Cornua Ave., Akron, OH 44313, (216) 836-5708.

Any gamers in University of Cincinnati Area? Let's get a club going, or just play some games. Bruce Monnig, 523 Calhoun Hall, University of Cincinnati, Cincinnati, OH 45221, (513) 475-5129.

Wanted! Adult pbm opponents for PL or TRC. Choose scenario and I'll choose side. AREA rated 1100. Steve Shields, 1041 Arrowhead, Yukon, OK 73099, (405) 374-1509.

Wanted! Adult boardgame in Central Oregon. Prefer Civil War, Napoleonic but remain flexible. Give me a call! John Cassel, 347-B S. Ewen St., Prineville, OR 97754, 447-4321.

Experienced adult gamer seeks pbm opponents non-rated for Guadalcanal, AK, FE, TRC, GOA or other classics of The Avalon Hill Game Company. H. Izoia, 224 East Parkway Ave., Chester, PA 19013, (215) 872-1952.

Ftf opponents wanted. I'm 25, have over 20 games including SL, GSL, RB, MD, SUB, FT, KM, JT and PL. Bruce A. Rinehart, RR. 1, Box 113, Bridgewater, VT 57319, (605) 729-2348.

Opponents, 20 yrs. or older, wanted for ftf play in Knoxville Area, GI, COD, COI, or SL. Also AKEA play. Timothy Deane, 2710 Sevier Ave., Apt. 2K, Knoxville, TN 37902, 573-9996.

Pbm's GL—have my own system, VTP—Pbm's own, WAS—my own pbm, mature players, please AREA or non-AREA 1200. Robert Hawkins, 5707 Trail Crest Dr., Arlington, TX 76017, (817) 572-2201.

El Paso Strategic Broadgamers Associations seeking members. Meeting every Sunday. For info contact: Don Denton, 3630 Van Buren, EL Paso, TX 79930, (915) 566-7072.

Tyro SL, SST gamer seeks ftf opponents for exp. and recreation. Sun City wargamers you're out there somewhere! Don Denton, 3630 Van Buren, EL Paso, TX 79930, (915) 566-7072.

There must be an adult STAL player somewhere in Houston; wanting to play ftf. STAL or other Avalon Hill games—14 yrs. exp. Eugene Allen, 7320 Mullins, #713, Houston, TX 77081, 721-8123.

Want ftf opponents in Plainview Area also pbm AZ, BB, DD, PK, TRC AREA rating 875. Mark Nelson, 2106 Amantillo, #2, Plainview, TX 79072, (806) 293-1685.

Experienced gamer seeks regular ftf partners will play most all games but prefer operational AZ, FRED, TLD, BR, CAE and etc. Michael Sincavage, 125 Envisions Rd., Sterling, VA 22170, (703) 430-4706.

24-year old, new to the area, seeks ftf opponents for SL, COI and COD. Any King County gamers out there? S.C. Kemp, P.O. Box 12343, Seattle, WA 98111.

Toronto gamers TRC ftf Area rated 1200 verified. Will play everyone who answers AD: Art Lupinacis, P.O. Box 319, Station C, Toronto, Ontario M6S 3E9.

I'm looking for local ftf opponents for SL, series, TRC, WSIM, DIP, others; any clubs in area? Bruce Grove, 57 Colborne St., Apt. #15, Kingston, Prov. Ontario K7K 1C9, 549-4687.

Any gamers in Holland? Expatriate American desires opponents for SL, WSIM, CIV, Avalon Hill SCI titles, any others. After Nov. 1, Eric Prase, MPNI, P.O. Box 11630, 2502AP Graven HAAG, Netherlands.

Adult new to area seeking club or ftf. I have 3R, SL, COI, GOA, BIS, WSIM, GE and CIV. John Coffee, Paddock House, Chapel Lane, Stoke, N. Andover, Hampshire, U.K. St. Mary Bouase 65.

21-year old German student would like to try optional rules in PL, pbm. Also sits. 21+ rated games preferred. I'm 1500 Prov. Hans R. Frey, Landsberger Str. 143, D-8000 Munich, W. Germany.

COLLECTOR'S CORNER

Wanted Vol. 14, No. 2, Vol. 13, No. 1 or copy of KM article. Will pay well and postage. J.A. Carter, 107 B Arizona St., Ft. Huachuca, AZ 85613, (602) 458-1197.

Attention! SL subscribe now to the monthly publication devoted to your favorite game, SL thru GI. One year (12 issues) for only \$12. On All Fronts, P.O. Box 265, Marshall, AR 72650.

For Sale 1914 Guadalcanal, FTWV, etc. Send SASE for list: Jim Hambacher, 4758 E. 26th St., Tucson, AZ 85711, (602) 790-5925.

For Sale: many old games of The Avalon Hill Game Company. Will consider trades. Call between 5 P.M.—9 P.M. Ed Prezutti, 25 Tremont Street, New Britain, CT 06051, (203) 223-6900.

Wanted COBO write or call. Donald Korb, P.O. Box 14039, Washington, DC 20004, (202) 566-4390.

For Sale: Mini GE 58, 1914, Guadalcanal; out-of-print wargames and magazines including GENERAL's. Send \$1.00 (refundable) and SASE for multi-page list to: Wally Williams, Jr., 611 S.E. 1st Ave., Gainesville, FL 32601, (904) 373-3175.

For Sale: The GENERAL 161-2, 4-6; 171, 3; 181, 4; 19—\$1.50 per magazine plus \$1 for postage on orders under \$10. Robert Kruck, 21122 N. Hwy., 21, Prairie View, IL 60069.

For Sale: Many wargames and magazines of The Avalon Hill Game Company. Good prices. Send SASE for list: Joe Kot, 315 Keys Ave., Springfield, IL 62102.

For Sale or Trade: 1914 game in excellent condition. Send offers to: John C. Henriksen, 2323 Pioneer Drive - Lexington, KY 40505, (606) 299-6765.

For Sale: 300+ games and magazines. Many out-of-print and collector's items. Send SASE for complete list: George McHugh, 7513 Flower Ave., Takoma Park, MD 20912, (301) 270-2068.

Getting out-of-games: Many old games and magazines of The Avalon Hill Game Company for sale. Send SASE to: Paul Chinnery, 408 E. Filer St., Ludington, MI 49431.

For Sale: Collector's items, games, out-of-print GENERAL's. Long list of items available. Send SASE for list: Mike Stephens, 2 Desmond Run, Sicklerville, NJ 08081.

Games for Sale or Trade: out-of-print games wanted. Send SASE. Anyone with info: miniature needed or inserts. John M. D'Addario, 35 Greenbush St., Cortland, NY 13045, (607) 753-0614.

Games for Sale/Trade: The Avalon Hill Game Company's catalogs, Battelme, P.M. Giant 15-page master catalog #3 only \$1—plus large SASE. HM Levy, P.O. Box 197-G, East Meadow, NY 11554.

For Sale: Old games from The Avalon Hill Game Company and others, sold generally low. SASE for list. Original BIS, Orig. ch. SASE for List. Scott Saville, 334 S. Collingwood Ave., Syracuse, NY 13206, (315) 463-1540.

Games for Sale: Large collection must go. Many out-of-print. Includes: Legends, 1914, GIAD, Dispatcher Civil War, David Blaylock, Rt. 1, Box 630, Canton, NC 28716.

For Sale: GUAD, 1914, GE'65, and BB'65. All in excellent condition, Asking price in line with The Avalon Hill Game Company's Discounted Parts List. Make offer. All inquiries answered promptly. Bob Turner, 2743 E. 14th Pl, Tulsa, OK 74114.

For Sale or Trade: Excellent condition SL, COI, COD and GI. Many inserts, extras. Trade for same condition TLD, Mike Eckhardt, Rt. 1, Box 269, Germantown, PA 19053.

For Sale: 1914 good condition, highest bid. Other collector's items. Send SASE for list: Robert A. Corne, 2105 So. 19th St., Philadelphia, PA 19145, (215) 803-3505.

For Sale: 108 back issues of the GENERAL, Vol. 24, #2 back \$216.00. Mine to very good condition. Don Matous, 3102-69th St., Apt #71, Galveston, TX 77551, (409) 744-4637.

Wanted: Copy of OSO Roadgame in Italy in good condition. Call or write to: Kenneth Kirchner, 3027 Planners Street, Sugarland, TX 77479, (713) 980-3278.

Games, games, games; out-of-print, classics from The Avalon Hill Game Company. Good prices SASE for long list. Ron DiRocco, 1530 Halstead Ave., Norfolk, VA 23502.

For Sale: The Avalon Hill Game Company's collectors' games and magazines from 1970 to 1980. Send SASE for complete list. Mark Brady, 604 Longview Ct., Vienna, VA 22180, (703) 255-3270.

For Sale: Bu' 62, GUAD, 1914, plus many others. Send SASE for list: Sharr B. Sobler, P.O. Box 608, Rock Springs, WY 82902, (307) 382-5554.

Most of The Avalon Hill Game Company's out-of-print games for sale. Many others as well. All games new. Very reasonable prices. Send SASE (fidel size) for details. U.S. A. Mail send I.P.C. Art Lupinacis, 113 Parkview Rd., Toronto, Ontario M8Y 3J2, 252-8196.

The "Opponents Wanted" advertisements on this page are intended as a service to the readership of this periodical. This service will continue so long as certain editorial policies are adhered to strictly. The editors of THE GENERAL reserve the right to excise any part of or an entire advertisement should these not be followed.

Want-ads will be accepted only when printed on the appropriate form or a reasonable facsimile. Such must be accompanied by the appropriate fee. This may take the form of uncanceled US postage; note that foreign postage is not acceptable. No refunds of this fee will be made, even should the ad not be printed due to failure to conform to our policies.

Please print or type the ad copy. If the ad is not legible, it will not be printed. Too, no dealing with products of other manufacturers will be printed and any mention of such will be excised. Ads are accepted for a single printing only. Should the reader desire that a specific ad enjoy a multiple printing, a separate number of copies equal to the number of times the ad is to be run must be submitted—although only one total payment need be included to cover the printings.

All material in THE GENERAL is protected by copyright and reproduction with intent to sell for strictly forbidden. Advertisers may sell photocopies of particular articles from SOLD OUT back issues NO LATER in stock (for a listing of those issues still in stock, consult the back issue section at the bottom of this page), provided that they charge no more for this service than their own expenses. Anyone offering such copies for a profit or distributing copies of back issues still available will be in violation of the copyright laws of the United States.

Finally, due to the pressure of various deadlines, often advertisements submitted weeks before an issue appears will not be printed in that issue. Please be patient; such will be printed in the immediately following issue. Please do not specify a particular issue for an ad to appear; such requests cannot be honored.

GENERAL BACK ISSUES

- 12-2: TB—H, DN; BB—V; BL—V; PB—SR; PL—DN; STAL—S; AZ—Q
- 14-3: AIW—H, DN, S, Q; TRC—S; 3R—S; STAL—SR; WAS—V; PB—Sc
- 14-5: SL—H, A, DN, Q; WS&IM—A; TRC—S; MD—S; SST—S; 3R—S
- 15-2: PL—V, Sc; STAL—V; 3R—V; DD—DN; RB—S; VTP—S
- 15-6: COI—A, DN, S, Sc, Q; WAS—V; AIW—S; SST—Sc; PL—V
- 16-1: AZ—Sc, S, DN; 3R—S; NP—S; PB—SR; 1776—S; DIP—S
- 16-2: BIS—A, Sc, H, DN, Q; PB—SR; AK—S; 1776—S; WS&IM—S
- 16-3: PL—A; WAS—S, H; TB—Sc; COI—SR; 1776—S; MD—V
- 16-4: MR—A, V, DN, Q; COI—S; 3R—S; TRC—SR
- 16-5: TRC—S; SUB—Sc; SST—S; WAS—S; PB—V; RB—V; NAP—S; COD—Q
- 16-6: DUNE—A; DIP—V; OS—V; AZ—DN, Sc, SR; PB—A, PBM
- 17-1: W&P—A, DN, V, Q; 3R—S; COI—S; MD—V; COD—A; MR—V; LW—S; WAS—SR
- 17-3: AK—S; 3R—S; COD—S, Q; AF—A, DN; TRC—V; VTP—V; COI—SR
- 17-4: FE—S, P, DN, V; MD—V, Q; COI—SR; VTP—S; 1776—Sc; WO—A; SST—V; NAP—S
- 17-5: CM—S, V, Q; RW—V; SL—V; STAL—V; PL—S; 3R—S, SR; CAE—V; KM—S; MR—S
- 17-6: STAL—S; WS&IM—V, Sc; WAS—V; 3R—SR; SL—S; TLD—Q; CL—S; VTP—S; TRC—S
- 18-1: FITW—A, Q; BIS—S; SL—S; DUNE—V; DIP—S; AK—A; PB—SR; AL—S; W&P—S
- 18-2: AF—A, Sc, Q; AK—V; 3R—DN; TB—V; SL—S, Sc; AIW—V; VTP—S; DIP—S; DD—S
- 18-3: GOA—S, DN, V, Q; AOC—V, Sc; AK—S; VTP—V; SL—S, Sc; WS&IM—SR, P; DIP—S
- 18-4: GL—H, V, A, Q; SL—Sc, A; LW—V; W&P—SR; AOC—S; P; FE—V; WAS—S; AK—S
- 18-5: 3R—S, A, V, DN, Q; SL—S, A, Sc; TRC—V; TB—V; RW—V; CL—A; DUNE—V
- 18-6: FT—A, Sc, V, DN; VTP—V, Q; MD—S, Q; SOTN—A, Q; SUB—Sc; BL—V
- 19-1: SOA—A, V, DN, SR, Q; TLD—A, Q; 3R—S, Q; DWTK—DN; TB—A
- 19-2: BB—H, Sc, S, DN; TLD—A, Q; SL—V; 3R—S; SOA—SR
- 19-3: GSL—A, Sc, V, SR, Q; DIP—A; RW—Sc; GE—V; 1776—Sc; LRT—V, Q; SL—A
- 19-4: CIV—A, V, DN; CM—V; DIP—A; GL—V; AL—V; TR—Sc; WO—Sc; SLA; 3R—S, Q
- 19-5: SON—A, S, H, Q; W&P—S, Q; DIP—A; WAT—V; WS&IM—Sc; SL—A
- 19-6: VTP—PBM, SR, 3R—V, Q; DIP—A; FT—V; BIS—V; NW—A; SL—A, Sc; SUB—V, Sc
- 20-1: GI—S, A, DN, V, Q; VTP—SR
- 20-2: TB—A, DN, S, Q; MR—V; LRH—A; SL—Sc; W&P—V; GOA—S, Q; DIP—A; PL—V
- 20-3: FRED—S, V, Sc, Q; PB—A; 1776—Sc; DWTK—S, V, Q; DIP—A; CON—V, S
- 20-4: FITG—S, A, Q; SST—PBM, V; AW—A; DUNE—PBM; DIP—A; SL—DN, A, Q; BL—S; KM—V
- 20-5: BR—SR, S, H, Q; LRT—S; DIP—A; GSL—Sc; GE—A; WS&IM—Sc; SON—Q
- 20-6: B-17—A, V, SR, Q; AF—V; LW—S; DL—S; FE—S; DIP—A; MD—S; BR—SR; GOA—Sc; SL—A; PLQ
- 21-1: UF—S, A, SR, DN, Q; SOA—S; GI—H, S; TRC—S; DD—S
- 21-2: NAB—S, DN; W&P—S, A, Q; NAP—S, Q; DIP—A; FR—S; FE—S; 3R—S; BFT—S; 1776—S; SL—A
- 21-3: BB—S, SR, Q; 3R—S; SL—A, H; SOTN—V; DIP—A; FRED—S; FE—S, Q; SST—S; TLD—S; PL—Sc; 1776—Q; SOA—Q
- 21-4: PGG—S, SR; PB—PA; 3R—S; TRC—S, V, Q; DIP—A; STAL—V, S; SL—Sc; PK—Q

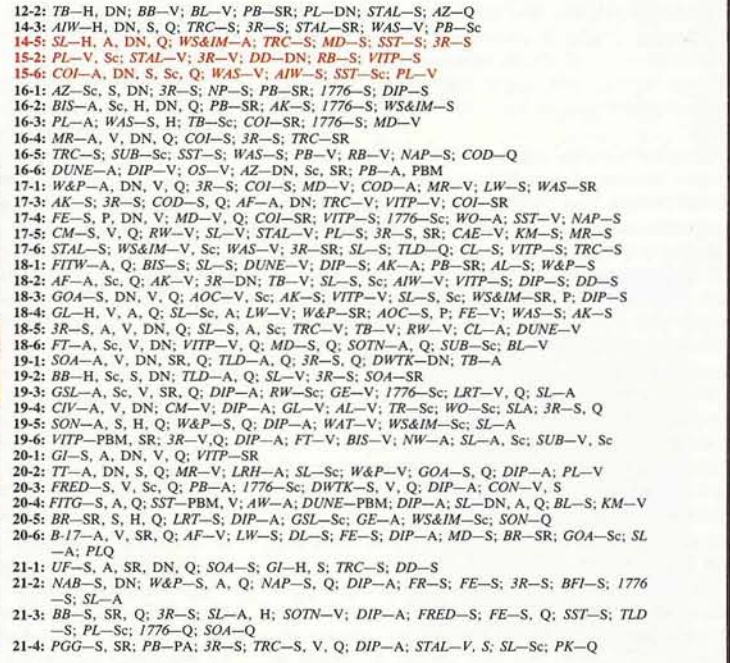



**HITLER'S WAR** \$16.00  
The Strategic War in Europe, 1939-45

**INSTRUCTIONS:**

Rate each category by placing a number ranging from 1 through 9 in the appropriate space to the right (1 equating "excellent"; 5, "average"; 9, "terrible"). **EXCEPTION:** Rate items 7a and 7b in terms of minutes necessary to play the game, in ten-minute increments. (Example: If you've found it takes two and a half hours to play the basic scenario of *FRANCE 1940*, enter "15" for category 7a.) For an explanation of the categories, refer to the AH Philosophy of Vol. 19, No. 4. Sub-categories are indicated by italics. Enter ratings only for those categories relevant to the game in question. Note that AH's ratings for **Complexity** and **Year of Publishing** have been provided; do not rate these categories.

- 1. Overall Value \_\_\_\_\_
- 2. Components \_\_\_\_\_
- 2a. Mapboard \_\_\_\_\_
- 2b. Counters \_\_\_\_\_
- 3. Player's Aids \_\_\_\_\_
- 3c. Complexity 4
- 3a. Complexity \_\_\_\_\_
- 4. Completeness of Rules \_\_\_\_\_
- 5. Playability \_\_\_\_\_
- 5a. Excitement Level \_\_\_\_\_
- 5b. Play Balance \_\_\_\_\_
- 6. Authenticity \_\_\_\_\_
- 7. Game Length \_\_\_\_\_
- 7a. Basic/Shortest \_\_\_\_\_
- 7b. Advanced/Longest \_\_\_\_\_
- 8. Year of Publication 1984

\$1.00

\$1.00

This coupon is valid only for mail order purchases of complete games direct from The Avalon Hill Game Company. Each postage coupon entitles the sender to deduct up to \$1.00 from the postage charges of any order for a complete game provided the amount deducted does not exceed the total postage charges for that order. Coupons are not usable for parts, magazines, or phone kit orders. Shipping charges are 10% of the dollar amount of your order if sent to a USA address. Shipping costs to Canada and Mexico are 20% of the order; overseas orders must add 30%. Any past GENERAL postage coupons previously offering different values may be used as the equal of this coupon. Example: Customer A lives in the USA and orders a \$15 game. His postage charge is \$1.50 which he may pay by sending in 2 postage coupons and \$15, or 1 postage coupon and \$15.50. Customer B lives in Canada and orders the same game. He must pay \$15 in USA funds plus 3 postage coupons or \$15 plus \$1 for each postage coupon less than 3 which he sends.

Good for Postage Charges Only on Complete Game Purchases

## WHAT HAVE YOU BEEN PLAYING?

Top ten lists are seemingly always in vogue these days. Whether the subject is books on the Best Seller List, television's Nielsen ratings, or even games, the public never seems to tire of seeing how their individual favorites stack up numerically against the competition. Our preoccupation with this national pastime is almost akin to rooting the home team on to victory every Sunday. So to further cater to your whims (and to satisfy our own curiosity) we unveil The *GENERAL*'s version of the gamer's TOP TEN.

We won't ask you to objectively rate any game. That sort of thing is already done in these pages and elsewhere. Instead, we ask that you merely list the three (or less) games which you've spent the most time with since you received your last issue of The *GENERAL*. With this we can generate a consensus list of what's being bought. The degree of correlation between the Best Selling Lists and the Most Played List should prove interesting.

Feel free to list any game regardless of manufacturer. There will be a built-in bias to the survey because you all play our games to some extent but it should be no more prevalent than similar projects undertaken by other magazines with a special interest-based circulation. The amount to which this bias affects the final outcome will be left to the individual's discretion.

The games I've spent the most time playing during the past two months are:

- 1. \_\_\_\_\_
- 2. \_\_\_\_\_
- 3. \_\_\_\_\_

## Opponent Wanted

50¢

- 1. Want-ads will be accepted only when printed on this form or a facsimile and must be accompanied by a 50¢ token fee. No refunds. Payment may be made in uncancelled U.S. postage stamps.
- 2. For Sale, Trade, or Wanted To Buy ads will be accepted only when dealing with collector's items (The Avalon Hill Game Company's out of print games) and are accompanied by a \$1.00 token fee. No refunds.
- 3. Insert copy on lines provided (25 words maximum) and print name, address, and phone number on the appropriate lines.
- 4. Please PRINT. If your ad is illegible, it will not be printed.
- 5. So that as many ads as possible can be printed within our limited space, we request that you use official state and game abbreviations. Don't list your entire collection, list only those you are most interested in locating opponents for.

Afrika Korps—AK, Air Force—AF, Alexander—AL, Alpha Omega—AO, Amoeba Wars—AW, Anzio—AZ, Arab-Israeli Wars—AIW, Assault On Crete—AOC, Bismarck—BIS, Blitzkrieg—BL, Battle Of The Bulge—BB, Bull Run—BR, Caesar Alesia—CAE, Caesar's Legions—CL, Chancellorsville—CH, Circus Maximus—CM, Civilization—CIV, Conquistador—CON, Cross Of Iron—COI, Crescendo Of Doom—COD, Dauntless—DL, D-Day—DD, Diplomacy—DIP, Down With The King—DWTK, Dragonhunt—DH, Firepower—FP, Flat Top—FT, Fortress Europa—FE, France 40—FR, Frederick the Great—FRED, Freedom in the Galaxy—FITG, Fury In The West—FITW, Gettysburg—GE, G.I.: Anvil of Victory—GI, Gladiator—GL, Guns Of August—GOA, Gunslinger—GSL, Hitler's War—HW, Jutland—JU, Kingmaker—KM, Legend of Robin Hood—LRH, The Longest Day—TLD, Little Round Top—LRT, Luftwaffe—LW, Machiavelli—MA, Magic Realm—MR, Midway—MD, Napoleon—NP, Napoleon at Bay—NAB, Naval War—NW, Origins—OR, Outdoor Survival—OS, Panzerarmee Afrika—PAA, Panzerblitz—PB, Panzergruppe Guderian—PGG, Panzerkrieg—PK, Panzer Leader—PL, Rail Baron—RB, Richthofen's War—RW, The Russian Campaign—TRC, Squad Leader—SL, Stalingrad—STAL, Starship Troopers—SST, Storm Over Arnhem—SOA, Struggle of Nations—SON, Submarine—SUB, Tactics II—TAC, Third Reich—3R, Titan—TT, Tobruk—TB, Tirreme—TR, Up Front—UF, Victory In The Pacific—VITP, War and Peace—W&P, War At Sea—WAS, Waterloo—WAT, Wizard's Quest—WQ, Wooden Ships & Iron Men—WSIM.

\_\_\_\_\_  
\_\_\_\_\_  
\_\_\_\_\_

NAME \_\_\_\_\_ PHONE \_\_\_\_\_

ADDRESS \_\_\_\_\_

CITY \_\_\_\_\_ STATE \_\_\_\_\_ ZIP \_\_\_\_\_

## CONTEST #123

To enter, indicate each Soviet Army Group, its initial hex, its composition, any attacks/advances it makes during your turn and the target hex(es) of each:

Army          Hex    Infantry    Mechanized    Assault/Advance    Target

\_\_\_\_\_  
\_\_\_\_\_  
\_\_\_\_\_  
\_\_\_\_\_  
\_\_\_\_\_  
\_\_\_\_\_  
\_\_\_\_\_  
\_\_\_\_\_  
\_\_\_\_\_  
\_\_\_\_\_

Production          in Army

Issue as a whole . . . (Rate from 1 to 10, with 1 equating excellent, 10 equating terrible)  
Best 3 Articles

- 1. \_\_\_\_\_
- 2. \_\_\_\_\_
- 3. \_\_\_\_\_

NAME \_\_\_\_\_

ADDRESS \_\_\_\_\_

CITY \_\_\_\_\_ STATE \_\_\_\_\_ ZIP \_\_\_\_\_

# CONQUISTADOR Variant Counters FUR TRADERS & BUCCANEERS

For use with variant rules found in Vol. 21, No. 5 of The GENERAL.

1 1 Knight	2 3 Lindrow	4 4 Gordon	10 12 Flint	13 15 Carlsen	16 18 Krogh	19 20 Christon	5-4	5-4	2-4	2-4	2-4	2-4	2-4
2-4	2-4	2-4	2-4	2-4	2-4	1-4	1-4	1-4	1-4	1-4	1-4	1-4	1-4
1-4	1-4	1-4	1-4	1-4	1-4	1-4	4-8	4-8	4-8	4-8	4-8	4-8	4-8
4-8	8-8	8-8	8-8	8-8		1 1 La Roche	2 4 Du Pont	2 4 De Monts	2 5 Champlain	5 8 Brule	6 10 Nicolet	12 15 Grislers	14 15 Radisson
15 15 St. Lesson	15 19 Perrot	16 20 Joliet	16 19 La Salle	17 20 Duluth	10 12 Le Vasseur	13 15 L'Ollonais	16 17 De La Nothe	17 18 Grammont	19 21 Du Casse	+3-8	+3-8	+2-8	+2-8
+1-8	+1-8	+1-8	0-8	0-8	-1-8	-1-8	-1-8	-2-8	-2-8	-3-8	-3-8		1 1 Hawkins
2 2 Gosnell	3 4 Smith	4 4 Hudson	10 11 Flood	12 14 Maasfield	15 17 Norgan	16 17 Peake	18 20 Davis		1 1 Nahu	2 3 Hudson	4 4 Lemaire	10 11 Brouwer	12 14 Roc
15 16 Van Noort	17 18 Van Horn	17 21 De Graff		Charter	Charter	Charter	Charter	Charter	Charter		1 Trading Post	2 Trading Post	3 Trading Post
4 Trading Post	5 Trading Post	6 Trading Post		1-4	1-4	1-4	1-4	1-4	1-4	1-4	1-4	1-4	1-4
1-4	1-4	1-4	1-4	1-4	2-4	2-4	2-4	2-4	2-4	2-4	2-4	2-4	2-4
2-4	2-4	2-4	2-4	2-4	2-4	2-4	2-4	2-4	2-4	5-4	5-4	5-4	5-4
5-4	5-4	5-4	5-4	5-4	5-4								

## COPIES

If the reader should need a copy of an article from an out-of-stock back issue of The GENERAL, The Avalon Hill Game Company does provide a photocopying service. The charge for this service is \$1.00 per page, with a minimum order of five pages required. Please specify the article, volume and number it appeared in, and the pages on which it can be found (as listed in this index). Standard Avalon Hill postage rates of 10% of the amount of the order must be included for domestic orders. (20% for Canadian orders; 30% for overseas orders.) GENERAL postage coupons do not apply.

## COMPANY HISTORY

In celebration of Avalon Hill's Silver Jubilee, an informal history of the world's first and largest wargame publisher was compiled. The 32-page, full-color booklet exposes the successes, failures, truths and myths of The Avalon Hill Game Company from 1958 to 1983. With a forward by Charles S. Roberts on the founding years and liberally illustrated, the Company History is wonderful nostalgia for the thousands of gamers who started wargaming with Avalon Hill products. The Silver Jubilee booklet is available for \$2.50 from The Avalon Hill Game Company, 4517 Harford Road, Baltimore, MD 21214. Please add the usual 10% postage and handling (20% for Canadian orders; 30%, overseas).



# ORIGINS XI

## THE ANNUAL NATIONAL ADVENTURE GAMING SHOW TOWSON STATE UNIVERSITY TOWSON, MD

JUNE 27, 28, 29, 30, 1985

**AN OVERVIEW:** Consider this your invitation to The 1985 National Adventure Gaming Convention. This form contains everything you'll need to know to plan an exciting weekend of fun and adventure in one of the most enjoyable hobby activities anywhere. By filling out and returning this form prior to May 30th, you'll guarantee your reservations in the activities of your choice in a veritable Adventure Gaming Utopia. We urge you to read through this form carefully so as to plan your activities and budget your time wisely to insure that you derive as much pleasure as possible from your visit. Nowhere else will you find as many tournaments, exhibits, new adventure gaming products, hobby personalities, and fellow hobbyists massed in one place for a virtual orgy of gaming activity.

If you have never attended a game convention before, you're in for a treat. ORIGINS XI looms as potentially the largest ORIGINS ever with many first-time exhibitors including industry giant Milton Bradley and several overseas companies. The ORIGINS 85 staff has hosted five of the ten previous ORIGINS National Gaming conventions in the Baltimore-Philadelphia area and is at peak strength for this year's extravaganza. The Towson State University campus in Towson, MD (just north of Baltimore) offers a combination of luxurious facilities and ample space the likes of which seldom graces a gaming convention of any scale. The advantages of this year's site include new lodging facilities and thoroughly air-conditioned event areas which are easily equal or superior to any such facilities used previously.

**DIRECTIONS:** TSU is accessible directly by four lane highway along the hub of Interstate I-95 and I-695 with easy access to I-70 and I-83 and contains thousands of parking spots readily accessible to convention attendees. Many of the Baltimore area's finest restaurants and motels are within a 10 minute drive, although food and lodging services abound on campus. Pre-registrants will receive more detailed maps and directions by return mail with their confirmation.

**FROM THE NORTHEAST** take I-95 South to the Baltimore Beltway (I-695). Take Beltway Exit 25 Charles Street South to the second light and turn left onto Towson Blvd. Follow signs to the registration area. **FROM THE NORTH** take I-83 South directly to the Charles Street South exit. **FROM THE WEST** take I-70 to I-695 and proceed northeast to Towson and the Charles Street South exit. **FROM THE SOUTH** take I-95 north to I-695 and proceed northeast to Towson and the Charles Street South Exit.

**MOTEL DIRECTIONS:** To the Holiday Inn in Timonium, take I-83 Exit 24 from I-695 North to the first exit. Proceed on Timonium Road east to the first light, and turn right. To the Quality Inn in Towson, take York Road Exit 26 from I-695 South. The Quality Inn is visible just inside the beltway on your left.

Plan to make a week of it. Baltimore is within an hour's drive of numerous points of interest for vacationing gamers: Aberdeen Proving Grounds with its massive AFV collection, Gettysburg battlefield, Fort McHenry and the USF Constellation, the nation's capital, and major league baseball in the form of the World Champion Detroit Tigers vs our very own Baltimore Orioles on July 1st, 2nd, and 3rd. A bit further afield one can sample the delights of Maryland's seashore at Ocean City to the east, Atlantic City and casino gambling to the northeast, Hershey Park to the North and King's Dominion to the south, and historic battlefields such as Antietam and Fredricksburg, or Harper's Ferry to the West. Charm City Travel, our motel reservation and travel agent, will be happy to arrange side trips for you to local points of interest. See "Motels."

**PRICING POLICY:** The ORIGINS policy has always been to spread the cost of participation between

the admission fee and event fees so that expenses correspond to the amount of participation. The ORIGINS 85 staff does not set prices for any event; these are determined by the various manufacturers, clubs, and individuals which sponsor each event and receive those revenues to offset their expenses in participation at the show. These prices vary widely to reflect the popularity of the event, the cost of putting it on, the prizes being offered, and the motivation of each sponsor. However, there are a great number of free events and one could easily entertain oneself without paying another cent beyond the price of ORIGINS 85 membership. The ORIGINS 85 staff is proud to point out that despite inflation, we have kept membership, lodging, and food prices BELOW the level of those at recent ORIGINS while upgrading the quality of the facilities available to attendees. In fact, Pre-Registrants to ORIGINS XI can purchase their attending memberships at a rate LOWER than that charged at the door for ORIGINS 81.

**PRIZES:** ORIGINS has a uniform policy for all events unless stated otherwise. All events designated as tournaments will have a standard 1st place plaque for the winner which may be picked up at the Tournament HQ anytime after the completion of the event. These are separate from merchandise certificates which will be given out as additional prizes for specified events. Merchandise certificates, redeemable at any manufacturer's exhibit, must be redeemed at the convention; they will not be honored by mail. Certificates awarding a dollar amount of merchandise as a prize must be used in full; they cannot be redeemed for cash in whole or in part. Any additional prizes offered are the responsibility of the sponsor and the participant. The ORIGINS 85 staff is not responsible for the awarding of any prizes not advertised as such and using this format in the convention program. Participants are urged to check the event listings if prizes are important to them for they vary widely. Some sponsors give out far more in prizes than they take in from entry fees, and for others the reverse is true. The only constant is that an event classified as a tournament will receive a standard 1st place ORIGINS 85 plaque.

#### HIGHLIGHTS:

- FOUR days of Adventure Gaming Events
- Over 500 events of all types and description
- One Free program book to each attendee
- Free Discount coupons to each Pre-Registrant
- Free Door Prizes at each booth for lucky attendees
- Over 100 Free demonstrations and seminars
- Dozens of championship tournaments in a wide assortment of games
- Pre-Registration for most paid events
- Painting Contest for Fantasy and Historical Figures, Units, Armies
- Unveiling of the industry's new products
- Game Auctions all three days
- Over 50 Historical Miniatures Events
- Hobby Personalities
- Video Arcade room
- Open Gaming Galore
- Free Movies

**EMERGENCIES:** In case of an emergency, a message to call home can be received by calling 301-298-3135 and we will attempt to find you—a feat made easier if you are pre-registered.

**ADMISSION & HOURS:** Pre-Registration is highly recommended. It helps us by taking away much of the pressure from on-site registration and in allotting the proper facilities to the most popular events. It helps you to avoid long lines, and guarantees you a place in the events of your choice. Most events have a limited number of openings and will sell out before the first die is cast. If you are pre-registered, you cannot be locked out of your favorite event, or if you are you will be notified by mail in time to make another selection. Moreover, if you pre-register you save

money over the gate admission price, earn discount coupons to spend at the exhibits not available otherwise, and may pre-order your official ORIGINS 85 SOUVENIR T-SHIRT at \$2 off the normal show price and have it waiting for you already made on Thursday even before the exhibit hall opens to the public. This \$6.00 T-shirt offer is available only to Pre-Registrants who order and pay for it with the enclosed Pre-Registration form prior to May 30th. Be sure to specify size and color desired. Available colors include: black, tan, silver, white, blue, and green. You must pre-register for the convention in order to pre-register for any events. Payment must be enclosed for your admission fee as well as any events. Attendance at ORIGINS 85 events and displays (except movies) is limited to those individuals wearing an ORIGINS XI badge. All pre-registrations must be filed on this form or a photocopy. If you need more forms, please request them. Pre-Registration forms must be postmarked no later than May 30th to guarantee acceptance.

Convention registration is \$18 per person for the entire weekend. Pre-registrations postmarked no later than May 30th qualify for a \$14 price. One day registration is available at the door only for \$10.00 per day.

Convention hours are Thursday, June 27th from Noon to Midnight, Friday, from 8 AM to Midnight, Saturday from 8 AM to Midnight, and Sunday from 8 AM to 6 PM. Sites for 24 hour gaming will be provided, but convention business will be handled only during the above hours. The Exhibit Hall will be open to paid attending members of ORIGINS XI on Friday and Saturday from 10 AM to 6 PM, and on Sunday from 10 AM to 4 PM.

Send pre-registration forms and payment to: ORIGINS XI, P.O. Box 139, Middletown, NJ 07748. Make all checks and money orders payable to ORIGINS XI. Send no cash. Canadian Pre-Reg must include Canadian/U.S. postal money orders in U.S. funds. All other checks and money orders must be in U.S. funds and drawn on U.S. banks. Confirmation will be by return mail. Should your Pre-Reg arrive too late to return confirmation, your materials will be held on file to be picked up at the Pre-Registration Desk when you arrive. Your confirmation will consist of a listing of events, lodging, and meal plans you have reserved, any refunds due you, your pre-registration receipt, and detailed maps and instructions. Bring your pre-registration receipt and package with you. Upon arrival, you will trade it for an envelope containing your convention program, any event or meal tickets you are entitled to, admission badge, and a receipt for lodging with instructions to proceed to the housing authority if you are staying on campus. If you lose your pre-reg receipt, merely ask for your materials by name and be prepared to show identification.

Everyone must be registered as an ORIGINS 85 member to gain admission—including event sponsors and exhibitors. Exhibit personnel have been registered by their firms, and must request their materials by company and individual name at the exhibitor registration desk. No one will be allowed to pick up registration materials for another person. Everyone must appear in person. If an exhibitor also wishes to register for an event he must do so on this pre-registration form and check the appropriate box for exhibitor status and list the firm he is with.

ORIGINS XI assumes no responsibility for lost materials. Lost badges, programs, event/meal tickets, or housing receipts must be repurchased if available at all.

**REFUNDS:** Due to the expense of registration generation and the need for event sponsors to be able to plan on a set number of participants it is not possible for us to issue refunds of any type due to a change of plans or a conflicting schedule. The only refunds is-

sued will be to registrants of cancelled or sold out events. We urge you to study the time periods of the events you register for to avoid conflicts, keeping in mind that multi-round tournaments can tie you up for long periods of time if you are not eliminated in the early rounds.

**PARKING:** Pre-registrants will receive a map suggesting available parking which is most accessible to the convention. Certain areas have been restricted to exhibitor, faculty, and staff use and require a special parking permit. Nevertheless, parking is plentiful, convenient, and free.

**FOOD:** Food service on campus is excellent and inexpensive. The University Dining Hall will provide two different meal plans for pre-registrants only. The \$25 plan will consist of six meals: dinner on Friday, three meals on Saturday, and breakfast and lunch on Sunday. A \$32 plan is also available which is good for eight meals: three each on Friday and Saturday, and breakfast and lunch on Sunday. This meal plan is an excellent buy and includes a wide assortment of beverages, salads, choice of multiple entrees, and desserts. The variance of choice in the daily salad and dessert bars is exceptional and includes soft ice cream for creative sundae designers. Meal tickets must be purchased no later than May 30th. Those looking for simpler fare can avail themselves of a wide variety of fast foods at concession stands on campus. A guide to nearby restaurants will be published in the convention program.

**LODGING:** On campus housing consisting of Dormitory accommodations is available for \$25 per person for a two day stay based on double occupancy. Additional days are \$12 each. There is a \$20 refundable deposit for key and linen per person which must be paid in advance to make the reservation. Keep in mind that all such room rates are based on double occupancy. IF YOU WISH TO STAY WITH SOMEONE YOU KNOW, YOU SHOULD MAKE ARRANGEMENTS FOR ONE PERSON TO PAY FOR AND RESERVE A ROOM FOR TWO PEOPLE UNDER HIS NAME ONLY BY PAYING THE COMBINED \$90 PRICE AND REFUNDABLE LINEN FEE ON ONE REGISTRATION. Each room has a connecting bathroom shared by one other room. If a group of four wants adjoining rooms they should specify in a covering letter accompanying both room reservations. Each dormitory will have available a number of lounges and rec rooms for open gaming. Pillows WILL be provided. Fresh towels will be available daily upon request.

**MOTELS & TRAVEL:** Motel accommodations exist within easy driving distance of the campus. Special reduced convention rates will apply only to those who book their reservations through CHARM CITY TRAVEL, 1 East Redwood, Baltimore, MD 21202. You may call at 301-244-8444 re: ORIGINS 85 motel or travel reservations. No Collect Calls Please. All room reservations are two night minimum stays and subject to 11% Baltimore County Hotel and Sales tax. A one night deposit is required to confirm your reservation with full payment due 45 days prior to the convention. Payment may be made by money order, personal check, or VISA/Mastercard. Rates vary but in all cases are considerably higher than on campus housing. If you wish to make your reservations yourself, feel free to do so, but be advised that the special convention rate will not apply. Shuttle service between the motels and the campus will be available only to those motels booked through Charm City Travel. Charm City Travel will also arrange transportation between the airport and the servicing motels. All motel reservations must be made directly with the motels or through Charm City Travels. DELTA AIRLINES is the official airlines for ORIGINS 85. Travel to Baltimore can be arranged through Charm City Travel or by calling DELTA's Convention Desk direct on 1-800-241-6760 and specifying that you are attending ORIGINS 85 in Baltimore.

**PAINTING COMPETITION:** In conjunction with ORIGINS 85, HMGS will be supervising and judging the Painting Competition. Registration will take place from Friday 1200 until Sunday 1000. Entries will be displayed throughout the weekend in the Ballroom on the third floor of the Student Union. HMGS will award prizes in the following categories: **FANTASY:** Best Figure, Unit, Army or Diorama. **HISTORICAL:** Best 15mm or smaller Army or Unit, Best 20mm or larger Army or Unit, Best equipment (any scale). In addition, there will be a Masters Award for previous winners, a Youth Award for entrants 18 and under, and a Best In Show which will be awarded the ORIGINS 85 Painting Competition Plaque.

**HMGS RAFFLE:** HMGS will raffle a 25mm Ral Partha 20 Figure, Northwest Frontier Unit, painted by Jay Hadley. Tickets will be \$1.00 or six for \$5.00 and can be purchased at the HMGS Table in the Student Union Ballroom.

**AUCTION:** Daily auction sponsored by Canam Associates. Times will be announced in the convention program and on signs in the registration area. Registration fee for each item will be 50 cents for items presented for sale. Items sold will be assessed a 10% fee with the registration fee deducted from this. Items not presented for sale will have their registration fees returned. All items will be sold in lots of ten. Additional information, as well as advance registration can be obtained by writing to: Canam Assoc., Route 130 North, RFD #1, Box 14, Delran, NJ 08075. Please send a SASE and indicate how many items you will be submitting so the proper number of forms can be sent to you. Some of the items to be available for sale are: a privately printed copy of *Ship O' The Line*, original copies of *Management* and *Chancellorville*, an unpunched round counter copy of *Tactics II* and the first commercially sold copy of *Battleline's Air Force*.

**EVENTS:** Events have been listed in three categories: tournaments, seminars, and demonstrations. Regardless of the category each event will have a specific number in bold type next to the name which will identify it as separate from every other event. The number will also be followed by an abbreviation which will identify the sponsor of that event. Together they constitute the event code which you must list on the pre-registration form when ordering admission to that event. Registration is not available for any free event, admission is first come, first served.

1. A session is normally a complete event in itself where a winner for the event is chosen (usually by points) after one playing of the game. Unless otherwise stated, you may only (1) enter one (1) session of any event. Example: You may enter only TS01-S1 or TS01-S2 (the AD&D open) but not both. Some events, however, encourage players to enter more than one session. Read the event description carefully!!

2. A round is an elimination stage of an event. You must win in the first round (R1) of an event to advance to subsequent rounds. Subsequent rounds are identified R2, R3, R3, etc.

3. There is a format for event descriptions. First is a 4-character code number for rapid identification of the event. Then comes the event title. On the send-in form, the title is followed by the event fee (if no fee, no preregistration can be made... don't try. Tickets for some events may only be purchased at the convention. Others are free and you simply walk in at the convention.)

In the event description section, the "Title Line" is followed by a description of the event. For RP (only) the event is followed by a statement of the game system used (Traveller, AD&D) if the system is not noted in the title line or event description. After this is the number of players in the round or session and for RP (only), the number of players per game. After this is the tournament rating system (TR=C2, for example. See Section 7.) Next is the method of winning (W: P, for example. Specifically, SE = Single Elimination, DE = Double Elimination, P = Points, S = Selection, E = Elimination (as in Demo Derbies)). This is followed by the running time for the event, the times of the other rounds or round/sessions if the event is a multiple-round tournament; and then by the cost to enter the event and the prizes to be awarded.

4. The above description applies to tournaments. Demonstrations, seminars and special events use variations of the system which should be self-explanatory (obviously, there's no prizes for a seminar).

5. If the "Prizes" section of a tournament description, certain conventions are used. MC means general Merchandise Certificates. MC/Att. means MCs will be awarded based on attendance. 1st: 25% R or similar following MC/Att. means Merchandise Certificates = 25% of the admission fees actually collected will be awarded to the 1st place winner. MC followed by a manufacturer's name or event code means the MCs awarded will be for that manufacturer's merchandise only. When Origins Plaques will not be awarded, a note to this effect will be made in the tournament description or at the heading for a section of events.

6. The Event Code definitions are as follows: (Note: (s) indicates a sponsored game club or individual) AB = Amarillo Design Bureau, AC = The Adventurers Club, AD = Adventure Systems, AH = Avalon Hill Game Company (s), AG = Advanced Gaming Technologies, Inc., AM = Adventures By Mail, BA = Mark Basset, BG = Bob Giglio, BR = Baltimore Role Games, CA = Chaosom (s), CG = Connecticut Game Club, CH = Campaign Headquarters/C-in-C, CL = Columbia Gamers, CO = Clash of Arms Games, CR = Carl Rigney, CS = Cheryl DRS DS&C Adventures, DW = Dan "Igor" White, EV = Escape Ventures, Inc., FA = FASA Corp., FG = Fantasy Games Unlimited (s), GA = Game-master Guides, GD = Game Designers Workshop, GN = Game News Magazine, GM = Steven Garcia/Chris Mazurek, GP = General Products Corp., GW = Games Workshop, HC = Historical Concepts, HH = Huscarle Hobbies, HM = Historical Miniatures Gaming Society, JA = Jenkintown Area Gamers, JG = Juggernaut, Inc., JG = John Prados, LZ = Lou Zocchi/Gamescience, MA = Mayfair Games (s), MB = Milton Bradley Corp. (s), ME = Mercer Adventure Gamers, MG = Monmouth Gamers, ML = Mark L. Gable, MD = Midland Players, MT = Mountaineer Gaming Association, MS = Micheal Strathearn, NE = Nelson Enterprises/Time Portal Hobbies, NY = New York Game Board, NW = North Western Pennsylvania Wargamers Assoc., OD = Omar DeWitt/AHKIS, PC = Panhellenic Council, PG = Paramount Games Club of Perry Hall, PH = Phoenix Salvage Company, PS = Paesetter, Ltd., RE = Ragnarok Enterprises, RM = Randy & Amy Martens, RH = Ruth Souard Pitt, RP = Ral Partha Ent., RS = Richard R. Sartore and Associates, Inc., RU = Rutgers University Gamers (RUG), SJ = Steve Jackson Games (s), SM = Steve Mecca, SS = Strategic Simulations Inc., ST = Stephen M. Smith, TA = Tag Industries, TB = Tom Brazil, TM = Theater of the Mind Enterprises, Inc., TR = Triangle Simulations Society, TS = TSR Inc. (s), UM = University of Maryland Historical Wargaming Society, UN = Unicorn Sanctuary, US = USMC, VG = Victory Games, VL = V.O.L.E., WD = Wilmark Dynasty, WE = West End Games (s).

Notes: For those who watch event-giver's names and codes, several changes have been made for past conventions. Be alert for them. For example, the U. of Connecticut group that gave "Lair of the Snow Trolls" and "Ziggurat" at Atlanticon '84 are now DS&C, the "Doom Crew" from Mercer Adventure Gamers is ME this year instead of MA (MA was preempted by Mayfair Games) and certain long time event-givers just aren't here and their codes are being used by others. The HM = Historical Miniatures Gaming Society code is a "blanket" designation, and the names of individual game-masters are given for all HMGS Events.

7. **TOURNAMENTS:** To aid you in selection of appropriate competitions, each event is rated according to difficulty and materials required as follows:

- A. Participant must bring copy of game materials to guarantee position.
- B. A copy of the game must be provided for every 3-8 players. Bringing your copy is advisable.
- C. Participant need not bring any materials.
- D. Other.

- 1. No experience needed. Rules will be explained to all.
- 2. General gaming experience required. Specific rules will be explained.
- 3. Players must be familiar with game.
- 4. For veteran players only.

#### SPECIAL EVENTS

##### GENERIC DUNGEONS

A limited number of "Generic Dungeons" will be offered to the AD&D fan who wishes to try a less expensive method of getting to play "Lots of D&D." These games are characterized by low price (\$2). No prizes, and no preregistration.... Tickets can only be bought at the convention. Short descriptions of the events will be given in the event listings, but the general data given for other events will not be given. Such data include: Game system: AD&D. Players: 6-10. TR=C3. W: None. R=3 Hrs. Fee=\$2. Prizes: None.

**AB02 STAR FLEET BATTLES PATROL TOURNAMENT:** Play as often as you want and whenever you want, the Amarillo Design Bureau will provide opponent matching. Best players will go to a play-off round. A desk will be located near the Room(s) where the Star Fleet Battles Captains tournament is being given during tournament hours and near registration at other times. This is an un-ticketed Official Tournament. Pay at the desk. Prizes: Approximately \$200 of TFG merchandise to winners.

**BR08 THE GREDADEIR VISUAL DUNGEON:** Under new management and with a new large-size

labyrinth, this 3-D Dungeon utilizes Grenadier figures which provide the hazard facing you as you penetrate the maze. Sessions start on the hour for every hour between TH16 & TH21, FR09 & FR21, SA09 & SA20 and SU09 & SU13. 16 Players per Session. TR=C1, W=SE, R/S=1 Hr. A second round will be held SU14, featuring a double-density slaughter. Fee=\$2 (Must be paid at the game, no tickets will be sold). Prizes: Grenadier figures for winner of each session, a large Grenadier figure for the overall winner.

**NY02 DIPLOMACY HOBBY MEETING:** Traditional open meeting. Discussions may include services, groups, tournaments, 'zines & controversies. A bid for Dipcon may be prepared. SA21. Free.

**NY03 OPEN GAMING CLEARING HOUSE:** The New York Game Board again offers their gaming service to convention attendees. From a desk near Registration, they will help arrange ad-hoc games or tournaments for the open gaming player. They will also act as general event information clearing house and will possess (Gasp!) a copy of the almost-mythical Master Event Schedule. Continuous during convention hours. Free.

**MP01-20 GENERIC TRAVELLER:** So you like to play Traveller! You really like to play Traveller!! Have we got an offer for you!!! The Midland Players offer this unusual event to dyed-in-the-wool "Traveller" fans. At frequent intervals (2 Hours, but interrupted by breaks for meals and other necessary functions), the Midland Players will offer inexpensive (\$2), mid-length (2 Hrs.) Traveller games. No plaques or prizes, just lots of Traveller. You may preregister for any or all of the 20 2-game sessions, they are all different. Unlike other events, only the titles will be given in the body of the event listings. General data is: 24 Players, 12/Game, TR=D2 (Bring paper, pencil, 6-sided and percentile dice). W: None. R/S=2 Hrs. Fee=\$2. Prizes: None.

**WD24 LOST WORLDS:** In this mobile game designed to aid the mobile conventioneer, players register at the Wilmark Dynasty desk in the ticket sales area and receive a "Lost Worlds" badge. Find another badge-wearer and play on your own. You buy 3 characters for \$1 (your choice). If you eliminate an opponent and have it confirmed by Wilmark Dynasty, you will gain points. If your third character is eliminated, you're out (You may buy more characters, however, Reenter as many times as you wish.) Person with the most points is the winner. Fee=\$1. This is not a ticketed event and it is rated as an Unofficial Tournament... no Origins Plaque will be offered. Other prizes: MC/Att; 1st: 50% R, 2nd: 25% R, 3rd: 15% R, 4th: 10% R.

**WD25 DRAGONRIDERS OF PERN:** Identical format to WD24 for Nova Game's contest of thread flanging.

#### MINIATURES TOURNAMENTS

This section of tournament descriptions is presented separately as there are a number of differences between many of the miniatures tournaments and other tournaments such as boardgame and FRP events. For example, many HMGS (Historical Miniatures Gaming Society) tournaments with less than 16 players per game/round/session are non-preregisterable/Unofficial Tournaments. This means Preregistration for the event is not possible, tickets must be purchased at the Convention. Such events have a (NP) after the Fee amount in their event description. It also means that no Origins Plaque is awarded and that the 40% Prize rule is not in effect. Many other miniatures events are Special Events called Demo/Tournaments which are non-ticketed and are free. Please read the event descriptions carefully to determine which miniatures tournaments are "Preregisterable" and which are not.

#### THURSDAY TOURNAMENTS/ DEMONSTRATIONS

##### 1800 (6:00 PM)

**HM01/RIS1 THE BEGINNING OF THE END:** The Meade Battlegaming Society presents Micro-armor battles, the Russian counter-offensive, 1942. Hosted by Steve Corby and Chris Fawcett. Entrants will be divided into teams of 2 players each. The rules are specially designed for this tournament. 16 Players (8 in each 1st Round Session). TR=D2 (Bring paper and pencil). W:SE (By team). R/S=4 Hrs. R1/S1: TH18, R1/S2: FR09, R2: FR14, R3: SA18. Fee=\$3. Prizes: MC/Att.; 1st (team): 25% R, 2nd (team): 12.5% R.

**TR01 PANZERSHIPHS DEMO/TOURNAMENT:** This free event partakes of demonstration and tournament, you can play in competition, but it's free. This Triangle Simulation Society event features WWII Pacific Naval action using "PanzerShiffs" original edition rules and 1/2400 naval miniatures. Ed Mohrmann, host, 6 players (unlimited watchers). TS=C2, R=3.5 Hrs. Prizes (in a free event): Players will receive a "PanzerShiffs" 1/2400 naval miniature.

##### 1900 (7:00 PM)

**HH02/S1 PANZIER TACTICS DEMONSTRATION:** Dennis Long hosts this demonstration of his WWII Micro-Armor rules. The rules are fast and easy but more detailed than most. Hands-on participation. Those planning to attend the Panzer Tactics Tournament will get first opportunity to participate. Free.

**TR02 NAPOLEONIC 15MM GRAND TACTICAL DEMO/TOURNAMENT:** Triangle Simulation Society and Ed Mohrmann host this free tournament for 15mm Napoleonic using the "On To Richmond" Napoleonic variant. Three Corps per side, 8 Players. TR=C2, R=4 Hrs. Prizes (in a free event): 2 copies of the "On To Richmond" rules will be awarded to players (by drawing).

#### FRIDAY TOURNAMENTS/ DEMONSTRATIONS

##### 0900 (9:00 AM)

**HM01/RIS2 THE BEGINNING OF THE END:** See HM01/RIS1 (TH18) for details.

**HM29 STONE'S RIVER:** Civil War Miniatures of Michigan present the epic struggle for middle Tennessee, pitting Braxton Bragg's Army of Tennessee against the Union's Gen. Rosecrans and the Army of the Cumberland at Murfreesboro in the winter of 1962. The game requires 16 "General Officers" (a.k.a. Players). TR=B4, W: P=10 Hrs. Fee=\$2 (This is a ticketed event!). Prizes: MC/Att.

##### 1000 (10:00 AM)

**TR03 PANZERSHIPHS DEMO/TOURNAMENT II:** Triangle Simulation Society and Michael Phelps host this free WWII South Atlantic naval action. "PanzerShiffs" rules and 1/2400 miniatures will be used. 6 Players. TR=C2, R=3.5 Hrs. "PanzerShiffs" 1/2400 naval miniature.

**TR04 WWII 20MM SKIRMISH DEMO/TOURNAMENT:** This free demo/tournament is hosted by the Triangle Simulations Society (Ed Mohrmann) and features armed reconnaissance in the European Theater. 8 Players. TR=C1, R=3 Hrs. Prizes (in a free event): The Player winning a draw after the game will receive the miniatures used.

##### 1200 (12:00 NOON)

**CH01/RIS1 ONE-ON-ONE WRG MODERN MICROARMOR:** One-on-one competition with a 3000 pt. WRG Modern Microarmor Force. Miniatures, 16 Players (4 in each 1st Round Session). TR=A3, W: SE. R/S=2 Hrs. R=1/S1: FR12, R1/S2: FR14, R1/S3: FR16, R1/S4: FR18, R2/S1: SA09, R2/S2: SA11, R3: SA13, R4: SA16. Fee: \$3 (NP). Prizes: C-in-C MC; 1st: \$20MC, 2nd: \$15MC, 3rd: \$10MC, 4th: \$5MC.

##### 1300 (1:00 PM)

**CL01 EMPIRE III TOURNAMENT #1:** The Columbia Gamers and host John Lange present a Napoleonic Battle for players familiar with Empires III. 8 Players. TR=B3, W: S. R=8 Hrs. Fee=\$4 (NP). Prizes: The best sportsman on each side will receive a prize.

**HH02/S2 PANZER TACTICS DEMONSTRATION:** See HH02/S1 (TH19) for details.

**HM02 TRICORNE 25MM SEVEN YEARS WAR TOURNAMENT:** Join the Seven Years War Association in their annual 25mm game. Bring your own SYW figures if desired. HOST: Ken Burger. 10 Players. TR=D2 (bring ruler and 2 D6 dice). W: S. R=4 Hrs. Free. Prizes: set of Tricorne rules to the winner.

**HM03/S1 THE BATTLES OF FREDRICK THE GREAT:** Refight Fredrick's battles with a new set of Grand Tactical Seven Years War rules specifically designed to complete huge actions within 3 to 5 hours. Host: Robert Coggins, 12 Players (6 per Session), 6/Game. TR=C1, W: E. S=3 Hrs. Fee=\$2 (nt). Prizes: The best player in each game will receive a prize from HMGS.

**HM04/S1 COLUMB. LINE AND SQUARE 15MM NAPOLEONICS:** Play CLMS with one of the Masters from New York. The games will be played on Dave Waxtel's terrain boards. Host: Dave Waxtel, 16 Players. TR=C2, W: S. S=5 Hrs. Fee=\$2 (NP). Prizes: HMGS award for best player on each side.

##### 1400 (2:00 PM)

**CH01/RIS2 ONE-ON-ONE WRG MODERN MICROARMOR:** See CH01/RIS1 (FR12) for details.

**TR05 RAID-20MM SKIRMISH DEMO/TOURNAMENT:** "Home-Brew" rules: Mercenary action in 20mm. Scenario placed in Africa in the early 1960's. Hosted by Ed Mohrmann of the Triangle Simulation Society, 8 Players. TR=C2, W: S. R=4 Hrs. Free. Prizes: A drawing will be held after the game. The winner will receive the miniatures used in the game.

#### 1600 (4:00 PM)

**CH01/R153 ONE-ON-ONE WRG MODERN MICROARMOR:** See CH01/R151 (FR12) for details.  
**HM05 NAPOLEONIC NAVAL SHIPS DEMO/TOURNAMENT:** Bill Bethke hosts this Napoleonic naval battle using 1/1200 Sailing Ships using "Wooden Ships and Iron Men" rules. 10 Players. TR=C2. W: S. R=5 Hrs. Free.

#### 1800 (6:00 PM)

**CH01/R154 ONE-ON-ONE WRG MODERN MICROARMOR:** See CH01/R151 (FR12) for details.  
**TB01/S1 NATO STRIKES BACK:** Tom Brazil hosts this modern-era game using "Challenger" rules. This will be a 3-battle mini-campaign beginning with a Soviet airborne attack on a West German airfield. The other 2 Sessions are NATO counterattacks. Players are urged to enter each session, as the overall winner will be selected on total points scored in all session entered. 8 Players per Session. TR=B3. W: P. S=4.5 Hrs. Fee=\$3 (per Session. \$3 gets you into one (1) session only). Prizes: MC/Att.

#### 1900 (7:00 PM)

**HH02/S3 PANZER TACTICS DEMONSTRATION:** See HH02/S1 (TH19) for details.

**HM06/S1 RALLY ROUND THE FLAG:** March 15mm Union or Confederate Brigades across a realistic terrain table to the drum beat of authentic, easy-to-follow "Rally Round the Flag" rules. Patrick McGuire, host. 8 Players. TR=C1. W: SE. R=4 Hrs. Fee=\$2 (NP). Prizes: Best general in each game receives an HMGS prize.

**HM07/S1 "LE BRIGADIER" 7 YEARS WAR RULES DEMO/TOURNAMENT:** The New York Gamers present a new set of 7YW Rules for Brigade Level actions. John Guarneschi, host. 12 Players (6 in each Session). TR=C1. W: S. S=4 Hrs. Free.

**HM08 "RETINUE" MEDIEVAL RULES:** Steve McHenry hosts this event using modified "Retinue" Medieval Rules for man-to-man combat in the 14th Century. 6 Players. TR=C1. W: S. R=3 Hrs. Fee=\$2 (NP).

#### 2000 (8:00 PM)

**TR06 OLD WEST SKIRMISH DEMO/TOURNAMENT:** The Triangle Simulation Society and Stephen G. Walburn host this 3-sided Old West shoot-out using 23mm miniatures. 8 Players. TR=C1. W: None. R=3.5 Hrs. Free. Prizes: A drawing will be held after the event and the winner will receive the miniatures used in the game.

#### SATURDAY TOURNAMENTS/ DEMONSTRATIONS

##### 0900 (9:00 AM)

**CG02 OLD FASHIONED COWBOYS AND INDIANS:** Featuring stupid rules, a ridiculous unrealistic scenario, unfair victory conditions, cheap unpainted 54mm plastic figures (including horses with broken legs), overpriced entry fee... but otherwise Great Fun!!! (Description written by GM). 16 Players. TR=C1. W: P. R=4 Hrs. Fee=\$2 (NP). Prizes: HMGS merchandise prizes.

**HH01 PANZER TACTICS:** Huscarle Hobbies and C-in-C offer this Official Tournament (With Origins Plaque) using fast, easy, but detailed WWII Micro-Armor rules. Enjoy some of the great tank confrontations of the Second World War. 24 Players (3-player teams. All players play in the first two "Rounds") and the best two teams fight it out in the 3rd Round. TR=C2. W: P. R=4 Hrs. R1: SA09, R2: SA18, R3: SU09. Fee=+4 (This is a ticketed event). Prizes: Over \$150 in C-in-C Merchandise Certificates.

**HM06/S2 RALLY ROUND THE FLAG:** See HM06/S1 (FR19) for details.

**HM10 WRG 25MM ANCIENTS TOURNAMENT:** This Official Tournament (an Origins Plaque will be awarded) requires 1250-pt. armies, up to 3 variations of troop lists from WRG Books 1, 2, or 3, 6th Edition Rules. For further information, contact Kruse Smith, 2345 McFarlane Ave., Lake City, FL 32055. 32 Players. TR=A3. W: E. R=3 Hrs. R1: SA09, R2: SA14, Optional R3: SA18. Semifinals: SU09. Finals: SU13. Fee=\$5 (This is a ticketed event). Prizes: HMGS prizes in addition to Origins Plaque.

**HM11 WRG 15MM ANCIENTS TOURNAMENT:** This Official Tournament (an Origins Plaque will be awarded) requires 1250-pt. armies, up to 3 variations of troop lists from WRG Books 1, 2, or 3, 6th Edition Rules. For further information, contact Kruse Smith, 2345 McFarlane Ave., Lake City, FL 32055. 32 Players. TR=A3. W: E. R=3 Hrs. R1: SA09, R2: SA14, Optional R3: SA18. Semifinals: SU09. Finals: SU13. Fee=\$5 (This is a ticketed event). Prizes: HMGS prizes in addition to Origins Plaque.

**HM12 WRG MASTERS TOURNAMENT:** The U.S. National Championship Tournament, sanctioned by WRG. For previously qualified winners. Re-

quires 1250-pt. armies, up to 3 variations of troop lists from WRG Books 1, 2 or 3, 6th Edition Rules. For further information, contact Kruse Smith, 2345 McFarlane Ave., Lake City, FL 32055. 24 Players. TR=A4. W: E. R=3 Hrs. R1: SA09, R2: SA14, Optional R3: SA18. Semifinals: SU09. Finals: SU13. Free. Prizes: Origins Plaque plus HMGS Prize.

**HM13 RETINUE:** Refight a medieval skirmish from the French Civil Wars in the late 14th Century using modified "Retinue" rules. Host: Michael Caig-head. 6 Players. TR=C2. W: S. R=3 Hrs. Fee=\$2 (NP). Prizes: HMGS Prize.

**HM28 SMALL UNIT ACTION RULES DEMONSTRATION:** The Potomac Wargamers bring you a demonstration, using single mounted figures, of several new approaches toward modeling firepower, morale and command and control problems of small units. Host: Wally Simon. 8 Players and unlimited on-lookers. TS=C1. W: None. R=1.5 Hrs. Free.

#### 1000 (10:00 AM)

**HM09 RANGE WAR: SALACIOUS, TEXAS:** Sheepman, Cattleman, Sheriff and Marshal fight for control of Salacious, Texas. 1st round shoot-out familiarizes players with rules and reduces their number to 6 for the final round. Host: Richard Bryant. 12 Players. TR=C1. W: E. R=1.5 Hrs. R1: SA10, R2: SA1130. Fee=\$2 (NP). Prizes: Winner: "Courier" Gift Certificate. Set of Gamescience Rules plus a consolation prize for 1st round losers.

**HM14 NAPOLEONIC NAVAL SHIPS:** Bill Bethke hosts this Napoleonic naval battle using 1/1200 scale ships. "Wooden Ships and Iron Men" rules will be used. 12 Players. TR=C2. W: S. R=5 Hrs. Free.

**HM15 DRUMS ALONG THE MOHAWK:** William Plotz hosts this French and Indian war historical skirmish/role-playing game. 6 Players. TR=C1. W: S. R=5 Hrs. Free.

**RS01/S1 THE OFFICIAL "SEEKREIG" TOURNAMENT:** This naval miniatures tournament features Santiago, the birth of American naval power in the Pre-Dreadnought era. Spain v/s the U.S.A. in this historic naval battle in 1898. 10 Players. TR=C2. W: SE. S=4 Hrs. Fee=\$2 (This is a ticketed event). Prizes: Origins Plaque + other prizes.

**TB01/S2 NATO STRIKES BACK:** See TB01/S1 (FR18) for details.

#### 1300 (1:00 PM)

**CL02 EMPIRE III TOURNAMENT #2:** The Columbia Gamers and host John Lange present a Napoleonic Battle for novice as well as experienced Empire III players. 8 Players. TR=C2. W: S. R=8 Hrs. Fee=\$4 (NP). Prizes: The best sportsman on each side will receive a prize.

**HM04/S2 COLUMN, LINE AND SQUARE 15MM NAPOLEONICS:** See HM04/S1 (F13) for details.

**HM07/S2 "LE BRIGADIER" 7 YEARS WAR RULES DEMO/TOURNAMENT:** See HM07/S1 (FR19) for details.

**HM17 THE GREAT WALL OF HAUB:** Can you get over the "Great Wall of Haub"? Find out in this simulation of a medieval storming action in 25mm. Host: Fred Haub. 8 Players. TR=C2. W: S. R=4 Hrs. Fee=\$1 (NP). Prizes: HMGS prize to player voted best sportsman by fellow players.

#### 1400 (2:00 PM)

**HM03/S2 THE BATTLES OF FREDRICK THE GREAT:** See HM03/S1 (FR13) for details.

**HM16 SEAPOWERT III: BATTLE OF JAVA SEA:** Recreate the Battle of the Java Sea in 1/1200 scale using "Seapower" Rules. Played on the floor. Novices will be paired with experienced players. 20 Players. TR=C1. W: S. R=3 Hrs. Free.

#### 1500 (3:00 PM)

**HM18 ON TO RICHMOND:** Command a Division in one of Paul Koch's nefarious American Civil War Scenarios. ACW Rules. 10 Players. TR=D3 (Bring copy of rules). W: S. R=3 Hrs. Fee=\$1 (NP). Prizes: "Courier" gift certificate to best player as voted by his fellow players.

#### 1600 (4:00 PM)

**HM19 HORSE AND MUSKET RULES FOR THE AMR:** A tactical level wargame that reflects the nature of battles during the American Revolution (AMR), including the preponderance of Infantry, wide use of Militia and the importance of leadership and training. Host: Alain Coughlin, 6 Players. TR=C2. W: S. R=4 Hrs. Free. Prizes: "Courier" gift certificate to player voted "Best" by his fellow players.

#### 1800 (6:00 PM)

**HM20 CHARGE PROJECT: 7 YEARS WAR:** Revival of the "Charge" rules for Seven Years War Association Members and other interested parties. Players must bring their own troops. No player limit. TR=D3 (Units must be large 25-30mm units or-

ganized for the "Charge Project"). W: None. R=5 Hrs. Free.

#### 1900 (7:00 PM)

**HM21 1914 BATTALION ACTION: THE GREAT WAR:** Refight a 1914 Battalion-size action between the French and Germans using 20mm figures and rules developed by Fred Haub and Terry Sirk. Host: Fred Haub. 6 Players. TR=B1. W: S. R=3 Hrs. Fee=\$1 (NP). Prizes: HMGS Prize.

**HM22 KOENIG KREIG:** Bring your own Koenig Kreig Brigadier or just yourself. Barry Gray will assign commands based on the number of participants. Battle will be fought on Dave Waxtel's terrain board. Unlimited players. TR=B2. W: S. R=5 Hrs. Fee=\$1 (NP). Prizes: HMGS prize to best player from each side.

**RS01/S2 THE OFFICIAL "SEEKREIG" TOURNAMENT:** See RS01/S1 (SA10) for details.

**TR01/S3 NATO STRIKES BACK:** See TB01/S1 (FR18) for details.

#### 2000 (8:00 PM)

**TR07 "HEART OF OAK" SAILING SHIP DEMO/TOURNAMENT:** A Napoleonic period naval action using Frigates. Are you another Hornblower or Bolitho? 1/1200 naval action by the Triangle Simulation Society. Host: Stephen G. Walburn. 10 Players. TR=C2. W: None. R=3.5 Hrs. Free. Prizes: Participants keep the 1/1200 Valiant miniatures used in the game.

#### SUNDAY TOURNAMENTS/ DEMONSTRATIONS

##### 1000 (10:00 AM)

**HM23 E-BOATS IN THE NORTH ATLANTIC:** Stephen McHenry hosts this WWII Naval Miniatures event. 6 Players. TR=C1. W: S. R=3 Hrs. Fee=\$2 (NP). Prizes: HMGS prize for best player.

##### 1300 (1:00 PM)

**HM24 NACH PARIS (FRANCO-PRUSSIAN RULES):** It's 1870 and you are there! Try this Franco-Prussian War game using the rules from The Courier, Vol. V, No. 6. Host: Paul Koch. 10 Players. TR=C2. W: S. R=3 Hrs. Fee=\$2 (NP). Prizes: "Courier" gift certificate to player voted best by his fellow players.

#### THURSDAY TOURNAMENTS

##### 1200 (12:00 NOON)

**AH20/S1 POWERS & PERILS NOVICE TOURNAMENT:** An exciting excursion through the streets of Dechat using pre-generated Characters and a detailed scenario. A wonderful introduction to Powers & Perils. 8 Players. TR=C2. W: P. S=3 Hrs. Fee=\$1. Prizes: MC/Att. + AH MC. 1 overall group of winners from all 6 Sessions.

**BR05/S1 THE MENDING STONE:** The Palantir of Athos has been shattered! Without its influence, Dimetric's demonic legions will overrun your homeland. You must find the Mending Stone to repair the Palantir! AD&D. 80 Players (40 in each Session), 10/Game. TR=C1. W: P. S=3 Hrs. Fee=\$4. Prizes: MC/Att.

**DS02/S1 ZIGGURAT:** Your quest for the 7th part of the Staff of Seven Parts has brought you to a mysterious Ziggurat. Can you recover the missing part? AD&D Var. 100 Players, 10/Game. TR=C3. W: P. R/S=3 Hrs. Fee=\$5. Prizes: MC/Att.; 1/game + 1 Overall for both sessions.

**ML01/S1 THE SNOW SERPENT AWAKENS:** See the Special Event Section for details of this Generic Dungeon Event. A short description is: The Snow Serpent has awakened! Can you stop it before it destroys the Northern Cities?

**PG01/S1 A REQUIEM OF QUIESCENCE:** Through a Demonic forest and over a cursed lake, you must retrieve the answer to the impossible riddle from Termaline before his island prison sinks. AD&D Var. 28 Players, 7/Game. TR=D4 (Bring Players Handbook and Dice). W=P. S=3 Hrs. Fee=\$5. Prizes: MC/Att.; 1/Session.

##### 1300 (1:00 PM)

**MP01 THE ANTARRAN CONNECTION:** See Special Events for data on the Generic Traveller Event.

**MS01/R151 RUNEQUEST III: THE GODDESS ARISES:** Roleplaying is stressed as the Characters defuse a war, rescue a kidnap victim, and generally sort out the mess. R2 is different as the winners from the two sessions (6 from each) confront and defeat a Great Evil. 8 Players, 8/Game. TR=B3. W=S. R/S=4 Hrs. R1S1: TH13, R1S2: FR13, R2: SA08. Fee=\$4. Prizes (r2 only): 1st: \$20 MC. 2nd: +10 MC. 3rd: \$8 MC. 4th-6th: \$4.

**SM01/S1 THE HOUSE OF IDIOCY:** See the Special Event Section for details of this Generic Dun-

geon. Returning booty-laden from an adventure, you find that the sagely mage who identifies your booty has committed himself to a institution treating mental illness. Can your group survive long enough to find him?

**WD10/S1 HOLY WAR:** Holy War has brought the realm to Chaos... recapture the artifacts which can aid in the rebuilding. AD&D. 24 Players, 8/Game. TR=C2. W: S. S=4 Hrs. Fee=\$14. Prizes: MC/Att.; 1 overall set of winners for the 4 Sessions. 1st: 50% R, 2nd: 25% R, 3rd: 12% R, 4th: 8% R, 5th: 5% R.

**WD22/S1 PARANOIA:** Paranoia! The Computer is your friend. The Computer wants you to be happy. If you are not happy, you could be used as reactor shielding. Paranoia RPG. 12 Players, 6/Game. TR=C2. W: S. S=4 Hrs. Fee=\$3. Prizes: MC/Att.; 1 overall set of prizes for the 2 Sessions. 1st: 50% R, 2nd: 25% R, 3rd: 15% R, 4th: 10% R.

#### 1400 (2:00 PM)

**AH01/S1 RUNEQUEST: A FISTFULL OF LUNARS:** A mysterious stranger and his band are disrupting commerce in a town in your Liege's Demense. Your group of adventurers must halt these activities. 16 Players, 8/Game. TR=C3. W=P. S=3 Hrs. Fee=\$4. Prizes: MC/Att.; 1 winner overall for 3 Sessions.

**AH21/R151 POWERS & PERILS ADVANCED TOURNAMENT:** An intensive adventure plumbs the depths of Powers & Perils in a challenging quest for the Tome of Kototh. 16 Players, 8/Game. TR=B3. W: S. R/S=2 Hrs. Two competitive "tracks": A=R1/S1: TH14, R1/S2: TH18, R2/S1: SA10 and R3/S1: SU10. B=R1/S3: FR10, R1/S4: FR14, RS/S2: SA14 and R3/S2: SU13. Fee=\$1. Prizes: MC/Att. + AH MC; 1 set of Winners overall for the entire tournament.

**ME01/S1 DOOM'S DAY:** Enter the Castle of Doom. Each player receives a painted Fantasy figure to battle his opponents. Each Victor keeps all figures he eliminates in combat. Miniatures. 20 Players. TR=C1. W=E. S=1/2 Hr. Fee=\$2. Prizes: Figures won. Players are encouraged to join multiple Sessions.

**MG04/S1 THE WIZARD'S TOWER: CARNAGE!** The infamous Southwest Quadrant of The Wizard's Tower has been rewritten for the younger player. Low-level (1-3) characters (a.k.a. Cannon Fodder) must penetrate the Tower's Tower only days after a major Devilish-Demonish Battle. For 12-18 age bracket. 30 Players, 10/Game. TR=C3. W=P. S=3 Hrs. Fee=\$3. Prizes: MC/Att.; 1 Winner overall for the 3 Sessions.

**WD23 COUNTDOWN:** The quiet Midwestern town of Pleasant Valley erupts into mayhem as a freak biological accident turns several of its leading citizens into stark, raving Banana Noses. Simultaneous movement featured in this different RPG. 20 Players. TR=C1. W: S. S=5 Hrs. Fee=\$4. Prizes: MC/Att.; 1st: 60% R, 2nd: 25% R, 3rd: 15% R.

##### 1430 (2:30 PM)

**ME01/S2 DOOM'S DAY:** See ME01/S1 (TH14) for details.

##### 1500 (3:00 PM)

**ME01/S3 DOOM'S DAY:** See ME01/S1 (TH14) for details.

**ML01/S1 THE SNOW SERPENT AWAKENS:** See the Special Event Section for details of the Generic Dungeon Event. A short description is: The Snow Serpent has awakened! Can you stop it before it destroys the Northern Cities?

**MP02 THE TERRORIST'S CREED, PART I:** See Special Events for data on the Generic Traveller Event.

**WD16/S1 ANYTHING BUT NEUTRAL:** It's just your luck to be assigned to another routine border patrol... then your luck changes—or does it? Star Trek RPG. 8 Players, 8/Game. TR=C2. W: S. S=4 Hrs. Fee=\$2. Prizes: MC/Att.

##### 1530 (3:30 PM)

**ME01/S4 DOOM'S DAY:** See ME01/S1 (TH14) for details.

##### 1600 (4:00 PM)

**AH20/S2 POWERS & PERILS NOVICE TOURNAMENT:** See AH20/S1 (TH12) for details.

**DS01 HORRORS OF THE DEMON'S DEN:** Can you recover a lost Book of Power from the evil forest of Demon's Den? A challenging adventure for those who play using their minds. AD&D Var. 100 Players, 10/Game. TR=C3. W=S. R/S=3 Hrs. Fee=\$5. Prizes: MC/Att.; 1/game + 1 winner overall.

**ME01/S5 DOOM'S DAY:** See ME01/S1 (TH14) for details.

##### 1630 (4:30 PM)

**ME01/S6 DOOM'S DAY:** See ME01/S1 (TH14) for details.



fying and 3 competition rounds ... everyone plays at least 2 games) and play-balance by victory points/PoC handicaps. Timed turns. Scoring by self-imposed goals, but a perfect record wins 1st place. 64 Players. TR=A3. W: P. R=4 Hrs. R1: FR12. R2: FR19. R3: SA08. R4: SA13. R5: SA18. R6: SU08. Fee=\$5. Prizes: MC/Att. + AH MC; Prizes for 1st six places.

**AH20/S3 POWERS & PERILS NOVICE TOURNAMENT:** See AH20/S1 (TH12) for details.

**PG01/S2 A REQUIEM OF QUIESCENCE:** See PG01/S1 (TH12) for details.

**RU02 COUNTDOWN TO WAR: THE OFFICIAL GDW TRAVELLER TOURNAMENT:** Your security team must stop Armand Carmona before he instigates a sector-wide war. This mission pits you against one of the largest Mega-Corporations. 40 Players, 8 Game. TR=C3. W: P. S=3 Hrs. Fee=\$4. Prizes: 1st: \$30 MC. 2nd: \$20 MC. 3rd: \$10 MC. 4th: \$5 MC.

**SM03/S1 NIGHT SANCTUARY & THE HOWLING HUNTER:** Caught in a storm, you and your fellow barbarians seek refuge in a nearby fortress. Will you survive the night?? Runequest. 16 Players, 8/ Game. TR=C4. W: P. S=4 Hrs. Fee=\$5. Prizes: MC/Att.; 1 group of winners overall for the 2 sessions.

**VL02/S1 WHERE'S THERE'S A WILL...:** See the Special Event Section for details of the Generic Dungeon Event. A short description is: Our beloved Uncle Bullroarer has (finally) departed by his well-deserved reward (?). His estate, on a small private island, includes a mansion and ground reputedly oozing with treasure. His human and non-human friends (?) and family (!) have gathered at the mansion for the reading of the will ... but the news of the treasure is out and ...

**WD13/S1 TWILIGHT 2000:** Join the U.S. 7th Airborne Division assault on Warszawa. Will the Polish Army aid the Warsaw Pact forces or resist them in the struggle for control of Poland. 16 Players, 8/ Game. TR=C2. W: S. S=4 Hrs. Fee=\$3. Prizes: MC/Att.; 1 overall set of winners for the 2 Sessions. 1st: 60% R. 2nd: 25% R. 3rd: 15% R.

**1300 (1:00 PM)**

**AH02/RS3 CIRCUS MAXIMUS:** See AH01/RS1 (TH21) for details.

**AH05 KINGMAKER:** Fight with York! Rally to Lancaster! Intrigue with Warwick! The War of the Roses distilled into a fast-paced, enjoyable essence. All games will be adjudicated at the end of 15 game rounds or 3 hours, whichever comes first. 36 Players. TR=A3. W: SE. R=3 Hrs. R1: FR13. R2: SU08. Fee=\$3. Prizes: MC/Att.

**AH22 MIXED BAG COMPUTER GAMING RUN-OFF:** Play involves a variety of the newest games by Microcomputers, Inc. Winners will be adjudicated by a Panel of 3 Judges. Computers will be supplied. 48 Players. TR=C2. W: S. R=2 Hrs. (or less ... elimination can be sudden!). R1: FR13. R2: SA9. R3: SU10. Fee=\$1. Prizes: MC/Att. + all entrants receive a discount coupon towards purchase of Micro-computer Games at the convention.

**DS04 THE STAFF OF DAWN:** Join the epic quest for the legendary Staff of Dawn, rumored to give its wielder command over the Sun. A unique two-part Wilderness/Dungeon Adventure. 100 Players, 10/ Game. TR=C3. W: P. R=3 Hrs. R1: FR13. R2: FR16. Fee=\$5. Prizes: MC/Att.; prizes for the 1st four places.

**FG03/S1 THE DRUMS OF DEATH:** To avoid a Congo bloodbath, your team of Mercenaries must locate and destroy a weapons cache planted by Communist Agents. FGU's "Merc" rule will be used. 20 Players, 10/ Game. TR=C2. W: P. S=3 Hrs. Fee=\$4. Prizes: MC/Att.

**GP01/RS1 SHOJI TOURNAMENT:** Although this game has the same roots as western chess, you'd hardly recognize this Japanese variant. 64 Players (32/1st Round Session). TR=D1 (games will be supplied). W: Sp. R/S=2 Hrs/2 Rounds. Two "tracks": A: R1&2/S1: FR13, R3&4/S1: FR19. B: R1&2/S2: FR15, R3&4/S2: SA09. Common RS&6: SA19. Fee=\$2. Prizes: MC/Att. plus \$2 MC to each participant and a discount towards purchasing the game used.

**GP03/RS2 THE OFFICIAL QUADRIM TOURNAMENT:** See GP03/RS1 (FR11) for details.

**ML01/S4 THE SNOW SERPENT AWAKENS:** See the Special Event Section for details of the Generic Dungeon Event. A short description is: The Snow Serpent has awakened! Can you stop it before it destroys the Northern Cities?

**MP07 THE HOSTAGE DILEMMA:** See Special Events for data on the Generic Traveller Event.

**MS01/S2 RUNQUEST III: THE GODDESS ARISES:** See MS01/S1 (TH13) for details.

**PS01/RS1 TIMEMASTER TOURNAMENT:** Adventures in any place, any time, in this universe of beyond, ... Join in this Pacesetter's tournament of adventures in the 4th Dimension. 8 Players, 8/ Game.

TR=C3. W: S. S=4 Hrs. R1/S1: FR13. R1/S2: SA09. R2: SA19. Fee=\$1. Prizes: MC/Att.; the best team from the 2 first round Sessions advances to R2.

**RH01/S1 RESCUE AT CARANAS/ANGURTH'S REVENGE:** Save young Prince Lorrin from sorcerer Angurth's evil plans. The best three players from each Session will face Angurth's cruel revenge in Round 2. A "Rolemaster" variant. 8 Players, 8/ Game. TR=C2. W: S. R/S=4 Hrs. R1/S1: FR13. R1/S2: SA10. R2: SA19. Fee=\$3. Prizes: MC/Att.; prizes for the 1st three places overall for the 2 Sessions.

**SJ03/RS2 NECROMANCER:** See SJ03/RS1 (TH18) for details.

**SJ06/RS1 ILLUMANATI:** Join in the tournament of World Domination sponsored by Steve Jackson Games. Expansion Set #2 will be used. 64 Players (32 in each R1 Session). TR=A3. W: SE. R1/S1: FR13. R1/S2: SA14. R2: SU08. Fee=\$3. Prizes: MC/Att.

**TS01/S3 THE AD&D OPEN:** See TS01/S1 (TH18) for details.

**WD10/S2 HOLY WAR:** See WD10/S1 (TH13) for details.

**WE02/RS2 COSMIC ENCOUNTERS:** See WE02/RS1 (TH18) for details.

**1400 (2:00 PM)**

**AH21/RS4 POWERS & PERILS ADVANCED TOURNAMENT:** See AH21/RS1 (TH14) for details.

**HC01 BATTLES OF THE FIRST EMPIRE: MARENKO:** The Designer provides special tournament scenarios for his detailed tactical Napoleonic simulation of Napoleon's early triumph at Marengo. 8 Players. TR=A3. W: SE. R=4 Hrs. R1: 14FR. R2: SA08. R3: SA16. Fee=\$2. Prizes: MC/Att.

**ME02/S5 ARENA OF DOOM: DOOM I:** See ME02/S1 (FR10) for details.

**MT01/RS2 THE PEARLS OF WISDOM:** See MT01/RS1 (FR09) for details.

**1430 (2:30 PM)**

**ME02/S6 ARENA OF DOOM: DOOM I:** See ME02/S1 (FR10) for details.

**1500 (3:00 PM)**

**AC01/S3 MURDER ON THE ORIENTAL DRAGON EXPRESS:** See AC01/S1 (TH19) for details.

**BR04/S1 RESEARCH BASE ALPHA, WHERE ARE YOU?:** There's been no communication from Research Base Alpha for 2 weeks; you are being sent to investigate why. Who knows what you will find? A Ringworld adventure. 56 Players (32 in S1, 24 in S2). 8/ Game. TR=C2. W: P. S=3 Hrs. Fee=\$4. Prizes: MC/Att.

**GP02/RS2 SHOJI TOURNAMENT:** See GP02/RS1 (FR13) for details.

**GP05/RS1 THE SHANG CHI TOURNAMENT:** Do you understand the Tao of War. Find out in this ancient Chinese game which is the most widely played game in the world. 64 Players (32/1st Round Session). TR=D1 (games will be supplied). W: Sp. R/S=2 Hrs/2 Rounds. Two "tracks": A: R1&2/S1: FR15. R3&4/S1: FR21. B: R1&2/S2: FR17. R3&4/S2: SA11. Common RS&6: SA21. Fee=\$2. Prizes: MC/Att. plus \$2 MC to each participant and a discount towards purchasing the game used.

**ME02/S7 ARENA OF DOOM: DOOM I:** See ME02/S1 (FR10) for details.

**MP08 THE SALVATION OF ARKAIE'S SOUL:** See Special Events for data on the Generic Traveller Event.

**PH01 STARSHIP "ENDOR": GHOST SHIP:** Phoenix Salvage Company is looking for a few good sentiments to help salvage abandoned and derelict spacecraft in the Lower Rift. High risk, high profit. Traveller variant. 30 Players/10 Game. TR=C1. W: P. S=3 Hrs. Fee=\$4. Prizes: MC/Att.; 50% R total, 7 prizes total.

**RU05 ASSAULT OF FORTRESS DIS:** Having survived to reach the dreaded Fortress of Dis, the final test is before you: enter and destroy the Fortress and the Darkness who resides within. AD&D. 40 Players, 8/ Game. TR=C3. W: P. S=3 Hrs. Fee=\$4. Prizes: 1st: \$30 MC. 2nd: \$20 MC. 3rd: \$10 MC. 4th: \$5 MC.

**WD11/S1 CHAMPIONS:** Superheroes match wits and Superpowers with those Arch-Villains and Evil Fiends ... Chaos!! Champions RPG. 16 Players, 8/ Game. TR=C2. W: P. S=4 Hrs. Fee=\$3. Prizes: MC/Att.; 1 overall set of winners for the 3 Sessions. 1st: 60% R. 2nd: 25% R. 3rd: 15% R.

**WD18/S1 THE WITHERED HEATH:** Middle Earth Role Playing! Off to the Withered Heath—the spawning place of Dragons—for a high Tolkien-style adventure. 10 Players, 10/ Game. TR=C2. W: S. S=4 Hrs. Fee=\$2. Prizes: MC/Att.

**WD21/S3 JAMES BOND:** See WD21/S2 (TH18) for details.

**1530 (3:30 PM)**

**ME02/S8 ARENA OF DOOM: DOOM I:** See ME02/S1 (FR10) for details.

**1600 (4:00 PM)**

**AH20/S4 POWERS & PERILS NOVICE TOURNAMENT:** See AH20/S1 (TH12) for details.

**CR01/S2 DEATH OF A NATION:** See CR01/S1 (FR09) for details.

**DW01/S1 THE ROOM OF WONDER:** See the Special Event Section for details of the Generic Dungeon Event. A short description is: Explore the one totally unexplored room in the Wizard's Tower and try to survive ... Unchanged!!

**MC02 WS&IM TEAM TOURNAMENT:** Third annual WS&IM 3-man team tournament. 8 teams will compete in a true test of seamanship, teamwork and skill. Close action rules and modifications will be taught and used. Limited communication. Rules are included with entry fee. Preselected teams are encouraged. Come early!!! 24 Players. TR=B2. W: SE (by team). R=3 Hrs. R1: FR16. R2: FR20. R3: SA09 (with MC03/S1). Fee=\$5. Prizes: 1st team: MCATT (50% R.) + Byes in MC03 (1 plaque per team member). 2nd team: Byes in MC03.

**VL04/S2 PAROUSIA (SPACE OPERA):** See VL04/S1 (FR09) for details.

**WD03 CALAMITY:** England's answer to Monopoly is this fast-paced insurance racket game. Learn it in minutes. A great beer and pretzels game (or maybe ale and chips ...). 36 Players. TR=B1. W: P. R=1 Hr. R1: FR16. R2: FR19. Fee=\$2. Prizes: MC/Att.; 1st: 70% R. 2nd: 30% R.

**1700 (5:00 PM)**

**VL01/S1 THE SHADOW KING:** Summoned to aid the denizens of Celandia, you must enter the barren lands of the Trolls and awaken the most Ancient and Terrible Power the world has ever known. A Chivalry and Sorcery Event. 8 Players, 8/ Game. TR=C3. W: S. S=4 Hrs. Fee=\$3. Prizes: MC/Att.

**1800 (6:00 PM)**

**AB01/RS2 STAR FLEET BATTLES FLEET CAPTAINS TOURNAMENT:** See AB01/RS1 (TH18) for details.

**AH06 THE "ON ALL FRONTS" G.I. TOURNAMENT:** A four round "Round Robin" tournament for players thoroughly familiar with the rules. Each player must bring some type of timing device. Winners on a Win/Victory Point basis. 60 Players. TR=A4. W: P. R=3 Hrs. R1: FR18. R2: SA09. R3: SA13. SA16. Fee=\$3. Prizes: MC/Att.; prizes for 1st four places.

**AH07 THE "ON ALL FRONTS" SQUAD LEADER TOURNAMENT:** A four round "Round Robin" tournament for players thoroughly familiar with the rules. Each player must bring some type of timing device. Winners on a Win/Victory Point basis. 30 Players. TR=A4. W: P. R=3 Hrs. R1: FR18. R2: SA09. R3: SA13. R4: SA16. Fee=\$3. Prizes: MC/Att.; prizes for the 1st four places.

**AH15 THE OFFICIAL AVALON HILL "DUNE" TOURNAMENT:** Don Tatum hosts this Avalon Hill event. Alliance rules will not be used, only one winner per game. Winners of the 6 first round games will advance. 36 Players. TR=B3. W: SE. R=4 Hrs. R1: FR18. R2: SA08. Fee=\$3. Prizes: MC/Att.; prizes for the 1st four places.

**AH19/RS1 WAR AT SEA:** Tim Hitchings parts the North Sea in this year's version of Avalon Hill's classic tournament. 64 Players. TR=A3. W: SE. R/S=2 Hrs. R1/S1: FR18. R1/S2: FR21. R2: SA08. R3: SA11. R4: SA14. R5: SA16. R6: SA21. Fee=\$2. Prizes: MC/Att.

**CA01/S1 THE OFFICIAL ELFOQUEST TOURNAMENT:** TRANSITIONS: An Elder of the Tribe is found murdered by a tribe of nearby Humans. The Woldriders must decide whether to attack or move on. 16 Players/8 Game. TR=C2. W: P. S=3 Hrs. Fee=\$4. Prizes: MC/Att.; 1 winner overall for the 2 Sessions.

**DW02/S1 THE ARCTIC ADVENTURE:** See the Special Event Section for details of this Generic Dungeon Event. A short description is: get away from the summer's heat to picturesque Hyperborea on a quest to rescue the Snow Princess.

**HC02 NAPOLEON IN SPAIN:** The Designer referees a multi-player double-blind version of this Napoleonic campaign game. Players command a Corps or Army. 9 Players. TR=C2. W: P. R=4-5 Hrs. Fee=\$3. Prizes: MC/Att.

**MA05/RS1 DC HEROS ROLE PLAYING GAME:** Play the Teen Titans as a team. The winning teams from the 2 first round session advanced to the finals in round 2. Reasoning and determination will determine the winning team of 6. 36 Players. 6/ Game. TR=C2. W: S. R=4 Hrs. R1/S1: FR18. R1/S2: SA09. R2: SU08. Fee=\$1. Prizes: MC/Att.

**MG02/S1 PRISON BREAK:** The mission is to rescue the chief of your bandit tribe from the dungeon of

the Wizard Cyteen before he returns from a journey. The Fantasy Trip system will be used. 16 Players, 8/ Game. TR=C2. W: P. S=3 Hrs. Fee=\$4. Prizes: MC/Att.

**MP09 THE MYSTERY OF ARLOS RESEARCH STATION:** See Special Events for data on the Generic Traveller Event.

**PC01/RS1 RETURN FROM HADES:** Betrayed, you awake in Hades!!! Have you the courage to escape and avenge yourselves on the one who put you here? 2 players from each R1 session advance to final round. AD&D. 8 Players (8 Game). TR=B3. W: S. S=4 Hrs. R1/S1: FR18. R1/S2: FR21. R1/S3: SA09. R1/S4: SA12. R2: SA21. Fee=\$4. Prizes: MC/Att.; 1st: 30% R. 2nd: 15% R.

**SJ01/RS1 AADA COMBAT RALLY:** This Steve Jackson-sponsored Car Wars tournament awards the Crown to the driver that has passed the most check points. 64 Players (32 in each 1st round session). TR=A3. W: P. R/S=3 Hrs. R1/S1: FR18. R1/S2: SA21. R2: SU08. Fee=\$3. Prizes: MC/Att.

**SJ07 TOON: CARDBOARD WARRIORS:** Join an intrepid crew of zany Adventurers in this wild and wonderful event featuring Steve Jackson's different role-playing game featuring Cartoon Characters disrupting a Gaming Convention. 30 Players, 10/ Game. TR=C2. W: P. S=3 Hrs. Fee=\$3. Prizes: MC/Att.

**VG07/RS1 COLD WAR FOR FUN AND PROFIT:** Victory Games hosts this 3-round single elimination tournament. Winner of game advances to next round. Cash prizes to 3rd round finalists. Strict time limit imposed. 64 Players (32 in each 1st round session). TR=A3. W: SE. R/S=3 Hrs. R1/S1: FR18. R1/S2: SA10. R2: SA18. R3: SU08. Fee=\$2. Prizes: 1st: \$75. 2nd: \$25. 3rd: \$10. 4th: \$5.

**WE02/RS3 COSMIC ENCOUNTERS:** See WE02/RS1 (TH18) for details.

**WD20/S1 VILLAINS AND VIGILANTES:** Daring Heroc challenge Evil forces which threaten all mankind! 8 Players, 8/ Game. TR=C2. W: S. S=4 Hrs. Fee=\$2. Prizes: MC/Att.

**WD22/S2 PARANOIA:** See WE22/S1 (TH13) for details.

**1900 (7:00 PM)**

**AC02/S1 THE WIERD OF SATHAR:** The Wierd of Sathar is an artifact of great power. You have been hired to find it. The problem is that nobody knows what it is. Characters provided. AD&D. 16 Players, 8/ Game. TR=A4. W: S. S=3 Hrs. Fee=\$4. Prizes: MC/Att.

**CS01 DEATH AT DAWN:** Escape or die! You are imprisoned for an offense against the Duke's justice. You hand in 4 Hrs. ... at Dawn. Players must be 18 or older. 32 Players, 8/ Game. TR=C3. W: P. R=4 Hrs. Fee=\$4. Prizes: MC/Att.; 1 set of overall winners for the 2 Sessions. 1st: 16% R. 2nd: 12% R. 3rd: 8% R. 4th: 4% R.

**PS03/S1 CHILL:** The manufacturer brings you this "Chill" event, featuring the most innovative RPG system in years. 8 Players, 8/ Game (in S2, 16 Players in 2 games). TR=C2. W: S. R=4-5 Hrs. Fee=\$1. Prizes: MC/Att.; 1 set of overall prizes for the 3 Sessions.

**UN01 QUEST FOR TYCHE'S ORB:** Unicorn Sanctuary brings you this adventure where good and evil prepare for war. Your experience is needed to retrieve the magic item that will insure victory, a dangerous task for quick minds. AD&D. 40 Players, 10/ Game (20 players advance to R2). TR=D4 (Writing materials, paper, dice, Players Handbook). W: S. S=3 Hrs. R1. 4 Hrs R2. R1: FR19. R2: SA08. Fee=\$4. Prizes: MC/Att.; 1st: 20% R. 2nd-3rd: 10% R.

**WD08/RS1 FOOTBALL STRATEGY:** This is Avalon Hill's Official Football Strategy Tournament, hosted by Wilmark Dynasty. Caliber of play still depends on the players, as always. 32 Players. TR=B3. W: SE. R/S=1.5 Hrs. R1/S1: FR19. R1/S2: SA12. R2&3: SA21, RS&6: SU08. Fee=\$2. Prizes: MC/Att.

**2000 (8:00 PM)**

**MP10 KIDNAP THE TRAITOR (COMBAT NARIEO):** See Special Events for data on the Generic Traveller Event.

**MS02/S3 THE QUEST FOR PEACE:** See MS02/S1 (TH20) for details.

**RM04/RS1 THE INTRUDER: AN OFFICIAL GDW TRAVELLER TOURNAMENT:** An alien vessel appears in Imperial Space ... it's time to send in the Marines and find out what it is ... and why it's here. (Notes: Sessions marked with (a) & (b) use different scenarios.) 16 Players, 8/ Game. TR=B3. W: P. R=4 Hrs. R1/S1(A): FR20. R1/S2(A): SA09. R1/S3(B): SA14. R1/S4(B): SA19. R2: SU09. Fee=\$3. Prizes: MC/Att.; 1st: 25% R. 2nd: 10% R. 3rd: 5% R.

**SM02/S2 THE HORROR OUT IN THE STICKS:** See SM02/S1 (TH20) for details.

**VL03/S1 INTO THE HIERARCH'S LAIR:** Negotiations were working... until the diplomatic mission vanished. Discover their fate before the Southlands perish in the final Dwarven/Elvish war. 60 Players. 12/Game. TR=B3. W: P. S=4-5 Hrs. Fee=\$4. Prizes: MC/Att.

**WD14/S1 MELANDA, LAND OF MYSTERY:** "In Search of Greater Things." The museum of Kali San, the poshest and wealthiest community in Melands, is offering extravagant sums for authenticated artifacts and relics. Who knows? You could get rich. Maybe. 30 Players (except in S3, where 40 can play). 10/Game. TR=C2. W: S. S=4 Hrs. Fee=\$3. Prizes: MC/Att. 1 overall set of prizes for the 3 Sessions. 1st: 50% R, 2nd: 25% R, 3rd: 12% R, 4th: 8% R.

**WD15/S2 THE IZORA GAMBIT:** See WD15/S1 (TH19) for details.

#### 2100 (9:00 PM)

**AH19/R1S2 WAR AT SEA:** See AH19/R1S1 (FR18) for details.

**BR03 ARENA OF THE COBRA KING:** In a world where magic and technology exist side by side, can your character survive the Pit or must his friends rescue him? Timemaster. 32 Players. 8/Game. TR=C2. W: P. R=3 Hrs. Fee=\$4. Prizes: MC/Att.

**CA02/S1 RINGWORLD:** ARM has sent you to Ringworld to stop the production of Drin, a highly addictive drug which is being distributed to Kzin throughout Known Space. 16 Players. 8/Game. TR=C3. W: P. R=3 Hrs. Fee=\$4. Prizes: MC/Att.

**DS05 THE LAIR OF THE SNOW TROLLS:** Ambushed by Snow Trolls, your weakened party struggles through the Arctic wastes to regain your lost possessions and claim vengeance on the evil Snow Trolls. AD&D. 100 Players, 10/Game. TR=C3. W: P. R=3 Hrs. Fee=\$5. Prizes: MC/Att.

**FG01/S2 AFTERMATH: MUTANT HUNT:** See FG01/S1 (TH18) for details.

**JA03/S2 REVENGE OF THE FOREST:** See JA03/S1 (FR09) for details.

**MG03/S2 THE WIZARD'S TOWER: HAVOCI:** See MG03/S1 (TH21) for details.

**MG05/S1 THE INN BETWEEN THE WORLDS:** Travel down the endless road to/from the Inn Between the Worlds, relying on your wits... and we mean you! You are your character. Survival requires that you be widely read in Fantasy and Gaming. Science Fiction. "Classical" Literature, etc. AD&D. Var. 10 Players, 10/Game. TR=C2. W: P. S=3 Hrs. Fee=\$5. Prizes: MC/Att.

**PC01/S2 RETURN FROM HADES:** See PC01/S1 (FR18) for details.

**RU07 OFFICIAL GDW IMPERIUM TOURNAMENT:** Command the United Forces of Terra of the veterans of the 1st Imperium in the life or death struggle for galactic supremacy. 32 Players. TR=A3. W: SE. R=3 Hrs. R1: FR21, R2: SA08, R3: SA12, R4: SA15, R5: SA18, Fee=\$13. Prizes: MC/Att. + GDW awards. Fees for 1st and 2nd places.

**SJ02/R1S1 OGRE-G.E.V./SHOCK WAVE:** This Steve Jackson-sponsored tournament begins with Ogre and ends with Shock Wave in the final round. 64 Players (32 in each 1st round session). TR=A3. W: SE. R/S=1 Hr. R1/S1: FR21, R2/S1: FR22, R3/S1: FR23, R1/S2: SA18, R2/S2: SA19, R3/S2: SA20, R4: SU08, R5: SU09, R6: SU10. Fee=\$3. Prizes: MC/Att.

**WE01 JUNTA:** Join this fast-paced tournament of South American politics that mirrors the reality of contemporary conditions in Latin America and can produce uncannily familiar situations. West End Games rules to be used. 49 Players. TR=A3. W: SE. R=3 Hrs. R1: FR21, R2: SU08. Fee=\$3. Prizes: MC/Att.

#### 2200 (10:00 PM)

**MP11 THE FINAL FLIGHT OF ATLANTICA:** See Special Events for data on the Generic Traveller Event.

### SATURDAY TOURNAMENTS

#### 0900 (9:00 AM)

**AC01/S4 MURDER ON THE ORIENTAL DRAGON EXPRESS:** See AC01/S1 (TH19) for details.

**AH01/S3 RUNEQUEST: A FIST FULL OF LUNARS:** See AH01/S1 (TH14) for details.

**AH18 STORM OVER ARNHEN:** Battle for the Bridge Too Far with Designer Courtney Allen critiquing your every move. 16 Players. TR=A4. W: SE. R=4 Hrs. R1: SA09, R2: SA14, R3: SA19, R4: SU08. Fee=\$4. Prizes: MC/Att. + AH MC.

**AH28 MACHIAVELLI:** Join in this unusual multiple round tournament of Avalon Hill's "Machiavelli" game. Advanced rules and natural disasters will be used. All players play in all three rounds with the best score after 3 rounds (using the rating point system)

winning. Bring a pencil and paper. 48 Players. TR=B3. W: P. R=4 Hrs. R1: SA09, R2: SA14, R3: SA19. Fee=\$3. Prizes: MC/Att.; 1st: 15% R, 2nd: 12% R, 3rd: 8% R, 4th: 5% R.

**BG01/S1 CIVIL WARS ROLEPLAYING IN 20MM:** Each player controls 3 characters in a small skirmish with emphasis on roleplaying. Players may enter both session as each is a completely different scenario. 60 Players (30/Session). TR=C1. W: S. S=4 Hrs. Fee=\$6. Prizes: MC/Att.; prizes for the 1st 4 places overall in the 2 Sessions.

**BR04/S2 RESEARCH BASE ALPHA, WHERE ARE YOU?:** See BR04/S1 (FR15) for details.

**CR01/S3 DEATH OF A NATION:** See CR01/S1 (FR09) for details.

**DS06 THE ISLE OF KAZAR:** The evil Kazar has stolen the Wizard Cassandra's most valuable ring! Can you first Kazar on his mysterious island and win back the ring? AD&D. 100 Players, 10/Game. TR=C3. W: P. S=3 Hrs. Fee=\$5. Prizes: MC/Att.

**JA02 DESERT SHADOWS OF DEATH:** An Official Chaosium Elfquest Adventure. Dart, young Wolfriider defender of Sorrow's End, leads the defense against an unexpected threat with surprising results. 32 Players, 8/Game. TR=C3. W: S. R=3 Hrs. R1: SA09, R2: SA13. Fee=\$4. Prizes: MC/Att.; prizes for the 1st three places given.

**MA02 HAMMER'S SLAMMERS:** Join Hammer's Slammer's and their opponents battling in a future where mercenaries are both king and victim (usually). Special tournament scenarios will be used. 32 Players. TR=A3. W: SE. R=3 Hrs. R1: SA09, R2: SU08. Fee=\$3. Prizes: MC/Att.

**MA05/R1S2 DC HEROS ROLE PLAYING GAME:** See MA05/R1S1 (FR18) for details.

**MC03 WS&IM INDIVIDUAL TOURNAMENT:** Mark Campbell hosts this perennial favorite. Improved rules will be used to reduce the effects of luck. Each round will test the player's knowledge of WS&IM, including Frigate, S.O.L. and actions in combination. Rules are included in the entry fee. Please come early!!! 64 Players. TR=A3. W: SE. R=3 Hrs. R1: SA09, R2: SA13, R3: SA16, R4: SA20, R5: SU08, R6: SU12. Fee=\$5. Prizes: 1st: \$100 MC or cash equivalent, 2nd and 3rd: MC/Att.

**MG04/S2 THE WIZARD'S TOWER: CARNAGE!** See MG04/S1 (TH14) for details.

**ML01/S5 THE SNOW SERPENT AWAKENS:** See the Special Event Section for details of the Generic Dungeon Event. A short description is: The Snow Serpent has awakened! Can you stop it before it destroys the Northern Cities?

**PC01/S3 RETURN FROM HADES:** See PC01/S1 (FR18) for details.

**PS01/R1S2 TIMEMASTER TOURNAMENT:** See PS01/R1S1 (FR13) for details.

**PS04 STAR ACE TOURNAMENT:** This Star Ace role-playing game adventure takes players light years beyond other game systems. 16 Players, 8/Game (best 4 from each game... or survivors... advance to R2). TR=C2. W: S. R=4 Hrs. Fee=\$1. Prizes: MC/Att.

**W4/R1S1 THE INVADER: AN OFFICIAL 'W' TRAVELLER TOURNAMENT:** See RM04/R 'FR20' for details.

**RU04 THE TALONS OF MAL-KOL-TAL:** Faced with p ison or a chance of freedom, you have chosen the latter. Now your journey into the mountains is about to reach its climax. AD&D. 40 Players, 8/Game. TR=C3. W: P. S=3 Hrs. Fee=\$4. Prizes: 1st: \$30 MC, 2nd: \$20 MC, 3rd: \$10 MC, 4th: \$5 MC.

**SJ04/R1S3 CAR WARS DEMO DERBY:** See SJ04/R1S1 (TH21) for details.

**WD04 CIVILIZATION:** The Official Avalon Hill "Civilization" tournament, hosted by Wilmark Dynasty. A world growth and conquest game wherein the spoils do not always go to the military victory. 36 Players. TR=B3. W: SE. R=3 Hrs. R1: SA09, R2: SU08. Fee=\$2. Prizes: MC/Att.; 1st: 50% R, 2nd: 30% R, 3rd: 20% R.

**WD10/S3 HOLY WAR:** See WD10/S1 (TH13) for details.

**WD12/S2 CHILL:** See WD12/S1 (TH19) for details.

**WD16/S3 ANYTHING BUT NEUTRAL:** See WD16/S1 (TH15) for details.

**WD17/S2 THE TOWER OF THE HIGH ONES:** See WD17/S1 (TH20) for details.

**WE02/R1S4 COSMIC ENCOUNTERS:** See WE02/R1S1 (TH18) for details.

#### 1000 (10:00 AM)

**ME03/S1 LABYRINTH OF DOOM: DOOM III:** Find your way through the Labyrinth of Doom. Each player receives a painted Fantasy figure. Players keep all the figures of eliminated opponents. Miniatures. 20 Players. TR=C1. W: E. S=1/5 Hr. Fee=\$2. Prizes: Players keep the figures of eliminated opponents.

**MP12 UNDERSEA EXPLORATION AND DISCOVERY ON OCANIA:** See Special Events for data on the Generic Traveller Event.

**RH01/S2 RESCUE AT CARANRA:** See RH01/S1 (FR13) for details.

**SS01/R1S1 THE OFFICIAL SSI BROADSIDES COMPUTER GAME TOURNAMENT:** SSI presents a 2-player (human v/s human) computer tournament of their popular "BroadSides" game placed in the Age of Fighting Sail. Players will face off using two identical vessels. SSI supplies the computers and software. 32 Players (8/1st Round Session). TR=C3. W: SE. S/R=1 Hr. 2 "Tracks;" R1/S1: SA10, R1/S2: SA11, R2/S1: SA15, R1/S3: SA13, R1/S4: SA14, R2/S2: SA16, Common R3: SU10, Common R4: SU11, R5: SU12. Fee=\$2. Prizes: Winner's choice of any SSI game.

**VG07/R1S2 COLD WAR FOR FUN AND PROFIT:** See VG07/R1S1 (FR18) for details.

**IC01/R1S2 FIRST OFFICIAL MERP TOURNAMENT:** See IC01/R1S1 (TH20) for details.

#### 1030 (10:30 AM)

**ME03/S2 LABYRINTH OF DOOM: DOOM III:** See ME03/S1 (SA10) for details.

#### 1100 (11:00 AM)

**ME03/S3 LABYRINTH OF DOOM: DOOM III:** See ME03/S1 (SA10) for details.

**SS01/R1S2 THE OFFICIAL SSI BROADSIDES COMPUTER GAME TOURNAMENT:** See SS01/R1S1 (SA10) for details.

#### 1130 (11:30 AM)

**ME03/S4 LABYRINTH OF DOOM: DOOM III:** See ME03/S1 (SA10) for details.

#### 1200 (12:00 NOON)

**AH20/R1S5 POWERS & PERILS NOVICE TOURNAMENT:** See AH20/R1S1 (TH12) for details.

**BR05/S2 THE MENDING STONE:** See BR05/S1 (TH12) for details.

**DW01/S2 THE ROOM OF WONDER:** See the Special Event Section for details of the Generic Dungeon Event. A short description is: Explore the one totally unexplored room in the Wizard's Tower and try to survive... Unchanged!!!

**NY01 DIPLOMACY:** Robert Sacks and John Boardman host this annual Diplomacy Tournament. All players must play in both rounds. All proceeds go to support hobby services. Victory by sum of points in both sessions. Up to 200 Players. TR=B3 (Bring lots of paper and a pen or pencil). W: P. R1=7 Hours, R2=6 Hours. R1: 12SA, R2: SU09. Fee=\$4. Prizes: MC/Att.; 1st 20% R + Origins Plaque, 2nd: 10% R + Cert., 3rd: 10% R + Cert. and 7 "Best of Country" Cert.

**PG01/S4 A REQUIEM OF QUIESCENCE:** See PG01/S1 (TH12) for details.

**RM01/S2 THE CHAMBER OF MIST:** See RM01/S1 (TH18) for details.

**SM03/S2 NIGHT SANCTUARY AND THE HOWLING HUNTER:** See SM03/S1 (FR12) for details.

**TS01/S4 THE AD&D OPEN:** See TS01/S1 (TH18) for details.

**WD08/R1S2 FOOTBALL STRATEGY:** See WD08/R1S2 (FR19) for details.

#### 1300 (1:00 PM)

**AH24 FIREPOWER:** Firepower designer Craig Taylor runs wild multi-player firefights using Avalon Hill's new man-to-man game of modern warfare. All players play in both rounds. 32 Players. TR=A2. W: P. R=2 Hrs. R1: SA13, R2: SA15. Fee=\$2. Prizes: MC/Att. + AH MC.

**CS01/S2 DEATH AT DAWN:** See CS01/S1 (FR19) for details.

**DS07 FINIEOUS FINGERS\*: THE RESCUE AT TELEMARK:** Play Finieous, Fred, Charly, Mergatroid of any of the Finieous Fingers\* comic characters in their fight against the Hobbit Thieves Guild and other surprises. 110 Players, 10/Game. TR=C2. W: P. S=3 Hrs. Fee=\$5. Prizes: MC/Att.; the best player in each group will receive a MC + a copy of the character they played (including a sketch signed by J.D. Webster. The overall winner will also receive an original autographed drawing of Finieous Fingers\* by J.D. Webster.

**FG02/S2 THE REVENGE OF THE SEVENTH SAMURAI:** See FG02/S2 (FR09) for details.

**MB01 CONQUEST OF THE EMPIRE:** Conquest of the Empire is a 7-player recreation of the Civil Wars that rocked the Roman Empire in the centuries following Caesar. 49 Players. TR=A3. W: P. R=3 Hrs. R1: SA13, R2: SU08. Fee=\$3. Prizes: MC/Att.

**ME03/S5 LABYRINTH OF DOOM: DOOM III:** See ME03/S1 (SA10) for details.

**MP13 THE HUNT FOR ARKAIIE'S TREASURE:** See Special Events for data on the Generic Traveller Event.

**PH02 STARSHIP "HIGH PARADISE"—RESCUE OF A PRINCESS:** Phoenix Salvage Co. is looking for a few good sapient to help salvage abandoned and derelict spacecraft in the lower rift. High risk, high profit. Traveller var. 30 Players, 10/Game. TR=C1. W: P. S=3 Hrs. Fee=\$4. Prizes: MC/Att.; total=50% R with 1st place overall getting 25% of this amount and each game's 1st and 2nd places getting 15% and 10% respectively.

**PS03/S2 CHILL:** See PS03/S1 (FR19) for details.

**SJ05 BATTLESUIT:** This Steve Jackson sponsored tournament brings you 21st Century man-to-man combat in the tradition of Ogre-G.E.V. 32 Players. TR=A3. W: SE. R=1 Hr. R1: SA13, R2: SA14, R3: SA15, R4: SU08, R5: SU09. Fee=\$3. Prizes: MC/Att.

**SS01/R1S3 THE OFFICIAL SSI BROADSIDES COMPUTER GAME TOURNAMENT:** See SS01/R1S1 (SA10) for details.

**VL02/S2 WHERE'S THERE'S A WILL...:** See VL02/S1 (FR13) for details.

#### 1330 (1:30 PM)

**ME03/S6 LABYRINTH OF DOOM: DOOM III:** See ME03/S1 (SA10) for details.

#### 1400 (2:00 PM)

**BG01/S2 CIVIL WAR ROLEPLAYING IN 20MM:** See BG01/S1 (SA09) for details.

**ME03/S7 LABYRINTH OF DOOM: DOOM III:** See ME03/S1 (SA10) for details.

**MG07 MONOPOLY:** Buy! Sell! Trade! build a Financial Empire! Maneuver for real estate, utilities, and transportation and try to gain a Monopoly in the classic Parker Brothers boardgame. 96 Players (6/Game in R1, 4/Game in R2 and R3). TR=A2. W: SE. R=3 Hrs. R1: SA14, R2: SA18, R3: SU08. Fee=\$2. Prizes: MC/Att.

**ML01/S4 THE SNOW SERPENT AWAKENS:** See the Special Event Section for details of the Generic Dungeon Event. A short description is: The Snow Serpent has awakened! Can you stop it before it destroys the Northern Cities?

**RM04/R1S1 FIRST CONTACT: AN OFFICIAL GDW TRAVELLER TOURNAMENT:** An utterly alien race establishes contact. Find out who they are and what they want as part of an Imperial Scientific Contact Team. (Note: Sessions marked with (a) and (b) use different scenarios). 16 Players, 8/Game. TR=B3. W: P. R=4 Hrs. R1S1(a): FR20, R1S2(a): SA09, R1S3(b): SA14, R1S4(b): SA19, R2: SU09. Fee=\$13. Prizes: MC/Att.; 1st: 25% R, 2nd: 10% R, 3rd: 5% R.

**SJ06/R1S2 ILLUMINATI:** See SJ06/R1S1 (FR13) for details.

**SS01/R1S4 THE OFFICIAL SSI BROADSIDES COMPUTER GAME TOURNAMENT:** See SS01/R1S1 (SA10) for details.

**VL01/S2 THE SHADOW KING:** See VL01/S1 (FR17) for details.

**WD09/R1S1 EMPIRE BUILDER:** Mayfair's Official "Empire Builder" tournament, hosted by Wilmark Dynasty. A fast-paced, high stakes, game of strategy. You challenge to become King of the Rails. B/S=1 Hr. S1: SA14, R1/S2: SA19, R2: SU08. Fee=\$2. Prizes: MC/Att.

**WD13/S2 TWILIGHT 2000:** See WD13/S1 (FR12) for details.

**WD20/S2 VILLAINS AND VIGILANTES:** See WD20/S1 (FR18) for details.

**IC01/R1S3 FIRST OFFICIAL MERP TOURNAMENT:** See IC01/R1S1 (TH20) for details.

#### 1430 (2:30 PM)

**ME03/S8 LABYRINTH OF DOOM: DOOM III:** See ME03/S1 (SA10) for details.

#### 1500 (3:00 PM)

**JA01 THE FINAL ENEMY: Invasion!** The Lunars have moved into Praxis, but when Lunar and Bison Rider hunt each other, both become quarry in a larger game. Runquest III. 32 Players, 8/Game. TR=C3. W: S. R=3 Hrs. R1: SA15, R2: SA19. Fee=\$4. Prizes: MC/Att.

**MP14 THE CONSPIRACY AT PHOENICIA:** See Special Events for data on the Generic Traveller Event.

**RU03 TREASURE OF THE DRAGON QUEEN:** Find and secure the fabled cache before the forces of darkness subjugating the region stumble across it. God knows what will happen if they do. AD&D. 40 Players, 8/Game. TR=C3. W: P. R=5 Hrs. Fee=\$5. Prizes: MC/Att.; 1st: \$30 MC, 2nd: \$25 MC, 3rd: \$15 MC, 4th: \$10 MC.





# ORIGINS XI

DISTRIBUTOR USE ONLY

**PRE-REGISTRATION FORM:** Fill out the form below and return it to ORIGINS 85, P.O. Box 139, Middletown, N.J. 07748. Be sure to enclose payment made payable to ORIGINS 85. Do not send cash. Pre-registration must be made on this form or a photocopy for each individual. Even exhibitors must use this form if they intend to register for events. Please print clearly. There will be no room matching—if two or more people wish to room together, only one should register for all, otherwise there is no guarantee of getting the same roommate. See "LODGING," page 1. Unless otherwise stated in the event description, you may NOT sign up for more than one session of any event.

NAME \_\_\_\_\_  
ADDRESS \_\_\_\_\_  
CITY \_\_\_\_\_ ST/PROV \_\_\_\_\_  
ZIP \_\_\_\_\_ AGE \_\_\_\_\_

### WEEKEND

ADMISSION: \$14 [ ] Postmarked prior to 5/30/85 \$18 [ ] after 5/30/85

Exhibitor [ ] Company Name \_\_\_\_\_

MEAL TICKET: \$25 [ ] 6 meals \$32 [ ] 8 meals

LODGING: \$45 [ ] (includes \$20 refundable deposit; you will be assigned a roommate)

\$12 [ ] one extra day [ ] Thu [ ] Sun

\$24 [ ] two extra days (Thu & Sun)

\$90 [ ] (includes \$40 refundable deposit, you already have a roommate and are registering for two of you.)

\$24 [ ] one extra day [ ] Thu [ ] Sun

\$48 [ ] two extra days (Thu & Sun)

T-Shirt

Size [ ] S [ ] M [ ] L [ ] XL

Color: \_\_\_\_\_

### THURSDAY EVENTS

#### 1200 (12:00 NOON) THURSDAY

- AH20/S1 POWERS & PERILS NOVICE TOURNAMENT \$1
- BR05/S1 THE MENDING STONE \$4
- DS02/S1 ZIGGURAT \$5
- PG01/S1 A REQUIEM OF QUIESCENCE \$5

#### 1300 (1:00 PM) THURSDAY

- MP01 THE ANTARRAN CONNECTION \$2
- MS01/R1S1 RUNEQUEST III: THE GODDESS ARISES \$4
- WD10/S1 HOLY WAR \$4
- WD22/S1 PARANDIA \$3

#### 1400 (2:00 PM) THURSDAY

- AH01/S1 RUNEQUEST: A FIST FULL OF LUNARS \$4
- AH21/R1S1 POWERS & PERILS ADVANCED TOURNAMENT \$1
- ME01/S1 DOOM'S DAY \$2
- MG04/S1 THE WIZARD'S TOWER: CARNAGE! \$3
- WD23 COUNTDOWN \$4

#### 1430 (2:30 PM) THURSDAY

- ME01/S2 DOOM'S DAY \$2

#### 1500 (3:00 PM) THURSDAY

- ME01/S3 DOOM'S DAY \$2
- MP02 THE TERRORIST'S CREED, PART I \$2
- WD16/S1 ANYTHING BUT NEUTRAL \$2
- WD01 ADD SECTS TO YOUR CAMPAIGN \$2

#### 1530 (3:30 PM) THURSDAY

- ME01/S4 DOOM'S DAY \$2

#### 1600 (4:00 PM) THURSDAY

- AH20/S2 POWERS & PERILS NOVICE TOURNAMENT \$1
- DS01 HORRORS OF THE DEMON'S DEN \$5
- ME01/S5 DOOM'S DAY \$2

#### 1630 (4:30 PM) THURSDAY

- ME01/S6 DOOM'S DAY \$2

#### 1800 (6:00 PM) THURSDAY

- AB01/R1S1 STAR FLEET BATTLES CAPTAINS TOURNAMENT \$4

#### 1800 (6:00 PM) THURSDAY

- AH21/R1S2 POWERS & PERILS ADVANCED TOURNAMENT \$1
- BR07 NEEDLE IN A STACK OF CHIPS \$4
- FG01/S1 AFTERMATH: MUTANT HUNT \$4
- HM01/R1S1 THE BEGINNING OF THE END \$3
- MP03 SURVIVAL OF THE FITTEST \$2
- RM01/S1 THE CHAMBERS OF MIST \$5
- SJ03/R1S1 NECROMANCER \$3
- TS01/R1S1 THE AD&D OPEN \$3
- WD21/S1 JAMES BOND \$4
- WE02/R1S1 COSMIC ENCOUNTERS \$3

#### 1900 (7:00 PM) THURSDAY

- AC01/S1 MURDER ON THE ORIENTAL DRAGON EXPRESS \$4
- AH08 THE RUSSIAN CAMPAIGN \$3
- BA01 MICRO VARIATIONS \$2
- RM03 MELEE/WIZARD DEMOLITION DERBY \$3
- WD12/S1 CHILL \$3
- WD19/S1 BAKER STREET IRREGULARITY \$3
- WD15/S1 THE IZORA GAMBIT \$3

#### 2000 (8:00 PM) THURSDAY

- MP04 THE TERRORIST'S CREED, PART II \$2
- MS02/S1 DRAGONQUEST: THE QUESTFOR PEACE \$4
- SM02/S1 THE HORROR OUT IN THE STICKS \$4
- WD17/S1 THE TOWER OF THE HIGH ONES \$4

#### 2100 (9:00 PM) THURSDAY

- AH01/S2 RUNEQUEST: A FIST FULL OF LUNARS \$4
- AH02/R1S1 CIRCUS MAXIMUS \$3
- BR02 HAREM TO THE RESCUE \$4
- DS03 TO SIEGE A CASTLE \$5
- MA01 DRAGONRIDERS OF PERN \$3
- MG03/S1 THE WIZARD'S TOWER: HAVOC! \$3
- RU01 KILLING TIME AT PEN STAR DOWN \$4
- SJ04/R1S1 CAR WARS DEMO DERBY \$3

#### 2200 (10:00 PM) THURSDAY

- MP05 MURDER ON THE ROMILEX JUMP \$2
- RE01 HISTORICAL ROLE PLAYING \$3

### FRIDAY EVENTS

#### 0900 (9:00 AM) FRIDAY

- AC01/S2 MURDER ON THE ORIENTAL DRAGON EXPRESS \$4
- AH02/R1S2 CIRCUS MAXIMUS \$3
- AH04 AIR FORCE/DAUNTLESS \$3
- AH10 AVALON HILL MASTERS \$4
- AH12 UP FRONT/BANZAI \$4
- AH23 STELLAR CONQUEST \$1

- CR01/S1 DEATH OF A NATION \$4
- DS02/S2 ZIGGURAT \$5
- FG02/S1 THE REVENGE OF THE SEVENTH SAMURAI \$4
- GP01/R1S1 THE OFFICIAL OKUDEN TOURNAMENT \$2
- GP04/R1S1 DOMINION TOURNAMENT \$2
- HM01/R1S2 THE BEGINNING OF THE END \$3
- HM29 STONE'S RIVER \$2
- JA03/S1 REVENGE OF THE FOREST \$4
- MC01 WS&IM MULTIPLAYER MONSTER GAME \$5
- MT01/R1S1 THE PEARLS OF WISDOM \$2
- MS02/R1S2 DRAGONSQUEST: THE QUEST FOR PEACE \$4
- SP01 CHICKAMAUGA \$3
- SJ04/R1S2 CAR WARS DEMO DERBY \$3
- ST01 DECISION ON THE DELAWARE (TIMEMASTER) \$3
- TS01/R1S2 THE AD&D OPEN \$3
- VL04/S1 PAROUSIA (SPACE OPERA) \$3
- WD16/S2 ANYTHING BUT NEUTRAL \$2

**1000 (10:00 AM) FRIDAY**

- AH21/R1S3 POWERS & PERILS ADVANCED TOURNAMENT \$1
- ME02/S1 ARENA OF DOOM: DOOM I \$2
- MP06 PRISON BREAK ON DELETH COLONY \$2
- PG02/S1 RELIGIONS AND ALIGNMENTS IN ROLE PLAYING \$2

**1030 (10:30 AM) FRIDAY**

- ME02/S2 ARENA OF DOOM: DOOM I \$2

**1100 (11:00 AM) FRIDAY**

- GP01/R1S2 THE OFFICIAL OKUDEN TOURNAMENT \$2
- GP03/R1S1 THE OFFICIAL QUADRIM TOURNAMENT \$2
- ME02/S3 ARENA OF DOOM: DOOM I \$2

**1130 (11:30 AM) FRIDAY**

- ME02/S4 ARENA OF DOOM: DOOM I \$2

**1200 (12:00 NOON) FRIDAY**

- AH09 VICTORY IN THE PACIFIC \$5
- AH20/S3 POWERS & PERILS NOVICE TOURNAMENT \$1
- CH01/R1S1 ONE-ON-ONE WRG MODERN MICROARMOR \$3
- PG01/S2 A REQUIEM OF QUIESCENCE \$5
- RU02 COUNTDOWN TO WAR: THE OFFICIAL GDW TRAVELLER TOURNAMENT \$4
- SM03/S1 NIGHT SANCTUARY & THE HOWLING HUNTER \$5
- WD13/S1 TWILIGHT 2000 \$3

**1300 (1:00 PM) FRIDAY**

- AH02/R1S3 CIRCUS MAXIMUS \$3
- AH05 KINGMAKER \$3
- AH22 MIXED BAG COMPUTER GAMING RUN-OFF \$1
- DS04 THE STAFF OF DAWN \$5
- FG03/S1 THE DRUMS OF DEATH \$4
- GP02/R1S1 SHOGI TOURNAMENT \$2
- GP03/R1S2 THE OFFICIAL QUADRIM TOURNAMENT \$2
- MP07 THE HOSTAGE DILEMMA \$2
- MS01/S2 RUNEQUEST III: THE GODDESS ARISES \$4
- NW02 WAGRAM EXPANSION AND UPDATE \$1
- PS01/R1S1 TIMEMASTER TOURNAMENT \$1
- RH01/S1 RESCUE AT CARANAS/ANGURTH'S REVENGE \$3
- SJ03/R1S2 NECROMANCER \$3
- SJ06/R1S1 ILLUMANATI \$3
- TS01/S3 THE AD&D OPEN \$3
- VG01 CIVIL WAR GAMES \$1
- WD10/S2 HOLY WAR \$4
- WE02/R1S2 COSMIC ENCOUNTERS \$3

**1400 (2:00 PM) FRIDAY**

- AH21/R1S4 POWERS & PERILS ADVANCED TOURNAMENT \$1
- CH01/R1S2 ONE-ON-ONE WRG MODERN MICROARMOR \$3
- HC01 BATTLES OF THE FIRST EMPIRE: MARENGO \$2
- ME02/S5 ARENA OF DOOM: DOOM I \$2
- MT01/R1S2 THE PEARLS OF WISDOM \$2

**1430 (2:30 PM) FRIDAY**

- ME02/S6 ARENA OF DOOM: DOOM I \$2

**1500 (3:00 PM) FRIDAY**

- AC01/S3 MURDER ON THE ORIENTAL DRAGON EXPRESS \$4
- BR04/S1 RESEARCH BASE ALPHA, WHERE ARE YOU? \$4
- GP02/R1S2 SHOGI TOURNAMENT \$2

- GP05/R1S1 THE SHANG-CHI TOURNAMENT \$2
- ME02/S7 ARENA OF DOOM: DOOM I \$2
- MP08 THE SALVATION OF ARKAIE'S SOUL \$2
- PH01 STARSHIP "ENDOR"—GHOST SHIP \$4
- RU05 ASSAULT OF FORTRESS DIS \$4
- VG02 WARGAME RESEARCH \$1
- WD11/S1 CHAMPIONS \$3
- WD18/S1 THE WITHERED HEATH \$2
- WD21/S2 JAMES BOND \$4

**1530 (3:30 PM) FRIDAY**

- ME02/S8 ARENA OF DOOM: DOOM I \$2

**1600 (4:00 PM) FRIDAY**

- AH20/S4 POWERS & PERILS NOVICE TOURNAMENT \$1
- CH01/R1S3 ONE-ON-ONE WRG MODERN MICROARMOR \$3
- CR01/S2 DEATH OF A NATION \$4
- MC02 WS&IM TEAM TOURNAMENT \$5
- VL04/S2 PAROUSIA (SPACE OPERA) \$3
- WD02/S1 IT'S MAGIC \$2
- WD03 CALAMITY \$2

**1700 (5:00 PM) FRIDAY**

- JP01 INNOVATION IN GAME DESIGN \$2
- VL01/S1 THE SHADOW KING \$3

**1800 (6:00 PM) FRIDAY**

- AB01/R1S2 STAR FLEET BATTLES FLEET CAPTAINS TOURNAMENT \$4
- AH06 THE "ON ALL FRONTS" G.I. TOURNAMENT \$3
- AH07 THE "ON ALL FRONTS" SQUAD LEADER TOURNAMENT \$3
- AH15 THE OFFICIAL AVALON HILL "DUNE" TOURNAMENT \$3
- AH19/R1S1 WAR AT SEA \$2
- CA01/S1 THE OFFICIAL ELFQUEST TOURNAMENT: TRANSITIONS \$4
- CH01/R1S4 ONE-ON-ONE WRG MODERN MICROARMOR \$3
- HC02 NAPOLEON IN SPAIN \$3
- MA05/R1S1 DC HEROS ROLE PLAYING GAME \$1
- MG02/S1 PRISON BREAK \$4
- MP09 THE MYSTERY OF ARLOS RESEARCH STATION \$2
- PC01/R1S1 RETURN FROM HADES \$4
- SJ01/R1S1 AADA COMBAT RALLY \$3
- SJ07 TOON: CARDBOARD WARRIORS \$3
- TB01/S1 NATO STRIKES BACK \$3
- VG07/R1S1 COLD WAR FOR RUN AND PROFIT \$2
- WE02/R1S3 COSMIC ENCOUNTERS \$3
- WD20/S1 VILLAINS AND VIGILANTES \$2
- WD22/S2 PARANOIA \$3

**1900 (7:00 PM) FRIDAY**

- AC02/S1 THE WIERD OF SATHAR \$4
- CS01 DEATH AT DAWN \$4
- PS03/S1 CHILL \$1
- RE02 THEORY AND PRINCIPLE OF MAGIC \$3
- UN01 QUEST FOR TYCHE'S ORB \$4
- WE02/S2 IT'S MAGIC \$2
- WD08/R1S1 FOOTBALL STRATEGY \$2

**2000 (8:00 PM) FRIDAY**

- MP10 KIDNAP THE TRAITOR (COMBAT SENARIO) \$2
- MS02/S3 THE QUEST FOR PEACE \$4
- RM04/R1S1 THE INTRUDER: AN OFFICIAL GDW TRAVELLER TOURNAMENT \$3
- SM02/S2 THE HORROR OUT IN THE STICKS \$4
- VL03/S1 INTO THE HIERARCH'S LAIR \$4
- WD14/S1 MELANDA, LAND OF MYSTERY \$3
- WD15/S2 THE IZORA GAMBIT \$3

**2100 (9:00 PM) FRIDAY**

- AH19/R1S2 WAR AT SEA \$2
- BR03 ARENA OF THE COBRA KING \$4
- CA02/S1 RINGWORLD \$4
- DS05 THE LAIR OF THE SNOW TROLLS \$5
- FG01/S2 AFTERMATH: MUTANT HUNT \$4
- JA03/S2 REVENGE OF THE FOREST \$4
- MG03/S2 THE WIZARD'S TOWER: HAVOC! \$3
- MG05/S1 THE INN BETWEEN THE WORLDS \$3
- PC01/S2 RETURN FROM HADES \$4
- RE03 CITY, DUNGEON & WILDERNESS... THE ROLEPLAYING SETTING \$3

- RU07 OFFICIAL GDW IMPERIUM TOURNAMENT \$3
- SJ02/RIS1 OGRE-G.E.V./SHOCK WAVE \$3
- WE01 JUNTA \$3

**2200 (10:00 PM) FRIDAY**

- MP11 THE FINAL FLIGHT OF ATLANTICA \$2

**SATURDAY EVENTS**

**0900 (9:00 AM) SATURDAY**

- AC01/S4 MURDER ON THE ORIENTAL DRAGON EXPRESS \$4
- AH01/S3 RUNEQUEST: A FIST FULL OF LUNAR \$4
- AH18 STORM OVER ARNHEM \$4
- AH28 MACHIAVELLI \$3
- BG01/S1 CIVIL WAR ROLEPLAYING IN 20MM \$6
- BR04/S2 RESEARCH BASE ALPHA, WHERE ARE YOU? \$4
- CR01/S3 DEATH OF A NATION \$4
- DS06 THE ISLE OF KAZAR \$5
- HH01 PANZER TACTICS \$4
- HM10 WRG 25MM ANCIENTS TOURNAMENT \$5
- HM11 WRG 15MM ANCIENTS TOURNAMENT \$5
- JA02 DESERT SHADOWS OF DEATH \$4
- MA02 HAMMER'S SLAMMERS \$3
- MA05/RIS2 DC HEROS ROLE PLAYING GAME \$1
- MC03 WS&IM INDIVIDUAL TOURNAMENT \$5
- MG04/S2 THE WIZARD'S TOWER: CARNAGE! \$3
- PC01/S3 RETURN FROM HADES \$4
- PS01/RIS2 TIMEMASTER TOURNAMENT \$1
- PS04 STAR ACE TOURNAMENT \$1
- RM04/RIS1 THE INVADER: AN OFFICIAL GDW TRAVELLER TOURNAMENT \$3
- RU04 THE TALONS OF MAL-KOL-TAL \$4
- SJ04/RIS3 CAR WARS DEMO DERBY \$3
- WD04 CIVILIZATION \$2
- WD10/S3 HOLY WAR \$4
- WD12/S2 CHILL \$3
- WD16/S3 ANYTHING BUT NEUTRAL \$2
- WD17/S2 THE TOWER OF THE HIGH ONES \$4
- WE02/RIS4 COSMIC ENCOUNTERS \$3

**1000 (10:00 AM) SATURDAY**

- ME03/S1 LABYRINTH OF DOOM: DOOM III \$2
- MP12 UNDERSEA EXPLORATION AND DISCOVERY ON OCANIA \$2
- RH01/S2 RESCUE AT CARANRAS \$3
- RS01/S1 THE OFFICIAL "SEEKREIG" TOURNAMENT \$2
- SS01/RIS1 THE OFFICIAL SSI BROADSIDES COMPUTER GAME TOURNAMENT \$2
- JP02 JUST ASK A DESIGNER \$2
- PG02/S2 RELIGIONS AND ALIGNMENTS IN ROLE GAMING \$2
- TB01/S2 NATO STRIKES BACK \$3
- VG07/RIS2 COLD WAR FOR FUN AND PROFIT \$2

**1030 (10:30 AM) SATURDAY**

- ME03/S2 LABYRINTH OF DOOM: DOOM III \$2

**1100 (11:00 AM) SATURDAY**

- ME03/S3 LABYRINTH OF DOOM: DOOM III \$2
- RE04 ECONOMY AND SOCIETY IN THE FANTASY WORLD \$3
- SS01/RIS2 THE OFFICIAL SSI BROADSIDES COMPUTER GAME TOURNAMENT \$2

**1130 (11:30 AM) SATURDAY**

- ME03/S4 LABYRINTH OF DOOM: DOOM III \$2

**1200 (12:00 NOON) SATURDAY**

- AH20/RIS5 POWERS & PERILS NOVICE TOURNAMENT \$1
- BR05/S2 THE MENDING STONE \$4
- NY01 DIPLOMACY \$4
- PG01/S4 A REQUIEM OF QUIESCENSE \$5
- RM01/S2 THE CHAMBER OF MIST \$5
- SM03/S2 NIGHT SANCTUARY AND THE HOWLING HUNTER \$5
- TS01/S4 THE AD&D OPEN \$3
- WD08/RIS2 FOOTBALL STRATEGY \$2

**1300 (1:00 PM) SATURDAY**

- AH24 FIREPOWER \$2
- CS01/S2 DEATH AT DAWN \$4

- DS07 FINIEOUS FINGERS\*: THE RESCUE AT TELEMAR \$5
- FG02/S2 THE REVENGE OF THE SEVENTH SAMURAI \$4
- MB01 CONQUEST OF THE EMPIRE \$3
- ME03/S5 LABYRINTH OF DOOM: DOOM III \$2
- MP13 THE HUNT FOR ARKAIE'S TREASURE \$2
- NW01 BORODINO UPDATE II \$1
- PH02 STARSHIP "HIGH PARADISE"—RESCUE OF A PRINCESS \$4
- PS03/S2 CHILL \$1
- SJ05 BATTLESUIT \$3
- SS01/RIS3 THE OFFICIAL SSI BROADSIDES COMPUTER GAME TOURNAMENT \$2
- VG04 JAMES BOND 007 SEMINAR \$1

**1330 (1:30 PM) SATURDAY**

- ME03/S6 LABYRINTH OF DOOM: DOOM III \$2

**1400 (2:00 PM) SATURDAY**

- BG01/S2 CIVIL WAR ROLEPLAYING IN 20MM \$6
- ME03/S7 LABYRINTH OF DOOM: DOOM III \$2
- MG07 MONOPOLY \$2
- RM04/RIS3 FIRST CONTACT: AN OFFICIAL GDW TRAVELLER TOURNAMENT \$3
- SJ06/RIS2 ILLUMANATI \$3
- SS01/RIS4 THE OFFICIAL SSI BROADSIDES COMPUTER GAME TOURNAMENT \$2
- VL01/S2 THE SHADOW KING \$3
- WD09/RIS1 EMPIRE BUILDER \$2
- WD13/S2 TWILIGHT 2000 \$3
- WD20/S2 VILLAINS AND VIGILANTES \$2

**1430 (2:30 PM) SATURDAY**

- ME03/S8 LABYRINTH OF DOOM: DOOM III \$2

**1500 (3:00 PM) SATURDAY**

- JA01 THE FINAL ENEMY \$4
- JP03 PENTAGON GAMES \$2
- MP14 THE CONSPIRACY AT PHOENICIA \$2
- RU03 TREASURE OF THE DRAGON QUEEN \$5
- VG05 MODERN WARGAME DESIGN \$1
- WD06 BRITISH RAILS \$2
- WD14/S3 MELANDA, LAND OF MYSTERY \$3

**1600 (4:00 PM) SATURDAY**

- AH20/RIS6 POWERS & PERILS NOVICE TOURNAMENT \$1
- CR01/S4 DEATH OF A NATION \$4
- DS08 CITY QUEST \$5
- TS02 THE RPGA NETWORK AD&D TOURNAMENT \$3

**1800 (6:00 PM) SATURDAY**

- BR06 EASY MONEY?? \$4
- FG03/S2 THE DRUMS OF DEATH \$4
- MG01/S1 SON OF PUN DUNGEON \$5
- MP15 PIRATES ON BOARD! \$2
- RM02 THE DEMON'S GAME \$6
- WE03 BORDERLANDS \$3

**1900 (7:00 PM) SATURDAY**

- AC02/S2 THE WIERD OF SATHAR \$4
- FA19 TRIANGLE TRADE \$2
- HC03 CRADLE OF CIVILIZATION \$2
- RE05 GODS, RELIGION AND FAITH IN ROLE PLAYING \$3
- RM04/RIS4 FIRST CONTACT: AN OFFICIAL GDW TRAVELLER TOURNAMENT \$3
- RS01/S2 THE OFFICIAL "SEEKREIG" TOURNAMENT \$2
- RB01/S2 NATO STRIKES BACK \$3
- WD09/RIS2 EMPIRE BUILDER \$2
- WD10/S4 HOLY WAR \$4
- WD19/S2 BAKER STREET IRREGULARITY \$3

**2000 (8:00 PM) SATURDAY**

- MP16 REVENGE ON THE ASTRA MARTA \$2
- SM04 SWORDS BELOW LANKHMAR \$5
- VL03/S2 INTO THE HIERARCH'S LAIR \$4
- WD11/S2 CHAMPIONS \$3
- WD15/S3 THE IZORA GAMBIT \$3
- WD18/S2 THE WITHERED HEATH \$2

**2100 (9:00 PM) SATURDAY**

- AH02/R1S4 CIRCUS MAXIMUS \$3
- BR01 RESCUE OF KING RICHARD \$4
- CA01/S2 THE OFFICIAL ELFQUEST TOURNAMENT: TRANSITIONS \$4
- DS09 THE TEMPLE OF THE LIZARD KING \$5
- MG01/S2 SON OF PUN DUNGEON \$5
- MG02/S2 PRISON BREAK \$4
- MG03/S3 THE WIZARD'S TOWER: HAVOC! \$3
- RE06 BRINGING CHARACTERS TO LIFE \$3
- SJ01/R1S2 AADA COMBAT RALLY \$3
- WD07 RAIL BARON \$2

**2200 (10:00 PM) SATURDAY**

- MP17 SOS.. LANDROUX HIJACKING IN PROGRESS.. SOS \$2

**SUNDAY EVENTS**

**0900 (9:00 AM) SUNDAY**

- AB03 STAR FLEET BATTLES: THE SEMINAR \$1
- AH03 GLADIATOR \$3
- AH13 SPEED CIRCUIT \$3
- BA02 MICROVARIATIONS II: THE GRAND SCALE \$2
- CA02/S2 RINGWORLD \$4
- DS10 THE TEMPLE OF THE MINOTAUR \$5
- GM02 NAVAL WAR \$1
- MP18 TOP SECRET: COURIER MISSION \$2
- PS03/S3 CHILL \$1
- RU08 DESTRUCTION OF THE BROTHERHOOD OF THE RIFT \$4
- WD11/S3 CHAMPIONS \$3
- WD14/S3 MELANDA, LAND OF MYSTERY \$3
- WD16/S4 ANYTHING BUT NEUTRAL \$2
- WD21/S3 JAMES BOND \$4

**1000 (10:00 AM) SUNDAY**

- AH28 B-17 \$2
- ME04/S1 DOOM'S REVENGE: PART III \$2
- WD05 TALISMAN \$2

**1030 (10:30 AM) SUNDAY**

- ME04/S2 DOOM'S REVENGE: PART III \$2

**1100 (11:00 AM) SUNDAY**

- GM01 FAMILY BUSINESS \$1
- ME04/S3 DOOM'S REVENGE: PART III \$2
- MP19 THE OUTLAND ADVENTURE \$2
- VG06 WARGAME DESIGN \$1
- VL01/S3 THE SHADOW KING \$3
- WD20/S3 VILLAINS AND VIGILANTES \$2

**1130 (11:30 AM) SUNDAY**

- ME04/S4 DOOM'S REVENGE: PART III \$2

**1200 (12:00 NOON) SUNDAY**

- PS02 TIMEMASTER \$1
- RU06 TO CATCH A THIEF \$4

**1300 (1:00 PM) SUNDAY**

- CG01 COLLEGIATE CREW: 4TH ANNUAL NATIONAL CHAMPIONSHIP \$2
- DS11 THE LAIR OF THE SERPENT DRAGON \$5
- JP04 GAME TACTICS AND GROUND TACTICS \$2
- ME04/S5 DOOM'S REVENGE: PART III \$2

**1330 (1:30 PM) SUNDAY**

- ME04/S6 DOOM'S REVENGE: PART III \$2

**1400 (2:00 PM) SUNDAY**

- ME04/S7 DOOM'S REVENGE: PART III \$2
- MP20 WANTED: EXPERIENCED TROUBLESHOOTERS \$2

**1430 (2:30 PM) SUNDAY**

- ME04/S8 DOOM'S REVENGE: PART III \$2

**TOTAL:** List the amounts for each category in the space provided. Include payment in full. No refunds.

Admissions: \_\_\_\_\_ Events: \_\_\_\_\_  
 Meal Ticket: \_\_\_\_\_ Lodging: \_\_\_\_\_  
 T-Shirts: \_\_\_\_\_ Total: \_\_\_\_\_

No pets, costumes or weapons of any kind are allowed at any time. Seeing eye dogs and uniforms worn by active duty military and police are allowed.



**ATLANTICON**  
 P.O. BOX 139  
 MIDDLETON, NJ 07748

**WD06 BRITISH RAILS:** Mayfair's Official "British Rails" tournament, hosted by Wilmark Dynasty. Tired of being the Railroad King from Sea to Shining Sea?? Well, the old Empire offers a new challenge. 24 Players. TR=B3. W: SE. R=2 Hrs. R1: SA15, R2: SU08. Fee=\$2. Prizes: MC/Att.

**WD14/S3 MELANDA, LAND OF MYSTERY:** See WD14/S1 (FR20) for details.

**1600 (4:00 PM)**

**AH20/R1S6 POWERS & PERILS NOVICE TOURNAMENT:** See AH20/R1S1 (TH12) for details.

**CR01/S4 DEATH OF A NATION:** See CR01/S1 (FR09) for details.

**DS08 CITY QUEST:** A unique city adventure in which you play as a member of a group of Assassins hired to slay a Wizard who turned to Good and betrayed your Guild. AD&D. 100 Players. 10/Game. TR=C3. W: P. S=3 Hrs. Fee=\$5. Prizes: MC/Att.: 1 prize to the 1st place finisher in each game + the GAMA Plaque to the overall winner.

**TS02 THE RPGA NETWORK AD&D TOURNAMENT:** Open only to RPGA Members. International scoring system with international scoring points being awarded. 80 Players. 8/Game. TR=A3. W: P. S=4 Hrs. R1: SA16, R2: SU09. Fee=\$3. Prizes: MC/Att.

**1800 (6:00 PM)**

**BR06 EASY MONEY??:** Group A: You thought it would be easy, grab the kids, get the money, scam—but ...? Group B: You've been kidnapped—escape! A Rolemaster event. 48 Players. 12/Game. TR=C2. W: P. S=3 Hrs. Fee=\$4. Prizes: MC/Att.

**DW02/S2 THE ARCTIC ADVENTURE:** See the Special Event Section for details of the Generic Dungeon Event. A short description is: Get away from the summer's heat to picturesque Hyperborea on a quest to rescue the Snow Princess.

**FG03/S2 THE DRUMS OF DEATH:** See FG03/S1 (FR13) for details.

**MG01 SON OF PUN DUNGEON:** From out of the slime of the swamps rises the mind-blanking spawn of Shawn Carroll's infamous "Pun Dungeon." as Jeff Leid leads players (A.K.A. Masochists) through a labyrinth of groaning horrors. Strong stomachs are recommended. Very loosely based on AD&D. 20 Players. 10/Game. TR=D1 (bring pencil/pen and paper). W: P. S=3 Hrs. Fee=\$5. Prizes: MC/Att.: 1 winner overall for both Sessions.

**MP15 PIRATES ON BOARD:** See Special Events for data on the Generic Traveller Event.

**RM02 THE DEMON'S GAME:** In the time before, there was a Demon Lord named Balor. He has now returned to wreak his vengeance upon the land. Stop him, or end up playing the Demon's game. Bring 3 15th-18th Level non-evil AD&D characters. GM's Randy and Amy Martens will select one. 12 Players. 12/Game. TR=A4 (players must be over 18). W: P. R=6 Hrs. Fee=\$6. Prizes: MC/Att.

**WE03 BORDERLANDS:** Be the first to industrialize and conquer in this West End Games tournament. Only the skillful survive. 36 Players. TR=A3. W: SE. R=3 Hrs. R1: SA18, R2: SU08. Fee=\$3. Prizes: MC/Att.

**IC01/R1S4 FIRST OFFICIAL MERP TOURNAMENT:** See IC01/R1S1 (TH20) for details.

**1900 (7:00 PM)**

**AC02/S2 THE WIERD OF SATHAR:** See AC02/S1 (FR19) for details.

**FA19 TRIANGLE TRADE:** The highest scoring team wins in this exciting Star Trek adventure. Based in the Triangler, where anything can (and will) happen. 60 Players. 10/Game. TR=B3. W: P (High Team). R=3 Hrs. Fee=\$2. Prizes: \$15 in FASA Merchandise for each member of the winning team, \$8 in FASA Merchandise for each member of the 2nd place team.

**HC03 CRADLE OF CIVILIZATION:** The Designer hosts the 4th Origins tournament for this multi-player military and diplomatic game. Players attempt to utilize their resources to advance their civilizations. 35 Players. TR=C1. W: P. R=4-5 Hrs. Fee=\$2. Prizes: MC/Att.

**RM04/R1S4 FIRST CONTACT: AN OFFICIAL GDW TRAVELLER TOURNAMENT:** See RM01/R1S3 (FR20) for details.

**WD09/R1S2 EMPIRE BUILDER:** See WD09/R1S1 (SA14) for details.

**WD10/S4 HOLY WAR:** See WD10/S1 (TH13) for details.

**WD19/S2 BAKER STREET IRREGULARITY:** See WD19/S1 (TH19) for details.

**2000 (8:00 PM)**

**MP16 REVENGE ON THE ASTRA MARTA:** See Special Events for data on the Generic Traveller Event.

**SM04 SWORDS BELOW LANKHMAR:** Return to Lankhmar, TSR's yet to be released all-new city adventure hosted by the game designers themselves! With the city plagued by Gnawers and Deep Delvers and with Fafhrd and the Mouser nowhere about, can you save the day? AD&D. 20 Players. 10/Game. TR=C4. W: P. S=4 Hrs. Fee=\$5. Prizes: MC/Att.

**VL03/S2 INTO THE HIERARCH'S LAIR:** See VL03/S1 (FR20) for details.

**WD11/S2 CHAMPIONS:** See WD11/S1 (FR15) for details.

**WD15/S3 THE IZORA GAMBIT:** See WD15/S1 (TH19) for details.

**WD18/S2 THE WITHERED HEATH:** See WD18/S1 (FR15) for details.

**2100 (9:00 PM)**

**AH02/R1S4 CIRCUS MAXIMUS:** See AH02/R1S1 (TH21) for details.

**BR01 RESCUE OF KING RICHARD:** Richard the Lion-Hearted has been kidnapped! According to magical sources, he is being held somewhere in Cornwall. Your mission: Locate the King and free him. A Chivalry and Sorcery event. 32 Players. 8/Game. TR=C2. W: P. S=3 Hrs. Fee=\$4. Prizes: MC/Att.

**CA01/S2 THE OFFICIAL ELFQUEST TOURNAMENT: TRANSITIONS:** See CA01/S1 (FR18) for details.

**DS09 THE TEMPLE OF THE LIZARD KING:** A cult of evil lizard-men will sacrifice the Emperor's virgin daughter at midnight unless you can penetrate their lair and stop them. AD&D. 100 Players. 10/Game. TR=C3. W: P. S=3 Hrs. Fee=\$5. Prizes: MC/Att.: 1 prize for best player in each game + the Origins Plaque for the best player overall.

**MG01/S2 SON OF PUN DUNGEON:** See MG01/S1 (SA18) for details.

**MG02/S2 PRISON BREAK:** See MG02/S1 (FR18) for details.

**MG03/S3 THE WIZARD'S TOWER: HAVOC!** See MG03/S1 (TH21) for details.

**SJ01/R1S2 AADA COMBAT RALLY:** See SJ01/R1S1 (FR18) for details.

**WD07 RAIL BARON:** Avalon Hill's Official tournament, hosted by Wilmark Dynasty and GM'ed by a past Champion. 36 Players. TR=B3. W: SE. R=2 Hrs. R1=SA21, R2=SU10. Fee=\$2. Prizes: MC/Att.: 1st: 50% R, 2nd: 30% R, 3rd: 20% R.

**2200 (10:00 PM)**

**MP17 SOS ... LANDROUX HIJACKING IN PROGRESS ... SOS:** See Special Events for data on the Generic Traveller Event.

## SUNDAY TOURNAMENTS

**0900 (9:00 AM)**

**AH03 GLADIATOR:** Bored by Sunday Mornings at Gaming Conventions? Work off your boredom with a brisk workout in the Arena! Join in this fast-moving (and rather bloody) Avalon Hill "Gladiator" tournament. Hand-to-hand combat in Rome's arena.... You might even be awarded a Wooden Sword.... If you survive. 64 Players. TR=A3. W: SE. R=1.5 Hrs. R1: SU09, R2: SU1030, R3: SU13. Fee=\$3. Prizes: MC/Att.

**AH13 SPEED CIRCUIT:** Qualifying races will be run on the Monza circuit with the top 12 finishers advancing to the finals, which will be run on a surprise track. 36 Players. TR=B2. W: E. R=2 Hrs. Fee=\$3. Prizes: MC/Att.: 1st: 40% R, 2nd: 20% R, 3rd: 10% R.

**BA02 MICROVARIATIONS II: THE GRAND SCALE:** Microgame Senarios large enough for four, mainly Melee-Wizard and OGRE-GEV. Victories by points based on damage done and received. 16 Players. TR=B3. W: P. R=2 Hrs. R1: SU09, R2: SU11. Fee=\$2. Prizes: MC/Att.

**CA02/S2 RINGWORLD:** See CA02/S1 (FR21) for details.

**DS10 THE TEMPLE OF THE MINOTAUR:** Your band must liberate the grapevine lands of Peace-water from the peril that has drawn hordes of primitives to the blazing Temple of the Minotaur. AD&D. 100 Players. 10/Game. TR=B3. W: P. R=3 Hrs. Fee=\$5. Prizes: MC/Att. to be best player in each surviving group + the Origins Plaque to the overall best player.

**GM02 NAVAL WAR:** Join this fast-paced card game tournament which is easy on the mind... but hard on the ships. How many games do you know that you can learn from scratch in less than 5 minutes. 42 Players (7/Game). TR=B1. W: SE. R=1 Hr. R1: SU09, R2: SU10. Fee=\$1. Prizes: MC/Att.

**MP18 TOP SECRET: COURIER MISSION:** See Special Events for data on the Generic Traveller Event.

**PS03/S3 CHILL:** See PS03/S1 (FR18) for details.

**RU08 DESTRUCTION OF THE BROTHERHOOD OF THE RIFT:** Locate the base of the most feared band of corsairs in the Nadine Sector and collect as much information on the Brotherhood as possible. Traveller. 40 Players. 8/Game. TR=C3. W: P. R=3 Hrs. Fee=\$4. Prizes: 1st: \$30 MC, 2nd: \$20 MC, 3rd: \$10 MC, 4th: \$5 MC.

**VL02/S3 WHERE'S THERE'S A WILL:** See VL02/S1 (FR13) for details.

**WD11/S3 CHAMPIONS:** See WD11/S1 (FR15) for details.

**WD14/S3 MELANDA, LAND OF MYSTERY:** See WD14/S1 (FR20) for details.

**WD16/S4 ANYTHING BUT NEUTRAL:** See WD16/S1 (TH15) for details.

**WD21 JAMES BOND:** See WD21/S1 (TH18) for details.

**1000 (10:00 AM)**

**AH28 B-17:** Avalon Hill once again offers this unique battle of B-17 v/s the Luftwaffe. Your pilot your bomber against the selected target while the Messerschmidts and Focke-Wulfs try to stop the 8th AF "Maximum Effort." 64+ Players. TR=A3. W: SE (Special). All competition takes place in one 2-Hr. span. Fee=\$2. Prizes: MC/Att.

**ME04/S1 DOOM'S REVENGE: PART III: The Doom Trilogy, Part III: The Final Battle.** Exit the Castle of Doom; beware of Doom's Revenge. Players receive a painted Fantasy figure. Keep all the figures you eliminate. Miniatures. 20 Players. TR=C2. W: E. S=1/2 Hr. Fee=\$2. Prizes: Players keep the figures of eliminated opponents.

**WD05 TALISMAN:** A fast-paced elimination tournament with fantasy characters vying for the Crown of Command. Highly lauded by Games Magazine. 36 Players. TR=B3. W: SE. R=2 Hrs. R1: SU10, R2: SU13. Fee=\$2. Prizes: MC/Att.

**1030 (10:30 AM)**

**ME04/S2 DOOM'S REVENGE: PART III:** See ME04/S1 (SU10) for details.

**1100 (11:00 AM)**

**GM01 FAMILY BUSINESS:** Join in this exciting card game of Mob Wars. An excellent way to eliminate your frustrations... and your rival "Businessmen." 36 Players (6/Game). TR=B1. W: SE. R=1 Hr. R1: SU11, R2: SU12. Fee=\$1. Prizes: MC/Att.

**ME04/S3 DOOM'S REVENGE: PART III:** See ME04/S1 (SU10) for details.

**MP19 THE OUTLAND ADVENTURE:** See Special Events for data on the Generic Traveller Event.

**VL01/S3 THE SHADOW KING:** See VL01/S1 (FR17) for details.

**WD20/S3 VILLAINS AND VIGILANTES:** See WD20/S1 (FR18) for details.

**1130 (11:30 AM)**

**ME04/S4 DOOM'S REVENGE: PART III:** See ME04/S1 (SU10) for details.

**1200 (12:00 NOON)**

**PS02 TIMEMASTER:** Join the Time Corps and stabilize reality! Fight the cunning aliens and savage renegades who would warp time for their own nefarious purposes. This Pacesetter RPG spans the 4th dimension. 8 Players. 8/Game. TR=C2. W: P. R=4 Hrs. Fee=\$1. Prizes: CMC/Att.

**RU06 TO CATCH A THIEF:** Time is running out; your band must secretly burglarize a well-guarded tower and escape with as much treasure as possible. Let the unwary beware! AD&D. 40 Players. 8/Game. TR=C3. W: P. R=3 Hrs. Fee=\$4. Prizes: 1st: \$30 MC, 2nd: \$30 MC, 3rd: \$10 MC, 4th: \$5 MC.

**SM01/S2 THE HOUSE OF IDIOTS:** See the Special Event Section for details of the Generic Dungeon. Short description is: Returning booty-laden from an adventure, you find that the sagely mage who identifies your booty has committed himself to an institution treating mental illness. Can your group survive long enough to find them?

**1300 (1:00 PM)**

**CG01 COLLEGATE CREW: 4TH ANNUAL NATIONAL CHAMPIONSHIP:** Jump the start. Call a "Big 10." Catch a "crab." Break an oar. Stroke your favorite college crew to victory. Beware the fat cox-wain. Weighnuff! 32 Players. TR=C1. W: SE. R=1 Hr. R1: SU13, R2: SU14. Fee=\$2. Prizes: MC/Att.

**DS11 THE LAIR OF THE SERPENT DRAGON:** An Evil Serpent Dragon terrorizes the land. It is your chivalrous duty as upholders of good to seek out this menace and destroy it! AD&D. 100 Players. 10/Game. TR=C3. W: P. R=3 Hrs. Fee=\$5. Prizes: MC/Att. to the best player in each surviving group + the Origins Plaque to the overall best player.

**ME04/S5 DOOM'S REVENGE: PART III:** See ME04/S1 (SU10) for details.

**1100 (11:00 AM)**

**GD01 BASIC TRAVELLER:** A Question and Answer session with Marc Miller on GDW's Science-Fiction role-playing game. Free.

**1200 (12:00 NOON)**

**FA02 STAR TREK: TRIANGLE INDEPENDENT CAMPAIGNS:** Mayhem, money, free traders, blackmail, diplomacy, trade, independence, secrecy, conflict, stealth, rich worlds, black market, spies... this is role playing the Star Trek Triangle. Free.

**1300 (1:00 PM)**

**AH17 ASL—HOW IT CAME ABOUT & WHAT'S STILL COMING:** The game's designers answer questions on the current state of the Advance Squad Leader Game System and on their future plans. Free.

**NW02 WAGRAM EXPANSION AND UPDATE:** Presentation of the capabilities of expanding Clash of Arm's Wagram game to include the Austrian advance on the extreme left flank of the French. Handouts included. New counters. Fee=\$1.

**VG01 CIVIL WAR GAMES: Victory Games' Civil War games will be discussed, as will the period and the state of the art in general. Fee=\$1.**

**1400 (2:00 PM)**

**AG01 STAR REALMS:** An introduction to Advanced Gaming Technology and their new play-by-mail game; Star Realms. AGT would like this opportunity to present their game to the gaming public and discuss its design with playtesters and interested gamers alike. Free.

**FA03 OPERATION ARMAGEDDON: STRATEGIC STARSHIP CAMPAIGNS:** An open discussion of starship combat campaigns. FASA designers will give tips on organizing and running your own strategic level campaign game. Q & A follows. Free.

**1500 (3:00 PM)**

**GD02 ADVANCED TRAVELLER:** Extended question and answer session with Marc Miller concerning GDW's popular Science-Fiction role-playing game. Deeper background subjects covered. Free.

**VG02 WARGAME RESEARCH:** Wargame research sources and techniques for turning raw data into game system values. A handout will be given out to focus the talk. Fee=\$1.

**1600 (4:00 PM)**

**FA04 ALIEN PLAYER CHARACTERS: ROMULANS & KLINGONS:** Who says playing the bad guys can't be fun? Role playing is really stressed when playing characters from other cultures in the Star Trek Universe. Free.

**HM25 NIP & TUCK WITH PLASTIC FIGURES:** The increasing availability of plastic miniatures allow for a lot of conversions. Techniques and hints by an expert. Host: Paul Koch. Free.

**WD02/S1 IT'S MAGIC:** A refreshing new look at the Arcane as it relates to fantasy campaigning. Included are acquisition, development and advancement plus entire new types and systems of magic. Fee=\$2.

**1700 (5:00 PM)**

**JP01 INNOVATION IN GAME DESIGN:** What is "new" in a game? Is newer better? Does innovation matter? A provocative exploration of trends by veteran innovator John Prados. Q&A Session follows. Fee=\$2.

**1330 (1:30 PM)**

**ME04/S6 DOOM'S REVENGE: PART III:** See ME04/S1 (SU10) for details.

**1400 (2:00 PM)**

**ME04/S7 DOOM'S REVENGE: PART III:** See ME04/S1 (SU10) for details.

**MP20 WANTED: EXPERIENCED TROUBLESHOOTERS:** See Special Events for data on the Generic Traveller Event.

**1430 (2:30 PM)**

**ME04/S8 DOOM'S REVENGE: PART III:** See ME04/S1 (SU10) for details.

## THURSDAY SEMINARS

**1500 (3:00 PM)**

**US01 SOVIET OFFENSIVE AND DEFENSIVE OPERATIONS:** A Marine officer will offer a slide presentation of Soviet Regimental/Battalion level offensive and defensive tactical doctrine, describing both its strengths and weaknesses. Free.

**UM04 THIRD REICH 4TH EDITION: A DISCUSSION:** A forum for Third Reich enthusiasts hosted by Brian Sutton. Meet fellow players to arrange games, discuss rules and trade stores. Tournament details

will be given for this year's tournament. All are welcome. Free.

**WD01 ADD SECTS TO YOUR CAMPAIGN:** A look at how to add color to your campaign through the addition of original religious cults. Fee=\$2.

#### 1900 (7:00 PM)

**AH14 UP FRONT SEMINAR:** Ken Whitesell hosts this open forum on rules, tactics and scenarios for Avalon Hill's Up Front game. Free.

#### 2000 (8:00 PM)

**UM02 STARFIRE CAMPAIGN THEORY:** Discussion of Starfire as a basis for campaign gaming, including the use of computer tools such as Database programs. Some new tactical rules and technology are also discussed. Free.

#### 2200 (10:00 PM)

**RE01** A look at the unexplored potential of different historical periods for role-playing, including looks at systems suited to use with modern and ancient periods. Fee=\$3.

#### FRIDAY SEMINARS

##### 0900 (9:00 AM)

**AH16 GETTING INTO POWERS & PERILS:** A basic introduction to the Powers & Perils system. A question and answer period will follow the introductory discussion. Host: Richard Snider. Free.

##### 1000 (10:00 AM)

**AM01 ADVENTURES BY MAIL OPEN SEMINAR:** Five staff members will be on hand to discuss Adventures by Mail's line of games and the future of the play-by-mail industry. Free.

**FA01 ASK STAR FLEET COMMAND: RPG SESSION:** Got a question about STAR TREK: The Role-Playing Game? Want rules clarified or to hear tips on handling problems as a player or gamemaster? Come ask the FASA design staff your questions. Free.

**PG02/S1 RELIGIOUS AND ALIGNMENTS IN ROLE PLAYING:** A discussion on the use of major Religions in Role Playing Campaigns and the utility of most Alignment Systems. Also, a new Alignment System will be presented. Fee=\$2.

**IC04 STARMASTER: SERP FROM ICE:** The designers of ICE's Starmaster SERP system will briefly describe the system and answer questions. Free.

##### 1100 (11:00 AM)

**GD01 BASIC TRAVELLER:** A Question and Answer session with Marc Miller on GDW's Science-Fiction role-playing game. Free.

##### 1200 (12:00 NOON)

**FA02 STAR TREK: TRIANGLE INDEPENDENT CAMPAIGNS:** Mayhem, money, free traders, blackmail, diplomacy, trade, independence, secrecy, conflict, stealth, rich worlds, black market, spies... this is role playing the Star Trek Triangle. Free.

##### 1300 (1:00 PM)

**AH17 ASL—HOW IT CAME ABOUT & WHAT'S STILL COMING:** The game's designers answer questions on the current state of the Advance Squad Leader Game System and on their future plans. Free.

**NW02 WAGRAM EXPANSION AND UPDATE:** Presentation of the capabilities of expanding Clash of Arm's Wagram game to include the Austrian advance on the extreme left flank of the French. Handouts included. New counters. Fee=\$1.

**VG01 CIVIL WAR GAMES:** Victory Games' Civil War games will be discussed, as will the period and the state of the art in general. Fee=\$1.

**IC02 ICE'S MIDDLE EARTH & LOREMASTER WORLDS:** A discussion of past, current and future modules set in JRR Tolkien's Middle Earth and ICE's Loremaster world. Overview presented and questions entertained. Free.

##### 1400 (2:00 PM)

**AG01 STAR REALMS:** An introduction to Advanced Gaming Technology and their new play-by-mail game; Star Realms. AGT would like this opportunity to present their game to the gaming public and discuss its design with playtesters and interested gamers alike. Free.

**FA03 OPERATION ARMAGEDDON: STRATEGIC STARSHIP CAMPAIGNS:** An open discussion of starship combat campaigns. FASA designers will give tips on organizing and running your own strategic level campaign game. Q & A follows. Free.

##### 1500 (3:00 PM)

**GD02 ADVANCED TRAVELLER:** Extended question and answer session with Marc Miller concerning GDW's popular Science-Fiction role-playing game. Deeper background subjects covered. Free.

**VG02 WARGAME RESEARCH:** Wargame research sources and techniques for turning raw data into game system values. A handout will be given out to focus the talk. Fee=\$1.

**IC03 ROLEMASTER & MIDDLE EARTH ROLE PLAYING:** A discussion of ICE's MERP and Role Master systems. General overviews and comparisons will be given and then questions will be answered. Free.

##### 1600 (4:00 PM)

**FA04 ALIEN PLAYER CHARACTERS: ROMULANS & KLINGONS:** Who says playing the bad guys can't be fun? Role playing is really stressed when playing characters from other cultures in the Star Trek Universe. Free.

**HM25 NIP & TUCK WITH PLASTIC FIGURES:** The increasing availability of plastic miniatures allow for a lot of conversions. Techniques and hints by an expert. Host: Paul Koch. Free.

**WD02/S1 IT'S MAGIC:** A refreshing new look at the Arcane as it relates to fantasy campaigning. Included are acquisition, development and advancement plus entire new types and systems of magic. Fee=\$2.

##### 1700 (5:00 PM)

**JP01 INNOVATION IN GAME DESIGN:** What is "new" in a game? Is newer better? Does innovation matter? A provocative exploration of trends by veteran innovator John Prados. Q&A Session follows. Fee=\$2.

##### 1800 (6:00 PM)

**FA05 GAME MASTERING THE FINAL FRONTIER:** Do your Star Trek games seem like reruns? If you are a gamemaster, come learn some tricks that will add excitement and interest to any space role-playing game. Free.

##### 1900 (7:00 PM)

**FA06 ROCK QUARRIES AND ENDLESS HALLWAYS:** Design scenarios for the Doctor Who Role-Playing Game. Interject humor into your designs without being silly. Use temporal anachronisms to spark player interest. Free.

**GD03 JOURNAL OF THE TRAVELLER'S AID SOCIETY:** Subscribers and other travellers are welcome to this question and answer session with the editor of the "Journal," Lauren Wiseman. Free.

**HM27 PLAYING WRG ANCIENTS, 6TH EDITION:** A pre-tournament meeting for participants to discuss WRG 6th Edition Rules and the WRG Army lists. Free.

**RG02 THEORY AND PRINCIPLES OF MAGIC:** A group of game designers and theorists will discuss the principles behind magic as practiced in role-playing systems, looking at historical and literary traditions and giving guidelines for improving magic in play. Fee=\$3.

**VG03 MEET VICTORY GAMES:** Meet the Victory Games staff and come prepared to ask questions and get answers about where Victory Games has been and is going. Free.

**WD02/S2 IT'S MAGIC:** See WD02/S1 (FR16) for details.

##### 2000 (8:00 PM)

**HM26 ASK THE COURIER:** Meet The Courier editorial staff. Discover future plans, etc. Here is the chance for you to tell them what you want for future articles of publication. Free.

##### 2100 (9:00 PM)

**RE03 CITY, DUNGEON & WILDERNESS... THE ROLEPLAYING SETTING:** A discussion of the problems in developing a believable setting for roleplaying and the types of situations which are best suited to certain systems and campaign styles. Fee=\$3.

**TT01 MY WORST NIGHT IN ROLE PLAYING:** A fun 2 hour talk with game designer and audience to share those memorable role playing experiences and weird happenings.

#### SATURDAY SEMINARS

##### 0900 (9:00 AM)

**AH25 A LOOK AT PERILOUS LANDS:** A quick look at the Perilous Lands supplement to "Powers & Perils," geared to show how it is used and to answer any questions. Free.

##### 1000 (10:00 AM)

**CL03 PLAYING EMPIRE III:** The Columbia Gamers explain and give examples on how Empire III is played and how it simulates Napoleonic warfare. An Empire III battle is scheduled following the Seminar. Free.

**JP02 JUST ASK A DESIGNER:** Ever wonder why things turned out the way they did in some of your fa-

vorite games? Designer John Prados shares some hobby lore and great simulation stories based on audience questions. Fee=\$2.

**MA03 STORY TELLING & THEATER: THE ROOTS OF RPG:** Check it out! An experience with Colry Galberston. Free.

**OD01 PLAY BY MAIL (ONE-ON-ONE):** Omar Dewitt (for AHKS) will give a seminar on the how-to procedures of playing board games by mail. 20 years of experience in finding opponents, developing PBM aids, recording moves and combat and resolving combat will be at your disposal. Free.

**PG02/S2 RELIGIONS AND ALIGNMENTS IN ROLE PLAYING:** See PG01/S1 (FR10) for details.

##### 1100 (11:00 AM)

**FA08 THE BATTLEDROID SUCCESSOR STATES:** FASA Game Designers discuss the Battledroid Universe, the men, the machines and the politics. A Q&A Session follows. Free.

**RE04 ECONOMY AND SOCIETY IN THE FANTASY WORLD:** A look at the social and economic systems which should provide a supporting structure in a realistic roleplaying world. Balancing realism and playability will be emphasized, with historical examples. Fee=\$3.

##### 1200 (12:00 NOON)

**NW01 BORODINO UPDATE II:** A presentation on how to update GDW's Borodino to be compatible with Clash of Arm's game rules. Handouts will be given showing new units, new rules and new scenarios. Fee=\$1.

##### 1300 (1:00 PM)

**AM02 BEYOND THE STELLAR EMPIRE DISCUSSION FORUM:** Adventures by Mail BSE Gamemasters will field questions and discuss the continuing developing of this highly popular Play-by-Mail game. Free.

**AH26 SUBSCRIBER FREE-FOR-ALL:** Editors of the "General," "Heros" and "Victory Insider" welcome constructive criticism, pot shots and kudos from subscribers. Free.

**GN01/S1 HOW TO WRITE FOR GAME NEWS:** Game News is looking for reviewers and writers. Let our Editor fill you in on the details. Free.

**NW01 BORODINO UPDATE II:** A presentation on how to update GDW's Borodino to be compatible with Clash of Arm's game rules. Handouts will be given showing new units, new rules and new scenarios. Fee=\$1.

**VG04 JAMES BOND 007 SEMINAR:** This seminar is an open discussion about the James Bond Game System: Where is it going, suggestions for GM's and players and a discussion of Bondiana. Fee=\$1.

##### 1500 (3:00 PM)

**AD01 ILLUMINATI/CAR WARS PBM PLAYER-FEST:** A chance for PBM players of "Car Wars" and "Illuminati" to swap stories, meet Allies and Enemies and question the designers about rules and tactics. Hosts: Steve Jackson, Draper and Susan Kauffman. Free.

**AH11/S1 THE PROGRAMMING OF GULF STRIKE:** The designer of Avalon Hill's Gulf Strike computer game will detail the internal structure of the program. Winchell Chung, Host. Free.

**FA09 STARSHIP COMMAND BRIEFING:** Q&A about Star Trek starships. Discuss new ship designs, Starship Combat Game rules questions, ship construction and combat efficiency ratings with the FASA Design Staff. Free.

**JP03 PENTAGOM GAMES:** A closer look at military wargaming and the similarities between their games and ours, featuring a look at the new work with "Red Teams," by designer John Prados. Fee=\$2.

**VG05 MODERN WARGAME DESIGN:** A discussion on the unique problems associated with designing wargames for the contemporary era. The seminar will cover Strategic, Operational and Tactical level issues. Handout will be available. Fee=\$1.

##### 1600 (4:00 PM)

**TT02 STALKING THE NIGHT FANTASTIC:** Fantastic role playing stalking the supernatural evil of the 1990s. GMs Richard Tsucholka and Chris Beiting will teach this event. Free.

##### 1700 (5:00 PM)

**FA10 CAMPAIGNS IN THE FINAL FRONTIER:** Discuss how to plan, start up and run role-playing campaigns in the Star Trek universe. A FASA Design Team gives practical suggestions. Free.

**GA01 ROLE PLAYING QUESTIONS AND ANSWERS:** A discussion concerning role playing games (i.e. Gamemaster Guides Supplements, Dungeons and Dragons, Sci-Fi games, etc.); on the expansion of such, trying to clarify areas vaguely covered. Free (Register at the Gamemasters Guide Booth).

**GD04 EUROPA SEMINAR:** All you ever wanted to know about GDW's huge Europa game system. Host: John Astell. Free.

**MA04 ROLE AIDS GUIDELINES FOR WRITERS:** What does the Editorial Director at Mayfair Games look for in an RPG Module?? Meet Mr. Glaberson and find out. Free.

##### 1900 (7:00 PM)

**FA11 THE KEY OF TIME: DOCTOR WHO COMPANIONS:** Create a campaign in the Dr. Who Universe. FASA Designers present techniques for designing, starting up and running long-term campaigns in time and space. Free.

**GD05 3RD WORLD WAR/ASSULT:** A general discussion seminar with Frank Chadwick, designer of the 3rd World War/Assault/Boots and Saddle game system. Free.

**LZ01 AIR COMBAT GAMING & DESIGNING:** Lou Zocchi, winner of the H.G. Wells award for all-time best air combat rules, teaches mapboard and table top air gaming design techniques. Free.

**RE05 GODS, RELIGION AND FAITH IN ROLE-PLAYING:** A discussion of religious systems, institutions and beliefs in role-playing including such topics as church organization, polytheism v/s monotheism, priestly magic and the social role of religion in a world. Fee=\$3.

##### 2100 (9:00 PM)

**RE06 BRINGING CHARACTERS TO LIFE:** A panel of experienced role-players will discuss ways for players and GMs to put more personality into characters and the world background for more enjoyable role-playing. Fee=\$3.

#### SUNDAY SEMINARS

##### 0900 (9:00 AM)

**AB03 STAR FLEET BATTLES:** Stephen V. Cole (the Designer) and various members of the Committee and the Joint Chiefs of Staff. Fee=\$1.

**EV01 GETTING FAMOUS: PLAYTESTING ELEMENT MASTERS:** For those interested in being regional playtesters of future releases from Escape Ventures' Element Masters. Instructions will be given for registration and follow-up. Free.

**GD06 TWILIGHT 2000:** Frank Chadwick hosts this discussion/seminar on what the world will be like in the middle of WWII. Free.

##### 1000 (10:00 AM)

**FA12 DOCTOR WHO: MEET THE DESIGNERS:** Informal Q&A session with the designers responsible for FASA's newest role playing system. Rules, game philosophy and fictional setting will be discussed. Free.

**MA06 MEET MAYFAIR:** Your chance to talk gaming, games and design with the creators of the DC Heros RPG. Also meet those behind the Role Aids Module line. Open discussion. Juggling acts on request. Free.

##### 1100 (11:00 AM)

**VG06 WARGAME DESIGN:** The essentials of wargame design; including map scale, level of complexity, time scale, sequence of play, component design and data-intro-values. Fee=\$1.

##### 1200 (12:00 NOON)

**TT02 STALKING THE NIGHT FANTASTIC:** Fantastic role playing stalking the supernatural evil of the 1990s. GMs Richard Tsucholka and Chris Beiting will teach this event. Free.

##### 1300 (1:00 PM)

**AH11/S2 THE PROGRAMMING OF GULF STRIKE:** See AH11/S1 (SA15) for details.

**JP04 GAME TACTICS AND GROUND TACTICS:** What do wargames have to do with real warfare? Experienced designer John Prados examines the principles of war using a detailed discussion of the play of one particular game as an example. Fee=\$2.

**GN01/S2 HOW TO WRITE FOR GAME NEWS:** See GN01/S1 (SA13) for details.

#### DEMONSTRATIONS

(Note: All Demos are free and no reservations for participatory spots are available.)

#### FRIDAY DEMONSTRATIONS

##### 0900 (9:00 AM)

**CO02 LA BATAILLE DE PREUSSISCH-EYLAU:** Clash of Arms Games presents: Enlightened France meets the Reactionary Oppressors of Europe upon the snowy fields of Eylau using Las Batailles Dan L'Age Napoleon 1er game system. 8Hrs.

### FA13 STAR TREK, COMMAND AND CONTROL:

Can you handle one of the most demanding jobs in the universe? Weak-kneed need not apply for bridge crew positions in the Star Trek Universe. 1Hr.

**FA14/S1 STAR TREK III SHIP COMBAT GAME:** The game that brings the excitement of starship combat to life without taking forever to play. The system is sophisticated, yet easy to learn. Both newcomers and experienced players are welcome. 3Hrs.

**EV08 OBTAIN THE COMMUNICATION CRYSTAL:** This Element Masters scenario begins when the characters' mentor sends them to obtain the other half of his Communication Crystal, presently held by an associate, located in the dangerous Borderlands. Presented by Escape Ventures Staff Members. 2Hrs.

**GW04/S1 WARHAMMER: BATTLE:** Take command of a Regiment of Renown in an exciting introductory adventure into fantasy tabletop wargaming. Good or Evil? The choice is yours. 2Hrs.

**LZ02/S1 DANTE'S INFERNO:** Characters go to hell to find and resurrect lost player-characters. A revised and improved edition of the Judges Guild FRP GAME TO BE MARKETED BY Gamescience. 2Hrs.

**MA07/S1 MAYFAIR GAMES DEMONSTRATION:** DC Heros RPG, Ellery Queen Mystery Magazine Game, Warbots plus others. Your chance to ask how. 6Hrs.

**NE01 INDUNAS, COLONELS AND EMIRS:** Introductory scenario for up to 6 players. One large or several small battles will be conducted. Game scale is 1 to 10. Company level combat. 2Hrs.

### 1100 (11:00 AM)

**FA16 STAR TREK: MAKE A MILLION:** Win your fortune in the Federation Stock Market. Players will vie to see who is the shrewdest financier in the Star Trek Universe. 1Hr.

**GW03/S1 WARHAMMER: ROLE-PLAYING:** Come and try your luck in the Warhammer Universe. The Realms or Chaos await!! 2Hrs.

**PA10/S1 CHILL BOARDGAME:** Search for a creature from the unknown on an ever-changing board in this demonstration of Pacesetter's Chill game. 2Hrs.

**RP01/S1 FANTASY MEDIEVAL 25MMs:** 8 Participants and unlimited onlookers learn RAL's Fantasy Rules as Law Confronts Chaos. Easy to learn, fun to play. 2Hrs.

**RE12 SUBURBAN SLASHER:** Become the psychotic killer of your choice with this new card and strategy game which recreates the worst of the "B" Horror Movies. 1Hr.

**RS01/S1 SEEKREIG NAVAL MINIATURES RULES:** Naval miniatures games using "Seekreig" rules and introducing some new variations. 2Hrs.

**IC05 STARMASTER:** A demonstration of ICE's STARMASTER. The new fast-paced complete SFRP game. Includes personal and ship to ship space combat.

### 1200 (12:00 NOON)

**FA17/S1 BATTLEDROIDS: A GAME OF ARMORED COMBAT:** The battlefields of the 30th-Century Successor States are dominated by the massive man-shaped robot vehicles. Command a Battle-droid that is more mobile, better armored and more destructive than a battalion of 20th Century tanks. 3Hrs.

### 1300 (1:00 PM)

**AH27/S1 DELUXE ADVANCED SQUAD LEADER:** Watch Deluxe Advanced Squad Leader being played with GHQ Miniatures in the new large scale. Hosts: Don Greenwood, Bob McNamara & Charley Kiber. 3Hrs.

**EV04 QUEST FOR THE DRAGON LIZARD EGG:** This Element Masters adventure concerns the characters' quest for a Dragon Lizard egg; scaling almost vertical cliffs on Dragon Lizard Island in constant peril of attack from deadly Sea Dragons. Presented by Escape Ventures Staff Members. 2Hrs.

**GW02/S1 JUDGE DREDD ROLE-PLAYING:** Role-playing in Mega-City One has arrived. Battle the likes of Judge Death and the Angel Gang but try to avoid needing the Robodoc. 2Hrs.

**JG01 VIKING RAID:** Juggernaut, Inc. presents this medieval battle, simulating a Viking raid on the French coast. Knights & Magic Rules will be used. 4Hrs.

**TA01/S1 MIDNITE AT THE WELL OF SOULS:** New from TAG, this demonstration will take up to six players through known space to Jack L. Chalker's "Well of Souls". Can YOU survive? 2Hrs.

### 1400 (2:00 PM)

**RS01/S2 SEEKREIG NAVAL MINIATURES RULES:** Naval miniatures games using "Seekreig" rules and introducing some new variations. 2Hrs.

### 1500 (3:00 PM)

**FA15/S1 BATTLESTAR GALACTIA:** All the action and excitement of the popular TV Series continues in this game from FASA. This fast-paced game of Starfighter combat lets you relive the action of ship-to-ship battles between the Colonial Vipers and the Cylon Raiders. 2Hrs.

**FA18/S1 THE DOCTOR WHO ROLE-PLAYING GAME LEARN THE GAME THAT LETS YOU BATTLE THE FORCES OF EVIL THROUGHOUT TIME AND SPACE.** Play the role of a Time Lord of Gallifrey or a talented human Companion as you match wits with Cybermen, Daleks and, of course, The Master. 4Hrs.

**GW01/S1 GOLDEN HEROS:** Action-packed Superhero adventure straight out of your favorite Comic Books. Easy to learn and great fun to play. Try it! 2Hrs.

**PA08/S1 CHILL RPG WITH GRENADIER MINIATURES:** Play Pacesetter's Chill role-playing game using Grenadier figures appropriate to the ambience. 2Hrs.

**RE10 GUNS AT NIGHT:** A look at this new role-playing game of the old west, with a brief explanation and mini-adventure to put players right into the background. 2Hrs.

**RP01/S2 FANTASY MEDIEVAL 25MMs:** 8 Participants and unlimited onlookers learn RAL's Fantasy Rules as Law Confronts Chaos. Easy to learn, fun to play. 2Hrs.

**TT06 FRINGEWORTHY:** Designer Richard Tucholka demonstrates this fantastic role playing game of interdimensional exploration and high adventure.

### 1700 (5:00 PM)

**EV03 IN SEARCH OF THE ISK PLANT:** In this timed Element Masters scenario, the characters' mission is to acquire some of the precious healing ointment derived from the Isk Plant to save their stricken ally. Presented by Escape Ventures Staff Members. 2Hrs.

**PA09/S1 WABBIT WAMPAGE:** Be a fabulous farmer or wascally wabbit in this game of Mayhem while fighting for carrots. 2Hrs.

**TT03 FASTER THAN LIGHT 2448:** High adventure in space in this new space role playing game. Will be demonstrated by designers from TRI TAC, Inc.

### SATURDAY DEMONSTRATIONS

#### 0900 (9:00 AM)

**CO01 LA BATAILLE D'AUERSTAEDT:** Clash of Armes Games presents: The forces of Revolutionary France and Reactionary Europe clash at Auerstaedt in the introductory level demonstration of Les Batailles Dan L'Age Napoleon 1er game system. 6Hrs.

**FA14/S2 STAR TREK III SHIP COMBAT GAME:** The game that brings the excitement of starship combat to life without taking forever to play. The system is sophisticated, yet easy to learn. Both newcomers and experienced players are welcome. 3Hrs.

**GD07 COMMAND DECISION MINIATURES:** Frank Chadwick hosts this encore play/demonstration to familiarize you with GDSs miniatures rules and development. 2Hrs.

**GW01/S2 GOLDEN HEROS:** Action-packed Superhero adventure straight out of your favorite Comic Books. Easy to learn and great fun to play. Try it! 2Hrs.

**MA07/S2 MAYFAIR GAMES DEMONSTRATION:** DC Heros RPG, Ellery Queen Mystery Magazine Game, Warbots plus others. Your chance to ask how. 6Hrs.

**PA08/S2 CHILL RPG WITH GRENADIER MINIATURES:** Play Pacesetter's Chill role-playing game using Grenadier figures appropriate to the ambience. 2Hrs.

**RE11 LONDON BY NIGHT:** An introduction to the world of role-playing in London during the Victorian period, including a brief exploratory scenario. 2Hrs.

**RP01/S3 FANTASY MEDIEVAL 25MMs:** 8 Participants and unlimited onlookers learn RAL's Fantasy Rules as Law Confronts Chaos. Easy to learn, fun to play. 2Hrs.

**TT05 ROGUE 417 INCURSION:** From the creators of the Morrow Project comes this fantastic after The Holocaust adventure and survival in this unique demonstration.

#### 1100 (11:00 AM)

**EV02 THE GREAT MIP MIGRATION:** In this Element Masters scenario, the characters must protect from predators one of the many prides of Mips migrating to the beaches of Faine for the "Mip Festival". 2Hrs.

**EV07 TRON SLAVE-BRIDGE RECONNAISSANCE:** The characters' mission in this Element Masters scenario is to determine the completion sta-

tus of the Tron Slave Bridges, and to find the patrol which has failed to return. Presented by Escape Ventures Staff Members. 2Hrs.

**GW04/S2 WARHAMMER: BATTLE:** Take command of a Regiment of Renown in an exciting introductory adventure into fantasy tabletop wargaming. Good or Evil? The choice is yours. 2Hrs.

**TA01/S2 MIDNITE AT THE WELL OF SOULS:** New from TAG, this demonstration will take up to six players through known space to Jack L. Chalker's "Well of Souls". Can YOU survive? 2Hrs.

**IC05 STARMASTER:** A demonstration of ICE's STARMASTER. The new fast-paced complete SFRP game. Includes personal and ship to ship space combat.

#### 1200 (12:00 NOON)

**FA17/S2 BATTLEDROIDS: A GAME OF ARMORED COMBAT:** The battlefields of the 30th-Century Successor States are dominated by the massive man-shaped robot vehicles. Command a Battle-droid that is more mobile, better armored and more destructive than a battalion of 20th Century tanks. 3Hrs.

#### 1300 (1:00 PM)

**AD02 COMBAT TACTICS FOR CAR WARS PBM:** Learn how to make full use of the Car Wars PBM combat system. Tips on tactics, strategy and vehicle design. Real arena combats described and analyzed. Host: Draper Kauffman. 2Hrs.

**GW03/S2 WARHAMMER: ROLE-PLAYING:** Come and try your luck in the Warhammer Universe. The Realms or Chaos await!! 2Hrs.

**LZ02/S2 DANTE'S INFERNO:** Characters go to hell to find and resurrect lost player-characters. A revised and improved edition of the Judges Guild FRP GAME TO BE MARKETED BY Gamescience. 2Hrs.

**PA09/S2 WABBIT WAMPAGE:** Be a fabulous farmer or wascally wabbit in this game of Mayhem while fighting for carrots. 2Hrs.

**RP02/S1 MEDIEVAL RULES ACCORDING TO RAL:** 8 Participants and unlimited onlookers learn RAL's Medieval Rules as Lord Crane again strikes for the Throne. Easy to learn, fun to play. 2Hrs.

**RE09 CHALLENGERS:** Find out what Superhero roleplaying could really be with this progressive new system which balances out skills, powers and abilities for a complete and convincing simulation of the best Comic Books. 2Hrs.

**TT04 MONSTER SQUASH:** Monster Squash, the frantically fun game of squashing clay monsters and robots returns in this crazy demonstration.

#### 1500 (3:00 PM)

**AH27/S2 DELUXE ADVANCED SQUAD LEADER:** Watch Deluxe Advanced Squad Leader being played with GHQ Miniatures in the new large scale. Hosts: Don Greenwood, Bob McNamara & Charley Kiber. 3Hrs.

**FA15/S2 BATTLESTAR GALACTIA:** All the action and excitement of the popular TV Series continues in this game from FASA. This fast-paced game of Starfighter combat lets you relive the action of ship-to-ship battles between the Colonial Vipers and the Cylon Raiders. 2Hrs.

**FA18/S2 THE DOCTOR WHO ROLE-PLAYING GAME: LEARN THE GAME THAT LETS YOU BATTLE THE FORCES OF EVIL THROUGHOUT TIME AND SPACE.** Play the role of a Time Lord of Gallifrey or a talented human Companion as you match wits with Cybermen, Daleks and, of course, The Master. 4Hrs.

**GW02/S2 JUDGE DREDD ROLE-PLAYING:** Role-playing in Mega-City One has arrived. Battle the likes of Judge Death and the Angel Gang but try to avoid needing the Robodoc. 2Hrs.

**JG02 NAPOLEONIC NAVAL BATTLE:** Juggernaut, Inc. hosts this Napoleonic naval battle for 4 participants and unlimited onlookers. Ship of the Line Rules will be used. 4Hrs.

**RP02/S2 MEDIEVAL RULES ACCORDING TO RAL:** 8 Participants and unlimited onlookers learn RAL's Medieval Rules as Lord Crane again strikes for the Throne. Easy to learn, fun to play. 2Hrs.

**TM01 OUTLANDS:** Shattered Earth lies waiting to be scavenged by her own colonies in this new Sci-Fi roleplaying game. Come play in this unique experience with T.O.M.E. 4Hrs.

**TT02 STALKING THE NIGHT FANTASTIC:** Fantastic role playing stalking the supernatural evil of the 1990s. GMs Richard Tucholka and Chris Beiting will teach this event.

#### 1700 (5:00 PM)

**EV06 LENEX SPECIMEN:** This Element Masters scenario features an effort to expand Vinyan science's

understanding of the continent's invaders. The characters' mission is to procure a specimen. Presented by Escape Ventures Staff Members. 2Hrs.

**PA10/S2 CHILL BOARDGAME:** Search for a creature from the unknown on an ever-changing board in this demonstration of Pacesetter's Chill game. 2Hrs.

### SUNDAY DEMONSTRATIONS

#### 0900 (9:00 AM)

**FA14/S3 STAR TREK III SHIP COMBAT GAME:** The game that brings the excitement of starship combat to life without taking forever to play. The system is sophisticated, yet easy to learn. Both newcomers and experienced players are welcome. 3Hrs.

**GW02/S3 JUDGE DREDD ROLE-PLAYING:** Role-playing in Mega-City One has arrived. Battle the likes of Judge Death and the Angel Gang but try to avoid needing the Robodoc. 2Hrs.

**JG03 WORLD WAR II SKIRMISH BATTLE:** Juggernaut, Inc. presents this WW II skirmish battle using Amended Panzertruppen Rules. 8 Players, unlimited onlookers. 4Hrs.

**MA07/S3 MAYFAIR GAMES DEMONSTRATION:** DC Heros RPG, Ellery Queen Mystery Magazine Game, Warbots plus others. Your chance to ask how. 6Hrs.

**PA10/S3 CHILL BOARDGAME:** Search for a creature from the unknown on an ever-changing board in this demonstration of Pacesetter's Chill game. 2Hrs.

**RE08 YSGARTH:** An introduction to the newest and progressive role-playing system available today, the first system which is realistic and playable while emphasizing character development, role-playing and believability. 2Hrs.

**RS01/S3 SEEKREIG NAVAL MINIATURES RULES:** Naval miniatures games using "Seekreig" rules and introducing some new variations. 2Hrs.

**TA01/S3 MIDNITE AT THE WELL OF SOULS:** New from TAG, this demonstration will take up to six players through known space to Jack L. Chalker's "Well of Souls". Can YOU survive? 2Hrs.

#### 1100 (11:00 AM)

**GW01/S3 GOLDEN HEROS:** Action-packed Superhero adventure straight out of your favorite Comic Books. Easy to learn and great fun to play. Try it! 2Hrs.

**LZ02/S3 DANTE'S INFERNO:** Characters go to hell to find and resurrect lost player-characters. A revised and improved edition of the Judges Guild FRP GAME TO BE MARKETED BY Gamescience. 2Hrs.

**PA09/S3 WABBIT WAMPAGE:** Be a fabulous farmer or wascally wabbit in this game of Mayhem while fighting for carrots. 2Hrs.

**RP02/S3 MEDIEVAL RULES ACCORDING TO RAL:** 8 Participants and unlimited onlookers learn RAL's Medieval Rules as Lord Crane again strikes for the Throne. Easy to learn, fun to play. 2Hrs.

**IC05 STARMASTER:** A demonstration of ICE's STARMASTER. The new fast-paced complete SFRP game. Includes personal and ship to ship space combat.

**TT02 STALKING THE NIGHT FANTASTIC:** Fantastic role playing stalking the supernatural evil of the 1990s. GMs Richard Tucholka and Chris Beiting will teach this event.

#### 1200 (12:00 NOON)

**FA17/S3 BATTLEDROIDS: A GAME OF ARMORED COMBAT:** The battlefields of the 30th-Century Successor States are dominated by the massive man-shaped robot vehicles. Command a Battle-droid that is more mobile, better armored and more destructive than a battalion of 20th Century tanks. 3Hrs.

#### 1300 (1:00 PM)

**AH27/S3 DELUXE ADVANCED SQUAD LEADER:** Watch Deluxe Advanced Squad Leader being played with GHQ Miniatures in the new large scale. Hosts: Don Greenwood, Bob McNamara & Charley Kiber. 3Hrs.

**FA18/S3 THE DOCTOR WHO ROLE-PLAYING GAME: LEARN THE GAME THAT LETS YOU BATTLE THE FORCES OF EVIL THROUGHOUT TIME AND SPACE.** Play the role of a Time Lord of Gallifrey or a talented human Companion as you match wits with Cybermen, Daleks and, of course, The Master. 4Hrs.

**GW04/S3 WARHAMMER: BATTLE:** Take command of a Regiment of Renown in an exciting introductory adventure into fantasy tabletop wargaming. Good or Evil? The choice is yours. 2Hrs.

**RE07 MIDDLE PASSAGE/PASSAGE TO CATHAY:** An introduction to the boardgame system which simulates the conflict and competition of trade and exploration in the great age of sail. 2Hrs.  
**TT04 MONSTER SQUASH:** Monster Squash, the frantically fun game of squashing clay monsters and robots returns in this crazy demonstration.

**1500 (3:00 PM)**  
**EV05 OFFICIAL ELEMENT MASTERS OPEN:** Players with characters surviving one of the demonstration scenarios are invited to compete in this free tournament. Get in as many demos as possible, as this will increase your chances. Presented by Escape Ventures Staff Members. 2Hrs.

**FA15/S3 BATTLESTAR GALACTIA:** All the action and excitement of the popular TV Series continues in this game from FASA. This fast-paced game of Starfighter combat lets you relive the action of ship-to-ship battles between the Colonial Vipers and the Cylon Raiders. 2Hrs.

**GW03/S3 WARHAMMER: ROLE-PLAYING:** Come and try your luck in the Warhammer Universe. The Realms or Chaos await!! 2Hrs.  
**PA08/S3 CHILL RPG WITH GRENADIER MINIATURES.** Play Pacesetter's Chill role-playing game using Grenadier figures appropriate to the ambiance. 2Hrs.

---

# Coming for Origins!

## "ASL"

### THE ADVANCED SQUAD LEADER RULEBOOK . . .

will make its debut at ORIGINS XI in a sleeved binder allowing for additions and deletions to gaming's most popular tactical wargame. No more errata or thumbing through four different rulebooks . . . at last everything available at your fingertips in a completely redesigned and rewritten format presented in full color with heavy stock foldout charts and playing aids.

### OTHER NEW ORIGINS RELEASES:

**BEYOND VALOR . . .** Module 1 of ASL includes 10 new scenarios, four new city boards, and the complete German and Russian TO&E plus informational counters for ASL on 11 counter sheets.

**STREETS OF FIRE . . .** Module 1 of Deluxe ASL contains ten scenarios and four of the new scale 2.2" hex mapboards for use with miniature figures for the ultimate in playability using ASL counters.

**NEW SQUAD LEADER MAPBOARDS . . .** Boards 9, 10, and 11 (the Rogues) have been redone with quality artwork and added to new boards 16, 17, 18, 19, and 24 for the ultimate variety in Squad Leader terrain.

**RUSSIAN FRONT . . .** A Strategic level game of War on the Eastern Front which may make you forget all about RUSSIAN CAMPAIGN.

**DEVIL'S DEN . . .** A Battalion and Company level game depicting the fierce fighting at GETTYSBURG, featuring a brand new full-color mapboard.

---

### SPECIAL . . .

Talk with Charles S. Roberts, himself—the father of wargaming—at The Avalon Hill Game Company Booth **201-310**.



## The Avalon Hill Game Company

4517 HARFORD ROAD ★ BALTIMORE, MD 21214



# AWARD WINNING COMPUTER GAMES

We've come a long way since our first BASIC programs were introduced in 1980. Just this past year we won more awards than any other computer wargame publisher.

## THE CRITICS CHOICES

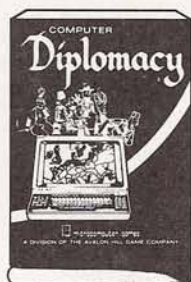

\$50



\$30



\$40

**COMPUTER DIPLOMACY**—Consumer Electronics Show's Showcase Award  
Multi-Player Game of the Year, *Family Computing*

**GULF STRIKE**—Wargame of the Year, *Family Computing*  
Game of the Month, *Byte Magazine*

"An excellent, ambitious, demanding simulation . . ."  
*Strategy & Tactics*

**TACTICAL ARMOR COMMAND (TAC)**—Wargame of the Year, *Electronic Games Magazine*

### You name it, we got it!

We produce computer games on virtually every topic imaginable for all the major machines including Apple, Atari, Commodore, IBM and Radio Shack.

And nearly every historical period is covered.

Visit your local dealer today or call us toll-free at **1-800-638-9292**.

When you think of computer wargames, think **AH MICROCOMPUTER GAMES**

"The thinking man's gamemaker!"



**microcomputer games**®

A Division of **THE AVALON HILL GAME COMPANY**  
4517 HARFORD ROAD, BALTIMORE, MARYLAND 21214

# Celebrating a Quarter Century of Progress!

We enter our 27th year  
of game publishing with  
the introduction of

## **FIREPOWER**



**\$22.**

For 26 years our name has been synonymous with quality. You don't stay in business that long with garbage. However, quality means different things to different people.

That's why we publish over 200 games—each a little different—each catering to different tastes in gaming.

Our latest innovation—

## **FIREPOWER**

### **A Game of Man To Man Combat**

Involving modern day weaponry, FIREPOWER is designed to test the tactical skills of two or more players, utilizing a scale of 5 yards per hex and thirty seconds per turn. Combat at this level is at its most basic and brutal; propaganda, war aims and the overall situation matter little. Full attention is focused on the immediate enemy, his

location, numbers and weapons, the local terrain and sheer survival. The object to winning is quite simple: employ superior maneuver and firepower to lead one's soldiers to victory.

### **A Detailed Look at Military Advances Since 1965**

FIREPOWER is a detailed look at the organization, weapons, equipment and tactics of many of the world's nations since 1965.

FIREPOWER gives players the opportunity to command squad units in recent or current wars, and to experiment with their own squad organizations. The destructive capabilities are massive, and the problems of command and control in devising effective tactics are a real challenge for any gamer.

### **Features Solitaire Play**

FIREPOWER offers "endless scenario variables", hundreds of differentiated weapons and vehicles, flexible mapboards, basic, advanced and optional rules, and solitaire playability—the latter a real challenge for gamers without a readily available live opponent.



Available in leading game stores  
or direct from

## **The Avalon Hill Game Company**

4517 Harford Road ★ Baltimore, MD 21214

For Quick Credit Card Purchasing, Call TOLL FREE 800-638-9292

# VICTORY #6

INSIDER

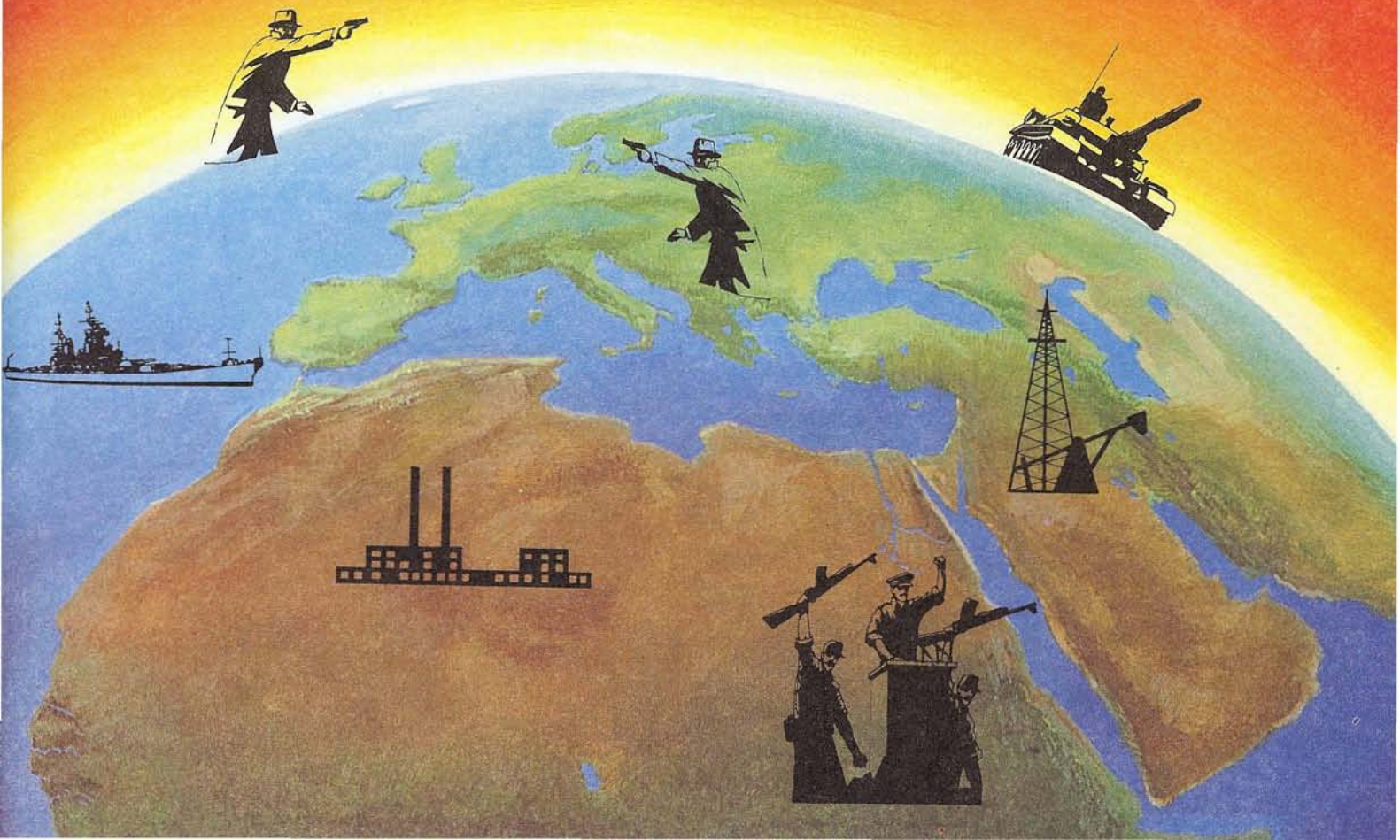



## Vietnam Errata

### Counters

The U.S. Armored Cavalry battalions designated 1/1 and 2/1 are independent units; they are not associated with the 1st Division.

### Charts and Tables

The Terrain Key lists incorrect Combat Modifiers for three terrain types. The correct values are: Mountains: -3, Forested Hills: -2; Cultivated - (RF)

Coastal hexes lightly outlined in yellow are landing beaches (see rule 3.4).

VC Supply conduits cost 0 personnel points (the value given on the NLF Player's Chart and Table Sheet is incorrect). The map is correct.

U.S. riverine points cost 1 U.S. commitment point each (the value given on the U.S. Player's Chart and Table Sheet is incorrect). The map is correct.

The Population Control Sheet has incorrect identifier codes for three regions: Vinh Binh (pop. 8) should have code IV-8, Yihn Long (pop. 11) should have code IV-6, and Kien Hoa (pop. 12) should have code IV-7.

### Rules

(3.3) Units employing strategic movement *can* be forced into incidental attacks just like any other units.

(4.2 and 5.6) The Combat Modifier for population centers is not cumulative with other terrain in a hex; the defender must choose which type of terrain he will receive the defensive benefit for, if there is more than one type of terrain in a hex.

(5.4) A defending stack has a minimum ground combat strength of 1, *plus* any relevant Regional Forces (e.g. an artillery unit by itself in a town would have an effective ground combat strength of 3 on defense).

(7.4) U.S. naval units may never be used during NLF operations, for any purpose.

(11.1) Ineffective ARVN stacked with effective units do contribute to the combat odds if an incidental attack is forced upon units passing through their hex.

(12.0) Segment 4C incorrectly states that the SVN draft level influences SVN morale. The draft level has no effect on morale.

(12.0) Delete the reference to "Pacification Programs" in Segment 5A of the Seasonal Interphase. It refers to a rule that does not exist in the current version of the game.

(17.2) The rules refer to the Thai RTA (Royal Thai Army) division. This division was also called the "Black Panther" division, and the counters bear the designation "BP."

(17.5) Newly created VC units may be placed on the borders of

the regions in which they are created; the production capacities of two (or more) regions may thus be combined to form a unit on borders.

(17.5) The heading "Placing VC Units" states that newly-created VC units can be placed in any hex not occupied by enemy units. This is true, with the proviso that regional maximums (described earlier in 17.5) must also be observed.

(17.5) Sea transport of VC supplies is uneconomical (and virtually never undertaken) using the ratio of NVN commitment: VC supplies listed in the rules. Adopt the following correction: calculate the amount of VC supply that gets through the U.S. blockade normally, per the procedure given in the rules, then add 2 VC supply for each NVN commitment expended to determine how much supply is actually received.

(17.6) If 2 or more regiments in an NVA HQ are augmented, consider the division's HQ augmented (at no additional cost). Once augmented, an NVA HQ moves at mechanized movement costs, its values do not change, however.

(18.0) NLF may not be set up in enemy-occupied hexes in any of the scenarios.

In *The Battle for I Corps* scenario: ARVN 1.1 was incorrectly listed in the set up as ARVN 2/1. Also, U.S. 1/2/1C was incorrectly listed as 2/2/1C. Play begins with the 1st turn of spring, 1968 (not 1967). A special rule for this scenario was omitted: there is no Strategic Movement Phase during the first turn of the scenario.

In the *Tet* scenario, U.S. starting artillery listed as 8 155mm should be 8 105mm.

The total population of South Vietnam is 360 (not 350 as the rules incorrectly indicate in a few places). Starting SVN population in the *Battle For South Vietnam* campaign scenario is 217. Starting VC population is 143. Starting SVN population controlled in the *After Tet* scenario is 239; VC population should be 121.

Add the following special rules to the *After Tet* scenario:

a) Begin play with the Unit Status Phase of the Seasonal Interphase of Spring 1968 (not with the 1st game-turn, as scenario instruction #9 incorrectly reads). Since phases 1-5 of the Interphase are skipped, there can be no coups, bombing, or reinforcements during this Interphase. Future Seasonal Interphases are played normally.

b) On Game-turn 1 of Spring 1968, skip the Strategic Movement Phase; on all future turns, this phase occurs normally.

NLF morale is modified only during the Politics Phase of the Seasonal Interphase, never during the season (the NLF record sheet erroneously provides a line for morale modifications during the seasons).

Executive Editor: Mark Herman  
Managing Editor: William E. Peschel  
The Victory Games Staff:

Mark Herman, Jerry Glichenhouse, Rosaria Baldari, Robert Kern, Gerry Klug, Susan Koch, Ted Koller, Michael E. Moore, Paul Murphy, Bob Ryer, Eric Lee Smith, Jim Talbot.

Project Oversight: W. Bill

Contents Copyright © 1984 by Victory Games, Inc.

*Victory Insider* is devoted to printing articles about the products of Victory Games, Inc.

All editorial and general mail should be sent to The Avalon Hill Game Company, 4517 Harford Rd., Baltimore, MD 21214. Subscriptions to *The General* are \$12.00 for one year; \$18.00 for two years. Address changes must be submitted at least 6 weeks in advance to guarantee proper delivery. Paid advertising is not accepted.

Articles from the public will be considered for publication at the discretion of our Executive Editor. Articles should be typewritten, double-spaced, and written in English. There is no limit to word length. Rejected articles will be returned if submitted with a stamped-self addressed envelope.

# Cold War Design Analysis

By John Prados

*Cold War* is exactly what it set out to be; a game mirroring the intense competition of international relations. Played by two to four persons, *Cold War* is a game in which the players vie with each other to take over the world. It is a multi-player game involving global scope, fascinating strategy, and simple game mechanics. It is a game of initiative, diplomacy, and political, military and economic control over regions of the world. The game includes no dice, combat results tables, or other accoutrements of the standard wargame.

Players represent the superpowers: the Soviet Union, China, Western Europe and North America. Each player has diplomats and agents which he may send to various regions of the world to build a controlling faction or to eliminate an opponent's influence. Action cards and strategic points are spent to initiate or counter the different play actions, from establishing a factory to going for military control. Opponents can play other cards and use points to counter the attempted actions. Each player has certain vital regions of interest to him. The winner is the player with the largest amount of political, military and economic control.

The original design came from an effort with co-designer Lenny Glynn to build upon the game system we created for a pre-World War II espionage game. We wanted to retain the intrigue element of the game, but add power politics and a modern element. We also wanted to focus on diplomacy and not allow major warfare. This enabled us to steer clear of combat resolution and the whole simulation question. The simulation content in *Cold War*, instead, centers on the ebb and flow of international competition that has characterized the post-World War II era.

In addition to establishing political, economic or military control, there are two personages that players deploy throughout the world: diplomats and agents. Each has their strengths and limitations.

Diplomats execute political functions. They allow players to build a faction in a region where they are present. Diplomats also enable the players to spend strategic points, for example, in return for playing an action card. Depending upon the event in effect during each turn, the presence of a Diplomat may entitle the player to draw additional Action cards.

Agents are used for more nefarious schemes. They may engage in economic warfare, assassinate members of the opposition, destabilize an opponent's control, establish insurgencies and carry out coups.

The central design feature of *Cold War* is that there is a *hierarchy* of possible controls. There is economic, political and military control. Political control is the highest degree of the three and requires three stages to achieve, unlike the two needed for the others.

Politically, once the player has a faction in the region, he may make

investments there by building a factory. The player's strategic point (SP) growth at the end of the turn is based upon the point values of the regions where he has factories. These investments can be built up to the level of economic control of a region, which provides greater SP returns.

Having a faction in a region means that the player has built a certain amount of support there. These factions can be increased into a political alliance, and from there into political control. Likewise, establishing a military presence in a region can allow you to end up with military control.

The events of each *Cold War* game will revolve around the attempts to establish control in your regions, and destabilize the regions of your enemies. Establishing control not only means accumulating SP's (and therefore the power to expand control into other areas), but determine victory in the end. Each type of control is worth a certain number of SP's, with the winner having the most.

Also, certain types of actions are not allowed in regions where the opponent has achieved specified kinds of control.

*Cold War* is not difficult to learn, and it is quick and exciting to play. Players will come away with many ideas for subsequent rematches.

## Strategies and Tactics

Most actions require spending Strategic Points. Therefore, the supply of SP's is a critical factor in determining your strategy. The player should use the pre-game setup phase to establish factories in SP-rich regions. Always try for factories or even economic control in your vital regions, since this doubles the SP income.

Concentrate on building up income during the initial turns. Undertake agent actions only if they do not impede your growth. Be sure to make at least one action designed to increase income on every turn unless the tactical situation is very critical. On an endgame turn, however, forget about growth and focus on control of all kinds; building up your own and breaking your opponents'.

Action cards are important in determining the capabilities of your agents. Each player holds a hand of seven, and may expend cards either to initiate or to counter actions. A card may be drawn in two ways: at the end of the turn and as a result of an event card. Event cards say that players with diplomats in certain regions are eligible to draw action cards. Thus, if you was to replenish your hand during the turn, attention must be paid to establish Diplomatic presences. Always occupy at least two of the three possible embassies, especially the Soviet Union.

Also, most action cards require spending SP's when played. Keep in mind your SP's, especially at the end of your player-turn, where you

## How To Fight The Cold War

*This is a brief description of how Cold War plays. It's not meant to be an exhaustive summary of the rules, and some areas will be glossed over to provide an accurate picture of just what this game is about.*  
WEP

*Cold War* is played on a map that is divided into regions, not hexes. There are four Home Countries (North America, Western Europe, the Soviet Union, and China); six sea zones and 27 regions. Some of the regions are countries (Israel, Yugoslavia, Brazil) while others are not (Central America, Andean Nations, and Southeast Asia). Each region has a set number of strategic points that is paid each

turn to the player controlling it. It is worth extra points if that region has been denoted as that player's vital region by the other players at the start of the game.

Beginning with a pool of Strategic Points (SP's), each player purchases factions, alliances, factories and military presence markers, and places them in any region. In addition, seven diplomat/agent markers are placed by each player. Since one marker is on the reverse of the other, deciding early how much emphasis to put on each is important. You can turn agents into diplomats, and vice versa, but it takes time.

Basically, there are seven different types of control a player can have over a region. They are separated into three areas: military (from establishing a Presence to Military Control), political (starting a Faction, building it into an Alliance and from there

to Political Control) and economic (starting with a Factory and ending with Economic Control). Players spend SP's to place these markers, or use their agents to perform assassination, economic warfare, destabilization, coups or insurgency.

Event cards are drawn each turn, giving players a chance to acquire SP's or action cards, cause a power vacuum in a region, or end the game.

In addition, action cards are accumulated and used to counter another player's action card, destabilize a region, or oppose an attempt to establish control.

The game lasts from 7 to 12 turns, depending upon the appearance of the "Game Ends" event card. Each player totals the number of SP's he has, and receives more SP's for having economic, military and political control of a region. The player with the most points, wins.

may need to play action cards to counter attacks by your opponents. As a rule of thumb, retain as many SP's as would be required to play all the defensive cards you have. This rule may be broken if you want to expand your SP growth investments during the initial turns.

A third point: on the *Cold War* rules summary sheet, there is a "Chinese Restaurant" menu where you may play one action from Column A (establishing various types of control) and one from Column B (actions against other players). These columns can be played in either order. Thus, with the right pieces already established in a region, you could, for example, eliminate an opponent's political control, and then establish control of your own. You could then *Expropriate* the opponent's factory or economic control and make it your own! The Chinese Restaurant gambit allows a number of dynamic possibilities.

Although you should keep an eye on the SP track, do not become mesmerized by it. It is true that the player ahead in SP's has an apparent lead, but the control situation may completely eliminate the lead. It is not unusual for a player to be ahead by thirty or more SP's at the beginning of the last turn and still lose the game. It tends to happen that the leader becomes the target by everyone during the last turn. Since his action card supply is soon exhausted, the leader is incapable of defending his worldwide control. Conversely, the safest strategy for the leader is to hold back all his defensive cards, spending SP's only to improve control.

## Additional Cold War Options

The following are five variants that may be used in any combination for playing *Cold War*. Any or all the variants may be used subject to agreement among the players before the beginning of the game. A variant cannot be used if any player objects, and no variant may be introduced after the game begins.

### The Dummy Player

Playing *Cold War* by three persons can be more fun if the fourth Superpower is played as a dummy. Any country can be selected to be the dummy. During the game setup, players take turns placing the pieces for the dummy player, and expending SP's for placing factions and factories. Vital region markers for the dummy are then placed in accordance with the regular rules. The action cards dealt to the dummy are placed face-up where the player for the dummy would sit.

During the game, players again alternate in a clockwise fashion taking the player-turn for the dummy. The player may take any action with the dummy that is possible under the rules. For defensive card play, any action in the dummy hand that could oppose an action must be played. In cases where the dummy hand shows more than one card that could oppose an action, the two players who are not moving on the player-turn in progress must decide.

### Vital Region Free Placement

Much conflict and competition is avoided under the regular rules be-

Not only can a *Cold War* game end sooner than expected, but the game can also be lengthened! This results from the fall of events cards and may happen anytime up to the last player-turn of the last turn. Thus, endgame play may suddenly become useless or even detrimental. Because of this, players should become aware of the temptation to launch "kamikaze" offensives, even on the apparent last turn of the game. "Kamikaze" strategies can be very effective, but they cannot be used without risk except for the very last player to move in the game.

The Middle East region has special significance. Should *any* of the players gain control, all other players must, in effect, pay him tribute. No matter how bad diplomatic relations and hostility may be present, they have a common interest in preventing any enemy from getting the upper hand in this area. A related item is the other vital regions, which are unique to each player. Again, the other players must pay tribute to opponents who gain control of them. Work hard, and defend hard your vital regions.

Potentially murderous in its impact is a Power Vacuum in a region. These are moderated by the event cards, and may force players to bid against each other in an effort to gain sudden control of the area. Don't start bidding in a power vacuum situation unless you have sufficient SP's both to win the contest and to keep on playing. It does not good to win a region, only to lose it because you don't have the SP's to defend it.

cause no two players may have vital regions in the same zones. Thus, this element is added by allowing a freer placement of vital regions. Players still take turns placing the markers as before, but may place them on any region *except* the Middle East.

### Free-wheeling Cold War

Diplomatic agreements between players allow trade or aid only through the exchange of Strategic Points. Under this variant, players who maintain diplomatic links with each other may also trade or buy action cards from each other, under any agreement set by the players.

### Wild-card Masterspy

Because of its steep cost, many players are deterred from using the Masterspy card, especially in the early stages of the game. Under this variant, the SP cost for playing the Masterspy action card is eliminated.

### Action Card Purchase

Players are sometimes inhibited from using action cards for fear of ending up with a hand having so few cards that their capabilities are minimized. During the Joint Economic Growth Turn, players may purchase up to two Action Cards in addition to the one or two they are allowed to draw from the deck. Each action card costs 5 SP's. No player may hold more action cards than normally allowed. Players may discard action cards in order to purchase new ones.

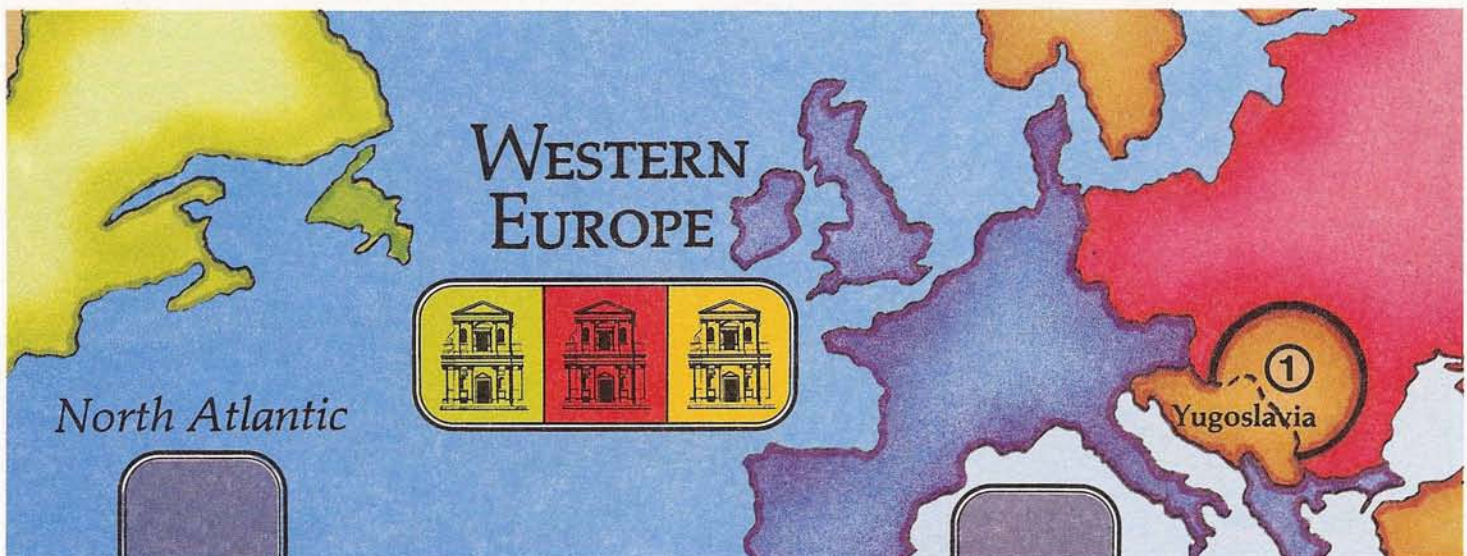

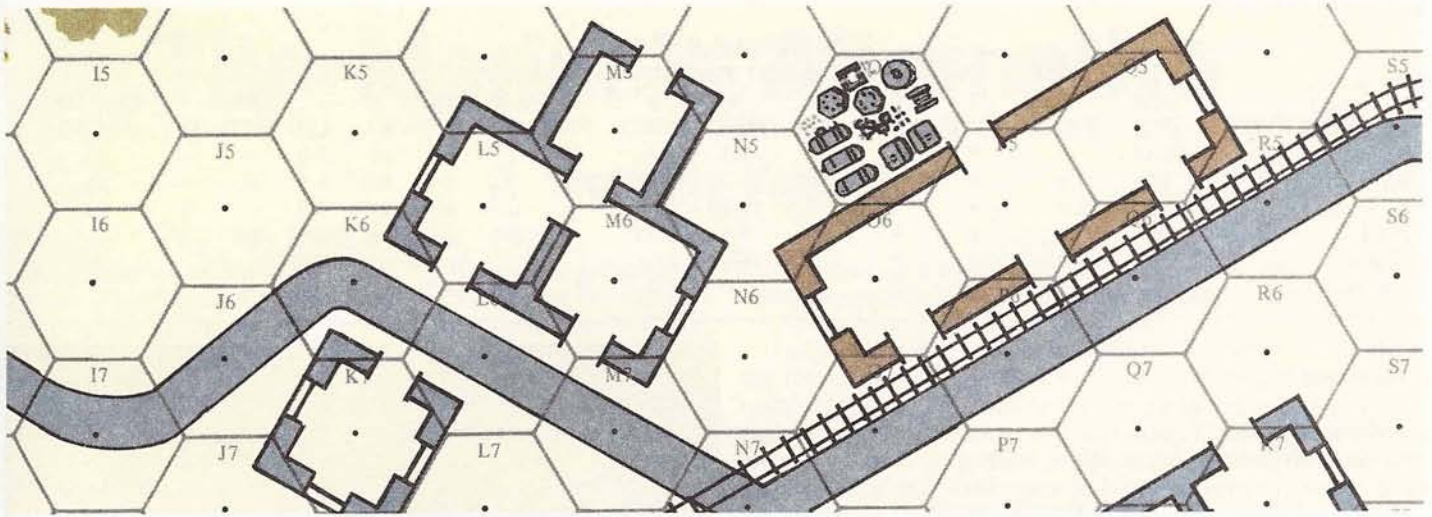

# His Majesty's Soldiers

## Adding The British To Ambush

By Stephen Negrus

*Did you know that, in addition to being a superb solitaire game, Ambush can also be played with two or more players? It's very easy to handle, and if there are any groups involved in this pleasant pastime, write an article telling us how you do it! We at the Insider are busily preparing a special Ambush issue, featuring a brand new scenario. It is so big, in fact, that there may not be much room for anything else other than the cover. In the meantime, let's whet your appetite with this special variant. WEP*

Ambush is, with B-17, one of the first solitaire wargames to burst on the market and is rapidly becoming a phenomenon. It has often been compared by Victory Games to *Squad Leader*. Like its predecessor, it has a very large dose of expandibility which contributed so much to SL's success. Yet, this has not been carried to its furthest. As I look over *Move Out*, Ambush's expansion module, I am saddened to see that few new rules have been added.

To rectify this, I leave before you, gentle sirs, a variant that will add a new dimension to the game. He who has mastered the tactics of the American squad will have two new varieties of troops to choose from, plus a couple of new weapons to add to his armory as well.

### The British

The British squad in WWII was renowned for its tendency not to break under fire. Therefore, during squad generation, the British squad is given five extra regeneration points. Its armament was generally lighter than the Americans, so subtract three from British weapon points. British forces did not have as much familiarity with motorized vehicles as the Americans, so subtract two from their driver skill die roll.

The British squad is allowed the following American weapons: grenades, satchel charges, medium (Vickers) machine guns, and pistols. All British ammunition is treated as American. In addition, since Thompsons were commonly used, the player has the option of taking this rather than the British model. They are also allowed the following new weapons which the American may utilize as well (see the end of the article): flamethrowers and mortars.

These weapons may be used exclusively by the British:

#### Bren Light Machine Gun

Cost: 8. It takes two port boxes. Requires one man to fire or move it, but after being moved, it requires preparation like a crewed weapon.

#### Piat

Cost: 6. Treat like a bazooka except as indicated on the weapons chart.

#### British Submachine Gun

Cost: 4. Takes one port box.

#### British Bolt Rifle

Cost: 2. Takes one port box.

In a scenario, when US troops are deployed through paragraph orders, substitute the following weapons for US weapons: British SMG for Thompson, British bolt rifle for SAR or carbine, Bren LMG for BAR, and PIAT for bazooka. No change is made in the attributes.

#### The Maquis

Another force that could be simulated in *Ambush* is the French underground force called the Maquis. Although these troops did not operate alongside U.S. forces, they made numerous raids and guerilla actions. These troops could be used in all scenarios but 4 and 8 with the following provisos.

Ignore all references to reinforcements. When a paragraph states that a U.S. soldier or vehicle appears, treat as no effect. The Maquis is not assigned jeeps. Any radio references are discarded. Before beginning scenario 3, read paragraph 1000.

The following additional steps are taken when using a Marquis squad. Eight additional points are given to the player to simulate the advantage of surprise the underground usually held over the Germans. Only one-half (rounded up) of weapon points assigned to a squad could be used. Halve the driving skill of any Maquisard in a captured vehicle, since they will not be given friendly vehicles.

In order to simulate their capabilities, a modifier of +1 is given to any PC check performed by one, and a -1 modifier is applied to all activation checks conducted in a scenario involving the Maquis. In addition, the Maquisard's ferocity is simulated by allowing him to kill (automatically) any prisoner in the same hex as he, and by not allowing him to make assaults to capture.

#### New Weapons

##### Concussion grenades

These grenades are treated as exactly the same as normal grenades except that they have less effect on personnel, and more on vehicles and buildings. When used against unarmored targets, conduct fire in the same way, but only allow it to affect one target only. Against vehicles or buildings, roll normally to hit but treat the grenade as an explosive penetration weapon, with penetration being light on a roll of 4-7 and medium on a roll of 8 or 9.

##### Mortars

These depict the British 2" and the American 60mm mortars. They cost eight and take up two port boxes. Mortar rounds are treated the same as grenades with the exceptions that they may not be thrown and that any damage inflicted by them is always located on the "Grenade,

## WEAPONS CHART

WEAPON TYPE	JAM (PC)	CHANCE TO HIT AT RANGE						DAMAGE EFFECT (ONE DIE)						OUT OF AMMO	
		BASE 8 SAME	7 ASS.	6 ADJ.	5 SHT.	4 MED.	3 LONG	PERSONNEL			PEN.				
Brit SMG	05/10	•	•	•	2-4	5-8	9+	0-1	2-7	8	9	7-9	—	—	50
Brit Bolt	05	•	•	•	2-7	8-16	17+	0	1-5	6-7	8-9	6-9	—	—	25
Bren LMG	05/10	•	•	•	2-10	11-20	21+	—	0-3	4-6	7-9	4-9	—	—	50
PIAT	05d	•	•	•	2-3	3-6	7-12	—	0-1	2-3	4-9	0-6	7-8	9	A
Mortar	05d	•	•	•	1-9	10-20	21+	As grenade (inside)						A	
Flamethrower	—	1	•	2	4	5-6	0	1-2	2	4-9	5-8	9	—	A	

Inside" table.

Mortars require one action to fire and one action to prepare. They may not be snap fired. Anyone loading or firing a mortar must crouch. After being prepared, a mortar must be fired on the next turn without being moved. A mortar may be fired at any hex on the board with the following modifiers:

1. The mortar is firing at a hex out of sight: -3
2. The mortar is not being crewed by two people: -2
3. The firer's weapon skill
4. The mortar is being fired into a woods hex: -2
5. The mortar is being fired into a rough, cover, brush, or rubble/crater hex: -1

A mortar may not be fired into an interior hex. They may not fire concussion rounds. A mortar round that misses scatters like a grenade or satchel charge.

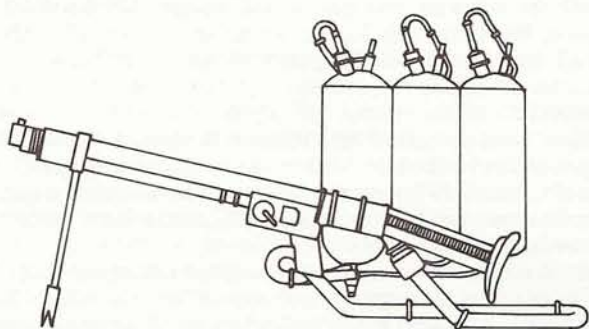

#### Flamethrowers

Flamethrowers cost 12, require the use of 1 person, and occupy 2 port boxes. One flamethrower shot requires the use of one weapon point. Any target fired upon by a flamethrower is considered, for calculating hit chances only, to be one hex closer than it actually is. Flamethrowers may not be fired inside its own hex. Everyone in the target hex is affected. Anyone killed, wounded, or incapacitated by fire while carrying a flamethrower must roll for explosion. This will occur on a roll equal to or less than 25 with percentile dice. These explosions kill the bearer and affect everyone in the hex like a grenade blast.

The following modifiers apply to flamethrower fire:

1. Firer is wounded: -1
2. Firing through non-adjacent aperture: -1
3. Snap fire: -2
4. User's weapon skill

In addition, houses and vehicles will be set ablaze by a flamethrower on penetration. Vehicles will explode at the end of the turn, killing all within and damaging all in the same hex with the equivalent of a grenade blast. Note that armored vehicles are only vulnerable at the rear, not at the tracks, to this form of attack. Anyone inside a burning house at the end of a turn will take damage as from a grenade, outside. Bunkers may not be set afire. Any German inside a burning house will immediately exit by evasive movement. If he does not possess evasive movement, than he will exit by the route which moves him farthest from enemy soldiers. Roll a die if there is a choice of hexes. No German will ever end his turn in a burning house. If he has MP's remaining to move to the hex beyond the house than he will do so. If not, he will lie prone that turn.

## SARGE SEZ . . .



## FALL IN!

The Victory Insider is looking for a few good writers to fill the pages of the premier magazine about Victory Games, Inc. What's the best way to approach playing 1809? (From behind with a very large stick.) What should players look for when setting up units in Cold War? (The nearest fast-food joint.) And what about the British in Pax Britannica?

If you are willing to tell us the answers to these musical questions, we're willing to pay for the privilege: \$18 per page or \$27 in VG/AH games.



# The Marine's Alternative

## A Vietnam Variant

By Carlo Amato

Pacification was an elusive goal during the American involvement in Vietnam. Many programs were attempted and, for the most part, failed. One program that was never really given a fair chance was the CAP program, and this article will provide the rules and background to allow players of VG's *Vietnam* game to try it.

In June of 1964, when General William Westmoreland took over as COMUSMACV, he immediately came into conflict with Marine Corps leaders concerning the proper way to conduct the war. Westmoreland favored the "search and destroy" strategy with large numbers of troops scouring the countryside, seeking to engage enemy troops whenever and wherever possible.

Seeing the Vietnamese people as the true objective, the Marine Corps instituted the Combined Action Platoon program (CAP). One U.S. rifle squad and a medic would be attached to a South Vietnamese Popular Forces platoon of 38 men to provide village security. The CAPs lived with the villagers, providing around-the-clock security from the VC.

The marines and PF's complemented each other. The marines supplied the technical know-how to direct supporting fire and the backbone to rally the PF's to stand and fight (typically, these troops fled at the first sign of VC). The PF's in turn eased the interaction between the Americans and villagers. And the villagers, confident that the CAPs would protect them, cooperated with the troops.

Westmoreland recognized the virtues of the CAPs, but did not encourage their use outside of I Corps. He complained, "I simply had not enough numbers to put a squad of Americans in every village." However, arithmetic does not bear this out. In 1967, South Vietnam had approximately 2,500 villages. To put a squad in every village would require forty thousand combat troops. It is important to remember, though, that every American combat soldier had about 8 persons whose job was to keep him supplied. A nationwide commitment to CAPs would not have been cheap, but was well within U.S. capabilities.

Of course, Westmoreland stuck with the search and destroy tactic. But why not give the U.S. commander the CAP option? It can be used in the campaign game as well as a play balance tool in the scenarios between players of unequal skill.

The following rules should be used with the Marine Alternative:

1. Allow the U.S. player to institute a nationwide CAP program at a cost of 120 commitment points. The U.S. player could build one in

I Corps alone at a cost of 20 commitment points, and later start a nationwide program for 100 commitment points.

2. The effects of the CAP program are:

a) each cultivated hex will defend itself with a strength of 1 if an NLF unit chooses to attack it. Essentially, the marines are giving each hex's regional forces, rule 11.2, the incentive to fight.

b) an NLF unit or stack of units can move through cultivated hexes with no movement penalty, nor do they have to attack. Cultivated hexes cannot force incidental attacks.

c) the cultivated hex can call in air and artillery support fire, and U.S. or ARVN replacements may be used to fill combat losses. However, if the CAPs suffer more than two point losses, combat ends (the CAPs have been overwhelmed) and no replacements need be lost. If the CAPs lose one, the U.S. player may opt to use a replacement point and continue combat, or allow the CAPs to be overwhelmed by not filling the loss.

d) Rule 7.2, Limits to Artillery Support, applies to CAP combat as well.

e) CAPs may never be used to attack. They are strictly defensive.

f) VC supply conduits may not be built in cultivated hexes that have CAPs.

g) Regional forces may still be used by defending Allied units normally. However, if the Allied unit is destroyed, or retreats out of the hex, the CAP is considered destroyed as well.

h) A side record of the hex numbers that have had their CAPs destroyed should be kept. At the end of any seasonal interphase, the U.S. player may reinstitute CAPs in up to three of them for every U.S. replacement point expended. However, no NLF unit may occupy the hex at that time.

g) An NLF unit can be considered to occupy a cultivated hex for pacification purposes (in the campaign game) or victory point purposes (in the scenarios) only if the CAP has been eliminated.

h) Cultivated hexes on the border between two Corps zones are considered to have CAPs if one of the Corps has them.

i) The CAP program may be dismantled any seasonal interphase, but may not be rebuilt. The U.S. player regains the full commitment he spent if he dismantles the program. A CAP program must be dismantled for, or with, final withdrawal.

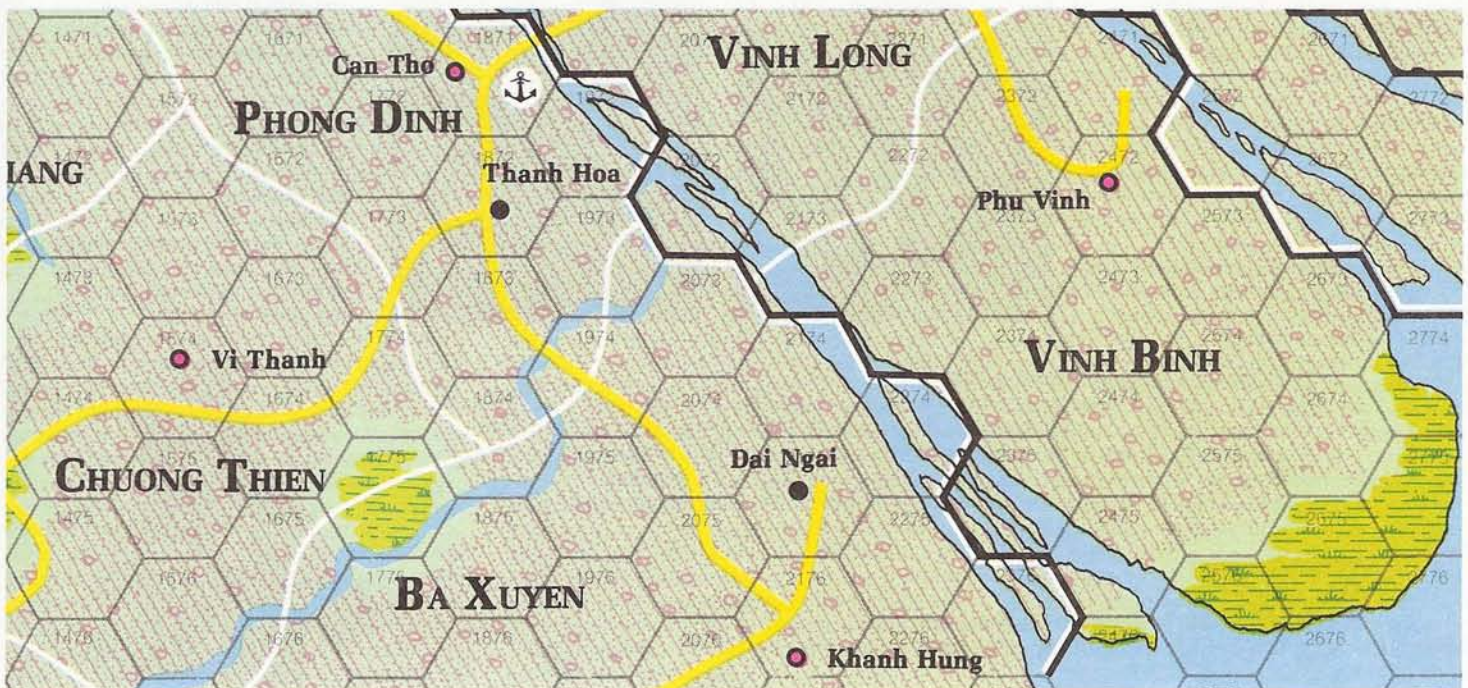

# With Victory Games, Inc.

## STRATEGY GAMES & SIMULATIONS

### You Get What You PLAY For. . .

✓ **Quality**      ✓ **Excitement**      ✓ **Challenge**

*Victory Games, Inc. knows as well as you do that the very best simulations and strategy games are a product of design experience bringing fresh, new ideas to the gaming public. Now the most innovative and respected company in the field is prepared to prove that point again!*

New Module for the  
Award-Winning Ambush!



**PURPLE HEART**  
\$22.00

Six new missions for the phenomenal *Ambush!* solitaire game system. Includes new maps and counters.

**PAX BRITANNICA**  
\$24.00

Multi-player game of colonization and empire building from 1880 to the outbreak of the Great War.

## Look for these New Releases!

A Dynamic Multi-Player  
Game of the Age of Empire

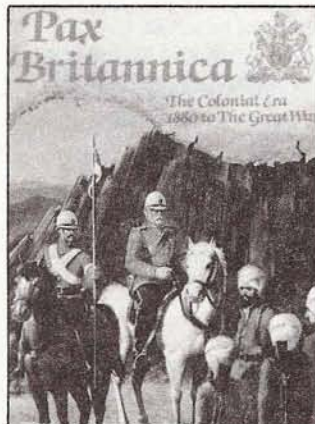

A Detailed Simulation of  
Modern War at Sea



Exciting Multi-Player  
Game of Modern Politics

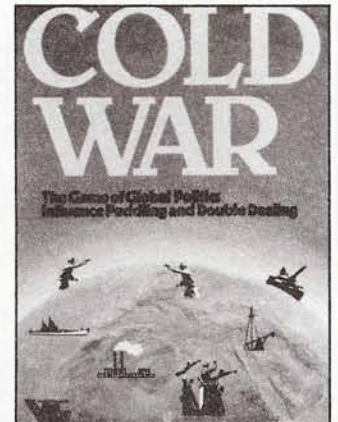

**COLD WAR**  
\$24.00

Multi-player game of intrigue and global influence-peddling in the contemporary world in an easy-to-learn format.

**SIXTH FLEET**  
\$30.00

More than 600 playing pieces and two maps in a panoramic simulation of naval combat in the Mediterranean.

#### EXCLUSIVE FOREIGN DISTRIBUTORS

**UK:** AVALON HILL GAMES, 650 High Road, North Finchley, London N12 ONL, England. Telephone 01-445-3044. **Australia:** JEDKO GAMES, 134 Cochrane Road, Moorabbin, Victoria 3189, Australia. Telephone (03) 555 1022. **Japan:** POST HOBBY, 26-5 5-Chome, Sendagaya, Shibuya-Ku, Tokyo, Japan. Telephone (379) 4081. **Sweden:** TARGET/TRADITION, Storgatan 29, S-114 55 Stockholm. Telephone (08) 61 93 01.



43 West 33rd Street  
New York, NY 10001

