



The AVALON HILL
GENERAL

May-June 1974 Vol. 11 No. 1

30th Anniversary
Commemorative Issue of
the Normandy Landings

AZ
2/74



The AVALON HILL
GENERAL
The Game Players Magazine

The Avalon Hill GENERAL is dedicated to the presentation of authoritative articles on the strategy, tactics, and variation of Avalon Hill games of strategy. Historical articles are included only inasmuch as they provide useful background information on current Avalon Hill titles. THE GENERAL is published by the Avalon Hill Company solely for the cultural edification of the serious game aficionado, in the hopes of improving the game owner's proficiency of play and providing services not otherwise available to the Avalon Hill game buff.

Publication is bi-monthly with mailings made close to the middle of January, March, May, July, September and November. All editorial and general mail should be sent to the Avalon Hill Company, 4517 Harford Rd., Baltimore, Maryland 21214. One year (6 issue) subscriptions are \$5.00. Please send checks or money orders only. Not responsible for cash lost in transit. All subscriptions sent via third class mail. Airmail and First Class delivery must be prearranged with the subscription department at additional cost. No paid advertising of any type is accepted. However, news of importance to the wargaming community is printed free of charge and is solicited.

Articles from subscribers are considered for publication at the discretion of our editorial staff. Articles should be typewritten, double-spaced, and embrace the tenets of good English usage. There is no limit to word length. Accompanying examples and diagrams should be neatly done in black or red ink. Photographs should have caption and credit line written on back. Rejected articles will be returned whenever possible. In any and all cases, Avalon Hill accepts no responsibility for unsolicited material. Authors of published articles which receive favorable response from the readership will be remunerated with free merchandise of their choice.

Back issues are available for \$1.00 apiece. All but the following out-of-stock issues are available:

All Volume 1; Vol. 2, No's 1, 5, 6; Vol. 3, No's 1, 2; Vol. 4, No's 3, 4, 5; Vol. 5, No. 1; Vol. 6, No's 4, 5, 6; Vol. 8, No's 4, 6; Vol. 9, No's 1, 3.

EDITOR: Donald J. Greenwood

GRAPHICS: Randal Reed, Scott Moores, A. Zygier

EDITORIAL STAFF: H. Anton, R. Beyma, D. Burdick, T. Buyniski, J. Davis, S. Duncan, R. Easton, R. Garbisch, G. Gygax, R. Harmon, C. Knabe, C. Lane, B. Libby, R. Livermore, D. Lowry, L. McAneny, D. Miller, T. Oleson, G. Phillips, L. Pinsky, R. Plock, J. Pournelle, L. Pulsipher, D. Roberts, M. Saha, B. Sinigaglio, H. Totten, L. Zocchi

CONSULTING EDITOR: Thomas N. Shaw

CARTOONISTS: T. Smiley, S. Harchak

To facilitate correspondence, we suggest that all envelopes to Avalon Hill be marked in the lower left-hand corner as follows:

Purchases of the GENERAL: Subscription Dept. — Gertrude Zombro

Purchases of Games, play-by-mail kits, and game parts: Order Dept. — Christy Shaw

Questions Concerning Play: Research & Design Department. Note: all questions should be thoroughly diagrammed. No questions will be answered that are not accompanied by a stamped, self-addressed envelope. Only questions regarding rule clarifications (not historical or design subjects) can be answered.

Articles for Publication, Letters to the Editor, Requests for Brochures, and Readers Response Page submissions: Editorial Dept. — Donald Greenwood.

Photograph Credits: Photo File, Avalon, California

Typesetting: Colonial Composition

Printing: Monarch Office Services, Inc.

Cover Art: "Mein Gott! Die Invasion!"

Al Zygier

Copyright 1974

AVALON HILL

4517 Harford Road, Baltimore, Md. 21214



Avalon Hill Philosophy Part 44

For a long time now we've been aware of your desire for more quality games. In the past, Avalon Hill has limited itself to 1 or 2 wargame releases per year with the idea of producing the best possible product. This policy has been very successful as testimonials to the new generation of Avalon Hill games will attest. Both *Richthofen's War* and *1776* have been extremely well received by both the wargaming fraternity and the public at large. Yet, during this time we've also been sensitive to the desires of our devoted followers—personalized primarily by you—the readers of the *GENERAL*. We've heard your complaints about the cancellation of your favorite games and despite what you may think, they have not been falling on deaf ears. The fact remains however, that all our discontinued games contained serious flaws which dictated their removal from the market. Yet, as many of you have pointed out, this is no reason to give up on the titles' other redeeming features. It is with this thought in mind that we set to work redesigning some of the more popular games with the idea of making them available once again. Redesigning such games wasn't all that much of a chore—after all we had the most comprehensive and expensive playtest possible to determine what was wrong with them—the actual release of the first edition.

The real problem with the project was one of marketing. We didn't want to flood the retail market with these games because it was not the general public which put up the clamor for their re-release—it was you—the tried and true wargamer. The answer seemed simple—set up a mail order line of games to sell directly to readers of the *GENERAL*. And that is what we will be doing effective this coming fall.

The games designed especially for mail order will be sold only direct from Avalon Hill. Oh, there may be exceptions and occasionally a store in your area may stock some of the mail order games, but we won't be pushing them and generally speaking they won't be highly retailed. The Mail Order division however will consist of all the Avalon Hill games—not just those designed especially for Mail Order. The \$1.00 postage charge per game ordered will still be in effect but subscribers to the *GENERAL* will not have to pay any postage costs. Starting with this issue a \$1.00 coupon will be included in every issue of the magazine. The coupon is good for \$1.00 off postage costs for any complete game order. No more than one coupon can be used per game purchase, nor can it be used for a parts order. Don't look for the games in your local store because chances are they won't stock them. We'll notify you when you can place your orders directly with us. Naturally, because these games are being produced primarily for readers of the *GENERAL*, the per game press run will be comparatively small thus cutting our savings from an economy of scale viewpoint. But there will be no middle man to pay

so prices should not rise. We haven't worked out the final price range yet, but will try to keep it to a minimum.

The mail order line will number 5 titles in 1974 with more to come in following years, it is unlikely whether any of the future mail order games will be remakes of earlier cancelled subjects. We've pretty much exhausted the list of those with redeeming qualities and future mail order titles will be on entirely new subject areas. There will be those who argue that we are destroying the "collector's item" value of cancelled games by reprinting them. This may be true in part, but note that all of the games being reissued will have very significant changes. They will not be simply a rehash of old titles. Besides correcting flaws in the original designs, these games will be different in many respects. They will be redesigned—not just edited for greater clarity. For the most part they are entirely new games and should not impair the value of the "first editions" which are something else altogether. *ANZIO* is a case in point. The recent avalanche of letters to "bring back Anzio" as a result of Tom Oleson's thesis on the game in Vol. 10, No. 5 only reinforced our already made decision to reissue the game. Tom himself was the man we chose to author that redesign effort.

There are many games about which most wargamers agree. *Panzerblitz*, for example, is esteemed nearly universally. *Anzio*, on the other hand, was admired greatly by only a relative few, but left unplayed by the majority. The controversy surrounding *Anzio* was not so much about the game's merits, but whether it was worth the trouble to learn, and to play. Few dispute the fact that it had an unusually detailed and colorful map-board, very attractive unit counters with great historical accuracy and character, and extremely elaborate rules which are obviously the product of careful, comprehensive research, and which do achieve a high degree of realism. Nonetheless, even the game's most fanatic admirers grudgingly concede that the units were cumbersome to set up and use, and that the rules in places were as confusing as a labyrinth.

Anzio was discontinued with considerable reluctance, all the more so as interest in the game refused to die out, and in certain aspects it remained a high point of game design, whatever its drawbacks. So we asked ourselves if the flaws and shortcomings of the game could be lessened, even eliminated, without sacrificing its many good points. Could it be made significantly easier—and more fun—to play, without losing realism and historical accuracy? Could it be made even *more* realistic, drawing on the advances in wargaming during the 5 years since it was designed? We believe the answer is emphatically "Yes," and we think you will agree. Therefore, we have decided to re-issue *Anzio*, in a completely revised form.

D-DAY - Variation & Play

by Robert W. Garbisch
with Brian Libby

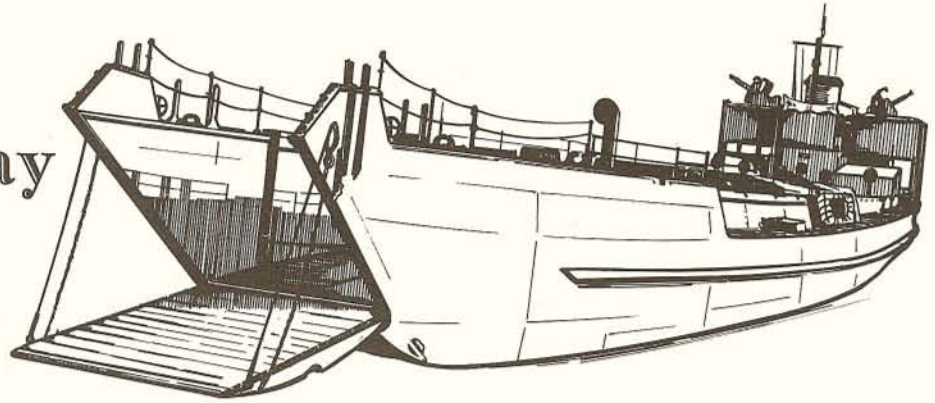

The sinister storm clouds foreshadowed an ominous stage setting. Occasional drizzles fell like gentle tears upon the silent earth. While a brilliant moon intermittently cast an aura of mystery.

A German sentry glanced up at the sky, which seemed to portend bad weather. It was very reassuring. Another quiet night and a chance to relax a little. Certainly no sensible man would dare risk an enemy landing today or even tomorrow.

As the winds continued to whip up a rough sea, plans were formulated to hold a commanding officers' conference and subsequent map exercise in Rennes. Every divisional commander, along with two regimental commanders, were expected to be at the Seventh Army meeting at 1000 hours, the 6th of June, 1944.

At the time, a lot remained to be done before that 600-mile-wide coastal gate to Europe would be securely barred. Preparations for the receipt of the Allied invasion were far from complete. Field Marshal von Rundstedt, Commander-in-Chief West, had repeatedly complained of the steady drain of the Western Army's able-bodied manpower and supplies. Two ingredients that were essential to build a strong, mobile reserve force. The continued military reversals on the Eastern Front and later those in Sicily and Italy, were gristmills of the Western strength.

On paper, the 58 German Divisions occupying France, Holland, and Belgium at the beginning of June 1944, did look quite impressive. Yet a closer examination of these so called divisions would reveal that over half this number consisted of weak coastal defense or training divisions. Of the ten Panzer and seventeen Infantry divisions listed, not a single one was really up to full strength in either men or modern equipment. It had become a standard policy of the OKW (Oberkommando der Wehrmacht—Supreme Command of the Armed Forces) to withdraw battle worn divisions from the Eastern Front to this area for rest and rehabilitation. As soon as they were brought up to full fighting efficiency they were returned to Russia.

Thus, on the eve of the Allied Invasion, the Germans were basically positioned as shown on map no. 1.

As can be observed, Army Group B, under the command of Field Marshal Rommel, was expected to be the main recipient of the Allied firepower. Rommel's defensive policy for his responsible sectors was simply to make the beaches the front line of battle. The invading troops were to be engaged at once, on the very coast, at their beachheads. Above all, long and costly movements to the battlefield were to be avoided. Rommel was quite aware of the strength of the Allied superiority in the air and he respected their controlling power.

Thus Rommel emphasized the fact that, "The enemy is at his weakest just after landing. The troops are unsure, and possibly even seasick. They are unfamiliar with the terrain. Heavy weapons are not yet available in sufficient quantity. That is the moment to strike at them and defeat them." (*Invasion—They're Coming!*, by Paul Carell, p. 15).

Across the English Channel, an entirely different tempo was being drummed. Here, during extremely tense hours, a crucial decision had to be made. The original scheduled date for the Allied invasion was set to be the 5th of June. However, an unexpected storm had thwarted the initial vanguard of troops heading for France and all operations had to be immediately reversed. Several days of bad weather were predicted but all signs indicated that the 6th of June would be a relatively calm day. If placed ashore on the 6th, there was a good chance that adequate supplies and reinforcements may not be able to land in order to sustain the beachhead. The success or failure of the entire Operation now rested with one man.

General Dwight D. Eisenhower, the Supreme Commander of Allied Expeditionary Forces, decided to take the gamble. The attack was delayed for 24 hours, D-DAY was now to be June 6, 1944. The place: Normandy.

It was here, that all the strategic requirements indicated that a surprise attack on the lightly defended Norman coast between Caen and Cherbourg would yield the best fruits of victory. Removed from large concentrations of German troops and airfields and with good terrain for airborne landings, a beachhead could be consolidated rapidly and greatly expanded with the proper influx of troops and supplies. Furthermore, the large port of Cherbourg lay close at hand and thus offered ideal handling facilities for those additional men and material so vital for the life of the Allied drive.

Defensively, the Germans were situated as shown on map no. 2. A common military rule-of-thumb practice was that a division could not effectively control a frontal sector much over six miles in length. Yet, here, each coastal defender was responsible for an average length of about twenty-five miles! The only immediate force available in this sector was the 21st Panzer Division stationed east of the Orne river.

Around midnight, 1,688 bombers and transport aircraft, with 512 gliders, were carrying the officers and men of the U.S. 82nd and 101st Airborne Divisions to their jump targets. The 82nd Airborne Division went down in the northern part of the landing zone. The 101st Airborne Division landed between Carentan and St. Mere Eglise. Casualties were higher than

expected. Meanwhile the 6th British Airborne Division succeeded in landing their men on the Orne Bay, north of Caen.

Alarm! Paratroops are landing! Confusion reigned in the rear areas of the 84th German Army Corps. At first it was undecided if these drops were possibly a reconnaissance or a commando raid. However, once additional reports continued to flow in from the landing sites it left no doubt that this was a large scale operation. The invasion had finally arrived!

At that moment, there were 6,480 transports and landing ships crossing the Channel in 12 lanes. Six battleships, 22 cruisers, 2 monitors, 119 destroyers, 133 frigates, 80 patrol boats, 360 MTB's and 25 flotillas of minesweepers surrounded the largest and strongest armada ever to be assembled. The German radar operators, when first picking up this vast array of naval shipping on their scopes, simply could not believe their eyes. Nothing like this had ever been seen before. At first it was thought that the equipment had malfunctioned or that some new form of Allied jamming device was being used. Not true. Each blip *did* represent an individual ship, and they were steadily drawing closer to the coast!

The invasion site was divided into five beach sections. (see map no. 2). The first elements of the 1st U.S. Army, composed of the 1st, 4th, and 29th Infantry Divisions, were to land on "Utah" and "Omaha" beaches. The 2nd British Army was directed as follows: British 50th Infantry Division would land on "Gold" beach, the Canadian 3rd Infantry Division on "Juno", and the British 3rd Infantry Division disembarking on "Sword" beach.

Many landing craft were destroyed in the water through artillery action and Rommel's underwater obstacles. Men abandoning a damaged or sinking landing boat had to take their chances with the numerous minefields, metal spikes and steel-girders scattered throughout the landing zones. Due to Rommel's devilish mastery in the art of erecting destructive obstacles, only 80% of the troops, 50% of the vehicles, and 25% of the equipment which the Allies had planned to put ashore that day, actually arrived.

The rest is now military history. The Germans had failed to grasp the importance of this Allied invasion in time to conduct a proper counter to their attacks. As evening came to the coast of Normandy, American forces had established a beachhead some 9 miles wide and 2½ miles deep. British forces were located between the Orne River and north of Ryes, 15 miles wide and 6 miles deep.

This was only the beginning!

THE VARIATION

The "state of the art" (game design to the uninitiated among you) has progressed steadily and rapidly in the 13 years since D-DAY made its appearance on the wargame scene. As such it is rather clear that the game lacks many of the "finer" niceties which the hard core has come to relish in recent years. As the "art" progresses many people tend to put down the achievements of the past for supposedly bigger and better things. Such a change came about in 1965 when D-DAY was revised in favor of a 17 square supply rule, SAC attacks, and no landings in Southern France. This writer is one of many

who thinks the "improver" overstepped his bounds and turned an excellent game into merely a good one in search of additional realism.

Who really is to say what constitutes realism in a game? Can the designer who authored the '65 D-DAY version really prove that the supply situation and Allied air superiority weren't actually accounted for in the original design in terms of built-in combat and movement factors? Design is largely a matter of scope and perspective and the would-be innovator who plays with another man's creation without absolute knowledge of the original designer's rationale is only kidding himself in thinking that he is

building a more realistic simulation. More likely, he is just topping off the original fudge factors with his own. Who is to say that the commandos listed separately in the variant that follows were not accounted for within the divisional scale of the game as it now stands, and that to include same in a game of this scale does not do grave injustice to the integrity of divisional units?

All of which is not to downgrade the variation which follows but merely to put it in its proper perspective. D-DAY is a simple game—easy to learn and easier to play. Robert Garbisch's variant is neither—yet it provides the hard core with a complex situation with many additional decision points and a lot of paperwork. There are those among you who will laud it and others who will dismiss it as unplayable. We merely hope you find it enjoyable and that it serves to give you pause to think back to that stormy June day 30 years ago when the largest amphibious invasion in the history of man took place.

For many months vast stockpiles of supplies—guns, tanks, mortars, trucks, mountains of ammunition, fuel, and food—have been gathered for this historic moment of truth. After many assessments of the German strength, including the coastal defenses and the disposition of enemy troops, the Allied commanders selected the Invasion beaches that would challenge the mythical walls of "Festung Europa."

Hundreds of thousands of soldiers had been especially trained in landing techniques. Thousands of landing craft were assembled to be ready at a moment's notice. The time had now come for the liberation of the Nazi oppressed European continent.

The date for the big push was set for June 6, 1944. History was to record this "longest" day as D-DAY!

The stage is now set and the act awaits the players. What follows is a set of variant rules that shall challenge the player oriented towards the ultimate in realism.

ORDER OF BATTLE

Allied Units: Additional units have been included in "Allied Units Available in Britain." Check the "Readers Response" page for these new units.

German Units: Revised time schedule of available new units. During the "Prepare for Play" set-up, the following units must start from any of the red star hexes: Infantry—30SS, 89, 363; Parachute—2; Panzer—3, 9SS, 10SS; at Paris—325 Static Division (in any one city hex). Six additional Static Divisions may be placed inland as "Training" Divisions. Check the Readers Response page for additional new German units.

STACKING LIMITS:

Every Division has a Stack Point Value of 2 points. Every HQ unit, Brigade, Regiment, and/or a Division that has been reduced to half or less than its original assigned Attack Factors has a Stack Point Value of 1 point. Maximum Stacking Points allowed per hex: Allied—4 points; German—6 points.

COMBAT RESULT TABLE:

The Avalon Hill Tournament CRT of either *Blitzkrieg* or *Guadalcanal* shall be used. The maximum advance or retreat is dictated by the units normal Movement Factor.

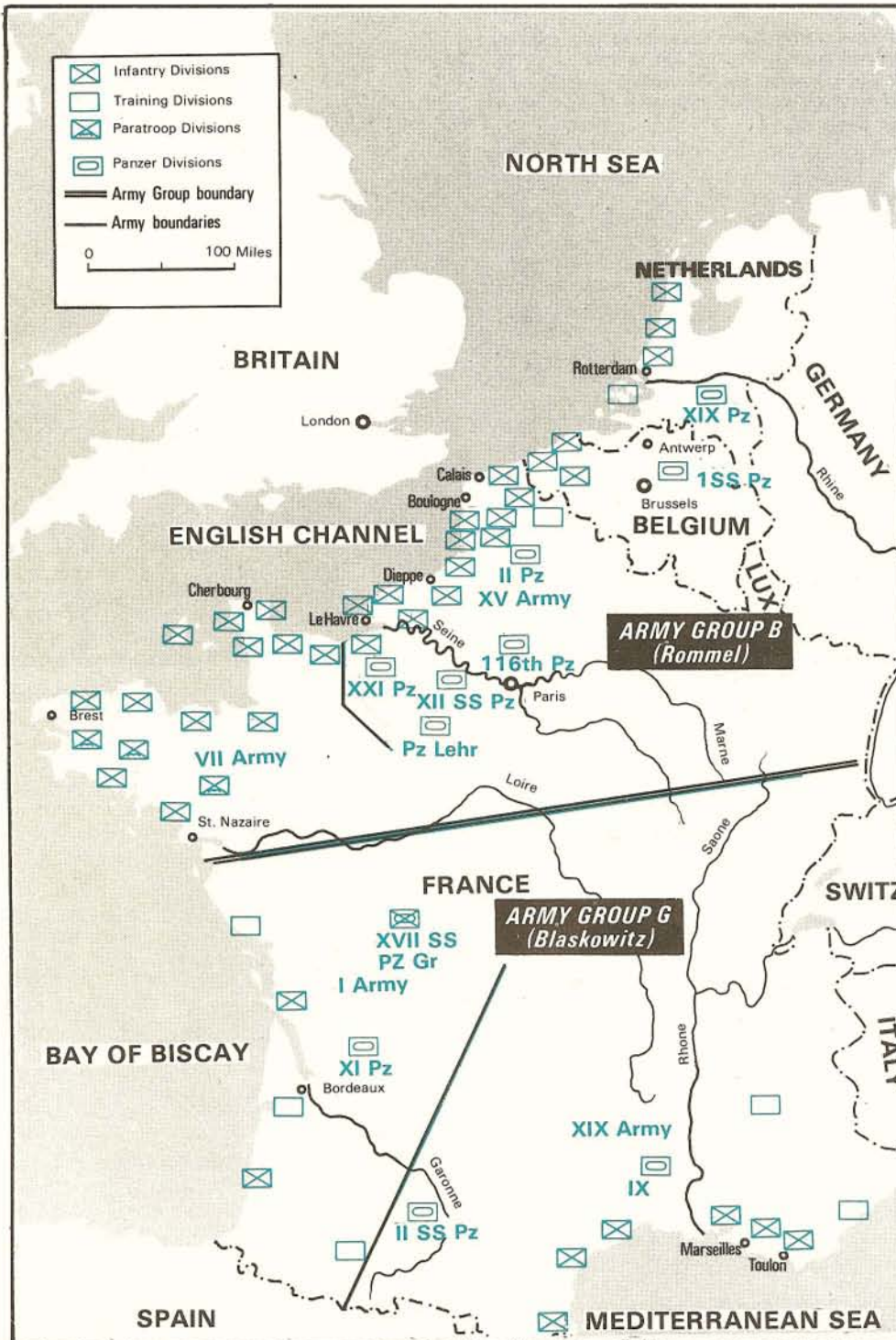

TOURNAMENT GAME ATTRITION TABLE

ODDS		1-6	1-5	1-4	1-3	1-2	1-1	2-1	3-1	4-1	5-1	6-1	ODDS
1	ATTACKER	2 3	2 3	1 3	1 2	- 1	- 1	- 2	- 2	- 3	- 3	- 4	ATTACKER
	DEFENDER	- 1	- 1	- 1	- -	1 2	2 2	2 3	2 3	3 4	4 4	4 5	DEFENDER
2	ATTACKER	1 3	1 3	1 2	1 2	1 -	1 -	1 -	1 -	1 -	1 -	1 1	ATTACKER
	DEFENDER	- 1	- 1	- -	- -	1 -	1 -	1 1	1 -	1 -	2 1	2 2	DEFENDER
3	ATTACKER	2 4	2 2	1 2	1 2	1 2	- -	- 1	- 1	1 1	- 2	- 3	ATTACKER
	DEFENDER	- 2	- -	- -	- -	- -	1 1	1 2	1 2	2 2	3 3	3 4	DEFENDER
4	ATTACKER	2 2	1 2	2 2	1 2	1 2	1 1	1 1	1 2	- 2	1 -	- 2	ATTACKER
	DEFENDER	- -	- -	- -	- -	- -	- -	- -	2 3	2 3	2 1	2 3	DEFENDER
5	ATTACKER	2 2	2 2	2 2	2 2	2 2	1 1	1 -	1 -	1 2	- 1	- 3	ATTACKER
	DEFENDER	- -	- -	- -	- -	- -	- -	1 -	1 -	3 3	2 2	2 4	DEFENDER
6	ATTACKER	3 2	3 2	2 2	2 2	2 2	2 2	2 1	- 3	- 3	- 3	- 4	ATTACKER
	DEFENDER	- -	- -	- -	- -	- -	- -	- -	2 4	3 4	4 4	4 5	DEFENDER
DIE-ROLL		FACTORS ELIMINATED	ADVANCE OR RETREAT	FACTORS ELIMINATED	ADVANCE OR RETREAT	FACTORS ELIMINATED	ADVANCE OR RETREAT	FACTORS ELIMINATED	ADVANCE OR RETREAT	FACTORS ELIMINATED	ADVANCE OR RETREAT	FACTORS ELIMINATED	ADVANCE OR RETREAT
		FACTORS ELIMINATED	ADVANCE OR RETREAT	FACTORS ELIMINATED	ADVANCE OR RETREAT	FACTORS ELIMINATED	ADVANCE OR RETREAT	FACTORS ELIMINATED	ADVANCE OR RETREAT	FACTORS ELIMINATED	ADVANCE OR RETREAT	FACTORS ELIMINATED	ADVANCE OR RETREAT

WEATHER EFFECTS:

The 5th to 15th turns and the 43rd turn until the end of the game are automatically "Clear." The 22nd to 33rd turns are automatically "Snow." All other turns, and their Weather Effect are determined at the start of each Allied turn by referring to the Weather Table:

Die-roll	1	2	3	4	5	6
Game Turn: 1 & 2	CLEAR			Sea Storm	FOG	
3 & 4	CLEAR				Sea Storm	FOG
16 to 21	CLEAR			FOG	Sea Storm	Rain & Mud
34 to 42	CLEAR			FOG	Sea Storm	Rain & Mud

Sea Storm—No Troop or Supply movement in or out of Ports and/or Beach hexes.
 FOG—No Air Support or Parachute Air Drop.
 Rain & Mud—Restrict *all* units to only 2 MF and no Air Support or Parachute Air Drop.
 Snow—All 4 MF units are reduced to 3 MF and no Air Support or Parachute Air Drop.

GERMAN PARACHUTE "AIR DROP" CAPABILITY:

The possibility of a *one-time* German Air Drop and the maximum number of German

Die-roll	1	2	3	4	5	6
AB factors	0	0	3	4	6	8

Parachute Unit Attack Factors allowed is determined by the following table in the "Prepare for Play" time:

SAC BOMBING:

Allied use only, utilizing standard AH rules. Maximum of 2 SAC Bombings per turn and 12 SAC Bombings per each of the two Air Time Periods. (note: The SAC Bombings also represent the Tactical Fighter Attacks on German

units not involved in the immediate front "Battlelines.")

For every "Hit" eliminate *one* Combat Factor from one of the "Bombed" German Units. The movement factor loss is for that turn only.

Die-roll	1	2	3	4	5	6	
Unit's Stack	1-2	No Effect	Lose 1 MF	Lose 2 MF	Lose 1 MF 1 Hit	Lose 2 MF 2 Hits	No Effect
Points	3-4	Lose 1 MF	Lose 1 MF 1 Hit	Lose 2 MF	Lose 2 MF 1 Hit	Lose 2 MF 2 Hits	No Effect
	5-6	Lose 1 MF 1 Hit	Lose 2 MF 1 Hit	Lose 1 MF 2 Hits	Lose 2 MF 2 Hits	Immobilize 2 Hits	Immobilize 3 Hits

"FLOODING" IN HOLLAND:

The Islands in Holland—hexes I-16, J-16, J-17, K-17 and K-18 can be subject to a flooded condition either separately or all at once. The procedure and its effects are as follows:

1. During the "Prepare for Play" turn the Germans have the initial option of flooding the entire area or any section of it.
2. Whichever side occupied the Island hex last, can declare the Island hex to be "flooded" during or after their turn.

3. The Allies can attempt to flood an Island hex by using a SAC or TAC factor to bomb the protective dikes and thus eliminate, if successful, any excess German units over the Stack Limit set for a flooded Island hex. Any German losses due to flooding shall be determined by the German player. Refer to the following table for the results of the Allied bombing:

Die-roll	1	2	3	4	5	6
Bomb Results:	miss	miss	miss	flooded	flooded	flooded

GERMAN POSITIONS—6 JUNE 1944

STATIC DIVIS.	INFANTRY DIVS.	SS
16LW—G14	77—V38	1SS—M17
17LW—Q28	84—R29	2SS—QQ42
18LW—L20	85—O25	12SS—U31
47—M22	91—R34	17SS—DD37
48—L20	271—SS36	
49—M23	272—UU39**	
148—RR25	275—AA41	
157—LL27	276—PP47	
158—DD42	277—TT38	
159—LL44	331—L21	
165—J17	352—S33	
182—M22	353—U40	
242—TT29		PARACHUTE UNITS
243—S35		3—V41
244—TT31		5—X39
245—P26		6/2—S34
265—X42		
266—V39		
319—S37*		
326—M23		
338—SS32		
343—V43		
344—N24		
346—R30		
347—F13		
348—Q27		
708—FF41	2—P23	OB WEST—U26
709—Q34	9—QQ32	8—T28
711—T32	11—H40	G—RR41
712—K19	21—T33	NETH—G13
716—S32	116—T27	1—LL44
719—H15	LEHR—X31	7—Y34
		15—M19
		19—RR31



*319 Static was located on Channel Islands and took no part in the war. Its combat factor was about 5-8-4, as it was beefed up to 40,000 men.

**272 INF was actually further south, off the map. —I can find no location for 189 Static; it may have been in the Pas de Calais.

—9SS Panzer Div. (along with 10SS Panzer Div.) was in Poland on 6 June. Both divisions were ordered to France on 12 June, arriving in Normandy about 28 June.

—3 and 15 Panzergranadier Divs. were in Italy on 6 June. They were ordered to France in mid-August, and arrived vicinity Verdun in the last week of August. These units were *not* SS.

—25 Panzergranadier Div. was in OKH Reserve. It was committed near Saarbrücken in November.

—106 Panzer Brigade, along with at least six other similar units, was formed in Germany in August, and committed in September.

—49 & 51SS Panzer Brigades were in Denmark; in September they were absorbed into 17SS Panzergranadier Div.

An inspection of the actual German deployment at the time of the invasion shows how futile it is to compare the German's set-up with any chance at victory in the game. The game, after all, was designed with playability in mind. Some may well argue that the existing Order of Battle is incorrect. Yet a closer inspection will show that units left out consist largely of smaller units which were absorbed into divisional sized units in accordance with the scope of the game to cut down on piece density. Other units not included were left out intentionally because they were soon withdrawn to other fronts. Still others because they were balanced by units left in the game which should, according to history, have been pulled out.

However, remember that *D-DAY* is not a strict historical simulation. It is a game which places you in command of the situation and not subject to the predetermined course of history. The designer has provided the player with what he considered the best representative force and trusted to his replacement system to avoid complex entries and withdrawals (such as plague *ANZIO*) to make a very playable game.

Once an Island hex or area is flooded it remains so for the balance of the game and it imposes the following restrictions:

- a. Stack Limit is now only *one* Division or 2 Stack Points per flooded Island hex.
- b. Upon entering a flooded Island hex, the unit must stop until the next turn.
- c. No AB units may be "air dropped" on a flooded Island hex at any time.

moved "out-to-sea" for at least 4 Complete Turns. If "eliminated" by the CRT, the unit requires at least 12 Complete Turns before it can be reactivated through normal replacement factors.

TACTICAL AIR SUPPORT:

To be used only in providing additional Attack Factors to Combat Units. TAC factors are nontransferable from one Time Period to another Time Period. The maximum limit of TAC factors per turn is: German—3 TAC, 2 TAC per Battle; Allied—6 TAC, 3 TAC per Battle.

Available TAC factors: Time Period (1st to 21st turns)—Germans: 9 TAC; Allied: 24 TAC
Time Period (35th to end of game) German: 6 TAC; Allied: 30 TAC

NORMANDY/LE HAVRE:

The two beaches are considered as one Invasion Beach area, use the allowable unit table of the Normandy area only.

ALLIED HQ UNITS:

At least one HQ unit must be brought ashore for every 24 Unit Stack Points.

ATLANTIC WALL DEFENSE:

The Germans will be allowed to indicate any 16 Coastal hexes, during the "Prepare for Play" turn, as "Atlantic Wall" Defense Fortification areas. If attacked from any Sea Coastal hex they will receive an added 2 Defense factors, as long as they are attacked from the indicated Coastal direction only and if occupied by at least one German unit of equal Defense factor value. If attacked from a combination of Sea & Land hex directions then the Defense "bonus" will not be applied to the defending German units.

ALLIED NAVAL FIREPOWER:

Naval Firepower can provide additional Attack Factors to any Allied unit within 2 -land

ALLIED ORDER OF BATTLE

4-4-4	4-4-4	4-4-4	4-4-4	4-4-4	4-4-4	4-4-4	4-4-4	4-4-4	4-4-4	4-4-4	4-4-4	4-4-4	4-4-4	4-4-4	4-4-4	4-4-4	4-4-4	4-4-4	4-4-4
4-4-4	4-4-4	4-4-4	4-4-4	4-4-4	4-4-4	4-4-4	4-4-4	4-4-4	4-4-4	4-4-4	4-4-4	4-4-4	4-4-4	4-4-4	4-4-4	4-4-4	4-4-4	4-4-4	4-4-4
4-4-3	4-4-3	4-4-3	4-4-3	3-3-4	6-5-4	6-5-4	6-5-4	5-5-4	5-5-4	5-5-4	5-5-4	5-5-4	5-5-4	5-5-4	5-5-4	5-5-4	5-5-4	5-5-4	2-2-4
2-2-4	1-1-2	1-1-2	0-1-4	0-1-4	0-1-4	0-1-4	0-1-4	0-1-4	0-1-4	0-1-4	0-1-4	1-1-2	1-1-2	2-2-4	2-2-4	2-2-4	2-2-4	2-2-4	2-2-4
4-4-4	4-4-4	4-4-4	4-4-4	4-4-4	4-4-4	4-4-4	4-4-4	5-5-4	5-5-4	5-5-4	5-5-4	6-5-4	3-3-3	3-3-3	0-1-4	4-4-4	4-4-4	5-5-4	5-5-4
2-2-4	5-5-4	0-1-4	4-4-4	4-4-4	4-4-4	4-4-4	4-4-4	4-4-4	4-4-4	5-5-4	5-5-4	5-5-4							
													SAC						
													Attacks: <input type="text"/>						
													Available TAC Factors:						
													Turn 1—21: 24 <input type="text"/>						
													Turn 35—50: 30 <input type="text"/>						

hexes from a Sea Coastal hex. Such support is limited to 2 factors per battle and it is non-accumulative. Naval Firepower is not available during any "Sea Storm" turn.

Available Factors for the First Invasion: 1st turn—5 factors; 2nd turn—4 factors; Balance of Game—2 factors per turn.

Available Factors for the Second Invasion: 1st turn—3 factors; 2nd turn—2 factors; these are additional factors which are in addition to those granted for the balance of the game.

REFORMING OF UNITS:

A player can combine several understrength units to reform one stronger unit at anytime during the game. The procedure is as follows: 1. During the Movement Phase of the player's turn, move the unit to be rebuilt to any City hex not in enemy ZOC.

2. Subject to Stacking Limits, move the remnants of other units that are to be combined with the understrength unit to the same City hex. They can not be moved for the balance of the player's turn, nor can they engage in Combat. They can defend themselves, if need be.

3. The Combat Factors of the remnant units are added to the unit that is being rebuilt, and the remnant units are eliminated and automatically placed in the "Dead Pile."

4. At the beginning of the following friendly turn, the rebuilt unit can be moved in the normal manner and engage in Combat at its new strength.

5. Armor, Panzer, Recon, and/or Panzer-Grenadier units can reform one another and Infantry units. Infantry can only reform into another Infantry unit.

LANDING INVASION COMBAT:

Allied units that are attacking from a Sea Coastal hex and suffer a "Defender Retreat" result shall incur the normal Combat Factor losses, plus the Defender Retreat factors shall count as additional Combat Factor losses. The remaining Allied units are then allowed to remain in the Sea Coastal hex. Adjacent German units are *not* required to counterattack the remaining Allied units in the Sea Coastal hex and may choose to remain on the defensive. However, if new German units are added to the square they must attack.

ALLIED REINFORCEMENTS:

Allied Units arriving on any garrisoned beach hex or Inland Port can move their full MF distance in the same turn and engage in attacks, if supplied.

SUPPLY UNITS:

Supply Units are required to support any attacks being made in a turn. The Germans have a limit of 8 Supply Units; the Allies cannot have more than 12 Supply Units.

One Supply Unit can support one or two attacks for one turn. It can supply any number of attacking Combat Units within 5 hexes (unobstructed by enemy ZOC). It is not required for attacks of 1-3 odds or worse, or for Combat Units attacking from a Fortress. The attacker is not allowed to place his Combat Units under an enemy ZOC if such movement would place it more than 5 hexes away from a

Supply Unit at the end of the movement phase of his turn. Supply Units can arrive, move their full MF distance, and support an attack all in the same turn. Supply Units have *no* Combat Factors and no ZOC. They are removed once they have supported an attack. Supply Units cannot be air-lifted.

USE OF PARACHUTE UNITS: (additional variants to the AH rules.)

All Airborne (hereafter referred to as AB) must be air dropped within 5-hexes of a Friendly Unit and direct contact must be made within one complete Game Turn and/or have an unobstructed Supply Line to an Inland Port or a friendly beach hex, in order to insure Supply. Otherwise, the Unit is immediately eliminated. AB units can effectively block all types of German units in retreat, from an Attack only, except for Panzer and/or Panzer-Grenadier units of at least equal (1-1) ratio to the blocking AB units; i.e., a retreating Panzer unit of 5 factors could effectively by-pass an AB unit of 4 factors, without attacking or losing any factors. This applies only during the initial Air Drop turn.

AB units Movement Factor is reduced to 2 MF and no Supply Unit is required for attacking only during the Air Drop turn.

AB units must spend at least 4 turns in reserve or out of enemy ZOC before it can be reused for any new Air Drop assignments.

Supply Units may be moved adjacent to any enemy Combat or Supply Unit, but only in the turn they are to be used to support attacks. Supply Units can be captured by any enemy Combat Unit (moving over or adjacent to it) and the captured Supply Unit can be used to support attacks in the same turn. Only by capturing Supply Units can a player have more Supply Units than the above limit. Unavailable Supply Units are non-accumulative. Note that the normal Avalon Hill Allied Supply capacity and range limit rules are voided when this rule is used.

GERMAN SPECIAL RULES:

1. "Prepare for Play" turn: 6 Supply Units can be placed anywhere on the mapboard.
2. Turns 4 to 12: 1 Supply Unit arrives per turn from any starred hex.
3. Turns 13 to end of game: 1 Supply Unit arrives every odd-numbered turn, except for during the "Snow" period.
4. "Snow" Period: 1 Supply Unit arrives on turns 25 and 29 only.

ALLIED SPECIAL RULES:

1. First and Second Invasions: the initial 3 turns are self-sufficient and no Supply Units are required for the attacking Combat Units used in the Invasion landings..

Thereafter, from the 4th succeeding turn on: 2 Supply Units arrive per turn.

2. Sea Storm: No Supply Units are allowed to arrive.

3. "Snow" Period: Supply Units arrive every even numbered turn.

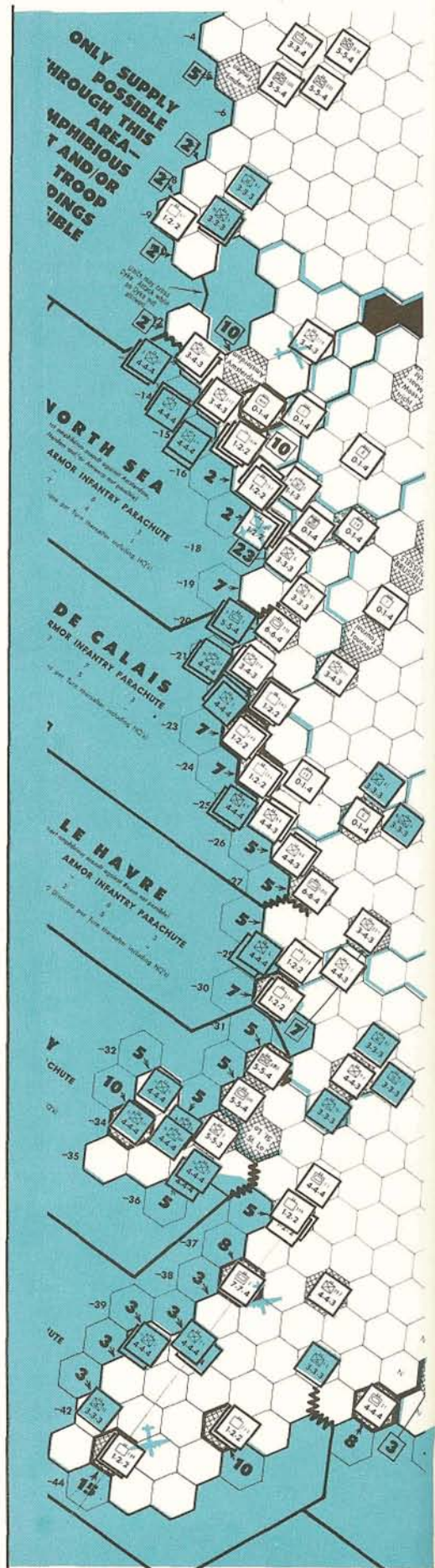

Beach by Beach

OR
A WORRIED AMERICAN LOOKS AT TWO ATLANTIC WALLS

By Donald Greenwood

With Dave Roberts and Bruno Sinigaglio

The "D-DAY DEFENDED" article penned by GARY GYGAX in Volume 10, No. 1 drew considerable criticism from American players who said it just t'weren't so; i.e., that the German stood an even chance of victory. They claimed that the combination of American replacements and airpower was just too much for the German to handle in the '65 edition. We grudgingly agreed with their hypothesis on one condition—that the German players they'd been manhandling didn't have too much on the ball.

To prove our point we elicited the aid of two staff members, Dave Roberts and Bruno Sinigaglio, who gave us their opening defenses—the same set-ups they used in copping top East Con tournament honors in 1972 and '73 respectively. Although the methods they use are as different as night and day, the end result is the same: a lot of German wins.

Let's explore their defenses beach by beach, compare the relative strengths and weaknesses, and see if we can't open another chapter in the never ending play balance debate.

For clarity's sake we will code name the Roberts defense "Up Tight" and the Sinigaglio set-up "Hard Smash." The former will be dealt with first.

UP-TIGHT NORTH SEA: As is the case with all good German defenses the North Sea is loaded for bear. 30 defense factors man the beaches and are backed up by a paratroop screen of 26 more. The presence of the Northern reinforcements adds additional bulk to the German defense. Note the positioning of the German reinforcements. The three 5's and solo 3 are seemingly a perfect force for dealing with any airborne operations to the north, while allowing the remainder of German reinforcements to deploy to the South. The paratroop screen prohibits any airborne unit to enter the main battle on the beaches leaving the Allied player with his choice of three 1-1's on any of the 5 defended beach squares. Although K19 is unmanned, any units moving inland will face a 1-2 versus the 2SS in Ostend. Not a very appealing prospect, but after inspecting the rest of the defense you may well agree that three 1-1's on F13, G14, and H15 offer as good a chance as any. Coupled with SAC attacks on the 275th and J17, and airborne operations against the 47th, a very lucky first turn could end the game quickly. Realistically speaking, such an attack will end the game soon, but more often than not, with a German win. Even with perfect results the Allied player will be hardpressed to clear Amsterdam for supply and without it this invasion can go nowhere.

UP TIGHT PAS DE CALAIS: As in real life Pas De Calais is the most heavily defended invasion site. Although supply is not that big a problem here, getting ashore is. Only four 1-1's are possible against Ostend, L21, O25 and P26, and even if successful they are

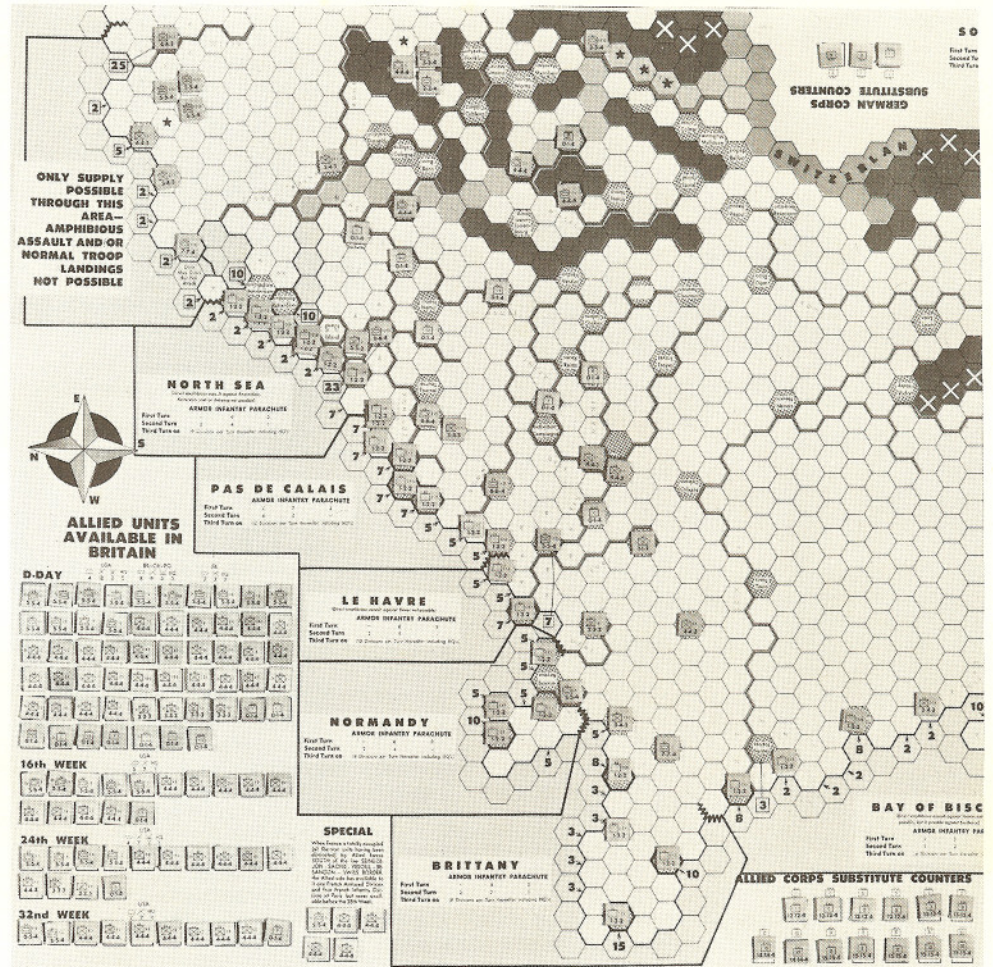
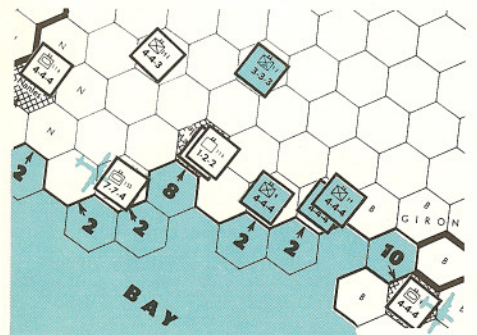

susceptible to German counterattacks. Barring lucky 1-2's on the fortresses, Calais holds little opportunities for exploitation.

UP TIGHT LE HAVRE: LE HAVRE is such a restricted invasion area that it is seldom selected as an Allied invasion site. Note the "sacrifice" of the 338 Static which can be attacked at 6-1. However, placement here instead of in R30 takes away the 4-1 on the 77th Inf. and the 1-1 on the 12SS which are possible otherwise. Le Havre still must be attacked at 1-2. Any invasion which must rely on successful 1-2's is extremely risky though, and may as well be forgotten.

UP TIGHT NORMANDY: Normandy is a traditionally easy area to bottle up and usually doesn't require too heavy a defensive commitment. Dave Roberts apparently agrees with the theory, as he allows an uncontested landing in Cherbourg and Q33. With Cherbourg freely taken, supply is no problem. Breaking out of the Normandy pocket is another story however. The strong paratroop screen ruins any chances for effective airborne tactics. Even with a successful 1-1 on the 3rd Paratroop Division in Carentan the German is strongly entrenched in Bayeaux, St. Lo. and Avranches. A Normandy invasion is a lost cause against this defense.

UP TIGHT BRITANNY: Although definitely the best invasion site in this defense, it is still well-handled. The best course of attack seems to be to drop a sacrifice paratroop in Y40 and land two 4-4's at V40 with the other 3 Allied units (including the Airborne) landing at U41 and UU42. SAC attacks should be carried out against the 2nd Panzer and Brest.

If successful, the Allies will be safely ashore with plenty of supplies and can take Lorient at their leisure. It will then be a case of playing the attrition game in the Rennes-St. Nazaire gap until the German decides to withdraw. However, the German forces in the West are so mobile that an orderly withdrawal to a strong position on the Seine can be carried out with little trouble either before or after the 2nd invasion. Should the SAC attack on Brest fail, the Allies will have a tough time of it and will have to expend another one immediately to gain the supply needed for quick build-up. Even so, Brittany remains the best invasion site—offering an almost guaranteed beachhead and the type of attrition game which the Allies excel in. Unfortunately, it will also result in a very long game in which the Allies will have to break a myriad of doubled positions manned by the cream of the German army.

UP TIGHT—BAY OF BISCAY: The Allied chances here seem to be best with landings of all units on HH42 and using SAC against ISS and 9PZ in Bordeaux. However, if they don't kill the unit in Bordeaux they are in serious trouble, because they are already at their maximum supply capacity. The German will have made La Rochelle 3-1 proof, and the only way the Allies will go anywhere at all is with massive expenditure of their SAC attacks.

This should eventually enable them to move out from HH42 and I142, but after that it is a dim prospect. The Germans should hold them south of the Loire until the second invasion, and then with their beach defenses released, the German should be able to form an incredible line on the Seine.

HARD SMASH NORTH SEA: This defense is vastly different from Roberts handling of the same situation but is every bit as effective. The beaches themselves are not

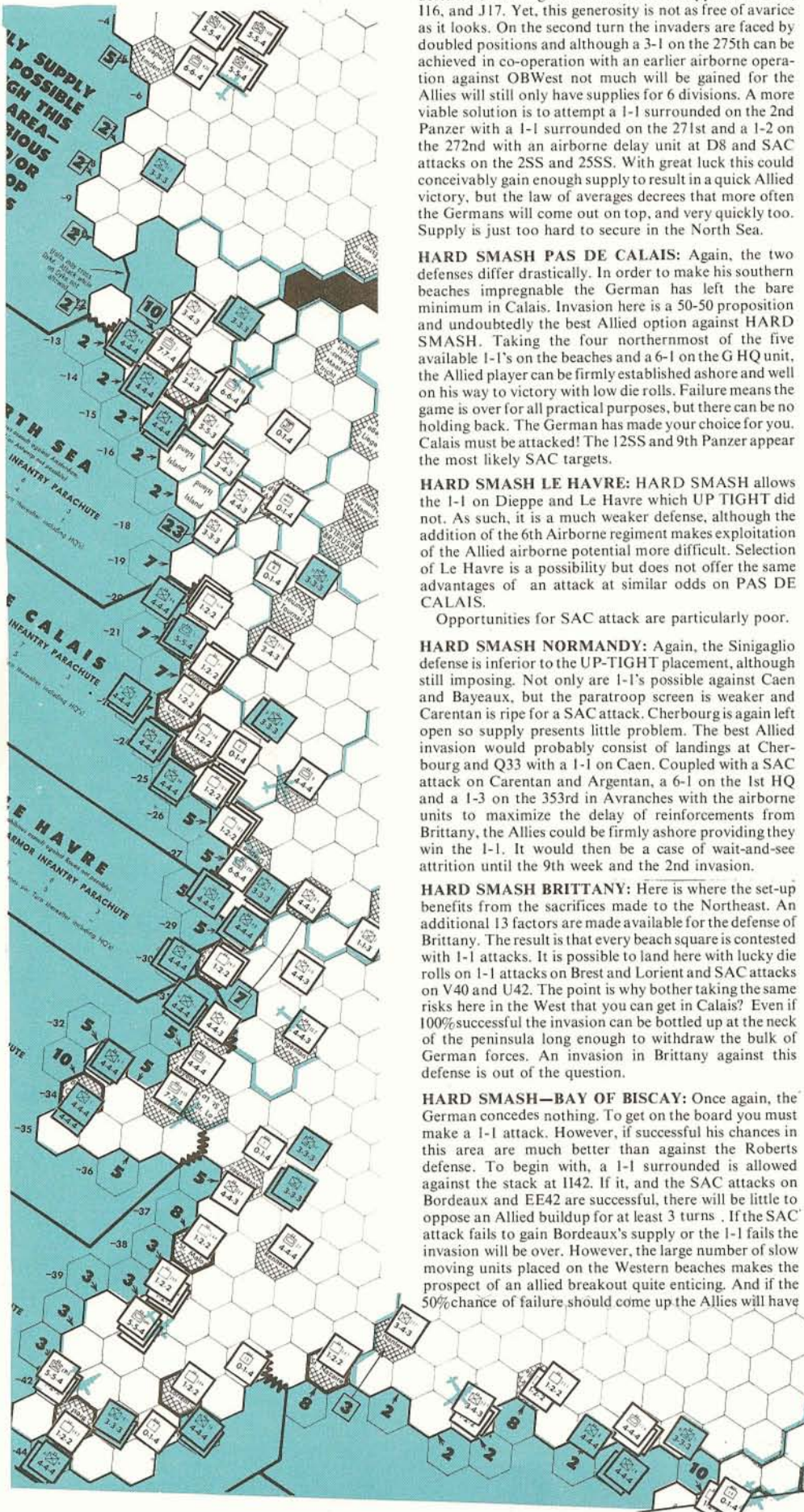

defended, enabling the Allies to land unopposed at H15, H16, and J17. Yet, this generosity is not as free of avarice as it looks. On the second turn the invaders are faced by doubled positions and although a 3-1 on the 275th can be achieved in co-operation with an earlier airborne operation against OBWest not much will be gained for the Allies will still only have supplies for 6 divisions. A more viable solution is to attempt a 1-1 surrounded on the 2nd Panzer with a 1-1 surrounded on the 271st and a 1-2 on the 272nd with an airborne delay unit at D8 and SAC attacks on the 2SS and 25SS. With great luck this could conceivably gain enough supply to result in a quick Allied victory, but the law of averages decrees that more often the Germans will come out on top, and very quickly too. Supply is just too hard to secure in the North Sea.

HARD SMASH PAS DE CALAIS: Again, the two defenses differ drastically. In order to make his southern beaches impregnable the German has left the bare minimum in Calais. Invasion here is a 50-50 proposition and undoubtedly the best Allied option against HARD SMASH. Taking the four northernmost of the five available 1-1's on the beaches and a 6-1 on the GHQ unit, the Allied player can be firmly established ashore and well on his way to victory with low die rolls. Failure means the game is over for all practical purposes, but there can be no holding back. The German has made your choice for you. Calais must be attacked! The 12SS and 9th Panzer appear the most likely SAC targets.

HARD SMASH LE HAVRE: HARD SMASH allows the 1-1 on Dieppe and Le Havre which UP TIGHT did not. As such, it is a much weaker defense, although the addition of the 6th Airborne regiment makes exploitation of the Allied airborne potential more difficult. Selection of Le Havre is a possibility but does not offer the same advantages of an attack at similar odds on PAS DE CALAIS.

Opportunities for SAC attack are particularly poor.

HARD SMASH NORMANDY: Again, the Sinigaglio defense is inferior to the UP-TIGHT placement, although still imposing. Not only are 1-1's possible against Caen and Bayeaux, but the paratroop screen is weaker and Carentan is ripe for a SAC attack. Cherbourg is again left open so supply presents little problem. The best Allied invasion would probably consist of landings at Cherbourg and Q33 with a 1-1 on Caen. Coupled with a SAC attack on Carentan and Argentan, a 6-1 on the 1st HQ and a 1-3 on the 353rd in Avranches with the airborne units to maximize the delay of reinforcements from Brittany, the Allies could be firmly ashore providing they win the 1-1. It would then be a case of wait-and-see attrition until the 9th week and the 2nd invasion.

HARD SMASH BRITTANY: Here is where the set-up benefits from the sacrifices made to the Northeast. An additional 13 factors are made available for the defense of Brittany. The result is that every beach square is contested with 1-1 attacks. It is possible to land here with lucky die rolls on 1-1 attacks on Brest and Lorient and SAC attacks on V40 and U42. The point is why bother taking the same risks here in the West that you can get in Calais? Even if 100% successful the invasion can be bottled up at the neck of the peninsula long enough to withdraw the bulk of German forces. An invasion in Brittany against this defense is out of the question.

HARD SMASH-BAY OF BISCAY: Once again, the German concedes nothing. To get on the board you must make a 1-1 attack. However, if successful his chances in this area are much better than against the Roberts defense. To begin with, a 1-1 surrounded is allowed against the stack at H42. If it, and the SAC attacks on Bordeaux and EE42 are successful, there will be little to oppose an Allied buildup for at least 3 turns. If the SAC attack fails to gain Bordeaux's supply or the 1-1 fails the invasion will be over. However, the large number of slow moving units placed on the Western beaches makes the prospect of an allied breakout quite enticing. And if the 50% chance of failure should come up the Allies will have

lost only 4 units rather than the 12+ of an effort at Calais (including valuable armor and parachute units). With pre-invasion SAC attacks to soften up the now reinforced 2nd invasion sites, the game will still be far from over.

OVERVIEW

Heavy armor belongs on the beaches, either adjacent to where the Allies want to attack, or right in their way in the most desirable squares. They thus are invulnerable to SAC and provide the strongest defense with the best chance to survive and be able to launch an immediate counter-attack. Especially note the 6-6-4's in Dieppe. Besides being maximum economy of force (12 defense factors against a possible attack of 10 from Pas De Calais and 8 from Le Havre), with Q28 vacant three 6-6-4's are both doing double duty in tying themselves into the defense network of adjacent beaches. The 5-5-4's in Normandy in the Roberts defense are all maximum economy of force, equaling 10 defense factors defending against possible attacks of 8 and 16 factors. Placing the 7-7-4 in St. Malo with 3 units of 4 attack factors in range guarantees that the German can get 3-1 and a soak-off against two 4-4-4's if they land on V39 barring a SAC attack in this direction.

Certain units have squares that soon should become obvious as the optimum place for them. Thus the 5-5's in Normandy defending against combinations of 4-4-4's, the 6-6-4's in the Pas defending against the possible 5-5-4's, the 3-3-3 in K18 defending against 4-4-4's (instead of, say in a paratroop screen in the rear where it would have no special merit against 3-3-3's), the 3-4-3's in paratroop screen positions on the northern positions which are hopefully so strong that he can't attack, and thus since he won't be there, you save the extra attack factor of the 4-4-3's to use in the south where you probably will want to attack. The choice of whether to place a 4-4-4 or 4-4-3 in the various Normandy-Biscay areas is far from random, but based on their ability to attack or occupy key squares after the most likely initial invasion positions are reached.

AN UNHAPPY COMPARISON

Which defense is better? I suppose that depends on what you want out of your defense. The Sinigaglio set-up is designed to meet and defeat the Allies on the beaches. Any prolonged struggle, due to the heavy commitment on the Western beaches will increase the chances of an Allied win. Yet, the Allies have no better than a 50% chance of a successful landing any place on the board. It is a gambler's dream and should result in an even number of Allied and German wins given players of equal ability.

The Roberts defense adheres to the "fight'em on the beaches" principle while utilizing the containment theory for the westernmost beaches. An invasion at Brittany can not really be stopped, nor can one in Bay of Biscay barring unlucky SAC attacks. This results in a long, drawnout game in which the Allies must break one strong doubled position after another before he reaches Germany and victory.

But any attempt at invasion further north is extremely risky. The strategic balance is better than in the Hard Smash defense, making a policy of containment more viable.

In short, the Roberts defense holds a better chance for a German win, but will require a much longer game, regardless of the winner. Both defenses hold at least a 50-50 chance of a German win.

by the Avalon Hill Staff*

A Compendium of Playing Aides

*Cast of Characters including: George Bradford, Don Greenwood, Richard Guida, Dan Hoffbauer, Richard Plock, James Pyle, Randall Reed, Tom Oleson, and Mark Saha

Wargaming is a time-consuming pursuit; especially if one exercises his involvement in it to the hilt. It's one thing to play a 3 hour Midway game once a month and quite a different matter to be involved in a dozen play-by-mail games while playing regularly a gamut of games that may include as many as 20 titles. Taking 20 minutes to set up that Midway game may have been annoying for our once-a-month jock but it's downright torture for the wargame "junkie."

The GENERAL will try to solve this and other less pressing problems of the wargamer within the body of what follows. Not a regular feature, this article encompasses all that we have to offer on the subject of playing aides.

THE BOARD:

The bane of any PBM'er is the constant setting up and putting away of games after just one move. If you play-by-mail or lack a place to store games overnight that you can't finish in one sitting then a game cabinet is a must for you. A game cabinet allows you to leave up to a dozen games set-up permanently in the same space usually taken by one gameboard. In addition, the "drawers" on which the game is set up can be removed and used to carry the gameboard from room to room without disturbing a single piece. And when returned and secured in your game chest, the set-up is protected from the vicious raids of one's children, pets or wife.

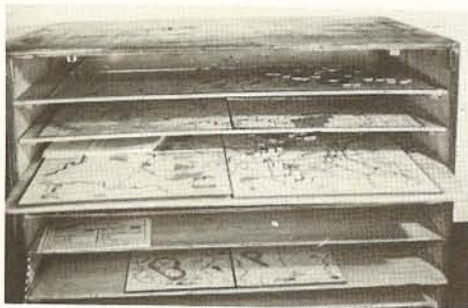

An example of a 7 drawer game chest which leaves 4 1/2" between drawers so that the game box may also be stored inside.

A game cabinet lends a new outlook to your playing. Instead of forgetting all about a particular move after writing it up, you are tempted to pull it out and look over your move for fresh approaches every day. Such contemplation has made more than a few players "see the light" in a particular game and made better players of them. And of course, there are the obvious advantages. You no longer have to painstakingly reposition each unit every time you receive a move. You already have his last set-up before you. Moving units to their new location and checking the legality of the move becomes one in the same. The only drawback of the game cabinet is that most of them are designed to hold

only the standard 28" X 22" mapboards. This presents difficulties when playing games such as Afrika Korps or Blitzkrieg which utilize the longer board. The problem is not insoluble however, and if you're willing to cut the boards in half along the center fold, even they can be laid into a standard sized cabinet with little difficulty. Of course, if you play more than one PBM contest of the same game at the same time or are inclined to play both face-to-face and by-mail the utility of a game cabinet might be lessened. The answer to this problem is, of course, the purchase of extra boards and counters for secondary games.

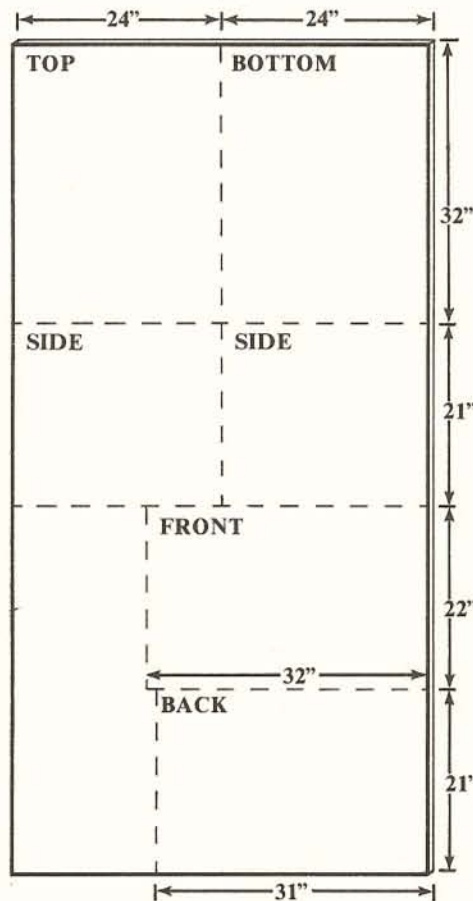

Game cabinets can be constructed in a variety of ways but generally speaking plywood is the least expensive material. The cabinet itself can be constructed from one 4 by 8 foot sheet of 1/2" plywood. Shelves can then be constructed from 1/4" sheets in the quantity required by the individual. The number of shelves usually ranges from 6 to 12. A project of this nature usually costs from \$15.00 to \$20.00 depending on the amount of shelves used and one's woodworking skills. It is a good idea to varnish the whole thing and to soap the strips of wood which provide the support for the drawers to prevent sticking.

GAME TRAYS:

A less expensive, albeit less refined, solution to the same problem is Tom Oleson's "game tray". Although less picturesque, a set of game trays can be made for about \$4.00 and are not as subject to abnormal shaped boards as is the case

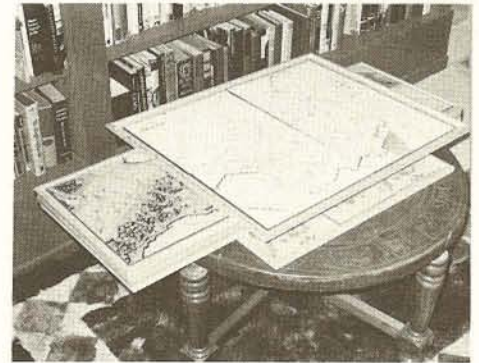

The primary advantage of a game tray system is the cost and it's adaptability to irregular shaped boards; witness the STALINGRAD, PANZERBLITZ, and ANZIO games in progress above.

PBM-TDT For Richthofen's War



by James E. Pyle



Since the Target Damage Table (TDT) for "Richthofen's War" is based on the results of the throw of two dice, it would seem harder to convert for PBM use than the conventional one die tables. The opposite is true. It is very easy to convert to PBM use.

First, one has to look at what the chances are for each two-dice throw. A 2 or 12 will each be thrown 2.78% of the time, 3 or 11=5.56%, 4 or 10=8.34%, 5 or 9=11.12%, 6 or 8=13.90% and 7=16.68%. Rounding these off to whole per cents they become 2 or 12=3%, 3 or 11=6%, 4 or 10=8%, 5 or 9=11%, 6 or 8=14% and 7=17%.

The next part is simple. If you use two dice in the game, you use two stocks for PBM. Using the last digit of the sales in hundreds, for two stocks there are 100 possibilities. The total of the whole per cents listed above comes to 101% (nobody's perfect). So all you have to do is match up the 100 possible stock results to the 101% for dice results from 2 to 12. My suggestion is:

Dice Roll: Stock Results

2:	1.1 - 2.2 - 3.3
3:	1.2 - 2.3 - 3.4 - 4.4 - 5.3 - 6.2
4:	1.3 - 2.4 - 3.5 - 4.5 - 5.4 - 6.3 - 7.1 - 7.8
5:	1.4 - 2.5 - 3.6 - 4.6 - 5.5 - 6.4 - 7.2 - 7.9 - 8.5 - 8.0 - 9.5
6:	1.5 - 2.6 - 3.7 - 4.7 - 5.6 - 6.5 - 7.3 - 7.0 - 8.6 - 9.1 - 9.6 - 9.0 - 0.3 - 0.6
7:	1.6 - 2.7 - 3.8 - 4.8 - 5.7 - 6.6 - 7.4 - 8.1 - 8.7 - 9.2 - 9.7 - 0.1 - 0.4 - 0.7 - 0.9 - 0.0
8:	1.7 - 2.8 - 3.9 - 4.9 - 5.8 - 6.7 - 7.5 - 8.2 - 8.8 - 9.3 - 9.8 - 0.2 - 0.5 - 0.8
9:	1.8 - 2.9 - 3.0 - 4.0 - 5.9 - 6.8 - 7.6 - 8.3 - 8.9 - 9.4 - 9.9
10:	1.9 - 2.0 - 4.1 - 5.1 - 5.0 - 6.9 - 7.7 - 8.4
11:	1.0 - 3.1 - 4.2 - 5.2 - 6.1 - 6.0
12:	2.1 - 3.2 - 4.3

Once you get the results of the stock results, you see what dice roll they correspond to and use that dice roll result on the game's TDT. The bonus for an ace is added after you find what dice roll result to use.



PBM equipment for RICHTHOFEN'S WAR is available from Spartan International, Box 1017, Bellflower, CA



RANDOM NUMBER GENERATORS

Although what follows may seem more suited for Popular Mechanics than the General, Dr. Plock has provided us with an amazingly detailed rundown on how the wargamer with a passing interest in electronics can apply his knowledge in a sparetime construction endeavor to build an interesting playing aid to complement his gaming hobby. If you have the know-how to wade through the sea of jargon which follows, or know someone who does—you may well be on your way to possessing a random number generator. Richard follows with plans for both a digital machine for use with pbm tables and a die face device for use with games using both one and two dice. In years gone by these unique gadgets were selling for \$50 and up at wargaming conventions—when you had the good fortune of finding one at all.

RANDOMIZERS OR ELECTRONIC "DICE"
by Richard J. Plock

In order to eliminate the problems associated with rolling dice (disturbing pieces, "cocked" dice, biased dice, etc.) I have constructed two different styles of battery operated electronic randomizers. They both operate on the same fundamental principle—a circuit is so designed as to oscillate at approximately 1 Mhz (one million times per second, for you non-technical types), with a pushbutton switch connecting it to a counting circuit. This counting circuit then displays the number of cycles (or time in microseconds) that the pushbutton has been depressed. Since people cannot control their reflexes to even a thousandth of a second, the number of cycles counted yields a truly random result. The circuits are designed to give true probabilities, there are no false counts or invalid states.

The first design displays the count as the pattern appearing on two die faces, going through each of the 36 possible configurations during the count. For games using only one die, the device can be made to suppress the readout of one of the faces. The second design generates a true digital readout, with two alternative counts: a standard 1—6 count for those cases where a true die probability is desired, and a 0-9 count when a decimal result is wanted (e.g., when using the pbm results tables in face-to-face play).

General Construction Information

These devices use the readily available and inexpensive TTL integrated circuits in the dual-in-line 14 and 16 pin packages, with the solid state light emitting diode (LED) lamps. I have purchased these items from Poly Paks, Box 942, South Lynnfield, Mass. 01940. I do not wish to imply that Poly Paks is best or cheapest, merely that these items are available there if you have trouble finding them. The prices paid (Summer 1973) are given with each item; the latest prices and sources of supply can be found in the advertisements in any of the hobby electronics magazines (Popular Electronics, etc.). The other parts (boxes, resistors, etc.) are available from any electronics supply store.

The particular construction shown utilizes printed circuit techniques. While it is possible (I suppose) to build them with conventional wiring, the problems associated with bulk and soldering connections make it almost imperative to use a PC board. The leads on a DIP unit are in two equal rows. The pins in a row are .1" apart; the rows are .3" apart. Holes of about .04" diameter are required. Should you not wish to drill holes, "P" pattern unclad and copper clad one or both sides perboard is available. This pattern has .042" holes punched on a .01" grid, and has been specifically designed for IC mounting. You can either etch a copper clad board, or use one of the copper tape techniques available—etching is quicker and easier. The patterns shown are for unpunched copper clad boards; use of pre-punched boards or copper tape circuits will probably require more space, although a similar layout should be used.

If you have never handled IC's and diodes before, be careful! Excessive heat when soldering, excessive mechanical force on the leads, and excessive voltage at the wrong lead can all irreversibly damage them. Once properly mounted they are quite shock resistant, but until then should be regarded as delicate. Use a low wattage, fine tipped, pencil type soldering iron with a good grade of rosin core electronic solder. It is a good idea to make a final check of the soldered circuit with a magnifying glass; the spacing is close and solder bridges are possible. If you prefer, you can use IC sockets to avoid soldering the IC itself; they are rather bulky and will require larger boxes.

Where substitutions are feasible, this fact has been indicated. Otherwise, stick to the exact designation shown. Many IC's have the same function but different lead numbers. Also note that in both cases alkaline batteries are specified. Rechargeable NiCad batteries may be substituted, but not the regular carbon-zinc ones. The current demands are too high, standard batteries will not meet them. Larger cell sizes (but NOT higher voltages) can be used. Under NO circumstances use a source over 6 volts; the IC's and LED's will burn out.

One final point—TTL units are specified to operate at 5 volts. They will, however, perform satisfactorily from 4½ to 6 volts. Below 4½ volts they become erratic, but the displays will still light up. Check your batteries at the first sign of erratic behavior.

DIE FACE RANDOMIZER
How It Works

This randomizer uses 14 LED's to simulate two die faces, 7 for each face. The LED's used were the small MV 5080 units; they emit an intense red light. The heart of the unit is the SN 7492 divide by twelve IC. The logic diagram (Figure 1) shows the circuitry used. The numbers in circles at the sides of the IC's are the pin numbers; they are not shown in any particular order, just the most convenient one for my purposes. The isolated circles with letters correspond to the letters shown on the PC board. Note that some of the IC's are shown in separate sections—there is only one 7404 unit (IC 1).

Starting at the left, we have inverters 1 and 6 from IC 1 (SN 7404 hex inverter) driving an RC timing circuit. Inverters do just that—the output is high if the input is low, and vice-versa. R₁, R₂, C₁, and C₂ have been chosen to produce about 1 Mhz frequency. This is not critical; anything between 100 Khz and 5 Mhz should work, so the values can be varied as much as a factor of two. This circuit produces square wave pulses at point A. Pressing the pushbutton (S1) feeds these pulses into the 7492 divide by six counter. This may seem confusing since the 7492 is called a divide by twelve counter, but it is built in two sections. One section is a divide by two counter (Input A, Output QA), the other a divide by six (Input B, Outputs Q_B, Q_C, Q_D). When coupled, you have a divide by twelve. We only use the second part, the divide by six.

TABLE 1

LOGIC TABLE FOR IC 2 AND DIE FACE 1

Input Count	7492 QD	7492 QC	7492 QB	1	2	3	4	5	6	7	Number Displayed
0,6	L	L	L	-	-	-	-	-	-	ON	1
1,7	L	L	H	ON	-	-	-	-	ON	ON	3
2,8	L	H	L	ON	-	ON	ON	-	ON	ON	5
3	H	L	L	ON	-	ON	ON	-	ON	-	4
4	H	L	H	ON	-	-	-	-	ON	-	2
5	H	H	L	ON	ON	ON	ON	ON	ON	-	6

The sequence of the count is shown in table 1. The count is made each time the input drops from high to low. The remainder of this section of the circuit decodes this output into the spots on a die face; table 1 includes this result also. The die spots are numbered 1, 2, 3 down the LHS, 4, 5, 6 down the RHS, 7 in the center. The next item in order is the "OR" gate—there are four in the unit; two are used for each die. An OR gate has a high output if any input is high, thus the unit shown has a high output if QB, QC, or QD is high. The inverter has been described; there remains the quad 2-input NAND buffer. A NAND gate has a low output if all its inputs are high; a buffer can maintain a low output state by absorbing current to a greater extent than a regular IC. They make good lamp drivers, but note they are designed to light lamps when the output is low. The LED's thus light up only when the corresponding buffer has low output. R₃ through R₁₀ (to include both dice) are current limiting resistors—they are to prevent the LED's from burning out. They should not be changed unless the LED's chosen are different, then different values may be required. Larger and brighter LED's are available at greater expense; if used, appropriate resistor substitution should be made. (Special note: If you really want to spend the money, green or yellow LED's are now available—at \$1.50 each.)

The output QD (after going through an inverter—this is for wiring convenience only) drives the second counter (IC 5), which operates in a similar fashion. Each time die 1 displays a 4, IC 5 increases its count by one. The result gives the 36 possible combinations of two dice. The switch S3 can be used to cut off the power to the LED's of the second die. This means there is no confusion when only one die is desired; also the battery drain is less. The LED displays form the greatest current demand of the unit; blanking one of them will extend battery life.

It should be noted that random results are obtained only after pressing the pushbutton; the output is NOT random when the unit is first turned on. My unit invariably displays a 4.

The construction details which follow are based upon a unit identical (or virtually so) to mine. The parts used and approximate prices paid are shown in table 2. For anyone who wants to make changes, a wiring diagram (Figure 2) is included; it makes the connections a little clearer than the logic diagram. It will also be helpful in checking the PC pattern if you draw your own.

with a game chest. Making a set of gametrays is simplicity itself. Merely cut a flat rectangle of

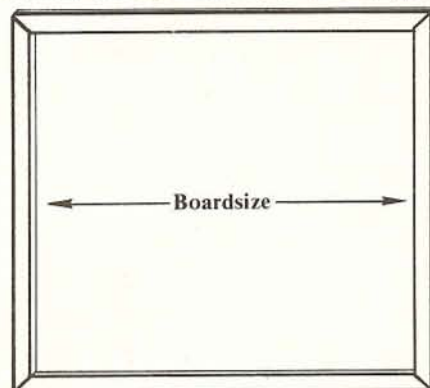

plywood, of a thickness suitable to prevent flexing (¼ - ⅜") to the size of the board in question with an extra ½" allotted around the perimeter. Then you take 4 strips of plywood ½" wide by 1" high, and nail or glue them to the bed area. Their length depends on the length/width of the game board plus the margin (½ × ½ = 1"). These raised strips around the sides make it possible to stack a number of games without disturbing the counters (nor will any but the top one get dusty). Not only is this handy to store games, but to move them as well, in case you need to change tables, etc. Although game trays won't tend to "stick" as they can in a poorly constructed game cabinet they are more subject to accidental ravages by passers-by.

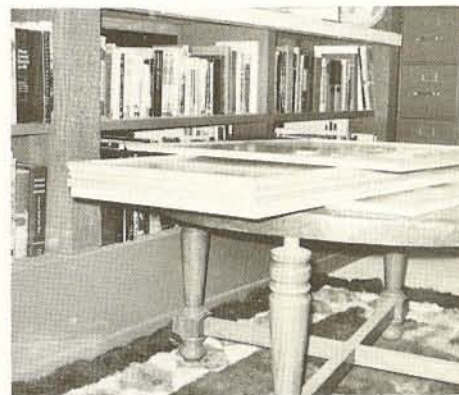

The main drawback to the game tray system is that a secluded place away from other daily activity is needed to store them if they are not to be upset.

UNIT DIVIDERS:

One of the biggest drawbacks of Avalon Hill games is their lack of "compartments" to separate and store different types of unit counters to facilitate easy set-up. The plastic tray of the bookcase line and the cardboard containers in the flatbox variety just don't cut it in any way, shape or form. There are many viable solutions to the "compartmentalization" problem which vary sufficiently in expense and accessibility to meet every gamers' whim.

The solutions vary from empty egg cartons, candy boxes, plastic ice-cube trays resealable plastic bags, and see thru fishing tackle boxes to the ultimate carpenter's chest of drawers. The problem with the first 3 mentioned items is not only their untidy appearance, but the fact that counters are subject to loss during transit from one location to another. Their obvious advantage is that they're free and if the former

objections don't stand high on your list of priorities they can be a useful alternative. The plastic bag idea has merit except that even these high quality products have a finite number of openings and closings before the inevitable wear and tear takes its toll. It is also a bulky system which is convenient to store and label. Probably the best solution for most is the fishing tackle box. Available in different sizes and prices ranging from under a dollar to several bucks, these "tackle" boxes are both pleasing to the eye, easily labeled, and secure against leakage.

The main disadvantage is that these boxes contain, on the average, only 16 separate compartments. This means that for a game like *Panzerblitz* two boxes would be needed. This too can become a bulky storage problem if you want to compartmentalize more than a few games. We've found the ideal solution to be large parts storage chests used by carpenters to store various size nails, nuts, and bolts and which are available in almost any department store. The one pictured on these pages retailed for \$13.00 at Montgomery Wards. They also have 37 drawer units for \$12.00, 30 drawer units for \$9.00 and 23 drawer sets for \$7.00. It would appear obvious that the 60 drawer unit is the best buy. Each drawer is subdivided into compartments which are formed by dropping clear plastic dividers into precut slots. Depending on the counters to be sorted, each drawer can be subdivided into 1, 2, 3 or 4 compartments. Each 5½" X 2" X 1½" drawer offers a multitude of storage compartment sizes depending on the number of departments to be used and the sizes desired. The really industrious can fashion cardboard separators which will easily wedge into position to further subdivide a drawer into as many as 12 compartments. When utilized in this fashion, a Unit Divider of this size can be used to store the counters of your entire game collection. Ours holds the units for 12 games, weighs 13 lbs., stands 22" tall, a foot across and 5½" deep. When doctored up like this one has been it not only becomes a great aid to play, but the perfect bookend for your "bookcase" games or centerpiece for your mantel.

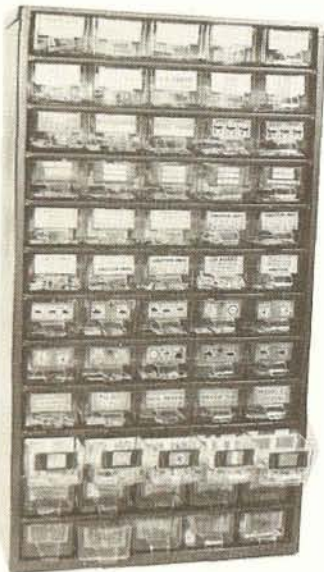

A deluxe 60 drawer chest containing 240 separate compartments. This one utilized cannibalized game OB charts to give a truly professional appearance. Such extravagance is not necessary of course but does lend a very impressive appearance to the gameroom of a dedicated wargamer.

CONSTRUCTION DETAILS

The first step should be the preparation of the PC board. This board is 4" x 2½", copper clad on both sides. I have supplied two patterns (Figures 3A and 3B) that may be used as a guide for etching purposes. I have tried to make them sufficiently accurate to permit their use as templates, or you can draw your own using them for reference. The "TOP" shown on figure 3A means just that—this is the top side of the PC board, and all components will be mounted on this side. The letters appearing at some of the points on the board correspond to the letters in the wiring and logic diagrams. They also refer to connections to be made to an item not mounted on the board. On the bottom side, be especially careful preparing the pattern around the LED connection holes; there is very little clearance. Make sure you have no shorts. These holes are shown in pairs because that is the way I made mine. I had originally planned on mounting the LED's directly on the board, but changed my mind. (Each pair of holes corresponds to one LED.) If you draw your own and can keep track of your connections, you might space these differently. The odd-looking tabs on one of the holes on the top side are there for a purpose—when the component is mounted you need something to make a soldered connection to. The small holes are all .04" in diameter. The four large holes in the corners are for mounting the PC board on the box cover; any convenient size will do. I used .125". The easy way is to drill the PC board and box cover together; then the holes are sure to be in register. The top side of the PC board will be facing the box cover. Instructions for the etching process itself come with the solutions—Radio Shack offers a complete kit.

Once you have the board etched and drilled, you can mount and solder the components. Figure 4 shows the location and orientation of each component mounted on the board; all are mounted on the top side. Note that the positive side of the diodes D1 and D2 are towards the edge of the board. They are specified as 1N914, but any small switching diode will do. You will probably have to test them to find the positive side. If they pass current in both directions (or neither direction), they are defective. Do not solder both leads of the diode at the same time; after doing the first, let the diode cool before soldering the second. After R1, R2, D1, D2, C1, and C2 have been mounted and soldered, the capacitors C1 and C2 should be carefully folded down over the resistors and diodes so as to take up less space. Be sure of the orientation of your IC's; Figure 5 gives the lead designation of a 14 pin "N" package IC, in case you get one that does not have a notched end. (The letter immediately after the unit specification number is the package style.) Be careful in mounting them, the legs (or pins) are made slightly sprung out to hold them in place. Again, do not solder all the leads of an IC at one time, give it a chance to cool. Remember, some of the leads must be soldered on the top side. The resistors R3—R10 are mounted parallel and adjacent, they should just barely fit. All components should be mounted as flat to the board as possible; the IC's are designed to have a small gap beneath them.

The battery holder should be mounted in the bottom of the box. Note that the batteries are the main bulk. Using 4 C cells requires a box 6" # 3" x 2¼"; using D cells would require a larger box. The holder can be glued in place (I used Silicone Seal), or holes drilled in the box to use small bolts. After it is mounted, the negative lead (black) should be soldered to point B on the PC board. Pass the wire through the hole from the top side to give a mechanically strong bond—do this for all such connections.

At this point the lid of the box (which should be phenolic, do not use a box with an aluminum or other conductive cover) should be prepared for the components to be mounted there. The actual location and sizes of holes will be determined by the requirements of the items used. The pushbutton will probably need a ¼" mounting hole. It should be centered near one end; make sure it is in such a position that it will clear the PC board when both are mounted. Slide switches come in all shapes and sizes—the holes drilled and slot cut (for the handle) will have to be tailor-made. Toggle switches can be used instead if you prefer; they are easier to mount. Again, make sure you have clearance. For the LED's, 1/16" diameter holes (NO LARGER) are needed. The positioning should be such that these mounting holes are approximately in register with the pairs of holes in the PC board. There should be two "H" patterns, each with holes about .2" apart, as shown in Figure 6. Overall, they should be at the opposite end from the pushbutton. Insert the leads of the LED's from the top side (they are reasonably long) and cement them in place with epoxy glue. Make sure that the positive lead of each LED is positioned towards the end of the box—away from the pushbutton. See Figure 3 for the lead determination and double check before cementing. (Use a 150 ohm resistor in series with a 6 volt source—if it lights you are OK; if not, try reversing it. If it does not light either way, it is defective.)

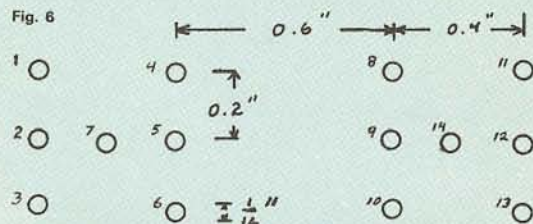

Exterior View of two-dice random die face generator

The final connections can now be made. The pushbutton (S1) is connected to the points A and A' on the PC board; use wires of reasonable length. One side of one of the slide switches (S2) is connected to the positive (red) battery holder lead. The other side of this switch needs two wires; one goes to the other slide switch (S3) and the second to the points C and D on the PC board. Note that there is only one hole; C is on the top side, D on the bottom. The second side of S3 is connected to point E on the PC board. Using the most flexible hookup wire available, cut 28 lengths and solder one end of each in one of the 28 holes for the LED connections. Be sure the wires are inserted from the top side of the board. Then carefully connect each wire to the appropriate LED lead; the LED's should already be cemented in place. Be extremely careful and cautious; not only must each lead be properly connected, but the LED's are extremely heat sensitive. After each connection is made, it is a good idea to coat the lead and soldered connection with an insulating material to avoid shorts.

After the last connections are finished, the PC board is bolted to the cover with 4-40 round head machine screws and ½" spacers. This must be done carefully—that bundle of 28 wires takes up room and is not very flexible. Mount the slide switches and pushbutton, put 4 batteries in the holder, screw on the lid, and you are in business. Turn both slide switches on; there should be lights in both displays. Press the button and all 7 LED's in each display should come on. One switch should cut off the right hand display while the other cuts off both. The only patterns to appear when the button is released should be those appropriate to a die face.

The photograph shows the unit with both "dice" (at the top) lit up—a 5 on die 1, a 6 on die 2. The cover screws and PC board mounting screws are clearly visible, as is the pushbutton. The slide switches are virtually invisible (black on black does not lead to good contrast), but the labels (ON in the lower left corner, a 1 and 2 in the right) show their locations. An interior view of the unit is also shown.

TABLE 2

PARTS LIST FOR DIE FACE RANDOMIZER

Item	Description	Number Required	Total Price
IC 1	SN 7404 N Hex Inverter	1	.35
IC 2, IC 5	SN 7492 N Divide by Twelve	2	2.20
IC 3	SN 7432 N Quad 2-input Positive OR Gate	1	.35
IC 4, IC 6	SN 7437 N Quad 2-input Positive NAND Buffer	2	1.10
L 1—L 14	MV 5080 Micro Mini Visible LED	14	5.00
D 1, D 2	1N914 Switching Diode	2	.20
C 1, C 2	0.01 F Disc Capacitor	2	.30
R 1, R 2	100 ohm ¼ watt Resistor	2	.30
R 3—R 10	150 ohm ¼ watt Resistor	8	1.20
S 1	SPST Miniature Pushbutton Switch NO	1	.30
S 2, S 3	SPST Miniature Slide Switch	2	.50
B 1	1½ volt Alkaline "C" Cell (4 in series)	4	2.50
	Plastic Battery Holder—4 "C" Cells	1	.80
	Phenolic Chassis Box (with phenolic lid) 6" x 3" x 2¼"	1	1.60
	PC Board Copper Clad Both Sides 4" x 2½" unpunched	1	.50
	Miscellaneous Hardware, Wire, etc.		.80

Total cost of parts (less taxes, shipping, etc.) \$18.00



Interior View of two-dice random die-face generator

Location and orientation of components on PC board

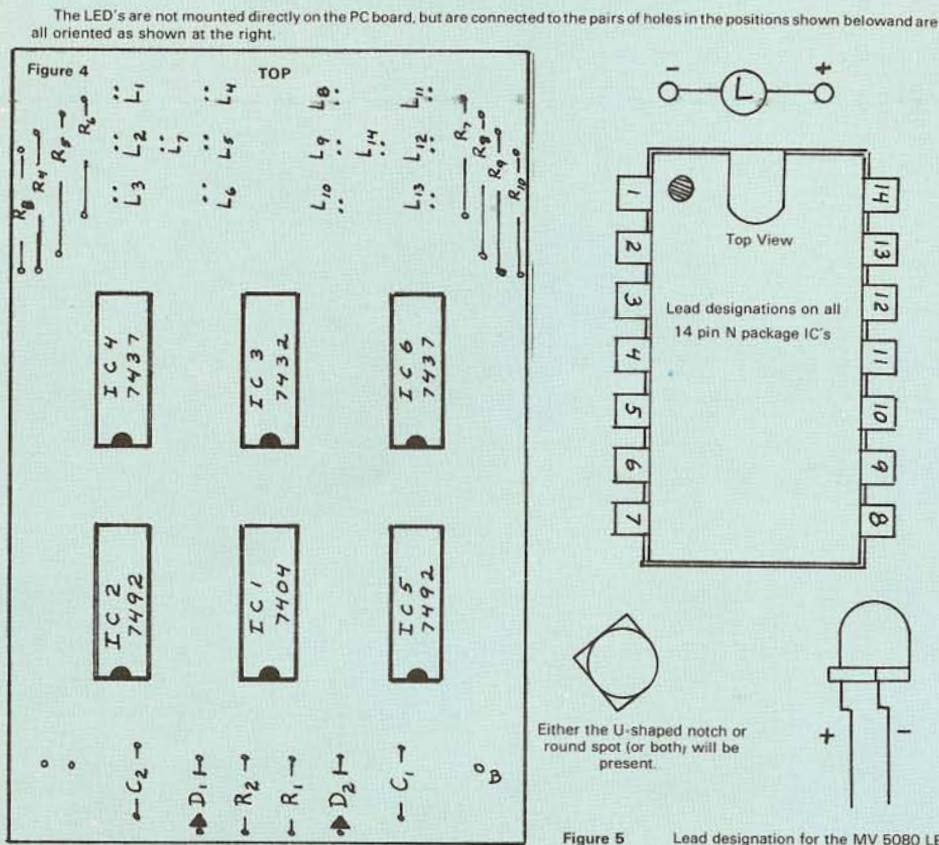

Figure 5 Lead designation for the MV 5080 LED

THE DIGITAL RANDOMIZER

How It Works

This unit makes use of the MAN-4 seven segment LED readout display to show a digital readout of from 0 to 9 inclusive; the operational heart is the SN 7490 decade counter. As in the case of randomizer #1, I have supplied a logic diagram (Figure 7) and a wiring diagram (Figure 8). Read the section "How it works" under Randomizer #1 before continuing; many of the points discussed there apply in this case also, and are not repeated.

As previously, two inverters from IC 1 (SN 7404) are coupled to an RC circuit to produce square waves of about 1 Mhz at point A; these pulses are fed into input A of the decade counter IC 2 (SN 7490) when the pushbutton S1 is pressed. Again the counter is built in two sections; this unit uses both by connecting the output QA to input B. The result is a binary-coded decimal output at the four terminals QA, QB, QC, and QD. When the 4PDT switch S3 is in position 1, all of the outputs of IC 2 are connected directly to the corresponding inputs of IC 3 (SN 7448 BCD-to-7-segment decoder/driver), giving a true decimal count, while at the same time sections A and B of the switch ground the reset terminals of IC 2. (Special note: If all that is desired is this decimal count, switch S3 and IC 4 are unnecessary; simply make direct connections between the outputs of IC 2 and the inputs of IC 3, and permanently ground the reset terminals of IC 2.) The SN 7448 is specifically designed for the purpose of driving 7-segment displays of the MAN-4 type—there are seven output terminals, one for each segment. Note that this IC has 16 pins; the numbering system is analogous to that for a 14 pin unit. While the SN 7448 is capable of driving the display by itself in this instance, when the outputs are high, a brighter light and greater contrast can be obtained with the use of the resistors R3—R9 connected to the power source. Do NOT change their values; as before, they are used to limit current and prevent the display from being overloaded.

When S2 is in the position 2, the displayed count goes from 1—6. The first point to observe is that the reset-to-zero pins (#2 and #3) of IC 2 are no longer automatically grounded, but are instead connected to the outputs QB and QC. These reset inputs function in such a way that when either is grounded (or low), the unit counts in a normal fashion. When both simultaneously receive a high pulse, it resets the count to zero. (If you do your own design, be careful. There is another pair of reset pins—reset-to-nine. These must be permanently grounded.) Thus, when QB and QC are both high for the first time in the count sequence (a BCD six), the counter returns to zero. Since the time required is much less than the time between counting pulses, the counts go from 0-5 without overlap or false probabilities. In order to make this a 1-6 readout, the B and C inputs of IC 3 are connected to the outputs of IC 4 (SN 7432 2-input OR gates); examination of the logic will show that these will correspond to the outputs QB and QC of IC 2 except when all three outputs QA, QB, and QC are low (a BCD zero), then both B and C inputs of IC 3 are made high, giving BCD six. Thus a count of zero yields a display of six, while all other counts yield a true display.

As in the case with randomizer #1, the output will be random only after pushbutton S1 is pressed.

Construction Details

This will describe how to build a unit essentially identical to my prototype; however, let me urge now that you make one change. If you value your sanity, and unless you are very adept at working in small spaces, do not use the same size box (4" x 1 1/4") that I used; the components just barely squeeze inside after some special cuts have been made. Unless you are as stubborn as I am, I recommend a minimum size of 4 1/2" x 2 1/2" x 2", preferably with a phenolic cover; learn by my headaches!

All of the construction warnings and recommendations given for randomizer #1 apply here except for those associated with the individual LED's and pattern on both sides of the board. The printed circuit board is 3/8" x 1 1/8", copper clad on one side. Figure 9 shows the etching and drilling pattern (bottom view). The rather odd shape is necessary to provide clearance for the box reinforcing, switches, etc. (see preceding paragraph). The two large holes are mounting holes—all hole sizes are the same as for unit 1. Figure 10 shows the location and orientation of the various components, all mounted on the top of the board. The positive lead of each diode is towards the center of the board (by IC 2). The MAN-4 display is not mounted directly on the board; a 14 pin socket is used. This elevates the display 1/2 inch, enabling it to be clearly visible while allowing clearance for wires and IC's between the board and case. Note the orientation of the insertion of the MAN-4 in the socket—pins #3, #5, #10, and #11 are missing (but the location are still numbered). Pins 1-7 should be on the side with the 4 resistors; 8-14 on the side with 3 resistors. Again, the two capacitors should be carefully folded down to take up less space. Notice especially the jumper wire next to IC 3 (SN 7448).

The battery holder is not mounted permanently in the case; it must be removable to get at all four batteries. Depending on the type, it may have leads of its own, or a battery clip may be required. The negative lead (black) is soldered to point B on the PC board, the positive (red) to one side of the switch S2. The other side of S2 is connected to point C. The short cutout in the PC board next to IC 1 is to provide clearance for this switch. The 4 PDT switch S3 is connected as follows: Section A—central lead to point K, terminal 1 to point B, terminal 2 to point E; section B—center to point L, terminal 1 to terminal 1 of section A, terminal 2 to point F; section C—center to point H, terminal 1 to point M and terminal 2 of section A, terminal 2 to point P; section D—center to point J, terminal 1 to point N and terminal 2 of section B, terminal 2 to point R. Note that these terminals and sections are not necessarily numbered; you have to do your own. The cutout next to the diode D1 is to accommodate this switch. Note that these cutouts are tailored to the switches available to me and the box I used. As before, one side of the pushbutton is connected to A, the other side to A'.

We're not urging that everyone go out and buy a Unit Divider Chest, but if you do have most of our games, do play them a lot, desire an attractive sorting system, and are willing to invest several hours in setting it up you can hardly go wrong with a purchase like this.

However, do not pitch blindly into the project. Each drawer and every compartment should be labeled as to its contents. If you take a little time in planning your "Unit Chest" and exercise some artistic ability you'll fare better than had you plunged into it immediately.

Come up with a color scheme that will tell you immediately which drawers belong to which games. For example, we colored all our *Origins* labels black, *Midway* red, *Bulge* white, etc.



Panzerblitz is probably the game in most need of a compartmental storage system. Sorting should be done by type to facilitate set-up for the game's many scenarios. Note that the drawers are broken into five categories: transport, armor, specialized armor, infantry, and artillery. Each interior compartment is likewise labeled as to its exact contents.

Be selective as to which games you want included in your "Unit Chest." Some games, such as *Gettysburg*, *D-Day*, *Stalingrad*, *Kriegspiel* and the "peace games" do not really require compartmentalization. In fact, it actually increases set-up time of games such as *D-Day*. Remember, units which are taken from a compartment have to be returned eventually. In most games, this is merely a matter of dropping the eliminated units into the proper compartments each turn. In *D-Day* where there is no set OB historical unit designations, returning the right amount of units to the right compartment can be a real problem because there is nothing to cross reference each unit with as you return it to the box unless you sort it by type rather than time, which is little help to the Allied player.

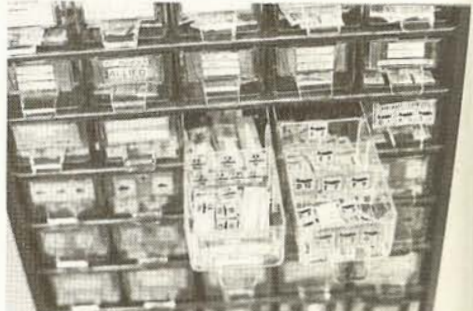

Not all counters should be classified by type. In many games, such as *MIDWAY*, grouping of counters by the times when they appear on the board is preferable. In this example, both battle and search board counters are grouped in the same compartment—classified by the times they appear in the game. Note that the outside label describes what is to be found in the compartments in that drawer, while each compartment is also labeled as to its contents.

Games such as *1914*, *Jutland*, *Panzerblitz*, *Luftwaffe*, *Origins*, and *Richtofen's War*

should be sorted entirely by type. Components for *Gettysburg*, *Guadalcanal*, *Anzio*, *Waterloo*, *Afrika Korps*, and *Bulge* should be divided by the times and areas in which they enter play. *Stalingrad*, *Midway* and *France '40* require a blending of the two systems.

The drawback of this system is of course the initial expense, in terms of both time and money plus the fact that it is not convenient for traveling.

CARDBOARD DIVIDERS:

A cheaper, and in some ways more convenient, system is available for the flat box games. These games, until recent production cutbacks, came equipped with two counter trays measuring 10 3/4" long by 2 1/2" wide. Because there are no compartments contained within the trays, they are useful only to separate one side's pieces from the other. However, 2" x 1/2" strips of cardboard can be inserted easily into place so as to form individual compartments. Once in place, the strips can be stapled or glued for permanent support. Each compartment can be as long or short as necessary, subject only to the length of the tray and number of compartments sought. If additional compartments are desired further cardboard strips can be glued in place lengthwise to subdivide the original compartments. Once placed in the trays, the weight of the mapboard placed overhead will prevent counter leakage if not jostled to excess.

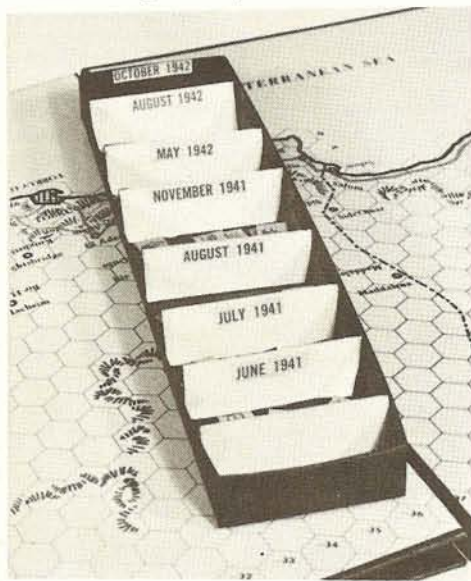

Every gamer can ease his unit counter storage problem by creating separators within the cardboard trays found in the flat box games such as has been done above for *Afrika Korps*. The weight of the board atop the trays serves to keep the units in place.

PBM HINTS:

Ever been placed in the embarrassing situation of your PBM opponent finding you guilty of moving a piece too far and sending your move back for revision? Of course, it probably wasn't intentional but rather was a result of moving a piece legally, leaving it to pay attention to that area and moving again. Chances are you have probably been guilty of this in your face-to-face games as well, but your opponent couldn't prove it and so it went unnoticed. It happens, but it doesn't have to. Merely get into the habit of rotating your counter facing after every move. That is, always have your units facing in the same direction. Whenever you move a piece

In preparing the case, let me reiterate my warning about the difficulty of using the size I did. The mounting holes and slots for the switches will depend upon the specific items used; in my unit they are in the bottom of the case, not the aluminum lid. The pushbutton mounting hole is centered at one end as near the edge as possible, barely clearing the PC board. At the other end, a slot 8" long and .3" wide is cut to accommodate the MAN-4 display. This slot is in line with the pushbutton mounting hole and comes to within .125" of the end. On each side, .625" from this end and as near the side of the box as possible, .125" holes are drilled for mounting the PC board. Now comes the tricky part—most of these boxes have their corners blocked by molded reinforcing or regions to receive the cover screws. This must have a cutout made about 1/2" from the bottom of the box at the end by the MAN-4 slot; this is needed to allow room for the corners of the PC board. The entire molding cannot be removed, it is needed to brace the PC board and to mount the lid. All I can say is that it is a cut and fit approach. They must be cut out enough to allow the top of the socket to reach the inner surface of the bottom of the box (or "top" of the unit) when the PC board is mounted. None of this is required with a larger box with a phenolic lid; mount everything on the lid leaving clearance for these reinforcements.

After finishing all the wiring and cutting of the box, the works are mounted. In my unit, you cannot mount one thing at a time; everything must be worked into position simultaneously and cautiously. In fact, my 4PDT switch is not really mounted; the fit is so tight I simply wedged it in place (NOT a recommended procedure). The board is held in place with 4-40 machine screws; the side with the components is against the surface of the box. If possible, 1/2" spacers should be used; if they are not used the screws should not be tightened excessively. If care is used, the MAN-4 readout can be inserted and removed via the slot; its surface should be flush with or slightly above the outside of the case. Put the batteries in the holder, screw on the lid (which just makes it), and try it out. Turning on switch S2 should light up the display with either a 0 or 6, depending on the setting of S3. Pressing the button should light all segments (an 8). With switch S3 in position 1, any number from 0-9 should appear when the button is released; in position 2, only 1-6 should appear.

Photographs of the unit in operation (showing a 4) and of the interior are shown. It may be noticed that the PC board is a prepunched one, however the pattern (Figure 9) is for an unpunched board which I recommend.

TABLE 3

PARTS LIST FOR DIGITAL RANDOMIZER

Item	Description	Number Required	Total Price
IC 1	SN 7404 N Hex Inverter	1	.35
IC 2	SN 7490 N Decade Counter	1	1.30
IC 3	SN 7448 N BCD-7-segment Decoder/Driver	1	1.50
IC 4	SN 7432 N Quad 2-input Positive OR Gate	1	.35
MAN-4	MAN-4 7-segment Alpha-numeric LED Display	1	4.00
D1, D2	1N914 Switching Diode	2	.20
C1, C2	0.01 F Disc Capacitor	2	.30
R1, R2	100 ohm 1/4 watt Resistor	2	.30
R3, R9	560 ohm 1/4 watt Resistor	7	1.05
S1	SPST Miniature Pushbutton Switch NO	1	.30
S2	SPST Miniature Slide Switch	1	.25
S3	4PDT Slide Switch	1	.40
B1	1 1/2 volt Alkaline "AA" Cell (4 in series)	4	1.85
	14 pin Integrated Circuit Socket	1	.50
	Plastic Battery Holder—4 "AA" Cells	1	.60
	Phenolic Chassis Box (Aluminum Lid)	1	1.20
	4" x 2 1/4" x 1 1/8"		
	PC Board Copper Clad One Side	1	.50
	3 3/4" x 1 1/4"		
	Miscellaneous Hardware, etc.		.55

Total cost (less taxes, shipping, etc.) \$15.50

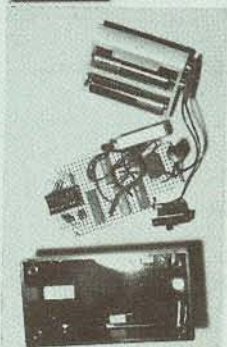

DIGITAL RANDOMIZER CONSTRUCTION DIAGRAMS

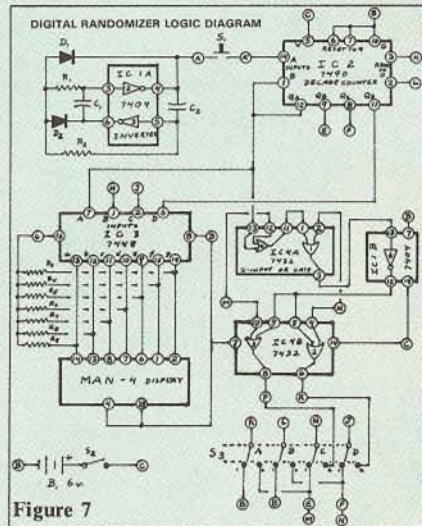
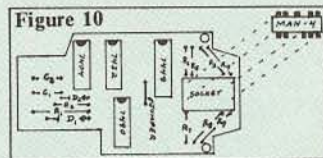
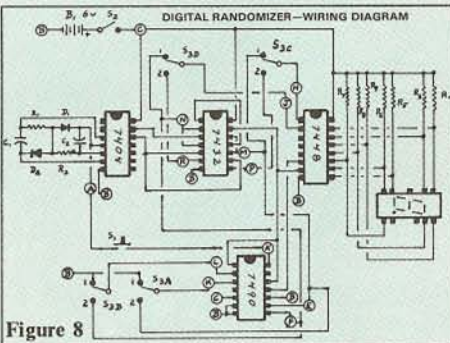
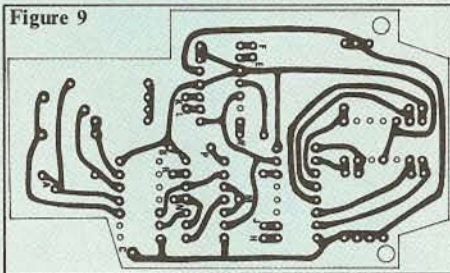

rotate it 180° to indicate that it has moved. By the time you have finished your move all pieces should once again be facing in the same direction. In this way you can always tell at a glance which units have and haven't moved.

Those who do not have regular access to a paper with sales-in-hundreds listings for PBM use and don't wish to involve a third party necessary for use of the ICRK system are not totally without hope. Such people can get along

quite nicely on just one paper per opponent. The trick is to "anchor" the CTD being used by giving 4 stocks and their sales-in-hundreds results to your opponent while he does the same for you with a paper of his choosing. As a stock is used it is underlined on both player's paper so that the attacker can not use the stock again. At the end of the game both players exchange the CTD listings they used to verify the results they listed for their opponents attacks. This system is not foolproof—an unscrupulous person *could* find the CTD list you're using if he tried hard enough, but it is doubtful whether anyone would sink that low in a friendly game.

In large metropolitan areas (or anyplace where opponents live within local calling distance) where many wargamers live within close proximity to each other, PBM can be outmoded by PBP (Play by Phone). The procedure is the same for PBM with the exception of determining results. Here, the attacker calls out a page in the local phone directory for every attack.

The defender then *immediately* responds with a number from 1 to 20 and the words top or bottom. The defender then refers to the proper page in the phone book and looks up or down the right hand column the proper number of entries. The last digit in the phone number thus located is used to resolve the attack. That name is now checked off and can not be used for future attacks. The process is repeated for subsequent attacks.

PBM HINTS:

PBM gamers often go cross-eyed recording the grid-co-ordinates of all their units for every move. This problem has been rectified somewhat by games such as *France '40* which print the co-ordinates on every square on that hex. You can do this in the older style games by writing in the co-ordinates for every game. Granted, unless you are very artistically inclined it tends to mess up your board.

An alternative is to use colored pencils to lightly shade alternate diagonal rows. Most errors in grid recording are made on the diagonal rows and distinguishing them from their neighbors in this manner usually cuts down mistakes of this nature 90%.

Give your opponent a break when it comes to selecting stocks for CTD's. Choose them from one section of the paper close to the date so that he doesn't have to clip out the whole paper and stuff it in an envelope. Don't use preferred stocks or those which regularly sell under 20 shares daily. And surprising as it may seem to many—you may use Saturday CTD's by specifying that your opponent look up the weekly stock results which appear in most Sunday papers. However, when using this option your letter must be postmarked by the previous Thursday.

And for those of you to whom the stock exchange is all that's evil in the world, there is always the ICRK system. This is a computer printout of random numbers. Both players are provided with a different one and a copy of each

is kept by a neutral third party to verify the results after the fact. For further info on this promising system we suggest you write the SICL, 5820 John Avenue, Long Beach, California 90805.

TIME:

"Methinks he doth taketh too long" is a line from an old English play which fits well into our hobby. Everyone has had the misfortune of playing someone who takes longer to make a move than Grant did to fight the Wilderness Campaign. Quick response moves such as *Football Strategy* and *Richthofen's War* can be easily controlled with a stop watch or any clock with a second hand. This is not the answer for more sophisticated games with a greater number of variables each turn however.

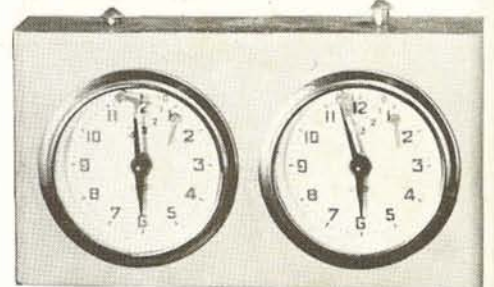

A USCF clock. Pushing the button on your side stops your clock and starts your opponents'. Chess clocks are expensive; ranging from \$19-\$35 but are usually high quality and guaranteed. Inquiries can be directed to the USCF at 479 Broadway, Newburgh, NY 12550.

Chess clocks are used to measure the time each side separately takes for his moves. In chess, a typical procedure is to allow 2 hours (per person) to make a grand total of 40 moves. If your flag falls before the 40 are made, you lose. You thus allocate your time as you please. For wargamers, two ways are feasible: for short games (e.g., *Panzerblitz*) decide how much time is to be spent, divide it (allowing for different numbers of units if necessary) and set the clocks appropriately. Say one hour on each. If your flag falls before the last move is made, you lose. (Note the flag will fall each hour—for longer games merely reset the clock accordingly).

THE DICE:

Dice (speckled cubes, messengers of fate or any of a dozen less fitting names) have been damned and praised by gamers ever since man made his first wager. Yet no matter how much we condemn them game designers always resort to them almost without exception.

Whatever your feelings on the relative merits of luck versus skill in wargames, dice are unavoidable if you follow the wargaming persuasion. However, substitutes can be found.

One of the simplest and least expensive is the Automatic Comput-A-Dice device carried by Radio Shack and selling for \$2.95. By pressing a plastic lever, two wheels start to roll. They stop automatically and light up a pair of dice faces on the TV-type window. The device operates on 2 "AA" penlight cells.

A host of other die-rolling gadgets can be found in gift and stationery shops. They range from a miniature revolving gambling cage to a

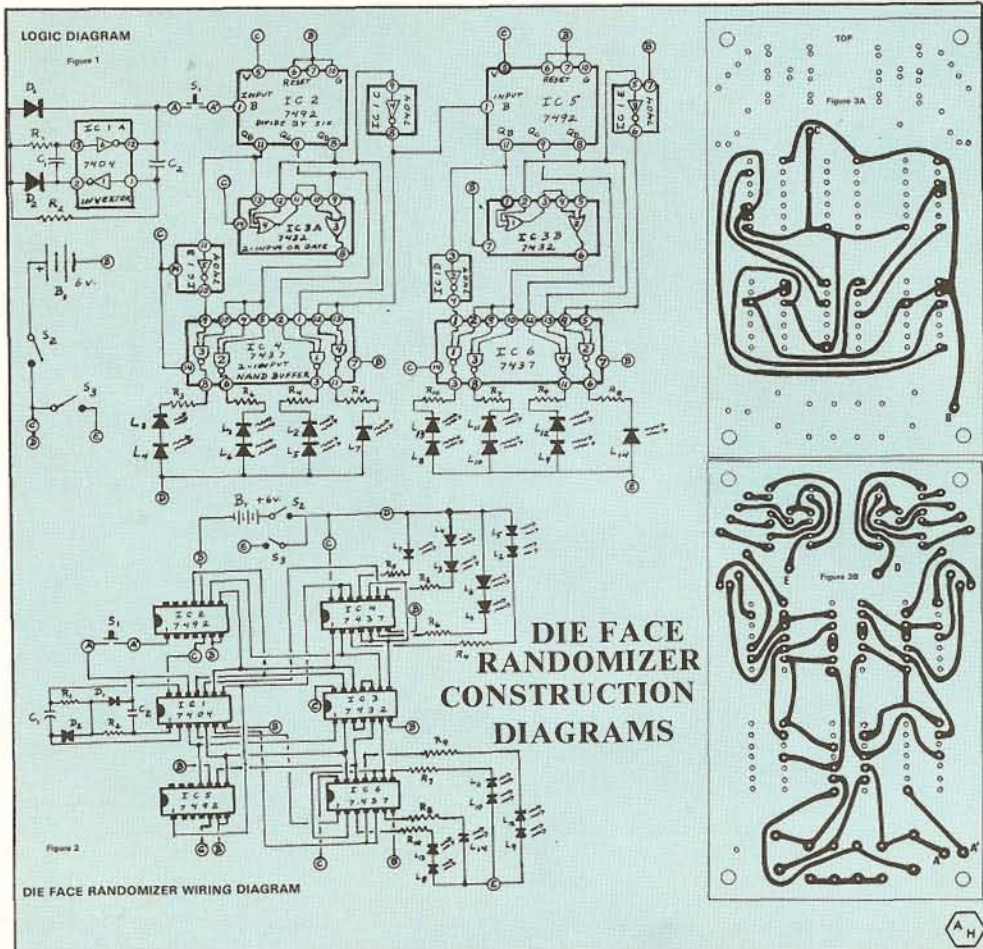



AVALON HILL COMPANY

4517 Harford Road
Baltimore, Md. 21214

To be acceptable, this section must be cut out along the lines indicated.

Place
First-Class
Postage
Here

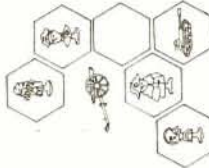

Place
First-Class
Postage
Here

DISCOUNT COUPON



Place
First-Class
Postage
Here

AVALON HILL COMPANY

4517 Harford Road
Baltimore, Md. 21214

To be acceptable, this section must be cut out along the lines indicated.

AVALON HILL COMPANY

4517 Harford Road
Baltimore, Md. 21214

To be acceptable, this section must be cut out along the lines indicated.

small catapult which shakes miniature dice and "throws" them onto a felt playing surface. Both are competitively priced in the \$4—\$7 range.

Other, much more sophisticated systems, are described at length in module form on these pages. Why bother you ask? Only to point out the unusual and innovative in most cases. However, there are exceptions. Most dice, unless they are specially made for gambling casinos, are "loaded" in a sense. Adjustments usually are not made for "carving" the pips in each die face. Thus, the "1" die face is heavier than the "6" with the result that when the other demands of physics are paid, the "1" die face is more likely to be on the bottom than the 6, thus exposing a 6 result. Taking such minute variations a step further we find individuals who can *actually control* the roll of a die. In most cases this is the result of not giving the die a true "roll"—but rather dropping or spinning it from a set height with a certain number facing up. Someone who does this consistently should be made to throw the die *against* the box so that it rebounds freely. The numerous mechanical gadgets described elsewhere in this article are free of any such underhanded possibilities.

FAVORITE GAME FETISHES:

Everybody has their favorite game which they play more than any other and take pride in having "the best set" available whether it be a hand-carved ivory chess set or a solid mahogany *Monopoly* game with real money! This desire to have the ultimate in physical quality is not strange to wargames either and there are many things the gamer can do to improve on his favorite game—if only to mount the CRT or frame it.

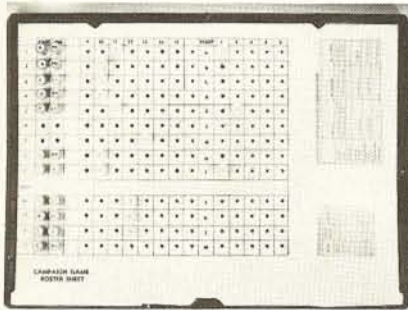

The pegboard pictured above is just one example of how a gamer with imagination and a little resourcefulness can add to the enjoyment of his favorite game. The above device is a recording aid for playing the Campaign Game of *Richthofen's War*.

Like unit divider schemes these special tricks can run the gamut from the very expensive electronic gadgetry to hand made knick-knacks. It would be impossible to list all the possibilities that exist but we'll cite a few of the examples we've seen in recent weeks.

Owners of Vol. 9, No. 3 of the *GENERAL* (now out of print) will remember Mr. Rick Miller of Mansfield, Ohio who made a set of glass enclosed *Blitzkrieg* coffee tables with drawers especially tooled to hold the unit counters which he mounted on wooden cubes topped by miniature figurines. A much less expensive proposition is Mark Saha's "carrier deck screens" which can be made from index cards and serve to keep the enemy from knowing your plane dispositions. Randy Reed's Peg Board Recorder for all the planes and pilots available in the Campaign Game of

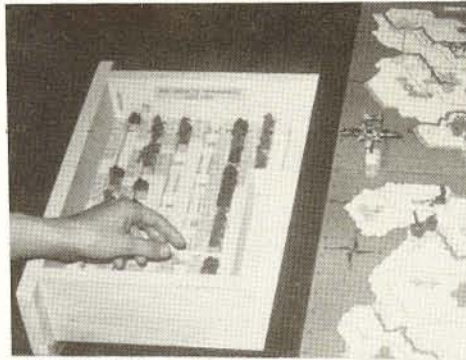

The *BLITZKRIEG* coffee table above is just one way in which a wargamer with a working knowledge of carpentry can make a handsome collector's item for himself. Notice the carefully etched drawers which allow places for each individual unit used in the game.

Richthofen's War is not such a matter of expense as it is of availability. The peg board and pegs were cannibalized from old *Choice* sets (an Avalon Hill title better forgotten), and the rest was merely a matter of judicious cutting of spare *RW* pieces and a bit of press type.

Perhaps the most practical extravaganza we've yet to see is the 3 dimensional *Panzerblitz* board which does away with many of the LOS difficulties at a glance. Such a board should have 4 different levels (although the one pictured here has only 3—slopes being treated as normal terrain); one each for gullies, normal terrain, slopes and hilltops. To make such a board one needs the normal *Panzerblitz* board plus three unmounted mapsheets. The original mapboard makes up the gully level. Over this

A Matrix Results Computer

By George Bradford

The object is to replace the die without losing any of its probability factors. This has been done by wiring 6 switches for the Attacker and 6 for the Defender to a set of 6 indication lights. Procedure in play would be as follows: The odds are determined, and the large dial is turned until it points to the proper odds surrounding it. This action moves the bank of lights across the results screen by sliding it along 2 rods by means of a pulley system, to the proper column.

At this point the Defender throws any switch of his choosing on the back of the set. Now the Attacker throws one of his 6 switches which completes the circuit and any one of the 6 lights could light up. There are 36 possibilities built into the set which corresponds with the common die.

The bank of lights rides close behind the glass screen on which is mounted a negative piece of film with all the Avalon Hill results printed on it, plus a column of 1-6 for special purposes like German supplies in Afrika Korps. This piece of film (it could be paper) can be removed and replaced with the appropriate one for any game. When one of the 6 lights on it lights up only the combat result directly in front of it, because it is shielded so as not to allow light to escape elsewhere.

The accompanying diagram shows the complete wiring. The use of colored wires for each circuit is recommended. With this system the defender also is allowed to take part in the outcome of the results, however he must not allow the attacker to see which switch he has thrown. The necessary elements would be: 6 small lights with sockets, 6 toggle switches, and sufficient knife switches to allow for 36 contacts. These latter must be adapted to have 6 contacts on each switch. The dial arrangement and the cabinet can be built to your own discretion.

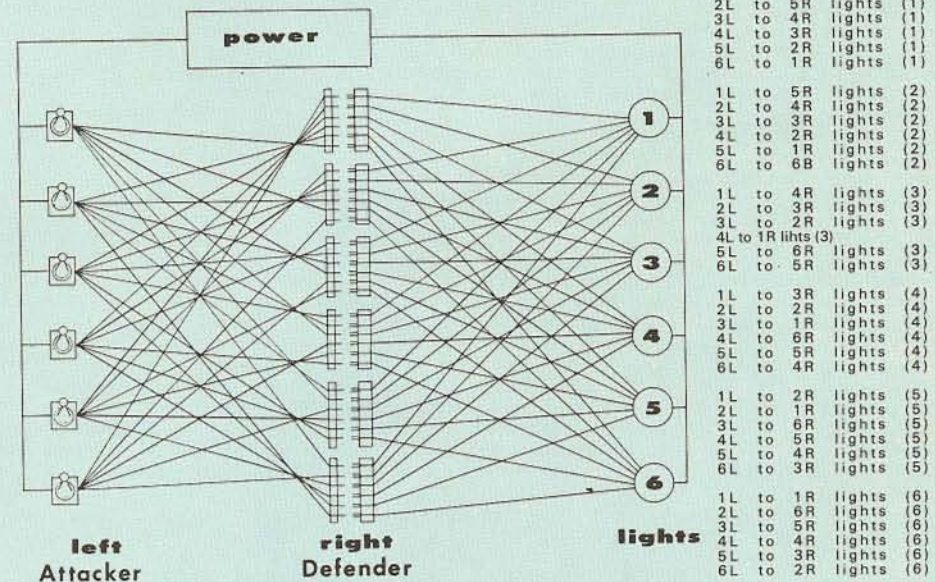
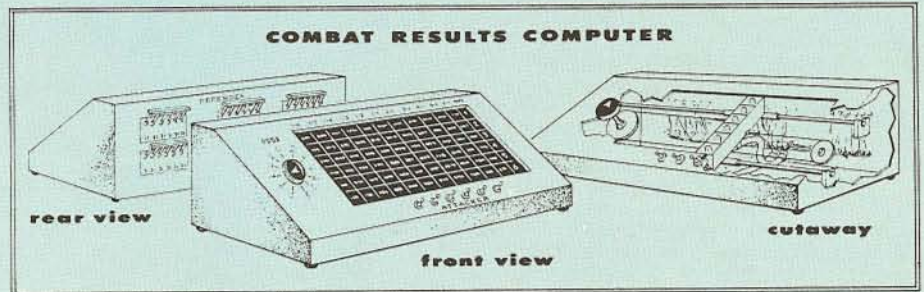

Ensign Guida graduated from M.I.T. with an S.B. in Electrical Engineering, an S.M. in Nuclear Engineering, and a tremendously comprehensive background in Computer Programming, where he invested two years of his time in Project MAC (Machine-Aided Cognition). During this time he had access to the University's Artificial Intelligence Laboratory where he did battle with a chess playing computer on numerous occasions. The results were in Mr. Guida's words: "reasonable"; the computer coming out on the short end of a 15-10 tally. Suffice it to say that Mr. Guida is an uncontested authority on the subject opened below. We thank him for taking time out from his duties at the Bettis Atomic Power Laboratory to tackle the GENERAL's look into . . .

THE COMPUTER AND WARGAMING

by Richard Guida

This article is a brief discussion of the possible roles the digital computer may play in Avalon Hill style wargaming. The intent of this article is to outline these roles, and discuss one example of them.

In Avalon Hill wargames, most of the "fog" of war is neatly quantized: unit strength, movement, position, terrain characteristics and how they affect movement and combat, etc. Such a war simulation system should lend itself nicely to some type of computer interaction. Possible computer uses may be broken into two general categories: direct computer command and coordination of the combat, economic or political forces involved, or human command with computer assistance of these forces. This article will restrict itself to consideration of combat forces only, although logical extension to political and economic activities should not be difficult to envision.

For the first category, it is safe to say that wargamers need not worry about having their skills mastered by a computer. It is instructive here to consider the game of chess, and how the computer is used to act as a "human" opponent. Many computer programs have been developed in the last ten years which enable the computer to engage most human opponents and win quite regularly. The quality of play is still perhaps an order of magnitude behind that of Bobby Fischer, however. The computer approaches the game of chess in much the same way a human does. In any turn, the computer considers all reasonable moves, and selects the best move from them. The selection process measures the merits of a particular move—e.g., increased control of the center of the board, protection of a friendly piece, attack on an enemy piece, etc.—versus the move's demerits—e.g., loss or unguarding of a friendly piece, or prevention of castling capability, etc. All of these factors are numerically weighted according to their relative importances, and then summed up to obtain one numerical figure for the "advisability" of a particular move. Obviously, the move with the highest advisability figure is the one which the computer will make. Equally obviously, careful thought by the computer programmer (when he prepares the program) must be given to the possible merits and demerits of any move, so that they may be properly weighted in the program code.

Another factor which is included in determining the advisability of a move is that of the move's future consequences. This factor is usually termed "look-ahead." When the computer is evaluating a move, it will hypothetically "make" the move and then attempt to determine its opponent's most likely counter-move in his turn. In this way, the computer can determine if its move will have immediate catastrophic or detrimental results. This is called one turn look-ahead. To practice two turn look-ahead, the computer must then hypothesize its next turn's move, as well as its opponent's response. Naturally, the further ahead the computer is able to look, the better it is able to foresee future catastrophic or winning results for its present move. However, the further ahead the computer does in fact look, the more time and effort it must expend evaluating the increased number of possible consequences. In fact, the additional computational time required increases approximately exponentially with each additional turn of look-ahead. With present technology, this makes it impossible to accomplish more than about a five turn look-ahead (in most instances) for any one move.

The dissimilarities between chess and Avalon Hill wargames will now be mentioned. First, the number of possible moves for a unit counter is perhaps an average of twenty times as for any chess piece, depending on the circumstances and game. Second, one side's turn in chess consists of moving a single piece, whereas as many as a hundred counters may have to be moved in a wargame turn. Third, all moves of the counters must be coordinated during the turn, a computational (i.e. thought) expense not incurred in the chess turn. Finally, combat resolution is by chance in wargames, introducing a variable which virtually destroys any hope for an effective look-ahead scheme due to the vast number of uncertainties introduced. All of these factors lead to the conclusion that the generation of an effective wargame-playing computer program is at present impossible.

Even in chess, the computer is still no match for the trained human brain. One of the basic reasons for this is that the computer can make local tactically sound moves, but has difficulty in planning an entire offensive or defensive operation, and making each individual tactically sound move fit into an overall plan of operation. This is the very property that a good human wargame player possesses. To put it simply, it is presently impossible to program into a computer the capacity to exercise strategic thought, precisely because strategic thought is such an amorphous quantity to define.

Turning now to using a computer to assist a human player (or players), two basic uses can be identified: the "bookkeeping" role, and the tactical movement and battle appraisal role. The first is somewhat self explanatory, but offers many interesting possibilities. A computer can be used as an unerring mediator in simultaneous movement games, although the programming effort involved may be significant. Or it can be used as just a data storage and retrieval system, to assist a commander in evaluating his own or his opponent's material state.

The more useful application of the computational "firepower" of the computer is in the appraisal or evaluation of a human commander's action. Accepting the fact that a computer cannot make strategic (or even tactical) decisions in a wargame due to the large number of variables and uncertainties, the proper role for the computer should be to assist a human commander in determining what his best tactical action and deployment may be. To give an example of this, consider the German initial turn defense of a beach in D-Day, for instance Pas De Calais. The German commander could use a computer program specifically for the task of beach defense evaluation. Thus, once he has selected and positioned his Pas De Calais defenses, he can request the computer to give him such information as: maximum odds the Allies can obtain against each beach and inland square, probability of capturing one or more fortresses or cities, most probable effects of Allied SAC attacks, and most probable Allied and German losses and positions after the first turn of the assault. These are all things for which a computer can easily be programmed to give the answers, and will require relatively little computational effort. It can be argued that this problem is in fact so simple that computer assistance is not needed, that the German commander should be able to do these evaluations by himself. Considering that there are seven beaches, and everytime the German commander shifts units in any way to improve his defenses, a new analysis is necessitated, it can be seen that the computational effort involved is not minor. By programming a computer to do the "nitty-gritty" evaluation work, the German commander ensures that no arithmetic errors are made, and that he will have more time to apply to the problems of overall strategy and coordination.

It is difficult to address in general terms many of the concepts this article attempts to present. The best way to grasp these concepts is to actually (personally) go to a computer and try to "interface" it to A.H. wargames. Of course, most wargamers do not have a computer or the training to use one. Many universities do have wargaming clubs and computers available for use by their members, however, so it is hoped that these comments may be of some use to the members of these clubs, and of some interest to the general wargamer.

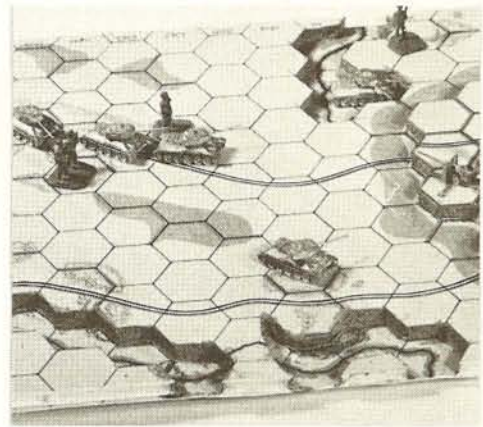

PANZERBLITZ buffs would love a 3-dimensional board such as this which all but eliminates at a glance most Line-of-Sight problems.

you paste a layer of "sandwich" board or 1/4" styrofoam, using a razor to cut out the gully hexes. The process is repeated over the 2nd layer—this time removing the non-slope and hilltop hexes, and one more time for the hilltops, removing the slope hexes.

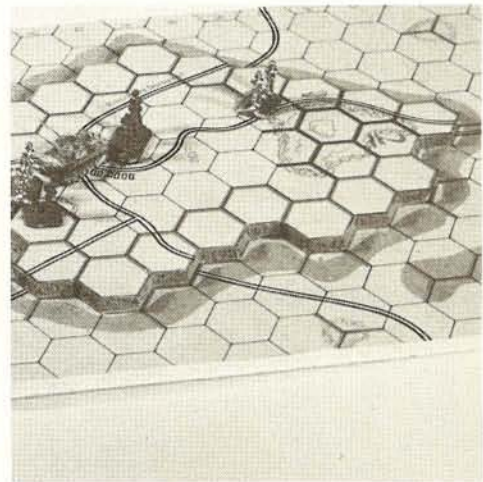

Miniature tanks, soldiers, guns, etc. of the GHQ variety can easily be substituted for unit counters in this system if you're so inclined.

The result is a 3 dimensional board over which you can continue to employ unit counters as usual or substitute miniature figures such as GHQ micro-armor. The cost of the styrofoam usually runs about \$2.00 for a 30" x 40" sheet.

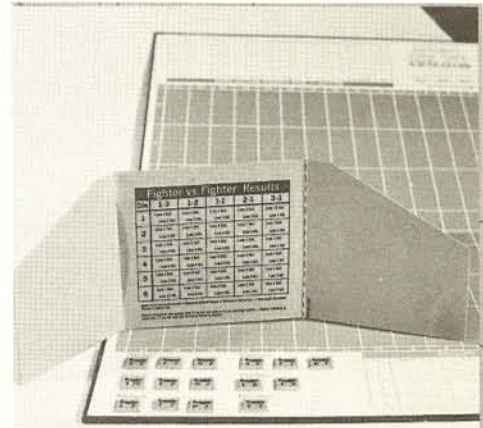

A trick to promote realism in MIDWAY is this battle board divider which keeps your carrier decks hidden until the enemy is actually overhead.

The unmounted mapsheets are almost impossible to come by. However, if we've whetted your appetite unfairly in this article we'll provide the answer. For the next month only, we'll honor requests for unmounted *Panzerblitz* mapsheets for \$3.00 a set. Remember, it will take at least 2 sets, and preferably 3 to construct your board. If interested, make your check payable to Avalon Hill Company and mark it to the attention of Donald Greenwood.

MOOD MUSIC:

Yes, even music comes under the heading of "playing aids." Although this isn't exactly the type of thing that turns us on, we've met individuals who claim they just don't feel right playing a wargame without appropriate martial music in the background. Far be it from us to knock others so we thought we'd tell you about two such records available from OAKLEAF VENTURES at their Box 286, East Orange, NJ 07019 address. Their two offerings in the field are, quite predictably titled, *LUFTWAFFE* and *WEHRMACHT*. Both sell for \$5.95 postpaid and are quality 33 1/3 RPM albums containing numerous war songs, victory marches, speeches, and radio commentary on the Third Reich. Of course this company is not alone in the field but merely one organization whose product we've heard and can recommend. Each to their own.

MORE:

Naval nuts will love the electronic search boards of Kurt Nordquest (*Jutland*) and Richard Plock (*Midway*) which enables players to search for their adversaries without giving away their own position. Such devices are expensive and require a great amount of skill to construct. For lack of space we fail to comment further on them here but if sufficient interest is shown by the readership we will present them extensively in later editions.

MISCELLANEOUS:

Simple adjustments to unit counters themselves can also be an aid to play. Color coding the sides of units in games such as *Blitzkrieg* and *Waterloo* does much to avoid the constant sorting through stacks of units to determine their make-up and strength. For example: in *Waterloo* a red side could denote a 4 factor unit; blue—a 3 factor unit; green—two factors. Thus, the PAA player could tell at a glance that a stack showing 2 green sides, 1 blue side, and one red side consists of factors without having to actually handle the stack and risk knocking over its neighbor.



The Competition Viewpoint

by Dan Hoffbauer

In the typical Avalon Hill battle game, the time required to play a complete match is "2-5 hours." Most AH gamers will scoff at this, claiming that it is not possible to play a full game of *Bulge*, say, in four hours. There is a very legitimate basis for this complaint upon examination of the normal AH player's gaming habits.

The average move in the middle of a *Bulge* game will take between 15 and 45 minutes per side. This time is taken up in making a decision on where each unit should move, on retracing the moves some units have taken when the player changes his mind, on rules arguments, and on combat resolution.

There is a way to beat this snail's pace. Place a time limit on each move. This can be very simply done with the additions of a few simple rules of conduct.

First, place a limit on movement time. This can be done, either with a limit on each individual move, or a limit on the entire game. In the first instance, the normal procedure is to use a stop watch or a watch with a second hand on it. The player not moving keeps the time and gives the other player a 30-second warning when time is running out. In the latter method, a chess clock must be used, with the moving player taking up as much or as little time per move as he desires. However, once the total time runs out, that player cannot move again.

For either method, the time limits do not include resolution of combat. However, a player cannot take more than 15 seconds to declare the units and the odds for each particular battle. Once the die is rolled, the defender is given only three seconds per square to retreat or advance any units, as is the attacker.

The most important stipulation in movement by time limit is the "touch" movement system. Simply put, you cannot move a unit again once you have touched it and then touched another unit. If you want to remove a unit, it must be done before moving any other unit and it must be within that unit's movement capability to retrace its step. You cannot "call a move back" under this system. This requirement alone forces each player into snap decisions under pressure. Incredible blunders are made possible which are not possible under so-called "normal" playing conditions.

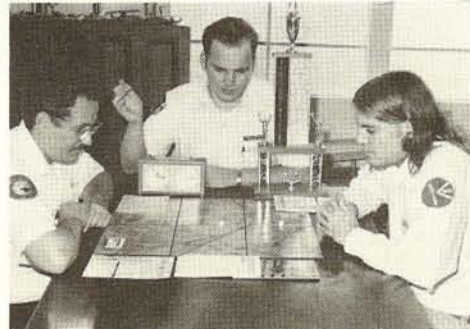

The time element is an important consideration in competitive gaming—especially as conducted by the SICL. Note the time clock being used by the neutral judge.

For instance, if a player does not allocate his time carefully during a move, many units will remain where they are. I have seen spectacular breakthroughs remain unexploited because the player did not allow enough time to move his most important units. Gaps open in the front, through which a quick player will be able to penetrate and turn a game completely around.

It is not possible to be a "computer gamer" when using a time limit. Those players who, given enough time, can make the perfect move, with each factor used to maximum extent, will be unable to exist in an atmosphere of fly-by-your-pants and snap decisions based upon quickly grasping the essentials of the situation. The superior tactician can usually prevail in a pressure situation. The so-called "idiot factor" can be brought into games without the use of an artificial rule. The better player will be able to make less mistakes. It is often the opinion of wargamers that nothing less than perfection will do in a move. Under a time-limit system, perfection is well-nigh impossible. The side with

the fewer and the less serious mistakes will win. This requires concentration, perception, and an ordering of priorities to make sure that the essential moves are made. Planning in advance is also a necessity, since you just do not have the time to think about your moves when it is your turn. You must already know where you want to go and what you want to do before you do it. Otherwise you'll end up with half your pieces touched.

In tournament play, as run by Spartan International, time limits under either method are used. Tournament umpires are present, to provide rules interpretation services in the case of very large tournaments, or to actively supervise, keep time, figure odds, roll the die, and handle all functions which do not require the decision of one of the players. This "formal" approach is very effective in keeping games moving and in equalizing players who do not know each other and are unfamiliar with each other's methods of play. A common set of face-to-face procedures under which people can game are a necessity as the competition in this field expands and as money prizes become more common and more significant.

It's not hard to get used to time-limit play, and once they're used to it, some find that they prefer a fast-moving, hard-hitting contest to a slow, dragging social gathering.

Spartan International has full details on time limit tournament play through its Box 1017, Bellflower, California 90706 address. Face-to-face tournament regulation booklets cost \$1.00.



Playability & Practicality—A Starter's Guide By Mark Saha

What's the fastest set-up time game in the entire Avalon-Hill catalogue? Think about it. Well? The answer may surprise you, but in my book the full tournament version *ANZIO* is a top contender. There are so few pieces on the board at game opening—and in preordained positions—that you can plunk them down in seconds and "get on with it," especially if you're willing to spend a pleasant hour or so on a rainy afternoon putting the game in maximum "playability" condition. Much of what I have to say about *ANZIO* applies to the other games in your collection too, so that's what this little piece is about—simple, practical steps to improving physical playability. But I mentioned *ANZIO* first, so let's start with that.

The next time you're around a stationery store, or the art department of your local college book store, stop and pick up a large piece of poster board. You'll also need a ruler, pencil, and razor blade but probably already have these. Of course, you knew there must be a catch when I nominated *ANZIO*—but really it's only a small catch. What you do is mount each of your Game II Order of Appearance cards on separate pieces of poster board; cut the poster board to allow ample margin and you won't even have to use paste to mount the O/A cards—cellophane tape, especially library tape, will do just fine. Now you can pick up the O/A cards and carry them around with pieces on them; more importantly, you can *leave* them set up—they can be easily stored under your bed, on the top of a bookcase, in a carefully prepared back space in a closet, etc. When you do feel like a game, they can be taken out and the board set up in seconds.

Now, I realize a lot of you nit-pickers out there are going to start yelling "foul"! Once you've agreed to leave the O/A cards set up, you want to argue, *GETTYSBURG* or *GUADALCANAL* become the fastest set-up time games. Well, you've missed my second point, which is *practicality*. Since those two games don't have many pieces in the first place, set-up isn't really a problem—not even O/A set-up. So there's really not much point to keeping a lot of mounted O/A cards for various games stacked around your room. Just *ANZIO* and, if you happen to be a nut on it, *1914*.

But I'm not finished with *ANZIO* yet. While you're at the stationery store, pick up a set of oversized 4" x 6" index cards. These can be used to make an O/A card each for the Republican and Monarchist armies, and these O/As can be mounted on the same poster board as their parent allies. The remaining Italian units (that start on the game board) are simply stored in the game box with your forts and fortifications. First, however, let's make sure you'll never get your Italian units confused: write "R" on the back of every Republican, "M" on the back of a Monarchist, and "G" on the 185th German sympathizer. Write the set-up hex number on the back of the remaining Italians . . . and now you can always tell which side an Italian is on by simply flipping it over. (While you're at this, you may as well write "S" on the back of the German substitute counters.)

There is one final use for the remainder of your oversized index cards, and you'll find them useful in this regard in play of many other A-H games. Any highly specialized or "out of the way" rules that you have trouble with can be neatly typed out on separate cards, and keeping these handy in a stack will do away with the need to go constantly flipping through the rules book. For instance, if you use the optional "Retreat Through ZOC" rule (*ANZIO* Battle Manual, page 11) you really should type out the rule and chart on a separate card. The same holds for many of the Order of Appearance rules on pages eight and nine (unless you prefer to Xerox these two facing pages and cut them out for handy reference).

If you're one of the (apparently) fortunate few who happen to own a copy of *ANZIO* but really haven't gotten into the game, you owe it to yourself to give these suggestions a try. You have to play the tournament version at least a couple of times to appreciate how good and playable it actually is (the mini-games are quite satisfactory, if your time is limited. Also, Game III "openings" make for excellent solitary; invade different areas to test Italian reaction and see whether the Germans can stabilize the situation)—but most people seem to be put off by the sheer mass and apparent complexity of set-up and clerical duties. Try these suggestions, and you'll find you can play the game as often as you like with little or no such effort. And, since most of the pieces remain on the O/A cards at all times, putting the set away after a game is no bother either.

GUADALCANAL is another game where playability can be improved immensely, and with even less effort. First, write the range of each artillery unit on the back of the piece—and you need never refer to that chart on page 10 of the Battle Manual again. Next, take the manual to your local Xerox operator and have copies made of the Artillery Firing Table, Units of Fire

Replenishment Table, and Psychological Effects Table. Cut these copies out, mount them on pieces of poster board (again, cellophane tape is fine), and keep them handy on the table at gametime. Also, you may find it convenient to write "P" next to every turn on the Time Record Card in which Psychological Effects are rolled. Finally, you should write "1st" on the back of each unit of the 1st Marine Division, for the withdrawal rule on them—but write it in the corner and circle it, to distinguish this from artillery range.

Keeping track of hidden units in *GUADALCANAL* is rarely a problem, and most Jap players prefer their own systems. But here, again, I find the oversized index cards quite handy. A ruler is a handy tool in determining correct grid-hex numbers; then, write this number on an index card and place the unit on the card just above that number. When all hidden units are in place (and there usually aren't many, except before the one big Jap offensive) simply cover the index card with a second one. This way you can glance under the card and recheck your positions even during your opponent's move. When you change your own positions, simply mark out one grid-number and write in the new one; and change cards when things start getting cluttered.

By now you should start getting the idea of "playability & practicality"; basically, all it means is that you don't have to accept the playability value of the game-as-published and you don't have to be willing to put in the considerable time and effort that professional "game nuts" devote to construction of elaborate physical game storage and play systems. Just a little common sense and improvisation and a pleasant rainy afternoon can streamline your game collection according to your own specific needs and problems. For a closer look, here are a few final items:

WATERLOO; write "G" on the back of French forces that start at Gosselies, and "M" on those at Marchienne. Write "Q" and "N" on the Anglo forces starting at Quatre Bras and Nivelles; number the arrival times of other forces "1" through "8" on the O/A card, and write the corresponding number on the back of the appropriate units. You may wish to use "8" and "8A" for June 18th arrivals to distinguish Anglo and Prussian units. Leave the rest of the counters of both sides blank. Now, it is a simple matter at the start of a game to invert your counters as you dump them from the game tray and sort them for arrival and deployment, or better yet—divide your gametray into the proper compartments.

MIDWAY; although the Midway Reduction Table is used only once or twice in a game, it's usually used. And the U.S.A. player may get the hint if you start scrambling for the Battle Manual to study the odds. Simply Xerox two copies of the table, cut them out, and tape them to the Search Board Screen with the rest of the charts.

PANZERBLITZ; if you're just learning the game, it's almost mandatory to type out on three separate cards the rules for the three different types of attack; also, on separate cards, whatever other factoring or terrain rules that are a particular problem with you. After a few games these rules become second nature and you can throw the cards away (or help start another new player with them), but until then they'll accelerate your first few games con-

siderably by placing at your fingertips information you'd otherwise be scrambling through the rules for during every move.

Obviously, this article is intended mostly for those just getting started in gaming—or who have been "put off" by a game that seemed just too much trouble to play. However, even if you don't happen to own any of the games discussed here, the basic principles I've offered can be used in making the games you do have more playable. If you own a game that you like but don't play as often as you'd really want, mostly because it seems to take so long to set up or because play for some reason seems sluggish and too much work, something can probably be done. It doesn't mean the game was badly designed; more often, as with *ANZIO* and *GUADALCANAL*, it's a matter of packaging and economics . . . information has to be compressed into the most efficient form for printing and distribution purposes. But that doesn't mean you have to live with these realities once you sit down at the gameboard—especially if you like the game and plan to keep it a few years.

D-DAY: Designate the late arriving German units with a star on the back so you don't have to look up which units start on the replacements stars every time. While you're at it—number the backs of the Allied units according to the turns they're available.

AFRIKA KORPS, BULGE, MIDWAY, BLITZKRIEG: As was the case with *Waterloo*, you can decrease your set-up time greatly by noting on the back of the unit when it becomes available and where. A simple "7" on a *Blitzkrieg* unit suffices to say that this unit is not available until the 7th turn. A red "1" on the backs of the 15th Panzer units serves to let you know that it is part of the Germans 1st reinforcement levy in May. Similar numbering systems for the other games do much to reduce playing times.



PBM EQUIPMENT

Tired of playing solitaire or humiliating the same opponent day after day? You may be good in your game room but what can you do against a good player from another part of the country? There's only one way to find out — play them by mail! PBM is an easy-to-learn and convenient-to-use system of playing fellow gamers across the nation. A special CRT and combat resolution system makes it impossible to cheat! PBM is an entirely different experience from face-to-face play. It has made better gamers of many who have tried it, and all those who have mastered it. PBM is the only way to participate in the many national tournaments held regularly for Avalon Hill games.

Each kit sells for \$4.50 postpaid and includes enough materials to play virtually dozens of games, including addendum sheets which list official grid-coordinates for those games not already possessing them and special charts and CRT's for postal play.

Kits are available for the following games:

- | | |
|----------------|---------------|
| * AFRIKA KORPS | * KRIEGSPIEL |
| * BLITZKRIEG | * LUFTWAFFE |
| * BULGE | * 1914 |
| * D-DAY | * PANZERBLITZ |
| * GETTYSBURG | * STALINGRAD |
| * GUADALCANAL | * WATERLOO |

SERIES REPLAY PANZERBLITZ

(Situation No. 6 Revised)
Russian—Richard Plock
German—Robert Livermore
Judge: Roy Easton

Situation 6, replayed here, involves a German mobile defense and victory is most often achieved by the player making the fewest mistakes. In this particular game, the Russian player lost because he refused to risk his units in situations where they might have broke the German line or died, depending on the roll of the die. Thus we have the direct opposite to the AFRIKA KORPS game featured two issues ago in which the players let the die decide the game. This commander demanded situations in which he was sure of the result—and as a result he did not win. The German player, for his part, lost a victory because he refused to sacrifice blocking units on two key squares and did not use all of his available units in the final battle. Options and rule interpretations used:

The indirect fire (regular version) and real-space line of sight determination were the only listed options used. In addition, while the game was played face-to-face, the play-by-mail rules and combat results table were used (using a decimal randomizer). Thus, the effect of fire was not known until after movement. Finally, the following interpretations (not specified by A-H) were agreed upon: Initial setup—Russian: Ten hexes to be full hexes; Russian may set up on hexes through row W inclusive. Indirect fire: The CP may direct fire and load on the same move.

The neutral commentary for each move is provided after the Russian comments in the shaded area.

Each diagram shows the current German move and the Russian preceding move since it is the German's withdrawals which control the tempo of the game.

Russian Comments Move: Setup

I feel the German has a slight advantage in this situation, but only a marginal one. If I (Russian) can reach the end of board no. 1 by the end of move no. 5 without losing any significant number of units OR I can reach there on turn no. 6 AND have significantly weakened the German (especially in mobility), I have a good chance. I must actually be leaving the board (i.e., on row A or B) at this time. Any earlier, and I should win easily; later and I have no chance.

I want my heavy tanks to be free to expose themselves to enemy fire without giving my opponent easy victories, hence they will not carry passengers (which would have a defense of 1). If I wish, I can reach the area south of hill 135 almost as fast from hill 130 as from hill 127, hence do not need many units on south edge. The only units visible from any part of board no. 2 are the Su 152's; he can do no better than 1-1 on one of them. Doing so leaves the CP and long range guns in poor position; I doubt if it is worth it to him. My trucks are almost useless; they will have the primary function of picking up units I have to unload when I am in a hurry.

SET-UP: The Russian set-up is reasonable but he should have the SMG units mounted on the farthest-forward tanks. The German units don't need to be in the gully and all should be on the roads.

TURN NO. 1 GERMAN COMMENTS

Since the German moves first, the setup and first move are taken together. Board number 1 has better terrain for a mobile defense or delaying action than board number 2, and thus one immediate objective is to hold the Russians on this board as long as possible. The idea is to take as far forward a blocking position as possible while retaining mobility and preventing losses.

The German probably can not prevent the Russian player from getting a minimum of between 15 to 25 pieces on board 3 (Russian marginal to tactical), if the Russian gets on Board 2 before turn 5. On the other hand the Russian player can not reasonably expect to get 10 or more pieces on board 3 by the end against a reasonably intact German force, if he gets on board no. 2 after move 6. Thus the German objective for the first five moves is to prevent the Russians from getting on board 2 before turn 5 while imposing on the Russian losses which are at least twice his own. This condition must be realized with a couple of restrictions in mind; 1) The losses ought to be very great and not in tanks and preferably not in vehicles at all. This is what is required to keep the German 'reasonably intact'. 2) The Russian player must not be permitted to get even two pieces behind the German's main force; otherwise he can greatly hamper the setting up of a defensive line.

Slowing the Russians down does not just depend on blocking roads physically as has been done with positions R9, Q9, P9 and O8 but also on leaving him open to heavy gun fire which can be executed by guns which can fire with immunity from counter fire points. We see that this holds for pieces 631, 621 and 32. Of course, one could argue that both the Wespe (621) and the Hummel (631) ought to be fired directly from board no. 2, but just as they are out of harms way, they are often too far out of the way to do harm. The most questionable placements here are those of pieces 33, 102 and 91. 33 is clearly out of action for at least four turns. But it is well placed for armor attempts against the town and experience has shown that it is rather difficult to pull halftracks or tanks off a pressured defensive line in order to cover a newly opened flank by dropping off a gun. No. 91 is placed out of harms way and to be in a prepared position when the Russians come over the hill, and to make sure that if by some fluke of fate, or blunder the Russians should get behind the Germans, at least there is no free ride into the town. 201 is unloaded to spot for 91.

German 1st turn: The Russian set-up is fine except that the SMG's should have been mounted on the farthest-forward tanks. The German halftracks are well placed, especially 446—but there is no need to keep the German armor so far in the rear.

Russian Comments Move No. 1

This is about as far as I can get without giving him any free shots (I.E., no targets for counter-fire) with those mobile guns. I think he would have been better advised to spot something on C2 (e.g., 88 mm battery) to cover the valley between hills 109 and 135; it would also cover the road through the forest and the area south of hill 135. The units in the south could have gone further, but I want to have my guns cover as much of the road as possible. I doubt if I will be able to move them their full movement factor next turn anyway—I must follow the same policy as this turn. (Hide behind ridges and in forests) I am going to try to dislodge the Wespe & Hummel next turn if at all possible. At least I am threatening any unit left east of hill 109, and the 75 mm gun at L7 in the bargain (by unloading my infantry on M7)—although I don't dare spend much time at such games.

A point to think about: not only do I have to reach board 3 to win, but I must also destroy at least 1 German unit to avoid a loss. Therefore I cannot sit still and be content with no attack; completely aside from the fact that it would make for a dull game, I would lose.

TURN 1: German: Since the 88 doesn't have a good field of fire from 1-B-6, why bother to dismount? Something should be covering Hill 104. The placement of halftrack 446 is good but Pz IV no. 931 should be up closer to the front line. I prefer to keep my CP mounted on a halftrack and I don't see any need to dismount East of 1-J-5.

TURN 2 GERMAN COMMENTS

I can hold the position 1M 4-5 for this turn and will probably risk the loss of some pieces if I hold longer than that. This means, however that the Wespe and Hummel still enjoy immunity from attack. This is particularly important with respect to the Russian capture of positions 1-K, 7-9 and positions 1L10, 1M10 or the hilltop positions 1M9 (hill 109) or 1L9. The Russians can occupy these positions on turn 2 if they please, but they will certainly lose something and can not get anything back. The Russians will probably take these positions on turn 3 when they can get their Su 152's into 1M 5. This means that if I keep my Wespe and Hummel where they are, I can no longer fire at those units with impunity. The Russian's occupation of these positions gives him a strong Northern flank on my positions around the main road and threatens Adski. It is an extremely powerful move which must be delayed as long as possible.

The taking of position 1M4 also makes position 1I2 untenable as a blocking position. Thus this position will probably have to be given up on turn 4. The placement of piece 931 prevents the Russian from unloading his infantry in square 1K2 and hence threatening squares 1J4 and 1I3 with close assault next turn.

The gun was loaded (no. 32) since the Russian can unload infantry in such a way that only the gun can attack them with an odds ratio no better than 1 to 2; the gun would certainly be lost in a subsequent close assault with no gain to show.

The position keeps the Russians off the hill one more crucial turn. It also keeps him away from the center and northern sections. It is true that quite a bit of territory was given up, but any more advanced position is not safe.

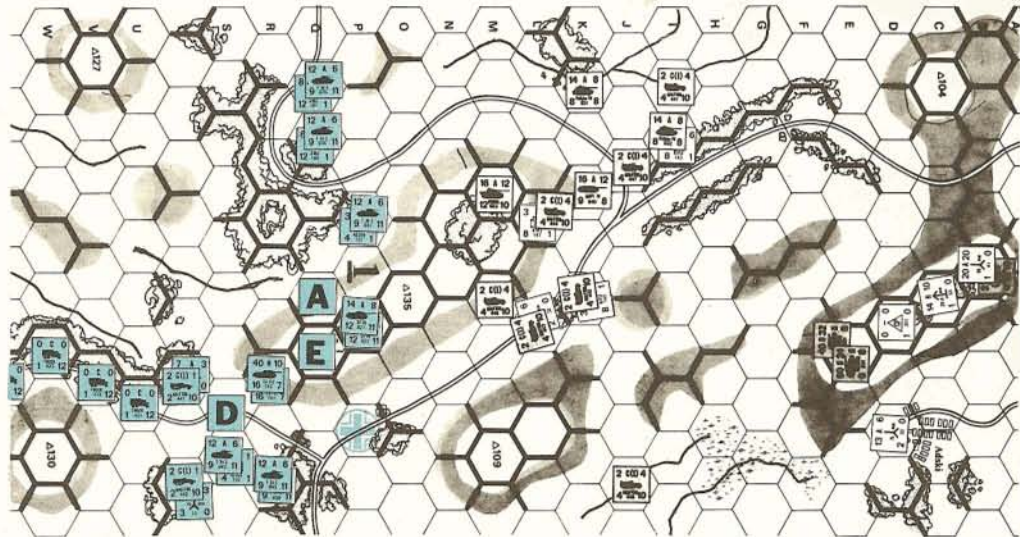

German 2nd turn: The Russian's initial move was a good one but there was no need to place the T-34's in 1-R-10 since the German had to fall back anyway, and as a result several movement factors

have been lost. The German might have been well advised to leave a halftrack in 1-P-9 where it would have slowed the Russian advance considerably.

Russian Comments Turn No. 2

He has saved his gun and blocked hex K4 which I wanted to use to get to J6. However, I can definitely dislodge the Wespe and Hummel this turn. They are worth far more than the (at best) four units he could get in return (e.g., 933, 934, 183, & 184/2-1 odds). The lone halftrack in the north is in deep trouble; I think I have it trapped.

The pieces in the north give him too many targets to handle; he must evacuate. His half-track is trapped. His 840, 931, and 953 are threatened and will have to leave. (Unless he simply picks off a passenger, his best shot is a 3-1 by the Panther. The return fire is 4-1. Likewise the JgdPz IV—its best is 1-1, return fire 4-1). He has no overrun possibilities. I must still watch out for that 88 mm gun, though.

I am on schedule, but can't seem to gain any. I would like to be about 1 hex further advanced to allow for possible delays.

TURN 2: German: This advance defense is a very good idea, and not much territory has been given up as a result. This is very important since the German must trade space for time throughout this game. Putting a tank (or Jp IV) in 1-M-5 is good practice and one in 1-L-7 wouldn't hurt. A halftrack on 1-P-9 will slow the Russian advance by the turn that it takes to destroy it. Squares 1-P-9 and 2-H-5 are very important and are probably worth the German's sacrificing halftracks to have wreck counters on both of those squares.

Russian: The lack of German blocking units in 1-P-9 or in 1-Q-9 has allowed the Russian to capture Hill 109 and this position forces the SPA's to retreat. Were they in 1-D-7, they would be able to fire. The limited field of fire of the 88 is now apparent and this unit must also be evacuated. German halftrack no. 446 is not trapped. On the whole, this is a good Russian move.

TURN 3 GERMAN COMMENTS

It's back to the drawing board, or I'm eating crow liberally sprinkled with hot peppers. Clearly the Russians can take the slope. The halftrack no. 446 is now in danger of being shot up seemingly by every piece of armor in the Soviet arsenal. The best move for it is to square

(no. 118) where only the SU 152's can shoot at it. Fortunately this means that at least one of these will be subject to counter fire from the Wespe.

The Wespe and Hummel have moved out of harm's way and into a position where they can pick up some of the units, viz., the CP and the gun. Shooting it out would have most likely resulted in an equal exchange, but the less in fire power and the fact that these have the most effective guns of any armed vehicle in the game makes it a bad trade at this early stage in the game. Losing these two even in an uneven trade, for say three Russian units, is not worth it. What we could *guarantee* here at best is a Russian tank and a Russian infantry piece. At the very minimum the exchange has to be tanks of equal firepower and given the unfavorable ratio of German to Russian firepower, even that now has doubtful merits.

The halftrack (no. 441) must move out of its position blocking the gully since the SU's can fire on it. Also the tank (931) is both spotted by and subject to CAT by the infantry in 1L2; the tank 963 must move, being subject to rather massive fire. Again each one of these is in a position to stay and trade fire with reasonable likelihood of getting casualties, but their loss on the Russian turn is even more likely.

Overall it doesn't look as if I can get 2-1 or even 1-1 casualties, but the Russian player can't get on board 2 before turn five either.

Russian Comments Move No. 3

It looks as though his "trapped" halftrack has come untrapped, I can't stay on hill 109 to fire on it because of the Wespe & CP. Can't surround it without exposing myself to a free 2-1 shot on a heavy tank or 3-1 on a light one. It is not worth one lousy halftrack. Not only that, the thing is in the way of the move I wanted to make with 933 and 934. I will have to use 937 & 938 instead; should be OK. I can't outflank the swamp to the north; I can only reach F11 where I can be shot at by his 75mm gun in Adski. If I stay in the gully, I can be completely blocked at E10.

The SMG unit on K5 will dislodge units hiding in the forest; the one on K2 will either load or close assault. I would like to have more units on the southern slopes, but the Wespe and Hummel are too dangerous at the moment. I have to stay on the ground behind slope lines or

else to the north. I am approximately on schedule, but have no leeway.

TURN 3: German: The move of 446 was a good one and the SPA's are finally back in the woods. The German is falling back in good order and is not being pressed by the Russian.

Russian: The failure to mount SMG units on the lead tanks now becomes important. The tanks at I and H should have SMG units not AT guns and Recon units. Since there is nothing on Hill 104, at least one tank should be in the gully at I-1-2. I doubt that there was a need to unload no. 185 but this unit can be easily picked up so there is really no problem. The failure to get no. 446 now will come back to haunt the Russian later. I doubt that the German would have fired no. 953 at any Russians in I-1-7 since this would have led to the loss of that unit and a hole in the German lines later.

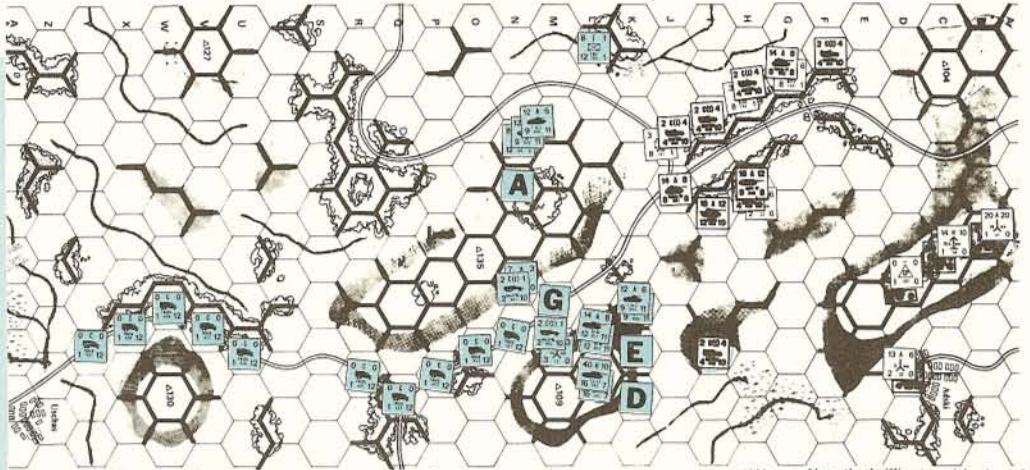

German 3rd turn: The Russian took advantage of the German failure to block 1-P-9 and 1-Q-9 to capture hill 109, forcing the

retreat of the Hummel and Wespe. Note the brilliant positioning of German halftrack 446 again.

TURN 4 GERMAN COMMENTS

The halftrack (no. 446) escapes by getting into the woods on the north side of the main road.

The placement of the Russian's infantry pieces (185, 186) render the advanced position taken by the German very dangerous. No. 185 can only be shot at by the tank (931) at an odds ratio of 1 to 2—hardly a good risk. It's true that the tank could over-run the infantry and get much improved odds, but it faces the full fury of the two Su 152's, which can attack 931 with at least 3-1 odds. (Su152 has "H" weapon class) Given the line of fire rule, the tank could fire at one of the SU 85's, but after halving and doubling the result is still only 1 to 2. The only condition in which the tank could possibly retain its position is that it could *guarantee* at least dispersal of 185, and this it can not do.

No. 186 can CAT whatever is in 1J4 or 1I3. Unless, therefore, I am willing to put enough units in *both* squares to *insure* that they cannot even be dispersed, I cannot afford to stay. Dispersal here is equivalent to loss on a subsequent turn since a defensive position usually can be held only for one turn without

risking losses and/or being outrun. It is impossible to do this without disembarking the infantry. Again this is not a very good idea since the infantry may have to be abandoned. It is true that the infantry no. 186 thus CATing is exposed to the fire of the Hummel (no. 631), but this requires that the Hummel remain another turn. The new Russian position may make this dangerous. Also, next turn is the time to move the Hummel so that it can be in a good position when the Russians enter Board 2.

The position 1D8 must be covered and unfortunately only units which are on the ridge square of hill no. 126 can accomplish this; nothing else can reach the position. This means that I will have to lose a piece, since one of the mobile pieces must move to cover the position, and hence cannot load. The piece that has the least value here is the CP unit. This means that the Wespe must move and thus the two tanks have been up to its position so that the fire power level remains nearly the same. This makes a drive along the southern part of the ridge squares of hill no. 126 somewhat less tempting to the Russian. The CP will probably be lost since it is doubtful that the tanks can stay

the turn required to pick it up. This shows how crucial disembarkation moves can be in a fast moving battle. Certainly the gain of firepower of no. 91 is not worth the risk or the trouble.

Adski will probably go next turn, since the Russian can disembark infantry in the forest squares within CATing distance of it.

Russian Comments Move No. 4

He has withdrawn, maybe too far. I should be able to crack Adski next turn; am threatening to CAT anything left in the town. My lead tanks have the wrong passengers. I should have had stacks (933 & 934) and (937 & 938) interchanged in position back on turn 2. Who'd have thought it??? (Blasted "trapped" halftrack.) Maybe I should have sent 933 and 934 into the gully anyway. If he leaves a hole in Adski, I can get through to board no. 2 next turn. This would finally put me a little ahead of schedule, which would be pleasant.

The SMG units threaten CAT's on the hilltop and against rows E and F in the forest by the road. He must pull back to the edge of the board next turn, probably just across the ridge. I am still just about on schedule. I still have not

CARRIERS			
Due to the difficulty of graphically showing 4 or more counters in the same hex, whenever two loaded carrier units occupy the same hex they are designated by a letter as follows:			
LETTER	DESIGNATION:	CARRIERS:	PASSENGERS:
A	T-34's	(932,931)	SMG (181, 182)
B	T-34's	(936,935)	SMG (185, 186)
C	Halftrck's	(441,442)	45mm (11, 12)
D	T-34's	(933,934)	SMG (183, 184)
E	T-34's	(937, 938)	76.2mm (33, 34)
G	T-34's	(941, 942)	Recons (131, 132)
H	T-34's	(937, 942)	Recon, 76.2mm (33, 132)
I	T-34's	(938, 941)	Recon, 76.2mm (34, 131)

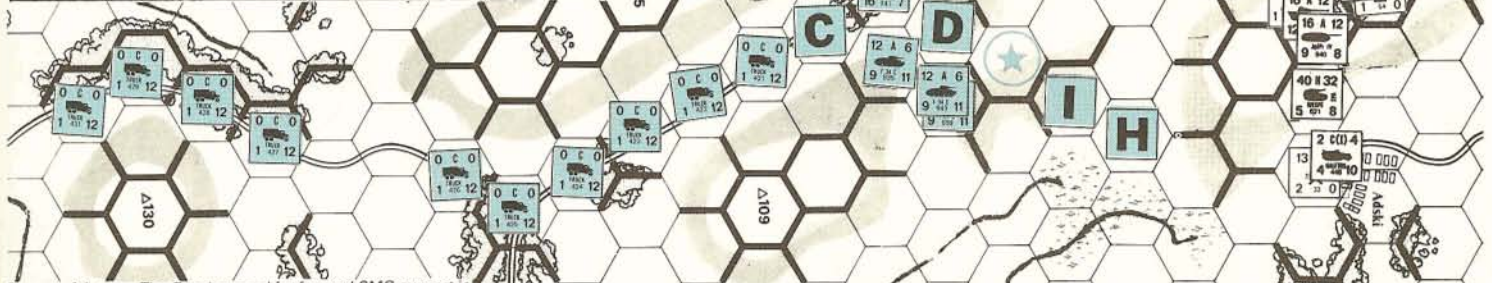

German 4th turn: The Russian need for forward SMG support is now more readily seen. The units at H and I should be shock troops—not recon and anti-tank guns. The German has now

formed a solid defense which the Russian will find hard to breach. 1-1-7 should have been occupied to force the German into making a

stand prematurely or give up the extra hex. By being so cautious the Russian is ruining his own timetable.

managed to penetrate his line, or eliminate any of his units.

TURN 4: German: The German has formed a good defensive line. The CP should not have been dismantled and will shortly be lost for that reason.

Russian: Tanks should occupy 1-E-8. If the Wespe wants to fire, the Russian will trade a T-34 for a Wespe, quite a good trade, from the Russian point of view. The Russian cannot win this game without taking a few risks and, so far, the Russian has refused to take any.

TURN 5 GERMAN COMMENTS

The Russian can't get on board 2 by turn 6. I can hold Adski, since I can put in enough strength so that the CATing recon units can't even disperse them. A blocking position is formed by halftracks on the slopes of hill no. 104 and the slopes connecting that hill with hill no. 126. I can thus prevent the Russian from getting on board 2 and still start Hummel, the Wespe and the 88MM (no. 41) back to suitable positions on board 2, such as 2-0-5. It will be difficult for the Russian to win now.

So much for the good news. Now to the bad news. The CP is definitely lost. The tanks had to move for the same sort of reasons stated previously. Now it may seem that I look upon my pieces the way Napoleon regarded his men—as his children. But there are good reasons for this concern. The Russian Player is relieved of great pressure when he gets a unit up on the German; from then on he can afford even exchanges, which permits him to increase pressure. Conversely the German is working from a deficit position for a win.

Unless one of us blunders, the outcome at this point looks very much like a tie. (0-0). Another point this illustrates is that given careful play, the Russian can pretty much decide whether or not the German can get even a marginal.

Russian Comments Move No. 5

His units in Adski show why I needed to have those stacks of units interchanged back on turn no. 2. With two SMG units, I could have launched a CAT assault at 1-2 odds against his JgdPz IV and Panther units. This would have

given me an even chance for a dispersal; which, if achieved, would have been disastrous for him. The recon units just do not have the strength.

Fortunately, the CP dies. Not only does this put a stop to any ideas of indirect fire, but the dead unit will be of help when the bloodbath comes. It may be thought I am being overly cautious, but if I reach board no. 2 having lost, say, 3 units to his one or none, I am in very deep trouble. A frontal assault is invariably required to reach board no. 3; and I would have to make sure of eliminating more units than I lose to boot. I want to make the frontal assault with an advantage in kills, preferably 2 or 3 units.

I think he will abandon Adski, although he might try to make a stand. It is a poor location for this; if he tries, I outflank him to the south. I wanted to put the Su 85's on hilltop 104, but the Hummel and mortar give him a 3-1 shot. I will play it safe; the board is now opening out. Worry: I am approximately 1 hex behind the schedule I need; his roadblock is too complete. As indicated, my trucks are finally going to be of some use.

TURN 5: German: A relatively unaggressive Russian offense has given the German a minimal victory at this point. The Russian will have trouble crossing Board 2 in the face of an intact German force. A little prior planning would have saved the CP. Units should never be lost without extracting something from the enemy and this exchange did not occur here. The German must now concentrate on destroying some Russian units.

Russian: The Russian has finally managed to attack a German unit but he is not advancing fast enough. There is a good reason for the Russian to move the SU-152's to 1-B-2 where they can command all of Hill 129. The German would probably not choose to attack them with the Wespe which would be halved due to attacking a unit on a hilltop, since an unsuccessful attack would result in the loss of the Wespe.

TURN 6 GERMAN COMMENTS

The grumblings of my opponent inform me that he is very displeased with the placement of

the Hummel (no. 631) on turn 5. This placement was not due to any tactical appreciation on my part of the painful dilemma, the placement has caused him. The absurdity is that the position resulted from a miscount by my opponent (who is a physicist). I accepted his count (intended to correct my own supposed miscount) partly because I have miscounted my fair share of movement distances, partly because it did not matter, since by either count the Hummel could reach the position I wanted it in (205) on turn 6, and partly out of weariness. It is also clear that he didn't appreciate the implications of the placement at the time of the move count either; otherwise, I'm sure, he would have counted yet another time.

I relate this humorous incident to illustrate some of the random and often absurd factors that determine the 'strategy' of face-to-face play.

Since the Russian did not put anything on the two squares of hill 104, the German can occupy the slope squares on the Southeast slope of hill 129 immune from danger of destruction or dispersal. This is a position of crucial importance both to the delaying action and to picking up the 120mm mortar (no. 91) in the town. It was probably a mistake to leave the piece in the town, but the position I have may permit its rescue.

My positions deny the Russian possession of the S-E slope squares, the town of Golod, and the adjacent forest squares, all of which are required if the town is to be held for one more turn. Of course, holding the town another turn is perfectly consistent with my delaying strategy.

The central fire position taken on 2-0-5 has a total fire power of 140 against any armor which is on level ground or in a river bed, anywhere between 2-0-5 and South of the town of Golod. The same hex has a power of 110 against infantry in the same area and terrain. The fire position is most effective against pieces placed anywhere South of the town and between the North slope of hill 129 and the edge of board 2. It has no reach Southeast of the hill. But the best line of advance is North of the hill anyway. Besides controlling the main and only through road, the positions North of hill 129 cannot be blocked against advance the way the positions South of the hill can. This can be done below the

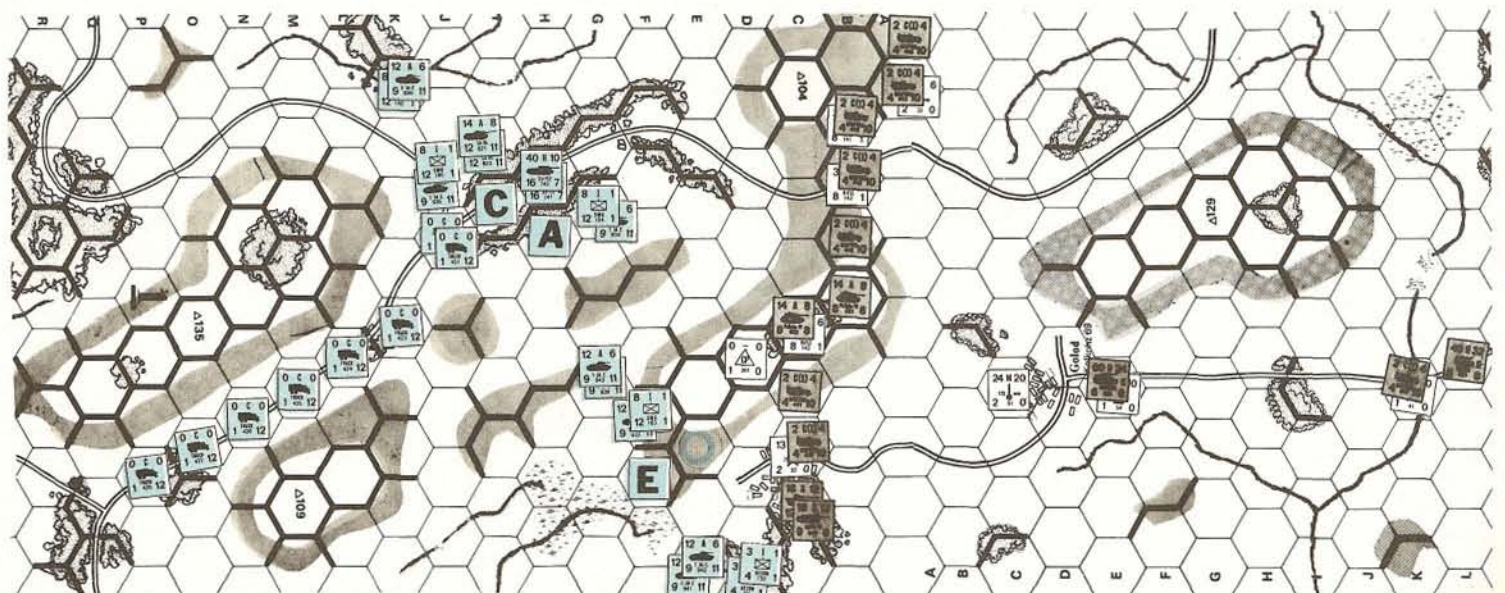

German 5th turn: The Russian should have occupied 1-E-8 last turn. Had the Wespe fired it may well have been traded for a T-34—

a good trade. By failing to expose his units to fire the Russian once again faces a full defense. The German has been forced to

withdraw, leaving his CP to the dogs. It shouldn't have been unloaded there in the first place.

swamp at 2-I-10 and by taking positions at 2L10, and 2M10. The Russian can only go around this block by turning North into the fire zone.

Of course another advantage of the selected fire position is that it is immune from attack until spotted or CATed. This is the place I intend to hold with the pieces which are there. In other words the Russian will have to shoot his way through here. This is really the last decent and probably the best place for a slugfest from the German point of view. If the position is also defended by tanks and halftracks, the Russian will have great difficulty flanking the position as we shall show without exposing himself to severe losses.

I unloaded the gun (no. 54) since its carrier is likely to be under attack during the fire fight which must occur if the Russian is to advance in time to get pieces on board 3 by turn 10. I'm picking it up with a halftrack so that I may have discretion concerning its disposition. I predict that the firefight, if it takes place will commence on turn 8.

Russian Comments Move No. 6

Damn, I forgot I needed hilltop 104 to keep him off the slopes of hill 129. I blew it; I should have taken the risk—probably with the Su 152's since their defense is larger. That would have stopped the trouble in the south. I am definitely behind schedule now.

Those blasted long range guns on hill 132 have me naked (or at least indecently exposed) if I try to hit Golod immediately or to bypass it to the north. The only hex they can't hit is open to fire from his heavy tanks.

I am going to try to outflank him to the south, but I am afraid I have too far to go. The route is a poor one, too slow. If he overlooks it, I am going to try to get to hex M10 next turn.

Right now the mortar in Golod has become an important unit. If he saves it and can block me off at the same time, I don't think I can win. If he does not save it, my 2 unit advantage may enable me to make a quick frontal assault.

TURN 6: German: Aided by the Russian mistakes of last turn, the German has formed a good defensive line with only one major hole—2-D-3 which is protected by the field of fire from 2-O-5.

Russian: Russian caution is probably in order on the southern flank but some tanks should have been moved into the woods at 2-B-2. Using normal LOS determination, 2-O-5 cannot fire at 2-B-2, but under the optional rule, such fire could be allowed. The Russian player is in deep trouble now and must take some risks in order to win. T-34's on 2-B-2 could get into the woods at 2-I-3 on the next turn.

TURN 7 GERMAN COMMENT

The only 'holes' in this defensive line are at 2E5 and 2I6. 2I6 has very poor potential considering the positions he can subsequently take. Only one is really safe from massive fire (2I7) and that position hardly threatens breakout. The other position does not give much possibility of outrunning my blocking forces, but it does offer the Russian a possibility of trapping a number of my units, five in all, including three tanks. This is a risky position for the German to be in, but, by remaining in the town he can rescue the gun and keep the Russians out. Considering that any encirclement of the town requires some units to be in open terrain facing 140 anti-armor and 110 anti-

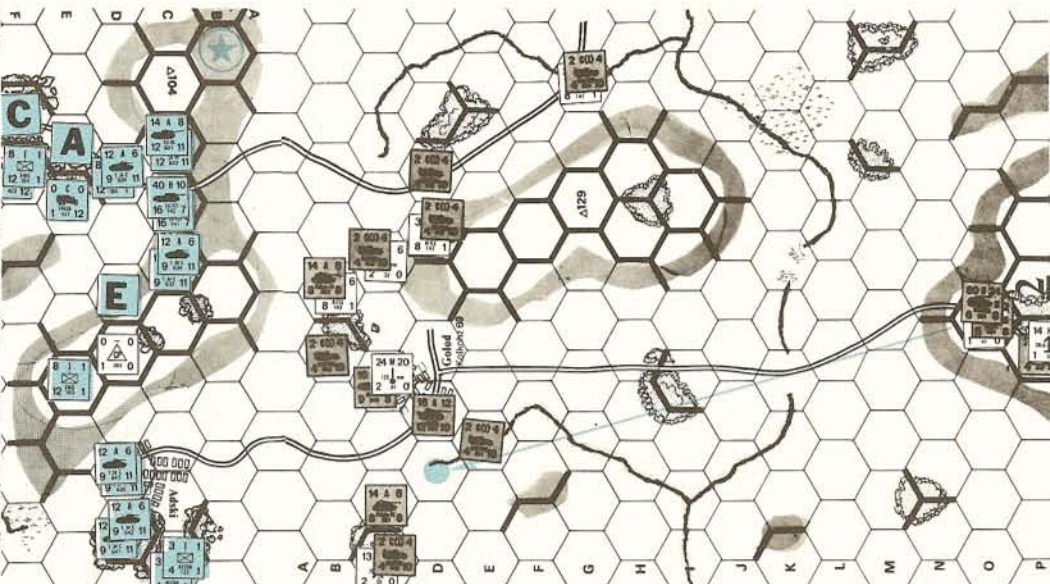

German 6th turn: The Russian should have occupied 1-B-2 with his SU-152's last turn where they could command all of Hill 129. German attacks on it there would have left the firers in poor

personnel fire factors, to say nothing of the tanks that can fire from the town and other places. It is probably impossible for the Russian to surround the town in such a way that a hole cannot be shot in it. Moreover the losses the Russian would have to take would be large, probably 3-4 pieces even without using the tanks in the town.

I don't think that he will try to trap me in the town. I'm positive the Russian can no longer win.

Russian Comments Move No. 7

He can count too; so much for L10 and M10 of the southern flank. I am forced to go north of the swamp, into the teeth of his power. He has me almost completely blocked, and any attempt to surround Golod cannot succeed. He can always clear a road by using his guns on hill 132 at 4-1 odds, then pull out his units.

My moves force him to pull back from Golod & hill 129 so that I will have at least 1 hole, but I do not think I can reach board no. 3 in time. I

position. The German, helped by the Russian reluctance, has formed a solid defensive front again with only 1 hole; 2-D-3, which is covered by the SPA's field of fire.

could take more risks, but I still think it would be foolhardy. I still have to keep my head down.

TURN 7: German: The German position is now quite good. Units at 2-H-4 and 2-H-5 prevent Russian occupation of these woods without a fight which would probably result in heavy Russian losses. A battle for Golod would bring on the German-desired general engagement.

Russian: This is a good, albeit cautious, move that puts pressure on the German center and northern flank. The essentially worthless 45mm guns have been unloaded at Golod. The T-34's in 2-C-1 can reach 2-K-1 next turn. Under the normal LOS rules, units on 2-O-5 cannot fire at this square but, under the optional rule, this may be possible since the LOS from 2-O-5 crosses a corner of the brown hex side. This square should have been occupied by the Russian on this turn. It is important to have all of the SMG units loaded on this turn so that they may be unloaded adjacent to German units on the next turn.

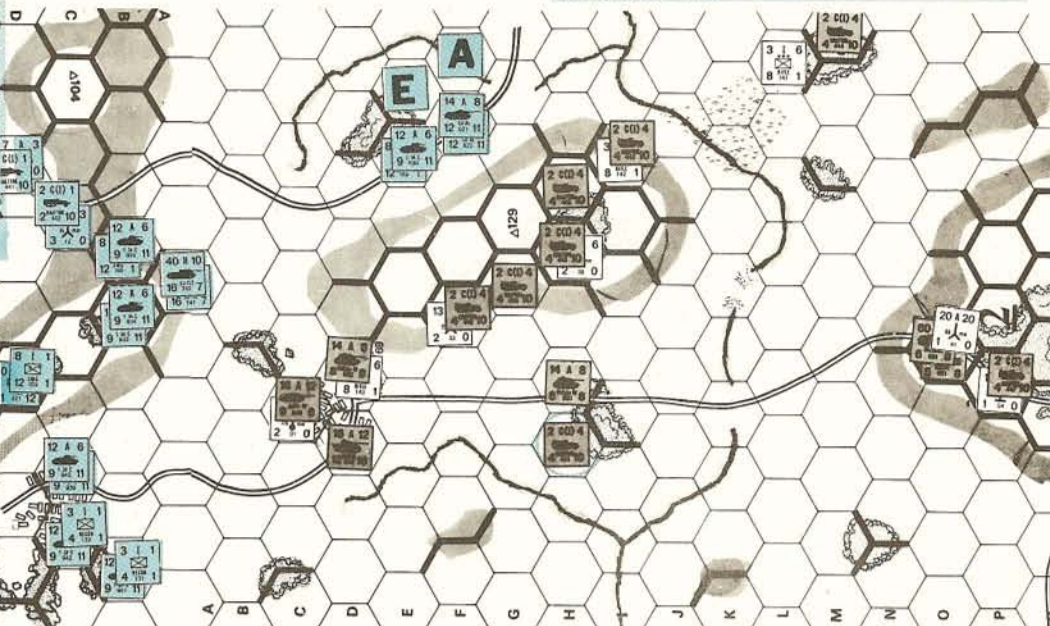

German 7th turn: The German position is now practically impregnable given the time pressures on the Russian. The German halftrack 441 denies access to the important central woods at 2-H-

4 & 5 to the Russians who now have to brave a hail of fire to dislodge them.

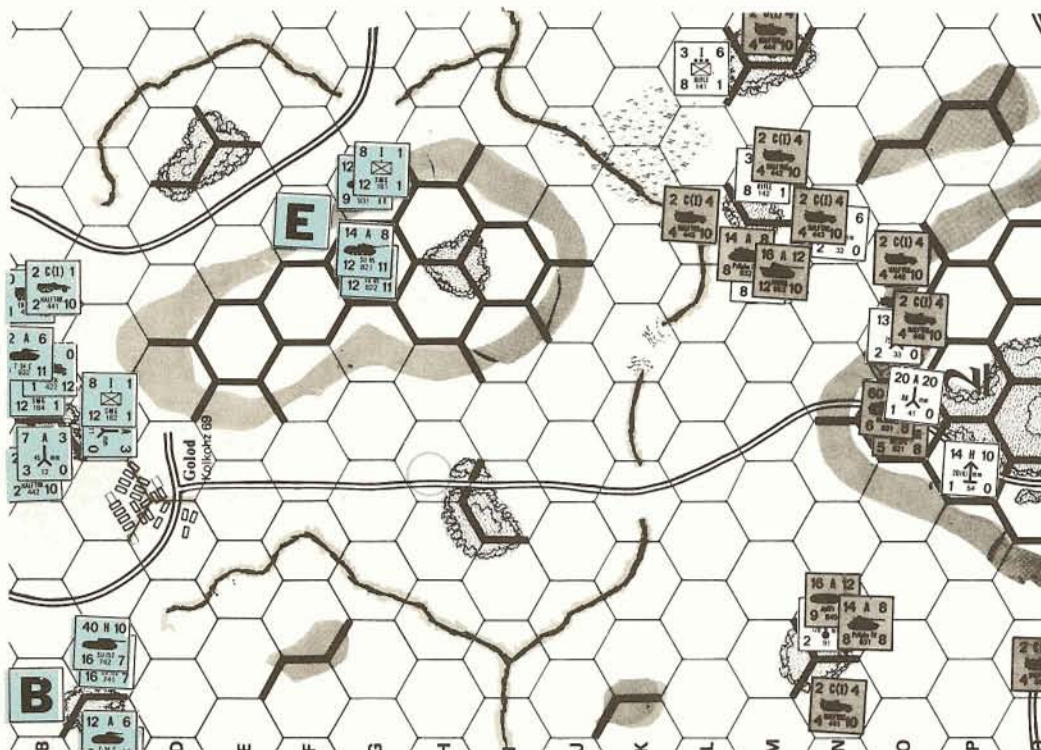

German 8th turn: The German gets a little careless. 2-H-5 should not have been abandoned without a fight. The Russian now has

free access to the road with which he can carry out his assault. This may have cost the German a marginal victory.

TURN 8 GERMAN COMMENT

The fire fight clearly can't happen until turn nine. He decided, wisely in my opinion against trying to trap the units in the town. Probably he should not try to engage my forces at all, since I can guarantee now that he can't get 10 pieces on board 3 simply by getting all my halftracks with some infantry or guns (total numbering at least ten) back in front of his force. This I clearly can do at this point.

He is in a poorer position for a fire fight since he has had to unload guns and infantry to force me out of the town. I have attempted to establish a fire position which is fairly evenly balanced on both the North and South sides of 205. Of course the Northern flank of the hill is easier going for the Russian and this must be considered. He can't get beyond 2P1-2 on the North side which keeps his feet well to the fire.

Russian Comments Move No. 8

This move is one of sheer desperation, and is fundamentally unsound; analysis indicates I should probably take my draw (which he cannot prevent). This assault is the only possible chance I have of eking out a win; if I do not attack now my chances of winning are zero. I do not think I have much chance anyway, but if everything goes right I may manage. It would help if he were to defend improperly; at least this gives him a chance to do that. The odds are at least 3-1 against me; about even that he will get a win. It will be bloody, but he should lose almost as heavily as I do. I don't know what he was saving his 75mm guns for. At least anything that shoots at me is spotted. I needed to be able to make a move like this on turn 7 to have had much chance.

I have to unload the infantry to be able to make close assaults, so any unit that does make it through will not have a passenger (with the possible exception of 942). That makes it rough to get the count to 10. I don't think the trucks have any chance, but I will bring them up

anyway. I will keep the rest of the units out of danger; they can no longer have any effect in the game.

TURN 8: German: Although the Russian cannot win the game now, the German should have left a halftrack on 2-H-5 to deny free Russian travel along the road. Occupation of this square would have prevented the SU-152's and T-34's from advancing adjacent to 2-O-5 and might have turned the game into a German victory. Had this mistake occurred on Turn 7, it would have been extremely costly. There is no reason for the 75mm AT to be loaded on Halftracks. They should have been unloaded and put on the firing line.

Russian: "Tout le monde a la Bataille" as the saying goes, but too late. The Russian had a choice to either stage this last desperate attack to try to salvage a win or to retreat and, having destroyed one German unit, manage a draw. I think that the Russian decision was a correct one but the general attack came a turn too late. The Russian should probably have avoided putting units on squares such as 2-N-7 and 2-M-3 where they are easy marks for overruns.

TURN 9 GERMAN COMMENT

It was an oversight not unloading the 75MM ATgun (no. 33). Also I could have put infantry on the slope in front of the fire position, but these would have probably been lost without changing the result and there is an absolute minimum of halftracks and passengers which we must be sure of getting back in order to prevent the Russian advance onto board 3. Actually, I can take up a position so that the Russian can not get a single piece on board 3.

The blocking position taken up by the halftracks speaks for itself; they cannot be overrun by any Russian vehicles and the Russian can't even get to the slope edge except in the North East.

My firing was determined by two factors: Russian casualties and my own. The 4 to 1 attack against 932 allowed 441 to leave 2N2. The other 4 to 1's were taken to reduce his fire power as much as possible. The overruns were done for two reasons: (1) the odds of dispersment were certain, while the odds of destruction of the defender were the same as shooting and (2) while overruns make the attacker more subject to counter attack, they also cause dispersal of the return fire. Of course, in one case, I could overrun two pieces, a gun and a tank at 2N8, and this gives even more reason for that overrun. I think that 0-0 tie is a virtual certainty now. I know that the Russian can not win even a marginal.

Russian Comments Turn No. 9

I made a mistake: should have put a halftrack on N7, left 948 and 34 on M6. I think he made several errors this turn: he should have hit the loaded tank (which I probably should have



German 9th turn: The Russian finally made his charge last turn but his plight was such that he made easy overrun targets of 938, 34 and 939. The carnage is quick and relentless but the German

failure to wipe out or disperse enough of the spotting units insures the draw.

unloaded), and definitely should have tried to get the three stacks in the south so that his units on M7 would not be spotted. That might have guaranteed him a win.

I have no choice; I am forced to try for the draw. He has 11 units to block my path, only requires 8. I would need two turns after this to get even 1 unit on board no. 3; there is no point in trying, especially since I need 10. He has destroyed 8 units, I have one so far. I need at least 8 more, can guarantee 3. I am going for 4-1 shots on everything I can see. I would like to use selective fire on the stack (41, 621, 631), but I can't get 4-1 odds on each one that way. I will bring up another infantry unit in case I need it next turn.

I have my draw. I destroyed 9 units this turn, giving me a total of 10.

TURN 9: German: This is the turn of the slugfest. The German should try to destroy as many Russian units as possible with 4-1 and overrun attacks. The T-34 no. 942 should have been destroyed since it is carrying a passenger. The infantry unit no. 143 should have CATed the Russian halftrack no. 441. Every possible German unit should be involved in the attack except those halftracks needed to seal off the roads west. The German failure to destroy or disperse all of the Russian units adjacent to 2-O-5 means that the German guns will stand an 80% chance of being eliminated on the next Russian phase.

Russians: With so many of his own units destroyed, the Russian has salvaged a draw by destroying many of the German units. Realizing that he couldn't win, the Russian wisely went for the draw and destroyed as many German units as possible.

Final Comments: This situation demands a very aggressive commander and this Russian just wasn't quite aggressive enough. The German made some serious mistakes which the Russian couldn't take advantage of because he was behind his schedule. (No comments on Turn 10 moves).

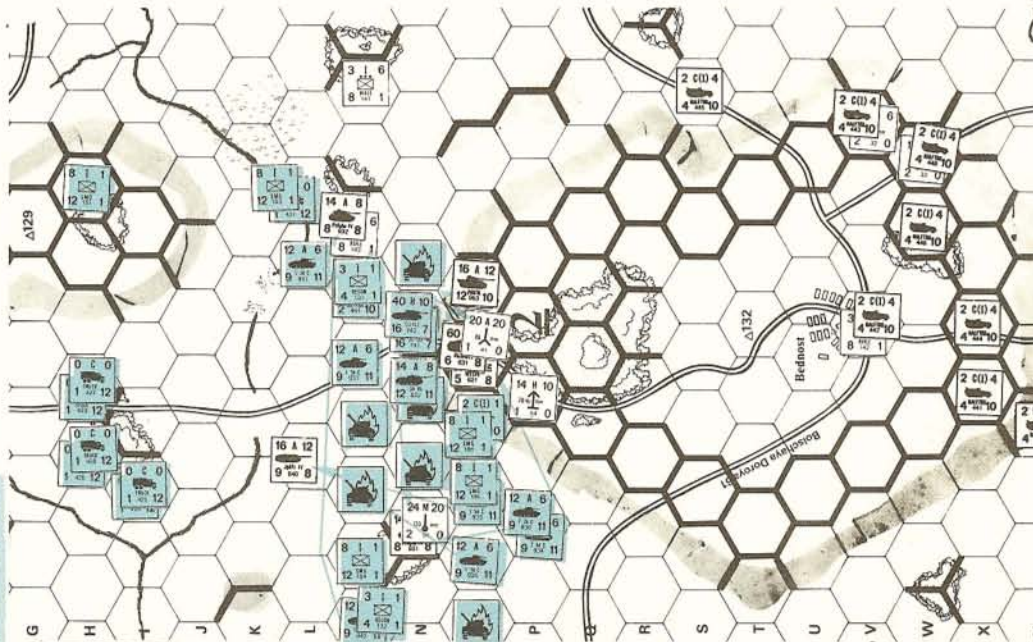

TURN	ATTACKING UNITS	DEFENDING UNITS	TYPE	ODDS	RESULT
Russian 5	SMG (183)	CP (201)	CAT	4-1	ELIM
German 9	88MM (41)	T34C (932)	Normal	4-1	ELIM
	Hummel (631)	SU85 (821)	Normal	4-1	ELIM
	Wespe (621)	T34C (943)	Normal	4-1	ELIM
	20(4)mm (54)	76.2mm (33)	Normal	4-1	ELIM
	120mm (91)	T34C (937)	Normal	4-1	ELIM
	MkIV (931)	T34C (941)	Normal	3-1	---
Russian 9	MkIV (932)	T34C (939)	Overrun	2-1	ELIM
	JdPzIV (840)	76.2mm (38)	Overrun	2-1	ELIM
	Panther (953)	T34C (938)	Normal	4-1	ELIM
	SU152 (741)	Panther (953)	Normal	4-1	ELIM
	T34C (931)	MkIV (932)	Normal	4-1	ELIM
	2 T34C's (941,942)	88mm (41)	Normal	4-1	ELIM
	SU152 (742)	Wespe (621)	Normal	4-1	ELIM
	T34C (934)	Hummel (631)	Normal	4-1	ELIM
	2 T34C's (933,935)	JdPz IV (840)	Normal	4-1	ELIM
	SU85 (822)	120mm (91)	Normal	4-1	ELIM
	T34C (936)	MkIV (931)	Normal	4-1	ELIM
German 10	SMG (186)	20(4)mm (54)	CAT	4-1	ELIM
	2 SMG's (184,185)	120mm (91)	CAT	Not Needed	---
	Recon (131)	MkIV (931)	CAT	1-3	---
		Rifle (143)	CAT	1-3	---
Russian 10	Rifle (143)	Recon Hftrak (441)	CAT	1-2	DISP
	SU152 (741)	Rifle (143)	Normal	4-1	ELIM
	SMG (183)	Rifle (143)	CAT	Not Needed	---

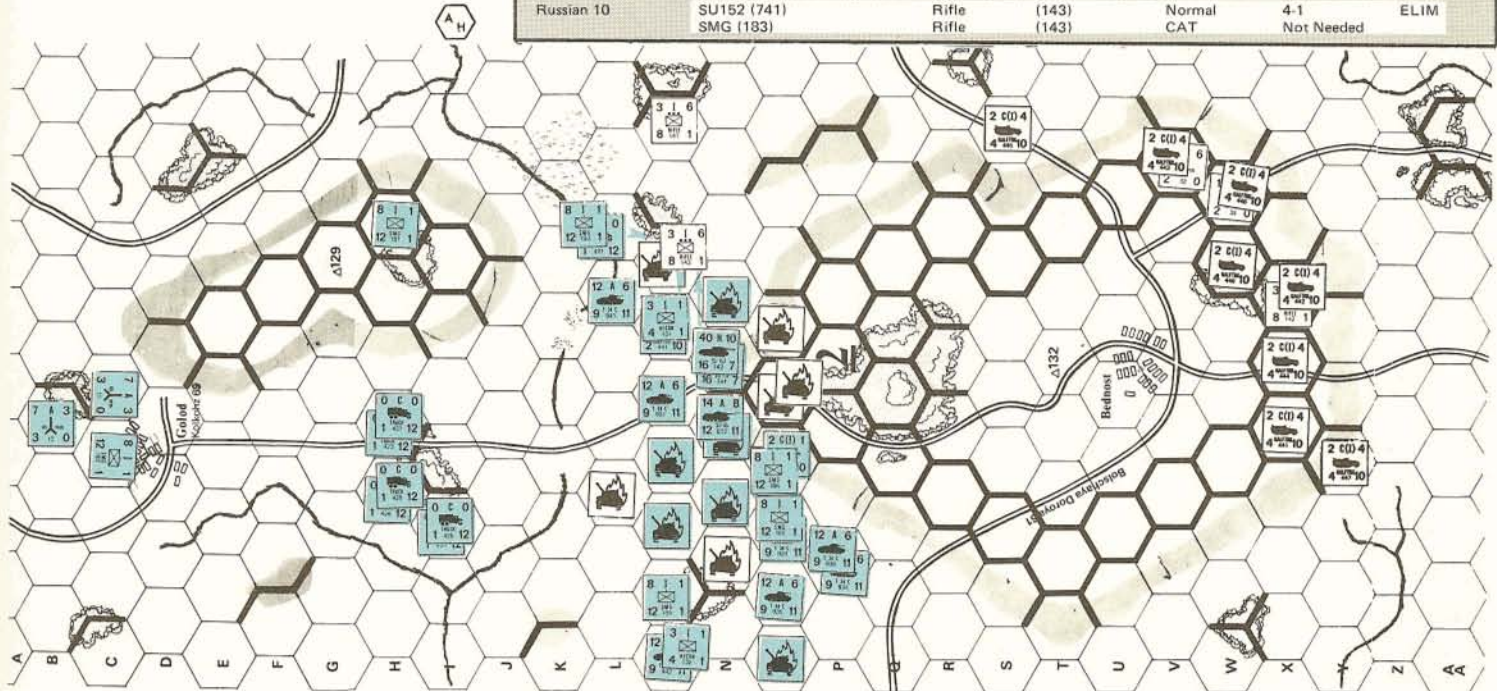

Of course, we are keeping that unique mapboard, but including a careful and comprehensive definition of all terrain features, to eliminate confusion. Also retained is what is probably the most historically faithful and detailed OB of any wargame, but this time we have indicated right on the unit counters their individual stacking values, and other information that speeds up play considerably.

A new feature is spacious and well-organized set-up sheets to end the fumbling. We have also re-presented the OBs in what we think is a clearer, cleaner way, but with no loss of accuracy.

What about the criticism that *Anzio* was impossibly long, and complex? The new 15-turn Basic Game, covering the initial 1943 invasion, and its aftermath, is relatively short and simple—but it retains the high points of the all-out Advanced Game. The Basic Game includes the possibility of an initial invasion at all the places actually considered by the Allied Command. The Allied player can also invade a second time, perhaps at *Anzio*, or some other location. The Basic Game also includes Step Reduction, Second Combat, Breakthrough Movement, etc.—the most important features of the *Anzio* game mechanics. As such, it is not only an enjoyable game in its own right, for those who prefer a relatively short game, but it is also the best introduction to the Advanced Game.

For the Advanced Game we tackled one of the more subtle criticisms levelled at the game—that chance played too great a part. One of the problems in simulating the Italian Campaign was the differing OBs that each side *could* have used, depending on how the campaign progressed, and the needs of other theaters.

"Lady Luck" is not entirely out of place in wargames, because she figures importantly in warfare, as in all human endeavor, but most wargamers dislike being too subject to the vagaries of a die roll. That was a legitimate criticism of *Anzio*. To a considerable extent, the German OOB depended on a series of die rolls, so Allied strategy was partly shaped to avoid increasing the *chance* of a lucky roll by the Germans, which could at a stroke greatly change the balance of forces.

The original game had many novel features, and we wanted to maintain that tradition, while also reducing the weight of chance. We did it by allowing each side to *select its own OOB*, within a historically possible range of options. For example, if as German Commander you want to use the two strong SS Panzer divisions in North Italy, you can do so. Or, as Allied Commander, if you do not want to release divisions to other theaters (a decision bitterly criticized by the actual commanders), you can keep them in Italy. Furthermore, as Allied Commander, *you* decide your strategic goal, among the various possibilities historically considered, and your decision determines the length of the game.

The combination of these Allied and German decisions—which can be made and kept secret for much of the game—determines the victory conditions of the game. As the real commanders did, you can

decide how much of the forces available to you to use, but then your performance will be judged on how well you use it. We think this is not only simpler, but more realistic, and more exciting, too!

The original game was known for a multiplicity of special rules. We have re-written these for clarity, and retained them for optional use. We have also included a series of new rules covering naval gunfire, tactical airpower, increased use of commandos, and paratroops (for *both* sides), limited intelligence, and a number of others.

With all this, the most avid devotee of realism should be happy, while the probably larger group preferring a playable game can start with the Basic Game, and also add to it appropriate parts of the Advanced Game, as desired.

The new game will change everything but the mapboard. Even that atrocious box has been done away with. We will sell present owners the parts they need to update their first editions separately but due to assembly costs they will probably find it cheaper to order the new game intact rather than piecemeal. At the very least, owners of the previous edition will need new counter sets, all the charts, and the rules.

Also making its appearance in the mail order ranks will be *JUTLAND*. This game was rather poorly designed initially and the reissue will be dedicated primarily to cleaning up the unworkable victory conditions, search procedures, and general ambiguities which plagued the older game. The components will be altered and upgraded somewhat in addition to a general redressing of the rules. One of the best improvements however will be the installation of three mini-game situations which makes *JUTLAND* a game that can be played in an afternoon, rather than a week as was the case with the old game. The new situations recreate the battle of Dogger Banks and add a pair of fictional confrontations between limited Battle Cruiser forces and a restricted British Sweep.

Probably of more interest to you is our redesign of *CHANCELLORSVILLE*. This divisional level game has long been the most sought after collector's item in all of wargaming — selling for upwards of \$30 a copy. The first edition of the game will probably continue to command that price as a collector's item because it is almost totally divorced from the new version. Randall Reed has taken the redesign under his aegis and created a totally new game system completely divorced from the "D ELIM" mode of the original game. The game utilizes four phases to bring in artillery fire from both long and short range on a CRT which can be aptly described as a "push" rather than "kill" table.

Unlike the original version where the Union player was faced with a "D-Day on a river" situation, Union forces are able to cross the Rappahannock as in the historical campaign. But a tough set of victory conditions keeps the Union from running roughshod over Lee's forces. The game system forces players to maintain reserves and use them judiciously or be faced with massive overruns. Players need not fear the

"D Elim" die roll as the CRT deals in "disruptions" and the player who can not cover the flank of a disrupted force is in trouble. All in all, we think it may be our next "classic" game — a real nail-biter for both sides. Everything has been changed from the original version. The bland *D-Day* style map has been redesigned and artistically rendered into a playable and aesthetically pleasing board. *CHANCELLORSVILLE*, like *JUTLAND* and *ANZIO* will be a flat box game.



The new Chancellorsville being playtested in the Avalon Hill gameroom.

We turned to a new designer and a new period for our 4th mail order game. Gary Gyax had previously published several titles on his own. One of these, *ALEXANDER THE GREAT*, got pretty good reviews and caught our eye as we've long been looking for an entry in the ancient period. Not content with the original, however, Don Greenwood sat down with Gary and worked on a redesign of his original prototype. After three prototypes we came up with the game currently being tested. The rules of the earlier edition were greatly improved, the Macedonian forces upgunned a bit, and of course, the physical components vastly improved.

ALEX represents a new type of game. It, in essence, creates a board game out of what are primarily "miniatures" rules. The player maneuvers and attacks with his unit counters in much the same way miniature players handle their figure trays. The matter of morale, so important in ancient warfare, is carefully simulated and recorded via a pair of Morale Status Tracks, and four different CRTs; one for each level of morale. The lower a side's morale, the less its ability to attack or defend successfully. Obtaining and maintaining an edge in morale is pretty much the crux of the matter in *ALEXANDER*.

The situation itself, the battle of Arbela, is one which is hard to simulate without throwing play balance and any semblance of "gameness" to the winds. Consider the original situation wherein Alexander, outnumbered more than 2 to 1, totally routed an opposing force of over 100,000 while sustaining a mere handful of casualties. The Persian who saw the rank in front of him cut down was definitely not inspired by themes of home, motherhood, and apple pie. More likely than not his reaction was how to extract himself from the fray in one piece. The Greeks were also inclined to bolt when the going got rough but far less so than the barbarian levies of Darius. This can be reflected in the game by simply starting the Persians at a lower point on the morale

Dear Avalon Hill People,

In regard to Tom Oleson's strategic analysis of the situation in the Mediterranean in 1943, in the Jan.-Feb. *General*... I demand equal time! I think that one of the most brilliant military leaders of history has been given short-shift without a chance to be heard.

Tom's article amounts to laying a charge of strategic incompetence against Allied planning in the Mediterranean. One of his strongest points is in citing the near disaster at Salerno as evidence of flawed strategic thinking. I draw precisely the opposite conclusion from this *near* disaster. To me it is the clearest possible evidence of Eisenhower's strategic brilliance. By Mr. Oleson's admission, Eisenhower rolled into the worst possible luck in finding the "secret" placement of the 16th Panzer in the hills just behind the Salerno beach. Despite this worst possible luck, the "near" disaster wasn't a disaster at all, but eventually led to the achievement of every objective in the Italian theater.

Any *Anzio* player knows that the worst possible luck landing at Rome will have quite different consequences. Italy wasn't the decisive theater, no matter what happened, the war couldn't be won in Italy. But the war could have been disastrously set back, or even lost if a stalemate ensued in the Mediterranean that would permit the Germans to shift forces to France and Russia for the 1944 campaigns. The conservative choice of Salerno over the high risk Rome alternative invasion site was entirely justified when one takes a longer view of the strategic situation in 1943.

But it is in proposing the "Corsica first" alternative that I think Tom truly overreaches himself. To a player who knows little more of the campaign than he would learn from playing the Avalon Hill game, this might seem to be an attractive possibility. The spreading umbrella of air cover over the north Italy beaches sure looks great in his illustration.

The flaw here is in extending the mechanics of the games invasion system far beyond their applicability. The game's invasion system is already breaking down in permitting even the possibility of an invasion in the Adriatic or north of Rome before the fall of the Foggia and/or Rome airfields. In fact, any such invasion was simply out of the question, it would be exposed to devastating raids and harassment by small expendable units of the German air and naval forces. This same factor, which is left out of the game for simplicity's sake, applies with even greater force to the possibility of landing in Corsica first.

Tom seems to assume that the Germans would just pack up and run the minute the Allies hit the beach. His evidence is plausible, that in fact this is just what the Germans did so when the Allies actually landed there 4 days after the Salerno landing. "After" is the key, to land in Corsica first, produces an entirely different situation. If this was the German intention, one wonders why they were there at all.

There could be only one purpose to landing in Corsica first. That is to secure airfields to support an invasion farther up the west coast of Italy. This means that a Corsica first invasion would have to secure the island and build the airfields, before the real invasion will take place. But before the main invasion pins the main German force in place, there is simply no reason for them to evacuate Corsica. The Germans could reinforce and supply by night in perfect safety across the mere 50 miles that separate Corsica from the mainland, while Allied reinforcements and supplies must come through 500 miles of submarine infested waters under enemy air superiority. The Germans would be defending some of the best defensive terrain in Europe, feeding in just enough to hold out, while the Allies would be forced to attack under the worst possible conditions. It would be Guadalcanal in reverse, and the conclusion would be inevitable, an Allied disaster. And for what purpose? To invade a little farther up the Italian boot.

But landing in Salerno first, as Eisenhower did it, was exactly right. He hit Salerno on September 9. As soon as the initial situation on the beachhead was straightened out, by September 11, the go ahead was given for the Corsica Operation, and the landings began on September 13. With the Salerno landing secure,

Letters to the Editor ...

there was now no reason whatever for the Germans to remain in Corsica and Sardinia, and they began the evacuation on September 18, and completed it by October 3. Could the Allies have prevented this evacuation? Not likely in an area of enemy air superiority. When looked at with proper perspective, what both sides did here made perfect sense, and Corsica was spared the horrors of what would have been a most vicious campaign as Mr. Oleson would have waged it.

In conclusion, although I found many fine points in Tom's article, I'm glad the "Corsica first" strategy wasn't used in the Mediterranean in 1943.

David Roberts
Houlton, Me.

★★★★★

Dear Editor

Some people may be interested (if only for the purpose of contacting the correct author) that my part of the "Origins Trilogy" in THE GENERAL 10-3 was "Italian Variants", even though my name was listed first.

People who are willing to forego a little realism may alter BLITZKRIEG so that the game is dominated by mobile, fluid warfare rather than by attrition reminiscent of World War I. There are a number of ways to vary the process, depending on the tastes of the players. Basically, each player receives an equal number of cities (and city hexes) at random throughout the board. This can be accomplished by flipping a coin for each city and placing an infantry division in each to signify ownership. When one player has received all the cities he is entitled to, the other continues to flip until he has his allocation as well. (The city to be flipped for should be selected from a different part of the board each time, so that the second player's cities are not partly concentrated in one area.) Players then take turns placing their remaining units, one at a time, in cities they control. Before the game the players should agree concerning which units will be held back as reinforcements. Initially unoccupied cities are minors, to be attacked using the minor cities table, but there are no minor countries as such. In addition, it may be interesting to give minor cities a zone of control so that it will be more difficult to ignore them.

After all units have been placed, the players flip to choose order of movement. The first player may move only one half of his movement/range factors (infantry 2, SAC 10, etc.) Thereafter normal movement factors are used, as are all other BLITZKRIEG rules. Variants include adding units from other games (particularly big armor units), allowing players to choose their own cities, etc. The game forces the players to solve a very unusual set of problems.

I was surprised to see myself mentioned in Pat Carroll's letter (GENERAL 10-3). I would like to correct some of the information Pat related concerning what was formerly the Michigan Organized Wargamers.

We found that the borders of Michigan were an artificial rather than a natural boundary. We have therefore expanded our services to include northern and central Indiana, northern Illinois and Ohio, and southern Ontario, and we are now known as the Midwest Gaming Association. In December of 1973, the beginning of our third year, we numbered over one hundred and seventy five members, interested in all types of wargaming and non-wargaming. We publish a 22 page bimonthly newsletter (containing news, announcements, and reviews, not articles) as well as other special publications. One of the latter is the *Great Lakes Gamers Census*, which includes 1,001 addresses of gamers in Michigan, Indiana, Illinois, Ohio, Ontario, Minnesota, and Wisconsin, as well as gaming interests when known. MGA guarantees postal games run by many member gamemasters against orphanization. We hold conventions and miniconventions at all seasons of the year, not just in summer, the latest being the MGA Wintercon II in Ann Arbor, Michigan. Many affiliated local clubs meet regularly, and we also regulate a team competition league for amateur play. There is also an organization for helping game designers.

We are actively interested in helping gaming organizations get started in our area, and in contact with organizations which already exist. Membership in MGA is \$1.50 per year for people in Ontario, Indiana, Illinois, Ohio, and Michigan. Persons outside that area (presumably collectors) may join for \$2.00. Membership includes a subscription to the newsletter, *Midwest Gaming Review*.

Lewis Pulsipher
Bellevue, Michigan 49021

★★★★★

Dear Sirs,

This is in response to the overly vicious attack upon my Allied defense plan for France 1940, by one Dan Richardson. Though my plan is clearly not a perfect one, it merits more than to be termed "rubbish." Mr. Richardson takes an overly realistic viewpoint of the situations created by my article. Certainly he is correct when he says an army should defend its homeland, but I feel this holds true only when the armies are real, not just unit counters on a map. All I care about is winning the game, not losing it in the same realistic way the Allies did in the original campaign.

First of all, Mr. Richardson complains about the positioning of the Dutch Army. Fine, why not just put the Dutch units right out in front of the German Army so they can "defend the homeland?" Needless to say, the Dutch Army will be nonexistent in a very short time, but apparently, this is what Mr. Richardson wants in order to gain realism.

Secondly, Mr. Richardson complains about the positioning of the Belgian Army. That's fine too; leave the Belgian Army in Belgium, at least it will be wiped out realistically while defending its native country!

Finally, Mr. Richardson argues that the position of Allied armored units in the Maginot Line is "just plain stupid." I disagree totally, due mainly to the fact that the Allied armor is in a position where it can attack the German flank advancing west of the Maginot Line during the planned Allied withdrawal. This could both slow down a German invasion of southern France and an advance across the rest of France. Furthermore, the invasion of southern France is of no importance. For every German unit that goes off the map, the Allies can match it with their weak 1-6's, 2-6's, 2-2's, and 2-8's (stationed on the edge of the map) along with Belgian and Dutch units. By doing this, the Allies are getting rid of units that do not serve a very useful purpose. Of course, the Allied player may need to remove a few 6-6's and the like also, but he should still be able to hold the short river line with reinforcements and the troops at hand. In this way, Mr. Richardson's valuable industries in southern France can be protected by the Allied forces dispatched to it.

Frankly, I do not know what Mr. Richardson is talking about when he claims the Germans will encircle the Allied Army and leave it without supply. It seems to me that the only way that the Allies can get themselves in a situation like this is when the Germans are tragically fortunate in their attacks.

In conclusion, I would like to say that Mr. Richardson's letter to your magazine is an insult to my integrity. Simply because I prefer to handle the dispositions of the Allied armies in a new fashion, Mr. Richardson takes the liberty of calling me an untrue wargamer! I suppose that there will always be narrow-minded people present in the world to agitate and disrupt the flow of new ideas by concerned wargamers.

Larry Wessels
Houston, Texas

★★★★★

Dear Sir,

Although PANZERBLITZ Sit no. 4 remains unreviewed in the 9/15/71 cards, there is obviously something the matter with it. The lesson is supposed to be a "German delaying action against a mobile force" which is "more economical (and often more effective) than a blocking action." However, as the situation is

given, the German can do little more than attempt a brief and futile blocking action before the Russian blasts his way onto the no. 3 board for victory. And the no. 1 board remains completely irrelevant to the entire action. It seems clear that what was intended was for the Russian to reach the no. 1 board, while the German executes a mobile delaying action to run out the clock before the Russian gets there.

But even this obvious correction doesn't really help; since the German has little chance of winning, his best bet is a hasty withdrawal that keeps his forces intact and results in a draw. The following reconstruction of victory conditions, which have been developed by an experienced opponent and myself, seems to solve all these problems; it forces the combatants to use the tactics Sit no. 4 is intended to illustrate, and has the further advantage of making a draw impossible. So go get your Sit no. 4 card, compare, and consider:

(a) German Victory Conditions: *Marginal*—German losses are held to less than fifteen and less than 30 Russian units are on the no. 1 board (not no. 3!). *Tactical*—German losses are held to less than 10 and less than 20 Russian units on no. 1 board. *Decisive*—German losses are held to less than 5 and less than 10 Russian Units on no. 1 board.

(b) Russian Victory Conditions: *Marginal*—the Russian gets a Marginal if the German does not achieve a Decisive. *Tactical*—the Russian gets a Tactical if the German does not achieve a Tactical. *Decisive*—the Russian gets a Decisive if the German does not achieve a Marginal.

(c) Finally, the player with the highest victory condition wins—as promised, there is no possibility of a tie.

Now, what are the tactics these conditions force upon the players? The German is in the worst dilemma; if he withdraws too quickly, the Russian wins by pouring onto the no. 1 board. If the German stands and holds, the Russian wins by eliminating German units. Thus, the German must truly execute a mobile delaying action, playing for time while avoiding a major engagement of forces.

The Russian, on the other hand, simply plays it as the Russians played it—he drives head-on, pushing fast and hard, practically regardless of losses. If the German stands and fights, well and good; and if the German withdraws, that's well and good too. It must be said, however, that the Russian has some pretty steep victory conditions to attain; he must achieve a Tactical, or he loses. Thus, he must destroy at least 10 German units, or get at least 20 of his own on the no. 1 board... or he loses.

It's no picnic for either side, I can assure you—the only thing I can guarantee is a damned exciting situation.

Mark Saha
Santa Monica, Ca. 90405

★★★★★

Dear Sir:

I think, in the light of recent reading, that it would be too much to expect for the Germans to have either the Me262 or Me163 as early as Jan. '44 in anything beyond prototype status. The Schwalbe was shackled by Hitler's novel ideas on jet-bombers (even though the Arado Ar234 was available by late '44) and could not attain fighter status before '45. Even for a "what if" this is pretty unlikely. The German rocket program did not really reach full development until '44 anyway due to bugs in the prototypes — the Komet proved to be a highly volatile beast. Of course, once it was worked out, JG400 can come in as early as Jan. '45 — but not too many more groups are possible, due to the tricky and demanding qualifications for rocket pilots. The same is true for the Bachem Ba349 Natter, which reached group status but were destroyed on their gantries by Allied tanks.

The Salamander, however, is quite possible. It was designed quickly, and could be whipped into production any time the German player wants it. He can have thousands of them — the only limitation is aircrew. Perhaps an additional Luft-Volksturm force of 3 to 6 or 7 groups can be made available any time after the Apr. '44 quarter. It's a lousy fighter, designed to be flown by lousy pilots, but there's no reason why any maladjusted German player can't have them in '44.

Sincerely,
Robert Harmon
San Francisco, CA 94080

READER BUYER'S GUIDE

TITLE: AFRIKA KORPS SUBJECT: REGIMENTAL-BATTALION LEVEL GAME OF THE AFRICAN CAMPAIGN 1941-42

AFRIKA KORPS is the 10th game to be reviewed in the RBG. It received a cumulative rating of 2.90 which ranks it sixth on the list of games reviewed thus far. For a flat box game now in its 14th year, AFRIKA KORPS came out of the RBG in fine fashion.

The game managed to set one record for the RBG with the 2.29 rating in the 'Completeness of Rules' category where it bested STALINGRAD by .23. This is a strange category for the game to shine in if one considers the many wild rule interpretations governing the capture of supplies (and their use to sustain attacks in the same turn) that have filtered down through the pages of the GENERAL by a host of answer men. In all fairness though, the only problems existing with the rules are probably the result of faulty rule interpretations which were made official by the GENERAL's answerman in bygone years. Eventually, we'll get around to revising the rules, if only to outlaw certain unrealistic events which they do not specifically outlaw now. But in the meantime, any rules which draw a 2.29 rating must be doing something right.

The game also did exceedingly well in the 'Ease of Understanding' category which makes it one of the best games with which to break new people into the hobby. Its 2.12 rating is only .05 off the mark set by STALINGRAD. This fine introductory status is all the more impressive in light of the popularity it still commands among the hard corps.

AFRIKA KORPS is a fast-moving game of maneuver utilizing a low piece density and a wide open, frequently traversed mapboard to insure a lot of action. The playing time of 2 hours and 15 minutes is just what the doctor ordered, although it often ends far earlier if one side or the other can gain a decisive break early in the game.

AFRIKA KORPS is probably destined for another 14 years of popularity. Games sharing its ease of play, excitement and skill level have been exceedingly rare.

1776 will be reviewed in the next RBG. We postponed it one issue despite your votes for it because we want the people reviewing it to have more of a chance to play before rating it. Any game can look good after merely reading the rules. The proof is in the play of the game.

1. Physical Quality	3.04
2. Mapboard	3.10
3. Components	2.92
4. Ease of Understanding	2.12
5. Completeness of Rules	2.29
6. Play Balance	3.39
7. Realism	3.57
8. Excitement Level	2.91
9. Overall Value	2.77
10. Game Length	2 hr.15 min

AH Philosophy Continued from page 28

scale. Given this type of historical 'built-in' edge the Macedonians can recreate the overwhelming victory they enjoyed in 331 B.C. Such a one-sided situation is hardly conducive to a spirited game, however, so we start the participants on an equal morale footing. Here, Alexander is really pressed to pull out a victory. He must rely on the superior quality of his forces to balance the advantage of numbers enjoyed by the Persian. Here again, the morale tables come into play causing the Persian army to melt away if too many of its units are fed piecemeal to the advancing Macedonians, in many ways negating the Persians' numerical advantage.

Maneuvering phalanx, cavalry, archers, chariots, and elephants can be a welcome change from tanks and halftracks. Each unit has definite strengths and weaknesses which must be recognized and utilized accordingly. This variance of the unit counters plus the availability of a host of optional rules regarding their use should prevent the game from being quickly played out. ALEX, like the others will be a flat box game.

Last, but far from least in the mail order department, will be PANZER LEADER — a western front sister game to PANZERBLITZ. Among other things, the game will feature more refined rules than found in PANZERBLITZ. In addition, there will be provisions for airpower, paratroops, amphibious landings, and naval gunfire. At present there are 20 scenarios which may or may not be reduced to 12. Included among them are such interesting events as the Battle for the Reichswald (9/7/44); the encirclement of Nancy (9/14/44); Arnheim (9/22/44); the battle for Bastogne (12/26/44); and Remagen (3/7/45).

Also included is an Opportunity Fire Phase which mitigates the "Panzerbush" syndrome (allowing tanks to gayly march past 88's into a nearby woods hex). PANZER LEADER should be a decided step forward in the area of realism in tactical games, without going through all the bookkeeping and subsequent headaches of a simultaneous movement system. As such, the game shouldn't be an unplayable monster. It will rely on Real Line of Sight and each hex will have an identifying center marker to aid in resolving points for setting up a straight edge. All in all,

we look for it to be the hottest number on the mail order line and perhaps the most popular game to be released in 1974. The potential is certainly there. It's been our most requested game topic for years. An added plus is that the four geomorphic mapboards will be compatible with the existing PANZERBLITZ boards to form those monster situations so many of you crave. PANZER LEADER, unlike the other mail order games will be a bookcase game selling for a bit more than the others due to the increased components.

Besides the mail order line, there will be two additional games released this fall to the retail trade. They will be BASKETBALL STRATEGY and THIRD REICH, a strategic corps-level game of World War II in Europe. Both are highly polished designs relying on abstractions to simulate the subject in playable form. THIRD REICH looks especially promising and has been the major attention getter among our playtesters. It is a multi-player game for between 2 to 6 players, using a combination area-hex game system. Diplomacy rules exist for multiplayer games wherein the game really comes into its own, although strangely enough it plays better than most in solo play. Happily though, this is one multi-player game which does not suffer when played by only 2 players — each player merely commands the entire Axis or Allied side.

Play is in "quarters" or 3 month turns. There are three scenarios of 12 turns each and a Campaign Game of 30 turns. Due to the many rules and high piece density, the game takes a long time to play until players become familiar with the system. The game system by the way is entirely new — unlike anything we've ever seen before. It utilizes allocations of BRPs (Basic Resource Points) to govern the launching of offensives, creating of units, economic growth, and political considerations.

Practically all elements of the war are brought into play. The German can build U-Boat fleets to try to starve Britain into submission and the Allies can respond with strategic bombers. The Germans are hampered by partisan activity behind their lines and can be dealt a near-death blow by the effects of the Russian winter. For the first time ever, land, sea, and air units are actually portrayed together in an historical simulation. It is an extremely exciting game with too many details to describe here. It does have one drawback though — the piece

density is so high that in some areas the players would be well advised to bring some tweezers with which to move their back-to-back counters. It is definitely a tournament level game aimed at the hard corps. The game system, by the way, is by John Prados. THIRD REICH will feature three sets of counters, a mammoth four-ply mapboard, bookcase packaging and a \$10 pricetag.

That about sums up our "sneak previews" of the new games you can expect this year from Avalon Hill. Hopefully, our reviews were less biased than the one which prompted ours.

This is, however, not all that we're doing in the way of design. We have not forgotten the existing games. We are aware that the state of the art has advanced and left some of our older titles in need of revision, and others in need of clarification. Rather than taking the easy way out, and just issuing errata sheets we are completely overhauling the rules of various titles and issuing new rulebooks, hopefully free of ambiguities and contradictions. We'll provide you with more information on this phase of our operation as the printing date approaches.

Turning now to the magazine feedback from last issue we find a number of interesting developments. 'Leyte Gulf' was voted the best article of the year despite having been bested two issues later by Tom Oleson's "Anzio — Portrait of a Game." This shows one of the fallacies of our bi-monthly rating system in which the rating of an article depends in large part on the quality of the supporting cast. If an issue was exceptional, articles will fare less well than had they been in a relatively weaker issue. To get a fair overall comparison we need the 'end of year survey' listing all the top articles together. Here is how that balloting came out.

BEST ARTICLE RATINGS

LEYTE GULF	2.86
OPERATION CRUSADER	3.14
CAMPAIGN AT WATERLOO	3.30
LUFTWAFFE ANALYSIS	3.38
ANZIO: PORTRAIT OF A GAME	3.70
D-DAY DEFENDED	3.72
ANATOMY OF A DEFENSE	3.75
ADVANCED BISMARK	4.26

The Design Analysis columns continue to bring up the rear of the ratings. This is partly our fault as we've yet to hit on the exact format we want for this feature. We think we're getting closer though and aren't about to give up now — not with all the new titles and design systems coming out of Avalon Hill. There will be much to say on the planning of new games and this is where we hope to say it.

DESIGN ANALYSIS RATINGS

PINSKY'S BULGE RECAP	3.47
POURNELLE'S FRANCE '40 CRITIQUE	3.70
REED'S RICHTHOFEN'S VARIANT	3.93
DUNCAN'S RETURN TO GAMING	3.98
SHAW'S MATRIX CONCEPT	4.04
ZOCCHI'S LUFTWAFFE CRT ANALYSIS	4.16

The rating of the editions as a whole backed up the feature article ratings. We reached a high with Vol. 10, No. 3 and followed it closely with Vol. 10, No. 4. This seems to indicate that it's the high class game variant which turns you on, rather than an in-depth game study. We have more of these in the works, although we're not about to limit ourselves to them entirely. But the apparent success of features like "Leyte Gulf" have insured that we will give such items top priority. This is one of the reasons we wanted to do away with the contests — to give us more room for variant counters on the heavy stock insert page, but 60% of you were for the contests so they'll continue and we'll do the best we can with the remaining space. The D-DAY feature in this issue is an example of a case in which the contest space could have been utilized for additional counters for the upgunned American and German units as well as fortification counters. Instead, we've had to settle for providing you with all the new units. You can tell which units are merely upgunned versions of the originals by looking at the historical designations. They are set in slightly larger type.

ISSUE RATINGS

Vol. 10, No. 3	2.73
Vol. 10, No. 4	2.78
Vol. 10, No. 6	3.03
Vol. 10, No. 1	3.05
Vol. 10, No. 2	3.12
Vol. 10, No. 5	3.13

The Series Replays are becoming better received all the time. The last one on BULGE just barely lost out to the feature article in our 600 point maximum scoring system. We expect the Replay to top the lead feature one of these days. They're getting closer as we continue to refine our presentation techniques. We still get letters complaining that the level of play in the Replays has been too low to merit plaudits. One such writer took Mr. Lowry (the American in the recent BULGE match) to task as being an incompetent. We find it hard to agree with that appraisal however and recognize Mr. Lowry as one of the leading authorities on that particular game. Many players have criticized but few have shown themselves willing to expose their play to the criticism of our impartial judges. It's one thing to recognize a good move, and quite another to execute it 100% free of mistakes. By and large our players are pretty respectable authorities, but when your every move is magnified and laid bare for all to see, it's pretty difficult to come off smelling like a rose with an audience of second guessers. Most of the errors or faulty judgements you commit in your own games are glossed over or ignored altogether in the course of FTF action. Indeed, we estimate up to 95% of all in-person games contain at least one major undetected illegal move.

SERIES REPLAY RATINGS

BULGE	2.58
MIDWAY	2.65
AFRIKA KORPS	2.89
STALINGRAD	3.01
1914	4.36
PANZERBLITZ	4.95

Putting on a Series Replay game is quite an endeavor in itself and is not a fun undertaking — either for the players or for us. Everything must be painstakingly recorded and commented on prior to the next turn without tipping your hand to your opponent. If someone makes an illegal move which isn't spotted until later, the whole thing has to be scrapped. Often, a dress rehearsal for the replays staged in advance to insure that both participants have the same interpretation of the rules and things usually go fine — often resulting in a really classic game. Thus, when the real thing starts, the games tend to drag and often are far less exciting than the preceding dress rehearsal — neither player wanting to stick his neck out unnecessarily. Series Replays are extremely expensive to produce, in terms of both time and graphics. And when some people complain that they can't follow along with the action because we show only one side's moves we begin to wonder whether it's worth it or not. If we showed every move graphically, the Replays would be intolerably long and consume the whole magazine. In many cases showing the defender's turn as he merely falls back to a new position is a waste of time and this same information can be readily absorbed by comparing the positions of the defending units to their positions in the previous move of the attacker. Showing the move of the side with the initiative seems to be the best course to pursue.

VOL. 10, NO. 6 RATINGS

GUADALCANAL: The Campaign, The Island, & The Game	351
SERIES REPLAY — BULGE	345
AVALON HILL PHILOSOPHY	110
BLITZKRIEG INVASION POSSIBILITIES	96
DESIGN ANALYSIS	81
A REALISTIC SOLUTION	78
GOLD RUSH	70
PANZERBLITZ REVISITED	69

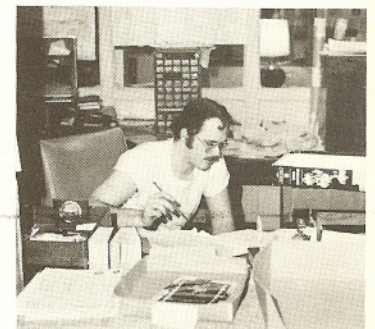

The strain of editing the new 34 pp format may be getting to our editor. 34 pp and only five articles! But next time—back to the Question Box, Design Analysis, and many more articles. At least that's what he tells us!

The Lake Geneva Tactical Studies Association will once again be sponsoring the Lake Geneva Wargames Convention, known throughout the wargaming world as Gen Con. 1974 marks the 7th anniversary of Gen Con and the event has been expanded to three days in honor of this; the oldest of American wargaming conventions.

All gamers of any persuasion are invited to the Horticultural Hall, 330 Broad Street, Lake Geneva, WI for a 3 day weekend of fun August 23rd—25th for the fun and competition of Gen Con VII. The doors will open at noon on Friday and close at 11 P.M. Saturday will commence at 7:30 A.M. and continue through 11. The convention site will open on Sunday for the last time at 9 A.M. and close at 8. The events schedule includes competition in every popular period of miniatures and the featured Avalon Hill *STALINGRAD* tournament utilizing 4-5-6 replacement rates. Inquiries should be sent to Gary Gygax, 330 Center St., Lake Geneva, WI 53147.



Speaking of *STALINGRAD* tournaments, the winner of Interest Group Baltimore's First Annual Tournament was Robert J. Beyma (above right) of Alexandria, VA who makes the trek to the Avalon Hill gameroom whenever there's loot to be won. Besides the pictured trophy Mr. Beyma walked away with 4 new games, courtesy of Avalon Hill. Among the entrants topped by Mr. Beyma was Bruno Sinigaglio—noted winner of last year's EAST CON in New York. The unsavory character at the left, by the way, is your intrepid editor, fresh from another all night stand on a current playtest. If you'd like to drop in at the gameroom to pick up half-priced games (damaged) or join in the testing or just plain play a game feel free to do so any Saturday between 10 and 5 at 1501 Guilford Ave., Baltimore, MD 21202.

The "Flying Buffalo's 2nd Annual Convention" will be held from 9 A.M. June 28th to 5 P.M. June 30th at 217 E. Garfield, Tempe, AZ. The big shtick here is computer-moderated multi-player wargames although tables will be available for more conventional games. For more details contact Richard Loomis, P.O. Box 1467, Scottsdale, AZ 85252.

When submitting questions to us for answers on rules of play, be sure to fully diagram all situations rather than merely listing grid coordinates. Also, be sure to mention that you are a GENERAL subscriber so your questions can be given priority over non-subscribers.

Infiltrator's Report



English gamers have been getting Avalon Hill games in increased supply thanks to the efforts of our exclusive agent in England, Michael Hodge (above right). Limeys interested in picking up Avalon Hill games should contact Michael at his 646 High Rd., N. Finchley, London address.



Pictured above are the volunteer workers of the Avalon Hill booth at the recent Model and Crafts Consumer Show in Anaheim, CA. The four Spartans (members of Spartan International—a professional gaming organization) played games during the show and fielded questions from the 25,000 in attendance on both Avalon Hill games and wargaming in general. Miss MACS was also a definite asset and aided immeasurably in the games playing. Is it any wonder we're swamped with volunteers to man our exhibits?

LOYAL SUBSCRIBER DEAL: This month's special offer is a collector's paradise. Recently while moving one of the company's executive officers to a new home, a cache of forgotten "library" games was unearthed deep in his basement. Avalon Hill has always kept a library of two copies of every game and version ever produced. Way back in the early sixties when the company moved, this library was deposited in the above mentioned basement and forgotten. Since then the library was restocked with new titles and is still full strength. But this unearthing of the old library provides a few more of those

scarce titles to be shuttled out among the collectors. Most of these games are in store condition; having never been played. Following is a list of what's available now in the way of collector's goodies:

Quantity	Title	Collector's Price
1	Nieuchess	\$15.00
3	U-Boat	\$18.00
	(1st edition w/metal ships)	
1	U-Boat (cardboard counters)	\$12.00
4	Management	\$10.00
3	Air Empire	\$15.00
4	Verdict II	\$10.00
3	D-Day '61	\$15.00
1	Jutland	\$15.00
1	Guadalcanal	\$15.00
7	Word Power	\$10.00
2	Civil War	\$30.00
2	Hex Gettysburg	\$30.00
1	Chancellorsville	\$30.00
1	Bismarck	\$15.00
1	C&O/B&O	\$18.00
4	Lemans	\$15.00
1	Dispatcher	\$15.00
3	Bismarck	\$18.00
	(1st edition—gaint boxes)	
3	Stalingrad (gaint boxes)	\$15.00
1	Waterloo (gaint boxes)	\$15.00
14	Baseball (flat box editions)	\$ 6.00
4	Football (flat box editions)	\$ 6.00

Now—how to parcel these out fairly to the many interested collectors of first editions. We started out by disqualifying Avalon Hill employees—several of whom were foaming at the mouth at the prospect of adding a perfect Civil War or Hex Gettysburg to their collections. Then we decided to limit it to GENERAL subscribers only. This still leaves many more collectors than games available, so here's how we'll handle it—if you're interested in any of the above games send us a list of the games you are interested in purchasing at the above prices along with a stamped, self-addressed envelope. Send no money! We'll then hold a drawing for each collector's item in which there are more requests than games. The winner will be notified that he can purchase the game and upon receipt of his check, the 1st edition will be sent. The postage coupon printed in this issue of the GENERAL will suffice for postage costs.

The Cincinnati Games Convention, scheduled for July 12-14, 1974, promises to be another 1st rate affair. The event will be held at the Xavier University Armory for a two-day admission charge of \$2.50 if preregistered prior to July. University dorms will be made available for convention attendees for the very reasonable rates of \$6 per night (single), or \$4.00 for double occupancy. These air conditioned, modern buildings are the utmost in convention facilities. The main event will be an Avalon Hill Tournament to be umpired by the Professional Wargamer's Association. The winner will receive \$100 cash. An additional \$150 in other prizes through 10th place make this the boardgame convention of the year!!! Participants may play any game in the tournament that an opponent is agreeable to, but must know how to play *Afrika Korps* which will be used when opponents can not be matched for other preferences. There is an additional \$2.50 fee to enter the tournament. Interested parties should write Jack Hesselbrock, 311 Miami Valley Dr., Loveland, OH 45140 or call 513-831-5343 prior to July. Prices will rise at the door.

OPPOONENTS WANTED

Will buy, trade or sell games. Want Bismarck and G-Canal. Will pay reasonable price. Also, seek members for the 152G-FBI-Bulge. Call or write Dennis Cook, 3526 S. Vista Dr., Birmingham, AL 35226-0019.

IFT opponents wanted for Richthofen's War or anything else you can teach. Mike Dickens, 6509 Chevy Chase St., Anchorage, Alaska 99502, 344-6668.

The real historical OOBI. No artillery, pilot systems, aircraft, mechanized movement. Pbm hard core. Fr. 1940. Send \$5. A.E. for the rules, pick either choice. Richard Cochran, 2914 E. Moreland, Phoenix, AZ 85008, 275-3723.

Will play all who write in P-Bitz, AK, D-Day, F-40. Either side play only. Prompt response guaranteed! Alan Davis, 1219 N. State, Ft. Lauderdale, FL 33304, 561-357-1111.

Opponents wanted, age 14, won't mind being wiped out in L-Waffe. Bismarck, Richthofen, War, and will learn others. Any clubs around? Joe Irwin, Stonybrook, Anaheim, CA 92804, 827-3532.

German war machine on move again! Will play advanced FT. L-Waffe, P-Bitz. Will play most any night. Frank Risky, 8533 Ramona St., Bellflower, CA 90706, 213-633-1792.

For sale one Management Game, Civil War. Both complete and in excel. shape. Highest Bidder over \$25.00 for each. G. N. Wulfsberg, 270 Igo Way, Boulder Creek, CA 95006, 408-338-2689.

Write for G-Burg for \$5.00. Excellent condition. For sale details. Tom Larsen, 4523 Engberg Ct., Carmichael, CA 95608, 487-7036.

Will trade Pbm opponents for Anzio, G-Canal. Will trade Luftwaffe for Anzio or G-Canal. Also separately interested in a club in my area. Please help. Vince Glady, Country Club Ln., Corona, CA 91720, 951-262-1111.

Average player, Jr. High School age desires IFT opponents in AK, PzBitz, K-Spiel, R-War, L-Waffe. Also will train others for reasonable price. River Forest, 2735 W. 111th St., Chicago, IL 60648, 773-435-3232.

Will trade Pbm opponents for Anzio, G-Canal. Also separately interested in a club in my area. Please help. Vince Glady, Country Club Ln., Corona, CA 91720, 951-262-1111.

Need IFT victims for Afrika Korps, (I'm German) or anything you have. Will buy good Guadalcanal and Waterloo. Richard Eaton, 4308 Douglas Ct., Pleasanton, CA 94566, 415-846-8365.

Anyone interested in forming a wargaming club in Rancho Cordova? If so, please contact me. We can get it together. Everett E. Haslett, 2709 El Capitan, Rancho Cordova, CA 95670, 362-2108.

For swap new PzBitz for Midway. Want Luft, or PzBitz, opp. ppm of Ft. Sacto-Roseville Area. Javier Soils, Jr., 824 Q St., Rio Linda, CA 95673, 929-1277.

Want Mini 1914 \$8.00 or best offer. Wanted Juliano, Anzio in good condition. Send description and price. Will trade. Also will find anything. Jeff Attebery, 717 Tangewood, Greenville, CA 95026, 530-294-309.

Experienced PzBitz/Bulge desires IFT opponents for almost all AH games. Michael Shields, 18 Amethyst Way, San Francisco, CA 94116, 415-777-1111.

I am interested in the art (science?) of war game design. Antonio Lead, 15450 Monica area interested? Antonio Lead, 15450, Santa Monica, CA 90404, 310-312-9292.

Cavaliers (Paul Mankiewicz) paingooos B-ball league at 6-1. Now forming 1914 Football league (see p. 21 Mar-Apr. Agenda). Also plan to form a new AH wargaming club. Call Mike W. LaVerne, Santa Ana, CA 92704, (714) 556-7119.

Pbm opponents wanted for 1914, PanzerBitz, F-40. IFT also wish to join a club in my area. Mark J. Cery, 46 Escanaba Dr., So. San Francisco, CA 04080, (415) 761-4919.

Wanted: Anzio good condition. Send price. Will trade. Also will find anything. Jeff Attebery, 717 Tangewood, Greenville, CA 95026, 530-294-309.

Will play John Penner's 1584 Canal St. Studio. CA 91664, 763-1967.

Will play John Penner's 1584 Canal St. Studio. CA 91664, 763-1967.

Will play John Penner's 1584 Canal St. Studio. CA 91664, 763-1967.

Will play John Penner's 1584 Canal St. Studio. CA 91664, 763-1967.

Will play John Penner's 1584 Canal St. Studio. CA 91664, 763-1967.

Will play John Penner's 1584 Canal St. Studio. CA 91664, 763-1967.

Will play John Penner's 1584 Canal St. Studio. CA 91664, 763-1967.

Will play John Penner's 1584 Canal St. Studio. CA 91664, 763-1967.

Will play John Penner's 1584 Canal St. Studio. CA 91664, 763-1967.

Will play John Penner's 1584 Canal St. Studio. CA 91664, 763-1967.

Will play John Penner's 1584 Canal St. Studio. CA 91664, 763-1967.

OPPOONENTS WANTED

New wargamer wants if G-Burg, A-Korps, S. G-Burg, D-Day, or anything else you can teach. Will play even if losing. Dave Roberts, 10875 SW 21st., Apt. 1, Miami, FL 33170, 278-5557.

Need IFT opponents for any Avalon Hill wargame. I am college age of good ability with a strong desire for any type player! Glenn Temple, 2701 SE 6th St., Pompano Beach, FL 33062, 305-782-8888.

Need complete "Anzio and/or 1914" lowest bid accepted (mail bids) also will Bismarck, PzBitz, Bulge, D-Day, etc. Fred Botter, 2241 Algonzo Road, Stone Mountain, GA 30083, 294-7584.

An invitation from Strategic Air Command to play R-War, L-Waffe. Also will Bismarck, D-Day, Midway, PzBitz, F-40, others, 1776 if possible.

Average player, prefer Allies. Glenn Brooks, P.O. Box 6, Calhoun, GA 30701, (404) 629-7148.

Need IFT opponents of high school age needs IFT. Have W-Loop. Will play anyone. Am I the only German on this fool island? Help! Peter Willey, 11 Spring St., Hills, HI 96720.

Need IFT opponents in Oahu area. Have most AH games. Steve Crossman, 17, 277 California Ave., Wahiawa, HI 96786, 762-6593.

Average player of college age desires ppm opponents for Anzio, G-Canal, Midway, 1616 Oak Park Ave., Berwyn, IL 60402, (312) 484-6511.

Average adult seeking IFT opponents for Richthofen's War, PzBitz, A-Korps, D-Day, G-Burg, Juliano, U-Boat, Bismarck, Bulge and other. I have all games. Thomas A. Konczal, 5228 S. Sawyer, Chicago, IL 60632, (312) 471-4171.

Will purchase AH games, out-of-print, new, current, etc. Price is no object. Will accept phm challenges to all AH games. Mike Nowinski, 1010 N. LaSalle, Chicago, IL 60610.

For sale: 1914 in mint store bought cond. Never been played. Will trade 3 weeks for bids. Don't miss! 1914 Closeouts, Chillochito, IL 61523, 274-2409.

Above average player college age. Pbm PzBitz, Fr. 1940, K-Spiel, Chooch, 9207 Ridgeview Way, Germantown, WI 53032, 262-2222.

Wishes to contact any gamers at Northwestern University in Ft. Fred Mecca, 9230 Irving, Evanston, IL 60203, 679-4917.

IFT board games and miniatures players wanted for Sparta and P.W.A. I need convention information. Paul DeVolio, 603 Columbus, Waukegan, IL 60087, 847-297-9999.

Will trade Outdoor Survival perfect condition for Juliano, Bismarck, 1914, PzBitz or Origins W.W.II. Stephen Tietz, 622 E. Carroll, Macon, GA 31206, 478-842-9999.

Desperately wanted and needed: Anzio, Juliano, U-Boat, Bismarck. Will play almost anything. Joe Sikorski, 1410 N. Lathrop Ave., Seattle, WA 98107, 325-7166.

Wanted phm opponents. Also will find anything. Will trade. Also will find anything. Jeff Attebery, 717 Tangewood, Greenville, CA 95026, 530-294-309.

Wanted phm opponents. Also will find anything. Will trade. Also will find anything. Jeff Attebery, 717 Tangewood, Greenville, CA 95026, 530-294-309.

Wanted phm opponents. Also will find anything. Will trade. Also will find anything. Jeff Attebery, 717 Tangewood, Greenville, CA 95026, 530-294-309.

Wanted phm opponents. Also will find anything. Will trade. Also will find anything. Jeff Attebery, 717 Tangewood, Greenville, CA 95026, 530-294-309.

Wanted phm opponents. Also will find anything. Will trade. Also will find anything. Jeff Attebery, 717 Tangewood, Greenville, CA 95026, 530-294-309.

Wanted phm opponents. Also will find anything. Will trade. Also will find anything. Jeff Attebery, 717 Tangewood, Greenville, CA 95026, 530-294-309.

Wanted phm opponents. Also will find anything. Will trade. Also will find anything. Jeff Attebery, 717 Tangewood, Greenville, CA 95026, 530-294-309.

Wanted phm opponents. Also will find anything. Will trade. Also will find anything. Jeff Attebery, 717 Tangewood, Greenville, CA 95026, 530-294-309.

Wanted phm opponents. Also will find anything. Will trade. Also will find anything. Jeff Attebery, 717 Tangewood, Greenville, CA 95026, 530-294-309.

Wanted phm opponents. Also will find anything. Will trade. Also will find anything. Jeff Attebery, 717 Tangewood, Greenville, CA 95026, 530-294-309.

Wanted phm opponents. Also will find anything. Will trade. Also will find anything. Jeff Attebery, 717 Tangewood, Greenville, CA 95026, 530-294-309.

Wanted phm opponents. Also will find anything. Will trade. Also will find anything. Jeff Attebery, 717 Tangewood, Greenville, CA 95026, 530-294-309.

Wanted phm opponents. Also will find anything. Will trade. Also will find anything. Jeff Attebery, 717 Tangewood, Greenville, CA 95026, 530-294-309.

Wanted phm opponents. Also will find anything. Will trade. Also will find anything. Jeff Attebery, 717 Tangewood, Greenville, CA 95026, 530-294-309.

Wanted phm opponents. Also will find anything. Will trade. Also will find anything. Jeff Attebery, 717 Tangewood, Greenville, CA 95026, 530-294-309.

Wanted phm opponents. Also will find anything. Will trade. Also will find anything. Jeff Attebery, 717 Tangewood, Greenville, CA 95026, 530-294-309.

OPPOONENTS WANTED

Knightsword Bld., Baltimore, MD 21239, 823-7347.

WANTED! IFT opponent for: 1940, Pz-Bitz, AK, K-Spiel, R-war, L-Waffe and K-Brieg. Will learn other AH games. Surely someone near me. Call Mike Weis, 3324 E. Haven Dr., Baltimore, MD 21207, 655-8580.

Pbm for M-Way, PzBitz, Waterloo, D-Day. Also will sell C&O B&O, LeMans, best price or trade. Mike Weis, 3324 E. Haven Dr., Baltimore, MD 21207, 655-8580.

Need complete "Anzio and/or 1914" lowest bid accepted (mail bids) also will Bismarck, PzBitz, Bulge, D-Day, etc. Fred Botter, 2241 Algonzo Road, Stone Mountain, GA 30083, 294-7584.

An invitation from Strategic Air Command to play R-War, L-Waffe. Also will Bismarck, D-Day, Midway, PzBitz, F-40, others, 1776 if possible.

Average player, prefer Allies. Glenn Brooks, P.O. Box 6, Calhoun, GA 30701, (404) 629-7148.

Need IFT opponents of high school age needs IFT. Have W-Loop. Will play anyone. Am I the only German on this fool island? Help! Peter Willey, 11 Spring St., Hills, HI 96720.

Need IFT opponents in Oahu area. Have most AH games. Steve Crossman, 17, 277 California Ave., Wahiawa, HI 96786, 762-6593.

Average player of college age desires ppm opponents for Anzio, G-Canal, Midway, 1616 Oak Park Ave., Berwyn, IL 60402, (312) 484-6511.

Average adult seeking IFT opponents for Richthofen's War, PzBitz, A-Korps, D-Day, G-Burg, Juliano, U-Boat, Bismarck, Bulge and other. I have all games. Thomas A. Konczal, 5228 S. Sawyer, Chicago, IL 60632, (312) 471-4171.

Will purchase AH games, out-of-print, new, current, etc. Price is no object. Will accept phm challenges to all AH games. Mike Nowinski, 1010 N. LaSalle, Chicago, IL 60610.

For sale: 1914 in mint store bought cond. Never been played. Will trade 3 weeks for bids. Don't miss! 1914 Closeouts, Chillochito, IL 61523, 274-2409.

Above average player college age. Pbm PzBitz, Fr. 1940, K-Spiel, Chooch, 9207 Ridgeview Way, Germantown, WI 53032, 262-2222.

Wishes to contact any gamers at Northwestern University in Ft. Fred Mecca, 9230 Irving, Evanston, IL 60203, 679-4917.

IFT board games and miniatures players wanted for Sparta and P.W.A. I need convention information. Paul DeVolio, 603 Columbus, Waukegan, IL 60087, 847-297-9999.

Will trade Outdoor Survival perfect condition for Juliano, Bismarck, 1914, PzBitz or Origins W.W.II. Stephen Tietz, 622 E. Carroll, Macon, GA 31206, 478-842-9999.

Desperately wanted and needed: Anzio, Juliano, U-Boat, Bismarck. Will play almost anything. Joe Sikorski, 1410 N. Lathrop Ave., Seattle, WA 98107, 325-7166.

Wanted phm opponents. Also will find anything. Will trade. Also will find anything. Jeff Attebery, 717 Tangewood, Greenville, CA 95026, 530-294-309.

Wanted phm opponents. Also will find anything. Will trade. Also will find anything. Jeff Attebery, 717 Tangewood, Greenville, CA 95026, 530-294-309.

Wanted phm opponents. Also will find anything. Will trade. Also will find anything. Jeff Attebery, 717 Tangewood, Greenville, CA 95026, 530-294-309.

Wanted phm opponents. Also will find anything. Will trade. Also will find anything. Jeff Attebery, 717 Tangewood, Greenville, CA 95026, 530-294-309.

Wanted phm opponents. Also will find anything. Will trade. Also will find anything. Jeff Attebery, 717 Tangewood, Greenville, CA 95026, 530-294-309.

Wanted phm opponents. Also will find anything. Will trade. Also will find anything. Jeff Attebery, 717 Tangewood, Greenville, CA 95026, 530-294-309.

Wanted phm opponents. Also will find anything. Will trade. Also will find anything. Jeff Attebery, 717 Tangewood, Greenville, CA 95026, 530-294-309.

Wanted phm opponents. Also will find anything. Will trade. Also will find anything. Jeff Attebery, 717 Tangewood, Greenville, CA 95026, 530-294-309.

Wanted phm opponents. Also will find anything. Will trade. Also will find anything. Jeff Attebery, 717 Tangewood, Greenville, CA 95026, 530-294-309.

Wanted phm opponents. Also will find anything. Will trade. Also will find anything. Jeff Attebery, 717 Tangewood, Greenville, CA 95026, 530-294-309.

Wanted phm opponents. Also will find anything. Will trade. Also will find anything. Jeff Attebery, 717 Tangewood, Greenville, CA 95026, 530-294-309.

Wanted phm opponents. Also will find anything. Will trade. Also will find anything. Jeff Attebery, 717 Tangewood, Greenville, CA 95026, 530-294-309.

Wanted phm opponents. Also will find anything. Will trade. Also will find anything. Jeff Attebery, 717 Tangewood, Greenville, CA 95026, 530-294-309.

Wanted phm opponents. Also will find anything. Will trade. Also will find anything. Jeff Attebery, 717 Tangewood, Greenville, CA 95026, 530-294-309.

Wanted phm opponents. Also will find anything. Will trade. Also will find anything. Jeff Attebery, 717 Tangewood, Greenville, CA 95026, 530-294-309.

OPPOONENTS WANTED

Wish to buy used Avalon Hill games especially West, Waterloo, D-Day, PzBitz. Will fit above plus 10-10, M-Way, K-Spiel. Will fit 1776 soon. No phm sheets. Want Juliano, no pieces missing. good condition. Also G-canal, Ranken, 15 Connor St., Uniontown, PA 15001, (412) 343-7901.

Any game designers please write! Will sell 1414, Bulge, K-Spiel, G-burg, to highest bidder. All in great condition. Will wait 2 weeks for bids. Hurry! Write to: Mike Weis, 3324 E. Haven Dr., Baltimore, MD 45502, 964-8305.

Will trade France 1940 for Outdoor Survival. Will fit all opponents in Midway, G-burg, Blitz, Luft, Rich, War, Best Seafood, 805 Zimmerman Rd., St. Paris, OH 43072, (513) 663-4749.

IFT 14 AH games. Chess and other war games. Will take the Wehrmacht if in Europe. John Ogden, 4137 Mayflower Blvd., White Hall, OH 43213, 235-2020.

Anzio for sale. Excellent condition. One primary axis unit missing. Also have two 1914 and G-canal, all four uncut, brand new, well self depending on offers. E. James Harney, 24 Benton Ave., Youngstown, OH 44515, 338-1111.

1958 1914, Waterloo, D-Day, PzBitz, Richthofen's War, etc. Rules time record card, board, original Appearance Cards & more! Original parts. Call for complete Anzio. 21. John Mitchell, P.O. Box 4, McAlester, OK 74501, (405) 422-5322.

IFT or phm PanzerBitz, Luftwaffe, or France 1940. Call for details. P.O. Box 4, McAlester, OK 74501, (405) 422-5322.

For Sale: 12 Avalon Hill games. No pieces missing. Write for list. Origins in the only non-war game. Has price piece postage. Really Worth It! Country Club Cir., Midwest City, OK 73110.

Play Average adult game seekers opponents for fit play. Also any land board game. Call for details. King's Cross Road, Rusk buddy a line. Nathan Mitchell, P.O. Box 1305, North Ok, TX 76069, 321-0659.

Wanted: Anzio, Juliano, Bismarck, 1914, PzBitz, Richthofen's War, etc. Rules time record card, board, original Appearance Cards & more! Original parts. Call for complete Anzio. 21. John Mitchell, P.O. Box 4, McAlester, OK 74501, (405) 422-5322.

IFT or phm PanzerBitz, Luftwaffe, or France 1940. Call for details. P.O. Box 4, McAlester, OK 74501, (405) 422-5322.

IFT or phm PanzerBitz, Luftwaffe, or France 1940. Call for details. P.O. Box 4, McAlester, OK 74501, (405) 422-5322.

IFT or phm PanzerBitz, Luftwaffe, or France 1940. Call for details. P.O. Box 4, McAlester, OK 74501, (405) 422-5322.

IFT or phm PanzerBitz, Luftwaffe, or France 1940. Call for details. P.O. Box 4, McAlester, OK 74501, (405) 422-5322.

IFT or phm PanzerBitz, Luftwaffe, or France 1940. Call for details. P.O. Box 4, McAlester, OK 74501, (405) 422-5322.

IFT or phm PanzerBitz, Luftwaffe, or France 1940. Call for details. P.O. Box 4, McAlester, OK 74501, (405) 422-5322.

IFT or phm PanzerBitz, Luftwaffe, or France 1940. Call for details. P.O. Box 4, McAlester, OK 74501, (405) 422-5322.

IFT or phm PanzerBitz, Luftwaffe, or France 1940. Call for details. P.O. Box 4, McAlester, OK 74501, (405) 422-5322.

IFT or phm PanzerBitz, Luftwaffe, or France 1940. Call for details. P.O. Box 4, McAlester, OK 74501, (405) 422-5322.

IFT or phm PanzerBitz, Luftwaffe, or France 1940. Call for details. P.O. Box 4, McAlester, OK 74501, (405) 422-5322.

IFT or phm PanzerBitz, Luftwaffe, or France 1940. Call for details. P.O. Box 4, McAlester, OK 74501, (405) 422-5322.

IFT or phm PanzerBitz, Luftwaffe, or France 1940. Call for details. P.O. Box 4, McAlester, OK 74501, (405) 422-5322.

IFT or phm PanzerBitz, Luftwaffe, or France 1940. Call for details. P.O. Box 4, McAlester, OK 74501, (405) 422-5322.

IFT or phm PanzerBitz, Luftwaffe, or France 1940. Call for details. P.O. Box 4, McAlester, OK 74501, (405) 422-5322.

IFT or phm PanzerBitz, Luftwaffe, or France 1940. Call for details. P.O. Box 4, McAlester, OK 74501, (405) 422-5322.

IFT or phm PanzerBitz, Luftwaffe, or France 1940. Call for details. P.O. Box 4, McAlester, OK 74501, (405) 422-5322.

IFT or phm PanzerBitz, Luftwaffe, or France 1940. Call for details. P.O. Box 4, McAlester, OK 74501, (405) 422-5322.

IFT or phm PanzerBitz, Luftwaffe, or France 1940. Call for details. P.O. Box 4, McAlester, OK 74501, (405) 422-5322.

IFT or phm PanzerBitz, Luftwaffe, or France 1940. Call for details. P.O. Box 4, McAlester, OK 74501, (405) 422-5322.

IFT or phm PanzerBitz, Luftwaffe, or France 1940. Call for details. P.O. Box 4, McAlester, OK 74501, (405) 422-5322.

IFT or phm PanzerBitz, Luftwaffe, or France 1940. Call for details. P.O. Box 4, McAlester, OK 74501, (405) 422-5322.

IFT or phm PanzerBitz, Luftwaffe, or France 1940. Call for details. P.O. Box 4, McAlester, OK 74501, (405) 422-5322.

OPPOONENTS WANTED

Wish to buy used Avalon Hill games especially West, Waterloo, D-Day, PzBitz. Will fit above plus 10-10, M-Way, K-Spiel. Will fit 1776 soon. No phm sheets. Want Juliano, no pieces missing. good condition. Also G-canal, Ranken, 15 Connor St., Uniontown, PA 15001, (412) 343-7901.

Any game designers please write! Will sell 1414, Bulge, K-Spiel, G-burg, to highest bidder. All in great condition. Will wait 2 weeks for bids. Hurry! Write to: Mike Weis, 3324 E. Haven Dr., Baltimore, MD 45502, 964-8305.

Will trade France 1940 for Outdoor Survival. Will fit all opponents in Midway, G-burg, Blitz, Luft, Rich, War, Best Seafood, 805 Zimmerman Rd., St. Paris, OH 43072, (513) 663-4749.

IFT 14 AH games. Chess and other war games. Will take the Wehrmacht if in Europe. John Ogden, 4137 Mayflower Blvd., White Hall, OH 43213, 235-2020.

Anzio for sale. Excellent condition. One primary axis unit missing. Also have two 1914 and G-canal, all four uncut, brand new, well self depending on offers. E. James Harney, 2