

ISSUE

8

March
2008

STAR FRONTIERSMAN Magazine

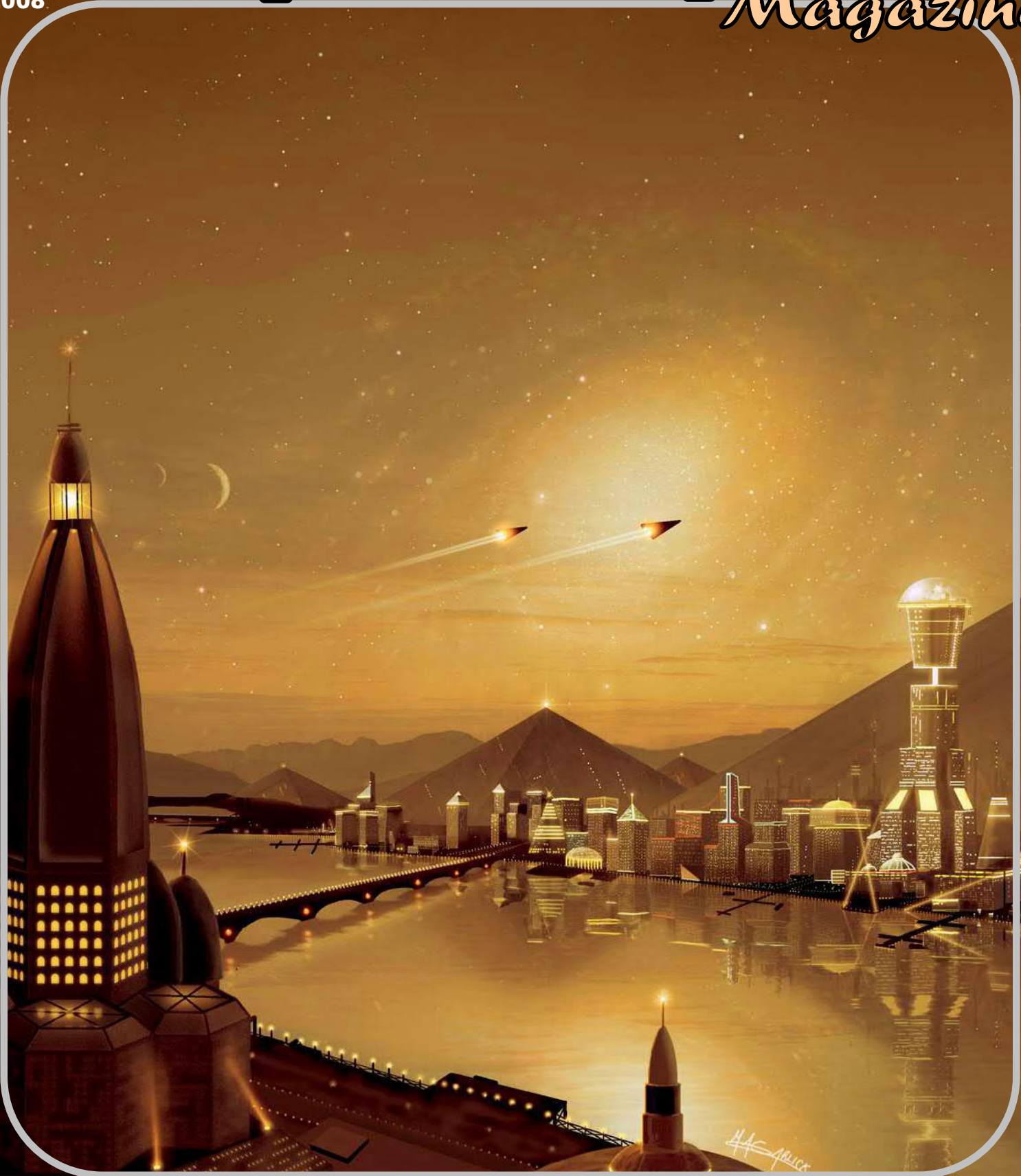

Art By Mark Garlick

Back in the RoboSaddle Again!

STAR FRONTIERSMAN

Magazine

i'm JUST ONE MAN!

FRONTIER TECHNICAL JOURNAL

Chronocoms, new and old, by Bill Logan1

YAZIRIAN CLANS

Calling all Clansmen! by Shadowshack8

TORRENT: DINOSAUR PLANET

A dangerous place indeed! by C.J.Williams11

SPAWN OF ZEBULON

The mysterious Eorna! by R. Kevin Smoot19

101 USES FOR A DEAD ROBOT

Short story by James Strain23

HOVERCYCLES

Known 'cycle gangs of the Frontier, by Shadowshack25

STARSHIPS

Explorer-class Heavy Scout, by Bill Logan.....29

THE LAW AND THE JUSTICE

Story by William Signs35

ABLATIVE DAMAGE

New damage system by Bill Logan45

EQUIPMENT

New gear for adventurers.....49

GORLIANS

Bull-headed brutes of the Frontier, by R. Bowman.....55

CREATIVE REFEREEING

How I help players have a good time, by Bill Logan.....57

MECHANON 2.0

New look & stats for Alpha Dawn, by Bill Logan.....62

KNIGHT HAWKS GAME CARDS

Print and use, by Bill Logan62

CLASSIFIEDS

Oh come on, you know you like these!.....Back cover

On the cover: Mark Garlick is an exceptional artist, and graciously gave us permission to use his artwork for the covers. You can be sure to find more of his imaginative pieces on future covers. Check out a sample of his works at <http://www.markgarlick.com>.

I know I've been leaving a lot of folks in the dark about what's going on and why the long delay with the Star Frontiersman. To be perfectly honest, the expectations of the size, scope, and quality of this webzine keep growing, and the demands on my time (non-hobby-related) keep growing and growing. These two things can't continue or I'll have to drop something. Since I won't drop the family, and can't drop my career... guess which one I'd drop if I had to choose one?

Sadly, this issue had much fewer submissions of size and quality. This is not to say that I don't appreciate all the hard work and quality submissions that I *have* received. I don't admonish a single one of you. It took a long time to accumulate enough material to form an issue the size and quality of which you've all become accustomed. Sadly, I've heard far more queries "where is issue 8? When is it coming out?" and far too few submissions. You'll notice an inordinate amount of material generated by me in this issue.

That's why I've decided that the scope of this webzine has exceeded the abilities of one man. I need to form a staff of people, each with a smaller role. I need to have a normalized method of submissions, and have a streamlined process so that I can put together a fully-tested, researched, proof-read issue whenever there is enough material accumulated to do so. Perhaps if ownership of the webzine expanded to include many of you, you'll all submit more regularly.

I still want to be the chief editor, and possibly one of the most prolific submitters of material. But I can't do all of this alone. Here's the list of staff members I need, but this might change over time as the process takes form:

Submission Editor – basically performs front-line triage on article submissions, providing answers such as *needs more examples*, *perfect as-is*, *needs full stats*, *elaborate*, etc. back to the submitter, forwarding accepted submissions to Line Editor. Forwards art submissions to Art editor. Important for gathering proper info from submitter (name to be credited, email addy, etc), and that nothing is purely plagiarized or could get us in legal trouble.

Line Editor – must be better with the English language than I am haha... able to proofread, edit, etc. Must make sure submissions fit within the Star Frontiers milieu, or that it's labeled as variant from accepted Star Frontiers canon. If artwork would make the article better (when wouldn't it?) he requests specific art from the Art Editor.

Art Editor – can be an artist himself, but need not be. Responsible for maintaining submitted artwork, associating it with articles submitted by the Line Editor, and for trolling the resources of gallery websites begging for free use of material. Must document permission and proper info from submitter.

Chief Editor (me)– I'll then receive artwork, articles, etc. and put them all in the layout, adding some material of my own to do what I've been doing all along, putting out quality webzines based off fan-created goodness. I'll even use this same process to submit my own articles. But I need to maintain quality oversight on all of it, or I won't feel right. Call me a control freak. Whatever ☺

More on this to come at
www.starfrontiers.us
Bill Logan
Referee@StarFrontiersman.com

FRONTIER TECHNICAL JOURNAL

By Bill
Logan

CHRONOCOMS

This article takes an up-close look at Chronocomms and their functionality in the Frontier. Ideas presented in this article are in use in my personal campaigns, in an attempt to correct a small portion of the naivety of the 1980's view of the future presented by the original editions of this game. At the same time, I try to keep the feel of this naivety by not going overboard with where personal communications might actually be in a society that spans the stars, as that might ruin the "frontier" feel to the game system.

HISTORY OF THE CHRONOCOM

The first appearance of a wrist-worn communications device came from the expedition to explore the Timeon system, by environmental scientists getting samples and performing atmospheric tests of Lossend in 148PF. They commissioned the communication devices in order to keep their hands free to use their envirokitts while still keeping in verbal touch with one another. At that time in history, humans, Vrusk, and Dralasites had already coordinated their frequencies and standardized on a communications methodology that was in line with Yazirian technology - but until this voyage, all communication was via hand-held devices. This early "handycom" could tell the time and could communicate on a single open frequency for 2.5km, resulting in small expeditionary trips from the mission's landers.

As the need for more portable communications gear rose, and people began settling the systems of the Frontier, the handycom evolved. Slowly taking more of the functionality of other hand-held devices, by 50PF it already had most of the functions of the Chronocomms sold in the modern Frontier. But the military still hadn't gotten a hold of it.

In 12PF, as PanGalactic Corporation was fighting for supremacy over the stars on a corporate front, agents of this and other corporate upstarts began clashing over unexplored and unclaimed prizes throughout the Frontier. These clashes seldom took the form of corporate mergers and negotiated financial arrangements: the Frontier was heating up, and it wouldn't throw these differences aside for another 15 years when the Sathar would arrive.

During these 15 years, the more militant elements of the maga-corporations began adding their needs to the otherwise domestic application of handycom technology. Multiple channels of communication became necessary to coordinate larger scale efforts,

and longer range became vital. The military required occasional subspace relay of communication, and demanded the development of secure encryption. Each corporation worked independently to create functions for the com gear of their special teams (of course, nobody called them *armies* - this was a corporate cold war). Many of the advanced features of the modern Frontier Chronocom are credited to the bright corporate minds of this era.

When the Sathar arrived in 3PF, corporations temporarily set aside their differences to fight this common enemy - and were forced to share trade secrets about their technologies. Before the fated meeting on Morgaine's World that would lead to the formation of the United Planetary Federation, the technical department figureheads of each of the mega-corporations met at the first Corporate Technical Conference on Lossend (Timeon system - in the same building in which the handycom was engineered nearly fifteen decades ago) to discuss formulating a better way for the Frontier to pass information, media, and communicate. The schematics of the subspace communications network (later to be known as S-CoN) was born from this meeting, and a new standard was born in portable communications: the Chronocom.

SATELLITE COMMUNICATION NETWORK

All worlds with Heavy or Medium population are covered by S-CoNs in the modern Frontier. Planets with Light populations lack satellites but have relay towers located at strategic locations to allow major population centers that exceed 5km in size to have the exact same coverage as a world monitored by a satellite - but as soon as you leave the major population centers the digital signal fails and you're back to using radio broadcast channels. Outpost worlds typically have no such towers, but entire population centers are usually within 5 kilometers in diameter.

The satellites themselves are made by Nesmith Enterprises of Triad - NET. They were built during Sathar War I to keep the forces of the corporate armies in touch while building the fleets that would later help form the fleets of the United Planetary Federation. The satellites are self-sustaining and are monitored by engineers around the clock, typically from remote locations. When a satellite goes down, Nesmith Enterprises of Triad can dispatch technicians to work on it within a day. All mega-corporations pay a small fee to NET for use of their services, which keeps the services free for the rest of the Frontier's population.

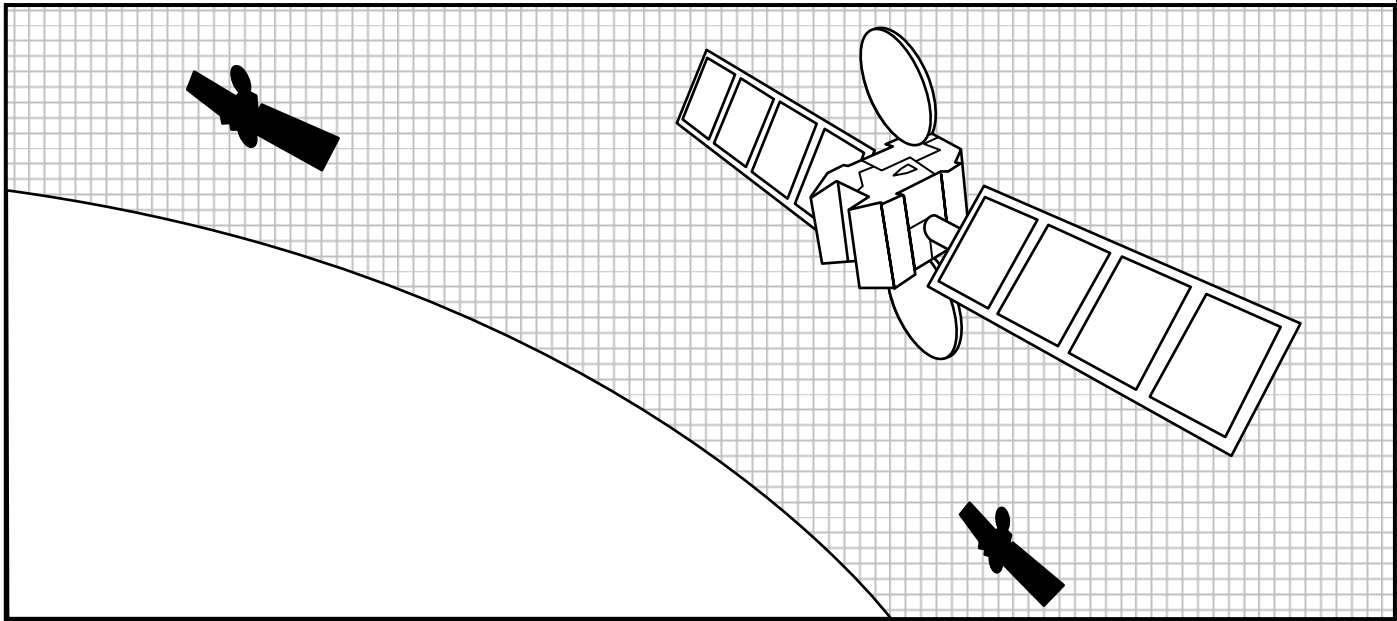

The satellites are able to pinpoint someone's location but will only do so for licensed Star Law detectives with proper clearance, and only under certain circumstances. For a huge fee, bounty hunters can obtain a license to give them similar rights for a single use of the triangulation process. Of course, triangulation is only possible if you know what world is under the boots of the person you're seeking.

THE BASIC CHRONOCOM

The modern Chronocom is a small, thin, watch sized device worn on the wrist. It has an adjustable band to fit all races. It has a very small but quite vibrant screen and a micro-camera capable of only a very short range. It is a combination wristwatch, calculator, and communicator. This is all well known, but there are many other functions and uses of this clever device that are examined below.

STANDARD FUNCTIONS

It's reasonable to assume that a Chronocom used in the modern Frontier has all of the functionality of a base-model cell phone from our own earth of today... but the special needs of the Frontier forces the inclusion of a few more abilities. Below is a list of basic standard functions found on all Chronocoms.

Power Supply. The power source is able to last nearly 5 years of regular use. It consists of a rechargeable chem-cell microbattery. It is recharged by vibration and motion; as a being walks about and performs normal everyday activities, he keeps the charge on his Chronocom full. If it sits idle for a year or so, it tends to lose its charge.

Memory. The specialized memory is divided into three main storage areas, each reserved for specific use. When one of these three memory areas is full, the wearer must delete some to allow more. Address Book memory (enough to store address, Chronocom number, and minor personal comments for up to 200 names), Voice Message memory (enough to store 200

minutes of voice messages), and Text Message memory (enough to store 200 short text messages). The memory can be removed from a small panel on the back of the Chronocom and switched to another device where the archives of messages and contacts can be viewed or modified.

Calculator. The device is a full-functioning calculator capable of doing math with different bases and floating points with a mantissa of 32.

Timepiece. The Chronocom has a free-running time which can be set by wearer/owner. If a Satellite Communications Network relay is present, it will synchronize with Galactic Standard Time. It is also possible to set the watch to self-adjust to local time. When this feature is activated, the timepiece evaluates solar and lunar activities through several sensors and estimates a local time.

For example, if your character is on Minotaur (Thesus) his Chronocom can show either Galactic Standard Time or (if he's calibrated it) local time. Since on Minotaur a day is only 15 galactic standard hours, Galactic Standard Time and local Minotaur time will not be the same.

The timepiece feature of the Chronocom includes up to 20 pre-settable alarms with various tones, and a calendar with reminder notes.

Messenger. The device is also capable of sending and receiving messages of either voice or text. Although it's less than convenient to use, the Chronocom actually has a miniature keypad capable of entering full sentences and paragraphs. It's possible to craft vocal or text messages and send them to one or more recipients. If the recipient's Chronocom lacks space for the message or is not on (or is out of range), the message gets queued for later delivery and will automatically retry until it makes connection. The recipient is made aware of receiving a message by annunciation on the display.

Subspace Relayed Messages. An S-CoN can relay messages of text or voice to other S-CoNs in orbit around other distant worlds. This takes a great deal of time, however, as subspace communication packets race across the Frontier at a rate of 1 light year per hour. Also, the satellite network doesn't know where the recipient is – the sender of the message must specify the destination world. If the recipient is not present at the destination the satellite will hold the message for 20 hours, trying once each hour until the recipient is found. If it never finds the recipient, it returns the message back to the place of origin as a "failed" message. Messaging cannot be used on a world without coverage by a Satellite Communication Network.

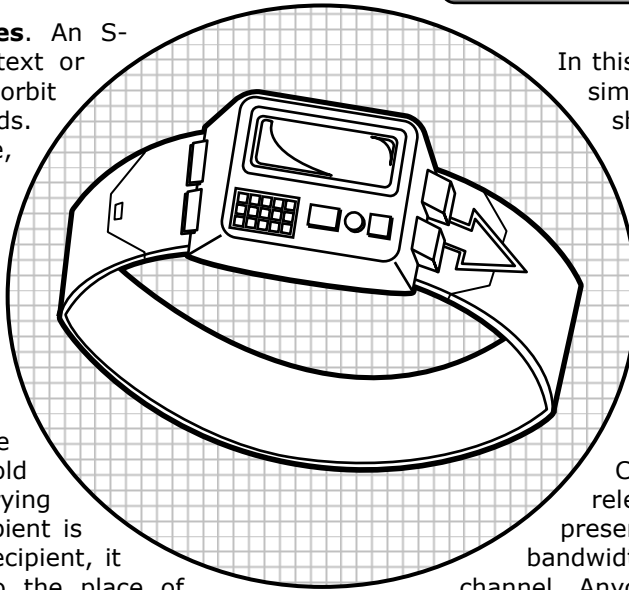

In this mode, the device will function similarly, but only within a very short range (5 kilometers is typical, though with favorable local weather conditions it may be as much as 7.5km or as low as 2.5km).

There are 20 channels for analog radio communication, each a different radio frequency. When in radio broadcast mode, you don't specify a recipient; individual Chronocom numbers are not relevant since no satellite is present to multiplex and coordinate bandwidth usage. You simply specify a channel. Anyone using that channel can hear anyone using that channel – it's not secure.

On the display of the chronocom will be the numbers of the channels you're currently set to listen to. For example, you might set your chronocom to communicate on all frequencies. Or you might just choose channels 1 and 2, etc.

For Example: your character is on Hentz, in the Araks system and wants to send a message to his employer on Gran Quivera (Prenclar system). The message would first be relayed to Yast's satellite in the Athor system, which would take 8 hours. The signal would be verified and repackaged and then passed on to the Prenclar system to the satellite in orbit around Gran Quivera, which would take 11 hours. Assuming the recipient is present on Gran Quivera, he'd receive the message in 19 hours. You'd not get your response for another 19 hours (assuming he responded immediately).

For example: two teams of explorers disembark from their lander, one to explore north of the ridge and one to explore south. The team members heading north all agree to use channel 10 for communications, and the southern team selects to use channel 11. Channel 1 will be for team-to-team communication. Therefore, the North team sets their chronocoms to channels 1 and 10, and the south team channels 1 and 11.

Digital Communication. If a Satellite Communication Network (S-CoN) is present in orbit around the world the character is on, the Chronocom's signal can reach anyone on that same planet as long as the recipient's personal number is known. This is referred to as having a *digital* signal.

If security is needed, any channel can be made *monitored*. When it's monitored – it shows on the display the quantity of all those within range connected to that channel. When you're communicating on a secure/monitored channel, that is the only channel you're able to communicate on at that moment.

The recipient is made aware of the incoming call by a small vibration on the wrist or an audible beep (depending on personal settings). Text on the display of the device will show the number of who's calling (or his/her name if that person is noted in the recipient's address memory area). The recipient can tap an acknowledgement to answer the call.

Torash (second in command of the north team) needs to inform the leader of the south team of her leader's treachery. She calls him on channel 1 and everyone sees on their display a call request on channel 1. He answers the call. She doesn't know if anyone else also answered it, so she says "Hi, Jon. We need to talk in private about something... switch to channel 2 and make it secure."

Once communication is accepted, the short range low-resolution camera built into the Chronocom activates and both beings enjoy a conversation with audio and video components.

If the recipient doesn't answer, the caller can choose to leave a text or voice message (no video message).

Both switch to channel 2 and hit the "secure channel" button on their Chronocoms. They wait a few moments and finally see "2 com devices secure on Channel 2" on the display and can now speak freely. If someone else pops on to channel 2, they'll be added to the conversation and all three will see "3 com devices secure on Channel 3" after an audible tone, alerting them of someone coming into the secure channel.

Analog Communication. If no S-CoN is present, the Chronocom switches to radio broadcast mode (referred to as analog signal mode, but don't confuse that with analog communication of 20th century cellular phones; it's more like radio communication).

OTHER COM TECHNOLOGY

There exists an entire host of various pieces of equipment that can be purchased or used that uses the Chronocom technology, frequencies, and networks. Communication via this technology is thoroughly wide-spread throughout the settled worlds of the Frontier.

The Visocom was discussed in issue 1 of the Star Frontiersman and represents but one of several other forms of personal gear available in the Frontier which uses Chronocom networks. Well-designed personal transportation devices (such as luxury skimmers and ground cars, most air cars) include hands-free Chronocom devices for use on civilized worlds (and most of them even have the analog communication feature for 5km ranged communication on worlds not covered by S-CoNs). Such pieces of technology usually cost less than a standard Chronocom because they lack certain features and because miniaturization isn't always necessary. On a heavily populated civilized world, it should not be a problem to find a way to call someone: public Chronocom stations exist in parks and on the corners of busy streets where for a single Credit you can make a short Chronocom call to anyone covered by the S-CoN, or for 10 Credits even send a message via the subspace relay features of those satellites.

Some militaries mount chronocom technology on the sleeves of uniforms, or the collars. Some other uniforms sport chronocoms over the heart/breast and shape the device specifically to designate rank or social position. Chronocoms are so wide-spread in the Frontier that they make their way even into religious institutions: it's not considered sacrilege for revered holy symbols to double as communication devices.

Some additional forms of Chronocom technology are also worthy of mentioning:

ADVANCED CHRONOCOM

The advanced Chronocom is a sleek if larger version of the basic one. It costs 250 Credits - two and a half times what a standard one costs. It's available in most commercialized markets in the free Frontier. It has all of the features of a standard version, with the following differences:

Memory. The advanced version has 2.5 the memory capacity of its inferior brother. Address Book memory can hold 500 contacts, Voice Message memory 500 minutes, and Text Message memory 500 short text messages. It can also hold 50 video messages (see

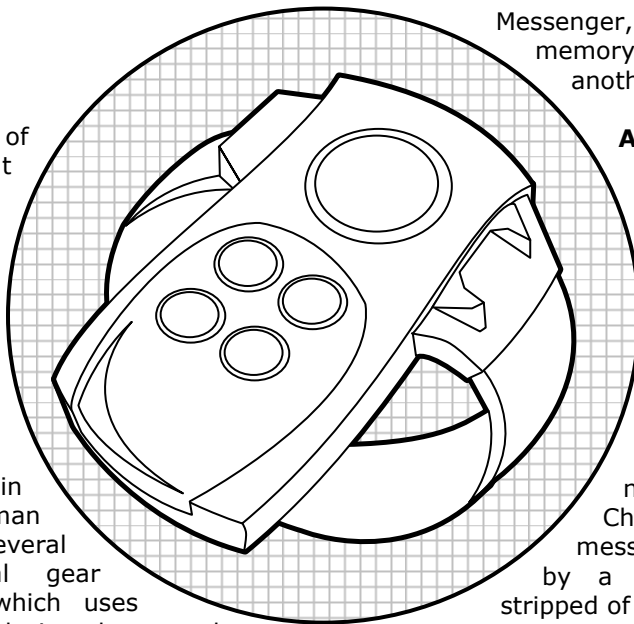

Messenger, below). The removable memory card can only be inserted into another advanced Chronocom.

Analog Communication. The typical maximum range of radio broadcast communication is 10km instead of 5km. Depending on weather conditions, that might allow a lucky signal to extend to nearly 12.5km.

Messenger. The advanced Chronocom can send video messages in addition to the normal types. Only an advanced Chronocom can receive a video message. Video messaging received by a standard Chronocom will be stripped of its video component.

Keypad. There is no keypad on the advanced version. There is instead a holographic projector and positioning detection array. It causes a holographic keypad to float in the air next to the user's wrist, which can be typed on as if it were real. It's translucent and obviously not a real keyboard - but it functions as one.

Screen & camera. The advanced version doesn't have a standard small crystal screen. Instead, it supports a miniature hologram projector array capable of making the head of the person you're communicating with (digitally) float above the wrist, large and personal. If communicating with someone also using an advanced Chronocom, the hologram will be three dimensional.

BIOCOM

Recent advances in bio-electronics has produced this interesting options for those not wanting to ever have their Chronocom taken away from them. It's a subdermal implant that gets inserted between layers of flesh on the back of the hand. It's expensive, but shares all the properties of a Basic Chronocom. It can even tell the time by pushing a button - the time becomes visible through the skin of the implant's recipient. All features are available through upraised sections on the back of the hand.

Biocoms can be installed only at a handful of medical facilities. Prenglar has a research and development team that works independently for several mega-corps that will implant one for just under 2,000 Credits. The implant attaches itself to the central nervous system of the wearer, drawing bioelectric power from its host. Implanting one will permanently lower the maximum STA of the wearer by 2 points, though it doesn't affect his current STA score unless his current score is greater than this new maxim.

Note that Biocoms cannot, at current, attach to dralasite physiology.

SIGNAL AMPLIFICATION TOWER (SAT)

Explorers, frustrated by the limited range of the standard Chronocom, have been using Signal Amplification Towers for years to explore new worlds. Since basic Chronocomms can only be counted on for 5km, the site of an exploration team's landing is often the center of a 5km diameter exploration area, meaning if exploration teams want to speak to one another they better not go past 2.5km distance from their landing ship. To improve this exploration range, explorers erect a simple aluminum-girded tower with a Chronocom relay device at its top.

The tower itself is erected by three people in about three hours. If fewer people are erecting it, adjust time accordingly. One person can do it in about nine hours. It's height is about 10 meters and its base is about three meters into the ground. Not counting extreme weather conditions, the tower will remain standing until it's disassembled when the exploration team disembarks (or later by a salvage and recovery team sent to clean up).

A SAT simply receives basic Chronocom signals at a range of 10 kilometers, and sends them just as far. This turns a multiple-team exploration radius from 2.5km to 10km, an extreme improvement to be sure. Making a network of these towers at 10km intervals will create a large area able to send and receive analog signals quite far!

The Signal Amplification Tower costs 750 Credits and is powered by a type 1 parabattery for up to 1 galactic standard year. When packed and folded, it fits securely (minus the parabattery) into a crate 1 meter on each of its sides. Some new models of exploration ship's landers have built-in Signal Amplification Towers connected to them, which is expanded telescopically to the proper height after landing, and is powered off the engines of the lander itself.

THEY'RE WATCHING YOU!

One of the fears of people using Chronocomms on a digital signal is that Nesmith Enterprises of Triad's communications satellites can triangulate the signal source of the wearer. If someone wants to use a digital signal, they really can't avoid this.

Star Law can pay a fee to NET to obtain triangulation information. Licensed bounty hunters can do this too (the fee is 100Cr per use - bounty hunting license number and voiceprint identification required). Criminals often use public chronocomms in order to keep their positioning off the grid, so to speak.

Analog signals can't really be triangulated because they broadcast in an omni-directional manner and the signal bounces off canyon walls, buildings, and other obstacles.

ADVENTURE IDEA

I like to fill any article I write with concepts for further adventure. This article should be no exception.

CRYSTAL CATASTROPHE

The creation of Chronocoms requires very specialized crystals. Although expensive to mine effectively, they're plentiful on asteroids in most systems. They're used in frequency control and modulation, and also as microphones (vocal sounds cause vibration on the crystal surfaces, inducing momentary current in the connected circuitry, which can easily be frequency-modulated for radio signals).

A large-scale mining operation on one of the many moons of Histran has recently gone dead-silent. Several attempts at communication have gone unanswered. Robotic exploration craft have returned images of a dark facility, with two of the three recently-mined crevices closed by what looks like explosions. The most recent of the robotic craft never returned.

The players are hired to investigate the mysterious event. Their employer is a government-owned mining company called the People's Invasive Crystal Mining Operation (PICMO). It doesn't matter how the players come across the job: they may be freelance trouble-shooters, technicians on loan from a friendly megacorp, or even agents who work for the Yazirian government. They are offered money for the recovery or information leading to the recovery of the miners, and a bonus if they also salvage the missing robotic exploration craft.

EXPLORING THE MINE

When they reach the mine by pre-programmed shuttle, they find that the crevices were destroyed but not by an explosion... it was an implosion which claimed the external structure of the facility. Something from within the depths of the moon has caused it!

On the surface of the moon and within its depths, no chronocom will function. Instead, all devices powered by chronocoms will hum with a distinct noise at all times.

While exploring the mine, the PCs will face zombified yazirian miners, most of which are crazed and aggressive. The longer they remain, they too will begin to feel the effects of undesired feelings of anger and hate.

Exposure	Check	Effect
A few minutes	INT	Easily angered, spiteful, jealous, not really violent
A few hours	INT -10	Bullies others, acts hateful, actively seeks confrontation.
A few days	INT -25	Attacks without cause, wants to hurt enemies.
A few weeks	INT -50	Ravenous with bloodlust, everyone is an enemy!

WHAT REALLY HAPPENED

The miners uncovered a huge crystal, the surface of which began picking up vibrations from the mining equipment and reverberating within the natural chasm in which it was found. The sonic effect causes an unexpected effect on the central nervous system of living beings... making them more and more aggressive over time. The miners have been warring with one another in a chaotic battle ever since they were consumed by the sonic sensations.

The robotic explorer craft was destroyed by several of these miners as it searched the opening of the shafts. The explosion caused yet more reverberations that have amplified the problem, and also caused the implosion of two of the three openings.

If the players find a way to shield the miners from the sonic sensations (a sonic screen would do the trick... but allow clever technical-based characters a chance to solve the problem with materials that may be found in the mine). Of course, many players will want to solve the problem with a lot of bullets.

STRESSFUL EXIT

When the players are finally leaving the moon, they'll find that they have a stow-away on their shuttle: a ravenous miner who was once a veteran cyborg warrior, retired to a less violent life of mining... and in the close confines of the shuttle, they'll quickly learn that violence is what this crazed yazirian is best at!

AFTERMATH

Assuming they all survive the catastrophe of the crystal mine, what will the players do with the information they've learned? Certainly certain militant groups and megacorporations would love to get their hands on the knowledge of the frequency and resonant effect caused by the natural phenomena. Will the players sell this to the highest bidder? Will they find it too lethal and dangerous, and destroy it? If so, what will their employer think?

50 Sonic-Raged Yazirian Miners:

STR/STA: 50/50 (temporarily boosted +25)
DEX/RS: 50/50 (unaffected by sonic-rage)
INT/LOG: 25/25 (temporarily penalized -25)
PER/LDR: 20/20 (temporarily penalized -25)
IM/PS: +5/+3 (temporarily boosted +0/+1)

Relevant Skills: Melee Weapons 1, Unarmed 1
Equipment: Simple melee weapon 1d10 damage (often a tool or broken piece of machinery).

Sonic-Raged Yazirian Cyborg:

STR/STA: 90/100 (temporarily boosted +25)
DEX/RS: 50/62 (unaffected by sonic-rage)
INT/LOG: 15/25 (temporarily penalized -25)
PER/LDR: 20/30 (temporarily penalized -25)
IM/PS: +7/+3 (temporarily boosted +0/+1)

Relevant Skills: Melee Weapons 5, Unarmed 5
Equipment: monofilament sword: 4d10, +10 to hit.

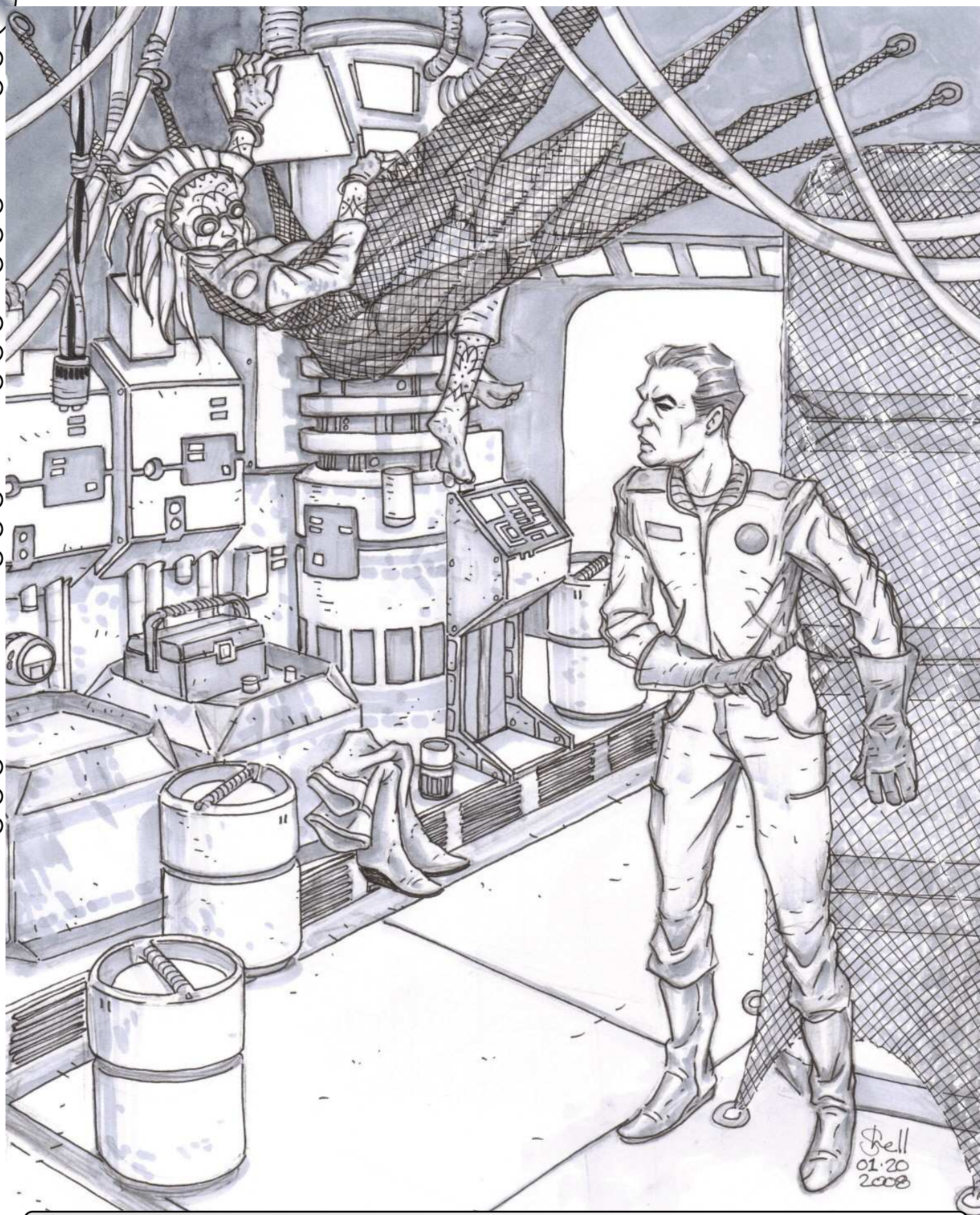

MARCH 2008

Avid readers (such as myself!) fond of the ongoing story of the Circle of Fate by Auden Reiter will enjoy this excellent illustration submitted by Shell - Orina is one of my favorite characters, and this image of when Nixon first introduced her to the readers captures the flavor of the moment quite well. Auden - if you're out there - please don't abandon the story!! I'm eager for the next installment!

YAZIRIAN CLANS

By Shadow Shack

CALLING ALL CLANSMEN...

This article was written by Shadow Shack on the development site (www.starfrontiers.us) and I just loved it. Some additional notes have been added by me in various places within the article.

First roll on the Planet of Lineage table. Then proceed to the relevant tables to determine your Yazirian's starting family Clan. It doesn't specify what planet your character is from; it specifies what planet his Lineage traces back to. Several planets have famous lineages that are found on the tables which follow.

PLANET OF LINEAGE TABLE

d100 Planet of origin

01-16	Hentz Lineage, Araks system
17-31	Hargut Lineage, Gruna Garu
32-43	Athor Lineage, Yast
44-51	Hakosoar Lineage, Scree Fron
52-55	Histran Lineage, Scree Fron
56-70	Non-Yazirian World of Origin
71-00	Completely Untraceable

HENTZ LINEAGES

- 01-13 **Anglann** (a.k.a. "Family of One") a religious clan. Current rulers of Yast and have held that title for over 240 years. Symbol is a seven pointed star, representing their creator. Anglann Yazirians gain a bonus of +5% to any Leadership roll involving other Yazirians.
- 14-16 **Backa** a very sensitive and understanding clan. Noted for their shorter stature, 2d10cm shorter than average height. Backan Yazirians gain a bonus of +5% to any Intuition rolls when dealing with other Yazirians.
- 17-23 **Brisara** a clan noted for their lust for flight, gliding is a past time taken very seriously and they often hold competitions. Symbol is a pair of golden wings, often printed across chest and back of any clothing worn. Brisaran Yazirians can glide 1.5m for each 1 meter of height descended.
- 24-34 **Gorlia** hot tempered clan, often feuds with Anglann and occasionally challenges them for rulership. All Gorlians wear an ivory ear ring and add 5% to their Battle Rage.
- 35-38 **Kesha** are pranksters and jokers who love humor, get along well with Dralasites. Keshan Yazirians gain a bonus of +5% to any Personality rolls when dealing with non-Yazirians
- 39-46 **Knar-Kenda** are a very aggressive clan of warriors, allied with Unglann and have served them during most of their rule. Their symbol is a silver star worn around the neck. Knar-Kendan Yazirians gain a bonus of +5% to any Melee weapons roll due to their unusual fighting style.
- 47-52 **Kuegla** are a clan of music lovers, always carrying a hand-made instrument in their pockets or around their necks. Kuegla Yazirians begin play with such an instrument of their choice.
- 53-60 **Tundaria** are worshippers of the beauty of space. They wear an ivory star cluster around neck or wrist. Tundarian Yazirians who gain starship skills learn a kinship with the stars and gain a bonus of +5% to any Astrogration roll.
- 61-67 **Turania** are a clan of desert nomads sporting a very thin coat of fur that barely covers their skin. They don't use symbols but are known to paint their fur in a pattern specific to their clan. Turanian Yazirians gain a bonus of +5% to any Environmental subskill roll while in the Desert.
- 67-70 **Vantaria** are lovers of rare and valuable objects. They wear a sable cloak or cape. Vantarians save 10% of their income to purchase rare goods, and gain a bonus of +10% to any Intuition roll to appraise the value of something.
- 71-80 **Zamoria** are hunters noted for their animal skin wardrobes. Zamorian Yazirians can fashion a 10-point skeinsuit from suitable animal hides, and may begin play with one.
- 81-00 No traceable clan, or traceable to multiple clans on Hentz.



THERE ARE NO OLD YAZIRIAN WARRIORS, ONLY UNLUCKY ONES
- VROST MARDESYE

HARGUT LINEAGES

- 01-12 **Barakha** is a strong Yazirian clan noted for their stocky build, proud hard workers. No STR/STA penalty for Barakhan Yazirians.
- 13-28 **Hargutia** original settlers and rulers of Hargut. Hargutian Yazirians receive a bonus of +5% to all Leadership rolls when dealing with other Yazirians.
- 29-35 **Khitala** is a clan that favors blade weapons. Members of this clan carry a silver-plated blade weapon and cherish it as their prized possession (the weapon usually has a story behind it). Starting Khitalan Yazirians may begin play with a Silverblade (treat as a normal Sword, but its material gives it a value of 100Cr).
- 36-44 **Khordova** is a highly respected warrior clan known for wearing spiked armbands, former enemies of Shurkian clan but have lived in peace with them for nearly a century. Their unique fighting style gives them a bonus of +5% to unarmed combat.
- 45-48 **Marala** is a sea dwelling clan able to hold breath for extended periods (#turns equal to STA).
- 49-52 **Nievara** is a clan known for their thick coats of fur adapted for colder climates, they don't tolerate heat very well (-5 STR, -10 DEX in desert climates). Nievarans can tolerate arctic conditions without penalty.
- 53-57 **Nistaria** is a mysterious clan often seen performing odd rituals. Members wear a multi-colored phosphorescent globe around their necks. Nistarian Yazirians get a bonus of +5% to any deception attempt.
- 58-64 **Regaria** is a fierce and barbaric clan known for multiple life enemies and natural brown and tan camouflage patterns on their dans (flaps). Regarian Yazirians gain a bonus of +5% to any roll to conceal themselves in natural environments.
- 65 **Rojoria** is a clan that has nearly been driven to extinction by the Regarians during past feuds, noted for their deep reddish brown fur and deep voices. Rojorian Yazirians carry a great deal of dishonor over their nearly defeated nature - and carry a penalty of -10% on all PER/LDR rolls against other Yazirians. Their lamenting music and poetry is well-known and prized - and Rojorian Yazirians can make a decent living as artists. Starting Rojorian Yazirians have an extra d100 Credits after recently having a work of art purchased.
- 66-72 **Shurkia** is another respected warrior clan known for their necklaces comprised of teeth removed from their slain enemies. Established the peace treaty with their former rival Khordova clan. Shurkian Yazirians gain a bonus of +5% to hit with any two-handed melee weapon.
- 73-76 **Velia** is a cruel and nearly evil natured clan noted for their jet black fur. Other Yazirians mistrust and fear Velia, but no clan wars with them. Velian Yazirians cannot leave Battle Rage without tearing up something in a messy fashion. They gain a bonus of +5% to intimidate other Yazirians.
- 77-80 **Xuthora** is a fierce, wild, and uncivilized clan not known for using much in the way of technology. Max LOG score for a Xuthoran is 45. Xuthoran Yazirians gain a bonus of +10% to hit with spears, knives, bows, and other archaic weapons.
- 81-00 No traceable clan, or traceable to multiple clans on Hentz.

ATHOR LINEAGES

- 01-18 **Amona** is a neutral-minded clan that works well with any race, symbol is a gold leaf of trust. Amonan Yazirians derive their lineage from Athor, but have roots on nearly every world where Yazirians can be found. Their manes are typically dark brown, the rest of their fur a light tan.
- 19-20 **Hyrkania** is another clan nearing extinction thanks to space fairing members cross-breeding with other/non clan related Yazirians. They are known for their athletic builds and uncanny speed & reflexes. Symbol is a silver lightning bolt. Members of this clan have ambidexterity (similar to Vrusk) and human movement speeds.
- 21-25 **Ophiria** are wood dwellers and nature lovers. Members wear a plastic embalmed insect around their necks. Ophirian Yazirians can survive off the land indefinitely if living in a wooded area. In addition, they may sustain one other person in this way for each 20 points of Intuition. For example, an Ophirian Yazirian with an Intuition score of 55 may sustain himself and 2 others by living off the land: hunting, trapping, foraging, etc.
- 26-45 **Pasamorla** is a peace loving clan who willingly fights for freedom, noted for well-groomed appearances and a feather cluster on a neck chain. If a life enemy is selected, it is usually Sathar-related or anyone else that threatens peace and prosperity. Pasamorian Yazirians gain a bonus of +10% to any Battle Rage roll when defending freedom or liberty (their own or someone else's).
- 46-50 **Styzhia** is a clan of tribal witch doctors known for small horns growing from behind their ears and a prehensile tail capable of wielding small tools (but not weapons). Some claim their shape to be a side-effect of terraforming on Athor. The horns are real, and the tail as well - but the tail is less agile than one would have you believe. Treat the tail as possessing half the DEX/RS of the character for any rolls using it.
- 51-65 **Wastrala** is a somewhat suicidal clan, members have a do-or-die mentality and when there is no hope of survival they are prone to doing extreme acts to take out their enemies with no regard to their own well-being. Symbol is a silver dagger worn around the neck. They make a good living as bodyguards because of the lengths they'll go to in order to protect their charge. Wastralan Yazirians can declare a "Do-or-die Moment" in a story where they'll disregard their own life and do something insane like this... once per adventure. When they do this, they gain a bonus of +10% to all actions they do that turn. If they survive it'll be a great moment to brag about.
- 66-80 **Zigara** is a warrior band known for dipping/plating their fangs and claws with metal. They may bite or claw for 1d10 damage plus their punching score (skeinsuits and inertia screens function normally). They prefer unarmed combat over melee or ranged, but will do what is necessary if their enemy is too far away or too well defended for their claws or teeth to be effective.
- 81-00 No traceable clan, or traceable to multiple clans on Athor.

HAKOSOAR LINEAGES

- 01-15 **Bakala** is a clan whose members are typically seen in groups of three all brandishing three weapons, symbol is a triangle. Bakalan marriages are polygamous – either two men and a woman or two women and a man.
- 16-40 **Kabarla** is a clan centered on the beliefs and basis of truth, justice, and law. On their homeworld they are often seen riding elegantly adorned mounts. They wear a symbol of a prancing horse-like animal. Kabarlan Yazirians gain a bonus of +5% to their Leadership rolls with others.
- 41-50 **Polara** is a clan that originated in the polar caps but have since adapted to most weather conditions. They are especially noted for their white fur. Polaran Yazirians are survivors – gaining a bonus of +5% to any environmentalist rolls.
- 51-65 **Tuborga** is a warlike clan known for grooming their hair into a mowhawk or top knot. They wage clan wars at the drop of a hat, and have warred with nearly every other clan at one time or another. Tuborgan yazirians gain a bonus of +5% to hit with ranged weapons because of their steady aims and calm under fire.
- 66-80 **Ziriya** is a somewhat rational clan lacking the typical arrogant and pushy attitude amongst most Yazirians. They are noted for dying their fur in non-natural colors. Ziriyan Yazirians have an unusual smell from the odd Zir spice they like to flavor their food with. Starting Ziriyan Yazirians have a packet of this expensive spice valued at 50 Credits.
- 81-00 No traceable clan, or traceable to multiple clans on Hakosoar.

HISTRAN LINEAGES

- 01-35 **Invia** is a taller breed known for their grey fur and icy blue eyes, add 2d10cm to height. Their STR and STA scores only have half the normal Yazirian penalty.
- 36-60 **Norso** is a religious clan that practices their version of human beliefs. Symbol is a hexagon with an X through it. Forbidden to use weapons that shed blood, restricted to clubs and stun weapons, or non-HTH sonic arms. Norson Yazirians study using these weapons to disable their enemies. When fighting other Yazirians, if the Norson Yazirian rolls doubles on their hit roll treat that hit as a potential knockout blow (STA check to resist).
- 61-80 **Venusia** clansmen are seekers of beauty, love, and harmony. An unofficial clan comprised of genetic cross-breeding intervention with human genes, resulting in a mix-breed group often sporting features and abilities from both Human and Yazirian races (figure 50% chance for each Yazirian trait: flaps for gliding, battle rage, night vision, height, body fur, four knuckles, etc).
- 81-00 No traceable clan, or traceable to multiple clans on Histran.

NON-YAZIRIAN WORLD LINEAGES

- 01-10 **Adopted.** Roll again to indicate clan of origin, full-bred clan member transplant from an exiled, defeated, dishonored, or unknown clan.
- 11-30 **Two-Clan Half-Breed.** Roll twice again to indicate clan of origin, half-breed between two rolled clans. Half-breeds are seldom accepted into either of the clans which comprise their genetic makeup. Your parents either never wed (and you lived with your mother's clan as a second-class citizen) or ran away together to some other non-Yazirian world.
- 31-60 **One-Clan Half-Breed.** Roll again to indicate clan of origin, half breed from one clan, other clan untraceable – see the above result for difficulties in getting along in various clan politics.
- 61-00 **Truly Clanless.** No traceable clan. Often referred to as "mutt" by other Yazirians.



by John Mince

DINOSAUR PLANET

By C.J.
Williams

TORRENT

Just outside of Frontier space is a world known as Torrent. It is a world untouched by any civilization. It is teeming with life both above and beneath its surface. Torrent a planet revealing the mysteries of the ancient past of every world. A planet dominated by dinosaurs.

Sixty-four percent of Torrent's surface is covered by water. The air has a high concentration of carbon dioxide, making breathing difficult. Areas closer to the equator are near impossible to survive without proper breathing apparatuses. The air can be filtered, and with properly formulated pills, a person's lungs can be made to breathe the air normally. Because of the humidity in those regions, an environmental suit is needed as well or else the person will collapse in moments from heat exhaustion.

In far southern and northern regions, near to the ice caps, most races can live and breathe normally without assistance, though they have a -5 penalty (-1 CS) to all actions requiring any kind of exertion (Referee's discretion) on account of the humidity. When traveling long distances, character's distance traveled is affected by

a .05 penalty per kilometer traveled

An outstanding feature of Torrent is its wildlife. Torrent is home to an estimated 35,000 variations of dinosaur and an estimated 200 million species of plant and animal life, not counting the untold number of insects. It is a planet in its early stages of life. Soil samples reveal that the planet is barely 1.5 billion years old and life has only been on the planet for barely a fifth of that time. It has been suggested that the Tetrarchs likely respected the early stages of life development as otherwise they would have likely conquered the planet and transformed its life long ago. Others suggest that it is likely that the Tetrarchs created Torrent.

Dinosaurs of all kinds are the trademark of Torrent. You can see them herding along the planes, skirted by predators. Deep in the forests insects and small animals dash about, seeking food and scrounging for scraps.

The Council of Worlds has identified Torrent as special and set it aside as a nature preserve.

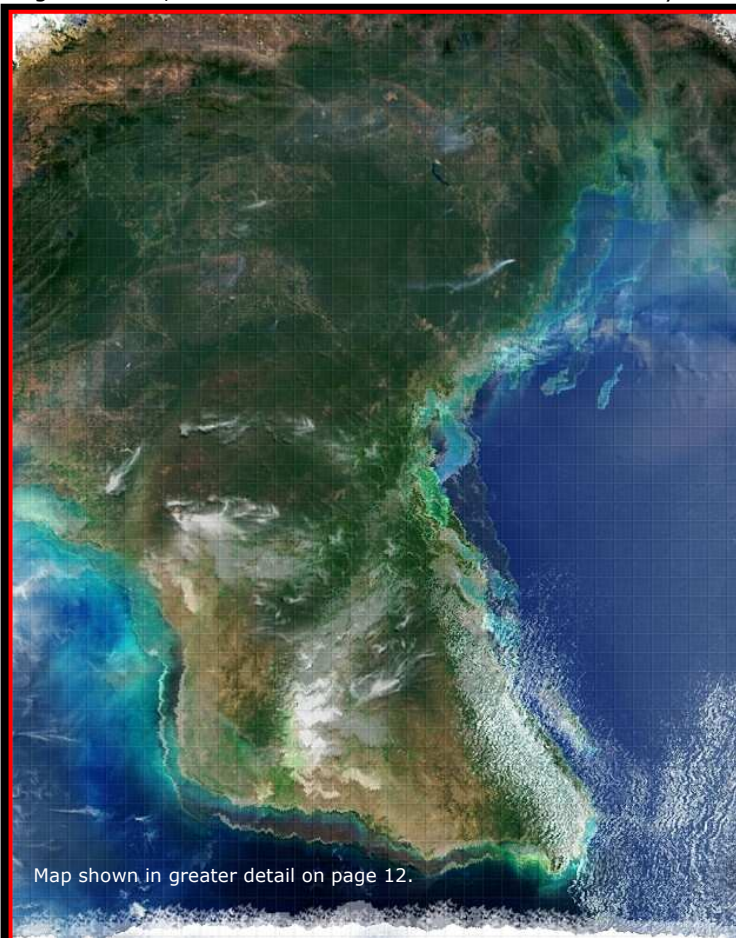

Map shown in greater detail on page 12.

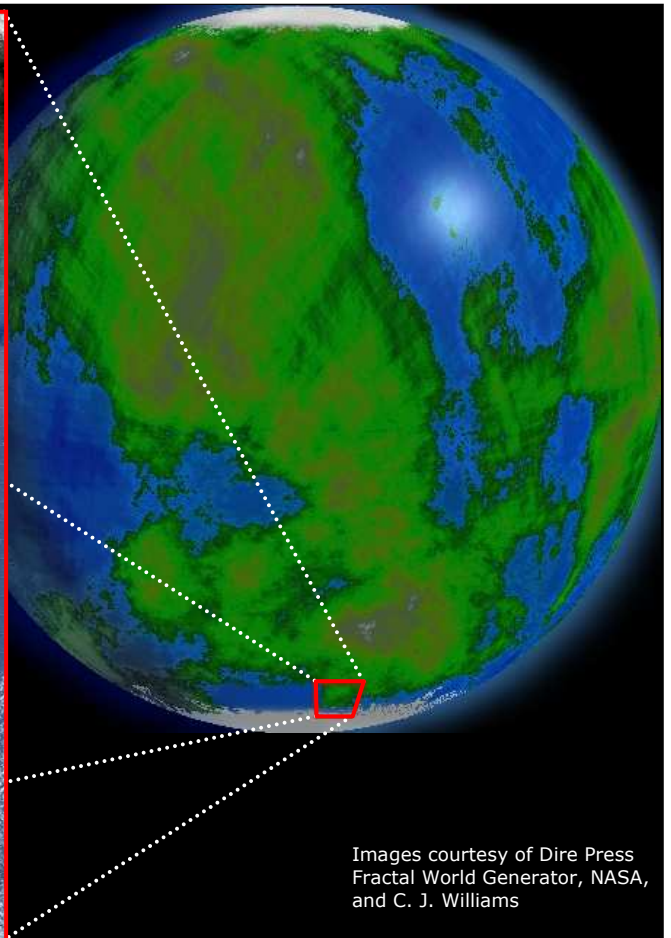

Images courtesy of Dire Press
Fractal World Generator, NASA,
and C. J. Williams



THE SOUTHERN VEIL

The accompanying map is a landing zone on Torrent, a massive peninsula known as the Southern Veil. Each square on the map is 10 km. The map is an image taken by the Promenant in low orbit.

You will note the rather large underwater coastline. Along the southern-most tip the water is only 3 meters deep at its lowest point. In other places around the peninsula, the water only goes as far as 10 meters deep. In some places this underwater coastline stretches as far as 30 kilometers out into the ocean. Beyond the underwater coastline is a steep dropoff.

The waters of the western coastline are known only as the Torrent, from which the planet gets its name. The name results from the fact that the waters cannot be traversed under or over its surface due to a massive and violent current caused by the warm current of the north end of the sea meeting the cold wastes of the southern cap. Attempts to pass through those waters will result in certain death.

On the eastern coastline you will notice the calm waters of the Blue Ocean and its many underwater capes, islands, and barriers. Throughout this area is a massive system of unexplored underwater caves running for many kilometers under the land mass.

At the very southern-most tip of the peninsula you will notice a yellowish area in the water. This is an area with a high concentration of an algae known as cleat, which releases large amounts of sulfates, iodide, and urea. It has a distinct pleasant odor like clean soap. Bathing in the waters can rid characters of many pollutants, including radiation. Despite being in a cold region, the algae causes the waters in this area to be a moderately cold, but comfortable temperature around 4° C.

HERBS OF NOTE

SIPROOT

Large Photosynthetic Plant; Tree. Drinking from this tree's roots or branches daily provides natural short-lived vaccination against most Torrent diseases and viruses. The plant apparently develops medicines by acquiring samples of saliva and blood from animals that sip its roots or branches to develop a drinkable panacea that defends against various biological infestations. This is a pansymbiotic relationship with all animals that ensures that the plant is able to reproduce by attaching its tiny seeds to the fur of animals drinking from its roots and limbs. Chewing the root or limbs also cleans teeth.

TREE MOLD

Tree mold is a fungus that grows as tiny, plate-like leaves in tall trees and is a bright green in color. It produces a sweet pungent scent that is unavoidable to taller dinosaurs. They track down the trees with the most tree mold in it. The tree mold is high in nutritious elements and natural sickness fighters (colds, flu, etc.).

ADVENTURE IDEAS

An adventure consisting entirely of survival amongst a planet of dinosaurs is different than the usual fare of intrigue and chasing villains. In this environment a Referee must throw creature after creature at his players to keep them on their toes until they adapt, are rescued, or die.

This, of course, does not prevent a Referee from carrying on intrigue amongst the planet of dinosaurs.

There are lots of ways to fit Torrent and its dinosaur inhabitants into your campaign:

- **Expedition.** Your party has been sent to explore the planet, observe its life, and most importantly find herbs that can be used for medicines, as well as identifying new genetic types for product research. Unfortunately, your shuttle crashes in transit far from destination, destroying most of the equipment you had for keeping the wildlife at bay. Now you must fend for yourself until your ship can rescue you.
- **Lost in Transit.** Your group of soldiers were en route to a military facility to bolster the ranks, when the ship is attacked by Sathar and left for dead. Your ship crash lands on a nearby planet where you must survive until saved by explorers or someone from the UPF looking for you.
- **Misjump.** Your intrepid group of adventurers were attempting to go to Starmist, but a misjump landed you in a different part of space, putting you over Torrent. You land to find out if there is any culture that can help you, but what you find is an entirely unexplored world with endless potential only just starting its trek through the developmental battlefield.
- **Hunters and the Hunted.** Your group has been hired by a rich gamer to track down and hunt a large dinosaur when all goes wrong. Little did you realize the cunning intelligence of the enormous Retributosaur.
- **Pirate Treasure.** Your adventurers have stumbled upon a treasure map on a ship's computer that leads them to Torrent. On their way to the treasure, they stumble across pirates, perhaps having been in hunt of the treasure themselves, or maybe to recover the booty they buried.
- **Saboteur.** The ship has clearly been sabotaged and your players are in the midst of the investigation when the ship is forced to crash land on Torrent. Now, not only must they survive against a deadly planet, they must find out who the saboteur (or saboteurs) is before they kill off the entire crew or the crew succumbs to the inhabitants of torrent.

CREATURE MANIFEST

There are many, many more creatures on Torrent, but these are the ones to watch out for at the Southern Veil, or which your players may be able to do something with. The truth is, this is only a small cross-section of the creatures you'll find on Torrent. There are many other landing zones on Torrent, and each one has its own dangers and things of interest.

Torrent has many, many more creatures on it, many of which are just variants of the ones presented in this article. Feel free to make your own dinosaurs and dangerous plants to add to the list of creatures inhabiting this lost world.

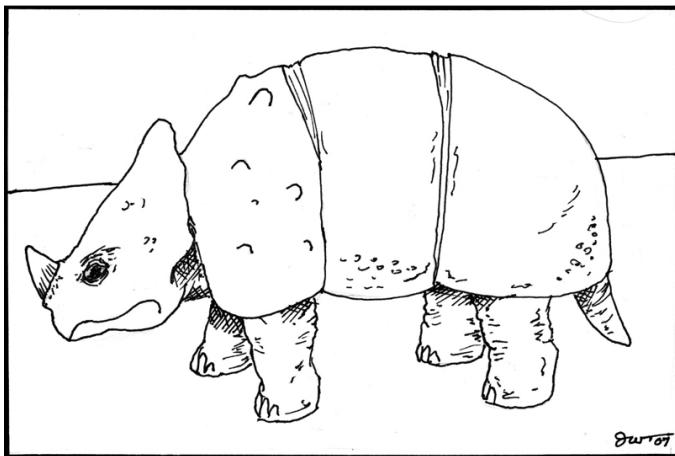
**ARMAGOR (CERATOPS)**

TYPE:	Large Quadruped Herbivore
NUMBER:	2
MOVE:	Fast
IM/RS:	4/40
STAMINA:	240
ATTACK:	60
DAMAGE:	4d10 Gore, Trample
SPECIAL ATTACK:	Charge at full speed
SPECIAL DEFENSE:	Armor, Needler weapons do not penetrate hide
NATIVE WORLD:	Torrent

DESCRIPTION: An armagor is over 1 metric ton and a thick skin covers the armagor's body protecting it from all manner of attack. It has a single horn on its snout that it uses to gore anything it perceives to be a threat. Quick-tempered, the armagor can run around 60 kph and is exceptionally territorial. Only a mateable armagor can get in the vicinity.

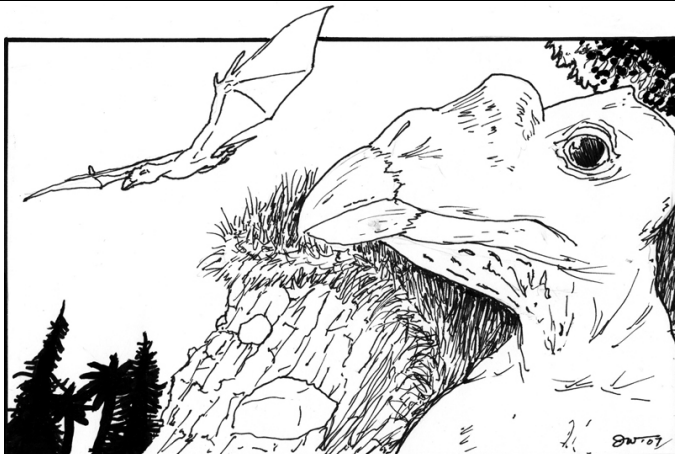
**CLAMORBEAK (PTEROSAUR)**

TYPE:	Medium Carnivore
NUMBER:	1-2
MOVE:	Medium (flying)
IM/RS:	4/40
STAMINA:	30
ATTACK:	45
DAMAGE:	1d10 claw, peck
SPECIAL ATTACK:	None
SPECIAL DEFENSE:	None
NATIVE WORLD:	Torrent

DESCRIPTION: These pterosaurs clack their beaks at many very loud clacks per second, producing what sounds similar to a jackhammer pounding on marble for several seconds. The sound is amplified by a resonating chamber on their very pronounced snout. If woken at night, they will resume their clamoring. The problem is, it attracts carnivores, as they know the sound means moving animals.

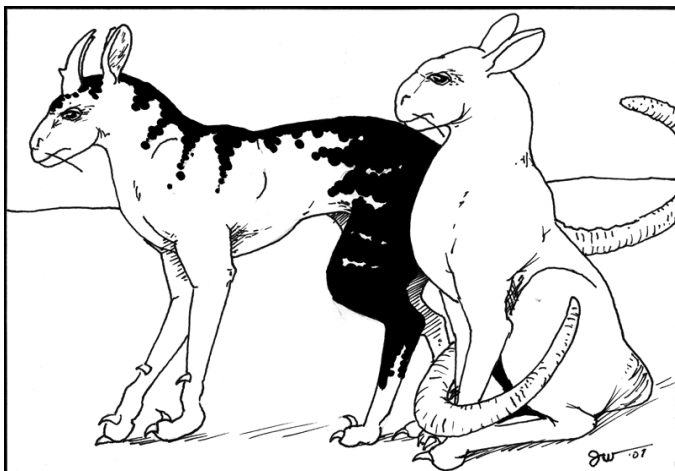
**GAINER**

TYPE:	Large Carnivore
NUMBER:	2-10
MOVE:	Very Fast (Special)
IM/RS:	8/75
STAMINA:	160
ATTACK:	85
DAMAGE:	4d10 claw, bite
SPECIAL ATTACK:	Charge and trip
SPECIAL DEFENSE:	Speed
NATIVE WORLD:	Torrent

DESCRIPTION: A gainer is a cat with a narrow head and long legs designed to make ever magnifying charges, increasing speed as it runs until it overtakes its victim or dies of heart failure. It looks like a long-legged cat mixed with a deer.

**HITCHHIKER (INSECT)**

TYPE: Small Omnivore
 NUMBER: 1 (or 40 gnats)
 MOVE: Medium (flying)
 IM/RS: 7/70
 STAMINA: 5
 ATTACK: 65
 DAMAGE: 1d10/hr
 SPECIAL ATTACK: Lays eggs in a host that begin eating the host after 1 day.
 SPECIAL DEFENSE: None
 NATIVE WORLD: Torrent

DESCRIPTION: A hitchhiker is a .1 m long flat fly that flies silently and gently attaches itself to a host in transit, laying eggs in the host, resulting in disease and larvae infestation that slowly kills the victim, and the larvae continue to feed on the corpse long after death until they morph into around 40 gnats.

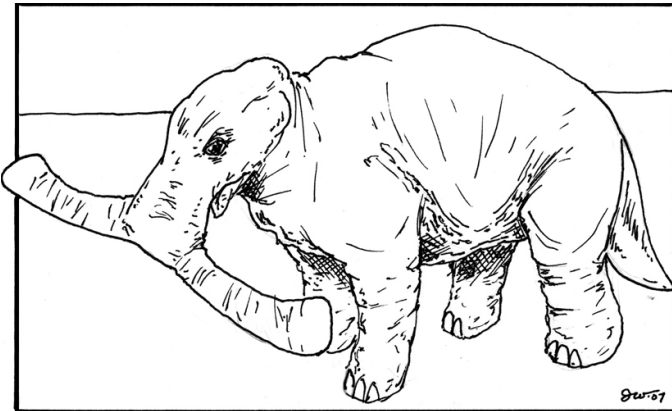
**KLASTIDON (TREERAKE)**

TYPE: Giant Herbivore
 NUMBER: 1-10
 MOVE: Medium
 IM/RS: 5/45
 STAMINA: 200
 ATTACK: 65
 DAMAGE: 3d10 toss, gore, trample
 SPECIAL ATTACK: None
 SPECIAL DEFENSE: Needler weapons do not penetrate hide
 NATIVE WORLD: Torrent

DESCRIPTION: The klastidon is a noble-looking elephant with large, flesh-covered, dull, flat tusks extending out to either side that it uses to pull down trees, challenge suitors, and defeat threats. It stands approximately 3.5 meters tall at the shoulders.

**LANGET (AVIAN)**

TYPE: Small Carnivore
 NUMBER: 2-20
 MOVE: Medium (flying)
 IM/RS: 4/35
 STAMINA: 30
 ATTACK: 50
 DAMAGE: 1d5 claw, peck
 SPECIAL ATTACK: None
 SPECIAL DEFENSE: None
 NATIVE WORLD: Torrent

DESCRIPTION: The langet is a carrion scavenger with dark blue to black feathers and a pale yellow beak. Its wingspan is approximately 1.5 meters. It only has interest in picking the meat from already dead carcasses.

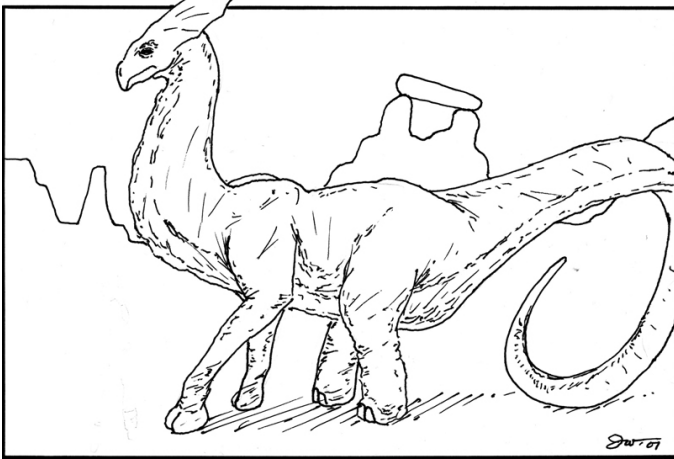

POLYCERATOPS

TYPE:	Giant Herbivore
NUMBER:	3-20
MOVE:	Medium
IM/RS:	3/30
STAMINA:	180
ATTACK:	45
DAMAGE:	2d10 trample
SPECIAL ATTACK:	Stomp
SPECIAL DEFENSE:	Needler weapons do not penetrate hide
NATIVE WORLD:	Torrent

DESCRIPTION: It is believed that a polyceratops can be domesticated and rode similarly to an elephant. It has a long neck and tail and the trademark ceratops plate with spiked points. Those with riding skill may do a skill check for riding a polyceratops. A polyceratops moves at 4 kilometers an hour and can run as fast as 40 kilometers an hour for 1d5 minutes despite its awkward shape. Its front legs apparently pull the dinosaur's body into the run while the hind legs bear the weight of the polyceratops's mass when coming down. It uses its front legs for pushing or pulling tall trees down to its mouth level to feed, not off of the leaves, but from tree mold that has taken root on the leaves and branches.



PTERIBAK

TYPE:	Medium Carnivore
NUMBER:	2-10
MOVE:	Medium (flying)
IM/RS:	6/55
STAMINA:	120
ATTACK:	60
DAMAGE:	2d10 claw, bite
SPECIAL ATTACK:	None
SPECIAL DEFENSE:	None
NATIVE WORLD:	Torrent

DESCRIPTION: A dangerous hunter, the pteribak seeks out medium size prey for feeding to its young. It has a long, pointed snout, oblong head, and sharp, saw-like teeth. It has a conspicuous waddle used to store up to 50 lbs of meat to feed to its young.



RETRIBUTISAUR

TYPE:	Giant Carnivore
NUMBER:	1
MOVE:	Very Fast
IM/RS:	7/70
STAMINA:	300
ATTACK:	75
DAMAGE:	7d10 claw, bite
SPECIAL ATTACK:	None
SPECIAL DEFENSE:	Needler weapons do not penetrate hide
NATIVE WORLD:	Torrent

DESCRIPTION: An impressive pear-shaped dinosaur with large back legs designed for fast charges and small forward arms designed for tearing and holding prey in place for feasting. It has a latter-like stripe pattern down its back, but no other distinguishing features.

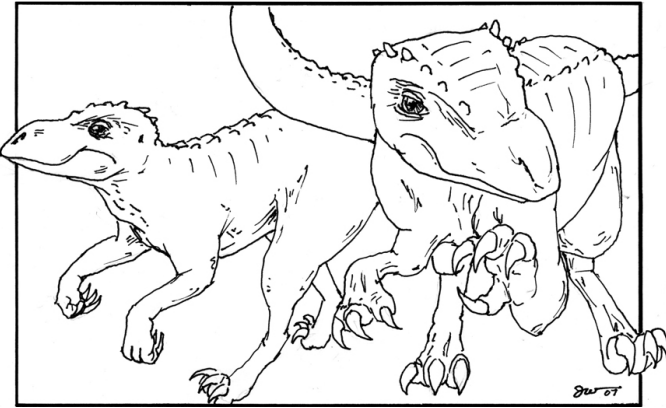
**RIPCLAW**

TYPE:	Medium Carnivore
NUMBER:	1-3
MOVE:	Fast
IM/RS:	7/70
STAMINA:	160
ATTACK:	80
DAMAGE:	3d10 claw, bite
SPECIAL ATTACK:	None
SPECIAL DEFENSE:	Needler weapons do not penetrate hide
NATIVE WORLD:	Torrent

DESCRIPTION: The ripclaw is lean dinosaur armed with large razor-sharp claws on their hands and feet. It also has horny protrusions and bumps on its skull and down its neck and some parts of its back and tail. They sharpen their claws on the wetting plant, a bamboo-like plant that thrives on being sliced apart or crushed. When you see a wetting plant that has been sliced apart, then a ripclaw is likely near by. The ripclaw's lower jaw is not joined, so it can disconnect its jaw and swallow large portions or even whole victims.

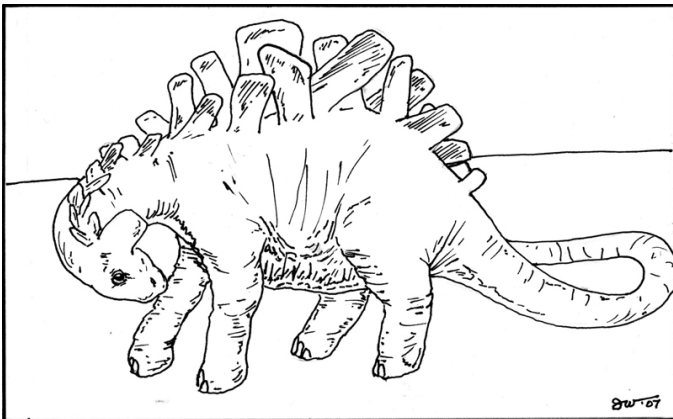
**SNAGGLEBACK**

TYPE:	Giant Herbivore
NUMBER:	1-4
MOVE:	Medium
IM/RS:	3/30
STAMINA:	180
ATTACK:	30
DAMAGE:	3d10 trip, trample
SPECIAL ATTACK:	Trips with its tail and stomps
SPECIAL DEFENSE:	Needler weapons do not penetrate hide
NATIVE WORLD:	Torrent

DESCRIPTION: A large dinosaur with plates on its back facing in chaotic directions, apparently used for confusing predators and protecting it against a predator's bites, as well as camouflage. The plates are also used for mating, filling with blood to produce a bright red display.

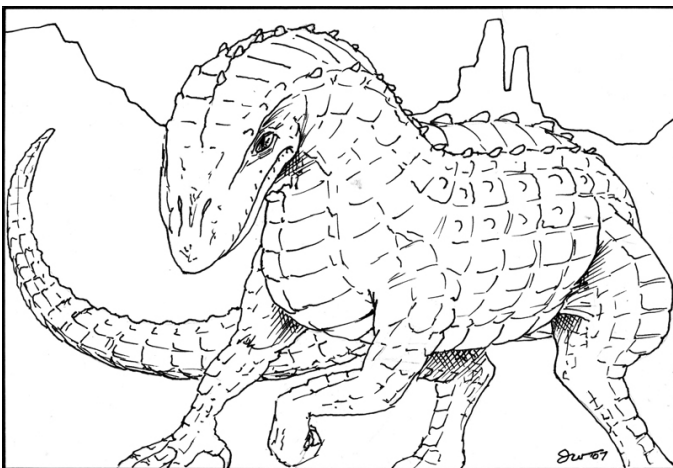
**TERRORSAUR**

TYPE:	Large Carnivore
NUMBER:	1-2
MOVE:	Fast
IM/RS:	8/80
STAMINA:	250
ATTACK:	70
DAMAGE:	4d10 claw, bite
SPECIAL ATTACK:	None
SPECIAL DEFENSE:	Needler weapons do not penetrate hide
NATIVE WORLD:	Torrent

DESCRIPTION: Standing approximately 4 meters tall, and having ridges and a few spikes all over its body, with a course, plated, reddish skin. The terrorsaur releases a blood-curdling screech to terrify its victims into shock and submission. At which point it charges the stationary, mewing, and shivering creature and eats without resistance.

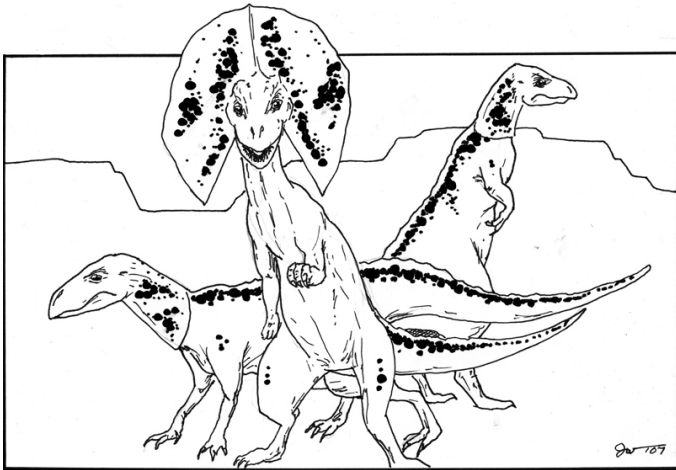

TRAPESAUR

TYPE:	Medium Carnivore
NUMBER:	3-6
MOVE:	Medium
IM/RS:	7/65
STAMINA:	55
ATTACK:	65
DAMAGE:	1d10 claw, bite; 1d5/turn acid
SPECIAL ATTACK:	Spitting acid causes damage, blindness, and eventual paralysis (-2m/turn)
SPECIAL DEFENSE:	None
NATIVE WORLD:	Torrent

DESCRIPTION: A multi-colored dinosaur standing approximately .7 m tall and has a multi-colored skin flap that flairs out around its neck for mating and intimidating. It has yellow and black mottled stripes down its spine and tail. 3-10 trapesaurs will surround a hapless victim, giving off the sound of a gelding dinosaur. They attack all at once clawing and biting their prey until it succumbs to exsanguination. They attempt to eat the prey while still alive.

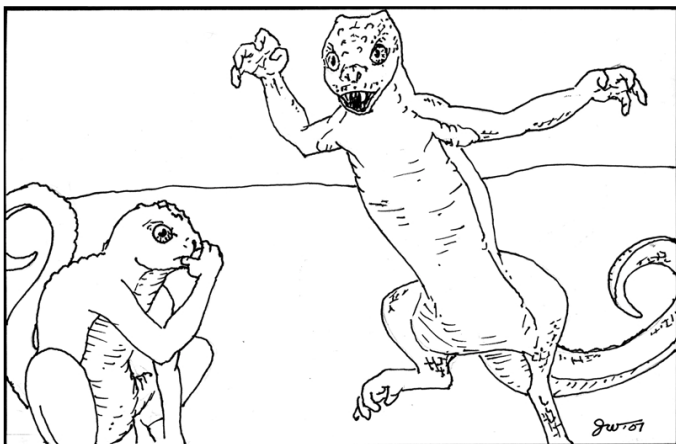

TYBOR MONKEY

TYPE:	Small Omnivore
NUMBER:	2-20
MOVE:	Medium
IM/RS:	6/60
STAMINA:	60
ATTACK:	50
DAMAGE:	1d10 claw, bite
SPECIAL ATTACK:	None
SPECIAL DEFENSE:	None
NATIVE WORLD:	Torrent

DESCRIPTION: The tybor monkey is a social scavenger and forager, subsisting on bugs, some plants, and stolen meat. It looks like a lizard in the shape of a monkey with large round eyes. Careful, these mischievous monkeys can wreak havoc in a camp. These semi-intelligent creatures are poised to be the dominant species on the planet.

OTHER SOURCES

There are great sources for adventure ideas with dinosaurs that can be found in classic literature.

Anne McCaffrey's Dinosaur Planet/Planet Pirates series' with Elizabeth Moon, and Jody Lynn Nye, where a team of geological investigators look for ways to exploit the planet's resources, only to find a planet of few resources and many dangers.

Xenozoic Tales (a.k.a, Cadillacs and Dinosaurs), an underground comic by Mark Schultz that has been made into a TV series and an RPG published by GDW, where men went underground after environmentally devastating the planet and come up four centuries later to discover that the world has reclaimed itself.

Editor's Note: This article has a lot of stuff for use in your games. Even if you don't locate these creatures on the planet described in the article - it's fourteen fully-detailed creatures!

Dinosaurs can scare the heck out of an adventurer. They're big, sometimes fast, and you don't really know just how smart they are. Will they work as a pack like wolves? Will they chase you beyond their established territory? Is there a way adventurers can learn to identify the markings of that territory? Are they just as curious about you as you are about them? What if one can actually befriend a dinosaur, like domestication of some household pets where the animal will consider the character a part of its family? These questions and more all await you on planet Torrent - or wherever you use these great resources. Thanks Corjay!

SPAWN OF ZEBULON

Adapted by R. Kevin Smoot

EORNA

Author's Note: The following race description assumes that the events of 'The Voltornus Adventure' were successfully resolved, and some several years have since past. With the discovery of the Eorna egg cryo-ship, the race that thought they were on the brink of extinction was revitalized with new generations to carry on the fight against the Sathar threat.

The Eorna have suffered greatly as a race. Although nearly forced to extinction by the Sathar, they have made a substantial recovery due to the diligent efforts of their Elders and a great deal of luck. Experts in genetics, the Eorna are the engineers of several other intelligent species who now travel in Frontier Space.

PHYSICAL STRUCTURE

The Eorna are a race of intelligent creatures descended from intelligent bipedal Voltornian dinosaurs. They have a rather large tail that is used for balance in walking. Their smaller forelimbs have developed hands for grasping and manipulating objects. Although basically reptilian, the Eorna are warm-blooded and have developed a fur-like coat of soft down over most of their bodies. The fur is technically a form of specialized feather, much like the undercoat of an adult bird or the soft feathers of hatchlings. The toothy maw of the raptor-like dinosaur they evolved from has been replaced with specialized teeth as the Eorna evolved to become warm blooded and omnivorous.

Like many reptiles, Eorna grow throughout their lifespan. Youthful Eorna might only be approximately 1 meter in height and about 1.5 meters in total nose to tail length. Usually one would encounter a mature Eorna (approximately 20 years old), which stands about 2 meters tall and is nearly 3 meters in total length. The eldest among the Eorna stand about 3.5 meters tall and can be over 5 meters in total length.

Most Eorna are rather sedentary, involved with mostly cerebral pursuits. Although they have lost much of the physical ability that their raptor-like dinosaur ancestors may have had in the past, the Eorna are still apt runners compared to the other Frontier races. Likewise, Eorna can spring or jump quite well because of their strong lower legs. Eorna can also swim with ease because their body shape is

very streamlined and their tail provides an extra means of propulsion and maneuverability. Any natural claws used for attacking or defending have long since been lost to evolution, with only vestigial aspects remaining.

SENSES

The Eorna senses are roughly equivalent to the human standard. As a race that has had eons of modern amenities, the Eorna have lost much of the keen senses that their ancestors may have had. Their eyesight is keen for details but is not adapted to extremes of either light or darkness. Their olfactory senses are a little more sensitive than your average human, but nowhere near as sharp as a Dralasite.

The Eorna brain is highly developed for extra sensory information. Often empathic or telepathic individuals among the Eorna can be encountered. All Eorna seem to have an aptitude for mental discipline and they also known to have technology to amplify or otherwise augment these abilities.

SPEECH

Eorna vocal sounds are very different from those made by Humans due to the different structure of the Eorna palate. Soft 'honking' sounds combined with clicks, hissing sounds, and rumbling growls form the basic sounds that an Eorna uses in its native language. Despite the differences, the Eorna can approximate all the sounds necessary to speak Pan-Galactic and the other main languages spoken in Frontier space.

The Eorna language itself is very well developed. The Eorna race, as a whole, was a race of artists, scholars, scientists, and philosophers. Because of these endeavors, the Eorna language is well adapted for the exchange of abstract philosophical concepts as well as information that is required to be very precise.

HISTORY

For Eons, the Eorna have had an advanced civilization built upon tenets of art, philosophy, and the sciences. Their mighty feats of technology allowed the peaceful race to lead lives of comfort and tranquility. Although they were not prolific spacers, the Eorna did develop spacecraft, even craft capable of travel to other star systems. It is

conceivable that there could be other Eornian enclaves located in other star systems, as of yet unexplored by the Frontier races.

For ages, the Eorna maintained this peaceful lifestyle. It all changed when the Sathar were encountered. The Eorna tried to make peaceful contact as the Sathar ships approached the system, but were overcome by the ruthless attack that followed, now called the "Day of Doom." The Eorna race was effectively wiped off of the face of Volturnus as the Sathar razed their beautiful cities. For many years the Sathar continued to conduct eradication missions on Volturnus and the entire population of Eorna was eliminated. The Sathar then left the system to continue their military expansion, although system-monitoring devices were left to notify them of changes in that region of space.

Unknown to their Sathar conquerors, a few small groups of Eorna, collectively numbering less than 100 individuals, escaped notice and survived by placing themselves in cryo-stasis within secret facilities deep underground. When they woke from their stasis they found their world in ruins. Sadly they also realized that their few remaining survivors did not constitute a large enough gene pool to continue the race. To meet the Sathar challenge, these few Eorna survivors began what they called the "Great Mission." Instead of fruitlessly fighting to continue their own race, the Eorna survivors artificially interfered with the evolution on Volturnus to produce new intelligent races. The Eorna hoped that one of the races would eventually achieve a high level of civilization, dedicated to beauty, but with sufficient technology and military skill to defend against and eventually destroy the Sathar. With only a handful of survivors out of cryo-stasis at a time, the Eorna worked diligently for many years on the Great Mission.

Frontier expansion into the Zebulon system caused those remaining Eorna a great deal of stress. The Sathar monitoring equipment had started transmitting upon the arrival of exploration and pirate space vessels in the vicinity of the system. The Eorna knew it was only a matter of time before the Sathar forces returned to Volturnus. The Eorna were also acutely aware that their engineered races were still quite primitive and obviously incapable of defending themselves. An amazing turn of events followed as a group of shipwrecked survivors of the Frontier craft, the *Serena Dawn*, managed to unite the primitive races of Volturnus and turn back the Sathar for a time. The most surprising news came as Frontier rescue vessels made their way to the Zebulon system. An Eorna cryo-ship containing over fifty thousand live eggs in

stasis had been found in a very wide orbit. The Eorna race would thrive again!

Since those events, the Eorna Elders had started to repopulate their species by hatching groups of eggs and indoctrinating them with the Eorna values. Frontier contact has had its impact on the development of the new generations as well, and the Eorna young embraced many aspects of Frontier life. Most of the advanced Eorna technology and historical data was already long gone, so the Eorna have adopted the more readily available Frontier equipment in recent times. Additionally, several of the child races the Eorna were guiding have made their own impact in the Frontier.

SOCIETY AND CUSTOMS

The rejuvenated Eorna society is still evolving. Frontier concepts are often at odds with the traditional Eorna values, and the Eorna still struggle with the changes. The Eorna Elders hold on to and try to encourage their pacifistic and philosophical views, even as they know inevitable changes are occurring. The traditional family units are gone, and now virtually all Eorna reproduction occurs according to breeding, hatching, and adolescent training programs. Youthful Eorna

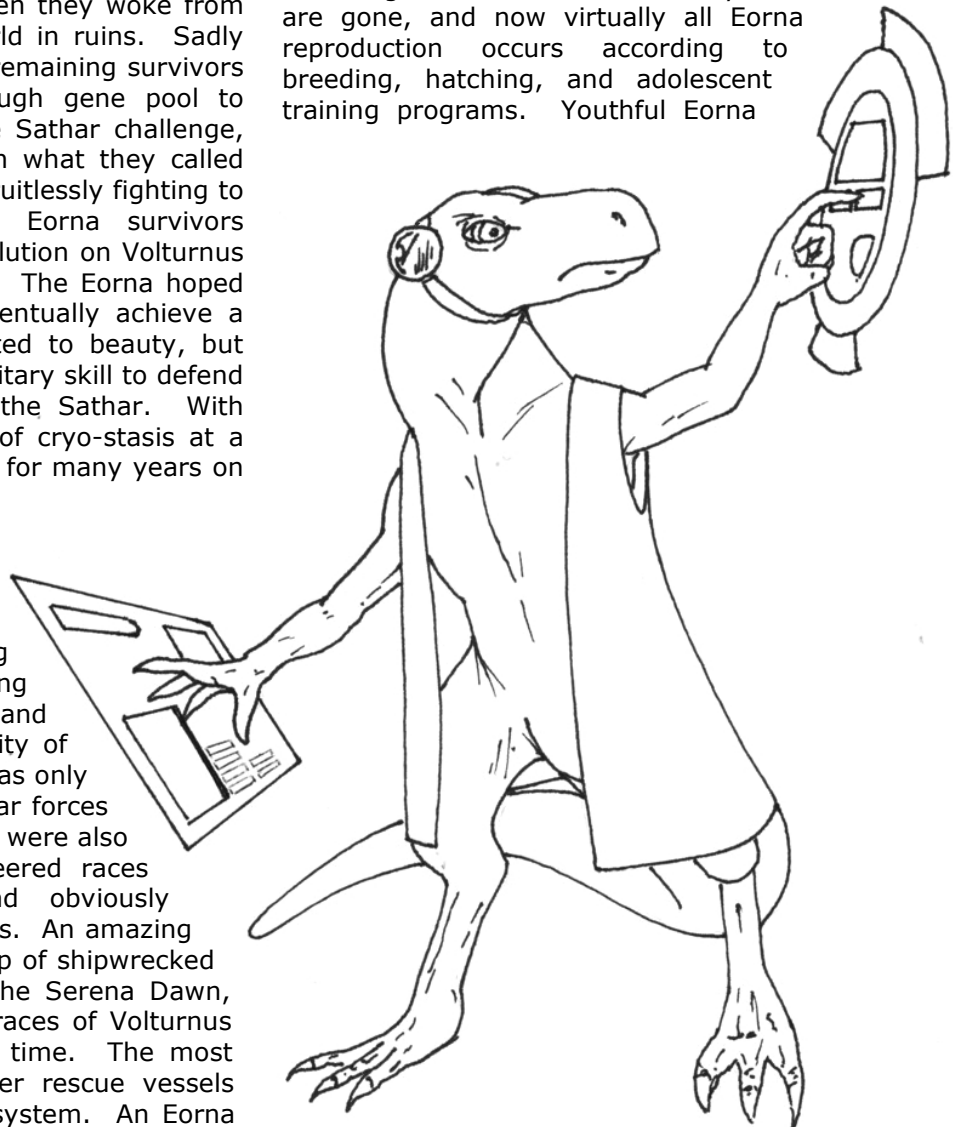

artwork by C.J. Williams

emerge from these programs ready to begin their own lives. There are a few Eorna who have started families outside of the breeding programs, but this is still rare at this time.

The Eorna have no priests or religious leaders, although some members of the newer Eorna generations have adopted forms of religion from other Frontier societies. As a form of spirituality, most Eorna craft works of art, music, or other similar expressive endeavors. They believe that the purpose of life is to come to know 'true beauty', which can take many forms. To an Eorna, creative work is akin to a religious experience. The Eorna hold destruction of art or life in disdain, and they tend to shun individuals who do not appreciate such values.

New generations of Eorna have much wider views than their elders. Eorna can now be found in virtually any profession and having widely varying views on different subjects, although the vast majority of the Eorna population still feels ties to the traditional values of their forebears.

ATTITUDES

The Eorna hold most representatives of each Frontier race in high regards. After all, they were on the brink of extinction and were saved by individuals from Frontier worlds. The Eorna are impressed by the manner in which, despite all the differences, the Frontier races have managed to pull together when it counts. Despite the positive predisposition to the Frontier races, the Eorna are wise enough to judge each person on his or her own individual merits. They are quite aware that even the noblest race will have degenerates and criminally minded individuals within each population.

The average Eorna is rather pacifistic and prefers serene artistic surroundings. Most Eorna abhor unnecessary violence. Any destruction or vandalism of works of art or intellect is likewise viewed with disdain. Because of these inclinations, many Eorna are drawn to biosocial fields of study and artistic endeavors. Events of their relatively recent history have also driven their sciences to the pursuits of genetics, cybernetics, medicine, and healthcare in general. It is becoming very common to see Eorna as medical officers on UPF ships.

The newer generations of Eorna can and do vary from these norms, and one could encounter an Eorna within any profession or field of study. Despite strict breeding programs (because of limited gene pool), some Eorna continue to be born with genetic anomalies and bizarre, even insane, attitudes and behaviors. It is not entirely uncommon to encounter an Eorna who can be violently tempered or even having criminal tendencies.

Overall, the Frontier races are rather accepting of the Eorna as well. The Vrusk appreciate the degree that an Eorna masters a field of study, and the Dralasites have a great fondness for the artwork produced by the Eorna. Strangely, the normally aggressive Yazirians have taken a liking to the Eorna and have become quite protective of them, inviting many Eorna to live among Yazirian territories.

The mega-corporations of the Frontier also have keen interest in the Eorna. Like most businesses, they have profit on their minds, but most are working towards endeavors that benefit both groups. Rediscovering and developing Eorna technology is a primary focus, but system development including mining, forestry, and other natural resources of Voltornus and the rest of the Zebulon system are also on the table.

SPECIAL ABILITIES

Genetic Protection – The Eorna are the 'fathers' of several of the Voltornian races, of which some are now a part of Frontier societies. The Eorna had the foresight to genetically encode certain behaviors into these races as part of their development. A race designated as a creation of the Eorna is predisposed to not harm a member of the Eorna race and is exceptionally susceptible to Eorna influence.

In order for a member of one of the child races to attack an Eorna, it must make a successful LOG check at the beginning of any combat, unless it is attacked first by the Eorna. In addition, the Eorna gain a bonus of +20% on any check or ability involving communication with one of these child races (in favor of the Eorna). This bonus also includes mental control or attacks by Mentalist or Telepathic Eorna if those optional rules are used.

Leaping and Vaulting – Due to their powerful lower limbs, the Eorna can leap and vault 1.5 times the values listed in the Alpha Dawn rules under Leaping and Vaulting.

Mentalist – An Eorna can hypnotize a character by talking to him in a non-combat situation. The character must make a Logic check; if he fails, he is hypnotized. A hypnotized character will think the Eorna is his friend, and will want to cooperate with it. He will see things the way the Eorna describes them, as long as his other senses do not contradict what the Eorna tells him. For example, a character would not believe that a fire was a pool of water. An Eorna can command a hypnotized person to do something at a specific time, and to forget that he has been hypnotized until that time. For example, a character could be commanded to turn off a security system at midnight. A character might be hypnotized to wipe certain memories from

recollection or to forget the events in short term memory. Each particular application would require separate Logic checks to determine success. Most Eorna have high standards of morals and ethics, and they rarely use this ability wantonly to cause an individual harm or for their own personal gain.

Optional Mentalist Variation – All Eorna have special access to the Telepath Skill (from the optional Mentalism Primary Skill Area). Eorna characters may not take skill levels in the other Mentalism PSA Skills (i.e. Metabolic Control or Psychokinesis) unless they have actually chosen Mentalism as their official primary skill area (if allowed). The Eorna must pay the normal experience point costs to acquire the Telepath Skill unless it was chosen as one of their starting skills. In addition the Eorna must pay all the necessary experience point costs to increase their ability with this skill. There is no additional experience point cost for this skill not being in the character's primary skill area.

An Eorna may, therefore, choose Biosocial as their Primary Skill Area, and might choose Medical and Psychosocial as his initial skill choices. Later, after earning some experience, this Eorna character could still choose to pick up the Telepath Skill (paying all appropriate experience point costs), which would normally not be available to characters of other races. The Eorna character would never have access to the other Mentalism skills because he did not choose Mentalism as his actual Primary Skill Area.

Note: Referees may choose which method of Eorna Mentalism to use in their campaign, but it is suggested to use the latter optional variation, even if the Mentalism PSA is not used in the campaign otherwise. If Zebulon's Guide rules are being used, it is suggested that the Eorna only have access to individual disciplines that deal with purely telepathic style powers (Empathy, Fear, Illusion, Link, Paralyze, Shield, Suggestion, Telepathy (all), or Trap); that is, unless they have chosen Mentalism as their actual Profession.

EORNA CHARACTERS

Note: Eorna player characters are generally assumed to be one of the newer generations of the race stemming from the egg cryo-ship or the breeding programs that followed. Freed from the necessity of adhering to the Great Mission for survival of the race (as described in the Voltturnus adventures), the new generations often follow a variety of different paths despite the strong urgings and indoctrinations by the Elders of their race. Up until their older years, Eorna are also approximately the same size as the other Frontier races, so special accommodations or equipment is not necessary.

EORNA CHARACTERS

Characteristics

Average Size	1.9 meters tall, 3 meters nose-to-tail
Average Mass	120+ kilograms
Average Lifespan	220 years
Reproductive System	heterosexual, ovoviviparous
Body Temperature	34 degrees Celsius

Ability Scores

STR/STA	+10
DEX/RS	-10
INT/LOG	+5
PER/LDR	-5

Movement

Walking	15 meters per turn
Running	35 meters per turn
Hourly	6 kilometers/hour
Swimming	15 meters per turn, 2 kilometers per hour

Special Abilities

Genetic Protection	Voltturnian races developed by the Eorna must make a LOG check to attack Eorna characters. Eorna have +20% on interactions with these races or with mental control/attacks.
Leaping & Vaulting	Eorna can leap and vault 1.5 times the normal distances.
Mentalism	Hypnotism ability (or optionally special access to Telepath Skill)

Eorna Elders would face certain problems during a campaign due to their large size (3 to 3.5 meters in height). In addition, Eorna Elders, such as the individuals detailed in the Voltturnian adventures, all have advanced experience, statistics, and motivations decided by the Referee, and should always be non-player characters.

Author's Note: Much information here was taken from pre-existing material (SF0, SF1, SF2) and I give full credit to the authors of that material for their wonderful creations. A few liberties were taken to roughly balance the Eorna Race against the other frontier races by extrapolating certain aspects of their physiology and culture, coming up with a playable variation/explanation that is not overpowered. The basic Mentalism ability is the same as the Sathar Hypnosis ability, but I suggest the optional variation strongly, not only for the Eorna but also for Sathar NPCs (replacing the aforementioned Hypnotism ability).

101 USES FOR DEAD ROBOTS

by James Strain

This article was edited by Grendel_T_Troll from the development site because I was under-the-gun with deadlines at work and home (thanks, man!). James Strain is even more talented an artist as he is a writer – I'm helping him with a site that will definitely be worth your time to check out – more to come on this. His art work will grace the pages of this webzine in months to come... watch for it!

A tangled pile of combat robots that Daelstrom had compiled took up most of one corner in the garage. The explorer had seen something like this somewhere before...his mind returned to the task at hand. He thought that they could get one or maybe two operational by parting out the others. Without someone to reprogram them, however, they would only succeed in making a functional robot that wanted them dead. Staring at the jumble of destroyed bots his mind started to wander... he was once told "There are a hundred and one uses for a dead robot."

Seven years ago...

In the sweltering tropical environment of the Ka'tar jungle, Daelstrom stalked his prey. On the Vrusk colony world of Ken'zah-kit, the small group that the young explorer was with set out in search of a missing robot. Somewhere out there was a robot that had wandered off from camp ignoring its programming as it walked into the dense foliage.

Daelstrom, really not much more than a boy at the time looked back over his shoulder at the Far Horizon. He could still see parts of the hull peeking through the curtain of leaves and vines. He turned back to the tracks they had found and moved deeper into the jungle. His father had only just let him join the crew of the Far Horizon a week or so back and he was excited to be out from under that overprotective wing.

The team could be heard tromping around near by. Daelstrom thought of the others in the search party. First was Tessa Warren, a raven-haired beauty from the planet Carolon. She was the ship's navigator as well as an explorer. Birzz'Kak a Vrusk ex-Tech. By profession he had worked his way up to ship's Engineer. Born with a rare genetic disorder similar to an over active growth hormone in humans, Birzz'Kak was huge by standards for his race; custom gear had to be made to accommodate his tremendous size. Lastly, there was Geer Vos Delum, a

Dralasite enforcer and, in Dralosite years, was almost as young as Daelstrom.

Geer Vos and Daelstrom were in the center of a search formation – diamond-shaped, with Birzz'Kak on trailing and Tessa on point. The fact that the two most inexperienced were put in the middle hadn't been lost on either of them. The two made, quietly, a pact that they, and not the two senior members of the search party, were going to be the ones to find the wayward 'bot. As the team assumed its standard 10-meter spacing, the two teens stepped into a small clearing. With a shape that would pass for a smug look on Geer Vos' face and with a nod he and Daelstrom spread further out into the canopy of the jungle.

The search party ventured deeper into the tangle of foliage and suddenly a crackle came over the com-link, followed by a brief transmission from the Far Horizon.

"Far Horizon to team one, over." Came the call from Davos Thorne. He was the ship's captain and Dael's uncle.

"Team one, go ahead Horizon." Came the response from Daelstrom. He had the communications up-link for the team. Quickly he patched them in for the rest of the message.

"It looks like sensors finally got a fix on the 'Bot, coordinates, grid two, section Z." the voice said with calm assurance.

"We copy Horizon, will advise, over." Tessa's voice issued the reply over the com. There was a slight pause as Tessa checked the small data slate that had the map.

"Team to proceed southwest one hundred and fifty-four meters from marker alpha over." A single click on each com-link confirmed the transmission from the rest of the team.

A short time later, as they filtered in to the designated area, they found a derelict boat. Thick with rust and moss, it was beached on the shore of a fast moving stream, its banks choked with heavy vines and underbrush.

"Guess sensors got a read on this hunk o junk." Geer Vos said, thumping the abandoned craft with his rifle butt to emphasize the point. Suddenly the shrubs right behind

the Dralasite exploded - the lost robot came out lunging toward the startled group.

The G. R. L. L. I. A. Model (or "Gorilla" as it was called) was a heavy-duty, anthropomorphic robot designed for recreation sports like wrestling or martial-arts sparing. Gorilla preformed in a simple labor capacity as well. Daelstrom quickly raised his auto rifle and took aim, but the robot was already too close to his friend.

The robot had been damaged since entering the jungle; the Gorilla's left arm had been almost torn off and the synth-skin outer covering had shredded in many places as well. The robot closed with the Dralasite and struck viciously, knocking it to the ground.

It was obvious to Birzz'Kak that the robot's safety robo-progs had been either disabled or destroyed. He toggled on his inertia screen and activated his exoskeleton. As the robot raised its arm above Greer Vos for another strike, he rushed forward with typical Vruskian speed driving into the robot. The two pitched over the side of the boat, rolling in a single awkward knot into the brackish water. Birzz'Kak yelling the verbal shutdown code the whole way.

"See to Geer!" Tessa yelled from across the small clearing as she sprinted to the stream.

"But I haven't learned Dralasite anatomy yet" came the response from the young explorer.

"Well I guess you'll just have to learn right now, get to it!" she replied. She drew a bead on the robot as it thrashed about violently with the Vrusk in the marsh-like waters. Birzz'Kak had activated his Exo-skeleton and its servomotors quietly whined their protest in the struggle with the robot.

"GEK TISK TING OFF'K MEEK!" The Vrusk clicked in broken Pan-Gal.

"Get clear dammit!" Tessa yelled back, her large caliber "hunting rifle" arcing slowly in sync with the combatants.

Geer Vos wasn't moving when Daelstrom reached him. His membrane was already swollen and discolored around the left ocular cluster and was oozing a dark orange fluid. He could tell the eye was badly damaged, but didn't know how to treat it. He activated the com-link instead.

"We've got a situation here, patch me through to Doc." It dawned on him he had never said those words for real before, in training sure, lots of times, lots of "situations" but this wasn't training.

Daelstrom was waiting for the Doc to come through and had just opened his first aid kit - shooting Geer with Stimdose from a hypo. He was reaching for a "pressure bandage" when the first shots rang out. Slowly Geer Vos started to move

"QuEE meeP?" he said in his native tongue. "Where am I?" came the Poly-Vox translation a millisecond later. BLAM! BLAM! The shots again and the short alien rolled to his "feet." he staggered towards the gunshots.

"What's happened now?" the hollow voice of Doc Maxnar asked across the com-link.

"Just send help quick. I'm activating a beacon now" and while doing so Daelstrom picked up his rifle and rushed to help the others.

The giant Vrusk had been putting up a valiant effort against Gorilla, but he had little training in hand to hand combat. To make things worse, the current had steadily taken the fight into deeper waters and the robot didn't need to breathe. The robot had somehow gained purchase on the back of the immense Vrusk - its legs locked around the Birzz'Kak's torso, and was pummeling him mercilessly. The only thing keeping the Vrusk alive was him leaping out of the water to take a quick breath before going back under, a bizarre and deadly Vrusk aquatic rodeo.

First Geer Vos, then Daelstrom came to the stream's edge along side Tessa. The shooting had stopped. At first, in the shallow water, most of the robot's body was exposed and Tessa had fired at it as Birzz'Kak tried to slip away. Now, the way things were shaping up, no such opportunity was likely to present itself. Therefore, she made one. Dropping her rifle and drawing her Vibro-Blade, she dove in to the water. The three of them disappeared beneath the murky surface.

For a dreadful moment all was silent; it seemed the entire jungle was waiting. Finally, Birzz'Kak sloshed out of the water and collapsed on the bank. Both Geer Vos and Daelstrom rushed to his aid. The robot had somehow latched a hold of the Vrusk around the neck with its badly damaged left arm. In the struggle, the arm had torn free. The robot's single-mindedness, however, meant it never let go. The two pried free and discarded the appendage. With great effort, they dragged him back to the clearing.

Daelstrom looked to Birzz's wounds and Geer searched the waters edge for any sign of Tessa. He found none. Then, from behind the dense brush, the sound of movement was detected. It was coming from down stream, heading towards the clearing, towards them. Geer Vos moved to an intercept course between the sound and the fallen Vrusk, his laser rifle at the ready. As the noise grew louder, Geer Vos called out the safe word - a code Tessa and others from the Far Horizon would know.

"Green!" he shouted, No reply.

"Green!" he called again and again no answer. Moments later the rogue 'bot lurched into view. Geer opened up on the bot his shot rang true and, with no albedo protection active on the robot, a smoldering hole was all that was left of the thing's chest.

"Do you think we should have got it with a tangle or something?" Daelstrom asked, a bit of sardonic humor tinging his question.

"Nah...you should have fraged it." silent as a shadow till now, Tessa's answer came from behind them. "You know there's a hundred and one uses for a dead robot."

She walked over to the discarded arm lying on the ground and picked it up. She stood over Gorilla dripping muck and the swamp water down on it, and then said, "Use number one, a club." A wicked grin began to curl at the corners of her mouth.....

HOVERCYCLES

by Shadow
Shack

FRONTIER CYCLE HISTORY

If you read up on Frontier history, Pan Galactixon is the earliest of the current manufacturers of ground and hover cycles, dating back to before the first Sathar War. Pan Galactic acquired the Galactixon Motor Company (GMC) when they were going through some financial woes resulting from troublesome quality control and reliability issues stemming from their Duracell-head motor (noted by the copper top on the electric motor cover), a motor that derived from prior generations such as the Eveready-head and Rayovac-head motors. PGC, in essence, saved the Galactixon Motor Company from bankruptcy and they continued to offer Duracell-head powered bikes during the transition.

The inherent beauty of the old Galactixon engines was their simplicity, they were very easy to work on and a proficient technician could perform a full rebuild in a short time, resorting to a healthy variety of both manufacturer and aftermarket parts availability (not to mention the wide array of "cannibalized parts", such as the infamous motor coil from the Gord flathead six motor or the brush housings from a Galactic Motors ventral-eight).

As such, PGC footed the R&D funding for the design of their next engine: the GENeration (aka the stockhead), and just before production the 13 company heads of Galactixon purchased the company back from PGC, and thus renamed their products under the new badge of "Pan Galactixon". The PGC era bikes had a mixed review, the older riders resent the newer product blaming PGC for ruining the designs while the newer riders talk smack about the older designs, but the truth is that the Galactixon Motor Company products were faulty before PGC acquired them.

Anyways, the GENeration motor proved to be a gamble that the 13 investor/owners didn't mind rolling the dice for. The motor ended up being everything it had been promised to be: a reliable engine based on the original timeless design. Their latest engine is the TG-880B (aka the Twin Generator aka the "twinjee") and has replaced the GENeration across the entire line-up.

Meanwhile, during the PGC transition there were some serious competitors from four distinct Streeel-sibling companies that challenged Galactic Motor Company during all three phases of their business tenure. Marks like Hyondow, Kyawaskai, Sushuzi, and Yamihai were belting out some high performance low cost machines that proved themselves both on the track and on the roads. They sported newer technology and bulletproof reliability, and when Streeel sensed that the Galactic Motor Company was in trouble they pulled a fast one and began dumping their products into the market at below-wholesale pricing. This illegal trade practice was quickly noticed by both the local economist leaders and the legal team of Galactic Motor Company, hence it was brought before the Council of

Worlds and it was decided that a tarriff would be placed on all ground and hover cycles produced under the various Streeel marks.

Several subsidiaries of Cassidine Development Corporation entered and left the market during the GMC/Streeel competition era. Manufacturers like CSA, Dorton, and Triamf began to lose ground to Streeel's screamers, and only Triamf survived (and barely at that). And other marks like Buckerton Motor Works (of Kdikit) and Danati (named after Pale's moon) silently soldiered on while providing their niche market products.

The modern ground and hover cycle market is thriving and competition is fierce. Pan Galactixon continues to duke it out with Hyondow for top market share each year, while Kyawaskai, Sushuzi, & Yamihai consistently slug it out for third place. Triamf is belting out some incredible products for all the niche markets, and Buckerton Motor Works continues to offer luxury comfort and decent performance. Danati is still the leader in handling despite the breakthroughs from Streeel's subordinates, but they are fully aware of this and continue to pour funding into superior suspension and braking technology, with their most recent (and most expensive) 999 model leading the way. And finally, Herik Fuell (former design engineer and current subsidiary of Pan Galactixon) has challenged Danati by offering some street sensible alternatives.

HOVERCYCLE CLUBS OF THE FRONTIER

Wherever the adventure may lead, sooner or later the characters may find themselves in a seedier part of town and subject to members belonging to one of the Frontier's numerous yet infamous hovercycle clubs. Such characters tend to be rather shady and not very foreword in conversation (especially concerning group business of which they will never speak), and most citizens know better than to start any trouble with them. Still the occasional being may find themselves on the wrong end of a bad situation, and things can get downright nasty when it happens.

Nok-A-Lug, a.k.a. "Lug-Nut", clan brother to Ook-A-Lug of the SS Omicron fame, has taken the time to compile a short list of the various well known organizations. Ranked alphabetically by name, each listing is followed by group affiliation (as to which races can be found amongst them), number of chapters and members within the organization (when applicable, most are loose estimates), the recognized symbol and colors that the members will be seen adorned with, and any known rival groups.

Just be warned that when encountering such individuals, the possibility exists that many more are close by. Taunts and jests can erupt quickly into something violent so it is wise to steer clear of such actions.

Club	Affiliation	Home Turf	Chapters	Members	Symbol	Colors	Known Rivals
Amazon Princesses	mostly female humans and yazirians	Rupert's Hole (Cassidine)	at least one per planet in Cassidine, Araks, Athor, Gruna Garu, Scree Fron, Dixon's Star, Truane's Star, Zebulon, Prenglar, Madderly's Star, Timeon, Theseus, and White Light	unknown	crossed swords over a shield	pink and black	Worn Out Skanks
Black Mandrils	Zigara Clan officers, mostly yazirian members. Hair dyed black when applicable	Yast (Athor)	semi-Frontier wide, at least one per planet in Araks, Athor, Gruna Garu, Scree Fron, Madderly's Star, Timeon, Dramune, Cassidine, and Prenglar	unknown	Flaming Mandrill head	orange and black	most other clubs
Blubberhood	mostly dralasites	Inner Reach (Dramune)	At least one per planet in Dramune, Cassidine, Prenglar, Madderly's Star, White Light, and Timeon	700-800	Dralasitic Jolly Roger	grey and green	Jailhouse Ixheads, Killing Joke, Outcasts
Centaurus	mostly vrusk	Zik-kit (Kizk'-Kar)	At least one per planet in Kizk'-Kar, K'aken-Kar, K'tsa-Kar, Fromeltar, Cassidine, and Prenglar	500-600	demonic vruskan skull on horse body	blue and green	Goblins, Motor Bugs, Yellow Bellies
Dust Devils	mostly human	Laco (Dixon's Star)	three	several hundred	flaming hoverfan and crossed daggers	tan and olive drab	Exiled Spirits, Paladins, Rat Fanners, Xenophiles, Zealous Zeroes
Exiled Spirits	all	Anker (Zebulon)	at least one in each planet of Zebulon, Truane's Star, Dixon's Star, Prenglar, Cassidine, Timeon, Madderly's Star, and Dramune	1200-1500	grim reaper	red and silver	Dust Devils, Shadow Hunters
Frontier Riders	all	Rupert's Hole (Cassidine)	at least one in every system	1500-2000	skeleton on hovercycle	red and blue	Jailhouse Ixheads, Triad Sathar
Goblins	mostly yazirians and vrusk	Hargut (Gruna Garu) and Kawdl-Kit (K'tsa-Kar)	at least one on each planet of Araks, Athor, Gruna Garu, Scree Fron, Kizk'-Kar, K'aken-Kar, K'tsa-Kar, Fromeltar, and Prenglar	1500-2000	half yaz/half vrusk demonoid	yellow and green	Black Mandrills, Centaurs, Motor Bugs, Yellow Bellies
Horsemen of Apocalypse	mostly human	Minotaur (Theseus)	at least one on each planet of Theseus, White Light, Madderly's Star, Timeon, Prenglar, and Cassidine	1000 +/-	fire-breathing horse head	black and gold	Shadow Hunters
Iron Minors	young adult/delinquents	Lossend (Timeon)	at least one on each planet of Timeon, Theseus, White Light, Madderly's Star, Prenglar, Cassidine, Truane's Star, and Zebulon	several thousand	steel hammer gripped by skeletal hand	black and blue	none, known to participate in skirmishes. Other clubs recruit members who come of age.
Jailhouse Ixheads	all	Clarion (White Light)	at least one on each planet of White Light, Madderly's Star, Cassidine, and Dramune	500-600	Chukkah Skull	black and tan	Blubberhood, Frontier Riders, Shadow Hunters
Killing Joke	dralasites	Groth (Fromeltar)	at least one on each planet of Fromeltar, Dramune, Cassidine, Prenglar, Truane's Star, and Zebulon	600-700	Joker playing card stabbed with dagger	red and green	Black Mandrills, Blubberhood
Leather-Heads	yazirian	Hentz (Araks)	12	400-500	studded leather hood	brown and gold	Nomadic Maulers, Venusian Skidmarks
Motor Bugs	vrusk	Ken'zah-Kit (K'aken-Kar)	7	200-300	spider with crossed swords underneath	blue and yellow	Goblins, Centaurs

MARCH 2008

Club	Affiliation	Home Turf	Chapters	Members	Symbol	Colors	Known Rivals
Nomadic Maulers	yazirian	Hakosoar (Scree Fron)	8, including one each at Histran, Hentz, and Yast	300-400	yazirian claw	red and yellow	Black Mandrils, Leatherheads, Venusian Skidmarks
Outcasts	all	Outer Reach (Dramune)	at least one in each planet of Dramune, Fromeltar, & Madderly's Star	800-1000	red circle with diagonal line over stylized UPF symbol	red and grey	Blubberhood, Paladins, Shadow Hunters
Paladins	all, veterans of UPF spacefleet, landfleet, planetary militia, star law, etc.	New Pale (Truane's Star)	at least one in each planet of Truane's Star, Zebulon, Dixon's Star, Prenglar, Cassidine, Madderly's Star, and White Light	2000-2500	flaming UPF symbol	red and white	Outcasts, Dust Devils, Zealous Zeroes
Quitters	all, former mega-corp execs and workers	Morgaine's World (Prenglar)	at least one per planet in Prenglar, Cassidine, Truane's Star, Madderly's Star, Fromeltar, Dramune, Theseus, Timeon, Whie Light, Gruna Garu, Araks, and Scree Fron	2000+	all megorp logos in a disposal bucket	green and brown	mega corporations, Shadow Hunters
Rat Fanners	all	Volturnus (Zebulon)	at least one per planet in Zebulon, Truane's Star, Dixon's Star, Prenglar, Cassidine, Dramune, Madderly's Star, and Timeon	1200-1500	rat riding single hoverfan	black and grey	Exiled Spirits, Dust Devils, Shadow Hunters
Shadow Hunters	mostly human	Kdikit (Madderly's Star)	several in each major city of Kdikit	100-200	demonic skeleton with laser rifle	black and yellow	Black Mandrills, Exiled Spirits, Frontier Riders, Horsemen of the Apocalypse, Jailhouse Ixheads, Outcasts, Quitters, Rat Fanners, Stellar Demons, Xenophiles
Stellar Demons	all	Gran Quivera (Prenglar)	Frontier wide, at least one per planet	unknown	steel demon head	red and black	most other clubs. Stellar Demons has Frontier-wide notoriety
Triad Sathar	all	New Hope, Triad (Cassidine)	one	30-40	sathar head	purple and white	Frontier Riders, Xenophiles, occasional tangles with Black Mandrills
Uneasy Riders	all	Gran Quivera (Prenglar)	several each in Gran Quivera, Morgaine's World, Triad, and Rupert's Hole	400-500	ghost on hovercycle frame	red and purple	Stellar Demons
Venusian Skidmarks	human and yazirian	Histran (Scree Fron)	2-3 each in Histran, Hakosoar, Hentz, Yast, and Gran Quivera	100-200	Winged yazirian "angel of death"	brown and grey	Nomadic Maulers
Worn-Out Skanks	female humans	Kdikit (Madderly's Star)	1	40-50	skeleton in lingerie	purple and yellow	Amazon Princesses
Xenophiles	all	Triad (Cassidine)	at least one in each planet of Cassidine, Prenglar, Madderly's Star, Dramune, Dixon's Star, Truane's Star, Gruna Garu, and Fromeltar	900-1000	Sathar and Zuraggor heads on a lance	purple and green	Triad Sathar, Dust Devils, Shadow Hunters
Yellow Bellies	vrusk and dralasites	Terledrom (Fromeltar)	one	75-100	rabid chicken	yellow and green	Centaur
Zealous Zeroes	all	Pale (Truane's Star)	one in each planet of Truane's Star, Zebulon, Dixon's Star, Prenglar, and Cassidine	400-500	executioner's hood	black and green	Paladins, Dust Devils

Eric "the Mouse" Stromm

Basic Information

Race: Human
 Gender: Male
 Age: 28years
 Handedness: Right
 Height: 1.25m
 Weight: 57kg

Ability Scores

STR/STA: 65/70
 DEX/RS: 60/50
 INT/LOG: 45/45
 PER/LDR: 35/35
 Initiative Modifier: +5
 Punching Score: +4
 Ranged Weapons: 30%
 Melee Weapons: 32%

Movement

Walking: 10 m/turn
Running: 30 m/turn
Hourly: 5 kph

Skills

Primary Skill Area: Military
 Melee Weapons: Level 1
 Projectile Weapons: Level 2
 Thrown Weapons: Level 1
 Technician: Level 1

Background

The dwarvish Eric "the Mouse" Stromm is often initially confused by others with the recently discovered race of Ifshnits, but his lack of body hair and gravelly low pitched voice quickly dispel that confusion. Being such a misfit landed Eric in trouble many times in the course of life. So it was a no-brainer that once he started getting involved with hovercycling that he would inevitably become involved with the seedy groups that ride them. He was eventually prospected into the Stellar Demons hovercycle club, becoming a full fledged member within another year (it was during that time he lost his left eye, punctured in bar fight). He became popular with the group, since his smaller stature allowed him to access the tighter quarters when it came to wrenching on those mean hoversleds.

One thing about Stromm, he loved hoverbikes. He was constantly altering and improving his bike and those belonging to his friends that rode with him. He travelled across the Frontier as a nomadic member of the Stellar Demons, never settling down with one chapter. As such, many of the parts he would add to his and the fellow members' rides typically hailed from other bikes. Being short and speedy made thievery a simple chore, and after a while he became familiar with chop shops and black market fencing of stolen hovercycles and their respective parts.

Late last year, this line of work landed him in the hot seat. He pinched 17 bikes over the course of one night and hid them in a warehouse facility, within the week he had all of them disassembled with their individual parts boxed up and ready for resale. Unfortunately those 17 bikes belonged to members of the dominant Palean club, the Zealous Zeroes of Point True. Not being a group of individuals that would report their rides stolen, instead they came down on the local Stellar Demons clubhouse and began a bloody war. Local law enforcement, with the aid of Star law, eventually discovered the reason for



Character by Shadow Shack, Illustration by Shell.

this war despite the numerous SD members that didn't seem to know anything about Stromm or his illustrious activities. The goods were eventually discovered during a city-wide search of Point True, and Stromm was about to go up the river.

Meanwhile the Zeroes were content with having their property returned, although reassembly was on their shoulders. Eric's court hearing fared well, all things considered, he landed 8 months of hard time for a charge that could have easily stretched out to upwards of 1-5 years per incident. Alas, he learned the art of thrown and hand weapons while in the big house, so his release back into society has made him a better man when things get down and dirty.

He is currently attempting to raise some capital to get his pair of hovercycles out of impound: a fully customized Pan Galactixon old school bobber and a heavily modified Sizuxi GSX900R. However, with the Zealous Zeroes looking for him, acquiring suitable ordinance took priority. He rationed off his belongings and took what credit he had to his name and acquired some suitable weaponry and a skeinsuit. Desperate for cash, he is taking on any and every job that comes his way, and being an ex-con those are few and far between.

Which brings him to present day status. This recently announced expedition to a newly discovered planet in the Xagy Dust Nebula could be his ticket. Not only should it pay well, but he'd be far away from Pale and the Zeroes that are gunning for him. This promises to be a profitable yet well deserved vacation.

Equipment

Albedo Suit, Inertia Screen w/50SEU PowerBeltPack, Automatic Rifle W/10 bulletclips, Sonic Sword, (2) Automatic Pistols w/11 bulletclips, 2 Doze Grenades, 3 Frag Grenades, Standard Equipment Pack (chronocom, ID), Everflame, I-R Goggles, 15m rope, Solvaway, Gas Mask, 5 survival rations, Techkit (grey market HPRC schematics), Additional Gear not carried: spare auto rifle, machine gun w/180r belt.

STARSHIPS

by Bill
Logan



3D digital images by Gavin Dady

EXPLORER-CLASS HEAVY SCOUT CRAFT

The civilian sect is ripe with explorers looking to make a name for themselves. Scientists from all walks look for an opportunity to find a new discovery and claim it as their own. Over time, they've relied on paying the high costs for modified military vessels dumped by the UPF or cycled out of production by corporate executive orders. The civilian scientific community, tired of getting hand-me-downs not actually created for exploration, are happy to hear the news of the release of the Explorer-Class Heavy Scout.

DESIGN GOALS

Designed specifically for private UPF-contracted exploration teams, the Explorer-Class Heavy Scout is an interstellar-capable starship capable of performing most localized experiments and procedures when surveying foreign soil, be it asteroid, rogue planet, comet, sun, or world.

The ship is basically a hull size 5 long cylinder, roughly 100 meters from bow to stern. It's twice the size and displacement as the ever-popular Assault Scout, but is nearly as quick and maneuverable thanks to its twin type B Atomic engines (unusual for a civilian craft because of the affordability factor).

Being able to land on a planet is normally a high priority for an exploration vessel. However, being able to sustain faster-than-light speeds normally requires a vessel too large to enter an atmosphere. This ship is no exception.

However, to allow explorers and scientists to land and carry out their missions, a smaller lander module, nicknamed the *Expedition* mounts to the top of the ship, mating with it. A valid hull-size 1 ship in its own right, the Expedition serves a multi-faceted role as escape launch, planetary lander, cargo and personnel ferry.

Finally, the ship was designed with exploration missions in mind. Its ten decks include the normal array of crew accommodations and control decks, but a surprising amount of laboratory space. The outside of the ship includes a decent amount of instrumentation

clusters as well. It is a ship designed to seek the unknown and put a name to it.

Since so much of the internal space is taken up with scientific and technological equipment, the cargo hold is located externally in a detachable bin, that can be jettisoned into open space so that the Expedition can detach from the starship and mount to the cargo bin and ferry it to wherever it is needed (between vessels, to dock at a planet's surface, etc.).

The diagram shown at right highlights the detachable Expedition and Cargo module locations, and the images at show the detachment and cargo carrying features via photographs taken live during maneuvers.

INCENTIVES TO PRIVATE GROUPS

The United Planetary Federation wants to encourage private groups to undergo peace-time exploration. Additionally, corporations like Pan-Galactic Corporation, Strel, and others are similarly interested in neutral third-parties offering up their exploration skills for hire. Because of this, the Explorer Class Heavy Scout starship is the first of its kind to have its sale subsidized by the UPF and seven mega-corporations, reducing the cost to the consumer. This basically cuts the price to half normal.

GETTING AROUND ON DECK

The starship is designed using the standard Knight Hawks perpendicular concept, with the "bottom" deck being at the tail of the craft. The top-most deck (Deck 1) is the smallest, and is located at the nose of the craft. Access to the Expedition is via a hatch on Deck 10, while access to the detachable Cargo Module is on Deck 7.

Hatches have standard airlocks. Internal doors slide into the walls at the push of a button on the door itself. Doors can be locked by typing a code on a key panel on the door, though a master key number is known to the ship's owner (and can be changed only by him or at a repair center).

Doors marked with a yellow and black border (on the deck plan maps on the following page, they're shown colored in yellow) are locked by default, and must be unlocked by someone trusted with the security key number.

The deck plans found on page 31 are typical, though individual designs may vary. Squares on the map are 2 meters across.

Elevator. A single elevator shaft runs through the entire length of the ship. It is relatively small in size. Eight human-sized occupants are possible, though this is less a weight limitation as it is a space limitation. The elevator can traverse one deck per 6-second turn. Since the ship has ten decks, the longest one would have to wait for a lift is one minute, assuming the elevator wasn't being held open at a given floor. The ship's owner is given a master override that allows him

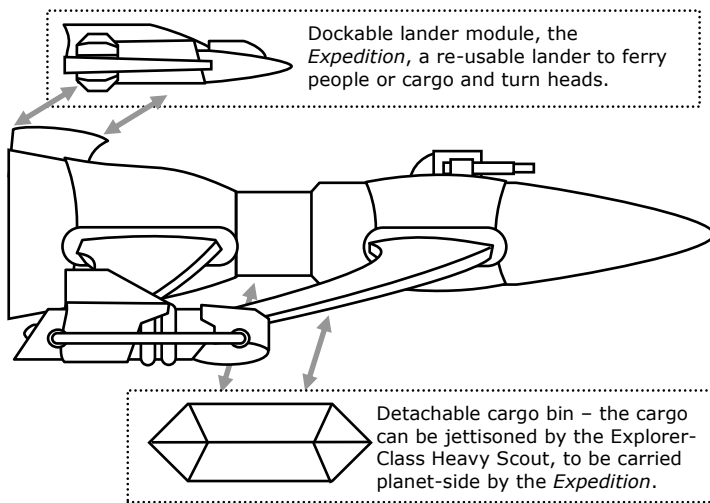
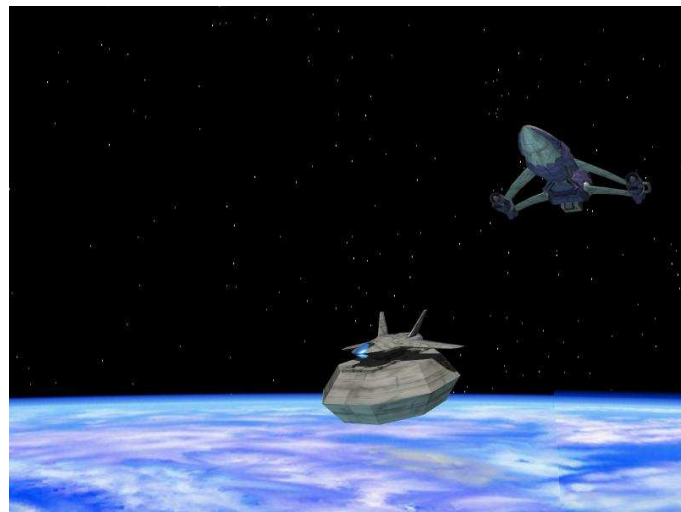

Dockable lander module, the *Expedition*, a re-usable lander to ferry people or cargo and turn heads.

Detachible cargo bin - the cargo can be jettisoned by the Explorer-Class Heavy Scout, to be carried planet-side by the *Expedition*.

to take control of the elevator, locking out all others, if he needs to.

Crew Cabins. Deck 6 has crew accommodations. Each room varies in size and shape, but all share a few common features: a modest bed, a small personal desk with computer terminal, intercom, and small night stand. They lack portals of any sort, though the conference lounge on this same deck has a single portal to view the planet around which the ship is orbiting.

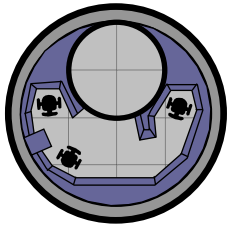

Deck 1: Weapons, Piloting

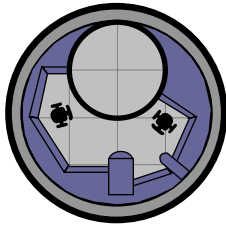

Deck 2: Sensors, Comms

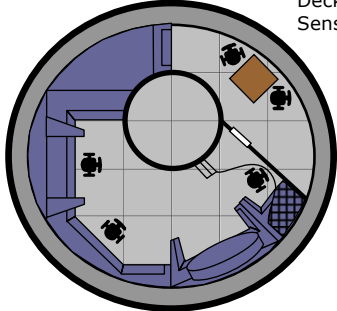

Deck 3: Astrogation, Command

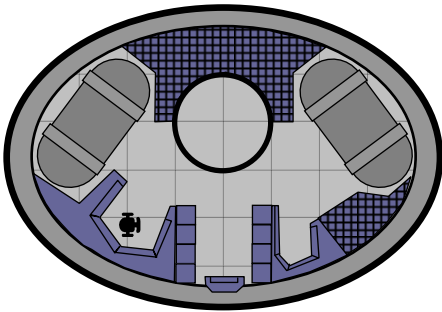

Deck 4: Hydro, chemical lab

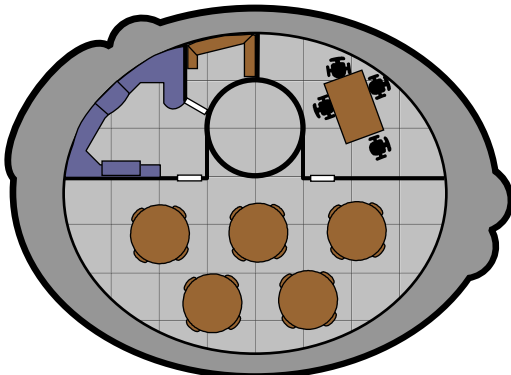

Deck 5: Mess hall, leisure lounge

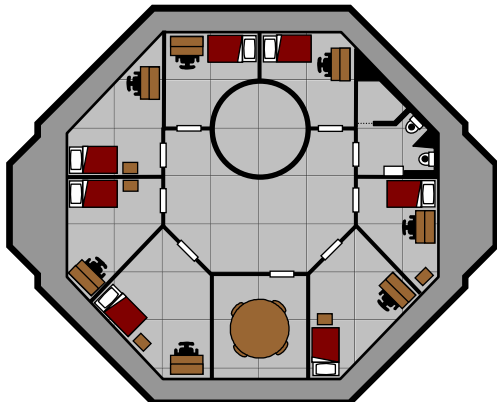

Deck 6: Crew accommodations

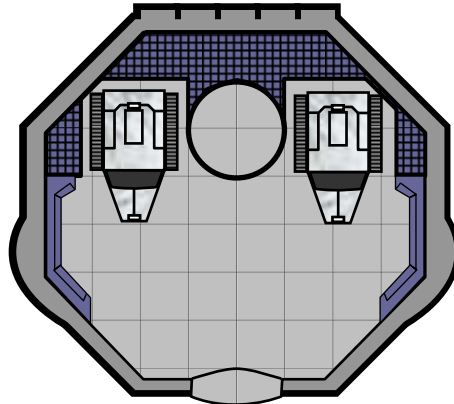

Deck 7: access to Cargo Module, planetary exploration vehicle storage.

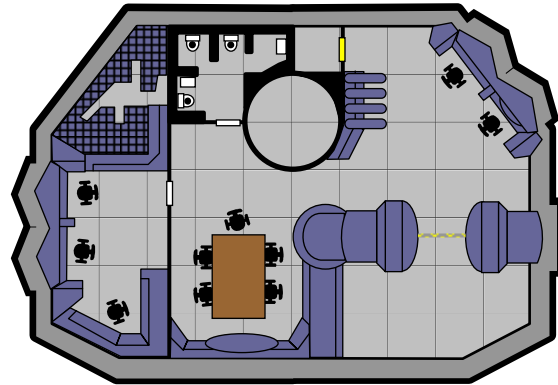

Deck 8: Labs, Masking Screen, Probes

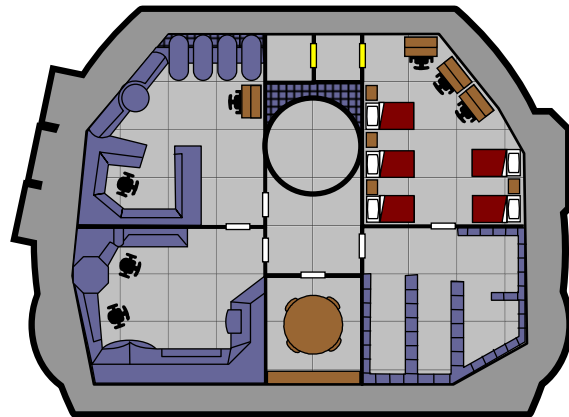

Deck 9: Labs, workpod, accommodations, equipment lockers.

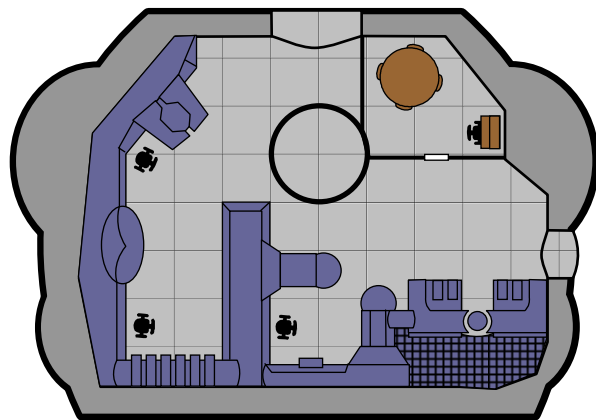

Deck 10: Engineering, access to Expedition

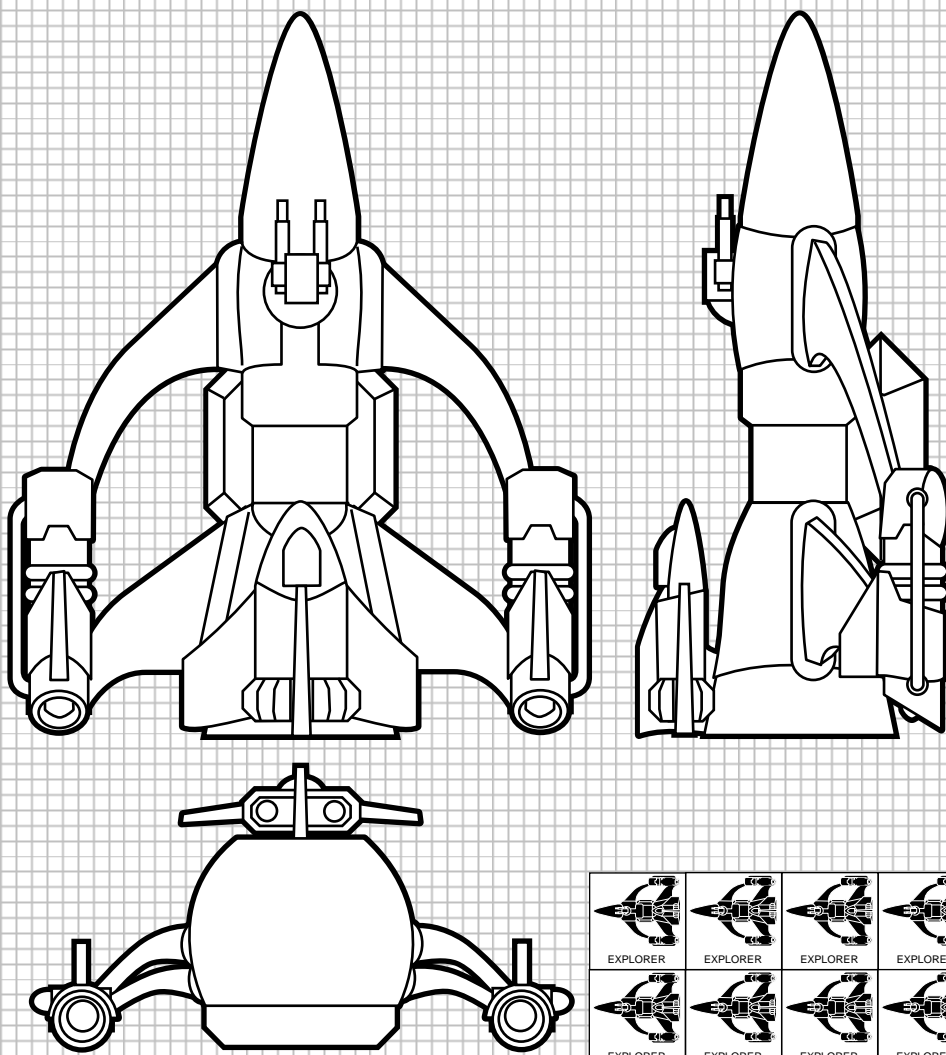

CONTRACT

When you purchase an Expedition Class Heavy Scout, you can take the option of purchasing it "under contract."

Gambling on the intrepid success of private exploration teams, the special interests (private investors, mega-corps, etc.) worked together to set up this special economic aid package.

WHAT'S IN IT FOR YOU

The core ship (not the Expedition) will cost the characters only sixty percent of the price the ship would normally cost using the Knight Hawks rules.

WHAT'S IN IT FOR THEM

But of course, this isn't a grant, it's a binding agreement; there's something in it for them as well.

For ten years after purchase, forty percent of the value of all findings are given to the investors, divided up among them according to the percentages they all contributed. The end

result: more adventurous private explorers, less expense for the investors. Everyone wins.

If the characters bound by the contract don't make any discoveries or stake any claim over any resource before the ten year period is over, they become responsible for paying back the forty percent that was paid, with one hundred percent interest.

CONTRACT BUY-OUT

Some characters may not like being bound like indentured servants to unknown parties. They might not enjoy being the pawns of the kings of space. Heck - they may even find one or more of those megacorporations clashing with them over some of their findings! After all, Streel would love to have 100% of the mining rights on that moon you just discovered! Therefore, there is an option to get out of your contract. All it takes is money... lots and lots of money.

But if you fear this, don't enter such a contract. Space is a big place full of Credits - find a way to get some, and just buy this wonderful ship full-price!

Deck 9 also has some accommodations, though these are not quite as stately as the crew's own cabins. This open area lacks personal space, and is typically used to house scientists or technicians hired on (or who booked passage) for specific exploration missions.

DEFENSES

The ship is not a military one. Its framework and superstructure lack the strength to take much damage, and the number and power of defenses are limited. However, even a civilian ship runs into trouble now and then, so the Explorer Class Heavy Scout vessel is equipped with only two defenses: a laser battery (controlled from Deck 1) and a Masking Screen dispenser (controlled from Deck 8). A Reflective Hull rounds out the defensive power of the craft.

BUY ONE TODAY!

Because of the subsidies paid by several megacorporations, the Explorer Class Heavy Scout ship is quite affordable. With a basic set of science and technical labs, ion drives, and not much in the way of luxury, the entire package will cost you less than a million Credits.

EXPLORER CLASS HEAVY SCOUT

Stats by RumRogue

ADF: 2 (or 1 with Ion drive)
MR: 2
Hull Points: 25
DCR: 35
Defenses: Reflective Hull, Masking screen
Weapons: Laser Battery

Hull Size: 5
 Engines: 2 Class B Atomic Drives
 Crew: 7
 Passengers: 5
 Life Support: Primary: 15, Secondary: 15
 Computer: Level: 4

Programs	Level	(FP)
• Drive Program*		
Atomic	5	(64)
or Ion	4	(24)
• Life Support: Primary	1	(2)
• Life Support: Backup	1	(2)
• Damage Control	2	(4)
• Alarm	2	(2)
• Computer Lockout	4	(8)
• Astrogation	4	(24)
• Skin Sensors	1	(1)
• Laser Battery	1	(4)
• Probe guidance/ analysis	3	(9)
• Laboratory analysis	3	(9)
• Remote probes	2	(4)

*NOTE: Only one type of Drive program is included. Not both. If an Ion drive is selected, the ship has an ADF of 1.

Equipment

- Basic Astrogation Setup
- Radar
- Energy Sensors
- Cameras: 1 set
- Skin Sensors
- Videocom Radio
- Laboratory
- Specialized Docking Clamps: 2 sets
- Atmoprobe Launcher
 Remote Probe Mount; external

PRICE

Atomic Engines Version:

Without Contract 2,007,600 Credits
With Contract 1,204,560 Credits

Ion Engines Version:

Without Contract 1,167,600 Credits
With Contract 700,560 Credits

Notes:

Price reflects building costs from a typical Class II shipyard. Price includes one type of Drive program. This ship can carry one Remote Probe and 5 Atmoprobes. All probes must be purchased separately. Price does not include the Expedition shuttle module or the Detachable Cargo Bin. Although the ship can operate without these options, the Explorer Class Heavy Scout is most interesting when used in conjunction with these. They are summarized below.

EXPEDITION SHUTTLE MODULE

Stats by RumRogue

ADF: 1
MR: 1
Hull Points: 5
DCR: 23
Defense: Reflective Hull
Weapons: None

Hull Size: 1
 Engines: 1 Class A Chemical Drive
 Crew: 1-2
 Passengers: 3-4
 Life Support: Primary: 10 Secondary: none
 Computer: Level: 1

Programs	Level	(FP)
• Drive Program		
Chemical	1	(3)
• Life Support	1	(2)
• Damage Control	1	(2)
• Alarm	1	(1)
• Computer Lockout	1	(1)
• Astrogation	1	(3)

Equipment:

- Shuttle Astrogation Equipment
- Videocom Radio
- Specialized Docking Collar

Total: 125,000 Credits

The Expedition is created as a basic shuttle. It does not come equipped with radar, but there is space for it. The Expedition is purchased separately, and is therefore not discounted if purchased with a Contract.

DETACHABLE CARGO BIN

It was the intention of the original designers of this starship to make several different types of modular cargo bins. However, after being pressured by the investors from PGC, Streele, and others, they focused the usefulness of the Cargo Bin on simple cargo. After all, if the ship's owner does nothing more than trade cargo for ten years, at least the investors make forty percent of trade costs!

Over time, the Detachable Cargo Bin will become common enough that pilots will pull into port, detach, and attach to an already-loaded and prepared bin full of cargo and destined for some other port. The space lanes will become full with modular transports making money off the needs of others.

For now, however, a Cargo Bin costs 50,000 Credits. It is properly sealed and can be entered from within the ship, but isn't designed for creature comfort: it's used to ferry stuff, not folks.

Clever characters may decide to create modified bins, however, for specialized needs and missions. This should be encouraged. Smuggling compartments, passenger seating, vehicle hangars, and robot troop deployment arms are all possible... but details of these are best left up to the Referee and players.

How about a connected series of adventures centering around a small Star Law detachment, sent on missions across the Frontier in search of crime to fight, nefarious villains to arrest, fame, and of course - fortune! Work on it with others at <http://www.starfrontiers.us!>

AGENTS
of

STAR LAW



Agent
Justin
Case

Marshal
Ruben J.
Cogburn

Agent
Gerrick To
"Dirty Hairy"

Sgt Muldoon

Stell
01.20
2008

MARCH 2008

THE LAW AND THE JUSTICE

by William
Signs

Clarion Marine Ship Osprey
Planarion Asteroid Belt, White Light System
24 Septa, 70 F.Y., 19:58:33 GST

The assault scout mated with the derelict freighter with a soft clank! Junior Lieutenant Rhanda Klast was studying the readouts from the energy sensors, monitoring the boarding party channel at the same time.

"Boarding party are in the cargo hold now, Captain," she reported in her clipped Valentin accent. The Osprey's commander, Lieutenant Maxxer Tabbe, did not even bother to acknowledge his second in command's report. Instead, he continued to study the displays at his station on the scout's sky bridge.

That's odd, Klast remarked to herself. The energy sensors registered a great deal of radiation from the three unshielded engines jutting out from the freighter's rear - in addition to heat signatures and electro-chemical activity consistent with Human and Yazirian life signs. Eighteen in all.

Plus, a trio of Zuraquor on the freighter's bridge.

The insectoids are native to New Pale, a race smashed flat and assimilated by the Humans who colonized it over three centuries ago; the Truane's Star government didn't even allow them offworld.

Even though... Klast thought to herself, using the Osprey's intranet to access the intranet on Fortress Redoubt. She instantly found out what she thought she'd remembered reading about Star Law's mission to recover the PGC frigate Omicron thirty-odd years ago. The scout's second in command was using the energy sensors to look for....

Cold spots.

Ten of them just now entering the Osprey's airlock, five Yazzies in the lead.

Reflexively, instantly, she shouts over her headset "it's a tr—"

Her body jerked violently...she could feel her heart stopping.

A hand whirled her chair about, grabbed her hair, and forced her to stare into Tabbe's sneering face.

"You will soon learn your place," the traitor told her. Holstering the electrostunner in his other hand, the screams of the scout's boarding party echoed over her headset as she slipped into unconsciousness.

"...pod laser's offline!" Carla's voice shouted out over her headset. Amid the fire, stench of death, the screaming of



by Rob Turner

a hundred alarm klaxons, radar lighting off on too many 'vettes still converging on the crippled McCoy - which was, sluggishly, trying to disengage itself from the enemy. The Innie militia ships and the rest of Task Force Cassidine was still too far off to do them any good.

* * *

Hands shaking from the numbing cold gripping her body, Hannah fired the maneuvering jets. The Dirk fighter was slewing entirely too slowly to face the oncoming enemy. Her starboard engine struggling fitfully to stay online, the port engine completely smashed. Both engines flooding the mortally-wounded assault scout with....

* * *

...radiation leaked into the ship from the Friday's Child's unshielded engines, Hannah could just feel it washing over her. As she curled up in a ball on her bunk, the six-year old girl, trembling, the door slid open again....

* * *

Fortress Redoubt Secure Docking Ring
1,500 kilometers over Clarion, White Light System
25 Septa, 70 F.Y., 00:02:21 GST

...she could still taste it, chalky and metallic at the back of her throat, even though the Innie docs told her they'd cleaned every trace of it from her system three years ago.

First Lieutenant Hannah Creed sat up in her bunk, staring blearily at the bare walls of her quarters aboard the patrol gunship Albatross. The thirteen-year veteran of Star Law's Spacefleet blinking dry, scratchy eyes in an effort to moisten them.

Untold minutes passed before she became aware of the terminal on her workstation desk bleeping for her attention. Hannah fell out of her bunk, wedging herself good between it, the nightstand, and the workstation chair. The Albatross' commander struggled to her feet, stabbing the talk button after a few fumbling tries, asking, "yes?"

Her second, Lieutenant Star Law M'kx V'razxis, was floating over the workstation terminal, the Vrusk female, as always, straight to the point:

"Squadron commander on the line for you, Captain."

"Patch it through," Hannah replied. M'kx's holo was instantly replaced by that of a white-haired, unkempt Yazirian male, the bridge of his own gunship in the background.

"First Lieutenant," said Commander Chek Groznl.

"Commander," Hannah replied.

Chek remarked, "You look like hell, Hannah."

"And," Hannah told him, "You're just as ugly as ever, old friend. I take it we finally have orders?"

"I just got off the line with Captain Freiling a few moments ago," Chek said, nodding his head. "JRF 3 is to jump for Kdikit, ASAP, to join Task Forces Prenglar, Cassidine and White Light and Joint Reaction Force 1."

"PatRon 109, on the other hand," Chek added, his tone indicating Hannah's not going to like what he was about to say, "is to undock immediately and jump for Plague System Delta --"

Hannah uttered a rude word in reply.

"I don't like it either, Hannah," Chek told her, "but Admiral Brannecken wants us to screen JRF 2, as it assumes picket station in-system."

Hannah nodded her head.

"It's going to happen pretty soon then?" she asked.

"Not over comms," Chek replied, telling her all she needed to know.

"Understood, Commander," Hannah said. "Albatross out." She terminated communications and stretched herself. The servos of her flight suit's exoframe whined as it shifted with her body's movements. Hannah then walked out onto the common area of the crew deck, the klaxons already clanging. The rest of Albatross' crew scrambled out of their quarters as M'kx's voice boomed over the intercom, summoning the ship's company to their stations on the gunship's bridge.

Space Ship Friday's Child Planarion Asteroid Belt, White Light System 25 Septa, 70 f.y., 00:03:00 GST

"Prisoner is secured, Progenitor," the worm's repellent image said to him, as he paced the bridge of this rustie-infested deathtrap of a starship. "Sshe awaits Your pleasure."

"The animal can continue to wait for what it's about to make me do," Samson Streel replied.

The worm's holo bent its multi-segmented body, before asking, "Will you require anything else, Progenitor?"

"Not from you," Streel snapped, terminating communications with the thing. Speaking Tabbe's name into the platinum-plated chrnocom on his left wrist, the traitor's holoimage appeared instantly.

"The prize crew have manned their stations, Master," he says instantly. "And the Osprey's intranet is presently uploading the data you requested to the freighter's intranet. After which, we will undock and take up escort position beside you."

"Master," one of the insectoids reported from the comm station, "the last of the fighters have docked inside the cargo bay."

"Order the pilots to remain inside their craft," Streel commanded the Zuraquor technician, "Then proceed to the cargo bay to begin final preparations on the Scorpions and the multi-missile drones."

"Tabbe," he said to the traitor, "send signal to your fellow Liberationists. Inform them they are to take no action whatsoever on planet until we have drawn out the whole of the Royal Marines and engaged them in battle. Have you heard from our other associates?"

"I am in communication with them as well, Master," Tabbe replied, bowing his head slightly. "They and those loyal to the cause of a free and democratic Clarion have gathered their ships in orbit around Luminere." Luminere was the planet between Clarion and the system's asteroid belt. "And will enter battle the instant we commence our assault against Fortress Redoubt and Clarion Spacedock."

"Very well," Streel said, cutting off any further communication. He then turned to the fat slob of a Human male manning the pilot's station and barked out the command to get this junkpile underway at once.

Truane's Star Ship Star Devil II Geosynchronous Orbit over Luminere (White Light III), White Light System 25 Septa, 70 F.Y., 00:03:59 GST

Commodore Clifford Thomas Creed relaxed in his flagship's command chair, staring at the main holotank. It showed him the grey, depressing, cratered surface of the planet misnamed Luminere. He listened to the reports of his marines on the surface; they told him the SIMPP on the planet's eastern hemisphere is now completely secured, along with the transports they will use to land troops on the surface of Gollywog.

The veteran Truane's Star naval officer took his eyes off the planet, looking instead at the fleet gathered around his Tartarus-class battle carrier. He nodded his head. Even the Liberationist rabble have managed to amass a force of actual warships, laying their hands on a pair of old heavy cruisers and a mothballed Dauntless-class battle carrier to round out their force of merchant escort carriers - old frigates and corvettes. The pirates, normally operating in the Planarion belt, now had a trio of escort carriers and a

quartet of frigates to bolster the handful of corvettes remaining after Star Law and the Royal Marines had driven them from their base forty days ago.

Most impressive, however, was Creed's own force... In addition to the Star Devil II, two other battle carriers, a pair of heavy cruisers, six cruisers, eight frigates and a dozen corvettes - the whole of the Truane's Star Navy's Seventh Fleet - were under his personal command. Six Streeel Divine Judgement-class cruisers, ten Streeel Marauder-class frigates, fifteen Streeel Hatchet-class corvettes, a Sathar heavy cruiser, a pair of Sathar cruisers and six Sathar destroyers were among them.

All of them were waiting for the Star Law forces in system to leave for Madderly's Star, and for the Osprey and the radioactive scrapyard calling itself a freighter to initiate its assault on the orbital facilities over Clarion... Once those two events had taken place, Creed and the ships at his command could proceed with the decimation of the Royal Marines; the conquest of the First Colony in a battle certain to have his name spoken with reverent pride for generations to come.

They might even rename Gollywog after me, he thought to himself, smiling at the prospect. If not that one, then another world, perhaps even Gollwin, once the final defeat of the morally inferior and their so-called Federation have both come to pass. With myself at the head of the fleet which administers the final blow. His smile became even wider as visions of the glory to come played in his mind's eye.

He would be the one who administered the death blow to the Streels as well... In time, he would permit Old Man Streeel and his three "sons" to live long enough to regret they day they had ever decided Clifford Thomas Creed be held back, simply because he came from a family of pirates, tramp spacers, and moral inferiors, with nothing more to their names than that radioactive flying scrapyard now making its way towards Gollywog.

Then, he would make them suffer, before he wiped them and their genetic legacy from the whole of space and time.

He permitted himself a smile, as he pondered that inevitable outcome. The communications tech chose this time to interrupt his commander's reverie with a report:

"Commodore, we have an update from Recon One."

"And?" Creed, not even turning to face the tech, asked in reply.

"Joint Reaction Forces 3 and 4 have just left Fortress Redoubt, on a vector which will take them to Madderly's Star. Recon Flight will follow them until they enter the Void."

"Very well," Creed replied after a pause. "Signal the fleet that we are leaving orbit at once."

"Pilot," he barked out, unable to keep the exultation from his voice. "Break orbit! Maximum burn!"

"Breaking orbit," the pilot replied instantly. Creed felt his ship's engines firing. "Going to maximum burn."

"Frigates and corvettes, accelerate to full speed and assume point!" the commander of the Seventh Fleet then ordered. "Cruisers, destroyers and escort carriers, fall in behind. Heavier units, bring up the rear!"

"Carriers," he added, Luminere slowly disappeared behind his flagship. "Launch Alfa strike."

United Planetary Federation Ship Gran Quivera
57,500 kilometers from Fortress Redoubt,
White Light System
25 Septa, 70 F.Y., 00:05:22 GST

"Snoopers," the radarman reported. "At plus eight-niner by twenty-one point four Alfa... Looks like a single Streeel Reaver starbomber, reconfigured for recon work, and an escort of six Streeel Stinger starfighters."

"Any of our batteries within range?" Captain Estella Freiling asked, not taking her eyes off the Clarion-class strike cruiser's main holodisplay.

"All portside beam batteries can reach 'em, Captain," First Lieutenant Ellica Shozz's voice replied from the cruiser's gunnery deck.

"Burn 'em," Estella replied, no hesitation. "Comms, vector Shield Maiden's combat patrol towards them, just in case we miss. Astro, I think it's time we let everyone else in on where we're really—"

"Splash one!" Ellica's voice half growled over comms, as the Gran Quivera's portside heavy laser and proton batteries let go at once.

"Make that two," the Yazirian female added a second later. "Remaining enemy breaking and attempting to run for it... Wait for it. Damn it, not just—that's four for us, now, five... Gods damn it! Shield Maiden's Boomerangs are on the last two... Whoa, they just let go with every beam they had...."

A long, low whistle over comms, and then:

"Dust to dust, and I mean that literally, Skipper."

Estella nodded. The ship's astrogator, First Lieutenant Jolee Cramer, reported. "Updated course telemetry uploaded to all ships, calculating estimated intercepts now."

"Royal Marines joining us, Captain," the radarman then reported. "Lionhearted launching fighters. Royal Marine frigs and assault scouts joining ours and JRF 4's on station."

The radarman quick to add: "Fighters launching from planetside and all orbitals, heading for the enemy at max burn."

"Report from Captain Dermond of the Clarion," the comm tech spoke up. "She sends her compliments and reports JRF 1 has emerged from the Void in good order and are currently on an intercept for the enemy."

"We're committed, then," Estella said to no one in particular, whispering the prayer to Universe uttered by spacers about to enter battle since before the time of Vincent Morgaine:

"Eternal Light of Space, show us the way in the darkness to come."

**United Planetary Federation Ship Albatross
65,200 kilometers from Fortress Redoubt,
White Light System
25 Septa, 70 F.Y., 00:06:00 GST**

"Captain," M'kx reported, breaking the silence of the gunship's red-lit bridge. "Gran Quivera has uploaded new course telemetry to our astrocomp."

"Show me," Hannah replied, seven gravities still pressing down on her chest, in spite of the Mhnome designed anti-g suit's gel padding. Her second in command displayed the new course in a window on the spherical holodisplay shared by both forward stations.

The new course has them entering the Void still... But, instead of the plague-infested system Albatross was supposed to have emerged at, she was now supposed to exit at a point 134,700,000 klicks from Clarion - roughly fifteen million kilometers from White Light's third planet, Luminere.

"A micro," she remarked to herself, liking this idea even less than jumping into a plague system.

"Tactical data coming through now," M'kx added. The point in space expanded, filling itself with battle carriers and heavy cruisers... Three of the former, all Streel-built Tartarus-class vessels, and three of the latter, two of which are Streel-built Dominant-class ships.

The third was a Sathar Divine Plague-class heavy.

"Surprise," Master Petty Officer Gorop remarked from its station at the torpedo guidance controls. "Surprise, surprise."

"An old Human joke," it added, "I believe."

"Very old," Chief Petty Officer Rondalyn Chase replied from the port laser battery station.

"None the less apt, however," M'kx remarked.

Hannah nodded in reply. For the five years this war has dragged on. Star Law has bled itself dry - literally - gathering evidence that the Streelies and the worms were somehow connected. It was a suspicion going back to pre-Fed times, to the end of the Pirate Wars nearly eight decades before. So far, all they had was bits and pieces, nothing that Old Man Streel and his three sons couldn't dismiss as Sathar agency, like they had the gods-damned Plague fifty years ago....

* * *

"...Gods damn it!" Dad snapped at her over comms. Hannah, fumbling at the controls to the rickety, half-rigged up cargo arm, almost dropped the pallet she was loading from the docking bay floor. The world below visible from the open cargo bay doors.

"S-sorry," the ten-year old girl stammered, managing to fit the pallet into the bay.

Reaching out to grab another, Dad spat back. "Story of your gods-damned worthless life, isn't it?! Isn't it?!" he screamed.

Hannah tried not to cry out. The electrowhip tore through her suit, cooking her flesh open, knocking her out of the operator's chair. The girl spun end over end in the bay. The whip struck out before the suit's autosealant had a chance to work.

"Answer me, you gods-damned little bitch!" Dad ordered her. The world below was closer to her than it had been a few seconds ago. Hannah screamed as the cargo arm whipped out, grabbing her in its pincers.

Tearing through her suit and slowly crushing her, the terrified girl was instants away from being as stone slaggin' dead as all those poor souls on the world below....

* * *

"...Captain?!" M'kx asked. Hannah cursed softly, jerking the stick in her left hand back and to the left to point the maneuver jets thirty degrees up angle and twenty-three and a quarter hours ascension. The jets fired for a few seconds to put Albatross on its new vector.

"Time to jump now eleven hours, fifty four minutes, six point two seconds," M'kx reported. "Interlinking with the other gunships to plot the micro."

Hannah nodded, her left hand let go of the stick. Exoskeletally-augmented fingers worked the keyboard in front of her, as she assisted her second in command and the other gunships' pilots and astrogators in plotting the microjump. She was thankful for having something to keep her mind from dwelling on the past.

**Clarion Marine Ship Lionhearted
60,100 kilometers from Clarion Spacedock,
White Light System
25 Septa, 70 F.Y., 00:07:26 GST**

"All craft away, Your Excellency," the starfighter operations officer reported from the flight bridge.

Crown Duchess Inheritrix Felicia, heir to the Royal Seat of Sinclair, Lord Commander of the Royal Marines, replied, "Acknowledged." She watched the Lionhearted's sixteen squadrons of Boomerang starfighters and War Pig starbombers streak forth into the night, surging ahead even of the combined militia and Star Law frigates and assault scouts forming the first wave of the counterattack.

The twenty-year old Clarion royal couldn't help but worry. Not just for herself and the forces under her nominal command, but for her people on the world below. For Mother, obstinate in her refusal to go into hiding, even knowing what those Liberationist bastards would do to her if the coup were to succeed and they'd ended up capturing her.

She sighed, biting on her bottom lip, eyes still on the main holodisplay... The traitors hadn't given Grandfather the option of facing them openly; a bomb in the Frontier Security Council chambers five years ago killed him and three of the Star Law Special Branch agents who'd insisted on protecting him even after he'd insisted he didn't need to be protected against cowards who blew up babies in

their prams in the name of liberating Clarion from the morally inferior and their evil influence.

Cowards are the worst kind of enemy, she thought to herself. The words of her ancestor, Crown Duke Consort Vincent, always came to mind whenever she dwelt upon the subject of the Liberationists and the Streelies. Her people knew - but could not yet prove - were behind them.

"Intercepts plotted and on the board, Your Excellency," the Lionhearted's chief astrogator reported. "Joint Reaction Forces 1, 3 and 4, plus our assault scouts will intercept first estimated enemy wave of frigates and corvettes in eleven hours, twenty minutes, twenty-five seconds precisely. Intercepting second enemy wave of cruisers and destroyers forty-one minutes, sixteen seconds after that. Fighters will engage one another in exactly nine hours, forty-nine minutes, fifteen seconds."

"Estimated intercept time between our frigates and the first enemy wave," one of the Royal Flagship's other astrogator reported. "Approximate twelve hours, six minutes from now."

Nothing left to do but wait, now that she'd done everything she could do. Lionhearted and her consorts moved through space at a ponderous ten meters per second squared - too slow for the carrier, its attendant cruiser and four escorting destroyers to do anything save mop up and guard the rear... The part of the battle Felicia could never stand, no matter how many times she'd been through this. The waiting always wears and worries her nerves to shreds... She bit one thumbnail all the way to the quick already, starting on the other fingers on that hand. Not very regal or commanding, but she didn't care; there's too much at stake, and she's become a spectator in the battle she is supposed to be leading. She had to do something more than just wait and watch.

This, she observed, worrying a pinky nail free, is as good as anything else I can think of.

**Clarion Marine Ship Osprey
Deep Space, White Light System
25 Septa, 70 f.y., 00:11:28 GST**

"Estimated time to Gollywog," the monkey stinking up the space beside him reported. "Seventeen hours, thirty-seven seconds, at present acceleration."

"Assuming," Lieutenant Maxxer Tabbe remarked, sparing a glance at the deathtrap spewing radiation in a long trail behind it. "it can maintain four gravities' acceleration for that long."

"That," the animal replied, having to nerve to address Tabbe as an equal, adding its odious breath to the stench of its fur. "is highly doubtful."

Tabbe allowed himself a smile, secure in the knowledge that the white fire of Liberation would spread from his homeworld to cleanse the Frontier of things such as it and its packmates. That he and his would reign unchallenged in the Kingdom the One had set aside for His Chosen. That the morally inferior, for all their power and technology, would not be able to stop them.

All the years of being held back, being forced to submit to the will of the harlot calling itself a queen, being made to watch it and its kind weaken and diminish the First Colonists, being forced to endure the insult of having one of them foul his deck.... All of that would soon be rewarded a thousandfold; all the generations to come would say his name with reverent pride. Remember Maxxer Tabbe as the man who'd led the strike which redeemed all the worlds of His Creation from tolerance of perversity, acceptance of depravity, free expression of filth and obscenity, religious persecution disguised as religious freedom, and racism disguised as diversity.

He would see the harlot dragged from its castle and punished the way the abomination he had to call his second in command was being punished now.

That prospect alone was enough to warm him, make him smile wider, as he grips the stick tightly in his left hand, his thumb poised over the firing button for the assault scout's main laser cannon, Tabbe patiently waiting for his role in the redemption of his people to begin.

**Space Ship Friday's Child
Deep Space, White Light System
25 Septa, 70 F.Y., 00:13:16 GST**

The animal was waiting for Him, straining against the chain securing its collar to the deck of the empty cabin. It has the temerity to open its mouth and utter , "Wha—"

Streel pressed a button on the control in His hand. Its screams echoed off the bare walls, the disgusting thing twitched on the soiled mattress it had been given.

"THE MORALLY INFERIOR ARE NOT PERMITTED TO SPEAK!" He told it. The filthy, hateful abomination continued to scream even after He has switched off its collar. "THEY ARE NOT PERMITTED TO QUESTION THEIR ANOINTED LORDS AND MASTERS! THEY ARE NOT EVEN PERMITTED TO THINK!"

"You," he added, leering down at it, spitting on its grotesquery of a body. "are only permitted to submit to the will of the One True God and the chosen stewards of His Dominion."

It apparently failed to understand that simple concept - moral inferiority meant total inferiority, after all - the animal worked its filthy mouth, attempting to speak.

Making Him administer another lesson, one of many He will be forced to teach it in the days to come. But the lot of those Chosen by the One was never meant to be easy. Not until the day, when the Final War had run its inevitable course, and all those like the thing lying on the deck at His feet were delivered to judgment and final punishment at the hands of the One who made them.

Then, once His Kingdom had been restored, only then, could Samson Streel - descendant of David - hope for rest and ease.

"You have been free far too long," He told the creature, "another thing the morally inferior mistakenly believe is their right, but, clearly something even you will come to see as a dangerous error."

"And," He added, voice dropping to a chill whisper, "in time, you WILL see clearly, you WILL realize you never truly were anything more than what you are now."

The unclean beast had the temerity to sit up, spit on His custom-made, two thousand-credit leather shoes.

Another lesson had to be administered.

"Submission to what you were meant to be," He told it, as it screamed and flailed about, "or death. Those are your ONLY two options. "And," He added, hand going to the buckle of His belt, "I will not permit you to die."

* * *

...alarms fading in the thinning air, Hannah found it harder to breathe with each passing instant, her voice a croak, as she shouted out, "Carla, get to one of the workpods! Get the hell out of here!"

"No!" Carla's voice insists over the headset. "Not without y—"

"Gods damn you!" Hannah replied, loading the self-destruct program into the engine comp's memory, "This is not a conversation, you hear me?! Get to one of the slaggin' workpods and - "

Something heavy hit her across the back of her skull, turning out all the lights....

* * *

United Planetary Federation Ship Albatross
134,700,000 kilometers from Fortress Redoubt,
White Light System
25 Septa, 70 F.Y., 11:59:49 GST

"Void speed achieved," Albatross' chief flight engineer, Ensign Dezgere, reported from her station along the rear wall of the bridge deck. "Drivefield generator coming on line and answering astrocomp commands."

The left-hand stick went slack in Hannah's hand. M'kx reported: "Astrogation has control of the ship, course plotted and uploaded to engine computer, Void entry in ten, nine, eight, seven, six, five, four, three, two, one - "

Space and time shifted; the sky assumed the distorted aspect of a funhouse mirror. Albatross sailed into the discontinuity poet and spacer alike had taken simply to calling "the Void." Hannah's stomach cartwheeled sickeningly about, as she saw....

...Cliff's eyes widening in terror, an instant before....

...a huge starship, bigger even than all the Morgaines in the slaggin' fleet put together, blasted its way through Star Law vessels, vaporizing three of 109's gunships in quick succession, Hannah....

...gripping the left-hand stick hard, shoving the throttle in her right hand all the way to the firewall, the pion engines resumed seven gravities' acceleration the instant the Albatross completed deceleration, emergence from the Void, and turnover. All six gunships sailed into the fray at 2,880 kilometers per second. Proton and electron beams sizzled across the night from all six heavies. Interceptor

and anti-beam missiles hissed forth from launchers along their flanks. The captain of the Albatross jinked furiously, crushing the firing button for both main lasers underneath her left thumb. At the same time she shouted for Gorop to "let fly!"

Truane's Star Ship Star Devil II
15,000,000 kilometers from Luminere,
White Light System
25 Septa, 70 F.Y., 12:00:01 GST

"What?!" Creed shouted at his comm tech, refusing to acknowledge the news he was receiving from the vanguard of his forces.

"Not possible," he whispered. The reports received via subspace radio updated the tactical holodisplay before him... All his carriers' fighters and bombers obliterated by fighters launched from the planet. The militia flagship and the three Star Law joint-reaction forces who were supposed to have either been in transit to Madderly's Star or already there.

"Not possible," he repeated, eyes widening in horror.

The proximity alarm screamed. Creed flinched, his radar man and his chief astrogator both reporting, "Star Law Liberty-class gunships emerging from the Void on attack vector, estimated time to intercept - "

"ALL SHIPS! BREAK FORMATION AND OPEN FIRE!" Creed shouted. "RAISE MAG SHIELDING, LAUNCH INTERCEPTORS AND ANTI-BEAM MISSILES! PILOT, EVASIVE - "

White light, this system's namesake, burned and blinded him. An explosion tore Creed's command chair loose from the deck, sending him spinning, end over end, before the light washed away and darkness rushed in.

United Planetary Federation Ship Albatross
134,386,620 kilometers from Fortress Redoubt,
White Light System
25 Septa, 70 F.Y., 12:01:49 GST

The six Star Law gunships sailed through the enemy formation, accelerating towards Void speed. Hannah sparing a look behind her, watched the two halves of her brother's ship shed debris as they drifted, one behind the other. The other two battle carriers expanded clouds of vaporized metal. One of the Truane's Star heavies was dead and dark - a gaping maw blasted through her midsection. The worm ship was radioactive junk. The remaining Truane's Star heavy blasted clear of the wreckage, dispatching the torpedos aimed for it. It matched vectors with its sister ship, as it effected recovery operations.

"New targets acquired," M'kx reported. "Intercept course plotted and uploaded to engine computer. Void entry in ten, nine, eight, seven, six, five, four - "

Don't know if my stomach can take another micro, so soon after the last, Hannah thought to herself, an instant before Albatross entered the Void a second time - emerging fifty thousand kilometers behind a Clarion Royal Marine Stiletto-class assault scout, bringing its laser battery to bear at the same time its maneuver jets fired.

And a ship entirely too familiar to her; one she knew just by the amount of radiation spewing from its unshielded engines.

Clarion Marine Ship Osprey
Deep Space, White Light System
25 Septa, 70 F.Y., 12:03:20 GST

Tabbe turned his ship over, even as the gibbering monkey manning the laser battery began firing wildly in the direction of the six fast-approaching Star Law gunships,. The ex-Clarion Royal Marine officer loosed a brace of Lancer missiles just as the assault scout finished pointing its nose at the enemy vessel. The flying deathtrap next to him attempted evasive maneuvers, as it brought its pair of laser batteries to bear.

Interceptors flew from the gunships, easily stopping the incoming Lancers. Anti-beam missiles filled the space between them and Osprey with clouds of ice and metallic foil. Tabbe stabbed out with a shaft of blue-white hot light from the main laser cannon. The attenuated beam caromed harmlessly off of the magnetic deflection shielding of one of the enemy vessels. The freighter opened its cargo bay doors, vomiting forth Scorpion drone fighters and manned Sathar and Stinger starfighters. The small craft arrowed forth at maximum burn towards the Star Law vessels.

"The freighter's attempting to make a run for it," the monkey at astrogation reported. Tabbe briefly watched the decrpit excuse for a starship attempt five gravities' acceleration, before turning his full attention back to the charging Star Law ships. Green crosshairs bracketed one of the enemy vessels. Tabbe fired the main laser again, following it up with a quartet of Lancers.

Again, interceptors stopped the incoming missiles. The laser burned a runnel through one of the gunship's flanks. Tabbe jinked furiously, shouting to the monkey at the engineering station to boost power to the Osprey's mag shielding as the gunship fired both of her main beams at once.

United Planetary Federation Ship Albatross
Deep Space, White Light System
25 Septa, 70 F.Y., 12:04:16 GST

Albatross' main beams pinned the assault scout between them, vaporizing it instantly. Hannah turned her full attention to the manned and drone fighters released from the cargo bay of Dad's ship. The rigged-up shambles of what had begun as a Pacific-class freighter tried to boost to five gravities, as it ran from a fight it couldn't win.

At least he's consistent, Hannah thought to herself....

...slag!

Hannah gritted her teeth. Her Dirk shook herself apart with each hit. Her eyes remained on the Pacific-class freighter, running like a scared rabbit from Darkworld Station, on the seagull in flight painted on its starboard side.

Gullwind.
Gar's ship.

Her people and the McCoy's crew are risking their necks for that miserable slag, just to bail him out of another one of his half-assed schemes!

Hannah watched as a pair of 'vettes swooped down on the Gull's backside. Their laser cannon punctured the cargo bay. The freighter's laser batteries returned fire, missing badly. Three more 'vettes and a squadron of Stingers converged on Gar's ship.

"Take the pressure off that freighter!" Commander Trivette's holo ordered, her own burning shambles of a bridge in the background.

"What?!" Hannah replied angrily, even as Var Krenko, her astrogator, reported that the crippled destroyer was changing vector, not retreating back to Inner Reach like she was supposed to, and was turning instead to aid the Gull.

"Gods damn you, McCoy!" the Dirk's commander insisted, moving closer to protect the McCoy. "He's not worth it!"

"Maybe, Lieutenant," Commander Trivette replied, "but...."

...they'd end up saving the Gull and her crew anyway, and all it had cost was the lives twenty-eight good and decent beings aboard the Melinda McCoy and the four aboard the Dirk.

Including the first, last and only one she'd let close to her.

The bridge lights dimmed, as missiles and beams slammed into the ship's magnetic shielding. Dezgere diverted power from the pion engine to reinforce the shielding. Interceptors and anti-beam missiles shot forth from the twelve defensive launchers in the Albatross' flanks to blunt another incoming volley of missiles and lasers. Hannah lit up the center of the largest concentration of enemy small craft; the twin laser cannon stabbed through their ranks. Rondalyn and Petty Officer Perriz Gansch slashed through the enemy drones and fighters with their remotely-controlled laser batteries.

"Mass-driver coil charged," Gorop reported. "Mass-driver loaded and ready to fire."

"Fire at will, Master Gorop," Hannah replied. The mass-driver mounted in Albatross' belly spit out thousands of depleted uranium projectiles at two percent of light speed. The resulting explosions of kinetic energy tore the fighters apart.

"Freighter has launched three dozen multi-missile drones!" M'kx shouted out amid alarms echoing across the bridge.

"GODS DAMN IT ALL!" Hannah swore through gritted teeth. Friday's Child was pulling away at five Gs, as 36 Steel-manufactured multi-missile drone craft arrowed toward Albatross at 150 meters per second.

Space Ship Friday's Child
Deep Space, White Light System
25 Septa, 70 F.Y., 12:05:00 GST

His bionic heart hammered violently in His aching chest. His breath came in great heaves and sobs, as He knelt over the animal, now huddled in a ball against the far bulkhead, its back to Him. The thing was crying,

whimpering, as if He had forced it to endure the sick, sadistic depravities it had forced Him to inflict on it.

The filthy thing had almost killed Him... His bionic lungs struggled to keep up with the oxygen demands of His body. His bionic eyes worked intermittently; the sight before Him either broke up into white noise or disappeared into darkness.

"You," He heaved at her, winning the struggle to rise to His feet, "will not kill Me, no matter what you do!"

"I," He added, dressing, "am armored in righteousness and the love of My Lord and Master, the One True God - who allowed your kind to break Him on the Wheel to save His Chosen from the isolation you imposed between us and Hi - "

The door hissed open, a worm hissing, "Progenitorrr -"

"WHAT IS IT, YOU REPELLENT CREATURE?!" He demanded, not bothering to turn and face His Sathar servitor.

"We arre underr attack," the worm replied. "A squadron of Ssstar Law gunshipss emerrrged from the Void a few momentss ago, destroyed the Ossprey, and arre now -"

"WHAT?!" Strel asked, turning to stare down the creature. "Not possible!" He insisted, knowing it could be, that anything could be, with that sneaky, gods-damned bastard Ironside Brannecken.

"The Ssstar Law forrcces which were ssupposed to leave for Madderly'ss Sstar," the worm reported, "chose instead to ambush our forcesss here, along with vesselsss sent from Madderly'ss Sstar and those of the Clarion militia."

"Gods damn it," He swore, as He finished dressing, regretting the vain decision to lead the chastisement of the Gollywogs and their harlot so-called queen personally. To say nothing of the equally-stupid decision which led him to hitch a ride aboard this decreptitude of a starship, instead of waiting for His Flagship to complete its refit at Fortress Watchtower... He should have gone on to Delta, where the ultimate instrument of His vengeance and His God's Perfect Hatred was now being equipped for the final campaign against the Dark Enemy and the moral inferiors under Her command.

"Gods damn it!" He repeated, shoving the worm away from Him, as He made His way down the dimly-lit passageway to the core lift.

He caught His breath once He was in a lift car creaking its way towards the bridge. Strel gathered His wits, calculating vectors, reaching the inevitable conclusion.

Brannecken had set Him up; his Special Branch fed the Liberationist traitors in the Wogs' ranks false information, which they, in turn, had relayed to the operatives of His Corporate Intelligence Service, who had dutifully informed Him of what they'd believed were Star Law's plans.

One of the many ways the morally inferior had conspired to frustrate Him in His plans to use the Sathar to destroy Star Law and the militias and prostrate the Frontier before them so that the fleet He had built could sweep them aside and reshape a grateful people in His image and His

likeness - as the One who ruled them all had meant for it to be. It was supposed to have taken six months for this to come to pass... Instead, it had been five long years of futility. Even though He held the four worlds His family had coveted for hundreds of years, Star Law and the militias kept finding new ways to outwit and overcome the Sathar - even with Zuraquor technicians and Truane's Star military officers commanding them. Even with Strel and Truane's Star troops and warships bolstering their ranks.

He stepped out of the lift car and onto the red-lit bridge. The fat slob commanding this wreckage reported.

"We've just sicced the multi-missile drones on 'em, Master, but the gunships are still closing rapidly. And me n' Jorgens have wrung all the acceleration we're gonna outta these old engines. We fiddle with the engine comp any more and -"

The lights went out briefly, and Strel heard the thunder of an explosion echoing throughout the ship.

A reedy voice said over comms:

"C.W., that was the port laser battery. Sumbitch went up like a Federation Day picnic, sending current all through the system... Bloup's fried real good, protoplasm's fused with what's left of the turret -"

"What about the rest of the ship?" the captain asked, apparently caring even less about some blob than Strel himself did.

"Breakers got tripped all over the place," the voice—which Strel assumed to be that of Jorgens - replied. "Most of the crew deck's without power. Same as the engineering spaces and the starboard battery. But the engines and the engine computer are both still on-line, and we're continuing to pull five gees. Though, with those gunships making seven, I don't know if -"

"Contact the commander of the Perfect Hatred," Strel commanded. "Have him withdraw any of his ships which have survived contact with the enemy along a vector intersecting ours."

"Once we regroup," He added, "we will enter the Void on course for Plague System Delta."

As I should have done in the first place, Strel silently rebuked himself.

**Truane's Star Ship Exalted
15,000,000 kilometers from Luminere,
White Light System
25 Septa, 70 F.Y., 12:05:30 GST**

"Why didn't you pursue the enemy?!" Creed demanded of the captain of this ship, the instant the Seventh Fleet commander stepped off the lift onto the Immortal-class heavy cruiser's bridge.

"Master," the captain replied, turning to face him, "we were engaging in recovery opera -"

He screamed, his eyes and twitching body wreathed in lightning, as he fell. Black smoke curled up from the flames consumed what remained of his corrupted flesh.

"No..." Creed hissed, holding the smoking electron pistol steady in his left hand. "EXCUSES"

He then eased himself into the command station's chair, waiting for the maintenance bots to cart away the garbage, before issuing these orders to the Exalted's pilot and chief engineer:

"This ship is capable of three gravities' acceleration. You - or your replacements - will deliver it AT ONCE! Astrogator, calculate the vector taken by the Star Law gunships, then plot and upload an intercept course to the piloting computer."

"At once, Master!" three voices replied as one. The heavy cruiser soon fired its maneuvering jets, turning onto the plotted intercept vector. Its six nuclear engines throttled up, causing the entire ship to creak and groan, as it achieved the thirty meters per second he'd desired.

"Good," is all the reply Creed gave, his steepled fingers at his lips, as he relaxed in his chair.

"Master," the ship's radioman reported. "I am intercepting a message from the freighter ferrying our Sire to Gollywog... They report the Star Law gunships which attacked us have destroyed the Gollywog assault scout travelling with them, and are now pursuing them."

"Where are they?" Creed asked the chief astrogator.

"Location information uploaded to your station, Master."

"What word of our Sire?" he then added, swallowing bile at having to address Old Man Strel by that name.

"He has ordered all surviving ships to regroup and withdraw to Plague System Delta," the radioman answered him.

Creed nodded his head, thinking, asking the chief astrogator: "In your opinion, can we reach the freighter before the Star Law gunships succeed in capturing or destroying it?"

"No, Master," the chief astrogator replied instantly, confirming Creed's own calculations.

"Then, we won't risk our lives in trying," Creed decided. "Cancel previous course, plot a new vector which will take us away from all enemy combatants."

"Then," he added, "plot a course for Plague System Delta. Pilot, maintain maximum burn."

**United Planetary Federation Ship Gran Quivera
93,748,830 kilometers from Fortress Redoubt,
White Light System
25 Septa, 70 F.Y., 12:06:15 GST**

The cruiser's twin heavy laser cannon impaled a Strel Divine Judgment-class cruiser through its starboard side, sending it spinning lifelessly end over end.

"Remaining enemy ships are withdrawing from combat," the radarman reported. Gran Quivera moved past the cruiser she had just destroyed as Estella studied the tactical holodisplay at her station... Only a pair of Strel

cruisers, a Truane's Star cruiser, four frigates and six corvettes are still fighting, the remainder either dead in space or vaporized.

A turkey shoot, the commander of Joint Reaction Force 3 observed, not having the slightest idea what a turkey was and why the Ancestors used to shoot them. It had been years since her Pre-Frontier History course in Academy.

The term was nevertheless apt; bastards never had a hope, not with over two hundred Star Law and militia ships and nearly three times as many fighters and bombers surrounding a force of sixty-five enemy warships and a few hundred fighters and bombers... They'd shot down fifty-two enemy vessels within a matter of minutes, losing only seven of the Shield Maiden's Boomerangs and a pair of Gollywog assault scouts.

Nothing to brag about, really, she reminded herself. Twenty-seven dead was still too many as far as she was concerned. Any death is still one too many, Estella added mentally, asking the ship's radioman, "You get what you needed?"

"Streelies tried their damndest to scramble their comms to the pirates, the Liberationists, and the worms," Gran Quivera's radioman replied "But, yes, ma'am, we've got 'em giving orders to all three."

"We," the radioman added, "even intercepted orders in Old Man Strel's name, telling the remaining ships out there to bug out, regroup around his position, and head for the Void."

Estella's eyebrows rose slightly at the Dral's report.

"Do you have a fix on his location?" she asked. "More importantly, any hard evidence he even gave those orders?"

"Yes and no, Captain," Jolee reported, the course telemetry now uploaded to the command station. "We don't have any clear indication Old Man Strel himself gave those orders; the comm to the Perfect Hatred - the cruiser we just scragged - was in gnat-talk, that's what the Streelies usually use when they don't want anyone listening in on their conversations."

"Circumstantial evidence at best," Estella remarked, sighing.

"Additional subspace comm traffic from Strel's alleged location," the radioman added. "Black Dogs are heavily engaged against Strel and Sathar drone and manned fighters, as well as three dozen Strel-built multi-missile drone platforms."

"Plotted," Jolee replied instantly. The holo on Estella's display refreshed. Six blips indicated the positions of Patrol Squadron 109, appearing behind the red dot marking the source of the alleged comm from Strel. More red blips stippled the display, showing the estimated vectors of the hostiles.

"Update on the source of that signal," the radioman added. "According to 109's comm traffic, it's an old Pacific-class freighter, though I'm not getting an IFF signal from it."

Estella nods her head again.

"Gran Quivera to Shield Maiden," she said over comms. "I'm uploading a vector to your air operations computer; I need for you to have your remaining craft change course accordingly and lend support to the Black Dogs. Battle Squadron 304 and Patrol Squadron 307, you'll accompany Shield Maiden's fighters and bombers."

"All other ships," she added, "are to make sure none of those bastards out there escape."

Clarion Marine Ship Lionhearted
18,662,400 kilometers from Clarion Spacedock,
White Light System
25 Septa, 70 F.Y., 12:07:02 GST

"Air operations," Felicia ordered almost instantly, "vector all available fighters and bombers against that contact."

She continued studying the telemetry downloaded from the Gran Quivera. The Crown Duchess Inheritrix listened to the comm reports being piped in over the Royal Flagship's intercom. She paid particular attention to the reports coming from the surface of the First Colony. Even though the Royal Guards, the Star Law Marine Urban Warfare Units, and Royal Security and Intelligence tactical squads had that situation largely in hand, rooting out the Liberationist cells before they have a chance to move against the Crown.

What worried her most was the attempt by the Officials - the Clarion Liberation Party's political wing - to storm Sinclair House and arrest Mother, the members of the Privy Council, and both houses of the Consensus... That fat pig Nit Gangreen, had declared himself Lord Protector of Clarion live on the Mosaic, just before the feed from the Consensus chambers had gone dark. Even if the Star Law and Royal Forces managed to run all the Resisters to earth, it wouldn't do a damn bit of good if the government itself was held hostage.

Most disturbing to her was the news that the Star Law ships currently pursuing the freighter transmitting orders to the rest of the Streelie forces had intercepted and destroyed the Osprey. RSI had suspected Tabbe's loyalties for some time, but hadn't been able to prove anything concrete. The rest of the crew hadn't been suspected of anything, and Felicia wondered if that had been an error on RSI's part.

More worrying to her is the question of how many more traitors had infiltrated her Marines and how far up in the ranks had they moved. To say nothing of how she should go about answering that question, without defiling the very Crown she'd pledged her life to defend and the Seat she would one day occupy. All the methods she could think of, save one, would do just that, while driving any suspected traitors deeper into hiding.

That left her with having to wait those traitors out - if any more had infiltrated the ranks of the Royal Forces. She didn't like that solution either; gods only knew how much damage any potential enemy within could do in the process of exposing himself to the scrutiny of the RSI, or even if the militia could recover from that damage.

A risk I'll have to run, she concluded, nodding her head absently.

"Radioman," she ordered, "have Knighthawk and the destroyers alter vector and intercept that freighter. Maximum burn."

"Orders relayed, Your Excellency," the Lionhearted's radioman reported. Felicia continued to monitor the comm reports. Study the holos.

Cowards, she observed, really are the worst kind of enemy.

United Planetary Federation Ship Albatross
Deep Space, White Light System
25 Septa, 70 f.y., 12:08:20 GST

The main beams and the mass-drivers swept aside the last of the multi-missile drones, even as they salvoed a brace of missiles towards the Albatross. The gunship's remaining interceptors stopped all but three of the inbound missiles. Those three caused the bridge lights to dim, as they struck the mag shielding squarely. Dezgere reported no damage, no casualties. As crosshairs on Hannah's holodisplay bracketed two of the three ancient Streel-built engines. Albatross' command pilot did not hesitate, vectoring twin beams of bluish-white-hot light towards the nacelles, both of which exploded in gouts of burning junk and radioactive plasma. This sent the scrapyard of a freighter spinning crazily through space - the surviving nuclear engine still firing at max burn. Its maneuver jets struggled to correct the ship's spin, before engine and jets both expired in a shower of sparks, leaving the vessel dead, dark and helpless. Just the way Dad liked his victims. And his family.

Her left thumb gently caressed the firing button, crosshairs bracketing what remains of the ship, as Albatross closed rapidly with it.

"Captain," M'kx asked, "shouldn't we start our deceleration burn about now?"

Hannah ignored her. Her eyes only saw that gods-damned ship in front of her.

"Captain?" M'kx repeated, a little more insistent. Hannah's thumb was that much closer to crushing the firing button.

To putting an end to someone who never truly deserved to live in the first place....

"...maybe, Lieutenant," Commander Trivette's holo replied. The McCoy's wrecked bridge was burning in the background. "but, he still needs our help...."

...and, they had a job to do.

"Gods damn it," she whispered through gritted teeth, as she jerked the stick back, firing the maneuver jets to turn the ship over to initiate the deceleration burn.

"Marines to the airlock," she ordered over comms, arming the grapples. "I say again, marines to the airlock."

"Gods damn you," she whispered again. The image of the Friday's Child was wavering in her holodisplay.

---End---

ABLATIVE DAMAGE

by Bill Logan

Damage in the Star Frontiers game is simple and quite playable, lacking realism but allowing a certain level of cinematic, heroic gameplay. After all, how many bullets can a character *really* eat before he's pushing up daisies?

This optional rule set makes damage a little more realistic. It is a pretty drastic change to the core rules, however, and should only be used by Referees wanting to introduce a certain level of grittiness to his games.

With several concepts freely borrowed from other out-of-print 1980's era role-playing games, this system is heavily tested and fun to work with. It has the benefit of being highly graphical, uses a simple form of hit location, takes into account both armor and penetration, and is pretty easy to get the hang of. Intrigued yet?

DAMAGE BOXES

The most dramatic change to the damage system is the introduction of damage boxes. It may seem alien, but once you've used it, it works pretty smoothly.

In this system, your character has several damage boxes. He has these damage boxes in ten different hit locations. Each hit location has a number of damage boxes equal to one tenth of your character's Stamina score (round in favor of the character).

You'll notice that each of the ten hit locations has ten damage boxes. You'll only use a certain number of these (one tenth your character's Stamina score, round up). You'll divide this among the top and bottom rows evenly, coloring in any unused boxes. The top row must always have equal or more available damage boxes.

For instance, if you have a 40 STA, you'll have 4 damage boxes: 2 on the top and 2 on the bottom. Each of the ten hit locations would look like this:



2: Chest

If he has a 45 Stamina, your character will have 4.5 (rounded up to 5) damage boxes: 3 in the top and 2 in the bottom. Excess damage boxes are filled-in and not used:



2: Chest

HIT LOCATIONS

When your character is hit, or when he hits an opponent, the tens digit of the hit roll represents the hit location. Each of the hit locations has a numeric reference: 0 for Head, 1 and 2 for two different Chest areas, 3 for Abdomen, etc.

For example: You fire your gyrojet pistol at your opponent. You have a 55% chance to hit. You roll a 47, a hit! You hit in area 7 (the left hand).

BUMPING HIT LOCATIONS

A skilled character can bump the hit location rolled by an amount equal to his skill level. This helps take some of the randomness out of the situation in a way that only a great deal of talent and training allows.

For example: The character from the above example has 2 levels in his Gyrojet Pistol. You rolled a hit location of 7, but can bump this up or down by 2 (your level). This means you hit your opponent in hit locations 5, 6, 7, 8, or 9 – your choice.

COVER

In this system, your character can take advantage of cover much more effectively. If you're behind hard cover, the only hit location that would be exposed is your head, weapon arm, and hand. That assumes you're fighting back.

If your opponent rolls a hit, but it hits an area protected by hard cover, you're unharmed.

A skilled character might be able to bump damage to an exposed hit location, so cover isn't 100% effective. It is, however, far more effective than wearing defensive suits or screens.

DAMAGE

When a character rolls damage against an opponent, you no longer sum the dice. For example, if your character successfully hit with a sonic sword (damage rating 5d10), you still roll 5d10. However, instead of summing the rolled dice, you simply count how many turn up greater than 5. That's how many of your opponent's boxes are "damaged."

DAMAGE TYPES

There are two types of damage your character can sustain: Bludgeon, and Wound. Bludgeon damage can knock you out, wound damage can kill you.

BLUDGEON DAMAGE

If the damage came from a source that bruises, bashes, whacks, or bludgeons, that damage is recorded as diagonal slashes (↗) through unmarked damage boxes. If you have no unmarked damage boxes in that hit location area but still have bludgeon damage to record, that area is filled and is considered *numbed*.

If your head, abdomen, or either chest location is *numbed*, your character is unconscious. You'll stay unconscious for an hour then wake up with one of those bludgeon damage slashes healed.

A hand or arm that is *numbed* means no weapon or tool use is possible with that hand or arm (at all, until that hit location heals)... while a *numbed* leg means half movement rate.

WOUND DAMAGE

If the damage came from a source that pierces, slashes, cuts, or causes intense tissue trauma, that damage is recorded as exes (⊗). Wound damage supersedes bludgeon damage; you'll first turn bludgeon damage into wound damage, then use unmarked damage boxes.

For example: your character's abdomen is undamaged. Since he has a STA score of 35, he has 4 damage boxes in this and all hit locations.



Later, he takes 2 points of bludgeon damage. Although hurting, his abdomen is not numbed:



Later, your character is shot by a blaster for 3 points of wound damage. You first turn the two slashes into exes (by drawing a second diagonal line through those boxes), then you'll put the last wound mark in an undamaged box:



If you have no unmarked damage boxes in that hit location area yet still have wound damage to record, that area is filled and is considered *thrashed*.

If your head, abdomen, or either chest location is *thrashed*, your character is dead, period.

A hand or arm that is *thrashed* means no weapon or tool use with that hand or arm (at all, until that hit location heals)... while a *thrashed* leg means half movement rate.

You'll notice that having your arm, hand, or leg *thrashed* really isn't much different than having that same location *numbed*. That's intentional. The real problem difference is in the healing rate.

HEALING

All hit locations recover 1 bludgeon slash per hour. In a few hours, most people will recover from being punched and kicked fairly well, unless they were beaten to a pulp!

All hit locations recover 1 wound ex per day with a successful Stamina check. It'll take a few days to recover from being cut up!

MEDICAL HEALING

Any medical or medicinal healing would heal an amount of damage equal to one tenth the amount it would otherwise heal. For example, Minor Surgery normally heals 20 points of damage according to the rule book. In this damage system, it will heal 2 damage boxes instead.

DEFENSES

Defenses are equally effective, in some cases slightly more so and in other cases slightly less.

SKENSUITS

Skensuits still absorb damage, just like always. However, they have 5 points of protection in each hit location (other than the head). You record this in addition to the damage boxes your character can sustain. It's simplest to record your skensuit's damage boxes as a single depletive number rather than a series of damage boxes.

Whenever your character takes damage in a hit location where your skensuit protects, your suit will take half of it (round up), and your character will take the remainder.

For example: Your character has a skensuit, and takes a hit in the right arm. He normally has five damage boxes in each hit location, and is hit for an amazing 5 points of damage! Normally that would have thrashed your right arm, but thankfully, your skensuit will absorb 3 of those points, you'll only take 2 wound points of damage.

Before being hit:

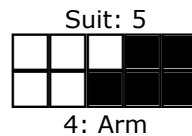

After 5 pt hit:

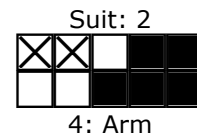

ALBEDO SUITS

Albedo Suits still absorb 100% of the damage from laser weapons. But they will only absorb 10 points per hit location. Laser damage has to get through the 10 points of Albedo Suit before it will begin harming your character.

INERTIA SCREENS

Whenever your character is struck for inertia damage (whether it's wound or bruise) and he's protected by an inertia screen, the screen will absorb half the impact of

MARCH 2008

the damage (rounded up) and drain 2 SEU. If, for example, you were struck for 7 points of damage, 4 of it would go away and only 3 of it would affect your hit location, all for the cost of 2 SEU. That's great protection!

If your character is protected by both an Inertia Screen and a skinsuit, the screen will first absorb half the impact (rounded up). The suit will then absorb half of what got through your screen (rounded up). Whatever remains is what hurts you... now that's some great protection! Of course, this person is a sitting duck for someone with a blaster pistol.

ALBEDO SCREENS

Each point of laser damage absorbed by an active albedo screen drains its energy source by 2 SEU. This is commensurate with the standard rules for albedo screens.

HARD ARMOR?

Although the Star Frontiers game system doesn't specifically support hard armor (plastisteel, ceramic, reinforced resins, etc.), this damage system would easily allow for it in one of two ways:

Option 1: Damage Target of 8

Normally, when rolling damage each die that comes up higher than a 5 counts as a point of damage. That means each die has a 50% chance of affecting a damage box. When striking hardened areas, treat each die that rolls higher than 8 a damage point. That changes the dynamics considerably.

If your character hits an unarmored (or skinsuited) opponent with a frag grenade for 8d10, you'll typically roll about 4 points of damage. If your enemy were armored with hardened armor, it would make each die only 20% likely to score a point of damage: you'll be lucky to score 2 points of damage against him!

Option 2: Damage Dissipation

Alternatively, you could have hard armor simply convert wound damage to bludgeon damage on a 1:1 ratio. This would help a character survive (and it would give a realistic reason someone might buy a helmet and flack vest!)

If you use hardened armor in your game, it would be reasonable to assume that a critical hit ignores the effect of the armor, treating it like a hit on an unarmored hit location. Nobody can be fully encased in armor; they wouldn't be able to move. A critical hit might be assumed to strike at pivot points and joints, where armor is reduced.

COMPATIBILITY

You should notice that this system does a pretty good job of staying compatible. One-tenth the amount of damage spread out among ten hit locations... mathematically it's quite similar. Weapons with damage codes already have a bell-curve, making the odds of rolling damage about the same in both systems. The system for skinsuits, inertia screens,

albedo suits and albedo screens is mathematically equivalent, simply working with one-tenth the numbers over ten times the area. It's a compartmentalized version that gives more realism to the damage system while not adding complexity to gameplay.

PUNCHING SCORE

One thing that doesn't convert is Punching Score. There really is no way to properly add PS to this system and maintain statistical equality to the original Alpha Dawn system. That's because Punching Score is woefully under-expressed, having very little impact on the damage caused.

So Referees should choose either to drop it altogether, or make it have more impact on the overall damage potential (which is something many house rules seem to do anyway).

One way to remedy this is to use the following table instead of the classic one from Alpha Dawn. This becomes an adjustment to the number of dice to roll, not to the overall result.

NOTE: Damage codes should not be able to be reduced by more than half, nor should they be able to be more than doubled, using this system.

STR	01-20	21-40	41-60	61-80	81-100
PS	-2d10	-1d10	--	+1d10	+2d10

For example: your character has a Strength score of 75. When he hits someone with a sword (normally does 3d10 damage), you'll do an additional +1d10 to the damage code, or 4d10.

NON-HUMANOID SHAPES

So we have ten hit locations. That seems to work pretty darned well for humanoids. You're about 40% likely to hit an important body location (head, chest, abdomen), and 60% likely to hit the arms, hands, or legs. But what about a yazirian's wings? What about all the legs of the vrusk? And hey... my dralasite has three legs!

In these cases, you'll have to use common sense. Even if it's described as an arm hit, you can describe an injury as striking a yazirian's wing. Leg shots typically will only harm the front legs... but an attack from the rear that hits location 8 or 9 on a vrusk would probably be described as his back legs.

In testing this system, we allowed any hit from the side to affect a yazirian's wings instead of his chest or abdomen. For this reason, these extra hit locations have damage boxes but have no hit location number next to them. It's reasonable that any hit to the arm or chest or abdomen could be "bumped" to a wing.

OPTION: DRALASITE MORPHING

Dralasites might (with Referee approval) be able to shift damage to different locations if they spend a half-hour or so doing nothing else. Spreading their damage as evenly as possible might be a big help to these little guys!

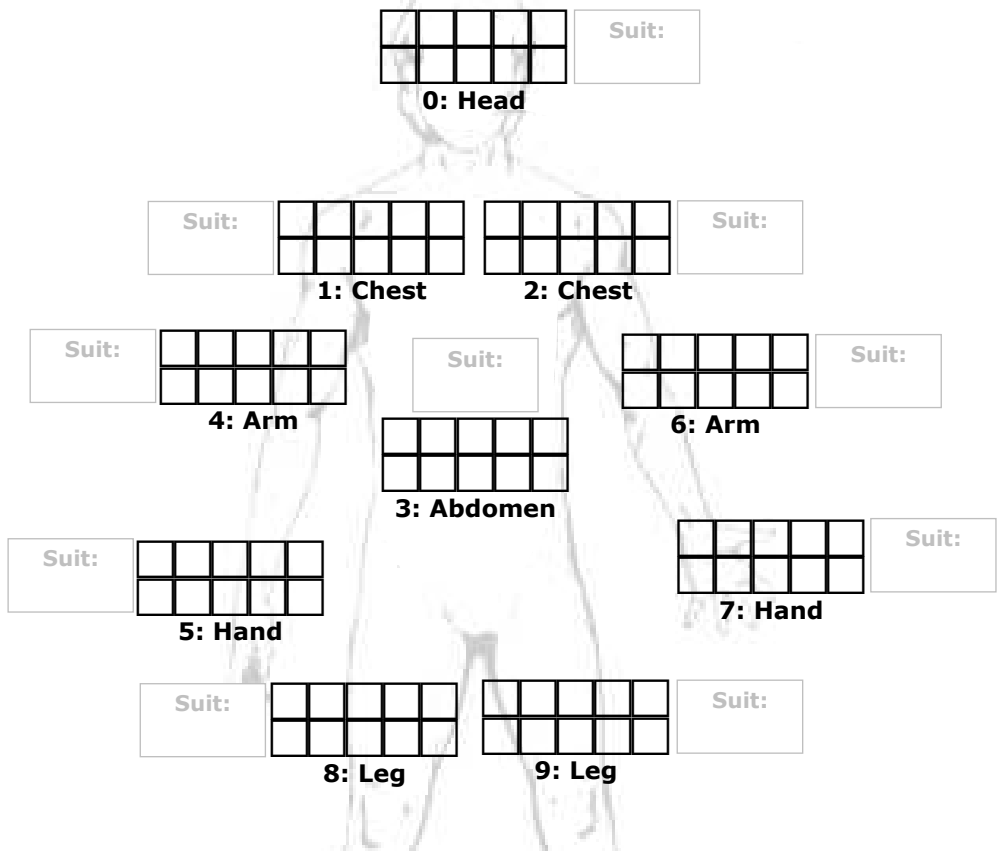

#: _____

#: _____

#: _____

#: _____

#: _____

#: _____

Bludgeon:

- Record in boxes.
- Each location heals 1 per hour.
- When last is filled with , that area is *numbered*.
- When locations 0,1,2, or 3 are *numbered*, character is unconscious.
- When locations 4,5,6, or 7 are *numbered*, that limb cannot be used.
- When locations 8 or 9 are *numbered*, movement is halved.
- When locations 8 and 9 are *numbered*, movement is quartered.

Wound:

- Record in boxes before recording them in boxes.
- All locations heal 1 per day with a single successful STA check.
- When last is filled with , that area is *thrashed*.
- When locations 0,1,2, or 3 are *thrashed*, character is dead.
- When locations 4,5,6, or 7 are *thrashed*, that limb cannot be used.
- When locations 8 or 9 are *thrashed*, movement is halved.
- When locations 8 and 9 are *thrashed*, movement is quartered.

EQUIPMENT

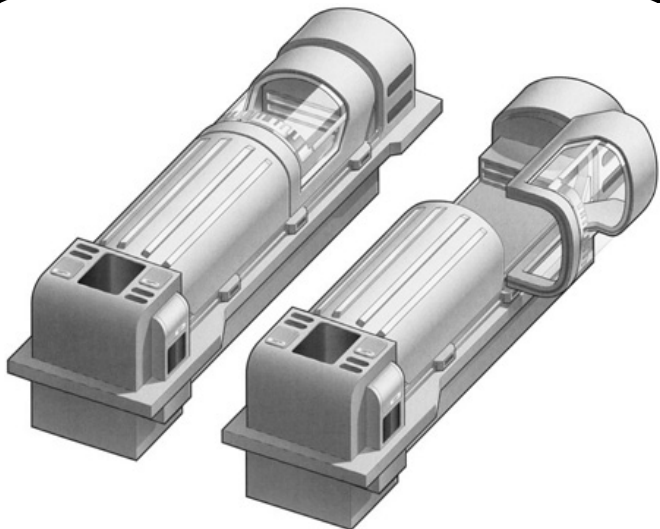

AUTODOC

By Chris Harper

Where is a dang medic when you need one? Are you tired of having to hire medics all the time to keep adventurers on the top side of the soil? Are you tired of their self-righteous know-it-all attitude? Who is a medic gonna call when they get shot? Well look no further. Just dump your shot-up buddy in the autodoc, and it will fix him right up. Got a bad hangover? A sunburn? or even a dismembered leg? Just hop in the autodoc. No job is too small or too big.

The Autodoc or "Coffin" is a level 6 autonomous medical robot that can provide most services that a medical professional can provide. The autodoc consists of an airtight capsule, where the character is placed. It is usually made of glass for observation. It also has built-in storage for instruments and storage for drugs and gases used during procedures.

USING THE AUTODOC

The injured or sick character is placed inside. The autodoc assesses and diagnoses the problem. Then administers the appropriate treatment. The autodoc will sedate the character during treatment. They will be totally unconscious during any procedures.

A character that has not gone below -30 stamina can be placed in the autodoc. They will be stabilized and field surgery will be performed. The autodoc makes a skill check for each treatment of skill level of 6. It will first do a diagnosis. Then it will determine whether first aid, minor surgery or major surgery is needed to heal the character.

Characters who are poisoned or infected: a skill check of controlling infection then cure disease will be administered. The character will not be released until all Stamina points are restored.

A maximum of 20 stamina points per day can be restored. The autodoc artificial intelligence can be convinced to modify treatment or to release a patient early if there is a legitimate reason. (i.e. The ship will blow up, or there is another patient that will die.) Of course this is up to the Referee's discretion what type of logic or personality the doc will have.

If the character has sustained a dismemberment of arm, leg, finger, etc. the part can be put into the autodoc for reattachment. Success on this varies.

If any skill checks fail for treatment the autodoc will instantly put the patient in a freeze field. It will not release the freeze field until the patient is brought to an advanced facility for treatment.

Autodocs are species-specific or can be modified with software and instruments for other races.

Autodocs can be used singularly or can be run in a succession of several capsules. They were used to good effect in the first Sathar war. The Marine carrier ship Januus used an autodoc with a series of 200 capsules on board for emergency battle treatment.

The autodoc will give a complete diagnostic of the character in its care and give the time for treatment and causes etc. It can also provide an autopsy of a dead character. These are provided through voice or by printout. The autodoc will converse with the characters to discuss treatment (provide options, etc.).

POWER AND STRUCTURE

The autodocs usually have a constant power source (such as a permanent installation, starship or a large vehicle), although a parabattery or generator can be used. The power usage is 20 SEU per day. The 'doc can be temporarily disconnected from the main power source and moved. Provided another power source is connected within 10 minutes. It is completely sealed and is insulated from adverse weather and the vacuum of space.

The autodoc can withstand 100 points of damage before it will not operate. If the doc has sustained damage the capsule will remain locked. It will take a tech to defeat security or another 30 points to the locking mechanism to get at any patients.

MAINTENANCE

The autodoc must have a power supply to operate. The autodoc can heal up to 500 stamina before it needs an overhaul. This will cost 1,000 credits, and must be done at a major hospital.

Autodoc. Cost 50,000, Extra capsules 10,000 (can add up to 10 capsules to one doc.), Comes with software for 1 species. Additional species programs and equipment are 5,000 ea. Size: 1.5 meters x 2.5 meters x 1 meter tall, Mass: 200 kg.

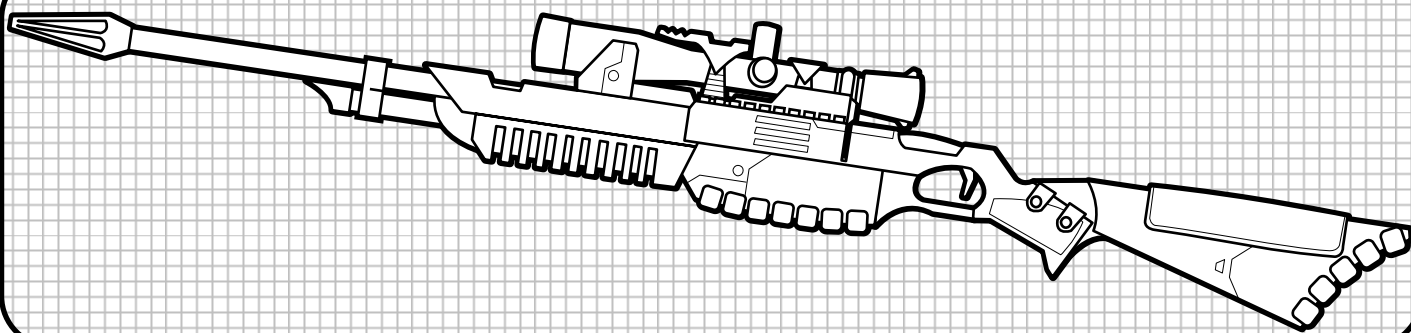

LASER SNIPER RIFLE

By Larry Moore

Sniper rifles are specialized rifles that allow characters to take out enemies from a distance with deadly accuracy. Based on the characters skill level and SEU setting, it's entirely possible to one-shot-kill an opponent that is unprotected by an albedo suit or screen.

Like the Semi-Automatic Sniper Rifle in Issue #4 of this webzine, the laser sniper is equipped with electronic range determination and targeting guidance, which halves the penalties associated with range. (AD pg.13 Telescopic Sites, "use the range modifier for the next closer range").

Laser sniper rifles have an extremely long range. They typically have a non-reflective finish – often coated in a flat black paint or camouflage. They have folding bipod struts that can be extended in order to steady the aim of the shooter and can be broken down to fit inside a gun case.

To-Hit example: Harry has a DEX of 50, PSA Military with Beam Lvl 3. He fires at a target who has soft cover at 800m. 25 [1/2 DEX] + 30 [Lvl 3] -20 [Long range w/ Scope] +15 [Aiming] -10 [Soft] = 40%

*Damage example: Harry set his rifle to 10 SEU so that damage would be 10d10 * 3 [Lvl]. Harry rolls a 51. 51 x 3 = 153 points of damage. I hope the target NPC had an albedo suit or screen.*

Laser Sniper Rifle

Cost: 1,500Cr
Weight: 5kg
Damage: 1d10 per SEU*
Ammo: 20 SEU PowerClip or power belt/back pack
Rate: 1
Defense: Albedo
Range: 20/100/500/1km/2km
Ammo Cost: Standard SEU PowerClip (100Cr)
Skill: Beam Weapons

* Characters of Military PSA may multiply their Beam Weapons skill level times the damage rolled, but only if he takes two turns doing nothing but aiming.

PHOTO-VOLTAIC PAINT

By Bill Logan

A recently-developed technology with far-reaching implications: paint that can be applied to nearly any surface that is photo voltaic (it can turn the photons from any sun source into energy).

It comes in a series of four specialized spray paint cans, contained in a small reinforced canvas case. The paint can be applied one coating at a time to any broad surface: a ground truck's top plating, the deck of a naval vessel, large strips of glass, the side of a building, etc. The order of the paint layers is important, as is the rate at which the layering is to be applied. It takes about four hours to apply. The applying technician then connects a set of specialized leads (that come in the kit), wires which will attach to any SEU power source (parabattery, for example, but not PowerClips – they are disposable). The sun will now recharge the device.

Depending on the power of the sun activity in the area in which the Photo-Voltaic Paint is applied, the device will be recharged at a rate of 1d10 SEU per day. Referees may adjust this rate based on weather conditions, proximity to a star, and strength of atmospheric protection from ultraviolet activity. The solar plating paint will only last for 1d10 weeks before it breaks down. It will be obvious when the breakdown begins, as the color of the surface will begin a chemically-reacted coloration change from near-black to brown, and the photo-voltaic effect will no longer function.

For example: Gnuett has a depleted SEU BeltPack. He sprays a piece of sheet metal he pulled off of his ground car with Photo-Voltaic Paint, a process which takes about four hours. Once applied, he attaches the leads to his new panel. Each day, his SEU BeltPack gains 1d10 SEU. The Referee rolls 1d10 and determines that Ghuett's application will continue to function for 7 weeks.

Photo Voltaic Paint

Cost: 250Cr
Weight: 1kg
Notes: Takes 4 hours to apply, provides 1d10 SEU charge rate per day, lasts 1d10 weeks.

EAGLE TRANSPORTER

By Scott Iles

The Eagle Transporter is a size class two system ship. It has rudimentary astrogation equipment and basic flight controls. Its unique feature is the detachable payload module, which can be swapped out quickly to convert the ship for various missions. Three of the most common modules are detailed below.

The Eagle is not equipped to enter the dense atmosphere of a Class-M planet, or to land on anything with more than a .1g gravitational field. It is used to transfer personnel and material between stations and trips between nearby planets.

- 1. COCKPIT MODULE** - This is the control center of the ship. There are seats and consoles for the pilot, co-pilot and communications/navigator. Note that the center position (Comm./Nav.) does not have a forward viewport.
- 2. ACCESSWAY** - This access passage connects the cockpit with the module in the center. The main life support systems can be accessed in this area. There are pressure doors at either in in the event of atmosphere loss.
- 3. ENGINEERING** - The monitoring equipment for the chemical drives is in this small area. Only two human-sized beings (or 1 Vrusk) can fit in this compartment.

PASSENGER MODULE

- 4. PASSENGER COMPARTMENT** - Forty-six comfortable seats allow the passengers to relax as much as possible on flights between bases. Video panels on the forward bulkhead display entertainment and flight status information.
- 5. AIRLOCK** - Most modules have two airlocks, one on either side. Storage lockers in each airlock have four standard spacesuits. It takes one minute for the airlock to cycle either way (pressurized to vacuum, or vacuum to pressurized).
- 6. GALLEY** - This small compartment contains foodstuffs and prep equipment. Normally, only the food for the next meal is stored here, with the rest of the supplies kept in underdeck storage compartments.
- 7. HEAD** - These are small, but fully equipped refreshment stations. A retractable curtain converts the outboard half of the space into a zero-g shower.

MEDICAL SUPPORT MODULE

- 9. PATIENT WARD** - Eight double bunks provide bed-space for up to sixteen patients. This module is used for responding to disasters and transporting patients to more advanced care facilities.
- 10. LOUNGE** - This is similar to the lounge in the passenger module, but replaces one of the tables with two double bunks for the medical staff to use or additional patient space.

CARGO TRANSPORT MODULE

- 8. LOUNGE**: This area allows the passengers and crew to get up and move around during flights. Entertainment displays and tables allow for socialization and recreation.
- 11. CARGO BAY** - This module opens up as much space as possible for the transport of cargo. Note that this module only has one airlock, on the starboard side. The hatch on the port side is used for loading in a pressurized environment.
- 12. CREW LOUNGE** - This small area allows the crew to rest during long flights. An Eagle with this module normally operates with only two crewmen.

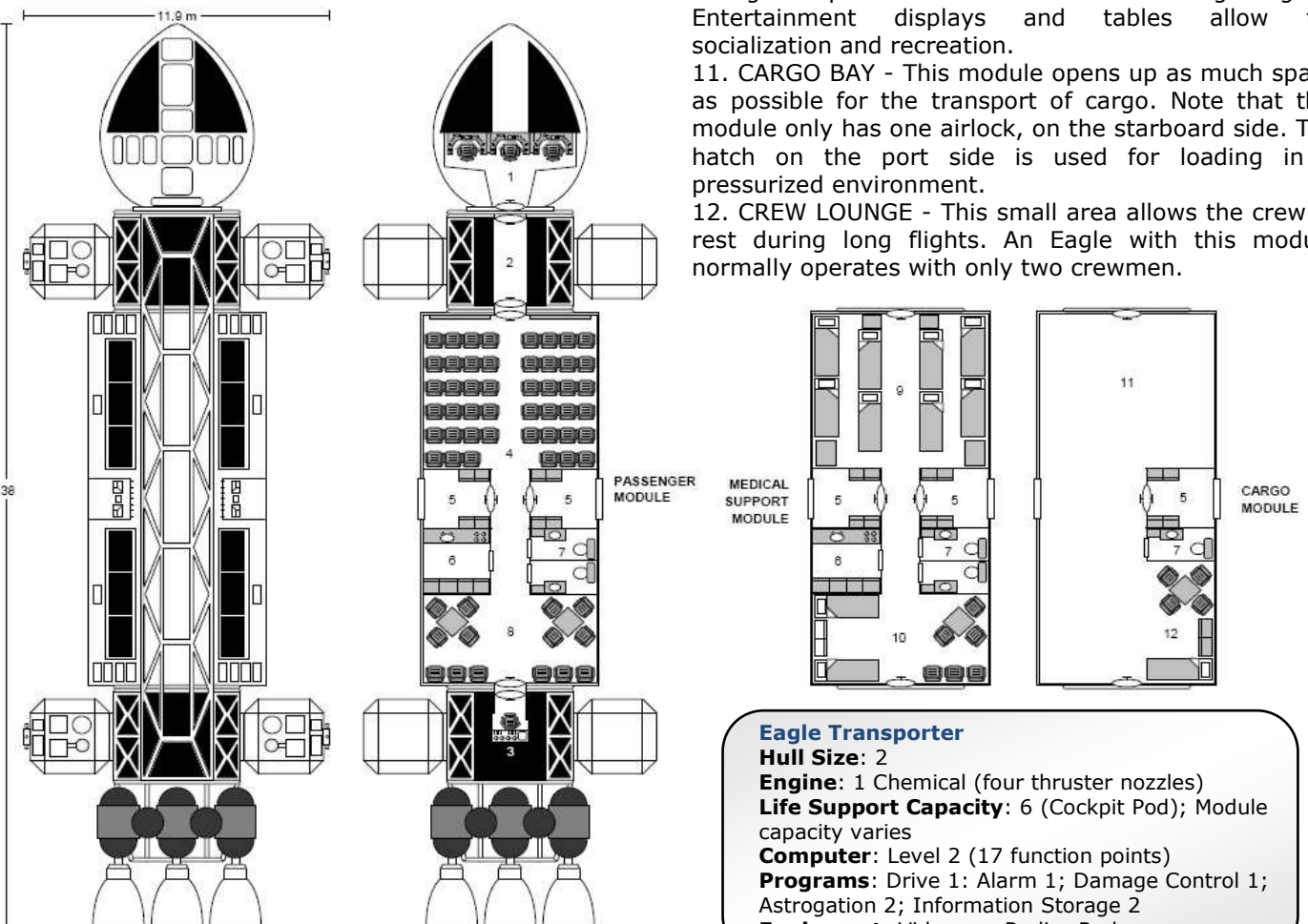

Eagle Transporter

Hull Size: 2

Engine: 1 Chemical (four thruster nozzles)

Life Support Capacity: 6 (Cockpit Pod); Module capacity varies

Computer: Level 2 (17 function points)

Programs: Drive 1: Alarm 1; Damage Control 1; Astrogation 2; Information Storage 2

Equipment: Videocom Radio; Radar

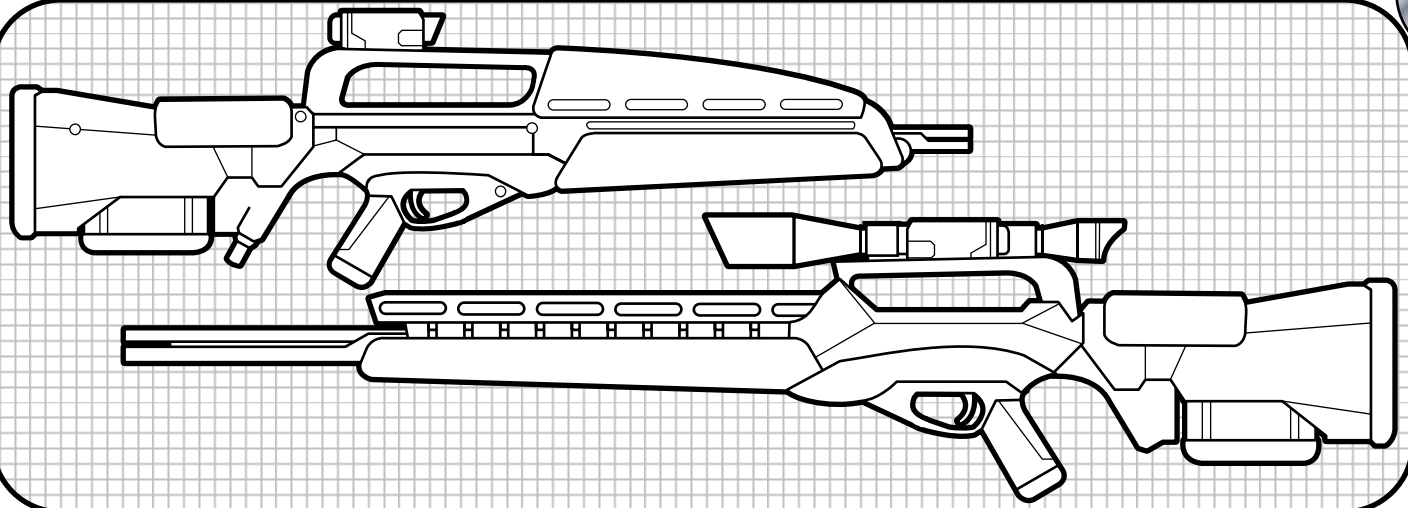

GAUSS ACCELERATORS

By Chris Harper

Gauss (magnetic coil) technology is basically an electric field that repulses an object. It then pulses to make the object travel. High rates of speed can be obtained. Early versions of gauss accelerators were in the form of simple guns. They utilized a power source with a series of capacitors to accelerate the projectile. These early versions were severely limited by the ever increasing gap needed between capacitors as the projectile increases velocity. Also the imbalance in repulsor magnetism needed as more power is applied.

The latest technology utilizes a pulsing inertia field that pushes the projectile. The hardened projectile reaches extreme velocities. This advancement made the concept of accelerators much more reliable and efficient. In addition the repulsor force field spins the projectile for stability.

The advantage of gauss rifles is that they have virtually no recoil and a very high velocity. Up to 5,000 meters per second, many times faster than conventional rifles. The disadvantage is that the weapons require nearly as much power in SEU to operate as a laser weapons, and still need caseless projectiles.

The gauss rifle fires a small caseless projectile, 5mm, which allows a high capacity clip. Due to the need for ammo and a separate power source, their high cost and being unreliable, gauss accelerator guns never reached widespread use throughout the Frontier. They have seen limited use by UPF marines.

When a gauss rifle fires there is no explosion of gunpowder. Just a sharp crack as the bullet breaks the sound barrier. Due to the hyper acceleration, the air that is displaced is turned to plasma by the bullet. This effect leaves a short red or blue streak trailing the projectile.

In spite of its drawbacks, gauss rifles are still encountered, mainly used by collectors or eccentric sportsmen. Their armor penetration is unrivaled.

Note: a gauss rifle won't fire from within an activated gauss screen!

GAUSS ASSAULT RIFLE

Cost: 1500Cr
Weight: 4kg
Damage: 3d10 / 10D10
Rate: 3 (1)
Defense: Inertia
Range: 10/40/100/300/600
Ammo: 20 SEU/ 100 SHOTS CASELESS (50Cr)
Skill: Beam Weapons

The gauss assault rifle uses 1 SEU per shot as well as a bullet. Though it holds a 20 SEU clip, it is commonly used with a SEU belt pack or a backpack. The magazine is located rear of the trigger and handle, and is packed with 100 long, thin projectiles. The rifle can fire up to three single shots per turn, fired independently (3d10 per bullet), and can also fire bursts of ten bullets (which cause 10d10 and follow all the normal rules for firing bursts). The scope mounted on it takes into account the ranges given, so no bonus for scope.

On a roll of 96-00 the rifle has overheated and will not fire for 1 turn. When firing a burst, the rifle's coils overheat on a roll of 90-00.

GAUSS SNIPER RIFLE

Cost: 2000Cr
Weight: 5kg
Damage: 4d10*
Rate: 1
Defense: Inertia
Range: -/70/200/500/1000
Ammo: 20 SEU/ 10 SHOTS CASELESS (5Cr)
Skill: Beam Weapons

* In the hands of a skilled character, a sniper rifle can be even more deadly. Military PSA characters can multiply their rolled damage by their Beam Weapons skill level, but only if two turns are spent aiming.

The sniper rifle uses 2 SEU per shot as well as a bullet. The sniper rifle holds a 20 SEU clip. It does not have an outlet for an SEU pack. The silent nature of the gauss acceleration helps to keep the sniper hidden while performing his art. The scope mounted on it takes into account the ranges given, so no bonus provided for the scope.

On a roll of 96-00 the rifle has overheated and will not fire for 1 turn.

ROBOTIC STEEDS

By Bill Logan

Robots are used all throughout the Frontier for various needs: hard labor, repetitive tasks, personal protection, even companionship. There have been many standardizations over the years, models of robots which are basically the same everywhere you go. Robotic steeds are another such standardization.

Robot steeds have a standard robot body type, and are powered by a Type I parabattery. They normally have four leg-like limbs, and are often modeled after an existing creature type which may be ridden from one settled world or another. They are programmed to accept normal reign commands, and are intelligent enough with their Level 3 robot brains that they can even interpret subtle knee movements by their riders.

Normally, these steeds are not programmed with the artificial intelligence and circuitry necessary for speech, and they are not normally built with the ability to interpret more than a few simple vocal commands. This is an exception to the rule that all robots of Level 3 and higher can speak.

They are, however, programmed with a type of loyalty normally not seen in robots. They form familiarities with their riders almost bordering on friendship, and stories exist in the Frontier of mounts which have done unusual things to protect their riders.

Robotic Steeds, like all robots, do not need to sleep. They need very little maintenance. They can keep watch over a camp while its rider sleeps. They don't require fed or watered. They can handle terrains that tracked and wheeled movements cannot. They don't require any special skill to pilot, operate, or maintain. In many ways, they're the perfect vehicle for ground-based movement.

As a programming choice, robotic steeds are intentionally designed to reject riders. They will defend themselves and not permit a rider to control it. A new rider has to gain a robotic steed's trust over time and with effort. This helps build a level of trust between the rider and the mount, and also helps prevent simple theft of a robotic steed. This is called a "Trust Lock" and is a type of security that robotics experts might wish to bypass in order to more quickly work with their new purchase.

Robotic Steeds cost less than a ground car but can handle terrain better than a ground cycle. They are seen as stylish, and scream the word "Frontier."

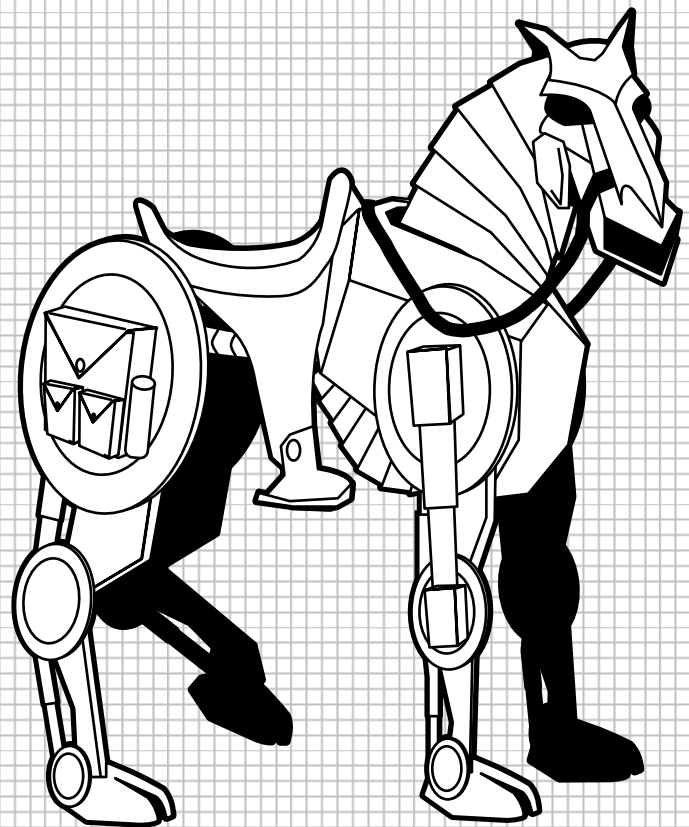

ROBOTIC STEED

Level	Level 3
Type	Robotic Steed
Body Type	Standard Body
Parabattery	Type I
Move Mode	Walk/gallop
Move Rate	10m/turn walking, 120m/turn galloping
Limbs	No arms, 4 legs (cannot use equipment)
IM/RS	+6/60
Stamina	100
Attack	50%
Damage	Robotic hoof: 2d10
Programs	Security Lock, Attack/Defense
Equipment	None

Mission:

Serve as Mount to Trusted Rider.

Functions:

Serve as Mount: Allow Trusted Rider to ride on back, interpret simple verbal and physical commands and carry them out, protect Trusted Rider.

Trusted Rider: Riders must gain the robot's trust before becoming a Trusted Rider. The longer a Robotic Steed has gone without a Trusted Rider, the longer it takes and more effort it takes to build trust. This prevents easy theft, and builds a bond between rider and mount.

COST:

4,500Cr

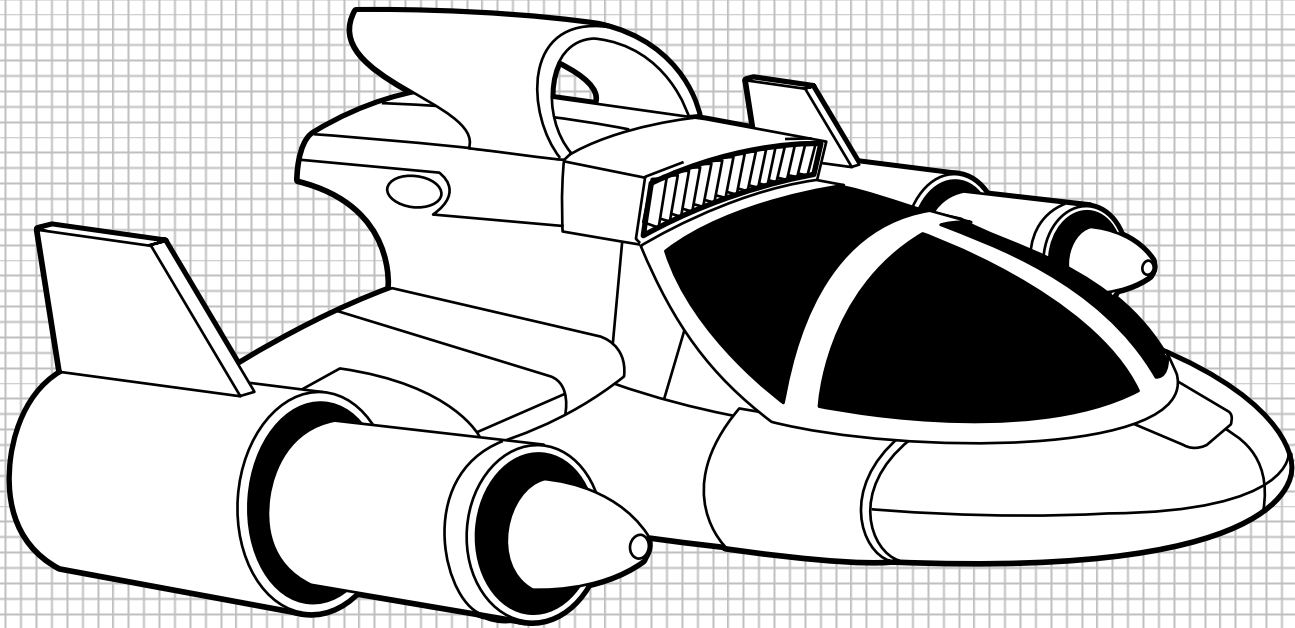

MANTA MINI-SUB

By Andrew Modro

The Manta mini-sub is a portable, inexpensive submersible vehicle available on the open market. It is often used by research organizations, but also sees use by the security departments of major corporations with ocean-going assets. It and other vehicles like it are common sights on aquatic worlds, where they replace ground cars as the major mode of civic transportation.

The Manta's extremely efficient design and magneto-hydrodynamic drive enable it to achieve relatively high speeds. The drive requires the use of a Type 3 parabattery to meet its power needs. It has a maximum depth capacity of 1100 meters (approximately 3600 feet). It can ascend at a rate of 210 meters (approximately 700 feet) per minute, or 21 meters per turn. It can descend at a rate of 120 meters (approximately 400 feet) per minute, or 12 meters per turn.

Two passengers can ride comfortably within the Manta. A third passenger can be stuffed into the interior in case of an emergency, but must be small. Two passengers can be accompanied by up to 50kg of extra cargo, which can occupy a storage volume of up to one cubic meter and is accessible from the interior of the mini-sub.

The Manta is equipped standard with basic GPS and comm gear, civilian sonar and forward-aiming floodlamps. It has life support capacity for 96 hours before needing to refresh. The Manta has no hardpoints for mounting weapons and cannot be modified except with great difficulty for this purpose. Mantas can be ordered with upgraded electronics systems, including better GPS, sonar and communications packages at the GM's discretion.

BATHYXPLORESR

By Andrew Modro

The Bathyexplorer is a two-man submersible vehicle designed for exploration of deep-sea environments. Its strong hull and powerful electronics enable it to survive and navigate in environments of crushing pressure and inky darkness. The Bathyexplorer is used most often by civilian oceanographic organizations, though some have been sold to wealthy individuals, recovery consortiums and maritime militaries as well.

The Bathyexplorer, like the Manta, is equipped with a magneto-hydrodynamic propulsion system, enabling it to move quietly and rapidly through the water. The sub uses a Type 3 parabattery to run its systems. Its maximum depth capacity is an astounding 6500 meters (approximately 21,325 feet). The Bathyexplorer can ascend at a rate of 200 meters (656 feet) per minute, or 20 meters per turn, and can descend at a rate of 110 meters (361 feet) per minute, or 11 meters per turn.

This mini-sub is designed for a two-person crew for exploration missions, though it can be piloted easily by a single being. It can carry up to 100kg of extra cargo occupying no more than two cubic meters of space total. In an emergency the Bathyexplorer can carry a third passenger, but this will strain the life support systems over an extended period.

This model comes standard with GPS and comm gear, and also includes advanced sonar and detection equipment and floodlamps. It has life support capacity for up to 100 hours of continuous operation. The Bathyexplorer has no hardpoints for mounting weapons, and cannot easily be modified to add them. Due to the purpose of the vehicle, it is ordered standard with top-of-the-line electronics packages and does not need to be upgraded, nor can it be ordered with lesser equipment.

Vehicle	Cost	Top Speed	Cruise Speed	Acc/Dec	Pass	Cargo
Manta	10,000 Cr	35 kph/ 60 m/t	20 kph/ 35 m/t	10/10	2	50kg/ 1m ³
Bathyexplorer	50,000 Cr	25 kph/ 45 m/t	15 kph/ 25 m/t	7/7	2	100kg/ 2m ³

A GORLIAN THUG?

by Robert
Bowman

GORLIANS

The Gorlians are mentioned in the original Alpha Dawn rules, in this example for Personality checks:

EXAMPLE: Dreevale the Vrusk has just insulted a Gorlian thug by accidentally spilling a drink on him. The Gorlian is very mad. Dreevale decides to try talking his way out of the situation. "Oops, pardon me, my good fellow, how absolutely clumsy of me," the player says. "Here, let me buy you a drink and let's forget about it. Dreevale's Personality score is 40. The referee notes that the Gorlian is mad and wet and itching for a fight. He tells Dreevale to subtract 20 from his score. Dreevale rolls 91, which is greater than his modified score of 20. The Gorlian punches Dreevale.

PHYSICAL APPEARANCE AND STRUCTURE

Gorlians are large (8 feet tall, or about 2.5 meters) mammals. They are muscular bipeds, with powerful arms and legs. They have thickly padded hands, each with four fingers and a thumb. Their feet are large and padded, ending in five clawed toes. Their torsos are wide and muscular. Gorlians have bullish facial features, with a short snout, and small horns projecting from their foreheads. Short, coarse fur covers most of their bodies, with color ranging from light brown for females to dark black for males. Males are generally slightly larger than females.

SENSES

A Gorlian's sense of touch, taste, sight, and hearing is very similar to Human's. Their sense of smell, however, is much more highly developed than humans. They can easily smell other beings nearby, even concealed ones, and make excellent trackers (see Special Abilities).

SPEECH

Gorlians produce sound through a larynx. They have a primitive language that sounds very guttural, with lots of snorts and grunts. They can learn Pan-Galactic, as well as Humans and Yarizian languages.

SOCIETY AND CUSTOMS

Gorlians have a society based on strength and honor. Their society is a similar to a tribal one, with tribes being referred to as herds by other races. In

the past, positions of leadership, such as the "chieftain", were won by fighting in gladiator-like duels to the death. In addition, mates were chosen and won through combat. In more recent times, positions and mates are fought for though non-lethal contests of strength and physical prowess that are still considered brutal. Chieftain positions, however, are still fought for to the death. Chieftains rule their herds with iron hands, and cannot show fear or weakness.

Female Gorlians can participate in duels, and can win mates and positions. Sometimes a female will become a chieftain; Gorlian custom does not prevent this, as long as she can defeat and kill her predecessor. Gorlians mate for life, and will have many offspring. All weak, diseased, or deformed offspring are killed. Gorlians give birth to live young, usually two at a time. A Gorlian born without a (fraternal) twin is considered very special.

Gorlians are not a scientifically or technologically advanced race. They can learn to use technology, but as a whole, their native technology tends to be primitive. Gorlians are now often hired as

GORLIAN CHARACTERS

Characteristics

Average Size	2.5 meters tall
Average Mass	120 kilograms (male) 110 kilograms (female)
Average Lifespan	100 years
Reproductive System	heterosexual, Viviparous
Body Temperature	38 degrees Celsius

Ability Scores

STR/STA	+20
DEX/RS	+0
INT/LOG	-20
PER/LDR	+0

Movement

Walking	10 meters per turn
Running	30 meters per turn
Hourly	5 kilometers/hour

Special Abilities

Tracking Ability	40% (can be raised by spending experience).
Incredible Strength	No penalties in high gravity worlds.

"muscle"; they make good mercenaries, guards, and thugs, and their tracking ability has enabled some to become excellent bounty hunters. Most Gorlians favor melee weapons such as axes, and some have begun using powered weapons. Gorlians are not unintelligent, but as a whole, they are more primitive than other Frontier races. Individual Gorlians can be very intelligent, and may be able to learn technological skills. Gorlians have an innate animal cunning that can make them very dangerous.

ATTITUDES

Gorlians seem to get along best with other mammalian races, such as Humans and Yazirians. They respect strength and combat ability, which has led them to have some affinity with Yazirians in particular. They are contemptuous of Vrusk and Dralasites, since these species are so different. They are not sure what to make of the Rim races, but do respect Humma's brawling and carousing attitudes.

The Gorlians as a whole have not had much contact with the Sathar. But they are hostile towards the worms, due to the threat they present, and have no problem fighting them if need be. But Gorlians do not have a centralized government, and have not been invited to join the UPF and serve in Federation military forces.

It must be remembered that Gorlians are very touchy beings to deal with. They have very short tempers, enormous strength, and are easily offended. Any slight or insult will result in a violent response. Bothering a Gorlian is not an advisable thing to do.

SPECIAL ABILITIES

Incredible Strength. All Gorlians are capable of incredible acts of strength. All Gorlians get a +20 bonus to their Strength/Stamina scores. This is summarized in the Ability Score modifiers listed in the table, but is such an extreme bonus that it qualifies as a special ability.

Referee note: Gorlians are so strong because they come from a high-gravity world. On such planets, Gorlians can function normally, and are not penalized.

Tracking Ability. All Gorlians automatically have the Tracking subskill at 40% (that's the same score a first-level Environ-

mentalist would possess). This score can be raised by spending experience. When using Zebulon's Guide rules, they have the Tracking Skill for wilderness areas, and Stealth skill for developed areas. Treat their sense of smell the same as Osakar.

Editor's Note: I play-tested this race in a two-sitting weekend gaming session by using it as an NPC on a mission that my children's characters embarked on. The large bonus to Strength and Stamina wasn't all that unbalanced. In fact, I found his terminally-low Intuition and Logic scores far more of a defining factor for the character. This bothered me a little, since the species is known as good trackers (normally Intuition should be high for such a race).

I deviated from the submitter's racial statistics in order to reflect the proposed changes I developed after the gaming sessions. My son had one more suggestion, which I did not make official for the race but will present here instead as an option:

It is reasonable that the race should only have a -10 to INT/LOG but a -10 to DEX/RS to reflect the bulky body.

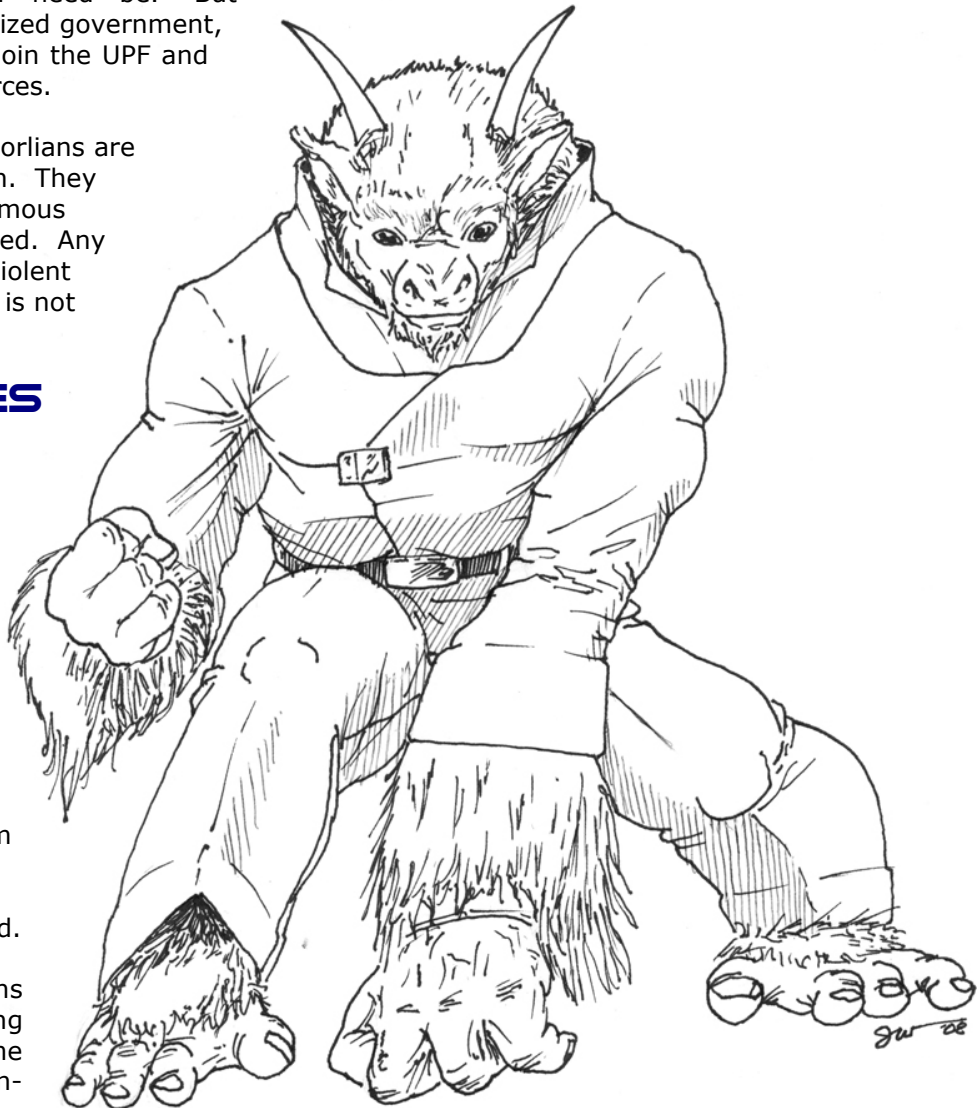

CREATIVE REFEREEING

by Bill
Logan

Author's Note: *I personally have no experience with literary devices, techniques, or elements. I am a pretty good Referee, though. Every time I game, I play the role of the Game Master, Dungeon Master, Storyteller, Narrator, or whatever. It's not my own preference - not some megalomaniacal need to be in control; it's just what the players want. One of my past players requested I write this, so here it is in all of its random glory (haha). So I guess this article is for Sean. Why don't you join our site and contribute, Sean?!*

THE STORY

Writers of screenplays and books have several literary devices, techniques, and elements they use to effectively tell their stories. Some are better than others. The same is true of Referees. While the Adventure section (below) represents the "who," "what," "where," "when," and "why" of a story, this section discusses many of the elements of "how."

FORESHADOWING

"As you stand on the summit and look out over the ruins of the city, you watch a large bird of prey circle around, looking for food. You smile as you watch the small ferret-like mammal standing in plain sight but in the shadow of the large bombed-out building, knowing that the bird cannot see it in the darker shadows. The ferret-like creature goes about its normal chore of searching for edibles, occasionally glancing up at the sky to make sure the avian hunter can't see it. To your surprise, the ground opens up on the unsuspecting furry critter. An underground tunnelspider claims another prize. So intently was the ferret-thing focused on the obvious predator, it never considered the unobvious one. You shake your head in sadness and pick up your gear, ready to head down into the ruins."

Foreshadowing is a literary device writers use to present prophetic fore-knowledge hinting at what is to come. In novels, the hint is often more for the reader than for the characters (who often don't get the hint until too late). Like most literary devices, foreshadowing can be borrowed to enrich your role-playing experience. Scenes of foreshadowing add a new layer to your storytelling, and provide players with a perspective they normally wouldn't have while rolling dice and moving their chit across a map. Unlike characters in a novel, the target audience of the foreshadowing IS the character - or rather, the player

who controls it. In the above example, if later the player's character was skulking through the described ruined city and heard the sound of an approaching enemy jetcopter coming after him, he might be wise enough to remember the ferret-like creature and dart for the darker shadows of the buildings. While he does, have an unexpected encounter occur from a direction he wasn't expecting!

"You continue your search through the ruins, glancing occasionally at the sky to see if the jetcopter's pilot has spotted you. So far so good. Suddenly, the ground shakes and you grope for a nearby lamp post as the ground beneath your feet begins to open. Another deadly tunnelspider, but this time its intended meal is much bigger! Roll initiative."

Unobvious Foreshadowing. Sometimes the hints of what is to come is obvious, but sometimes it's more subtle. For example, in the classic story of Romeo and Juliet, both of the ill-fated main characters announce openly to one another that they would rather die than live apart. Such a statement, alone, means one thing. But when you look at what happens later in the story, you recall what was said earlier and it gives far more meaning to the words you recall. Proper use of subtle foreshadowing can cause the story to grow in depth -- not by the events occurring now, but by enhancing and strengthening the events that occurred prior.

Warning. There are dangers to foreshadowing, of course. Overuse of this device can cause the players to have too much knowledge of what is to come. Similarly, if the foreshadowing is too subtle then many players might miss the hints.

If done properly, foreshadowing can dramatically add power to your storyline. In the movie *The Sixth Sense*, most viewers had no idea of the status of Bruce Willis' character, despite all of the many clues: no communication with anyone around him, people ignoring him, always wearing the same clothes, never being actually shown to travel or drive, etc. Once we learn of his dark problem, these other things all made sense and added profound impact to the story.

RED HERRING

Sometimes a foreshadowing leads to nothing. Sometimes, a character sees something that seems somehow important and meaningful, but carries no meaning into the story. Red herrings are important because they keep players from always knowing that every description of detail is a foreshadowing. They can also be helpful to muddy the water when things are

far too clear to the casual observer (like adding a handful of extra suspects to an investigation). Red herrings are another literary device, details which alone add interesting pieces to the whole of a story but have no real impact on the main plot. Random encounters, scenes of drama, diversions... all of these things are typically red herrings. Clever Referees will add details such as this to help make the Frontier seem real, that more is going on than a group of adventurous characters saving the diplomat's daughter.

Inspiration from Red Herrings. Red herrings can sometimes add enough interest that they spark later creativity. For example, when visiting an outpost world, the players find that there is a revolution going on. They aren't a part of it, but it causes them some difficulty docking and finding their contact. Later, they encounter a squad of revolutionists who mistake the players for members of the local government. Through good role-playing or fast guns, the players safely navigate their characters through the situation and get off that world. The war had nothing to do with anything... but added depth to the encounter with their contact. Later, if a Referee is inspired to do so, he might develop an entire adventure that involves the revolt and its impact on the rest of the Frontier.

ALLEGORY

Perhaps a bit over-the-top for a role-playing experience, Allegory is when all the elements of a story as a whole are representative of something else completely. This technique turns an entire story into one large metaphor. Because the Referee isn't in complete control of the story (the players control the character's actions), it is difficult to have a complete story behave allegorically. That doesn't mean certain parts of a story can't be allegorical, for example.

Allegory shouldn't be obvious. For example, if you know a great deal about World War II and would like to add elements of it into your Frontier, don't do it obviously. Create situational and political allegories to the Weimar Republic, drawing from your wellspring of knowledge on the subject. Don't do the obvious; a Sathar named Hissssstler who commands legions of his Third Reich is probably too much. When using allegory, use it as a framework. If clever players draw parallels to things from our own history or present, that will help the player become immersed in the story without the need to have obviously derivative work.

CLIMAX

There is a point in every story that you remember the most. It's where all the efforts, trials, and tribulations of the main characters finally culminate into some sort of amazing scene or series of scenes that make the story's wrap-up inevitable. It's often where the characters face their main antagonist, and victory and defeat sit poised as equal eventualities. In the movies, the climax is accompanied by a rising dramatic musical score. It's the climax of the story that drives us to rise from the edge of our seats and either gasp in worry or cheer in triumph.

In a role-playing game, the climax is one of the most important parts of the adventure. Many excellent gaming sessions have been plagued by poor climaxes. An adventure can have all of the elements that make a story memorable and epic - then fall horribly flat when the main characters breeze through the main conflict in an unmemorable manner. This is called Anti-Climax, and can break an adventure.

Confessions of a Bad Referee: *I once ran an adventure where the characters had to rescue a powerful empath because she was the key to breaking down the mental defenses of a Sathar scout captured while on patrol. The only problem was that the empath was being held in a PanGal prison ship. Since PanGal wouldn't cooperate (the empath was simply "too dangerous" and was being kept sedated and her powers suppressed), the characters were hired by the UPF (along with appropriate warnings of plausible deniability) to board the prison ship, secure the release of the prisoner empath, and escape, meeting up with UPF officials at an obscure location.*

The mission was great, the story solid, and all was great. But I didn't plan well for the climax of the story. The players succeeded in the prison ship break-out, dragging along a drugged empath girl (who turned out to be only twelve!) as she slowly came to her senses. Once she was in front of the Sathar (my story's sad climax) she broke his will in a non-spectacular manner, while the PC's just watched and couldn't take part... then released an empathic blast that knocked everyone unconscious (including the PCs). The player's characters woke up along with everyone else, with the Sathar and the girl missing. Story over. Players yawned. I thought it would strike their curiosity and set the stage for a later adventure - and it did, but should have been just a part of the story, not my climax. The rest of the adventure lost its impact and depth because the players lost interest (they were just along for the ride) during the climax.

Referees should be careful not to craft a masterful adventure plotline where the climax doesn't directly involve the player characters!

QUICK DECISIONS

When telling a story (of any type) you'll lose the attention of your audience when you allow long lulls in the progression of the main plot. Players will lose interest if they have to wait for you to look up answers or procedures. Know your rules, and when you don't know something, judge quickly and move on.

There is nothing wrong with making an incorrect judgment. Some players are by-the-book "rules lawyers" and might seek to correct your quick judgment. Stick by your guns: you're the Referee. Just be polite and say "I'll make sure to read up on those rules by next session, but this is how I'm doing it for now to keep the story flowing."

MEMORABLE MOMENTS

Every game has them... moments where the players get to shine, do something so cinematic that the image of it is talked about for many years to come. Role-playing games are great for those moments.

It takes a while to learn to recognize those moments. Skilled Referees feel them coming. They're not always at the climax of the story, though they often are. It's important to really make the moment memorable by adding elements to it to spruce it up.

My son was playing a Yazirian, and the rest of the player's characters had been shot down or stunned by members of the Redhawks, a notorious band of thugs and killers they were sent to disburse. He started getting really into the situation, I could see it in his eyes. He was worried for his character and was wondering if he or any of the others were going to survive this adventure.

He rolled for battlerage... and even with the pitiful chance of success, he succeeded. Even though the odds were against him, and even though battlerage wouldn't be enough to save him, I knew I had to let him have his moment. I could see it in his face: the memorable moment of the adventure was here.

"Time slows for you... everyone else feels a single heartbeat but you feel like that heartbeat stretches out for many seconds. The storm strengthens, the rain coming down in the alley with great power – as if providing a soundtrack to the impending burst of rage you're about to unleash. The remaining Redhawk's eyes widen when they sense your building surge of raw animal power – but it's too late... you unleash it!

"Roll initiative..."

accent. If a player gambles at a casino on Lossend, and befriends the dealer, if he later visits Lossend that player might enjoy visiting that dealer again, and will notice if he talks or acts differently than before!

Mannerisms. But characterization isn't just about a voice. You can use facial expressions or body language to represent the specific mannerisms of a character: You can put your hand on your belly, you can close your right eye... whatever. Players will associate those actions with that character whenever they see them, and this can be worked into stories.

The Tell-tale Stance of Mr. Smith: *My family's character's employer, a slow-speaking Mr. Smith, always stands with his feet pointed outward and his hands clasped behind his back. Every time the players have meetings with him, I rise from my seat and stand in that manner, speaking in Mr. Smith's slow soft way.*

Once, when the characters were sent on a mission to escort some crates over to the next city, they got curious and opened them up on the way -- only to find them empty. They turned their ground transport around and came back. Worried about possibly being blamed for theft, they stealthily approached the parking garage where their transport was supposed to be parked, scouting out the area. They could see - in the shadows - someone was conducting an inspection of crates that looked identical to the empty ones in their transport! There were too many armed thugs for them to get involved, but they did notice that the one selling the crates stood with his feet pointed outward, his hands clasped together behind his back. They knew not to fully trust Mr. Smith after that point, and still verify everything he tells them.

If Mr. Smith wasn't good at getting them jobs, they'd have ditched him long ago!

THE ADVENTURE

The adventure shouldn't be a stand-alone entity. Even adventures designed for a single night's session should have broader implications. This section discusses the *who, why, where, when, what, and why* of a story, including the player's involvement.

CHARACTERS ("WHO")

All NPCs are Characters. All characters should have depth to them, even the most unimportant ones. This is one of Stephen King's greatest strengths. You should feel free to use voices (change the pitch or add an accent, or even just speak at a different volume) or speaking patterns (speak slowly or use certain phrases or regional dialects and slangs). Don't be afraid to give life to merchants, guards, politicians, and corporate suits.

Voice. Of course, part of the key to making a stable, believable setting is consistency. If you make one person speak with a certain accent when he is from Athor, all Athorians may likely require a form of that

Player Characters. But it's not only the importance of the non-player characters a Referee has to cater to – the Player Character (PCs), although controlled by the players rather than the Referee, take a great deal of consideration.

When overseeing character generation, it is important to help insure the players are happy with their characters. Players bore quickly of a character they can't enjoy. Each player has different reasons why they might not connect. For younger, less experienced role-players, it's often just about statistics. Allowing a re-roll of a terminally low score might be all that it takes, and what's the big deal about that?

Other players (myself included) like characters to be potentially epic in nature. It's not that I need my character to be statistically superior to anyone. Quite the contrary; I prefer a character with a terminal flaw or two to round out his general awesomeness. For me, it's all about the character's background and what lies in store for him. For players like me, spending a little extra time and effort tying my character into the

storyline and helping to fate the character for grander things is vital.

For some players (such as my wife), having an opportunity to add a great amount of detail is important. She wants to know her character's family structure, number and names of siblings, and know a great deal about her past. When I Referee for my wife, I make sure to help her develop these things about her character, and to work these things into the storyline.

GOAL ("WHAT")

There has to be a reason the characters immerse themselves in a setting and face conflicts. What is it that the players must have their characters accomplish?

Having a great setting and interesting characters are a good start, but if the characters have no carrot to dangle in front of them, how can they be led to struggle against the main conflict?

Exposition. Part of the difficulty with providing the players with goals is figuring out how to give them those goals. If they have an employer, it gets pretty simple: they are called into a mission briefing room and provided with their goal. This is a really easy way to do it in the beginning, and often leads experience characters to strike it off on their own and become freelance.

But sometimes the goals of an adventure come from other sources. Some of the most memorable adventures have goals that the players themselves come up with (like returning to a place of a previous session in order to retrieve something they lost or wish to claim).

If the players are freelance, or you wish to give them an adventure in an unusual way, there are a number of ideas you can draw from. Sometimes, the characters are just in the wrong place at the wrong time, and events transpire that launch them into a series of connected adventures. Or a simple routine activity in their daily lives turns out to be far from routine. Don't forget the letter from a loved one or contact, begging for their help.

Obviousness. I prefer to make sure the players have an obvious specific goal. As a player, I always want to know what my character should be focused on or I get bored and start spinning dice. As a Referee, I hate it when I have to lead the players along because they're doodling on their character sheets unable to focus. It's important to keep the players aware of the goal, remembering the goal, and focused on it.

If the goal of your adventure is to survive an attack, keep your story focused on the survival. If the goal of your adventure is exploration, don't let an encounter with space pirates derail the storyline and focus the adventure on the conflict.

Personal Goals. Some players design characters with personal goals, and this is great. As a Referee I'm

thankful for it because it helps serve as a springboard for further adventure. As a player I'm able to measure the success of my character against the yardstick of his personal goals.

One of my character's families was killed during the political struggle between two megacorps, where disputes over mineral rights turned violent. I stated on the character sheet that his goal was to see dirty megacorporations topple. During game play, each time there is an opportunity to stand in opposition to the forces of an obviously corrupt corporate official, my character gets renewed in his efforts. The success of my character isn't measured in experience points and attributes... it's measured by his own passion.

If one or more players have personal goals, be careful not to make all adventures center around just a few characters. That leaves some players out of the spotlight.

CONFLICT ("WHY")

Single-sitting adventures involve conflict of one type, but this isn't what I'm referring to here. When a Referee prepares an adventure for the players, he should always keep his mind on the overall conflict. It's the conflict that defines why the characters are heroes. It's the adversity the player characters face that defines them, makes them stand apart.

Conflict in a role-playing game is even more important than it is in conventional storytelling mediums. Players thrive on the action their characters face. Even the greatest role-players enjoy imagining their characters struggling against adversity only to climb victorious in the end. The greater the conflict, the sweeter the reward.

Villains and lackeys are an important part of any conflict. They are tangible beings against which all blame may be thrown. It's easy to target a fictitious villain with your indignation. It's therapeutic to finally defeat the foe that's been the source of all the problems the player's characters have faced. It's not always necessary to make the main villain a single person. There are many cults and cadres, groups and megacorporations that all make excellent villains.

However, conflict should not be merely a list of enemies to face. Some of the greatest stories from movies and books have struggles against powers and principalities that aren't personified by a tangible force. Players may struggle against their own inner demons, against the mistakes of their past. They may stand against a force of nature or a catastrophic ill-fated prophecy.

When defining your adventure's conflicts, you need to consider the farther-reaching conflict that can help define the character's struggles for many adventures to come. The players may not even be aware of the true nature of their conflict during the first few adventures.

Example: Characters facing lackeys of a corrupt official might face off only against the lackeys in the first adventure, discovering that it is the corrupt official behind it all. The next adventure might result in learning that there is a conspiracy among many government officials. After several adventures, they eventually learn that Sathar have hypnotized the officials into their current state of indecency. As their adventures lead them along this chain of discoveries, they eventually learn of several resistance groups fighting against the corruption of the Sathar. Over time, the heroes find that their main struggle isn't against the lackeys, isn't against the corrupt government. The main conflict of their story is the struggle to lead the many resistance groups into one force capable of fighting the Sathar themselves!

SETTING ("WHERE, WHEN")

Consistency. Your players want a consistent setting. That is not to say it must be stable – just consistent. You should keep notes of what you place where in the Frontier. If you describe that there is a giant statue of Talow-Kaim (some early explorer who gave up his life to save the first settlement) in the center of the largest port city on Kdikit, make sure you describe it every time the players land there. Elsewhere in the Frontier, have an NPC use a comparative statement like "as large as the toes of Tallow-Kaim."

A Living Frontier. The entire Frontier is alive with activity. Worlds turn, people live and love and war, new things are discovered. The Frontier isn't a totally static place where the players are the only dynamic element. It's important to have things happening in the Frontier that aren't a part of the player's involvements. Sometimes these backdrop story elements work their way into the player's adventures in the form of subplots. Sometimes they are catalysts for entire new storylines. Even if the players have no involvement at all, make things happen, even if they become red herrings to the central storyline.

Challenge: *It might be fun collaborating on the development site (www.starfrontiers.us) to come up with a table of 100 backdrop story elements. Things like:*

01 *After a mistaken identity leads to a grave insult to personal family honor, an innocent Yazirian kills a drunken Vrusk diplomat. The local government makes a knee-jerk reaction, and all of the few local Yazirians are being rounded up for questioning and possible deporting. Political ramifications are endless.*

Rolling on such a table at the start of each sitting can lead to some interesting setting ramifications, adding complexity to a story setting. If the players are on a dominantly Yazirian world when this result is rolled, simply change the races involved (or make it happening on another world and have the players hear about it in conversation with another character, or see a news flash on a public holo vid terminal).

The more alive the Frontier is, the more the players will be interested in taking part in it. I once experimented (not using Star Frontiers, but the concept is still the same) with providing handouts at the start of the sitting, representing news flashes about things going on in the setting. Some players didn't care and skimmed the headlines only. Other players read through, looking for clues and insights to help them with their current adventure sitting. I even put a small list of rumors their character had heard (different for each player's handout) so they would have some insight (For example: "Rinko, your jogging partner, has been talking a great deal about the prices of SEU. He thinks the energy costs are going to nearly double if the Free Thoughts Brigade succeeds in bombing the refinery on Kdikit.")

Exciting Locales. This is more of a cinematic element than a literary one. The players will become more excited about their setting when they find themselves in unusual locations that fill their mind with images and ideas. A really cool location will be memorable.

In the Indiana Jones movies, Professor Jones finds himself in ancient temples, hidden crypts, and old underground cities. In Star Wars, the act of turning off the deflector shields around the Death Star becomes a daring raid on a stormtrooper-infested jungle moon.

Filling the location with interesting things can be as cliché as you'd like. Go ahead and borrow from existing imagery from movies and books. It's your setting, but it's everyone's experience. If my character finds himself in a situation that I can relate to as a player because of a movie I've seen, it only adds to my ability to become immersed in the experience of your setting.

ENVIRONMENT

Another interesting way to spruce up an adventure location is through creative application of environmental forces at work: gravity, rain, storms, atmospheric density or gaseous makeup, lava/magma, or just about anything else you can imagine. Having a climactic encounter with your main enemy on the shores of a methane lake when low gravity allows you to hurl your enemies 10 meters with a good kick makes for an interesting final encounter!

WRAP-UP

This article is a shortened version of how it originally was written. It was nearly ten pages, but my proofreader said it was too long to be interesting.

I'd like to hear your pointers on running a game. I tried to keep all my examples and references relevant to Star Frontiers, but an article on running adventures as a Dungeon Master, Storyteller, Judge, Game Master, or Chill Master is all good to read as well. I am interested – so please submit an article for the next issue of Creative Refereeing.

MECHANON 2.0

By Bill
Logan

MECHANON

Author's Note: *Zebulon's Guide to the Frontier* provided statistics for a playable character race called the Mechanon. Many of us failed to embrace the very different rules presented in that book, though some of the elements of it seemed palatable. I am one of those individuals who read that book and nearly dismissed it out of hand. However, I was inspired by several discussions in the forums at www.starfrontiers.us to return to that book and look for value within it.

The Mechanon – despite having woefully under-developed text and regrettably abysmal artwork, had potential for such value. After receiving some superior illustration from Shell, I had to put this together. Knowing that few people would embrace a species designed specifically for the variant rules in *Zeb's Guide*, I opted to make it a pure Alpha Dawn species, playable alongside the races presented in the core rulebook and in previous issues of this webzine. After two sessions of playtest and tweaking, I present to you the Mechanon.

Please note that not all of the text in this article is my own... much of it is derivative work. For example, the section on Society and Customs was nearly unchanged. I make no attempt to claim ownership of the words written by the original developers of this game or its species, but hope instead that my additions to the race help make it a more playable one.

PHYSICAL STRUCTURE

The mysterious species is one of steel and plastics, bearings and servos. Easily mistaken for conventional robots on first meeting, they move with mechanical grace and sense with electronic accuracy. They are roughly humanoid, possessing two arms and two legs.

As soon as someone spends more time with them, though, they realize the differences... Mechanons are truly a race sentient robots. There are actually two distinct classes of the species: the Warrior and the Thinker.

The Warrior class is more agile in appearance, less bulky, but even when standing still seems to have the appearance of recoiled power, raw strength coiled up and ready to be unleashed. The warrior class has a prehensile tail that helps it keep balance during complex movements, helps it to land on its feet while

falling great heights, and serves as a weapon while in battle. They have an extra joint in their legs, allowing more power to be placed in their leaps and kicks. Their speed, when unleashed, can be breathtakingly deadly.

The Thinker class stands a bit taller, and has broader shoulders. They have a broad chestplate and collar that has many crystals and gems, which are just for beauty (just as humans have their eye colors and their hair types). Their intricate patterns appear random to the casual onlooker, but to the mathematical brains of the other Mechanons serve as a special form of rank insignia, showing the Thinker's position in society.

A Mechanon's skin is actually a series of overlapping plates, built of an unusual metal that flexes and shifts during movement, providing protection to the inner workings of the species even while performing dramatic maneuvers.

The top of a Mechanon's head is a plate consisting of a cluster of various-colored crystals. These strange crystals form an intricate array of sensory clusters as well as form the basis to the artificially intelligent storage and computing device, a computing technology unknown but much sought after by the other races of the Frontier. They can be easily replaced when damaged (even by the Mechanon himself), but otherwise won't fail over time like other technological sensors and computers can.

Mechanons of both classes have special gauntlet plates that cannot be easily removed or modified (though can be repaired if damaged by Thinkers with robotics skill). The gauntlets of each class serve very different purposes.

SENSES

Mechanons are usually equipped with sensors that give them visual and audio input roughly equivalent to Human eyes and ears. The warriors are also equipped with infrared and starlight optics (they can see equally well in the dark, like a Yazirian) and have heightened hearing.

The Thinker class is believed to be equipped with all available optical enhancement devices (infra-red, ultra-violet, magnifying, x-ray, etc.) and have extremely heightened hearing (it is said they can even decode radio frequencies such as those generated by chronocoms).

No Mechanon can smell or taste and their touch seems to be the standard type for advanced robots (much less than Human).

Mechanon

the forehead crystals
contain 'sensory' receptors
acting as eyes, ears, etc.

Warrior

Warriors have
beam weapons
in their
gauntlets.

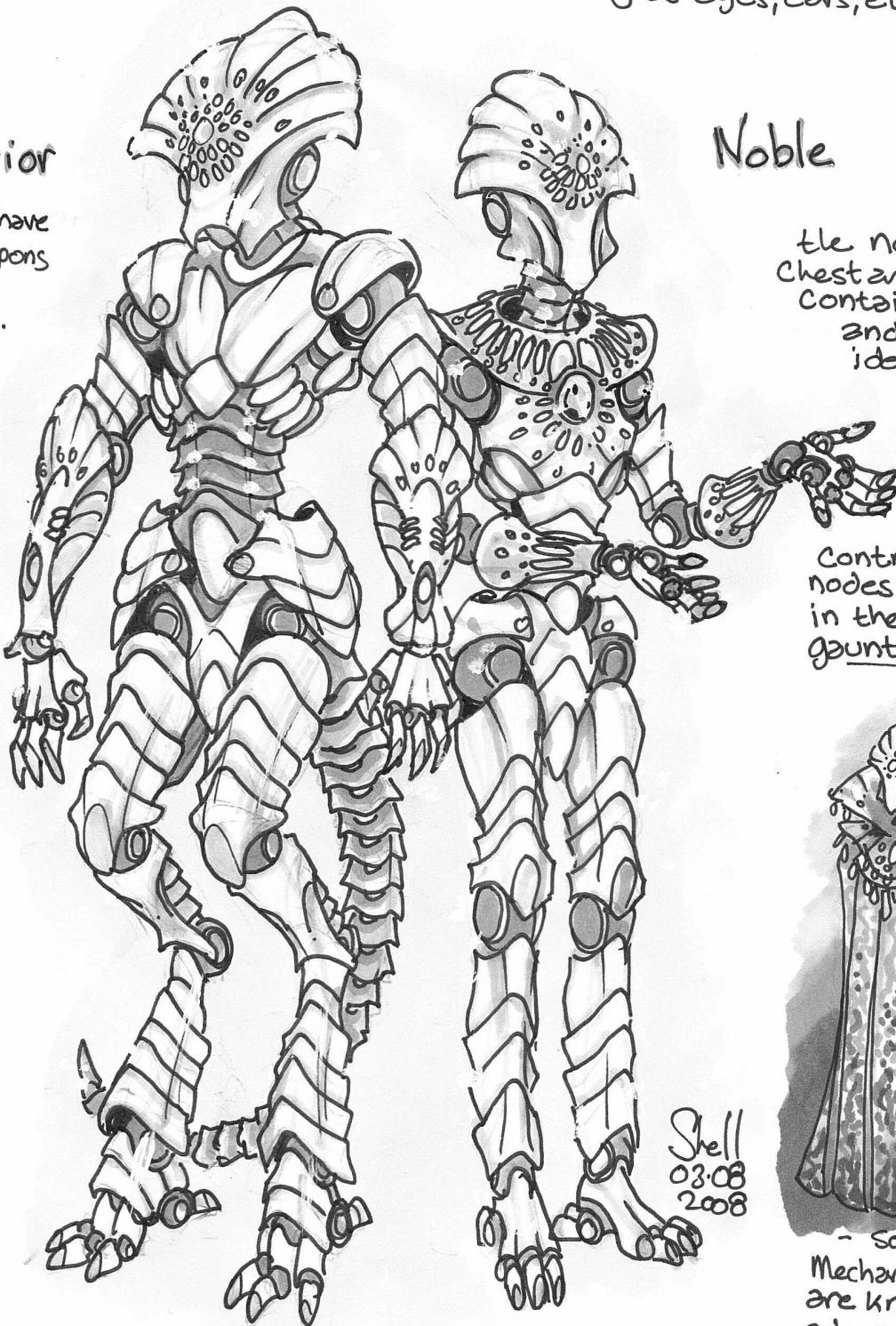

Noble

the noble's
Chest and collar
contain caste
and rank
identifiers

Control/function
nodes are
in the Noble's
gauntlets.



Shell
03.08
2008

- Some -
Mechanon Rulers
are known to
adorn themselves
and wear robes!

MARCH 2008

SPEECH

Mechanons have their own language that sounds like a complex series of supersonic and subsonic frequencies. No other race can hear this frequency, and it has a natural scrambling to it that prevents devices from decoding it effectively.

Mechanons with Logic scores greater than 50 can learn new languages in the normal manner, by spending experience points.

Mechanon Thinkers have built-in poly-voxes and can program them with almost any language through direct observation or through a download to their poly-vox memory. These are not conventional poly-voxes, however. Standard language programs from conventional poly-voxes are not compatible.

Mechanon Warriors lack this poly-vox, but can learn languages in the conventional manner. Few bother with this, however, as combat skills serve the Warrior much better in its career pursuits.

When the species speaks audibly, whether through a Thinker's poly-vox or through normally learned languages, the Mechanon's voice is high and always sounds mechanical.

SOCIETY AND CUSTOMS

Mechanons evolved on Volturnus from primitive Eorna robots. Through a series of incredible coincidences they eventually became a sentient, sapient race of creatures which could propagate mechanically. The robots used on the Frontier in everyday life are to the Mechanons what baboons are to the Yazirians: there is a certain similarity, but the differences are far greater and of more importance.

Little is known about Mechanon society. What is known indicates that it has a complex and strict caste system which does not allow for advancement from a lower caste to a higher one. The more intelligent Mechanons occupy higher castes. It is known that an aggressive tendency to dominate and destroy organic, intelligent life was once a strong factor in Mechanon society. Indeed, it resulted in the famous Mechanon revolution on Volturnus in FY 54 and the eventual mass exodus of Mechanons from that planet. But recent studies have shown that this is no longer a primary drive within the majority of Mechanons encountered. In fact, of 100 randomly tested Mechanons, only five showed any signs of animosity or superiority complexes relating to organic sentients.

Some robopsychologists are beginning to suspect that two completely different Mechanon societies may be evolving: one bent on peacefully coexisting with the other races, and another, smaller faction bent on destroying them.

Mechanons use standard robots to perform menial tasks, just as the other races do. Philosophy and the arts are completely non-existent and Mechanons cannot understand what organic beings see in these

pursuits. Mechanons have no sense of public vs. private property. Supplies simply are created, exist, and are used as needed. There is no family unit. There are few laws in Mechanon society. Every Mechanon is programmed with a strong tendency for specific behavioral directives during construction. Noticeably fewer restrictions are placed on members of higher castes. At present, the Mechanon's crystalline technology is the envy of every government and megacorp in the Frontier.

ATTITUDES

The Mechanons seem to get along with most races now. Their fascist tendencies have waned since they colonized their own planet, and they are now trying to become respectable members of the UPF community. Many people who have dealt with them in the last decade testify that they are no more difficult to work with than any other race and are possibly easier to deal with than some. Still others, though, contend that the Mechanons are planning the overthrow of all biological races in the Frontier and cite their past cooperation with the Sathar as proof. The matter is hotly contested, and only time will settle it.

SPECIAL ABILITIES

Since the Warrior and Thinker classes differ dramatically in their abilities, each class has its own list of special abilities, summarized below.

ALL MECHANON

Night Vision: All Mechanons have sensors providing light-amplification vision that works the same as Yazirians. They do not require sunglasses to operate without penalty during the day, however, as their sensory subsystems react and restrict light. It takes time for their restriction systems to react, however. If suddenly exposed to bright light while relying on their Night Vision, a Mechanon has -15 to all actions for the duration of one round of combat.

Infra-Vision: All Mechanons have the ability to switch their optics to receive infrared light instead of normal unfiltered visual-range light. This allows them to see heat patterns, outlines and shapes as they appear different in temperature to those objects around them. This functions the same as infrared goggles, and aids them in hunting and searching an area for hidden intruders. Even other robots and Mechanons have body temperatures of some sort.

WARRIOR MECHANON

In addition to all of their built-in weapons and defenses described below, a warrior can learn to use any weapon and operate any defense. It is not unheard of for a Mechanon warrior to have favored melee weapons (which they use in an unusual combat form that includes liberal use of their tails) or ranged weapons (laser rifles, for instance, are much more potentially damaging than their gauntlets). It is not considered dishonorable for them to embrace such external offenses and defenses... if Mechanon even have a sense of honor.

Ambidexterity: All Warrior Mechanons are ambidextrous, just as the Vrusk are. This extends to their tails as well (no off-hand penalty for attacking).

Enhanced Movement: Warrior Mechanons have limber bodies and an extra forward-arcing joint in their legs, providing enhancements to their speed and leaping ability. These enhancements are not always in effect, however. A warrior can activate his maneuverability enhancements for a maximum duration (in combat turns) equal to the tens digit of his Stamina score, then must wait for an equal amount of time to cool his circuits before re-activating. During this time, all movement rates (running, leaping, etc.) are increased by approximately 50%. For example, a Mechanon Warrior character has a Stamina score of 55. He can enhance his movements for 5 turns, then must wait 5 turns before doing it again.

Built-in Weapons: All members of the warrior class have built-in weapons, usually the equivalent of an electrostunner, in each of their gauntlet plates. The chance to hit is derived from the Beam Weapons skill, which must be learned like all other characters. This is a natural weapon, not an external piece of equipment. It is powered by their own bio-electric field, energy stored in a special 20-SEU capacitance device in their arms. This energy recovers at a rate of 1 SEU per hour in each arm. Therefore, even when fully depleted, they are ready for full use again in a galactic standard day.

Natural Weapons: Warrior-class Mechanons also have titanium talons and prehensile tails, each of which can do 1d10 damage. Their chance to hit is the same for all other natural weapons: the Unarmed Combat skill, which must be learned like all other skills. Normally, the warrior can attack with only one weapon per turn (like all other characters). If they wish to endure the penalty for using two weapons (-10 to each attack), they can attack with another limb or even their tail. If they wish to attack with both hands and their tail, that would be a penalty of -20 to each attack, etc.

Natural Defenses: Warriors have an amazing capacity to sustain damage, much like heavy duty robots can. However, too much of their inner bodies are consumed by their sentience circuitry and mobility servos, as well as their sensory devices. Therefore, their bodies are not quite as durable as one might expect. Any physical attack which strikes the warrior Mechanon subtracts 1 from every damage die rolled. For example, a character shoots a gyrojet rifle at a Mechanon Warrior. That weapon normally causes 3d10 damage. The Mechanon takes 3d10-3 damage. Energy weapons work normally against the Mechanon Warriors.

THINKER MECHANON

The Thinkers possess the abilities common to all Mechanon (night vision, infra-vision), and also have the following special abilities:

Poly-Vox: As described in the Speech section, above, all Thinkers have built-in circuits similar to Poly-Voxes. This allows them to become effective diplomats when dealing with members of other races. Most Thinkers

have Pan Galactic programs stored at all times in their poly-voxes. The devices can store a number of languages equal to the tens digit of their Logic scores. For example, a Thinker Mechanon with a Logic score of 65 can have up to six languages stored at one time, one of which is almost always Pan Galactic.

Enhanced Sensor Array: The Thinkers have the ability to sense greater ranges of frequencies of both light and other ambient energies. They can see in the X-ray spectrum, as well as see ultra-violet and infra-red light. They can tune their hearing to pick up ranges of frequencies normally only reserved for electronic devices. Decoding these signals is not always easy, however. It is believed that they have learned to decode open Chronocom frequencies, but not coded frequencies used by the Frontier military. Only one such type of sensor may be active at one time.

Built-in Toolkits: Any biosocial or technological skill the Thinker Mechanon has levels in normally requires a toolkit for success. The Thinker is assumed to have any of the tools required, built into his body. His fingertips fold back and special tools extend as needed.

Control Robots: Thinkers have special gauntlets that can be used to control robots similar to the way in which a "Robot Brain" computer program functions. They can put a number of levels worth of robot under their control equal to twice the tens digit of their Leadership scores. For example, a Thinker with a Leadership of 50 can control 10 levels worth of robots at one time. They can even attempt to take control of a foreign robot that is not programmed for such control. Their chance of success equals 10%, but this can be increased by spending experience points. It takes one full turn of concentration and manipulation of its gauntlet to attempt this, and during this time the Thinker can perform no other action. The target robot must be within 10 meters. Once control is stolen, treat the robot as if it were under the control of the Thinker. Control will continue for a full 20 hours (one galactic standard day) before it must again be assumed. This ability cannot be used on other Mechanon, who have no robot level.

SPECIAL RESTRICTIONS

The Mechanon have a lot of special abilities granted by this race description, moreso than most other races in the Frontier. Life is not all perfect for these mechanical beings, however, as there are restrictions to being a Mechanon.

Learning Disability: Mechanon brains are not organic. Their abilities are defined by bits and bytes in a crystalline computer, not synapses in an organic brain. When learning skills, they must overcome the limits of their own electrogenetic programming predispositions. In game terms, this means they must pay an extra 5 experience points for all skill purchases. For example: a Thinker has a Level 2 Medical skill. His player would normally have to pay 15 experience points to increase it to Level 3. However, because his

character is a Mechanon, he must pay 20 experience points.

Non-robot: Despite their obvious robotic heritage, the Mechanon are not robots. They cannot have equipment added to them as normal robots can. They cannot be programmed. They have no access plate. They cannot be controlled by robot brains. But this means they are not immune to some of the things against which normal robots have protection. They may be stunned (their controls momentarily ionize, freezing them in place while their electromagnetic fields repair themselves), and are not immune to critical hits. They must sleep (though they sleep by shutting down and rejuvenating their circuits, running internal diagnostics). They must breathe and must eat and drink, just as conventional characters must. However, their unique physiologies allow them to eat and drink nearly anything to fuel their internal energy generators (remember, they don't even have senses of taste or touch).

Cannot Heal: Mechanon do not naturally heal. They have an immune system (filters, etc) and of course cannot catch conventional diseases and viruses, but they do not naturally heal. Instead, they must be repaired. It is instinctive for a Mechanon to know how to heal itself, but this will not happen on its own. A Mechanon can apply reconstructive techniques to itself once per day to fix 1d10 points of damage. This is automatic. A Thinker who has the robotics skill can use that skill to repair the damage caused normally, using the standard repair rules (the Mechanon is considered Level 0 for this purpose alone).

Author's Note: During playtest, the Mechanon were potent but not unstoppable. Their limitations were easy to manipulate: bright lights giving them -15 penalties for one turn, their natural ranged weapons being energy-based, their natural defenses being inertia-based, etc.

In the two playtest games I ran, I had two distinct groups of Mechanon: the orthodox and the paradox. The orthodox Mechanons were those that believed that all biological beings were inferior. This was like a religion to them, and their thinkers I ran nearly like high-priests, their warriors more like templars. The paradoxical Mechanon were viewed as a splinter group, unloved and hunted by the orthodox. The paradox group wanted to embrace, and be embraced by, all sentient races. They dismissed the belief that they are superior. Their thinkers were artists and environmentalists, scouts and diplomats. Their warriors were those who sought the militant destruction of the "High Orthodoxy."

You can use these political groups, or invent some of your own. It would be equally interesting to make groups based not on political differences, but on real religion. Or even based on territorial rights, taking morality out of the equation altogether. Drop me an email and let me know if you've found this race usable: referee@starfrontiersman.com. Perhaps the other races of Zebulon's Guide to the Frontier could use similar treatment.

MECHANON CHARACTERS

Characteristics

Average Size	2.8 meters tall (warrior)
	3.0 meters tall (thinker)
Average Mass	120 kilograms (warrior)
	100 kilograms (thinker)
Average Lifespan	225 years
Reproductive System	Parthenogenesis
Body Temperature	42 degrees Celsius

Ability Scores

	Warriors	Thinkers
STR/STA	+15	-10
DEX/RS	+10	+0
INT/LOG	+0*	+10*
PER/LDR	-10**	+15**

* Must shift 10 points from Intuition to Logic.

** Must shift 10 points from Personality to Leadership.

Movement

Walking	8 meters per turn (warriors while enhanced: 15m/turn)
Running	25 meters per turn (warriors while enhanced: 40m/turn)
Hourly	4 kilometers/hour

Special Abilities: All Mechanon

Night Vision	Can see in the dark. -15 to all actions in the first turn Mechanon is exposed to bright light.
Infra-Vision	Can see in the IR spectrum, like IR goggles.
Learning Disability	Must pay an extra 5 experience points for all skill purchases. Warriors must choose Military PSA. Thinkers may not.
Cannot Heal	Must repair self or be repaired by others with Robotics skill, rate is 1d10 per day.
Non-Robot	Must eat, sleep, drink. Can be stunned, and can be affected by critical hits.

Special Abilities: Warriors Only

Ambidexterity	No penalty for "off-hand" weapon use.
Enhanced Movement	Can activate for a number of turns equal to tens digit of STA, then wait equal number of turns. Movement increased to 15m/turn, 40m/turn. Leaping and falling distances x1.5.
Built-in Weapons	2 electrostunners, 20SEU. Recovers at a rate of 1SEU per hour naturally in each gauntlet.
Natural Weapons	Claws on hands or feet (and prehensile tails) cause 1d10 damage, plus PS.
Natural Defenses	Skin armor subtracts 1 from each damage die rolled. Inertial protection only.

Special Abilities: Thinkers Only

Poly-Vox	Can store language patterns for a number of languages equal to tens digit of LOG score.
Enhanced Sensor Array	Can tune optics to see in X-ray, UV, and other frequencies. Can tune hearing to nearly any frequency. Can receive chronocom signals.
Built-in Toolkits	Automatically have any tools for any biosocial or technological skills, built-in.
Control Robots	Can control a number of robots equal to twice the tens digit of LDR score. Can assume control of enemy robot 10% chance (can be improved by spending experience).

FIGHTER Hull Points
8

ADF 5

Weapons:
Assault Rockets
□□

MR 5

Defenses:
 Reflective Hull

DCR 30

ASSAULT SCOUT Hull Points
15

ADF 5

Weapons:
Laser Battery
Assault Rockets
□□□□

MR 4

Defenses:
 Reflective Hull

DCR 50

FRIGATE Hull Points
40

ADF 4

Weapons:
Laser Cannon
Laser Battery
Rocket Battery
□□□□
Torpedo
□□

MR 3

Defenses:
 Reflective Hull

Masking Screens
□□

Interceptor Missiles
□□□□

DCR 70

DESTROYER Hull Points
50

ADF 3

Weapons:
Laser Cannon
Laser Battery
Electron Beam Battery
Rocket Battery
□□□□
Torpedo
□□

MR 3

Defenses:
 Reflective Hull

Masking Screens
□□

Interceptor Missiles
□□□□□□

DCR 75

MINELAYER Hull Points
50

ADF 1

Weapons:
Laser Battery
Laser Battery
Mines
□□□□□□□□
□□□□□□□□
Seeker Missiles
□□□□

MR 2

Defenses:
 Reflective Hull

Interceptor Missiles
□□□□

DCR 75

LIGHT CRUISER Hull Points
70

ADF 3

Weapons:
Disruptor Cannon
Laser Battery
Electron Beam Battery
Proton Beam Battery
Rocket Battery
□□□□□□
Torpedo
□□□□

MR 2

Defenses:
 Reflective Hull
 Electron Screen
 Stasis Screen

Interceptor Missiles
□□□□□□□□

DCR 100

HEAVY CRUISER Hull Points
80

ADF 2

Weapons:
Disruptor Cannon
Laser Battery
Laser Battery
Electron Beam Battery
Proton Beam Battery
Rocket Battery
□□□□
□□□□
Torpedo
□□□□
Seeker Missiles
□□□□

MR 1

Defenses:
 Reflective Hull
 Electron Screen
 Proton Screen
 Stasis Screen

Interceptor Missiles
□□□□□□□□

DCR 120

ASSAULT CARRIER Hull Points
75

ADF 2

Weapons:
Laser Battery
Proton Beam Battery
Rocket Battery
□□□□
□□□□

MR 1

Defenses:
 Reflective Hull

Masking Screen
□□□□

Interceptor Missiles
□□□□□□□□□□

DCR 150

10 Fighters
If not attacked during a turn, all fighters docked on this carrier are re-armed with Assault Rockets.

BATTLESHIP Hull Points
120

ADF 2

Weapons:
Disruptor Cannon
Laser Battery
Laser Battery
Laser Battery
Proton Beam Battery
Electron Beam Battery
Electron Beam Battery
Torpedo
□□□□□□□□
Seeker Missiles
□□□□
Rocket Battery
□□□□
□□□□

MR 2

Defenses:
 Reflective Hull
 Electron Screen
 Proton Screen
 Stasis Screen

Interceptor Missiles
□□□□□□
□□□□□□

DCR 200

**KNIGHT HAWKS BOARDGAME
WEAPONS & DEFENSES**

Weapon	None	RH	PS	ES	SS	MS	ICM	Dmg	DTM	Range	Notes
Laser Cannon	75	60	75	75	75	25	--	2d10	+0	10	FF, RD
Laser Battery	65	50	65	65	65	20*	--	1d10	+0	9	RD
Proton Beam Battery	60	60	25*	70	40	50	--	1d10	+10	12	RD
Electron Beam Battery	60	60	70	25*	40	50	--	1d10	+10	10	RD
Disruptor Cannon	60	60	50	50	40	50	--	3d10	+20	9	FF, RD
Torpedo	50	50	50	50	75	50	-10ea	4d10	-20	4	MPO, LTD
Assault Rocket	60	60	60	60	60	60	-5ea	2d10+4	-10	4	FF, MPO, LTD
Rocket Battery	40	40	40	40	40	40	-3ea	2d10	-10	3	LTD
Mine	60	60	60	60	60	60	-5ea	3d10+5	-20	--	LTD
Seeker Missile	75	75	75	75	75	75	-8ea	5d10	-20	n/a	LTD

*Weapon causes half rolled damage (rounded up) on Hull Hits.

CLASSIFIEDS

DISCOVERY AWAITS

Do you have what it takes to become the Frontier's New Top Vrusk Model?

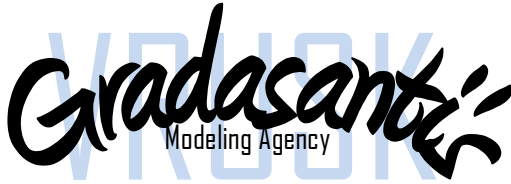

Can you walk the hoverway,
do you look good in tight synthcloth?

Dare to be bold.
Dare to be beautiful.

Dare to call...
your path to fame is paved by

Gradasanti's Vrusk Modeling Agency.

Chronocom Subspace Relay#
73608822327155431891

ROBOT REPROGRAMMING

We won't ask how you got it, we won't need to see ownership papers.

Come to
Vualo's Robot Chop Shop
We have all the spare parts you'll ever need to replace deactivated security panels, defeated entry locks, or damaged intrusion defense subsystems.

Modify robot functions500cr
Modify robot mission 1500cr
Remove security lock.....500cr

Located conveniently behind the Fraris Wall at Eleventh Street on Prenglar, we're probably on your way back from your most recent destination.

Chronocom Subspace Relay#
22654308822327151891

TRUCE!

Tordia,

*Come on, hasn't this gone on long enough?
I'll settle for half the creds you owe – truce?*

-Groko

ROBOT GUARDS

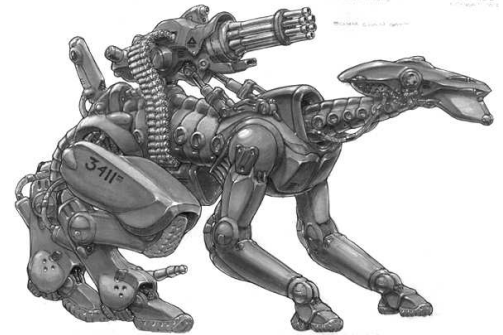

Guaranteed to protect your home. Will destroy intruders, fast and efficient. Will bury bodies and then wipe memory of destruction from own robot brain. Perfect liability dodge.

Not responsible for accidental family disappearances.

Chronocom Subspace Relay#
51856025128198869351

HELP WANTED



We are looking for talented:

- Engineers
- Technicians
- Computer Programmers

to help with a new development in Frontier communications equipment, codename: G.O.D.N.E.T.

It will revolutionize how information is shared in the Frontier. Qualified applicants must be willing to implant Non-Disclosure Penalty chips in their cortex to help NET ensure propriety.

Dralasites may not apply due to their immunity to NDP chips.

Warning: Applicants who are found to be spies from Interplanetary Industries will be dealt with severely.

Chronocom Subspace Relay#
27123273651430885189

PRECISION MEMORY REMOVAL

Forget about her.
She isn't worth all your pain.

Chronocom Subspace Relay#
51891736715423230882

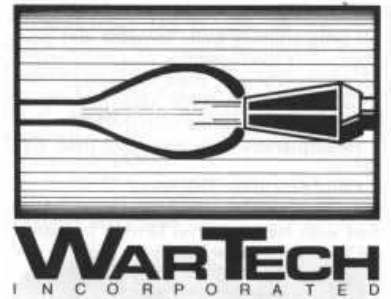
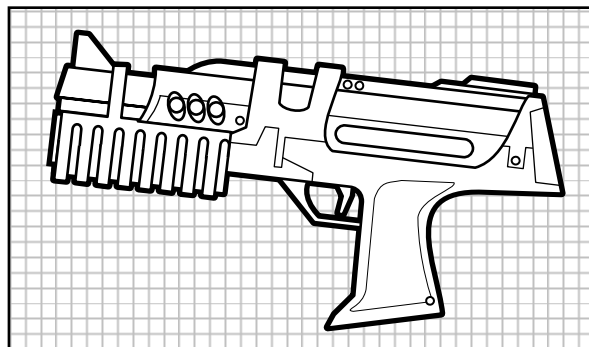

The new **Frontiersman Heavy Pistol**, from WarTech, is the finest blaster pistol released to date. Complete with three settings: stun (*similar to an electrostunner*), damage (*same as a laser pistol set to 5SEU*), and kill (*same as a laser pistol set to 10SEU*). What makes this pistol truly special is its pump-action SEU starfire grenade. Firing a charge of electrokinetic energy wrapped in a self-formed plasma shell, it drains the power source by 10SEU and causes an effect identical to a fragmentation grenade (though it's a beam effect, not an inertia effect). Also, the grip holds two 20-SEU PowerClips, allowing a payload of 40SEU for the busy warrior. Field-tested. Military approved. The quality you expect from **WarTech**.

Chronocom Subspace Relay#
08295185686912351518

1,500cr