

Also This Month: Hammer's Slammers - Potter's Field • Conan - Bitter Oranges • FantasyCraft - Bazyl's Billof Brawlers

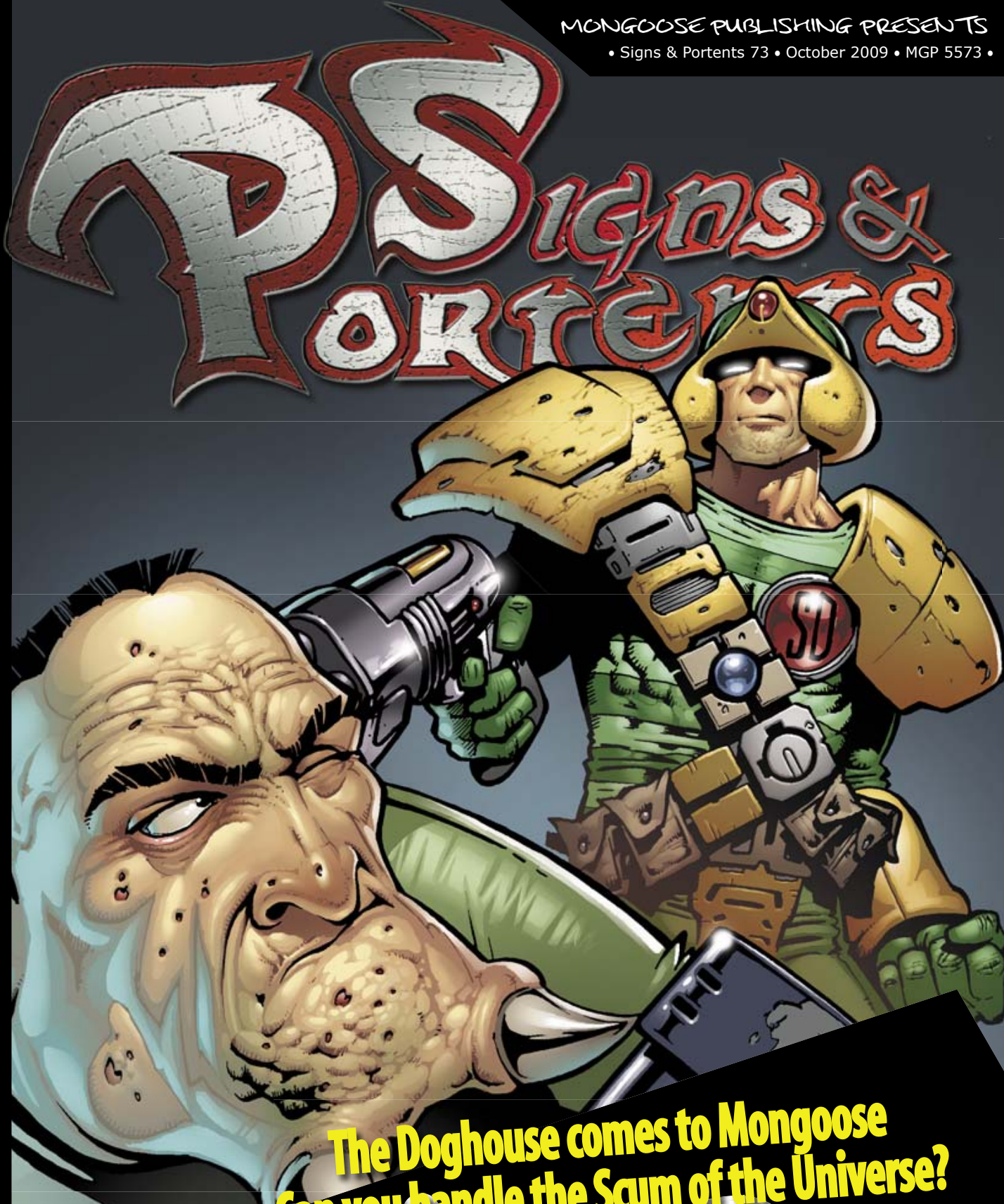

The Doghouse comes to Mongoose
Can you handle the Scum of the Universe?

Strontium Dog

COMING THIS ISSUE

□ □ □	Mongoose News	4
□ □ □	Convention Diary	5
□ □ □	Featurettes	6
□ □ □	New Releases	8
□ □ □	Conan's Score of Steel	12
□ □ □	Find your Mark	18
□ □ □	In Potters Field	26
□ □ □	Bazy's Bill of Brawlers	38
□ □ □	Mean Streets of MC1	44
□ □ □	Bitter Oranges	48
□ □ □	Lone Wolf Uncovered	56
□ □ □	Magic of the Inner Spheres	66
□ □ □	Goblins of Genertela	70
□ □ □	Psionic Healing	76
□ □ □	Legacy of War	80
□ □ □	S&P Contribution Information	102

□ □ □	Mongoose
□ □ □	Features
□ □ □	Traveller
□ □ □	Lone Wolf
□ □ □	Survival Guides
□ □ □	Conan
□ □ □	RuneQuest
□ □ □	Paranoia
□ □ □	Flaming Cobra
□ □ □	Generic
□ □ □	Information

Editorial



So October is upon us and the days are getting shorter... apart from at Mongoose Towers that is! Yes the lack of light does not deter us... it makes us stronger! We thrive in the night and beaver away at our computers, fearing the dawn light that swiftly approaches! Winter 2009/10 is rolling on in and bringing with it some very exciting new projects for the Mongoose Editing Team.

There have been several rumours flying around many forums, all of which (and more) will be confirmed or denied in the State of the Mongoose next month. For now though dear readers I am afraid that we are keeping things under our hats. However I will say one thing, which is that this editor in particular is rather excitable about her schedule over the next few months and has been doing an awful lot of "pre project studying" for one project in particular that has made her very happy... no it has nothing to do with horses!

To reassure you all though we have things in the pipeline that are well worth the wait so stay tuned and have a good month.

Charlie

Credits

Editor

Charlotte Law

Managing Director

Matthew Sprange

Mongoose Studio Staff

Nick Robinson, Will Chapman, Richard Ford, Sandrine Thirache and Kelly George

Layout & Graphic Design

Will Chapman

Interior Artists

Tim Kelly, Clint Langley, Wayne Reynolds, Luis David Gomez, Pascal Quidault, Ben Wooten, Gill Pearce, Rich Longmore & Carlos Esquerra



Cover Art

Jason Brashill

Contributors

Lawrence Whittaker, Simon Beal, Bryan Steele, Charlotte Law, Gareth Hanrahan, Darren Pearce, Gill Pearce, Richard Hazelwood, Shannon Appelcline, Maurice de Mare, Loren Dean, August Hahn & Rodrigo Vilanova de Allende

Mongoose News

By Charlotte Law

2000AD hits the Virtual Shelves

Fans of the *2000AD* comics will be pleased to know that they are now available on Drivethru. The ever popular comic features a host of favourite characters such as Judge Dredd, Halo Jones, Rogue Trooper and the Strontium Dogs. Check out the advert on page 25 of this issue for more information.

Flaming Downloads

Fans of *Dragon Warriors* and *Corporation* will be glad to hear that several free downloads have been posted onto our website for these two *Flaming Cobra* lines. For *Dragon Warriors* there is a brand new fanzine, a complete adventure, rules updates and some new armour types. *Corporation* fans will find some new character records, division asset and NPC sheets and a blank mission brief.

See the news page on the Mongoose website for more details and where to find them.

Paranoia Gold Dust

Those of you who purchased the *Black Missions* special edition of the new *Paranoia: Troubleshooters* rulebook will be pleased to hear that a select few of you will be able to complete your special edition collection. With the release of the next two rulebooks, *Paranoia: Internal Security* and *Paranoia: High Programmers*, we will be releasing a very limited number of special

editions for each. The special editions will be called *Blue Line* and *White Washes* respectively and will be strictly limited to 100 copies of each. These are only available directly through the Mongoose website and pre-orders are now being taken so act fast so as not to miss out!

Earthdawn Unleashed

Redbrick have now confirmed their 2010 release schedule for *Earthdawn*. It is jam packed and promises a wealth of goodies that are sure to please. More information about this will be revealed in the State of the Mongoose, coming at the end of November.

Licensed to Thrill

In the last few days of September a rather strange thing happened. Kelly and Matthew completely disappeared from the Mongoose studio, last seen heading in the direction of the capital. Rumours are rife about where they could possibly have gone, however they were muttering something about a licensing show... watch this space.

Sculpting Good Times Ahead

Mongoose-contracted sculptors have been very busy recently. They are currently beaver away on a Black Project but are not showing their work to anyone right now... as soon as we see it, you'll see it!



Convention Diary

Furnace 2009

The Garrison Hotel, Sheffield, UK
Sat 10th - Sun 11th Oct 2009

www.rpgfurnace.com

.....

Ludicrus '09

Kesgrave Community Centre, Ipswich, UK
Sat 5th - Sun 6th Dec 2009

www.ludicrus.org

.....

Siege of Augusta

Doubletree Hotel, 2651 Perimeter Pkwy, Augusta, GA, USA
Fri 22nd - Sun 24th January 2010

<http://www.siegeofaugusta.com/cgi/index.php>

.....

More events will be added to this list on a monthly basis as they are confirmed

The Awesometer

Generic events that get our hearts racing (or sometimes not) each and every month!

Charlotte Law's TOP 5 Things to have on your desk

- 1. Cuddly Mongooses – at least two to allow your co-workers to put them in amusing positions when they get bored.
- 2. Achievement – evidence of something you have done to make you look good to visitors, and to massage your ego when the messy stuff hits the fan.
- 3. Chocolate – by the bucket load.
- 4. Legal addiction – Nicotine, Red Bull, Lucozade... whatever gets you through the long hours.
- 5. A picture of a really nice beach... for daydreaming purposes.

AWESOME

Awesome is definatley the right word for this October release, Rock + Jack Black + Hack n Slash = BRUTAL LEGEND!!!



Haloween!!!! We love Haloween at mongoose, especially when all those 'Like your Mask' jokes start floating around!

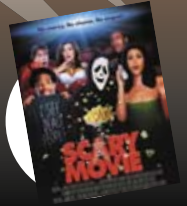

With Haloween comes Scary Movies, nothing beats a cuddle up on the sofa with your loved one!

Weather...well if you cant think of anything blame the weather!

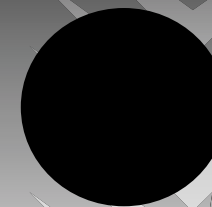

Dark Knights...i mean Dark Nights, days just arnt what they used to be.

2 Months of Xmas Shopping to look forward too :(((



GRUESOME

The Timeline

A visual guide to get your tails wagging for future mongoose releases

November: It is time to finally unleash the Alien Vargr

December: Traveller is the next line to turn French

January: Look out



TRAVELLER



Quote of the Month

What words have been flying around the office more than the dogs ball?

I Feel Violated!

Such a small sentence yet so many possible meanings... as we have discovered this month in Mongoose towers! Who should get the credit for this particular quote of the month? Pretty much everyone has said it at some point in the past few weeks, for a variety of different reasons, from having something rather disgusting explained to them, to Fordy flashing his belly, to medical procedures... we've had all sorts of happenings!

The Time Chart

What have we been spending our time on at Mongoose this Month?

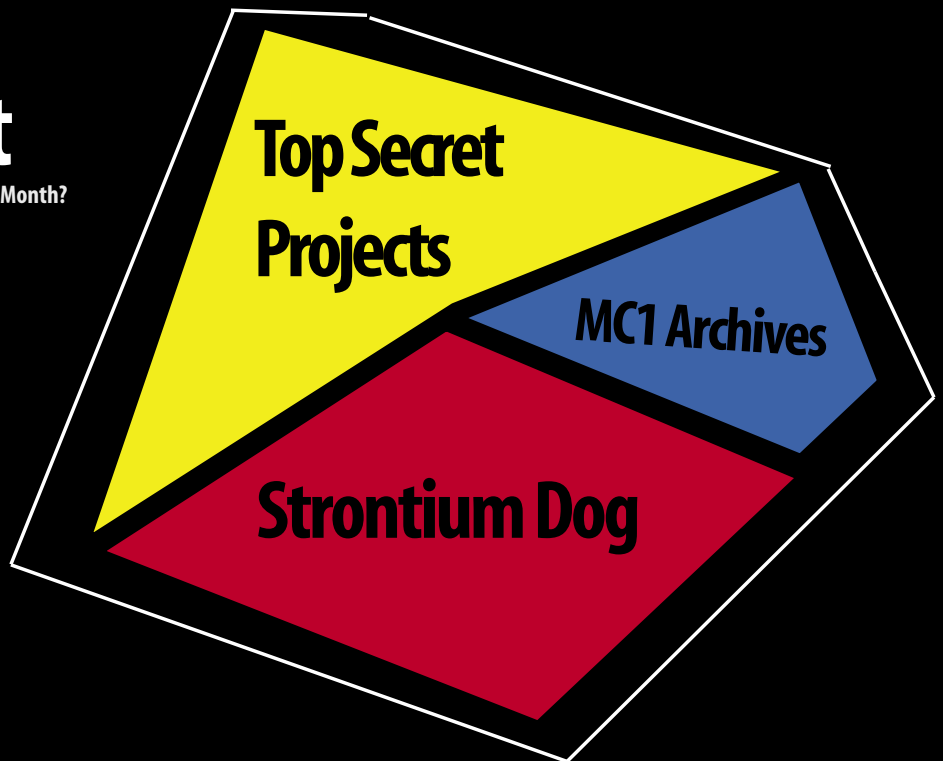

for the Mega-City One Archives

February: Its a Secret..... No Really.....

March: This ones a big Secret too



???

???

October 09 Releases

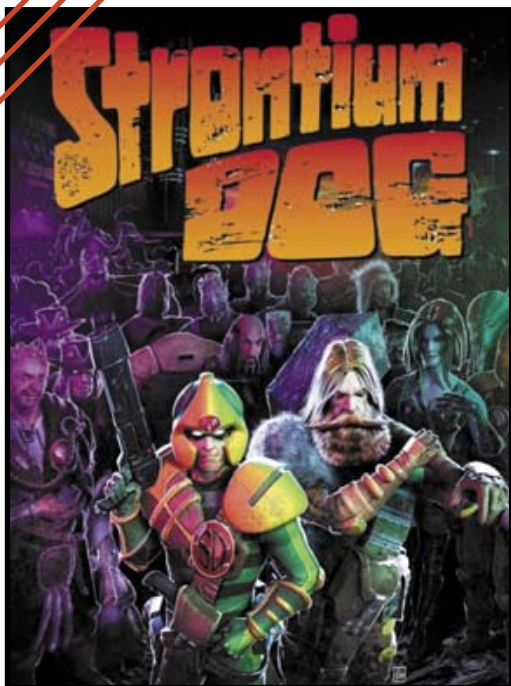

Strontium Dog

Price: \$39.95

Format: Hardback (184 pages)

MGP10002

Earth, the late 22nd century. Following the atomic war of 2150, Britain has been devastated by nuclear holocaust. The survivors rebuilt their lives, but many were warped by the mutating effects of Strontium 90 fallout. Unable to live or work amongst the 'norms', mutants were forced to grow up in ghettos and take the only job open to them – bounty hunting. These Search/Destroy Agents hunt the criminals too dangerous for the Galactic Crime Commission. One such Strontium Dog is Johnny Alpha, whose eyes emit piercing Alpha rays and enable him to see through solid objects - and into men's minds.

Using the Traveller core rules, Strontium Dog allows players to take the part of mutant bounty hunters, combing the galaxy for their prey – dead or alive!

Requires a copy of the Traveller rulebook.

Judge Dredd - Democracy Falls

Price: \$24.95

Format: Softback (128 pages)

MGP10004

Democracy Falls – a hub of opportunity for those in the Cursed Earth with the skills, gear and guts to try and survive within its gang-patrolled wall. Located a few hundred miles west of Mega City One on the ruins of one of America's ancient heartland capitals, 'D-Falls' is a dream for Cursed Earthers...and a nightmare to the Justice Department. It has always loomed in the distance, standing as a reminder that the Mega Cities are not the only civilisations to thrive in this day and age.

The Justice Department has always turned a blind eye to the existence of Democracy Falls, choosing to use its resources more efficiently than laying siege to it. The appearance of a new criminal game in the lower blocks has changed the status quo, forcing the Chief Judges to take action. This new game, called Bloodrace, is well-known to have started in Democracy Falls – and it just claimed it's first Judge's life.

Democracy Falls is a scenario for the Judge Dredd: Traveller game setting, placing several Judges in a dangerous and foreign city in the Cursed Earth, where fast cars and faster bullets are normally the Law of the land.

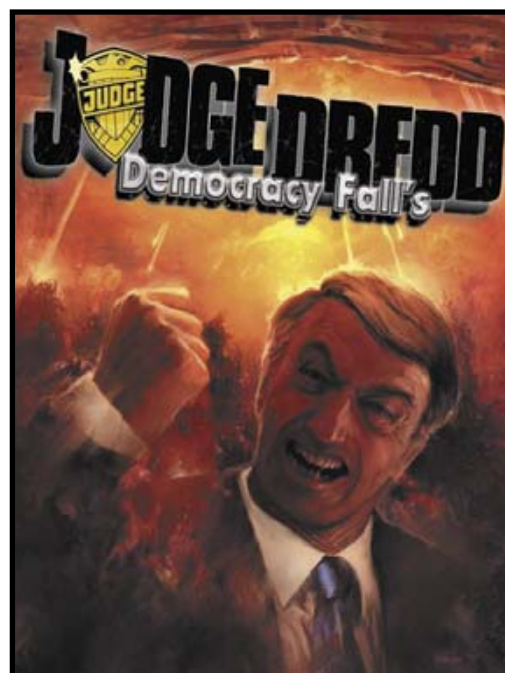

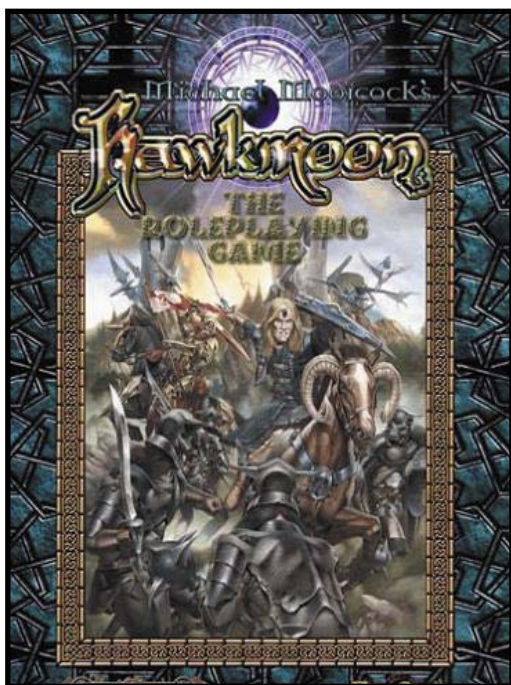

Hawkmoon (French)
 Price: \$40.00
 Format: Hardback (168 pages)
 MGP 8169

L'Empire Ténébreux de Granbretagne a conquis presque la totalité du monde avec sa science pervertie et ses vastes armées dirigées par les nobles aux masques d'animaux affichant leur nature bestiale sur leur visage autant que dans leur coeur. Gouverné par le Comte Airain, le petit Duché de Kamarg a réussi à repousser les nombreux sièges et les manigances que la Granbretagne a lancées contre ce petit état rebelle. Autrefois assassin ayant pour mission de tuer le Comte Brass, le guerrier connu sous le nom d'Hawkmoon porte sur le front un joyau noir démoniaque qui tente de s'insinuer dans son esprit.

Mais lorsqu'il découvre que son destin est celui du Champion Eternel et qu'il doit porter le Bâton Runique, le monde redécouvre la magie et retrouve l'espoir !

Poursuivant le thème du Champion Eternel, Hawkmoon entraîne les joueurs dans un futur lointain, dans un royaume où la science affronte la sorcellerie !

Basé sur le système de règles de RuneQuest, Hawkmoon est un jeu complet et indépendant

Lankhmar Unleashed
 Price: \$34.95
 Format: Hardback (200 pages)
 MGP 8165

City of Thieves. City of Adventure. City of the Black Bones. City of Seven-Score Thousand Smokes. The Imperishable City.

Lankhmar. It is here that the dynamic heroes of Fritz Leiber's tales plied their trade and used as a base for their many adventures. Now you too can experience the thrill of adventure in a world populated by thieves, madmen and evil sorcerers.

This is a completely updated volume covering Lankhmar and the world of Nehwon, compatible with both RuneQuest and RuneQuest II.

Follow in the footsteps of the two heroes and track down the fabulous treasures of half-forgotten myths and legends!

Welcome to Lankhmar!

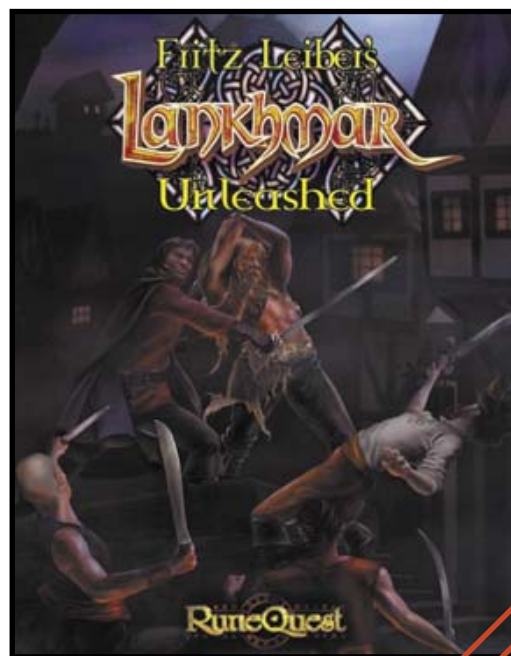

October 09 Releases

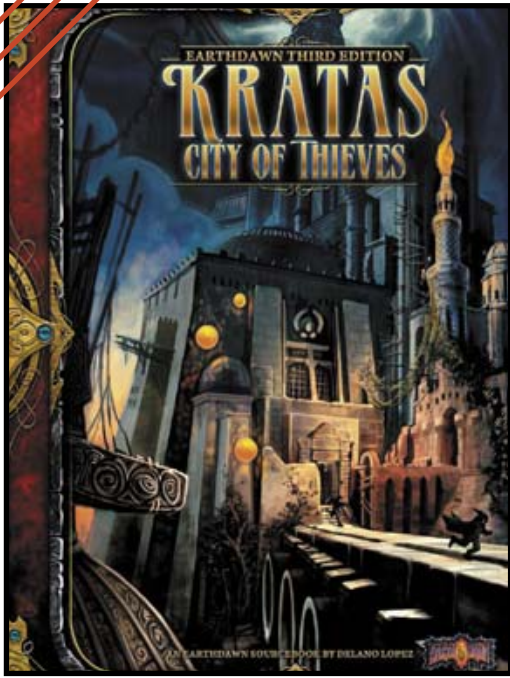

THE CITY OF THIEVES

Located in the center of Barsaive, the city of Kratas is a veritable hub of information and stolen goods. Despite its location near almost all major trade routes, few honest merchants pass through the city, for Kratas is ruled and run by thieves. Its people are the clever and desperate, the illegally wealthy, and the horribly destitute of the province.

Adventure and intrigue—both can be found here, in the dirty streets of the City of Thieves!

Kratas: City of Thieves offers gamemasters and players an in-depth look at Barsaive's most disreputable city. This book provides detailed descriptions of Kratas, its gangs, and the characters who call this city home, along with new and original content for adventures in the world of Earthdawn. Requires use of the Earthdawn Player's and Gamemaster's Guides.

Earthdawn - Kratas: City of Thieves

Price: \$39.95

Format: Hardback (272 pages)

Lone Wolf 12 - The Masters of Darkness

Price: \$21.95

Format: Hardback (300 pages)

You are Lone Wolf – the last Kai Master of Sommerlund. Upon your triumphant return from the twilight world of Daziarn, you discover that your mortal enemies – the Darklords of Helgedad – are poised to conquer all of Magnamund.

In THE MASTERS OF DARKNESS your mission is to journey to the infernal city of Helgedad, to the very heart of the Darklords' evil empire. There you must confront Darklord Gnaag, Archlord of the Black City, in a battle that will determine the future of your entire world.

The ultimate challenge awaits you in this exciting and terrifying climax to the Lone Wolf saga.

Using high quality paper and hardbound for durability, this Collector's Edition of the latest Lone Wolf gamebook marks the return of the last Kai Lord.

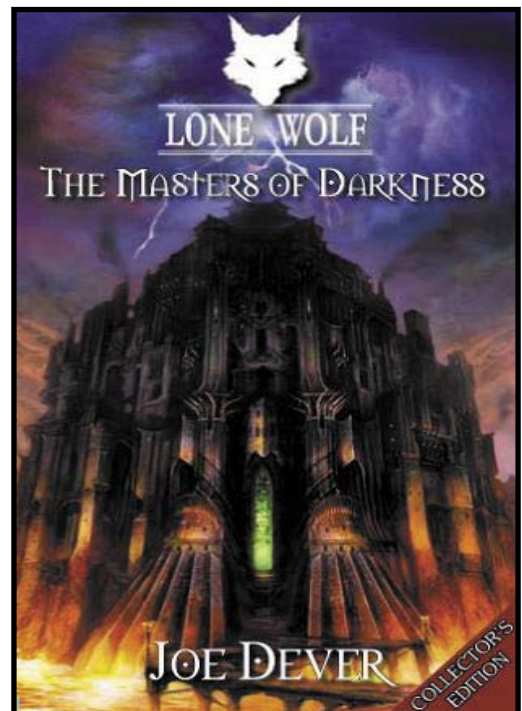

GAMESFEST 4



**A ONE-DAY CONVENTION ENCOMPASSING RPG'S,
BOARD GAMES, WAR GAMES, CCG'S, COMICS,
BOOKS, FILM, VIDEO & PC GAMING.**

24 OCTOBER 2009

WATFORD COLOSSEUM

DOORS OPEN 9.00AM TO 5.00PM

TICKETS ADULT £5.50, UNDER 16'S £4.50

WWW.GAMESFEST.CO.UK



CONAN'S[®]

SCORE OF STEEL

Every month the guys at Mongoose will be looking to bring you their reviews and opinions on some of the hottest events happening around the world, from Movies, Video Games, Books and naturally Hobby Gaming, of course we all need some scoring assistance.



Outlander

By Simon Beal

DVD Details

Released: Out now

RRP: £17.99

Region: 2 (Europe) - DVD details may vary in other regions

Running Time: 110 mins

Aspect Ratio: 16:9

Audio: Dolby 5.1

Extras: Commentary, deleted scenes, visual effects tests, animatics, making of featurette, artwork galleries, trailer

The thud of a DVD dropping through the letterbox is a very satisfying sound and one I never tire of hearing. Ripping open the packaging of *Outlander*, I was greeted by a rather funky lenticular cover – the type that you tilt and it gives the illusion of movement. Yes it is a gimmick but one I've not seen for a while and it adds a certain retro-cool factor.

The Plot

In essence, the plot of the film is very simple – a spaceship crashes in Norway in 709 A.D. Only one of the two crewmen survive, Kainan (Jim Caviezel) but a deadly

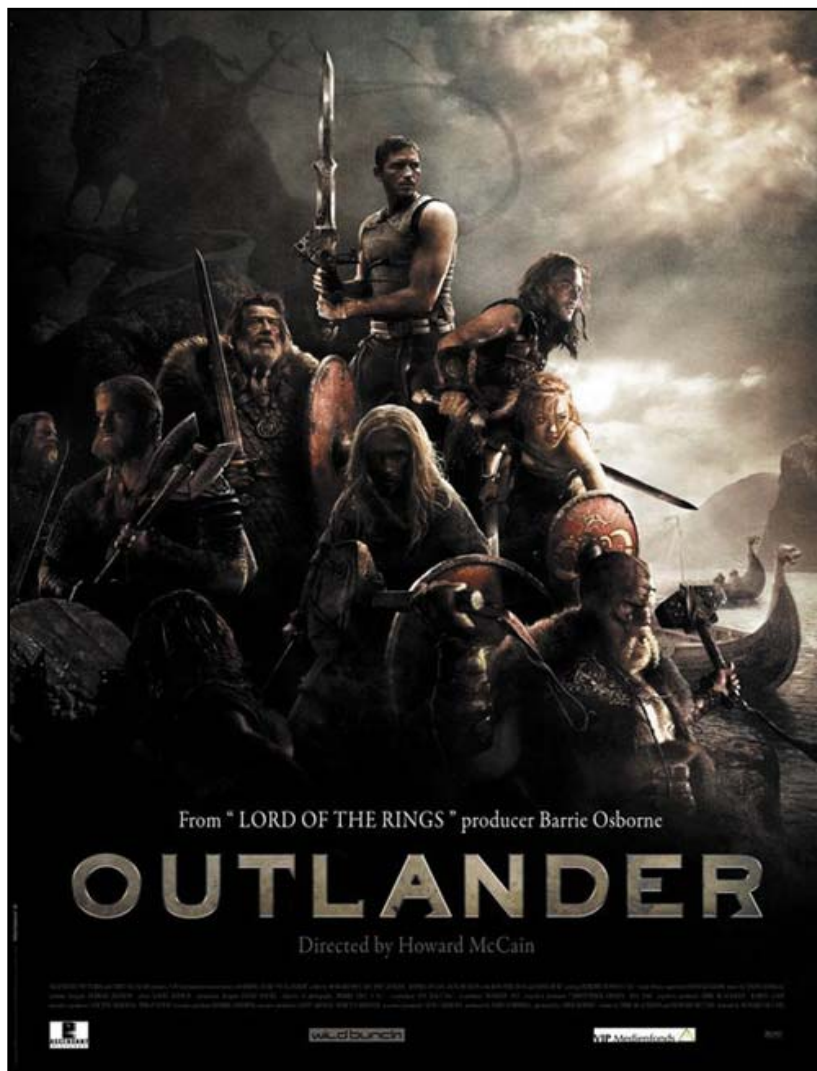

monster called the Moorwen was also onboard the ship and is now loose in the land of the Vikings.

However, there is a little more to the story than this. Prior to Kainan's arrival, two Viking tribes are at war with each other – one is led by Rothgar (John Hurt) and the other is led by Gunnar (Ron Perlman). Rothgar has recently become king after his brother was killed in an ambush whilst attempting to unite the Viking tribes. Gunnar failed to attend and is blamed for the attack. Wulfric (Jack Huston) is the rightful heir but is not yet ready to be king and is trying to prove himself to Rothgar, whilst seeking vengeance against Gunnar.

Once the Moorwen is loose upon the lands it starts killing indiscriminately. One of its savage attacks destroys one of Gunnar's villages, killing every man, woman, child and beast including Gunnar's family. Gunnar naturally thinks that Rothgar's tribe is responsible and that they wiped out the village in revenge. And so the conflict gathers strength.

Shortly after his arrival, Kainan is captured by Wulfric and taken back to the tribe. To begin with they think that Kainan is responsible for the deaths until the Moorwen attacks their village. Kainan helps the Vikings hunt down the 'dragon' and gradually wins the respect of the tribe and instils himself into the heart of Rothgar's daughter, Freya (Sophia Myles).

As the tribe fight against the Moorwen and Gunnar's tribe, Freya becomes more involved with Kainan and Wulfric

continues in his efforts to prove he is a worthy leader. However, Wulfric thinks that leadership comes from the sword alone, whereas Kainan uses his wit and becomes a trusted advisor to Rothgar. As the story progresses Kainan has flashbacks of his life before arriving on Earth, revealing the truth behind the Moorwen and how the creature and Kainan came to land on Earth.

Much of Kainan's technology is unavailable throughout the movie so there is no deus-ex machina to destroy the Moorwen, Kainan and the Vikings must use swords and their wit to defeat the beast. However, towards the end of the film, technology is used in a minimal way to provide the Vikings with the means to damage the creature, where before their weapons had little effect.

Conclusion

In many ways, *Outlander* is a take on the classic Beowulf myth and it has been well conceived, successfully mixing science fiction and Viking fantasy. Another theme running through the film as that of misunderstood conflict and that through adversity, such rivalries can be overcome to fight a greater threat.

For the most part, the story is well thought out and engaging. There are some great characters and solid performances by many of the actors really bring the personalities to life. The effects, sets and costumes are all very detailed, making the world seem real and lived in. I particularly liked the tree-throne

in the shield hall and the Moorwen is a fantastic monster that passes as both an otherworldly creature and a dragon (from the perspective of the Vikings).

The sound is also of a high quality and well engineered. If you have a surround sound system, crank it up and you really feel like you are in the middle of the action.

The movie is well directed and reasonably fast paced but it also has a few nice moments of introspection and exposition, building up the lore of both Kainan's people, the Moorwen and the Vikings. There are also a few poignant moments where events mirror what happened to Kainan's own people.

There were a few disappointing aspects to the film such as Freya, who went from being a strong female character to the more traditional damsel in distress, which was very disappointing. *Outlander* also suffers from 'cute kid syndrome' but fortunately this is minimal and does have some relevance to the story. There are a few other tiresome clichés but explaining those might give away too much of the plot.

Overall *Outlander* is an entertaining movie that somehow just didn't live up to my expectations. It is an entertaining romp but has a few points that let it down. However, considering it was shot on a relatively low budget the production value is very good and the makers did a fine job.

Score: 7/10



Extras

Outlander has a good range of extras. The commentary is voiced by a number of the crew including writers, producers and the director (Howard McCain). Their comments are insightful, giving various details about the making of the movie and background into the myths. They are also quite jovial at times sharing anecdotes and jokes making it enjoyable to listen to.

The deleted scenes section includes alternate and extended scenes in varying stages of production. Most scenes were removed for reasons of pacing but they provide some additional insight into the story. There is an alternate beginning that





nically frames the story and also has a little foreshadowing but this was removed for both pacing and budgetary reasons.

The making of featurette is interesting but short, giving further background to the how the film was made. There is also an art gallery of stills, effects tests and animatics that give further insight into how the film was realised. Also included in the extras is the original *Outlander* trailer.

Roleplaying

Outlander has several concepts that can be used in roleplaying games. The idea of a technically advanced race crash landing on a primitive world makes an ideal *Traveller* scenario that could even be the foundation for a long running campaign, should the players decide to stay. Much like in *Outlander*, this idea works best when any technology the players' might have is either damaged, unusable or unavailable, forcing them to rely on more primitive means.

This setting can borrow further ideas from *Outlander*. Perhaps there is some political rivalry between two factions and the players' arrival causes further tensions. The players could also be taken prisoners and must prove themselves, ultimately helping their captors or escaping to help the opposing side.

Another possibility with this setting is that the players require the help of the inhabitants in order to get their ship working and leave. This setting requires some careful planning as to the nature of the problem that prevents the players from leaving and how the primitive inhabitants can help.

Alternatively, this scenario can be flipped on its head and used as the basis for a fantasy or historical game. In this setting the players' are the primitives and the starship crash lands bringing with it alien survivors, savage beasts or both. How will the players react to an outlander arriving in their lands and how will they defeat the creature that now prowls their territory?

Moon

by Gareth Hanrahan

Sony Pictures, 97 mins.

We're whalers on the moon, we carry a harpoon, for they ain't no whales so we tell tall tales and sing our whaling tune

In *Moon*, Sam Rockwell is a whaler on the titular celestial body, hunting the elusive moon-whale for... oh, hang on a sec. He's a *miner*, not a whaler. Let me start again.

He's a miner on the moon, he's up there all alone, 'til he crashes his buggy and finds a duplicate of himself and it's the most awkward flat sharing situation ever.

Sam Bell (Rockwell) is an employee of Lunar Industries, harvesting Helium-3 from the surface of the dark side of the Moon. He's the only inhabitant of Sarang base, unless you count his faithful computer companion, GERTY (voiced by Kevin Spacey). It's a three-year contract. Sam's job is to maintain the robots that suck up the lunar regolith, maintain the little base and fire off supply rockets to Earth every few days. The HE3 powers Earth's fusion reactors, providing safe, clean energy for all, as Lunar Industries tells us at every possible opportunity.

There are downsides, of course. Sam's isolated from his wife and young daughter back home. The relay satellite that's supposed to give him near-relay-time communications with Earth is offline, forcing Lunar Industries to send all communications to the dark side base via Saturn, with the attendant long delays. Sam himself is feeling the effects of the isolation; his concentration is shot, he's exhausted, even hallucinating. GERTY is acting suspiciously – at one point, Sam catches the computer having what seems to be a real-time conversation with Lunar Industries.

And then...

Spoiler Warning

One of the robot harvesters breaks down and Sam drives out in a rover to fix it. He

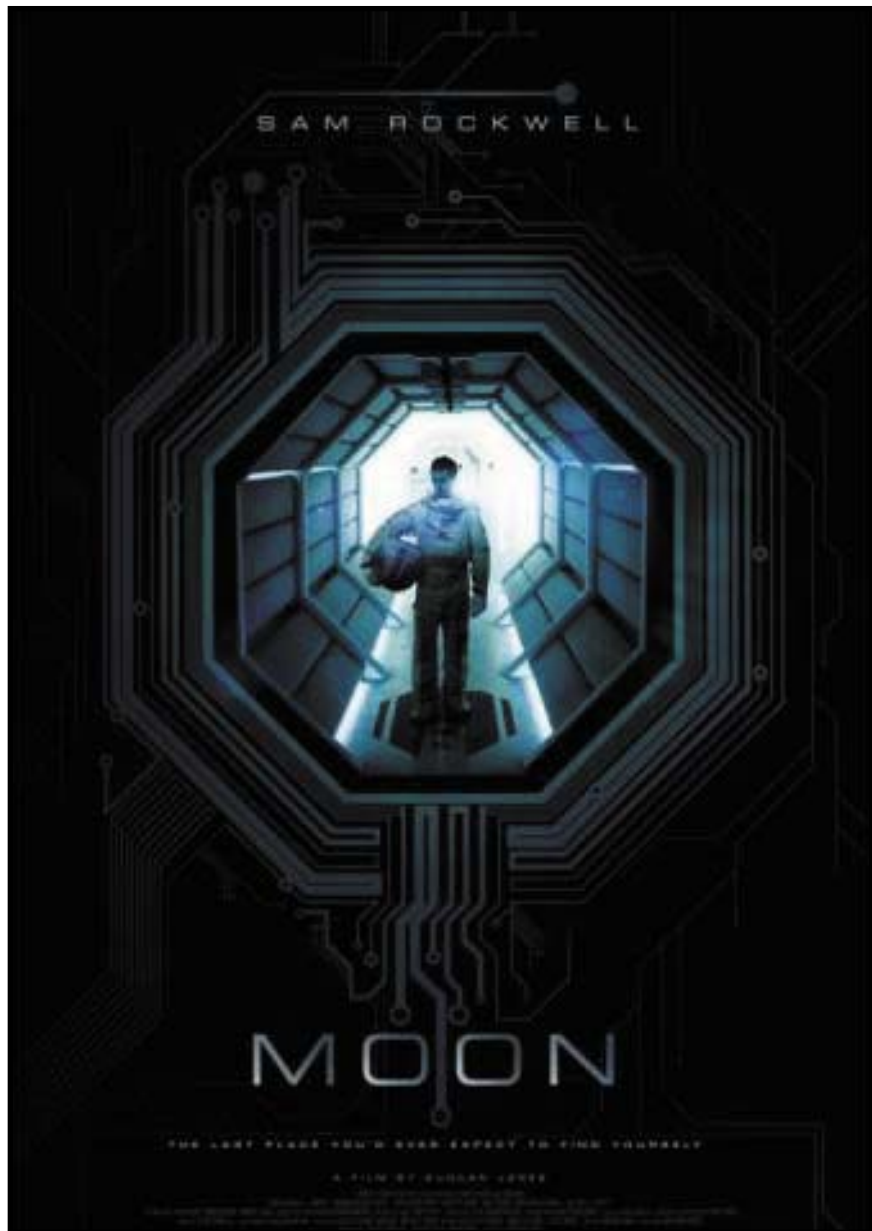

hallucinates again, seeing a girl walking on the lunar surface and is so distracted he crashes.

He wakes up back in the infirmary in Sarang base. Sam's unsure how he made it back and despite GERTY's insistence that he should rest and wait for the rescue team, he becomes determined to investigate. He returns to the rover crash and inside the wrecked vehicle he finds... another Sam. Sam brings the injured Sam back to the base.

One must be a clone of the other, but neither Sam is willing to entertain the possibility that he's the clone. As Sam-

from-the-rover's health declines, they start looking for answers. Exploring outside the base, they discover a grid of jammer towers that block transmissions from reaching the base – the story about the lunar relay being off-line was a lie. GERTY is initially evasive but eventually helps one Sam find proof that *both* Sams are clones. A secret chamber in the base contains a cloning facility – when a Sam completes his three-year contract, he's sent to a 'hibernation pod', which incinerates him. A replacement clone is then activated for another three-year stint. Replacement clones are also deployed when a Sam is killed. The rover crash activated another clone.

By driving out beyond the range of the jammer towers, the healthier Sam is able to contact Earth, only to discover that more than 10 years have passed, his infant daughter's grown up and the *original* Sam Bell is back home, apparently unaware that he's been cloned dozens of times.

The two Sams struggle to come up with an escape plan before the rescue party arrives, until the weaker Sam realises he's dying. He proposes that the healthier, newer Sam return to Earth in the helium delivery rocket, while he returns to the rover to die. GERTY shows them how to wipe the computer memory banks, so the rescue team will never know that an extra Sam was activated. The new Sam escapes and a final montage of news reports suggests that his testimony brings down Lunar Industries.

Silent Running* meets *Waiting for Godot

Moon would sit quite comfortably on your DVD shelf next to *Silent Running* or maybe even *Dark Star*. It could even be a stage play as 90% of the movie takes place in the cramped confines of Sarang base and the external shots – starkly beautiful in a desolate way – are all just rovers driving across the dusty surface or the base itself. There's little action or direct confrontation. It takes a long time for the two Sams to confront the mystery of their existence head on; instead, they avoid the issue, arguing over a matchstick model and living arrangements in the base. At times, the pace is frustratingly slow, especially as the older Sam-clone's health declines.

If you like Sam Rockwell, then it's the movie for you. If you don't (and I'm lukewarm

on him), then you'll need some added patience to cope with the movie's more indulgent sequences. It was conceived as a vehicle for him and you certainly get the full Rockwell range of kookiness and pain. The other main character, GERTY, is oddly positioned initially as a HAL-style villainous computer and then a helpful sidekick and never makes a really strong showing in either guise. (In a brilliant touch, GERTY's face is a series of computer smileys). Others who saw the movie were really touched by Rockwell's performance, so it's entirely likely that your humble reviewer is just a cold-hearted monster with no capacity for empathy.

The story, which was co-written by the director, Duncan Jones (and every review of the movie is contractually obligated to mention that he's the son of David Bowie), never answers *why* Lunar Industries bothers with such an elaborate system for staffing its lunar base but it's more an extended meditation on the nature of life and death than a sci-fi mystery. Our lives are just as controlled and bizarre as the Sams – it's just easier to see the strings in *Moon*.

Score: 7/10



Moon & Gaming

Moon's single protagonist means you can't transplant the story directly over to a group roleplaying game. You could do it as a solo game, or with two players playing the Sams but having six clones of Sam running around would just get silly. Generalised to 'the Player Characters are all working somewhere isolated and something weird happens', it becomes an excellent starting

point for an adventure. The players are all asteroid miners, and they find an alien artefact, or a wrecked ship, or they discover that they're actually being sent through a one-way wormhole to colonise a new world. It's also a textbook case of how to isolate characters and force them to rely on themselves instead of calling for help.

Sam's discovery of another Sam is a fantastic science-fiction shock. Having the Player Characters meet duplicates of themselves is tricky to run but you can pull the rug of reality out from under them in other ways. Maybe the characters discover they're clones from old video records (or, in a fantasy campaign, magical duplicates of long-dead heroes), or that the laws of reality are totally different to what they surmised (sorcery in a *Traveller* game, for example). Lock the players' expectations into one mode of play ('*this is going to be a gritty science-fiction game where you're travelling merchants working for an agricultural megacorp*') then hit them out of left field with something that blows away all their assumptions ('*hey, we're basically trading in spice from Dune – exposure is mutating us into psychics!*')

With a little reworking, Sarang base could be dropped into a *Traveller* game as a mining outpost. You could even use it as *PARANOIA* inspiration, replacing GERTY with Friend Computer. An interesting *PARANOIA* variant would be for clones to believe they're the same person as the original ('*Yes, I fell down that shaft. No idea how I survived but they found me and I woke up here in the hospital.*')



*READ IT,
PUNKS!*

**ARE YOU GETTING
THE GALAXY'S
GREATEST COMIC?**

2000 AD
THE GALAXY'S GREATEST COMIC

Finding your Mark...or Tom...or Henry...

By Bryan Steele

When playing or Refereeing a game of *Strontium Dog*, the hardest part of putting together a cohesive mission for the Dogs can be figuring out the direction they should be going. The galaxy is a very big place and there are a LOT of scum bags out there to apprehend – or terminate.

This article is a small glimpse of the sort of scenario ideas that fans will find in the upcoming product *Bounties and Warrants*. In that publication, warrant cards like the ones that appear in this article will have entire write-ups concerning the targets, scenes and rewards. Consider this article a sneak preview of the sorts of missions the Dogs will be sent upon when *Bounties and Warrants* hits the shelves.

More importantly...find these creeps!



Warrant

Name: Shale Roads

Aliases: Shatterbones Shale, Lonely Roads

Profile: 492-8712E

Record

Yander 3 – Injury to a GCC agent

Granite Planet – Aggravated Assault

Roleer 7 – Aggravated Assault, Possession of Illegal Weaponry

Warrant Designation: Apprehend and Return

Reward: Cr25,000

Warrant Status: Open

LVS:

Gravelbottom Cafe; New Quartzite; Granite Planet – 12/07/85 (Ferr 87 D91826-H)

Notes

Violent but not deadly, Roads is a typical member of Granite society. As such he is strong, tough and does not know his own strength.

Known Associates:

Hemo Tight (Weapons Smuggler, GCC file E81273.177)

Geode (Transport Pilot, GCC file R7167.99)

The Obsidian Gang (Granite Criminals, GCC file G7112.91)

Convicted on many different individual counts of assault with lethal and illegal weaponry, Roads recently crossed the line by shooting a high-calibre pistol into the leg of a local GCC research agent.

Target has been spending a great deal of time with his old gang members recently at a food club called the Gravelbottom Café on the Granite Planet. Locals are afraid of what he can do and has done, allowing him to live in their midst without arrest.

Roads will assuredly resist arrest and do so with moderate amounts of violence. Agents should be aware and forewarned.



Finding your Mark...or Tom...or Henry...

Warrant

Name: Devon Grayson

Aliases: Devon the Devil, Disaster Devon, Grabber Grayson

Profile: 817.7725D

Record

Solderon – Grand Theft Shuttle

Kudji Beta – Grand Theft Auto, Trafficking in Stolen Merchandise

Warrant Designation: Apprehend and Return

Reward: Cr10,000

Warrant Status: Open

LVS:

Barrio 13; Io Colony – 11/01/85 (Jup1 18 A81922-R)

Notes

Generally non-violent, Grayson is a professional thief of vehicular devices. He is a master electrician and mechanic; no engine system is foreign to him.

Known Associates:

Connie 'Control' Smythe (Forger and Fence, GCC file Ty/9083/632-C)

Yuri Bollivic (Known Smuggler, GCC file 65-742AA)

Recently connected to several high-credit thefts of important shuttles within the Kudji government. He uses these shuttles' clearance tags to smuggle illegal food products out of the system.

Target lives in a rented hovel in a human gathering point on the Io Colony; Barrio 13. Between shuttle thefts and smuggling runs, he can be located there.

Grayson may or may not be armed when agents come for him. He has no history of violent behaviour but lives in a somewhat dangerous part of the colony.

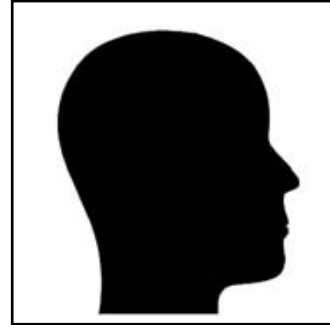

Warrant

Name: Bartlett Nighs

Aliases: Break-Neck Bartlett, Body-Bag Bartlett

Profile: 902.1139F

Record

New London; Earth – Drug Smuggling, Sale of Controlled Substances , Assault with Deadly Weapon

Luna City – Sale of Controlled Substances, Piloting While Inebriated

Warrant Designation: Dead or Alive

Reward: Cr20,000 dead; Cr30,000 alive

Warrant Status: Open

LVS:

New London; Earth – 22/03/85 (Terr 100 7128E)

Notes

Former gang member and mutant troublemaker, Bartlett Nighs has shown he has a light addiction to the drug 'mazer'. Mazer increases adrenaline flow along with endorphins, augmenting speed and strength.

Known Associates:

Abelard Rancid (Murderer, GCC file 987/4972/6-Closed)

Benjamin 'Benny Bedlam' Lamstein (Mutant Terrorist, GCC file 546.3991X)

Tabula Waits (Mutant Hiring Agent, GCC file 102/87937-AA)

Nighs has just added Assault to his charges due to his drug sales placing a local celebrity in the hospital during a drug-deal gone wrong. This updated his minor criminal status to that of a dangerous offender; and increased his designation to Dead or Alive.

Target has spent the last three years living in the mutant ghettos under New London. He is known for his multi-coloured layer of thick fur all over his body and a terrible lisp. He should not be too difficult to find for skilled agents.

Nighs has a mild addiction to a street-level combat drug and has shown a history of carrying weaponry; there is no reason to believe he will not react with violence to apprehending agents.

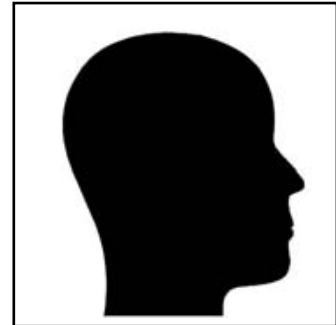

Finding your Mark...or Tom...or Henry...

Warrant

Name: Adam Wight

Aliases: Adam Winter, Arcane Adam

Profile: 192.8468X

Record

Salem Colony; Mars – Use of Unauthorised Psychic or Metaphysical Talents

Holdren 4 – Escape from Maximum Security Confinement

Warrant Designation: Dead or Alive

Reward: Cr30,000 dead; Cr50,000 alive

Warrant Status: Open

LVS:

Salem Colony Commons; Mars – 17/05/85 (Ares 81 881/4212D)

Notes

A known telepath and kineticist, Wight is capable of reading thoughts, conjuring lightning and moving objects with his mind. He should be considered dangerous at all times.

Known Associates:

Malak Brood (Deceased Sorcerer, GCC file 798AB9-Closed)

Falpetta DiMorne (Mutant Psychic, GCC file 182.810AA)

Darlok Wylde (Human Warlock, GCC file 328.5520X)

Wight has left a series of psychic and cross-dimensional turbulence wherever he goes. This effect is considered too dangerous to be allowing Wight to remain free. The GCC wants to place him back into dimensional custody if possible.

Target has returned to his original homeland, the controversial 'psion block' of the Salem Colony on Mars. Local witnesses claim he is living in an abandoned library grounds on the northern end of the community.

Wight is a moderately powerful psion with some sorcerous learnings. He was said to be a model prisoner at Holdren 4 and managed to escape without harming any staff personnel. It is unknown if he will defend against capture violently. Measures should be taken against both magic and psionic attacks.

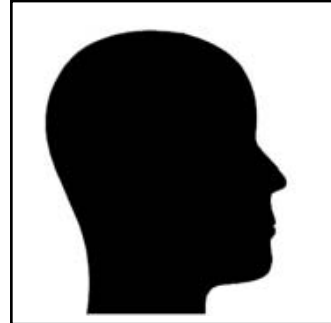

Warrant

Name: Theodore Mauler

Aliases: Two-Gun Teddy, Mad Ted Mauler

Profile: 762.155K

Record

Earth – War crimes in the fight against the Mutant Army

Mars – Anti-mutant Acts of Terrorism

Io Colony – Anti-mutant Acts of Terrorism, Murder

Cronus Station – Assault, Possession of Illegal Arms

Warrant Designation: Termination

Reward: Cr250,000

Warrant Status: Open

LVS:

Cronus Radiation Monitor Station; Uranus Orbit – 17/08/85 (Sola 17 T3391.62R)

Notes

One of the leading executioners in Nelson Bunker Kreelman's reign of terror in the 60s that escaped judgment. He is well trained and very dangerous.

One of the more vocal members of Kreelman's anti-mutant party, Mauler did not give up the fight against mutantkind after Parliament passed its 'peaceful' end to the uprising. Instead he made some cybernetic and chemical modifications to his body and made the 'war on mutants' his personal goal.

Known Associates:

Nelson Bunker Kreelman (Former Minister of the Military; deceased, GCC file 002/1197-K)

Doctor Pearl Rayment (Unlicensed Body Modification Specialist, GCC file 81.009.233-V)

Mauler's opened military records state he is a skilled close-quarters marksman and an expert in melee weapon fighting. His augmentations have only made these skills more deadly, adding personal weaponry of military-grade to his body arsenal.

Target has been located on the radiation monitoring station Cronus in the most outside orbit of the planet Uranus. Scanners show he is ferrying a number of low-grade nuclear components through the area and protecting them with violence and threatening actions.

Mauler hates mutants and has turned his body into a living carriage for numerous weapon systems and defensive measures. He **will** defend himself violently and with lethal force; agents are cleared to do the same.

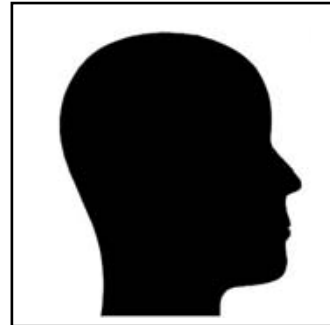

Warrant

Name: Scarr the Howler

Aliases: N/A

Profile: X29.7915

Record

Adrenaldo – Assault, Armed Robbery, Murder

Meris System – Assault, Contraband Trafficking, Extortion, Murder

Warrant Designation: Termination

Reward: Cr175,000

Warrant Status: Open

LVS:

Morn City Mall; Meris 6 – 22/11/85 (Gemn 74 A9182/57D)

Notes

An active but low-level member of the system-wide Meris Mafia criminal organisation, Scarr is one of Roon the Howler's right hand thugs. He is a dangerous alien creature.

The Meris Mafia has recently escalated its basic Mafioso equipment to include standard issue blasters on Roon's orders, adding to the effective lethality of Scarr and other mafia members.

Known Associates:

Roon the Howler (Meris Mafia/Brother, GCC file X33.8410)

Four-Claw Ford (Mutant Mafioso, GCC file 546/81675-A)

Rip the Howler (Meris Mafioso, GCC file X33.8426B)

All howlers are dangerous aliens; Scarr is a good example as to why. He is very strong and fast from a life of predatory hunting and training to be a good raider. These are all skills that have only gotten more practice as a mafia strong arm.

Scarr's normal collection territory is that of the Morn City Mall on Meris 6. Target spends long hours going from storefront to storefront collecting illicit moneys from the owners. This takes 6–8 hours every Runsdag. Agents should use that window to confront Scarr.

Target is a howler; expect violent reaction to any agent presence. Morn City Mall has an average patronage of 100–150 consumers walking the stores and halls. Agents must take measures to keep bystander casualties and collateral damage to an extreme minimum.

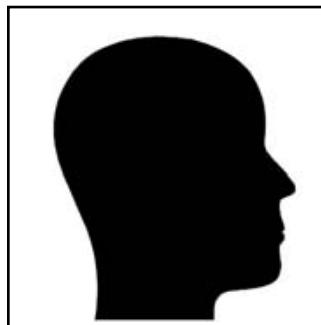

WANT TO DOWNLOAD THE GALAXY'S GREATEST COMICS?

YOU CAN NOW GET THE LATEST ISSUES OF
2000AD AND GRAPHIC NOVELS OF YOUR
FAVOURITE CHARACTERS STRAIGHT ONTO YOUR
COMPUTER AT DRIVETHRU COMICS



Visit comics.drivethrustuff.com

In Potter's Field

By Gareth Hanrahan

Whetstone.

The original settlers thought that this harsh, rugged planet would sharpen them, hone them into better people. They built settlements in the more sheltered valleys, to avoid the howling winds and rainstorms that lash the planet's more hospitable continent. They planted Terran crops and watched most of them wither and die but a few plants survived to seed the next generation. After 200 years of adaptation, Whetstone became almost habitable. For the first time in six generations, life on the planet was more than a hand-to-mouth struggle for survival.

Another generation later, civil war engulfed the planet. Whetstone's newfound prosperity created a sharp divide between the valley cities and the Hillfolk. The Hillfolk believe that the city dwellers are immoral and corrupted by soft living and off-world influences. The city dwellers consider the Hillfolk to be backward primitives. Control of the government switched back and forth between the two sides increasingly quickly, until war broke out. The Hillfolk fired the first shot, claiming that the cities had falsified the results of the last election and that the city-dominated planetary government was illegitimate.

The City of Jacobsford hired Hammer's Slammers.

Referee's Introduction

This scenario puts the players in command of a small village in the highlands. The ranks and skills of the characters are not important; the scenario is more concerned with their decisions. The scenario takes place over seven weeks. Most of the challenges faced by the characters are logistical and moral ones, not tactical.

Before running the scenario, print out the map of Potter's Field and review the information about the village and the events. You should also print out the briefing cube handout and give that to the players.

At the start of the scenario, the characters are separated from the Slammers (if the PCs are part of a different unit, replace all references to the Slammers with references to their unit); they were left behind for some reason at the end of the last contract. Perhaps they were assigned to mop up the last enemy resistance, or were injured, or their vehicle broke down, or some administrative or logistical screw-up delayed them. They are on a civilian transport that will drop them off on Whetstone. En route, they receive a transmission from regimental command, giving them a briefing on the current situation and a new set of orders.

It is assumed that the characters are part of a large merc unit. If they have only a small mercenary unit, then assume they have been sub-contracted by the Slammers.

Whetstone – Operation

MATTERHORN

Tactical Update: Our contract is with the City Fathers of Jacob's Ford. The enemy is the Hillfolk militia. Our mission is to provide support and armour to the City Fathers Forces (CFF). Initially, the CFF offensive against the Hillfolk progressed well but in the last six months they have proved unable to put an end to Hillfolk resistance. The enemy has retreated to the mountainous regions of the west, where narrow roads and harsh conditions make it impossible for CFF armour to penetrate enemy defences. The enemy have adopted guerrilla tactics and have acquired modern weapons from offworld, including some powergun artillery. CFF comms & surveillance satellite assets have been eliminated.

The regiment has landed at Jacob's Ford. Our combat cars and infantry, together with CFF units, will seize key locations in the western hills and set up firing emplacements for our MBTs. Committing the hovertanks to the mountain roads and goat paths is counterproductive until we locate Hillfolk bases.

Mission Update: Your transport has been redirected to the old landing field at Brooke's Landing. Rendezvous with elements of K Company including two combat cars and travel to the town of Potter's Field.

Potter's Field was captured by the CFF two months ago. The town's chief military asset is the communications tower, which is a vital relay in the CFF comms network. You are to take command of the town's administration and defences, relieving Captain Burton of the CFF and ensure the safety of the comms tower. Be advised that there may be Hillfolk guerrilla forces operating in the heights around Potter's Field – Captain Burton will continue operations against them using Potter's Field as a base. You are to give Captain Burton any reasonable aid, so long as it does not conflict with your mission to defend the town and relay.

Planetary Briefing: Whetstone is an Earthlike world (C867636-7) with a population of some 34 million. The planet has few notable resources. High winds and other extreme weather conditions are common in the settled areas of the planet.

The energetic upper atmosphere of Whetstone and the high mountains make long-range radio communications difficult. You may be out of touch for long periods of time; plan your tactics accordingly.

Cultural Briefing: Whetstone was settled primarily by colonists from the old United States, with a minority from Indonesia. The primary cultural division is between the valley settlers and the Hillfolk. The valley settlers are much more urbanised and engage in interplanetary trade; the Hillfolk are isolationist and traditionalist. The primary religion, an offshoot of the Way emphasising self-denial and the virtues of hardship, is highly influential among the Hillfolk and their pastors are important figures in society.

Winning the hearts and minds of the non-combatant Hillfolk is vital to the success of any military operations in the highlands. Emphasise that the conflict is between the CFF and the Hillfolk militia, not the civilian population. Respect their cultural mores, especially their religion. Offer any assistance possible without jeopardising the security of the communications relay.

Briefing Cube Ends

Potter's Field

The town is located high up in the mountains, at an altitude of 1,400 metres above sea level. The population of Potter's Field and the surrounding mountain pastures is just over 1,000, all Hillfolk. The primary economic activity is goat farming. Before the war, it was a quiet backwater, a nice place to live if you wanted a quiet, less ambitious life. It resembles a Swiss mountain village; all steep-roofs covered in snow and narrow streets. Power is provided by a hydroelectric plant in the valley below.

1. Town Square: The main square of Potter's Field. In better days, large markets were held here every week. Now, there are fewer goats and more boarded-up buildings. The CFF have built a watchtower and checkpoint on the main road here, so half the square is blocked off with barbed wire and sandbags. In the middle of the square is a large clock, made of metal from the first starship to visit Whetstone.

2. Church: This impressively severe edifice is built of local stone. The spire is the second tallest structure in town – only the communications relay is taller. There is little decoration inside the church, and it is unheated – mortification of the body encourages devotion to God. Over 75% of the towns' citizens crowd into the church twice a week to pray and attend Pastor Hunt's fire-and-brimstone sermons.

3. Karl's Place: A large four-storey building that houses the town's main restaurant and public house. Karl's Place once catered to lowlander tourists but they have stopped

coming since the Hillfolk started the war. It is the centre of social life in the town; both Hillfolk and CFF occupiers drink here.

4. The Window House: This large mansion was once the property of a wealthy landowner, who fled to Jacobsford when the war started. It is called the Window House because the east-facing side is one huge window, giving fantastic views over the valley. Most of the rooms in the house are locked, the furniture covered in dust-sheets and the paintings and other ornaments removed. The CFF are using the Window House as their command post and administrative centre for the town. In addition to Captain Barton and his staff, there are another half-dozen civilian clerks to deal with the town's paperwork.

5. CFF Base: A small prefabricated base, home to four dozen CFF soldiers. Other military assets on the base include a C3 computer network, two combat jeeps (armoured, and with a pintel-mounted powergun), three standard jeeps and an earthmover.

6. Prison Camp: A small camp used for holding captured Hillfolk Militia. It consists of a fence surrounding six tents, a pair of chemical toilets and a pair of prefabs for administration and interrogation. The camp is currently home to four captured militia members, awaiting transport to a better holding facility. The camp is on the far side of the CFF base from the town, and the Hillfolk are forbidden from going near it. There are all sorts of rumours in the town about what's going on in the camp.

Conditions in the camp are harsh but within the limits prescribed by the rules of war.

7. The Tower: Located a short distance outside town on the hillside, this communications relay provides radio coverage for the whole valley. It was built shortly after the colony was established as a backup but went unused in favour of communications satellites. Now that these satellites have been shot down, the relay is suddenly much more important.

Major NPCs

The inhabitants of Potter's Field can be divided into two groups – the Hillfolk and the CFF occupiers. None of the Hillfolk in the town are active members of the militia but there is some support among the townsfolk for the war on the CFF. The CFF have taken over the government of the town and occupied it but they did this without firing a shot. The militia did not have the resources at that stage of the war to defend what is a backwater – the main action is further west along the valley.

Captain Burton: The commander of the CFF in town. He is in his mid-fifties and is looking forward to retirement. He considers the Hillfolk to be misguided barbarians, held back by their adherence to religion and tradition. He speaks grandly of CFF plans to bring health care and education to the hills. His condescension and mistrust of the Hillfolk make him a poor administrator and he is much too ready to use force where diplomacy would do.

Army, 5 terms 765699
Leadership 1, Tactics (Military) 2, Persuade 1, Carouse 1
Autopistol (3d6-3, Auto 4)

Lieutenant Morten: Morten comes from Hillfolk stock but his parents moved to the cities in search of work when he was young. He still remembers Hillfolk traditions and has the charisma to be a useful ambassador towards the civilian population. His troops have expressed fears that he is too sympathetic towards the Hillfolk and so Morten is overcompensating by being harder on the Hillfolk than he should be.

If Morten can befriend one or more of the characters, then it will make the later parts of the scenario much more interesting... play him as a man in a hard position who doesn't know the right thing to do.

Army, 3 terms 898774
Leadership 2, Tactics (Military) 1, Recon 2, Gun Combat (rifle) 2
Assault Rifle (4d6, AP), Flak Jacket (Armour 6)

In Potter's Field

Lieutenant Belasco: A real rotten apple. Belasco's been bounced around the CFF many times, until he ended up here in this backwater where he cannot do that much harm. He is lazy, undisciplined and interested only in what he can steal on the side. Most of his men are thugs. He comes from a wealthy and influential family, who have covered up his past misdeeds and kept him in the army when he should have been kicked out years ago. Belasco has no special antipathy towards the Hillfolk; he doesn't really like *anyone*.

Army, 2 terms 76A589
Carouse 2, Persuade 1, Melee (brawl) 1, Gun Combat (rifle) 1
Assault Rifle (4d6, AP), Flak Jacket (Armour 6)

Nicole Abnett: The head civilian clerk assigned to the CCF occupation force. A middle-ranking bureaucrat who has no idea of how to survive in a warzone, Abnett is willing and eager to hand over as much responsibility as she can to the mercenaries. 'I was only following orders' would be a point of pride for her.

Citizen, 2 terms 665897
Admin 1, Streetwise 1, Diplomat 1, Advocate 2

Pastor Hunt: The local priest of the Way, Hunt is an old, bitter man who has watched Whetstone slip into moral decay and corruption. The world that God made to test the faithful has birthed a generation of fat, greedy merchants and imperialist warmongers. He is a fervent supporter of the Militia and would be out there fighting if he had the strength. Hunt is a fanatic, but an honest one – he acts as he preaches, as best he can.

Citizen, 6 terms 473797
Persuade 3, Art (oratory) 2, Streetwise 2

Julia Brunner: The voice of the civilian population, elected by the townfolk to bring their concerns to the CFF occupiers. Brunner's primary worry is that the occupation would escalate, turning the CFF against the civilians, if the military start blaming the town for the actions of

the Militia forces in the surrounding hills. She is frustrated by Burton, who mostly ignores her, and by Morten, who refuses to talk to her as he fears it would make him seem too sympathetic to the Hillfolk. She loathes Belasco, and she and Pastor Hunt have never seen eye to eye on anything.

Citizen, 4 terms 555748
Admin 1, Streetwise 2, Diplomat 2, Leadership 1

Karl Jones: The owner of Karl's Place. He claims neutrality as it's better for business but he is secretly sympathetic to the cities – he agrees that the Hillfolk are too hidebound and restricted by tradition. He is easily the richest businessman left in Potter's Field and has his finger in everything.

Citizen, 3 terms 878788
Carouse 2, Persuade 1, Admin 1, Streetwise 2

Miranda Jones: Karl's daughter. She is extremely popular among the young people of the village. She supports the militia and strongly opposes the occupying forces. Karl tries to keep her in check but Miranda's fury at the CFF is growing too strong to be contained.

Citizen, 1 term 596766
Carouse 1, Persuade 2, Stealth 1, Streetwise 1, Gun Combat (pistol) 0
Autopistol (3d6-3, Auto 4)

CCF Trooper: 777665 Army, 1 term
Recon 1, Gun Combat (rifle) 1, Drive 0, Tactics 0, Stealth 0
Assault Rifle (4d6, AP), Flak Jacket (Armour 6)

Militia Soldier: 779644 Army, 2 terms
Recon 2, Gun Combat (rifle) 1, Stealth 2
Rifle (3d6), Flak Jacket (Armour 4)
Some Militia have stolen Assault Rifles or Buzzbombs.

Mission Structure

The mission is divided into seven weeks. The characters arrive at the start of week

one. Several events are suggested for each week; the Referee should use these events as he sees fit, adjusting them for the actions of the Player Characters.

Communication

Maintaining regular communication is a major problem in this scenario. Electromagnetic interference from the upper atmosphere makes long-range radio contact difficult. The mountains block direct laser or microwave communications and Whetstone's underdeveloped hardwire telecommunications network has suffered in the war. If the characters try to contact the regiment by radio, they must make a Comms check, modified as follows:

Random Atmospheric Disruption (Radio only): –1d6. Reroll this twice per week.

No radio tower: –4DM

It is easier to contact the CFF command post down in the valley; as long as the relay is active, there is no need to roll for atmospheric disruption.

Laser communications only work if a friendly unit is within line of sight to serve as a relay. Each week, roll 2d6; on an 11+, there is a friendly unit to provide a laser relay.

Week One Landing

The civilian transport carrying the characters lands at Brooke's Landing. This was a small local spaceport before the war but was one of the first places attacked by the militia. Now it's mostly burned-out buildings but the ferrocrete field itself is still largely intact.

North, south and west of Brooke's Landing are huge mountain ranges. The bulk of the Slammers are several hundred kilometres north and west, on the far side of the mountains. Potter's Field is almost due west.

Elements of K Company are waiting for the characters to arrive. The 'elements' depend on what the PCs have with them. The scenario assumes that the PCs have access

to two combat cars, so if they do not have two combat cars with them on the civilian transport, K company brings two cars with them. At the very least, the K Company elements include:

- **Sgt. Davis**, an engineer and communications technician.
- **Six troopers**, new recruits with powerguns and body armour
- **Four infantry skimmers**
- **Supplies and spare parts** for maintaining and upgrading the relay.

The Truckers

As the characters' gear is being offloaded from the transport, a pair of trucks arrives at Brooke's Landing. They are CCF transports. The lead driver approaches the characters and says that he was told that they were heading for Potter's Field and that his orders are to hand his cargo over to the characters so they can bring it up the narrow mountain roads. The cargo consists of:

- Medical supplies for 100 people – antibiotics, synthetic blood, bandages, disinfectant, painkillers.
- Survival gear for 100 people – tents, winter coats, portable heaters, water purification tablets.
- Meals Ready to Eat – 5,000 self-contained, self-cooking meal packs .
- Two man-portable landmine detectors.
- One remote-controlled bomb disposal robot.
- One set of Mechanical Interrogation equipment.
- Four rolls of barbed wire.
- 36 Kuiper CCRM Assault Rifles.
- 200 boxes of ammunition.

There is no way to fit all the merc's gear *and* all this CCF equipment onto the combat cars. Options are:

- Ignore the CCF request, which will infuriate Captain Barton when they arrive.
- Make several trips, risking damage to a combat car each time. The characters will also have to leave troops behind at Brooke's Landing to guard the cargo.
- Force the CCF trucks to drive up into the mountains.

The Road to the Hills

It takes some six hours to drive from the landing site to Potter's Field, assuming you don't get lost. The road to Potter's Field was once good for a mountain road but it has suffered in the war. In several places, the road is cut into the hillside, so there is a steep climb on one side and a sheer drop on the other. Militia have pushed boulders down into the road in several such locations, forcing the characters to stop and remove the boulder or to gingerly drive past it, often with part of the combat car's skirt going over the edge. In other places, high winds threaten to knock vehicles off the road.

Driving in these difficult conditions require a Drive check for the Poor Roads. If the characters stop to deal with every hazard, instead of trying to navigate them, add another six hours to the journey time. Driving past a hazard requires another Drive check – the hazards count as berms. See the *Hammer's Slammers* rulebook, page 168/169 for details on difficult conditions and hazards.

The characters may try contacting Potter's Field via radio but this proves impossible – the comms tower is not working properly and the signal is too weak to be intelligible. Sergeant Davis promises he can get the comms tower working in a few hours.

Improved Explosive Devices

The militia have planted improved explosive devices in several places. These roadside bombs work like anti-vehicle mines (see page 172 of the *Hammer's Slammers Core Rulebook*) but may apply damage to the vehicle's side instead of its belly. Roll 1d6 for each device encountered – on a 4+, the damage hits the vehicle's side. The 100 armour of a combat car makes it immune to such primitive attacks but the CCF jeeps and trucks are much more vulnerable. On the initial drive to Potter's Field, the characters will encounter only one such roadside bomb but the militia will plant more over the following weeks.

Each week, roll 2d6. On an 8+, a random trip out of the village will run into a roadside

bomb; on an 11 or 12, they run into 1d6 such bombs.

Deserters

About half-way to Potter's Field, the convoy's forward element spots three people walking on the road ahead. They take cover as soon as they notice the approaching vehicles. It could be an ambush, and the characters could easily blast the three unknowns with a powergun barrage. However, it is not an ambush; the three are CCF deserters from Potter's Field, who assumed the convoy was a CCF force. The leader of the three deserters is named Murvick; he and his pals were part of Lieutenant Belasco's unit but got sick of the cold and the wind and decided to head home. All three are suffering from frostbite and exhaustion, and may not survive another long march downhill.

Arrival in Town

The characters' first impressions of Potter's Field vary depending on when they arrive. If they stopped to deal with hazards on the road, they arrive at night.

If arriving by day, the characters are welcomed by the CCF patrols on the streets. The civilians look curiously at the characters' high-tech vehicles and strange uniforms; they seem confused and wary. The characters are greeted ceremoniously by Captain Barton, who assembles his whole staff for inspection and insists on making a short speech in the Window House as he officially places the town's defence in the hands of the mercenaries.

If they arrive by night, it is a much less pleasant introduction. They are challenged by CCF patrols as soon as they approach and one paranoid young trooper even lets off a burst from his rifle (he misses wildly but equally trigger-happy PCs may start something). As soon as the identity of the characters is determined, they are directed to the Window House. Captain Barton is asleep but Belasco and some of his cronies are still awake and drinking in the lower rooms of the Window House. Eventually, Captain Barton will be roused and come downstairs in a foul mood,

In Potter's Field

cursing the mercs for not showing up on time and demanding to know why they did not radio him to tell him they would be late. If they explain that the comm tower is malfunctioning, he responds angrily that he sent his own technicians up to repair the problem hours ago. Pointing out that his own technicians obviously failed does not improve his mood.

Crash Space

Where are the characters going to stay while in town? There are four obvious options:

- **The CCF Base:** There is enough room to station the merc troops, combat cars and equipment in the base but it will be very crowded.
- **The Window House:** There is plenty of room on the upper floors of the mansion, although technically the characters are trespassing on CCF territory if they stay there. The Window House is supposed to be for civilian and officer use only.
- **Karl's Place:** There are some rooms for rent in this establishment. This is ideal for characters who want to get to know the locals but it is also the least secure.
- **Tents:** It's freezing out there. Enjoy.

The characters also need to decide where to station their combat cars and other vehicles.

Defence of the Village

Now that the defence of the village is in the characters' hands, they need to make plans. There is one main road up from the valley below and four smaller roads leading out into the mountains and up to the pastures. The town is surrounded on all four sides by mountains and hillsides. Maintaining law and order is also the characters' problem, although Barton can graciously loan them troops if needed.

Barton introduces the characters to their civilian liaison, Banks. She can fill the characters in on the other personalities in town. Meanwhile, Barton starts preparing

to hunt down the militia in the surrounding countryside.

Technical Sergeant Davis reports that getting the comm tower working again is going to take longer than he thought – he has several choice words to describe the ham-fisted CCF techs that tried and failed to repair it.

Stuck Jeep

Captain Barton contacts the characters. One of the CCF jeeps has run into difficulties some 30 clicks outside town. It will take too long for his heavy earthmover to drive out there and the other jeeps might not have the pulling power to help. A combat car would easily be able to manage the job – can they send one of their vehicles out to help?

Driving along the road requires a Poor Roads driving check; remember to roll for Improved Explosive Devices too. When the characters (or their troops) find the CCF jeep in a gully, they have to rig a tow-rope to drag it out. While doing so, they come under fire from a Militia sniper in the hills. The sniper keeps firing (+1DM to hit, 3d6+3 Super AP damage) until the characters return fire. At this range, it is impossible to tell whether or not the counter-attack hit the sniper and he sneaks away after making his attack.

The Sermon

Pastor Hunt gives a fiery sermon from the pulpit a few days after the mercs arrive, claiming that the CFF are bringing in 'alien butchers' to break the true sons of Whetstone – but just as the blade is sharpened by the rough stone, so too will the Militia be honed to a razor edge by these new foes. All of the Hillfolk NPCs, with the exception of Karl Jones, attend the sermon, as does Lieutenant Morten.

Week 2

Mechanical Problems

The drivers report that the combat cars are having trouble with the cold weather –

their drive fans were not properly adjusted to cope. It isn't *that* cold but there is a small chance that the combat cars might break down if left unadjusted. Making the repairs will take one week per combat car. If the characters decide to risk it and do not adjust the cars, roll 2d6, adding +1 for every week that has elapsed. On a 12+, the car breaks down and takes 1d6 hits to its drive mechanism.

On the bright side, after several days of extensive work, Davis gets the transmitter relay working again. Regimental command is still on the far side of the mountains but the characters can get occasional messages to them when a patrol comes within range or when they bounce messages off the atmosphere. Command orders the characters to make the best of Potter's Field, to defend the town and the relay and to hold until called for.

CFF support

The CFF forces spread out into the countryside, looking for signs of the elusive militia. Over the course of the week, CCF soldiers and jeeps scour the rocky hillsides, searching for the enemy. They run into several IEDs and come under sniper fire a few times but find little of use.

Frustrated with this slow progress, Burton approaches the Player Characters. The mercs have much more firepower than they need – to patrol and defend the town; they need boots on the ground, not combat cars. He, however, could use those combat cars to put the fear of God into the militia. He offers to trade eight soldiers for one combat car – the soldiers will be under merc command and the combat car under his.

If the characters accept this offer, then they will either need to drive the combat car, or else send merc drivers out under the command of one of the Lieutenants. This is a great way to get to know Belasco and Morten but it is less effective at actually finding the militia. The sniper attacks stop after it becomes clear that the rifles have next to no effect on the combat cars and

that computer-aided tribarrel bursts make cover a lot less safe.

If they do not accept the officer, then Burton grumbles and complains that they are supposed to be on the same side and threatens to lodge a protest with the City Fathers. Furthermore, one of his troopers is shot and killed by a sniper a day later. If they had a combat car, that would never have happened.

Drinks in Karl's

In an attempt to welcome the mercenaries to Potter's Field, Karl Jones invites them for dinner and drinks in Karl's place. He also invites Pastor Hunt, Julia Brunner and Nichole Abnett. The obvious subtext is that Karl wants to draw a line under the CFF occupation of Potter's Field. Brunner is cautious but willing to talk. Abnett is terrified of Pastor Hunt, who spends the whole meal staring at the mercs as if he is trying to set fire to them with his mind.

The evening is not helped by Miranda Jones, who deliberately messes up ever order and ends up dumping a plateful of hot goat stew over one of the Player Characters. That is the only time in the whole evening when Pastor Hunt smiles.

A Petition

At the dinner, if it is appropriate, or else the next day, Julia Brunner contacts the characters. Before they arrived, Captain Barton instituted a policy that all civilian vehicles needed a permit to enter Potter's Field. Only a small handful of these permits were ever issued and many of the goat herders and farmers in the upper pastures are complaining that they need to drive to town to pick up vital supplies like fuel, anti-parasite sprays, spare parts and feedstock. Will the characters either cancel the need for permits or issue more?

Abnett warns the characters that Barton worried about militia using civilian vehicles as cover – they could be smuggling weapons or explosives, or even drive a car bomb up to the CFF base and wipe it out. She recommends not changing the policy.

Fire in the Sky

A high-flying CFF drone is shot down by a powergun blast from somewhere in the mountains. The wreckage crashes near Potter's Field. This event has nothing to do with the characters but will remind the players of the difficulties in using flying machines or satellites in the *Slammers* universe – the unlimited range of the powergun makes anything that goes above the horizon very vulnerable.

Week 3

Drinks in Karl's II

Lieutenant Belasco and his men come into town to drink at Karl's place. Things rapidly get rowdy, as the CFF troopers pick on off-duty mercs and Hillfolk. They're obviously spoiling for a fight to work out their frustrations over the failure to find the militia. A huge brawl starts in Karl's place.

How heavily do the characters come down on the combatants? Do they send in armed troopers to break things up, or do they let the fight blow itself out. If they break up the fight, who do they arrest? Belasco blames the Hillfolk for starting the fight, just like they started the war. If they don't break up the fight, someone gets severely injured – roll 1d6 to see who (1–3 Hillfolk, 4–5 CFF, 6 Mercenary).

Allegations of Rape

Two days after the brawl at Karl's, Miranda Jones arrives at the Window House with another girl, who she introduces as Gwen. With constant prompting and reassurance from Miranda, Gwen tearfully tells her story. She was walking home at night near Karl's place when she was confronted by a CFF trooper, who raped her at gunpoint.

A medical examination of Gwen confirms that she had violent penetrative sex recently but it cannot be proven if it was forced or just rough. There is no bruising that might suggest she was restrained but if she was threatened at gunpoint, she presumably did not struggle overly with her attacker. She does not know the name of the CFF trooper but might be able to recognise him if she saw a photo.

The characters do not have the equipment for a full forensic investigation but they could send samples off to Jacob's Ford – it would take a day to drive there and a day to drive back, as well as 1d3 days for the tests.

A Streetwise roll picks up some rumours:

- Gwen has slept with several of the CFF troopers in the past. Because of this, she is ostracised as a collaborator by many in Potter's Field.
- Someone remembers seeing a CFF trooper having a loud, drunken argument with a girl near Karl's place. The girl could have been Gwen.
- Gwen was seen at Pastor Hunt's house yesterday. If the PCs contact the Pastor, he tells them that Gwen showed up at his door after the attack, terrified out of her wits and tearful. He contacted Miranda Jones for help. He did not advise the girl to go to the authorities, as he believes the occupying forces will just protect their own.

If the characters show Gwen photos of the CFF troopers or bring her to the base, she eventually identifies a man named Anton as her attacker. Anton – one of Belasco's men but a good soldier – remembers being in Karl's place, being served drinks by Miranda... then it's all a blur. He was incredibly hung-over the next day and his sidearm is missing (he wanted to leave it back in base but Lieutenant Belasco told all the men to carry weapons, just in case they were attacked by Hillfolk).

If no-one else suggests it, then a bitter-sounding Lieutenant Morten suggests an alternate possibility – Anton's drink was spiked so he would not remember having sex with Gwen; Miranda and Pastor Hunt then came up with the story of a rape to discredit the CFF.

Rumours of an attack on a girl spread quickly through Potter's Field. Unless the characters are seen to be taking action, public sentiment against the occupiers grows; another Trooper is attacked during the week by a gang of youths.

In Potter's Field

Siege

Towards the end of the week, gunfire is seen in the hills above the village. Barton contacts the characters – his men have located a Militia cell in an outlying farmstead. The CFF are visiting all the farmsteads in turn; Lieutenant Morten spotted something odd when interviewing Varley, the owner of the farmstead – the trapdoor to the cellar was partially open, as if someone was listening to the conversation from below. He fled but one CFF trooper, Kerley, was unable to escape and was taken hostage. The farmer and his family are also said to be hostages but Morten believes they are Militia sympathisers.

There are at least half-a-dozen Militia soldiers and they have a lot of firepower – most of them just have flechette rifles but they also have at least one powergun and a few of buzzbombs. The initial CFF attack on the farmstead ended with two dead CFF troopers and one fragged combat jeep.

Barton wants the mercs to lend support with their heavier armour and combat cars. If they present overwhelming force, then maybe the Militia will give themselves up and spare the hostages.

The farmstead consists of one large central building and half-a-dozen outhouses. Some of the outhouses are linked by hidden tunnels to the basement of the main house (this is not uncommon in Whetstone society, as staying underground keeps you out of the constant wind). All the buildings are made of solid stone and present a formidable challenge to any attempt to storm the place quickly.

The leader of the Militia cell refuses to give his name, preferring to refer to himself as Alpha (but village rumour soon identifies him as Gerrit Mitchell from the town of Westwood, further up the valley). He will not surrender to the 'CFF tyrants', and claims that any attempt to attack the farmstead will result in many deaths – the hillsides will run red with blood. He demands that they supply him with a pair of jeeps so he and his men can leave. He will take Trooper Kerley with him as a hostage and leave

one of the jeeps with Kerley. Any attempt to interfere with this plan will result in Kerley's death and the deaths of other hostages and CFF.

Barton suggests that the best plan would be to stall by pretending to get the jeeps until he has assembled all the CFF and merc troops in Potter's Field, then using a powergun barrage to blow open the farmhouse and storming the place through the breach. The PCs may come up with a better plan.

If they do give the jeeps to the militia, then 'Alpha' loads all the weapons and supplies into the jeeps and drives off with his five soldiers and Kerley. They head up a goat path and vanish into the wilderness. The burnt-out jeeps are found later by a patrol. A burned corpse lies in the back seat of one vehicle, identifiable by dental records as Private Kerley of the CFF.

If the PCs manage to capture the Militia alive, or force them to surrender, then Barton asks that they be held in the camp outside town. Do the PCs want to hand their prisoners over to the CFF?

A Great Success

Searching the cellar of the farmstead reveals that the Militia were storing weapons there. Most of the weapons were removed weeks before the siege – it looks like the powergun and buzzbombs were the last of the heavy weapons here. Presumably, with the CFF takeover of Potter's Field, the Hillfolk Militia decided that this hiding place was too risky and decided to move their cache. Barton hails this as a great success – they have the enemy on the run!

Week 4 Sniper!

Shots ring out in the early morning from the hillside just above the town. The sniper is back and he is closer than ever. His initial attack kills Nichole Abnett when she steps outside the Window House to catch a breath of morning air. Until he is caught, the sniper continues to fire on

anyone within view who is wearing a CFF or merc uniform.

The sniper, an ex-Militia madman named Marsh, is equipped with a TL8 Sniper rifle (3d6+3 Super AP damage). He is at Very Long range (-2 to hit) but has a Gun Combat (slug rifle) skill of 3 and a Dexterity DM of +2, giving him a +3DM to hit with his attacks. He knows the terrain very well and is wearing a camouflage suit that hides his heat signature and helps him blend in with the hillside. He moves after every two or three shots. He also has a pocketful of frag grenades that he will use on anyone who gets too close.

Marsh: Army, 4 terms Recon 3, Gun Combat (rifle) 3, Stealth 2
Sniper Rifle (3d6+3, Super AP), Ghillie Suit (Armour 2, +1DM to stealth checks)

Supply Shortages

Shops in the village begin to run out of vital supplies. There is still all the goat meat you can eat, but bread, vegetables, salt and other ingredients are running short, as is motor fuel, heating oil and some machine parts. A supply convoy that was supposed to arrive two days ago is late. Eventually, news reaches Potter's Field that the Militia intercepted the trucks and stole most of the supplies.

Brunner asks the characters if they can escort the next supply convoy. It means sending a combat car down into the valley to the next big town, then escorting the truck back. It will take the best part of a week.

Interrogation

With the discovery of the old weapons cache in the farmstead, Captain Burton is convinced that the Militia must be stockpiling weapons higher up in the mountains and he is determined to find it. His men have captured several Militia members – one of them must know something about the second cache.

Did the characters bring the Mechanical Interrogation kit up from the landing site

way back in Week One? If so, then they can use that to 'painlessly' extract the information from the prisoners. Otherwise, Belasco promises to beat it out of them.

If the characters go for the latter option, then tales of torture and brutality in the camp quickly spread through the town. Pastor Hunt's next sermon is a searing indictment of the CFF, claiming that they are 'raping and torturing civilians not a stone's throw from this very church'. A mob, led by Miranda Jones, assembles outside the church that night and marches on the CFF base, throwing stones and shouting abuse. Unless stopped, they move onto the prisoner camp, again hurling stones and in some cases attempting to scale the fence. The mob stops short of actually breaching security.

Belasco can get the required information out of the prisoners but at a terrible cost. Two of the prisoners die under interrogation.

If the characters use Mechanical Interrogation, then one character gets to put on the neural interface helmet and read the mind of one of the captured Militia. The neural interface experience is a nightmarish one, putting the Player Character in the body of a scared, confused young goat herder who has no real idea why he is fighting. Soldiers came to his mountain village one day and conscripted him and all his friends into the Militia; they gave him a gun and told him that the lowlanders were going to sell all the Hillfolk into slavery, or feed them to devils, or make them live in slums in the cities. The stories of *why* they were fighting changed but always there was the threat of death if he tried to run or betrayed Militia secrets to the enemy.

In the vision, the young Militiaman is in the village of Westwood, further up the valley from Potter's Field. The village is crawling with armed Hillfolk as well as civilians; the whole place is surrounded by mines, explosive devices and concealed bunkers. Under the village is a warren of tunnels, stocked with supplies for a major push

into the valley, possibly as a precursor to an attack on Jacobsford itself.

Tactical Decisions

If the characters share this information with Captain Burton, he decides that Westwood is too heavily defended for his small command to deal with. He decides that the best thing to do is to pass it up the chain to CFF command and let them deal with it. Lieutenant Morten looks aghast at that – the most likely response from CFF command is that they will blast Westwood into cinders with an artillery strike. The CFF massively outguns the Militia; if the Militia sit still, they can easily be pounded into submission.

This will, unfortunately, kill everyone in Westwood. Burton admits that there will be civilian casualties but anyone in Westwood is certain to be a Hillfolk sympathiser if not actively part of the Militia. It's the City Fathers' decision, ultimately. He dispatches a scout team up to Westwood to gather tactical data while he prepares a report for command.

The artillery strike will be called in at the beginning of next week.

Powerdown

During the night, the power cable connecting the town to the hydroelectric generator down in the valley is cut. The town has backup generators for its own needs – but the communications relay has no such secondary power source. As long as the relay is without power, Potter's Field cannot communicate with command and the artillery strike cannot be called in.

Finding the breach will take several hours, perhaps days, and the technicians examining the line will be vulnerable to Militia snipers or guerrillas. Sergeant Davis says that he could connect a combat car or maybe a jeep up to the relay's power systems but that the best approach is to either fix the power cable or take a generator from the village.

Investigating who cut the power cable turns up one obvious suspect – Lieutenant

Morten. He left the base during the night, and has the technical skills to accomplish it. If challenged, Morten claims that it could just as easily have been Hillfolk saboteurs. Either way, the characters have a choice whether or not to reactivate the relay and allow Burton to call in the artillery strike.

If Morten has befriended one of the characters, then he confesses that he did indeed cut the power cable – he does not want to be a party to more civilian deaths.

The Fate of Westwood

The rest of this scenario assumes that Burton calls in an artillery strike (see *Burning Westwood*). If the characters want to avoid this, then their only options are either keeping the communications relay offline or dealing with the weapons cache in Westwood some other way. Westwood is very heavily defended, so unless the characters can get their hands on a supertank or come up with an astonishingly clever plan that is quite outside the reach of this scenario, they will not be able to deal with Westwood themselves.

Week 5

Burning Westwood

Unless the characters managed to stop it, the artillery strike on Westwood hits during the night at the start of Week 5. Shells arc over the valley from the far side of the mountains, burning through the clouds and falling onto Westwood. The high winds endemic to Whetstone make artillery fire notoriously inaccurate, so the CFF compensates by firing a lot more ordnance than is needed to destroy the target. Westwood is destroyed, along with half the mountainside around it. The destruction lights up the night and wakes everyone in town.

Crowds gather in the snowy streets to watch the fire rain down on Westwood.

Panic on the Streets

As the crowds grow, so too do their concerns. All sorts of rumours fly through

In Potter's Field

the crowd – the CFF is bombing other villages; the planet's under attack from space; those are nuclear shells; it's a Militia base that contained so many explosives that they are all exploding at once, not an attack; but the rumour that takes hold is that the CFF bombed Westwood because one of the captured Militia came from there.

This time, the mob won't stop at the fence. They are howling for blood and want all prisoners in the camp freed immediately. Worse, Lieutenant Morten is unwilling to intercede, so unless the characters act, the defence of the camp will be left up to Lieutenant Belasco, who has no hesitation about ordering his troops to fire into the crowd.

Killer In The Night

Miranda Jones has the sidearm lost by Anton back in Week 3. The attack on Westwood made something within her turn cold and hard, turned her from a stridently vocal supporter of the Militia into something much more dangerous. She now wants revenge on those responsible for the attack – and the Player Characters are among her targets.

Her plan is a simple one. She will wait until one of the Player Characters visits Karl's Place. She will engage the character in conversation, ostensibly about the attack on Westwood. She will let the character persuade her; she will flirt with him and hope he takes her back to the PCs' living quarters. She will then shoot him with a CFF firearm. If she can blame the attack on Belasco or another CFFer, all the better but she is not thinking that far ahead. She just wants to hurt someone.

Assuming her target survives, the characters must decide what to do with Miranda. Arresting her will turn one of their few allies against them. Barton suggests that she be interned in the prisoner camp with the rest.

Week 6 Hurricane

The characters receive a weather update from CFF command. They are expecting a strong hurricane to come blowing up the valley, with estimated wind speeds in excess of 150kph. They are ordered to make any necessary preparations and to warn the civilians to prepare for high winds.

The civilians are already making the town secure. They know the mountain weather. They call such times Sword Winds, as the wind can cut through you like a blade. Potter's Field is as well prepared as any place can be for such a storm.

The characters have three decisions to make:

- What do they do about maintaining defences during the hurricane? Only a madman would attack during such a storm but, as that sniper proved, some of the Militia are crazy...
- What do they do about the prisoner camp? The CFF base is barely adequate shelter but the prisoner tents will never survive a wind of this intensity. The prisoners must be moved – but to where?
- What do they do about the communications relay? Sergeant Davis points out that the tower is old and in poor condition. He recommends taking the transmitter equipment down before the winds grow too intense – it means the transmitter will be offline for a few days but that it is certain to survive the winds.

There are no attacks during the storm; the Militia are not that crazy.

The prisoners can be moved to any location in town, under heavy guard. This is the first time that the characters have really seen all the captured prisoners in one place and there are surprisingly few of them. There were four prisoners when they arrived and after more than a month of constant patrols and hunting, Barton has only added another five to the total (See *The Graves*).

The relay tower collapses at the height of the storm. The old structure, built in the early days of the Whetstone colony, has had enough. Perhaps seismic disturbances from the shelling of Westwood have something to do with it, or maybe it was just the never-ending winds. Whatever the reason, the tower falls.

After The Storm

Captain Barton is furious if the relay is destroyed – he was in regular communication with his superiors through the relay and needs to get back in touch as soon as possible. He demands the use of a combat car to get him to somewhere where he can contact CFF command via laser communicator. If the relay was saved, then he demands that they get it back up and running as soon as possible – the spire of the church in town is tall enough to serve as a replacement.

Trampling On God

Pastor Hunt categorically refuses to allow the characters to install the communications relay on the church spire. He would sooner die than let any of the unclean invaders step into the House of God! He is an old man and easily overpowered but that will turn the Hillfolk completely against the characters.

If the characters hesitate, then see *Secret Briefing*.

Secret Briefing

Barton only reveals this secret at this point only if either

- He trusts the Player Characters completely
or
- The comm relay is still intact but they are hesitant about seizing the church spire

Barton informs the mercs that CFF Intelligence believes that the Militia are going to make a push down the valley, despite the loss of Westwood. They will attempt to seize Potter's Field in the next few days. The CFF are going to abandon

the town, along with any civilians loyal to the legitimate government. Anyone who remains in the town will be treated as an enemy combatant and the town will likely suffer the same fate as Westwood. Barton needs the comm relay operational so he can confirm that the CFF are still planning to retreat from Potter's Field.

The Graves

In the aftermath of the hurricane, a small landslide causes earth to shift near the prisoner camp, revealing a dozen recently buried bodies. They are all wrapped in plastic. These are the bodies of Militia soldiers who died in prison, thanks to Belasco's brutal treatment of them. Some were beaten to death; others shot, others died of exposure. Even Barton is shocked by this but Belasco just shrugged. *'You told me to take care of the problem. You didn't ask how.'*

Any credibility that the CFF still retained in the town is utterly destroyed if the characters reveal the existence of the mass grave. If Morten has befriended any of the PCs, he suggests darkly that Barton may be planning to erase any evidence of mistreatment of prisoners under his command by allowing Potter's Field to be shelled like Westwood.

Week 7

Rumours of Attack

The mountains are eerily quiet after the fury of the hurricane. There are no partisan attacks, no roadside bombs, no snipers. The CCF patrols pull back to the town but the last patrol reports rumours of Militia tanks moving along the mountain roads. Driving a tank along these incredibly narrow mountain paths takes tremendous skill.

Word spreads through the town; some, like Pastor Hunt, welcome the news but most people are scared. They may be more sympathetic towards the Militia than the City Father Forces but any prospect of fighting near the town is alarming. There are stories that some of the more

extreme Militia groups are known to purge 'unbelievers' and 'collaborators' and that anyone who has had contact with lowlanders is a suspect in their eyes.

Brunner approaches the characters, asking if they have heard anything about a Militia attack and if they are still going to defend the town. She refuses to take no for an answer – the presence of heavily armed mercs may be all that is holding Potter's Field together.

Pulling Out

The CFF prepare to depart. Barton contacts the characters, informing them of a change to their orders. Both CFF and mercenary units are abandoning the town. Radio interference makes it very difficult to contact the mercenary regiment for confirmation of these orders – the characters might be able to contact the regiment later if atmospheric conditions improve.

Morten's Conscience

Just before the CFF leaves, Morten resigns from the military. He has had enough of the CFF's mishandling of the whole war and he despises Barton for being willing to sacrifice Potter's Field. He turns to the characters for aid. This speech is the crux of the whole scenario, so make it a dramatic confrontation.

'They're going to wipe out this town, the same way they destroyed Westwood. No-one gives a damn any more. Bastards, all of them. It's cop, all of it.'

'Look, the one thing the City Fathers still respect is power. They need you mercs, with your tanks and your powerguns. They wouldn't dare hit the town if you were still here. I know we can't beat the Militia if they really try to take Potter's Field, but just by being here when they come, you can stop the CFF from using their artillery.'

'Stay. I don't know if the Militia will kill us or not if we surrender, but it'll keep the town alive either way.'

Morten is gambling that the presence of the mercenaries will keep the CFF from shelling Potter's Field. There is no way of knowing what will happen when the Militia capture the town – the Militia might take prisoners, or Morten and the PCs might end up in that mass grave outside town. However, as long as the fate of the mercenaries is unknown, Morten believes the CFF will hold off on any artillery attacks. Leaving Potter's Field in the hands of the Militia is less damaging to the CFF than losing the mercenaries by killing the PCs with an artillery strike.

Heroic and self-sacrificing as Morten's suggestion is, the Player Characters may have other ideas.

Contacting The Regiment

If the characters manage to contact their regiment, either through the comm relay or by another message, they can speak to their commanding officer (assumed to be Colonel Hammer). The colonel has a hard choice for the characters.

'I can confirm that the CFF have ordered all mercenary units to withdraw from Potter's Field. They have not informed us of any plans to shell the town, but I think your man Morten has the right of it. Cop.'

Listen – I won't order you to stay.

If you want to be safe, you pull out now with the rest of the CFF.

If, however, your combat cars suffer a 'breakdown' and you have to stay, then I'll do my best to keep you alive. I can bring D company up into the Witchfell Peaks. From there, they'll be able to give you direct fire support. The bad news is that I don't know how long it will take D company to find a path up to the peaks. You'll have to hold until they get there, and by then, it might be too late.

It's your call.'

So, do the characters stay? If they leave, then the CFF will annihilate Potter's Field as soon as the Militia take it. If they stay, then they will have to battle a superior force until the Slammers' tanks are in position.

If they leave...

If the characters do leave Potter's Field, then the CFF waits until the Militia enter the town and then launch an artillery strike. Fire rains down, annihilating everything and everyone in Potter's Field. The mercenary units contracted to the CFF will lodge a complaint, the Bonding Commission will investigate and in four year's time Captain Barton will be the scapegoat for the City Father's war crimes but all that is far in the future and is cold comfort to the dead.

The Attack

If the characters stay, they face the Militia attack.

The forces attacking Potter's Field consist of three Thysenn-F Colonial Light Tanks (see page 138 of *Hammer's Slammers*), together with some three dozen infantry

in light jeeps or on foot. One in six of the infantry carries a buzzbomb in addition to his standard rifle. There is little scope for manoeuvre on either side, as the ground is too steep to go offroad safely.

The commander of the Militia is named Daniel Hunt – he is a nephew of Pastor Hunt. From his tank, he announces that Potter's Field is under Militia control and that all mercenary or CFF units in town should lay down their weapons and surrender and that they will be treated honourably if they have acted honourably.

Do the characters surrender? If they do, then Hunt's treatment of them depends on the opinion of the townsfolk, especially Pastor Hunt. If the characters tried to keep the peace and treated the Hillfolk fairly, then they will be taken prisoner and ransomed back to their mercenary commanders at the end of the war (or you can run another scenario where the PCs have to escape from the Militia). If they treated the Hillfolk badly, then the best they can expect is a bullet in the back of the head and a shallow grave.

If they do not surrender, they must fight. Hunt's tactics are simple – his three tanks approach the town along the road, firing at any visible targets. His infantry then sweep around and take out any vehicles with buzzbombs. With restricted manoeuvrability, the characters will likely be stuck between the tanks and the infantry.

To survive, the characters need to stall the Militia advance. Trickery, clever tactics and traps can help with this. Each round of combat (or every few minutes, out of combat, if the characters try diplomacy or trickery) roll 2d6, with a +1 DM for each previous roll. On a 12+, D company has arrived in position and can bring their powerguns to bear on the enemy.

If D company comes through, the tide of battle changes in an instant. Cerulean blue bolts of death lance from the far side of the valley, blasting the light tanks into cinders. Overwhelmed, the Militia infantry break and flee. With the Militia in the valley broken, there is no reason for the CFF to shell the town. Potter's Field is safe.

The Whetstone War

If you want to expand this scenario into a full war, then the factions are as follows:

City Fathers (Attackers): 11, Planetary Capital

Hillfolk Militia (Defenders): 9, Difficult Terrain, Dug In





PARANOIA™

Troubleshooters

Bad things happen if you don't buy it!

MONGOOSE PUBLISHING

www.mongoosepublishing.com



Bazyl's Bill of Brawlers

By Loren Dean

City folk watch the processions with rapt interest: gaudy, party-coloured wagons and pennants in caravan, forming a circle on the outskirts of town, tents springing forth like enormous vibrant flowers. Excitement's in the air, the sire song of coming entertainment distracting children from their chores. When a carnival comes to town, everyone turns out for the good time. The performers are exotic, beautiful and dapper and the polished ringmaster hawks sights and sounds to beggar the imagination.

Yet there is a dark mirror of this festivity, another procession not so colourful, where the boisterous carnival is pressed aside by the rough belligerence of desperate pit fights. Still come the carts and wagons to the edge of town but instead of a tent, an amphitheatre magically rises from the earth, the space within cleared of cover and concealment. Colourful barkers are absent; no announcements are made aloud but whispers spread about the arrival. Mothers warn their children to keep well away, watching sadly as their husbands head out for less festive entertainments. The gladiators have arrived, you see and there will be blood tonight.

This article, prepared for the burgeoning Fantasy Craft GM, presents Bazyl's Bill of Brawler, a crew that can offer your heroes challenge, enmity or even a strange and specialised set of contacts. Read on, if you think you can handle the pain.

The Brawlers are a corrupt and violent gladiatorial ring that you can add to any setting or backdrop. They set up near cities, towns and thoroughfares – anywhere coin's to be had. They arrange fights between their champions and local takers and participate in a number of illicit related activities including drug and human trafficking, prostitution and worse.

Bazyl himself is a wily drake, with a circle of close cohorts to help run the show. His right hand (on several levels) is long-time associate Casdon Basette, a pech with a

sinister air and a talent for numbers. Helping them are Anta Mandrake, a sly recruiter of fresh meat for the ring, and Frida, a dour apothecary of flexible morality who keeps the ring's champions (reasonably) healthy.

The Brawlers arrive with little fanfare. Bazyl's cronies are quite adept at spreading word of mouth, which lets the crew promise anything without needing to deliver the same. First, Casdon shape shifts into a child of the area, befriends some locals his perceived age and talks about the "big fellas" and their wagons parked outside town. Having trouble with secrets, the children tell their friends – and more importantly their parents. A day or two later, Anta enters town and starts glad-handing, buying drinks, complimenting the locals on their "obvious physical prowess," and suggesting they try their might to "earn some extra coin." Takers are brought to the camp to meet Bazyl, who uses his spells and hypnotic gaze to make sure they sign up to fight.

Bazyl also spearheads the building of the arena, casting Move Earth to dig the ring and form a mounded circle around it. He takes his time, as anyone spying on the encampment is bound to spot him and his spells, leading to even more rumours, excitement and visitors when the Brawlers open for business.

Fight night is always a spectacle. Bazyl's a skilled master of ceremonies and easily keeps the crowd on the edge of their seats through fight card after fight card. Casdon runs the betting wagon, to which Anta drives traffic between hawking souvenirs and anything else she can sell.

The Brawlers maintain a stable of up and coming gladiators and stage a variety of scenarios and match-ups, from simple one-on-one or even team-on-team confrontations to king-of-the-hill events (uneven sides, with the smaller number occupying a central spot in the ring) to baiting (a single large creature or animal, usually tethered and made to fight off a

crowd of attackers). Events are sometimes declared "first blood," "last man standing," or "to the death," depending on Bazyl's gauge of the crowd's mood and the fighters' willingness.

Main events are held for late in the evening and feature the Brawlers' top gladiators. They are pitched to upcoming fighters as "a shot at greatness" to overcome anxiety about facing such impressive opponents and every trick at the crew's disposal is used to secure a thrilling line-up. By this point the crowd is often near a frenzy, so betting runs fast and furious for these events, which are almost always fought to the death.

When the last blood is shed and the crowd has gone home, Casdon and Bazyl count the money while Anta and Frida see to the surviving champions. Frida patches wounds (saving blood when she can as a favour to Casdon) and Anta congratulates the winners. The fighters get a small cut of the gate coin and wagers and the process repeats for as many nights as contenders sign up. Promising locals are sometimes offered the chance to travel with the Brawlers as professional pit fighters, though there are a number of hidden pitfalls accompany such offers (as discussed later).

Trouble can visit the arena in a variety of ways. The local law might decide that blood sports are not in the best interest of the community, sending one or more officials to roust the Brawlers. Bazyl (or Casdon, or Anta) can generally bring such officials around to their way of thinking, though it is often enough to make them consider moving on early.

Also, relatives or associates of former or current gladiators (or local challengers) may come around looking for payback (against Bazyl or one of the fighters) or to rescue their loved one. Of course, those looking for trouble at the arena often find it and many do not live long enough to warn others.

Bazyl

"Roll up, good people: see, and thrill! I give you ... the Gladiators!"

Bazyl is a drake with deep crimson scales, tinged with black. He wears a massive amount of jewellery (rings, bracelets, a thick, gold rope necklace and several ostentatious piercings in the delicate leather of his wingtips and earflaps) and he is roguishly attractive, even to non-drakes. He spent his formative years in travelling carnivals but quickly branched into much more lucrative gladiatorial events.

A criminal to the core, Bazyl has no real morality. He does what is best for him – and while he will not admit it, he is quite willing to sacrifice any or all of his crew if it means he lives to profit another day. This also makes him quite amenable to enslaving others, as fighters or in any other capacity that makes him more coin.

Bazyl (Large Beast Flyer — 112 XP): Str 14, Dex 16, Con 10, Int 10, Wis 10, Cha 10; SZ M (1x1, Reach 1); Spd 40 ft. winged flight, 30 ft. ground; Init IV; Atk V; Def II; Res II; Health II; Comp IV; Skills: Bluff IX, Impress V, Sense Motive VI, Spellcasting VI (Spells: Charm Person III, Invisibility, Move Earth, Quench, Tongues I, Unseen Servant); Qualities: *Attractive I, cagey II, class ability (Assassin: cold read I; Burglar: he did it!; Courtier: master plan I), condition immunity (fixated, frightened), feat (Agile Flyer, Hidden Spells, Repartee Basics, Repartee Mastery, Repartee Supremacy)*

Attacks/Weapons: Fire Breath (fire damage attack II: 20 ft. beam; dmg 1d6 fire per 2 TL, Ref DC 15 for 1/2 damage), Bite II (dmg 1d10 lethal; threat 17–20), Claw III (dmg 2d8 lethal; threat 19–20), Hypnotic Domination (baffling attack III: Will DC 20 or baffled for 1d6 rounds, upgrades: gaze)

Gear: Booze (1 use), concentrated knockout poison (3 uses)

Treasure: 2C, 2L, 1T

Casdon Basette

"Psst! C'mere, lemme show you something..."

Ticket seller, accountant, bookmaker, vampire – Casdon is all these things. A pech con artist, he died and rose again over a century ago when he tried (and failed) to swindle the wrong mark. He has been drifting with Bazyl for decades and it is a good fit: he is easily as amoral as the drake and arguably more dangerous. For now he is content in the Bazyl's shadow – after all, so long as the Brawlers stay in business, there is always a supply of fresh blood.

Despite his combat prowess, Casdon prefers to avoid fights if he can help it, relying on his array of vampiric abilities (especially his beguiling and shape shifting) to escape tense situations. He also has an unhealthy (most would say twisted) attraction to children. He loves to take a child's form to spread rumours of the crew's arrival in town – it feeds his superiority over weak living creatures. And if one of the children he talks to never makes it home, well, he doesn't know anything about that.

Fantasy Craft lets the GM build any monster he wants, allowing endless variation. By example, Casdon has some of a vampire's common weaknesses but none of the lethal vulnerabilities. He dislikes sunlight and suffers a variety of penalties when exposed to it but does not burst into flame. He does not sleep in a coffin and is not any more vulnerable to a stake in the heart than your average commoner. He actually rather likes garlic, especially when it is mashed and spread on toast.

Casdon Basette (Small Folk Undead Walker — 100 XP): Str 12, Dex 12, Con 10, Int 10, Wis 12, Cha 12; SZ M (1x1, Reach 1); Spd 30 ft. ground; Init IV; Atk II; Def IV; Res II; Health V; Comp IV; Skills: Bluff IX, Impress V, Sense Motive V; Qualities: *Achilles heel (divine, fire, flash), attractive I, beguiling, class ability (Assassin: cold read I; Burglar: he did it!; Courtier: Master Plan I), damage defiance*

(cold), damage reduction 3, darkvision II, fast healing, feat (*Darting Weapon*), killing conversion, light-sensitive, nocturnal, shapeshifter I, superior climber II

Attacks/Weapons: Bite V (dmg 3d6 lethal, threat 16–20), Drain Blood (life draining attack II: Fort DC 15 or suffer 1 lethal damage per TL, Casdon healing the same amount, upgrades: supernatural attack (bite)), Sap (dmg 1d6 subdual; threat 19–20; qualities: *finesse*)

Mounts and Vehicles: Coach (Spd 20 ft. ground (Run 40 ft.); Travel 4; SZ/Def L/9)

Gear: Booze (1 use), concentrated knockout poison (3 uses)

Treasure: 2C, 2L

Anta Mandrake

"Of course it's legal."

Bazyl calls Anta his "facilitator," as it falls to him to drum up business and find new gladiators. Anta is here for the money. He makes large quantities of coin, operating on commission for Bazyl and will not hesitate to vanish the moment the money stops flowing.

Handsome in an oily, worldly way, Anta is every lady's chivalrous paramour, every gentleman's backslapping drinking cohort, and every peasant's chance at the opportunity of a lifetime. He can function in high society and low, and recruits gladiators from both to fight and die in Bazyl's arenas.

He is also a bit of a coward but he covers it well. In a confrontation, he always backs down gracefully, though he later pays one of the Brawlers to "take care of" the problem.

Anta Mandrake (Medium Folk Walker — 50 XP): Str 10, Dex 14, Con 10, Int 10, Wis 10, Cha 14; SZ M (1x1, Reach 1); Spd 30 ft. ground; Init IV; Atk II; Def II; Res II; Health

Bazyl's Bill of Brawlers

II; Comp IV; Skills: Bluff IX, Impress V, Sense Motive VII; Qualities: *Attractive I, class ability (Assassin: cold read I; Burglar: he did it!)*

Attacks/Weapons: Sap (dmg 1d6 subdual; threat 19–20; qualities: *finesse*)

Mounts and Vehicles: Coach (Spd 20 ft. ground (Run 40 ft.); Travel 4; SZ/Def L/9)

Gear: Booze (1 use), concentrated knockout poison (3 uses)

Treasure: 1C, 2L

Frida

"Quit your squirming — I can't keep the stitches straight."

The Brawlers' cook and healer, Frida is a stout, homely woman. She has also got a mean streak, smiling at others' pain even as she bandages them. The Brawlers appreciate her skills but few are friendly with her. She stays because she was never much good at healing regular people — she is just too standoffish. Bazyl's gladiators, on the other hand, are glad for her skills and Bazyl sees that she is well paid in both coin and amusement.

Frida is mean to the core and does not mind a good scrap but is not a skilled fighter.

Frida (Medium Folk Walker — 36 XP): Str 10, Dex 10, Con 10, Int 10, Wis 10, Cha 10; SZ M (1×1, Reach 1); Spd 30 ft. ground; Init I; Atk I; Def IV; Res III; Health III; Comp III; Skills: Crafting IV, Medicine VI, Resolve IV; Qualities: *Expertise (Medicine), feat (Alchemy Basics, Bandage, Basic Skill Mastery (Healer))*

Attacks/Weapons: None

Mounts and Vehicles: Cart (Spd 20 ft. ground (Run 40 ft.); Travel 2; SZ/Def L/9)

Gear: Bandages (10), chemist's kit, doctor's bag

Treasure: 1C, 1M

Gladiators

"We who are about to die salute you!"

Most arena contestants are low-end pit fighters trying to take their shot or press-ganged thugs with no hope for the future. Bazyl usually keeps a dozen or more of these sorry souls on hand to stoke the audience before a night's big matches. He keeps them well supplied with booze and suppresses their non-combat instincts with magic. Every now and again, when one shows promise, Bazyl cuts the fighter in legitimately, elevating him to the ranks of the elite. Most however are fated to die, messily, at the hands of the Brawler's champions, to the roar of a bloodthirsty crowd.

Gladiators (Medium Folk Walkers — 36 XP): Str 10, Dex 10, Con 10, Int 10, Wis 10, Cha 10; SZ M (1×1, Reach 1); Spd 30 ft. ground; Init IV; Atk IV; Def III; Res II; Health IV; Comp I; Skills: Athletics III, Intimidate III, Notice III, Tactics III; Qualities: *Class ability (Soldier: rugged weapons), feat (All-Out Attack, Combat Instincts)*

Attacks/Weapons: Glaive (dmg 1d8 lethal; threat 19–20; qualities: *keen 4, reach +1*), metal shield (dmg 1d4+2 subdual; threat 20; qualities: *guard +2*), short sword (dmg 1d8 lethal; threat 19–20; qualities: *keen 4*)

Mounts and Vehicles: Cart (Spd 20 ft. ground (Run 40 ft.); Travel 2; SZ/Def L/9)

Gear: Partial chainmail with light fittings (DR 3, Resist Edged 2; DP -1; ACP -1; Spd -5 ft.; Disguise -8)

Treasure: 1C

Gwetha (Champion)

"Stay down. I don't want to have to kill you."

A lithe saurian, Gwetha is always in motion. He bounces and bounds, pulls and sheathes knives, flips coins — anything not to keep still. He got started on the road as a carnival acrobat and knife-thrower but

accidentally killed a spectator. Bazyl took him in and shielded him from the law and he has been fighting for the drake ever since. Thanks in large part to Bazyl's magical persuasion, Gwetha is convinced that the arena is his last chance, so he fights every night, without hope of a normal life.

Gwetha is the champion most called upon to engage in non-lethal tests of skill (balance, footraces and the like). When he does fight, his specialty is "Last Man Standing" events, where he can win by wearing his opponent down. He is deadly with a knife and willing to kill when needed but finds it distasteful.

Gwetha (Medium Folk Walker — 80 XP): Str 12, Dex 14, Con 10, Int 10, Wis 10, Cha 10; SZ M (1×1, Reach 1); Spd 30 ft. ground; Init V; Atk V; Def IX; Res II; Health VI; Comp III; Skills: Acrobatics VI, Athletics V, Prestidigitation V; Qualities: *Always ready, aquatic I, class ability (Burglar: I'll cut you! I); Captain: battle planning I (guard yourselves!, steady now!); Scout: sneak attack I, cold-blooded, darkvision I, feat (Knife Basics, Knife Mastery, Knife Supremacy), treacherous, tricky (Called Shot), veteran II*

Attacks/Weapons: Dagger × 4 (dmg 1d6 lethal; threat 19–20; qualities: *bleed, hurl*), long sword (dmg 1d12 lethal; threat 20), Tail Slap II (dmg 1d8 lethal; threat 19–20; qualities: *reach +1*)

Mounts and Vehicles: Riding horse (Spd 50 ft. ground (Run 250 ft.); Travel 7; SZ/Def L/IV)

Gear: Partial studded leather armor (DR 2, Resist —; DP -1; ACP -0; Spd —; Disguise -0), game, spirits (1 use)

Treasure: 2C

Saren (Champion)

"Admit it. I scare you."

Saren is a massive ogre and a willing participant in Bazyl's arena. He requires no magical compulsion as the money's

good and he gets to throw people around without the intervention of pesky town guards. He stomps around the pit, bellowing and roaring, basking in the adulation and fear of the crowd and keeps himself well groomed to display the flamboyant and meaningless runes tattooed on his flesh. Often, he fights in the nude, which tends to intimidate men of smaller stature.

A one-on-one, bare-knuckle brawler, Saren flings opponents around like dolls, finally snatching them up in his thick arms and crushing them to death. He has been known to stage impromptu puppet shows with the pulped remains of his victims – a crowd favourite and a perfect fit for his gallows humour.

Saren (Large Folk Walker — 88 XP): Str 14, Dex 12, Con 12, Int 10, Wis 14, Cha 10; SZ L (2x2, Reach 1); Spd 30 ft. ground; Init V; Atk V; Def VI; Res II; Health VI; Comp III; Skills: Athletics III, Haggle V, Intimidate V, Tactics III; Qualities: *Banned action (Outmaneuver, Tumble), class ability (Captain: battle planning I (crush them!, stand fast!)), feat (Wrestling Basics, Wrestling Mastery, Wrestling Supremacy), tough I, treacherous, veteran II*

Attacks/Weapons: Slam III (dmg 2d8 lethal, threat 19–20), Squeeze III (dmg 2d12 lethal, threat —)

Treasure: 3C

The Machine (Champion)

“Flesh is weak — yours especially.”

A fiendish clockwork horror, The Machine is all blackened steel, steam leaking from its joints, with an ever-burning hell-flame in its throat and arms ending in long wicked spikes. This abomination does not fight for money or glory; it fights to kill. It approached Bazyl a short time ago and offered to fight for free. Bazyl was happy to accept, assuming the mad thing would be destroyed in a gruesome outpouring

of profit but The Machine survives. This gives Bazyl pause but as long as the metal monster refuses pay, as long as it is happy with the slaughter, the drake will keep it on.

The Machine enters the arena using Disguise Self to appear as a small robed figure. It dances and chants weirdly during Bazyl's introduction, using this time to Consecrate the arena to Evil (for combat bonuses in the fight to come). At the peak of Bazyl's introduction, The Machine dismisses its Disguise, emitting a horrendous roar and blowing the robe to scraps to revealing itself in all its diabolical glory.

Most fights against The Machine are to the death and it revels in the opportunity to spray gore and dance among a fallen challenger's entrails. Occasionally, The Machine is put forth as a challenge of courage. Bazyl announces that anyone can wager on the time they can stay in the circle with it. In these events The Machine uses all its abilities to frighten the challenger, aiming to drive them headlong out of the arena so Bazyl can collect his due.

The Machine (Medium Construct Outsider Walker — 93 XP): Str 14, Dex 12, Con 10, Int 12, Wis 10, Cha 10; SZ M (1x1, Reach 1); Spd 30 ft. ground; Init V; Atk V; Def VI; Res II; Health VI; Comp III; Skills: Athletics III, Intimidate X, Prestidigitation III; Qualities: *Always ready, class ability (Captain: battle planning I (no prisoners!, press on!), Scout: sneak attack I), damage reduction 3, devoted (Evil II), interests (Alignment – Evil), natural spell (Command I, Disguise Self), treacherous, tricky (Called Shot), veteran II*

Attacks/Weapons: Talon III (dmg 2d6 lethal; threat 19–20; qualities: *aligned (Evil)*)

Gear: Partial chainmail with light fittings (DR 3, Resist Edged 2; DP –1; ACP –1; Spd –5 ft.; Disguise –8)

Treasure: None

The King (Champion)

“I'm the King! I'm the King! Yay! Yay!”

A burly human with more muscle than sense, The King fights for fun. He was a village idiot in a nameless hamlet Bazyl's crew passed through a while back – an easy mark for the drake. The King believes Bazyl is his only true friend, having no idea the cruel joke his name is to the draconic sociopath. When not fighting, the King helps around camp. He has a soft spot for Frida and believes she secretly loves him, though he is far too bashful to say anything.

In the ring, The King is an unsurpassed master at fighting large crowds. He merrily wades into throngs of opponents, swinging his maul like a blunt scythe, laughing jovially the whole time. It is possible he does not even realise he is hurting anyone. He just swings and swings, as fast and hard as he can, until he is the last one standing, when Bazyl proclaims him, once again, “King of the Hill!”

The King (Medium Folk Walker — 89 XP): Str 16, Dex 12, Con 10, Int 7, Wis 10, Cha 10; SZ M (1x1, Reach 1); Spd 30 ft. ground; Init V; Atk V; Def VI; Res II; Health VI; Comp III; Skills: Athletics III, Haggle V, Intimidate V, Tactics III; Qualities: *Always ready, class ability (Captain: battle planning I (Crush Them!, I Want Them Alive!); Scout: trophy hunter), feat (Combat Instincts, Cleave Basics, Cleave Mastery, Cleave Supremacy), frenzy III, never outnumbered, treacherous, tricky (Called Shot), veteran II*

Attacks/Weapons: Dagger × 4 (dmg 1d6 lethal; threat 19–20; qualities: *bleed, hurl*), Maul (dmg 2d6 subdual; threat 19–20; qualities: *massive*)

Mounts and Vehicles: Riding horse (Spd 50 ft. ground (Run 250 ft.); Travel 7; SZ/Def L/IV)

Gear: Partial chainmail with light fittings (DR 3, Resist Edged 2; DP –1; ACP –1; Spd –5 ft.; Disguise –8)

Treasure: 2C

Bazyl's Bill of Brawlers



Grimslade (Champion)

"Do you honestly believe I give a fig about your applause?"

This fearsome Minotaur lived in a cave outside a mid-sized town and over the years acquired a significant hoard of treasure taken from adventurers come to "save" the townsfolk from him. Over time, he grew bored with his solitary life and when he met Bazyl and Casdon he became a silent third partner in the pit fighting enterprise, bankrolling the initial crew. The other Brawlers have no idea about Grimslade's true involvement in the outfit, nor that he commands a bigger cut of the profits. Grimslade has made his money back tenfold over the course of his pit fighting career and continues to fight solely to pad his nest egg (which he has on anonymous deposit with several moneylenders and banking houses throughout the world).

Grimslade stands silent and motionless in the arena during his introduction, letting his challenger claim as much of the crowd's adulation as desired. When the fight starts, however, the minotaur erupts into motion, charging across the ring and savagely smashing his opponent. Grimslade is not showy but he is certainly thorough. By agreement with Bazyl at the outset, all fights with him are to the death. He is not interested in playing with an opponent and often eats the heart of fallen challengers in front of the crowd – both to show his contempt for all and to reclaim their praise.

Grimslade (Large Folk Walker — 97 XP): Str 18, Dex 12, Con 12, Int 12, Wis 10, Cha 8; SZ L (2x2, Reach 2); Spd 30 ft. ground; Init X; Atk IX; Def IV; Res VII; Health VI; Comp II; Skills: Notice III, Survival III; Qualities: *Always ready, class ability (Captain: battle planning I (guard yourselves!, no prisoners!)), condition immunity (flat-footed), feat (Charging Basics, Charging Mastery, Rage Basics), fearless I, ferocity, improved sense (scent), natural spell (Orient Self), treacherous, veteran II*

Attacks/Weapons: Large broad axe (dmg 2d6+3 lethal; threat 19–20; qualities: AP 2, massive), Gore III (dmg 2d8+3 lethal; threat 19–20; upgrades: bleed)

Gear: Partial chainmail with light fittings (DR 3, Resist Edged 2; DP –1; ACP –1; Spd –5 ft.; Disguise –8)

Treasure: 2C, 1G, 1T

GM Notes and Adventure Seeds

First and foremost, Bazyl and his crew are a pack of dirt bags. They make their living on the corpses of others and are not the sort to be swayed by pleas for pity, compassion, or to "do the right thing." Still, this does not mean they must be villains (or even adversaries). You may find that Bazyl's crew make great contacts (of questionable morality, of course, but that is powerful grist for the roleplaying mill). Bazyl and his crew might also be introduced in any of the following ways.

Mama Told Me Not to Come

A dependent or relative of one or more heroes goes to see one of Bazyl's fight bills and is a little too open about their relationship with the party. Bazyl kidnaps the dependent or relative, promising to return them only if the party agrees to "a little show" (he even offers to throw in a cut of the gate). The heroes can work through a few fights, in which case Bazyl frees the hostage as promised, or they could attack the drake, in which case they face the entire crew.

You Do Not Talk About ...

A gladiator in the stable shakes off Bazyl's domination long enough to seek help. He stumbles into the PCs, half maddened with flooding memories and conflicting emotions and if the PCs calm him without killing him he begs them to get him to safety. Unless they move fast, though, Casdon may catch up with the gladiator, seeking to reclaim the ring's "property" and silence any who know of the drake's magical manipulation.

Moving Heaven and Earth

The heroes are approached by a warrior from a distant land with a sad tale. His betrothed lady-love was kidnapped from their remote homeland and now he is on a globetrotting quest to rescue her. He has finally located her but she is in the clutches of Master Bazyl, whom the warrior believes is dabbling in human trafficking. The warrior is weak and penniless but with Bazyl taking private bits on his exotic flower, he must press on. Of course, he stands little chance without the party's help.

Kid, I Can Make You a Star

One or more heroes are approached by Anta Mandrake to participate in a gladiatorial bill. Those who accept are matched against reasonable threats from among other locals and should they win they get not only a cut of the gate and wagers (a very *small* cut) but also a generous helping of the high life, including tasty food and intimate companions with good teeth and no last names. Along the way, Mandrake also looks to addict the hero(es) on one or more exotic drugs he has in stock (and introduce them to Bazyl's magical dominations), though it's likely their companions will sooner intervene.

It's Loose!

The Machine tires of Bazyl and the silly trappings of "fair" combat and goes on a rampage! It scatters townspeople like chaff and carves a bloody swath across the countryside (or through the city, as the case may be). Bazyl quietly puts out a bounty, which may put his crew and the party on the same side in hunting the thing down. Though Bazyl's "employment" of the creature prior to its rampage is not technically illegal (depending on the campaign world, of course), Bazyl still tries to conceal his involvement, even if he has to destroy the construct in the process. Clever heroes may discover the drake's secret, earning a reward from the local constabulary, or they might use the information or parlay their capture or destruction of The Machine for Bazyl's favour in future adventures.

Michael Moorcock's

ELRIC

DE MELNIBONÉ

Entrez dans le monde des Jeunes Royaumes et participez à la saga du Champion Eternel!

PROCHAINEMENT

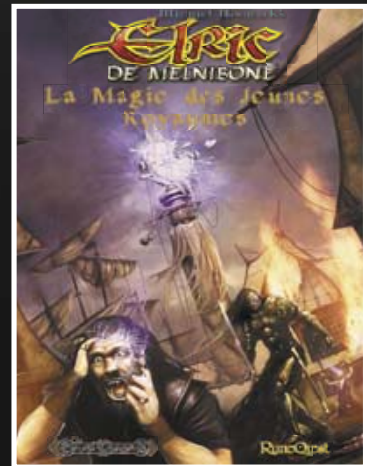

MONGOOSE
PUBLISHING

Mean Streets of MC-1

By August Hahn

Welcome back to Mega-City One, a megalopolis with city blocks that stretch the entire length of the American eastern seaboard. While Judges keep the peace for the most part in this huge urban jungle, some parts are wilder than others. Many blocks are rampant with crime, so eaten up by gangs and violence that normal citizens live in constant fear for their lives.

This article presents four scenarios that take place in blocks like these, basic encounters that can offer Games Masters a challenge to drop into existing campaigns or a springboard for starting whole new stories of their own. Each scenario has a setup, a detail of the encounter and a conclusion for wrapping things up and continuing the action even further.

Scenario One: One for the Road

'Judges, this is Sector Dispatch. There is a confirmed report of juves carjacking vehicles and street racing at the Carl Frobisher Memorial Hab. One building fire has already been started and contained. Proceed to that location and deal with the situation before further property damage occurs.'

Setup

The judges arrive on the scene to find a street in anarchy. There are fire vehicles hovering around a hab engulfed in smoke, half a Ford Strato sticking out of one wall. There are scattered bodies on the sidewalks and a meatwagon doing all it can to clean up around the debris. Shouts and hollers of 'Judges go home!' rain down from nearby windows and the whole block is on the verge of anarchy.

Detail

The encounter deals with three individual elements. Players can handle all or only some of them as they see fit and as their

skills allow. The only part that they should be 'forced' to confront is the one that will confront them – Drag Racing.

Up in Smoke

The building on fire, Carl Frobisher Memorial Hab, is a 40 floor habitation block. The first floor is mostly intact but floors two through 20 are engulfed in flames. A dangerous fire escape (-2DM to Athletics skill rolls, one for each floor that is on fire) allows a somewhat safer way to reach the upper stories to rescue the 3d6 people still trapped on every floor. A hover bus is near the roof to transport those rescued but the Fire Squad has its hands full and could certainly use the help.

Let the Bodies Hit the Floor

There are juves looting the bodies that the meatwagon has not gotten around to yet. While this might seem like a minor infraction considering the chaos it is still a crime and Judges are expected to stop it. Six in all, these juves are armed with antique revolvers and are dangerous in their own right.

Scav Juve, Str 7 (+0), Dex 8 (+0), End 7 (+0), Int 6 (+0), Edu 5 (-1), Soc 6 (+0)
Athletics (Co-ordination) 0, Computer 0, Drive (wheeled) 0, Gun Combat (slug pistol) 0, Streetwise 0

Drag Racing

There are still two ground cars unaccounted for, an Oostin Macro and a Ford Slabster. Two Scav Juves have taken them out for a spin and are now using this stretch of road for a race. The Judge will become involved when the juves see them and decide to change their game to Tag, trying to run them down with their stolen autos. The leader of the juves, Joy Borge, is in the Oostin Macro and is wearing a bright red dress taken from a citizen his gang assaulted before they came here for some 'fun'.

Taking It From Here

In the middle of dealing with this block's anarchy, Judges are liable to make a name for themselves with the locals. If Joy Borge escapes, as he will certainly try to do, he will be back with a bigger car, a bigger gang and draggier than ever.

Scenario Two: Cowboys and Indians

'Dispatch to Judges, proceed to Small Largehorn miniplex with all haste. There is a riot in progress in front of the Custer General Store between rival gangs. Violence has escalated to include citizens and employees. Contain the situation before hostilities spill out of the mall and into the block beyond. Backup is not currently available.'



Setup

The trouble here started when a member of the Scalpers, a ganger named Cho Cisce, was refused service by a servodroid at Custer General because of his manner of dress, namely the fact that he was not wearing anything at all. Cho, seriously inebriated, staggered back to his gang and whipped them into a frenzy over the incident. Unfortunately for the Scalper's plan to come trash the store, Small Largehorn is the favourite hangout for a rival gang called the Rustlers.

Detail

This is a fairly freeform encounter based around a riot in progress. Two gangs are tearing into each other in the hallway in front of Custer General Store. Ostensibly the Rustlers are 'defending' the store but they are just as likely as the Scalpers to loot it once the fighting stops. Several citizens are hurt but no one has been killed yet. That is where the Judges step in.

There should be anywhere from four to six gangers on either side per Judge. Keep in mind that the gangs are interested in fighting each other first and do not all turn en masse on the Judges when they show up. During combat gang members not directly engaged by Judges keep brawling among themselves unless given good reason to flee or fight the Law.

The primary challenge here is that after five rounds of combat the gangs will both try to flee. If any of the perps make it out of the doors on the south side of the mall, the mission is technically a failure and the Judges will face reprimands for their inability to contain the incident.

Armed with electro-prods (Rustlers) or las-saws (Scalpers).

Gang Members, Str 11 (+1), Dex 7 (+0), End 8 (+0), Int 7 (+0), Edu 7 (+0), Soc 7 (+0)
Athletics (Co-ordination) 1, Drive (wheeled) 0, Streetwise 1

Taking It From Here

To make this more than just an open brawl with gang thugs, introduce in hostages or have one of the gangers set the mall on fire, always a popular diversion in Mega-City One. Rustlers may let it slide but any Scalper that makes it out of

Small Largehorn is going to have, no pun intended, an axe to grind.

Scenario Three: Reservoir Robodogs

'Dispatch to Judges. Reports are coming in of multiple guard dog robots that have left their designated homes and are on the loose. They seem to have gone off their programming and should be considered hazards to public safety. You are authorised to demolish any canine unit that will not respond to a switch off command. Codes have been uploaded to your bleepers for this purpose.'



Mean Streets of MC-1

Setup

Bored hackers from a part of Mega-City One far from the scene of this encounter have flexed their digital muscles, burrowing into the computers of Lethal Response Inc. and implanting a virus in their automated update centre. When the daily software maintenance check was broadcast in the Judge's sector, a location chosen at random for the hackers' little 'joke', every robodog was given the same set of instructions. Now they are viciously obeying their new directives, much to the detriment of anyone or anything in their way.

Detail

The Judges are called to the scene of the latest attack by the 'rogue' robodogs, a dead citizen who just happened to be parking on the wrong street at the wrong time. Investigating the scene turns up a trail of machine oil leading away, a result of the citizen's one good attempt to defend himself against his metal murderer. This can aid the Judges in tracking down the robodogs though creative players should be able to figure out other ways (monitoring incoming reports, scanning for electronic signals, using their skills to track the robots directly and so on) to find them.

The robodogs are all converging on the same place, Tarren Tina Reservoir, a huge concrete aqueduct hub providing the water supply for several sectors. As a perverse twist, the hackers responsible for this steel rampage have programmed their robotic victims to wait until every affected doggie droid has gathered up and then jump into the reservoir. This will destroy the dogs and short out their memories, erasing any trace of the hacker's involvement.

The robodogs are locked on aggressive behaviour and will not hesitate to attack Judges if they get within striking range. The total encounter should include at least two robodogs per Judge and more if the players prove to be handy at dealing with the robots.

The remote code mentioned in the

Judges' briefing is an automatic shut down command installed in the bleepers they are carrying. Attaching one to a robodog is a standard action, requires an unarmed melee attack if the dog is active. The bleeper switches the robot off immediately if 8+ is rolled on 2d6. If it fails the hacker's virus (a nasty piece of code called Ray-B33Z) has overridden the shut down command; this makes the dog immune to further attempts. As per orders the Judges should

'Rabid' Robodog, Reprogrammed Lethal Response Inc. Defender

Config; Animal (Dog)

Size: Medium

Characteristics: Str 8 (+0), Dex 10 (+1), End 7 (+0), Will 9 (+1).

Personality Traits: Gruff, Fierce

Skills: Athletics (Co-ordination) 2, Melee (Unarmed) 2, Stealth 1, Tactics 0

Armour: 2 points (Plasteen Skin)

Attacks: 2 - 1x Bite (1d6+1), 1x Claw (1D6+2)

try to shut down the robodogs before destroying them. Tek-Div wants intact robots for study.

Taking It From Here

Savvy Judges with electronic skills might try to dismantle a dog themselves to find out why the robots went crazy. This could in turn lead them to the hackers and open up a whole new plot arc involving these twisted geniuses. Even if they do not, the hackers will not forget the Judges that spoiled their fun.

Scenario Four: Do the Deux

'Dispatch to Judges, we have a possible narcotics exchange in progress at the corner of Calhoun Drive and Faraday Avenue. Suspects have a large transport vehicle and are distributing an unknown substance to citizens without vending clearance. Erratic behaviour by the consumers of the substance has been observed. Investigate and apprehend.'



Setup

Jacque and Jillian Pardeu, refugee chemists from the Paris Quarter of Euro-Cit, have recently moved to Mega-City One on 'questionable' diplomatic credentials. In need of funds and genuinely obsessed with the science behind bio-toxins and metabolic enhancements, the Pardeu twins are up to the same tricks that got them thrown out of their home country.

This time things are a little different. Their previous experiments in chemical stimulants went through several stages, finally culminating in their seventh formulation – Sept Un. It was a comment from the last of their clinic subjects, a statement made right before his internal organs exploded, that got them thinking about their next project. The subject had called their formula 'a little like a fizzy pop'. When the Pardeus got to Mega-City One and saw how crazed citizens became over new energy drink fads, their course was set.

Detail

Before the Judges arrive the Pardeus are in their green painted hoverbus, handing out samples of their second try at a bio-boosting stimulant. Called Deux, it has a remarkable physical effect on drinkers and promotes a short lived but dangerous feeling of euphoria and 'immortality'. They have been out here distributing Deux all day, resulting in multiple incidents of reckless, damaging behaviour around the block. Before the Judges can apprehend the Pardues, an easy task since they are unarmed and harmless, they will have to deal with as many of the following events as the Judges wish.

Surf's Up!

The road ahead of the Judges is blocked with flowing water. One of the fire plugs has been blasted open and juves on

power boards are flying around the geyser of water in nothing but their skivvies. Shouting slang normally reserved for surfers in Oz, they are more a distraction than a real menace.

Tourney of Fools

Several gang members and even some normal citizens with a taste for adventure have blocked off one side of the crossroads leading into Calhoun and Faraday with refuse, creating an area for medieval style fighting with random weapons and bin lids for shields. Not content with this, some of the more violent of the 'knights' have fashioned spears, hopped aboard Krapasaki TD-4s and decided to joust with oncoming traffic. The Judges get involved when they get chosen as the next contestants.

Off the Wall

Juves whacked out of their mind on Deux have decided to try some urban sports of their very own. They are climbing to the roofs of local habs and jumping off, spraying Boing! on themselves in midair so their landings get cushioned and they go flying in random directions. Some make it, others do not. Either way the Judges have to deal with the mess.

'Extreme' Addiction

The Pardeu twins may not be dangerous but before the Judges can take them in the chemist's loyal fans have something to say about the matter. Dozens of citizens and gangers, all drugged and unreasonable, could make for a hazardous situation if the Judges cannot defuse things. This is a great place for roleplaying and Diplomacy checks since most of the 'perps' involved are innocent people. If combat does break out, use the Gang Member statistics in Cowboys and Indians, arming them with random melee and ranged weapons, mostly pistols and shotguns. Do not forget to add the bonuses for Deux.

Taking It From Here

The Pardeu twins were not just holding this distribution block party as an experiment. It was also a demonstration for interested criminal buyers looking for a cheap new drug to glut the ever growing market for recreational chemicals. Even once they are in custody, the Pardeus might play a part in the Judges' lives, willingly or unwillingly leading them through a crime network that could go as high up as the campaign requires.

New Craze Item – Deux

This bubbling green libation hides a complex series of nerve stimulants, pain killers, artificial adrenalin and barbiturates behind a light, vaguely citrus flavour. One small plastic bottle of Deux comprises a dose that is easily swallowed as a standard action by addicts. This is known as 'Deux Dropping' or 'Doing the Deux'.

One dose of Deux adds +2 to Reflex saving throws and Initiative rolls. It also provides a +5 ft. bonus to base land speed and immunity to fear effects of any kind. These bonuses last 10 minutes and come at the cost of a -5 to Will saves and an automatic failure for Concentration skill checks for the same duration. Multiple doses do not stack but increase the duration by five minutes for each one consumed while the effect is active.

Deux is extremely cheap, costing only 25 credits a bottle.

Bitter Oranges

By Rodrigo Vilanova de Allende

OVERVIEW

The Player Characters are hired by a local lordling from Zingara in order to kidnap the young daughter of a wealthy Argossean merchant across the border; they must do this before the girl's fiancée arrives at the villa to marry her. The Player Characters must deliver the maiden safe and sound to their patron. If successful in kidnapping the girl, the Players still face the problem of reaching their employer before they are stopped by the Argosseans who will be hot on their heels in pursuit.

This adventure is designed as either a one-shot session or as a 2–3 session adventure for low/mid level characters. Focusing on character stealth and fast reaction, the adventure involves several combats that can nonetheless be avoided with sufficient guile on behalf of the Players. Borderer, barbarian, soldier and thief classes are better suited for this adventure. The Games Master may choose to develop the NPC's presented here into recurrent antagonists, as the outcome of the adventure will surely leave (at least) one party seeking vengeance over the other. Alternatively, the Players can play the role of the maiden's rescuers.

PREPARATION

Non-Player Characters appear in the Appendix but they can be easily switched by the Games Masters NPCs. The adventure revolves around the Zingara/Argos borders with the characters either starting at a Zingaran border town or arriving to the Argossean's merchant villa near said border. From there, once the girl is kidnapped, the adventure will drift towards the Zingaran noble's manor, unless the Player Characters get lost or waylaid by the many obstacles in that dangerous area. Shemite mercenaries, Argossean gladiators, Kushite escaped

slaves (from Zingaran plantations) and pirates are good options to play in this adventure.

The characters will begin, unemployed, in a tavern either in the Argos-Zingara border; there they will be approached by a stranger who will offer them a job: to kidnap a young Argossean woman across the border. This is a good starting point for characters en route to another country (as part of a long term campaign) or if they find themselves tired of life at sea or trying to leave Central Hyboria.

Both the Games Master and the Player Characters need a copy of Conan the Role-playing Game. This adventure is designed for 1–3 beginner (3rd to 6th level) Players, although adjustments can be made to suit a particular campaign or the Players can choose to play any of the NPCs described in the annex.

The main feelings throughout this adventure should be greed and lust.

CHAPTER ONE: WEDDING PROPOSALS

In rural Argos, few men and women ever rise above their commoner status. Sometimes an ambitious Argossean can succeed in life, reaching the upper levels of Hyborian society. One such man is Bizos, the famous "King of the Oranges," a widower who has one joy in his life: his daughter Valena. Bizos desires to leave a lasting heritage to Valena, to that end he has bought through less legal means, the gambling debts of a young nobleman of Messantia, offering to 'forget' about said debts in exchange of him marrying his daughter thus upgrading the descendants of Bizos into the Argossean nobility.

Meanwhile, in Zingara, several nobles are planning a coup against the crown in Kordava. One conspirator is Karloto, whose lands border with Argos and Bizos's lands. Karloto is aware that he is the weakest link in the conspiracy and is trying desperately to solidify his position, thus he hired a Shemite scholar who promised him all the power he wants in exchange of the resources to continue his research. This will conclude with the Shemite's need for a maiden to sacrifice in a ritual to some dark god. Karloto has chosen as a victim the daughter of Bizos, since he is resentful of him from past trading transactions and would take revenge on him.

The characters arrive at the Zingaran border town on Karloto's domains where they are approached by a stranger with a foreign accent. This is Gabral, baron Karloto's councillor. Gabral will comment on the poor conditions the characters are in and treat them to dinner and drink, asking them to meet him later at a nearby clearing out of town. There, they encounter baron Karloto, disguised with a cape, who offers them a hefty reward if they cross the border to a nearby villa and kidnap the daughter of the owner.

If asked, Karloto looks annoyed but Gabral explains that the merchant refused to give his daughter in marriage to Karloto even after he paid a huge dowry for her and that Karloto has every right to claim what is his. Whether the Characters believe such a lie or not is up to them, since Gabral and Karloto seem satisfied with it.

The Characters have very little time for their deed since the arrival of young Valena's betrothed is expected the next day and the wedding is imminent, both Gabral and Karloto stress to the

Players the fact that Valena must be untouched when delivered.

CHAPTER 2: THE BORDER AT NIGHT

The border of Zingara and Argos, between the Rabirian Mountains and the Plains of Pallos is a dangerous region. Travellers risk encountering corrupt border patrols, no better than regular brigands, while the marshes to the South harbour several groups of escaped slaves from the Zingaran plantations near the coast, usually ambushing anyone who comes near their hideouts. Finally, the most infamous danger of the Zingara-Argos border is also present in the region: the terrible man-eating ghouls who dwell somewhere up north.

Bizos's Villa is a couple of hours ride from the border, although a shortcut exists through the northern woods, which leads to a small abandoned hunting cottage where Karloto has agreed to rendezvous with the Characters once they have secured Valena.

Other options include the well-travelled main road that winds south of the forest, with the inherent risk of facing the border patrols and the marshlands to the south, which is a long detour but seldom used.

If the Characters take the main road to Bizos's villa, they will encounter the Argossean border outpost fully staffed since a huge storm will fall that night. The outpost has 18 militia and later in the night a patrol of 5 additional militia will arrive from the Forest. The Characters will have to come up with an idea to sneak past the guards; Move Silently, Track, Hide and Spot contested rolls should be made. In the case of discovery, the guards will try to extort all the money and equipment from the Characters unless they come up with a very good excuse for themselves!

On the other hand, the Characters may wish to gain time by crossing the Forest. In this case, they arrive at the clearing where the abandoned hunting cottage is. This is a very sturdy old house, currently being inspected by a party of Argossean militia (5 riders strong) on their way to the outpost. If detected, they will try to capture the Characters (again, contested Hide, Move Silently and Spot checks will be required).

The Characters instead may want to follow the "safest" route, which takes them through the southern marshes. If this is the case, they risk getting lost (Knowledge: Geography or Survival DC: 18) in which case they will be in deep trouble once the storm begins. The Storm will be very strong, causing a -8 penalty on all perception related checks (Geography and Survival included) and it will last throughout most of the night. If the characters get lost or if they are delayed somehow, assume the storm has reached them and apply all pertinent rules (Conan Core Rulebook, p. 222).

Getting caught by the storm in the main road will be a difficult experience but unless they get lost (failing a Geography or Survival check by more than 10) the characters will arrive at Bizos's villa early in the morning just as the wedding ceremony is beginning. If the storm hits the characters in the marsh, Handle Animal and Survival rolls will be required in order to avoid the Character's mounts falling into deep bog pits thus drowning or suffering heavy injury while in the marshes (apply rules in pp. 221 and 327). After the storm, the Characters will have to face either being attacked by a swamp snake (they are roused after the storm) or ambushed by Ajunge's freedmen. This encounter is at the Game Master's discretion. If the characters manage to leave the marshes and continue their mission, they will arrive at Bizos's villa after the wedding ceremony, having little time to abduct Valena before the

wedding night. The most dangerous situation can occur if the characters get lost in the Forest during the storm. The Game Master will have to determine if they wander north, if that is the case, the characters will find themselves in the midst of ghoulish territory and they will have to escape somehow. Assuming the characters are trapped in the storm while crossing the Forest and do not get lost, they will arrive at the villa at dawn. Otherwise, the adventure continues as expected.

CHAPTER 3: BLOOD AND ORANGES

Once in Argos, the Characters perceive the ever present fragrance of orange blossoms as they near Bizos's villa; they will cross several fields of orange orchards. These fields are very well tended and have channels and irrigations ducts spread all over (+1 difficulty on all movement-related checks), the main feature of this is a small aqueduct that goes from the villa to a pool in the edge of the fields. Since the earth is well-watered, all tracking rolls have a +2 bonus). The Characters can approach the villa either through the orange fields or through the main road, leading to the main house. Riding through the fields is a complicated affair and should have a -2 penalty in all related skill checks.

The main road has the inconvenience of approaching a hamlet about to have a huge party: people will be coming and going (unless the Characters arrive late at night or during the storm) and there will be surveillance all day and night. The Characters will need to come up with an ingenious plan in order to go through the main road unchallenged.

Entering the villa is not a difficult affair and Valena can be found either in her chambers on the top floor of the manor or in the chapel, saying her maiden vows for the last time. The main difficulty will be to actually pass unnoticed by any of the

Bitter Oranges

villa's staff, working hard for the wedding the next morning.

If the Characters are discovered or if Valena manages to scream for help before being subdued, the house will fall into turmoil, taking a couple of minutes (enough for the Characters to either find Valena's whereabouts or to exit the house) for the guards and general staff to mount a serious defence. Although not fighters, the household men will aid the men-at-arms in the defence/rescue of Valena. Any fight taking place in the villa can quickly turn into a bloody affair. If the Characters do not exit the villa quickly, they run the very real risk of getting killed by sheer numbers or getting Valena hurt. Bizo's and Archipo of Karapia (Valena's fiancée) will arrive at dawn and immediately start a search party for Valena. Assume there are 15 men-at-arms in the villa (1st level soldiers).

CHAPTER 4: ESCAPE FROM ARGOS

The Characters now have to reach the hunting cottage, the border town or Karloto's manor. The nearest place is the shack in the woods, followed by the border town and finally the Zingaran's manor, located north of the town. If the Characters managed to travel to Bizo's villa and kidnap Valena without delay, the storm falls now, making it difficult for the Players to reach either destination.

On account of the storm, the Southern road, leading through the marshes is impassable so the route is either the main road or the woods. If taking the main road, the Characters will have to make a successful ride check in order to beat a messenger from the villa in reaching the border outpost, if the message arrives first, the characters will reach the outpost in full alert, looking for the kidnappers, if not, there will only be a couple of militia. Also, Valena will try to escape when nearing

the outpost, making it difficult for the Characters to pass unnoticed.

If challenged by the border militia, the Characters will be pursued up to the town's limits, which could be a good thing since this will put Ajunge's raiders off attacking. Otherwise, Ajunge's men will ambush the Characters as soon as they are close to the town. Although mainly looking to subdue the Characters and steal everything they are carrying, Ajunge will try to kidnap Valena as a potential ransom and escape into the marshes as soon as he gets hold of her. If the Characters do not rescue Valena quickly (they are knocked out or get lost in the marshes), the girl will be ravished by the slaves once they reach their camp.

If the Characters choose to cross the woods, Valena will attempt to escape and hide in the woods. The Characters have to find and re-capture her before she gets into real danger. A contested roll between the Characters and Valena's hide skill will be more than enough for the Players to find her. If by any chance, Valena wins the roll three times in a row she will be lost and fall into the clutches of a marauding band of ghouls, leading to a ghastly fate.

When the Characters arrive at the cottage, they will find Zalador, one of Karloto's henchmen. He has orders to wait with the Characters there until things calm down. The Characters will have to decide if they stand watch and roll Constitution appropriately; at some point during the night a terrifying howl will awake Zalador who will exit to check on the horses. The last the Characters will see or hear of Zalador are his screams as two ravenous ghouls fall on him, quickly dismembering him. The Characters now have a decision to make, stand fast in the cottage and defend themselves against the attack of the ghouls (2-6 ghouls, depending on the Characters' status, see Conan Core Rulebook, p. 386) or try to make a run for the horses and escape the demon-infested woods. Leaving the

shack may require several rolls to be made (Dexterity, Move Silently, Spot, Ride and so on, depending on the situation) with a failure meaning the ghouls fall upon the Character in question. Once out of the clearing the riders may be able to escape unless they fail a geography check and get lost in the woods. Staying in the hut will mean the Characters have to fight the ghouls until they are dead or dawn comes, leaving the Characters free to reach their destination.

CHAPTER 5: MAIDEN'S DELIVERY

If the Characters deliver Valena into Karloto's hands, he will notice the innocent beauty of the girl: Karloto met Valena years ago, when she was only a child, not a fully "grown" woman. Gabral will notice this and try to keep the girl for himself in order to perform the dark ritual he has in mind. If Karloto fails a Will Check vs. Valena's Charisma, he will decide to keep the girl for himself and take her to his chambers; of course this will not sit well with Gabral who will plan on taking the girl by force. If Karloto shows no interest in the girl beyond her utility in the dark ritual of Gabral, the Shemite proceeds with the preparations which will be done in the cellar of the manor.

At this point, the characters may ask for their reward or wait a little longer. Either way, the Characters will be presented with the option, by Karloto, of remaining in his household or collecting their payment. Valena, while being dragged screaming either to Karloto's chambers or Gabral's dungeon, will plead with the Characters to free her in exchange for anything they may wish, since her father is rich (although not that rich!). If the Characters decide to leave Karloto's domain at that point, the adventure is ended, with the Game Master having the option of harassing the Players in the future with a vengeful Archipos or Bizo's headhunters.

On the contrary, if the characters remain Gabral's and Karloto's interests and obsessions will finally clash and their long standing partnership will come to an end, depending on the whims of Valena's keepers.

If Karloto decides to keep Valena for his personal pleasure, Gabral tries to enlist the help of the Characters in stopping Karloto and recovering Valena so he can perform the ritual, which will grant power unlimited to all concerned. If the Characters support Gabral, they storm Karloto's chambers to face him naked before a terrified Valena; Gabral will be quick to stab Karloto to death, even though the arrangement with the Characters was only to restrain him long enough for him to perform the ritual. After murdering his former liege, Gabral will order the Characters to take Valena to his dungeon and to stop any of the mercenaries loyal to Karloto and Zingara's law, which will certainly include Pakolito, captain of Karloto's guards.

Assuming the Characters inform Karloto of Gabral's schemes, the Shemite will bribe Pakolito and his mercenaries, attacking Karloto and the Characters in his chambers, Karloto is sure to use the Characters as cannon fodder but will defend himself although he will not risk his life for an "Argossean wench".

Assuming Karloto agrees with Gabral's plans, or Valena is actually brought into the manor's dungeon, the ritual will go accordingly with the girl being sacrificed to a dark entity, which Gabral clearly has no understanding of. If the Characters witness the ritual, Gabral will summon a Child of the Dark (Conan Core Rulebook p. 379) which he will not be able to control, the fiend will brutally kill Gabral and proceed to attack all those present in the dungeon and then disappear.

Siding with Valena in Karloto's manor will end in a bloody confrontation

between the Characters and the Zingaran's guards. If the fight lasts long enough (approximately 2/3 of the Zingarans are incapacitated), there is a possibility (Game Master's discretion) that Archipos will arrive with the militia guard to rescue Valena. It is up to the Characters to flee or stay and try to sort things out with whoever survives the melee.

EPILOGUE

If Valena survives and is returned to her father or fiancée, the fate of the Characters will depend on where and how they deliver Valena: if she has been defiled, either by Karloto, Ajunge or somebody else, Archipos will take that as a personal affront and take all the possible measures to exact vengeance on those responsible for "his" dishonour. If Valena is returned to her family in Zingaran soil, Bizos and Archipos (assuming they survive) will grudgingly return to Argos but if she is delivered in Argossean land, they will try to seize the Characters and throw them into jail, sending them in chains to the Provincial magistrate to stand trial as kidnappers.

If Valena dies, Bizos will swear vengeance on the Characters and everyone else involved, offering an extremely big reward for the Character's heads. Rafario, Bizos's forester will personally track down the Characters and kill them one by one.

The safest option is to leave Karloto's lands as soon as possible and even then, the Game Master may choose to make either Archipo or Rafario recurrent enemies, constantly dogging the Characters' every step.

There is also the possibility that the characters ally themselves with Ajunge, working together for any of the Character's or the slaves interests, while this can lead to interesting developments, the provincial magistrates in Argos and the lords

of Zingara will not tolerate Ajunge's activities in the long term. Another possible twist to this adventure is if the characters actually sell another girl, which is not Valena, to Karloto since the Zingaran only has a brief idea of how Valena is, it should not be difficult for crafty Characters to pass off another girl as the daughter of Bizos. Finally, there is the possibility that the adventure ends with the Characters lost in the middle of ghoulish territory, which would lend itself to a completely different (yet terrifying) adventure.

ANNEX ONE: CHARACTERS

Baron Karloto

6th lvl. Zingaran noble.

Hit Dice: 6d8 (33hp)

Initiative: +1

Speed: 30 ft.

Parry defence: 16

Dodge defence: 13

Base attack: +4

Attack: Broadsword +6 (1d0 +2 / 19-20 x2/ AP 3)

Special Qualities: Title, Rank Hath Its Privileges, Wealthy, Regional Feature +1, Social Ability (ride), Lead by Example +2, Enhanced Leadership, Sneak Attack +1d6.

Saves: Fort +2, Ref +3, Will +4

Abilities: Str 15, Dex 13, Con 10, Int 10, Wis 9, Cha 12.

Skills: Bluff 3, Diplomacy 6, Gather Information 4, Handle Animal 5, Intimidate 5, Knowledge (history) 1, Knowledge (local) 3, Knowledge (nobility) 1, Knowledge (warfare) 1, Ride 5, Sense Motive 2, Spot 2.

Feats: Power Attack, Cleave, Mounted Combat.

Reputation: 5

Baron Karloto is the heir of one of the most miserable corners of Zingara. A petty little man, he is considered by Kordava as no more than a haughty bureaucrat. Karloto nonetheless is a covetous man willing to bet his life on the nobles vying for the crown, if successful, his lot in life could improve greatly, thus he is going to try anything that improves his chances of glory,

Bitter Oranges

including enlisting the help of Gabral. Whether Karloto will ransom Valena or give her to Gabral is not certain.

Gabral, the left-handed

7th lvl. Shemite scholar.

Hit Dice: 7d6 (28 hp)

Initiative: +0

Speed: 30 ft.

Parry defence: 13

Dodge defence: 12

Base attack: +5

Attack: Dagger +5 (1d4+1/19-20 x2/AP 1)

Special Qualities: Knowledge is power, Sorcery Style (x3), Scholar, Independent, Bonus Spell (x1), Advanced Spell (x4), Iron Will, +1 dmge. on coup de grace.

Saves: Fort +2, Ref +2, Will +6.

Abilities: Str 12, Dex 11, Con 11, Int 13, Wis 12, Cha 15.

Skills: Appraise 5, Bluff 7, Concentration 3, Craft (alchemy) 3, Craft (herbalism) 5, Decipher Script 4, Diplomacy 5, Forgery 3, Gather Information 2, Listen 2, Handle Animal 1, Heal 3, Knowledge (local) 7, Knowledge (arcane) 8, Knowledge (religion) 7, Knowledge (Nature) 4, Move Silently 1, Ride 2, Search 2, Sense Motive 4, Spot 5.

Feats: 3.

Reputation: 7

Magical Attack Bonus: +3

Power Points: 7 (max. 21)

Sorcery Styles: Counterspells, Summoning, Curses.

Spells Known: Warding, Lesser Ill Fortune, Demonic Pact, Summon Demon * (when cast, it will automatically go wrong), Desperate Ward, Incantation of Amalric's Witchman, Doom, Weapon Curse.

Since his early childhood as the youngest son of a Shemite priest, Gabral realised fate had played foully with his destiny. Resentful of his father's trade and family values, he fled into the slums and dark cults of Southern

Shem's cities. Still, it was not until recently that he managed to learn the trappings of magic. An exile by then, he reached Zingara and met Karloto who was easily manipulated in giving him the position of his councillor. Now, Gabral expects Karloto to provide him with the invocation that will surely grant him the power he has longed for.

Valena, daughter of Bizos

2nd lvl. Argossean commoner

Hit Dice: 2d4 (7 hp)

Initiative: +0

Speed: 30 ft.

Parry defence: 10

Dodge defence: 11

Base attack: +1

Attack: bare handed +1 (1d3 -1)

Saves: Fort +1, Ref +0, Will -1

Abilities: Str 9, Dex 10, Con 12, Int 11, Wis 9, Cha 16.

Skills: Craft (weaving) 3, Handle Animal 3, Listen 1, Swim 3, Profession (husbandry) 2.

Reputation: 1

A pretty maid in a border town. Valena is quite excited about her recent betrothal and has imagined for herself a fairy tale life. Although scared, she will try to escape from the Characters at every opportunity unless restrained somehow. She hates the Characters but she is way more afraid of her destiny in Karloto and Gabral's hands.

Bizos the king of oranges

3rd lvl. Argossean scholar (merchant)

Hit Dice: 3d6 (15hp)

Initiative: +1

Speed: 30 ft.

Parry defence: 11

Dodge defence: 11

Base attack: +1

Attack: Knife +1 (1d4 / x2 / AP 0)

Special Qualities: Scholar.

Saves: Fort +2, Ref +1, Will +4

Abilities: Str 10, Dex 10, Con 12, Int 13,

Wis 12, Cha 13.

Skills: Appraise 5, Bluff 6, Craft (herbalism) 2, Forgery 4, Gather Information 4, Intimidate 2, Knowledge (local) 6, Knowledge (geography) 4, Perform 2, Profession (merchant) 6, Profession (farmer) 5, Sense Motive 5.

Feats: Negotiator, Knowledgeable.

Reputation: 3

The so-called King of the Oranges is a wealthy merchant and landowner who has a keen eye for opportunity and a clearer view of his objectives. His wealth comes from his successful trade in the popular oranges of Western Argos, which he trades to Shem, Stygia and Aquilonia. After many months of searching for the right opportunity, Bizos has found a way to obtain his most recent wish: acquiring the considerable gambling debts of a young noble of Messantia in exchange of him marrying Valena.

Archipos, heir of house Karapia

6th lvl Argossean noble

Hit Dice: 6d8 (26 hp)

Initiative: +6

Speed: 30 ft.

Parry defence: 14

Dodge defence: 13

Base attack: +4

Attack: Arming Sword +4 (1d0 +1/ 19-20x2/AP 2)

Special Qualities: Title, Rank Hath Its Privileges, Wealthy, Regional Feature +1, Social Ability (allies), Lead By Example +2, Enhanced Leadership.

Saves: Fort +3, Ref +4, Will +6

Abilities: Str 13, Dex 14, Con 13, Int 11, Wis 12, Cha 14.

Skills: Appraise 3, Bluff 6, Diplomacy 4, Gather Information 3, Handle Animal 1, Intimidate 4, Knowledge (history) 2, Knowledge (local) 2, Knowledge (nobility) 3, Knowledge (religion) 1, Ride 4, Sense Motive 4, Spot 2.

Feats: Parry, Persuasive, Quick Draw,

Improve Initiative, Weapon Focus.
Reputation: 5

Archipos is a spoiled young man drowning in gambling debts. Since he has squandered all his family's wealth he had to accept Bizo's offer of marrying Valena. Although disgraced, Archipo still has a high idea of himself and will not tolerate any further umbrage on his house's honour.

Ajunge of Kush

7th lvl. Kushite barbarian
Hit Dice: 7d10 (43 hp)
Initiative: +2
Speed: 40 ft.*
Parry defence: 14
Dodge defence: 16
Base attack: +7/+2
Attack: Spear +8/+3 (1d8 +3/ x2/ AP1)
Special Qualities: Fearless, Track, Versatility, Bite Sword, Crimson Mist, Trap Sense +2, Endurance, Uncanny Dodge, Mobility, Diehard.
Saves: Fort +7, Ref +6, Will +3
Abilities: Str 14, Dex 13, Con 15, Int 12, Wis 13, Cha 12.
Skills: Climb 4, Craft (herbalism) 3, Handle Animal 1, Hide 5, Intimidate 7, Jump 5, Listen 5, Move Silently 5, Perform 1, Spot 5, Survival 7, Swim 3.
Feats: Fleet footed, Power Attack, Run*, Weapon Focus.
Reputation: 8

Ajunge is an escaped slave. He has managed to create a network of fugitive slaves in the region, growing in reputation both with Zingarans and with the slave population. Surviving through hunting skills and sheer luck, his numbers grow with every season, making it harder to provide for his people. Thus, Ajunge has decided to raid the border town's warehouses, in hope of securing food to survive the winter. Taking advantage of

the incoming storm, Ajunge is waiting for an ambush on the outskirts of the town when the Player Characters come by with Valena captive. Although Ajunge may not even be a random encounter in this adventure (depending on the Characters' decisions), it can be an interesting antagonist, since he is, above all, a pragmatic leader and can even be persuaded to deal with the characters if approached in a clever way.

Rafario

6th lvl. Argossean borderer
Hit Dice: 6d10 (37hp)
Initiative: +3
Speed: 30 ft.
Parry defence: 14
Dodge defence: 15
Base attack: +6/+1
Attack: Hatchet +7/+2 (1d6 +1/ x3/AP 1), Hunting Bow +8/+3 (1d8+2 /x2/AP 1), Short Sword +7/+2 (1d8+1/19-20x2/ AP 1)
DR: 4 (leather jerkin)
Special Qualities: Track, Favoured Terrain (Forest) +2, Endurance, Improved Combat Style (archery), Diehard.
Saves: Fort* +7, Ref* +6, Will +3
Abilities: Str 13, Dex 14, Con 15, Int 12, Wis 13, Cha 10.
Skills: Climb 3, Craft (herbalism) 3, Handle Animal 3, Hide 7, Move Silently 5, Listen 4, Knowledge (geography) 4, Ride 4, Survival 6, Spot 5, Swim 4.
Feats: Weapon Focus (Bow), Run, Self-Sufficient, Point Blank Shot, Precise Shot, Track, Rapid Shot, Shot on the Run, Diehard*, Endurance*.
Reputation: 5

Rafario is one of the oldest and most loyal aides of Bizo. He has a strong affection for the young maiden, which is one reason for his zeal in the search for Valena.

Zalador the Weasel

5th lvl. Zingaran thief
Hit Dice: 5d8 (25hp)
Initiative: +3
Speed: 30 ft.
Parry defence: 13
Dodge defence: 14
Base attack: +3
Attack: Short sword +4 (1d8+1/19-20x2/ AP 1), Dagger +5 (1d4+1 /19-20x2/ AP 1)
Special Qualities: Sneak Attack Style (x2: Dagger, Club), Sneak Attack +3d6/+3d8, Trap Disarming, Eyes of the Cat, Trap Sense, Light Footed,
Saves: Fort +1, Ref +6, Will +1
Abilities: Str 12, Dex 14, Con 11, Int 12, Wis 10, Cha 13.
Skills: Appraise 3, Bluff 6, Climb 3, Decipher Script 1, Disable Device 2, Disguise 3, Escape Artist 3, Gather Information 5, Intimidate 5, Hide 7, Knowledge (local) 4, Knowledge (geography) 3, Move Silently 7, Open Lock 2, Search 3, Sense Motive 5, Sleight of Hand 4, Spot 6, Use Rope 4.
Feats: Weapon Focus (Dagger), Stealthy, Two Weapon Combat.
Reputation: 3

Zalador is more a thug than anything else but he has been with Karloto since his youth. If he is not killed in the Forest, he will be beside his master ready to kill anyone who confronts him.

Pakolito the sellsword

6th lvl. Zingaran soldier
Hit Dice: 6d10 (34hp)
Initiative: +2
Speed: 30 ft.
Parry defence: 18
Dodge defence: 14
Base attack: +6/+1
Attack: Broadsword +8/+3 (1d10 +4/ 19-20x2/ AP 3)
DR: 6 (Mail Hauberk), if ready for combat.
Special Qualities: Bonus feats (x4),

Formation Combat (Light Cavalry), Officer.

Saves: Fort +6, Ref +3, Will +3

Abilities: Str 14, Dex 13, Con 13, Int 11, Wis 12, Cha 10.

Skills: Climb 3, Intimidate 6, Jump 2, Knowledge (geography) 2, Knowledge (warfare) 4, Ride 6, Search 4.

Feats: Parry, Weapon Focus (Broadsword), Weapon Specialization (Broadsword), Power Attack, Cleave, Mounted Combat, Brawl, Blind Fight.

Reputation: 5

Pakolito is a typical Zingaran mercenary, dedicating his life to selling his sword to the highest bidder. Currently, things have been low for him, hence his allegiance to Karloto, although the worst stereotypes about Zingarans can be said to be true for Pakolito.

18 Argossean Border Militia

2nd. Lvl. Borderers.

Treat as "Bandits" (Conan Core Rulebook, p. 357) but equipped with hand axes (1d8/x3/AP 2), Short swords (1d8/19-20 x2/AP 1) and light lances (1d10/x3/AP 2) and wearing quilted jerkins (Damage reduction 3) except for the leaders (1 in 6 militia) who will be wearing a leather jerkin (DR 4).

The Argossean border militias are volunteers, named by the local magistrate, in charge of security along the borders of Argos. Although not soldiers, they can defend themselves in case of foreign raids while sending word to the provincial garrison. In times of war, the militia is reinforced by regulars from Messantia. The militias go in groups of 5-6 and will not hesitate to escape a confrontation in order to warn the outpost which will mobilise in full force to confront the threat of the Players.

30 Kushite/Black Kingdoms escaped slaves

1st. lvl. Barbarians.

Hit Dice: 1d0 (9 hp)

Initiative: +1

Speed: 30 ft.

Parry defence: 12

Dodge defence: 11

Base attack: +1

Attack: Club +1 / Hunting bows +1 / Spears +1

Special Qualities: Fearless, Track, Versatility.

Saves: Fort +3, Ref +3, Will -1

Abilities: Str 13, Dex 11, Con 12, Int 10, Wis 9, Cha 9.

Reputation: 2

The freed men of Ajunge's band are mostly Kushite slaves, escaped from several southern plantations of Zingara. The Kushites will be captured on sight by both Zingarans and Argosseans. They survive by hunting in the marshes and raiding travellers along the road that nears the marshes. During the adventure, their leader has planned a raid on the border town, although quite numerous, the slaves are not used to fighting so they break and run if several of their numbers fall (roll a will check for every 3 men dead or dying. DC: 12 +1 for every man below 0hp). The slaves try to steal the Characters equipment and horses as soon as the opportunity arises and then flee to the marshes.

15 Zingaran mercenaries

2nd lvl. Soldiers.

Treat as "Turanian Light Cavalry" (Conan Core Rulebook p. 354-355) but with the following adjustments: Arming Sword +2 (1d0 +1 / 19-20 x2/AP 2), Light Lance +2 (1d10 +1 / 19-20 x2/AP 3), Targe, Mail Shirt (if prepared for combat).

Pakolito's mercenaries are standard soldiery in Zingara, not terribly bright, nor terribly loyal to anything but gold.

CONAN[®]

2010



MONGOOSE PUBLISHING
www.mongoosepublishing.com



LONE WOLF

THE TOWN OF RUANON: UNCOVERED

BY DARREN PEARCE

'Aye, Aaron Vanalund was my father. He lost his life doing Kai's will and that's how I intend to lose mine eventually. I would rather die a heroes death than waste away alone and forgotten in the annals of time'
Oren Vanalund, Baron of Ruanon.'

BRIEF HISTORY

Ruanon is the capital town of the Baronial Province of Ruanon and has not always been a prosperous place. It began life many years ago as a collection of settled huts and hovels, having drawn the hardy Sommlending to the southern area of Sommerlund, where the Maaken Range lay rich with many ores and minerals. These fortune seekers soon settled down just south of the Ruanon Forest and began to carve a small life out for themselves. This settlement, firstly known as a simple miner's camp could not foresee the part it would have to play in MS 5054.

Ruanon prospered over the years and attracted more and more settlers, who established small homes in the dirt. Eventually these wooden huts and shacks were demolished, new buildings were constructed and Ruanon began to take shape as the people started to build more than a transient life of mining and toil for themselves. They began to cull wood and material from the local forest and stone from the Maaken Range to

extend and fortify their little village which they named Ruanon after the province in which it was built.

Over the next few years, life seemed to be going fairly well, although there were a few bandit raids on the mine carts and wagons over this period of time. The ruler of Ruanon, Baron Aaron Vanalund fought back against these incursions and it was around MS 5010 that he lost his life in a vicious bandit attack against the village, in which several buildings were destroyed. His son, Oren was left to take up the mantle of leadership. Oren rebuilt the village and established a group of Border Rangers to watch over the surrounding lands.

With the extra income from the profitable mines and other exports, Oren transformed Ruanon in MS 5020 into a town and fortified the walls with heavier materials, thick wood and stone to keep out wild animals and the more foolhardy of the local bandits. The Ruanon of today is very different compared to the small village of the past and the people have undergone great hardships leading up to the massacre of the Kai in MS 5050. Oren has built up quite a reputation and has a family of his own, including a daughter named Madelon who has drawn the eye of a man known as Barraka: a renegade Vassagonian noble who attacks the town in MS 5054 during the events of Chasm of Doom.

PHYSICAL DESCRIPTION

The capital town has a large watchtower that sits in the centre of a high stone defensive circular wall. There are two main gates set into the wall, they are made of strong Ruanon Oak and have double-steel cladding to protect against battering rams and other heavy assaults. The first gate leads to the north and the Ruanon Forest, the other leads to a split-road in the south part of the wall. The roads lead off to the City State of Casiorn at the south-east and the Maakengorge itself to the south-west. There are four small watchtowers set at the cardinal points of the compass around the town; each tower has a signal fire that can be lit in times of trouble.

Several Sommlending banners fly from a large building off to the eastern side; this is the Baronial Castle of Ruanon. It is a heavily fortified building that has been extended over the years by those who have taken the mantle of ruler for the capital. In the centre of the town is a massive stone well and there are several small market stalls that surround it in the town square. There are also gardens for the townsfolk to rest and relax in, with some beautiful

The Town of Ruanon



To the
Ruanon
Forest

Key

- | | |
|-----------------------------|--------------------------------|
| 1. Bryony the Clothes maker | 12. The Watchtower |
| 2. Ruanon General Wear | 13. Watchtowers |
| 3. Ruanon General Store | 14. Baron's Castle |
| 4. Ruanon Grocery | 15. Town Well |
| 5. Ruanon Bakery | 16. Market Stalls/ Town Square |
| 6. Bradin Greystone | 17. Petra's silks |
| 7. Butcher Reece | 18. Osvath's Craft |
| 8. The Miner's Rest Inn | 19. Umbolt's Toys |
| 9. The Lucky Ore Tavern | 20. Mere Swans Pipes |
| 10. Mining HQ | 21. Omer Fidler |
| 11. The Windmill | 22. Town Hall |

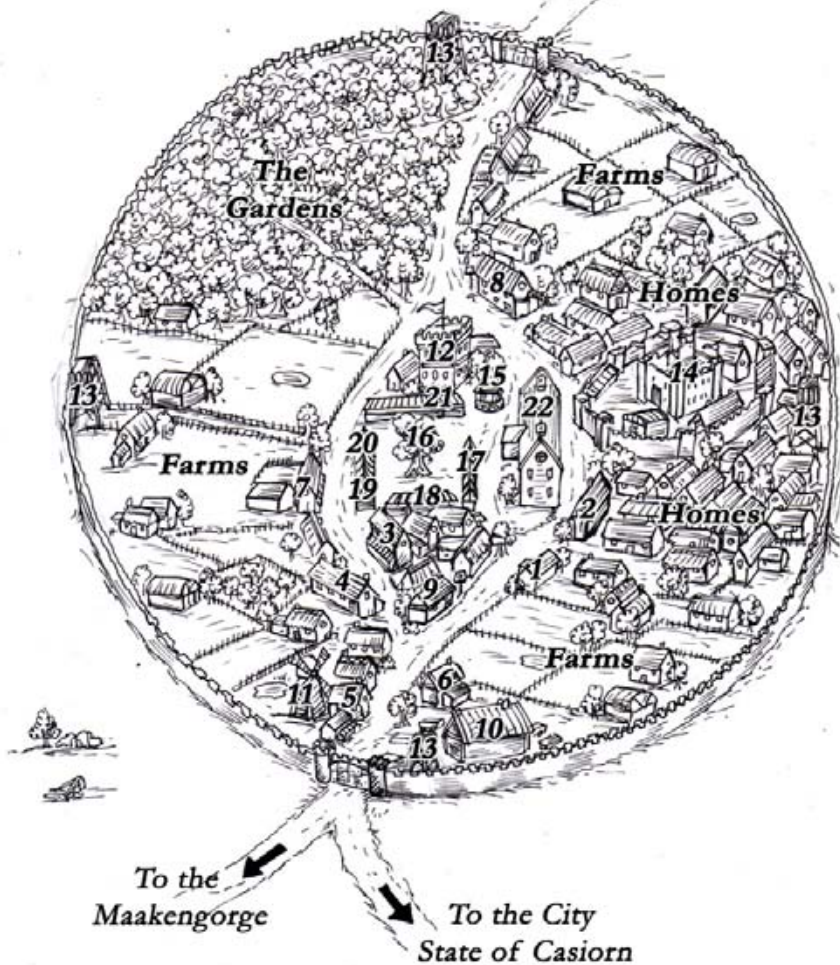

mountains and this gives Ruanon a sombre look compared to some of the brighter places in Sommerlund. This look matches the no-nonsense townsfolk's attitude and echoes their stalwart nature. During the day grey smoke whispers up from the chimney pots and the colourful market stalls of the town square, as well as many of the various revellers that ply their trade at that location add a much needed dash of colour and life to the town.

By night Ruanonis lit by many torches and oil lamps that surround the inner part of the defensive wall. They appear to glow like hundreds of dancing fireflies and shimmer softly under the cloak of darkness. The homes and houses of the townsfolk have brightly lit windows and warm hearth-fires to stave off the cold wind that lances down from the Maaken Range, funnelled into the area by the mountain peaks.

Sommlending blooms within, especially the famous Ruanon Rose, which is a pale white/blue flower shot through with a slight dash of crimson.

Around the outskirts of the village in MS 5000 there were several farms that provided, wheat, barley, grain and of course meat to the population. These buildings were encircled into the new defensive wall at the command of Oren as the outlying farms were attacked by bandits one too many times. A large

white stone and wooden windmill serves to provide flour to the bakers at the southern end of Ruanon and there are many mine-carts strewn around a large building close to the southern gate, this is the miner's headquarters and is made of dark grey stone quarried from the Maaken.

The homes and residences of the town are made from the same stone, thatched roofs are slowly being replaced by a more durable black slate from the nearby

PLACES OF INTEREST

The Watchtower

Situated centrally in the town close to the large well, this massive white and grey stone square tower serves as the central rally point for the town guard as

well as the home of its current captain; Jerem D'Val. The golden sun flag of Sommerlund blazes brightly from a large silver flag pole atop this building and there are several balconies from which Toranese Archers can take aim at enemies below. The tower is split into several levels inside, with the bulk of the storerooms and barracks below, D'Val's room is at the top.

Watchtowers

These are set at every cardinal compass point around the town, north, east, south and west. They are 10 feet taller than the high wall and have a retinue of guards posted atop at all times, at least two of these are archers. They are made of heavy wood, with four legs and a ladder that provides access to the top section of the tower. The lower legs are bound with a tube of iron that prevents damage from attackers seeking to cut the legs apart. A signal fire stands ready atop these towers to be lit at a moment's notice and serves as an early warning system to inform the King's Regiment of an attack upon Ruanon itself.

Baron's Castle

Over the years the various rulers of Ruanon have all made alterations to the castle, changing the appearance of this Motte and Bailey constructed castle. It has been brought down from the hill; the ground has been excavated around it and the single square keep has been extended with the addition of a heavy stone outer wall and an inner set of buildings, including stables, guard barracks, blacksmith and training area. It now resembles a ring-style castle more than anything. The western wall has a double-strength steel portcullis constructed by a dwarf craftsman who dwells in the town. There are numerous archers and soldiers stationed within as well as the Baron Oren himself who is a formidable warrior. Many Sommlending banners fly from the square keep at the centre and once again the buildings are constructed of the dark grey Maaken stone and heavy Ruanon Oak.

Town Well

The primary source for clean water in the town, this was once just a hole in the

ground ringed by a few stones. It is now a large circular grey stone edifice that has a twin wooden bucket and pulley system built in to allow more than one bucket to be drawn at the same time. The well was repaired by Oren's craftsmen in MS 5010 after it was damaged in the bandit attack that cost him his father. He had a small commemorative plaque set in the east facing the rising sun. It reads, 'Aaron Vanalund - faithful servant of Kai.'

Market Stalls/Town Square

A few sturdy wooden market stalls, covered in a variety of colourful gold and red curtains, banners and sheets serve as a central gathering point in the Town Square. The square is just off to the west of the well and is marked by these stalls as well as a small section of cobbled pavement. It has a large Ruanon Oak at the centre that serves as an impromptu notice board where important information is often pinned, or love letters from besotted townsfolk which are carved into the bark. It is a busy place during the day but at night it turns into a ghost town with only a few guards to patrol it.

Market Stalls

Petra's Silks: If you want some interesting silks and satins all the way from the warmer climes, Petra, a short green eyed, curvaceous dark haired woman who comes from Casiorn is happy to sell you these things for the right price. She's an incessant talker who loves to gossip.

Osvath's Craft: This young woman, Andrea Osvath, is a capable crafter and a clever debater. Originally a Sommlending resident from Holmgard, she prides herself on making almost anything. She can turn her hand to woodwork or metal work and her stall is full of useful tools and even a few weapons. She wears a leather apron and has a warrior's build and as all Sommlending are, she is trained in the use of the sword and bow.

Umbolt's Toys: Berv Umbolt, a middle aged Sommlending man from Toran came here seeking his fortune, instead he discovered that he had a knack for making wooden toys and now he sells

these to the children of Ruanon. He enjoys a modest lifestyle and his stall is always packed with the latest static or in some cases clockwork model. His figurines of the Kai are always best sellers and so too are the roughly made models of Giak.

Mere Sawns Pipes: For those elderly folk of Ruanon or those who are seeking a little more class in their lives, this older man with a short cropped white beard and sparkling eyes tends to his shop with a careful hand. He crafts, scrimshaws and inlays some of the finest smoking pipes and stands in all of Magnamund. He also mixes and makes various fine tobaccos as well as selling the tools required to maintain and look after a pipe. He is a consummate storyteller who can weave quite an enchanting tale.

Omer Fidler: If you're after a beautiful sounding instrument, a guitar, mandolin, fiddle or anything with strings then Omer is your man. He comes from the distant land of Vassagonia and is a masterful musician. He often sings and plays part time at the Miner's Rest Inn, entertaining the local populace with his ballads and songs. When not doing this, he sells various musical instruments and offers advice to budding musicians at his market stall here in the town square. Omer has a sharp wit, he does not back down from a fight and he is not afraid to tell someone what he thinks of them. Omer carries a torch for Ana Hiden, a girl who he has loved since he was a teen; she is the love of his life and the muse to his music. She on the other hand does not see his affections and spends her life following her own dreams, singing and playing in Ruanon at the Miner's Rest, she hopes to travel to Holmgard and perform in the great theatre there one day.

Town Hall

In MS 5000 the building was nothing more than a simple grey stone long hall with a thatched roof. Over the years it has changed, partly due to fire damage from the last bandit raid and partly due to the steady ascension of Ruanon to town status. Now the Town Hall is an imposing three storey structure that has numerous town officials and contains the office of

the Lord Mayor, a man known as Kadek Adelson. The front of the building has been white-washed and it is decorated with the blazing sun of Sommerlund over the arch of the front door. There is a dark slate roof and three chimney pots atop it and heavy shutters over the windows that can be closed in case of an attack and a retinue of armed town guard patrol the area around it.

The Gardens

Once a clandestine meeting place for young lovers from the village in MS 5000, these thickly forested areas are now inside Ruanon's defensive walls. They have been tended to and shaped to form a natural garden where townfolk can relax and enjoy fine weather. There are several small benches set along a rough stone pathway that leads through the gardens. At night they remain a favourite meeting place for enamoured young couples and whilst patrolled by the town guard, there are still enough hidey-holes and hidden spots to prevent discovery.

Farms

Dotted around the edges of the defensive wall are several farmsteads, they all follow similar construction designs and are made from hefty stone and thick wood. They have enclosures for their animals such as cows and pigs and they have fenced off fields for crops. Land disputes between farmers are few and far between but a couple of badly placed farms do overlap each other causing strife occasionally when animals escape and feast upon the abundant crops of barley, wheat and vegetables.

Homes

There are a few remnants of the previous village's residencies namely old thatched roof cottages and huts. Mostly now in MS 5050 the houses have been demolished and stronger ones built. The Maaken Range provides all the material Ruanon builders require and the forest gives them the timber they need. The homes are of a similar design, some are single storey, some are town houses with more than one, yet they all share grey stone walls and either timber or black slate rooftops.

There are no opulent residences in the town yet, since it does not quite have the financial income to support the nobility, or the correct social structure. The only true affluent residents are the mayor and the Baron Oren himself.

Shops and Services

There are a few shops in Ruanon, these are mostly geared towards selling mining equipment, general supplies, food, vegetables and the luxuries that the townfolk have come to know such as good quality clothing and sundry items. There is one dwarf blacksmith who does a roaring trade as a smith and armourer. This is just a sample of some of the shops and services in the town.

Bryony: In a small flat building lives a clothes maker who calls herself Bryony. She hails from Sommerlund, was born in Ruanon and has looked after her family business ever since the village began to transform to a town. She is a soft spoken, short haired, dark eyed, plain featured woman with a scar under her left eye. She sells good quality clothing from her home and resents the newly opened clothing store that she sees as trying to take away her business.

Ruanon General Wear: A large two storey clothes shop has recently opened in the town to serve the growing population's desire for bigger and better things. This shop is not above underhanded tactics to force the little businesses out of its territory. Bryony has been the subject of such tricks recently and it has turned many of her customers against the store. The current manager, Meryl D'Val is the wife of the Captain of the Guard, Jerem. She is a sly, snide middle aged woman. She uses her position as his wife to enjoy a better social status than she deserves.

Ruanon General Store: A friendly place to shop, it sells all kinds of tools, sundry items and things that the townfolk can not live without such as metal buckets, chains, rope, soap, nails and hammers. It fulfils the function of an ironmongers as well as a general store, many of the tools are crafted and sold to the shop by the local blacksmith. It is run by a husband and wife team, a friendly enough couple

who are in their late forties. Jen and Alan Tilden work hard to give their customers a pleasant place to shop and keep their store fastidiously clean.

Ruanon Grocery: Vegetables grown from the local farms are sold here in this store. It is a large building that is twice as long as it is wide. It has many aisles packed with groceries and some of the finest, plump tomatoes in all of Sommerlund are sold here. It is tended by a staff of six people and the owner, Gehla Hanar is a dwarf woman who has a knack for clever patter and a sharp eye for a troublemaker. She helps gather the crops in the local farm and likes to get her hands dirty. She is also a member of the town militia and can be called into active service along with the blacksmith, who she has a romantic interest in.

Ruanon Bakery: The most prominent bakers in Ruanon Town is run by Marlyn Rhyen. He is a young man with a talent for making excellent pastries and baking soft and delicious bread. His bakery is attached to the local windmill and he makes sure he does his fair share of work in both places, that way, according to him; he can ensure that his baked goods are the finest in the town. He has won several prizes during the annual town show that occurs during the Feast of Fehmarn.

Bradin Greystone: A dwarf blacksmith and quite a taciturn fellow, Bradin has a craggy face and close-cropped beard compared to most dwarves. He dresses in a thick protective leather apron and operates a smith and forge built into his modest house near the headquarters of the Ruanon mine company. He makes armour, weapons, shoes horses and even builds iron work for the townfolk as long as they pay him enough. He will accept goods and services as well as hard coin. He knows of Ghela's affections for him and he is starting to think that she might make a good wife.

Butcher Reece: This is the primary port of call for all meat related produce in Ruanon. Reece is a friendly portly man with a loud voice and a wicked sense of humour. He tends to engage in the local

faire and enters the strongman contest; which he has won three years in a row so far. His shop always doubles its business during this time since he offers a variety of special sausages made just for the faire and his pork, pickle, cheese and onion pies are always sure to go down a treat.

The Miner's Rest Inn

In MS 5018 a large flat single-storey inn was constructed of thick Ruanon timber and heavy Makken stone. After it was damaged due to a fire in one of the rooms, the inn was rebuilt as a two storey building and had the majority of its timber roof replaced with dark brown slate, a rarity in Ruanon, imported from Casiorn. It serves as the focal point for travellers from all across Sommerlund and Vassagonia and so forth. It is run by a father and daughter team, Triss and Mikel Storn who have looked after it for five years since it changed hands in MS 5045 due to the death of the previous owner. The expansive taproom is often full of people who come to hear Ana sing and Omer play. There are many tall tales told here and the fantastic escapades of the Kai often make up the brunt of the storytelling.

The Lucky Ore Tavern

This single storey, slightly gaudy (for Ruanon standards) tavern is always packed with customers for local miners and visitors from miles around flock to the establishment to bathe in the perceived radiance of a piece of iron-pyrite that is set smack-bang in the centre of the taproom. This 'fool's gold' may appear to be worthless but since moving it from a mine shaft where it was found in a pool of sunlight, the proprietor, a miner's daughter by the name of Karyn Val has had nothing but good luck. In fact come MS 5054 when Barakka attacks, the tavern is actually left unscathed and Karyn escapes with her life. It is a jovial place and fairly bawdy at times. Karyn, a slightly plump but pretty woman with a wicked sense of humour, blonde hair and sparkling blue eyes, tends to her customers in a friendly and sometimes flirtatious manner. It seems to suit the atmosphere of the Lucky Ore. Some say the rock is blessed by Kai some say it is just a piece of worthless stone.

The Ruanon Mine Company

This large building, made mostly from heavy wood and a few choice pieces of dark grey stone, is the headquarters of the mine company in Ruanon. It provides miners with a place to stay for free, gives them food and drink and cut-price purchases on mining gear and repairs. It also serves as a place where claims can be made inside the mountains and disputes can be settled by the local Mine Chief, Dungar Steelbrow. A hefty set dwarf who brooks no argument, he is a friend of the baron and enjoys a high status in the town due to his connections and excellent track record at the mine. He is always looking to hire guards to protect the rare ore shipments and minerals that are brought back from the Maaken Mines. He is currently dealing with a small cave in that happens in MS 5050 that tests his ability as a negotiator to the full.

The Windmill

The current miller, Arturo Nels is a big man, tall and well built. He can carry many sacks of flour at a time and he has a sonorous booming voice that carries quite well. He looks after the large windmill that is close to the bakery and works in tandem with the local baker. Both men do their fair share of the work and Arturo is also extremely good at fixing the mill should it decide to break down. The mill is quite a large building and has four sails that rotate to power the large mill stone and produce flour. It is also said that the mill is haunted by the ghost of the previous owner, a woman who took her own life when she found out she was unable to bear a child to her husband. The mill is known to stop and start erratically and Arturo has heard the odd sobbing sound in the night coming from the millstone room.

POPULATION

In MS 5000 Ruanon had around 3,000 people living and working in the village. It has increased in the last 50 years to nearly 5,000 people with an influx of workers coming from as far as Vassagonia and remaining to build lives for themselves

beyond the various jobs and tasks they came to do. During the Feast of Fehmarn the population can increase by at least 200 to 300 more people as revellers come to partake of the town's specially brewed wine and a limited run of a special produce from the baker and butcher.

CULTURE

The most important time for Ruanon is the Feast of Fehmarn; this is a time for the miners to down their tools and the town to revel. During this feast the town also holds a local faire where the bakers, butchers and farmers are invited to show their best. Talent contests are held for musicians, artists, singers, dramatists and there is even a Strongman contest, so far the butcher has been the only one to win it three years in a row. The baker makes special bread during this time, known as Sunbread which has a rich flavour and is emblazoned with the rising sun. The feast is also a time when all grievances are heard by the Baron in his castle and he holds an open court there for such things. It is also traditionally a time when the town holds elections for new government officials, such as the Lord Mayor.

A massive pole with a golden sun emblem is erected at the centre of the town square during this time. The pole has numerous ribbons of red and gold attached to it and the townsfolk dance around it clockwise, entwining these ribbons just as the warmth of Kai entwines their souls. They traditionally sing a small song whilst doing so.

'Around, around, the sun we go, not widdershins or bad luck will flow. Love to Kai and love to all, on the Feast of Fehmarn's call.'

This is also a time for young couples to propose and married couples to reaffirm their vows; this is done in the gardens and usually between two Ruanon Oaks that stand there as the sun streams between the branches and creates a natural spotlight upon the ground.

SOCIETY

There is a regimented social stratum in Ruanon Town. The people know that Baron Oren is their liege lord and it is to him that they pledge their loyalty and fealty. His servant the Lord Mayor Kadek Adelson is the voice of Oren to them and they obey the government's laws to the full. Everyone eats pretty much the same but the top echelon of society get the best produce in the city, these would be the baron, lord mayor and the politicians.

Baron Oren Vanalund

A fair man and the father of Madelon, the baron misses his own father a lot and keeps his anger against the bandits in check. He is the de-facto law in Ruanon and the capital, his word is rarely questioned and he always rides with his men to battle should things come to blows.

Lord Mayor Kadek Adelson

A pragmatic and fair man, who is not prone to attempting to grab power like several of his predecessors were. Kadek is a wise counsel to the baron and a shrewd governor. He makes sure that the laws of the town are just and fair and expects nothing but loyalty from anyone he hires or those under his command. He is concerned for the well being of the tailor, Bryony and secretly carries a small flame of admiration for the woman. He is not pleased by the newly opened clothing store and the sharp business practises of the proprietor. It is only a matter of time before he orders the Captain of the Guard to investigate his wife, this he believes will be a true test of the measure of the man.

Captain Jerem D'Val

Jerem is the brother of Remir D'Val, one of the most prominent warriors in Sommerlund's history. Whilst his brother looks after the King's Guard in Holmgard, Jerem enjoys a slightly more sedate post in Ruanon. He is a tall and youthful man with a sharp scar on his left

side from where a Giak pike nearly ended his life and a slight limp from where his knee was damaged by a mace. He is no less a warrior than his brother and is an extremely fastidious man and after hearing reports of his wife's business practises from the Lord Mayor, he knows that one day he will be called to act against her. He longs for that day, just to get the whole sordid mess over with for good or ill.

Ruanon Town Guard

Under the command of Jerem, these stalwart men and women do their best to protect the town against threats from within and without. They are all trained in the arts of the bow and sword and many of them have had extra training as Sommlending Border Rangers to supplement their abilities. As far as Jerem knows there are no bad apples amongst his troops but he is always watchful and expects a high level of loyalty from the guard, which they have so far given.

Politicians

Under the watchful eye of Kadek, these are the movers and shakers, near nobility of Ruanon. Since it really does not have a noble or upper class, these are the closest to it. They handle the affairs of the town that the Lord Mayor entrusts them with and report directly to him. They are regularly rotated during the Feast of Fehmarn unless they have done a sterling job beforehand. They are always taken from the citizens of the town and those who have a good track record and have not been in trouble with the guard are good candidates.

Townsfolk

These are the core of the town, the lifeblood and heart of Ruanon. They range from the common folk, workers, taverners, farmers and so on to the shop owners and lamp lighters. They are a colourful bunch of people and many of them are also enlisted members of the Ruanon Town Militia. There are no slums or hovels in Ruanon; the poorest of the folk here are pretty much given a roof over their heads since they can work at

the mine as long as they have a strong back and arms.

Miners

These folk come from all across Sommerlund, from neighbouring countries and even from the hardy stock of Ruanon itself. They work tirelessly in the mines for decent pay and a good roof and meal. They are a stalwart bunch and prone to becoming involved in trouble and several fights over trivial matters. They will also down tools over any perceived insult from their employers.

Ruanon Town Militia

They are often looked down on by the town guard and certain criminals but the militia are there to fight when called. They comprise anyone who can use a sword or bow, anyone who has an inkling of battle knowledge or who pledges themselves to protect the town in times of danger. Some say the folk that join are mad, since for little pay, they can be exposed to great personal risk.

GOVERNMENT & LAW

Baron Oren makes the laws that he passes down to the Lord Mayor, who in turn passes them to the Politicians who finally hand out letters or summons to the Captain of the Guard. The law in Ruanon is swift and brutal for those who break it. Should an individual be caught stealing then they are incarcerated in the Watchtower dungeons before they are sentenced, this can range from a warning to fines, to an enforced stay in the Maaken Mines to work off their debt. Murder is investigated to the full and the guilty are taken outside of the city and executed, there is no pomp and circumstance since the baron does not believe public executions are the way forwards.

Impersonation of a town official carries a penalty of fine, exile and branding. Other crimes are dealt with on a case

to case basis and the sentence varies from severe to light. Should the criminal be a protected noble or someone from a foreign country, then steps are taken to perform extradition and Oren expects the country to punish the individual to the full extent of their law. Should this not happen, then if the individual returns and is caught again, Oren will weigh the nature of their crime and decide what is to be done with them, regardless of the protocol expected by the foreign government. He gives one chance only.

ECONOMY

Ruanon is rich in ores and gemstones with many minerals. It exports a lot of iron and steel to other countries and regions. The Maaken Iron and steel ores are often made into fine quality weapons and items which provide the town with much needed income. It imports luxury goods from Vassagonia and enjoys a good trade relationship with Casiorn. It also exports wooden items made from the Ruanon Forest to the north, mostly furniture and some household goods.

INTERNATIONAL RELATIONS / REGIONAL RELATIONS

Ruanon enjoys a healthy relationship with the rest of the cities and towns in Sommerlund. It regularly trades wooden items to Eshnar in the east and enjoys a cordial relationship with Vassagonia to the southeast and the City-Sate of Casiorn. It keeps a close watch on the Maakengorge to the south and further beyond that, the war-torn Stornlands. Baron Oren is often concerned about invaders from the southern region and therefore keeps a close eye through

espionage in that area. It is no friend to the Darklords of course but that is a given considering who the Ruanon people are.

Secrets

In MS 5054 a renegade Vassagonian noble known as Barakka will come to Ruanon. This plunges the people into a violent battle and sees the town invaded, Barakka's plan is simple. He kidnaps Madelon, Oren's daughter and plans to sacrifice the woman at the ancient Temple of Maaken. If he had succeeded then Vashna would have been released and all of Lone Wolf's work would have been for naught. Instead he is thwarted by Lone Wolf who is in turn aided in the defence of Ruanon by Remir D'Val who establishes a barricade around the Watchtower. The King's Guard join the Ruanon Town Guard and the militia battling the foe.



LONE WOLF

Available at www.mongoosepublishing.com

TWILIGHT SECTOR

SPACE OPERA¹⁰



Campaign Setting Sourcebook

October, 2009

terrasolgames.com

TRAVELLER

Compatible Product



Fantasy Craft

Fantasy Craft



CRUEVA

**YOUR DUNGEON
YOUR DRAGON
YOUR WAY!**

FantasyCraft

Legendary Fantasy Action
from the makers of Spycraft 2.0

Out Now



CRAFTY

**MASTER
CRAFT**

WWW.CRAFTY-GAMES.COM

Magic of the Inner Spheres

By Maurice de Mare

"The inner spheres, consisting of the planes of air, earth, fire, water, negative and positive energy, are the six spokes to life's great wheel. Without the inner spheres, there is no air to breathe, no earth to walk on, no fire to warm your body, no water to quench your thirst, no life to sustain you and even undead would cease to be."

– Excerpt from "The Inner Spheres, a treatise"

The Inner Spheres is of interest to various practitioners of magic; druids, mages and certain priests all share a drive to explore the Inner Spheres for good or ill. Each day brings new discoveries of lore and magic, a small sample of those discoveries is presented to enrich the campaign.

Magic Items of the Inner Spheres

Glidebane Root

Aura faint transmutation; **CL** 5th

Slot -; **Price** 500 gp; **Weight** 1 lb.

Description

This gnarled, rune covered, blue hued root is about a foot long. As a standard action you can hurl the root at an earth elemental of any size, hitting the earth elemental requires a ranged touch attack. The glidebane root has a range increment of 30 feet. If an earth elemental is hit by the root, it needs to succeed on a DC 18 Will save or its earth glide ability is suppressed for 3d6 rounds. If a glidebane root hits an earth elemental, it crumbles and cannot be used again.

Construction

Requirements Craft Wondrous Item; **Cost** 250 gp

Medallion of Summoned Winds

Aura moderate evocation; **CL** 6th

Slot neck; **Price** 25,000 gp; **Weight** 1 lb.

Description

When this elegant, silver and blue medallion is grasped with all of the wearer's hands, it summons powerful winds to shield the wearer from harm. The winds circle around the wearer's body; they do not impede the wearer's movement and do not protect him from melee attacks. As long as the medallion is grasped, the force of the winds increases each round until they reach the windstorm level. Letting go of the medallion reduces the wind force by one level each round.

Round	Wind force	Ranged attacks Normal/Siege weapons
1st	Moderate	-/-
2nd	Strong	-2/-
3rd	Severe	-4/-
4th and longer	Windstorm	Impossible/-4

Construction

Requirements Craft Wondrous Item, *wind wall*; **Cost** 12,500 gp

Runes of the Inner Spheres

Aura moderate varied; **CL** 7th

Slot -; **Price** 30,000 gp; **Weight** 1/2 lb.

Description

These thin, polished, darkwood disks are each embossed with a single rune representing one of the six inner spheres: the planes of air, earth, fire water, negative energy and positive energy. As a standard action, you can trace you finger along a rune to produce a magical effect. If a rune is activated it fades away but returns

the next day. As a move action, you can connect two disks to create a greater rune. A greater rune is triggered in the same way as a normal rune, once triggered both runes that make up a greater rune fade away, returning the next day. A new set of runes is usually bundled together in purple silk, but there exists a lively trade in single runes.

Rune(s)	Effect
Air	<i>shocking grasp</i>
Earth	<i>magic stone</i>
Fire	<i>burning hands</i> (Reflex DC 11 half)
Negative	<i>ray of enfeeblement</i>
Positive	<i>disrupt undead</i>
Water	<i>obscuring mist</i>
Air + Fire	<i>hypnotic pattern</i> (Will DC 13 negates)
Air + Water	<i>sleet storm</i>
Earth + Fire	<i>summon monster IV</i> , magma mephit only
Earth + Water	<i>soften earth and stone</i>
Negative + Air	<i>death's wind</i> (Fortitude DC 15 partial)
Negative + Earth	<i>draining earth</i> (Fortitude DC 13 negates)
Negative + Fire	<i>coldfire</i> (Fortitude DC 16 half)
Negative + Water	<i>black ice</i> (Reflex and Fortitude DC 13 negates)
Positive + Air	<i>invigorating breeze</i>
Positive + Earth	<i>eternal rest</i> (Will DC 13 negates)
Positive + Fire	<i>searing light</i>
Positive + Water	<i>shining water wave</i> (Reflex DC 13 half)

Construction

Requirements Craft Wondrous Item, *black ice*, *burning hands*, *coldfire*, *death's wind*, *disrupt undead*, *draining earth*, *eternal rest*, *hypnotic pattern*, *invigorating breeze*, *magic stone*, *obscuring mist*, *ray of enfeeblement*, *searing light*, *shining water wave*, *shocking grasp*, *sleet storm*, *soften earth and stone*, *summon monster IV*; **Cost** 15,000 gp

Sash of the Shifting Wave

Aura moderate divination; **CL** 6th

Slot belt; **Price** 2,500 gp; **Weight** 1/2 lb.

This silk sash, which has a deep blue colour, gives the wearer knowledge of several techniques belonging to the Shifting Wave style, as taught by the monks who dwell atop the Black Cape's cliffs. If the wearer succeeds on a trip attack he can choose from the following techniques: 1) Crashing Wave: you violently hurl your opponent to the ground dealing 1d6 bludgeoning damage. 2) Whirling Trip: your fast, whirling movements leave your opponent dazed after being tripped. A DC 15 Will save negates this effect.

Construction

Requirements Craft Wondrous Item, Improved Trip; **Cost** 1,250 gp

Spells of the Inner Spheres

Black Ice

Conjuration [Water]

Level: Sor/Wiz 2

Components: V,S

Casting Time: 1 standard action

Range: 100 feet + 10 feet per caster level

Area: a 20 ft. square

Duration: 1 round/level

Saving Throw: see text

Spell Resistance: Yes

The *black ice* spell covers any surface with a thick layer of heat draining ice. Any creature in or entering the area after the spell is cast must make a successful Reflex save or fall. This save is repeated on your turn each round that the creature remains within the area. A creature can walk within or through the area of *black ice* at half normal speed with a DC 15 Balance check. Failure means it can't move that round (and must then make a Reflex save or fall), while failure by 5 or more means it falls. A creature that falls on the black ice must make a Fortitude save or gain a 1d4 Dexterity penalty. A Dexterity score cannot drop below 1.

Coldfire

Necromancy [Fire]

Level: Sor/Wiz 4

Components: V,S

Casting Time: 1 standard action

Range: 100 feet + 10 feet per caster level

Target: 1 creature

Duration: 5 rounds

Saving Throw: Fortitude half

Spell Resistance: Yes

Black flames engulf the target, burning away the target's life-force. The target must make a Fortitude save or suffer 1d4 Constitution damage for each round the spell is active. A successful save halves this damage. Creatures without Constitution scores are not affected by *coldfire*.

Death's Wind

Necromancy [Air]

Level: Sor/Wiz 3

Components: V,S

Casting Time: 1 standard action

Range: 30 feet

Area: 30-ft. line

Duration: 2 rounds

Saving Throw: Fortitude partial

Spell Resistance: Yes

Drawing from the planes of air and negative energy you summon forth a moderate wind that extends from you in a straight line. As long as the spell is in effect, anyone caught in the area of effect suffers 3d8 + 1 point per caster level (maximum +15) of negative energy damage and must succeed on a fortitude save or gain one negative level as the icy wind drains away life itself. The wind will remain to blow for 2 rounds.

If an affected subject has at least as many negative levels as HD, it dies. Each negative level gives a creature a -1 penalty on attack rolls, saving throws, skill checks, ability checks and effective level (for determining the power, duration, DC and other details of spells or special abilities).

Additionally, a spellcaster loses one spell or spell slot from his or her highest available level. Negative levels stack.

Assuming an affected subject survives, it regains lost levels after a number of hours equal to your caster level (maximum 15 hours). Usually, negative levels have a chance of permanently draining the victim's levels, but the negative levels from *death's wind* do not last long enough to do so.

An undead creature struck by the wind gains 5 temporary Hit Points for 1 hour.

Draining Earth

Transmutation [Earth]

Level: Sor/Wiz 2

Components: V,S

Casting Time: 1 standard action

Range: 100 feet + 10 feet per caster level

Area: 30-ft. radius spread

Duration: 1 min./caster level

Saving Throw: Fortitude negates

Spell Resistance: special

All natural earth and stone in the affected area becomes infused with negative energy and the ground ruptures under the unnatural strain. Traversing the affected area becomes difficult: it costs 2 squares of movement to enter an affected square. The DC of Balance and Tumble checks on affected squares increases by 5. All who touch the affected ground must succeed on a Fortitude save or suffer a 1d6 Strength penalty. A Strength score cannot drop below 1.

Eternal Rest

Abjuration [Earth]

Level: Clr 2, Sor/Wiz 2

Components: V,S

Casting Time: 1 standard action

Range: 25 feet + 5 feet per two caster levels

Area: 50 sq. ft./level

Duration: 1 week/level

Magic of the Inner Spheres

Saving Throw: Will negates
Spell Resistance: Yes

Most often used on the soil of graveyards, *eternal rest* infuses the affected area with positive energy. The remains of the dead in the affected area are warded against easy animation for as long as the spell lasts. Anyone wishing to animate the dead using remains affected by *eternal rest* must succeed on a DC 25 spellcraft check to successfully create undead. Even if the check succeeds, the resulting undead have -1 HP for every HD they possess. Undead touching the affected soil suffer 1 point of positive energy damage for every round of contact.

Invigorating Breeze

Conjuration (healing) [Air]
Level: Clr 2, Drd 2, Sor/Wiz 2

Components: V,S
Casting Time: 1 standard action
Range: 25 feet + 5 feet per two caster levels
Area: 40-ft. radius spread
Duration: 1 round + 1 round per two levels
Saving Throw: No
Spell Resistance: No

A gentle breeze, full of positive energy, flows in a circular manner throughout the affected area. All creatures in the area of effect gain fast healing 2 for as long as they stay in the area of effect. Constructs and undead are not affected by this spell.

Shining Water Wave

Conjuration [Water]
Level: Sor/Wiz 2
Components: V,S
Casting Time: 1 standard action

Range: 30 feet
Area: Cone-shaped burst
Duration: instantaneous
Saving Throw: Reflex half
Spell Resistance: Yes

A wave of light filled water bursts from your hands extending outward in a cone. The water is drawn through the positive energy plane giving it a holy water like quality. The wave of water deals 1d6 positive energy damage per caster level to undead. To all other creatures it deals 1d3 damage per caster level.

Comics are now only a click away!

Hundreds of comics are now available for download from Clickwheel.net, including current and back issues of *2000 AD*, the *Judge Dredd Magazine* and much, much more!

Download the FREE Clickwheel Comics Reader from the Apple App Store to your iPhone or iPod Touch to access comics anytime, anyplace.



iPod + Thrills

Welcome to the future, Earthlets



Exclusive!

2000 AD HALLOWEEN SPECIAL

Visit Clickwheel.net now and download this exclusive **2000 AD** collection. Featuring 6 classic spine-chilling stories including Judge Dredd, A Love Like Blood, Durham Red, Fiends of the Eastern Front and more!

Download it now - if you dare!

The Goblins of Genertela

By Shannon Appeldine

Red elves (called “Slorifings” by Aldryami, who know better and “goblins” by peasants, who do not) are a little-known and little-seen cousin to the more common green and brown elves of Genertela. This hybridised elf race was introduced in *Elfs: A Guide to the Aldryami*. Therein you can find an overview of their nature (pages 10–11), some discussion of their philosophies (pages 25–26), characteristic generation rules (page 59) and a few red elf backgrounds (pages 62–64).

However, *Elfs: A Guide to the Aldryami* does not describe any red elf communities, largely because the greatest of those are all in Pamaltela, in the great swamps to the west and east of that continent. Most reds elves thus lie far from the realms that are the central focus of *Glorantha: The Second Age*.

However, there are exceptions. This article examines those red elves who live far from their original home by offering a better understanding of where they can be found in Genertela, including a specific example of a community: the Sodal Marsh in Ralios.

Finding Red Elfs in Genertela

Though most elves live in Pamaltela, they can still be found in small numbers in Genertela if one knows where to look. There are two ways in which red elves will typically be encountered on the northern continent.

First, as discussed in *Elfs: A Guide to the Aldryami*, they might be wanderers or mercenaries, travelling across Glorantha because of instinctual needs. Currently it is a time of “springing,” which means that red elves are compelled to travel, to seek out and to settle new lands. Other peoples may see this as curiosity but in truth red elves are driven by their natural urges to find new places where they might expand their species successfully.

These tribes of red elf wanderers are usually led by a “Nythini” – the much-respected red

elf species known colloquially as “goaders” or “danger seekers.” They embody the risk taking of the red elves and are able to taunt their fellows into visiting unknown lands for the worst reasons.

Second, red elves have indeed settled across Genertela. This is perhaps their greatest secret, for they often remain hidden. This is because red elves are drawn to the least desirable parts of the world – the dark ravines, the dank swamps and the algae-encrusted ponds. Even when they take more desirable lands, red elves have a unique ability to remain unnoticed, which is helped by the fact that most of their Genertelan homes are very small. As a result of these factors, most Genertelans would be shocked to learn that a clan of red elves probably lives within a few days’ travel of them – but their shock would turn to disinterest when they learned such a clan is typically just 2–20 members in size.

Chaos has been one of the biggest constraints upon the red elves’ expansion in Genertela, for it often hides in the same swamps and fens that red elves like the most. Though the red elves do not avoid chaos, they are often destroyed by it. If it were not for chaos, the typical red elf clan in Glorantha would probably number in the hundreds, not the tens.

Placing Red Elfs in Existing Campaigns

You could easily locate a small clan of red elves within any of the major settings published to date for *Glorantha: The Second Age*:

- Blood of Orlanth – A small clan of red elves could be found in the marshy lands near Sky End Lake.
- Dara Happa Stirs – There is a long history of red elves in the lands of the sun worshipers. They first settled the land in the wet, dark days after the Flood. Some still hide along the Oslir River and its tributaries, though only in very small numbers, to avoid the all-seeing eye of Yelm.

- Fronela – Relatively large clans of red elves (topping 100 members in most cases) live in Dilis Swamp, just west of Sog City.

However, there is one Second Age locale that has received more detail than any of the others: Ralios. The lands of Safelster are described in *Glorantha: The Second Age*. Eastern Ralios and Northern Ralios (including the elf forest of Ballid) are detailed in the recently released *Ralios*. You can also read about the locales of Dangk and Hrelar Amali in “Breaking the Stone,” a two-part adventure that ran in *Signs & Portents* #58 & #59.

This article builds on the Second Age Ralios setting by detailing a red elf community in the same area.

Sodal Marsh

‘Why do we give them the swamps? It is because nothing pure grows there, nothing clean. The swamps are hybridised lands, split between the Grower and the Taker. They are red lands where life and death rule together and so it is only fitting that they are tended by a red race. But if you would like them, Man, we would not object, for you are a hybrid too.’

–Terinia Softwood,

Mreli Philosopher

Sodal Marsh is a flood plain covering approximately 10,000 square kilometres in western Ralios. It centres on the Tanier River and around Lake Bakeel – although the crystal-clear water of the lake keeps the northern area of the Marsh much fresher than the rest. The size (and depth) of the marsh varies based on the time of year. It is the least passable when the Tanier overflows its banks, which often occurs during Storm Season.

The marsh sits atop an important trade route between the cities of Safelster – to the east – and the fertile lands of Tanisor – which lie in the bowl of the Tanier River to the west. The flat-bottomed riverboats of the Safelsteran city of Kustria are the most active along the route.

New Red Elf Backgrounds

Background	Basic Skill Bonuses	Advanced Skills	Starting Money
Slorifing 'Red Elf' (Chutti)	Perception +10%, Persistence +20% Pick Two +15% First Aid, Lore (Animal), Lore (Plant), Lore (World) Pick One +10% Blowgun, Dodge, Staff	Language (Slorifing Variant) +50%, Life Sense Pick Three Healing, Lore (Astronomy), Lore (Geography), Lore (Philosophy), Lore (Regional), Lore (Theology), Martial Arts	1D6 silver
Slorifing 'Red Elf' (Nythini)	Athletics +10% Persistence +15% Resilience +15% Pick Two +10% Dodge, Perception, Riding, Stealth Pick One +10% 1H Axe, Blowgun, Dagger, Spear, Throwing	Language (Slorifing Variant) +50%, Life Sense, Survival Pick Two Disguise, Engineering, Lore (Any), Mechanisms	1D6x1D6x10 silver
Slorifing 'Red Elf' (Thorsteni)	Influence +5% Persistence +10% Resilience +10% Pick Three +15% 1H Axe, 1H Sword, 2H Axe, 2H Sword, Blowgun, Dagger, Dodge, Polearm, Shield, Sling, Spear	Language (Slorifing Variant) +50%, Life Sense, Lore (Chaos), Sense Chaos Survival	4D6x50 silver

Trading boats usually stay toward the centre of the Tanier, though that boundary can become unclear as the river overflows. When boats stray too far from the steadily flowing water of the Tanier, they can encounter some of the less pleasant denizens of the marsh, which are described later. Sometimes, there is also the opportunity to interact with the Marsh's most spurious inhabitants ...

The Red Elfs of Sodal

Sodal is one of the larger marshes in Genertela and one of the least chaos infected, thus it should not be a surprise that it houses one of the largest red elf communities on the continent. Despite this claim, the goblins' numbers rarely exceed the 1,000 mark, which still makes Sodal considerably smaller than the red elf communities of Pamaltela.

There are five species of red elfs found in the marsh. As with red elfs across Glorantha, each of the species is notably differentiated

from the others but they still work together as a unified society. The five species are:

The Thorsteni: A unique species of red elf found nowhere else in Glorantha. They are killers and hunters of chaos and they are the primary reason that Sodal Marsh, which was renowned for its chaos monstrosities in the Dawn Age, has now become one of the least chaotic marshes in Genertela.

Their own lore claims that their species had become extinct in Glorantha during the Darkness but was discovered by Arkat during his HeroQuesting and brought back to aid in his conquest of Ralios. Thus, they are one of the few elf races in all of Glorantha that thinks fondly of the troll-loving, light-hating hero of the west.

Because of their role as the warders of the swamp against Oblivion, the Thorsteni are the natural leaders of Sodal.

The Orveltor and *The Scythanni*, two of the most common species of red elfs, take on

their normal roles as warriors and hunters in Sodal. In these roles, they tend to support the Thorsteni upon chaos hunts, acting as minions and fodder.

Oddly, the Orveltor in Sodal Marsh are sometimes born with 1–6 extra arms. This does not seem to be a chaos mutation but it has led to tales of there being many of the chaotic krashtkid in the swamplands, when there are actually very few thanks to the efforts of the Thorsteni. As noted later, the red elfs use these tales to their advantage.

The Nythini have some presence, as is typical for any red elf enclave that lies near the lands of other races. These Goaders, or Danger Seekers, are always testing the resolve and limits of their society. Because of the danger of their occupation, there never tend to be more than 20–30 Nythini living in Sodal at any time.

Finally, *The Chutti* entered the marshes several hundred years ago, springing from

The Goblins of Genertela

Dilis Swamp in Fronela. They tend to be philosophers. They have brought some of the ideas of the west with them, including a strict caste system, which is almost irrelevant among the differentiated red elves.

All of these red elves may be generated using the “average” red elf stats (see *Elfs: A Guide to the Aldryami*, page 59). There is a 10% chance that an Orveltor born in the marsh has 1d6 extra arms. Increase its DEX by that much but decrease its CHA by a similar amount: it will be distrusted in civilised lands that fear chaos (though it is not actually chaotic).

The Orveltor and Scythanni species backgrounds have already been published (see *Elfs: A Guide to the Aldryami*, pages 64–65) but new backgrounds for the other three species.

Monstrous Denizens of the Marsh

The red elves are not the only denizens of Sodal Marsh. As “RuneQuest Elf Monsters” noted in *Signs & Portents #67*, crocodiles, dinosaurs and snakes are just a few of the more dangerous animals that can be found in swamps. Any other type of reptile or amphibian might be equally appropriate.

In Genertela, chaos is another problem in swamps. Though the vast majority of chaos in Sodal Marsh is slain by the Thorsteni, it still constantly seeps in from nearby lands. In particular, there is a small clan of krashkids (see *RuneQuest Monsters II*, pages 88–89), thanks to the nearness of the Underworld to this swamp.

Finally, Sodal Marsh was a home to giant monsters before the Dawn, including gargantuan dinosaurs, lizards and other beasts. They have been slowly dying out but a handful still survive. One of them is described here.

Stherguff, the Dinobeast

Stherguff was born in the long-ago Red Age, when the powers of Glorantha had not yet decided how things would be constructed.

He was one of the first dinosaurs and thus had many characteristics that would be fully realised by saurians that came after him. Among these were the wicked tail and protective spine plates of the Stegosaurus, the horned head of the Triceratops and the armoured body of the Ankylosaurus.

There were also two other attributes that made Stherguff unique among his kind: a brilliant intellect and the power of speech. Unfortunately, that intelligence is now very muddled, for Stherguff has grown old and senile. His speech is less frequent, too, as a result. Nonetheless, he remains an exceedingly dangerous beast.

The red elves know to stay clear of Lake Bakeel when Stherguff is foraging for his omnivorous diet of whatever gets close to him. Few would be foolish enough to actively seek out Stherguff, except perhaps for members of the EWF, who have their own theories about the relations between dragonewts and dinosaurs and would love to test them against one of the oldest and greatest dinosaurs in Glorantha. Some scholars might also be interested in seeking out Stherguff for the ancient knowledge that he holds – though in this Age it is difficult to get the beast to speak.

Characteristics

STR	71
CON	54
DEX	7
SIZ	131
INT	11
POW	27
CHA	2

Stherguff Hit Locations

D20	Hit Location	AP/HP
1–2	Tail	18/37
3–4	Right Hind Leg	14/37
5–6	Left Hind Leg	14/37
7–10	Hindquarters	18/38
11–14	Forequarters	18/39
15–16	Right Front Leg	14/37
17–18	Left Front Leg	14/37
19–20	Head/Neck	22/37

Weapons

Type	Weapon Skill	Damage
Horn Gore	70%	1D10+4D12
Tail Smash	80%	5D12

Stherguff may attack with both weapons as a single combat action provided he has two different targets.

Special Rules

Combat Actions: 2

Strike Rank: +9

Movement: 6m

Traits: Dark Sight, Poison Immunity, Trample (4d12)

Skills: Athletics 150%, Lore (Animal) 50%, Lore (Philosophy) 25%, Lore (Regional) 90%, Lore (World) 50%, Perception 45%, Persistence 99%, Resilience 110%

Typical Armour: Plated, Armoured Back (AP 18 Forequarters, Hindquarters, Tail, no Skill Penalty), Plated, Armoured Thick-Boned Head (AP 22 Head, no Skill Penalty), Tough Hide (AP 14 Legs, no Skill Penalty)

Locations within the Marsh

The lands of Sodal March are constantly changing, as the currents move and plots of earth rise above and fall below the stagnant waters. However, the following notable locales are at least somewhat constant.

1. Uffled's Fence: A kilometre-long dyke that keeps the Marsh from spreading into the city of Dangk during the flood season. Sometimes the red elves of the marsh pick away at the dyke to try and expand their domain, while the peasants of Dangk constantly build it back up. (See *Glorantha: The Second: Age*, page 128, and *Signs & Portents #58*, pages 28–38, for more on Dangk.)

2. The Toll Booth: A small fortress made of mud, rock and vine usually looms over the Tanier River where it enters Sodal Marsh. Sometimes it is empty but more often it is home to somewhere between 6 and 12 Orveltor red elves – who are much more willing to divulge their presence than most red elves in Genertela. They demand toll from any boats coming down the river from Lake Safelster.

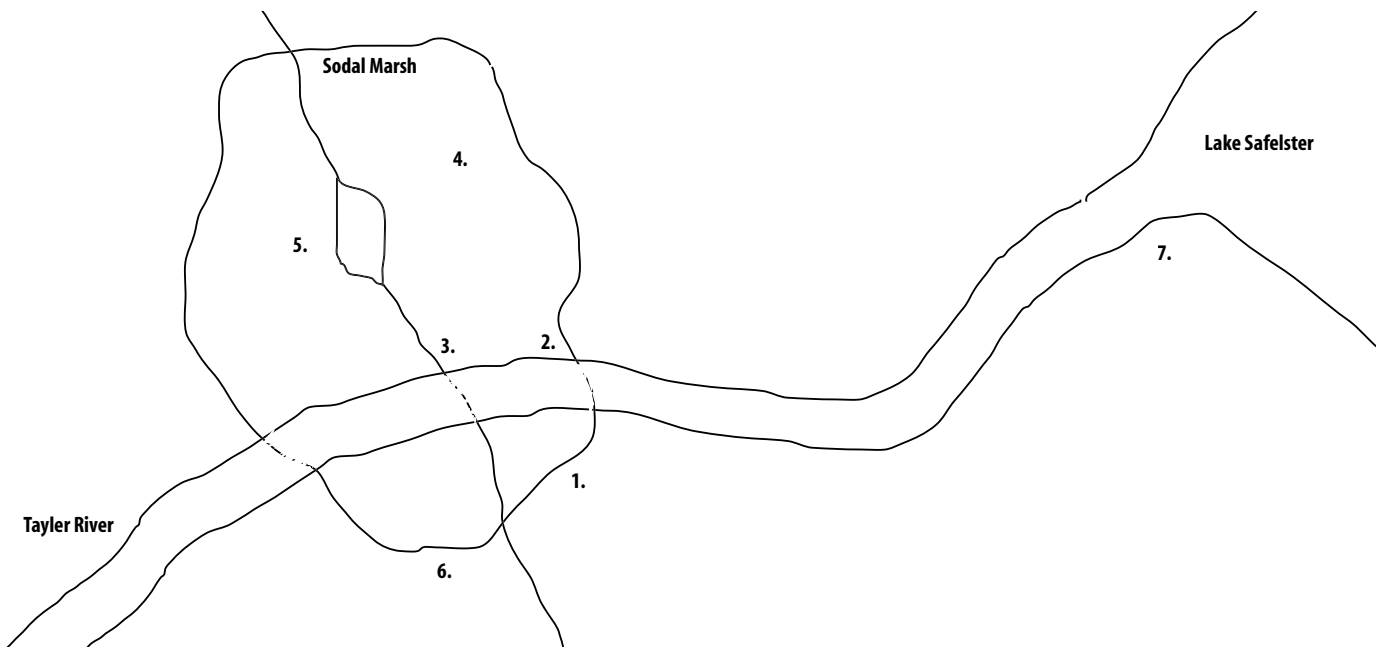

This toll can take just about any form. If something is shining, interesting or unique, the goblins will take it. It does not need to be particularly valuable. In return for this toll, the goblins will assiduously describe everything they know of the current state of the Marsh, including strong currents, the location of notable monsters and even (on occasion) where particularly valuable plants have recently bloomed. Any information they offer is 75% likely to be correct.

The goblins do not directly attack those who refuse to pay them but the penny-pinchers are likely to have a bad day in the swamps, as the Orveltors will incite crocodile, alligators and other beasties to attack the boat and may guide the boat (from beneath) into strong currents that will take it far off course.

3. The Crossing: The spiritual heart of the swamp lies where the Tanier River branches off smaller tributaries running down toward Dangk and up toward Lake Bakeel. Physically, the exact location of this nexus is hard to ascertain but any one boating to the swamp can *feel* it as they approach, because an aura of claustrophobic depression begins to settle upon everyone and everything.

The Crossing is inhabited by a particularly ancient limnade (a species of Naiad, as discussed in *RuneQuest Monsters*, pages 97–99) named Green Moss. She knows all Fertility, Water and Death rune magic and is also a rune priestess of Sludj, Gata's secret daughter who rules over swamps.

Green Moss can usually be appeased by an offering of fish – or some other fresh food – left as a boat approaches The Crossing. However, there is a 1% chance during any visit that she will surface and demand more.

If boaters do not make an offering to Green Moss at all, there is a 25% chance that she will not notice and a 50% chance that she will assault the boat, calling upon the animals of the swamp and the red elves alike and using her own nymph powers to try and overturn the boat and/or drive it back in the direction it came.

Green Moss is also a powerful source of information about the marsh. She knows most of what has gone on in it for the last 1,000 years (or more). She is willing to answer questions for seekers but she usually requires additional payments, sometimes in precious metals and gems, sometimes in quests that are required for the good of the marsh.

4. The Council Pool: The red elves of Sodal Marsh do not have petitioners very often. That is partially because they are not that powerful, even here in their own home, partially because they do not really encourage people to treat with them and partially because they make visiting them pretty unpleasant.

The Council Pool is located in the northern part of the Marsh, as far as possible from the rivers and the marsh boundaries. Even when the Tanier is not flooding, this area is muddy and sodden. Knotted trees and vines make it particularly hard to move toward the pool (though the goblins have no trouble slipping between the trunks with alacrity).

The Council Pool itself is dark and rancid. It smells foul but nothing smells worse than the “king” and “queen” of the Council, both inanimate simulacra formed from the smelliest mud, vines and gourds – created long ago in mockery of a similar farce in the nearby Ballid Elf Forest (see *Ralios* pages 34–35). Sometimes visitors find themselves speaking to these “beings” alone.

Most of the time, however, the red elves themselves will deign to speak with foreigners. When they do so, a ‘knight’, currently the Thorsteni Gulbak, and a



'priest', currently the Chutti Ralloo, join the two "greater" nobles. These two are the true leaders of the marsh, for the purpose of speaking with outsiders.

Gulbak and Ralloo would rarely accede to requests that would require any elves to leave the marsh but they are sometimes willing to offer protection to outsiders entering the marsh or to trade requested goods. They might ask almost anything in return, from the seemingly useless, to that which is greatly prized.

5. Lake Bakeel: A crystal-clear lake fed by the northern branch of the Tanier River. It's clear, potable water – lying in the middle of a swamp – has created legends that it has healing powers. This may or may not be true but the ancient creatures that live within the lake are actually the source of its purity. Stherguff, the Dinobeast, is just one. Some of the other inhabitants of the lake are equally monstrous, while others are simply notable for their longevity.

The red elves of the marsh steer clear of the lake, while Green Moss is magically barred from it.

6. Krasht Altar: The muddy land of the marsh is a soft spot in Gata's mantle. As a result, one can burrow down through it straight into the Underworld. For this reason, the Marsh was a haven of krashtkids throughout the Darkness. There is still a constant influx of these chaos monsters but there are very few who now permanently dwell in the swamp, thanks to the work of the Thorsteni, aided by an elaborate ruse maintained by the red elves.

A cult of krashtkid worshippers called "The Dark Teeth" has dwelled in this area as long

as there have been humans in Ralios. It may have originated among discontents among the native Galinini people. The cult now lives in secret in the city of Dangk. They meet once a season at their altar, a rough arrangement of stones at the edge of the marsh which has enchanted with rivers of blood over the ages. They come here hoping to see their personal demons.

A krashtkid is occasionally drawn to the area thanks to the cult's worship and its sacrifices but their numbers are now few enough that the cult might well have grown discouraged waiting for these scant sightings. Thus the elves of the marsh have been forced to take on the role of the krashtkids. At most worship days, a band of the many-armed mutant Orveltor will cavort in the distance if no krashtkid appear – looking in silhouette enough like the chaos beasts to fool distant observers.

On the other hand, if a krashtkid *does* appear, the Thorsteni are ready for that eventuality. Ambushing the chaos beasts attracted by the evil ceremonies is *much* easier than hunting the beasts through the swamps, and thus the red elves consider the krashtkid worshippers a useful tool. (The citizens of Dangk would probably think otherwise.)

7. The Secret Swamp: The goblins of Sodal Marsh set up a secret enclave in the flood plains west of Lake Safelster near the end of the First Age, when Arkat caused great chaos in the region. Unlike Sodal Marsh, this secret swamp has traditionally been led by the Chutti, with the philosopher "Listens to the Speech of Men" the current leader. He is an odd goblin who has taken on many habits of humanity. He also constantly sends out scouts to the nearby cities to spy on the churches there.

Though the Secret Swamp only numbers about 35 red elves, the nearby city-states would probably be very unhappy if they learned of the goblins that are practically in their midst.

Bibliography

This book mainly drew on the books listed below, though some inspiration came from the archives of various *RuneQuest*-related online mailing lists.

"Breaking the Stones", *Signs & Portents #58*, Mongoose Publishing, 2008. This article provides some details on the Sodal Marsh as it relates to the nearby city of Dangk.

Elfs: A Guide to the Aldryami, Mongoose Publishing, 2007. The original elf book contains all of the broad details about the red elves in Second Age Glorantha.

Glorantha: Genertela, Crucible of the Hero Wars, Avalon Hill, 1988. Though long out-of-print, this book remains one of the top resources on the overall geography of Genertela. It's the only place I know of which actually showed the extent of Sodal Marsh prior to this article.

Glorantha: The Second Age, Mongoose Publishing, 2006. Details on all the Ralios lands southeast of Sodal Marsh appear here.

Lords of Terror, Avalon Hill, 1994. I didn't directly consult this book when writing this article, but it's a great source for information on the cult of Krasht if you want to flesh out the Dangk cultists mentioned here.

Ralios, Mongoose Publishing, 2009. Details on the Ballid Forest in this book inspired the red elves' own mockery of the same. It also details the rest of Ralios that didn't appear in the earlier volume.

"Abaddon promises to deliver a whole new generation of dark fantastic fiction. New voices, new nightmares, stylish, powerful and taboo breaking." – Clive Barker



ISBN: 978-1-906735-15-9
£6.99/\$7.99 • Science Fiction

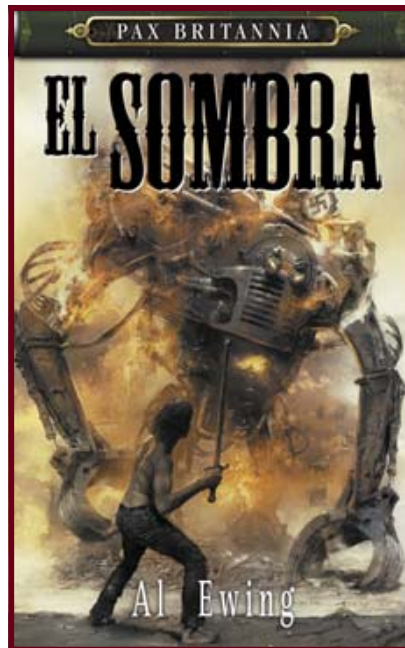

ISBN 978-1-905437-34-4
£6.99/\$7.99 • Science-Fiction

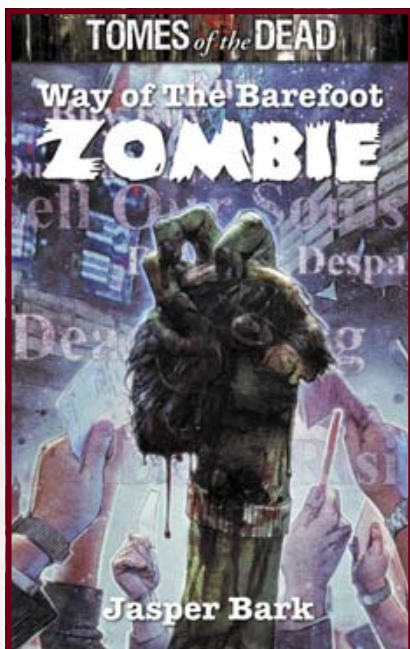

ISBN: 978-1-906735-06-7
£6.99/\$7.99 • Horror

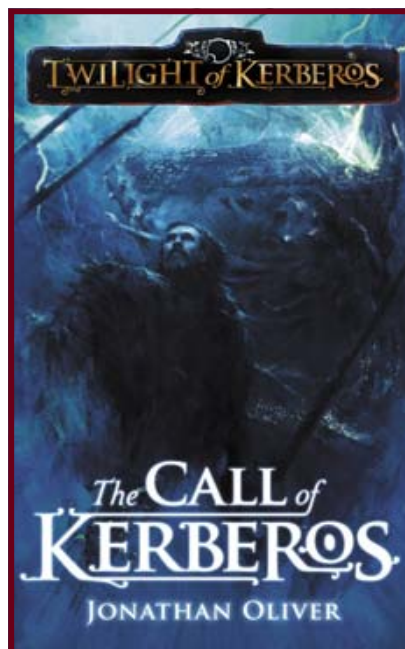

ISBN: 978-1-906735-28-9
£6.99/\$7.99 • Fantasy



AVAILABLE FROM ALL GOOD BOOKSTORES!

WWW.ABADDONBOOKS.COM

Psionic Healing

By Richard Hazlewood

Introduction

Traveller Book 4: Psion does not include rules for Psionic Healing. This article will provide rules for psionic healing and introduce another psion career, the Psionic Healer. Psionic Healing is an advanced talent. The learning DM for this talent is -1.

Psionic Healers do not use their psionic powers to heal another person, called the patient. The healer uses their psionic abilities to cause the patients own body to heal itself. As such, the Healer must be in physical contact with the patient. Skin to skin contact is required for any of the healer's abilities to be used. If direct physical contact with a patient would normally cause damage, then the Healer would suffer that damage. Psionic healing may be used by a psion on himself; however, Mental Healing may not be used by the psion on himself. Since the patient is healing themselves, during the healing process they need to eat twice as much food as normal, in certain situations, this condition may be important.

Healing

The advanced psionic talent of Healing allows a psion to use a patients own natural healing ability to heal themselves. Healing has no range and the psion must physically touch the patient to use this talent.

Triage

Using a Significant Action during combat, a Healer can perform the psionic equivalent of First Aid on a patient. See Medical Treatment in the *Traveller Core Rulebook*. One important aspect of Triage is that it can be used to completely block pain. Any limitations on actions by the patient due to pain would not apply after the patient had been triaged. The Psion expends 1 PSI point to administer the Triage. Medic skill may be added as a positive DM to the roll.

Triage a Patient: Healing, Psionic Strength, 1-6 Seconds, Average (+0). Cost: 1 PSI.

Physical Healing

Patient wounds and injuries may be healed rapidly. The patients Strength, Dexterity and Endurance lost to injury, disease, poison or other trauma may be healed using this ability. The psion expends 3 PSI points and can heal 1d6 points of damage to one characteristic at a time. Multiple healings to a characteristic may be made but if the rolled amount of healing exceeds the amount of damage to that characteristic, then the additional healing points are lost. This ability may not be used to restore permanently lost characteristics. Medic skill may be used as a positive DM to the roll.

Heal 1d6 Physical Damage: Healing, Psionic Strength, 10-60 Minutes, Average (+0). Cost: 3 PSI.

Mental Healing

Psionic Trauma and mental instability can be healed. The process to heal mental damage is long and complicated but a psionic healer can heal mental illness faster and more completely than normal psychological techniques. Psionic Trauma is healed at a cost of 10 PSI points to heal each level of psionic trauma. Psionic Trauma is explained in detail in *Book 4: Psion* under Psionic Trauma. Mental Instability can also be healed with this ability but the process is significantly more involved. The type of mental illness must be defined on the Behavioural Effects table in *Psion*. The dice roll for the particular mental illness is the number of PSI points that must be expended and the number of successful rolls to heal that particular illness. One roll may be made per day. If three rolls are failed in a row, the healing has failed and the entire process must begin again. For example, to heal a patient of Schizophrenia, a 6 on the Behavioural Effects table, requires 6 PSI points be expended for 6 days. If the Psion does not have enough PSI points to complete one days healing at a single attempt, he may split the healing into two or more sessions but each session must be rolled for and successful for the healing of that day to

count as a success. Mental Healing may not be used by a psion on himself, only on others. Skill in Social Science (Psychology) may be used as a positive DM to each roll.

Heal One Level of Psionic Trauma: Healing, Psionic Strength, 1 day, Difficult (-2). Cost: 10 PSI.

Heal Mental Illness: Healing, Psionic Strength, 1 day for each Behavioural Effects roll, Difficult (-2). Cost: Behavioural Effects Roll per day.

Refereeing Mental Healing

The process of healing Mental Trauma should be used by the Referee as a role-playing opportunity. The Healer must actually enter the mind of the patient and help the patient face the underlying cause of the trauma. There have been several science fiction movies and TV shows that have had a character enter the mind of another individual. Movies like *Nightmare on Elm Street* or *The Matrix* can be used as inspiration. The Healer should have to help the patient overcome whatever form their Mental Instability has taken. Severe Mental Instability should present potentially dangerous and frightening scenarios within the patient's mind. The Referee should award DMs based on good, or bad, role-playing as appropriate.

Characteristic Boost

The Psionic Healer can boost the physical characteristics (Strength, Dexterity or Endurance) of a patient for a short time. Characteristics may not be boosted higher than the racial maximum (15 for humans) nor can the number of characteristic points gained exceed the Healers current level of Psionic Healing. The characteristic boost reaches its new level immediately, remains at that peak for 10 minutes and then declines at the rate of 1 point per minute until the normal level is reached. This power works as normal on wounded characters but their Characteristic returns to the wounded level rather than the normal value. It cannot be used as a 'quick heal'.

Boost a Physical Characteristic: Healing, Psionic Strength, 1–6 Seconds, Average (+0). Cost: 2 PSI points per point of characteristic increased.

Rejuvenation

Similar to the basic psionic talent of Regeneration, Rejuvenation allows a healer to help a patient restore permanently lost characteristic scores and to regrow lost limbs or body parts. With the Referee's permission, Rejuvenation may be used to recover lost characteristic points due to aging, providing a psionic form of anagathics. A characteristic may be restored by the expenditure of a number of psionic points per day equal to the new value of the characteristic. The healing proceeds for a number of days equal to the new characteristic. For example, to restore a characteristic from 7 to 8, a psion would have to expend 8 PSI points and make 8 successful rolls. Each day the Healer must make a successful roll and if

the healer fails to make the roll three days in a row the rejuvenation fails and must be started over again. If a psion does not have enough PSI points to expend at one time for a days healing, he may divide it up into several sessions but each session must be rolled for and all the rolls for that day must be successful for the day's healing to be successful. Radiation damage may also be healed with this ability. One psionic point is used to heal one Rad of exposure. Medic skill may be used as a positive DM to each roll.

Restore Permanently Lost Characteristic: Healing, Number of days equal to the new characteristic value, Difficult (-2). Cost: PSI points equal to new characteristic value per day.

Heal 1 Rad of Radiation Exposure: Healing, 10–60 Minutes, Average (+0). Cost: 1 PSI.

to heal themselves. In societies that do not condone psionics, a Psion Healers can hide their ability behind the belief that they are incredibly skilled medics or psychologists. Even societies that fear psions and telepaths will often allow the psionic healer to practice openly.

Qualification: Intelligence 7+
-1 DM for every previous career
+1 DM if Psionic Strength 8+

Assignments: Choose one of the following:

- **Churgion:** You are a Healer from a society that does not fully understand your abilities.
- **Physicalist:** You are skilled in the healing of physical injuries.
- **Mentalist:** You are trained in the healing of mental illness and psionic trauma.

Career: Psion Healer

Psionic Healers are those rare people that can use their mental powers to aide a patient

Career Progress

	Survival	Advancement
Churgion	Intelligence 6+	Education 7+
Physicalist	Education 6+	Intelligence 7+
Mentalist	Intelligence 7+	Education 6+

Mustering-Out Benefits

Roll	Cash	Benefit
1	1,000	Ally
2	2,000	Psionic Equipment
3	5,000	+1 Intelligence
4	10,000	+1 Education
5	20,000	Scientific Equipment
6	30,000	Ship Share
7	50,000	TAS (or Equivalent)

Psionic Healing

Ranks and Benefits

	Churgion	Skill or Benefit	Physicalist	Skill or Benefit	Mentalist	Skill or Benefit
0						
1		Medic 1		Medic 1		Social Science (any) 1
2						
3		Any Science (any) 1		Life Science (any) 1		Social Science (any) 1
4						
5		Admin 1		Admin 1		Admin 1

Skills and Training

	Personal Development	Service Skills	Advanced Education (Minimum Edu 8)
1	+1 Endurance	Healing	Advocate
2	+1 Intelligence	Deception	Life Science (any)
3	+1 Education	Athletics (any)	Any Science (any)
4	+1 Psionic Strength	Medic	Computers
5	Streetwise	Survival	Engineer (any)
6	Melee (any)	Stealth	Leadership
	Specialist: Churgion	Specialist: Physicalist	Specialist: Mentalist
1	Healing	Healing	Healing
2	Streetwise	Medic	Social Science (any)
3	Deception	Life Science (any)	Social Science (any)
4	Medic	Stealth	Diplomat
5	Stealth	Comms	Persuade
6	Talent	Talent	Talent

Healing: Gain one level in Healing skill. Talent: Gain one level of skill in any psionic talent possessed by the character.

Mishaps

2d6	Mishap
2	Severely Injured – Roll twice on the Injury table and take the lower result.
3	You suffer Psionic Trauma as a result of your efforts to help others. Gain one level of Psionic Trauma.
4	You are injured while trying to save a patient. You are exposed to 1d6*10 Rads of radiation.
5	You encounter something that your healing powers cannot heal. Your confidence is shaken and you leave your career in disgrace.
6	You learn something while trying to heal a patient that you shouldn't. Gain an Enemy.
7	Injured – Roll on the Injury Table.
8	Your powers uncover a traitor in your ranks. You cannot prove anything and are driven from your career by the traitor. Gain an Enemy.
9	You save a rogue psion, an enemy or criminals. You are forced to leave your career. Gain the patient as a Contact. Gain 1d3 Rivals.
10	Your talents are exposed and you are forced to flee for your life. Gain an Enemy.
11	You discover that one of your patients has been the subject of government experimentation. Gain an Enemy and 1d3 Rivals within the government.
12	Traumatised – After years of healing other people's trauma, you are psychologically unable to continue. Roll on the Behavioural Effects table in <i>Psion</i> and gain that mental illness.

Events

D66	Event
11	Disaster! Roll on the Mishap table but you are not ejected from this career.
12	You are called upon to heal a vicious criminal or murderer and you are placed in a moral quandary. If you save their life, gain them as an Ally but also gain 1d3 Rivals. If you choose not to save them, you still gain 1d3 Rivals.
13	A friend is attacked for being a psion and you try to heal him. Roll Psionic Strength 8+. If you fail, you have exposed yourself to the same crowd and must roll on the Injury Table.
14	You are sent to the sight of a plague or major natural disaster. Roll Intelligence 8+ or Psionic Strength 8+. If you succeed, gain one of the following: Medic 1, Any Science (any) 1, or Survival 1. If you fail, roll on the Injury Table.
15	A criminal gang tries to recruit you to their organisation. If you accept, you may join the Psion:Rogue career next term without rolling for Qualification. If you refuse, gain the gang as an Enemy.
16	You become very close to one of your associates. Gain an Ally.
21	You are part of an experiment in psionics. Roll 1d6 for the result: 1. Gain +1 Psionic Strength 2. Gain one level of Investigate 3. Gain one of the following: Sensors 1, Comms 1, Engineer (Electronics) 1 or Mechanic 1 4. Roll for a new Talent with a +1 DM on the Learning roll. 5. Gain one level of any Talent you already possess 6. Permanently reduce your Psionic Strength by one
22	You are seconded to the military. Roll for Survival, Skill and Event on the Psion Army, Psion Navy or Psion Scout career tables. You may transfer to that career next term without rolling for Qualification if desired.
23	You are given advanced training in a specialist field. Throw Education 8+ or Psionic Strength 8+. If you succeed gain one level in any skill you already possess.
24	You become involved in a feud between rival psionic groups. Throw Psionic Strength 8+ or Investigate 8+. If you succeed, gain a +1 DM on a Benefit roll. If you fail, roll on the Injury Table.
25	Your healing abilities gain you renown and fame. Gain a +1 Social Status.
26	You serve aboard a space ship or station. Gain one of the following: Vacc Suit 1, Pilot (Small Craft) 1 or Zero-G 1.
31-36	Life Event. Roll on the Life Event Table
41	You are part of a close group of friends. Gain 1d3 Contacts
42	You inadvertently scan someone and discover a deep secret. Roll 1d6 to determine that secret: 1. Has been unfaithful to their spouse 2. Is a traitor to the government 3. Is involved with a criminal gang 4. Is working for a rival interstellar government 5. Is a government spy within your organization 6. Knows the location of a valuable treasure (1d6*50,000 Cr.)
43	You are lost or abandoned in the wilderness and must learn to survive on your own until rescued. Gain one level of Survival or gain Recon 1 or Navigation 1.
44	You are given advanced training. Throw Intelligence 8+. If you succeed, raise any level 0 skill to level 1.
45	The psionic underground contacts you and asks for your help. If you accept, throw Intelligence 8+ or Deception 8+. If you succeed, gain one level of Streetwise or Stealth. If you fail, you must take the Rogue or Psion Rogue career next term. If you refuse to help, gain a +1 DM on your next Advancement roll and 1d3 Rivals.
46	Working in a war zone, you desperately try to save as many people as you can. Throw Intelligence 8+ or Psionic Strength 10+. If you succeed, gain one level of Medic, Healing or Social Science (any). If you fail, gain one level of Psionic Trauma due to the stress.
51	You undertake a course of intense physical fitness. Throw Intelligence 8+. If you succeed, make an extra roll on the Personal Development Table.
52	You are invited to join a psionics advisory board, along with other psions. If you accept, roll 1d6 for the benefits of membership: 1. +2 DM on your next Advancement roll 2. Gain one level of skill with any psionic talent you already possess 3. +1 Social Status 4. +1 Psionic Strength 5. Gain one level of Advocate or Admin 6. Mishap – Roll on the Mishap table but you are not ejected from this career
53	You have the chance to trust another psion. Throw Intelligence 8+. If you succeed, gain an Ally. If you fail, your trust was misplaced and you are betrayed; gain an Enemy.
54	Your work has hardened you to the psionic trauma. If you have any psionic trauma, reduce it by one level. If you have not received any psionic trauma, you may ignore the first level of trauma that you receive in the future.
55	You heal a Noble or other important person. Gain either +1 Social Status or a Noble Ally.
56	You are assigned to a secret project. Gain one level of one of the following: Investigate, Deception, Sensors or Any Science (any).
61	You receive a bonus for your hard work. Gain a +1 DM to one Benefit roll.
62	You spend a lot of time working with very injured patients. Gain a level to your Healing skill.
63	One of your superiors takes an interest in your work. Gain a +2 DM on your next Advancement roll due to their help.
64	One of your patients is very grateful for your healing. Gain an extra Benefit roll.
65	Your work with psionics has exposed you to many different talents. You may roll for a new Talent with a +2 DM on the Learning roll.
66	Your healing talents are greatly appreciated and you are automatically promoted.

BY SIMON BEAL

LEGACY OF WAR

EPISODE 11:
GREAT MINDS

Episode Date: March 2268

"I don't trust telepaths. Never have, never will."

Michael Garibaldi "The Gathering"

Background

Over 1,000 years ago before the last Shadow War, a race called the Taratimude were tricked into service by the Shadows. The physiology of these avian-like beings was extremely adaptable and it was not long before the Shadows modified their organic technology to be used by these new servants.

The Taratimude were prone to fits of emotion and anger and when combined with the subversive nature of the implants it resulted in the Taratimude falling to chaos and destruction. Overwhelmed by the tech, the Taratimude fought each other until little of their civilisation remained.

At the end, a few survivors regained enough self-control to overcome some of these effects and control the tech. The

most notable of these was Wierden, who rejected the Shadow's teachings and with the help of the other survivors formed the order of the Techno-mages.

Rendezvous

As agreed in their previous meeting with Captain Gideon, the players should arrive in the Zafra system at the agreed time. However, when they reach their destination there will be no sign of the Excalibur.

As the players start to get nervous, a small ship will appear in front of them (no jump gate will have opened). It is unlikely that the players would have seen a Techno-mage pinnacle before and as they discuss what it is they will receive an incoming transmission.

Galen appears on the view screen.

"Hello. Unfortunately Matthew couldn't make it so I'm here instead. Standby, I'm coming aboard."

Galen will dock his ship and suggest they all sit down to discuss recent events. If they

ask him how he appeared in front of their ship, he will reply *'I chose to appear when I wanted you to see me.'* Galen will then proceed to explain why he is here.

'The Excalibur was recalled to Mars on a matter of urgency, so Matthew asked me to come instead.'

Dr Chambers and Max Eilerson have been translating and studying the plague data you recovered from Kandar III and the Ikarran's you visited out beyond the rim. This data, together with other information they obtained has given them an understanding of how the plague works.'

In a nutshell, it is a nanotech virus and the best way to cure it is by creating a nanotech anti-virus. Unfortunately our understanding of nanotech is somewhat limited but I have an idea.'

Galen smiles before continuing.

'There used to be a race called the Taratimude. Only my kind has ever heard of them, and that is because they were the very first Techno-mages. Their civilisation was wiped out over 1,000 years ago but one colony escaped complete destruction.'

I believe there could be something on this colony that could help. Techno-mages are forbidden to go there as it is ridden with booby traps triggered by our presence. Since the Excalibur is otherwise engaged, that leaves you go there and investigate.'

Possible questions:

- How was their civilisation destroyed?
'The fate of the Taratimude is unknown.'
- What is there that could help us?
'I could tell you many things that might be there but only by going will you know the truth.'
- Why are you being so cryptic?
'I tell you what you need to know. Nothing more, nothing less.'
- Where is the colony?
'It is a little known system known as Omicron 4, which lies just beyond Centauri space near the rim.'
- Is this world inhabited?
'I do not believe so but due to the aforementioned traps, I cannot say with certainty.'

Once Galen has answered their questions, he will give the coordinates to Omicron 4 and arrange to meet them again in a few weeks time.

Omicron 4/II

Travelling from the Zafran system to Omicron 4 takes eight days in hyperspace. The colony is located on the second planet in the system.

Planetary Conditions

Omicron 4/II is an ocean planet with only four small continents covering less than 20% of the surface. The continents are lush and green with moderate temperatures and frequent rainfall. The atmosphere and gravity are similar to that of Earth and other than heavy downpours there are no extreme weather conditions.

The players will not be able to find or detect any of the Techno-mage traps that Galen mentioned. Likewise, no life signs will be detected due to an unknown source of interference (no doubt a result of the Techno-mage's presence here 1,000 years ago).

Omicron Wildlife

As one would expect, the planet is rich in wildlife. A variety of trees and plants fill the horizon. Cattle graze the plains and a host of creatures lurk in the forests. Fortunately

most of the wildlife is harmless to bipedal races. Aggressive feline creatures prowl in the warmer regions but thankfully the colony formed on one of the cooler and safer continents.

History

This was the furthest colony from the Taratimude home world and thus the last place where their kind unleashed their rage. It was here where Wierden had his revelation and regained a measure of control over the tech.

After convincing some of the remaining survivors that there was another way, Wierden formed the Techno-mage order. For this to work, they had to leave behind their old lives, literally and metaphorically, and so they each left Omicron 4 to find a new home.

Those that Wierden could not convince continued to fight and destroy their last refuge. As the new Techno-mage order departed, they left a number of traps to prevent the destruction from spreading further and end the suffering of the Taratimude.

In 2263, a group of telepaths fleeing the tyranny of the Psi Corps found Omicron 4/II. This little known world was perfect for them but fear of discovery led them to make their homes underground in a cave system near the Taratimude colony.

Colony Ruins

Since there are only four small continents, the colony can be found quite easily. Although it survived the Taratimude destruction, it did not avoid it completely. Many of the buildings have collapsed due to damage and decay. Vines have grown over many of the remains as nature has slowly reclaimed its lands.

The colony is the size of a small town but less than 10 buildings remain intact. Those that have survived are overgrown and gaining access to them is hard work and time consuming.

Obelisk

In the centre of the settlement is a broken stone obelisk. Several large chunks are strewn around the base and only 10ft of it remains standing. When intact, the four-sided pillar stood 30ft high.

Each side has an inscription on it. Three of these are written in the language of the Shadow's, which the players might recognise as the Shadow principles:

- 'Evolution through bloodshed'
- 'Chaos through warfare'
- 'Perfection through victory'

The fourth side is written in the Taratimude language. It will take 1d6+2 hours to translate (but you can reduce this if they have already translated the text on the tomb). The main inscription has been scored through and reads 'In honour of our masters.' Below this an additional inscription has been added in a different style reading 'Victory is fleeting, chaos has consumed us.'

Tomb

To the western side of the settlement is a small tomb that can barely be seen due to the overgrowth, which once cleared will allow the tomb to be examined further.

The tomb is about 7ft long, 3ft wide and stands 2ft high. It appears to be buried several feet into the ground making it just over 4ft in height. There is a short inscription and a glyph symbol on the surface. If scanners are used they will detect very faint life signs from inside the tomb but no other information can be gleaned without opening it.

Unlike the buildings that are made of stone, the tomb is made from an unknown alloy. To force the tomb open with explosives would require so much that it would destroy anything inside.

Translating the Inscription

After 1d6+2 hours of study and a Social Science (Linguistics) check, the inscription can be translated as 'Here lies Lodan. Only death will release me.' The translation time can be reduced if the players have translated the obelisk above.

The last statement has a double meaning. Not only did death release Lodan from his burden but tracing the glyph with blood will unlock the tomb. There is no other way to open the tomb without damaging the contents inside. If the players get stuck here, one of the NPCs can always nudge them in the right direction by mentioning any of the following:

- The tomb is not completely sealed so there must be a method of opening it.
- The glyph must have some significance.
- The inscription is ambiguous. It could be referring to his demise or it could be an instruction.
- It might only require a symbol or representation of death.

Lodan's Remains

Inside the tomb are the remains of Lodan. Only the skeleton of his avian like body remains. Microfilaments interwoven around the spine connect three small organic nodes that now rest on the ground beneath the spine. It is this organic technology that gives a Techno-mage his power and is also what was giving the faint life readings.

An examination of the technology will reveal it to be of Shadow origin. The players

should now have enough pieces of the puzzle to conclude that the Techno-mages use Shadow technology. This is one of the Techno-mages greatest secrets known only to members of the Circle and Galen (who discovered it by himself).

There is also a small silver orb hung around the skeleton's neck. Again, this seems to be some sort of organic technology but the players will be unable to unlock its secrets (only a Techno-mage can do that).

Booby Trap

Once the players have found some of the technology, there is a chance they could trigger a booby trap. The traps are set to go off at the presence of Techno-mage implants or similar technology. This will only happen if the players try to connect or power the items. If they do, a being will be conjured in the likeness of Wierden who will attack anyone with Techno-mage technology or anyone who attacks his image.

Wierden Image

Str: 10 (+1), **Dex:** 10 (+1), **End:** 10 (0), **Int:** 8 (0), **Edu:** 8 (0), **Soc:** 8 (0)

Skills: Athletics (Co-ordination) 1, Investigate 1, Knowledge (Techno-mages) 2, Spell Casting 3, Recon 2, Stealth 1

Spells: Armour (10), Chain Lightning (3d6, -1 for each additional target up to a maximum of three)

Information: Wierden was one of the Taratimude, the bat-like humanoids who were enslaved by the shadows. Wierden's image is surrounded by a blue glow (an armour spell) and holds a staff from which he fires his lightning bolt spell.

Cavern Entrance

The cavern entrance to the telepath settlement is very near to the tomb but has been covered by overgrowth to hide it from prying eyes. If anyone gets too close to this, the telepaths will try to divert them away as detailed later on.

If the players persist, they will discover it on an Investigation check -2 DM. If they proceed to enter the cavern, the telepaths will initiate their test.

The Mind's Eye

The underground caverns that became home to the telepaths are on the western edge of the settlement which is quite near to the tomb. When the players discover the tomb, the telepaths will become interested and allow the players to continue unhindered. When the tomb is opened and the tech revealed, the telepaths will want to know more and will initiate their test.

John (Human)

Str: 9 (+1), **Dex:** 9 (+1), **End:** 8 (0), **Int:** 8 (0), **Edu:** 8 (0), **Soc:** 11 (+1), **Psi:** 11 (+1)

Skills: Diplomat 2, Life Science (Telepathy) 1, Persuade 1, Survival 0

Talents: Blocking 1, Communication 1, Scanning/Probing 2, Sensing 0

Information: John was one of Byron's followers in the lead up to the telepath crisis of 2262. After Byron's death, several factions emerged and John was a popular choice. He is charismatic and many looked to him for leadership. One year later they discovered Omicron 4/II and made their home there.

Sarah (Human)

Str: 8 (0), **Dex:** 7 (0), **End:** 7 (0), **Int:** 7 (0), **Edu:** 10 (+1), **Soc:** 9 (+1), **Psi:** 11 (+1)

Skills: Deception 1, Investigate 1, Life Science (Telepathy) 0, Survival 0

Talents: Biokinetics 2, Blocking 1, Communication 0, Scanning/Probing 0, Sensing 1

Information: Sarah is John's lover. She is also the group's main protection from outsiders as she is the most proficient at Reality Fabrication (especially with the aid of other telepaths).

Other Telepaths

The other telepaths in John's group vary in talent and ability. Assume similar stats to above but they can be of any P Rating. You may change telepathic feats and abilities as required.

Diversion

If the telepaths think they will be discovered or their way of life is threatened, they use Reality Fabrication to lure or scare any visitors away. The manner of illusion will depend on the circumstances but some suggestions are as follows:

- Sensors indicate that a storm is approaching.
- Dangerous, predatory animals lurk in the undergrowth making it too dangerous to explore here.
- A ship is detected in orbit. If the players are concerned that it is an Earthforce ship the telepaths will detect this thought and when close enough the ship can be identified as an Earthforce vessel.

The Test

If the telepaths are intrigued by the players or the party can provide information about the Techno-mages and their technology, the telepaths will want to speak with the players. However, before the telepaths reveal themselves they need to make sure the players can be trusted. Since a deep scan could reveal their presence, the telepaths will create a false reality to test the players.

The test will consist of a Centauri telepath who is on the run from government agents. He is hiding in the cave discovered by the players. Note that they will only see it as a small cave, and not the cavern complex that actually exists.

This illusion can take place at the same time the players are examining the ruins. Once some trust has been established between Valo and the party, Valo can question the players as to what they are doing and specific aspects about their investigations.

Valo Tyree (Centauri)

Str: 8 (0), **Dex:** 9 (+1), **End:** 7 (0), **Int:** 7 (0), **Edu:** 10 (+1), **Soc:** 9 (+1), **Psi:** 8 (0)

Skills: Deception 1, Gun Combat (Energy Pistol) 1, Investigate 1, Life Science (Telepathy) 0, Survival 0

Talents: Biokinetics 2, Blocking 1, Communication 0, Scanning/Probing 0, Sensing 1

Information: Valo inadvertently gained secret knowledge of a plot from within House Callo to assassinate Emperor Mollari. Agents from House Callo have been pursuing Valo and he has been on the run for several weeks. He paid some mercenaries for passage to a remote destination where he could hide out and ended up here.

If Valo is startled by the players, he will draw his pistol but will not fire unless he is forced to. However, if the players have not found the cave then Valo will come out of hiding to investigate.

Valo will initially be very cautious and will ask if the players have seen anyone else in the area. He will be reluctant to explain his presence here, but eventually the players will get his story. A short time after, a Centauri ship will be detected in orbit and a shuttle will land with a small force of soldiers. Valo will ask the players for their help. Will they risk their lives to protect him or will they leave him to fend for himself?

Centauri Soldier

Str: 9 (+1), **Dex:** 9 (+1), **End:** 8 (0), **Int:** 7 (0), **Edu:** 7 (0), **Soc:** 8 (0)

Skills: Athletics (Co-ordination) 1, Gun Combat (Energy Pistol) 1, Investigate 0, Medic 0, Melee 0, Persuade 1, Recon 1

Equipment: Centauri Rifle (5d6+3), Flak Jacket (6)

If the players do not intervene, they will see the soldiers point at the cave and head towards it. Valo will run but the soldiers will shoot him in the leg and capture him. Valo will be dragged into the shuttle and it will take off. The soldiers will ignore the players as long as they do not get involved.

If the players question the soldiers, they will give a terse reply and state that it is a matter of internal security. If the players decide to help Valo at any point then a fight will ensue which you can play out as if it were a real fight. If anyone is injured or dies during this fight, treat it as normal but afterwards they will be unharmed. Destiny Points cannot be used here.

Back to Reality

If the players do not help Valo then they will fail the test and the telepaths will not reveal themselves. As far as the players know, the cave is not deep so they will not explore it further.

If the players did try to help Valo, the telepaths will know the players can be trusted not to give away their presence here. The players will see a rippling effect

as the illusion ends and reality comes into view. Anyone who died will wake up (they were simply unconscious) and any injuries will have disappeared.

The telepaths will then reveal themselves but will not invite the players into the caverns. John will then give his story and ask for the players to do the same. John will of course know if the players lie or attempt any deception.

John will ask about the players' discoveries here as he wants to know more about this place. He will also show them an item that was found here; a Techno-mage staff. If there are any telepaths in the party, John will invite them to join his group here.

Techno-mage Staff

Examining the staff will reveal it to be made from the same alloy as the tomb. Traces of the tech are woven around the top of the staff. Its purpose will remain a mystery since only a Techno-mage can activate it. If the players explain this to the telepaths they will be allowed to take it with them in exchange for some food and medical supplies (the staff is of no use to the telepaths).

Inside the Caverns

It is unlikely that the players will be invited inside but if they do somehow manage to explore the caverns they will see that it is a vast cave system. The telepaths have dismantled the ships they arrived in and used the parts to divide up certain sections of the caverns, add doors and other modifications.

Some of the tunnels and caverns appear to be naturally formed and other parts are obviously excavated. If the players ask about this, the telepaths will reveal that the caves were already excavated and concluded that they were created by the former inhabitants.

Visiting the Excalibur

The players will head to their next meeting with the Excalibur as arranged. Once there, Gideon will ask for all of the players and other command staff to join him on the Excalibur. Only Gideon and Galen will be present from the Excalibur crew.

Earth's Cure

Gideon will begin by explaining why the Excalibur was recalled to Mars.

'I have some good news and some bad news. Earth thinks they have found a cure to the plague. Unfortunately it is based on Shadow tech and although it will keep everyone alive the population of Earth will become slaves to the tech.'

'I tried to warn them not to use it but they would not listen and they are already planning to administer it. To make matters worse, since they think the plague is cured, The Excalibur and its crew are being reassigned. Obviously I could not allow this, so, well, we are now...'

Galen will interject. *'Renegades'*.

Gideon will then explain that the cure uses organic technology implanted in the subject. This implant then grows, effectively replacing the immune system. Once it has fully developed within the host it will destroy the virus but the implant cannot be removed as it becomes so integrated with the host.

During December 2267, Gideon and Galen gained access to a Legacy Base in sector 420 and witnessed similar technology being used to create slaves that were easily be controlled by their masters. With knowledge of the Legacy Prison, Gideon is convinced that any prisoners who were taken from the facility in sector 260 were converted into these peons.

Implanting the cure technology must be performed by specialists and it could take over a year before everyone on Earth has undergone the procedure. This means that both the players and the Excalibur have time to find a real cure before it is too late.

Since the evidence suggests that the Legacy Group are behind the fake cure (which they are), it is a fair assumption that they will be making every effort to stop the Excalibur from intervening. The only option Gideon had was to leave Earthforce so both the Excalibur and the players can finish what they started.

Findings from Omicron 4/II

Galen will ask the players to relate their findings from Omicron 4/II. They are sure

to bring up the revelation about Techno-mages using Shadow tech. Galen will explain:

'Yes, your findings are correct. This secret is known only to a few within my order and it is forbidden to speak of it to anyone who does not already possess the knowledge. Matthew also discovered this but kept the secret at my request. A request that I now pass to you.'

Galen will also reveal the true history of the Taratimude and the Techno-mages.

Galen will know that the players have found some Techno-mage items and will ask for them. If necessary he will explain that only Techno-mages can use them and they could be potentially quite dangerous in the wrong hands. He will examine them in the following order.

Techno-mage Staff

If the players recovered the staff, read out the following:

'Galen studies the staff with interest for several minutes before his eyes light up.'

'The Staff of Wierden. The most sought after and treasured of Techno-mage artifacts. Wierden created our order and his staff was thought to be lost forever.'

'Thank you for this. Our order owes you a debt of gratitude.'

Galen will bring this before the Circle. They will discover that Wierden left it on the colony as a control mechanism for the traps he left there, thus allowing the Techno-mages to finally visit the birth place of their order.

Implants

Galen will explain their function but will not go into much detail:

'This is the tech that is implanted to give a Techno-mage his power.'

If questioned further, he will explain that initiates to the order only receive the implants after years of studying under a mentor. The process is painful and irreversible; removal of the tech (called 'flaying') results in death for the Techno-mage concerned.

The Orb

The orb is the most important item concerning the goals of the players and the Excalibur, as Galen will explain:

Galen studies the orb for a short while before exclaiming 'Ah'. The device glows and a hologram projects from the orb showing a solar system. Planets can be seen orbiting the sun, each labelled 'Fallav I' to 'Fallav VI'. The image then zooms into Fallav III where a 'V' shaped space station orbits the planet.

Text similar to that on the tomb scrolls across the image before the orb deactivates.

'How interesting,' Says Galen.

The space station is a standard Zener base, which the players may recognise from the one orbiting Arraki III. Galen will explain that Fallav IV was the Taratimude homeworld and it was destroyed during their war, including the jump gate.

The station orbiting Fallav III is a Zener research station, which Galen now believes to be the place where the tech is engineered. Lodan left this information for his brother Wierden in the hope he would destroy it or use it to somehow free any survivors from the tech.

'If this station is still equipped to create Techno-mage implants, it could have what we need to create the cure. I must leave to check something but I will be back soon.'

Expect me, when you see me.'

Galen will then stride out of the room and depart the Excalibur in his pinnacle.

Communication Upgrade

Gideon will explain that his technicians have devised a way that their ships can stay in contact without compromising security. Using the data supplied, an engineer can get this up and running on the players' ship in two to three hours.

Mutiny

During the journey back from Mars, there were several of the Excalibur's crew who disagreed with Gideon's decision to become renegades of Earthforce. These

few began to sow dissension amongst the ranks and slowly started winning people over to their side.

To make matters worse, the authorities have been informed of both Captain Gideon's decision to leave Earthforce and also his alliance with the players.

By the time Galen has left and the players finish their meeting with Gideon, the situation has got out of hand and before the players get chance to leave the Excalibur, the mutiny will be in full effect.

The first signs of trouble will be power outages and before anyone can determine what is going on, the players will be trapped on the ship. They must help Gideon regain control of the Excalibur before Earthforce arrives and a shooting war begins.

Captain Matthew Gideon

Str: 9 (+1), **Dex:** 9 (+1), **End:** 9 (+1), **Int:** 8 (0), **Edu:** 10 (+1), **Soc:** 10 (+1)

Skills: Astrogation 1, Computers 1, Diplomat 1, Gambler 2, Gun Combat (Energy Pistol) 2, Medical 1, Melee (Unarmed) 2, Persuade 2, Pilot 1, Recon 2, Vacc Suit 1, Zero-G 0.

Equipment: PPG (3d6-3, -1 recoil)

Lieutenant Lucas Stack

Str: 8 (0), **Dex:** 7 (0), **End:** 7 (0), **Int:** 8 (0), **Edu:** 8 (0), **Soc:** 9 (+1)

Skills: Astrogation 1, Computers 1, Diplomat 1, Gun Combat (Energy Pistol) 1, Medical 0, Persuade 1, Pilot 1, Recon 1, Vacc Suit 0.

Equipment: PPG (3d6-3, -1 recoil)

Information: Lucas is the instigator of the mutiny and is leading the revolt on the Excalibur. He is loyal to Earth and likes to do things by the book. Consequentially, he has often disapproved of Gideon's way of doing things; disobeying orders followed by breaking away from Earthforce was the final straw.

Crew

Str: 7 (0), **Dex:** 9 (+1), **End:** 7 (0), **Int:** 9 (+1), **Edu:** 8 (0), **Soc:** 9 (+1)

Skills: Gun Combat (Energy Pistol) 1, Pilot 1, Vacc Suit 0, Zero-G, plus any 2 from Astrogation 1, Comms 1, Engineer (any) 1, Gunner (any) 1, Mechanic 1, Sensors 1

Equipment: PPG (3d6-3, -1 recoil)

Security Forces

The Excalibur has two companies of soldiers, which also double as ship security. Each company has three platoons of 10 men. 'Eagle Company' remains loyal to Gideon but two of the platoons in 'Bear Company' have joined the mutineers. Unable to convince the last platoon to join them, they have been bound, gagged and locked away.

If this platoon can be found and released, they would be a great help in tracking down the remaining mutineers.

GROPOS Soldier (Human)

Str: 8 (0), **Dex:** 10 (+1), **End:** 9 (+1), **Int:** 8 (0), **Edu:** 8 (0), **Soc:** 8 (0)

Skills: Athletics (Co-ordination) 1, Gun Combat (Energy Pistol) 1, Investigate 0, Melee (Unarmed) 1, Recon 1, Stealth 0, Survival 0

Equipment: PPG (3d6-3, -1 recoil), Flak Jacket (6)

Tactics

There are not enough mutineers to take over the ship, so their goal is to avoid capture and keep the Excalibur disabled until Earthforce reinforcements arrive. The mutineers will begin by rerouting power from engines and jump drives so the Excalibur is unable to move. They will then disable communications and transports to slow down anyone trying to fix the damage.

The mutineers will try to stop anyone fixing the damage they have done, so any engineers sent to fix problem areas will need to be guarded or risk being captured or even killed (if necessary). Lieutenant Stack will also attempt to lockdown the shuttle and fighter bays to stop anyone leaving or making contact with the players' ship.

The mutineers will also continue to sabotage other areas so it is vital for Gideon's people and the players to find and capture the saboteurs. The Excalibur is a big ship so they will need to send lots of small groups out to find the mutineers and fix the damaged areas.

The players can either volunteer, or Gideon will ask them to perform a specific function. This might be escorting a technician to find and fix a particular area (especially if any of the players are engineers), or the players might simply be tasked with rooting out the mutineers and determining which crew members are loyal to Gideon.

If any of the players are not onboard the Excalibur, they will eventually realise that something is wrong. Contacting the Excalibur will get no response and the crew might decide to dock or board the Excalibur to discover what the problem is.

Alternative Scenarios

Rather than have the players on the offensive, the mutineers could either corner or capture the party. The players must then free themselves and fight their way out to get to a safe place such as the bridge.

Safety

Once the Excalibur is back under Gideon's control he will suggest that the players return to their ship (the crew there were probably wondering why they lost contact) and set course to a new location before Earthforce catches up with them. The Excalibur and the players' ship will then part company until Galen returns.

The mutineers will be detained and most likely dropped off at the next civilised planet or outpost. Although Gideon has broken away from Earthforce he is not a murderer.

Earthforce

If the players and Gideon's forces take too long to regain control of the Excalibur, there is a good chance an Earthforce vessel will exit from hyperspace. Depending on the current situation, the

vessel will either open fire or attempt to board the Excalibur.

If you decide to use this additional encounter then you should still give the players a chance to escape, so only bring the Earthforce ship in when the party still has a chance to regain control and escape.

Ending the Episode

The episode ends once the Excalibur is safe and both ships have gone their separate ways (for now). The players will have a few weeks before Captain Gideon contacts them to discuss their next move.

NEXT TIME IN THE LEGACY OF WAR

The players team up with the Excalibur once more to retrieve some Techno-mage items from the Zener space station orbiting Fallav III. This technology could be the key to providing a real cure to the plague.

Omega Destroyer			Tons	Price (MCr)
Hull	75 ktons 4 sections each	Standard Hull375 Structure 375 Partially Streamlined		7,500
Armour	Crystaliron	12 pts	11,250	4,500
Artificial Gravity		30% Hull Coverage from Rotating Section	27,000	27,000
Jump Point Generator		Jump 3	7,500	30
Manoeuvre Drive		Thrust 3	1,125	562.5
Power Plant		Rating 6	2,812.5	7,031.25
Bridge		4 Command Modules	1,200	120
Computer	Core / 9	Rating 100		130
Electronics	Advanced	DM +1 Military Countermeasures x 5	3 100	2 125
Weapons	Bays	2 x Light Particle Beams	100	80
	Fixed Mounting (Fore)	4 x Beam Laser	—	16
	Fixed Mounting (Aft)	2 x Beam Laser	—	8
	Turrets	20 x Double Heavy Pulse Cannons 20 x Double Heavy Pulse Cannons 6 x Interceptors (Triple Sandcaster) 6 x Interceptors (Triple Sandcaster)	40 40 12 12	50 50 7.5 7.5
Ammunition		12,000 Interceptor rounds (sandcaster barrels)	600	
Fuel	18,810 tons	Two Jump 3 – Twenty weeks of operation	18,810	
Cargo	1,200 tons	Armoured Bulkheads	1,320	24
150 Staterooms		Double Occupancy	600	75
Barracks		Room for 60 Marines	60	6
0 Low Berths			—	—
Extras	Airlock		1	1
	Armoury x 2		3	1
	Briefing Room		4	0.5
Craft	Ship's Boat, 2 Pinnaces	Standard Hangars	130	82
	24 Starfury Heavy Fighters		624	649.2
	Cobra Bays x 2	Launch Tube for Starfuries	1,000	500
Software	Manoeuvre/0			—
	Intellect			1
	Library			—
	Evade/1			1
	Jump Control/3			0.3
	Fire Control/5			10
Maintenance Cost (monthly)				4.0476
Life Support Cost (monthly)				0.45
Total Tonnage & Cost			74,406.5	48,571.75

TWIN
LIGHT
PULSE
CANNON
TURRETS

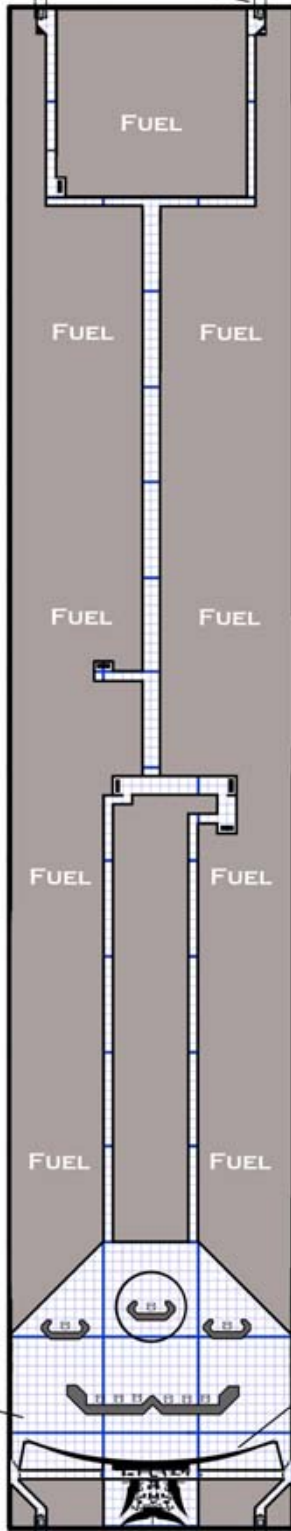

COMMAND BRIDGE DECK
(LEVEL 1)



QUARTER DECK 1
(LEVEL 2)

STATEROOMS

COMMON
AREAS

ESCAPE
PODS

COMMAND
BRIDGE

VIDEO
SCREEN

TWIN
LIGHT
PULSE
CANNON
TURRETS

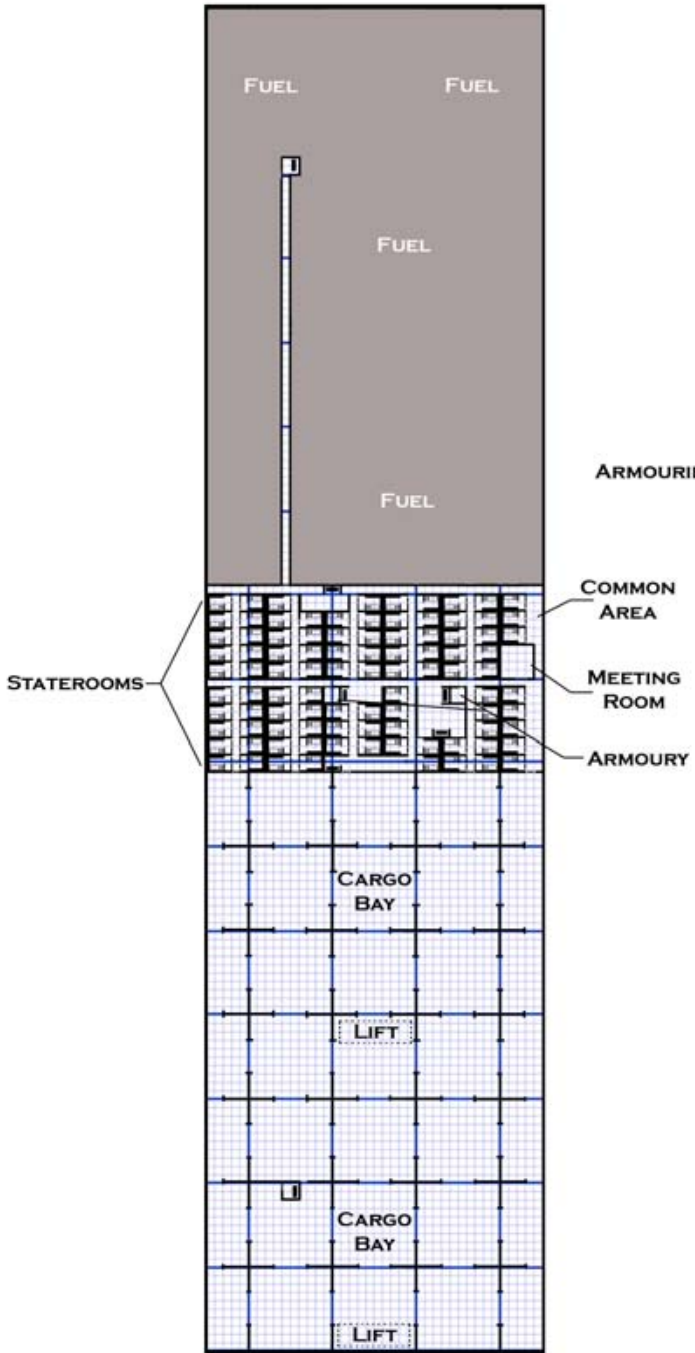

CARGO DECK 1
(LEVEL 3)

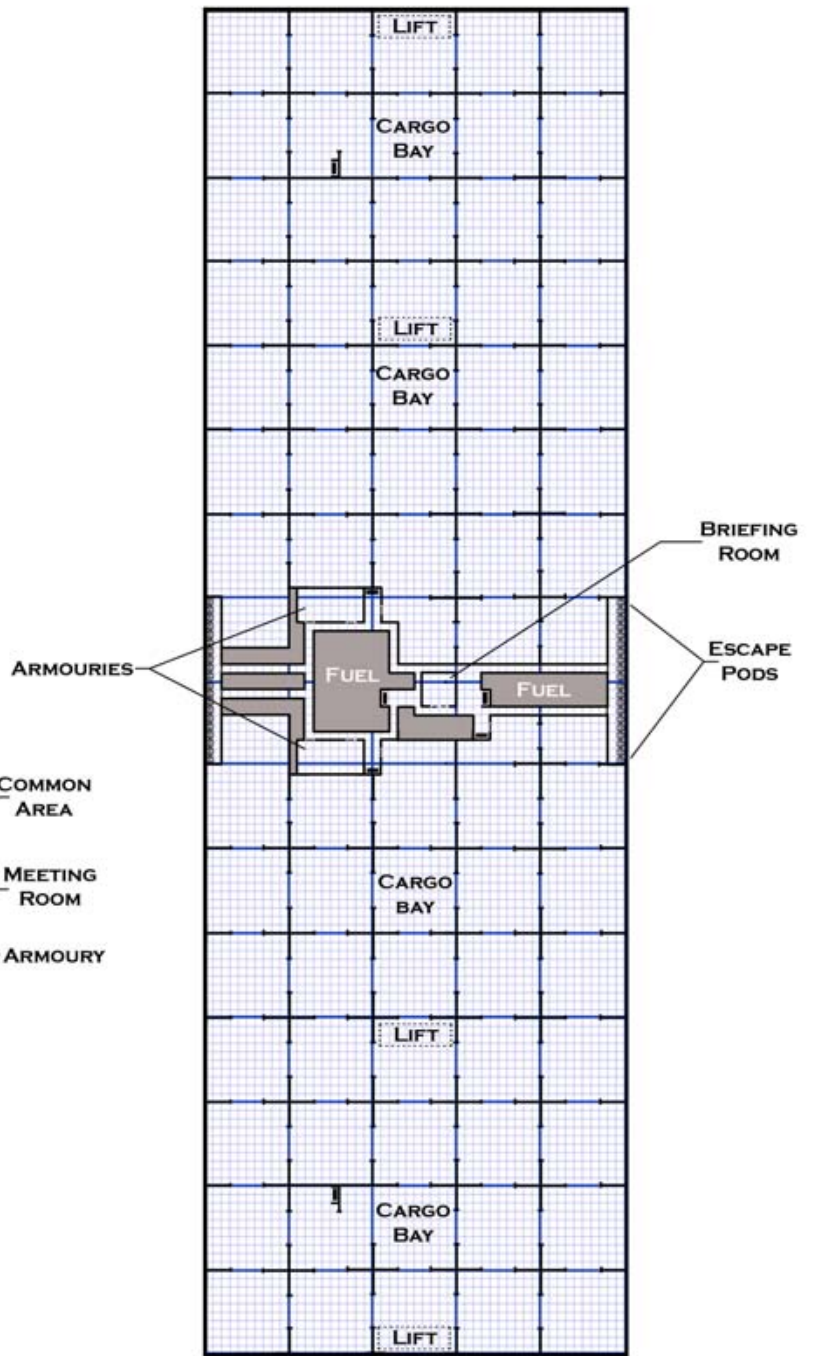

CARGO DECK 2
(LEVEL 4)

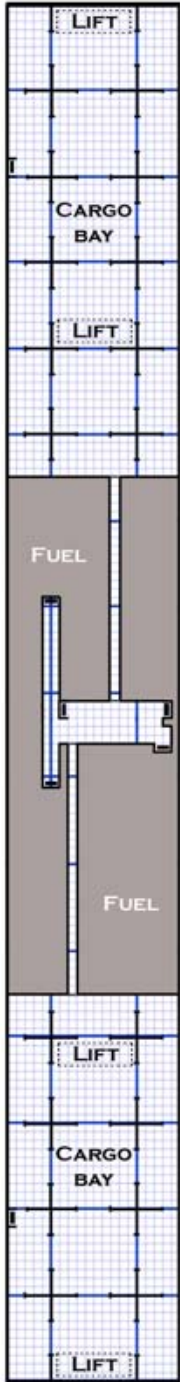

CARGO DECK 3
(LEVEL 5)

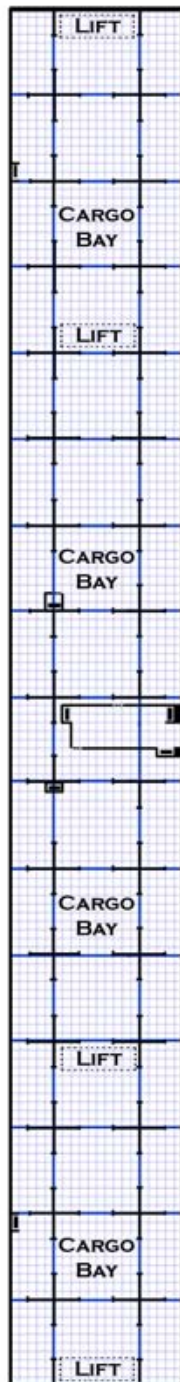

CARGO DECK 4
(LEVEL 6)

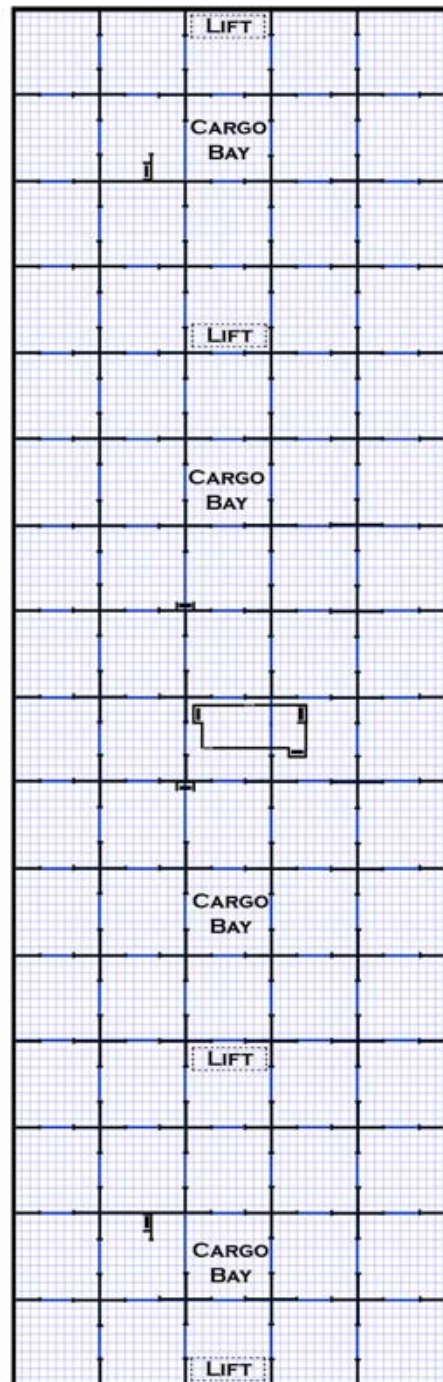

CARGO DECK 5
(LEVEL 7)

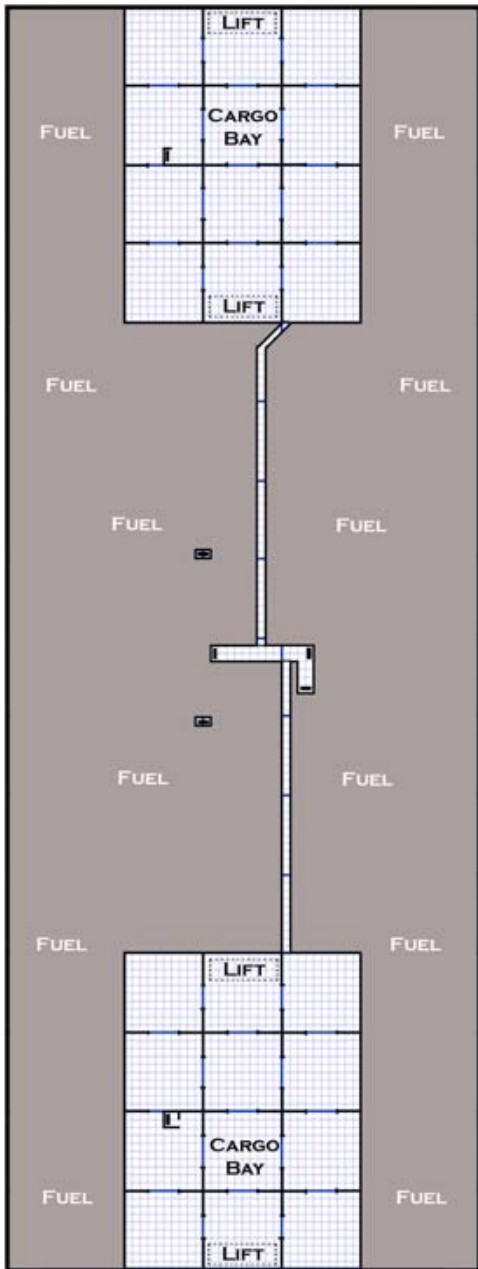

**CARGO DECK 6
(LEVEL 8)**

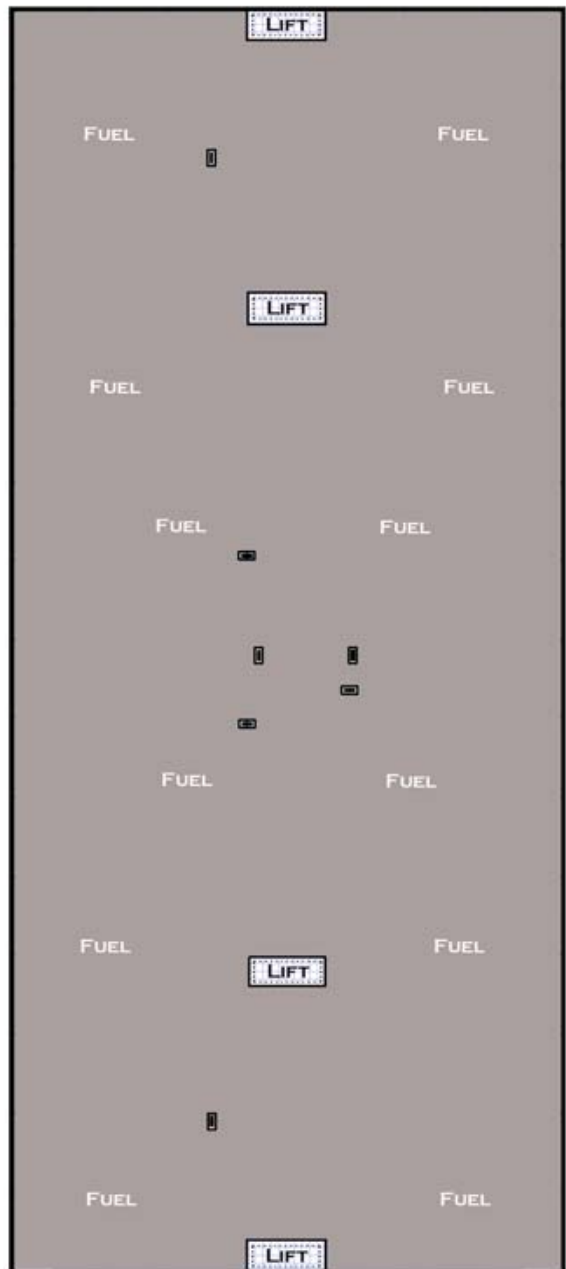

**FUEL DECK 1
(LEVEL 9)**

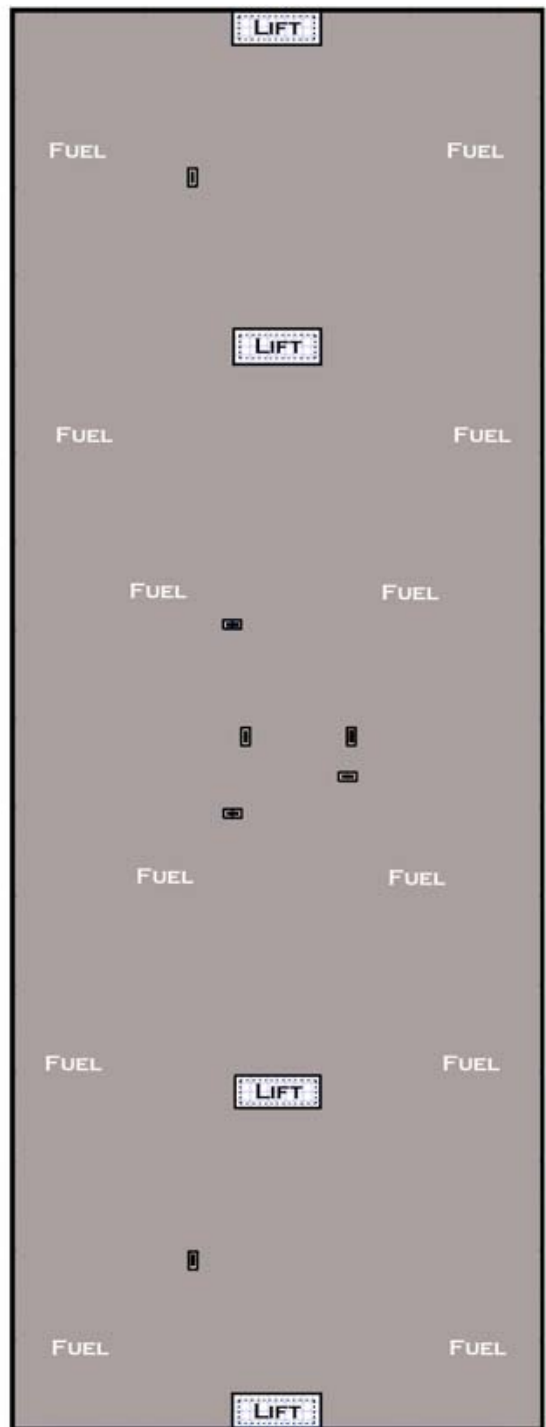
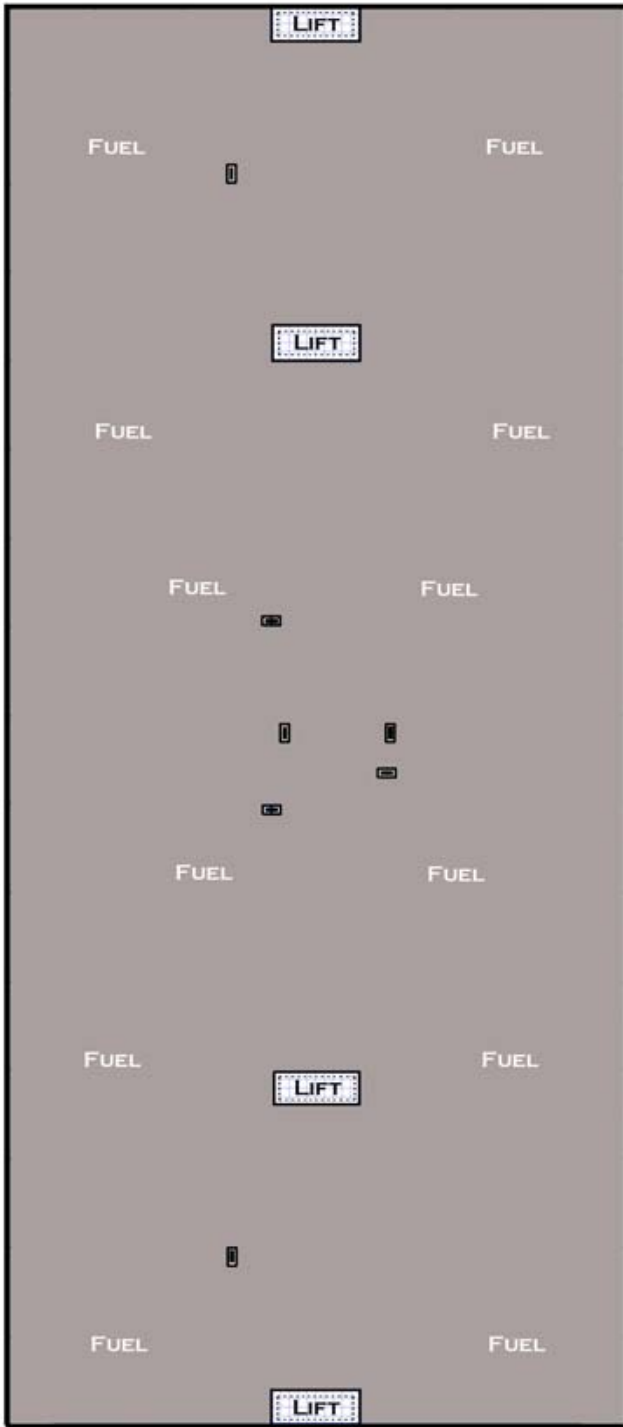

FUEL DECK 2
(LEVEL 10)

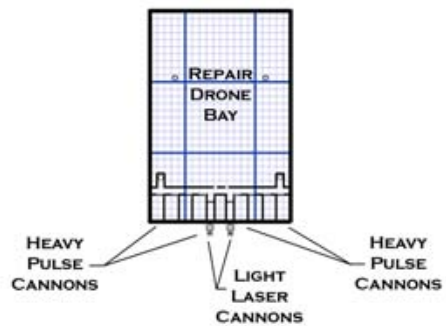

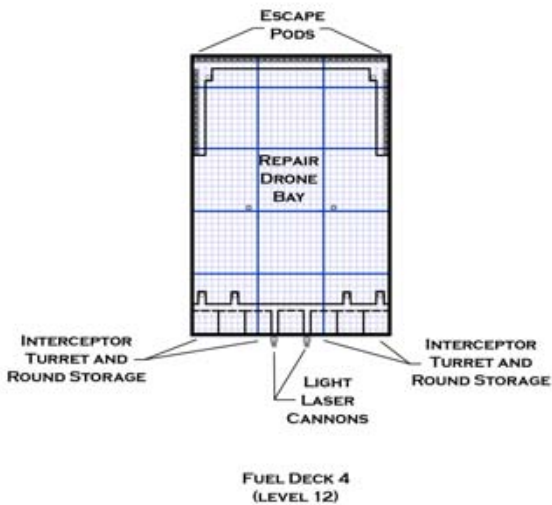
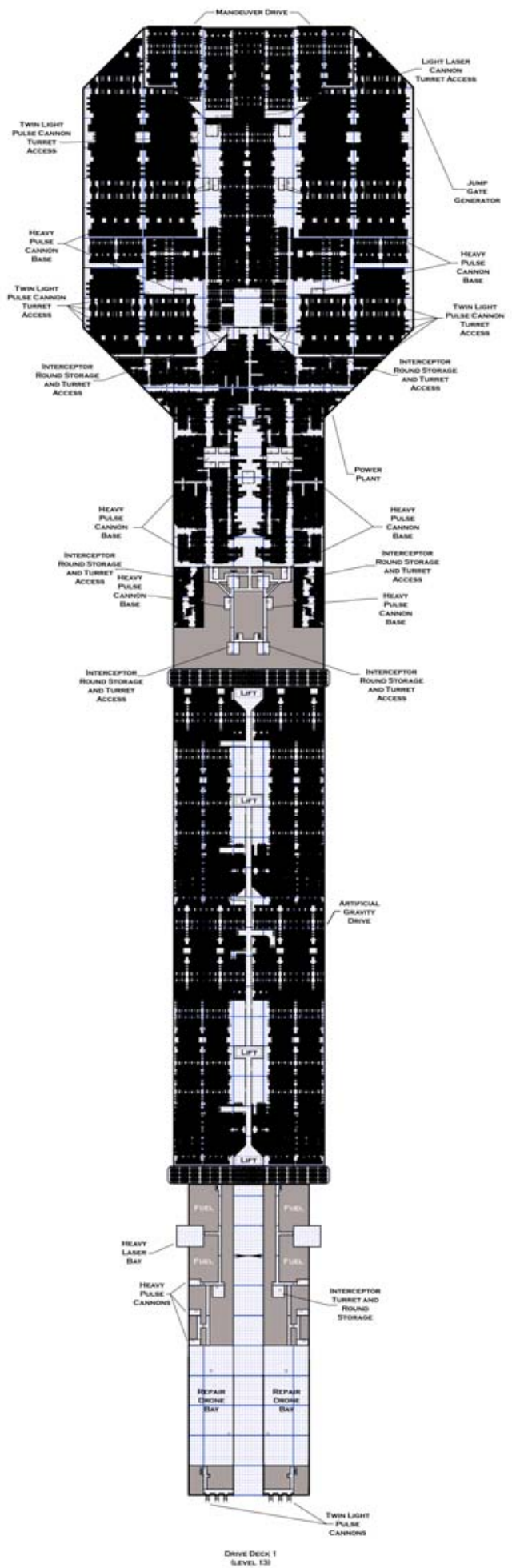
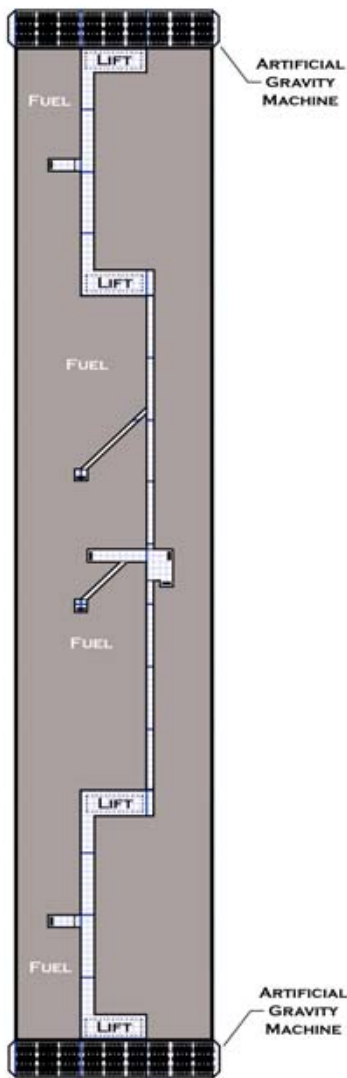

Drive Deck 1 (Level 13)

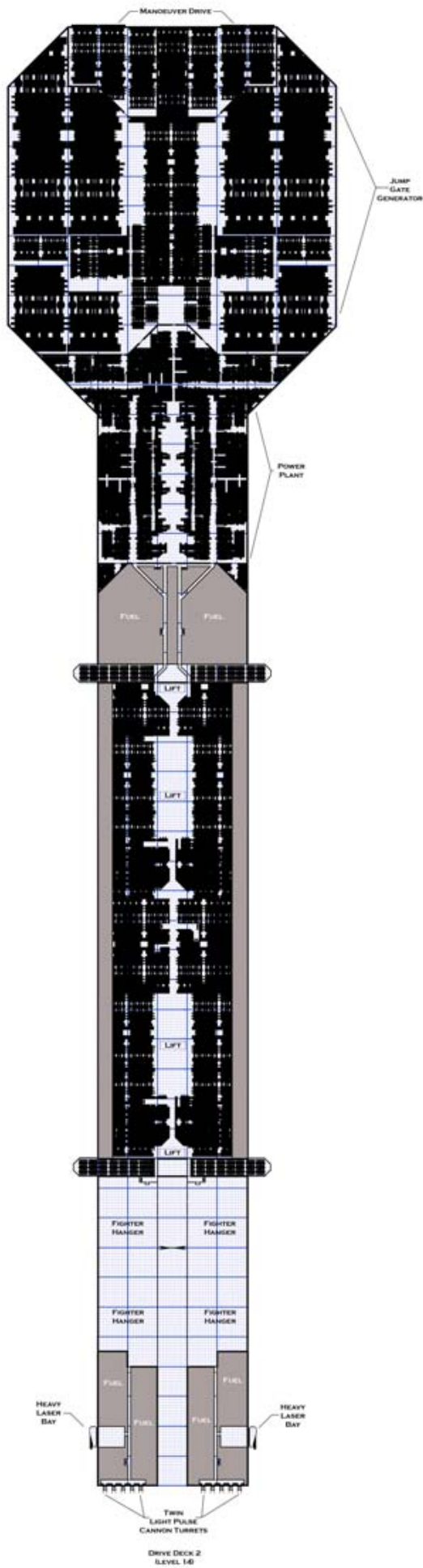

DRIVE DECK 2
LEVEL 14

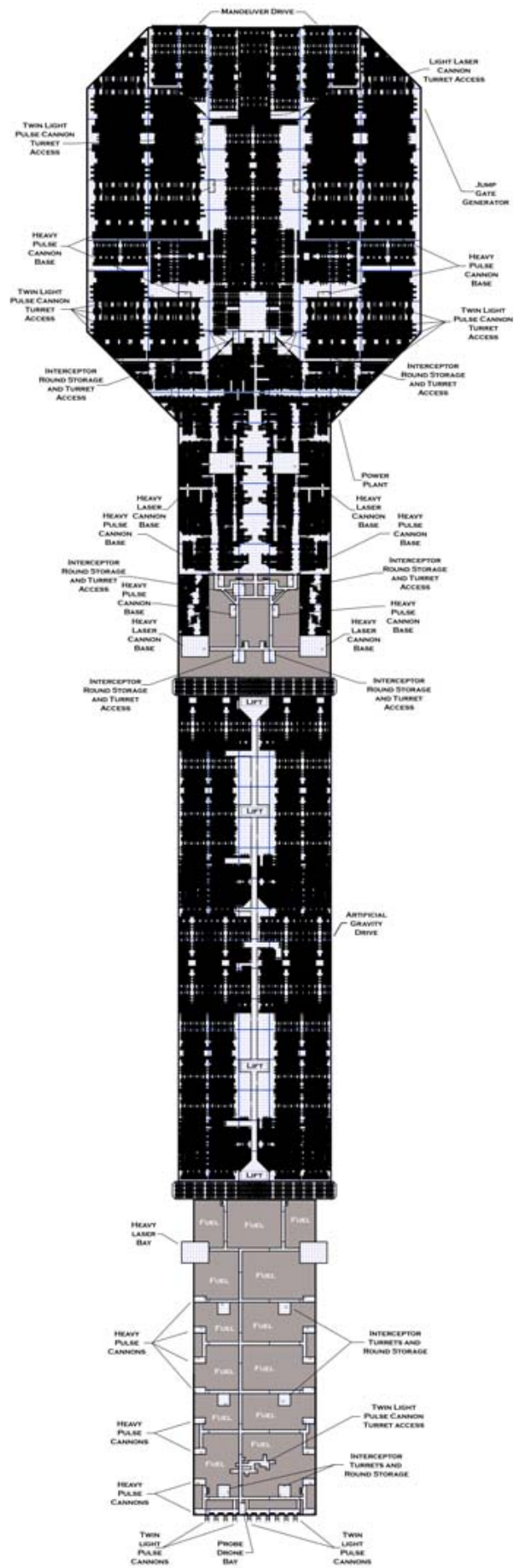

DRIVE DECK 3
LEVEL 15

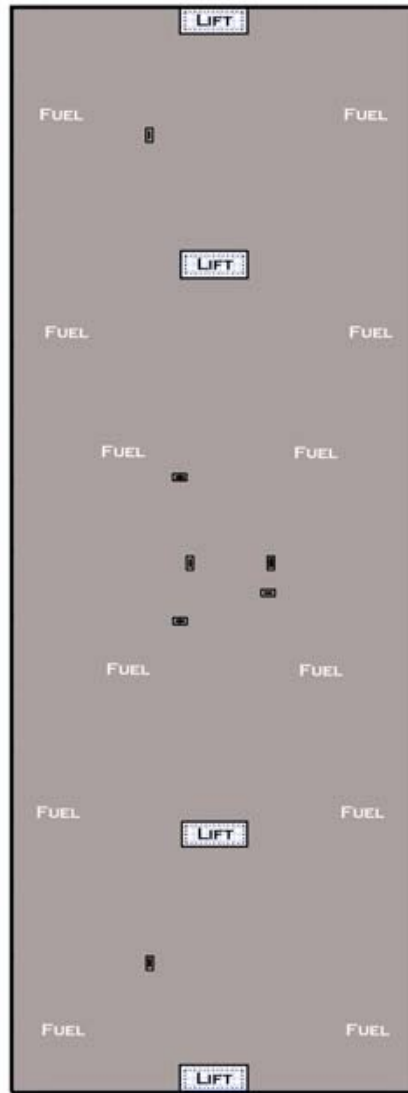
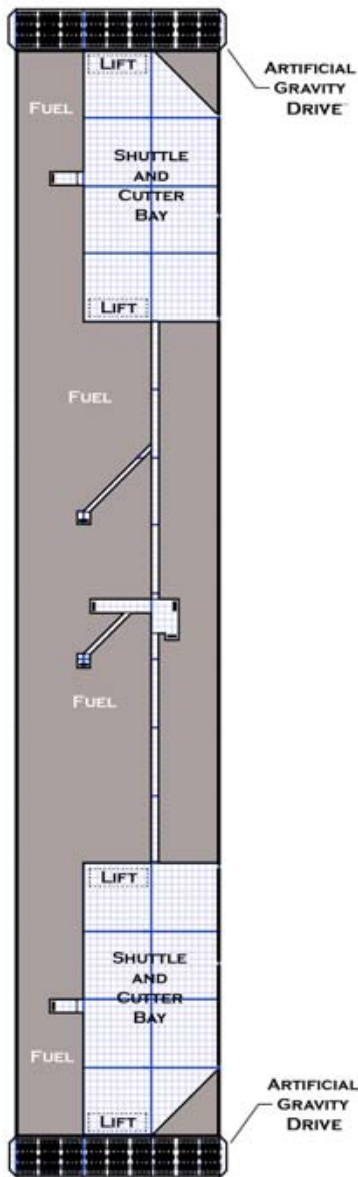
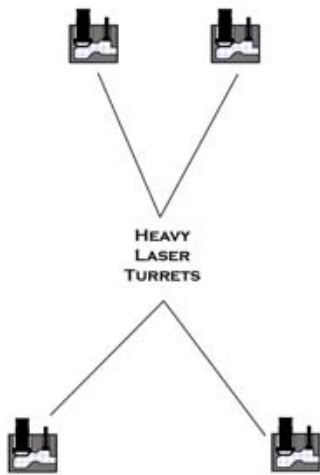

FUEL DECK 5
(LEVEL 17)

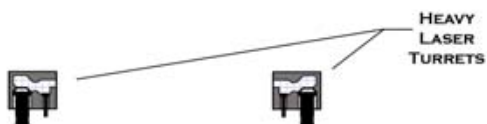

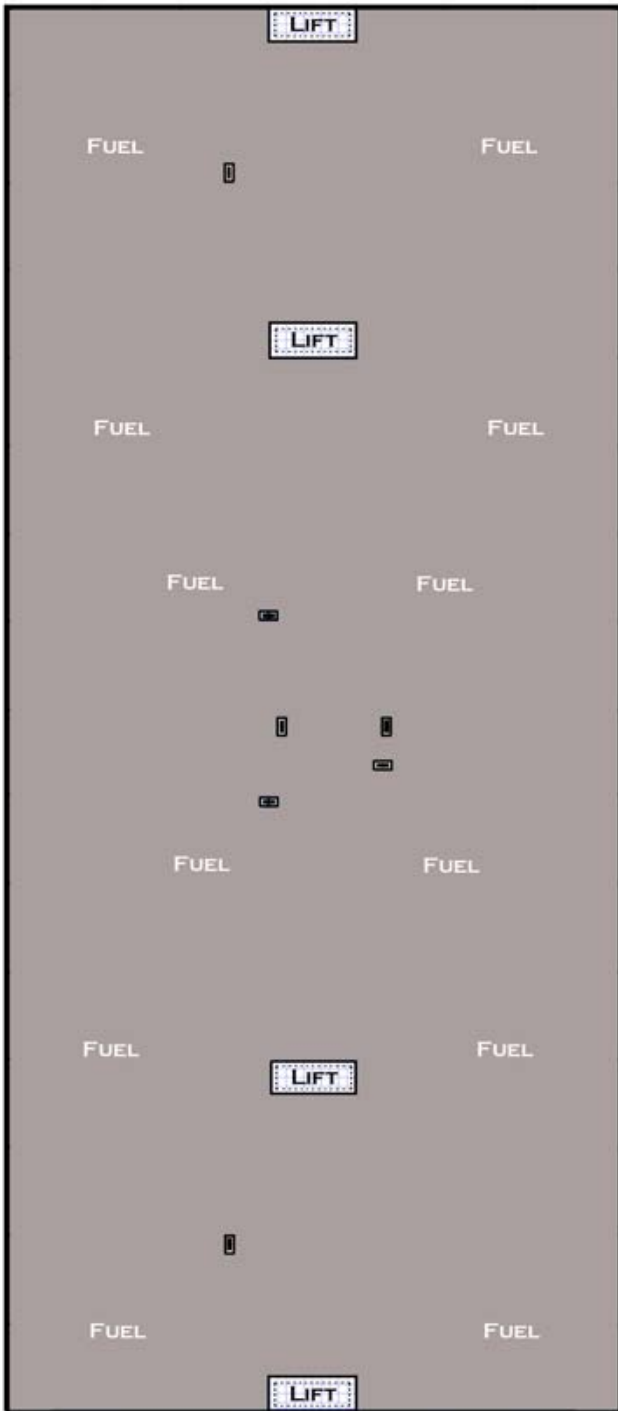

FUEL DECK 6
(LEVEL 18)

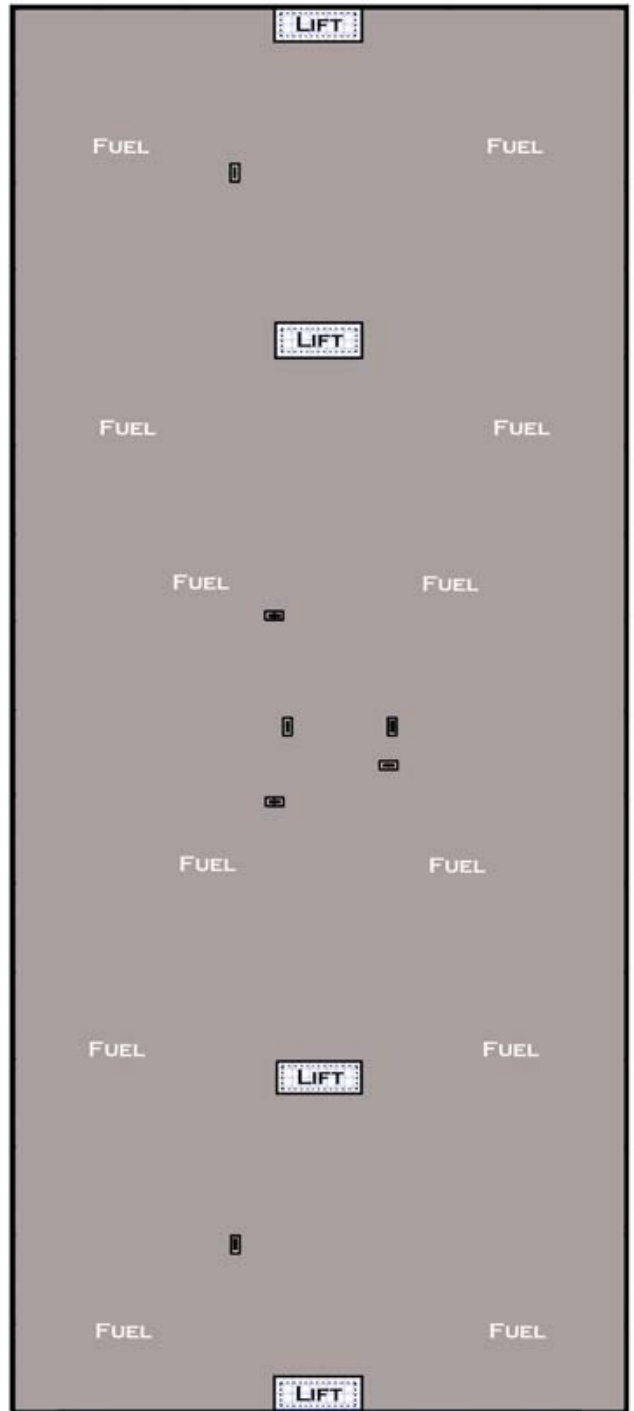

FUEL DECK 7
(LEVEL 19)

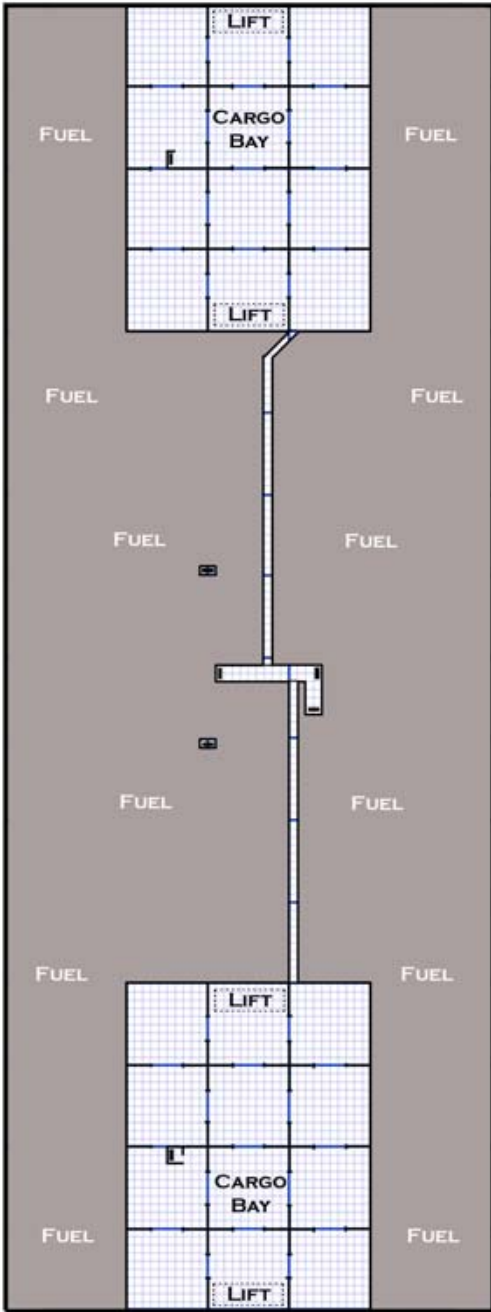

CARGO DECK 7
(LEVEL 20)

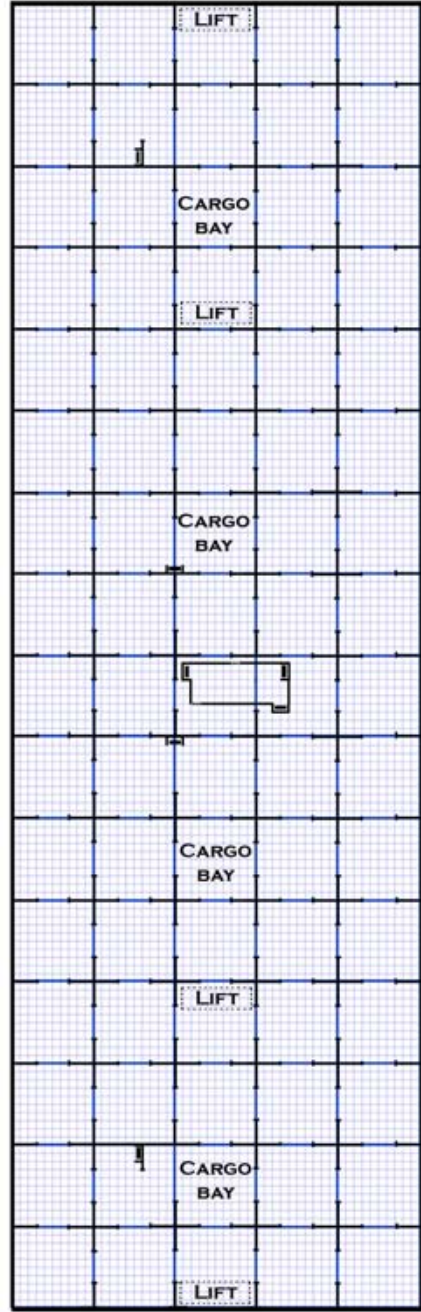

CARGO DECK 8
(LEVEL 21)

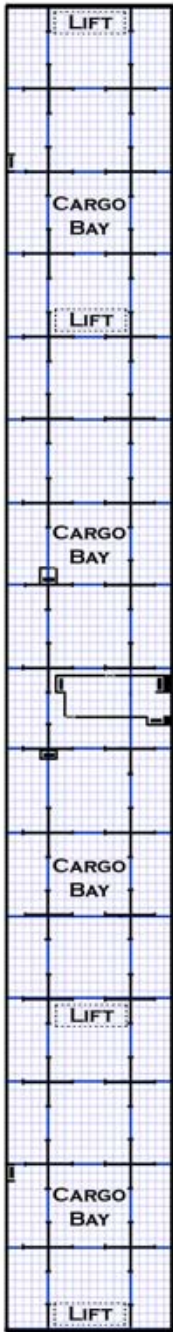

CARGO DECK 9
(LEVEL 22)

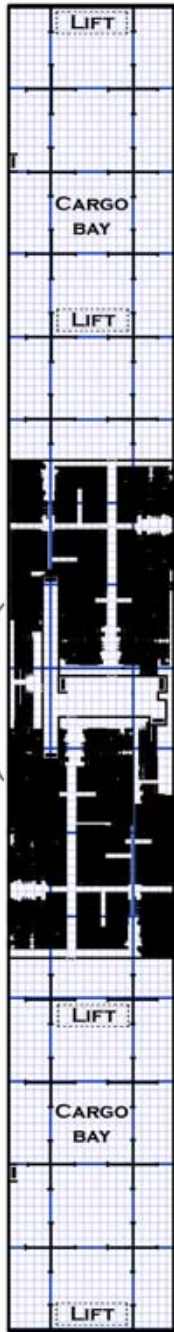

EMP DECK
(EMERGENCY POWER DECK)
(LEVEL 23)

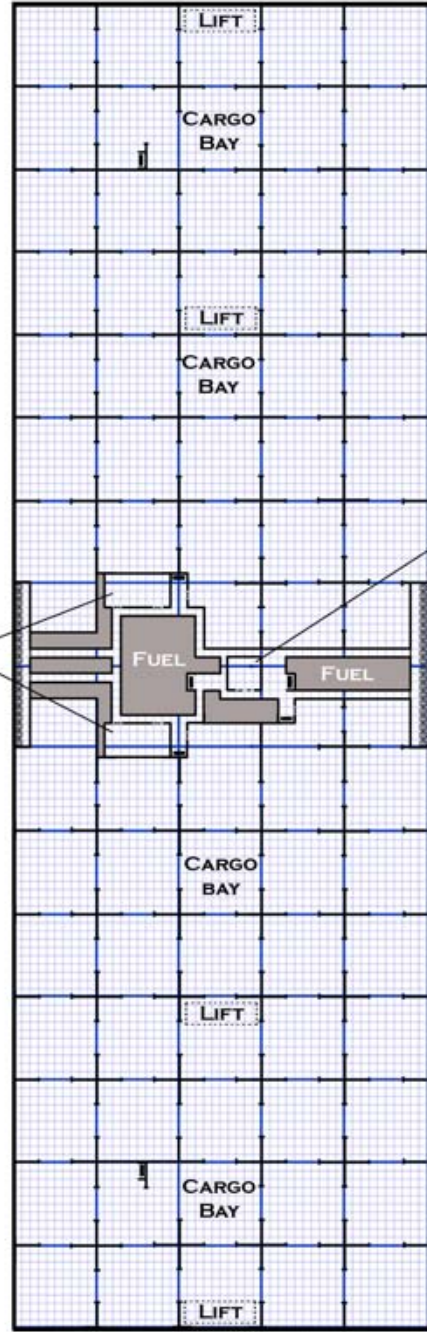

CARGO DECK 10
(LEVEL 24)

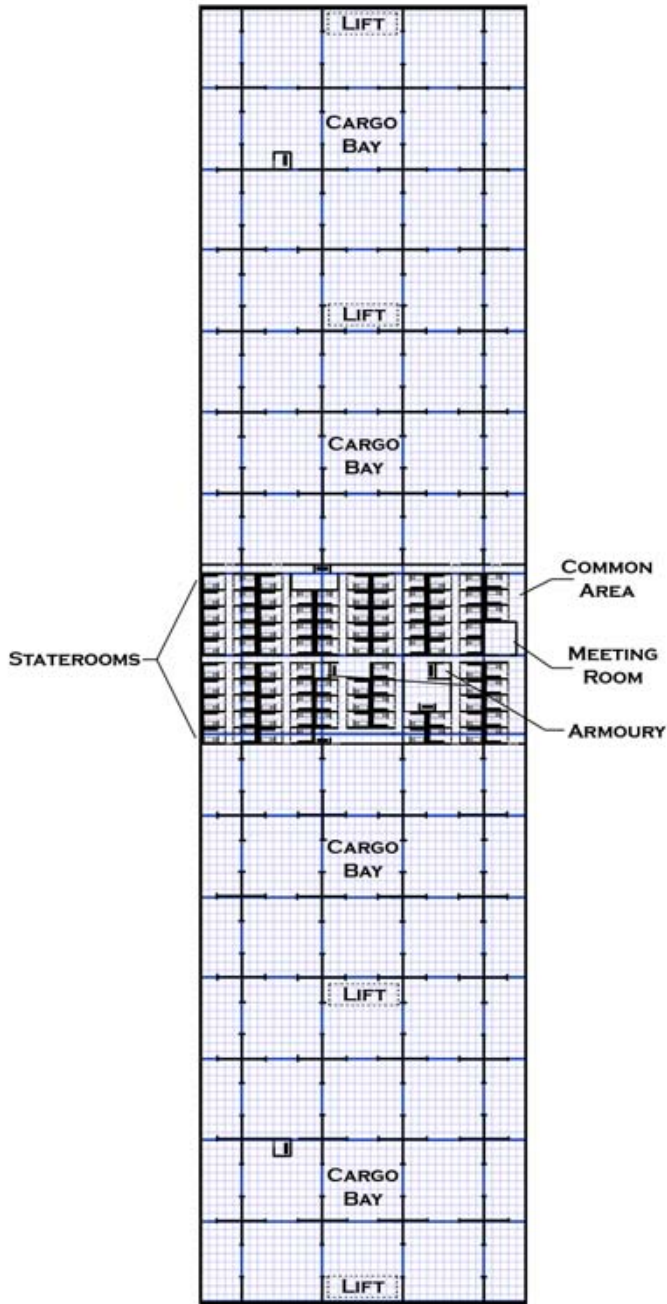

CARGO DECK 12
(LEVEL 25)

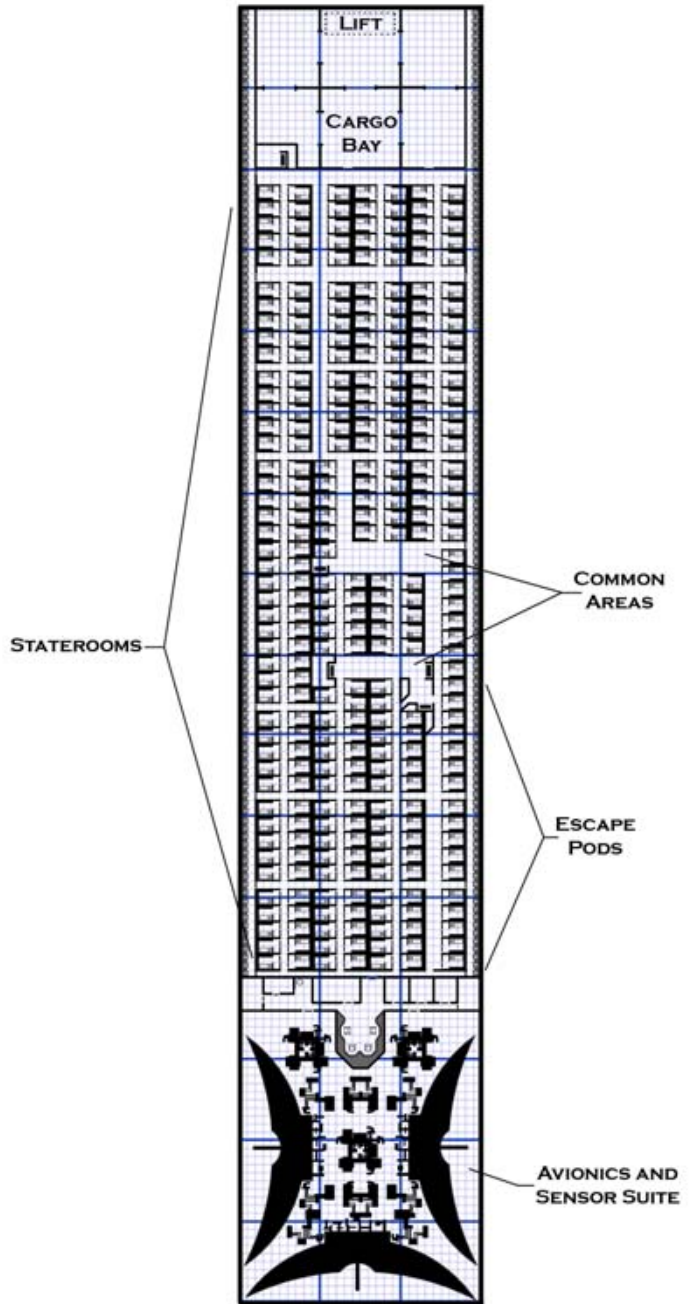

QUARTER DECK 2
(LEVEL 26)

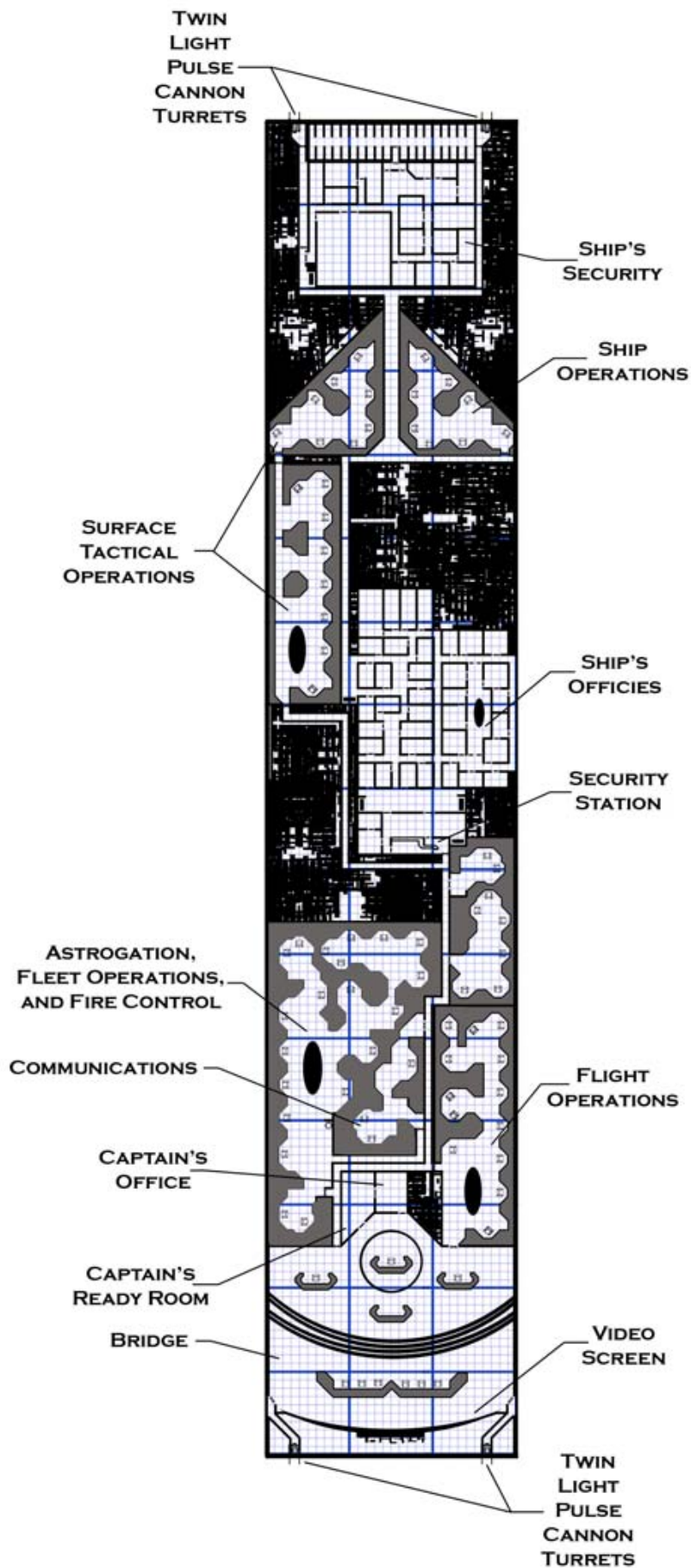

COMMAND DECK
(LEVEL 27)

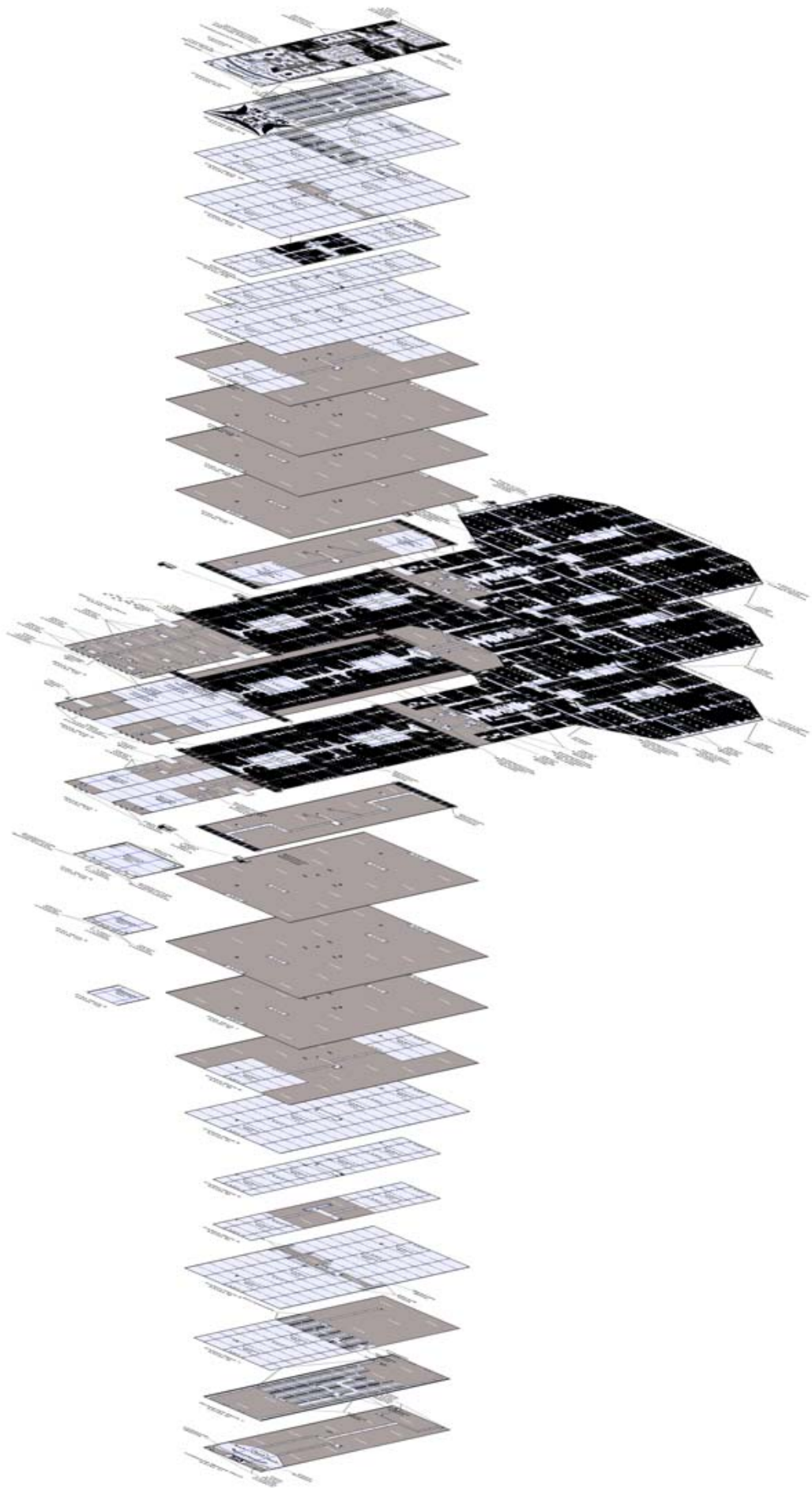

Contributing to S&P

If you think that you have what it takes to write for S&P and you have some good ideas, then we want to hear from you. Drop the editor an email at claw@mongoosepublishing.com requesting the submission guidelines. This information will tell you all that you need to know about writing for S&P and even contributing art to S&P.

From how to approach submissions through to the published piece, our standardised guidelines will navigate you through, so why not give it a go?!

Advertising in Signs and Portents

Do you have a product that you would like to advertise to a readership of over 70k worldwide?

For companies wishing to advertise in Signs & Portents please contact the Editor – claw@mongoosepublishing.com – for details of advert specifications and fees.

Mongoose Catalogue

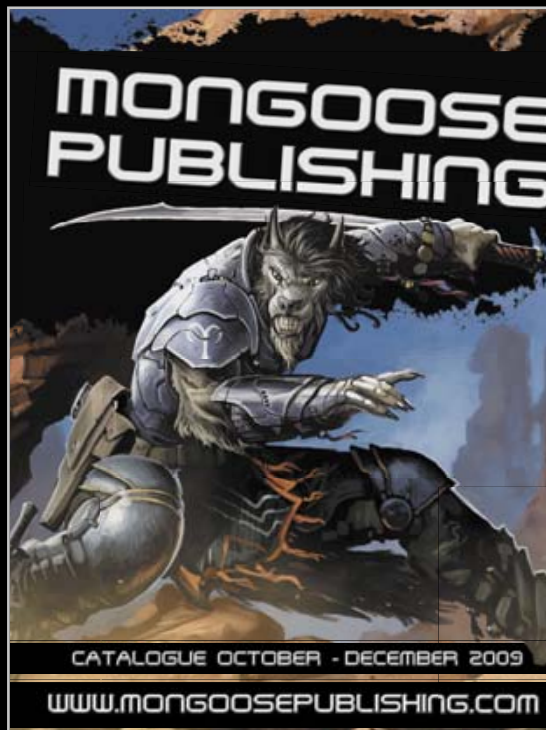

Get your Mongoose Catalogue Today

all you have to do is order online or through our mail order system directly from the Mongoose HQ and get your hands on this finely designed piece of Mongoose craftsmanship.

20 pages that detail all our current lines, old favorites and upcoming releases with information on each product including price and reference, it is a must have for anyone wishing to purchase any Mongoose Product.

In November's Signs & Portents

New Articles!

An all new Vargr scenario, a new Vargr ship, more from Strontium Dog and a generous helping from Paranoia

Plus More From!!

Simon Beal's Legacy of War and Darren's exploration of the world of Lone Wolf

Available from -
www.mongoosepublishing.com

Signs and Portents brought to you by

**MONGOOSE
PUBLISHING**



Mongoose Publishing Product List

Battlefield Evolution

MGP 4442 Battlefield Evolution: World At War	\$29.95
MGP 4443 Battlefield Evolution: Modern Combat	\$29.95
MGP 4444 Battlefield Evolution: Pacific War	\$24.95

Victory at Sea

MGP 4050 Victory at Sea Main Rulebook	\$29.95
MGP 4052 Victory at Sea: Order of Battle	\$29.95
MGP 4053 Victory at Sea: Age of Dreadnoughts	\$29.95

RuneQuest Core

MGP 8100 RuneQuest Core Rules	\$24.95
MGP 8102 GM Screen	\$14.95
MGP 8103 RuneQuest Monsters	\$34.95
MGP 8104 RuneQuest Companion	\$24.95
MGP 8106 Legendary Heroes	\$24.95
MGP 8108 Arms and Equipment	\$24.95
MGP 8111 Rune of Chaos	\$9.95
MGP 8138 RuneQuest Spellbook	\$29.95
MGP 8143 RuneQuest Deluxe	\$39.95
MGP 8157 RuneQuest Empires	\$24.95
MGP 8158 RuneQuest Pocket Deluxe	\$24.95

Glorantha

MGP 8149 Ruins of Glorantha	\$24.95
MGP 8101 Glorantha: The Second Age	\$34.95
MGP 8105 Cults of Glorantha, Volume I	\$24.95
MGP 8107 Magic of Glorantha	\$24.95
MGP 8109 Player's Guide to Glorantha	\$27.95
MGP 8112 Uz: The Guide to Trolls	\$27.95
MGP 8115 The Clanking City	\$24.95
MGP 8120 Cults of Glorantha, Volume II	\$24.95
MGP 8123 Jrustela	\$24.95
MGP 8124 Dragonewts: Guide to the Eravssarr	\$24.95
MGP 8129 Dara Happa Stirs	\$34.95
MGP 8156 Ducks: A Guide to the Durulz	\$24.95
MGP 8148 Dwarfs: A Guide to the Mostali	\$24.95

Lankhmar

MGP 8110 Lankhmar	\$34.95
MGP 8113 Nehwon	\$27.95

Eternal Champion

MGP 8119 Hawkmoon The Roleplaying Game	\$29.95
MGP 8144 Hawkmoon: Secrets of Tragic Europe	\$24.95
MGP 8145 Castle Brass	\$29.95
MGP 8121 Granbretan	\$27.95
MGP 8131 Hunters of Granbretan	\$ 9.95
MGP 8116 Elric of Melniboné	\$33.95
MGP 8140 Elric of Melniboné: Bright Shadows	\$24.95
MGP 8150 Elric of Melniboné: Companion	\$24.95
MGP 8146 Elric : Magic of the Young Kingdoms	£29.95
MGP 8151 Elric: Cults of the Young Kingdoms	\$24.95

Traveller

MGP 3800 Traveller Core Rulebook	\$39.95
MGP 3805 760 Patrons	\$29.95
MGP 3802 Spinward Marches	\$24.95

MGP 3801 Book 1: Mercenary	\$24.95
MGP 3803 Book 2: High Guard	\$24.95
MGP 3804 Adventure 1: Beltstrike	\$29.95
MGP 3806 Supplement 2: Traders and Gunboats	\$24.95
MGP 3807 Supplement 3: Fighting Ships	\$24.95
MGP 3809 Traveller Core Rulebook: Pocket Edition	£19.95

Conan

MGP 7800 Conan the Roleplaying Game: 2nd Edition	\$49.95
MGP 7702 The Scrolls of Skelos	\$24.95
MGP 7704 The Pirate Isles	\$24.95
MGP 7706 Across Thunder River	\$34.95
MGP 7708 Shadizar: City of the Wicked	\$39.95
MGP 7709 Messantia: City of Riches	\$39.95
MGP 7710 Aquilonia	\$34.95
MGP 7713 Hyboria's Fiercest	\$24.95
MGP 7714 Tales of the Black Kingdom	\$19.95
MGP 7715 Hyboria's Finest	\$24.95
MGP 7716 Heretics of Tarantia	\$9.95
MGP 7718 The Lurking Terror of Nahab	\$9.95
MGP 7719 Tower of the Elephant	\$9.95
MGP 7721 Tito's Trading Post	\$24.95
MGP 7722 Stygia	\$29.95
MGP 7723 Faith and Fervour	\$24.95
MGP 7724 Ruins of Hyboria	\$29.95
MGP 7725 Argos and Zingara	\$24.95
MGP 7727 Reavers of the Vilayet	\$9.95
MGP 7728 Shem	\$24.95
MGP 7729 Conan Compendium	\$24.95
MGP 7802 Return To The Road of Kings	\$34.95
MGP 7803 Bestiary of the Hyborian Age	\$29.95
MGP 7805 Secrets of Skelos	\$29.95
MGP 7808 Player's Guide to the Hyborian Age	\$24.95
MGP 7809 Trial of Blood	\$34.95
MGP 7812 Cities of Hyboria	\$24.95
MGP 7811 Cimmeria	\$29.95
MGP 7815 Betrayer of Asgard	\$29.95
MGP 7813 Khitai	\$24.95
MGP 7807 Adventures in the Hyborian Age	\$29.95

Flaming Cobra

MGP 6100 Spycraft 2.0	\$49.95
MGP 6103 Spycraft: World on Fire	\$34.95
MGP 6122 Dragon Warriors RPG	\$39.95
MGP 6123 Dragon Warriors Bestiary	\$24.95
MGP 6126 Apocalypse Z	\$19.95
MGP 6114 Fantasy Craft	\$49.95

Lone Wolf

MGP 1250 LW1: Flight from the Dark	\$21.95
MGP 1251 LW2: Fire on the Water	\$21.95
MGP 1255 LW3: The Caverns of Kalte	\$21.95
MGP 1257 LW4: The Chasm of Doom	\$21.95
MGP 1261 LW5: Shadow on the Sand	\$21.95
MGP 1265 LW6: The Kingdom of Terror	\$21.95
MGP 1267 LW7: Castle Death	\$21.95
MGP 1268 LW8: Jungle of Horrors	\$21.95

Mail Order Form

MY DETAILS

Title (Mr/Mrs, etc.) Forename

Date of Birth (dd/mm/yyyy) / / Surname

Address (1st line)

Address (2nd line)

State/Country

Post code/Zip code

Country

email

Code	Product	Price
		\$
		\$
		\$
		\$
		\$
		\$
		\$
		\$
		\$
		\$
		\$
		\$
		\$
		\$
		\$

Total (including postage) \$ / /

Postage rates: USA \$5 + 10% of total; Rest of World \$5 + 20% (UK cheques please email for rates: kgeorge@mongoosepublishing.com)

PAYMENT OPTIONS

Cheque (US only) (made payable to Mongoose Publishing Ltd.)

Mastercard

Visa

Visa Delta

Card No.

Valid From Expiry Date

Signature Date

Return Address: Mongoose Publishing, 52-54 Cricklade Road, Swindon, Wiltshire, SN2 8AF, UK.

The data provided will be held and processed under the terms of the Data Protection Act and will not be shared with third parties. We may from time to time email you with special offers and subscription information.