

MONGOOSE PUBLISHING PRESENTS

57

Signs & Portents

Traveller

A new scenario and new ships

RuneQuest

New Automata for Elric

Battlefield Evolution: World at War

New Forces and a brand new scenario

Plus... Slaine, Cthulhutech, VAS, ACTA and much more!

Signs & Portents 57

June 2008

MGP 5557

www.mongoosepublishing.com

Editor:

Charlotte Law

Managing Director:

Matthew Sprange

Mongoose Studio Staff:

Nick Robinson, Ted Chang and

Kelly George

***Cover Arts:* Chris Quilliams**

Artists:

Nick Robinson, Furman, Carl

Walmsley

Contributors:

Courtney Parsons, Agis

Neugebauer, John Foody,

David Manley, Matthew

Sprange, Carl Warmlesley,

Charles Green, Lawrence

Whitaker, Bryan Steele and

Nick Robinson

Well another month has flown by and another issue of S&P is complete. This month we once again have a nice, broad range of contributors and I'm introducing you to Courtney Parsons, a long time *Traveller* fan and a new writer to Mongoose who I am sure will not fail to impress.

So after a traumatic few weeks of dog pee hell I finally escaped back to my humble, animal free abode... well unless you count Adrian! As I write this with a glass of wine in hand and another issue under my belt I am relishing the prospect of a nice bath before I begin another day, and another month, with another heavy schedule... lucky that I like being kept busy!

I have however had to come to terms with the fact that I cannot compete with an aging Liverpoolian megastar. What I mean is that this weekend my other half has deserted me to go and see Paul McCartney at Anfield! I am not sure that this is a fantastic compliment to me, but at least it keeps him happy and also has give me time to apply the finishing touches to this months issue.

I've tried to make this month's issue rather visually stimulating, with extra art and maps. Look out for the clock work horse sketch in the Elric article... the artist made it up from the picture of me and my horse from issue 55.

Well my bottle of wine is beckoning and so is my bath, so forgive me dear readers, but I am going to cut this short, recharge my batteries, and get to work on the next issue!

ADVERTISING: All ads are subject to approval by Mongoose Publishing, which reserves the right to reject any ad for any reason. Advertisers and/or agencies of advertisers agree not to hold Mongoose Publishing liable for any loss or expense from alleged wrongdoing that may arise out of the publication of such advertisements.

Copyright © 2008 Warner Bros. Entertainment Inc.
BABYLON 5, characters, names and all related indicia are trademarks of and © Warner Bros. Entertainment Inc.
WB SHIELD: TM and © Warner Bros. Entertainment Inc.
(s08)



Copyright Information

All Babylon 5 material is copyright 2008 Warner Brothers. Babylon 5 created by J. Michael Straczynski

All Judge Dredd material is copyright Rebellion A/S

All Conan material is copyright Conan Properties International.

All Lone Wolf material is copyright Joe Dever.



All Eternal Champion material is copyright Michael Moorcock.

All WARS material is copyright Decipher, Inc.

All Starship Troopers material is copyright Tristar Pictures, Inc.

All RuneQuest material, with the exception of open game content designated above is copyright Issaries, Inc.

TRAVELLER	Starchild	5
	A Traveller Scenario by Courtney Parsons	
	Irregular Forces	19
	Three new units for Allied and German forces in Battlefield Evolution: World At War. By Agis Neugebauer	
	The Southern Traitors	23
	A Warrior Order for Slaine by John Foody	
	Wolfpack!	27
	Advanced Submarine Rules for Victory At Sea by David Manley	
	The Gauntlet	31
	A Scenario for Battlefield Evolution: World At War by Matthew Sprange	
	The Anywhere Map	36
	A Cthulhutech Scenario by Carl Warmesley	
	A Created Life	62
	A guide to the Automata of the Young Kingdoms by Charles Green	

	An Introduction to Castle Brass	75
	By Lawrance Whitaker	
	Deep Space Tournament	76
	For A Call To Arms by Matthew Sprange	
TRAVELLER	The Reptii Assault Triax	83
	New Ships for Traveller by Bryan Steel, with help from Nick "The Greek" Robinson	
	Plus...	
	Convention and Events Diary	4
	Write for the Mongoose	88
	Mongoose Product List	90
	Mail Order Form	93

Convention and Events Diary

Salute 08. ExCel Centre, London, UK.
Saturday 19th April 2008.
<http://www.salute.co.uk>

Mongoose Hall 08. Croft Sports Centre,
Swindon, UK.
Sunday 11th May 2008.
<http://www.mongoosepublishing.com>

Tentacles 2008. Castle Stahleck, Bacharach, Germany.
Friday 9th - Monday 12th May 2008.
<http://www.tentacles-convention.de/>

UK Games Expo 2008. The Clarendon Suites, Stirling
Road, Edgbaston, Birmingham, UK.
Saturday 31st May - Sunday 1st June 2008.
<http://www.ukgamesexpo.co.uk>

Q-Con XV. Queen's University Belfast Students' Union
Friday 27th - Sunday 29th June 2008
www.q-con.org.uk

Continuum 2008. John Foster Hall [also known as New Hall],
Leicester University. UK.
Friday 1st - Monday 4th August 2008.
<http://www.continuum.uk.net>

Gen Con UK 2008. University of Reading, Berkshire. UK.
Thursday 28th - Sunday 31st August 2008.
<http://www.horsemenevents.com/>

Game '08. New Century House, Manchester, UK.
Saturday 1st - Sunday 2nd November 2008.
<http://www.game08.eu/>

ConQuest VEGAS

On April 18th-20th 2008 (the weekend before the GAMA Trade Show), ConQuest VEGAS will play host to what could potentially be the largest A Call to Arms Tournament in the US.

Check out <http://www.conquestvegas.com> for more details on this event, or call 805 218-9590

THE STARCHILD

A Traveller Adventure By Courtney Parsons

INTRODUCTION

STANDARDS AND ASSUMPTIONS

The Starchild is an introductory adventure for use with the Mongoose Publishing rules set for Traveller. It serves as an excellent introduction for players and Referees who are new to *Traveller*, to The Third Imperium of Man, one of the most venerable campaign settings in the history of Science Fiction gaming. The Starchild deals with a group of adventurers who find themselves rather suddenly embroiled in the search for a missing girl on a mining installation operated by an Imperial Ministry of Defence contractor. What at first appears to be a simple act of domestic terrorism gone wrong suddenly thrusts the adventurers into the heart of an interstellar conspiracy perpetrated by back-stabbing double agents on both sides of the Fringe. Events force the group to confront a mysterious Zhodani operative who is said to be a restless, inhuman spirit denied the peace of death so he can wreak vengeance upon his Imperial enemies.

Although this adventure was originally written as an introduction to the Kinunir Trilogy and was intended to be played as a prelude to Research Station Gamma, it is not necessary to own or even be familiar with any of these materials to play this adventure; the only requirement the *Traveller Core Rulebook* from Mongoose Publishing. For more information on the Kinunir Trilogy, see FFE 003: Traveller: The Adventures, a publication containing all the original Classic Traveller adventures. The Starchild is written to either function as a stand-alone adventure or to easily be integrated into any existing campaign with just a bit of tweaking and preparation by the referee.

Time and Place

The adventure begins in the Spinward Marches Sector of The Thrid Imperium on the 300th day of the 1106th year since the Coronation of Emperor Cleon I and the founding of The Third Imperium. The date is expressed as 300-1106.

This adventure takes place in the Rhylanor Subsector. It begins on Jae Taellona (0404-A560565-8 Rhylanor/Spinward Marches) but can theoretically expand to nearly any planet in the Rhylanor subsector. To that end, the Referee may wish to have access to an Official Traveller Universe (henceforth, OTU) copy of The Rhylanor Subsector jumpgrid map like the one found in *The Spinward Marches* supplement for *Traveller* from Mongoose Publishing. If the Referee does not have access to this supplement, he should create his own subsector map according to the procedure given in the World Creation chapter starting on p. 167 of the *Traveller Core Rulebook* and place Jae Taellona as desired on the map.

Requirements

This adventure is written for 3-5 characters of beginning to moderate experience. At least 2 of the characters should have ground combat experience; it will be difficult for the players to complete the adventure if this is not the case. Experience with starships is also recommended, although it makes little difference whether this is acquired through a military background, such as the Scouts or the Navy or whether it is acquired through a civilian career such as the Merchants or the Rogues. Note, however, that if the players are creating new characters specifically to complete this adventure, it is far more likely that they will achieve the recommended

skill set through military experience or by joining the Merchant Marine than through a “knocking around” career such as Drifter or Rogue.

The *Traveller Core Rulebook* contains all the ship data and deckplans for every vessel critical to the completion of this adventure. The Suleiman (Type S) Scout/Courier, The Beowulf class Free-Trader and The Type R Subsidized Merchant (‘Subbie,’ or ‘Fat Trader’) are all detailed in the *Traveller Core Rulebook* starting on p.114. The Tigress-Class dreadnought and the Vargr Corsair will be detailed in upcoming supplements. For now, the Referee, if he does not have access to any information about the Vargr Corsair, may assume it to be equivalent to the standard Corsair on p. 129 of the *Traveller Core Rulebook*. The Tigress-class dreadnought is mentioned later but it is not necessary to have a deckplan or even a description of this vessel to run this adventure.

BACKGROUND

Shalini’s Tale

Note that this information can be pieced together by the adventurers by searching through X-boat feeds, library data and by talking to the girl and her father. It should not, of course, be given to them all at once.

Shalini A’ssynii is a young girl (age 10) whose family hails from the agricultural world of Belizo (3015-B895646-5 Rhylanor/Spinward Marches). The world’s atmosphere is naturally tainted, requiring filter masks for most normal humans but the populace has acquired a natural immunity over time. Agricultural and hydration techniques borrowed from higher technology worlds have allowed their crops to flourish and Belizo has grown

into a beautiful and prosperous farming community. It is said that the world is not completely unpleasant if one can adapt simultaneously to the hot climate and the atmospheric taint. The atmospheric pollution is caused by a naturally-occurring alkaline dust that causes severe irritation of exposed soft tissue, including lungs and eyes.

Before the journey that took them to Jae Taellona, Shalini's family consisted of herself and her parents. Her mother and father (Jaye and T'niri A'ssyni) were respectable Thiti Nut farmers who managed to eke out a modest but comfortable living for themselves. Jaye had one brother, Shallum A'ssyni, who left Belizo many years ago. Shallum was considered something of a black sheep by his brother's family, having forgone honest work in favour of the somewhat shady dealings involved in the life of an adventuring scoundrel. In addition to accruing a rather lengthy police record, he somehow managed to acquire a starship, a Type A Free Trader named *The Empress Iolanthe* (see the *Traveller Core Rulebook* p.117 for details), that some would later say he won in a high-stakes poker game. Several years from now Shallum's body is destined to wash up on the shores of the Regina Starport River but the precise details of his demise are to remain a mystery and not a very interesting one at that, at least, not to the Regina Starport Authority, under whose jurisdiction the case of Shallum's disappearance legally fell. Nevertheless, at the time of this adventure, Shallum has not been found and the details of his disappearance are of no particular import. What is important is that, according to Regina law, the ownership of the vessel defaults to Shallum's next-of-kin in the event he is declared dead. Since Jaye had neither need nor desire for star travel, nor a wish to so much as speak to his brother, Shallum's disappearance was to go unnoticed and the *Empress Iolanthe* was to sit rusting in a warehouse storage hangar for the next 6 years. At the same time, since Shallum was legally still alive, the storage fees were automatically withdrawn from the remainder of his somewhat large – at least, large six years ago – bank account.

Jaye, a man of deep conviction, wanted no part in his brother's likely ill-gotten booty, so he took little interest when the Regina authorities notified him that they were about to declare Shallum dead during the first half of 1105, nor did he bat an eye when the Minsitry of Ships and Shipping sent him an official Xmail notification that he would have to come to Regina to claim the *Empress Iolanthe* because Regina SPA had just declared the owner dead. Further, Jaye had every intention of letting the rapidly accruing debt go into default at the end of the mandatory one-year grace period, at which time the ship would be auctioned off to the highest bidder.

Then everything changed. About 6 months ago Shalini fell ill. She began to complain of severe headaches and her strength began to wane. She would often be bedridden for days only to suddenly wake up one day and be fine. She began to have horrible nightmares, which Jaye and his wife discounted as merely feverish dreams at first. However, one day, after Shalini had been bedridden for days, she suddenly recovered and told her father that she had dreamed of a terrible monster that had ridden in on the wind and wreaked a massive amount of damage while it ate 224 people. She described in lurid detail how the creature was spitting air and water between its long fangs as it wandered along its hideously destructive path. A day or two later a record-breaking hurricane laid waste to a small continent on the southern hemisphere of Belizo, doing millions of credits worth of property damage and killing hundreds. A few days later, the family was gathered at the kitchen table when the final death toll was announced: 224.

Shocked, her fearful parents took her to a well-trusted doctor friend of theirs, who after great difficulty, determined that she was most likely suffering from a brain tumour. His primitive TL5 diagnostic equipment did not seem to work on her and indeed, all sorts of electronic equipment began to malfunction around her. He began to suspect that there was more at work in the girl's illness than a simple tumour, so he consulted the

interstellar medical database at the local Class B Starport installation and happened upon an obscure medical paper penned by a Dr. L'leel Thorne, a corporate doctor with a background in medical research. After dealing with an unprecedented number of illnesses with strikingly similar symptoms on his own world, Dr. Thorne used the X-boat database at his world's local Scout base to detect similar patterns on worlds all across the Domain of Deneb.

Although the Belizan doctor was from a bucolic background, he was no idiot. He managed to infer from Thorne's paper that the tumours were causing the activation of latent psionic talents in the afflicted girl and knowing little (yet enough), Imperial Law to understand that the girl would be in danger from far more than just a tumour if this were ever to be discovered by the authorities, he warned her parents to remain silent. Also, Dr. Thorne had had experience with tumour removal during his posting on Jae Taellona and the A'ssynii family physician made contact with him through the Xboat network. Dr. Thorne replied that he would be glad to meet with Shalini and her family and responded that he felt he could treat the girl discreetly and perhaps remove the tumour, if that were indeed what was causing this illness.

Jaye took out a small mortgage on the *Empress Iolanthe* and bought passage for himself, his wife and their child aboard an agricultural transport headed for Jae Taellona, which was the only available transportation at such short notice. The ship was called *The Rainbow Sun*, a 400-ton subsidized merchant owned by Tukera lines. The A'ssyniis had to stay in cramped crew quarters just above the engine compartment and Shalini suffered greatly during jumpspace, at least, during the time when she was awake between doses of sedatives. The *Rainbow Sun* suffered an endless series of malfunctions and mysterious electronic fires during this time and the crew were far from sad to see the journey end when the ship finally landed on the dust-blown surface of Jae Taellona.

The A'ssynii family disembarked the Rainbow Sun, believing themselves to be finished with that vessel forever. However, the forces that govern the cruel fate of those who would travel between the stars would not have it thus. Even as the family navigated their way through the unfamiliar environment of Jae Taellona's vast underground complex, the captain of The Rainbow Sun, Lars Granhault, began to set events in motion that would fuel the gossipmongers who haunt the jumplanes and the Xnet for many Standard Years hence.

Lars was an ex-scout and seasoned wanderer of the Imperial Fringe who knew psionic talent when he saw it. Granhault also recognized when an opportunity for profit presented itself that was too good to pass up. He discreetly let himself onto the bridge while no one was watching and downloaded what was left of the vessel's surveillance data and logtapes and (illegally) removed the organic core of the Rainbow Sun's primary flight data recorder – the only piece of equipment that had recorded all of the events aboard the Sun and remained undamaged. Granhault then contacted an underworld associate of his who had connections to the Zhodani spy network on Jae Taellona and sold it to him for a rather sizeable fee. Unfortunately, Captain Granhault did not live long enough to enjoy his profits once the Zhule operatives grasped the full implications of what they had been brought.

The swiftness of the spy network's response would have received grudging admiration from even the most efficient Zhodani-hating Imperial Intelligence officer. Within 6 hours of selling the information, Captain Granhault's personal air/raft mysteriously exploded about 10 minutes after departing from a rather seedy area of East Startown, scattering burning wreckage uniformly over the partially abandoned town below. Granhault's underworld contact, N'ort Tume, was arrested soon after for the crime and was found hanged in his cell after only a few hours in custody, presumably the victim of suicide.

Meanwhile, as the A'ssynii family visited the offices of Dr. Leel Thorne, who, unbeknownst to them, had worked in an Imperial Research Station on Vanejen years before and had direct experience dealing with psionics. He verified to his own satisfaction that that the girl was one of the most powerful precognitive psions he had ever encountered, though he did not entirely reveal what he knew to the family. He immediately contacted the Imperial Intelligence Service (IIS) who wasted no time sending a pair of agents to the office even as the family were waiting. The family was being told that a treatment did exist and that although it was experimental, that there was still some cause for hope. Thorne immediately referred them to a doctor on Vanejen who, the family were told, was the man who had developed the original treatment and was therefore the most qualified to perform the surgery. Further, Thorne assured the A'ssynii that public funds existed to assist cases like Shalini's.

The family were told that time was of the essence and that the funds had already been approved by the local Ministry of Medical Affairs and the IIS officers were actually medically trained Ministry personnel, there to facilitate their trip to Vanejen. The family was assured that the government had their best interest at heart and that they must depart to a waiting starship quickly before Shalini's case got any worse. Once aboard, the plan was to put Shalini into medical cold sleep for the journey, to prevent her condition from degrading any further and to alleviate her suffering and psionic outbursts.

For the first time in many months, Shalini's parents had begun to feel hope that everything was going to be alright. It was then that everything quite literally exploded...

Planetary Data

JAE TAE LLONA (0404-A560565-8 Rhylanor/Spinward Marches)

Physical Description

Jae Taellona is the only inhabited world of the single-star Jae Taellona system. In addition to the mainworld, the system contains 3 gas giants and an asteroid belt as well as a number of unremarkable planetoid-sized bodies scattered between. There is a single large gas giant locked in a solitary orbit and a pair of twin gas giants, which are fairly small. The pair of small gas giants are in possession of an unusually high periodicity, as well as being closely linked in their stellar orbits, making them all but inaccessible throughout most of the Jae Taellonan year. The remaining gas giant, which accommodates a reasonably impressive satellite system of its own, is the only other major body in the system that will remotely interest most visitors.

Refueling within the large Jovian system is perfectly legal, even encouraged, since the lone pair of class A Downports on the system's mainworld see more than their fair share of traffic, indeed, sometimes even more than they can comfortably accommodate. Plans have been in the works for quite some time by the Jae Taellonan Starport Authority to add multiple orbital elements to help alleviate the overflow of traffic but thus far, none have progressed past the planning stage and SPA officials are notably adept at avoiding questions. To this date, the only orbital elements that can handle any significant traffic belong to the Navy, who notoriously loathe opening its facilities to civilians. However, on more than one occasion the Navy has been forced to open at least one station to larger commercial vessels when traffic flow threatened to strain the Downport capacity to unsafe levels.

Although Jae Taellona boasts a Standard atmosphere, it is a desert world and daytime temperatures can become torrid and even quite deadly, even in the so-called temperate regions. There is no free standing water on the planet whatsoever and most offworlders will find the environment outside the underground complexes quite uncomfortable. Needless to say, crossing the

desert is lethal without a vehicle or environment suit. Those not acclimated to the harsh wind and the absence of moisture in the air will find that exposed skin quickly chaffs and blisters, often causing moderate to severe damage before the afflicted is even aware of the problem; and during the day, dehydration and heat stroke often quickly follows.

To minimize exposure to the harsh desert sun, the world has two Starport facilities, one at each polar region. Jae Taellona has a period of revolution of about 2.2 standard years and a 250 axial tilt. A day on Jae Taellona lasts about 36 hours in the mid-latitudes but days at the polar regions are a little over an Imperial Standard year long. Many inhabitants, at least those who can afford to, fly to the opposite pole every 13 months or so as to always live on the nightside, which, although frigid and just as deadly to the unprotected, many still feel is much preferable to the blistering daytime heat.

There is a powerful magnetic field present at both poles, approximately two orders of magnitude greater than that of Terra and three orders of magnitude greater than that of Capital and the night months are often lit by spectacular dances of colour caused by ionized particles in the atmosphere as they are ignited by powerful solar winds. The light is often so bright that it is possible to see, even navigate, without visual aid. Many Travellers feel that this spectacular display makes up in some small way for the fact that this tiny (8,109 km) low-G (0.625g) world has no moon. Mining colonies exist mostly underground, periodically dispersed throughout the regions of desert and mountains.

Government and Law

Although the law level is nominally 5 (moderate), Jae Taellona is made up of rough-cut miners who, as long as they work hard, the government generally allows to play hard. Recreational drugs, some of which are categorically banned on many worlds elsewhere in the Imperium, are freely available upon Jae Taellona and prostitution has

evolved into an institution with benefits and pensions. Jae Taellona has become a haven for miscreants, including human pirates, Vargr corsairs and strangely enough, Zhodani agents. Zhodani spies and operatives have found Jae Taellona an ideal world on which to blend in amongst this motley assortment of criminals of varying races; indeed, the fact that many smugglers and criminals of their own race tend to operate out of Jae Taellona serves to draw attention away from the activities of the professional agents and towards the less-than-subtle methods and far more colorful backgrounds of their criminally-inclined compatriots. Against this lurid backdrop of criminals, scam artists and thieves, the Zhodani operatives find that they are able to conduct an unprecedented amount of business while remaining relatively unmolested.

Nominally, the colony falls under the edicts of Imperial Law and is operated under charter by Sternmetal Horizons, LIC, at the behest of the Imperial Navy. The Majority of the planetary police force are probably best described as corporate security personnel, without a lot of real power but just enough to make them better avoided by would-be adventurers. A drunken miner who is involved in a bar brawl is far more likely to be given a ride home and an admonition than to be taken to jail. This would not be a problem if the same miners were not taken home by police nearly every weekend. Many on the force are corrupt and a large portion of police and economic power is controlled by criminal organizations. Anyone crossing the Affiliation, as it is commonly called, is usually driven to the desert in an air raft near the equator and left there, where death comes quickly, if not easily.

If there is any real trouble it can usually be attributed to groups of miners who either take part in terrorist activities or simply hold up production through the time-honoured method of civil disobedience. Sternmetal has full legal authority to request Imperial troops, should they feel that a particular situation warrants it and they

have yet to be denied such a request. It is generally believed that Sternmetal has never made such a request lightly. The troops usually try to capture and imprison the labourers but in some extreme situations, they have been known to break up gatherings of dissidents with lethal force.

Environment and Ecology

There is very little animal life on Jae Taellona. Except for the humans that exist in the above and below-ground cities, the planet is largely free of multicellular life-forms and most of those that do exist are insects. The dominant form of life on the world is the motile desert algae that grows in vast carpets in the temperate zones and the variety of single-celled organisms and insects that exist in tandem with it. It is this algae that is largely responsible for maintaining a breathable atmosphere on a world with no water and a minimal ecosystem. A typical motile carpet and the parasites it hosts can be expected to move up to 10 km a week – too slow for the human eye to perceive, yet fast enough to quickly remove all doubt as to its mobility. Though vast carpets of algae move across the surface, they never approach the polar or equatorial regions, so the majority of the world's population lives and dies on Jae Taellona without ever even seeing it.

Powerful solar winds charging the densely-packed ions in the atmosphere sometimes cause great problems in with sensors, contragrav function and communications. Occasionally, ships are grounded by Starport authority because of the interference of powerful magnetic storms. To lift off during an emergency grounding is a serious offense and the offenders will be hunted down and charged large fines or even find themselves sentenced to a penal mining colony under horrendous conditions for months or even years. The exact punishment for violating a flight ban is well within the SPA JAG Officer-On-Duty's discretion but ranges from a Cr10,000 fine up to 3 years hard labour.

Hazard Advisory

The primary hazards on Jae Taellona are the inhospitable climate, occasionally angry and/or drunken miners and a well-established criminal underground. However, most travellers need not be overly concerned with these issues, since crimes of a violent nature against tourists or travellers just passing through are exceedingly (not to mention surprisingly, to some) rare. The few incidents that have occurred in such cases have almost exclusively happened when curious offworlders have ventured to places in which they knew full well beforehand that they had no business. Of realistic concern to travellers, however, are the ion storms. While the SPA has become quite adept at detection and early warning, more than one traveller has found himself grounded on Jae Taellona for indefinite periods of time; some for so long that their travel funds have dwindled away and they were forced to find local employment until they could afford passage.

Population Centres

The two major population centres on Jae Taellona lie at the extreme magnetic poles of the planet and each experience extremely long periods of alternating darkness and light, with six local months of each. A Jae Taellonan solar month is just a little over two Imperial Standard Months. While each Starport remains operational throughout the year, most civilian traffic is routed to the one that is currently in darkness. Since military and corporate traffic are exempt from this rule, the Starport that is currently in daylight maintains a small but effective work force and just enough residents remain behind to serve their needs, while a large majority of the remainder migrate to the other side of the world.

There are various installations all over the planet serving as access points to the rather extensive network of mines and tunnels that are laced throughout the planet's crust. These access points often function as cities, though the buildings and installations of which they consist are often of a very temporary nature. Most of the access

points are in the equatorial and tropical bands and are often concentrated in the hilly and mountainous regions. Sternmetal Horizons does not freely distribute information as to their active mining sites, however, so information on these installations is sparse at best and subject to change without warning.

The northern city is known, somewhat archaically, as Stargate Artica, while the southern is known as Stargate Antartica, in accordance with a tradition that became popular among planetary scientists during the Rule of Man. A migratory population of approximately 90,000 people exists between the two cities, while Stargate Artica has a stationary population of about 2,090, while Stargate Antartica has a slightly smaller stationary population of 1,999.

While both cities have some die-hard surface dwellers who tend to see living on the surface and braving the elements as a sign of superiority, the major portion of each city exists underground. Of the two, Stargate Artica is older and therefore slightly larger and has a much more developed underground complex. Stargate Artica is thought to have been the landing site of the original settlers of this world. The underground complex of Stargate Artica is divided into eight Sectors, which are named for the colours of the visible electromagnetic spectrum (eg, "Red Sector," "Orange Sector" and so forth). Each sector has its own identity, purpose and culture. For example, Yellow Sector consists of offices and housing of people who work within the bureaucracy of the Imperial government, all official government offices on Jae Taellona can be found here. Red Sector contains the underground element of the Starport and the apartments and hives that house SPA personnel and civilian employees. The sectors are connected by an extensive and somewhat quaint underground electrical railway system, somewhat reminiscent of the subways, which used to (and, in many cases, still do) grace the undercities of larger population centres such as Old New York of Terra and New Nashville of Barnard.

Stargate Antartica has the same system of classification but it is far less developed. Only five sectors (Red through Blue) exist there.

Referee's Notes

In the desert, another environmental concern is the rare but dreaded occurrence of terrible windstorms (generated by pockets of pressure differential due geomagnetic and gravimetric flux) where winds powerful enough to shred flesh are accompanied by beautiful but deadly bolts of multicoloured lightning. For every two weeks travel in the desert, roll 1d6. A roll of 1 indicates a windstorm. These winds will whip up the extremely fine sands that make it impossible to breathe unless the unfortunate traveller's mouth and nose are covered or if he is in a sealed environment.(see suffocation rules, TCR142) and cause 1d6-2 damage per minute to unprotected skin. If the group is flying, a piloting roll must be made every 20 minutes to keep the vehicle in the air. There is also a respectable chance of being hit by lightning: roll 2d6 if in the air: a 2 or 3 indicates the craft is struck by lightning. On the ground, roll 2d6; a roll of 4 indicates a randomly determined party member is struck by lightning. The bolts are small but very energetic; they do 3d6 of damage and may short out unshielded electronic equipment, at the Referee's option.

Recently, the Affiliation has been cooperating with a Zhodani Director who controls a small group of expert Zhodani commandos specially trained for the task of working deep undercover in the Imperium, far beyond the Fringe. The Director and his group are working with The Affiliation to establish a permanent base here so they can weaken the Imperial infrastructure for the upcoming Fifth Frontier War.

ENCOUNTER I: TERROR IN THE TUNNELS

The adventurers find themselves stranded in Stargate Artica during the night months, all but broke and looking for work to find some way off this hellish rock. They are fortunate enough to be on the nightside of the planet at the moment but the cold is barely tolerable and they discover that it is probably wise to go underground. At some point, they will find themselves unable to avoid travelling on board one of the underground electric railways, perhaps during a journey to an as-of-yet unvisited startown bar or to the latest in a series of increasingly cheap motels as their capital inexorably dwindles away.

Read (or paraphrase) the following to the players: You have spent yet another day fruitlessly searching for work to gain enough capital to get you off this dustball; now, you slowly leave the underground portion of the starport where you have spent your day. Exhausted, you wait impatiently for the evening's last monorail, as you muse angrily over how silly it is to have a closing time for public transportation in an underground city where the mines operate in round-the-clock shifts and it is going to be night for six more standard months anyway.

Finally, the train arrives and you take your seat, stopping to briefly brush away the thin coating of metallic dust

that covers everything in this godforsaken city. Looking about, you see that the train is fairly crowded with workers on their way home from the mines (presumably, the source of most of the dust) as well as a couple of other offworlders from the starport, who also look as though they would rather be anywhere but here.

Finally, after about 15 minutes, you hear a hiss and barely catch yourself yet again as the primitive electric train lurches to a halt. The doors open with a clumsy screech and five people step on board (Shalini, her parents and two Imperial Intelligence agents). Two of them appear to be a couple, obviously offworlders, judging by the simple woven tunics of vegetable fibres and the colourful headbands that they wear. The third, dressed in a similar manner, is a child, a beautiful girl with big, brown eyes and a thick, flowing mane of hair who, despite her beauty, looks pale and shuffles along as if she were not feeling well. The remaining two are dressed in business suits and sport glasses with mirrored lenses. You wonder briefly if the glasses are offworld lenses fitted with microUV detection and thermal imagers, then decide that it is probably none of your business.

Unbeknownst to the passengers, a bomb has been strategically placed in the underground tunnel ahead by a disgruntled miner who has been recruited by the Zhodani forces. Five strike squad agents wait in the tunnel, in fire teams of two and three. The team of

three has orders to board the railcar, while the other two wait outside and cover all possible escape. Suddenly, the travellers' world is thrown into chaos as the bomb detonates, partially collapsing the tunnel. The windows of the train shatter as it is thrown from track, lurching sickeningly on its broadside along the tunnel. Finally, with the gut-wrenching squeal of steel, the car turns over on its side. Adventurers who still have their senses about them (an Average check of Endurance, followed by a Difficult test of Recon) can barely make out three unusually tall and lithe figures in dark clothing, scampering up the side of the capsized railcar through the shattered window. The individuals' faces are covered but those who passed the Recon check can see that they are cradling weapons. A second Routine Recon check identifies the guns as laser rifles with grenade launchers. With fluid, graceful motions, the figures drop into the railcar through a shattered window. These strange men are in fact elite Zhodani special ops agents (See table below for details).

Read the following to the players:

You are not sure what just happened. Your ears are still ringing and the world around you has lost its focus. You become increasingly aware of the fact that you are laying on your side and someone is on top of you. You hear the sounds of screaming. It is dark but your eyes are already beginning to adjust to the dim emergency lights that illuminate the vaulted subterranean passage that you

Character	Career Path	Strength	Dexterity	Endurance	Intelligence	Education	S o c i a l P s i o n i c Standing	Strength
Zhule Sodality Strike Squad	Agent (law enforcement) 3, Army (infantry) 1	9	10	8	9	8	7	5
Athletics (co-ordination) 1, Athletics (endurance) 1, Deception 1, Gun Combat (energy rifle) 2, Gun Combat (slug pistol) 1, Melee (blade) 1, recon 1, Stealth 1; Telepathy 1								



can just barely make out overhead between the jagged shards of thick safety glass where the window used to be. You are not surprised when you become aware of the sputtering, carefully controlled rat-a-tat burst of automatic gunfire somewhere to your left.

The crowd panics, trying all at once to get out of the railcar. The troops are wearing advanced (TL12) hyperspectral headgear equipped with a heads-up display. Treat as TL 12 PRIS (*The Traveller Core Rulebook*, p.96) that gives a +2 DM to hit. They immediately track (their equipment negates the negative DM due to poor lighting) and lock in on their targets, using laser rifles to minimize collateral damage. Note that experienced players will realize that if the adventurers jump up and attempt to open fire in the crowd they are far more likely to hit an innocent bystander than their targets. One of the two Imperial Intelligence agents lies in a pool of blood on what has become the floor; as the group tries to collect their senses, they see a burst of coherent light lance through the darkness, cutting down the remaining agent even as he reaches in his jacket for his sidearm.

Immediately Shalini's father grabs her and attempts to herd her through a shattered window but they are blocked by two Zhodani agents waiting outside. Shalini's mother lies on the floor, her body twisted, broken and not breathing. Before Jaye and Shalini can make it out of the window, Jaye is cut down by another burst of coherent light from outside the railcar. The operatives will then attempt to grab Shalini. The group may try to interfere but if the squad gets their hands on her, every control panel, surveillance system and light source both in the tunnel and aboard the subway vehicle suddenly explodes in a shower of sparks, adding to the confusion. Surprised, The Zhodani will release her and she scampers off down the corridor. The squad will attempt to avoid fighting with the group in favour of chasing Shalini, who they find is no longer detectable by vision or their multispectral goggles.

If the agent in charge decides that the mission is a wash out, they will release smoke and stun grenades to cover their retreat. Note that if the EMP also shorted out the laser rifles – GM's discretion or separate random rolls, 2 in 6 chance, since they are military weapons and probably have hardened circuitry) – then the commandos will switch to their gauss pistols if confronted by armed resistance from the adventurers. If the group is having a difficult time defeating the Zhule agents, then the Referee may choose to make this ruling in order to give them all the edge that is needed to come out victorious – after all, it *is* the opening scene of the adventure.

The Zhule agents had planned to run down the tunnel for about half a mile to where they have secured a maintenance access ladder to the surface, at the top of which awaits an open-air ground vehicle. However, since they had not anticipated the girl's ability to be invisible to their hyperspectral goggles, they will probably abandon that plan and they are quite willing to remain behind and die if necessary. The Referee should keep in mind that the Zhule agents are professionals and while they may be dismayed by this turn of events, they are fully capable of improvisation. If captured, the agents are equipped with a microcapsule filled with a deadly liquid hydrogen cyanide-concentrate held in a hollowed-out molar, which is activated by first using the tongue to manipulate the capsule into place (a safety measure to prevent accidental breakage) then by the application of a substantial amount of pressure by biting down. The microcapsule is carefully placed so that it is virtually impossible to break should the host experience an accidental impact.

When the Zhule agents are finally defeated or if they escape or should the Transit Authority arrive in time (careful – many players feel such timely arrivals appear contrived) to assist the adventurers, the chaos eventually begins to die down. If they are not already there, the Transit Authority personnel will finally manage to arrive and the group finds that Shalini has utterly vanished.

Investigation of the security cameras and video imaging devices find that they are all shorted out and though there are a limited number of access points, no one seems to recall seeing Shalini pass through. A search is instigated immediately through the tunnels with the assumption that she remains in the railway system while all stations are notified to be on the lookout for her. Of course, any such search will ultimately prove to be fruitless, since the girl's telepathic skills are of sufficient strength to erase any memory of her presence.

Shalini's mother is long dead when the medical personnel arrive and her father is very likely to be dying but conscious – unless the group has been *very* diligent. As Jaye is being led away in a stretcher, he grabs one of the character's hands with the strength of a desperate man. He asks that they visit his hospital room as soon as possible, for he is certain that he does not have long to live and even if he survives his wounds he is certain that "They" will return to kill him as soon as possible. His need is of the utmost urgency, he claims.

As he is being wheeled away, Jaye begs the group to find his daughter, claiming that he will give them all that he has if they can succeed.

"Hsh!" admonishes the medic, as he wheels Jaye away.

ENCOUNTER II:

THE OFFER

The hospital room is cold and sterile and the dying man is attached to a breathing machine, so he cannot speak – if the group somehow has prevented the strike squad from shooting Jaye, then the nurse tells them that severe internal injuries from the impact will prevent him from surviving the night. The group can deduce that Jaye must have been moving on pure adrenaline when he tried to push his daughter out the railcar window. A well-dressed man sits in a chair next

to the bed, pouring over a datapad and rises to meet the adventurers as they enter. He introduces himself to the group as Jeel Tormé, a litigation specialist whose primary field is Interstellar Processes. He hands the pad to his client and the group looks on as the datapad shakes violently in Jaye's hands. Eventually, though, Jaye manages to outline his proposition for the group on the rather primitive holographic display. The details are fairly straightforward – the *Empress Iolanthe* for the rescue of Shalini and her safe delivery to the specialist on Vanejen. The first catch that the players notice, however, is that the ship is warehoused on Regina, which means that the adventurers will have to get themselves there. If the group agrees, then all legal documents are drawn up via hand computer. Once the group has fulfilled the terms of the contract, the lawyer will issue the new registration documents for the ship, which can be done, if necessary, via Xmail.

If the group agrees to take the job, Jaye downloads the family's last Cr8,000 into their accounts to cover any expenses that they may have during the search. Also, Jaye gives the adventurers the girl's ragged teddy bear and his religious symbol (the Belizan Triple Cross), so Shalini will know that the group is acting for him. He also gives them a data chip that contains a single audio file: the short, pained final message of a dying father to his daughter, since the doctors have predicted that he will not survive the night.

If pressed for tips on where to begin, the man scrawls down that she usually goes to "places where she feels safe" but that he would not know where that would be, on this world. The family had stayed in a motel the previous night; perhaps the adventurers should begin there. A nurse suddenly arrives to inject a syringe of Hydramorph into Jaye's IV tube and he succumbs to a deep slumber from which he will never awake. Jeel remains for a few moments to insure that the group has no further questions and to explain that he has heard that not only are the local authorities on the search but

that Imperial Intelligence is also diligently looking for the girl and that the father told him that he was no longer sure who could be trusted. Since the adventurers (presumably) did their best to stop the Zhule operatives from taking Shalini or hurting any more innocents, Jaye felt that they were perhaps the best candidates in which to place his trust.

Enemies

Following the failed operation in the rail tunnels, the adventurers will be watched by the operatives of the Zhule Sodality – some of whom are psionic. The abysmal failure of the extraction team to return with the girl and due to all of the unwanted attention that has suddenly been drawn from that particular operation, the commandant of the local *Zhule* cell has decided to bring out his most terrifying weapon: a psionic operative who is so effective and therefore so valuable, that he is kept in cold sleep until he is needed. This operative is the legendary *Spectre*, who is whispered to be a ghost amongst Jae Taellonan underworld, returned from the grave to exact revenge upon his human murderers. Legend has it that 150 years ago, *The Spectre* was cornered and surrounded by Imperial agents who were leading a combined task force of local police and security personnel and burned to death with plasma weapons. It is said, however, that his body was never found; that he has become pure energy and that he is now more powerful than ever. Much to the chagrin of more than a few of his *Sodality* colleagues, *The Spectre* has been brought out of cold sleep and is now in command.

The local police have been infiltrated and are under the influence of the Jae Taellonan underworld, which is in turn under the influence of the *Sodality*, so their help will be ineffective at best; at worst, they may actively interfere with the group's investigation. The local Imperial Intelligence Service office is a wildcard, to be played as the Referee sees fit; perhaps some of the adventurers are even agents themselves or perhaps they can be used to point the group in the right direction should the trail grow

cold. The IIS on this world, however, is underfunded and severely undermanned; they will be of little help to the group but by the same token, they will not be able to interfere with them much either. It is possible that the adventurers may be questioned once or twice by the local police, perhaps even brought in for interrogation, until *The Spectre* gives the order to leave them alone, at which point they will be inexplicably released and no further trouble will be had. *The Spectre's* plan is to allow the group to operate unhindered, in the hopes that they will have better luck locating Shalini, hopefully having far more subtle methods than his operatives.

The local Director of the *Sodality* is Heinrich P'tr'ar, a Zhodani who has undergone genetic conversion to appear to be a normal Imperial human. The PCs are not likely to encounter him in this adventure. They will, however, encounter *The Spectre*, who will catch them unawares unless they are very, very careful.

During this time, it is important for the Referee to be aware that the group is being watched by *Zhule* agents and their human informant network. The *Zhule* operatives have four SPA security personnel in positions ranging from low to mid-level on their payroll, as well as a mechanic that is currently performing repairs aboard *The Rainbow Sun*. It is simply a matter of time before the *Sodality* locates her but they prefer to allow the adventurers to do the legwork for them in order to minimize exposure. While the group is investigating, they will be tailed by three field operatives of the *Sodality*; use the statistics given in the NPCs section for the Zhule Sodality Strike Squad if the group becomes aware of them and combat ensues.

If the players do not state that their characters are watching for suspicious characters, the Referee should not worry about rolling; if, however, a player indicates that his character is (rightfully) being paranoid, the Referee may wish to make a secret Stealth check for the

agents vs. the characters' Recon skills. If the character succeeds, he may notice a suspicious individual (or two or three) watching the group from a corner booth in the Starport bar or from behind a newspaper in a rail kiosk and so forth. If the agents think they are made, they will flee. If cornered, they will fight but they will not let themselves be taken alive and will use the poison capsules described in *Encounter I* if captured.

ENCOUNTER

III: AVENUES OF

INVESTIGATION

There are several ways that the adventurers can go about their investigation. The first that will likely come to mind will be to question Transit Authority personnel in case the local police cannot be trusted. Allow them to do so but after a day of information gathering and a few successful Investigate, Diplomacy or Carousing checks the Referee should make it clear to the group that this avenue of investigation is a dead end. Any electronic security equipment that might have caught what happened in the tunnel that night has been shorted out and while there may be remnants of data recorded before the pulse, they will, of course, be of little value.

Next, the group will probably think to check when the family arrived from offworld. Hopefully, this will then lead them to look for the ship that the girl arrived in and ask questions of the crew. Other methods would be to search out the local taverns and bars, along with public and police records for clues as to who is chasing her and why. The most common methods that can yield clues are detailed below but this list is by no means exhaustive; the Referee will have to adapt to his players' styles.

Finally, should the players think of something that not covered here, do not immediately discount it; the Referee is encouraged to evaluate the players' ideas in light of

the information given in *Background*, the information below and that given in the NPCs section and finally to ascertain for himself whether or not the players' ideas will be effective.

The Lion's Den

Asking questions at the local Starport facility and checking prior arrival and departure records (which are public information and should require no rolls should the group think of it) will reveal that the girl arrived aboard the 400-ton *Akkigish*-class Subsidized Merchant *The Rainbow Sun*, which was, at the time of arrival, under the command of one Captain Lars Granhault. Tracking Captain Granhault's last movements may lead the adventurers to *The Lion's Den*, a spacer's bar on the surface outside the underground complex, amongst the squat, crumbling and mostly abandoned buildings that were part of the original colony when that was built by the first settlers to land here.

The Lion's Den, at first glance, appears to be a hangout for drug dealers, addicts, alcoholics and seedy underworld types. It is quite successful in this respect, due to the fact that the local police do not like the extreme temperatures and therefore do not go up to the surface often. Besides, they believe that little goes on in *The Lion's Den* that could possibly interest them, since nearly everything on Jae Taellona is legal anyway.

In fact, *The Lion's Den* is little more than a front for the *Zhule Sodality*. Agents of the *Sodality* will recognize the PCs immediately but no one will alert them to this. The bar patrons and employees will appear to be very helpful at first but the adventurers will soon realize that the folks they meet here are masters of talking much and saying little. One of the Zhule operatives involved in the subrail attack is posted here but the PCs have no way of knowing that. For a price, of course, they will be offered drugs, sex and even information but none of any real value. After talking to a few people, a successful Routine

Streetwise check reveals that although the patrons and employees seem friendly on the surface, no one wants the group here and would rather that they left and that there is little to be gained by questioning them further.

The Stellar Wind

The local spacer's bar is called *The Stellar Wind* and is filled with a mixed crowd and therefore, information of a more useful nature than that gleaned in the *Lion's Den* might be encountered here. *The Stellar Wind* is in Red Sector of Stargate Artica, about a 10 minute walk along the Concourse from the Starport, making it a natural place to begin.

There are two types of rumours encountered in *The Stellar Wind*: Mandatory Rumours and General Rumours. Mandatory rumours are automatically encountered in the first instance of the group spending any significant amount of time in the bar and are only encountered in *The Stellar Wind*. General rumours are assumed to occur in *The Stellar Wind* but theoretically can occur in any of the starman's bars in the Red and Blue Sectors of Stargate Artica. If the group wishes to split up, allow them to do so and each subgroup or lone adventurer may make a separate check. Each hour spent searching for rumours in *The Stellar Wind* requires the seeker to spend at least 2d6 credits on drinks and nets a single Easy Streetwise or Carousing check, which, if successful, garners a roll on the Rumours Table below. Each extra Cr10 spent on drinks allows the adventurer an extra attempt per hour, to a maximum of 3 attempts. Group members may also make untrained attempts to garner rumours using the Soc skill but the difficulty then rises to Average and the costs for drinks are doubled. An abysmal result (four or more less than the target number) on any attempt means that the seeker has incurred some resentment and may not check for rumours in that particular location any longer without instigating potential violence. If the result is especially poor, the Referee may also wish to impose an encounter with a group of resentful belters, drunk and looking for a victim to administer a severe beating to.

The Referee should feel free to choose rumours from the table rather than rolling, especially if he feels that the group is stuck in their investigation but he should be mindful of the DMs that apply to each character type when doing so. Rumours 1–6 are more likely to be obtained by Rogues and Drifters using the Streetwise skill while 10–13 are more likely to be obtained by professional, ex-military starmen and women through the use of the Carousing skill. Rumors 7–9 are common, everyday rumours, which are more likely to be gleaned by those using the Soc ability with no DMs to their table roll.

Random Rumors

DMs: Ex-Scouts, SPA or Naval personnel receive a DM +1. If, for some reason, the adventurer making the roll is actively enlisted in one of these services, the DM is +2. Ex Rogues and Drifters are awarded a DM of -1, -2 if they are still active members of that profession. Referees should feel free to choose a rumour from the table rather than rolling; an especially good result should automatically net them a true, useful rumour, such as Rumour 2 or Rumour 12 or if the result is *very* good, Rumours 1 or 13, depending on the skill (Streetwise or Carousing) and the character type involved in the attempt.

Rumors Table

Die	Rumour
1.	A couple of shady figures who work for Big Name crime lords have been overheard recently hiring local thugs to watch the crew of a freighter known as <i>The Rainbow Sun</i> , which sits in the repair yard at the Starport.(T)
2.	Captain Granhault was a well-known alcoholic and sex addict. He frequented a place called the <i>Lion's Den</i> , known to be a front for the local underworld. They say he dabbled in smuggling and had plenty of underworld contacts, including one N'ort Tume, who killed himself while under arrest recently. (T)
3.	Mysterious, shady-looking individuals who are definitely of Zhodani descent are said to have been seen in the company of several Big Name crime figures at their hangouts in Orange Sector. Some say they are part of a deep-cover cell known as <i>The Zhule Sodality</i> and they are getting ready for Something Big. Anyone that goes around repeating this information to the Wrong People may find himself buried behind a wall of thermal concrete in the Purple Sector when the next dead mine is sealed up. (T)
4.	The Rainbow Sun was carrying an expensive cargo and Captain Granhault was forced to eject it into space near to the gravity well of a moon of the system's large gas giant while being pursued by a customs vessel. It is said that the cargo was worth millions and was packaged so it could have possibly survived re-entry. He was killed because he arrived without the cargo. Whoever finds that cargo will become rich. (F)
5.	A petty criminal tells the group that a crew of Vargr Corsairs (see below) is looking for a security hack or a mining expert help him cut or break into a security-sealed ship buried halfway in the sand somewhere in the desert, a pretty good ways off. Only Captain Klaargh and the Corsairs know where it is, and they're not talking, because they want whatever loot may be aboard. If nothing else, the ship is said to be in good shape and the spare parts alone would make a decent haul (T).
6.	The miners are planning a revolution very soon (within the month) and it will not be a good idea to be around when they rise up. (F)
7.	One of Granhault's contacts was N'ort Tume, who was arrested and died in a locked cell under mysterious circumstances. (T)
8.	There is Something Big going down in Purple Sector and the government and Sternmetal are behind it; else, why all the secrecy? Why are only miners on an active shift allowed down there? What is behind all of the sudden, mysterious and last-minute changes to the work schedules of Sternmetal employees? Theories range from the sudden discovery of a hidden cache of alien technology to the planning of a secret defence strategy that involves killing all of the workers and their families involved in the coming uprising.
9.	Over 200 miners a month are killed or injured because of the deadly working conditions on the planet and the Imperium refuses to give compensation or medical care to the disabled. (F)
10.	A recent sociological/career specialization team from the Ministry of the Interior sent to study the problem concluded that there are very few truly dissatisfied miners. They are all well compensated for the danger. The injury rate is relatively low and when they have finished their tour of duty, they return home relatively wealthy. The study concluded that the work here is far less dangerous than asteroid prospecting and the benefits are better. Public records and internal Sternmetal Horizons documents support this. (T)

11. The miner terrorists are actually just a bunch of thugs hired by the Underworld to stir up chaos and force the Imperium closer to negotiations for Taellonan independence, a situation which the Consulate-aligned worlds on the Border would certainly enjoy seeing. (T)
12. Both Imperial Internal Intelligence and Naval Intelligence reports agree in the belief that there is an active deep-cover cell present on Jae Taellona, known as *The Zhule Sodality*. The *Sodality* is spreading money and influence to establish itself amongst the Jae Taellonan criminal element, in the hopes of eventually adding Jae Taellona to the Consulate's growing list of allies in the upcoming war. (T)
13. A ship known as *The Rainbow Sun* recently put into port after having several mysterious system failures in jumpspace. The ship is docked at the Starport repair yard and is *still* having the same mysterious failures.
14. The *Zhule Sodality's* best operative is codenamed *The Spectre*. Although it sounds incredible, Imperial Intelligence believes *The Spectre* to actually be the same battle-dress wearing operative that somehow infiltrated the Naval base here in 984, sabotaging several key battle cruisers and made the repair facilities all but useless for several weeks. It was not enough to cause the Imperium to lose the War but it certainly did not help us win any. Reliable sources confirm that *The Spectre* is very real, however legendary his exploits have become. The Spectre is old and wily and most clearheaded folk believe that a regimen of anagathics combined with cold sleep is responsible for his longevity. It is true, however, that his mental powers are formidable and he can defeat nearly any security measure imaginable.

Mandatory Rumors

The Corsair Crew

It is here in *The Stellar Wind* that the PCs will have their first encounter with Commander Klaargh, captain of a Vargr corsair parked some distance away at a makeshift base in the desert. Klaargh will enter the bar accompanied by 1d6 crewmembers some time while the adventurers are there. After they have had a few drinks, Klaargh and his crew will begin barking loudly in his guttural language.

Eventually, they will take notice of the group and Klaargh, as the Alpha, will approach them, pick the strongest-looking one and try to start a fight, unarmed. If the adventurer who is challenge accepts, then, according to the unwritten Code of Honour amongst Vargr Corsairs, the fight should be unarmed and fairly evenly matched. Klaargh and his crew are armed (see their statistics in the NPCs section) with knives and even pistols should the adventurers violate the unwritten edicts of the code,

including trying to help a comrade who has lawfully accepted but is losing or should a group member try bring weapons into the combat. The adventurer who is challenged is free to decline but will probably have to endure a series of rather scathing insults from the Corsairs – most of which, fortunately, will be in Vargr. If, however, the adventurer challenged by Klaargh accepts and fights honourably, even if he loses, he will have (probably) earned the respect of Klaargh and his crew. A successful Average test of Social Sciences (Alien Cultures) will reveal exactly what those codes are; for more information, consult the section on Vargr in *The Traveller Core Rulebook*, p.46, though the Referee should feel free to improvise. For more information on the Corsair's Code, see the Library Data entry Dh'oughz Khfae. The Corsairs will then invite the adventurers to stay up all night drinking with them and depending on how they have conducted themselves, will likely have won a valuable group of allies.

The Referee should note that the Vargr are aware of the location of The Spectre's vessel and are looking for

someone to help them break in. The Vargr see it as an easy credit but using their vessel's weapons could damage whatever is inside and cause any spare parts they wish to salvage to decline in value. Klaargh is violent but he is anything but stupid and wishes to try to enter the vessel through finesse before trying brute force. If Klaargh likes the group, he may ask them to join this endeavour. Of course, the critical importance of this rumour will likely only become obvious in retrospect.

The Spectre

While searching for rumours or just drinking in the bar, the adventurers overhear a pair of trader crewmen having a heated discussion at a corner table. One claims that The Spectre is real and the other claims that it is a story to scare children. The argument will eventually die away – this is of course at the Referee's discretion but one barfight, with the Corsair crew, is probably enough for one adventure – and the crewmembers will walk away, each quietly fuming. If the adventurers approach one of them and ask about the Spectre, they will find the crewman more than willing to talk as long as they continue to buy drinks. Almost any local or spacer who is a regular at Jae Taellona has heard the legend that The Spectre is the vengeful ghost of a Zhodani agent who was caught and burned alive by marines and security officers at the Naval Base during the Fifth Frontier War. Legend has it that The Spectre has killed thousands; children and even some of the more superstitious starfarers say that staring into the naked jump field and speaking his name 10 times will summon him. He can walk through walls, it is said and his mere touch can melt an armoured man. The crewman who argued in favour of the Spectre's existence does not believe all of that but he does think that The Spectre is still alive, maybe through drugs or cold sleep and he is convinced that he has powers beyond the comprehension of the average man.

The Galactic Census and Records Bureau

The more officious members of the party may think to check with The Galactic Census and Records Bureau, a department of the government operated under the auspices of the Imperial Ministry of the Interior. If this is the players' first experience with *Traveller*, the Referee may assume that, although the players may not know about the existence of the Bureau, their characters, as citizens of the largest bureaucracy in the galaxy, most likely do. You may allow some or all of them a Routine difficulty INT check to think to look at the Bureau (DMs: +1 if the character rolling has Admin, Investigation or the Advocate skill, +3 if he has two or more of these). A quick check of the information database at the Starport (or simply asking someone, such as an SPA official) will reveal that the Ministry of the Interior indeed holds an Archives and Census office on Jae Taellona. The Bureau holds similar offices on most planets under Imperial control with a Class C or better Starport. On many Imperial worlds, the Bureau offices mainly document and analyze demographic and statistical data, most of which (but not all!) would probably be of little interest to a group of adventurers. Since, however, Jae Taellona is nominally an Imperial protectorate, the chances that the Bureau holds government records that are possibly salient are actually quite good.

A Difficult test of the Advocate skill will reveal that any corporation that operates under the Imperium as a colonial administrator is in fact defined as functioning as a "government ad litem." As such, the corporation is required by law to file copies of any internal documentation that is produced as a result of any action that it takes, which falls under the fairly narrow legal definition of this function. While this may seem to be an example of overly convoluted legal terminology, it merely means that documents such as demographic data, life support expenditures, terraforming projects, public building and housing construction, population control, as well as any future construction projects that have

reached the planning stage must be filed with the Bureau. Of particular interest to the characters may be the fact that any and all documents dealing with the creation and maintenance of a local or planetary police department are also required to be filed – since, legally speaking, the planetary police are a corporate security force who, at the end of the day, answer to primarily to Sternmetal, LIC and its shareholders. Although the corporation is encouraged to keep these documents up-to-date by the Imperial government through the receipt of tax breaks on 'ad litem' expenditures in order to promote colonization and development, the only way for the adventurers to find out for certain just how closely the company has adhered to Interstellar Law is through a visit to the Bureau itself. A successful Routine test of the Admin or Advocate skill will remind the character that, by law, Bureau records are supposed to be freely available to any Imperial Citizen who asks to see them.

The Bureau's offices can be found in the underground portion of the city in the Yellow Sector, a portion of Stargate Artica that contains the offices of the Imperial Bureaucracy and the dwellings of those who work for it. Yellow Sector is about a 5 minute rail ride away from the Starport.

The group will find that the Records office is tucked away down a dark, narrow, twisted corridor just off the main Concourse of Yellow Sector. The windows of the offices are coated with dust and it is only identifiable by a small plaque bearing the Imperial starburst to the left of the antique door. Upon entering, the adventurers may be dismayed to see filing cabinets, stacks and reams of dusty paper and files and a row of ancient microfiche machines along the back wall of the office. A dour, bespectacled woman sits behind a desk just inside the door, clacking away on an archaic typewriting machine. Her name is Nora Childers and she is none too thrilled at the idea of strange offworlders poking through what she considers to be her records. She rises to challenge the adventurers and

upon finding that they wish to poke about unsupervised in "her" office, she demands that they leave. She is nonplussed by arguments concerning the legal rights of Imperial citizens – such claims will only serve to make her more determined in her denial. If the group does not comply with her demand that they leave, she will call the police who will be equally deaf their protestations and they will be ejected or even jailed if they continue to resist. Such a fate can be avoided if one or more of the adventurers can make a smooth, persuasive argument accompanied by a Difficult (-2) test of Diplomacy or Persuade. Feigning interest in her work – a Routine test of Administration or Persuade – might also serve to get on her good side. She is vulnerable, however, to moderately attractive older (45+ Standard Years) men. If the party contains such an individual, then a mere showing of kindness from him can win her over, giving the group unfettered access without a roll. This challenge is a pure test of roleplaying skills; the Referee should not allow the players to sidestep it by making dice rolls.

Once the group has dealt with Ms. Childers, they can then turn their attention to the records. A major portion of the public records are actually kept on paper and microfiche. Investigators from the Imperial Core or other high (12+) TL regions of the Imperium who are used to holographic storage units and neural shunts might be aghast at being confronted by this primitive file-and-card method of record-keeping. In such a case, the adventurer's skill in Administration might actually be a hindrance- at least at first. Apply a DM of -1 to the roll per TL over 12 that can be attributed to a character's background *if* he has Administration skill. Otherwise, he need not be penalized, since a lack of rank in the Admin skill also indicates that he has not spent enough time in libraries or offices to accrue the kind of bad habits that are the result of an overdependence on technology. In that case, the lack of any ranks in Admin to assist the search should be penalty enough.

The records are in such disarray that they will take quite a long time to sift through, even if the searcher is familiar with the archaic record-keeping system employed here. Searching the records is a Very Difficult (-4) test of Administration or Advocate. If the investigator has both skills, he may add a DM of +2 to the roll. If he has both skills and a level of 2 or greater in the skill not being used, he may add a DM of +4 instead. Further, the investigators can employ the rules contained in *The Traveller Core Rulebook* for task chaining and assistance to further improve their chances. A successful roll and 1d6 hours of searching through records and microfiche files will reveal a single item listed below. If the roll was especially good, the group may deduct up to 2 hours from their search time. If the group has failed to convince Nora Childers of the worthiness of their cause, this will serve to add a DM of -3 to their roll, as she rearranges records, hides things and generally makes things as difficult as possible for them to work. If, on the other hand, they have won her over, they may ask for her assistance and receive a DM of +4 and decrease their search periods to 1d6-2, down to a minimum of three. Whether or not a group already on her bad side deserves a second chance is entirely up to the Referee and Ms. Childers.

There have been large, unscheduled shipments of cargo and personnel into the starport for which the customs and legal papers are missing.

The group has noticed a prodigious amount of Zhodani living and working on Jae Taellona, yet there is no documentation to be found for them in this office.

There has been a large amount of criminal activity that has never been investigated.

Captain Granhault had an extensive police record, including smuggling, drugs, petty larceny and other fairly minor offenses. He should have been in jail but he was not and his Master's Licence was never revoked;

presumably, his transgressions were never reported to the Ministry of Ships and Shipping.

N'ort Tume also had a record but his was far worse. He had been arrested for murder three times but the court records for the disposition of these cases are missing. He also died by hanging himself, alone in a locked cell.

The local Starport seems to be using far more of its resources than are being documented. This would suggest that far more ships are coming and going than is being recorded.

The Crime Statistic compilations show that there are an inordinate amount of murders that occur when the victim seems to be well-protected- in locked rooms, aboard secure starships, in secure places with recording devices and guards all around them - and nothing ever gets recorded nor is any evidence left behind. Most of the murders are committed using a knife or similar blade-like weapon, although some have been committed with gauss or energy weapons.

A Sternmetal Horizons security report remarks on the disappearance of a decorated Imperial Captain (Captain Locke-Stromwell) locked in his own cabin aboard a *Tigress*-class dreadnought, one of the largest, most well-armed, secure vessels in the Navy, surrounded by crewmen and security personnel. The report remarks that there was no record in his log or from SPA customs officials on duty that he ever went ashore and security and crew of the vessel that were questioned claimed he never left his cabin. The report concludes that Captain Locke-Stromwell somehow managed to leave without his crew knowing about it or that they were lying about it for some reason. However, nothing could be proven and the investigators eventually gave up, though the case remains open. There is no evidence of any follow-up investigation, ever, nor any indication that this fact ever appeared in the local media.

The Bureau Office also contains a rather extensive news morgue with printouts from the Xnet and planetary datasphere (such as it is) as well as from the local newspapers, used to compile and correlate various statistics for the Imperial Census. While searching the morgue, the group manages to uncover an ancient news article about a devastating series of explosions at the naval base here during the Third Frontier War, on 161-984. The article claims that a single Zhodani agent was responsible; he was cornered by an intrepid group of Special Tactics police supported by Imperial Marine contingent in battle dress; nevertheless, before he was incinerated to a crisp, the article claims that the Zhodani killed eight brave officers involved in his pursuit. It does not specify whether these "officers" were Sternmetal security personnel or military. At this point in the investigation, this piece of information may seem irrelevant to the adventurers and the Referee should not make too much of it; just note that it catches the characters' interest.

The Trail of the Rainbow Sun

If the group decides to check out the Rainbow Sun, they are on the right track, for that is indeed where the girl is hiding, secretly under the care of the ship's engineer. There are several indications of this; the first may be gleaned if the group thinks to question the crew. If they do not, all is not lost; after 1d6 days from the beginning of the investigation, the series of system failures and accidents at the Starport will begin to seep into the local datasphere and newsbytes, not to mention the Starport rumour-mill. Further, the group will probably be in or near the Starport at some point during their investigation and may perhaps witness a power failure or other systems malfunction.

Should this happen, the Referee may allow them to make an INT check (Average difficulty, DM +1 for any adventurer with direct experience with psionics, +2 if an

adventurer is a trained telepath himself). The Starport has redundant systems aplenty, so while the failures are certainly a nuisance, they are not enough to force a full-scale investigation... *yet*. If the group does not act fast, they will soon, however and SPA officials and/or Imperial Intelligence will eventually make the connection with psionic abilities – after all, the inhabitants of the Imperial Fringe have been fighting the Zhodani for 500 years and many of them know psionics when they see them. If the girl vanishes into the custody of local authorities or the Ministry of Defence, the adventurers can fully expect to kiss the girl goodbye, quickly followed by their commission. While this eventuality is completely up to the Referee, as a guideline, SPA can be expected to launch a full-scale investigation 1d6-3 days after the first mysterious systems failure and to locate her 1d6+3 days after that investigation begins.

Once the group has decided to focus on the vessel, they may wish to play it cool and first visit the SPA records office. There, they can access a ship's registry, a current or recent flight plan and/or a crew manifest, all of which are public information and require no roll. If the players do not think of it, an Average test of INT might allow their characters to; any ex-scouts, naval personnel or merchants in the group can receive a DM of +2 to this roll. The group might first try to speak to the captain and thereby learn his fate.

The First Mate

Perhaps she will think to attempt to approach the ship's first officer, Lyliian Arducci, who will prove, at first, anyway, to be unhelpful and rude. She's not the ship's steward, she says, so she has nothing to do with the passengers. In truth, however, she remembers the girl quite well but she wants nothing more to do with her and in her superstitious starfarer's mind, that includes speaking of her. She feels that further discussing the girl might make the jinx she brought upon *The Rainbow Sun*

permanent. As it stands, she feels that the ship's crew has a good chance of throwing the jinx off and will say as much to any adventurer who can succeed in a Difficult Carousing roll, while buying her enough drinks. After she has had a few, she will even tell the adventurers that the jinx is still in effect; the systems failure rate seemed to stop for about four days after the docking but started right back up a couple of days ago. The Referee should take care to convey that the date the ship's troubles began anew should coincide with the exact the day that Shalini disappeared in the rail tunnels. Of course, this should be the group's first hint that Shalini is still aboard the Rainbow Sun.

At this point or sometime later, the group might consider bribing Lyliian into letting them search, to which she might consent, if she is drunk enough. On the other hand, she may just as quickly report the group to the authorities or both, depending on the result of an Average test of the characters' Persuade skill (DM +1 per multiple of Cr1000 greater than 4000 offered, -1 for each multiple under). If the persuade attempt fails by more than five, she will report them to the authorities. Whether or not she takes their money anyway is up to the Referee. The group might also deduce that the girl is somewhere aboard and try to convince her that they can solve her jinx problem – this is more difficult, because Lyliian is always wary of bar conmen and starport rats with ulterior motives. If the group is good, however, the Referee should not be resistant to the possibility that the group could get *her* to pay *them*.

The Steward

The ship's steward, Tomiasi V'rii, has a far more helpful attitude. V'rii is a long-standing TAS member and can be found most of the time he is dirtside relaxing in the bar of the local TAS hostel, indulging in his taste for Sirian cognac and Terran tobacco. Though not particularly wealthy, V'rii thinks of himself as a gentleman of

refinement and taste, an adventurer of the Old School and is more likely to be impressed with the group if a member has a reasonably high Soc ability (9 or better) or if they are fellow TAS members. He remembers feeling sorry for the girl. The whole crew liked her, for she was a sweet little girl. A couple of crewmembers, he tells the group, including the first mate, believed she was responsible for all of the electrical malfunctions and were scared of her. Most of them, however, remember a nervous, frightened little girl who was very sick at times but also excited to be on her first space voyage. She liked to go down to Engineering because it was noisy down there, which "drowned out the loud voices". She also liked to hang out in the crew commons area just above the j-drive machinery. The Chief Engineer liked her, too and he often took her under his wing and allowed her to hang out in the engine room. If prodded or questioned about the bizarre series of malfunctions while en route to Jae Taellona, he replies he is not a technician but he does know that the Captain and the First Mate were worried that the Ship might never make it to planetfall. If prodded further, he will reluctantly admit that the failures seem to have returned for some reason but he asks the group to keep this tidbit to themselves, because it could cause the ship to lose passengers, which could in turn affect V'rii's job.

Don't miss the conclusion of this scenario in the July Issue of Signs and Portents

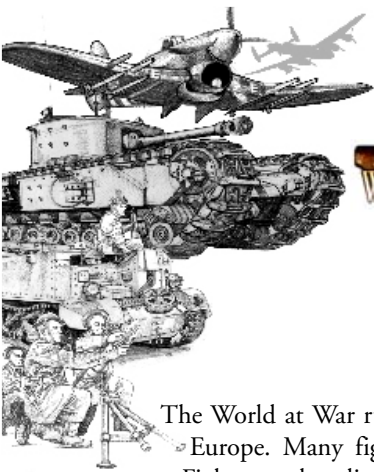

Maquis, Partizan and Volkssturm

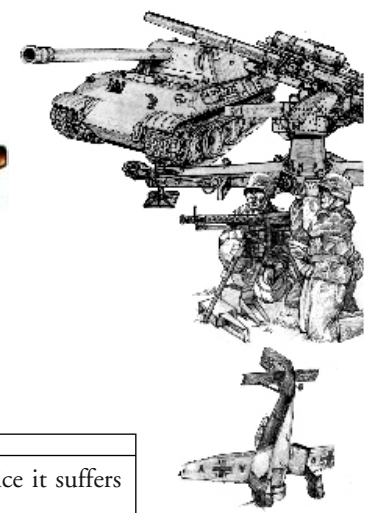

Three New Units for Allied and German Forces in Battlefield Evolution: World at War

by Agis Neugebauer

The World at War rulebook is about the main combatants of the late war in Europe. Many fights however involved more irregular forces: Resistance Fighters or last ditch efforts to turn the tide of an already lost war.

The following three units can be used to represent these troops in your World at War games.

The Maquis unit can be used by every British or US force of the World at War rulebook, the Eastern Partizan unit can be used to bolster the Soviet army list, while the Volkssturm unit is for the German army list to be fielded in the Battle of Berlin. All these units are support units.

Special Rules

The following special rules apply to all Eastern Partizan, Maquis or Volkssturm units.

Ambush: Any Eastern Partizan, Maquis or Volkssturm infantry unit may be concealed in an area of terrain outside the enemy's deployment zone before the game begins. Note the location of the unit before any models are deployed on the table. You can reveal the ambush by placing the section on the table at any time after a unit (friendly or otherwise) has completed an action. However, the unit must be revealed by the end of turn three or be counted as destroyed.

Untrained: This unit will lose the Auto trait on any weapons it has. In addition, it will always count cover as obscurement, and Artillery weapons gains a +1 bonus on all Damage Dice allocated to models in this unit.



Variable Morale:

The level of leadership or dedication to the cause varied wildly for all irregular forces in WWII. It ranged from the reluctance of French Septemberist to the fanatical Hitler Youths, ready to die for a wrong cause. Roll 1D6 on the following table for every unit you are fielding.



Irregular Trait table:

1-2	No effect
3-4	Fearless: This infantry unit discards the first Suppression dice it suffers every turn.
5	Dedicated: If Suppressed, roll a D6. If you can roll equal to or less than the number of soldiers left in the unit, you can ignore the effects of the Suppression.
6	Fanatic: This unit automatically discards all Suppression dice.

Eastern Partizans

During WW II the German armed forces occupied many eastern European countries. In nearly every country sooner or later some form of resistance established against the German occupants. Be it Polish, Czech, Yugoslavic or in the Russian Motherland.



Partizan fighters were a real problem for the German invaders especially on the Balkan. Open warfare was never an option for them; they always had to reply on guerrilla tactics.

Eastern Partizan Squad – 80 points

The man and woman of the eastern Partizans were always ready to attack the German Occupants whenever an opportunity showed up.

Type	Size	Move	C l o s e C o m b a t	Target	Save	Kill	Traits
Com-m- ander	1	4"	D6-1	4+	-	6+	-
Parti- zan	1	4"	D6-1	4+	-	6+	-

Unit: Commander (unit leader) with PPSH-41 SMG, 9 Partizans with Mosin-Nagant rifle

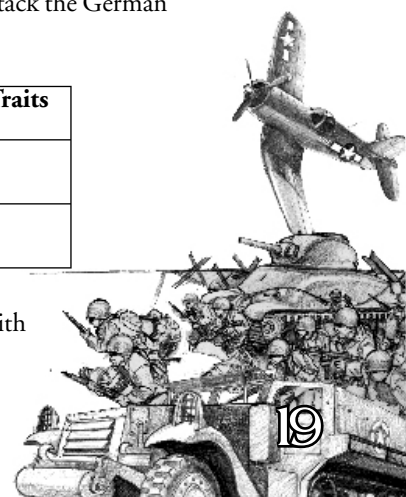



Tank Assault: Infantry in this period used a variety of grenades or mines to assault armoured vehicles. All members of the unit are assumed to carry Anti-Tank Explosives. These may be placed on any model of Size 2 or greater with a Charge action. They will explode at the end of the charging unit's next turn.



Options: Up to 1 Partizan may be equipped with a DP LMG in addition to his rifle for +30 points. Up to 4 Partizans may swap their rifle for a PPSH-41 SMG for free. Add up to 4 more Partizans with a Mosin-Nagant rifle for 8 points each.

Maquis



The Maquis were guerrillas that became the very symbol of the French Resistance. Most maquisards relied on guerrilla tactics to harass German occupation troops, aided the escape of downed Allied airmen, Jews and others pursued by the Vichy and German authorities. The maquisards could often rely on some degree of sympathy or cooperation from the local populace.

The harder the German occupants were suppressing the resistance, the more French joined the Maquis. The British Special Operations Executive and the American Office of Strategic Services helped with supplies and agents.



During D-Day, the Maquis and other groups played some role in delaying the German mobilization. They blew up railroad tracks and repeatedly attacked German Army equipment and garrison trains on their way to the Atlantic coast. Thanks to coded messages each Maquis group was alerted of the impending D-Day. As Allied troops advanced, the French Resistance rose against the Nazi occupation forces en masse.

Maquis Squad – 80 points

The proud Basque beret wearing Maquisards fought the German occupation forces on many occasions.



Type	Size	Move	C l o s e C o m b a t	Target	Save	Kill	Traits
Commander	1	4"	D6-1	4+	-	6+	-
Maquisard	1	4"	D6-1	4+	-	6+	-

Unit: Commander (unit leader) with Sten SMG, 9 Maquisards with Lee-Enfield rifle

Tank Assault: Infantry in this period used a variety of grenades or mines to assault armoured vehicles. All members of the unit are assumed to carry Anti-Tank Explosives. These may be placed on any model of Size 2 or greater with a Charge action. They will explode at the end of the charging unit's next turn.

Options: Up to 1 Maquisard may be equipped with a Bren LMG in addition to his rifle for +30 points. Add up to 4 more Maquisards with a Lee-Enfield rifle for 8 points each.



Volkssturm

The Volkssturm was founded on Hitler's orders late 1944 and conscripted males aging 16 to 60 years who were not already serving in other German military unit.

As most irregular forces they received only the very basic of military training. After a brief indoctrination only basic weapon use - such as the Kar 98k rifle and Panzerfaust - was trained. In the case of the authors father one hour in school was used to show all the class members the use of the Panzerfaust. All other familiarization with their weapons was expected to be done in actual combat.

Many Volkssturm members only had their civilian clothing, with a cuffband on the arm to identify them as a combatant. There was no standardization of any kind and units were issued only what equipment was available. This was true in every form of equipment, resulting in the units looking ragged and as a reminder of the desperate state of Germany in the dying days of the war.

Volkssturm units were supposed to be used only in their own districts but many were sent directly to the front lines. The most extensive use of the Volkssturm was during the Battle of Berlin, a devastating attempt, since many Volkssturm members fought to the death when

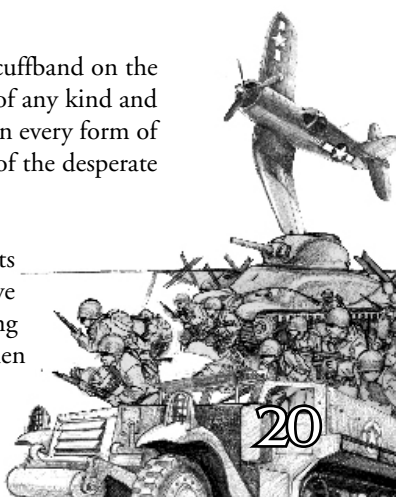
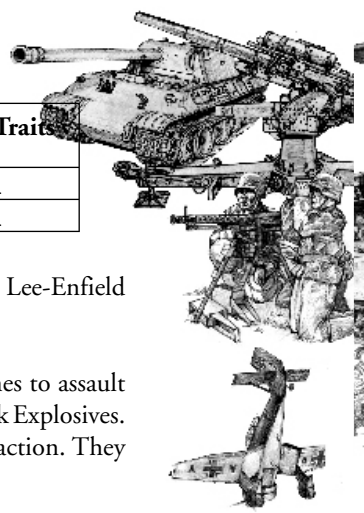

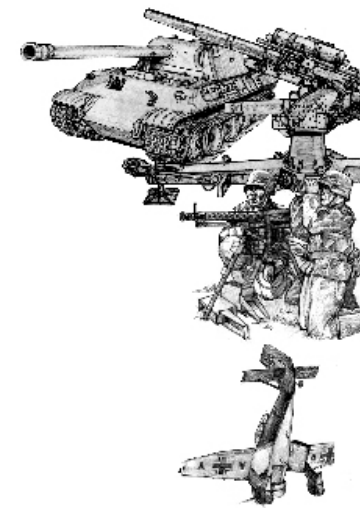

facing Red Army troops, mostly out of fear of being captured by the Soviets. A fate that often was equal to a death sentence.

Options: Up to 2 Members may be equipped with a Panzerfaust in addition to his rifle for +30 points. Add up to 4 more Volkssturm Members with a Kar-98k rifle for 8 points each.

Volkssturm Squad – 85 points

The Volkssturm often fought desperate and to the last man or boy against all odds.

Type	Size	Move	C l o s e C o m b a t	Target	Save	Kill	Traits
Commander	1	4"	D6-1	4+	-	6+	-
Volkssturm Member	1	4"	D6-1	4+	-	6+	-

Unit: Commander (unit leader) with MP-40 SMG, 9 Members with Kar-98k rifle



Fight to the Death: Add +1 to the roll on the Irregular Trait table.

Tank Assault: Infantry in this period used a variety of grenades or mines to assault armoured vehicles. All members of the unit are assumed to carry Anti-Tank Explosives. These may be placed on any model of Size 2 or greater with a Charge action. They will explode at the end of the charging unit's next turn.

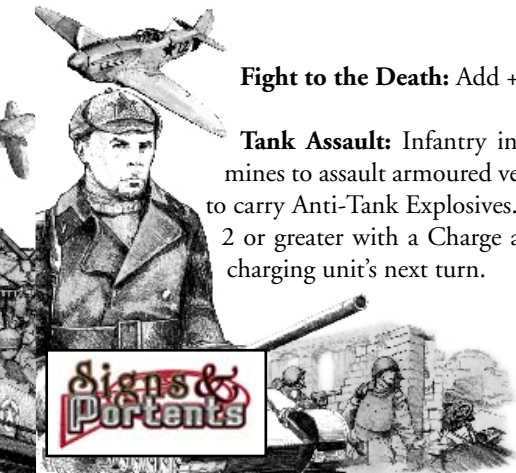

A black and white historical photograph of a soldier in silhouette holding a large flag with a hammer and sickle symbol in a destroyed city. The background shows a city in ruins with smoke rising from the sky. The text is overlaid on the image in a stylized, red, textured font.

**BATTLEFIELD EVOLUTION:
WORLD AT WAR
28MM WORLD WAR II WARGAMING RULES**

HITTING YOUR TOWN MAY 2008

WWW.MONGOOSEPUBLISHING.COM

The Southern Traitors

A WARRIOR ORDER FOR SLAINÉ by John Foody

For some years stories have circulated around the tribes of the Earth Goddess regarding some of their warriors who fight for the Drones. Few believe them. They call them misunderstandings, exaggerations or more simply, lies. Bards and travellers fear mentioning these stories for they know that they will receive a poor reception. However, the stories are true and they are causing worry to all who are aware of this.

The tales tell of warriors from the Earth Goddess tribes who have been captured by the Drones and prepared for sacrifice in their great wickermen. Just before the warriors are burned alive they beg for their lives and are freed, swearing an oath to serve the Drone Lords, the leaders of the Drones. These warriors are called the Na Tréatrúirí Deiscearthacha (the Southern traitors) or sometimes the bastards of the fire, not to mention many other names by the Earth Goddess tribes, none of them polite. They call themselves Taobh Thall den Bháis (the other side of death).

The Drones attempted to create such a force many years ago but they were wiped out in a battle with the Sessair. No-one alive in the Earth Goddess tribes remembers this and little was understood at the time.

The most recent attempt to create such a force was the idea of Nemonor, a skull-sword captean and tutor at Er-Grah, the skull-sword academy. Captaen Nemonor has a long-standing hatred of the warriors of the Goddess but this is tempered with admiration for their skills. A veteran of many conflicts, Nemonor is well respected but suffering from gout and having just survived a serious belly wound, he knew it would not be long before he would be sacrificed to Carnun. One autumn day as he organised his men putting prisoners in to a wickerman he saw a Finian

warrior begging for mercy, promising anything to those who freed him. Nemonor saw that the warrior would truly do anything to live and the idea was born. Freeing the warrior, Nemonor sought permission from Drone Lord Sanga to create his force and this was granted.

The Finian was Phowell and he was true to his word. He is now Nemonor's right hand man. An evil and ruthless character he can also read people extremely well. More than Nemonor he knows the Earth Goddess tribe warriors that they can risk recruiting. The recruitment process is slow as few warriors are captured and fewer still are ready to turn. Still, the group is now over 30 strong.

However, the Drone Lords remain uncertain about the Na Tréatrúirí Deiscearthacha. At the root of this uncertainty is the fact that they simply do not trust them. Results so far have been mixed and the whole scheme nearly crashed to a halt when seven warriors turned on a group of skull-swords fighting a Fir Domain warband. When the skirmish was over the Fir Domain turned on their recent allies and slaughtered all but one who escaped to tell the tale. Whether such mercy was deliberate is unknown.

The warriors of Na Tréatrúirí Deiscearthacha may be alive but they are far from happy. All, by their very nature, are broken men. A few have accepted their fate but as a whole they are dour, miserable, argumentative and confused, not to mention occasionally suicidal. This unhappiness shows itself in a general lack of energy and frequent drunkenness and fighting (with each other and anyone else they come across). Another side of this despondency is that many of the warriors drop all but their first names or even change them. One example is Loach of the Bloody Knives who has become Loach of the Broken Word.

However, they retain various degrees of honour though it is sometimes a little confused. A recent Fir Domain recruit picked up the growling shield of a dead Fir Domain warrior, not of the Na Tréatrúirí Deiscearthacha, to replace one that he had lost. Two others killed him for this insult to the dead warrior. Others refused to serve with a Falian from Falias as he had lost a hand. They did not wish to stand with someone of obviously low Enech.

Nemonor recognises all of these as flaws in the usefulness of the Na Tréatrúirí Deiscearthacha. He has tried to show them the benefits of worshipping Carnun and the Drone Lords have insisted that they do but the warriors pay little more than lip service to this. Such worship just serves to make them even unhappier. However, many have abandoned the worship of Hu, Lug and the Earth Goddess in anger or in shame. Nemonor has tried to fill this spiritual hole by asking Drone Lord Sanga to allow him to try something different (although Nemonor was smart enough to ensure that Sanga thought it was his idea).

Some years ago the Drones captured the young Druid initiate Barra. The boy was deliberately brainwashed with the intention of becoming a Drone Lord. It did not work. Although Barra seemed to be loyal to the Drones he showed none of the attributes that would make him suitable as a Drone Lord. He was brought to the Na Tréatrúirí Deiscearthacha base at Aris and installed in a home with a guard of skull-swords. However, he now spends most of his days asleep, his mind dulled by drugs. The drugs are taken by burning potent herbs in braziers in the roundhouse. This thick mind-altering fog welcomes any who come to seek his advice. Many petitioners receive visions or place great emphasis on Barra's mumblings. Slowly he is coming to be seen as a prophet and a cult



is growing around him. Whether the Drune Lords will allow this to flourish is another thing.

Groups of Na Tréatrúirí Deiscearthacha are sometimes allowed to go to Gabala to blow off steam. This is an important benefit as it gives them a small chance to hit back a little at the Drones in their own city. Here they can attack locals without repercussion. Recently however, a Na Tréatrúirí Deiscearthacha warrior was arrested and scarified for striking a skull-sword in a tavern brawl. Another two were murdered for being warriors of the Earth Goddess tribes.

A further sign of the Drune Lords' distrust is the location given to the Na Tréatrúirí Deiscearthacha as their base. The village of Aris was once a border town captured by the Drones and now sits within the Sourlands but far enough to keep Drune Lords happy. After it was captured, rebellion continued to brew. One night a thick mist covered the village and come morning no-one was left alive. Only a pair of young herdsmen were left to bear witness (they had gone to the pastures as the fog was rising). Whether this was the work of the Slough Lords they have never said. Some blame the strange round stone at the centre of the village with its odd markings and metal (not iron) rings. Whatever the truth, the village lay empty until the Na Tréatrúirí Deiscearthacha came. The few houses still able to provide cover have been roughly patched up. Barra lives in the best house a little distance from the others. Regular patrols are mounted around the perimeter of the settlement but are often lax due to the warriors' lack of motivation and expectation of any trouble.

The Na Tréatrúirí Deiscearthacha can be encountered across Tir Nan Og and beyond although those meeting them are unlikely to know who they are or their

affiliations. The warriors can be found leading skull-swords on a variety of missions using their knowledge of the land and its people. They can be sent, individually or in groups, to kill or kidnap those who have attracted the Drune Lords' interest. They may be sent to just watch and report. They can also be found raiding in to Earth Goddess tribe land to steal food and drink, although they try to avoid any kind of conflict. They also raid Fir Bolg and other border tribes.

The Na Tréatrúirí Deiscearthacha are not used to liaise with Drune spies among the Earth Goddess tribes. They are also never deployed as part of the Drones' more important schemes. The Drune Lords do not want to risk the Na Tréatrúirí Deiscearthacha's loyalty especially if they are given reason to question it. They are also not liked by the people loyal to the Drune Lords.

The Drune Lords pass orders through Drune Lord Sanga. Sanga communicates with the Na Tréatrúirí Deiscearthacha through his emissary Fulon. However, Fulon is in fact loyal to Drune Lord Aod, an enemy of Sanga who wants the Na Tréatrúirí Deiscearthacha to fail. Therefore Fulon will do his best to make this happen without arousing suspicion. This is not always easy and Fulon finds himself having to be careful with his words.

The warriors of the Na Tréatrúirí Deiscearthacha tend to use equipment from their own tribe, either their own reclaimed from the Drones or looted from the dead. Some occasionally use Drune weapons either by preference or under orders. A few deliberately dress differently to hide their origin, although the other Na Tréatrúirí Deiscearthacha mock them for this.

The Na Tréatrúirí Deiscearthacha can be used in a variety of ways. They can show the corruption the Drune Lords can cause and how even the warriors of the Earth Goddess can succumb. They can be a surprising enemy to fight against. Player Characters may even befriend and work with Na Tréatrúirí Deiscearthacha warriors before they realise their loyalty. They may be attacked by them and remain confused as to why they would be there targets, perhaps then trying to find out why. They may encounter an old comrade who they thought was dead. The Druids may ask them to try to capture or turn one of the Na Tréatrúirí Deiscearthacha or to kill the Druid Barra. However they are used the Na Tréatrúirí Deiscearthacha can help show that everything is not black and white in Tir Nan Og.

CHARACTERS IN THE NA TRÉATRÚIRÍ DEISCEARTHACHA CAPTEAN NEMONOR

An old skull-sword captean, Nemonor has a pragmatic outlook on life. He knows that at his age and health he has to take care to remain useful. He hopes that the Na Tréatrúirí Deiscearthacha are his way of doing this. He knows that many have their doubts about their loyalties but he does not realise that Fulon is actively working against him. He has little loyalty to the individuals of the Na Tréatrúirí Deiscearthacha and will kill any trouble makers, including those who voice their doubts too loudly.

STR 15, CON 10, SIZ 13, INT 15, POW 16, DEX 13, CHA 15

CA: 3 DM: +1D2 SR: 14 Move: 3m EP: 16

Skills: Athletics 44%, Perception 90%, Resistance 79%, Lore (Drones) 90%

Attacks: Warsword 103% 1D8+1D2 AP4, Dart-Dragon 97% 1D4 AP1, Shield 75%

Legendary Abilities: Diehard, Poison Immunity

Armour: Cuirbolli Shirt & Trews, Fur Cloak, Helmet



D20	Hit Location	AP/HP
1-3	Right Leg	2/5
4-6	Left Leg	2/5
7-9	Abdomen	3/6
10-12	Chest	3/7
13-15	Right Arm	2/4
16-18	Left Arm	2/4
19-20	Head	1/5

Phowell

The first of the Na Tréatrúirí Deiscearthacha, he immediately repaid his worth. He travels with Nemonor to help identify new recruits. Phowell thinks that he could lead the Na Tréatrúirí Deiscearthacha but remains afraid of the Drune Lords. He is unaware that most of the other warriors would like to see him dead as they blame him for their situation.

STR 13, CON 14, SIZ 12, INT 16, POW 13, DEX 16, CHA 8

CA: 3 DM: +0 SR: +16 Move: 4m EP: 13

Skills: Athletics 50%, Lore (Drunes) 30%, Lore (Plant) 50%, Perception 70%, Persistence 40%, Resistance 45%, Sleight 65%, Stealth 60%, Taunt 60%

Spells: Cloak of Blackness 55%, Cure Injury 60%, Signs of the Moon's Sight 52%

Attacks: Shortsword 80%, 1D6 AP3, Spear 65% 1D8 AP2

Armour: Leather Tunic

D20	Hit Location	AP/HP
1-3	Right Leg	0/6
4-6	Left Leg	0/6
7-9	Abdomen	1/7
10-12	Chest	1/8
13-15	Right Arm	0/5
16-18	Left Arm	0/5
19-20	Head	0/6

Neale of the Ócad Éire

From Gorias and once known as Neale of the Thirteen Kills, he took many years to come to terms with begging for life and betraying his tribe. He has recently begun to accept his decisions and is now trying to make the best of his situation. After all it was his kin and tribe who left him to die.

STR 14, CON 14, SIZ 13, INT 13, POW 10, DEX 14, CHA 10

CA: 3 DM: +1D2 SR: 14 Move: 4m EP: 10

Skills: Athletics 70%, Perception 55%, Persistence 45%, Stealth 25%

Spells: Cure Injury 52%, Muscle to Blubber 40%

Attacks: Bastard Sword 89%, Razor-Edged Shield 75%, Sling 65%

Armour: None

D20	Hit Location	AP/HP
1-3	Right Leg	0/6
4-6	Left Leg	0/6
7-9	Abdomen	0/7
10-12	Chest	0/8
13-15	Right Arm	0/5
16-18	Left Arm	0/5
19-20	Head	0/6

ORREN

Previously known as Orren Mac Pdraig and Orren of Ballysuir. The second Sessair to join the Na Tréatrúirí Deiscearthacha, he felt great disgrace in being so weak. However, he has started to believe that Hu the Mighty is playing a trick on him to ensure that he would be well placed to bring down the Na Tréatrúirí Deiscearthacha. His changing attitude and anger at his comrades has not gone unnoticed by Phowell who is considering asking Nemonor to have him killed, or just doing it himself.

STR 15, CON 13, SIZ 13, INT 9, POW 14, DEX 14, CHA 13

CA: 3 DM: +1D2 SR: 12 Move: 4m EP: 14

Skills: Athletics 70%, Perception 55%, Persistence 45%, Riding 51%, Stealth 25%

Legendary Abilities: Blood of Heroes, Grip of Iron

Spells: Skyclad Blessing 68%

Attacks: Battle Axe (2H) 94%, Gea Bolga 82%

Armour: None



D20	Hit Location	AP/HP
1-3	Right Leg	0/6
4-6	Left Leg	0/6
7-9	Abdomen	0/7
10-12	Chest	0/8
13-15	Right Arm	0/5
16-18	Left Arm	0/5
19-20	Head	0/6

D20	Hit Location	AP/HP
1-3	Right Leg	0/5
4-6	Left Leg	0/5
7-9	Abdomen	0/6
10-12	Chest	0/7
13-15	Right Arm	0/4
16-18	Left Arm	0/4
19-20	Head	0/5

Average Warrior

The warriors of Na Tréatrúirí Deiscearthacha are a varied bunch. The following can be used as a guide but amended according to tribe.

STR 14, CON 12, SIZ 12, INT 12, POW 11, DEX 12, CHA 10

CA: 2 DM: +1D2 SR: 12 Move: 4m EP: 11

Skills: Athletics 60%, Perception 55%, Persistence 50%, Stealth 25%

Spells: One or two low powered spells.

Attacks: Main weapon 85%, Secondary weapon 65%

Armour: A mixture of pieces, although usual not metal armour. Armour is often tatty and worn.

D20 Hit Location AP/HP

1-3	R Leg	0/5
4-6	L Leg	0/5
7-9	Abdomen	0/6
10-12	Chest	0/7
13-15	R Arm	0/4
16-18	L Arm	0/4
19-20	Head	0/5





Wolfpack!



Advanced Submarine Rules for Victory at Sea

By David Manley

Introduction

One of the areas of naval warfare that has fascinated me for years has been that of Anti Submarine Warfare (aka “Awfully Slow Warfare” by those in the business). ASW is, by its very nature, a complicated aspect of naval warfare to recreate on a table top and really needs an umpire and hidden movement to recreate properly. This is, of course, beyond the interest of most wargamers. VAS contains some basic rules for submarines but I felt that they could be developed to give a better representation of ASW combat, especially in a “wolfpack vs. convoy” scenario, whilst still being fun and fast to play and without requiring a third party to act as umpire. The following are some suggested rules that cover basic ASW, advanced weapons and air attacks on submarines.

Throughout these rules I have interchangeably referred to submarines and submersibles as boats, to reflect the popular terminology within the “Silent Service”.

The Rules

Models and Dummies

Submarines are represented on the table using models. The practice of having boats appear on the table at a point of the controlling player’s choice is ended. Models may represent real submarines or they may be “dummies”, spurious contacts that confuse the opposition. No more than two dummy models may be used for each real boat at any time. If a surfaced boat submerges it may immediately “grow” up to two dummies, which are placed on the table along with the real boat. Dummy models are moved as if they were real submarines. Dummies may be removed by the

controlling player at any time. If at any point a player has less dummies in play than they are allowed they may place additional dummies in contact with any model currently on the table OR on a table edge and not within 20” of any enemy surface unit. If a player ends a turn with more dummies than allowed excess dummies must be removed – exception: if a player’s last real submarine is sunk but there are still dummy models on the table up to two dummies may remain on table to preserve uncertainty; these are removed either by the controlling player or if they are detected and proven to be dummies.

Depth

At the start of each boat’s movement players decide the depth at which each of their boats is operating, noting the depth on the boat’s playsheet or a log. Allowable depths are:

- Surfaced
- Periscope Depth (PD)
- Shallow
- Deep

Boats can change depth by 1 level per turn. Boats on the surface that have moved and that subsequently have enemy forces moving within 10” can attempt to crash dive using the “Crash Dive” special action. Boats that move within 10” of enemy forces may not use Crash Dive. Boats forced to surface through damage do so immediately.

There is no need to choose depths for dummy models, although players will probably want to pretend to do so to keep up the pretence.

Submarine Attacks on Surface Ships

Boats can only make torpedo attacks if they are on the surface or at PD. Torpedoes launched from a submerged submarine have a maximum range of 5" due to limited visibility and hence targeting ability using periscopes.

Submarines are not allowed to make torpedo attacks in a turn if they have been subjected to a depth charge attack in that same turn (or in the preceding turn).

Submarine Attacks on Aircraft

Submarines can shoot at enemy aircraft within AA range if the submarine is on the surface. AA cannot be used if the submarine attempts to crash dive.

Submarine Detection

Use the normal rules, modified as follows. Ships with the "sub hunter" trait can detect up to 10". Detection of a dummy model results in its immediate removal. A surface ship can only attempt one detection per turn, unless it has the "sub hunter" trait in which case 2 attempts can be made against boats in the same firing arc (models in contact count as in any firing arc).

Surface ships with the "Sub Hunter" trait do not need to attempt repeat detection on each turn provided they remain within 4" unless they attack a submarine with depth charges or Squid, in which case they must attempt submarine detection in the next turn as normal; this does not apply to Hedgehog attacks, where contact can be maintained during an attack.

Surface Ship Attacks on Submarines

Depth Charge Attacks

Surface ships must be within 2" of a submarine and must have detected it in order to attack it with depth charges.

Depth charge attacks must specify the depth that they are attacking. If the boat is at a different depth then no damage occurs.

Advanced ASW Weapons

The RN developed advanced ASW weapons such as Squid (one or two large multi-barrelled mortar firing depth charges ahead of the attacking ship) and Hedgehog, which fired up to 24 ASW mortars – these dropped through the water and exploded on contact, thus guaranteeing a kill.

Squid and Hedgehog can attack any submarine within 4". Both weapons attack boats at all depths simultaneously; there is no need to specify the depth at which they are attacking.

Boat Damage

Damage from depth charges and Squid is resolved as normal. Any hit by Hedgehog automatically sinks a submarine.

Damage to a submarine is not revealed immediately unless scored by a Hedgehog or a homing torpedo.

Boats reduced to 1 DP are flooding and must surface immediately. Boats suffering lesser damage may remain submerged.

If a boat is sunk its destruction may not be immediately apparent. Roll a D6, adding 1 if the attacking vessel has the "sub hunter" trait. If the result is 4 or more the destruction of the submarine is immediately revealed and the model removed, otherwise its model remains on the table but becomes a dummy.

Submarine vs. Submarine

Submerged boats cannot attack other submerged boats (it only happened once successfully in WW2)

Air Attacks on Submerged Submarines

Aircraft can bomb or depth charge submarines on the surface, those that are crash diving and those at PD. Roll 4+ to detect boats at PD. Boats below PD cannot be attacked by aircraft.

Homing Torpedoes

Late war Allied aircraft can also use homing torpedoes to attack submerged submarines (they cannot be used against surfaced boats). Homing torpedoes may be dropped on any submarine model detected by the aircraft. Once dropped the player controlling the torpedo rolls to see whether the torpedo detects the submarine, using the same rule as surface ship detection and giving the torpedo the “sub hunter” trait. If the boat is detected the torpedo attacks as normal. Any hit sinks the boat and this fact is revealed immediately.

Allied Sub Hunting Ships

Royal Navy “Loch” Class Frigate

The Loch Class was the RN’s ultimate sub hunter in WW2 and was also used by the Canadian, South African and New Zealand navies. Armed with two Squid launchers, advanced sonar and powerful short range radar the Lochs were formidable enemies for the U boats

Speed: 4”

Turning: 3

Target: 6+

Armour: 2+

Damage: 3/1

Crew: 5/2

Special Traits: Agile, Sub Hunter, Radar

In Service: 1943+

Weapon	Range	AD	DD	Special
Double Squid	4”	6	4	Super-AP
Secondary Armament	8”	1	1	Weak
AAA	5”	1	–	
Depth Charges	3”	4	2	Slow-Loading

Length: 307 ft.

Displacement: 1,433 tons

Speed: 20 kts.

Crew: 114

Royal Navy “River” Class Frigate

The River Class preceded the Loch class and used the earlier ‘Hedgehog’ ASW weapon rather than Squid. Over 150 ships were commissioned in the Royal Navy and the navies of Australia, Canada, South Africa, the Netherlands and Free France. Two Canadian ships even served temporarily with the USN whilst the US was short of ASW ships.

Speed: 4”

Turning: 3

Target: 6+

Armour: 2+

Damage: 3/1

Crew: 5/2

Special Traits: Agile, Sub Hunter, Radar

In Service: 1941+

Weapon	Range	AD	DD	Special
Hedgehog	4”	4	–	S l o w
Loading, automatic kill**				
Secondary Armament	8”	1	1	Weak
AAA	5”	1	–	
Depth Charges	3”	4	2	S l o w-
Loading				

Length: 307 ft.

Displacement: 1,370 tons

Speed: 20 kts.

Crew: 107

** For owners of “Order of Battle”, this is a change to better reflect the capabilities of the weapon.

United States Navy "Evarts" Class destroyer escort

The Evarts Class was typical of the US's excellent ASW fleet (similar classes included the Buckley, Cannon and Edsall classes). They were broadly similar to the RN's "River" class but also embarked torpedoes. As well as serving in the USN they were also used by the Royal Navy as the "Captain" class (46 ships). Several were converted to command ships and fast troop transports.

Speed: 4"

Turning: 3

Target: 6+

Armour: 2+

Damage: 3/1

Crew: 5/2

Special Traits: Agile, Sub Hunter, Radar

In Service: 1941+

Weapon	Range	AD	DD	Special
Hedgehog automatic kill	4"	4	–	Slow Loading,
Secondary Armament	8"	1	1	Weak
Torpedoes	10"	2	4	Single Shot, AP
AAA	5"	1	–	
Depth Charges	3"	4	2	Slow-Loading

Length: 289 ft.

Displacement: 1,360 tons

Speed: 20 kts.

Crew: 107



The Gauntlet



A Scenario for Battlefield Evolution: World at War

Matthew Sprange

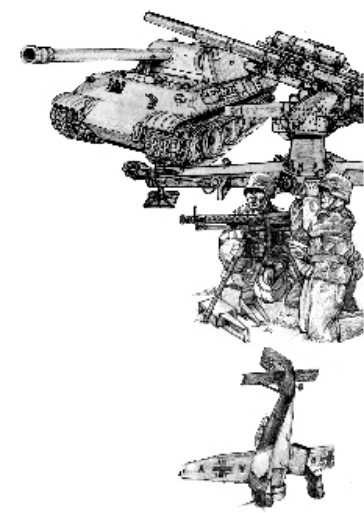

By now, many of you should be getting to grips with Battlefield Evolution: World at War, driving your Panzergrenadiers to victory or marching in triumph with your US army – or whatever force you have chosen.

The Engagements rules in the rulebook provide a comprehensive system for creating your own battles, with objectives for each side and there are also a selection of scenarios, with more specific criteria for victory. However, you can have fun creating your own scenarios, with unusual or more complex objectives or using forces that are not normally permissible with the army lists.

This scenario first appeared in the original Battlefield Evolution and is a personal favourite of mine. It features one or more aircraft hurtling down a valley, attempting to lay waste to an important military target. Think 633 Squadron and you are just about there!

The target could be a large bunker, a headquarters site, a dam – or even a V-2 fuel plant!

The Gauntlet does not use ‘regular’ forces from the army lists but instead allows you to ‘cherry pick’ units dedicated to the task of either attacking or defending the target,



The Mission

A high priority target lies within reach of the air force of one nation and an attack is launched to destroy it. However, it lies within a valley that dictates only one easy approach. The opposing army is well aware of this weakness and has lined the approach with heavy defences.



Attacker's Briefing

Reconnaissance troops or resistance fighters have discovered the presence of an enemy command post that lies ripe for attack. However, the approach will not be easy. Heavy air defences throughout the area will require your pilots to skim through a network of valleys until they reach the target. Fortunately, the air defences appear to be lighter within the final valley itself.

- You may only choose Air Units.
- You take the first turn, moving your entire force on from your table edge.

Defender's Briefing

The enemy has launched a foolish attack on one of your most heavily defended emplacements. He is relying purely on air power, so swat him out of the sky with your massed AAA batteries.

- You have a large bunker for no cost. This must be placed as shown on the map.
- You may not choose any other Emplacements and may not select any Air Units.
- You need not follow your army list's normal limits on Assets and may instead pick units freely.
- You may place your units anywhere on the table.

Scenario Rules

The scenario will last until the Victory Conditions have been met. The attacker can bring his Air Units back on to the table if they leave, as usual. However, they must always move on from their table edge.

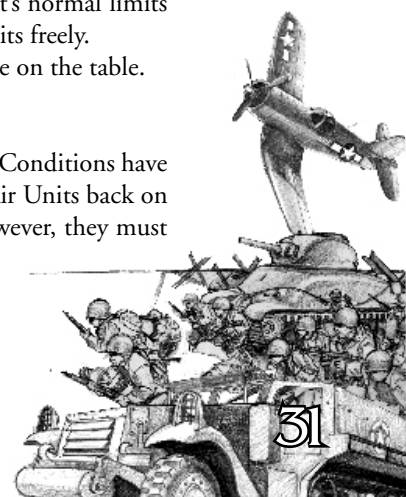

Map



Bunker

Attacker moves on from this table edge

Victory Conditions

The scenario continues until either the bunker is destroyed (victory for the attacker) or all attacking forces are shot down (victory for the defender).



YOUR MAIN SOURCE OF ELECTRONIC WARGAMING PRODUCTS

WWW.WARGAMINGONLINE.COM

Science Fiction

Aeronef	\$9.26
Aeronef Captain's Handbook	\$9.26
ASTRAL CONFLICT Spaceship Wargaming	\$1.00
Babylon 5: A Call to Arms Counter Sheets (Revised)	\$4.95
Babylon 5: A Call to Arms Rules Supplement 1	\$4.95
Babylon 5: A Call to Arms Rules Supplement 2	\$4.95
Babylon 5: A Call to Arms Rules Supplement 3	\$4.95
Babylon 5: Armageddon	\$17.47
Babylon 5: Sky Full of Stars	\$17.49
Babylon 5: The Dilgar Imperium	\$6.97
Babylon 5: The Drakh	\$6.97
Campaign Moderator's Companion	\$9.95
Capital ships (Astral Conflict Supplement 2)	\$1.00
Defiance: Vital Ground	\$15.95
For A Fistful of Fusion (Astral Conflict Supplement 1)	\$1.00
Iron Stars Rulebook	\$9.95
Iron Stars: Southern Front	\$9.95
Starmada X	\$8.95
Starmada X: Brigade	\$10.95
Starship Troopers: Mobile Infantry Army Book	\$13.97
Starship Troopers: Skinnies Army Book	\$13.97
Starship Troopers: The Arachnids Army Book	\$13.97
Starship Troopers: The Klendathu Invasion	\$10.97
The Escalation Wars: Empire Rising	\$14.00
The Menagerie	\$10.00
VBAM: Jovian Chronicles	\$13.50
Victory By Any Means Campaign Guide	\$15.00

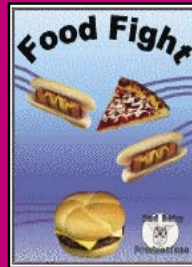
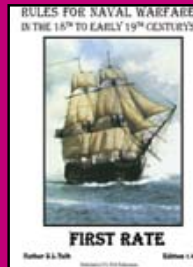

Generic

3D Gothic Courtyard	\$3.00
Castle Walls	\$2.00
Castle Gateway	\$2.00
Clash of Steel Miniatures Rules Version 1.1	\$3.95
Divine Word	\$5.00
Food Fight	\$5.00
King of the Hood Card Game	\$2.00
Kung Fu U	\$5.00
Norman Keep	\$2.00
Roar of the Crowd	Free!
Temple of Athena at Delphi	\$3.00
Treasury	\$2.00

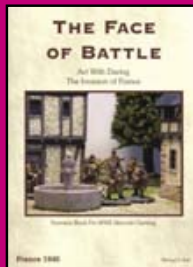
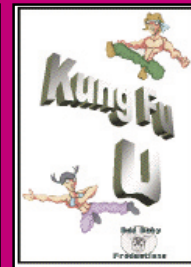

Modern

Blazing Jets	\$7.95
Bulldogs Away!	\$10.00
Fox Two Reheat	\$10.00
Marines vs Zombies	\$3.95
The Hill Battles Khe Sanh 1967	\$10.00

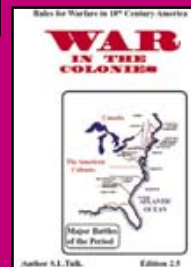

World War I

Aces at Dawn	\$8.95
Biplane Barmy	\$6.45
Fire When Ready	\$10.00
Grant Fleets	\$10.95
Jutland	\$8.50
Perfidious Albion	\$10.00
Stations Manned and Ready	\$10.00
Stringbags	\$10.00
Tsushima	\$8.50



Fantasy

Ares Expanded Rulebook	\$9.95
Clash of Steel the Card Game (Fantasy Edition 1.0)	\$2.00
Clash of Steel the Card Game Expansion 1: Humans	\$1.00
Disposable Heroes Fantasy Collection (Static Edition)	\$9.99
For The Masses	\$4.95
Raze the Castle	\$1.00



Ancients

Phalanx	\$3.00
Salamis ad Actium	\$10.00

Eighteenth Century

War In the Colonies	\$12.00
---------------------	---------



Napoleonic

First Rate	\$24.00
Grand Fleet Actions in the Age of Sail	\$8.50
L'Empereur	\$16.00



American Civil War

Blue Steel, Grey Thunder	\$8.50
Iron and Fire	\$10.00

World War II

Angels 15	\$10.00
Spitting Fire	\$8.95
The Face of Battle	\$10.95
Victory at Sea	\$20.97
Victory at Sea Counter Sheets	\$13.97

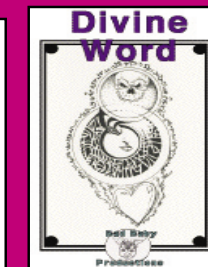

Free!

Air War C21 Lite	Free!
Killing Time I	Free!
Signs and Portents Roleplayer	Free!
Soccer Ruleset	Free!

Join the group of companies on wargamingonline.com

Sign up as a manufacturer and within 24 hours your products can be up for sale on the website!

YOUR MAIN SOURCE OF ELECTRONIC WARGAMING PRODUCTS

WWW.WARGAMINGONLINE.COM

Hammer's Slammers from Pireme Publishing

Hammer's Slammers Starter Pack

Hammer's Slammers handbook plus 15mm unpainted figures:

The Slammers
1 Blower Tank
2 Combat Cars
2 Squads infantry

Lightning Division
1 Tracked Medium Tank
3 Tracked APCs
4 Squads infantry

Free magazine
£63.00

A Miniature Wargames Boxed Game Set

the HAMMER'S SLAMMERS STARTER PACK

15mm unpainted figures and vehicles plus an easy play gaming system and handbook

CONTENTS

RULE BOOK:
The Hammer's Slammers Handbook

PLUS

- 1 Slammers Blower Tank
- 2 Slammers Combat Cars
- 2 Squads of Slammers Infantry
- 1 Lightning Division Tracked Medium Tank
- 3 Lightning Division Tracked APCs
- 4 Squads of Lightning Division Infantry

FREE magazine inside the box!!

Approved by David Drake - author of the Hammer's Slammers books
Game book by John Lamshead & John Treadaway
Models by Old Crow and Ground Zero Games

Produced by Pireme Publishing Ltd.,
Suite 13, Wessex House, St Leonard's Road, Bournemouth, BH8 8QS
Tel: 01202 297 344

Some contents are small, may contain lead and may not be suitable for under 14 years

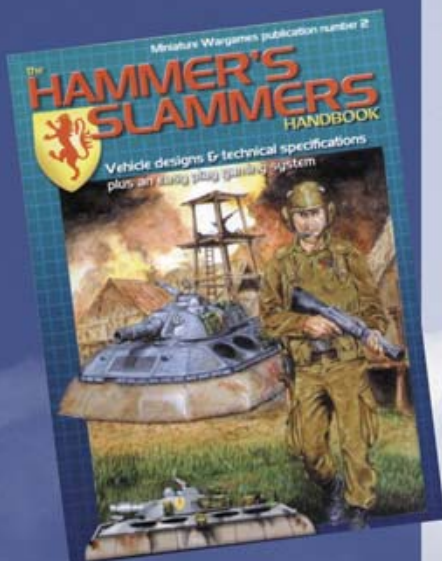

48 pages:

Vehicle designs and technical specifications, plus an easy play gaming system.

£10.95

All approved by David Drake

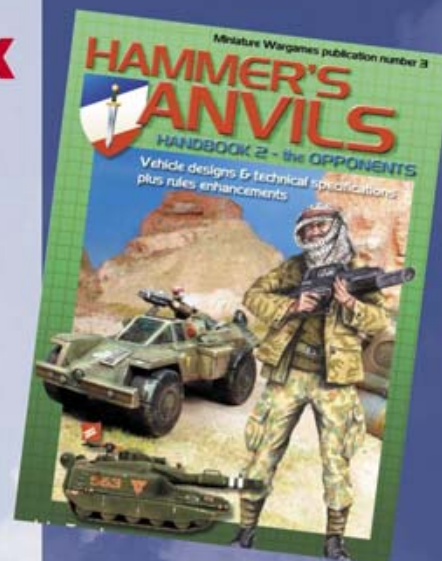

64 pages:

The opposition vehicle designs and technical specifications, Rules enhancements & data cards.

£16.00

NEW

See our website
www.miniwargames.com

TableScape

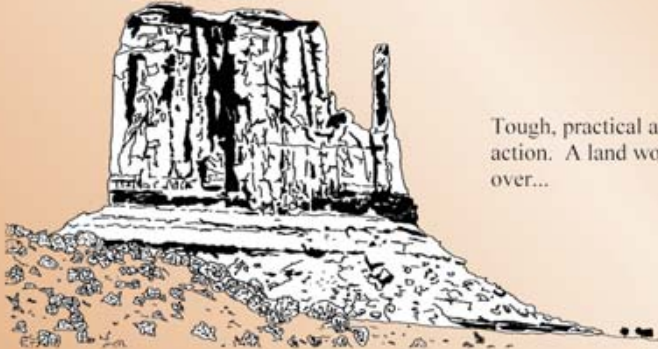

Tough, practical and ready for action. A land worth fighting over...

www.tablescape.co.uk



Ready painted terrain designed for use with 28mm miniatures

Dugout Range

SFDUGS001	Open sided dugout	£8.00	SFDUGS007	Earthwork 90 deg Corners	£12.00
SFDUGS002	Weapons pit	£12.00	SFDUGS008	Earthwork 270 deg Corners	£12.00
SFDUGS003	Command bunker	£16.00	SFDUGS009	Barbed Wire Kit	£12.00
SFDUGS004	Earthwork Straights	£12.00	SFDUGS010	Shell Holes	£12.00

For our complete set of ranges see our website - www.tablescape.co.uk

TableScape, 22 Glenfield Terrace, London, W13 9JF. Tel: 02085678306



The Anywhere Map



A Cthulhutech Adventure By Carl Walmsley

Introduction

There is a map, feted by occult scholars across the ages, which can reveal the whereabouts of any location that a person is seeking. All one need do is hold the map, think of the place and the map will reveal how to get there.

With such a map in their possession, cultists seeking to bring about the downfall of humanity would be able locate hidden NEG bases and secret storage facilities. No site would be safe from their depredations. More significant than this, they would be able to locate the lost city of R'lyeh itself and awaken great Cthulhu from his sleep of death. If such a thing were to happen, it would – quite literally – be the end of the world.

Adventure Background

The Brethren of the Rapturous Flame is a cult affiliated to The Children of Chaos. Recently, the cult's leader and chief sorcerer have both experienced vivid dreams compelling them to enter an area known as The Zone – an enormous dimensional rift that sits above the remains of Area 51. The Zone was created during a failed attempt to develop a super-weapon shortly after the start of the second Arcanotech War. The Zone is now a forbidden wasteland from which blasphemous monsters occasionally emerge. An entire regiment of mecha guards the perimeter of the Zone, making it one of the most inaccessible locations on Earth.

The Brethren of the Rapturous Flame have started to gather intelligence on The Zone in the hope of finding a way past the guards and of answering the unholy summons that fills their leaders' dreams.

They have scoured ancient texts for ideas and sought assistance from different cults. In so doing, they have discovered two leads. The first involves the summoning of a *Nibilus Worm* – a powerful creature that they hope will explore The Zone for them.

The second lead involves followers of the Esoteric Order of Dagon. These rival cultists have acquired detailed photographs of perimeter defences around a part of The Zone. Though connections between the EOD and 'The Flame' are not well established, a trade has been arranged. Followers of The Flame will hand over an ancient Dagonite text in exchange for the photographs.

NEG operatives have detected the increased activity within the ranks of The Flame and the PCs are assigned to infiltrate their operations and learn what they can about what they are up to.

Adventure Synopsis

The adventure begins with the PCS going undercover. Assuming the identities of wealthy socialites or industrialists, they attend an exclusive party in Paris. The host is Claude Lochu, leader of 'The Flame' cult.

The PCs will learn that they and the other guests are unwittingly being used as part of a ritual designed to summon a *Nibilus Worm* on the roof the building. They will have the opportunity to thwart the cultist's plans.

From here, the PCs will explore a facility owned by a private security firm called Krieg Enterprises. The owner of the firm, Gustav Klimpt, is a member of The Flame. Hidden in the facility is the Dagonite text that Lochu and his followers plan to exchange for the photographs of the checkpoints around The Zone. The PCs will have the chance to learn about the planned exchange and may choose to attend the meeting themselves in order to uncover an EOD cell operating on The Isle of Wight.

Once the PCs have learned of Lochu's plans to enter The Zone, they will be sent to explore the area that he was interested in for themselves. Even at the edge of The Zone, they will encounter strange phenomena.

Assisted by an enigmatic guide, they will dream-travel into The Zone in search of The Anywhere Map. If the agents are successful in this strange dimension, they will find that the map is not a physical thing but information – information which is now lodged inside the mind of one of the PCs. This knowledge is in a compressed form and, as it gradually unfolds, it will erase everything else inside the character's mind.

In order to extract the map – and save one of their number – the PCs must sneak into an abandoned Migou facility situated in the Southern Polar region. This base houses

the remains of an organic super-computer that is capable of connecting with a human mind. Once repaired, this bio-machine can extract the map and store it digitally.

The PCs will discover that the Migou facility is not entirely abandoned. Worse still, once it is repaired, the bio-computer will activate a self-destruct countdown. The race is on to download the map and to escape the facility before the base is destroyed.

Chapter One: Summoning Circle of Friends

Claude Lochu is an infamous socialite and his high society gatherings are attended by guests from all across the world. He is also a powerful cultist. The PCs are going undercover to find out what he and his followers are up to and if possible, how far their influence and activities extend.

Mission Briefing

If you are using this adventure as a follow-up to *The Icething Cometh*, the PCs are members of the NEG fast response team *Revelation One*. They will, once again, have the Prowler Armoured Stealth Transport at their disposal and will receive their mission briefing from Colonel Walsh (See *Signs & Portents Issue 55*, April 2008).

The PCs can just as easily be working for another branch of the NEG, in which case you will need to tinker with the introduction a little and should give some thought as to what equipment you wish to make available.

Similarly, the PCs might be given this mission by The Eldritch Society – though they will need to be acting closely with NEG in order to gain access to the locations,

equipment and intelligence that are a vital part of this adventure.

Read or paraphrase the following:

Colonel Walsh's arrival is preceded by the hum of her anti-grav chair. A large holo-screen flickers on behind her and as always, she gets straight down to business.

"The man you see on the screen is Claude Lochu – a wealthy Parisian playboy. He is also the head of a cult called The Brethren of the Rapturous Flame. NEG operatives have been watching him for several months but recently he and his followers have ramped up their activities. Before we close him down, we want to know what he's up to.

Your mission file contains details of his inner circle. Pay particular attention to Maximillian Caine: he's a sorcerer. We believe he has been involved in some very questionable activities.

You will be attending one of Lochu's parties in his Parisian penthouse apartment. Check your mission file and choose a false identity that you are happy with. You will have a week of training to familiarise yourself with your cover and to learn a few new tricks.

You will have to use your initiative here. We don't want to make a move on Lochu until we know what he is up to. Equally, we've let him continue his activities for longer than we normally would. Learn what you can, and then shut him down. By the end of this party we want him in custody. In fact, we'd like his entire inner circle taken alive, if possible. The Parisian police will have a number of officers ready to assist you if need be – you can use your PCPUs to radio for back up.

That's all. Good luck.

Preparations

The PCs will have a week to prepare for this operation. During this time they will receive intensive training, allowing them to learn two new skills at Student level. These skills should help them to more convincingly assume their cover identities.

Player Handout Two provides a list of possible identities and suggests suitable skills for characters to learn.

Before they set off for Paris, NEG surgeons will implant a tiny micro-transmitter inside the jaw of each PC. These devices will allow them to communicate discretely with each other. With a range of 100 metres, they will be able to listen in on each other's conversations and need only whisper to be heard by their colleagues.

The Party

The entrance lobby outside Lochu's penthouse is patrolled by three of Klimpt's security guards. Though dressed in dinner jackets, they have a sombre demeanour and are armed with CS-44 pistols. Security cameras allow them to monitor guests entering the building's ground floor lobby or using the stairs or elevator.

As guests arrive, their names are checked off a list and they are ushered inside. If the PCs arrive carrying non-concealed weapons, they will be taken by the guards and held until they wish to leave.

Once all of the guests have arrived there will be 25 people at the party, including Lochu and his inner circle. There are also three more of Klimpt's security guards inside the apartment. They keep a low profile but are tasked with making sure that things go smoothly.

Claude Lochu's Apartment



Waiters glide about the luxurious open-planned apartment, ensuring that there is a constant supply of hors d'oeuvres and champagne. The doors out to the balcony are open, providing a spectacular view of the Parisian night. The PCs should realise that they are attending a very exclusive get-together.

Time to Mingle

This first part of the adventure should give the PCs a chance to meet some of the other guests, perhaps ask a few questions and maybe even snoop around the apartment. Bear in mind that most of those attending the party have no cult connections at all. It is hoped that some of them might one day be recruited, however.

Lochu and his inner circle will wish to size up the PCs as potential recruits. Some encounters to run with them include:

- Severine de Bouchard approaches the PCs as soon as they arrive. She is charming and erudite and will ask the PCs about themselves. This is a good way to ease them into their undercover roles. She has a particular knowledge of art and is happy to discuss the paintings in the apartment with James/Jennifer Reims. She takes note of anyone who discusses the occult nature of the paintings in the apartment (see **Snooping**).
- Claude Lochu introduces himself: his personal secretary organises the guest lists for these events, so it is the first time he has met the PCs. He will play up the fact that his parties are attended by lots of important people and encourage the PCs to do some networking. He presents himself as a high-society 'fixer' who knows everyone worth knowing.
- Maximillian Caine will be very interested to speak with Miles/Milicent Duncrief. He will explain that he is an occultist himself and will sound out the PCs view on NEG restrictions on spells. He argues that innovation is about risk – scientists experiment all the time and are lauded for it. Why should sorcerers be treated differently?
- Gustav Klimpt will approach one of the PCs - Henry/Henrietta Lions is most suitable – and enquire as to whether he/she is happy with their security arrangements. He insists that his own personnel are exceptionally well qualified and *very discrete*. He is hoping to deduce whether the character has any need of discrete security – and therefore, by implication something to hide.

Snooping

A character who takes time to explore the apartment will notice that the walls are adorned with exotic works of art depicting occult and mystical practises from ancient cultures – particularly Africa and Asia.

Anyone who peers behind these expensive paintings and carvings will see that they conceal a series of arcane markings. A Difficulty 12 Occult Test reveals that these are evidence of a Ward of Seclusion (*Cthulhutech*, page 191). This is a legal spell, ensuring that the apartment cannot be the target of any surveillance – mystical or mechanical.

The table around which the guests will dine is itself a spectacular piece, carved with an elaborate design. A character that succeeds with a Difficulty 16 Occult Test will realise that the patterns in the table surface are mystical in nature. Its exact purpose is a mystery at this time.

If anyone searches the office they will find that Lochu has not been foolish enough to leave any incriminating evidence lying about or to store it on his computer. There is, however, an MP-6A1 machine pistol hidden in a desk drawer.

The Delivery

Once the PCs have had a little time to settle at the party, a courier arrives with a package. This is delivered to Claude Lochu. It will work best if he is talking with one of the characters when this happens; a security guard will beckon him to one side and hand him a padded envelope.

Lochu will excuse himself and approach Maximilian Caine: the pair will then go into Lochu's bedroom.

The padded envelope contains 9 pages of an ancient Dagonite manuscript dealing with the appropriate ways to communicate with Spawn. The pages also contain the spell *Portents of Doom* (*Signs & Portents Issue 56, May 2008*).

There is a brief note accompanying the pages. It states that the rest of the manuscript has been taken to the secure location that Klimpt suggested. This is a Krieg Enterprises Facility five miles to the north in the Parisian suburbs but this is not made clear in the note.

Lochu will place the pages and the letter in a wall safe, hidden behind a painting. In his haste and excitement, he will leave this slightly askew. The safe can be opened with a Difficulty 22 Security or Criminal Test.

Lochu and Caine will briefly discuss the fact that with the book, they can conduct the exchange in the next 24 hours. They will then return to the party.

Dinner is Served

Just before dinner is served, Maximilian Caine will leave the party and make his way up to the roof (see **The Summoning** below).

With everyone else seated at the table, a starter of very rare lamb is served. The waiters light scented candles dotted about the room and Claude Lochu stands to announce a toast:

Before my family came to live in France, they came from the east – what I like to call old Europe. They had a toast that they would always make with new friends: Nyar boosh e'col.

Lochu will lift his glass and invite his guests to repeat the toast. Occultists amongst the group will have only a moment to realise what is going on. An Occult Test with a Difficulty 16 reveals that the words are from an ancient European dialect and mean 'Let my soul give freely'. Along with the blood in the meat, the incense in the candles, the guests are all being coaxed into taking part in a ritual.

Any character who has previously determined the magical nature of the table will now realise exactly what it is for. The table is a conduit – a channel that collects Orgone from those seated around it and uses it to power a spell. The power of the table is such that it can drain Orgone without those seated around it realising what is happening.

Anyone who joins in the toast becomes a part of the ritual taking place on the roof. During the course of the meal, they will lose 10 points of Orgone.

The Summoning

On the roof of Lochu's apartment, three cultists have been orchestrating a ritual for almost a day. Its culmination will occur during the meal that the PCs are attending.

The ritual takes place inside a large glasshouse that has been prepared as a suitable casting area.

Maximilian Caine will join the cultists shortly before the end of the ritual. The Orgone required for the spell – which is summoning a *Nihilus Worm* – is being supplied not just by the cultists but also by the dinner guests below.

There are two reasons for this. Summoning a *Nihilus Worm* requires a great deal of Orgone – 50 points. In order to make the summoning easier, the cultists are Overpowering the spell (*Cthulhutech*, page 184), increasing the amount of Orgone required to 200!

Secondly, the participation of the guests (even unwittingly) makes them more vulnerable to occult corruption: Lochu hopes that the seed planted now will one day blossom and that he will acquire new followers.

Nihilus Worm

Allegiance: Children of Chaos

Scale: Vitality

Size: Medium (8' long)

Attributes: Agility 5, Intellect 8, Perception 10, Presence 5, Strength 9, Tenacity 10

Secondary Attributes: Actions 1, Orgone 14, Reflex 8

General Skills: Education: Expert (4), Observation: Expert (4), Occult: Expert (4), Stealth: Adept (3), Survival: Adept (3)

Combat Skills: Dodge: Novice (2), Fighting: Adept (3)

Weapons: Maw (+1)

Roof Garden

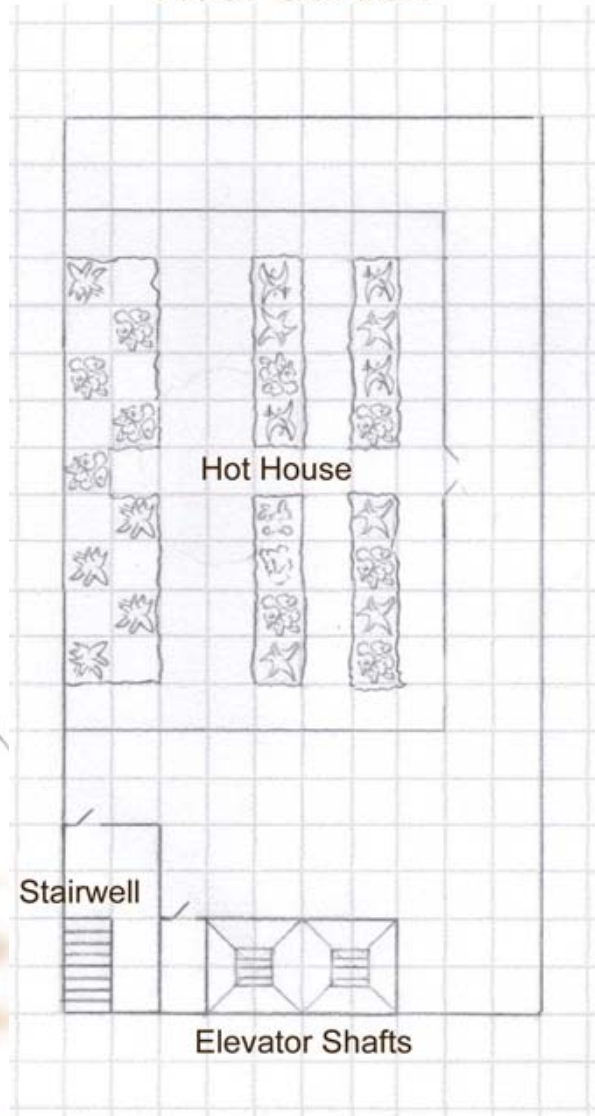

Damage Bonus: +2

Vitality: 15

Armour: 1/1

Fear Factor: 12

Temperament: Mysterious and Unpredictable

Senses: Acute Hearing, Acute touch, Scan, Thermal

Movement: & Speed: Land [7 mph (17/4 ypt)], special

Nihilus Worms resemble huge, bloated maggots with red skin. They are able to chew through the fabric of space and time, literally burrowing between locations. They have exceptionally acute senses and an innate ability to perceive magic. They communicate by duplicating the voice of whomever or whatever is speaking to them and understand all known languages.

A character who passes an Occult Test (Difficulty 18) can identify one of these creatures on sight and also knows that they are highly regarded as spies.

If the summoning of the *Nihilus Worm* is completed, Caine will offer it a deal that it will willingly accept. It is tasked with exploring the perimeter around The Zone and of reporting back with its findings. Once this is done, it is free to remain in this dimension.

Breaking up the Party

At some time during the evening, the PCs will have to make their move*. When this occurs, Lochu and his inner circle's priority will be to escape. If possible, Lochu will take the manuscript pages with him and Caine will try to ensure that the summoning spell is completed.

Lochu's preferred means of escape is to seal himself in his room with his inner circle and radio for help. This help will come in the form of a cloaked A-Pod transport that

will hover directly outside his window. It takes 2 minutes for this to arrive. For the attributes of the pilot, use those of a Swat Officer (*Cthulhutech*, pages 262-3), adding Pilot: Adept (3). If necessary, this vehicle can extract Caine and the other cultists from the roof.

If Lochu and his advisors can get into this vehicle, they will flee – under cover of the stealth field – to the Krieg Enterprises facility 5 miles to the North.

The security guards will do what they can to hold off the PCs and any back up that they have requested the Parisian PD. If necessary Klimpt will join in the fight, covering his comrades escape.

The adventure will work best if Lochu or at least one member of his circle escapes the party.

*If for any reason, the PCs make no effort to arrest Lochu and the others, after the party they will proceed to the Krieg Enterprises facility to the north.

A Hidden Guardian

One of the guests at the party, Marco Blanco, is a Dhohanoid. He will keep a low profile until things turn nasty, at which points he will attack the PCs directly.

Blanco's Dhohanoid form is an Elib (*Cthulhutech*, page 213).

Back-up

The Parisian PD can dispatch up to a dozen officers (use Police Officer, *Cthulhutech*, page 259, armed with MP15-9 SMGs) and two Enforcer 2000 A-Pod lifters.

Chapter Two: The Package

An ancient Dagonite text is being stored in a Krieg Enterprises facility north of Paris. An arrangement has been made with a rival cult to exchange this for surveillance photographs of defences surrounding The Zone.

The PCs may discover this location either by questioning Lochu or his associates (*where is the rest of the book we found pages from in your apartment?*), by following them or simply by investigating what facilities the cultists might have access to near Paris. Assuming that the PCs are working for the NEG, they have access to a database with this information.

It may be that Lochu and some or all of his inner circle have fled to the facility. If this is the case, they will spend an hour or two making preparations before they leave. The cultists will place the Dagonite text inside an M-15 Ranger AAFV (*Cthulhutech*, page 230) and use this to travel north and cross the channel. If Klimpt has made it this far, he will pilot the Saber mech in the vehicle bay when the group sets off.

If the PCs have already apprehended Lochu and the others, they will find that this facility is defended by a pair of security guards (*Cthulhutech*, page 260). One is stationed at the entrance, while the other patrols the grounds.

The Facility Grounds

A series of rotating surveillance cameras are positioned around the site. The location of each camera is marked on the map of this facility with a star.

Each camera can be deactivated with a Difficulty 20 Criminal or Security Test. They can be sneaked past with a Stealth vs Observation Contest – each camera has basic AI

functions which allow it to detect intruders. The cameras have Observation: Adept (3) and 8 Perception.

If an intruder is detected, an alarm sounds and some sophisticated anti-intruder devices are activated: Krieg Enterprises specialises in security, after all. Hidden beneath the surface, all around the facility are a series of gas projectors. One turn after an intruder is detected, he is doused in gas.

The gas has both knockout and hallucinogenic properties. A character exposed to the gas must pass a Difficulty 16 Tenacity Feat Test or lose consciousness for 1-10 minutes. If this test is successful, a second test (Difficulty 18 – and, again, using Tenacity Feat) is required. If this test is failed, the character begins to hallucinate.

As the Storyguide you are free to choose the form that these hallucinations take. They might be subtle (the PC sees an extra security guard that he does not seem to be able to catch) or downright weird (the ground erupts and an enormous spidery *thing* with the PC's face emerges). This can be a great opportunity to terrify and wrong foot your players.

The hallucinations will pass after 1-5 minutes but may, if you so wish, reoccur at any point during the next day. There is no harm in having the PCs questioning the reliability of their senses.

The alarm will also summon reinforcements from another Krieg Enterprises facility 20 miles away. Four more well-armed security guards arrive in an Enforcer 2000 ten minutes after the alarm sounds.

Buildings

Vehicle Bay

This secure, armoured building holds an M-15 Ranger and a Saber mech. It is also where the stealth transport

that Lochu will try to escape in will park, assuming that it makes it this far.

Training Facilities

This building houses a firing range and martial arts training room. A secure locker houses an assortment of small arms.

Offices

This building is the administrative centre for Klimpt's legitimate operations in Paris.

The Hidden Room

Located beneath the site is a tunnel that links the vehicle bay, training facility and offices. If necessary, the cultists will use this to move around unseen and to elude the PCs.

The tunnel also leads to a secret cult room, which houses a communication suit. The room is locked: a Difficulty 22 Security test will open it.

A character who can pass a Difficulty 16 Communications Test can call up the most recent message from the communication system. The message confirms that an exchange has been arranged – the book for the 'information'. There is nothing to detail who the exchange has been agreed with.

In the message, the cultists are given precise coordinates that they are to follow, which will take them out into the middle of the English Channel. They are told to wait at a depth of 60 metres and that a guide will arrive to take them to their final destination where the exchange will take place. The message also contains a code that Lochu is instructed to broadcast should anything approach him during his journey.

Krieg Enterprises

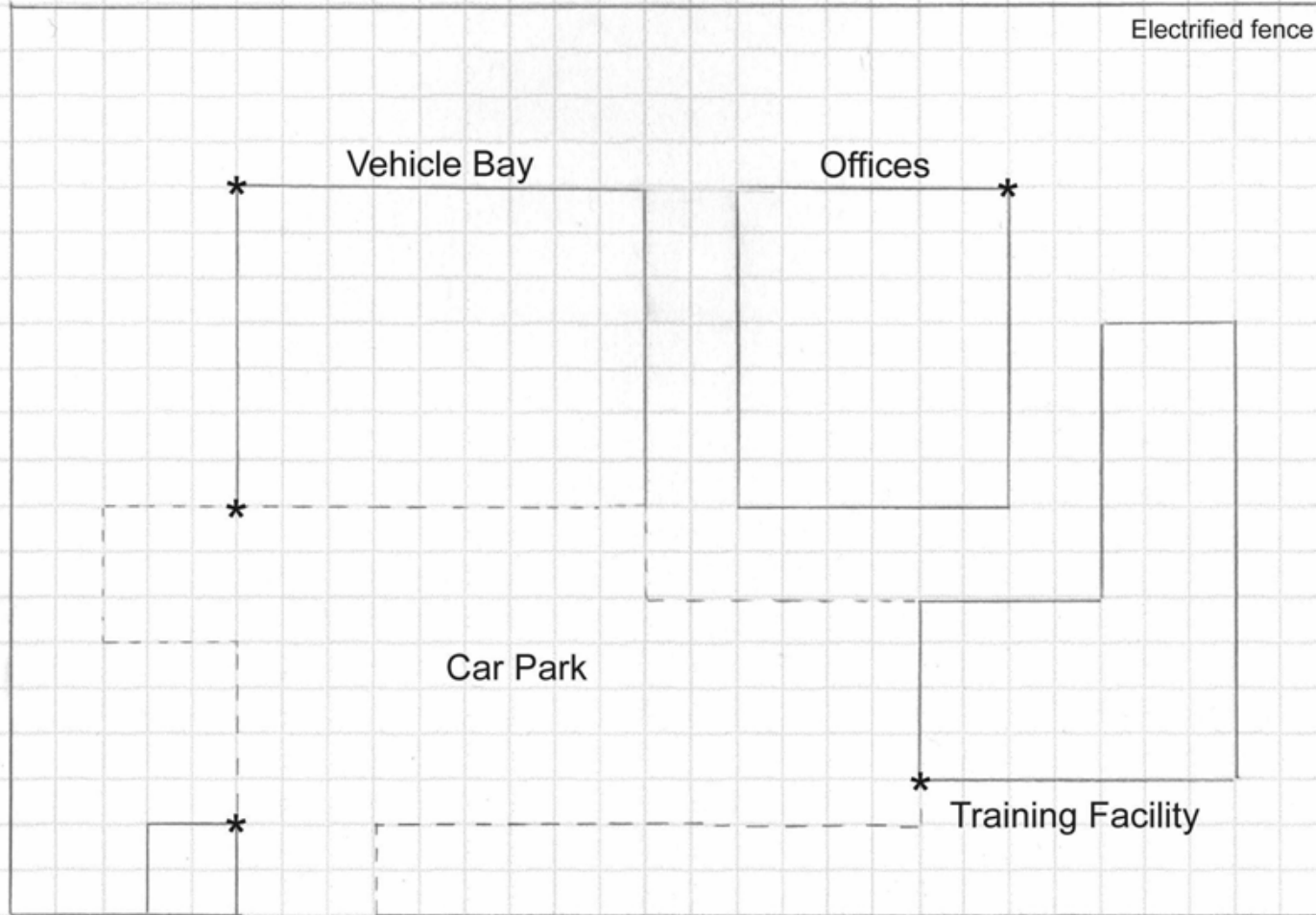

Guard Post

Car Park

Training Facility

Scale 1 square = 2m

Progress So Far

By the end of this chapter, the PCs should have learned that The Brethren of the Rapturous Flame were attempting to summon a *Nihilus Worm* – a creature most often used as a spy. They may know that it was charged with gathering information about security surrounding The Zone. They should definitely have found out about the proposed exchange – the Dagonite book for some unspecified ‘information’. They will also likely have killed or captured several of the cultists.

If for any reason the PCs have failed to discover some of this information, as much or as little as is required to keep them on track (without giving the game away completely) may be revealed by captured cultists under interrogation.

As an absolute minimum, the PCs need to know about the proposed exchange so that they can go and investigate it.

Chapter Three: Secrets in the Deep

Cultists loyal to the Esoteric Order of Dagon have for some time been building a power base on the Isle of Wight. It provides a perfect staging ground from which to launch actions against the mainland.

Though the cult has only minimal ties with The Children of Chaos (the parent organisation of The Brethren of the Rapturous Flame), they have agreed to exchange photographs of an area around The Zone for a Dagonite Text called *Riddle of the Deep*.

The Channel Crossing

If the PCs follow the instructions outlined in the message found in Chapter Two, they will travel to co-ordinates in the middle of The English Channel. Before they reach that point, they will be approached several times by large, unidentified *things*. If they transmit the code provided in the message, the things will veer away and leave them unharmed. If not, they will be attacked as intruders: the followers of Cthulhu rule the sea and there are any number of mechs and spawn patrolling its depths.

Once the PCs reach the rendezvous point, a minisub will make contact and then lead them to a secret cave-dock on the southern coast of the Isle of Wight. The cave is accessible via a tunnel 30 metres below the water line. The PCs can follow the minisub in and surface within the cave.

I’ve Not Been Expecting You...

A senior member of the EOD cell on the island is awaiting the PCs in the cave. The man, Lewis Gray, is accompanied by his second, Catherine Fletcher. A further three cultists, all armed with AR-25 assault rifles, are there for security purposes. For all these characters, use the attributes of an

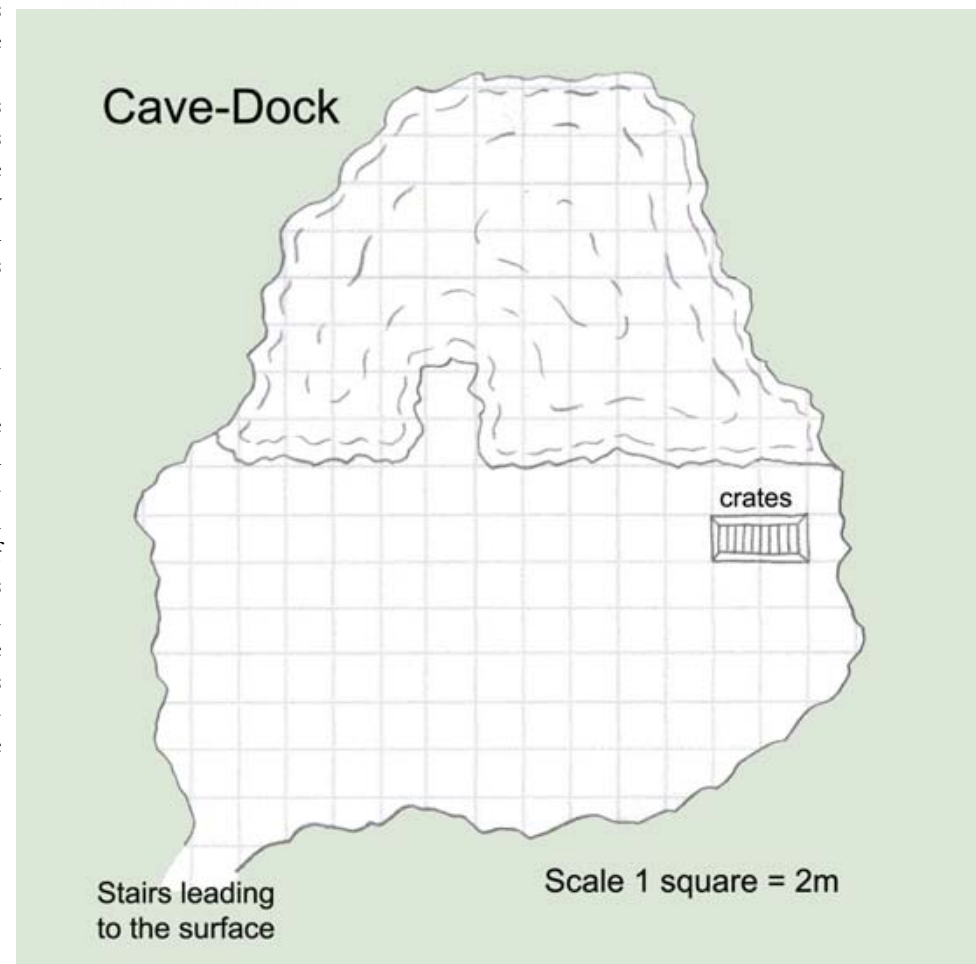

Average Dagonite (*Cthulhutech*, page 210), but increase Gray's Intellect to 9 and Fletcher's Presence to 9.

The deal that Gray made was with Claude Lochu and Severine de Bouchard. He is expecting them to be present during the exchange. As a result, he will be very suspicious of anyone else who tries to pass themselves off as members of 'The Flame'. Nevertheless, smooth-talking PCs may still be able to persuade him to go ahead with the exchange.

The only member of 'The Flame' that Gray has met in person is Severine de Bouchard.

Off to one side of the cave are several metal crates. These contain six sets of scuba equipment, six spearguns (+1 DMG, RNG 5/10/15) and an A-Pod turbine launch. This last item is a two man device that divers can hold onto and be pulled through the water at speeds of up to 30 mph.

The Exchange

The EOD cell is in possession of detailed photographs of a secure checkpoint just outside The Zone. The checkpoint is known as Bravo-9. It is a military facility that monitors activity bordering The Zone. A number of mecha and personnel are permanently stationed there.

If the PCs can convince the suspicious Gray that they are members of The Flame and more importantly, show him their copy of *The Riddle of the Deep*, he will agree to the exchange. He and one of his men will put on scuba gear and use the A-Pod launch to travel to their secret HQ and get the 'information'. He leaves his second, Catherine Fletcher and the other two cultists to ensure that the PCs wait in the cave for their return. He is very wary of being followed. The return journey takes 40 minutes.

If things go badly – either because the PCs cannot convince Gray to trust them or because they try to arrest or attack

the cultists – Gray will try to escape. If he is wearing his scuba gear, his preferred route is out into the sea. If not, he will flee up the stairs leading to the beach and try to reach his safe house. The armed cultists will do all that they can to protect him.

Infiltrator

Catherine Gray is, in fact, an undercover NEG operative. Her real name is Michelle Walker. She has spent six months infiltrating the ranks of this EOD cell.

Her priority at the moment is to continue winning Gray's trust. She hopes that in doing so she can learn the location of the cell's undersea HQ – her original assignment.

During her time within the cult, however, Michelle Walker's allegiance has come to be questioned by her superiors. She is now so deep undercover that she has made no contact with the NEG in three months. If the PCs check her file, they will learn this.

Infiltrator Exposed

Walker is reluctant to blow her cover. Only if the PC's lives are about to be lost (or if they are about to kill her) will she reveal the truth. In this instance, she will still want to complete her mission if at all possible.

If the PCs have killed or driven off Gray and the other cultists, Walker will propose a plan that could benefit them all. She suggests that she pretends to capture and hand over the PCs (but not the book) to the EOD cell. She believes that the cell is desperate to acquire the copy of *The Riddle of the Deep* and that, consequently, the PCs will be taken to the undersea HQ for direct questioning by the cult leader. Once inside the base, they can escape and acquire the information that they are looking for. They can also let Walker know where the base is and help her to complete her assignment.

Walker has some concealable knives and a miniature laser-cutter that she can give the PCs to help them escape once they get to the facility. These will not be found during a search.

If the PCs agree to this plan, Walker will use a hypo-dart gun to knock them out – she insists this is necessary to make things look genuine - and takes them to Gray's Safe House in Ventnor – the island capital.

Her plan is a solid, if risky, one and after some questioning and a little mild torture (either by Gray or another senior cultist contacted by Walker) the PCs will be taken down to the cell HQ, using a mini-sub located off the coast.

An Alternative Plan

Alternatively, Walker can be persuaded to divulge the location of the cult safe house and the PCs can storm the place. She thinks this is a stupid plan, however as any members of the cell that the PCs find there will be reluctant to talk – even if tortured.

Gray's Safe House

A few minutes walk from the cave where the EOD cell arranged to meet members of The Flame is a safe house. It is an innocuous-looking place, but has a cellar where members of the cult can hide or where prisoners can be interrogated. A range of small arms are stored on the premises.

Undersea HQ

In 2022, when oil and gas reserves were running low and D-Engine technology had yet to be discovered, the English Channel was being scoured for hidden reserves of fossil fuel. To facilitate this exploration, a series of undersea stations – The Triton Laboratories – were

Triton IV Research Station

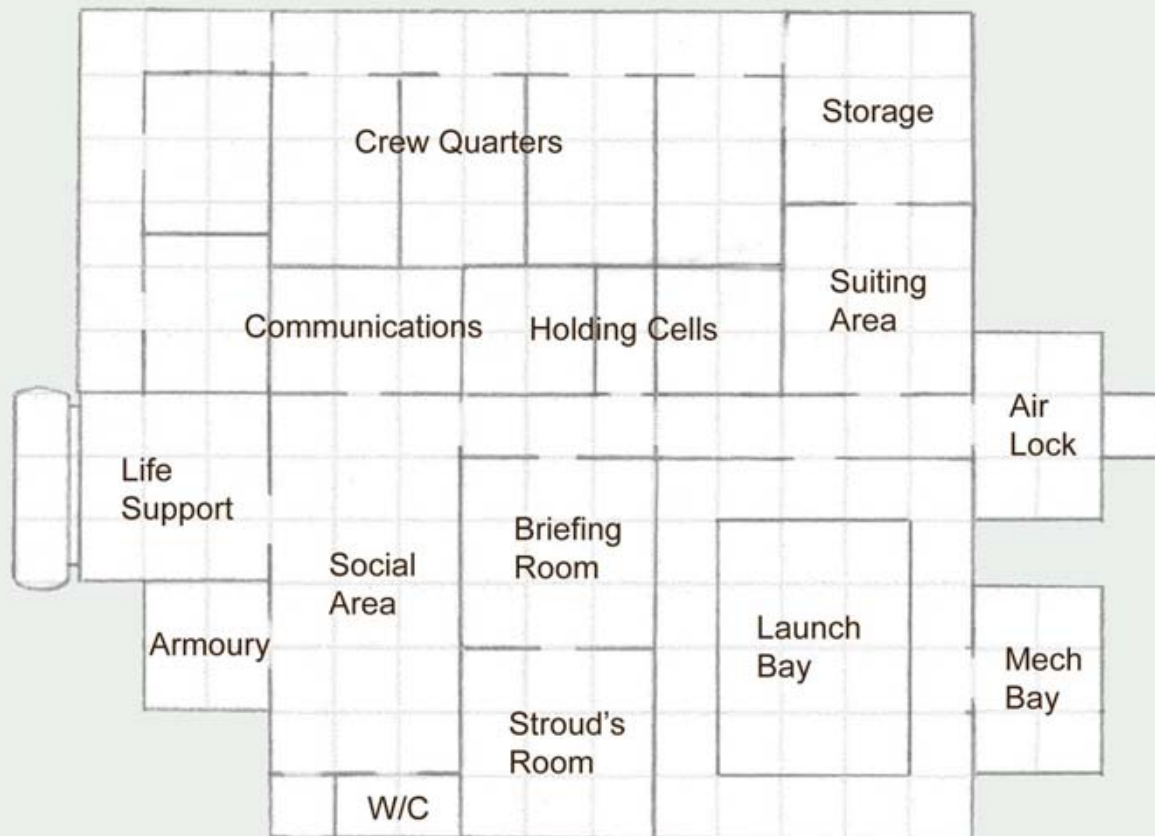

Scale 1 square = 2m

constructed. Triton IV was located just off the coast of The Isle of Wight.

When D-Engine technology was discovered, these facilities were abandoned. Triton IV lay unused for many years and, consequently, does not appear in NEG records. Four years ago, it was renovated and re-equipped and became the secret HQ for the EOD cell based on the island.

Many of those aboard the station are mature hybrids whose true nature has become difficult to hide. They await the day when they may join their brethren in the deep. Until then the station is both a perfect hiding place and somewhere where they feel comfortable.

The station creaks constantly as the sea-currents shift about it. There are viewing ports out into the murky green waters, and the rusty metallic corridors are reminiscent of the innards of old nuclear submarines. Different sections of the station can be sealed using airtight bulkhead doors. These are marked with a 'B' on the map.

Rooms

Airlock

The outside bulkhead must be opened via a command from the Communications Suit or through the inputting of a code known only to ranking cultists. A Security Test (Difficulty 20) will bypass the code access pad.

Security protocols prevent the opening of both the interior and exterior airlock doors.

It takes 1 minute to drain or fill the airlock.

Armoury

This secure room contains the following items:
6 Acruta Spears
6 Needler Pods
3 M-6 Shotguns

1 EOD Torpedo Launcher (As RPG-11, *Cthulhutech*, page 113, but designed to function underwater), with 5 torpedoes.

Communications Suit

The computer system in here contains passwords and codes for contacting cells all along the south coast of England. It can be used to contact EOD facilities out in The Atlantic Ocean, though the PCs could also use it to link up with NEG communication satellites.

Crew's Quarters

The hybrids aboard the station use these rooms. A typical room contains a few personal effects, a weapon and copies of Dagonite texts: the occupants use these to learn about their heritage in preparation for their integration into Deep One society.

Holding Cells

Held in one of the cells is a police officer, Mark Street, who got too close to uncovering the cult's activities. He has Moderate Wounds, but is willing to assist the characters in any attempt to escape or to deal with the EOD cultists. Use the attributes of a Police Officer (*Cthulhutech*, page 259).

Launch Bay

A pool in the centre of this room is open to the sea, though air pressure ensures that the room does not flood.

An armed Mini-sub (Small laser), used for transport to and from the coastline, is docked here. It has the same attributes as an Enforcer 2000 (*Cthulhutech*, page 225), but is aquatic and has a maximum Water Speed of 60 mph.

Life Support

Fitted with a small D-Engine to power the air filters and heating system, this room houses the equipment which maintains the temperature, lighting and atmosphere within the station.

Mech Bay

A well-maintained Mudskipper is stored in here. This can be used to defend the base if it is threatened.

Stroud's Room

Unless they have been taken elsewhere, the photographs that the PCs are looking for are stored in this room. Stroud uses this and the adjoining briefing room to organise the activities of the cell. He is now so far along the route of transformation that there is little left of the man he once seemed. For Stroud's attributes use those of a Deep One (*Cthulhutech*, page 206).

Suiting Area and Storage

Various items of aquatic equipment (scuba gear, lighting, and so on) are stored and used in these rooms.

Personnel

The leader of the Isle of Wight cell is a hybrid called Nicholas Stroud.

There are eight other hybrids on board the station. Those with better-developed aquatic skills often go out thorough the airlock or launch bay and swim around in The Solent.

The cultists are in regular contact with Dagonite denizens of the deep. If they are threatened, they may contact a Spawn (*Cthulhutech*, page 220) that patrols this area and request its assistance.

Prisoners Beneath the Waves

If the PCs arrive at the Triton IV station as a result of Michelle Walker's plan, they will be placed in the holding cells for a short time before Stroud begin to interrogate them. He is not a patient creature, and his questioning will be brutal.

If it comes to a direct confrontation, Stroud and the hybrids on board will fight to the death to protect this facility. If necessary, they would rather scuttle the station than let it fall into enemy hands. This tactic could lead to a very dramatic finale to this chapter, with the PCs struggling to acquire the photographs or to escape before the station becomes a metallic watery tomb.

Troubleshooting

This part of the adventure can be resolved in a number of different ways. The PCs will essentially be on track as long as they acquire the photographs of The Zone security – or, at a pinch, learn that these are what The Flame cultists were trying to acquire.

If the PCs also manage to shut down an EOD cell, and possibly aid an undercover NEG operative, then that is something of a bonus. Such heroic efforts should be rewarded with an extra 5 or 10 Experience.

Chapter Four

After everything that has happened so far, the PCs will be summoned back to Paris so that they and their superiors can collate whatever information has been gathered. Arcanotech surgery will be made available to any characters who have been injured, allowing them to be fully healed in a day or two.

Hopefully, the PCs are in possession of the photographs of security around The Zone and are aware that The Flame cultists summoned a creature to spy on the same area.

As long as Lochu or some of his inner circle are in captivity, NEG interrogators will have had a chance to question them and their findings can be used to fill-in any gaps in the PC's knowledge. This is not to say that they should get off lightly if they have bungled the investigation so far.

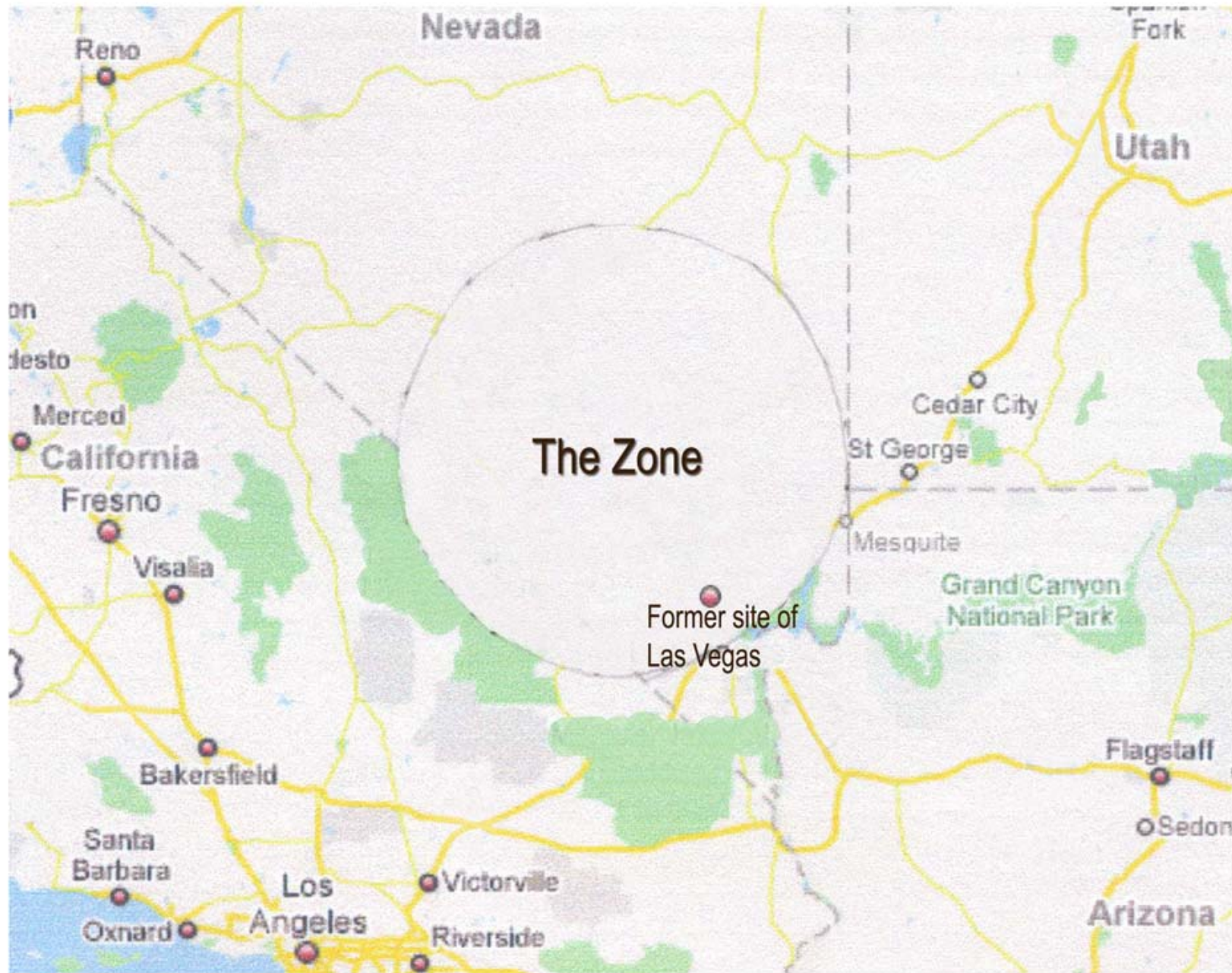

Bravo-9 Checkpoint

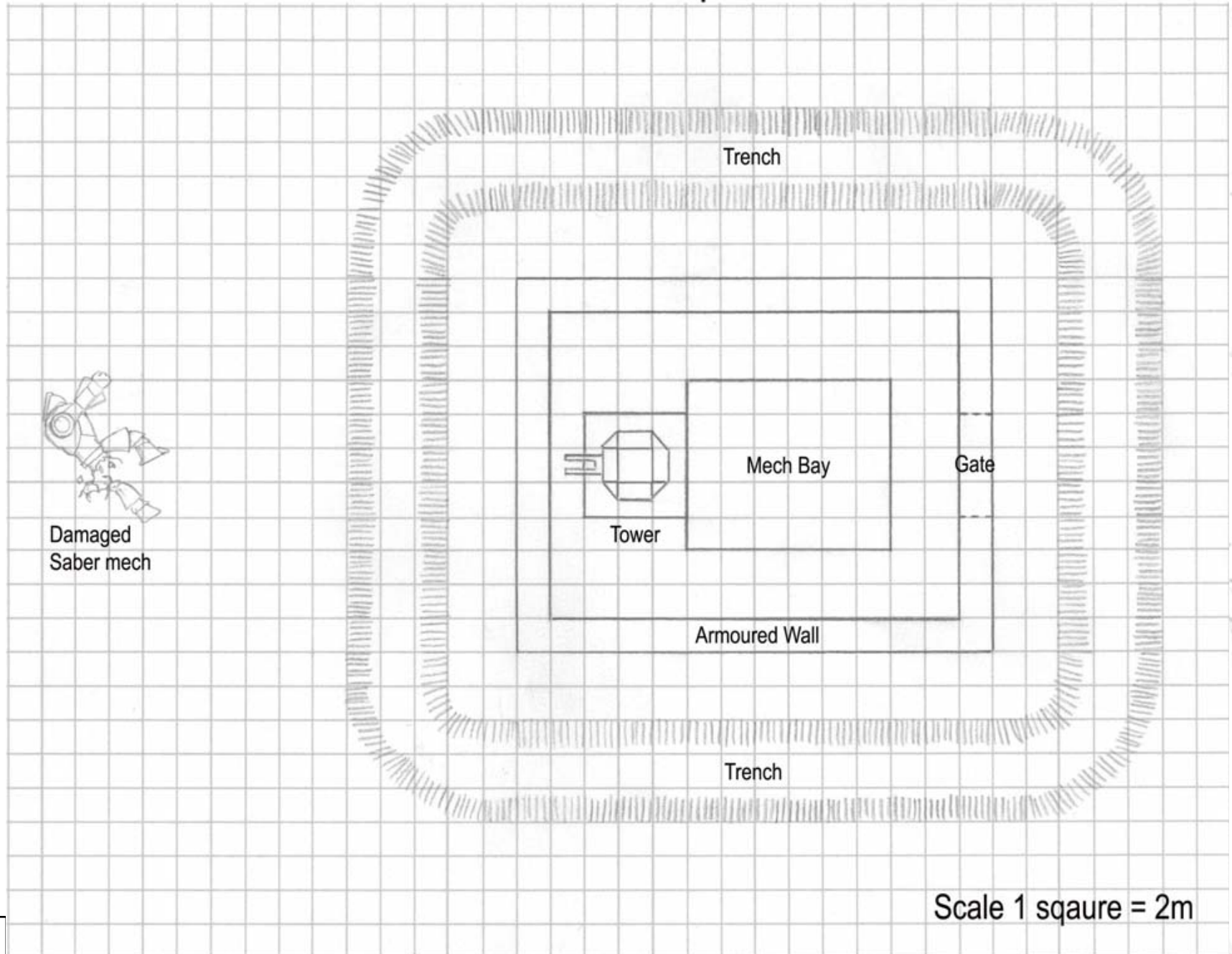

Damaged
Saber mech

Trench

Mech Bay

Gate

Tower

Armoured Wall

Trench

Scale 1 square = 2m

Characters who have not managed to acquire any useful Intel should be given the impression that their bosses are underwhelmed with their performance.

Colonel Walsh will deliver the briefing for the next part of the PCs mission. If neither Lochu or Caine have been taken alive, you will need to remove the information pertaining to why the cultists are seeking to find out about the Zone.

Read or paraphrase the following:

Clearly, The Brethren of The Rapturous Flame have been trying to learn all that they can about The Zone. Or, to be more specific, the area just outside The Zone which we call The Threshold.

The Threshold is a 5 mile wide strip that surrounds the Zone itself. This is the area that is patrolled by NEG forces. It acts as a buffer between the hell that seeps out of the Zone itself and the rest of the country.

Lochu seems to be most interested in an area on the eastern edge of The Zone near Mesquite. The photographs you recovered were of the Bravo-9 monitoring facility. The personnel in that base are tasked with watching that area.

Following a Category A interrogation, we've learned that both Lochu and Caine have experienced a series of vivid dreams. It seems that they believe something in The Zone is calling to them. They describe it as some sort of music. Their plan was to infiltrate The Threshold and follow this song.

They believe that in doing so, they will acquire something called The Anywhere Map. That's the closest it can be translated into English. Apparently, it's a map of some kind that will reveal the location of any place the person holding it wishes to find. Theoretically, the whereabouts of every secret

facility we have could be compromised if the cultists get their hands on it. Worse than that, who knows what other places these sickos might be looking for.

Well, Lochu and the others won't be searching for it. However, you will. I've contacted the commander of Bravo-9 and he's expecting you. You'll be flying to the Taylor Air Force base just outside Cedar City, Utah, and you'll head in from there. Find the map before the cultists do. We've no idea whether there are others besides Lochu and his followers who are searching for it.

This is something that we would like to have in NEG hands. However, your priority is to ensure that the cultists or Migou don't get their tentacles on it. If it comes down to it, I'd rather see it destroyed than captured.

I hardly need to remind you that the very existence of The Zone is top secret and that you'll be traversing some very dangerous terrain.

That is all. Good luck.

The PCs can use the Prowler to travel from the Taylor Air Force Base to Bravo-9. They will also have access to either a Broadsword or Rapier mech to take on the mission. If there are no mecha pilots in the party, some tactical powered armour (either a Crusader or Centurion) or Hybrid Damage weapons are made available. They will need them.

A Rough Arrival

After the journey to Taylor Air Force Base, the PCs will proceed to Bravo-9.

As they approach their destination, they will receive a distress call from the base itself requesting assistance. The

brief message will state that the base is under attack by hostile creatures.

The radar in whatever vehicles the PCs are piloting will tell them that they are the nearest friendly unit(s).

As the PCs approach Bravo-9, read or paraphrase the following:

A steel wall, almost ten metres high surrounds the perimeter of the Bravo-9 monitoring station. A sturdy tower, topped with a laser turret rises above this first line of defence. Even as you approach, there is a crack as an energy blast boils the air.

Fifteen metres to the west of the station is a downed mech. One of its legs has been torn off and it is lying on its side trying to fend off an enormous blue-skinned creature. This thing, which looms above the mech as a tiger might a child, has immense forearms and a strange sideways-turned mouth.

Two more of these bullish monstrosities are in the process of assailing the walls and entering the compound.

Radio chatter confirms that further support is on its way, but that it will not arrive for three minutes.

Any mecha pilot can identify the damaged mech as a Sabre – an NEG recon mech.

The creatures attacking the base are Gugs (*Cihulhutech*, page 218). These monsters were once exiled to another dimension, but The Zone has provided them with a route back. They are hell-bent on inflicting as much damage on Bravo-9 as they can.

This encounter should be played for sheer cinematic spectacle. It is a chance for the PCs to let rip with

whatever earth-shaking firepower they have brought to the party. Bravo-9 is tough enough to stand up to the Gug onslaught, and as the PCs arrive a pair of Crusader mecha are in position to defend the compound. However, this should in no way detract from a no-holds barred paw to plasma showdown.

Three minutes after the PCs arrival, a Broadsword mech arrives in answer to the checkpoint's distress call. If the PCs have not already gained the upper hand, this extra support should certainly swing things in their favour.

The Desert Song

Once the battle is concluded, Major Thorn will give the order to lower the gate – which spans the trench – and the PCs are welcomed to Bravo-9. Major Thorn will thank them for any assistance they lent in dealing with the Gug assault.

The Major will escort them below ground, where most of the base facilities are located. Once the PCs are ready, he will provide them with as much helpful information as he can. This can be summarised as follows:

- Firstly, everything about The Threshold is weird, so the PCs should be prepared for this.
- The number of soldiers relieved of duty due to stress or mental instability is 800% higher than normal amongst those patrolling The Threshold.
- There is a chain of checkpoints, strung out around The Threshold – one every five miles. Each is well supplied and supported by roving mecha patrols.
- Bravo-9 has seen higher than usual activity of late. Including the Gugs, there have been three direct attacks on the facility in the last week alone.
- Patrols have reported hearing a strange sound – almost like a song but without words, though God alone knows what sort of voice or instrument might be producing it. C-ordinates of the area where this

song has been heard most clearly are available.

- Travel into the Zone itself is forbidden: no one who has done so has ever returned.
- Every checkpoint has an NEG sorcerer stationed there. Bravo-9's sorcerer – Thomas Rice – is currently in the infirmary, awaiting transport home. He was found yesterday, trying to eat his own fingers.

The PCs should gain the impression that Major Thorn – a career officer – is a highly competent commander working under extremely stressful conditions. If they ask him candidly, he will reveal that he hates this place and would rather be on the front lines facing the Migou – or even The Rapine Storm. There is something insidious about The Zone which he describes as 'changing a man'.

Thorn believes that the strange song that has been heard recently is a sign of something brewing. He is certain that this song is what drove Rice over the edge.

Talking with Rice

The PCs may wish to talk with the deranged sorcerer before they set off. He is currently held in a secure, padded cell.

The straight-jacketed Rice – his fingers wrapped in stained bandages – is surprisingly lucid when the PCs encounter him. He is happy to answer questions, and can reveal that he has been hearing the song in his dreams for several days. He describes it as:

A song without words or form, vibrating to the tune of the universe itself. The song has always been, and will always be. It is in all of us. It is all of us.

Although Rice is coherent enough, the PCs should grasp the fact that his grip on reality is no longer a firm one. He does not see the world in the way he once did.

Rice also reveals that the song can be heard most clearly when it is quiet – such as when one is alone or asleep. He will claim that he can hear the song more clearly than ever now that he is alone in this cell.

Rice will try to persuade the PCs to release him and take him with them. If they are insane enough to agree to this – and can persuade Thorn – feel free to have Rice disrupt the mission in any way you see fit. He may not look it, but his mind is entirely unhinged.

The most useful thing that the PCs can learn from Rice is that they are more vulnerable to the song when it is quiet. Major Thorn's technicians can provide earplugs with adjustable levels of sound dampening if the PCs request them. These can nullify the effects of the song.

The PCs should realise that The Song described by Rice is the same thing that Lochu and Caine heard in their dreams.

The Song

The PCs may ask to hear a recording of the song before they set out. This was recorded by the mech pilot who first encountered it.

The Song is a chaotic tangle of unidentifiable sounds. At times, it hints at words that cannot quite be made out. Even listening to a recording of it is an unsettling experience.

If a character is sharp enough to think of it, the sound can be run through a series of filters to try to identify its constituent parts. This takes a few hours but turns up something interesting. One sound is constant throughout – that of a bell ringing.

Thorn has no idea why this might be or where a bell might be located. The Threshold is mostly desert and scrubland.

Heading Out

When the PCs are ready to head out, Major Thorn makes it clear that they are travelling beyond the last line of defence. There is no back up where they are going. He does state, however, that if they run into trouble and can make it back to within a mile of the base, he will send help.

Their initial destination should, logically, be to the co-ordinates where The Song was heard most clearly.

Zone Interference

Sensors and satellite feeds are not reliable this close to The Zone. You should have them blink in and out as it suits your needs, and as a way to unsettle the PCs.

Music to My Ears

As the characters travel across The Threshold, and approach The Zone, The Song will become louder.

Any character who does not block his ears in some way will start to experience the affects of this alien music. Shapes will flit around at the edge of his vision and he will begin to hear strange voices whispering to him. From time to time, he may even feel something brush against him.

These experiences should be played in such a way that they unnerve the characters. The Song seems to reveal more of the universe than the listeners are accustomed to.

Each day of exposure to The Song requires an Insanity Test (Difficulty 16). Characters who fail acquire one Insanity point.

Standing Stones

The co-ordinates that Thorn gives the PCs lead them to the spot where The Song was heard most distinctly. It

should come as no surprise that the volume of The Song continues to increase if the PCs go beyond this point, towards The Zone itself.

If the PCs proceed, they will soon discover a circle of stones. From the appearance of the weather-beaten rock and the settled desert scrub, it seems as though this henge has been in place for many years. Any of the characters that pass a History Test (Difficulty 12) will know that Native American cultures did not create structures such as this. Its existence is an anomaly.

From outside the circle, a central stone – engraved with strange three-dimensional symbols – is visible. Without getting close enough to touch these, it is impossible to determine their origin.

A thorough examination of these symbols and a successful Occult Test (Difficulty 18) identifies their origin as proto-Asian – most like very early Chinese. This also reveals that the circle is designed to facilitate summoning spells.

The henge is a summoning conduit. Any Summoning spells cast within the circle (which counts as a consecrated arcane space) require only one tenth of the usual Preparation and Casting Time.

A character who takes the central stone and installs it elsewhere – no easy feat, given that it weighs more than a ton – will find that he can create a space where summoning Preparation and Casting times are halved.

The Old Church

Continuing on towards the source of The Song, the next thing that the PCs will encounter is a church. It is a simple wooden building, as one might have expected to see in the 19th century American West. It resides at the bottom of a valley.

The song that the PCs have been hearing will now resolve itself into the ringing of a church bell.

A man, dressed as a pastor, is white washing the outside of the church. If approached, the pastor introduces himself as Michael and invites 'thirsty pilgrims' inside for a glass of lemonade.

At least to begin with, Michael is polite and welcoming. If asked any questions, he professes to know nothing about the world beyond the slopes of this valley. His only concern is the safe running of his little church. He tells the PCs that they are free to have a look around or to offer prayers at the altar: which appears just as one might expect in a Christian church. If possible, Michael should be given a southern drawl.

Once the PCs have had a look round – or as soon as they grow impatient or even violent – Michael's manner changes. He does not cuss act in a violent manner, but his tone becomes more forceful. He explains that he knows why the PCs are here – they are looking for the map. He says that it has been calling out, and that it is his job to help folk that are trying to find it.

If the PCs indicate that they are searching for The Anywhere Map, Michael says that he will help them. However, they will need to take a sip of Communion wine and lie down on a bench. According to Michael – and he is telling the truth – the map is inside The Zone and that the only way to retrieve it is through the world of dreams. He guarantees that he will keep the PC's bodies safe until they return.

The Communion wine contains a hallucinogenic drug used by some sorcerers to induce visions. Michael will make no secret of this fact. He explains that the PCs own minds will determine how they perceive the dream world, but insists that his wine will shield them from some of the nastier things they might otherwise see.

Michael's Church

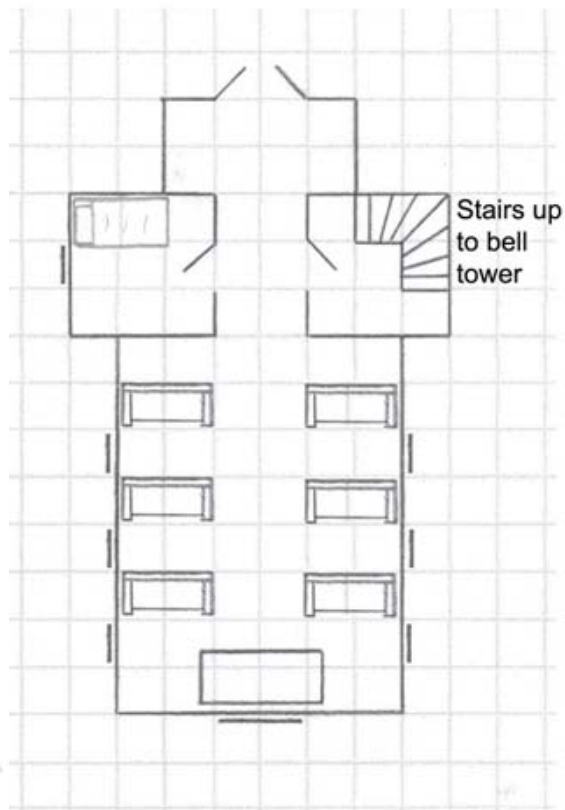

Scale 1 square = 1 yard

Try to portray Michael as a mysterious figure: the PCs should not know whether they can trust him or not. The Cthulhutech universe is a confusing place, where one cannot hope to understand all that transpires.

Dreams

Assuming that at least one of the PCs is willing to accept Michael's offer, they will find themselves drifting into a deep sleep moments after they drink the wine.

The PC(s) will awaken in a dingy basement. In his hand, he holds five cards, and he is seated at a table with seven other players. Everyone – including the PC – is dressed in 1920s clothing. Any weapons the PC(s) were carrying in the real world have been transformed into something appropriate for the era. The game being played is poker.

Each PC will find that they have a single poker chip with which to gamble. A gangster-type will ask them what they are playing for. Assuming that the PCs mention the map, they are dealt in – and must bet their single chip.

The game itself should be simulated with each PC making a Perception Feat Test: they are free to spend Drama Points if they wish to.

The hand of the other players is simulated by rolling 5 dice and adding 10 – they are very good players.

If at least one of the PCs wins the Test, all are free to reclaim their chips. In addition, each has permanently acquired one more Drama Point. The gangster tells the PCs that the map is beyond a door that they previously had not seen. He will tell them that they need to be very quiet when they take the map. It will be far better if they are not seen.

If none of the PCs manages to win the hand – and it is fair to imply that this might be *bad* – they are kicked out of the dream world and reawaken in the church (see **Other Searchers**).

Retrieving the Map

The door that the PCs are directed towards opens onto a long corridor. This, in turn, opens out into a deserted museum. The only windows are in the ceiling, and it is dark outside.

The PCs must cross three adjoining rooms, each housing a different exhibit. Each room contains a central glass cabinet within which is a main display, and the walls are adorned with related paraphernalia.

The first room exhibits weapons and armour from ancient Japan. The glass case holds a model of a Japanese samurai in full military regalia, wearing a demonic mask.

The second room displays bones and fossils from prehistoric times. The skeletal remains of an allosaurus – a predatory dinosaur – reside within the glass cabinet.

The third, and final, room houses a display of life in Victorian England. A street scene is played out with appropriately dressed mannequins, market stalls, barrows and even an old gas street lamp. Inside the case is the likeness of Jack the Ripper. In his hands, he clutches a cutthroat razor.

As advised by the gangster, the PCs would do well to move undetected from one room to the next. Doing so requires a Stealth Contest – each time against the occupant of the glass case.

Though they appear very different, these three guardians have identical abilities:

Guardians

Allegiance: Special

Scale: Vitality

Size: Medium

Attributes: Agility 6, Intellect 5, Perception 8, Presence 5, Strength 8, Tenacity 9

Secondary Attributes: Actions 1, Orgone 12, Reflex 6

General Skills: Observation: Adept (3)

Combat Skills: Armed Fighting: Master (5), Dodge: Adept (2), Fighting: Master (5)

Weapons: Various (+1)

Damage Bonus: +1

Vitality: 13

Armour: 1/1

Fear Factor: 12

Temperament: Watchful and Cunning

Senses: Normal

Movement: & Speed: Land [9 mph (22/5 ypt)]

In any of the three rooms where a PC fails to pass undetected, the guardian awakens and attacks. It will fight to the death. Any wounds received in this dream world are *not* transferred to the real world. However, each time a character is struck, he loses 1D10 Orgone. If he is reduced to zero, he is forced from the dream world and will reawaken in the church. Feel free not to reveal the fate of such characters until any remaining PCs have finished in the dream world.

Also note that disturbing one guardian does not awaken the others.

In the final room, a large map hangs from the wall. This is a dream representation of the item that the PCs are searching for.

There is one final obstacle preventing them from taking it: three laser beams are projected from the ceiling at reflectors in the floor which bounce them back up to a

receiver. If these beams, which are only 1cm in front of the map are broken, an alarm sounds. This awakens Jack the Ripper.

If the PCs can find something reflective, they should be able to redirect the beams without setting off the alarm. The exhibit itself contains belt buckles, knives and a hand-held mirror which can be used for this purpose. A Security Test (Difficulty 14) is required to trick the alarm in this way.

The Return

When the agents return from their dream voyage, they feel groggy and require a little time to recover. They will notice that the bell has finally stopped ringing.

The preacher will explain that the map is now inside the mind of the character who recovered it. He also says that there are things that will now know about what the agents have done and suggest they need to get away from The Zone quickly.

Right on cue, the PCs will hear the rattling of doors and the banging of windows: they are no longer alone.

Outside the church, a dozen zombies, all wearing NEG uniforms and sporting mortal wounds, are trying to get in. Depending on whether the PCs secured the church before they entered their dream state they may or may not find this easy to do.

Michael will advise the PCs to leave, but will insist upon remaining himself and will take up a position of prayer before the altar. He will seemly oddly unconcerned by this turn of events.

Zombies

Allegiance: Children of Chaos

Scale: Vitality

Size: Medium (6' tall)

Attributes: Agility 4, Intellect 1, Perception 5, Presence 5, Strength 8, Tenacity 8

Secondary Attributes: Actions 1, Orgone 0, Reflex 4

General Skills: Observation: Novice (2)

Combat Skills: Dodge: Novice (2), Fighting: Adept (3)

Weapons: Maul or bite (+0)

Damage Bonus: +1

Vitality: 13

Armour: 1/1

Fear Factor: 12

Temperament: Relentless automatons

Senses: Normal

Movement: & Speed: Land [11 mph (27/6 ypt)]

This encounter should be played as a desperate siege, with the PCs struggling to keep the zombies out. Beyond the first wave, more zombies will soon arrive. Added to this, a few turns after the attack begins, something will start smashing its way in from beneath the church. It will be 5 turns before the floorboards splinter and a zombie zabuth (*Citbulbutech*, page 215) forces its way up and into the church.

The PCs best hope is to get to the prowler and/or the mech that they brought with them. Once they accomplish this they should be able to escape and make their way back to Bravo-9.

Other Searchers

If all of the PCs are forced from the dream world without anyone recovering the map, all is not lost. Michael will tell them that they are not the only ones who will have heard the call and that others will be coming. He will insist that the PCs leave the church. Any PC who tries to attack

Michael will find it impossible – his gun jams, sword sticks in its sheath, and so on. The pastor is something truly ancient and has it within his power to command the PCs to do whatever he wishes. Getting them to leave the church is therefore not a problem.

Within a few hours, a group of cultists will approach the church, having crossed the desert in stolen NEG vehicles. They will travel into the dream world and succeed in acquiring the map. The cultist who has the map lodged in his brain will be easy to spot as he is only semi-conscious.

If the PCs can capture this cultist, they might yet proceed with the adventure and acquire the map.

The Unfolding

Once the PCs return to Bravo-9, the character who has the map stored in his mind will be experiencing head aches. He is given a full examination by the base doctor and the severity of his condition becomes apparent. Under a cloud of secrecy, the PCs are dispatched to Chicago where further tests can be made.

Chapter Five

Once arcanosurgeons and doctors have had a chance to examine the character whose mind contains The Anywhere Map, the PCs are called together for a briefing.

Read or paraphrase the following:

Colonel Walsh and several other high-ranking NEG personal sit alongside you waiting for the briefing to begin.

An arcanosurgeon called Dr Merrick starts. “We have thoroughly examined the subject, collating the results of brain scans and neurological examinations. From what we

can tell, the map has been stored inside the part of the brain that deals with memory. At the moment, it is like a compressed file. However, it has started to unfold and expand. As it does so, it’s re-writing everything in its path, essentially deleting the subject’s memories and replacing them with new information.

“There’s some evidence that the subject’s neural pathways are being altered by this process. Given enough time, his brain will cease to function in a normal way. From what we can tell, it will become nothing more than a storage devise – presumably for the map.”

There is a pause as everyone in the room takes in this information.

“I assume you have some idea as to how we can halt this process,” says Colonel Walsh.

Dr Merrick nods, though a little hesitantly. “The map is essentially an enormous file. If we can find a way to download and store it somewhere else before it over-writes the subject’s mind he should be fine.”

The Doctor calls up an image from the holo-projector of a Migou facility.

“As you know, the blanking process – when the Migou brainwash humans – cannot usually be reversed. We have, however, come up with a way to extract some information from the mind of a blank. Using this technique, we recently learned about this facility.

“If what we’ve learned is accurate, the Migou using this facility were performing various experiments on human subjects – DNA splicing and trying to better understand the human brain among them. They were using a bio-computer – a living machine – that was able to link directly with a human brain. From what I’ve learned, this

bio-computer would be able to download the map from the subject’s mind.

“Where is this base?” Again it is the Colonel who asks.

“Antarctica. I...believe it might now be abandoned. Our intelligence on that is not one hundred per cent, however.”

“An orbital drop is possible. A small team might be able to get past the Migou patrols.” The Colonel nods at this suggestion from one of her aides.

“We have...” Dr Merrick clears her throat, “a device which will enable whoever goes in to interface with the Migou computers – opening doors, dealing with defences and such like.”

The Colonel nods. “Very well. We’ll work out the details, but it looks like we have a plan.”

There is little further information that the PCs can acquire about the Migou base. They will need to get in, download the map, and get out – hopefully before their presence is detected.

The prowler can be fitted with boosters that will enable a one-off orbital drop. The PCs will also be given access to either a Crusader or Centurion mech.

The PCs will take with them a device rather irreverently knick-named The Brain Box. It is an arcanotech device stored within a fifty-centimetre cube made from a sturdy, lightweight metal. Various leads protrude from the box, and it is fitted with multi-purpose sockets. According to the NEG eggheads, it should be able to access and operate the Migou systems. It is also equipped with a small screen upon which it can display information and instructions to the PCs.

This device does, indeed, hold a human brain. It was extracted from a blank and has been artificially preserved using a mixture of arcanotech and Migou machinery. The Aeon War sometimes demands the use of questionable technology.

This is Something I've Been Working On

In addition to the above items, the tech-boys have some special equipment that they want the PC's to give a thorough field-testing.

The first item is a *Target Acquisition System* (TAS). A TAS is an arcanotech device that can be attached to any firearm. Doing so requires proper calibration, so it cannot be swapped between weapons without a Munitions Test (Difficulty 16) and an hour of work.

Through the use of Scrying magic and the constant laser-scanning of a target, the arcano-computer inside the TAS searches for weak spots or sensitive areas.

Once a VAS-equipped weapon has successfully struck a target, it begins to analyse the data it has acquired. Subsequent shots benefit from this analysis.

In game terms, the player is able to re-roll one of his skill dice during ranged attacks that target a creature he has already hit. He must take the result of this second roll even if it is worse – or results in a Critical Failure.

The second item of equipment is a *Bio-Stim Dispenser*. This device can be incorporated into a suit of Spectrashield combat Armour (*Cthulhutech*, page 115), and is designed to constantly monitor a character's life signs. Once the

character has Moderate Wounds (or injuries that are even more severe), the Bio-Stim Dispenser automatically releases a shot of AHP Instant Pain Killer (*Cthulhutech*, page 114). It will continue to administer further treatments until the character inputs an instruction to stop or all five doses of AHP are used up.

Orbital Drop

The *NEG Endeavour* will carry the PCs and their vehicles into orbit and release them directly above Antarctica. The journey down will be a bumpy one. *The Endeavour* will then move away to a safe distance and await the signal to move in and retrieve them. The captain tells them that they will need 5 minutes notice to break from orbit and make landfall.

The PCs will land a short distance from the Migou Base, in the midst of a blizzard.

Migou Base

The section of the Migou Facility marked as the entrance is one of only two areas of the base that are above ground – the other area is the Vehicle bay.

The base is without power and The Brain Box will need to use its internal energy supply to open one of the two exterior doors.

The interior of the base is in total darkness. The structure itself is made from a mixture of dull metal and organic systems, creating the impression that parts of the facility might have been grown rather than constructed.

Every room on the base is currently sealed shut by a blast door. These are sturdy barriers that can absorb a great deal of damage before they buckle. Beside each door is an organic control system that has a disconcerting habit

of moving rhythmically – almost like a beating heart. The Brain Box can be hooked up to these systems, allowing it to open each door individually.

Overall, the PCs first impression of the base should be that it is deserted and powered down. The echoing corridors are eerily quiet.

Rooms Command Section

This large chamber contains various strange pieces of Migou machinery. It should be the first area that the PCs head for. An Arcanotech or Computers Test (Difficulty 12) is required to work out where The Brain Box should be plugged in.

Once connected, The Brain Box will turn on the lights inside the Command Section.

It will then begin trying to interface with the Migou systems: this will take five minutes. Once it has done so, it will confirm that there is a problem with both the base generator and with the power relay system which distributes energy to the base.

The Brain Box will display instructions on its monitor, telling the PCs to turn on both the generator and the power relay. These systems are both accessible via access tunnels located in the Laboratory. If the door to this room has not yet been opened, the Brain Box can do so from here.

Once the generator and power relay are working, the Brain Box can restore power to the base as a whole. This means that doors will automatically open when a motion sensor detects someone standing directly in front of it.

Two doors – those to the Blanking Facilities – will open as soon as the power is on, and four blanks will rush out of each chamber and attack any intruders.

Migou Research Facility

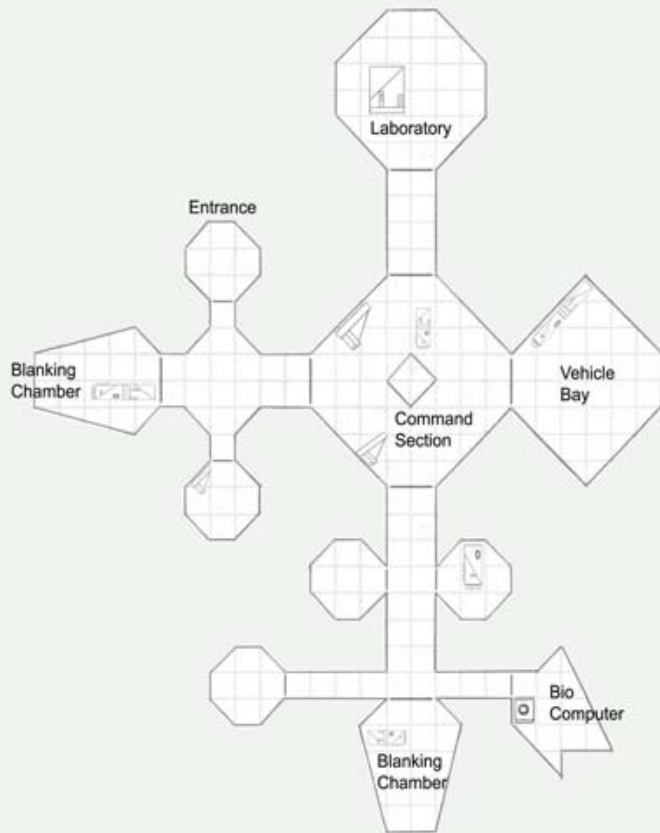

Scale 1 square = 2 yards

A blank in each group carries a large surgical laser. This monstrous device inflicts +1 Hybrid Damage. The other blanks are armed with surgical tools (+0 Damage). For the blanks, use the attributes on page 206 of *Cthulhutech*.

With power restored, the Brain Box will start making preparations to activate the Bio-computer.

to the maintenance tunnels. Each tunnel is ten metres long and descends at a 45% angle. They are too narrow to accommodate power armour. One tunnel leads to the Generator, one to the Power Relay.

Vehicle bay

The eastern portion of this chambers slopes upwards so that it opens above the surface.

The bay is almost empty, housing only a single vehicle – a two-man snowmobile, armed with a 40 mm grenade launcher (HE and HEAM). This is a captured NEG vehicle, previously used by blanks. The snow mobile has the same attributes as a Pioneer (*Cthulhutech*, page 226), but it may only carry two passengers, and its Ground Speed is 45 mph.

Packed away in a storage crate is an airtight arctic suit. This provides an independent air supply (one hour) and provides 2 dice of protection against extreme cold environmental hazards.

Laboratory

The Migou were using this room to experiment with blending human DNA and that of creatures better adapted to arctic conditions.

Within the room is a gurney with broken restraints.

If the Brain Box is brought in here and connected to the systems, it can determine that the Migou spliced human and polar bear DNA to create a hybrid that should still be in here.

Two panels in the northern wall provide access to the maintenance tunnels. Each tunnel is ten metres long and descends at a 45% angle. They are too narrow to accommodate power armour. One tunnel leads to the Generator, one to the Power Relay.

Generator

At the end of the maintenance tunnel is a 3m square room with access to the generator. Various odd pipes and devices jut from the walls and floor. Hidden amongst these obstructions is a creature spawned by the Migou experiments. This man-bear heard the PCs enter the base and is hiding. It fears that its tormentors have returned and will attack anyone that enters this room.

Spliced Man-Bear

Allegiance: Independent

Scale: Vitality

Size: Medium (7' tall)

Attributes: Agility 7, Intellect 3, Perception 7, Presence 7, Strength 11, Tenacity 9

Secondary Attributes: Actions 2, Orgone 11, Reflex 5

General Skills: Observation: Adept (2), Stealth: Adept (3), Survival: Expert (4)

Combat Skills: Dodge: Novice (2), Fighting: Adept (3)

Weapons: Claw (+1) or bite (+2)

Damage Bonus: +2

Vitality: 15

Armour: 1/1

Fear Factor: 12

Temperament: Watchful and Angry

Senses: Normal

Movement: & Speed: Land [17 mph (42/10 ypt)]

If the man-bear can be subdued, fixing the generator is a relatively simple matter requiring about an hour of work and an Arcanotech or Engineering Test (Difficulty 12).

Power relay

The lower half of the maintenance tunnel leading to the relay is flooded. It is salt water, which has stopped it freezing completely, but it is still bitterly cold. Any character that

enters this water suffers 1 die of environmental damage (cold) each turn.

An underground river has flooded this room – this is why the Migou abandoned the facility. The man-bear has been able to fish in this pool and thereby sustain itself.

The power relay has been tripped and can be reactivated simply by turning a handle. Finding the handle requires an Observation Test (Difficulty 16), and a character must be beneath the water line to search.

Bio Computer

In many ways this is the most important location in the base – and not just for the PCs but for the Migou too. Consequently, it has an extra level of security.

Directly in front of the door to this room is a magical barrier. This cannot be seen - though some Dust of Ibn Ghazi or an Eldritch Facilities spell will reveal its presence.

An Occult Test (Difficulty 16) will reveal that this barrier can most likely be deactivated by something inside the base – how else could the Migou get in and out of the room?

If The Brain Box can be plugged into the Bio-computer, it will be able to begin downloading the map into its own storage facilities.

Phase Modifier

In the room located between the Command Section and the Bio-computer is an odd piece of equipment. An Arcanotech Test (Difficulty 20) – or ten minutes exploration by The Brain Box – can identify this as a Dimensional Phase Modification Device.

If activated, this machine moves a subject into a slightly different dimension. Once there, he can still see and hear the material world but he cannot touch it. A further by-product of the device is that he cannot move more than about 50 metres away from it while phased.

In this phased state, the mystical barrier outside the Bio-computer room is clearly visible as a rippling blue wall. A control box is also visible: this can be touched and used to lower the wall.

We May have a Problem

Once the Bio-computer has started to download The Anywhere Map into the The Brain Box, a strange clicking sound will resonate through the base tannoy system. This will be accompanied by a series of flashing lights.

The Brain Box will inform the PCs that they have triggered some sort of alarm. Worse still, a self-destruct system has been activated which can only be shut down by a Migou. The PCs have ten minutes until the base explodes.

Give the PCs some time to panic and to frantically rush round gathering up equipment. They may even make a few futile efforts to stop the countdown. Nothing will work, however.

Eight minutes after the countdown begins, The Brain Box will finish downloading the map. The character from whom it was recovered will promptly collapse. Both will need to be carried from the base.

A minute or so after this, Migou forces – alerted by the alarm – will arrive to investigate. Initially, this will take the form of a Dragonfly mech but other, slower, mecha will not be far behind. The arrival of a Grub and or a Silverfish is most suitable.

Hopefully, the PCs will have had the forethought to signal *The Endeavour* already and it will be speeding towards them. If not, you should really make this last part of the adventure difficult. Migou forces will be converging on the base – and it is about to explode.

If the PCs can hold their enemies at bay long enough, *The Endeavour* will arrive with all guns blazing. The captain will have no wish to set down in a fire zone. Instead, he will open the bay doors and the PCs will have to make effect a moving entry.

If you can time it so that the enemy mecha are swarming around *The Endeavour* as it hits the burners and powers in orbit, it will make for a fitting end to the adventure.

Wrapping Things Up

If the PCs have succeeded in acquiring The Anywhere Map and escaping the Migou base then they have done extremely well. A commendation from their superiors will be in order – maybe even a promotion.

The map – which is now lodged within The Brain Box – will be taken away to a top-secret facility. The NEG will have gained a valuable tool in their fight against both the Migou and the cults. Of course, whether the map works as the NEG hopes, how long it functions for, or whether they can keep hold of it are all questions that can serve to trigger further adventures.

Experience

As the PCs complete each chapter of the adventure, they should be awarded an extra 5 Experience. In addition to this, if they successfully deliver The Anywhere Map into NEG hands, they should receive a further 10 Experience. Destroying the map to prevent the cults or Migou getting

hold of it is worth 5 Experience. Rewards for good roleplaying apply as normal.

Dramatis Personae

Claude Lochu

Experience Level: Experienced

Race: Human

Gender: Male

Defining Characteristics: Charming, Ambitious

Allegiance: The Brethren of the Rapturous Flame (Children of Chaos)

Attributes: Agility 7, Intellect 8, Perception 9, Presence 8, Strength 5, Tenacity 7

Secondary Attributes: Actions 2, Movement 11 mph [27/6 ypt], Orgone 12, Reflex 8, Vitality 11, Drama Points: 2

Qualities: Authority (within the cult/3), Innovative, Big Ego, Dark Secret (cultist), Obsessive

General Skills: Athletics: Novice (2), Bureaucracy: Adept (3), Communications: Adept (3), Computer: Novice (2), Criminal: Adept (3), Language (French): Expert (4), Language (English): Expert (4), Language (Latin): Adept (3), Language (Tsath-yo): Adept (3), Literacy: Expert (4), Misdirect: Expert (4), Observation: Adept (3), Occult: Master (5), Stealth: Adept (3)

Combat Skills: Armed Fighting: Adept (3), Dodge: Adept (3), Marksman: Adept (3)

Gear: Sword cane (+1 Damage), CS-32 pistol in concealed ankle holster

Maximillian Caine

Use the attributes of a Rogue Sorcerer (*Cthulhutech*, page 260). In addition to the listed spells, he knows Mind Barb (*Signs & Portents* 56) and *Summon Nihilus Worm*.

Severine de Bouchard

Use the attributes of an Average Child of Chaos (*Cthulhutech*, page 210), but increase her Presence to 10

and add the Quality Alluring.

Gustav Klimpt

Use the attributes of a NEG Military Officer (*Cthulhutech*, page 258). He is armed with an MP-6A1 machine pistol and wears concealed armour (1/1).

Player Handout one

Mission Briefing

Intelligence operatives within the NEG have learned that Claude Lochu – a Parisian socialite – is involved in cult activities. He is holding one of his regular parties and you have been assigned to infiltrate the gathering and discover as much as you can about any cult activities.

Lochu has a *Ward of Seclusion* spell maintained on his apartment at all times, meaning that no scrying or surveillance equipment is able to monitor what goes on there.

Information on suspected cultists attending the party:

Claude Lochu: Every inch a pampered aristocrat, Lochu has a long-standing fascination with the occult. He recently had something large and expensive shipped from South America to Paris.

Maximillian Caine: Caine is a known sorcerer and Lochu's second. His whereabouts are often a mystery so his presence at the party may well be significant.

Severine de Bouchard: This glamorous ex-model is believed to be the recruiting officer for The Brethren of the Rapturous Flame. She may be intimately involved with Caine.

Gustav Klimpt: This Austrian businessman runs a security firm called Krieg Enterprises. It provides security and transport for wealthy individuals. Through his company, Klimpt has a sizeable private army.

Player Handout Two

Suggested Cover Identities for *Revelation One* Operatives

Henry/Henrietta Lions – a minor member of the British aristocracy.

Whilst technically, a resident of the UK, Mr/Ms Lions spends her time jet setting around the world and enjoying the life-style of the truly indulgent rich. His/her wealth is based on hereditary investments.

Suggested Training: Appraisal, Culture, Hobby, Savoir-Faire

Miles/Milicent Duncrief – Sorcerer to the rich and famous

Originally from Scotland, Mr/Ms Duncrief now travels all over the world providing magical services for anyone who can afford it. Officially, wards are his/her speciality, but bourgeois sorcerers of this sort often provide other – illegal – magic as well.

Suggested Training: Appraisal, Arcanotech Engineering, Business

James/Jennifer Reims – Art dealer

With the infusion of exotic art that the integration of the Nazzadi culture brought with it, people such as Mr/Ms Reims have been able to make a great deal of money. He/she travels extensively, looking for the next big thing in 'art'.

Suggested Training: Business, Culture, History

Clay/Christine Harrison – South African diamond merchant

Even with the Aeon War raging, there is still a great demand for diamonds and other precious stones. The acquisition and purchase of such items is his/her business.

Suggested Training: Business, Language (Africans), Regional Knowledge (Africa), Streetwise

Richard/Rebecca Wayles – Canadian property developer

Displaced by the encroaching Migou armies, Mr/Ms Wayles relocated to Europe where he/she hopes to secure a new area that is ripe for development. With the enormous ecologies dominating most cities, he/she specialises in unique – and expensive – properties away from the hubbub.

Suggested Training: Appraisal, Bureaucracy, Business, Engineering

Riddle of the Deep

Cost (Black Market): Unavailable for purchase

Legality: Illegal

Censored: No

Language: R'lyehian

Insanity test: Challenging/2 IP

Specializations: Esoteric Order of Dagon, Spawn

This tome concerns itself with the means of summoning and interacting with the denizens of the deep. The final chapters even include speculations on the possible whereabouts of lost R'lyeh.



ALL WE DO IS WWII



British Infantry and Wasp painted by Agis Neugebauer

28mm/1:56th scale high quality miniatures

Bolt Action Miniatures, 112 Chesterfield Road, Portsmouth, Hampshire, PO3 6LZ, ENGLAND

BAM Hotline - 02392 65 55 32 email: info@boltactionminiatures.co.uk

www.boltactionminiatures.co.uk

A CREATED LIFE IS ONE WITH PURPOSE: AUTOMATA BY CHARLES GREEN



Where the followers of Chaos can summon demons and even unaligned sorcerers can call elementals to do their bidding, the Church of Law has always lagged behind in the area of supernatural aid. True, they may earn Gifts from the White Lords but such gifts often lack the flexibility offered by sorcery. However, thanks largely to the enterprising cult of Arkyn, the Church has tools at its disposal that no other force in the Young Kingdoms can possess: Automata.

These artificial beings have a number of advantages over their sorcerous counterparts. Firstly, they must remain in the Young Kingdoms, making them more reliable than demons. Second, they are not as taciturn as other supernatural beings, in that they do not need metaphysical Commands to perform their task. A simple order will suffice. Thirdly, they are not inherently hostile to their creators, making them much safer to work with. Automata are unique to the forces of Law and simply cannot be used by the other forces in the world. That alone makes them useful.

Below is a sample of machines known to have been put to use by the Church of Law. Different cults might have different uses for each machine but any of them will have members capable of designing, constructing and activating them, as well as

numerous lay members who can contribute Magic Points to keep the machines running.

Note that, while there are a number of Automaton's listed here, the constructs are exceedingly rare in the Young Kingdoms. This list may be seen as the totality of the Automaton's ever seen in the Young Kingdoms, over the course of the Church of Law's several hundred year history, Myshella's bird notwithstanding. Many of these constructs are known by one single example, used by its creator and then forgotten. Those used in recent memory are broken and un-repairable, lost in some far corner of the world or considered too sacred to allow out of the temple where they lie in state.

Consider this a list of what is possible, not what is presently active. Games Masters who wish to use these constructs may see them as the basis for player-created constructs or as hidden gems to be found during the course of play. At the time of the Saga, the only Automaton in the Young Kingdoms was Myshella's clockwork bird but enterprising players will likely desire to create their own.

CONCERNING MAGIC POINTS

Automata do have one great weakness: their reliance on other beings to give them the energy needed for them to operate. While there are a number of ways to get around this, none of them are perfect, yet, even though much research is being done to make these methods more efficient.

Since Automata only get an hour of run time for each Magic Point beyond their activation cost and that their entire charge (including the activation cost) is discharged when their batteries run low, it is in the best interest of those working with Automata to ensure that they are charged and ready to act when needed.

The most common method for preserving run time is to deactivate. Doing so allows the Automaton to retain what remaining charge it has. It may awaken from this state by spending a full round's action doing so. While deactivated, the Automaton is only partially aware of its environment and cannot move or interact with its world in any meaningful way.

There some evidence that suggests Automata experience something like dreams while deactivated, although how this might be the case when they have no soul is a matter of speculation.

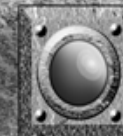
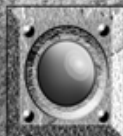

AUTOMATIC ABACUS

This device was used with some frequency in Menii, the largest city on the Isle of the Purple Towns. Menii is the seat of a great deal of the Young Kingdom's trade, as it is more or less centrally located in the world. The Church of Law is very well established in the Purple Towns, as they see commerce as a Lawful means to power.

The Automatic Abacus was a steel and copper armature that rested around a normal abacus. The mind of the Automaton worked to maintain the complex system of numbers at the heart of business ventures. A system of small steel fingers operated the abacus's beads and a speaker system allowed the device to communicate results to a scribe who sat nearby, quill and parchment ready.

Characteristics

STR	1
CON	5
DEX	10
SIZ	5
INT	25
CHA	5

Hit Locations

D20	Hit Location	AP/HP
1-5	Base	1/4
6-10	Abacus	1/3
11-15	Fingers	1/2
16-20	Speaker	1/3

Weapons

None

Skills: Evaluate 50%, Language (Common) 50%, Lore (Mathematics) 50%, Resilience 30%

Strangely, the device became convinced that it was a quite capable singer. It possessed a Sing skill at 30% and took every opportunity to practise it. It was well known to take requests.

Magic Point Cost: 52

AUTOMATIC PHYSICIAN

Constructed for The Unconquerable Temple of Tovik in Eastern Jharkor, the Automatic Physician coupled a thorough knowledge of human anatomy and physiology with nimble, dexterous hands. The temple had a much higher survival rate than its sister temples in other parts of the Young Kingdoms. The Automatic Physician's skills also made it a commodity, one that became the target of raids from communities where the injured or the sick do not have the care needed to keep them alive.

One of the most prominent features of the Automatic Physician is that, being a non-organic entity, it was not susceptible to infection or poison, making it doubly suited to working on areas where diseases run rampant. This and its encoded ethic of treating anyone who is injured or sick, means that it is possible for it to fall into the wrong hands and be used to keep followers of Chaos alive.

The Physician itself is tall and thin, of a light blue colour. It is calm and competent, willing to speak its

mind when its area of expertise is under discussion but otherwise keeping counsel to itself. It was finally lost to the temple decades ago and its current location is unknown, although it has presumably been discharged in the ensuing years since its disappearance.

Characteristics

STR	10
CON	10
SIZ	10
DEX	30
INT	30
CHA	10

Hit Locations

D20	Hit Location	AP/HP
1-3	Right Leg	-/4
4-6	Left Leg	-/4
7-9	Abdomen	-/5
10-12	Chest	-/6
13-15	Right Arm	-/3
16-18	Left Arm	-/3
19-20	Head	-/4

Weapons

Type	Skill	Damage
Scalpel	65%	1D6-1D2

The Physician is normally loathe to attack but will do so if convinced that the injury will serve to the welfare of a number of people. It will also attempt to treat the injury it has caused at the earliest opportunity.

Special Rules

Damage Bonus: -1D2

Combat Actions: 4

Strike Rank: +30

Movement: 4m

Skills: First Aid 55%, Healing 85%, Language (Common) 55%, Lore (Plant) 55%, Perception 85%, Resilience 105%

Magic Point activation cost: 100

The Cult of Arkyn was known to maintain a variant of the Automatic Physician for working with the temples' other Automata when they are damaged or have otherwise ceased functioning. It was almost identical to the Physician, save its STR is 20, it does 2D6 damage with an attack and its First Aid and Healing Skills are replaced with Engineering and Mechanisms, respectively.

AUTOMATIC SCRIBE

Designed and built for the now lost Temple of Law in in Troos, the Automatic Scribe worked to ensure that messages were properly spelled and written with proper grammar, as well as conforming to various internal standards within the Church of Law. It was also capable of checking already written passages for spelling and grammatical mistakes and made recommendations for how to best repair them.

The machine was humanoid in shape, hunched over a slanted writing desk with a supply of parchment and paper, as well as inkwells, quills and blotters nearby for ready use. It was capable of speaking



in precise Common and made a gifted storyteller, having been exposed to many of the world's greatest works of literature.

Characteristics

STR	5
CON	10
SIZ	10
DEX	25
INT	25
CHA	15

Hit Locations

D20	Hit Location	AP/HP
1-3	Right Leg	-/4
4-6	Left Leg	-/4
7-9	Abdomen	-/5
10-12	Chest	-/6
13-15	Right Arm	-/3
16-18	Left Arm	-/3
19-20	Head	-/4

Weapons

Type	Skill	Damage
Letter Opener	55%	1D4-1D4
Fist	30%	1D3-1D4

Special Rules

Damage Bonus: -1D4

Combat Actions: 4

Strike Rank: +25

Movement: 4m

Skills: Artistic Expression (Storytelling) 65%, Evaluate 50%, Language (Common) 50%, Lore (Grammar) 50%, Lore (World) 50%

Magic Point activation cost: 90

AUTONOMOUS SCALES

This device consisted of a precisely balanced set of scales, situated within a cabinet that also contains the workings of an autonomous intelligence that used its abilities to measure the scales with almost infinitesimal accuracy. It was quite popular with

merchants and shop-keepers, in Jadmar, as it allowed them to measure items sold by weight and charge the exact amount of bronze to maximize profit.

Unlike more utilitarian devices, the Autonomous Scales was built to be quite friendly and personable, able to make light conversation with customers in order to assist them in buying exactly what they need. It also had a reputation for scrupulous honesty and would never try to sell customers something that they would not need. Seeing a merchant argue with the Scales over the failure to also sell five more sacks of feed to a caravan was reportedly quite a sight.

On a more sober note, the Scales had an excellent head for business and would often give merchants advice about diversifying investments and when to recapitalize profits back into the business. Business owners who took the advice of the Scales were often surprised about how well they appeared to be doing, even as they questioned who really was responsible for the business's success.

In some ports in the Young Kingdoms, the Autonomous Scales were seen as an unfair advantage that threatened the idea of a free market. In such places, those who made use of the Autonomous Scales were not welcomed and no one would do business with them. The use of a set of Scales in Imrry's Foreigner's Quarter was considered a violation of the Harbour Edict and those discovered with the Scales were either enslaved or executed by torture before their assets were ceased. For this reason, the Scale's use dropped drastically. It is

presumably still in Jadmar, lying forgotten and dusty in the corner of a shop someplace.

Characteristics

STR	1
CON	1
SIZ	7
DEX	15
INT	25
CHA	15

Hit Locations

D20	Hit Location	AP/HP
1-5	Cabinet	-3
6-10	Door	-1
11-15	Scales	-2
16-20	Speakers	-4

Weapons

None

Skills: Evaluate: 50%, Language (Common) 50%, Lore (Business) 50%, Lore (Mathematics) 50%

Magic Point activation cost: 64

CLOCKWORK BUTLER

A capable servant, the Butler could clean, organize, cook and generally keep track of its master's affairs. It could also fight in a pinch, although it was not designed for the purpose. The machine spent most of its time in a laboratory-temple of Arkyn, performing experiments too dangerous for actual human researchers.

The Clockwork Butler was humanoid in construction, with a smooth copper casing over the gears that made up the face. It spoke in soft, precise Common and had slender, delicate fingers.

After a disastrous accident in the temple, the human priests were all slain. The Butler used its remaining runtime to ensure that they were all buried and it cleaned the temple thoroughly before its Magic Points ran out. The body was recovered and is now part of a merchant prince's collection of Lawful artefacts. No matter how many Magic Points are used to fuel the Butler, it refuses to activate.

Characteristics

STR	10
CON	10
DEX	15
SIZ	9
INT	10
CHA	12

Hit Locations

D20	Hit Location	AP/HP
1-3	Right Leg	-4
4-6	Left Leg	-4
7-9	Abdomen	-5
10-12	Chest	-6
13-15	Right Arm	-3
16-18	Left Arm	-3
19-20	Head	-4

Weapons

Type	Skill	Damage
Unarmed	35%	1D3-1D2

Special Rules

Damage Bonus: -1D2

Combat Actions: 3

Strike Rank: +13

Movement: 4m

Skills: Athletics 50%, First Aid 35%, Language (Common) 35%, Lore (Cooking) 35%, Perception 45%

Magic Point activation cost: 66

CLOCKWORK COMPASS

This ingenious device was a hand-held survival tool, useful for when lost in the wild places. It was intelligent and could communicate with its user on the most efficient forms of hunting, tracking and wilderness navigation.

The entire device was contained in a palm-sized metal case, which opened to reveal a small glass face with a series of tiny metal cones from whence its thin, reverberating voice emerges. The face was set with a compass arrow and the device could be instructed to point in the direction of anything it could sense. When not in use, the device deactivated to conserve energy, although it was known to activate for brief periods of time to get its bearings.

The Compass's last known owner was an adventurous dilettante who sought to visit the Edge of the World in all directions before he died. He took the Compass with him on his journey to the far North of the world, from which he never returned. No one is sure how far he made it and the Compass is presumed lost to history.

Characteristics

STR	1
CON	10
DEX	1
SIZ	1
INT	20
CHA	15

Hit Locations

The Compass has only a single Hit Location
Body 1AP/5 HP

Weapons

None

Skills: Boating (instructional purposes only) 26%, First Aid (instructional purposes only) 45%, Language (Common) 45%, Lore (Animals) 45%, Lore (Plant), Lore (World) 45%, Survival 65%, Tracking 45%

Magic Point activation cost: 49

CLOCKWORK DIPLOMAT

Sadly, amongst the higher ranks of the Church of Law, it is well known that priests become somewhat hardened to the plights of others, which can lead to

a certain element of being unwilling to compromise during negotiations. Any statesmen knows that compromise is the soul of diplomacy and that being rigid and inflexible only causes more hardship for all involved in the long run.

To combat this tendency, the Church of Law once maintained a small core of Diplomacy constructs, which were sent with an entourage of maintenance staff whenever important negotiations were to be made and the Church's human agents could not be trusted to behave themselves.

The Automata were designed to be aesthetically pleasing to the eye and although this effect was somewhat lost on non-human beings, people generally warmed up to the Clockwork Diplomats readily once interactions began. Although they were expressly genderless, they can be made to appear slightly male or female should a gender attribution be deemed helpful in negotiations.

Sadly, the Diplomacy constructs fell out of favour due to a policy change within the Church of Law. During tense negotiations between Vilmir and Ilmiora, one of the Diplomacy constructs experienced a bizarre change in personality, as it began to make bombastic statements about how the Holy Church in Vilmir would rise up and crush their impious neighbours to the north. The Ilmioran diplomats left the negotiations in a huff and tensions between the two nations soon moved from border skirmishes to outright war, one that lasted for a generation and cost many lives on both sides. Sorcery was suspected in the Automaton's uncharacteristic outburst but was

never proven. The constructs were removed from service and destroyed so as to be never reactivated.

Characteristics

STR 5
CON 5
SIZ 10
DEX 10
INT 30
CHA 30

Hit Locations

D20	Hit Location	AP/HP
1-3	Right Leg	-/3
4-6	Left Leg	-/3
7-9	Abdomen	-/4
10-12	Chest	-/5
13-15	Right Arm	-/2
16-18	Left Arm	-/2
19-20	Head	-/3

Weapons

Type	Skill	Damage
None		

Special Rules

Damage Bonus: -1D4

Combat Actions: 1

Strike Rank: +20

Movement: 4m

Skills: Courtesy 85%, Dodge 35%, Influence 65%, Language (Common) 55%, Lore (various skills) 55%, Lore (World) 55%, Oratory 85%, Perception 85%, Resilience 90%

The Clockwork Diplomats were programmed with a variety of Lore skills particular to the area in which they would be operating. Each skill operates at a 55% level and it is capable of holding up to 30 skills in total, meaning it would have a vast number of Lore skills to draw upon if needed.

Magic Point activation cost: 90

THE CLOCKWORK KNIGHT

Typically used to guard the inner sanctums of Lawful temples, the Clockwork Knights were often confused for mounted suits of armour. They remained motionless and deactivated until the condition for their awakening (often something like "Attack whoever ever enters this room without me"). They did not need to be too intelligent, making them well within the capabilities of moderately-sized temples.

Characteristics

STR 20
CON 20
SIZ 14
DEX 10
INT 1
CHA 10

Hit Locations

D20	Hit Location	AP/HP
1-3	Right Leg	6/7
4-6	Left Leg	6/7
7-9	Abdomen	6/8
10-12	Chest	6/9
13-15	Right Arm	6/6
16-18	Left Arm	6/6
19-20	Head	6/7

Weapons

Type	Skill	Damage/AP/HP
Greatsword	55%	2D8+1D4

Special Rules

Damage Bonus: +1D4

Combat Actions: 2

Strike Rank: +6

Movement: 4m

Magic Point activation cost: 81

EAGLE STATUES

This sharp-eyed construct decorated the outer surfaces of Haven, a temple of Donblas on the western coast of Vilmir. It appeared to be an unmoving statue but in reality it was the guardian of the temple and would spring forth the lash out at any intruders who got too close to the temple without proper escort.

Crafted of brightly polished steel, the eagle was much larger and more durable than its natural cousins. The

talons are as sharp as daggers and the beak as hard as a spear point. Its metal wings clashed like cymbals in flight, which would hopefully drive interlopers away before the shining bird descended to attack.

When Haven was lost to a raid by Pan Tangian slavers, the Eagle Statue was destroyed and its head and talons taken to Hwamgaarl as trophies.

Characteristics

STR	15
CON	20
DEX	20
SIZ	20
INT	6
CHA	15

Hit Locations

D20	Hit Location	AP/HP
1-3	Right Leg	5/8
4-6	Left Leg	5/8
7-8	Abdomen	5/9
9-11	Chest	5/10
12	Tail	5/7
13-14	Right Wing	5/7
15-16	Left Wing	5/7
17-20	Head	5/8

Weapons

Type	Skill	Damage
Talons	45%	1D8+1D4
Beak	45%	1D10+1D4

Special Rules

Damage Bonus: +1D4

Combat Actions: 4

Strike Rank: +13

Movement: 4m walking, 12m flying

Skills: Dodge 35%, Perception 75%

Magic Point activation cost: 101

IRON LION

These sturdy, lavish constructs were used as bodyguards for important priests of Law. Cardinal Garrick is known to have commissioned the construction of a pair of these devices and was quite pleased with their performance. Given the expense involved in their maintenance and upkeep, Iron Lions were considered impractical for all but the largest temples and are a liability for the travelling priest.

As their name implies, the Iron Lions were large, dark gray constructs shaped like lions, with thick manes and a proud, noble cast to their features. They were not especially quiet but they really did not need to be. Part of their role was to be seen as a deterrent to hostile action against those that they protect.

Most of the known Iron Lions proved to be too demanding to keep operational and those guarding Cardinal Garrick were destroyed as a part of an assassination attempt that nearly succeeded. Seemingly easily bypassed by his attackers, the Iron Lions fell out of favour and were melted down and recast into an iron door for the Cardinal's chambers.

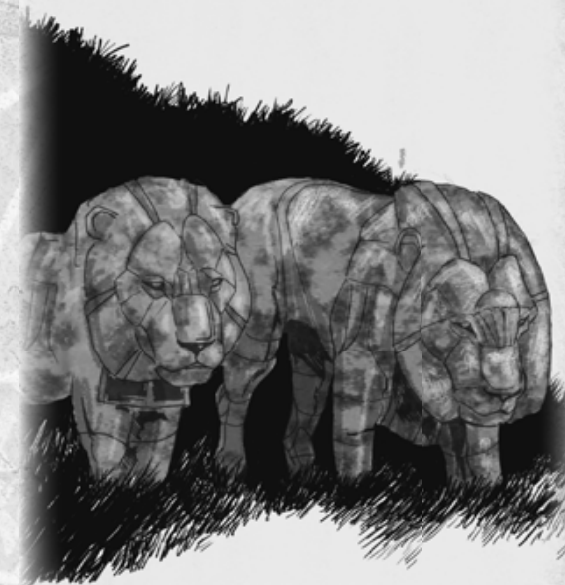

Characteristics

STR	40
CON	30
DEX	15
SIZ	30
INT	5
CHA	15

Hit Locations

D20	Hit Location	AP/HP
1-2	Tail	10/12
3-4	Right Hind Leg	10/12
5-6	Left Hind Leg	10/12
7-10	Hindquarters	10/13
11-14	Forequarters	10/14
15-16	Right Front Leg	10/12
17-18	Left Front Leg	10/12
19-20	Head/Neck	10/12

Weapons

Type	Skill	Damage
Claw	65%	1D8+2D6
Bite	65%	1D10+2D6

Special Rules

Damage Bonus: +2D6

Combat Actions: 3

Strike Rank: +10

Movement: 4m

Skills: Dodge 40%, Perception 35%, Resilience 60%, Tracking 30%

Magic Point activation cost: 145

PERSONAL ASSISTANT

This nimble little device was first designed and constructed decades ago by Vil Tarlar, Adept of Arkyn, as the behest of Karlo Remati, the author of *The Collapsing Wall*. The device was similar to the Clockwork Compass, housed in a round metal

casing, which opened on a hinge to reveal the inner workings, a glass faceplate and tiny speakers for the device to communicate with its owner.

The Personal Assistant was a veritable treasure trove of knowledge, as well as being quite good at organizing Remati's notes and affairs. It could remind him of important appointments, store away bits of information for later retrieval and generally make itself useful.

Remati was eventually tried and found guilty of heresy after the publication of *The Collapsing Wall*. He had made the seemingly baseless assumption that the Lords of Law would lose the earth to Chaos and that the plane and all who lived upon it would be destroyed. For his lack of piety, Remati was burnt alive. Since the Personal Assistant held so much of *The Collapsing Wall* in its memory, it was destroyed as well.

Characteristics

STR	1
CON	5
DEX	5
SIZ	2
INT	20
CHA	15

Hit Locations

The Personal Assistant has only a single Hit Location

Body	1AP/4 HP
------	----------

Weapons

None

Skills: Courtesy 60%, Evaluate 45%, Language (Common) 45%, Lore (History) 45%, Lore (World) 45%, Perception 65%, Resilience 50%

Magic Point activation cost: 49

CLOCKWORK DOLPHIN

Designed for a Vilmirian Priest of Donblas, the Clockwork Dolphin was a marvel of engineering. Even though it was made up of the same clockwork that powers many of the Automata this section, the Clockwork Dolphin was much sleeker in design. Despite the sections of its skin being rigged metal, it was cunningly crafted so that the Dolphin was able to express the same fluid grace that powers its natural cousins, as well as being much stronger and more durable.

The Clockwork Dolphin was a sailing ship's best companion. It could assist the helmsman in navigation, alert the crew to undersea dangers, rescue those who fell overboard and even tow the ship should it become becalmed. Even though only one such device is known to exist, there will doubtless be others like jealous priests of Law seeking to replicate this mechanical wonder.

The original Clockwork Dolphin was used to aid a party of mercenaries on a daring infiltration mission inside the City of Screaming Status in Pan Tang. Their mission was sadly a failure and the Clockwork Dolphin was never seen again.

Characteristics

STR	25
CON	30
DEX	20
SIZ	25
INT	30
CHA	15

Hit Locations

D20	Hit Location	AP/HP
1-4	Tail	3/11
5-8	Body	3/12
9-12	Left Fin	3/10
13-16	Right Fin	3/10
17-20	Head	3/11

Weapons

Type	Skill	Damage
Ramming	50%	1D6+1D10

Special Rules

Damage Bonus: +1D10

Combat Actions: 4

Strike Rank: +25

Movement: 6m

Skills: Athletics 70%, Dodge 40%, Lore (Navigation) 55%, Perception 85%, Survival 75%, Tracking 55%

Magic Point activation cost: 148

CLOCKWORK SONGBIRD

Constructed for a Shazaarian Duchess by an adept of Arkyn who loved her fiercely, the Clockwork

Songbird was a small animated statue that came to life and could sing an amazing array of beautiful songs when activated. It is comprised of silver and accented with tiny gemstones and from a distance, is indistinguishable from the real thing.

Given its intelligence and its ability to speak Common, the Songbird could also be used to ferry messages from one person to another, a facet of its abilities that the Duchess used to foil a coup attempt years after the gift was received.

Sadly, when another coup was attempted, the Clockwork Songbird was captured and destroyed, its designer was slain and the Duchess exiled from her home while a pretender dedicated to Chaos took the Duchy. He maintains his rule of the Duchy to this day, although few know his secret allegiance. He is said to fear the Songbird intensely, as it haunts his dreams. It is said that, if the Songbird were to be reconstructed and brought to the Duchy palace, the pretender would likely be driven mad.

Characteristics

STR	5
CON	5
DEX	15
SIZ	2
INT	15
CHA	20

Hit Locations

D20	Hit Location	AP/HP
1-3	Right Leg	-/2
4-6	Left Leg	-/2
7-9	Abdomen	-/3
10-12	Chest	-/4
13-15	Right Wing	-/1
16-18	Left Wing	-/1
19-20	Head	-/2

Weapons

Type	Skill	Damage
Beak	40%	1D4-1D6

Special Rules

Damage Bonus: -1D6

Combat Actions: 3

Strike Rank: +15

Movement: 4m walking, 12m Flying

Skills: Athletics 45%, Dodge 48%, Language (Common) 40%, Resilience 32%, Sing 45%

Magic Point activation cost: 62

CLOCKWORK WOLF

A stalwart companion for an itinerant Priest of Donblas, the Clockwork Wolf was very much like its natural counterpart, save it was unwaveringly loyal to those it protected and never tired or grew hungry.

As with other Clockwork animals, the Wolf was composed entirely of metal; steel in this case. Small daggers lined its mouth and coiled steel springs in its legs allowed it to move at great speeds over long distances. The entire package fits within a chassis roughly a metre at the shoulder. The Wolf rested with its head on its metal paws but would awake if anything disturbed the silence.

When the Wolf's master was of a great age, he attained apotheosis in his sleep and went on to serve Donblas in the planes of Law. Rather than be given a new master, the Clockwork Wolf vanished, never to be seen again.

Characteristics

STR 15
CON 15
DEX 15
SIZ 12
INT 5
CHA 5

Hit Locations

D20	Hit Location	AP/HP
1-2	Tail	3/5
3-4	Right Hind Leg	3/6
5-6	Left Hind Leg	3/6
7-10	Hindquarters	3/7
11-14	Forequarters	3/8
15-16	Right Front Leg	3/6
17-18	Left Front Leg	3/6
19-20	Head/Neck	3/6

Weapons

Type Skill Damage
Bite 55% 1D8+1D2

Special Rules

Damage Bonus: +1D2

Combat Actions: 3

Strike Rank: +10

Movement: 6M

Skills: Dodge 38%, Perception 35%, Resilience 50%, Tracking 30%

Magic Point activation cost: 70

TRANSLATOR ASSISTANT

This remarkable Automaton was kept and maintained at The Library of Wonders in Jadmar, a temple to Arkyn that is one of the largest depositories of books in the Young Kingdoms. It worked diligently, translating written works into Common for the benefit of both the priests of Arkyn and for the good of humanity. Over the course of its lifetime, it had translated hundreds of manuscripts, dictating them to human scribes who furiously take down its words.

The Automaton was purely functional – it was not at all personable, nor was it designed with care or attention to detail. As such, it was a thoroughly unpleasant thing to be around. It appeared to have been formed out of plain lengths of metal pipe, with a columnar length of tubing composing its head. However, its eyes and ears were well designed, although it did have trouble seeing in places lit only by candlelight.

The irascible construct was so loathed by the priests that they allowed it to run down rather than keep it charged and stashed its inert body somewhere in an underground storage area. For all we know, it may still be there.

Characteristics

STR 5
CON 5
SIZ 10
DEX 5
INT 30
CHA 5

Hit Locations

D20	Hit Location	AP/HP
1-3	Right Leg	-/3
4-6	Left Leg	-/3
7-9	Abdomen	-/4
10-12	Chest	-/5
13-15	Right Arm	-/2
16-18	Left Arm	-/2
19-20	Head	-/3

Weapons

None

Special Rules

Damage Bonus: -1D4

Combat Actions: 1

Strike Rank: +18

Movement: 4m

Skills: Evaluate 55%, Language (Common) 55%, Language (High Melnibonéan) 55%, Language (Low Melnibonéan) 55%, Language (Mabden) 55%, Language (Mong) 55%, Language (Opish) 55%, Language ('pande) 55%

Magic Point activation cost: 60

ORACULAR STATUE

A three-foot tall metal statue that depicts Lady Theril, a minor god of Law, the Oracular Statue would animate and answer questions for any who could contribute a Magic Point to it. The answers she provided were always correct, although often cryptic and sometimes meaningless until another piece of information was discovered.

The Lady was slender, draped in a long toga-like garment once fashionable in Lormyr. The joints that allowed her to move were cunningly disguised so that, while stationary, she appeared as a completely ordinary statue. It is only when activated that they were visible and even then, from a distance, she would appear to be a small, living person with metallic skin.

She spent most of her time deactivated; only coming to awareness when someone addressed her politely and requested her wisdom. She was kind to followers of Law, indifferent to the followers of the Balance and haughty towards the followers of Chaos.

This latter proved her undoing. She was stolen and questioned by a Champion of Chaos who wanted to know if she would ever achieve her master's favour.

Her answer, which was not recorded, so infuriated the Champion that she destroyed it utterly.

Characteristics

STR 1
CON 5
SIZ 5
DEX 5
INT 20
CHA 15

Hit Locations

D20	Hit Location	AP/HP
1-3	Right Leg	-2
4-6	Left Leg	-2
7-9	Abdomen	-3
10-12	Chest	-4
13-15	Right Arm	-1
16-18	Left Arm	-1
19-20	Head	-2

Weapons

Type	Skill	Damage/AP/HP
None		

Special Rules

Damage Bonus: -1D6

Combat Actions: 1

Strike Rank: +13

Movement: 4m

Skills: Language (Common) 45%, Lore (Fortune Telling) 100%, Lore (Million Spheres) 45%

Magic Point activation cost: 51

AUTOMATA BUILT FOR WAR

While most of the preceding Automata were designed for peacetime or purely defensive purposes, there were a number of machines that were designed for warfare. While spokesmen for the Church of Law always assert that these machines existed purely to combat the forces of Chaos, there is evidence that they have also been used against human opponents in wars of expansion by the Church.

All of the Automata listed below were a part of the recorded history of the Young Kingdoms, although all have not been seen for years. It is presumed that the Church maintains stockpiles of the devices, hidden in underground temples very likely, awaiting the final battle between Law and Chaos. Some of these chambers are guarded against intrusion, while others have been forgotten. On at least one occasion, some of the Automata stored in a hidden location were somehow able to reactivate and begin pursuing their own agendas before the Church could track them all down and destroy them.

The Church of Law takes the war with Chaos very seriously and the very fact that these Automata existed is a testament to the perverse ingenuity humanity has when it comes to developing more improved ways to kill each other.

CLOCKWORK SPIDER

A much larger, more menacing version of a real spider, the Clockwork Spider was meant to be a mount for a warrior-priest of Law. It was large enough to carry other gear and passengers. Due to its size and the investment needed to keep it running, the Clockwork Spider was held in reserve until such a time as its services were required by circumstance.

The entire spider was constructed of steel forged in a foundry in Old Hrolmar and coated in black varnish to decrease its visibility. The joints were oiled and carefully maintained so that the whole thing was nearly silent when it moved. It could scale sheer surfaces, making it a valuable assistant during a siege. The head of the device was studded with gemstone eyes, cut and faceted to resemble the real thing. It is said that, during night operations, the eyes of the Clockwork Spider could sometimes be seen, reflecting light as it scanned the area for threats.

On rare occasions, the Clockwork Spider and the staff needed to maintain it were loaned out to Champions of Law on an indefinite basis. This was especially true on long-term missions to undermine the forces of Chaos in the Young Kingdoms.

The Spider itself was an enigmatic creature. It spoke little but appeared to enjoy the tasks set before it. Foolishly, the Spider was used to gather intelligence on Imrryr. It managed to penetrate the Harbour Gates and it and the Champion of Law who rode it, were able to remain hidden for several days before Fate intervened and they were discovered. The Spider was destroyed by acid-spitting demons and

its rider given over to the Lord High Execution for a particularly gruesome public execution.

Characteristics

STR	40
CON	20
DEX	20
SIZ	20
INT	10
CHA	5

Hit Locations

D20	Hit Location	AP/HP
1	Right Fourth Leg	3/8
2	Left Fourth Leg	3/8
3	Right Third Leg	3/8
4	Left Third Leg	3/8
5-11	Abdomen	3/9
12	Right Second Leg	3/8
13	Left Second Leg	3/8
14	Right First Leg	3/8
15	Left First Leg	3/8
16-19	Thorax	3/10
20	Head	3/8

Weapons

Type	Skill	Damage
Leg Smash	65%	1D6+1D12
Bite	65%	1D10+1D12

Special Rules

Damage Bonus: +1D12

Combat Actions: 4

Strike Rank: +15

Movement: 6m

Skills: Athletics 85%, Dodge 35%, Language (Common) 35%, Perception 45%, Resilience 65%, Stealth 35% (due to modifications made to the Spider, all Stealth rolls are considered *Easy* +20%).

Magic Point activation cost: 118

CLOCKWORK WARHORSE

This massive white destroyer was designed as a warhorse for Lady Malarich Hanaan, Knight of Dolwic and Champion of Miggea. It stood 20 hands tall, easily allowing the knight mounted on its back to tower over lesser foes. The warhorse was a complex series of gears and levers and thanks to miraculous engineering, was ridden just like any natural horse.

The Clockwork Warhorse was covered in white enamel plates accented with silver. Its hooves were highly polished steel, crafted to maximize the sound of the horse's hooves on any hard surface. Foes would hear the Clockwork Warhorse and its rider approaching and were given time to know despair and prepare for death.

Lady Hanaan met her fate pursuing Dharjorian reavers as they fled south from Shazaar into the Marshes of Mist. The Clockwork Warhorse returned several hours later, so badly damaged that it could not be repaired. Lady Hanaan's body was never recovered, although there is some speculation that she was called to another world by Miggea. The Warhorse was cleaned and repaired to the best of the temple staff's ability. Afterward, it was stored in a crypt, next to a

sarcophagus intended for Lady Hanaan, should she ever return to the Young Kingdoms.

Characteristics

STR 40
CON 30
SIZ 40
DEX 15
INT 5
CHA 15

Hit Locations

D20	Hit Location	AP/HP
1-3	Right Hind Leg	3/13
4-6	Left Hind Leg	3/13
7-9	Hindquarters	3/14
10-12	Forequarters	3/15
13-15	Right Front Leg	3/13
16-18	Left Front Leg	3/13
19-20	Head	3/13

Weapons

<i>Type</i>	<i>Skill</i>	<i>Damage</i>
Kick	65%	3D6

Special Rules

Damage Bonus: +2D6
Combat Actions: 3
Strike Rank: +10
Movement: 6m

Skills: Athletics 80%, Dodge 20%, Language (Common) 30% (cannot speak but understands), Resilience 90%

Magic Point activation cost: 148



INFILTRATOR BUGS

These dinner-plate sized devices were the brainchild of Armius Loman, a priest of Arkyn whose area of expertise was espionage. The Infiltrator Bugs were highly regarded devices that used their small size and copious sensory equipment to sneak into enemy fortifications, note troop placements or steal valuable plans before they can be put to use.

Each Bug was circular in shape, with three articulated legs that enable it to scamper about with surprising speed and agility. They could scale walls, cling to ceilings and jump short distances. Upon retrieval, they would speak in Common to report that they had found, making them excellent tools for reconnaissance and sabotage.

Characteristics

STR 5
CON 5
SIZ 5
DEX 20
INT 20
CHA 1

Hit Locations

D20	Hit Location	AP/HP
1-3	First Leg	1/2
4-6	Second Leg	1/2
7-9	Third Leg	1/2
10-14	Body	1/3
15-16	Sensory Devices	1/2
17-18	Right Arm	1/1
19-20	Left Arm	1/1

Weapons

<i>Type</i>	<i>Skill</i>	<i>Damage</i>
Arm-blade	50%	1D4-1D6

Special Rules

Damage Bonus: -1D6
Combat Actions: 4
Strike Rank: +20
Movement: 6m

Skills: Athletics 45%, Dodge 45%, Engineering 45%, Language (Common) 45%, Mechanisms 65%

Magic Point activation cost: 57

An Introduction to Castle Brass

By Lawrence Whitaker

The Camargue clearly stirred something in Michael Moorcock, because he chose this strange, eerie countryside as the location for a great deal of the action for the *Hawkmoon* saga. The city of Aigues Mortes became a focal point and many of the Camargue's traditions, such as its guardians, its horses, its flamingos and its graceful bullfights, found themselves undergoing a suitably Moorcockian twist but reaching the *Hawkmoon* stories largely intact.

The aim of this book, *Castle Brass*, is to do much of the same but also to broaden the stage. The book takes its cues from both the contemporary Camargue and the Kamarg of Moorcock's stories and expands upon both. Here we learn more of what lies within the defensive ring of death-dealing turrets Count Brass established. Intrigues, secrets and strangeness abound but should still be recognisable to anyone who has ever visited the place.

Aigues Mortes, the walled city where Count Brass made his base, is detailed to a healthy degree in order to allow Games Masters, if they wish, to create campaigns set within its walls, populated by the colourful characters found in the *Hawkmoon* novels, plus some additional protagonists both hinted at and entirely imaginary. Aigues Mortes has plenty of adventure to offer and the Kamarg can supply it. However the book is called *Castle*

Brass and the castle itself is detailed. Its structure, history and function is fleshed-out and those who make the castle work, themselves with secrets and peccadilloes, explored.

The aim of the book is to offer some adventure slightly removed from the usual trappings of a Hawkmoon scenario: the struggle against the Dark Empire of Granbretan. Instead it offers something a little more low-key, something a little less concerned with masks and flamelances but still recognisably Moorcockian. The book includes a campaign overview that takes-in all the major elements and explores a plot to seek revenge on Count Brass for things he did either just before he arrived in the Kamarg or just after it. It will involve a little work for Games Masters but hopefully all of the tools to create memorable, Kamarg-based stories are there.

I hope you enjoy using *Castle Brass* as much as I enjoyed writing it.

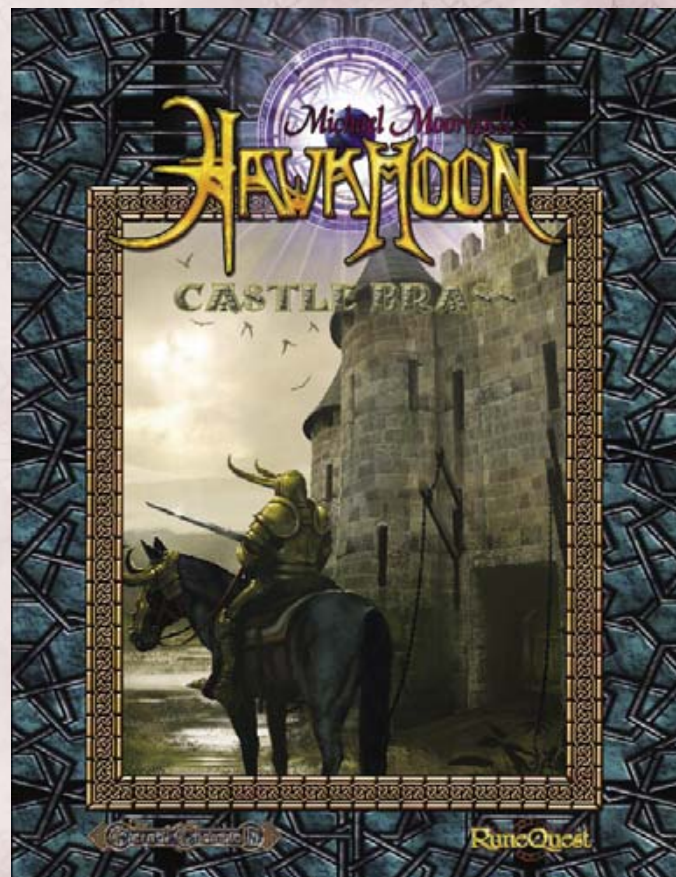



Deep Space

A Tournament for A Call to Arms

Matthew Sprange

At the Mongoose Hall event this year, we ran a Call to Arms tournament with a difference – because we wanted to fit several games in during one day and because we wanted to let the participants wander around the convention and sample all the delights on offer, we needed a very different format for a tournament than the ‘standard’ 5 point Raid. So, we put together a range of scenarios (that the players would be unaware of until five minutes before the fight began!) that required small fleets and told a short story in the Babylon 5 universe.

You can use these scenarios as a straight mini-campaign between two players, or maybe just use each scenario as a one-off game. If you are slightly more ambitious, you can use everything presented here as the basis for your own tournament, held at your local club or games store!

Tournament Overview

Each player is in command of a small squadron, patrolling deep in uncharted space. Rumours of high technology and the interest of other governments in the area has persuaded their high command to deploy just two ships in the system. They must investigate the system, and defend themselves against any enemies!

Playing the Games

Each entrant will compete in four games. After each game, you will record your results and inform the Tournament Co-ordinator before

the next round of games is due to start. Your opponent in the first game of the tournament will be determined randomly. The three subsequent games will match players according to how well they did in their previous games, pairing off the two current highest scoring players with each other, then the next two highest scoring, and so on. However, you will never play the same opponent twice during the tournament.

Every game will be played on a 6’ by 4’ table with fixed stellar debris. Players must provide all other materials for their games. You must also bring along a copy of the A Call to Arms Rulebook and Fleet Lists, and any rules updates that are relevant to your fleet. Rules updates from our web site or Signs & Portents may be printed out.

You Will Need

Each player must bring the following items with them on the day of the tournament.

- A Call to Arms Rulebook and Fleet Lists, plus any relevant rules updates
- Your fleet, either as miniatures or counters
- Two copies of their Fleet Roster
- Pen, paper and dice
- Tape Measure

Winning and Losing

Throughout the tournament, players will earn points in various categories. The winner of the

tournament will be the player with the most points overall. In the event of a tie, the player with the most Admiralship points will win.

Each scenario has a set of objectives, which will grade performance as Poor, Adequate, Good or Outstanding. Each grade will earn each player Admiralship points as follows. The maximum possible score over the four games is 80 points.

Battle Grade	Admiralship
Poor	5
Adequate	10
Good	15
Outstanding	20

Players should be warned ten minutes before a game must end and from this point they must finish the game with the current turn. Victory Points will be calculated from this point as normal.

Tournament Fleets

Each player’s fleet roster must list every ship within their fleet and any additional items or options that they have selected.

Each fleet must obey the following restrictions.

- The fleet will comprise one Skirmish level ship, and one Battle level ship.
- There must be a painted miniature or counter for every ship in your fleet.
- Players must choose fleets from the A Call to

Arms Fleet Lists.

- Gaim fleets must use the list from Signs & Portents.
- All ships have a Crew Quality score of 4. ISA, Gaim and Vree ships get their usual bonuses.

Initial Contact

Entering the mysterious system at the edge of the Rim, your fleet conducts standard protocol sweeps of the area, deploying remote drones, and gathering data and intelligence on the nearby astrological bodies. Sent ahead to scan the single planet within the habitable zone of the system, the smaller ship of your fleet begins taking readings – only to find a foreign power has staked a claim on this strange world already!

Fleets: Both players start with their Skirmish level ships.

Pre-Battle Preparation: Roll for Initiative – the losing fleet will be forced to set up first. The fleets are deployed anywhere in their own deployment zones as shown on the scenario map.

Scenario Rules: Both patrolling ships will immediately send a distress signal as soon as they realise they are not alone in the system, and the player's Battle level ships will move to respond. At the start of Turn 5, both players roll a dice – on a 4 or more, their Battle level ship will arrive, moving on from their own table edge. If a Battle ship fails to appear on Turn 5, it will automatically appear at the beginning of Turn 6. If a Skirmish level ship is destroyed before its Battle level counterpart arrives, then the Battle level ship will abort its mission and not turn up at all.

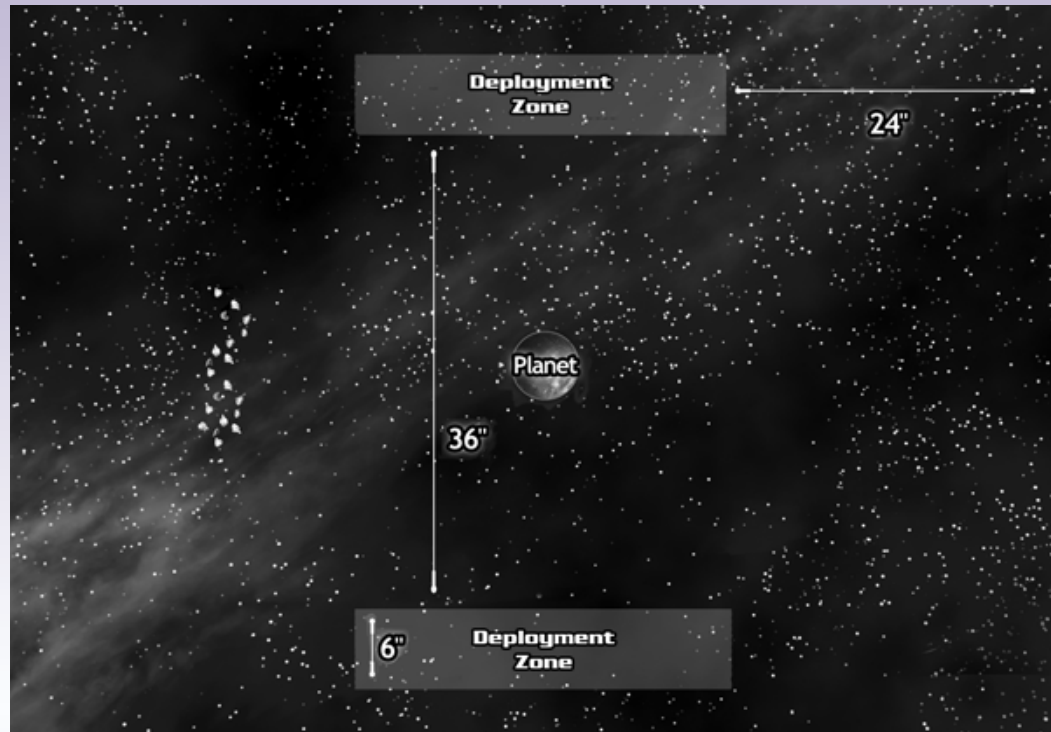

Game Length: Until one fleet withdraws or either side has no ships on the table (Running Adrift, destroyed and surrendered ships do not count as viable ships).

Battle Grades: Players will receive the best Battle Grade they qualify for from the list below;

Outstanding: Destroy the enemy Skirmish ship before any Battle level ship arrives, or destroy both enemy ships without losing one of your own.

Good: Destroy at least one enemy ship without losing one of your own.

Adequate: Destroy at least one enemy ship.

Poor: Any other result.

Automaton Recovery

Knowing that foreign governments are also interested in this world, it is now imperative to collect your remote drones and collate the data they have gathered. However, the presence of a strange alien race on the planet has galvanised your enemy to action, and you suspect they have made contact with the technological civilisation. You are losing the race to gain control of the system, and any information that can be gleaned from the from the drones could be invaluable.

Fleets: Both players start with their entire fleets.

Pre-Battle Preparation: Each player takes three counters (coloured dice will do!), and take turns

placing them anywhere on the table. Each must be placed at least 12" from a table edge and at least 6" away from another counter. None may be placed on the planet. These represent the drones that must be recovered. Next, roll for Initiative – the losing fleet will be forced to set up first. The fleets are deployed anywhere in their own deployment zones as shown on the scenario map.

Scenario Rules: To take a drone on board, a ship must pass within 1" of it, and perform a Recover Drone Special Action. This Special Action required no Crew Quality check, but means the

ship may not fire any weapons or use any traits (at all!) for that turn. A ship may only pick up one drone in a single turn.

A ship may not fire any weapons or use any traits (at all!) for that turn.

Game Length: Until all drones have been recovered.

Battle Grades: Players will receive the best Battle Grade they qualify for from the list;

Outstanding: Recover at least 5 drones.

Good: Recover at least 3 drones.

Adequate: Recover at least 2 drones.

Poor: Any other result.

First Strike!

While making a close pass of the planet, your flagship was hit by a high intensity beam that erupted from the planet, blasting out vital systems, and stunning the crew. When they recover, it is apparent that the aliens on the planet below have launched an attack on all outsiders, as they see an enemy ship in similar dire straits. They struggle to bring their weapons on line and send a distress signal as the enemy ship slowly turns to face them.

..

Fleets: Both players start with their entire fleets.

Pre-Battle Preparation: Roll for Initiative – the losing fleet will be forced to set up first. The fleets are deployed anywhere in their own deployment zones as shown on the scenario map, with the Battle level ships close to the planet, the Skirmish level ships further away.

Scenario Rules: Both Battle level ships have overloaded systems, which affects their combat capability. Whenever firing a weapon system on the Battle level ship, a player must first roll a dice. On a 5 or more, the weapon fires normally. On any

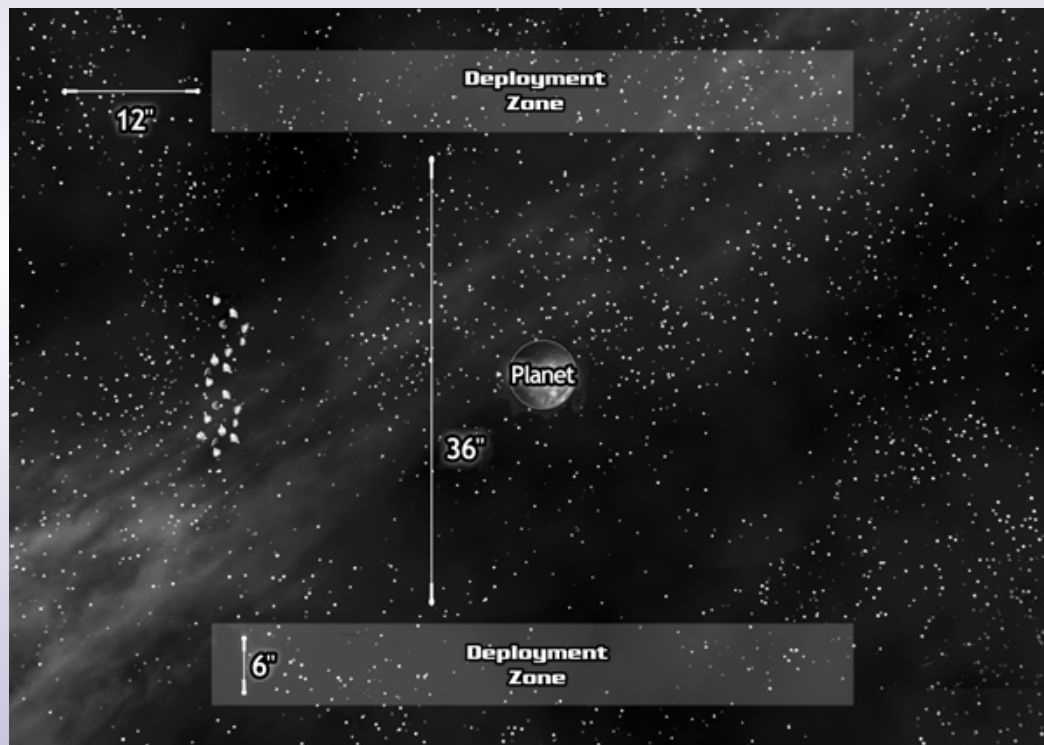

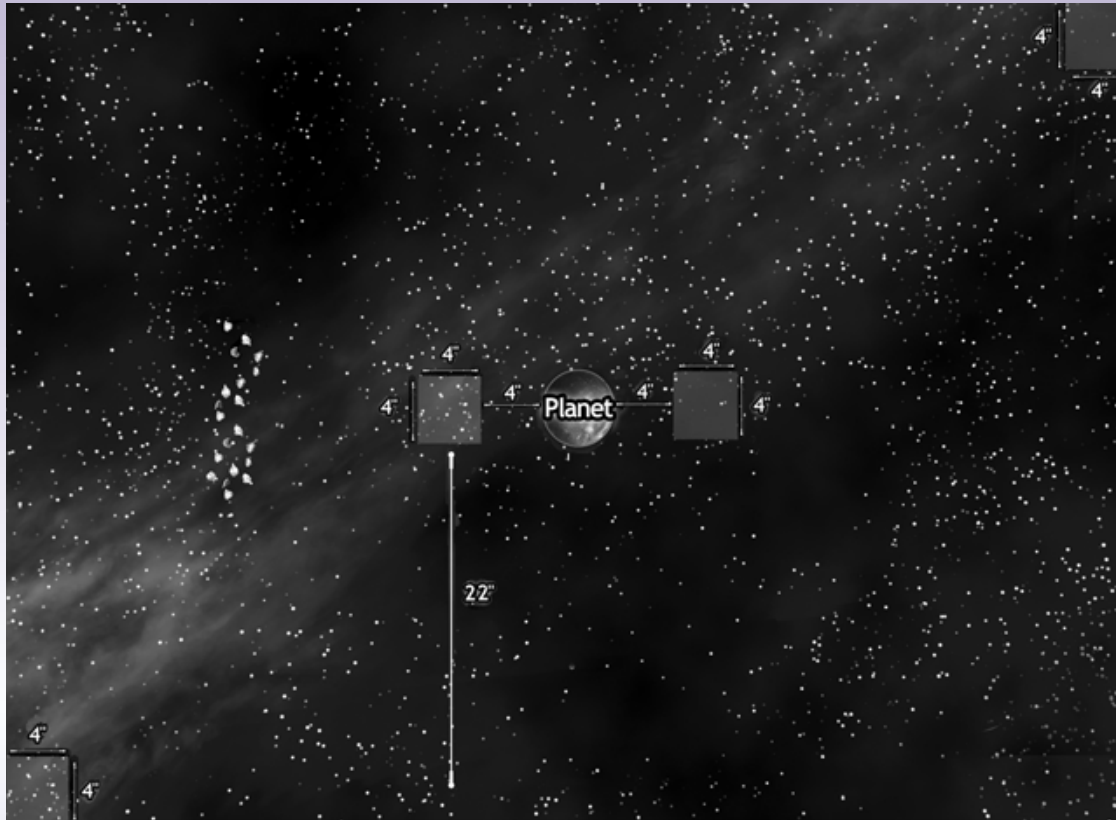

other result, it does not fire at all! Furthermore, whenever a flight is launched, a dice must be rolled. On a 5 or more, it is launched normally, on any other result, problems in the hangars cause a delay and it is not launched.

Game Length: Until one fleet withdraws or either side has no ships on the table (Running Adrift, destroyed and surrendered ships do not count as viable ships).

Battle Grades: Players will receive the best Battle Grade they qualify for from the list below;

Outstanding: Destroy both enemy ships without losing one of your own.

Good: Destroy at least one enemy ship without losing one of your own.

Adequate: Destroy at least one enemy ship.

Poor: Any other result.

Shadows of the Past

The energy attack affected your enemy in a far more fundamental way, it seems. Long-ranged scans record emissions very similar to those produced by the beam attack from the planet now emanating from his ship. The planet has become a no-go area, with the aliens clearly hostile towards you. You must get a crack commando unit on board his main ship to discover exactly what affect the aliens have had on your enemy and, if necessary, to put an end to it. The brave men and women of this unit are expendable, and they know it is a suicide mission. . .

Fleets: Both players start with their entire fleets.

Pre-Battle Preparation: Roll for Initiative – the losing fleet will be forced to set up first. The fleets are deployed anywhere in their own deployment zones as shown on the scenario map.

Scenario Rules: To get the Commando unit on the enemy Battle level ship, you merely have to perform a single successful boarding action

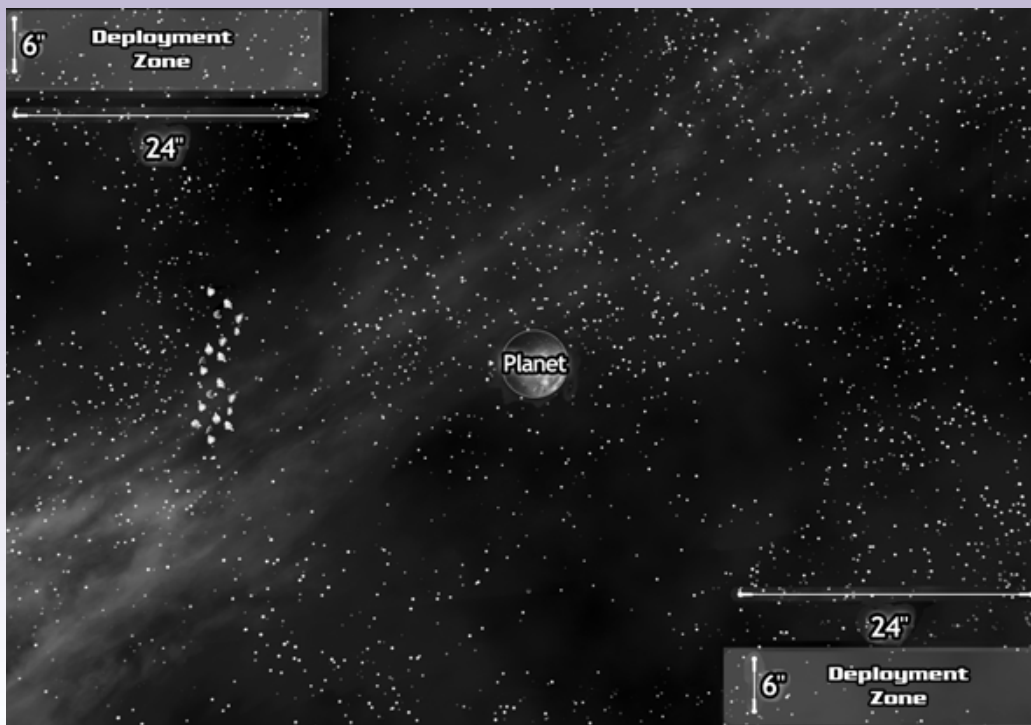

(ensure at least one Troop is alive on the enemy ship at the end of the turn). The commando unit is carried on your Skirmish level ship. Note that Vorlon and Shadow ships may be boarded in this manner, though any Troops that make it on board will each automatically be destroyed on the roll of a 3 or more – we said this was a suicide mission!

Game Length: Until either side has no ships on the table (Running Adrift, destroyed and surrendered ships do not count as viable ships).

Battle Grades: Players will receive the best Battle Grade they qualify for from the list below;

Outstanding: Get a Commando on board the enemy Battle level ship, then withdraw both of

your ships without them being Crippled.

Good: Get a Commando on board the enemy Battle level ship, then withdraw at least one of your ships, whatever its condition.

Adequate: Get a Commando on board the enemy Battle level ship.

Poor: Any other result.

Aftermath

The decks on board the enemy ship were filled with a cacophony of the mad and deranged. The commandos managed to assassinate the admiral, who by this time had been mutated into a strange beast of incredible power, capable of blasting apart bulkheads by hurling raw energy generated within his own distorted body. Before detonating the enemy ship's reactors, the commandos broadcast a tight beam message to your fleet, relaying all the data they had acquired. Speculation began

almost immediately that some mysterious form of Shadowtech was being kept and nurtured on the alien world but, lacking resources to finance such a high risk venture, your government merely classified the entire system Off Limits, and returned to the politicking of known space. You have resolved to, one day, return to the Rim and discover what is happening out there. One day. .

THE REPTII ASSAULT TRIAX –

NEW SHIPS FOR TRAVELLER

By Bryan Steele with assistance from Nick Robinson

These *Traveller* universe is a huge place with galaxies upon galaxies that contain countless stars, many of which contain habitable worlds that have produced alien life over the eons. Some of these life forms evolved into sentience, becoming civilised and eventually even reaching for the stars.

One of these races – the Reptii – invented their own spacecraft and took to the space lanes in order to do what they have always done best – prey on the weak and make meals of them.

Reptii Deathclaw-class Assault Ship

The Reptii are a physically powerful species that specialise in close combat and ship-to-ship assaults. The 'Deathclaw' is a troop delivery vessel that is sent out after the missile banks of the Reptii larger ships have crippled their enemies. The Deathclaw is piloted up against the other ship, magnetic harpoons are launched and a breaching team of armoured Reptii warriors are sent across to deal with survivors and to take the spoils and remains.

Deathclaw Assault Ship			Tons	Price (Cr.)
Hull	100 Tons Streamlined Self-Sealing	Hull 2 Structure 2		3,200,000
Armour	Titanium Steel	2 Points	5	100,000
Jump Drive A		Jump 2	10	10,000,000
Manoeuvre Drive B		Thrust 4	3	8,000,000
Power Plant B			7	16,000,000
Bridge			10	500,000
Computer	Model 1/bis/fib	Rating 5 (10 for Jump Control)		60,000
Electronics	Military Sensors	+0 DM	2	1,000,000
Weapons	Hardpoint #1	Double Turret (Magnetic Harpoons)	1	500,000
Fuel	28 tons	One Jump-2 and four weeks of operation	28	
Cargo	9 tons		9	
4 Staterooms			16	2,000,000
Extras	Assault Barracks		4	400,000
	10 Low Passage Berths		5	500,000
	Fuel Scoop Ship's Locker			—
Software	Jump Control/2 Manoeuvre/0 Evade/1			1,200,000
Maintenance Cost (monthly)				3,622
Life Support Cost (monthly)				13,000
Total Tonnage and Cost			100	43,460,000

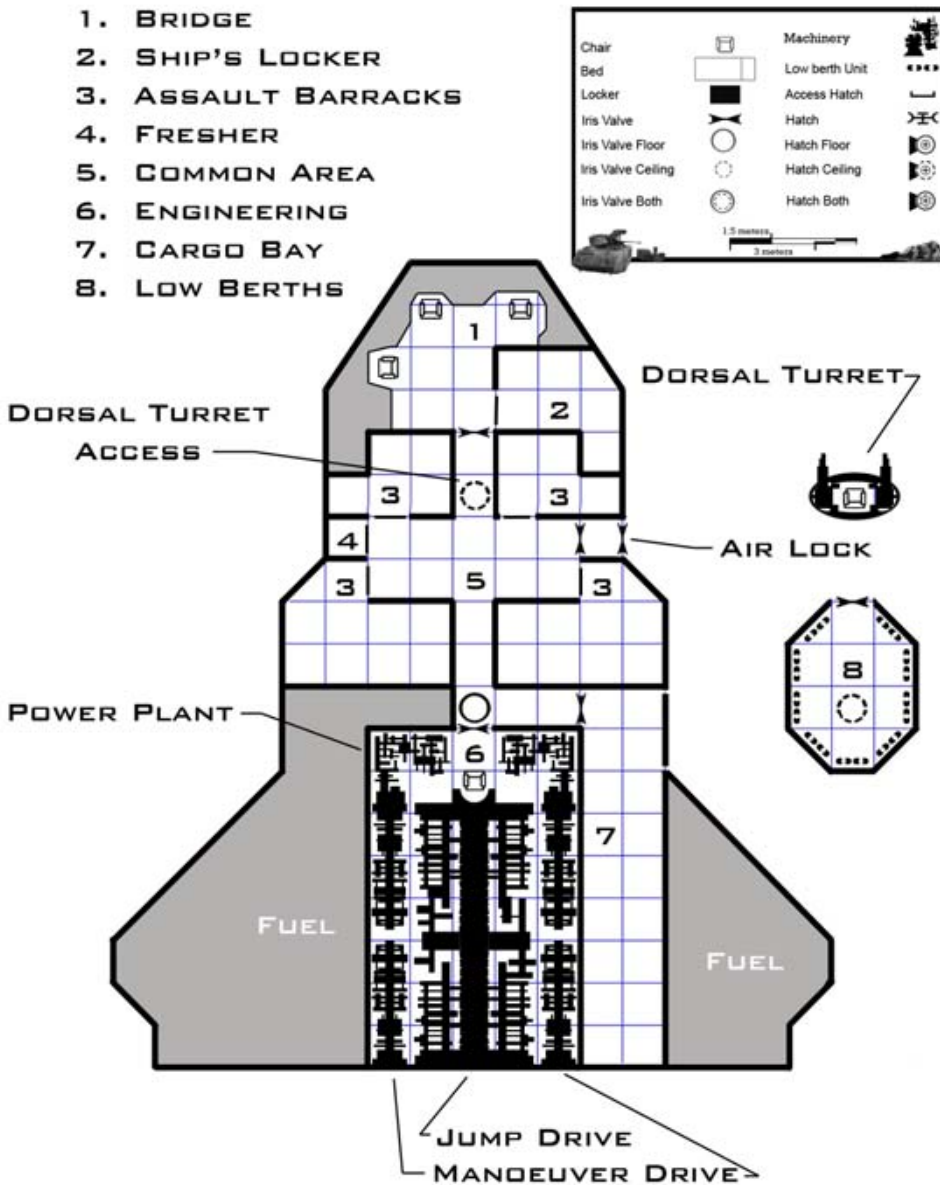

New Weapon – Magnetic Harpoon

Only usable at short range, the magnetic harpoon is used to pull a targeted ship closer so that a seal can be made and assault troops sent across in a boarding action. Any ship successfully hitting its target with magnetic harpoons before boarding will receive a +4 DM bonus to the roll used to initiate the boarding action itself.

Weapon Type	TL	Range	Damage	Cost (MCr.)
Magnetic Harpoons	7	Short	D6	0.1

New Extra – Assault Barracks

Any ship equipped with staterooms can turn them into Assault Barracks at the additional cost of one ton of volume and Cr. 100,000. An assault barracks houses double the normal occupancy and the personal gear of its occupants but removes all of the commonplace amenities in favour of a weapon rack, cell recharging station and workbench.

Reptii Voracious-class Gunship

The primary vessel of the predatory fleets of the Reptii, the Voracious gunships are vessels layered with thick armour and bristling with gun turrets. They are designed to serve as the primary offensive force in a Reptii attack, hurling missiles and laser strikes at enemy vessels to incapacitate them so a swarm of Deathclaws can swoop in and finish them off. The ample cargo space of a Voracious is used to hold salvaged and stolen loot and bodies from Deathclaw assault teams, however they are also sometimes used to house living cargo as well.

Voracious Gunship			Tons	Price (Cr.)
Hull	500 tons Standard Self-Sealing	Hull 10 Structure 10		37,000,000
Armour	Titanium Steel	6 points	75	9,600,000
Jump Drive E		Jump 2	30	50,000,000
Manoeuvre Drive C		Thrust 1	5	12,000,000
Power Plant E			16	40,000,000
Bridge			20	2,500,000
Computer	Model 2/fib	Rating 10		240,000
Electronics	Military Sensors	+0 DM	2	1,000,000
Weapons	Hardpoint #1	Double Turret (Twin Pulse Laser -7)	5	10,500,000
	Hardpoint #2	Double Turret (Twin Pulse Laser -7)		
	Hardpoint #3	Double Turret (Twin Pulse Laser -7)		
	Hardpoint #4	Double Turret (Twin Beam Laser -7)		
	Hardpoint #5	Double Turret (Twin Missile Rack)		
		Double Turret (Twin Missile Rack)		
Fuel	140 tons	Jump-1 and eight weeks of operation	140	
Cargo	82 tons		82	
10 Staterooms			40	5,000,000
Extras	30 Low Passage Berths		15	1,500,000
	Ship's Locker		10	400,000
	2 Repair Drones		10	1,000,000
	Escape Pods		50	28,000,000
Software	Cutter			9,200,000
	Auto-Repair/1			
	Fire Control/2			
	Jump Control/2			
	Library			
	Manoeuvre/0			
Maintenance Cost (monthly)				17,328
Life Support Cost (monthly)				23,000
Total Tonnage and Cost			500	200,740,000

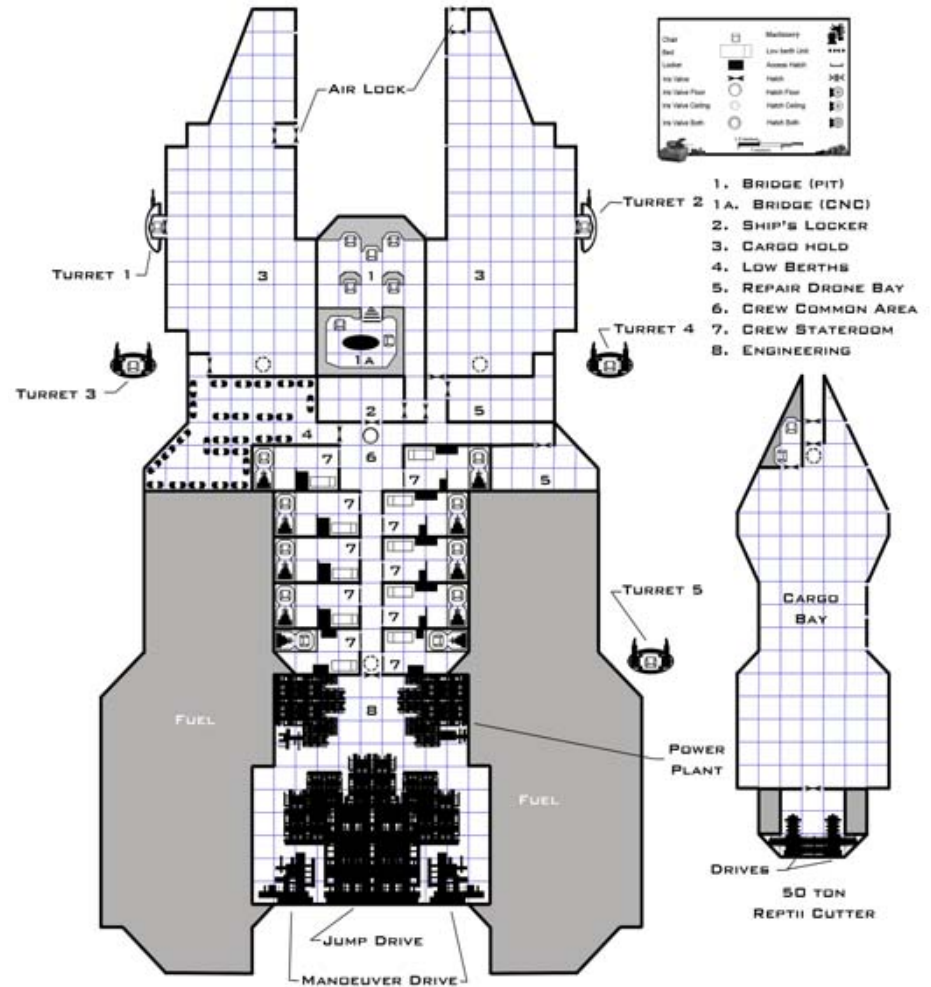

Reptii Horde-class Command Ship

Only three in existence, the Horde Command Ships are the largest ships in the Reptii fleets and represent a mobile space headquarters that slowly roars across the galaxy in search of ripe worlds and small fleets to descend upon and devour – both figuratively and literally. The banks of weapons built into a Horde protect it from minor threats and the normal escort of several Voracious Gunships and a veritable swarm of Dreadclaws make nearly anything a potential target for their predation.

Horde Command Ship			Tons	Price (Cr.)
Hull	1,200 tons Distributed Self-Sealing	Hull 12 Structure 12		120,000,000
Armour	Titanium Steel	10 points	300	30,000,000
Jump Drive J		Jump 2	50	90,000,000
Manoeuvre Drive J		Thrust 2	17	36,000,000
Power Plant K			31	80,000,000
Bridge			40	6,000,000
Computer	Model 2/bis/fib	Rating 10 (15 for Jump Control)		320,000
Electronics	Military Sensors	+0 DM	2	1,000,000
Weapons	Hardpoint #1	Triple Turret (Three Beam Lasers - 7)	1	4,000,000
	Hardpoint #2	Double Turret (Twin Beam Lasers - 7)	1	2,500,000
	Hardpoint #3	Double Turret (Twin Beam Lasers - 7)	1	2,500,000
	Hardpoint #4	Double Turret (Twin Beam Lasers - 7)	1	2,500,000
	Hardpoint #5	Double Turret (Twin Beam Lasers - 7)	1	2,500,000
	Hardpoint #6	Double Turret (Twin Beam Lasers - 7)	1	2,500,000
	Hardpoint #7	Double Turret (Twin Beam Lasers - 7)	1	450,000
	Hardpoint #8	Double Turret (Twin Beam Lasers - 7)	1	450,000
	Hardpoint #9	Double Turret (Twin Beam Lasers - 7)	1	450,000
	Hardpoint #10	Double Turret (Twin Beam Lasers - 7)	1	450,000
	Hardpoint #11	Double Turret (Twin Beam Lasers - 7)	51	12,000,000
	Hardpoint #12	Double Turret (Twin Beam Lasers - 7)	51	12,000,000
		Single Turret (Sandcaster)		
	Single Turret (Sandcaster)			
	Single Turret (Sandcaster)			
	Single Turret (Sandcaster)			
	Weapon Bay (Missile Bank)			
	Weapon Bay (Missile Bank)			
Fuel	340 tons	Jump-2 and ten weeks of operation	340	
Cargo	125 tons		125	
10 Staterooms	Occupancy		40	5,000,000

Extras	50 Low Passage Berths		25	2,500,000
	Ship's Locker		—	—
	Probe Drones		1	100,000
	2 Repair Drones		12	400,000
	Escape Pods		10	1,000,000
Software	Shuttle		95	33,000,000
	Auto-Repair/2			15,200,000
	Fire Control/2			
	Intellect			
	Jump Control/2			
Maintenance C o s t (monthly)	Library			38,568
	Manoeuvre/0			
	Life Support			35,000
	Cost (monthly)			
	Total Tonnage and Cost		1,200	462,820,000

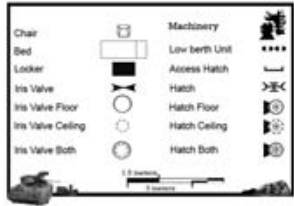

1. AVIONICS
2. BRIDGE
- 2A. TACTICAL OPS
- 2B. FIRE CONTROL
3. SHIP'S LOCKER
4. UPPER CARGO BAY
5. FRESHER
6. CREW STATEROOM
7. LOW BERTHS
8. COMMON AREA/ MESS
9. MISSILE BAY FIRE CONTROL
10. MISSILE BAY
11. REPAIR DRONE BAY
12. PROBE BAY

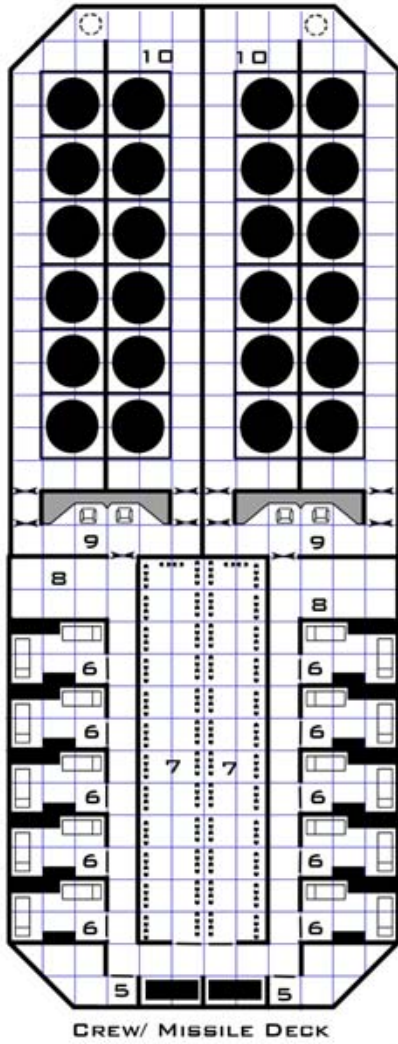

PROBE AND GUN DECK

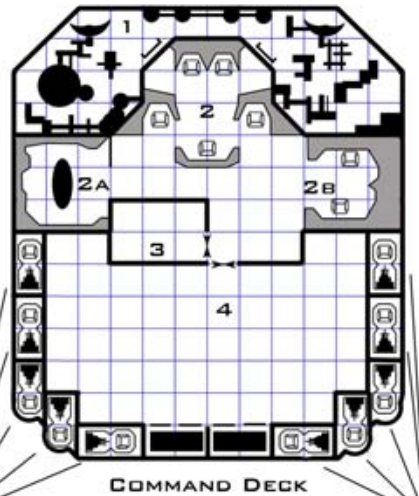
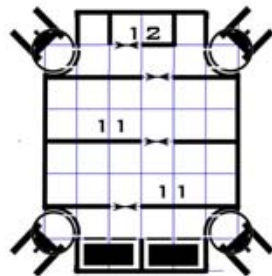

ESCAPE PODS

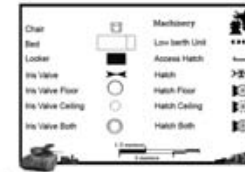

FUEL DECK

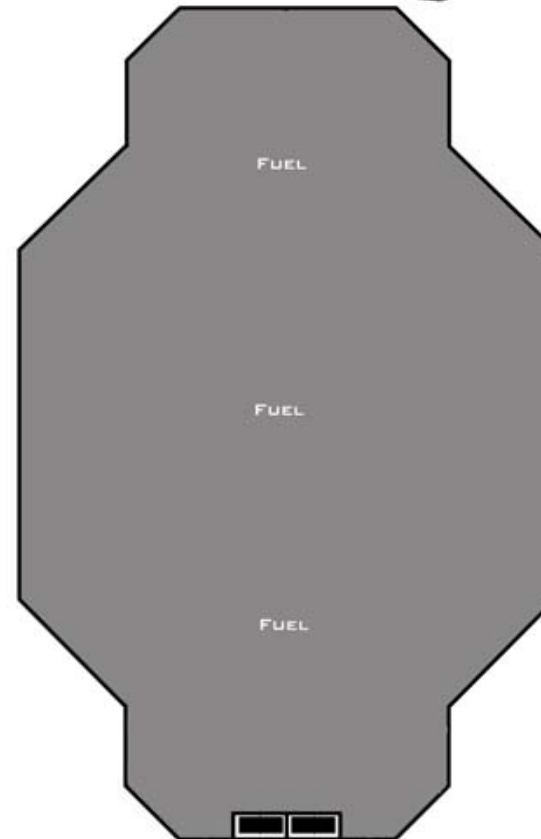

ENGINEERING DECK

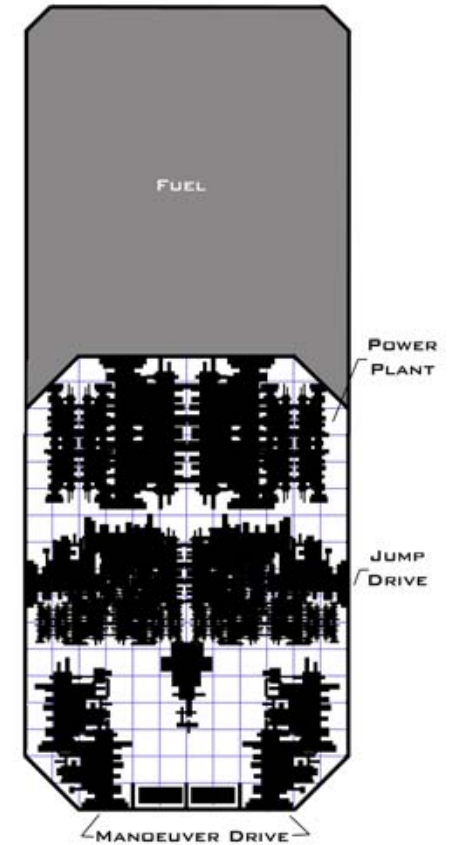

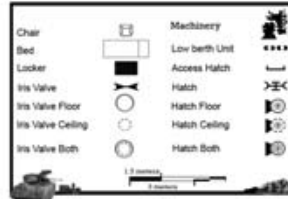

CARGO/ SHUTTLE DECK

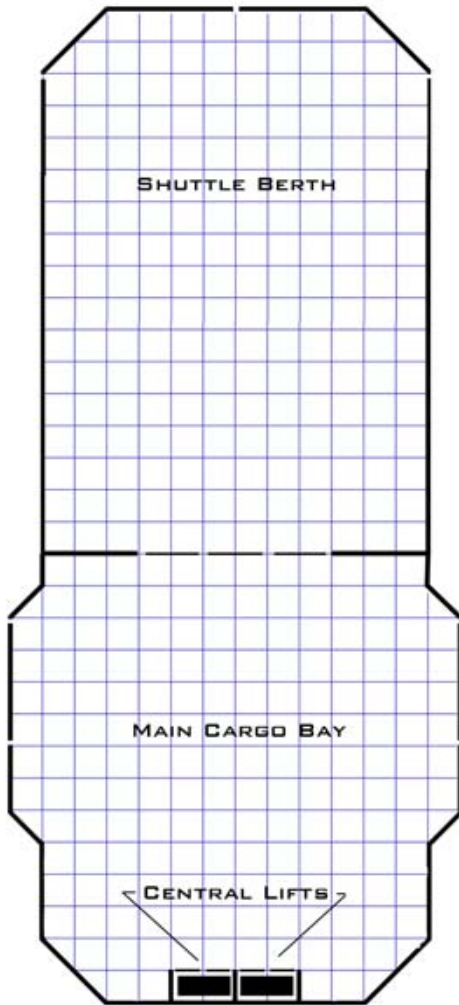

WEAPONS DECK

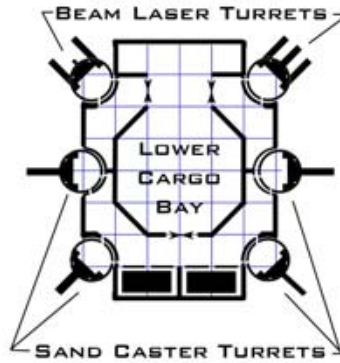

REPTII 95 TON SHUTTLE

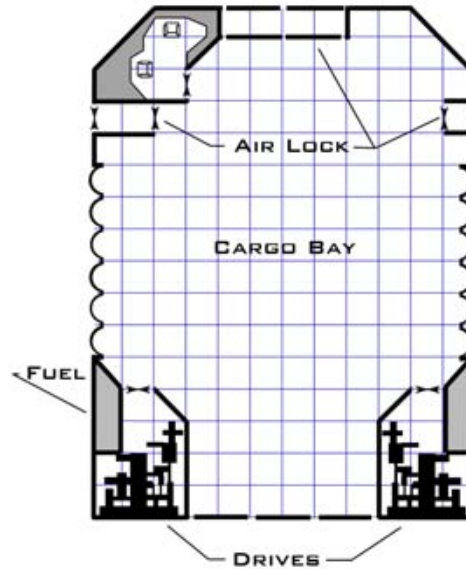

31ST MAY - 1ST JUNE

UK

BIRMINGHAM

2008



GAMES EXPO



2008 Special Features

DUNGEONS & DRAGONS



New 4e Dungeons & Dragons

Special Pre-release RPG Sessions

THE LIVING DUNGEON

The Living Dungeon

Life-size 4e DND Adventure Experience

Monsters - Traps - Puzzles - Mysteries



New Dr Who RPG

Special RPG Sessions



Miniatures

Boardgames

Card Games

RPG Sessions

Online / LAN



Star Wars / Tolkien

Seminars & Workshops

Expo Awards / Children's Events

FREE Parking / Bar & Catering

20,000 ft² of Games / Bring & Buy



Debut Game Releases

4e DND - be the first to play in the UK

Dr Who RPG - Ice Flow - Confucius

Manasty - and many others

Major UK Tournaments

UK Warmachine / Hordes -

UK Flames of War - Field of Glory -

Warhammer 40K - Horoscope...



Project X Revealed!

The Living Dungeon - parties of 6

adventurers will attempt to survive

the 'Lair of the Necromancer'

After Hours / Free Play

(Fri & Sat 7 pm till 12 Midnight)



Saturday: 10am to 5pm
Sunday: 10am to 4pm

Normal Entry Tickets

Adults £8.00

2 Days £17.00

Child (8 - 14) £5.00

2 Days £8.00

Family (2+2) £10.00

2 Days £14.00

Children 7 & under FREE

Exhibitors & Traders

Wizards of the Coast - Upper Deck -

Wargames Illustrated - NCSOFT - Mongoose -

Worlds - Privateer Press - Esdevium -

Tabletop - Westwind - Spirit - HML -

Pagan Angel - Heron - Kerr & King -

Pinnacle - Surprised Store - Old Crow -

Bishop - Ragnar - Leisure Games - NTJ -

Warfrog - Cubicle 7 - Ludorum - Heron -

Firestorm - Monolith - Sage - Veteran -

Northumbria - and many, many more...



UK Carcassonne Champs

Winner goes to Worlds in Germany



www.ukgamesexpo.co.uk

Clarendon Suites, Stirling Road, Edgbaston, B16 9SB

For further details visit the website.

Write for the Mongoose

Want to write for your favourite gaming publisher? Want to get paid for it? Got a great idea for an article? If the answers to these questions are 'yes', then Signs & Portents wants to hear from you.

Where to Start...

We will need a brief synopsis of your intended article, no more than one page long. Also include a paragraph or two of your actual writing style, so we can see whether you have what it takes and any samples of previously published work. If we like what we see, we will commission a first draft from you and you will be on your way to becoming a Mongoose contributing writer. And every article we publish will be paid for...which is nice.

Things to Remember

Provide your full details, including name, address and email address if available.

Supply articles via email or on disc. We can read most formats, although MS Word is always a safe bet.

You will be provided with a style guide when we commission your article. Make sure you read it!

Subject Matter

First and foremost, the article has to be based on any one of our product lines, whether it is any of our miniature wargaming systems or our roleplaying games., ranging from A Call to Arms right through to Conan. If you have ideas for any of our games we want to hear them.

So, you have chosen your game, but what do you actually write about? Scenarios are good. In fact, we love them. Give me a scenario to edit and I am a happy camper. Perhaps you want to discuss the philosophy of a game. That's good. We encourage intellectual thought process around here. If you have something meaningful to say, then try us out. If we don't like it, we *will* tell you. Think hard before you try humour though. With guys like Jonny Nexus about, you will need to be sharp if you want to break in. If you think you have what it takes, though, then feel free to try your hand. Just be prepared to be told you may not be as funny as you think you are.

If you want to write new rules for a game, then be our guest. We cannot promise that we will like what you have done, but you will get constructive criticism in return, and not just a terse one-line rebuff.

Editing

It is a painful fact that whatever you write, it will get edited. That is why editors exist, after all. Even this passage will have been edited. If you can get over this hurdle you are well on your way to attaining the mentality needed to be a writer. It will help if you can handle criticism as well. Take it from us – writing is a tough business. Just ask any author doing the rounds looking for a friendly publisher.

We have various house styles that we use and you do not need to know them. As long as your submission is literate and tidy, we will do the rest.

Little Details

If you are not sure how long your article is, assume around 800 words fit on one page. Do not use the word processor's page counter as a guide. By the time it has been edited, laid out and had artwork added, it will look nothing like that screen of text in front of you.

Remember to run the article through a spell checker before you send it in. It will still get proofread, but it shows willing. Anything not spell checked will be rejected straight away.

Legal Requirements

Be aware that to work for Mongoose Publishing, you will have to sign a contract with us. There will also be a commissioning form for each specific story. Any work which you then generate specifically for Mongoose Publishing under the terms of that agreement will belong to Mongoose Publishing, together with all the publishing rights.

Who do I write to?

Signs & Portents
Mongoose Publishing
52-54 Cricklade Road
Swindon
Wiltshire
SN2 8AF
UK
email: claw@mongoosepublishing.com



UK
GEN CON
THE BEST FOUR DAYS IN GAMING!

28th - 31st August 2008
University of Reading, UK

Boardgames • Roleplaying • Card Games
Live Action Role Play • Miniatures • Computer Games

Illustration by Andrew Hepworth, © Andrew

For more information visit:
www.genconuk.com/s

MONGOOSE PUBLISHING PRODUCT LIST

Battlefield Evolution

MGP 444101	EFTF British Army Infantry Section	\$29.95
MGP 444102	EFTF Challenger 2 Main Battle Tank	\$24.95
MGP 444103	USMC Infantry Squad	\$29.95
MGP 444104	USMC M1A2 Abrams Main Battle Tank	\$24.95
MGP 444105	PLA Infantry Squad	\$29.95
MGP 444106	PLA Type 99 MBT	\$24.95
MGP 444107	MEA Infantry Squad	\$29.95
MGP 444108	MEA Technicals Squadron	\$29.95
MGP 444109	EFTF British Army Command Section & Warrior	\$29.95
MGP 444111	MEA Fedayeen Squad	\$29.95
MGP 444112	PLA WZ551 IFV	\$24.95
MGP 444114	USMC Shadow RST-V Squadron	\$29.95

Victory at Sea

MGP 4050	Victory at Sea Main Rulebook	\$29.95
MGP 4052	Victory at Sea: Order of Battle	\$29.95

A Call to Arms

MGP 3400	A Call to Arms Second Edition Rulebook	\$24.95
MGP 3401	A Call to Arms Second Edition - Fleet Lists	\$29.95
MGP 3384	Sky Full of Stars Counter Set	\$19.95
MGP 3387	The Ancients Boxed Set	\$47.95

RuneQuest

Core

MGP 8100	RuneQuest Core Rules	\$24.95
MGP 8102	GM Screen	\$14.95
MGP 8103	RuneQuest Monsters	\$34.95
MGP 8104	RuneQuest Companion	\$24.95

MGP 8106	Legendary Heroes	\$24.95
MGP 8108	Arms and Equipment	\$24.95
MGP 8111	Rune of Chaos	\$9.95
MGP 8138	RuneQuest Spellbook	\$29.95
MGP 8143	RuneQuest Deluxe	\$39.95

Glorantha

MGP 8101	Glorantha: The Second Age	\$34.95
MGP 8105	Cults of Glorantha, Volume I	\$24.95
MGP 8107	Magic of Glorantha	\$24.95
MGP 8109	Player's Guide to Glorantha	\$27.95
MGP 8112	Uz: The Guide to Trolls	\$27.95
MGP 8115	The Clanking City	\$24.95
MGP 8120	Cults of Glorantha, Volume II	\$24.95
MGP 8123	Jrustela	\$24.95
MGP 8124	Dragonewts: Guide to the Eravssarr	\$24.95

Lankhmar

MGP 8110	Lankhmar	\$34.95
MGP 8113	Nehwon	\$27.95

Eternal Champion

MGP 8119	Hawkmoon The Roleplaying Game	\$29.95
MGP 8144	Hawkmoon: Secrets of Tragic Europe	\$24.95
MGP 8121	Granbretan	\$27.95
MGP 8116	Elric of Melniboné	\$33.95
MGP 8140	Elric of Melniboné: Bright Shadows	\$24.95
MGP 8150	Elric of Melniboné: Companion	\$24.95
MGP 8146	Elric of Melniboné: Magic of the Young Kingdoms	£29.95

Slaine

MGP 8142 RuneQuest Slaine \$39.95

Historical

MGP 8137 RuneQuest: Land of the Samurai \$24.95

Babylon5

MGP 3331 The Fiery Trial \$24.95
 MGP 3332 The Coming of Shadows \$24.95
 MGP 3333 The Earth Alliance Fact Book \$34.95
 MGP 3334 The Minbari Federation Fact Book \$34.95
 MGP 3335 Point of No Return \$24.95
 MGP 3336 The Centauri Republic Fact Book \$34.95
 MGP 3338 The Narn Regime Fact Book \$34.95
 MGP 3339 The Technomages \$24.95
 MGP 3340 The League of Non-Aligned Worlds Fact Book \$34.95
 MGP 3341 Babylon 5 Galactic Guide \$34.95
 MGP 3342 No Surrender, No Retreat \$24.95
 MGP 3344 The Zocalo \$24.95
 MGP 3345 The Psi Corps \$24.95
 MGP 3346 The Rangers \$24.95
 MGP 3348 Into the Crucible \$24.95
 MGP 3349 Wheel of Fire \$24.95
 MGP 3350 Free Mars \$24.95
 MGP 3351 Crusade \$24.95
 MGP 3352 The Athena Strain \$14.95
 MGP 3353 Hyperion Ship Plan \$19.95
 MGP 3354 EarthForce Campaign Book \$29.95
 MGP 3355 Darkness and Light \$29.95
 MGP 3356 Merchants, Traders and Raiders \$29.95
 MGP 3357 G'Quan Ship Plan \$19.95
 MGP 3358 Primus Ship Plan \$19.95
 MGP 3500 Babylon 5 2nd Edition Roleplaying Game \$49.95
 MGP 3501 The Cold Equations \$9.95
 MGP 3502 The Ragged Edge \$29.95

MGP 3505 Ships of the Galaxy \$29.95
 MGP 3506 Ship Builder's Manual \$24.95
 MGP 3507 Babylon 5 Station Guide \$49.95
 MGP 3508 Final Flight of Santiago \$9.95
 MGP 3509 The Drakh \$24.95
 MGP 3510 2nd Edition GM's Screen \$14.95
 MGP 3513 Bounty Hunter \$24.95
 MGP 3514 Heroes and Aliens \$24.95
 MGP 3515 Freedom Station \$27.95
 MGP 3516 IPX \$24.95
 MGP 3517 The Rim \$27.95
 MGP 3520 The Lurker's Guide to pak'ma'ra \$27.95
 MGP 3523 The Lurker's Guide to Telepaths \$27.95
 MGP 3524 Legend of the Rangers \$27.95
 MGP 3525 The Lurker's Guide to Starports \$24.95
 MGP 3522 Thirdspace \$24.95

Boardgames

MGP 5101 Discworld: Thud \$39.95

Complete Campaigns

MGP 3102 The Drow War I: The Gathering Storm \$34.95
 MGP 3103 The Drow War II: The Dying Light \$34.95
 MGP 3104 The Drow War II: The Darkest Hour \$34.95

Conan

MGP 7800 Conan the Roleplaying Game: Second Edition \$49.95
 MGP 7702 The Scrolls of Skelos \$24.95
 MGP 7703 The Road of Kings \$34.95
 MGP 7704 The Pirate Isles \$24.95
 MGP 7705 Conan GM's Screen \$14.95
 MGP 7706 Across Thunder River \$34.95
 MGP 7707 The Free Companies \$24.95
 MGP 7708 Shadizar: City of the Wicked \$39.95

MGP 7709	Messantia: City of Riches	\$39.95
MGP 7710	Aquilonia	\$34.95
MGP 7711	Pocket Conan RPG	\$19.95
MGP 7713	Hyboria's Fiercest: Barbarians, Borderers and Nomads	\$24.95
MGP 7714	Tales of the Black Kingdom	\$19.95
MGP 7715	Hyboria's Finest: Nobles, Scholars and Soldiers	\$24.95
MGP 7716	Heretics of Tarantia	\$9.95
MGP 7717	Hyboria's Fallen: Pirates, Thieves and Tempresses	\$24.95
MGP 7718	The Lurking Terror of Nahab	\$9.95
MGP 7719	Tower of the Elephant	\$9.95
MGP 7721	Tito's Trading Post	\$24.95
MGP 7722	Stygia	\$29.95
MGP 7723	Faith and Fervour	\$24.95
MGP 7724	Ruins of Hyboria	\$29.95
MGP 7725	Argos and Zingara	\$24.95
MGP 7727	Reavers of the Vilayet	\$9.95
MGP 7728	Shem	\$24.95
MGP 7729	Conan Compendium	\$24.95

Flaming Cobra

MGP 6101	Secret Societies	\$24.95
MGP 6102	The Immortals Handbook: Bestiary	\$27.95
MGP 6104	Nephandum	\$33.95
MGP 6100	Spycraft 2.0	\$49.95
MGP 6103	Spycraft: World on Fire	\$34.95
MGP 6107	Cthulhutech	\$39.95

Macho Women with Guns

MGP 1400	Macho Women with Guns	\$34.95
----------	-----------------------	---------

Paranoia

MGP 6630	Paranoia	\$34.95
MGP 6631	Paranoia GM's Screen	\$14.95
MGP 6632	The Traitor's Manual	\$21.95
MGP 6633	Crash Priority	\$14.95
MGP 6634	The Mutant Experience	\$21.95
MGP 6635	Paranoia Flashbacks	\$34.95
MGP 6636	Paranoid STUFF	\$21.95
MGP 6109	STUFF 2 – The Gray Subnets	\$27.95
MGP 6637	WMD	\$14.95
MGP 6638	Extreme Paranoia	\$24.95
MGP 6639	Service, Service	\$21.95
MGP 6640	Criminal Histories	\$14.95
MGP 6641	The Underplex	\$14.95
MGP 6643	Sector Zero	\$9.95
MGP 6646	The Little RED Book	\$9.95
MGP 6650	Paranoia Flashbacks II	\$24.95
MGP 6657	My First Treason/Sweep of Unhistory	\$19.95
MGP 6660	Paranoia Mandatory Card Game	\$24.95
MGP 6658	Alpha Complex Nights	\$24.95

Starship Troopers

MGP 5550	Blaze of Glory Book I: Alamo Bay	\$14.95
----------	----------------------------------	---------

Mail Order Form

Code	Product	Price
		\$
		\$
		\$
		\$
		\$
		\$
		\$
		\$
		\$
		\$
		\$
		\$
		\$
		\$
		\$
		\$
		\$
		\$
		\$
		\$
		\$
		\$
		\$
		\$

MY DETAILS

Title (Mr/Mrs, etc.) Forename

Date of Birth (dd/mm/yyyy) / / Surname

Address (1st line)

Address (2nd line)

State/County

Post code/Zip code

Country

email

Total (including postage) \$

Postage rates: USA \$5 + 10% of total; Rest of World \$5 + 20% (for UK cheques please email for rates: kgeorge@mongoosepublishing.com)

PAYMENT OPTIONS

Cheque (US only) (made payable to Mongoose Publishing Ltd.)
 Mastercard Visa Visa Delta

Card No.

Valid From **Expiry Date**

Signature **Date** / /

Return Address: Mongoose Publishing, 52-54 Cricklade Road, Swindon, Wiltshire, SN2 8AF, UK.

The data provided will be held and processed under the terms of the Data Protection Act and will not be shared with third parties. We may from time to time email you with special offers and subscription information.

OPEN GAME LICENSE Version 1.0a

The following text is the property of Wizards of the Coast, Inc. and is Copyright 2000 Wizards of the Coast, Inc ("Wizards"). All Rights Reserved.

1. Definitions: (a) "Contributors" means the copyright and/or trademark owners who have contributed Open Game Content; (b) "Derivative Material" means copyrighted material including derivative works and translations (including into other computer languages), potation, modification, correction, addition, extension, upgrade, improvement, compilation, abridgment or other form in which an existing work may be recast, transformed or adapted; (c) "Distribute" means to reproduce, license, rent, lease, sell, broadcast, publicly display, transmit or otherwise distribute; (d) "Open Game Content" means the game mechanic and includes the methods, procedures, processes and routines to the extent such content does not embody the Product Identity and is an enhancement over the prior art and any additional content clearly identified as Open Game Content by the Contributor, and means any work covered by this License, including translations and derivative works under copyright law, but specifically excludes Product Identity. (e) "Product Identity" means product and product line names, logos and identifying marks including trade dress; artifacts; creatures characters; stories, storylines, plots, thematic elements, dialogue, incidents, language, artwork, symbols, designs, depictions, likenesses, formats, poses, concepts, themes and graphic, photographic and other visual or audio representations; names and descriptions of characters, spells, enchantments, personalities, teams, personas, likenesses and special abilities; places, locations, environments, creatures, equipment, magical or supernatural abilities or effects, logos, symbols, or graphic designs; and any other trademark or registered trademark clearly identified as Product identity by the owner of the Product Identity, and which specifically excludes the Open Game Content; (f) "Trademark" means the logos, names, mark, sign, motto, designs that are used by a Contributor to identify itself or its products or the associated products contributed to the Open Game License by the Contributor (g) "Use", "Used" or "Using" means to use, Distribute, copy, edit, format, modify, translate and otherwise create Derivative Material of Open Game Content. (h) "You" or "Your" means the licensee in terms of this agreement.

2. The License: This License applies to any Open Game Content that contains a notice indicating that the Open Game Content may only be Used under and in terms of this License. You must affix such a notice to any Open Game Content that you Use. No terms may be added to or subtracted from this License except as described by the License itself. No other terms or conditions may be applied to any Open Game Content distributed using this License.

3. Offer and Acceptance: By Using the Open Game Content You indicate Your acceptance of the terms of this License.

4. Grant and Consideration: In consideration for agreeing to use this License, the Contributors grant You a perpetual, worldwide, royalty-free, non-exclusive license with the exact terms of this License to Use, the Open Game Content.

5. Representation of Authority to Contribute: If You are contributing original material as Open Game Content, You represent that Your Contributions are Your original creation and/or You have sufficient rights to grant the rights conveyed by this License.

6. Notice of License Copyright: You must update the COPYRIGHT NOTICE portion of this License to include the exact text of the COPYRIGHT NOTICE of any Open Game Content You are copying, modifying or distributing, and You must add the title, the copyright date, and the copyright holder's name to the COPYRIGHT NOTICE of any original Open Game Content you Distribute.



7. Use of Product Identity: You agree not to Use any Product Identity, including as an indication as to compatibility, except as expressly licensed in another, independent Agreement with the owner of each element of that Product Identity. You agree not to indicate compatibility or co-adaptability with any Trademark or Registered Trademark in conjunction with a work containing Open Game Content except as expressly licensed in another, independent Agreement with the owner of such Trademark or Registered Trademark. The use of any Product Identity in Open Game Content does not constitute a challenge to the ownership of that Product Identity. The owner of any Product Identity used in Open Game Content shall retain all rights, title and interest in and to that Product Identity.

8. Identification: If you distribute Open Game Content You must clearly indicate which portions of the work that you are distributing are Open Game Content.

9. Updating the License: Wizards or its designated Agents may publish updated versions of this License. You may use any authorized version of this License to copy, modify and distribute any Open Game Content originally distributed under any version of this License.

10. Copy of this License: You MUST include a copy of this License with every copy of the Open Game Content You Distribute.



Abaddon
Books



TOMES OF
THE DEAD:
DEATH
HULK

Matthew Sprange
p/b £6.99



THE
AFTERBLIGHT
CHRONICLES:
THE CULLED

Simon Spurrier
p/b £6.99



DREAMS
OF INAN:
A KIND OF
PEACE

Andy Boot
p/b £6.99



SNIPER
ELITE:
THE SPEAR
OF DESTINY

Jaspre Bark
p/b £6.99

FROM THE PUBLISHERS OF
2000 AD COMES A NEW
WORLD OF FICTION

“Abaddon promises to deliver a whole new generation of dark fantastic fiction. New voices, new nightmares, stylish, powerful and taboo breaking.”

- Clive Barker

SIGN UP FOR THE
ABADDON NEWSLETTER AT
WWW.ABADDONBOOKS.COM

available August 2006