

NOVEMBER

77

Polyhedron[®]

NEWSZINE



RPGA[®]
NETWORK

© 1992 TSR, Inc. All Rights Reserved.



Convention Sights

Views of Aloha Con—July 4th, Honolulu, HI
and Glathricon—June 12-14, Evansville, IN



Polyhedron[®]

NEWSZINE

Volume 12, Number 11
Issue #77, November, 1992

SPECIAL FEATURE

- 9 Downunder the Living City – by Wayne Straiton**
Tackle this mystery and give your characters a chance to get their feet wet.

FEATURES

- 14 Weather – by Harold Johnson**
Here's a way to tell if the wind blows for good or ill on the world of Krynn.
- 24 The Living City – by Jack D. Graham**
A few coins and a few hours at Elonia's Beauty Shoppe can turn even a modest citizen into a temporary star.
- 27 Enigma**
This issue's contest.
- 28 Hey Rocky – by Kevin Rau**
A veteran judge offers advice on preparing to run your next Network event.
- 29 Cutting Remarks – by Mike Sellner**
A crossword that will challenge your knowledge of gaming and, well, other forms of popular entertainment.
- 30 The Bard's Corner**
Don Bingle of the PM players penned this skit about the perils of being a gamer in the 90s.

EDITORIAL

- 4 Notes From HQ – by Skip Williams**
A few hints to aspiring authors about the types of submissions we'd like to see.
- 5 Letters – by the members**

DEPARTMENTS

- 2 The Network in Pictures**
- 7 The Everwinking Eye – by Ed Greenwood**
Dress warmly and keep your weapons handy as we embark on a tour of the chilly Moonsea.
- 18 The Living Galaxy – by Roger Moore**
Our columnist takes a stop at Pluto on the way to unveiling the secrets of creative adventure design.
- 22 Into The Dark – by James Lowder**
Bring the mischief of one of fiction's greatest villains, Dr. Fu Manchu, to your television screen.



About the Cover

Could this scene of watery peril await your PCs? Go "Downunder the Living City" (page 9) and find out. Art by Terry Pavlet.

Publisher
James M. Ward

Editor
Jean Rabe

Associate Editor
Skip Williams

Graphic Director
Larry W. Smith

Cartographer
Brian J. Blume

Production Staff
Tracey Zamagne
Norm Ritchie

Subscriptions
Charmaine Snyder



Notes From HQ

What You Can Do For Your Newszine

Right now, you are holding the most important benefit of Network membership in your hands. POLYHEDRON® Newszine serves as the Network's voice and is the one item that every member gets to enjoy (provided that you make sure HQ has your current address).

The Newszine and You

The single biggest reason people don't get Newszines is because they move and don't tell HQ. This is a serious problem, and here's why: Jean and I usually start work on a Newszine six months before the cover date. We're a little behind on this issue because of the GEN CON® Game Fair; nevertheless, I'm working on this missive during the second week of August and this is the November issue. After the Newszine goes through editing, typesetting, and layout it is shipped to our printer two months before the cover date. One to three weeks later, our computer generates mailing labels and we ship them to the printer. This means that if you move, then tell us about it you are certain to miss a Newszine, since the mailing labels are printed five to seven weeks in advance. As we've mentioned before, a forwarding order in the U.S. does not help you get your Newszine because it travels by third class mail, which does not get forwarded. To get uninterrupted delivery, you must give us a change of address *before* you move. Believe it or not, we have members who wait six months or more to file a change of address with us. Those people do not get their back issues, so try not to become one of them.

The best way to file a change of address is to give us a call. Have your membership number handy when you call—it helps us locate your records more quickly. Mailing in a change of address is risky, since mail can be pretty slow at different times of the year. Putting your new address on a tournament voting sheet and hoping somebody at HQ will notice your address has changed is foolish. Some members actually write "New Address" in big letters on their sheets, so we do notice the change, but some convention organizers wait weeks or even months to return their results. Also, results might wait days or weeks here at HQ

before they are processed—even in the best circumstances you're almost certain to miss an issue. Call instead.

Getting Involved

Five or six years ago, not many members took the opportunity to share ideas with their fellow members through the Newszine.

Things are quite a bit better these days. Convention announcements and classified ads are fairly pouring in, and so are entries for our *Living City* and *New Rogues Gallery* features. All of this is very good for the Newszine and for the membership.

On the other hand, letters to the editor are still pretty scarce, our *Network News* section has all but died in its infancy, submissions for feature articles (material that is not for a regular column or continuing feature) are rare, and submissions that don't deal with the AD&D® game are practically nonexistent.

How You Can Contribute

Every member is invited to submit material for the Newszine. Here are a few ways to do so:

Letters to the editor: When you see something in the Newszine or elsewhere that makes you want to write a letter, don't delay. We try to keep the topics in the letters column current. If you wait more than a week or two before sending us anything it's likely to be stale by the time your fellow members read it—so we probably won't print it.

The New Rogues Gallery: Remember that the Newszine accepts material for any popular role playing game. If you're one of those readers who has complained about too much AD&D game material in the Newszine, a *New Rogues Gallery* submission would be a great way to get material for your favorite game printed.

The Living City: This feature is very popular with both readers and authors (we get more *Living City* submissions than anything else). Accordingly, we can afford to be picky when reviewing them. Your *Living City* submission has the best chance of being accepted if it follows our format (see *Elonia's Beauty Shoppe* in this issue for an example), follows the rules for

the AD&D 2nd edition game, and offers a fairly comprehensive description of what the business or NPC does and for whom. Connections and interactions with other characters or institutions in Ravens Bluff are a definite plus. Check out the *Eor-mennoth* entry in issue #76 for an example of an NPC that has been well integrated into the Ravens Bluff setting. HQ still gets complaints that *Living City* NPCs are too powerful. If you feel this way, submit something that features low-level NPCs.

Feature articles: We're always on the lookout for new spells, magic items, and monsters. We also like to get "how to" articles, puzzles, and personal anecdotes about conventions and other gaming experiences. Two things to note here: First, we rarely let articles of this type run more than four pages in the Newszine; this means your submission should be no longer than 16 double-spaced pages. Second, we publish very little fiction. You are much better off submitting a short story that involves the characters in an accompanying *New Rogues Gallery* or *Living City* submission than you are with a stand-alone short story.

Adventures; Virtually all the Newszine's adventures started out life as sanctioned Network tournaments. You are better off submitting adventures to our tournament program than to the Newszine. Once your scenario has been run successfully as a tournament it has a good chance of seeing print in the Newszine. If you do want to submit a scenario directly to the Newszine, keep it short—10 double-spaced pages or less.

Things to remember: We cannot look at anything you submit unless you also use a *standard disclosure form*. A form appears in this issue. Be sure to ask for our submission guidelines. If you want us to acknowledge your submission, include a stamped and addressed postcard. If you want us to return your submission, include an addressed envelope that is large enough to hold your manuscript and has enough postage to cover the cost of mailing it back.

Good Gaming,

Skip

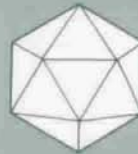

Letters

Greetings from Oregon

I suppose after almost a year and a half in the RPGA™ Network I might have some thoughts on the magazine. Overall, I like what you guys are doing.

There are a few things you did over the past few issues that I particularly liked. One was printing "Fluffynolia." I've begun to map out my own Fluffy adventure recently, and now I have a vague understanding of how that works.

Perhaps you can tell me what to do if an adventure is sent to the RPGA Network by someone who will not be at the GEN CON® Game Fair. Does the writer have to be there in person? Can people run other people's adventures at cons? And how is that arranged? (Of course, I'm assuming the adventure had better be pretty darn good.) Is there a limited selection of games that can be run as RPGA Network tournaments?

You can count on at least one letter writer who likes *Wolff & Byrd*. It isn't so much a game-joke comic as a genre-joke comic, and I like that. Jokes about saving throws can miss alarmingly often. I hope you keep putting them in every so often. The "Doctor Whoot" storyline in *Bloodmoose & Company* is also very familiar for obvious reasons—what does Bloodmoose do at home?

At first I wondered what a movie column was doing in an RPG magazine, but *Into The Dark* has grown on me.

Michael Hopcroft
Portland, OR

Michael, it seems that Into The Dark has grown on quite a few members. Many members write in that they use the plots from movies as role-playing scenarios.

Now, on to your comments about tournaments. RPGA Network tournaments are played throughout the world—not just at the GEN CON® Game Fair. In fact, we support between 120 and 150 conventions a year. If you write a tournament and we accept it, that scenario will play at many conventions. Of course, we try to make sure that at least one of those conventions is one the author will attend. So, when you submit a tourna-

ment, include a letter saying which conventions you go to. Some authors even request that their tournament be used at a specific convention, and we do our best to accommodate them.

The Network is always in need of tournaments. As of this writing, we had a backlog of tournaments to read through. Now that the Game Fair is over, however, and several of our other projects are out of the way, we'll be reading manuscripts.

We are particularly interested in receiving two-and three-round AD&D® game tournaments. At the moment it seems we have quite a few one-round tournaments for a variety of game systems. However, many conventions throughout the world run multi-round events.

If you're interested in writing tournaments for the Network, send us a note and we'll send you our tournament writing guidelines.

For a sample of what a tournament looks like, read Valley of Death in this issue. Most adventures we run in the Newszine were first played as tournaments. So, if you want to have an adventure published in the POLYHEDRON® Newszine, write a tournament.

Dear Name And Address Withheld

This is in reply to your August hack job of a letter. You sound like you're from the Milwaukee area, since you mention the Winter Fantasy™ convention and the GEN CON Game Fair. I write this with no hostile intent, I'm kinda even on your side.

The Network is not declining. I have been working with HQ for the past two years. Compared to what the Network was like in 1985, the HQ staff is just coming into their own.

The opportunity to get published in the Newszine is reward enough for the MEASLY membership fees, and more than many could hope for without them. When the Newszine does publish your work, you get your name on it and, best of all, the Network just "borrows" your stuff—you still own it.

The Network has doubled their production of Newszines, and not their

price! I think that is quite acceptable.

I could defend the Network staff all day—those four overworked individuals, backlogged to the beginning of time, staying late hours on a regular basis, and busting their hit points to produce good, quality, work at the pace the world seeks to have it. But that is not why I'm writing.

I have been GMing and playing for 14 years now, and there isn't a module in existence that can't be played well. You have to draw your fun out of a scenario. Good play comes from the imagination, not a sheet of paper. In fact, writing too

POLYHEDRON™ Newszine (the official newsletter of TSR Inc.'s ROLE PLAYING GAME ASSOCIATION™ Network) is published monthly by TSR, Inc. The mailing address for all correspondence is: P.O. Box 515, Lake Geneva, WI 53147. Telephone: (414)248-3625.

POLYHEDRON Newszine is mailed free to all RPGA™ Network members. US membership rates are \$20 per year (bulk mail delivery only); Canadian rates are \$25; foreign rates are \$32 per year (surface mail) or \$60 per year (air mail). All prices are subject to change without notice. Changes of address for the delivery of membership materials must be received at least 30 days prior to the effective date of the change to ensure uninterrupted delivery.

POLYHEDRON Newszine welcomes unsolicited submissions of written material and artwork that are accompanied by our Standard Disclosure Form. No responsibility for such submissions can be assumed by the publisher in any event. No submission will be returned unless it is also accompanied by a self-addressed, stamped envelope of sufficient size.

Unless special arrangements to the contrary are made prior to publication, materials submitted to the publisher for publication in POLYHEDRON Newszine are accepted solely upon the condition that the materials may be edited and published in POLYHEDRON Newszine or used in RPGA™ Network sanctioned tournaments, conventions and events without cost to the publisher. TSR and the RPGA Network shall make no other use of the materials unless TSR and the author or artist enter into a written agreement regarding such use.

TSR grants to prospective authors a non-exclusive right to use copyrighted materials of TSR in their submissions to TSR. An author, however, shall have no right to publish or to permit someone other than TSR to publish a submission that includes any copyrighted materials of TSR without first obtaining the written permission of TSR to do so.

All letters addressed to the RPGA Network or to TSR, Inc., will be considered as submissions and may be printed in whole or in part at the discretion of the editor unless the sender specifically requests otherwise in writing.

Unless otherwise stated, the opinions expressed in POLYHEDRON Newszine are those of the individual authors, and do not necessarily reflect the opinions of TSR, Inc., the RPGA Network, or its staff.

Standard Disclosure Forms, POLYHEDRON Writing Guidelines, Tournament Request Forms, Membership Forms, Club Forms, and Classified Ad Forms are available from Network HQ.

BUCK ROGERS and XXVc are trademarks owned by The Dille Family Trust.

* designates registered trademarks owned by TSR, Inc.
* designates trademarks owned by TSR, Inc.

Most other product names are trademarks owned by the companies publishing those products. Use of the name of any product without mention of trademark status should not be construed as a challenge to such status.

©1992 TSR, Inc. All Rights Reserved.

much information into an adventure limits the players' options and steals the individual freedom of each GM. A good scenario is just an outline for an exciting adventure. Just last year I GM'd the winning team in *Beholder Wars*, the Game Fair's AD&D® game open tournament. Believe me, there were many complaints about that baby. It seemed everyone hated it. What irked me was the efforts of some players to monotonously race their way to the end. But I wouldn't let them avoid the many devious personalities that I felt appropriate for the NPCs and NPTs (non-player things) in the adventure. Before long everyone was caught up in the game and had to add their own bits of hilarity. During one session, no one sat down, in another the players were on the floor laughing. All had suspense, intrigue, and role playing to thank. None of these things can exist on paper alone, no matter how well written a scenario is. Nor can a GM do it alone. You need to start a chain reaction, and then everyone plays off of each other. Not even a bad case of hack and slash gaming should kill role playing.

You see, it's all up to you. Show people a good time of real role playing gaming, whether you are the GM or a vocal player, and they'll come back for more.

One final comment. I've seen the "royal members" of RPGA in action as GMs and Players and they're awesome! If you ever run into Jean, ask her about a certain regenerating carp. If only you could have seen it! (If only I could have seen it, members of my club told me about it, and I heard the laughter from four cubicles away!)

Other than that, look us up if you truly are in the area, we'd be happy to drive you crazy with role playing!

Brian Miller
President, Wizards Circle
New Berlin, WI

This letter is in response to "Name And Addressed Withheld" in issue #74. I read this letter with disbelief, setting down the Newszine several times before reading it through. I felt that HQ's reply could have been a bit stronger on some points, and I wanted to add my voice.

I wrote a reply several pages long. I quoted examples from POLYHEDRON® Newszines #1-10 to show how the Network has changed for the better. I calculated out how much work was involved in a year's worth of tournaments, con-

sidering the total number of rounds and each scenario's player characters. I mentioned my file cabinets full of scenarios, none of them "nearly unreadable." I replied to each of this person's points in turn, a bit less diplomatically than HQ did. I reread the whole thing, smiled in satisfaction, then realized what I really wanted to say. I erased the letter from my computer and started over.

What I really wanted to say is: You folks do a really good job!

Willi Burger, Jr.
New Fairfield, CT

Thank you, Brian, Willi, and all the other members who wrote in to support us after reading the Letters column in issue #74. It's very gratifying to learn that so many members agree that the Network is moving in the right direction. As for Brian's carp, we assume he's referring to one of the hengeyokai characters from Bend in the River the 1991 club event at the Game Fair. The method was simple, just run with it for all it's worth (but being able to purse your lips so you look like a gaping fish doesn't hurt).

Kids are Gamers, Too

I'd like to respond to the letter on young gamers by Robert Cannon in issue #71 and to the HQ follow-up.

First, I'd like to say I know where Robert is coming from. I have gamed since the age of 10 myself, and I have played RPGA™ Network events since I was 15. So I know first-hand that the treatment of young gamers is far from what it should be.

While I'm older now (22), I know how tough it is to sit at a table with guys more than twice your age. You sometimes get comments like "kid," "pup," and other non-flattering remarks that describe just how old you are compared to them. So, I would like to offer some wisdom I've picked up over the past 12 years.

First, don't carry a chip on your shoulder toward every gamer over 30. There are quite a few very friendly and good gamers out there over 30 who don't have an age prejudice. Also, try not to stereotype them, it's stereotypes that put younger gamers on the dirty end of the stick in the first place.

Second, try to get into campaigns on a trial basis. Try to get your foot in the door by saying "Give me a few weeks to

see what you all think." When you do get in a game, know the rules fairly well. I'm not talking page by page, but a working comprehension. Also, you might want to avoid playing chaotic types. The young, out-of-control player is one of the stereotypes I referred to earlier. Try your hand at a cool-headed character, then try other things.

Next, don't be discouraged when you run into the older, arrogant types who have a low opinion of young gamers. If, in a tournament style game, you run into this type, be assertive! Don't get pushed aside; show them you have something constructive to add.

Now, I'd like to address a question brought up by HQ about perhaps starting an under 16 division. No! No! No! I know this question was brought up with good intentions, but I feel its impact would be counter-productive. I know I got better as a player from playing with older, more experienced, and, frankly, better gamers. I picked up on things they did and what they brought out in their characters. I often (almost always) lost, but I gained valuable experience that let me rise to a comparable level of skill. A 16 and under division wouldn't allow young players to learn from the best. Also, a segregated division by age would put yet another barrier between the generations. What mingling that happens now between the younger and older gamers would almost totally cease.

To conclude, I'd like to say to the younger gamers, "Stick with it." I've found role playing rewarding and fun. And it doesn't matter how many letters are written asking people to treat younger players better. There will still be some prejudice and condescension out there. So try to deal with it the best you can. And every time you get slighted because of your age by older gamers, remember how you feel. Someday you will be the older gamer. Let those memories guide your treatment of the crop of gamers after us. Maybe someday this won't be a problem if today's young gamers now remember.

I remember.

John Reynolds
Evansville, IN

Thanks for the advice, John. We hope all our tournament players, young and old, take it to heart.

We'll record one resoundingly negative vote for a 16-and-under division, What does everyone else think?

The Everwinking Eye

Moonsea Shores

by Ed Greenwood

"It lies across your path like a cold, gray, deadly sword, storms and serpents of the deep both lurking to claim those who try to cross it, aye. Yet think not so ill of the cold Moonsea—sword it may be to you, but 'tis also your shield, against the ogres and worse. If it was not there, they'd long ago have swept away elves and all, to seize what we call Sembia for their own, and perhaps you'd be bowing to Orogh the One-And-Twentieth, Ogre-King of all the North!"

Hlammadar Urlyn, Sage of Elmwood,
Speeches I Have Given
Year of the Bloodied Sword

We've spent some time clearing up details over tankards and a warm fire, but I assure you Elminster has no intention of abandoning our exploration of the Realms. During a recent meeting, he declared himself heartily sick of dealing with the cold and ruthless citizens of Mulmaster, but added with a tight grin that it was high time to turn to the *other* cold and ruthless inhabitants of the Moonsea area: those who rule in Zhentil Keep, far to the west and north.

To get there, one must set sail across the icy, purple-gray waves of the Moonsea.

The Moonsea and its Cities

The grim stone cities on the north shore of the Moonsea supply much of the metal used in the Inner Sea lands. Their glowing furnaces refine ores that have been laboriously hewn from the rock in deep mines north and east of Glistler, in the orc-haunted Dragonspine Mountains—and from beyond that, in cold and desolate Thar.

Long ago, the Moonsea was known to all as the Dragon Sea because dragons met to breed in the peaks around it, and some wyrms could almost always be seen aloft above its waves. Their aerial raids in search of food took a heavy toll on beast-men (ogres), who often streamed south in hordes from the broken lands and bare rock plateaus of Thar toward the elven forests. The dragons reduced these conquering armies to mere hand-

fuls of desperate raiders.

The climate is harsh, and land is a brutal frontier of human civilization, but the raw wealth of cities here outstrips that of many older and prouder cities to the south.

From Mirrormoss Bay (to the elves, Neirthoura, "Stars-In-The-Water"), where the Dragon Reach narrows to its northern end, ships of even deep draft can sail up the broad river Lis (to the elves, Nuathlis) to Lisenmouth, and to the deeper, darker waters of the Moonsea.

To the east of the Lisen Sands rise the brooding fortresses of Mulmaster and Ironfang Keep. North across the often-stormy waters rise rugged peaks where dragons still lair and the broken, scattered stones of lost Hulburg and Sulyaspryn.

East of these now-desolate anchorages is the narrow Ice Gorge, where great treasure is said to lie hidden. Some two hundred winters ago, an ice bridge collapsed beneath the weight of a horde of orcs carrying rich booty back from raids on the Vast. Hundreds of screaming orcs fell into the rocky depths of the gorge, laden with much gold, gems, and stolen weaponry. If any part this lost hoard has ever been recovered, no whisper of it has come to human ears.

A ship turning west from the Lis and going along the south coast of the Moonsea would first come upon the quiet town of Elmwood, home to fishermen and skilled woodcarvers. A few streets lined with stone cottages rise from the modest harbor. Small, rock-walled farms surround the village. The farmers rear sheep and goats, and grow radishes, carrots, and potatoes.

West of Elmwood's farms is the broad mouth of the clear, swift-running River Duathamper ("Elvenflow"). It is navigable with portaging (by small, narrow boat only) upstream as far as Hammer Ford, where Halfaxe Trail crosses it. No trade came this way while the elves held the Elven Court; they barred humans from the vast woodland that marches along the Moonsea coast for three days' ride west of the river. Old fears die hard, and since the elves left, few have dared to venture far into the vast green depths.

The Elven Court falls away southwest

from the coast at Elventree, a forest settlement where the elves met and traded with other races while they held these lands in strength. Long a haven for rangers, artists, half-elves and druids, it has become an outpost of Harpers and the abode of at least two powerful "good" wizards: Shalantra the Sorceress (CG hf W14) and Halave "the Black Wyvern" (CG hf m W12). Halave is famous for the spell he devised that enables him to take on the shape and powers of a wyvern during darkness.

Elventree is a place of forest trails, cave homes, and hollowed-out trees. The settlement is lit by *glowing globes* of various soft hues, and enlivened from time to time by soft harp music and piping.

Orcs, Zhentarim, and Mulmasterite raiders avoid this tranquil refuge amid the trees—it is said to be protected by arch lichs and other kindly but powerful undead, to be frequented by a flight of faerie dragon pranksters, and to have a magical guardian monster of some sort lurking in its harbor.

Elventree has no ruler or laws; its ways are those of the Harpers, the elves, and the followers of Mielikki, Eldath, and Silvanus. It is defended by the more powerful of its inhabitants—who include the clergy of temples to Mielikki and to Midnight (formerly Mystra) hidden in the vicinity.

The interior of the temple to Mystra is said to be a dark void where a glowing, white, disembodied female arm floats in company with magical creatures akin to will-o-wisps. The arm carries out the will of the Goddess. It is said that at least one archmage of awesome power tends the arm. He is a mysterious human who keeps himself masked and often goes about in the shapes of other creatures.

A ship sailing west from the tiny bay that is Elventree's harbor will pass near the muffled, mournful tolling of The Bell In The Depths, a now-sunken tower believed by most sages to be Northkeep, the earliest human stronghold on the Moonsea. Something guards these underwater ruins against intrusion; precisely what is not known, for those who have sought to explore it have not returned. The sage Sardor of Thentia warns that lacedons and scraggs inhabit

this area, and few have cared to investigate further.

Busy Hillsfar lies to the west of Northkeep, situated on the best natural harbor on the Moonsea.

Hillsfar is detailed in the *Forgotten Realms Adventures* hardcover sourcebook. Until recently, it was an open, inviting (some would say lawless) trading city, the tolerant mercantile alternative to regimented Mulmaster and Zhentil Keep.

Since the coming of Maalthiir, First Lord of Hillsfar, that has changed. His army patrols as far south as The Standing Stone, and has twice seized Yulash from the forces of Zhentil Keep. Uncaring corruption has been replaced by armed vigilance. Money still talks in Hillsfar, however, and it is still a busy trading-center, second in importance only to Zhentil Keep and the rich cities of Sembia.

West of Hillsfar, the south coast of the Moonsea is a broad sweep of prosperous farms. This area used to be the tangled, treacherous Beast Marches, but some six hundred years ago dwarves and men cut back the forest in an attempt to slaughter ever-increasing hordes of monsters. This event is known as "The Burning." The cause of the infestation was discovered to be a colony of fell Deepspawn (described in the sourcebook *FR11/Dwarves Deep*). Despite elven protests, the trees were not replanted, and men settled there.

A ship sailing on along the south coast will approach the western end of the Moonsea, where it narrows to the mouth of the River Tesh; the many-spired city of Zhentil Keep stands there.

From the walls of that proud city, the Moonsea coast sweeps around east again, to form its rugged northern shore. The wilderlands march east in windswept desolation until one sights the ruins of Phlan (described in several TSR, Inc. novels, modules, and computer games).

North from this shore and from the north bank of the Tesh, Elminster warns, the rule of law extends only as far as the tip of one's sword. I got the impression that Elminster hasn't much interest in the humans who dwell north of the Moonsea; he dismissed them as hard, brutal men in leather and furs who swing over-hasty swords.

East of Phlan stands the small but wealthy cities of Melvaunt and Thentia. Both have aggressive navies and energetic, fiercely independent merchants. Thentia was only lightly damaged in

the recent great flight of dragons (see page 38 of the *DM's Sourcebook*, in the original Realms boxed set), but Melvaunt lost many ships, and several of the great stone towers of its outer walls were toppled.

Both cities were quickly rebuilt, and today Melvaunt is again a trading power in the Moonsea area.

Formerly a close ally of Zhentil Keep, Melvaunt protested several times against arrogant Zhentarim authority. After they came to power in Zhentil Keep, the Dark Network unwisely treated Melvaunt as a vassal state rather than as a military ally. Finally, in a naval battle between Zhentil Keep and Mulmaster, the Melvauntian ships turned and rammed the Zhentilarian fleet. So complete was the surprise that many Zhentarim wizards were lost into the cold waters before their spells could prevent utter disaster—and more perished in the bloody deck-to-deck battles that followed on Zhentil Keep's few remaining warships.

Zhentil Keep's revenge was swift, and various important citizens of Melvaunt were horribly slain by magic during the night following the battle.

For the first time, this brutality backfired; the response from Melvaunt—delivered to the Lords of Zhentil Keep on a platter—was a slain Zhentarim wizard, transfigured by so many iron weapons that his body was suspended inches above the platter. A message was affixed to the tallest weapon's shaft. It was a list, written in the dead man's blood, of all wizards and priests of power in the Dark Network. These words headed the list: "If Zhentil Keep lifts hand against Melvaunt again, these esteemed citizens will pay this price. We would trade in peace, if you will—but if you won't, we do know how to use the iron we sell. See?"

Some of the people on the list had thought their full names and membership in the Dark Network were secrets, and since that time Zhentil Keep and Melvaunt have had an uneasy, unspoken truce. This dispute—along with many other naval skirmishes on the Moonsea—has helped neighboring Thentia retain its own independence.

Although it would please the citizens of none of them to hear this pointed out, Zhentil Keep, Melvaunt, and Thentia are very much alike. All three are fortified, and all derive their wealth from mined metal. All are younger than more southerly cities of Faerun, and all have proud, ambitious nobilities who

have risen only recently from the ranks of the most wealthy merchants. All have dreams of empire. Lyran of the noble Nanther family of Melvaunt, for example, readily agreed to a reckless—and disastrous—attack on Shadowdale when the Zhentarim reminded him of a weak family claim on the lordship of the dale, and Thentia has carefully cultivated an alliance with the town of Elmwood, across the sea. Only Zhentil Keep, enriched by its commanding location astride the only traditional human overland trade route linking the Moonsea with Cormyr and the trade routes to the west, seems likely to achieve such prominence.

Melvaunt and Thentia are dirty places, marked by the smoke of their smelters and forges. We'll look at them next time around, Elminster promises me; in the meantime, he notes that folk dwelling in or traveling through the Dragonreach should be aware of some important news, which follows.

Current Clack

- An entire caravan has been destroyed near Shadow Gap. A lone trader camped within sight of the disaster swears that the magic that blasted oxen, mules, carts, drovers, and all was not a wizard's attack, but the doing of a berserk beholder!

The trader's tale is borne out by a Cormyrean patrol who reported seeing a pack of wild dogs turned to stone by a moving sphere on the horizon. The sphere appeared angered by the dogs' barking. Additional confirmation comes from the utter destruction of a fortified inn, *Talagard's Turret*, nearby. The inn was destroyed by something that could petrify, kill from a distance, make stone vanish, and leave no traces.

The adventuress Iliitheene Rathcrauna, a wizardess of Selgaunt, told folk in Mistledale of a menacing beholder that rose up out of the trees near her encampment—but fled when she created the images of three death tyrants (undead beholders), and directed them to rise together and attack.

The ranger Aressa of Highmoon has sent this warning to Sembian and Cormyrean outposts, and to Hillsfar: "Travelers in the Dragonreach should beware a wandering beholder, likely to launch vicious attacks." The origin of this eye tyrant—and the reason for its present rampage—remain a mystery. □

by Wayne Straiton

This adventure is set in Ravens Bluff, The Living City. With a few adjustments it can be used in a variety of AD&D® game fantasy worlds.

The player characters have been hired to discover why the water level of the Dragon Reach and the Sea of Fallen Stars has been dropping an inch a day. It is up to the DM to decide how the PCs learn about the adventure; they might answer an advertisement, receive a private message from an official they know, meet a merman or sea elf who is concerned about the problem, or get involved in some other plausible way.

Unknown to anyone in The Living City, the water is receding because a *well of many worlds* leading to the Elemental Plane of Fire has opened on a sunken ship about 50 miles out to sea. Water is pouring through the *well*, and the heroes must close it to save Faerun's oceans.

The action in this scenario takes place underwater, so the PCs will not be able to wield any slashing or bludgeoning weapons. Weapons which can be effectively used underwater include: crossbows, daggers, picks, knives, military forks, spears, short swords, and tridents.

Keep track of the armor each PC wears, as this affects the character's armor class and ability to swim.

Players' Introduction

The beach seems quiet and still this morning, as it usually does shortly after dawn. The cool fall breeze and the constant din of small waves washing over the sand is pleasant and relaxing.

The serenity of the moment is broken by the pounding of advancing hoofbeats. As the lone rider approaches his cloak flutters about him, revealing the Ravens Bluff insignia embroidered on his shirt. The man is Lord Calvin Longbottle, Regent of the Harbor.

It seems he is alone—no guards, no harbor masters. As he slows his horse to a trot you notice his stern expression. The wind rises to a howl, and the ocean seems to attack the beach, as if assuming the mood of the moment. Lord Calvin talks loudly to be heard above it.

Downunder The Living City



An AD&D 2nd Edition game scenario
for 4-6 characters, levels 2-5

Illustration by Gary M. Williams

"You were selected for this mission because of your great accomplishments—handpicked by Sunny Sunriver and approved by Lord Mayor Charles Oliver O’Kane." Lord Longbottle pauses and turns his face into the wind so it can whip the hair away from his eyes.

"The Dragon Reach, and therefore the Sea Of Fallen Stars beyond, has been dropping one inch a day for the past three days. We fear that it will drop further still, maybe until the whole sea dries up. City wizards have learned that the source of this calamity lies within an area of one hundred square miles, beginning 50 miles out from the city.

"I commend you for agreeing to seek out what is causing this disaster and to stop it. We don’t know if the water drain is a natural phenomenon that will suddenly cease on its own or if it is the result of an act of evil magic. No matter what the cause, it must stop or be reversed soon or the city will be ruined.

"So far, we have kept this terrible news from the general population of Ravens Bluff, although we know a few experienced ship captains have spotted the receding water level.

"Enough chatter on my part. If you succeed, you can each keep as your reward a magic item, which we will discuss in a moment, and 300 pieces of gold, which will be given to you upon your return." Lord Calvin raises his hand, and you hear the pounding of horses’ hooves. Three more riders approach. They are city guardsmen; their horses laden with large sacks.

"One sack contains dried food in water-proof containers. This is enough to last you five days. The other two contain magic items that will help you breathe underwater. It is up to you how the magic is divided. The items are: a *ring of water breathing*, *necklace of adaptation*, *pearl of the sirines*, *cloak of the manta ray*, *helm of underwater action*, and an *iridescent toun stone* that can be used in water.

"Call for me at the harbor master’s office when you return. May the gods be with you."

If the PCs want to purchase a few things before setting off, let them. Smart warriors will purchase weapons that will have more effect underwater.

Hopefully, the PCs also will think to take fresh water with them for drinking.

Lord Calvin will provide the PCs with a boat if they need one.

Adrift

You venture away from Ravens Bluff on your mysterious mission to save the sea. You are several miles from shore when you spot something floating on the waves. Initially you believed it a hunk of driftwood. Closer inspection, however, reveals it is a young boy clinging to a battered piece of wood.

The unconscious 8-year-old is laying across a shattered section of ship’s hull. He has no shirt or shoes, only tattered canvas shorts, and he is badly burned from the sun. One side of his face is so blistered that he can only squint out of that eye. It is obvious he has been adrift for days and won’t live much longer. A little fresh water will revive him, but it will require a *cure light wounds* to heal his blisters.

Boy: Int Ave; AL NG; AC 10; MV 0 (normally 12); HD 1; hp 1 (normally 4); THAC0 20; #AT 1; Dmg By weapon; SZ M; XP 200 for healing him.

The Boy’s name is "Bach," but he started calling himself "Double" after the shipmates dubbed him "Double Bach." He has grown up not trusting anyone and assumes that everyone has a what’s-in-it-for-me attitude. He’ll be grateful for any cure spell, though he will pretend to be mute until the party hesitates to take him to shore. He definitely has had enough of the open sea. Bach also has no great desire to part with any information—unless the PCs transport him to shore.

He knows that his ship, the *Moonwind* out of Mulmaster, was carrying a wizard when it went down in a storm three days ago. The ship, bound for Ravens Bluff, sank off the coast when it was tossed into a reef. Bach knows the wizard was powerful and had wonderful magic. The wizard could take a piece of cloth from his robe and place it on the floor causing a pit to appear (this is the *well of many worlds*). Bach has no other useful information, but he can regale the PCs with tales of sailors climbing in the rigging and singing bawdy songs.

Weird, Man!

Eventually, the PCs will have to take to the water and search for the wreck of the *Moonwind*. When they do, the PCs soon encounter Chuck, an unusual water weird. Chuck is drunk and slurs his telepathic words. Do not tell the PCs Chuck is a water weird. Let them figure it out, or let them assume he is just an unusual creature.

The wizard aboard the *Moonwind* summoned Chuck from the Elemental Plane of Water and into a cask of ale. When the ship sank, Chuck was released from servitude, but has no way to get home. He doesn’t find this to be a problem, as nagging relatives had just arrived for a lengthy stay, and he welcomes any excuse to avoid them.

However, he is not without problems at the moment—the major one being his current condition. Being summoned into a cask of ale rendered him intoxicated on this plane.

The drunken Chuck likes people, although he only has seen a few in his lifetime. Chuck vaguely remembers that every person he met died when he pulled them under the water to "visit." He has a hard time understanding the concept of drowning, but he wants to learn all about it.

If the PCs are swimming underwater, Chuck assumes they are holding their breath. He will keep them under to see how long it takes them to "drown." If they are on the surface, he tries to pull them under. When he realizes they cannot drown, he telepathically questions them about this. He will not provide any information in return unless they first satisfy him about this "drowning" matter.

If they do so, Chuck gives the PCs general directions to where a "big wooden thing with walls" sank; he will not act as a guide. All he remembers about the wizard who summoned him is that the man called him during a storm, the walls rocked, and the wizard bumped his head against something hard. A black object fell out of the wizard’s robe and onto the floor, unfolding. When the walls started to fill with water Chuck decided to swim outside and watch all the people float to the bottom.

When the "big wooden thing with walls" hit the bottom of the ocean, Chuck felt released from the wizard’s service. He also felt a great current moving toward the "big dead wooden thing with walls," but he was able to swim away.

Water Weird: Int Very; AL CN; AC 4; MV 12; HD 3 +3; hp 18; THAC0 15; #AT 0; Dmg Nil; SA Drowning; SD Special; MR None; SZ L; ML 13; XP 420 for getting information.

A Morkoth Menace

You continue on your watery journey, mystified about the condition of the water creature you encountered. Ahead and below you spot a glint of silver.

The glint is a morkoth who has spied the PCs. He swims along just out of sight, but close enough so that the party will eventually notice his luminescent silver patches. He intends to trick the group into following him back to his lair. The PCs are better off passing over this encounter or fighting the morkoth before he reaches his cave.

If the PCs follow the morkoth, he leads them to his cave. The morkoth's lair is deadly; it is a cavern consisting of six spiraling tunnels, each is 120' long and leads to a central chamber. The tunnels are narrow, forcing the PCs to go single file. As a PC passes over a tunnel, he must make a saving throw vs. spell with a -4 penalty. Failure means he is *charmed* and will be devoured at the morkoth's leisure.

However, if the morkoth is not able to *charm* the PC before that PC comes within 60 feet of the center of the lair, the tunnels' hypnotic effect is broken and no *charm* is possible.

Morkoth: Int Exceptional; AL CE; AC 3; MV sw 18; HD 7; hp 35; THAC0 13; #AT 1; Dmg 1-10; SA Hypnosis; SD Spell reflection; SZ M; ML 13; XP 450.

The morkoth carries three *javelins of piercing*, a full jar of *Keoghtom's ointment* and a scroll with two *cure disease* spells. All of these items are kept in a large *bag of holding* (150 cubic foot capacity). He will use the *javelins* only as a last resort, as he knows they are valuable. He fights to the death.

In addition, in his cave is a small, rotting wooden chest. It contains a *potion of rainbow hues* (the vial is marked with a rainbow), 240 gp, 10 pp, a *trident* +2, and a tiny, exquisite ruby worth 5,700 gp.

Giant In A Half Shell

Many yards below you, a light moves about on the sea floor. It doesn't seem to follow to any pattern.

As you approach, you see what appears to be a giant lobster with extremely bright eyes. It is the leader of a pack of giant lobsters.

If the PCs make noise or do something to make their presence known, the lead lobster turns to menace the PCs. This lobster actually is an *apparatus of Kwalish* operated by Alexandra, a juvenile storm giantess who is roughly as mature as an eight-year-old human.

Alexandra is out playing with her new giant lobster friends in her *apparatus of Kwalish*, which was a gift from her father. She has named her *apparatus* Zachary. This name is painted in Common on the *apparatus's* side. However, because the water is murky, the PCs would have to be within 20 feet to read the writing.

The lobsters are not smart enough to realize that the *apparatus* isn't another giant lobster.

When Alexandra spies the party, she turns the *apparatus* to face them in a mock attack, claws-a-snapping, and will persist until she realizes that the party is causing structural damage to Zachary. If the group continues to attack the *apparatus*, Alexandra will fight for real. The other giant lobsters fight only if they are attacked.

If it appears the PCs are going to destroy Zachary, Alexandra will throw open the hatch in an attempt to communicate with them.

Alexandra is a likeable youngster and looks forward to growing up. She is sly enough to try to pass for a human adult; she enjoys playing make-believe. She is quite able to pass herself off as a woman, as she stands only six feet tall and the party will not be able to discern the true coloration of her skin while under water.

She wants to know all about the PCs—where they are from, what they are doing here, do they have any presents for her, etc. She knows nothing about the sunken ship, drunken water creature, or any other recent happenings.

After talking with the party awhile, Alexandra realizes it is getting a little late in the day. Although she knows she should go home, she is lost. She won't mind admitting this and asking for

directions. She frequently has to ask sea creatures for directions. She only wants to be pointed west.

Storm Giant: Int Very; AL CG; AC 0; MV Sw 15; HD 9; hp 45; THAC0 11; #AT 1; Dmg 1-4; SD Immune to electricity; SZ M; ML 12; XP 300 for giving her directions.

Apparatus of Kwalish: pincers do 2d6 points of damage per successful attack (25% of success regardless of the target's armor class, but Dexterity adjustments apply); body AC 0; structure can take 100 points of damage before springing a leak; 200 points to bash in a side.

Giant Lobsters (5): Int Animal; AL N; AC 0; MV Sw 3; HD 4 +4; hp 24 each; THAC0 12; #AT 2; Dmg 1-6/1-6; SZ L; ML 13; XP Nil for killing them, 200 for leaving them alone.

Intelligence Test

To find the wreck, the PCs eventually must venture well below the surface. Read the following once the PCs begin searching the depths in earnest.

You continue on your mission, in awe of all the wonders beneath the waves. It truly is a beautiful place. Just ahead, a school of strikingly colorful angel fish, each about the size of a man's hand, playfully chase each other through an equally beautiful patch of seaweed. One particularly beautiful fish, purple with bright yellow spots, swims toward your group. It seems to be curious about you. If you were not on such a crucial errand for Lord Calvin Longbottle, you could really enjoy yourselves.

Allow the PCs to react to the fish in any way they see fit. No matter what they do, however, they eventually attract the entire school's attention. The sprightly fish surround the PCs and automatically swallow the *ioun stone*. The affected character inadvertently takes a big gulp of seawater and begins to choke. The character will drown in four rounds if something is not done to save him.

There are a variety of ways to handle this situation. The choking character cannot reach the surface by himself in less than four rounds, but other PCs, particularly the character wearing the *cloak of the manta ray*, could sprint him to the surface. The PCs can find the fish that swallowed the stone by casting

detect magic. PCs with animal-related spells could use *speak with animals* to persuade the offending fish to spit out the *ioun stone*. Of course, they could simply find a way to kill the fish (there are 78 in the school), cut them open and retrieve the *stone*. This will take more than four rounds.

The PCs can buy time for their helpless comrade by sharing some of their water-breathing items, particularly the *ring of water breathing* or *necklace of adaptation*, like skin divers sharing an air tank.

Use your judgment—if the PCs come up with a viable way for getting the *stone* back, let them.

Angel Fish (78): Int Non; AL N; AC 10; MV Sw 9; HD 1-1; hp 1; THAC0 20; #AT 0; Dmg Nil; SZ T; ML 8; XP Nil.

A Sinking Feeling

Some time after their brush with the angel fish, the PCs encounter a strong current. They cannot avoid it, nor can they successfully fight it. After a time, tell them they have been dragged to the ocean floor where a veritable forest of tall seaweed grows. The current still is powerful, but not overwhelmingly so, and the PCs easily can grab onto pieces of seaweed to keep from being swept away.

The PCs have encountered some turbulence caused by the seawater rushing through the *well of many worlds*. If the PCs attempt to investigate the cause of the current, they find a large crevice in the sea floor. The freshly wrecked bow of the *Moonwind* rests on the PCs' side of the crevice, right at the edge. When the PCs approach the wreckage or the crevice, a pair of giant lampreys ambush the PCs. They get one free attack, then have the PCs roll for surprise.

Giant Lampreys (2): Int Non; AL Nil; AC 6; MV Sw 9; HD 5; hp 25, 26; THAC0 15; #AT 1; D 1-6; SA Drain blood; SZ H; ML 8; XP 175 each.

Once a lamprey successfully strikes a victim, it holds on, draining 10 hp a round until the victim reaches 0 hit points. The only way to remove a lamprey is by killing it.

Ahoy, The Ship!

The *Moonwind's* stern and midships rests on a ledge 300 feet down into the crevice. The wreck is perpendicular to the crevice and the stern sticks up at a

30 degree angle. The crevice is 500 feet deep, and runs for miles in either direction. It is 100 feet wide at the top and even wider at the bottom. The crevice walls are rough and slope inward; it is very dark inside. The wreck lies about 100 feet from the crevice wall. See the map on page 13 for details.

A powerful vortex has formed over the ship. A few fish are being sucked into it, along with shells, bits of plants and even grains of sand. Have any character who gets within 150 feet of the crevice make a Strength check. Failure means the PC is pulled toward the ship. He will be sucked through a hole in the stern deck and into the *well of many worlds*.

There are several ways the party can use to approach the ship and avoid the vortex. Anchoring ropes to the sea floor will work. If the PCs do this, do not ask for any Strength checks. Climbing down the crevice walls to get to the ship could work, but only if the character is light enough to float (otherwise the character cannot cling to the overhanging wall). The character must make a successful climb walls roll because the walls are slippery and turbulence from the vortex buffets the character.

Probably the best method to get to the ship is to swim outside the 150-foot current radius to directly beneath the ship and approach the ledge from there. This should be safe for everyone.

The ship has been weakened considerably from the current and is in very bad shape. Any PC who dangles over the jagged breach in the stern deck (with a light) sees that the water is being sucked into a 6-foot diameter black hole (the *well of many worlds*) in the floor.

Any PC who can reach the hull without being sucked into the vortex can easily hack through the battered hull and gain access to the interior.

The Ship

The door to the stern cabin is accessible from the main deck. However, the body of the ship's captain, which is infested with aquatic rot grubs, has been partially sucked through a hole in the bulkhead near the door. His legs and left arm are on the PCs' side of the door. His head and right arm are inside the cabin, blocking the door. To open the door, the PCs will have to hack through it. If they are not careful, the captain's body will be freed and sucked through the *well*. There are two rings on the captain's right hand. One is a non-magical gold

band set with three sapphires (value 3,790 gp). The other is a silver band, which is a *ring of protection* +2. If the PCs search the captain's body, they find a magnifying glass worth 50 gp, a cloth map that claims to lead to a valuable treasure (and might in a future adventure), and a silver neckchain with a carved ivory parrot hanging from it (worth 900 gp). The PCs also discover the aquatic rot grubs, which promptly attack. As with normal rot grubs, infestation only can be healed by fire or a *cure disease* spell.

All documents on the ship have been ruined by the sea water. The mage and all his possessions have been sucked into the *well*. The PCs can clearly see the *well*, but it looks like a simple hole to them.

Aquatic Rot Grubs (10): Int Non; AL N; AC 9; MV 1; HD 1 hp; hp 1 each; THAC0 Nil; #AT 0; Dmg Nil; SZ T; ML 5; XP 15 each.

These creatures viciously burrow into any living flesh that touches them. No attack roll is necessary. If there is question of whether bare skin has been exposed, multiply the victim's AC by 10. This is the chance, rolled on percentile dice, that the rot grubs are touching bare skin. Flame, which gives the victim 1d6 hit points of damage, automatically kills the rot grubs, as does a *cure disease* spell. It takes three turns for the aquatic rot grubs to burrow into their host's heart, killing him.

The Well

The PCs have two options: deal with the *well*, or return to Ravens Bluff and tell Lord Calvin about it, letting him find someone who can deal with it.

If the PCs choose to deal with the *well*, all they have to do is pick it up and fold it. Of course, they better be anchored quite firmly to get close enough to touch it. PCs not anchored automatically get sucked inside.

Any character who gets drawn into the *well of many worlds* falls 20 feet and lands in the Elemental Plane of Fire. Besides taking 2d6 points falling damage, each character also takes 2d6 points of steam damage per round until he runs 25 feet in any direction to get away from the steam. Visibility is zero in the steam. Characters who emerge from the steam are temporarily protected from the great heat on the Elemental Plane of Fire because of the dampness in their hair and clothing. However,

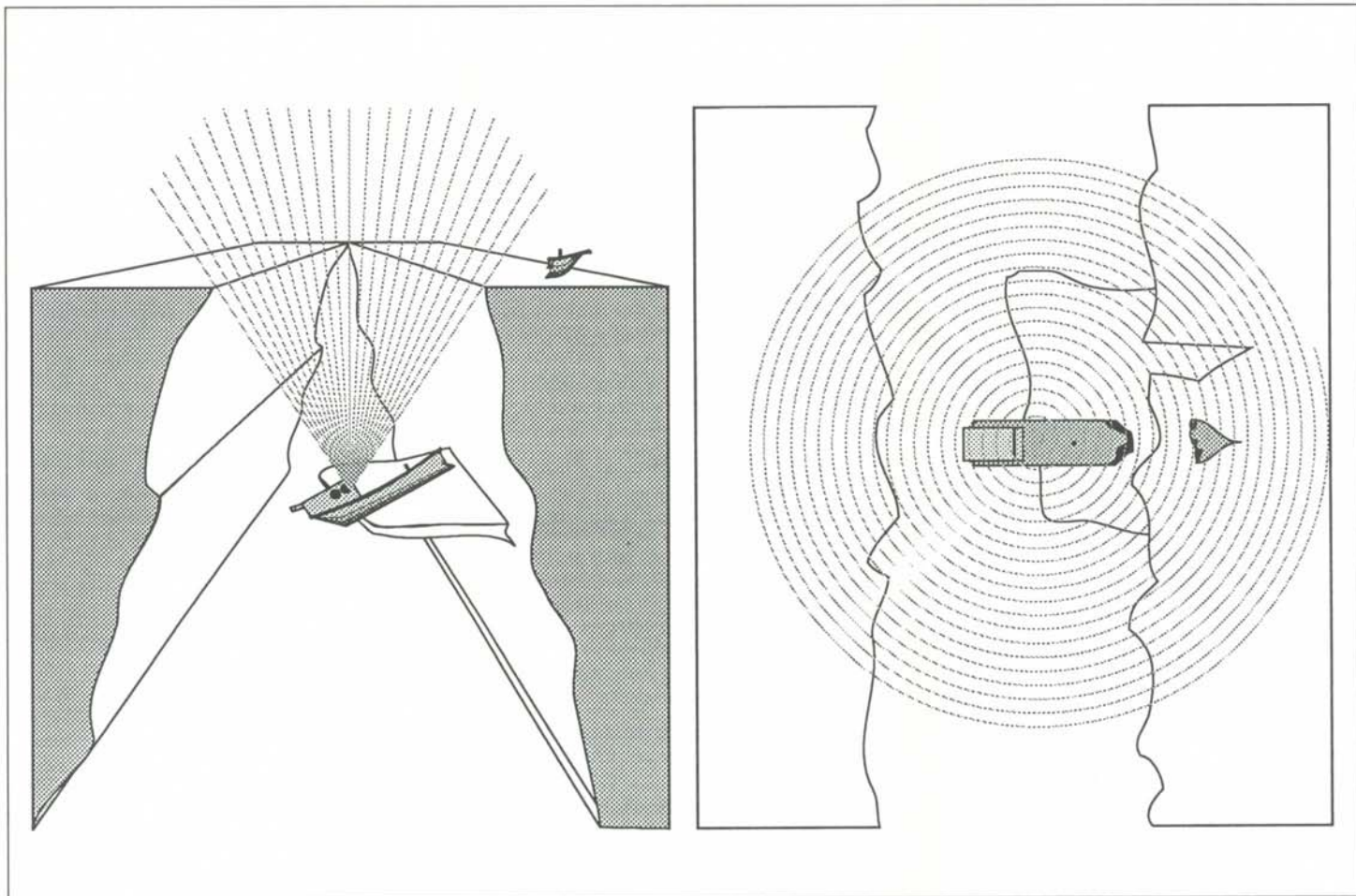

they find themselves in the City of Brass and surrounded by hostile efreet.

The efreet are upset that an ocean is pouring into their streets and will take great delight from watching the characters' dry out and expire in the heat. Of course, it is possible that the PCs may be able to quickly plead their case and offer to get rid of the water in exchange for their lives. Use your judgment if they plead well enough to get out of their predicament and back into the ocean.

If the PCs fold up the *well* and return to Lord Calvin Longbottle, the regent praises them and gives them 300 gp each. There is no way Longbottle is going to let them keep the *well of many worlds*. It is too dangerous an item to be in the hands of characters wandering around the city. If the PCs won't willingly hand it over, Longbottle will assemble enough guards to take it from them. Clear-thinking PCs should understand Longbottle's concern over the item.

Optional Encounters

The currents swirl about irregularly. Looking around, you see three gargoyle-like creatures several feet away. They swim forward to attack.

Kapoacinth (3): Int Low; AL CE; AC 5; MV Sw 15; HD 4 + 4; hp 24 each; THAC0 17; #AT 4; Dmg 1-3/1-3/1-6/1-4; SD +1 or better weapon to hit; SZ M; ML 11; XP 650 each.

Horrors from the depths! Undead swim in these seas. From below you approach six watery ghouls.

Lacedons (6): Int Low; AL CE; AC 6; MV Sw 9; HD 2; hp 9 each; THAC0 19; #AT 3; Dmg 1-3/1-3/1-6; SA Paralyzation; SZ M; ML 12; XP 175 each.

A pack of seals swims playfully in your direction. As the creatures near, you can tell they have the faces of wolves and are apparently hostile.

Lesser Seawolves (7): Int Average; AL NE; AC 6 (7); MV 30, Sw 12; HD 2 + 2; hp 12 each; THAC0 19; #AT 1 (3); Dmg 2d4 (1-2/1-2/1-4); SZ M; ML 11; XP 175 each.

A humanoid form springs from the sandy bottom and paddles toward you. The closer it gets, the clearer its features come into view. It looks like a troll. But are there trolls underwater?

Scrag: Int Low; AL CE; AC 2; MV 3, Sw 12; HD 6 + 12; hp 62; THAC0 13; #AT 3; Dmg 1-4/1-4/9-16; SA Special; SD Regeneration; SZ L; ML 16; XP 1,400.

Weather Report For Krynn

Onto Every Campaign, A Little Rain Should Fall

by H. Johnson & J. Terra

Weather can breathe excitement into a role playing adventure, as few monsters offer a greater challenge than the raw, untamed elements.

Years of study have defined the weather for the continent of Ansalon on the world of Krynn.

Because Ansalon is in the southern hemisphere, roughly straddling what would be Krynn's equivalent to our Tropic of Capricorn, the prevailing winds are from the northeast. Ocean currents flow west and southwardly, and warmer climes are in the north.

Normally, a southern land would experience a reverse of the seasons of the northern hemisphere, so that summer occurs during the equivalent of our January through March, and winter would occur during our June through August.

However, the Krynn world calendar was developed by the people of Ansalon, so that the months equivalent to the European winter months are in fact the winter months for Ansalon. It is important that you understand this as you read on.

The climate regions of Ansalon are: Tropical, Savanna, Desert, Temperate, Transitional Mixed, Tundra, and Arctic.

The weather charts are designed to aid the DM in determining the weather on any given day anywhere on Ansalon. With a little work they can be used with other fantasy worlds. Weather can be important if there are spells to be cast that require a certain condition. Weather also can have an impact on adventuring—especially if it hinders travel. And, finally, weather sets a mood and creates an atmosphere: rain is bleak, snow is quieting, storms are terrorizing, heat and humidity encourage hot tempers.

Here is a list of the monthly ranges in temperature and other weather conditions divided by climates. To find the daily weather, determine the climate and the month, and then roll the indicated dice to calculate the day's actual weather. The columns and how each alters the daily weather are as follows:

1. Temperature Highs and Lows: The first entry in each climate type is a set of two numbers separated by a slash. These are the average highs and lows for the days of that month. The actual daily temperature is likely to vary from these averages. To determine the variation, roll 1d6 and 2d10 and read the dice as follows:

6-sided Odd = Lower than normal (subtract 2d10). Even = Higher than normal (add 2d10).

2. Chance of Cloudiness: Cloud cover is determined by rolling the listed die and checking the following chart.

1-3 = Clear day
4-5 = Partly cloudy
6+ = Overcast

Precipitation will only occur if there are clouds. If it is only partly cloudy the precipitation is only a trace.

3. Chance of Precipitation and Catastrophic Weather: The first number is the chance that it will rain, sleet, snow, or hail. Roll percentile dice, and if the number is less than or equal to the score given, there will be precipitation during the day.

If the temperature is greater than 40 degrees the precipitation will be rain.

If the temperature is greater than 40 degrees, but the low falls below 32 degrees it will hail.

If the temperature is between 30 and 39 degrees it will sleet.

If the temperature is lower than 30 degrees it will snow.

Roll the percentile dice again to determine if the weather turns spectacular or catastrophic. The exact nature of the catastrophic weather is the DM's decision. He should consider what would be most appropriate for the time of year. Unless noted otherwise, special weather events will last for 2d12 turns. A list of possible catastrophic weather conditions, organized by climate conditions, is included at the end of this article.

4. Amount of Precipitation: Roll the indicated die. The amount of precipitation equals 1 inch per number, or $\frac{1}{10}$ of an inch if the die type is followed by an asterisk (*).

To determine the time of day that it begins to precipitate, roll 1d6 and 1d12.

If 1d6 = 1,2,3—read the number on the 1d12 as that time in the AM, if 1d6 = 4,5,6, then the number on the 1d12 is that time in the PM. The precipitation will fall at the following rates based on the season.

Winter: $\frac{1}{10}$ of an inch or 1 inch per hour.

Spring: $\frac{1}{10}$ of an inch or 1 inch per half hour.

Summer: $\frac{1}{10}$ of an inch or 1 inch per 10 minutes.

Autumn: $\frac{1}{10}$ of an inch or 1 inch per half hour.

Catastrophic Weather

Heat

Drought: This means no precipitation for the next 2d20 days.

Electrical Storm: Wild lightning wages a battle across the land, setting small fires, hammering buildings and burning those unfortunate to feel its lash. Characters traveling in the open must save vs. breath weapon (Dexterity bonuses apply) once per half hour, or suffer 1d8 + 2 points of damage.

Faerie Fire: An eerie electrical fire dances along trees, masts and buildings, illuminating them with an eldritch flame. The fire is attracted to metal, and causes minor shocks for 1 point of damage for those who fail to save vs. paralysis.

Flash Fire: This sweeps unpredictably across burnable terrain. It attacks all within 10 feet of the flame with a THAC0 of 9 causing 2d6 points of damage if it hits.

Heatwave: Temperatures for the next 2d6 days are automatically higher than the base and the die roll to find the exact temperature is doubled. Those caught without shelter during the day must consume a pint of water each hour, or make a system shock check. Failure means the character suffers 1d6 points of heatstroke and must further make a Constitution check at a -4 penalty. If this second roll fails, the victim begins suffering delusions and hallucinations. When a heatstroke victim reaches 0 hit points, he must make a second system shock roll at a -20 penalty. Failure indicates death, success results in the

character falling into a coma, with a continual loss of hit points of 1 per hour until the PC reaches -10 hit points and dies.

High Humidity: This intense humidity halves movement rates and adds a penalty of 2 on all action rolls (saves, attacks, ability score checks, etc.).

Inversion: This is the same thing as a modern ozone alert; those in the area must make a Constitution check to remain active for the day.

Mirage: This effect distorts distance. It can act like a moderate fog, or project an image of something miles away in the heatwaves on the horizon.

Sandstorm: Fierce, hot windstorms attack with a THAC0 of 13 for 1d6 points of damage each turn.

Wind

Dust Devil: This attacks all in its path with a THAC0 of 19 for 1d3 points of damage. In addition, it rips cloth and snatches light objects up into the air and carries them along for 2d100 yards.

Dust Storm: These choking, blinding storms attack each turn with a THAC0 of 17 causing 1d4 points of damage.

Hurricane: Heavy rains, a furious windstorm, and massive flooding accompanies the rain. A hurricane wind attacks each turn with a THAC0 of 5 for 2d8 points of damage; it lasts for 2d4 days. A hurricane dumps 2d10 inches of rain on the area, which comes at the rate of one inch every half hour during the height of the storm.

Tornado/Cyclone: These great whirlwinds uproot trees, rip apart houses and gouge the land in a 1d10 × 5-foot radius. They attack with a THAC0 of 11, inflicting 2d6 points of damage. They last 1d6 turns and move at a rate of 18.

Windstorm: This breaks saplings, rips off roofs and attacks each turn with a THAC0 of 15 for 2d4 points of damage.

Rain

Blinding Fog: This weather effect impairs vision (see the PHB or the *Tales of the Lance DM's Screen*) and halves travel speed.

Flash flood: A sudden downpour results in a crashing wall of water that sweeps away all in its path who fail a Strength check. This check must be made each round until the character reaches high ground. Those who are swept away are subject to drowning, being attacked each round with a

THAC0 of 13 for 1d6 + 1 points of damage.

Flood: The waters have risen enough to turn the land into a swamp. The dangers of hidden objects lie beneath the dark waters. Further, anyone crossing on foot must make a Strength check at a +2 bonus or be swept along as if by a flash flood.

Squall: A sudden downpour drops all its water within 2d20 minutes, blinding those in it, and attacking like a windstorm.

Thunderstorm: Lightning cracks, thunder booms, and the wind whips the rain down in drenching, blinding sheets. Anyone out in the storm must save vs. petrification every half hour or suffer 2d8 points of electrical damage.

Waterspout: This is a half-size tornado, bringing a rain of fish and debris.

Cold

Blizzard: The snow cracks and whirls and the whipping winds quick-freeze the moisture on characters' faces. Those caught within a blizzard are blinded and confused, wandering aimlessly. The storm attacks once each turn with a THAC0 of 15 for 1d4 points of damage.

Deep Freeze: An arctic wind whips across the land. Temperatures for the next 2d4 days are automatically lower than the base, and the die roll to find the exact temperature is doubled. Prolonged exposure each hour or immersion in water requires the character to make a system shock check. If it failed, the character suffers 1d4 + 1 points of frostbite, and he must make a Constitution check to remain conscious. If rendered unconscious he will lose 1d6 hit points each turn until rescued. If a character's hit points fall to 0, he must make a system shock roll at a -20 penalty. Failure indicates death, while success results in a coma with the character losing 1 point per hour thereafter. The character dies when his hit points fall to -10.

Ice Storm: Freezing rain and huge hail descends on any characters exposed to the elements, causing 2d4 points of damage per turn.

White Out: Characters are blinded by a flurry of snow and snowy ground cover. Characters in this environment must move and act as if they are in total darkness. These effects last for 2d4 turns.

Geologic

Avalanche: Thunder echoes from the mountainside, and the mountain moves, descending in a crushing roar 1d6 × 100 yards wide. Those caught in the avalanche must save vs. paralysis or suffer 2d10 points of damage and be buried alive. Buried creatures lose 1d6 points per turn until rescued. If the avalanche is snow, then PCs suffer from deep freeze effects as well. Victims are buried 2d8 + 4 feet deep.

Earthquake: The land shakes, collapsing buildings, toppling trees, shattering cliff walls and opening wide crevices. All those caught by an earthquake are attacked once per turn with a THAC0 of 5. The damage per successful attack is 2d8, and the quake's duration is 4d6 rounds. A successful save vs. paralysis reduces damage by half.

Eruption: Lava, cinders, and ash bubble up from the earth or explode violently across the countryside, resulting in flash fires, earthquakes, and a pall of ash (treat as a blinding fog and heatstroke).

Mudslide: This is similar to an avalanche, but any victims caught in it suffer 1d10 points of damage. They are not buried, but are carried along as in a flood.

Celestial

Auroras: A natural display of fireworks dances across the sky, throwing shades of crimson, amber and cyan toward the heavens.

Comet: It is a bad omen to see a comet in the sky. Characters viewing a comet suffer a -2 penalty on all NPC reaction checks for the next three days.

Meteor Shower: Like a hailstorm, this condition has an attack of once per turn. It has a THAC0 of 9 and causes 2d6 points of damage. A successful save vs. paralysis halves damage. A meteor shower lasts 2d6 minutes.

Solar Eclipse: This is a terrifying omen that lasts 2d12 minutes. During this time, all Reaction Checks are at a -4 penalty, and light becomes twilight.

Weather Effects on Terrain and Actions

The effects of weather on travel are listed on the *Tales of the Lance DM's Screen* under Terrain Obstacles. Weather can also affect the success of a PC's actions or limit visibility and movement.

Snow and ice melt at a rate of a half

inch per day for each 10 degrees above 30. Mud dries and floods subside at a rate of one inch per day for each 10 degrees above 50. Mud and melting snow turn the land into marsh or moors for determining travel speed.

After rains of one inch or more it can get foggy. Such fog banks are 2d10 feet thick and will linger until the sun has been out for at least an hour.

Weather Wisdom

Many are the folk sayings and traditions to help warn of impending changes in the weather. Some of the most common are listed here.

Earthquakes

- When dogs lie with tails tucked and horses stomp and prance, beware the waking mountain peaks as earth begins to dance.
- When ants an exile make, watch for the ground to shake.
- When cattle low for no excuse and crickets cease to talk, it's time for aspen now to quake and mountain sides to walk.

Fair Weather

- The screech of an owl makes fair weather from foul.
- When fluffy clouds are driven west like herded sheep, there will be three more days of calm and sleep.
- If bats flutter in the air, the morrow will be fair.
- Should lightning flash to no acclaim, the weather will remain the same.

Fair or Foul?

- Blood sky at morning brings dire warning, ember sky at eve will bring a reprieve.
- When birds seek the open sky, clear weather is passing by; but when birds the grass tops sail, be sure a storm is on their tail.
- When no stars shoot before the dying moon, ignore the cries of ill wind's gloom.

Fire

- When cats claw madly at the wicker, somewhere near flames will flicker.
- When grass turns brown and starts to wither, watch out or else hot flames draw hither.
- At eve should trees turn red with anger, beware the approach of fire and danger.

Fog

- When hounds sneeze and bay the moon, a mantle of fog will be rising soon.
- Black gnats on things all about, a thick dark fog will soon be out.

Frost

- A halo around the moons at night, expect the morn a frosty white.
- Snails curl tight, winter's frosty white.

Hail

- Ants flee, cattle gather beneath a tree, it will not fail there will be hail.

Hot

- If clouds sail across sky's pool, a wind will turn the weather cool. But should the sky turn golden gray, expect hot weather today.
- Dew at dawn, warm days here, dew is gone, sun will sear.
- Hawk soaring high, hot weather is nigh.

Hurricane

- When asses stomp and rub and bray, expect a gale is on its way.
- Dead fish and bracken wash ashore, tie down your shutters, storm's at your door.
- Tall grass and trees bend and droop, an ill gale is on the stoop.

Rain

- About the sun a glowing crown foretells that rain will soon come down.
- Should cattle pause and circle, with their tails pointed out, expect the sky to pour, and the raging thunder shout.
- Breakfast smells better than before, rain at the door.

Squall

- Frogs' chorus suddenly quiet, expect a watery riot.
- When choppy seas suddenly grow calm, time to batten the hatches down.
- When dolphins before the mackerel run, a storm approaches e'er the setting sun.

Thunderstorm

- The sun is veiled by dark clouds of sorrow, t'will bring a storm upon the morrow.
- If ducks dive deep beneath the waters, a thunderstorm will soon come after.

Tornado

- The sky becomes a yellow-gray, a cyclone is on the way.
- Dogs chasing their tails means a tornado is coming.
- When chickens clutch and throw double bounties, beware the fury of wind and seas.

Windy

- When swine are restless, grunt and squeal, a windy time is at their heel.
- When spiders are in a hurry, behind them clouds will scurry.

Season

Autumn

- When clouds of gnats cluster over all, be prepared for a pleasant fall.
- Many bees, many eggs in nest, it will be a good harvest.
- Calfing bellow, goat kid bleat, I fear there won't be much to eat. (Lean harvest)

Spring

- When the kingfisher refuses to build a nest, winter has a month more of distress.
- When the crocus raises its sleepy head, it signals spring's dreaming at last has fled.
- Stags butt and goatlings caper, at last the snows will fade and taper.

Summer

- Crickets are summer's orchestra warming up.
- When foxes clean and wink, we are at summer's brink.
- The dogwood blossoms dance their way to summer days.
- Panting dog and shedding hair, means that summer days are near.

Winter

- If moss turns gray and furry, look for winter flurry.
- Wild geese fly and northward go, a vanguard to the winter snow.
- Fat caterpillars covered with fur, herald cold weather when winter draws near.
- When the dog lies down with the cat or lovers spat, a brutal winter is on its way.
- Golden skies at wintry dusk, winter will be a shrivelled husk.
- Squirrels play and show no worry, to their work they do not hurry. Winter's cold will not come early. □



**Don't Be
Left Out In The Cold
Come To The**

WINTER FANTASY Convention

Three fun-filled days of gaming await at MECCA January 8, 9 & 10, 1993.

That's right. The WINTER FANTASY Convention is moving to MECCA -- the site of the world-famous GEN CON® Game Fair.

The WINTER FANTASY Convention is sponsored by the RPGA™ Network, the biggest and best international organization for role playing games.

Featured events include role playing, board games, miniatures, and more.

There will be a benefit AD&D® tournament for the Milwaukee Zoo and a feature tournament authored by FORGOTTEN REALMS® Creator Ed Greenwood

❄️ **Lodging:** Two Milwaukee hotels are offering special rates.

Hyatt Regency 333 W. Kilbourn Ave. Milwaukee, WI 53203 414-276-1234 \$55 a night	Hotel Wisconsin 720 North Old World Third Street Milwaukee, WI 53203 414-271-4900 \$26 a night
---	---

You must mention the WINTER FANTASY Convention to get these special rates.

**Convention Preregistration:
\$16.00 (Network Members \$10.00)
Preregistration fees effective to Dec. 1st.**

To preregister write:

**Winter Fantasy, RPGA Network,
P.O. Box 515, Lake Geneva, WI 53147**

Use the reverse side of this form to
preregister for events and activities.

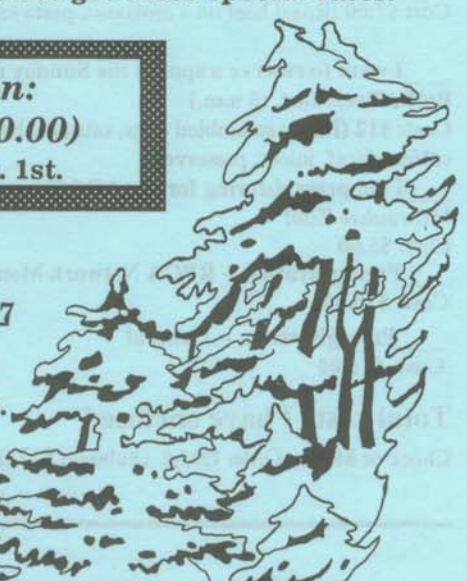

Preregister to play in up to four events. Mark your preference of time slots.									
Events	Friday				Saturday			Sunday	
	1	2	3	4	5	6	7	8	9
	8 a.m.	Noon	4 p.m.	8 p.m.	8 a.m.	Noon	4 p.m.	8 p.m.	10 a.m.
AD&D* Benefit <i>The Paper Chase</i>		X		X		X		X	X
AD&D Feature <i>The Ring Of Death</i>	RD 1		RD 1		RD 1		RD 1	Final	Final
AD&D Masters <i>Adrift</i>	RD 1			RD 1		RD 1			Final
AD&D Grand Masters <i>A Curse Called Ethel</i>			X				X		
AD&D Living City <i>Fear and Loathing in Ravens Bluff</i>			X		X		X		
AD&D Club* <i>The Secret of the Scorpion</i>		RD 1			RD 1			Final	
AD&D Special <i>Chain of Souls</i>	X			X		X		X	X
GAMMA WORLD* Game <i>Fire Island</i>		X					X		X
Star Wars <i>Evil Walks Behind You</i>				X				X	X
Shadow Run <i>Blood Money</i>	RD 1		RD 1		RD 1		Final		
Call of Cthulhu <i>Dark Legacy</i>		RD 1		RD 1		RD 1		Final	
DAWN PATROL* Game <i>A different game each slot!</i>		X	X	X	X	X	X	X	X

* Network clubs should use a separate club form to register, available from your club president.

In addition, there will be many other games available on site, including war games, miniature events, card games and role playing scenarios. Some of these featured activities include Battletech, a big Space Hulk bash, Axis & Allies, Alternate Visions game tournaments, and more!

Mail This Completed Form To:
RPGA Network, P.O. Box 515, Lake Geneva, WI., 53147

Don't be left out in the cold! Come to the WINTER FANTASY Convention!

I want to reserve a Friday afternoon boxed lunch!
 Cost: \$7.00 (Turkey and ham hoagie, chips, cookie & soda)

I want to reserve a Saturday afternoon boxed lunch!
 Cost \$7.00 (Roast beef on a croissant, pasta salad, brownie, soda)

I want to reserve a spot at the Sunday morning RPGA Network Buffet Breakfast. (8 a.m.)
 Cost: \$12 (Fancy scrambled eggs, sausage, bacon, fruit, cereal, milk, coffee, decaf, juices, preserves)

I am preregistering for the AD&D benefit tournament for the Milwaukee Zoo!
 Cost: \$5.00

Preregistration -- RPGA Network Member
 Cost: \$10.00

Preregistration -- General
 Cost: \$16.00

Total costs I have enclosed

Check or Money Order Only! (Subtract \$3.00 if judging events)

Name _____
 Address _____
 City _____
 State _____
 Zip Code _____
 Day Phone _____

I will arrive at the convention at (day, time): _____

I want to judge. I have marked my preference of games and time slots with a "J."
 I want to run my own games. Please send me a judge form so I can describe and schedule my own events.

Judges receive a \$3.00 discount on Convention Registration Fees.

Krynn Weather Tables

	Temp High/Low	Chance of Clouds	Chance of Precip	Amount of Precip
Aelmont (January)				
Tropical	65/48	1d6	20%/04%	1d8* 10ths
Savanna	61/41	1d6	15%/01%	1d6* 10ths
Desert	71/39	1d6	05%/03%	1d3* 10ths
Temperate	39/30	1d10	35%/02%	1d10 inches
Mixed	31/24	1d10	35%/01%	1d6 inches
Tundra	27/19	1d8	20%/02%	80%/05%
Arctic	0/-18	1d20	80%/05%	1d20 inches
Rannmont (February)				
Tropical	60/41	1d6	10%/03%	1d4* 10ths
Savanna	57/36	1d6	10%/—	1d4* 10ths
Desert	70/35	1d6	05%/02%	1* 10th
Temperate	32/23	1d8	40%/01%	1d8 inches
Mixed	26/20	1d10	35%/—	1d6 inches
Tundra	20/12	1d6	15%/01%	1d6* 10ths
Arctic	-5/-23	1d12	75%/04%	1d12 inches
Mishamont (March) (Beginning of Spring)				
Tropical	66/46	1d8	20%/04%	1d10* 10ths
Savanna	63/41	1d6	15%/—	1d6* 10ths
Desert	75/46	1d6	10%/03%	1d4* 10ths
Temperate	41/33	1d8	45%/02%	1d8 inches
Mixed	39/32	1d12	40%/01%	1d8 inches
Tundra	26/18	1d6	20%/02%	1d8* 10ths
Arctic	0/-15	1d12	80%/05%	1d20 inches
Chismont (April)				
Tropical	74/56	1d8	40%/05%	1d12* 10ths
Savanna	66/45	1d6	15%/01%	1d8* 10ths
Desert	82/57	1d6	10%/04%	1d6* 10ths
Temperate	52/41	1d10	50%/03%	1d8 inches
Mixed	47/40	1d12	50%/02%	1d6
Tundra	39/25	1d6	20%/03%	1d10* 10ths
Arctic	12/-4	1d12	80%/06%	1d20 inches
Bran (May)				
Tropical	82/68	1d10	50%/06%	1d4 inches
Savanna	75/53	1d8	20%/02%	1d8* 10ths
Desert	90/68	1d6	10%/05%	1d4* 10ths
Temperate	62/51	1d8	45%/04%	1d6 inches
Mixed	55/46	1d10	40%/03%	1d4 inches
Tundra	47/32	1d6	15%/04%	1d8* 10ths
Arctic	19/5	1d10	80%/07%	1d12
Corij (June) (Beginning of Summer)				
Tropical	86/73	1d10	65%/7%	1d6 inches
Savanna	77/54	1d8	30%/3%	1d6* 10ths
Desert	93/70	1d6	10%/6%	1d3* 10ths
Temperate	67/53	1d10	50%/5%	1d4 inches
Mixed	58/50	1d8	45%/4%	1d3 inches
Tundra	50/30	1d6	20%/5%	1d6* 10ths
Arctic	26/7	1d10	75%/8%	1d10

Argon (July)

Tropical	90/75	1d20	80%/08%	1d4 inches
Savanna	80/54	1d8	40%/04%	1d8* 10ths
Desert	95/70	1d6	10%/07%	1d4* 10ths
Temperate	70/56	1d12	50%/06%	1d12* 10ths
Mixed	62/52	1d10	50%/05%	1d3 inches
Tundra	54/30	1d6	20%/06%	1d6* 10ths
Arctic	32/9	1d8	75%/09%	1d12 inches

Sirrimont (August)

Tropical	95/76	1d20	70%/09%	1d6 inches
Savanna	85/66	1d10	25%/05%	1d6* 10ths
Desert	104/88	1d4	-/08%	—
Temperate	79/63	1d10	35%/07%	1d10* 10ths
Mixed	75/59	1d8	40%/06%	1d6* 10ths
Tundra	66/42	1d6	10%/075	1d4* 10ths
Arctic	34/22	1d6	60%/10%	1d10 inches

Reorxmont (September) (Beginning of Autumn)

Tropical	87/73	1d20	60%/08%	1d6 inches
Savanna	80/62	1d8	15%/04%	1d4* 10ths
Desert	99/80	1d4	-/07%	—
Temperate	75/60	1d8	20%/06%	1d8* 10ths
Mixed	70/55	1d6	30%/05%	1d6* 10ths
Tundra	60/49	1d6	05%/06%	1d3* 10ths
Arctic	30/10	1d6	60%/09%	1d10

Hiddumont (October)

Tropical	80/69	1d12	50%/07%	1d4 inches
Savanna	72/54	1d6	10%/03%	1d4* 10ths
Desert	83/66	1d4	-/06%	—
Temperate	65/49	1d8	20%/05%	1d6* 10ths
Mixed	60/41	1d6	25%/04%	1d6* 10ths
Tundra	53/39	1d6	10%/05%	1d3* 10ths
Arctic	24/03	1d8	70%/08%	1d10 inches

H'rarmont (November)

Tropical	76/64	1d10	40%/06%	1d4 inches
Savanna	66/50	1d6	10%/02%	1d4* 10ths
Desert	80/63	1d6	05%/05%	1d3* 10ths
Temperate	56/41	1d8	25%/04%	1d10* 10ths
Mixed	52/36	1d6	25%/03%	1d8* 10ths
Tundra	47/31	1d6	15%/04%	1d4* 10ths
Arctic	19/-5	1d10	75%/07%	1d12 inches

Phoenix (December) (Beginning of Winter)

Tropical	70/59	1d8	35%/05%	1d4 inches
Savanna	62/45	1d6	15%/01%	1d6* 10ths
Desert	75/44	1d6	10%/04%	1d4* 10ths
Temperate	48/33	1d10	30%/03%	1d12* 10ths
Mixed	44/30	1d8	30%/02%	1d3 inches
Tundra	39/22	1d8	20%/03%	1d6* 10ths
Arctic	10/-12	1d12	80%/06%	1d20 inches

The Living Galaxy

Adventures From Your Library, Part 1

by Roger E. Moore

This and a future installment of *The Living Galaxy* are going to separate the hard-core, do-anything game masters from the wannabes. Our mission (should you decide to accept it) is to build an entire adventure for a science fiction role playing game, complete with setting, characters, and plot, from resources in your local library.

I've pointed out several times in the past that good GMs keep their minds open, always looking for ideas for their campaigns. It's also been noted that research is a mighty tool that can produce outstanding results. And we've seen, too, that creativity is the key to becoming the best of all GMs. Here we're going to put all of this together.

Because we're dealing with science fiction games and not fantasy ones, I'm going to dive primarily into news and science-fact magazines as resources. I like using these because magazine articles are generally short and easy to digest and because the information you get is as accurate as current research and reporting allows. It is my belief, too, that real life is as good as fiction as a source of ideas for a science fiction campaign. You'll encounter things in the real world that will inspire far more excitement, awe and terror than anything you'll find in a novel or short story, because the real universe is an unpredictable and dangerous place.

A Creative Way To Do It

We're going to use a system for creative thinking that I've adapted from material in a marvelous little book called *Your Key to Creative Thinking*, by Sam S. Baker (New York: Bantam Books, 1970—I got an old copy from a friend). You might be able to find this excellent book in your library. The steps we'll follow are these:

1. Outline the problem.
2. Gather as much information about the problem as possible.
3. Brainstorm—write down as many ideas as you can on how to solve the problem, both sensible ideas and crazy ones, keeping them all.
4. Think about the facts and solutions.

Let them simmer in your mind, and maybe even walk away from the problem for a while to let your thinking loosen up.

5. Go over what you've written down and pick the most creative ideas.

Astute readers will see that bits and pieces of this system have appeared in this column before, but this is the first time it's been completely written out here. You can use this system in highly imaginative ways to solve any problem you have. This method works wonders for GMs using any role playing system.

Adventure-Making Outlines

Now, on to the adventure-making process itself. We need to start with a system for creating an adventure. I know of several such systems, and they're all from magazine articles that I edited for DRAGON® Magazine (many libraries now carry that magazine; check with the reference or information desk). Oddly enough, though DRAGON Magazine is primarily about fantasy role playing games, many of the adventure-creating articles I've seen published in the past few years were written for espionage games, particularly the TOP SECRET® and TOP SECRET/S.I.™ games from TSR, Inc. Here are the best:

—Issue #48 (April 1981): "Instant Adventures," by Michael Kelly (reprinted in the *Best of DRAGON Magazine* anthology, volume V). This article presents 47 ideas for adventures with brief notes on their requirements and estimates of the length of time involved in making them up. This article works for almost any genre of role playing game, and the ideas are bound to spark fires in every GM's mind.

—Issue #109 (May 1986): "Administrator's Advice," by John J. Terra. This is highly recommended for its detailed outline (which will be used here) on adventure generation. The scenarios in which secret agents are involved aren't that different in many cases from those explored by futuristic adventurers, and the advice on managing espionage games can be adopted straight into science fiction campaigns. Interstellar espionage agencies and other adventure-prone, covert organizations can be designed with this material, as

can NPC foes.

—Issue #114 (October 1986): "A Recipe for Espionage," by Russell Drouillard. Another excellent article, this one covers NPC creation, making the most of settings, plot selection, and adventure generation. Some extremely interesting ideas for scenarios are tossed around here in brainstorming fashion, and they're worth a look (the MacGuffin Hunt quest given in the section "Words into action" is particularly exciting and cinematic in style).

—Issue #152 (December 1989): "Make the Most of Your Missions," by Merle and Jackie Rasmussen. Here are a large number of "mission starters," brief ideas for adventures that GMs can develop further to suit their campaigns. Though this was written for the TOP SECRET/S.I.™ game, its basic advice applies to any espionage game and to many science fiction adventures as well. Many plot situations are also given, guaranteed to get the ideas rolling for your next gaming session.

—Issue #153 (January 1990): "A Funny Thing Happened on the Way to the Mission," by Merle and Jackie Rasmussen. Almost everything that could go wrong on an espionage mission is lovingly laid out in this excellent article on plot complications. Complications are essential in any adventure if the GM wants to keep the action fresh, as well as keep the agents on their toes at every turn. This material is of special interest to GMs running campaigns set on planets and campaigns in which covert missions are commonplace.

—Issue #168 (April 1991): "Why Spy?" by Michael L. McDaniel. More details on running spy campaigns is given, and the neo-*Thunderball* adventure outline is entertaining and educational. NPC creation and campaign style are also described.

From the above articles (particularly "Administrator's Advice"—thanks, John!), we shall set up a short outline of how to create an adventure:

1. Select an interesting setting (we'll pick a world for this example).
2. Pick the general situation in which the PCs will be involved, making up a brief plot outline.
3. List the NPCs involved.
4. Draw up the maps needed.

5. Flesh out the plot.

6. Make up a time line showing when each event in the scenario is to take place, focusing on things that will occur no matter what the PCs do and on things that will happen if the PCs do nothing to stop them.

7. Set up the initial PC objectives.

8. Add any other plot complications and alternate objectives.

9. Write up the adventure.

This list is not carved in stone, by any means. A good GM can skip around a bit, fixing this part or writing down that part as he likes. We'll try to stick to this system throughout this article and see how well it works.

The Library: First Trip

Science-fact and current-events magazines are almost always carried by local public libraries. In this case, we're arming ourselves with pen and notebook and heading for the Lake Geneva Public Library—because I live near it and because I know from past experience that it has a great periodicals section. I park my car, go inside, and get directions from a librarian to the (ominous theme music here) *Readers' Guide to Periodical Literature (Unabridged)*. It is with this that we will build the main setting for the adventure.

The *Readers' Guide* series is a huge set of big green hardbound and soft-bound books, published at regular intervals. It indexes articles from an enormous number of magazines currently available across most of North America. You'll usually find it in or near a library's magazine section. It looks frightening (especially when you open a random volume and see that it is jammed with tiny print), but once you learn to use these volumes, you will be amazed. Here's how you use them:

Each annual volume of the *Readers' Guide* breaks down all of the article references within it by topic. If you want to find articles on the Persian Gulf War, you look up "Persian Gulf War" and see what's there. Cross-referencing is very heavy, so in this case you could also check "Iraq," "Hussein," "Kuwait" and so forth, getting new article references or topic headings to search.

Each volume also explains how to translate a reference into meaningful terms. For example, in the May 1991 volume, page 208, under the subject heading "Earth," we find:

The Earth Without the Moon. N. Comins. *il Astronomy* 19:48-53 F '91

Does this sound interesting? It's an article entitled, "The Earth Without the Moon," by N. Comins. The article, which is illustrated ("il"), is from the February 1991 issue of *Astronomy* magazine (volume 19), pages 48-53. You might want to find that article and photocopy it, by the way, because of the information it offers on possible Earth-like worlds that have no large satellites—just the kind of stuff you might use in your campaign.

You've just had a crash course in finding magazine articles. Not every magazine in print is in the *Readers' Guide*; for example, POLYHEDRON® Newszine is not, and neither are DRAGON Magazine and DUNGEON® Adventures. Lots of others are, however, and they're more than enough for our purposes. Let's return to the Lake Geneva library.

I find the *Readers' Guide* in a back room on a long table. For the purposes of this article, I'm selecting only the most recent editions of the *Readers' Guide*, from 1990 to date. The 1990 volume is hardbound; the 1991 and 1992 material comes in softbound books and booklets, updated monthly and quarterly, because it's too new to be hardbound yet (I'm writing this in April 1992, so things may have changed by the time you read this). I pull out the 1990 volume and flip it open.

Because each volume uses key topic words to organize its information, I quickly brainstorm a few headings I want to check, then jot them down in my notebook. I start with the following: Astronomy, Planets, Space flight, Stars. As I comb through the volume in subsequent minutes, I discover and jot down many more headings, such as Artificial intelligence, Artificial satellites, Asteroids, Astronauts, Black holes, Comets, Life on other worlds, Lunar bases, Mars, Meteorites, Meteors, Nebulae, Satellites, Venus, and about a billion others. I'm already starting to run into the old problem of "wall-to-wall data" here, so I decide to quickly settle on a setting, a planet or something, on which to base the adventure. Choosing quickly helps me avoid becoming logjammed with too much data, thus doing nothing.

Checking "Astronomy" gives me only more references, nothing that catches my eye. One of the topics I'm referred to, "Asteroids," has lots of article references on the Cretaceous asteroid impact that supposedly killed off the dinosaurs—an interesting idea, but not one I want to explore right now (I still

jot down the idea and the phrase "See 1990 RG—Asteroids" in my notebook in case I decide to follow up on this later). I try "Planets" and see that there is an article on water-covered worlds in the galaxy, in the April 1990 issue of *Astronomy* magazine, but again I make a note of it and pass. I want something really alien, something strange, something . . . like . . .

I tap my pen against my teeth. The heading "Pluto" apparently has some article references. Sure, why not? Pluto is about as alien as you can get around here. The adventure will be set on a world very much like Pluto, in some other solar system. Maybe it's the only planet there, or maybe it's a research base; I don't know yet, but there's lots of time to decide on that. I turn to "Pluto."

Wow! Four article references stand out in particular, from various 1990 issues of *Astronomy*, *Scientific American*, and *Sky & Telescope*. I jot down the issues and page numbers, then continue looking under other headings. Under "Space colonies," I find an article on colonizing the Oort Cloud, the cometary belt surrounding our Sun, in the November 1990 issue of *Ad Astra*. That might have stuff I can use on building a Pluto colony, so I jot it down. "Space flight to Pluto" brings two more articles. I flip back to "Planets," remembering something there, and write down an article reference, again from *Ad Astra* (March 1990), on the current search for a planet beyond Pluto.

After a little more searching, I put away the volume, feeling I've exhausted what I can find in it, and pull out the softcover volumes for 1991 and 1992. Articles are fewer now, but one on the possible existence of many Pluto-like worlds appears in *Science News* (September 21, 1991), and another on Pluto appears in the January 1991 issue of *Astronomy*. I write them down, then go look for the magazines.

It turns out to be a good thing that I started with 1990, because the magazine storage shelves hold nothing further back than that year (larger libraries, of course, will store them much further back than that). I find issues of *Ad Astra*, *Astronomy*, *Science News*, and *Scientific American*, but this library doesn't collect *Sky & Telescope*; I'll have to look for it elsewhere at another time. A glance at each article reveals that several are not of much help to me; I don't need those telling me how to find Pluto using a big back-yard telescope, for example, so I put those

back. I collect all of the useful issues into one stack, then take them to the checkout desk and leave.

The total time I spent in the library was just one hour. The setting is selected, and it's going to be a doozy.

Building The Planet

At the moment, I know very little about Pluto, and I spend some time reading over the articles. I once knew a little about this world: It is very cold, very dark and very inactive. Nothing ever happens on Pluto. I recall that a satellite, Charon, was discovered too.

Choosing a setting like Pluto has a powerful effect on the adventure background, of course. Why would anyone want to go to a place as miserable as Pluto? Perhaps there are no planets in this system worth colonizing, and this world would have been skipped over itself by humanity except for one good reason or another. Perhaps the stellar system is on a route from one world to another and is to be used as a "stepping stone" of sorts, a way station for starships that can't make it the whole way without stopping in the middle. This works fine in GDW's *MegaTraveller* system, with its short-jumping starships. In West End Games's *Star Wars: The RPG*, the world might hold a secret Rebel base, located there because it is so remote and unlikely to be found by the Empire. In other games, the world's colony might be a research outpost, a mining colony, a fuel-processing factory-city, a haven for xenophobic political or religious dissidents, a military spacecraft-testing facility, or a secret xenoarchaeological site where ancient artifacts have been discovered. Perhaps bizarre life forms, such as the Outsiders from Larry Niven's *Known Space* novels, have set up their own colony. I'll figure it out later, but first I want to read the articles.

Boy, did I ever pick a bizarre setting! Because Pluto is so small and so hard to observe, little is known about it or its moon, and what is known is subject to change with each new observation. No spacecraft has ever visited Pluto, and none will for many years to come. It was discovered (some say by accident) in 1930; Charon was found in 1978.

Some astronomers describe Pluto as an "ice dwarf," a small planet that apparently has a rocky core with a thick layer of water ice over that and a thinner layer of methane ice over that. Pluto is actually part of a double-planet

system with its moon, Charon. Both were likely formed in the outer solar system eons ago, and some sources think there maybe be other Plutolike bodies farther out from the Sun. Aside from gas giants like Uranus and Neptune, the only other bodies beside ice dwarfs that far out are comets drifting into the system from the Oort Cloud, each up to 10 km across. The Sun is just a bright star in Pluto's black sky.

The best estimates make Pluto the smallest of all the known planets, only 2,300 km across. A cross-section of the planet appears to show the water-ice layer is a couple hundred kilometers thick over the core, and the methane ice about several dozen kilometers thick. The methane coating is a dark, dull red color from the interaction of sunlight with methane over time. Pluto apparently has bright polar caps and a very thin atmosphere of methane, perhaps with nitrogen, argon, and other minor gases. Its orbit is highly elliptical, meaning it's egg-shaped. At the present time, Pluto is fairly close to the Sun, about 30 times the distance of Earth to the Sun. At its most distant point, it is about 50 times as far from the Sun as Earth is. It takes about 248 years for Pluto to make one orbit of the Sun.

Charon orbits Pluto every 6.4 days, staying roughly 19,640 km from Pluto's center (though this probably varies). This moon is roughly 1,200 km across, with a water-ice layer about 100 km thick (if the cross-section picture in one magazine is right). Charon is darker than Pluto, probably gray in color. The two worlds are both tidally locked, meaning that they have the same face turned toward each other all the time, as the Moon faces the Earth. Because Pluto and Charon are so close together in size (Pluto has only six times the mass of its satellite), Charon doesn't really just orbit Pluto. Both worlds revolve around a spot roughly 1,200 km above Pluto's surface, the balancing point of their masses, which leads some astronomers to call this a "true" double planet. (By comparison, the center of mass of the Earth-Moon system lies within Earth, making the Moon a "true" satellite of Earth.)

There's a little bit of weird stuff here, too. Pluto has an atmosphere that literally falls out of the sky—not a place for Chicken Little. When Pluto comes in toward the Sun, the frozen methane in the ground turns into methane gas and builds up the atmosphere. When Pluto heads farther back into the cold and the

dark, the methane turns into "snow" and falls, reducing the atmosphere to almost nothing. The surface temperature on Pluto at present is about 58°K (-215°C), or about 58° above absolute zero, the point at which *all* motion ceases. That's pretty darn cold—and it will get much colder as Pluto heads away from the Sun.

There's a little bit more, but I've got the basics. Jeez, why would anyone want to go to a Plutolike planet? I now recall reading that the ice on frigid worlds in the outer solar system is as hard to cut as steel. I'm sure some future civilization could mine Pluto, but for what? I leave the question open and flip through the *Ad Astra* article on colonizing the Oort Cloud.

Ah, this is interesting. The writer, Richard Terra, points out that cometary material is not likely to be very dense. Frozen water, carbon dioxide, methane, and ammonia make up most of a comet nucleus, which is irregular in size and could range from 100 m to 10 km across. Metals and complex organic molecules could be found on it, and there is likely to be some iron, aluminum, and "heavy hydrogen" (deuterium) that would be useful to colonists (the deuterium could fuel nuclear reactors, for example, each comet supplying tens of thousands of metric tons of it). Best of all, comets are relatively light, porous, and fragile. The materials on them could be easily mined by simply heating the "ore" (chunks of ice, really).

A colony that mined comet nuclei would have to be very self-supporting; it's very lonely out in the empty wilderness this far from the Sun. Terra imagines that colonies out there would be extremely isolated, also being both small in size and constantly threatened by the grossly hostile environment. Each would have a much-constrained, closed-system economy, being unable to trade with other colonies further in the same system. Because a comet's surface probably cannot support man-made structures, the colonists would have to live on large artificial space stations of the type envisioned by Gerard O'Neill in his book, *The High Frontier* (see this column in issue #68 for details). Colonists would be likely to cooperate for survival's sake, pooling their skills and resources. The colony size could hardly grow very much, and resources would be carefully watched. Long-term colonies would have to avoid the dangers of a small gene pool. Such colonists would become (if they weren't at first) a "close-

knit, interdependent and self-reliant bunch.”

Much of this will affect the adventure I’m going to create. But first, I want to finalize the setting.

Nacht Is Born

Okay, so I have the world model. Now I fiddle with it to make it less recognizable, but just by a bit. I take the Pluto model and get rid of Charon. Instead, I add a comet nucleus as a captured moon of this new world, Nacht (named by its discoverers). The nucleus is large (relatively speaking), about 6 km across, and has a highly eccentric orbit; I won’t bother naming it right now, assuming it hasn’t yet been discovered. Nacht itself has an eccentric orbit around its primary, a star with no habitable planets or colonies in its system. I deliberately take this last step to remove the possibility of any assistance reaching the player characters, once they become involved in the mission. I want to cast an atmosphere of alienation and loneliness over the adventure; Pluto as a setting suggests that theme. Darkness and despair are also suggested.

Based on the physical data on Pluto I dig up from the magazine sources, I make all the appropriate notes about what this world Nacht looks like from space, what its surface is like, what its peculiar moon is like, and so forth. (By the way, the moon, though it is a comet nucleus, has no comet’s tail because it is too far from its sun for its surface to boil off and create the tail.)

I also have an idea in my head that I want to place one human colony on or around Nacht. My brainstorming notes from earlier on give many possibilities for what sort of colony could be here, but I have to settle on one set. After much thinking, I decide to continue the themes of isolation and hopelessness the setting suggests (I figure almost no one would ever go here with the intent to stay!), and the following develops:

About 53 years before the adventure starts, a robot probe enters this system from an Earthlike world around a nearby sun. The robot probe discovers most of the major worlds in the system (except the cometary moon of Nacht), then returns to the world from which it came (we’ll call it Gaea). Here, scientists from a private astrophysical university and research center study the data and decide that Nacht might possibly have a certain valuable material that the world needs. A major space-mining

corporation offers to fund an expedition out to Nacht for a one-year mission, its purpose to carefully investigate this world and determine if: 1) any of that substance does exist; and 2) if it can be safely mined in quantities large enough to make an interstellar mining project worthwhile. Based on my research notes, I’ll say that the substance being sought is radioactive deuterium, to be used in nuclear power plants.

An expedition is put together, but without fanfare. For one thing, the mission is a secret one; radioactive materials are highly sought by everyone, and no word of the expedition is allowed to be leaked to the public. Then, too, the world’s nations are drifting toward a world war, and news of the troubles overrides everything else. Shortly after the starship leaves for Nacht’s system, war breaks out. The university is caught in a bombing raid and partially destroyed; many records are lost or misplaced. The mining firm backing the expedition drops all projects that are not directly war-related. The war drags on for eight years. The failure of the mining ship to report back after a year is taken as evidence that it was lost, and the project is hastily scrapped by officials who don’t want it to be known that they were hunting for radioactive materials (nuclear devices were used in the war, and atomic weapons and power plants now have a bad name). Years pass; corporate management changes; files are left alone in secret vaults; everyone forgets.

The time is the current campaign date. A woman approaches the player characters, who are assumed to be available for hire with a starship capable of reaching the Nacht system. The woman is a research assistant for a local historical society. While combing through papers found in a safe in the ruins of the old university, she uncovered references to an interstellar expedition that was to be sent off just before the war started. The bare bones of the mission plan are known, but no clue remains of whether the mission was carried out or what the results were. The lady has contacted the mining firm noted as being a co-sponsor of the research mission, but no information was given out.

The characters’ first goal is this: Could they please contact the corporation themselves and find out more about this expedition? The woman is not wealthy, but she can offer them a reasonable sum if they help for a few days.

“Don’t do anything illegal,” she says, noting sourly that she doesn’t trust the company. She thinks it is holding out on her to cover up old illegal deeds.

The truth of the matter, of course, is that company representatives genuinely know nothing about the old mission and don’t know that records of the mission still exist in corporate files. The researcher has an abrasive manner and is rather stubborn in pursuing her goal; the company’s ignorance has only fueled her determination to get to the bottom of the story and find out about this alleged deuterium-mining expedition, given the code name File Blue in several accounts.

I leave several ways open for the characters to get the information they need. Officials can be bribed to let the characters look at old records. Characters might try to be hired by the company, then sneak into the corporate library files. Computer hackers might navigate the firm’s computer database. An old friend working with the company or an allied firm might get the information. In any event, the news is that yes, an expedition was launched just before the war’s start, but it never returned. The company’s coverup is implied but not stated outright. Details on the expedition are sketchy, since it was put together at one of the company’s space-mining stations elsewhere in the system. The station was destroyed during the war by enemy nuclear attack.

If the researcher gets the information, she carefully studies it and becomes highly agitated. There is the remote possibility that the members of the File Blue expedition, which carried lots of survival materials and construction and mining equipment, might have withstood whatever calamity overtook them—but they have been out on their own for many decades. What happened to them? She now desperately wishes to hire the characters to go to the Nacht system and hunt for any evidence of the expedition’s presence, with the intent of rescuing any and all survivors. What terrifying adventures await the heroes?

Play with these ideas and see what you come up with. I will continue this topic at a later date. Next month, we have the winners of the *Weird SF Player Character Contest* from earlier this year, then a column on barbarians in space—is such a thing possible? Enjoy. □

Into The Dark

That Devilish Doctor

James Lowder

In the fall of 1911, Arthur Henry Ward began writing "The Zayat Kiss," the first story to feature the criminal mastermind known as Doctor Fu Manchu. The story wasn't published until late the following year, under Ward's pseudonym, Sax Rohmer. Fu Manchu—and his perennial adversaries, Nayland Smith and his Watsonlike sidekick Dr. John Petrie—were an instant success, and Rohmer went on to publish enough material about them to fill over a dozen books.

Fu Manchu soon became a master of many mediums. An early comic strip retold Rohmer's stories, as did a radio drama, "The Shadow of Fu Manchu." The Devil Doctor was showcased in a few of the pre-Batman issues of *Detective*, though his biggest splash in comic books was as Shang-Chi's dad and nemesis in Marvel's long-running *Master of Kung Fu* series.

As you might expect, Fu Manchu also made his presence known in movies and television. Since the twenties there have been a dozen feature films, three serials, a television pilot, and a 39-episode syndicated TV series, "The Adventures of Fu Manchu."

As depicted by Rohmer, the Devil Doctor is an embodiment of the "Yellow Peril," a xenophobic western fear that the eastern races are trying to conquer the world. Some of the early Fu Manchu films picked up on this. Thankfully, filmmakers (and creative types in other mediums) have lost that facet of Rohmer's character, making him instead a super-scientist. I've even heard that someone wrote a short story casting Fu as a nice old doctor, with Nayland Smith as a racist looney who is wrongfully convinced Fu is an agent for the "Yellow Peril." If any of you know the title or author of the story, drop me a note care of the Newszine.

As for the five entries in this month's Fu-a-thon, they're rated as follows:

You can't get any better
Entertaining and enjoyable
There are worse films
Wait for cable
A waste of good tape

**
*

The Mysterious Dr. Fu Manchu

1929, 81 Minutes

Paramount

Director: Rowland V. Lee

Cast: Warner Oland, Jean Arthur,
O.P. Heggie

***1/2

For this, the first full-length feature starring Fu Manchu, the screenwriters pillaged many of the earliest Rohmer stories (the ones collected under the book title, *The Insidious Dr. Fu Manchu*). In true Hollywood fashion, they use the names and a few other story ideas, but weave their own tale of murder and intrigue.

In *The Mysterious Dr. Fu Manchu*, the Devil Doctor is actually a highly respected expert on oriental diseases. As the film opens, he supports the westerners who are fighting against the Boxer Uprising in his native Peking—supports, that is, until they bombard his home in an attempt to kill the rebels hiding in his garden. His wife and young son dead, the mild-mannered doctor swears revenge against all the leaders of the western forces and their families to the third generation.

Which brings us to the meat of the yarn. After murdering the eldest member of the Petrie clan with a trick worthy of the Batman television series, Fu sets his sights on the remaining father and son—the last two deaths he needs to complete his revenge. His greatest weapon is Lia Eltham (Jean Arthur), who he has hypnotized to fall in love with young Jack Petrie. She will lure the last two victims to their doom—but only if heroic Inspector Nayland Smith can't capture the sinister doctor in time.

Played by the ever-able Warner Oland, who would go on to make his name as Charlie Chan, Fu is polished and polite, though when challenged, he's as deadly and menacing as any screen villain. His domination of the story's last 20 minutes makes the film worth viewing, praise that goes in part to the wonderful writing in the finale. Fu's last line is a gem.

O.P. Heggie is the best Nayland Smith I've seen and less like Sherlock Holmes than most of the more recent portayals. But the romantic leads are both as-

toundingly bad, with Neil Hamilton winning the prize for worst delivery of dialogue. Jean Arthur just screams a lot and says, "Oh, no, no—no!" The film was produced in both sound and silent format (which is why there are so many title cards in the opening Boxer Uprising sequence), so we can write off some of the awkward vocal work to lack of experience.

The film's newly created origin for Fu Manchu is pretty cliched, but succeeds in avoiding the racism of the source material; Fu is motivated by the death of his family, not the desire to conquer all the white peoples of the earth.

Paramount went on to produce two more entertaining movies with Oland as Fu Manchu—*The Return of Fu Manchu* and *Daughter of the Dragon*.

The Mask of Fu Manchu

1932, 72 Minutes

MGM

Director: Charles Brabin & Charles Vidor

Cast: Boris Karloff, Lewis Stone,
Myrna Loy

Of all the Fu Manchu films, this one has the most overt fantasy elements. The evil doctor directs his minions to steal the mask and scimitar of Ghengis Khan from Nayland Smith (Lewis Stone) and Sir Lionel Barton (Lawrence Grant). With those mystic relics, the Devil Doctor will call all of Asia to rise up and storm the West. As you can see from that bit of enlightened plotting, *The Mask of Fu Manchu* adopts the racism of the Rohmer book upon which it's based. Throughout the film, we are subjected to stereotypes and truly offensive comments by the heroes.

The only things that make *The Mask of Fu Manchu* worthwhile are the performances of Karloff, as Fu Manchu, and Myrna Loy, as Fu's corrupt daughter, Fah Lo. Karloff works expertly under the heavy make-up, creating the screen's most successful Devil Doctor. Even his cultured British accent adds to the menace as he tortures Sir Lionel, strapping him beneath a huge bell and ordering it tolled until he reveals the artifacts' location.

The Mask of Fu Manchu had a troubled production history, with Charles "King" Vidor being replaced as director by Charles Brabin, who reshot a number of scenes for reportedly silly reasons. At times, you can sense more than identify a difference in tone between scenes, especially toward the close. The finished film has the slick look of an MGM product, but also has the anchor of an offensive screenplay to keep it from being as entertaining as Karloff's and Loy's performances.

The Face of Fu Manchu

1965, 96 Minutes
Hallam/Seven Arts

Director: Don Sharp

**Cast: Christopher Lee, Nigel Green,
Howard Marion Crawford, Tsai
Chin**

***1/2

When Fu found his way to the silver screen again in the sixties, he had lost much of the Yellow Peril baggage. In *The Face of Fu Manchu*, the doctor is the head of an international empire of crime. Like the rest of the five-film series starring Christopher Lee as Fu, this one centers around the Devil Doctor's attempt to blackmail the world into following his commands.

In this episode, Fu is after the secret of the Black Hills Poppy, the "seed of life" that can be changed into a poison so deadly a pint of the stuff could kill everyone in London. The story is filled with typical James Bond sorts of SF trappings—secret tunnels leading to elaborate HQs, cars hiding inside trucks, and so on—even though it supposedly takes place in the late twenties. Surprisingly, Fu Manchu is allowed to succeed in some of his scheming, like killing off an entire English town, before Nayland Smith and Dr. Petrie put an end to his nefarious plans.

The cast is adequate for the story, with Lee giving a nicely restrained version of Fu Manchu. Nigel Green shows very little emotion as Nayland Smith, his expressions ranging all the way from boredom to disdain. The real stand-outs are Tsai Chin as another of Fu's evil daughters, Lin Tang, and Howard Marion Crawford as Dr. Petrie, though he obviously spent a lot of time watching old Sherlock Holmes films to see how Nigel Bruce created a likeable Watson.

Oddly, the film really self-destructs toward the close, with a strange tacked-

on ending that takes place in Tibet and some terribly filmed fight scenes. Like the other flick in the series, it ends with a voice-over of Fu Manchu saying, "The world shall hear from me again." They did, only one year later, in *The Brides of Fu Manchu*.

The Blood of Fu Manchu

1968, 91 Minutes
Warner/Seven Arts

Director: Jess Franco

**Cast: Christopher Lee, Gotz George,
Howard Marion Crawford, Tsai
Chin**

*1/2

Fu Manchu is at it again, this time injecting beautiful women with a deadly poison and sending them off to kiss his enemies to death. From his hiding place in the Amazon, the Devil Doctor strikes at Nayland Smith (Richard Greene) and various world leaders. Early in the film, he succeeds in poisoning Nayland, so the would-be hero spends much of the story blind and pretty helpless. It's up to Dr. Petrie and young archaeologist Carl Jannsen to save the day. In *Face of Fu Manchu* a character named Carl Jannsen was an older gent and a biochemist. Either the scripters forgot about him or they hadn't watched the first movie in the series.

Such logic flaws are rampant in *The Blood of Fu Manchu*. At one point the heroes turn away some soldiers who are going to help them fight Fu. The jungle's too thick for horses, they say. Janssen & Company then proceed to ride off into the jungle, only to send their own horses away a short time later, when someone spots a large snake in the trees. Once the horses have been shooed back to the village, they shoot the snake and march off on foot. And we're supposed to believe Fu Manchu can't outwit these clods?

The Blood of Fu Manchu is a typical product of director Jess—or Jesse or Jesus, depending upon the film—Franco. We are subjected to lots of hack cinematography, more gratuitous close-ups than an installment of Wayne's World, and more than anyone's fair share of bondage, rape, and torture. Franco is better known for such exploitation classics as *Barbed Wire Dolls* and *Wanda the Wicked Warden*.

Like many extended film series, the Christopher Lee/Fu Manchu series got worse and worse with each new entry. *The Blood of Fu Manchu* was fourth and

the last that was even mildly entertaining. Lee and most of the cast sleepwalk through the script. Tsai Chin tries valiantly to be menacing as Lin Tang, but her part is too small for that to help.

Like its director, *The Blood of Fu Manchu* goes by many names—*Kiss and Kill*, *Against All Odds*, and *Kiss of Death*. For some strange reason, it was released in black & white in the U.S. in 1968, though all the tapes I've seen are in color.

The final Lee/Fu Manchu movie, *The Castle of Fu Manchu*, was so bad, it was lampooned on "Mystery Science Theater 3000." If you're tempted to watch *Castle*, go for the MST3K version.

The Fiendish Plot of Dr. Fu Manchu

1980, 108 Minutes
Orion/Warner

Director: Piers Haggard

**Cast: Peter Sellers, Helen Mirren,
Sid Ceasar**

*

This dog was the last film done by the talented Peter Sellers and the most recent attempt to bring Sax Rohmer's characters to the screen. Like the infinitely superior *Dr. Strangelove* and *The Mouse that Roared*, it features Sellers playing multiple roles—both Fu Manchu and Nayland Smith. The problem is, the script just isn't funny.

Fu Manchu celebrates his 168th birthday. As his dacoits sing "Happy Birthday to Fu," he prepares to imbibe the *elixir vitae* that has kept him alive and healthy for so long. A bumbling servant, played by Burt Kwouk (Catō in the Pink Panther series), catches fire and uses the remaining elixir to put himself out. The hunt is on for the rare items Fu needs to make a new batch. Nayland Smith, rather unhinged after being tortured by the Si Fan years past, is brought out of retirement to help Scotland Yard foil the Devil Doctor's plans once more.

Fiendish Plot is filled with the sort of tired, crude humor you might expect from a film that boasts Hugh Hefner as executive producer. Lots of solid actors are given dreadful parts, the worst being Sid Ceasar's foul-mouthed FBI agent. Director Haggard has a hit-and-miss record, with the superior supernatural thriller *The Blood on Satan's Claw* and the equally terrible *Venom* to his credit. This one was definitely a miss. □

The Living City

Elonia's Beauty Shoppe

by Jack D. Graham

Elonia's Beauty Shoppe is a two-story stone building located in Ravens Bluff's "uptown" section (the central business district, located between the waterfall and the wharves). The Shoppe is located in a hilly section, not far from a wealthy residential neighborhood. Elonia Starre owns and operates this prosperous business. Elonia's daughter, Salena, is the only other employee.

Elonia's Beauty Shoppe specializes in personal beauty in almost any form a customer could wish. The most commonly requested services are:

Hair Cut	5 sp
Hair Wash	3 sp
Shave	4 sp
Hair Removal	1-3 gp
Hair Coloring, Temporary	2-4 gp
Hair Coloring, Permanent	4-6 gp
Skin Coloring, Temporary	5-7 gp
Skin Coloring, Permanent	7-9 gp
Facial Treatment	2 gp
Facial Painting	3-4 gp
Manicure/Pedicure	3 gp
with Gem Glitter	5-10 gp

The less-commonly requested services the Shoppe provides include tattooing, disguises, and illusory enhancement of a customer's beauty. These services sell for 10 gp and up.

Elonia also sells the following beauty supplies in a variety of colors and styles:

Hair Coloring, Temporary	1 cup	1-3 gp
Hair Coloring, Permanent	1 cup	3-5 gp
Skin Coloring, Temporary	4 cups	3-5 gp
Skin Coloring, Permanent	4 cups	5-7 gp
Facial Paints	1 oz.	10 sp-1 gp
Nail Paints	1 oz.	2-10 sp

Elonia also sells perfumes and colognes and, by special request, disguise kits. Prices for these items are 15 gp and up.

Elonia's customers are primarily upper-class people, but Elonia is a commoner and will not turn away anyone because of social status. The Shoppe is very popular with the fine ladies of

Ravens Bluff, and is a lively center for rumors and gossip about the city and its elite; Elonia is one of the city's best-informed talebearers.

Elonia's Beauty Shoppe has three main sections. The front section is an open area where customers can sit and talk while Elonia and Salena work on them at public stations located in the same room. There also is a small counter and display case where Elonia keeps dyes, paints, powders and perfumes for sale.

There are three small rooms behind and to one side of the public area. These are private work stations dedicated to the less common services the Shoppe offers.

Room 1 has needles and dyes for tattooing. The walls are covered with numerous small paintings of animals, monsters, symbols, and other images available for tattoos.

Room 2 is where Elonia performs illusory beauty enhancements on her customers. These are not popular, but many customers get them for special occasions such as weddings or formal parties. Elonia keeps a bottle with a dozen pinches of *dust of illusion* here. However, she prefers to use her spells and seldomly employs the *dust*.

Room 3 contains everything Elonia needs to create a complete disguise. There is a rack of costumes, and shelves full of paints, dyes, wigs, padding, and even putty that can be used to conceal or create scars or other features. This room has two doors, one that opens into the front room, and one that opens into the store room.

The Shoppe's rear section includes a large store room where Elonia keeps most of her supplies. This room also contains a work area for mixing dyes, perfumes, and paints. A door in the storage room opens onto an alley. A few customers who don't wish to be seen entering or leaving the Shoppe use this door, but it is used mostly for receiving deliveries and emptying the trash. This door is padlocked and barred when not in use. The remainder of the rear section is a small office with a desk and a cabinet for records. The desk has a locked drawer with a small strongbox, also locked, that never contains more than 25 gp in assorted coins. Elonia

quickly deposits any excess into a bank account. This doesn't happen very often, however, as most of Elonia's upper class customers buy their services on credit and pay their bills directly to Elonia's banker every three months. A stairway leads from the office directly to Elonia's room on the second floor.

The main entrance to the Starres' living quarters on the second floor is an outside staircase at the front of the building. The apartment is lavishly furnished in the latest fashion. The Starres have a living room, dining room, two bedrooms, a library, and a study room. Elonia keeps a *mirror of mental prowess* in her room.

Elonia Starre

7th Level Female Human Illusionist

STR: 10
INT: 16
WIS: 15
DEX: 16
CON: 9
CHA: 15

AC Normal: 8

AC Rear: 10

Hit Points: 18

Alignment: Chaotic Good

Languages: Common, Elvish, Dwarvish, Thorass

Age: 44

Height: 5' 5"

Weight: 122 lbs.

Hair/Eyes: Red/Blue

Weapon Proficiencies: Dagger, staff

Nonweapon Proficiencies: Ancient history (15), spellcraft (14), disguise (15), etiquette (15)

Magic Items: *Dust of illusion* (12), *mirror of mental prowess*

Spells/day: 4 3 2 1 plus 1 illusion/phantasm of each level

Spell Books:

Level One: *charm person, detect magic, hypnotism, read magic, cantrip, phantasmal force*; Level Two: *Elonia's Glamour**, *ESP, glitterdust, alter self, hypnotic pattern*; Level Three: *hold person, sepia snake sigil, invisibility 10' radius, spectral force, wraithform*; Level Four: *Phantasmal killer, polymorph*

other, polymorph self

* New spell detailed at the end of this article.

Elonia has bushy, bright red hair which is always immaculately groomed. Overall, she is a walking advertisement for her own services and she easily catches looks of admiration from passing males.

Elonia retired from adventuring 18 years ago when her husband, Maxale Starre, was killed by a hydra. Her decision was sealed some time later when she discovered she was pregnant with Salena. Maxale was a rogue by trade, and a master of disguises. It was he who taught Elonia the art of makeup and disguise.

Elonia opened her business 15 years ago. It took five years of hard work to make it successful. Now, she has many loyal customers and an excellent reputation.

Elonia is curious by nature and occasionally uses spells such as *ESP* to get information. She also uses her *mirror of mental prowess* to follow up on particularly juicy bits of gossip. This, coupled with her many conversations with clients easily makes her one of the best-informed citizens of Ravens Bluff, at least regarding the recent comings and goings of the wealthy and socially active. Elonia wouldn't dream of selling information, but she'll gladly share tidbits of local knowledge with any polite, talkative customer. She is wise enough, however, to know when adventurers or burglars are pumping her for information that might hurt a neighbor. She will gladly share information with PCs trying to solve a crime or do a service to the city government, but won't cooperate with characters who can't convince her of their good intentions.

Salena Starre

1st Level Female Human Illusionist

STR: 10
INT: 15
WIS: 14
DEX: 16
CON: 11
CHA: 16

AC Normal: 8

AC Rear: 10

Hit Points: 3

Alignment: Chaotic Good

Languages: Common, Elvish, Dwarvish, Thorass

Age: 17

Height: 5' 10"

Weight: 130 lbs.

Hair/Eyes: Strawberry Blond/Blue

Weapon Proficiencies: Dagger

Nonweapon Proficiencies: Artistic ability, painting (15), spellcraft (13), disguise (15), etiquette (16)

Spells/day: 1 plus 1 illusion/phantasm

Spell Books:

Level One: *read magic, cantrip, phantasmal force*

Salena's hair hangs down to her hips. She does not wear as much makeup as her mother, but still is prettier, though Salena will never admit it.

Salena helps her mother in the Shoppe. She has free access to her mother's spell books and other research materials, and she is trying to learn all she can about business and the art of spell casting before she leaves for a life of her own. Recently, some of her friends have been talking about leaving Ravens Bluff and seeking out their fortunes, perhaps by travelling to Waterdeep. Salena is unsure about what she will do. She feels that her mother would be against her becoming an adventurer, but the prospect of an adventuring life excites her. Salena also feels that adventuring could teach her a lot about magic and about life in general. Actually, Elonia has always assumed Salena would make a career out of magic, at least for a few years. Elonia would prefer that Salena join the city watch or become someone's house wizard, but it would be fine with Elonia if Salena chooses the risks and potentially great rewards of adventuring.

New Magic

Elonia's Glamer

(Illusion/Phantasm, Reversible)

Level: 2nd

Range: Touch

Components: V, S, M

Duration: 6 turns + 2 turns/level

Casting time: 3

Area of Effect: One creature

Saving Throw: Neg

With this spell, the caster enhances the recipient's personal beauty. The recipient's eyes become brighter, the hair and skin become more richly colored and lustrous, teeth become whiter, etc. The

recipient is surrounded by a subtle glow in dim light and is covered with minute sparkles in bright light. These effects raise the recipient's Charisma score by two points (19 maximum). The effect is completely illusory and can be disbelieved. The material component is a pinch of ruby dust.

The reverse of this spell casts a lackluster pall over the recipient which reduces Charisma by two points (minimum 2). The material component for this version is a pinch of chalk. □

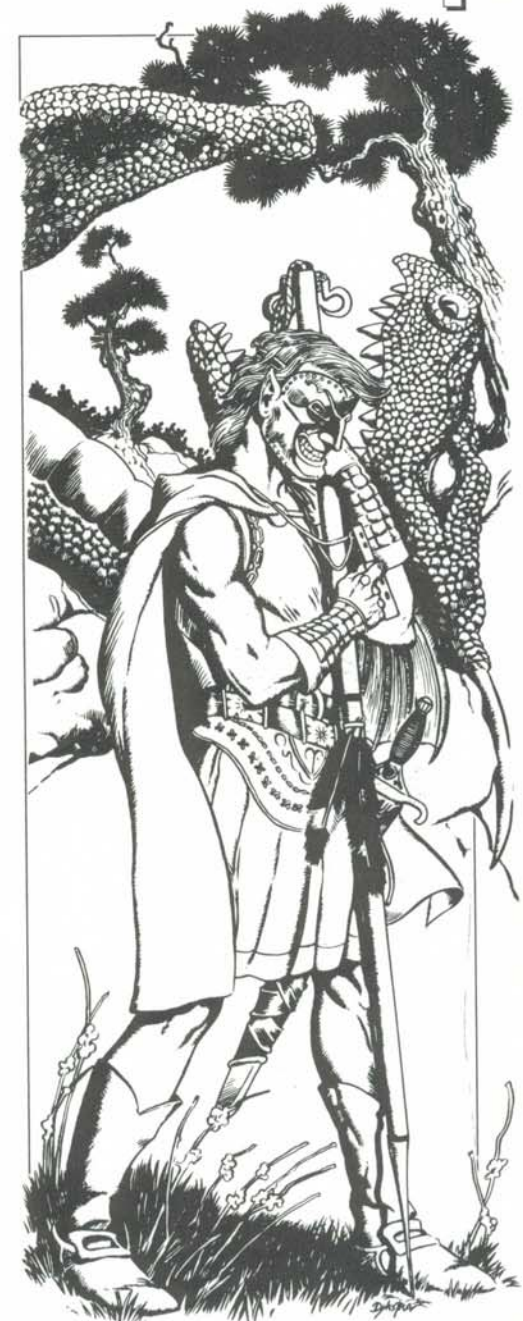

Elonia's Beauty Shoppe

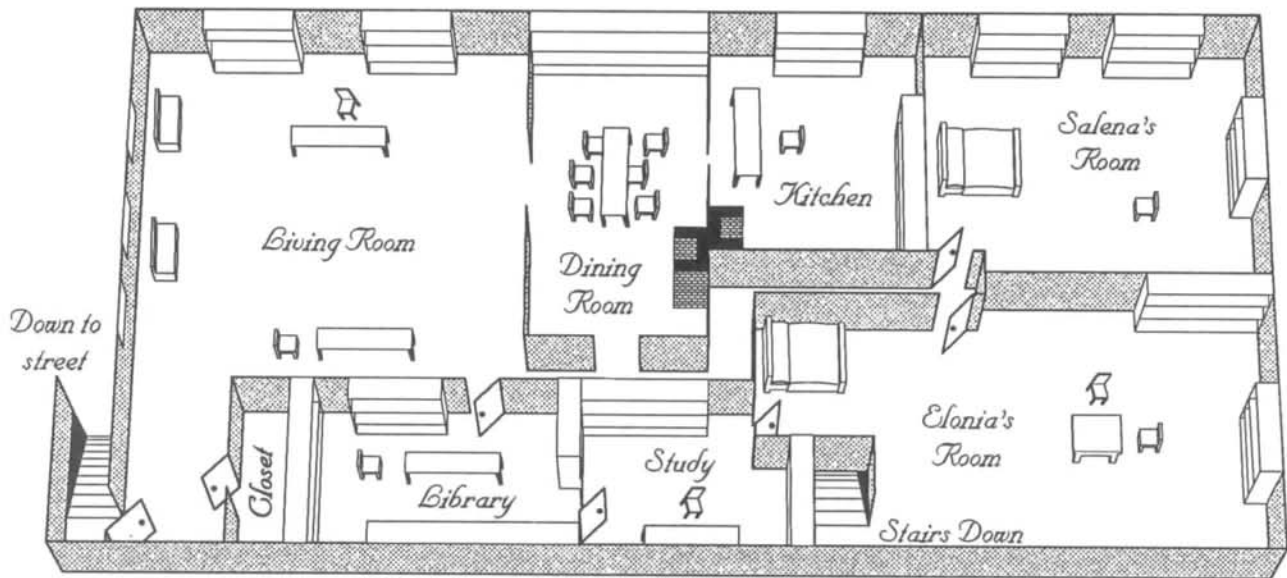

Upper Floor

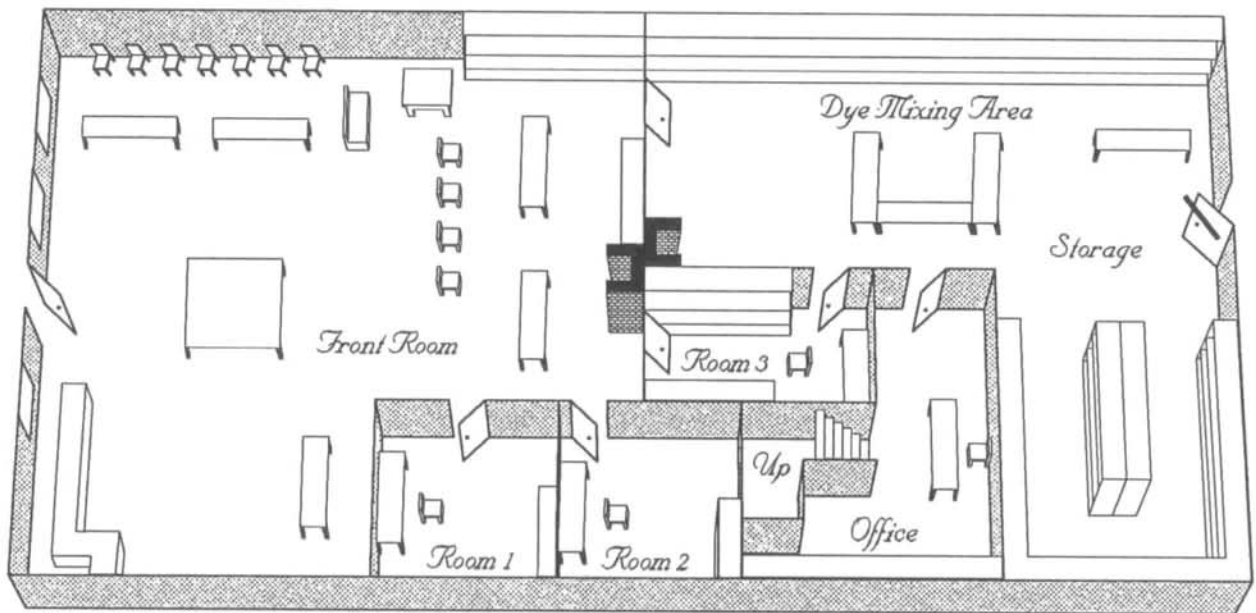

Ground Floor

□ Five Feet

Enigma

Who Is This Mysterious Woman?

Tell us all about this woman. Include a complete history and game statistics for any popular game system. Where does she come from? What does she do? Don't forget to include information on her headdress and other jewelry.

Rules

All entries must be *typed* or computer-printed, double-spaced, on plain white paper.

Your name and Network membership number must appear in the upper right-hand corner of each page.

Your entry must have a title, and you must say which game system you are using.

All entries will be treated as submissions to POLYHEDRON® Newszine. A *standard disclosure form* must accompany each entry. If you submit multiple entries, include a separate form for each one. A form appears in this issue.

No entry should exceed five double-spaced pages.

All entries must be postmarked by January 18th, 1993.

Entries will be judged on quality of presentation, originality, completeness, and playability.

The Prizes

The grand prize will be Steven Schwartz's original pen-and-ink drawing of our mystery woman. It is black and white, signed by the artist, and is about 14 inches high and nine inches wide. The grand prize winner also will receive a one-year membership extension.

The first place entry will earn its author a one-year membership extension and a nifty prize selected by HQ.

The second place entry will earn its author a one-year membership extension.

Network HQ will designate any number of **judges' choice** entries. Each of these will earn its author a two-month membership extension.

That's all. Good luck and good writing. □

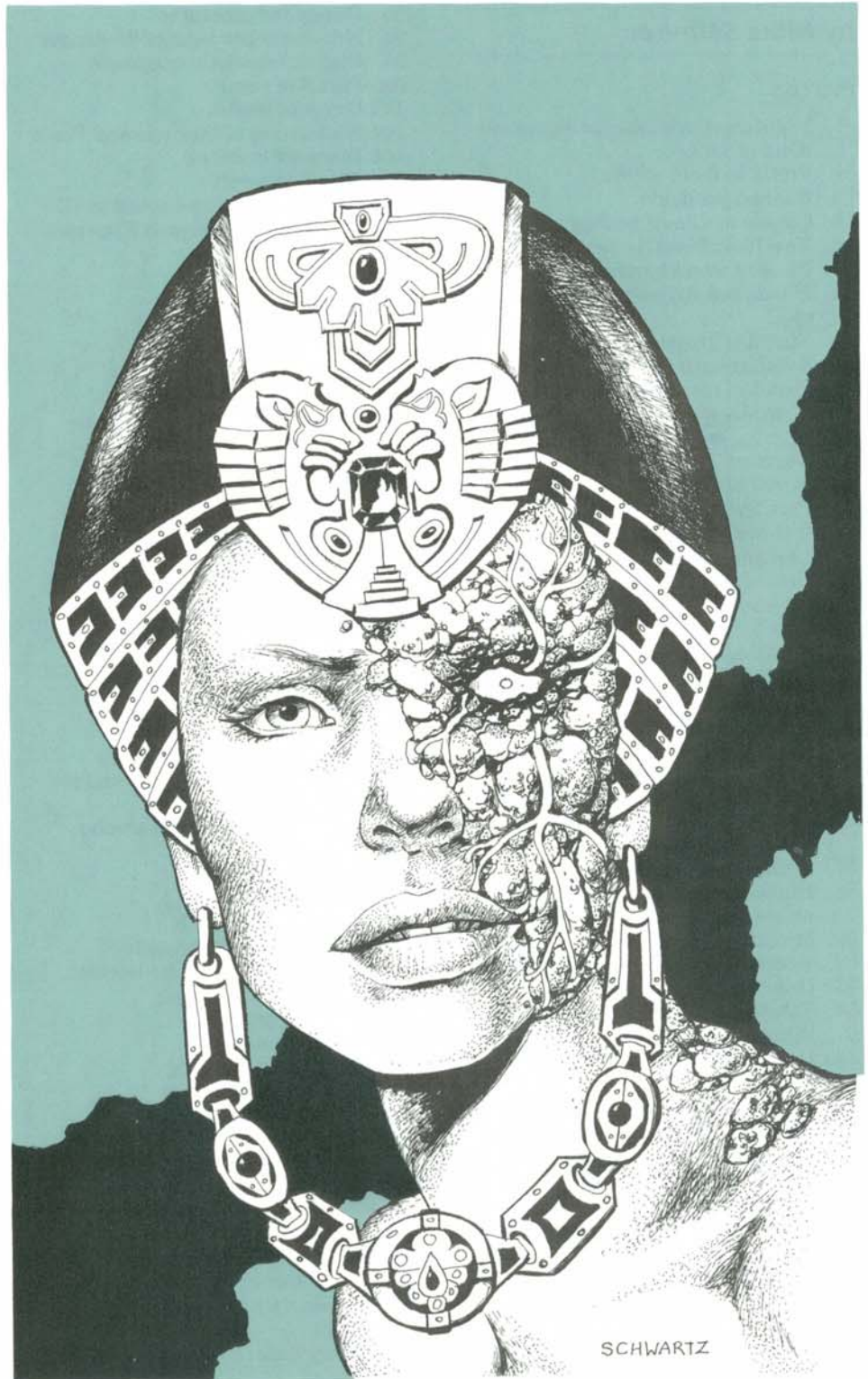

Cutting Remarks

A Macabre Crossword Puzzle

by Mike Selinker

Across

1. Nightcrawler's teleporting sound
5. Kind of wolf
9. Prefix in front of "fix"
12. Banned pesticide
15. Candle or Christ ending
18. *The Time Machine* race
19. Place of worshipping
20. *Unearthed Arcana* 1st level MU spell
21. *Starship Troopers* initials
22. Southeastern Network club
23. Part 1 of result from 68-Across
25. Wizard's stat
26. _____ of the deep
27. Warriors' league
28. Sword material
29. Part 2 of result
32. It times an exposure
34. "An anomalous _____ of evil" (Jotunheim)
36. A Gabor
37. Part 3 of result
39. Reacting to a barbazu's touch
42. Nader's *Unsafe _____ Speed*
44. Before, poetically
45. Part 4 of result
52. Airborne koboldkin
53. At the epicenter of
54. Marvel's Spaceknight
55. Fudge's partner in *A Friend in Need*
57. *Pirates and Plunder* assent
58. Highest male and lowest female voices
60. Mjolnir's owner
62. Worshipper of 60-Across, maybe
63. One might lead gnolls
64. See 96-Across
67. What you're reading
68. Hysterical DRAGONQUEST® Game chart
73. Author Moore and bard A-Dale
74. Original edition 7th level clerics
75. The Sea Hag's henchmen
76. Splendor and rulership
77. Fighter face-off
79. Shoes named for a Greek goddess
80. _____-magnon
83. Lead-in for color or lateral
84. A party's constituents
85. Druidic bent toward animals
88. See 58-Down
89. Part 5 of result

95. One-celled creatures
96. Hit points per head of 64-Across
97. Classic futuristic magazine
98. Part 6 of result
102. Oxygen: prefix
104. Nicknames of Stallone and Plath
105. Diorama material
106. Part 7 of result
109. Receive a 5th level priest spell
113. Legendary Chicagoan Kupcinet
114. Babe
116. Secreted
117. Part 8 of result
119. Regret
120. Gin concocter Whitney
121. Street of Nightmares
122. Plus
123. Worst AC in the D&D® Game
124. The final arbiters
125. Manticore's home
126. Giant squid sepia, e.g.
127. Survive
128. Charm with no save

Down

1. Djinn officials
2. "Thanks _____!"
3. Wry grimace
4. Creatures introduced in C2
5. Earth genie
6. Another genie, originally
7. Tournament series once called "Star"
8. Spell wizards hate on scrolls
9. Grunts
10. It can be explosive
11. Joust participant
12. Judge of 2000 A.D.
13. Darkenbeast's cow-cycle
14. DRAGON® Magazine letters column, once
15. The biggest ray
16. Druid's home
17. Panoramic painting
24. Kate's TV roommate
30. Black Tentacles mage
31. Ethereal pop singer
33. Complainant
35. One result from a two-sider
38. "Well? _____ no?"
39. Color of Lake Geneva
40. S.H.I.E.L.D.'s Sergeant
41. Use a hippogriff or hippocampus
43. *Civilization* progress chart, for short
46. "Jack Sprat would _____ fat..."
47. Any of the Slave Lords series
48. A middle Hell
49. Sold out, on marquees
50. His helm's not affected by *anything*
51. SF author Diane
56. Game *Melee* and *Wizard* became, for short
58. Tavern choices
59. Actress Ullmann
60. Capote, to admirers
61. Flame horror
62. Dragonkind artifacts
63. Aboleth features
64. Address to a satyr or androsphinx
65. Spanish girl's name
66. Platter spinners
67. Gives a no-star review
68. Anagram for Ygorl
69. Orioncomm SW1, e.g.
70. Actor Mineo
71. Items for rakoxen or rothe
72. A hobbit's _____ is hairy
73. Clyde Caldwell specialty
77. 1984 Mr. T vehicle
78. Show for soldiers
79. DMG's "ultimate warship"
80. Garrison's necessity
81. Try again
82. Great orc
84. Like many treasure splits
85. Annis, for one
86. Words to a rogue
87. Cousins of snyads
88. Horn that causes siege damage
90. Guns foolishly fired one-handed
91. Intermediate: prefix
92. Set up a tent
93. What an arrow of direction shows
94. Any Rabe relative, to Jean
98. 1957 classic car
99. _____-scarum
100. Makers of boots and cloaks
101. Being that fights among itself
103. Of kings and queens
104. Creator of the Lorax
107. Like a barl nep's radioactive slick
108. Kinks smash
110. Garfield's foil
111. Soul singer Hendryx
112. Rams' dams
115. Shout to a toreador
118. A kind of grub

The answers will appear next issue.

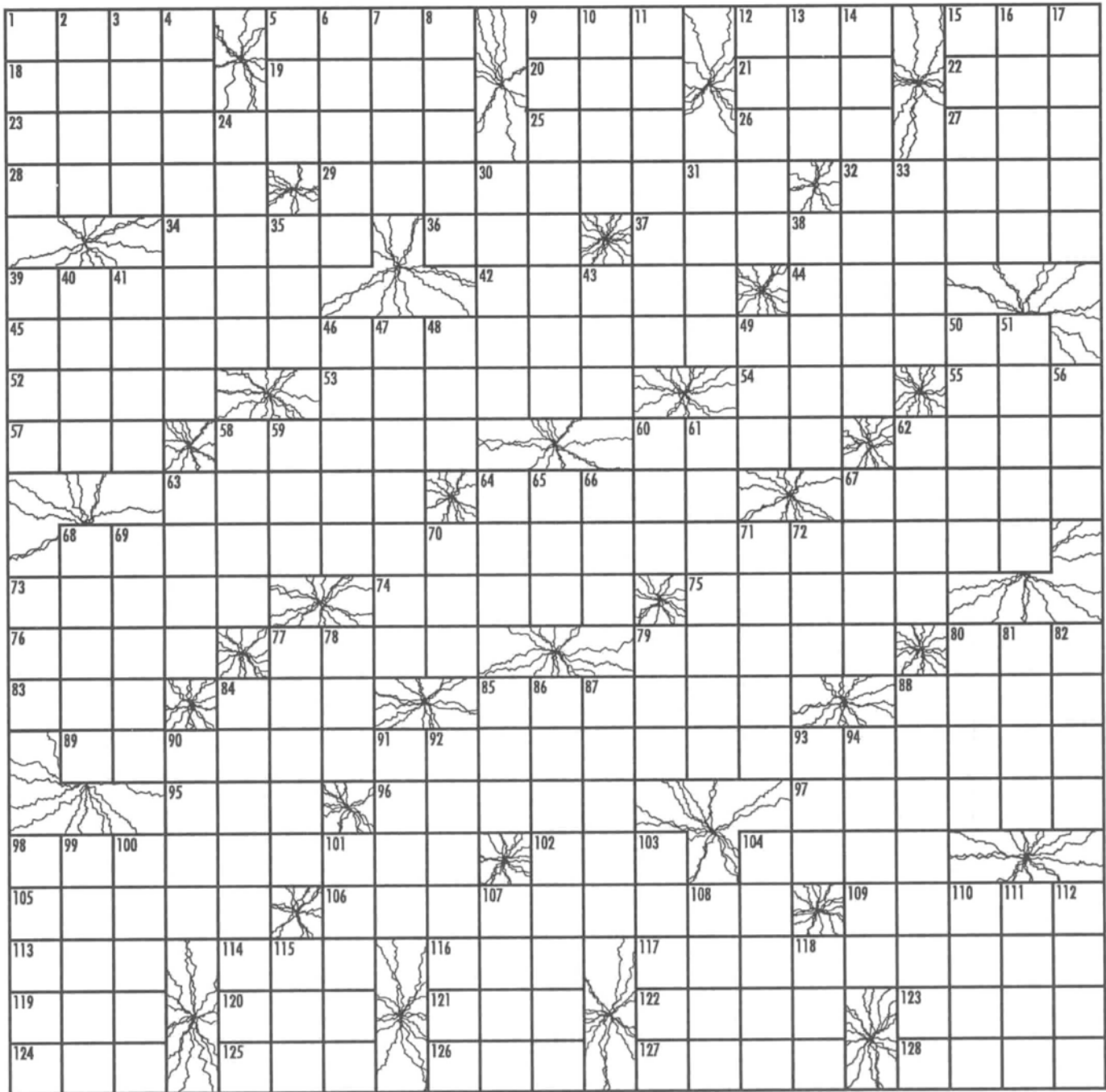

The Bard's Corner

Rainy Days And Mundanes Always Get Me Down

By Don Bingle

A skit presented by the PM Players at the 1991 GEN CON® Game Fair.

Announcer (in best Rod Serling imitation): Imagine a roadside cafe in a small town astride an interstate highway in Illinois. Peaceful, serene, and uncomplicated by the hustle and bustle of modern life. A place lacking violent crime, religious fanatics, and heavy metal music. It is about to be visited by two men who have spent several days innocently enjoying the intellectual and dramatic pursuits of role plying gaming at the GEN CON Game Fair in Milwaukee, Wisconsin. They firmly believe they are entering the cafe for a quick meal of meatloaf surprise on their journey home. But their belief is a fantasy, and their grasp of reality is about to be seriously disrupted. . . for they are about the enter "The Highlight Zone."

Musical interlude of theme music from *The Twilight Zone* TV series.

The Storyteller and the Listener enter, stomping their feet and shaking water off themselves as they close a wet umbrella and head for a booth. They wear RPGA™ Network jackets. A bored looking man is reading a magazine in an adjacent booth.

Storyteller: Sorry I wasn't very talkative in the car, but with the rain coming down so hard, I needed to concentrate.

Listener: That's okay. I just wanted to hear about your big adventures up in Wisconsin.

Waitress comes over and leaves menus, then hovers at a nearby counter with pen and order pad at ready.

Storyteller: Well, I was in big trouble in that TOP SECRET® game.

Waitress perks up at the words "top secret."

Listener: Oh yeah? Tell me about it, but first let's order. (*Motions to waitress.*) I'll have meat loaf and a chocolate shake.

Storyteller: Yeah, and I'll have a pork tenderloin, fries, and a cola.

Waitress leaves, hollers order offstage, and returns to the counter, where she fixes drinks within earshot.

Storyteller: Well, we wanted to check out this guy, so Keith suggests we break into his apartment and look for this stash we thought he was hiding. We leave some of the guys as lookouts downstairs and there we are, standing at the door and Keith is getting ready to pick the lock. (*Waitress looks concerned and leans closer*) I say, "What if somebody's home? Let's at least knock on the door." So we do and the guy answers! Well, Keith is obviously not prepared for suddenly meeting the guy face to face, so I stick my foot in the door and say, "Hello, we're Jehovah's Witnesses."

Listener: You mean he didn't know who you were?

Storyteller: Nah, it all happened too quick. (*Waitress starts to bring drinks over to the table slowly.*) I'm fast-talking the guy and we make our way into the apartment and I say, "Let us kneel down and pray." I give him a shove down to his knees and, wham! (*Hitting the table hard.*) I pistol whip him.

Waitress stifles a scream and drops her tray of drinks. Both gamers look at her.

Waitress: Er. . . uh . . . I . . . er. . . I'd better get a towel. (*Waitress forces herself to walk back to the counter, then dashes to a pay phone. She dials "0".*) Get me the county sheriff, Now!

Musical interlude: "One Adam Twelve, One Adam Twelve. Man with a gun . . ."

Listener: One hit and he was down? Must've been a pretty good roll. What did you do then?

Storyteller: Well, we ransacked the place and Keith gets all worried that they're gonna suspect that we did it just to find this stash of top secret spy stuff. I said we should make it look like a run-of-the-mill robbery by heisting the TV and stereo. (*Man in the next booth suddenly looks up and leans to listen.*) So, we're dumping electronic stuff down the laundry chute and arguing about whether to truss up the unconscious guy or what. (*Man swallows hard and begins to inch his way out of his booth.*)

The rest of the team is in a tizzy because they think the neighbors have called the cops. (*A siren becomes faintly audible in the background.*) So we hunker down in the lobby of the building to see what's up.

Policeman arrives and man and waitress rush to him and excitedly point at the gamers.

Man: Over there (*Pointing*) The one's in the gang colors. (*The policeman looks in disbelief and begins to saunter casually toward the gamers.*)

Storyteller: Of course, I had my Uzi under my jacket. I never go anywhere in one of these things without an automatic weapon, loaded and ready to fire. (*Policeman does a quick about face and gets on the radio.*) Well, a big gun battle develops and Keith's guy sneaks out and tries to steal a get-away car, which he does. But he runs over one of the cops, which tends to get them mad.

More sirens, and red, flashing lights. SWAT team members come "hutting" in and take up firing positions.

Storyteller: There we were blasting away for almost an hour, but Keith's guy and I survive and limp away in this bullet-ridden heap he stole.

Policeman (with bull horn): This is the police. You are surrounded. Place your weapons slowly on the table, then put your hands in back of your heads.

Both gamers look around, obviously puzzled, to see who the police are talking to. When they realize it is them, they slowly raise their hands.

Listener: You know, I've got a funny feeling we're not in Wisconsin anymore.

Musical interlude of theme music from *The Twilight Zone*

Announcer: The story you have just seen is based on a true incident, showing once again that there is a fine line between reality and fantasy. When you are near that line you have entered "The Highlight Zone." *Music swells and fades as the gamers are handcuffed and lead out of the restaurant.*

BLOODMOOSE™ AND COMPANY

by Gary M. Williams © 1991

...SO BY ORDER OF THE UNIVERSAL INTERGALACTIC FEDERATION PRESIDENT, YOUR SENTENCE IS HEREBY COMMUTED, HAVING SERVED 11 MONTHS, 29 DAYS, 23 HOURS 59 MINUTES AND 30 SECONDS. THANK YOU... AND DON'T COME BACK.

YEAH 'N' THANKS FER NUTHIN'!



Where the Gamers Were

Scenes from the
GEN CON®/Origins™ Game Fair—
August 20 – 23, Milwaukee, WI



P O L Y H E D R O N