

the

No. 5, \$2

JOURNAL

of the Travellers' Aid Society

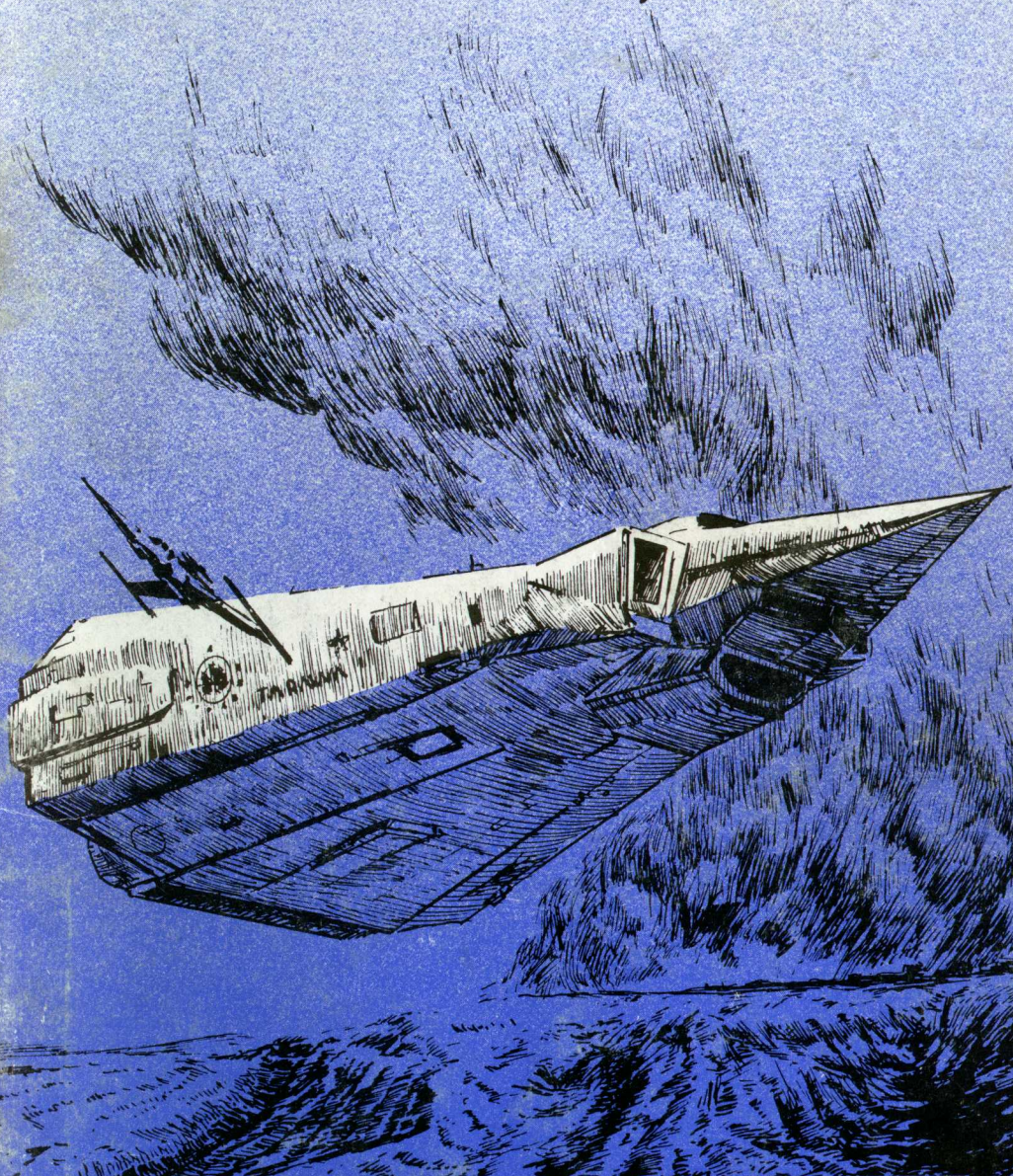

IMPERIUM

TRAVELLER

In addition to the basic three-booklet Traveller set, the following *Books*, *Adventures*, *Supplements*, and *Games* are available for more Traveller action!

Mercenary (*Book 4*) aims at the military adventurer with extensive rules for detailed army and marine characters, new skills, and coverage of battle resolution. A full chapter covers the new weapons of the future. . . . \$5.98

High Guard (*Book 5*) deals with detailed characters who have served in the planetary or imperial space forces (including rules for college, medical, and flight schools). Design, construction, and combat for starships ranging in size from one hundred to one million tons is presented. . . . \$5.98

The Kinunir (*Adventure 1*) concerns a class of imperial battle cruisers, and leads a band of adventurers into industrial espionage, afoul of the law, and ultimately to the answer to a mysterious disappearance years ago. Included are rumors, situations, library data, and deck plans and statistics for a 1200 ton military starship. . . . \$4.98

Shadows/Annie Nova (*Double Adventure 1*) is a set of two adventures, printed back-to-back. Each is playable separately, and both are complete with pre-generated characters (if they prove necessary), a situation, ref's notes, and detailed plans or drawings. Shadows is an alien complex on a frontier world, and Annie Nova is a mysterious starship abandoned in orbit. . . \$4.98

1001 Characters (*Supplement 1*) is a set of pre-generated characters ideal for non-player character or patron encounters. A final chapter rates nine characters from fiction— test your familiarity with science-fiction . . . \$3.98

Animal Encounters (*Supplement 2*) contains 111 different animal encounter tables, already produced, and tagged for specific terrain and world types. Ideal for impromptu adventures and situations. . . . \$3.98

The Spinward Marches (*Supplement 3*) is a set of 16 pregenerated subsectors situated on the edge of the Imperium. Each subsector contains a map, a list of world data and statistics, and some background data. A final chapter recapitulates the meanings of the various world factors for easy reference, and an index leads the referee to worlds by name. . . . \$3.98

Citizens (*Supplement 4*) presents character generation rules for 12 new character types, including barbarians, doctors, scientists, nobles, and rogues. Each type includes forty examples pregenerated, and ready for use as patrons or non-player characters. Check out rogue number 19. . . . \$3.98

Mayday (*Game 1*) modifies the starship combat rules in Book 2 to conform to a hex grid, and supplies die-cut counters. The game is playable with encounters, or as a two-player situation. Boxed. . . . \$5.98

Snapshot (*Game 2*) is close-combat set aboard starships. Hijacking, piracy, mutiny, and personal conflict are all possible using these combat rules and the starship deck plans. Usable with Traveller, or by itself. . . . \$7.98

Game Designers' Workshop

203 North Street, Normal, Illinois 61761

the
JOURNAL
of the Travellers' Aid Society

Cover Article

Imperium: Ground Combat Module by Roberto Camino 16

Amber Zone

Foodrunner by Mike Metlay 12

The Werewolf Disease by Anders Blixt 32

FeatureArticles

Special Psionic Powers by John Morrison 25

Speculation without a Starship by Loren Wiseman 34

Traveller Module

LSP Modular Cutter by Marc Miller 6

Features

From The Management 2

Traveller News Service 5

Ship's Locker 30

Ref's Notes: Sample Robots 14

Dates in this issue of the *Journal* are given in accordance with an arbitrary Imperial calendar of 365 days. The expression of date consists of a three-digit day number (showing the current day of the year), followed by a dash and a four-digit year number (showing the current year since the founding of the Imperium).

The date of this issue is **183-1106**; or the 183rd day of the 1106th year of the Imperium.

The Journal of the Travellers Aid Society is a science-fiction gaming magazine dedicated to **Traveller**, GDW's role-playing game set in the far future,

Editor— Loren K. Wiseman

Spiritual Advisor— Marc W. Miller

Publisher— Game Designers' Workshop

Artists in this issue: William H. Keith, Cover, 10, 12, 14, 16, 32, 34. Gary Kalin, 30, Charmaine Geist, 7, 8, 9.

The Journal of the Travellers' Aid Society is copyright 1980 by **Game Designers' Workshop**. Printed in the USA. All Rights Reserved. ISSN: 0193-3124. All editorial and general mail should be sent to *The Journal*, Box 432, Normal, IL 61761.

The Journal of the Travellers' Aid Society is published quarterly with an individual issue price of \$2. One year subscriptions are \$7 in the United States and Canada. Foreign Subscriptions (outside the US or Canada, and not to FPO or APO addresses) are \$14 per year, which includes air mail postage. Please make all payments in US funds drawn on a US bank. Advertisers should inquire for an advertising rate card.

Submissions: We welcome articles and illustrations for the *Journal*. Please inquire before submitting manuscripts; we will send a style and want sheet.

From the Management

This issue of the Journal of the Travellers' Aid Society marks the start of its second year of publication, and in honor of the occasion, we have expanded to 40 pages. Even allowing for advertisements, this means about five more pages of text per issue, which we will try to use to best advantage.

One of the things we will be including in subsequent issues is a second Amber zone. This feature is one of our most popular, and we will bring more out in response to overwhelming reader demand.

To further celebrate, we have included a special Variant in this issue; Imperium Ground Combat Module, by Roberto Camino. Roberto will undoubtedly be familiar to some of you, as he has been the author of a number of variants on GDW games.

To involve our readers in the celebration, the staff of the Journal invites all of our readers to write telling us what they liked and didn't like about our first year, and what they would like to see in the future. We have already received a number of such comments, some of which we have decided to implement, such as the increased number of Amber Zones' mentioned above. Others, such as the suggestion that we eliminate everything but Traveller material from our pages ("get rid of the ads, and don't bother with a table of contents," he said, "I read every issue cover to cover anyway"), we decided against. A number of other ideas should be decided by our readers. Would you like to see more of our regular features such as Ship's Locker or Bestiary? Is there any interest in a Traveller classified ad section, for people to advertise for opponents and information (we have had only one such request, which has been printed at the end of this editorial, but if there is enough of a response, we could make Classifieds a regular feature). How many of you are interested in reading in depth reviews of other SF games? Is there any interest in an article or series of articles on using miniatures in Traveller games? The only way we can respond to your wishes is if we know about them. Let us know what you want to see in the Journal.

This year at Origins (June 27, 28, 29 at Chester Pennsylvania) we are again running a Traveller tournament and a Traveller seminar. The tournament is an actual session using Across the Bright Face (one of the double-adventures just being released). Winners will be determined based on a scoring system which takes into account survival and time. Then, after the tournament is completed, Double Adventure Number 2—Bright Face/Mission on Mithril will be released for sale at the GDW booth at the convention. Mail orders for the adventures will be filled in early July.

We will be doing the same thing (with another adventure, of course) in the Traveller tournament at Gen-Con XIII in late August (see the ad for Gen-Con XIII in this issue).

Back in Journal number 3 we mentioned a game called Azhanti High Lightning — and now it's out! This game is a giant, with fourteen deck

plans, die cut counters, a rules booklet (not Snapshot, but another fast-moving system), dice, and a supplement (number 5) which describes the Azhanti-class ships in detail, along with their Imperial Marine contingents.

The multi-colored maps are quite striking, and the counters included represent crew members, Imperial marines, mercenaries, adventurers, Zhodani, Vargr, and a wide selection of action markers. The game is boxed in one of our large (11 1/4 x 14 1/2 x 1") boxes and features a beautiful cover painting rendered in four-color process. The game system of Azhanti High Lightning is usable alone, or in combination with Snapshot and Traveller. This game is truly magnificent . . . you'll have to see it to believe it!

The request for a classified ad, which I mentioned above, is from one of GDW's staffers, John Harshman:

"I am trying to assemble a detailed and expanded star system generating system for Traveller, to define the physical characteristics of stars and their associated planets. The system would attempt three things: 1) to conform to the most accepted (or failing that, the most interesting) modern theories of stellar and planetary formation 2) to avoid violating any known principles, and 3) to be capable of generating the solar system and the mix of stars around it (the only empirical checks on validity we have).

Ideally, the star-generation procedure would involve only two random variables: mass and age, with all other characteristics following from these. All stars would be assumed to be population I, similar in composition to Sol. Modifications to standard characteristics would be made for variant chemical makeup, effect of companion stars on evolution, and whatever else seems

good. To design this system, I need a lot of information on stellar evolution: characteristics of stars of various masses at various ages (or at least current theories thereof); also of great use would be statistical data on stellar distribution.

The planetary generating system is entirely unformed. Numerous questions must be answered. Is the Titus-Bode law real, and if so what are its variables? Assuming that the elementary composition of planets will vary as the temperature in the primal gas cloud at the time of their formation (a valid assumption?), how does temperature vary with distance from the protostar for various masses? What is the chance for formation of a double planet (like the earth/moon system)? What produces asteroid belts? Etcetera, etcetera.

If you know a lot about astrophysics and/or planetology (or at least more than I do), I want to use your brain. You will be rewarded by profuse thanks, recognition in print, and free copies of anything that emerges from the project. If you're interested, write me (John Harshman) in care of GDW, Po Box 432, Normal, IL 61761."

Loren K. Wiseman

Traveller is available overseas through GDW distributors in the UK and Australia.

United Kingdom: Traveller (and its additional booklets, adventures and supplements) is printed under license from GDW in the UK by Games Workshop, 1 Daling Rd, Hammersmith, London, W6.

Australia: Traveller is imported and distributed by Jedko Games, 18 Fonceca St, Mordialloc, Vic. Australia.

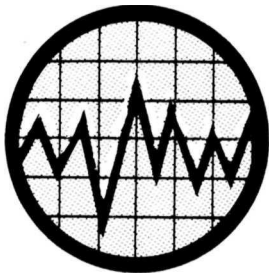

JUST DETECTED

Games:

Artifact

An alien artifact is discovered on the moon, and combat ensues for possession of the artifact and the scientific treasures which can be gleaned from it.

84 counters, one 12 x 14 map, and rules booklet in a box. \$3.95

Design-Glenn Williams

Publisher-Metagam'mg, Box 15346, Austin, TX 78761.

Books:

Worlds at War

A study in interplanetary conflict. An overview of future history lavishly illustrated with color paintings of starships, troops and battles. Many of the pictures could prove useful for illustrating Traveller adventures or perhaps inspiring them.

Hardbound, 52 pages. \$5.99.

Author- Steven Caldwell.

From-Media Resources, 1024 W. Washington Blvd, Chicago, IL 60607.

Play Aids:

Scouts and Assassins

A 20 page booklet detailing variant rules for the Scout service and a new character type, the assassin. Included are service and discharge tables, several new skills, and an 11 x 17 foldout diagram of a "Serpent" class scout ship. \$3.00.

Design- Donald Rapp.

Publisher-Paranoia Press, 1207 Scott Ave, Ft Wayne, IN 46807.

Pen-Latol's World

A detailed study of a planet populated by an intelligent non-human race, including descriptions of terrain, flora and fauna.

One 22 x 27 map and 8 1/2 x 11 32 page booklet. \$7.95.

Pub Usher-Group One, 1737 N Walnut Grove, Decatur, IL 62526.

Magazines:

The Space Gamer

Long printed by Metagaming, The Space Gamer is now published by Steve Jackson. The March/ April issue (no. 27) is the first under the new management. This issue includes articles on design theory, time travel and how to game it, variants galore and reviews of several games, including Snapshot. Bi-monthly, subscriptions (6 issues for \$8, 12 issues for \$15) from The Space Gamer, 7207 Onion Crossing, Austin, TX 78744.

Signal

A variable page newsletter published by John and Linda Ross-Mansfield. Each issue is crammed full of game, magazine and book reviews, as well as the latest releases of all major and most minor game companies. Bi-weekly, subscriptions (12 issues for US\$3) from Signal, John Mansfield, 46 Coulton St, Oromocto, N.B. CANADA E2V-2C8.

Ares

SPI's SF/Fantasy gaming magazine. Issue no. 1 contains a game, World Killer, three fiction pieces, a science fact article and capsule reviews of over fifty SF/Fantasy games. Bi-monthly, subscriptions (6 issues for \$14) from Ares, c/o SPI, 257 Park Ave, NY, NY, 10010.



TRAVELLER NEWS SERVICE

REGINA/REGINA (0310-A788899-A

Date: 004-1106

¶ The Travellers' Aid Society has obtained an exclusive interview with Major Windan Lorimer, Imperial Marines (ret), recently returned from six months of duty as a captain of auxiliaries engaged in counter-insurgency actions on the planet Efate (Regina 0105-A64930-D).

¶ In the interview, Major Lorimer revealed that four months ago his battalion became engaged in a firefight and subsequently captured twenty insurgents, two of which were officers. Subsequent medical examination revealed that one of the two was actually a Zhodani officer serving as an advisor to the Ine Givar cadres.

¶ In response to queries concerning Major Lorimer's claims, Rear Admiral Lord Santanocheev, CINCNINT/RS (Commander-in-Chief, Naval Intelligence, Regina Subsector) today held a press conference during which he claimed that Naval Intelligence was convinced that there was neither Zhodani nor Ine Givar involvement in the Efate disturbances.

¶ "What we have on Efate is a local, very minor situation. We're handling it with local forces and a few mercenary contingents. If it were serious, we could commit army or marine assets. We have some very potent assets in this subsector, but we haven't felt the need to commit them. This is not a serious situation," he reported.

¶ When asked about the report of a Zhodani officer, Lord Santanocheev replied, "Naval Intelligence has this man in custody, and I can assure you that he is not a Zhodani officer, or a Zhodani anything. I fought the Zhodani twenty years ago in this subsector. I know the Zhodani, and this man is not a Zhodani."

¶ When contacted afterwards, Major Lorimer refused to comment on the admiral's remarks, beyond insisting that his original reports had been accurate. Ω

DENTUS/REGIIMA (0601-C979500-A S)

Date: 361-1105

¶ Word was received today that two weeks ago the Imperial Battle Cruiser Adamdun mistakenly engaged and destroyed the merchant craft Bloodwell of the Oberlindes Line. The Bloodwell, according to the crew of the battle cruiser, was not showing its ID transponder signal and would not answer broad-beam hails. The ship was under full acceleration, and after it refused to change vector in response to laser warning fire, was engaged by high-G missile fire and destroyed. A subsequent (and unsuccessful) search for survivors resulted in the identification of the ship.

¶ Oberlindes Line officials called the story "an obvious cover-up of a tragic display of incompetence" and claimed that the Bloodwell's ID transponder had just undergone its annual maintenance check and could not have failed to function. As in all commercial vessels, the ID transponder was supposedly tamper-proof, and could not have been turned off by the crew. Legal action is expected. Ω

Traveller News Service is another Imperium-wide benefit of membership in the Travellers' Aid Society.

LSP Modular Cutter

In the course of the Third Frontier War (979 to 986) the Imperial armed forces developed a requirement for improvements in the standard assault boat for opposed planetary landings. The then current model had been developed in peacetime over 150 years previous, and the war was demonstrating some of its faults. Ling Standard Products developed the contract-winning design, and its Modular Cutter was put into production in 988— too late for the war, but just in time for the next, the Solomani Rim War (990 to 1002).

The LSP Modular Cutter is a single frame ship with modular inserts for use in a wide variety of tasks. Some were part of the original concept, while others were developed in the course of time for additional military or civilian uses. Each module is circular in cross-section, with a dorsal channel for the strut connecting the cutter's bridge with its engine section. Modules are readily removed and replaced, and do not interfere with the ship's streamlining.

The LSP Modular Cutter is essentially an alloy cylinder thirty meters in length and six meters in diameter. The nose is hemispherical and simple manufacturing techniques are used throughout. Displacement is 50 tons (or 700 cubic meters) and the ship is capable of accelerations up to 4G. Normally unarmed, the cutter carries fuel tankage of 15 tons. Base price is MCr9.25, excluding modules. The widespread use of the LSP modular cutter by both Imperial and subsector armed forces has made a number of them available as surplus, and many are still found in service throughout the Imperium. Such units are occasionally found at prices (and qualities) as low as MCr2.5.

Performance of the cutter is affected by its load. Normally accelerations of up to 4G can be achieved (with new or well-maintained maneuver drives). By operating the cutter without a module, the boat is reduced to thirty tons displacement; operating under such conditions, it can easily make 6G. Such use is not recommended however, as the single structural strut connecting the bridge and drives is not strong enough to withstand such abuse for long.

The modular cutter is capable of interplanetary operation, and is streamlined for operations in atmosphere. It is equally at home in vacuum, standard and corrosive atmospheres, and underwater. Its electronics are rudimentary, but nevertheless include scanners and detectors with ranges to about one light-second in vacuum, to the horizon in most atmospheres, and to thirty or forty kilometers underwater.

ORIGINAL MODULES

In the original procurement specifications, the Imperial Navy called for an assault boat, with no requirement for other applications. The LSP bid included the assault boat module, plus an interchangeable weapons pod and fuel skimmer. This aspect of the bid was credited with a substantial contribution toward winning the contract.

Assault Boat Module. Primary to the cutter's intended purpose is the assault

Top View

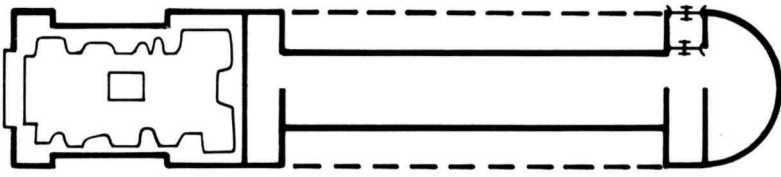

Side View

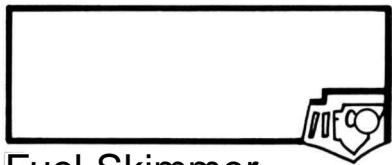

Fuel Skimmer

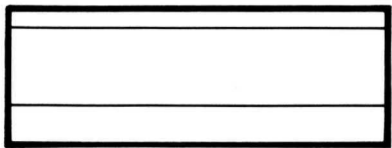

Passenger Module



ATV Cradle

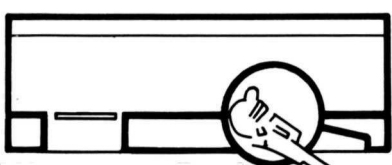

Weapons Pod



boat module, fitted out for 16 troops in combat gear. Twin exit hatches are fitted to the lower surface of the module, with power spades under the flooring. In assaults, the cutter lands and the hatches retract. Immediately, the twin spades extend and scoop an emergency entrenchment (elapsed time: fifteen seconds or less). The troops then jump into the

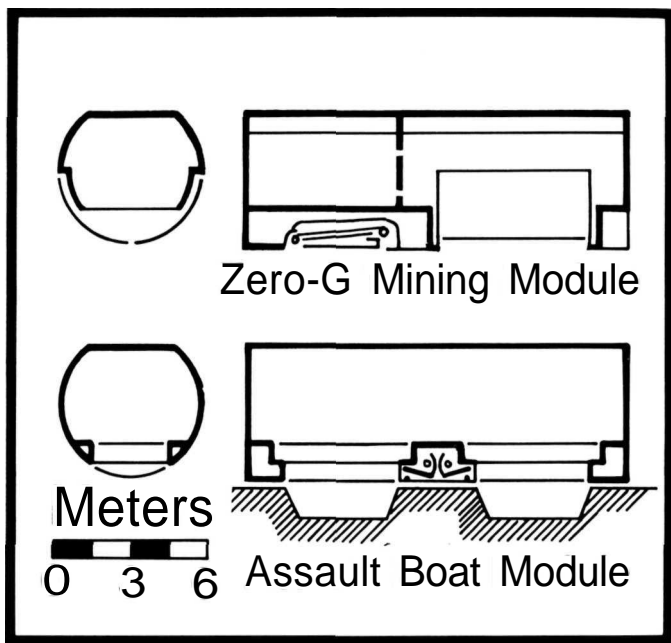

trenches and the cutter takes off vertically. The result is fast, safe delivery of ground troops with a minimum of exposure. By delaying take-off a few seconds longer, any number of military operations can be undertaken: mortar positions can be set up, command posts positioned, or aid stations established, all with a minimum of exposure.

Auxiliary hatches on the module's sides facilitate normal exit under safe conditions, and recovery of troops under all conditions. Base price: MCr2.5.

Weapons Pod. The cutter may be converted to a gunboat with the installation of the weapons pod. Consisting of a single turret and accompanying power plant, the weapons module can be supplied with beam or missile weaponry, and has ample room for support crew (life support for four is integral to the pod), a missile magazine, and even deadfall ordnance. In addition, the module is entirely self-contained, and can be left pre-positioned in orbit to provide fire support for ground troops. Base price (for single turret, with beam laser): MCr7.2.

Fuel Skimmer. With this module in place, the cutter can skim hydrogen from a gas giant atmosphere for use by its mother ship as fuel. The skimmer can also be used to dip water from oceans for the same purpose. In the case of unstreamlined mother ships, this module is invaluable. In addition, the skimmer provides the capability of gathering fuel for smaller power plants, for other cutters, for troop installations, and for weapons modules. Capacity: 26 tons (attachments on the module connect this tankage with the 15 ton cutter tankage, allowing simultaneous refuelling of the cutter itself. Base price: MCr2.0.

ADDITIONAL MODULES

At the conclusion of the Solomani Rim War, the basic military contracts for the modular cutter dried up, and Ling Standard Products began an aggressive marketing

plan aimed at civilian and commercial uses for their cutter. Surprisingly, the presence of naval surplus cutters on the market did little to interfere with this program, as they furnished a continuing market for spare parts, and for newly designed and produced modules.

Zero-G Mining Module. Marking a major effort to sell cutters to asteroid prospecting concerns, the Zero-G Mining module provides major bay for the containment of ore samples, plus a waldo arm for manipulation, controlled from a separate pressurized control section. Complete with living quarters for two, the module provides a cheap, effective prospecting vehicle. Base price: MCr3.5.

Passenger and Cargo Module. A simple concept, this module has perhaps seen the most widespread use; it converts the cutter to a standard civilian model. The seating (four abreast) accomodates 24; when the seats are removed, cargo in standard containers can total 24 tons. While passengers enter and leave through the entry hatch (forward, at the air lock to port, cargo (especially large items) is off-loaded by detaching the module and sliding the containers out the module ends. Base price: MCr3.0.

ATV Transport Module. All terrain vehicles are handled by this module, which is a cradle attachment with a windscreen provision. The vehicle is held by special attaching lugs, while the windscreen preserves the cutter's streamlining. On the world surface, the windscreen retracts to allow the vehicle to be lowered to the ground. Base price (excluding ATV): MCr1.2.

Pressurized Shelter. This module is intended for use as quarters on a planetary surface. With air locks at each end, and staterooms for eight (double occupancy), this module can support up to eight people for several months. The fusion power plant and air recycler under the flooring make the shelter comfortable, while storage can hold supplies for months of activity. In addition, grav plates in the floors can adjust local gravity to a normal or to a preferred level.

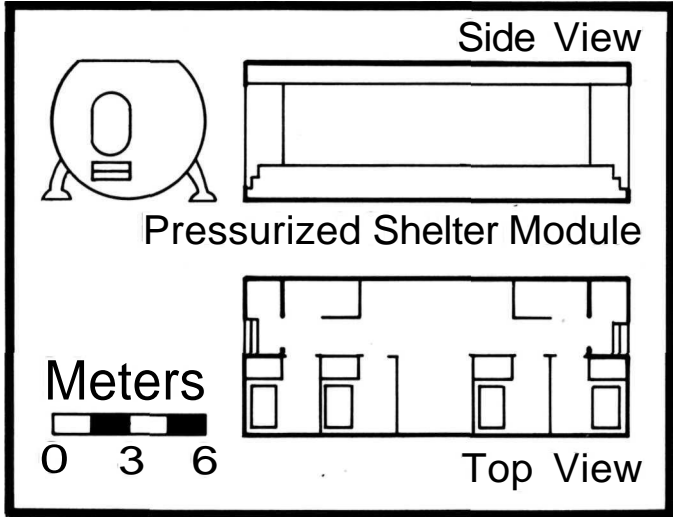

This unit can be positioned in orbit or zero-G, although it is not of itself mobile. It is also possible to use this module as supplementary quarters aboard a starship. Although rarely used for paying passengers, it is quite suitable for troop shipments or additional crew. Pressurized shelter base price: MCr4.5.

Other specialized modules have also been produced by LSP and other companies.

TRAVELLER-



The Final Frontier

The release of Traveller three years ago marked the beginning of a brand new concept in Role-playing games. Up until then, most of these games (with the exception of the less open-ended versions, like En Garde) offered a rather limited amount of "background". The game would begin where the adventure began, with characters whose past except for previous adventures) was nebulous, and in a playing area isolated from any "real world" to serve as a way of binding the adventure together. The characters would seek their treasures, fight their villains and then leave the area once more; when they reappeared, it was the beginning of a new adventure of basically the same type, possibly with more difficult objectives or circumstances to overcome.

But Traveller is different . . . the game does not function in a limited realm of castles, mazes, or other relatively limited playing areas — it sets out to

allow the player to wander through an entire, consistent *universe!* The rules set forth means to undertake almost anything: hunting for rare metals in the asteroids, rescuing a captive senator, running a small shipping line, or leading a mercenary band in a last ditch defense on some distant world. The scope and breadth of Traveller is that of science fiction itself; the potential is there to create or recreate any of the myriad facets of the genre.

Unfortunately, the very scope of this fantastic system can make it too awesome, a staggering burden on the first-time Traveller player or referee.

It isn't easy to step into the world of Traveller for the first time. Both player and referee must face some very difficult problems which no other role-playing experience can prepare them for. Instead of a limited realm in which to adventure, several separate worlds

must be invented, each one as complex, at least potentially, as the labyrinths of one of the game's fantasy forbears. Nor is it really possible to skimp on detail, since the fact that the game deals with space travel means that, almost certainly, the players will be wanting to travel to more than one planet.

And, as if this weren't enough, there is an added problem which will plague at least some Traveller fans. Many people who read science fiction have the urge to make the Traveller universe as consistent as those they read about; not, perhaps, perfectly accurate scientifically, but at least building steadily on a background of well thought out ideas. This makes the effort involved in putting together a Traveller subsector just a little bit harder; it requires that extra touch of ingenuity and inventiveness that will turn an ordinary adventure into a truly excellent one.

Having said all of this, the game seems even more overwhelming than ever! Confronted by so much work, so many rulebooks, supplements, and adventure material, it seems likely that both referee and player will flee screaming, never to return to any form of role-playing again!

Yet this needn't be so. There are always ways to learn Traveller without holding a Ph.D. in astrophysics; some simple concepts for both the referee and the player to keep in mind which will allow the game to "come alive".

First of all, remember that the vast wealth of material which has been published for Traveller need not be absorbed in a single gulp. Certainly there are rules for just about everything; but not every rule will be needed for every game. If you don't plan to bother with psionics, don't worry about the rules. When you need them, look them

up. Traveller is a game of *possibilities*, it is up to the participants to pick and choose what they want to use. So start simple, with the basics of characters, combat, and the specific rules which let them get through some "introductory" adventure. Then build on them — soon you'll be using as much as you need for even the most difficult situations, without the least problem.

Imagination is the single, most basic item for people who play Traveller — for referees and players alike. Without it the game is lifeless, for it takes more than just a set of rules and a pair of dice to bring a new world to life.

The referee must have vast amounts of imagination to draw upon, for to him or her falls the duty of creating the Universe and the dynamic force of the game. The players will have to take much of their cue from the referee, who must provide not only the goals and basics of the adventure, but also much of the conflict that goes into completing it. Imagination is his or her mainstay; while he or she may draw on material from novels or SF movies, it is not enough to merely replay that material in the game. (If nothing else, the chance is strong that the players, SF fans themselves, will have read the novel or seen the film themselves; hence, he or she will lose them early on!) Only by using originality will the referee turn some time-honored theme into a fresh, original adventure; above all things, the referee must be willing to think.

Nor should the players be content to sit back and watch the referee come up with all the ideas. Their imaginations are needed too; only by trying to envision what the referee has created will they truly enter into the spirit of role-playing. They should think, act, and even speak

continued on p. 28

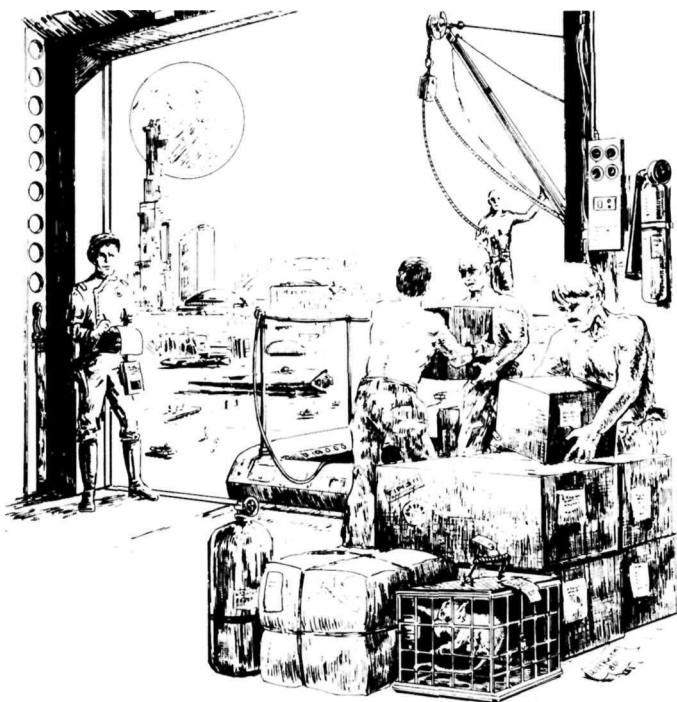

FOODRUNNER

Roup (Regina 0407 - C77A9A-6) is a small water covered world situated along the Imperial xboat route through Regina subsector. Its history is one of strict controls by a cruel but fair dictatorship, that of the Leader. The reason for these controls is the population distribution on Roup: all of its billions of people live huddled in the cities built on the peaks of an underwater mountain range, the only dry land masses on the entire planet. The entire planet suffers from the symptoms of massive overpopulation, i.e. crowding, disease and massive food demands. Because of the strain on Roup's economy that an off-worlder population would cause, and because of the often vicious nature of life there, Roup has been posted as an amber travel zone, and only a tiny scout base is kept there to maintain the xboat link.

Roup's entire industry is geared to

the feeding of the population by killing and processing of Roup's plentiful sea life into food concentrates, used as emergency rations by the Regina subsector navy but primarily Roup's only food source. Roup stands at Tech Level 6, hampered by its tainted atmosphere and its people's needs, and above all else, two things are prized by its people: living space (most live in the streets) and real food.

Amber Zone

The players are approached by a middle-aged, rather vulgar person who professes to be the manager of a small shipping service that deals in both legal and illegal cargo. He needs a crew of from four to eight for an armed and renovated free trader to transport twenty tons of sealed cargo to the Roup scout base, where the officials have been

bribed to turn their backs while the natives pick up and pay for the cargo. The pay must be delivered back to the manager for the players to collect their reward, that being clear title to the free trader. The cargo consists of 200 crates, 10 kg each, containing rare foodstuffs of all sorts, including 10 kg of a highly expensive and perishable Pysadian melon as well as a case of a very rare *trockenbeerenauslese* wine.

Referee's Information:

The referee can start this adventure from anywhere he or she wishes in the Spinward Marches. While at first this job may look ridiculously easy, there are several minor details that the players don't find out until it's too late...

First, the ship is in orbit, and the manager provides the players with a one-way shuttle ticket to its parking orbit. This way, the players can't back out of the deal when they see their reward, which is frankly a poor excuse for a starship, being worth a possible resale price of Cr 10000000. All but 20 tons of its cargo space have been replaced by jump and maneuver drives B, giving the ship jump-2 and 2G capability, more fuel tankage, (80 tons), and two single turrets (two pulse lasers). However, every piece of machinery on board except the computer is in a state of disrepair (throw 8+ with 2D for any item to break down during use; as always, repair DM's are governed by mechanical or engineering skills) including the drives (which have been burning unrefined fuel and haven't been overhauled in two years). This disrepair includes such usefull components as the

airlock, the toilet, the kitchen unit, and both turrets.

Second, upon landing (assume the ship rattles a bit, but doesn't crash), the group of cargo handlers will come out onto the tiny, open type C landing field to offload the cargo. The group will consist of 111 men: 100 stevadores with concealed knives (the planet's only commonly available weapon, quite illegal), 10 guards armed with SMGs, and the overseer, a government functionary representing the leader, who carries a revolver and a locked briefcase containing the payment for the cargo, Cr 40000000. Food is such a valued commodity that 1D groups of criminals (size and arms up to the referee) will attempt to hijack the food and the cash. The only shelter in the area is the ship and the nearby repair shack which is occupied by scouts, who have been told to ignore what happens on the field for the next couple of hours. Nobody among the natives is armored, except for the overseer, who wears a flak jacket under his coat. Needless to say, the players will almost certainly get caught in the crossfire.

Assuming that they survive, and manage to get off Roup, the manager will not be pleased if they return without his money or if the lock on the briefcase is broken. Subsequent events are left up to the individual referee.

Mike Metlay

212
685-3880



212
685-3881

*Fantasy Game Center
Wargame Headquarters
for Greater New York*

*10:30 A.M. TO 6:00 P.M. DAILY OPEN TILL 9.00 ON THURS.
11 EAST 33rd STREET, NYC, NY 10016*

We Pay Shipping On All Mail Orders. Sorry No C.O.D.'s

Sample Robots



Terry Scofield wrote us recently to suggest a modification to the Power Plant Table included in the "Robots II" article (JTAS, number 3). Terry's idea greatly simplifies the process of building a robot, and solves a number of problems present in the old table. Terry suggests:

"Any size power plant may be built, (within reason) to fit individual needs, at 20% greater expense than for standard models. The table below was generated assuming:

Power Output = Mass

$$\text{Cost} = \sqrt[3]{\text{Output} \times \text{Cr } 500}$$

(+ 20% for non-standard)

The power plants given below are standard, all others are non-standard.

Plant Output & Mass:	Cost (Cr 1000):
5	0.85
10	1.08
15	1.23
20	1.36
25	1.46
30	1.55
40	1.71
50	1.84
75	2.11
100	2.32

I've used a cubic root here, but smaller roots could be used. Players can . . . buy lots of small power plants to reduce their vulnerability, but it will now cost hundreds of credits. For a couple hundred credits more you can get the next size power plant, and the constant mass ratio makes it easier to plan construction."

Another change we suggest the readers make in the original robots tables is to make the weight of a single light work arm 5 kg instead of 10 kg. 10 is really too heavy, and the reduction in weight brings the light arms more into line with what was originally intended. Other work arms remain the same.

The following sample robots were constructed using the above changes:

MEDIUM SECURITY ROBOT

Designed to operate in areas where some form of security patrol is required but the incidence of hostile attack is low, this robot has also been given a humanoid shape to permit it to use staircases, escalators, and other human-style facilities. It incorporates chassis type III, with legs for locomotion, a TL12 brain, two light work arms (one incorporating an auto-pistol) a standard 25 kg power plant and an outside surface polished to reflect standards. Programs include weapon handling (auto-pistol) and medium security.

100kg

Cr 155265

EXEC ROBOT

This robot is specifically designed to serve as a pilot or navigator on board ships in merchant service. It has been given a human-like shape in order that it may use controls, chairs, and other tools designed for human use. It incorporates chassis type III with legs for locomotion, a TL12 brain, two light work arms and a standard 25 kg power plant. It has not been fitted with a weapon, but can make use of standard human weapons if so programmed.

Usual programming includes either pilot-2 or navigation-2, with general vehicle programming. Optional programs include general weapon handling, air/raft, ship's boat, electrical, mechanical, or engineering, depending upon

the wishes of the purchaser. Such robots are usually custom programmed at the time of purchase, and thus the purchase price given does not include programming costs.

100 kg

Cr 154565

FIRE-FIGHTING ROBOTS

These robots come in two basic units: a single control unit and a number of remote units, usually six.

Control Unit:

Chassis type I, with tracks for locomotion, TL12 brain, remote control "master" unit, basic sensors, and a standard 10 power plant. Programming consists of a special program to permit the use of the remote "slave" unit, and fire-fighting/rescue.

50 kg

Cr 100330

Remote Unit:

Chassis type II, with tracks for locomotion, basic sensors, enhanced night vision, passive infrared and UV sensors a type 10 power plant, a "slave" unit, a medium work arm, and a special fire-fighting package consisting of a tank of water or fire-retardant chemicals, basic fire-fighting tools, and a provision for the transport of an injured human.

75kg

Cr 76912

VALET/STEWARD

Designed for use on board passenger starships and yachts, these robots are specially constructed to be pleasing to the eye. Incorporating a type II chassis with legs for locomotion, two light work arms, TL12 brain, a vocoder/vocoder, and a standard 15 power plant. No weapons or armor are fitted initially, but types with these features can be obtained. Programming consists of valet, with general vehicle or air/raft sometimes included as an option.

75 kg

Cr 77588

Loren K. Wiseman

IMPERIUM

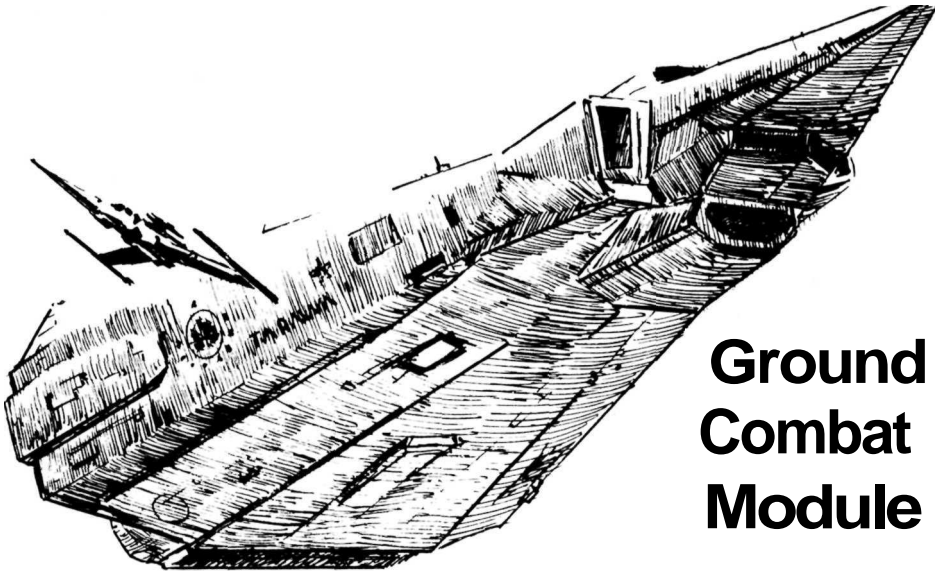

Ground Combat Module

INTRODUCTION

This variant is an alternate method of resolving surface combat for Imperium. Players may elect to conduct all surface combats in this manner or only a certain number of battles (say ten) with each player able to demand (say up to five times) that a particular surface combat use the variant rules. In general, this variant only affects the surface combat subphase, related topics such as the transportation of divisions remain essentially unchanged.

Each system is represented by ground maps of the planetary surfaces in the system. Each division is replaced by its equivalent in regiments when on the ground maps.

SEQUENCE OF PLAY

The surface combat subphase is expanded to:

A. Phasing Player's Surface Movement Phase.

B. Phasing Player's Surface Combat Phase.

LANDING

Immediately after the phasing player's planetary surface/space interaction subphase, he may land regimental equivalents of all surviving troops on any hex except ocean and wasteland hexes. The regiments of a division need not land in the same hex, but in the case of regular troops their transport must land in the same hex as one of the regiments. The landing consumes the participating ground unit's entire movement allowance. Units may land in an enemy occupied hex; the enemy troops have a defensive first fire against them. All surviving units are considered to have been landed successfully.

MOVEMENT

Troop regiments have an unlimited movement allowance, but they must

stop upon entering an enemy occupied hex. There is no zone of control. Artillery regiments have a movement allowance of one. Planetary defense counters are immobile; once placed, they may not be moved. Landing and takeoff is a special type of movement. Transports, scouts and fighters may land/take off from any hex except ocean or wasteland. Other ships may only land/take off from spaceports. Troop and artillery regiments may move from one body to another in the system, (e.g. from Earth to Mars) using transports. This consumes their entire movement allowance.

Situations may arise where units may move through terrain they would not be permitted to remain in. The most common example is ocean hexes for non-amphibious units.

There are no stacking limits during or after movement.

SURFACE COMBAT

All surface combat occurs between opposing units in the same hex. Surface combat in a hex is conducted in the same manner surface combat in a planetary box would be conducted in the standard rules, except for the following.

Either players artillery may join in, if in range. When attacking a non-regimental unit, such as a ship or planetary defense counter, two troop regiments may total their combat factors against it. Certain modifications may be made due to terrain and unit training. The surface CRT is still used.

Artillery Regiments: They represent the heavy firepower assets of regular troop divisions, long ranged missiles and the like. Artillery regiments have a maximum range of two to three hexes, but, of course they cannot fire from one body to another. They have separate attack and defense factors. They may make four attacks during their owning player's surface combat phase, against

one or up to four separate targets in any hexes within range. Artillery units may be suppressed, however. If the opposing player (the non-phasing player) commits at least one unit to attack an artillery regiment, that artillery regiment may only make one attack. If the artillery regiment is entitled to a defensive first fire that first combat phase, it could not be suppressed before its defensive first fire. If an artillery regiment is being attacked during the opposing player's surface combat phase, it defends with its defense factor, and may make one attack against any unit.

For the purposes of planetary bombardment, all the surviving regiments of a division are treated as one target.

Planetary defense counters defend with a factor of 6, all others defend with a factor of 3.

GROUND MAPS

The bodies in each system are represented by ground maps. World and outpost markers are not placed on the ground maps, rather they are represented by urban hexes and spaceports. The ground map of each body consists of two parts: north and south hemispheres. For the multi-hex bodies, the hexes on the perimeter of the ground maps are equatorial hexes. Each equatorial hex tends into both hemispheres; together the matching north and south halves make up the equatorial hex. Earth's equatorial hexes have been labelled from 1 to 12 on both hemispheres to illustrate the pattern of matching. Follow the same pattern for all worlds. The two hexes labeled "1" are actually one equatorial hex. A unit may be physically placed on either "half" of the equatorial hex; in game terms it occupies both "halves". The only way a unit may move from one hemisphere to another is to cross the matching "halves" of an equatorial hex; in reality it is crossing

just one hex. For all purposes, the two "halves" are indivisible; they count as one hex.

The small disks represent planetoids. They are divided only by north and south hemispheres. Each hemisphere counts as only one hex, units may move freely from one to another.

The large hexes with dots represent groups of asteroids. Each counts as one hex for movement.

Terrain: At this level, terrain is necessarily broad. The designated terrain type is indicative of the predominating influence in the hex. The presence of just a few islands in a hex whose major surface area is ocean can, for the technology levels assumed, cause the hex to be treated as a clear land hex, and so on.

Rough represents not only extremely high and extensive mountain ranges such as those above the Indian subcontinent, but also major chasm and canyon formations, crater ridges, and other difficult obstacles. Units with mountain training (all counters with a small "n" and jump troops) add one to their combat factor while in rough.

Jungle represents dense vegetation eluding jungle proper, forest, and swamps. Units with jungle training (all counters with a small "j" and jump troops), add one to their combat factor while in the jungle.

Ocean represents large bodies of non-toxic liquid. All units may move through ocean hexes, but only amphibious units (all counters with a small "a") may remain in ocean hexes. Attacks on amphibious units in ocean hexes subtract one from the die roll on the surface CRT. Zeros are treated as no effect.

Waste/and represents terrain in which only a few special units could operate for any length of time. It includes active volcanic regions, oceans of lethal liquids, and radioactive desolation. All units

may move through wasteland hexes, but only jump troops may remain in them.

Glacial represents areas covered by water ice or its equivalent.

Urban represents significant concentrations of population and the necessary dwellings, industry, and agricultural lands to support them. In game terms, the combined urban hexes of a system take the place of the world marker.

Spaceports represent the major investment in docking, repair, and fueling facilities, and buffer zones necessary for the landing and takeoff of larger ships. While transports, scouts, and fighters may land and take off from anywhere except ocean and wasteland, all other ships may only land and take off at spaceports. In game terms, the spaceport of a secondary system takes the place of the outpost marker. The changing of control of the spaceport results in the destruction of the outpost marker on the star map.

ODDS AND ENDS

An Imperial outpost is lost (or a Terran outpost is conquered) if the conquering player was the last to have a regiment or planetary defense counter in the spaceport, and all enemy units are eliminated from that star system's bodies.

An Imperial world is lost (or a Terran world conquered) if the conquering player was the last to have a regiment or planetary defense counter in all the urban hexes, and all enemy units are eliminated from the system's bodies.

To replace a portion of a division, (e.g. two of the four regiments) the player must pay the full price of the division.

A transport may carry four regiments from different divisions in lieu of a division if desired.

Roberto Camino

EARTH

North Hemisphere

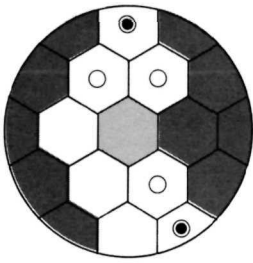

South Hemisphere

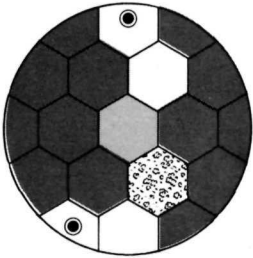

MARS

North Hemisphere

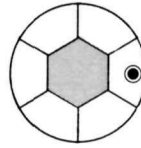

South Hemisphere

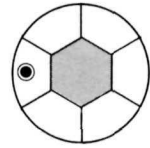

8

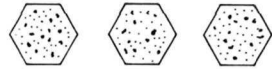

ALPHA CENTAURI A SYSTEM

North Hemisphere

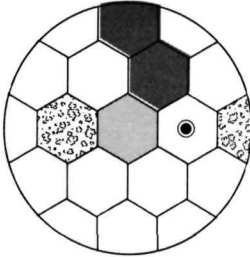

South Hemisphere

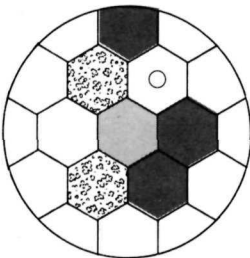

ALPHA CENTAURI B SYSTEM

North Hemisphere

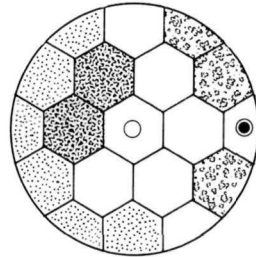

South Hemisphere

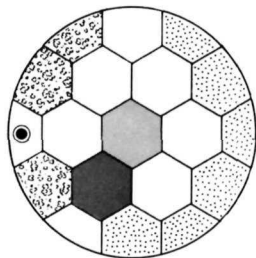

7

North Hemisphere

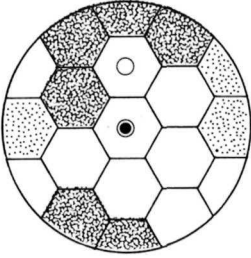

AMARKU SYSTEM

South Hemisphere

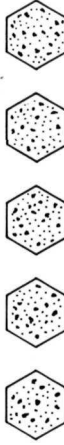
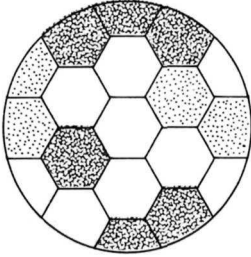

6

North Hemisphere

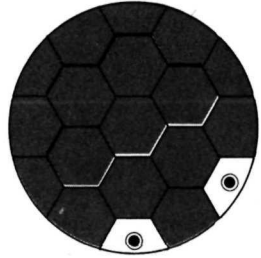

NUSKU SYSTEM

South Hemisphere

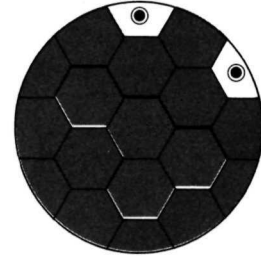

North Hemisphere

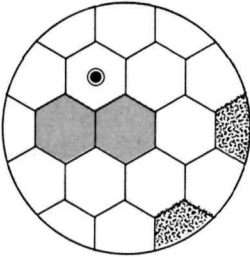

MIR1ABILIS SYSTEM

South Hemisphere

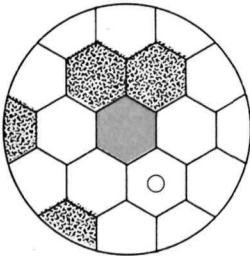

North Hemisphere

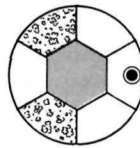

EPSILON ERIDANI SYSTEM

South Hemisphere

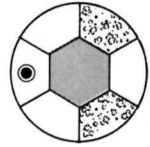
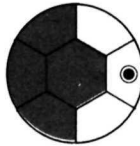

5

DINGIR SYSTEM

North Hemisphere

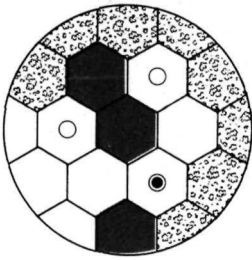

South Hemisphere

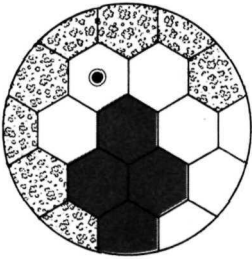

LAGASH SYSTEM

North Hemisphere



South Hemisphere



4

North Hemisphere

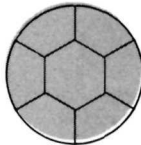
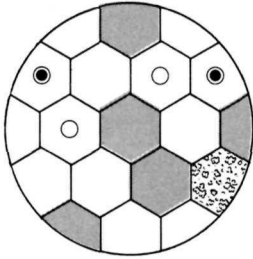

GASHIDDA SYSTEM

South Hemisphere

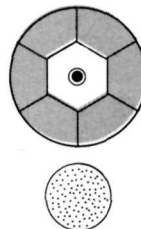
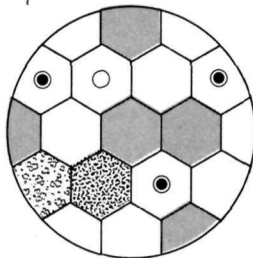

North Hemisphere

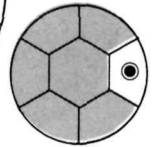
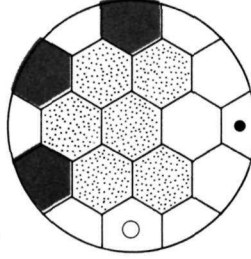

ISHKUR SYSTEM



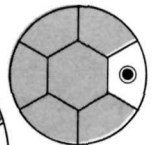
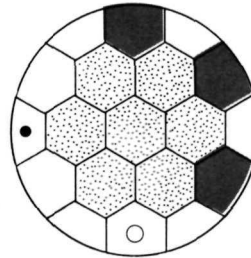



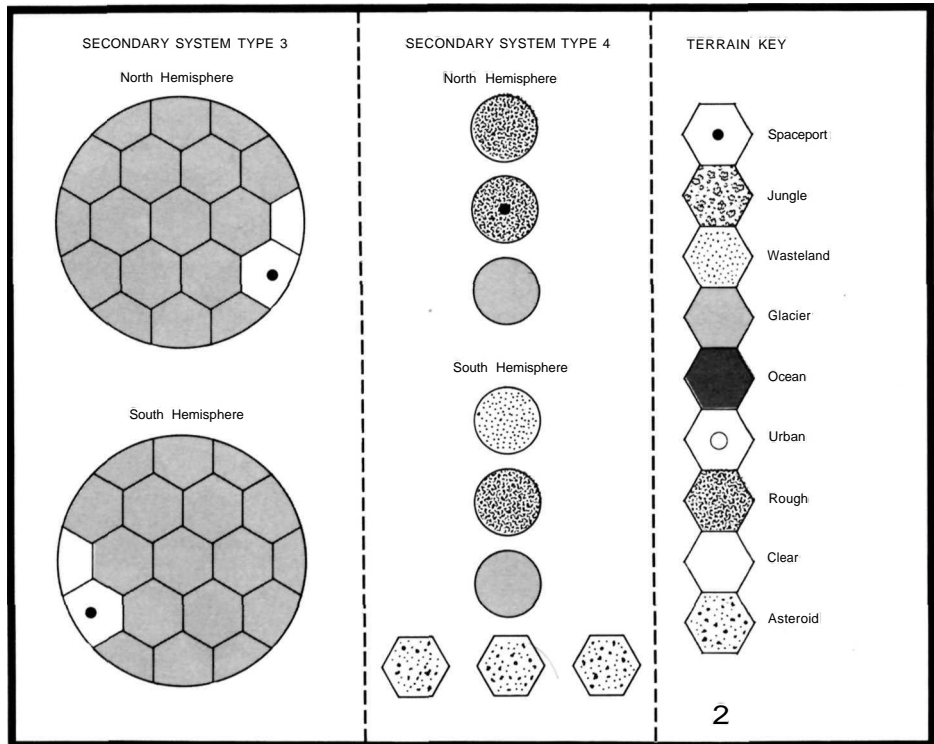
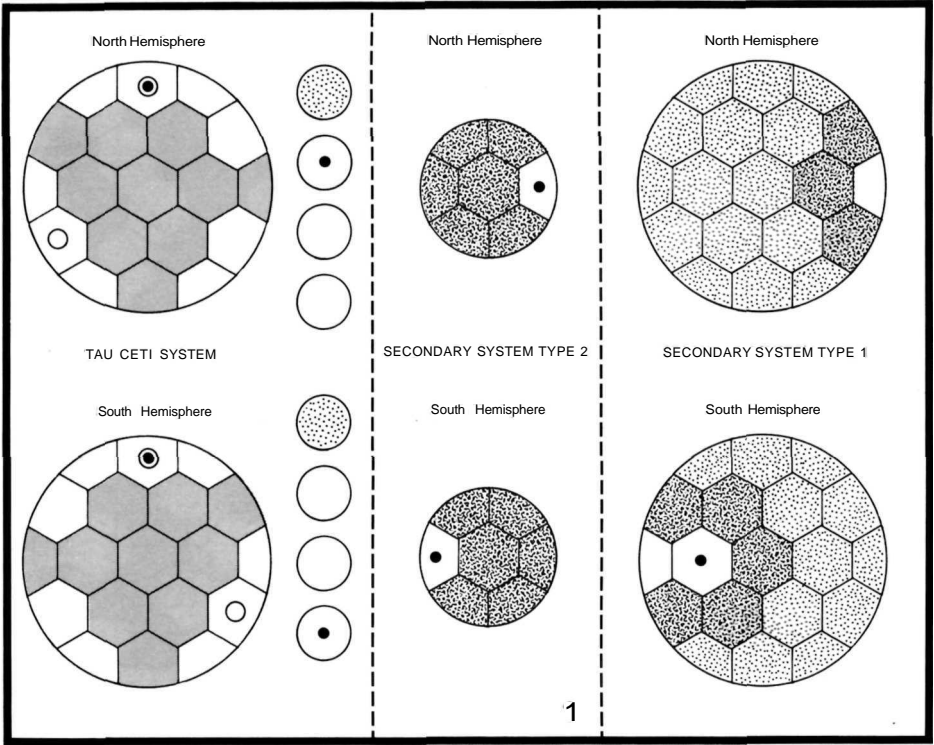

































South Hemisphere



















3





TERRAN UNITS:

<i>Division</i>	<i>Regiments</i>			
10	 3	 4	 4	 5 3
3	 2	 3	 3	 4 2
5	 3	 3	 3	 3 3
11	 2	 3	 3	 4 2
1	 1	 2	 2	 3 1
4	 1	 2	 2	 3 1
6	 1	 2	 2	 3 1
8	 1	 2	 2	 3 2
9	 2	 2	 2	 2 2
19	 2	 2	 2	 2 2

<i>Division</i>	<i>Regiments</i>			
23	 6	 6	 6	 7
2	 5	 5	 5	 6
101	 4	 4	 4	 5
7	 4	 4	 4	 5

Unit Symbols

-  Infantry
-  Artillery
-  Jump Troops

Abbreviations

- J Jungle trained
- A Amphibious trained
- M Mountain trained

IMPERIAL UNITS

Division *Regiments*

Division *Regiments*

18    
 2 3 3 4 2

44    
 6 6 6 7

22    
 2 3 3 4 2

36    
 5 5 5 6

48    
 4 3 3 4 2

60    
 4 4 5 4

129    
 3 3 3 3 3

29    
 3 3 3 4

484    
 1 2 2 3 1

521    
 1 2 2 3 1





741    
 2 2 2 2 2

792    
 2 2 2 2 2

845    
 1 2 2 3 2

1135    
 1 1 3 3 2

982    
 1 1 1 2 1

1471    
 1 1 1 1 1

Special Psionic Powers

While the Traveller rules give a reasonably complete range of psionic abilities, there have always been a few which seem to have defied classification. The rules, however, do admit a "special ability" category but do not go into much detail; this list is meant to fill that gap, and give gamemasters a start in designing their own system of special abilities.

It is suggested that a player be allowed to roll more than once under the special ability classification while setting up a character, but not more than five times (each time with the appropriate DM). The abilities possessed, however, will be determined secretly and randomly by the referee (a player will know that he or she has unusual talents but will not know what or how many they are) until such time that a power would be brought into play (in a life-or-death situation for example). At this point the user would gain the first level power that was used (this allocation system has not been thoroughly play-tested, and could probably use improvement).

Some of the abilities are from SF short stories and novels. I have not credited them, as searching through my library for the references would take the better part of a month. I leave that task to you.

Psipyretics: The ability to spontaneously generate heat. A user of this power can produce a patch of heat,

reasonably well targeted, on a surface. The standard patch is a circle of 1 cm radius, and thus has an area of 3.1416 square cm. The Level 1 ability costs 1 psionic strength point, and can melt snow or provide a soothing warmth; it is good as a therapeutic source of heat, as it can be targeted onto an internal organ. It has little value as a weapon, but can be a lifesaver in extreme cold. For every level beyond the first, the cost increases by 1 strength point and either the area or the intensity may be doubled. Thus, the level 2 ability can produce a circle of 1.41 cm radius, or a smaller patch that can be used to light fires. Referees should note that characters will probably want to try to explosively ignite a fuel tank, and that the unheated fuel will have a cooling effect. If this power is used in a stress situation, or must be targeted, the character using it must roll his or her dexterity or less, with a DM of psipyretic ability. The psi strength points are used up even if the heated patch is improperly targeted.

Roll 11+ every other month for an increase in ability, up to the psi ability of the character. This ability lasts 10 minutes per use.

Jaunting: The ability to teleport interstellar distances under limited conditions. A user can make a Jump (equivalent to a jump drive) equal to his or her level of expertise in this power. Although the usual restrictions do not apply, the target must be an area

where the user has been before, of planetary mass. This will cost 12 psi strength points, minus the level of expertise, plus the range of the jaunt. Thus, a 6th level jaunter could make a jaunt of J-6 if he or she had a strength of 12, while a first level user could make a J-1 with the same strength (the level of ability corresponds to the maximum jump.) While the jaunt is limited to the users body and any prosthetics, one kilogram of equipment may be taken along for 3 extra psi points, and must be actually worn on the body (as per teleport restrictions). The maximum jaunt that can be executed is J-6.

Because this not strictly a teleport, the increase and decrease in temperature do not apply. Note that this is an extremely powerful talent, especially at the higher levels; it is suggested that the user only have a chance to increase ability after a jaunt, and then only on a roll of 12 exactly (no DM).

Precognition: The ability to see possible events. A user will go into a trance-like (and unprotected) state. While in it, he or she meditates on one path of action (limited to one decision) and will get in return the repercussions of that action. (For example, the user may think about "what will happen if I open that red door?" and learn that he or she would be exposed to vacuum.) Higher levels can make multiple decisions, for example "what would happen if I were caught buying psi-double on this world?" were asked and "you would be exiled." is the answer, a second level precognitive could then ask "would the psi underground contact me?" and receive the answer "no." There are four levels of use; the first decision costs 1 psi point, the second 2, the third 3, and the fourth 6. Note that players can only ask about the immediate future; you can't get out of the 1 (or 3) extra psi

points cost by starting at a future event.

Note: This was actually designed for solo adventures, where the ability is fairly self-explanatory (one could peek ahead without suffering the consequences). Implementing it in a multiple player game is a little harder. It is recommended that an advancement system such as in jaunting (above) be used. This ability takes ten minutes to perform, during which the player can perform no other action.

Patina Reading: The ability to tell the past of an item. Similar to clairvoyance, but is focussed on a single object. The user gains all relevant facts in the past of that item. First level ability is one day, and costs the user 1 psi point. For example, the reader would know from a piece of cloth whether it had been discarded within the last 24 hours by the person the reader were tracking. It is up to the referee to determine the details of what is relevant in a particular case. More levels can produce further viewing, which of course takes more psi points. Every level of expertise corresponds to one psi point and increases the time that can be covered by a factor of three; thus the twelfth level patina reader costs 12 points and allows reading back to 531441 days (1456 years). Although this seems an over-powerful talent at first, most people will not progress beyond 7th level ability (2187 days, or about 6 years), and even then there is not too much chance that the object has a great deal of significance. (some players will use this ability to try to learn to use an artifact. Remember, though, that seeing someone do something and actually doing it are two different things. Reading an artifact before attempting use will give slightly better saving throws, but will not eliminate danger. A particular item may only be read once.

This ability increases one level on a roll of 12 exactly. Roll once each month the ability is used (no matter how many times it was used that month). Reading the patina of an object takes one hour per strength point used, thus a 12 point read would take most of a user's day.

Howl: The ability to create a psionic disturbance. While non-psi individuals are not affected by a howl, the effects are devastating upon the psi-active, but particularly to telepaths. When a howler starts his or her ability, it will take all remaining strength points that the user has. It is the equivalent of an attack on all psis within a radius of 2x meters, where x is the user's level of expertise, with a strength equal to the number of psi points expended. Normal minds are unaffected, non-telepathic minds are affected at half strength, and anyone with even a rudimentary level of telepathy will be attacked at full strength. Note that while a first level user can only affect those within one meter (2 or 1 meter) a 10th level user can affect over a radius of one 1/2 kilometer (2 or 512 meters).

Because of the power of this ability, I suggest that it be raised only once a year on a roll of 11+. The referee may give +1 DM for extreme use, but these DM's should only be granted in special instances, such as an entire year of psi study.

Detect: The ability to find things. Similar to life detection, but the item may be any device, composition, etc. The range and cost is the same as life detect, but the level of expertise will determine success in finding it (take the area of the item to be found, multiply it by 10 to the level of the user, and divide by the area of the search range. The result is the percentage chance of

locating the item). Multiply the chance by 10 if the user has seen the item in the past. For the area of search, use the following formula:

$$\text{Area} = \pi(\text{range} \times \sin(.5 \times \text{angle}))^2$$

Where Area is the area of search in square kilometers; TT is 3.141592; range is the range that is specified in the range table, in kilometers; sin is the ordinary sine function; and angle is the angle over which the search is conducted, in degrees. True, it is a difficult formula to memorize, but with modern calculators hardly more than a minutes worth of keypunching.

Empathic Healing: The power to drain wounds off others onto yourself (the wounds can then be healed in whatever manner is most convenient). By using this ability, other peoples' wounds on strength, dexterity, or endurance can be transferred to the the user's body. Although it takes but one strength point to activate, it may only be used on a given person once per day. The level of expertise shows how many points may be transferred. When taking hits in this manner the user may receive them on whichever of the first three characteristics he or she prefers.

A character may raise his or her level of ability by throwing 11+. A chance to increase comes once a month, but only the power has been used that month.

That's my list. I have tried to arrange the discovery and advancement levels so that the homebodies will have a harder time finding their abilities than those who strike out and adventure, for that is how I feel a game like *Traveler* should be played. Naturally, other referees will want to devise their own list of special abilities, using the above as a guide and source of inspiration.

John Morrison

continued from p. 11

as if they were functioning in this other world of Traveller; doing so will vastly increase the fun of the game for all. Never be content to sit back and do nothing; to tamely follow the referee's lead makes the game static, boring — Traveller should always be a game of *participation*.

Spontaneity is another ingredient in the success of the game. In Traveller, the possibilities are endless. Don't become locked into the "commando raid on the prison fortress" syndrome; it can be fun once or twice, and is good as an introduction to the game, but repeated several times, with slight variations of objective, turns Traveller into another quest game — a criminal misuse of a fine system.

Insert some new ideas into the game. The pirate attack, the kidnapping, the accident in space; these are ways of directing an adventure into a new and different direction. Don't endlessly repeat the idea of meeting a patron, undertaking a mission, returning with the goodies, etc. An unplanned-for adventure will make for much more excitement among the players and will give the referee the chance to use the ideas he could not otherwise inject into the game.

Of course, these accidental adventures should not be the only kind; a balance is required, at all times.

Players, too, can interpose a note of spontaneity between one firefight and another. Do things impulsively; don't just wait to see what the referee plans to spring next! Live your character's role — do things you think this character might do. You can often make the game far more lively, just by behaving just as any real person might behave!

Finally, let me recommend patience as a virtue which will serve the begin-

ning Traveller player in good stead. Don't try to leap into the midst of the grandest spectacular since Star Wars — don't bite off more than you can chew by wanting to fight the war to end all wars over the fate of the galaxy; not the first time, at least! Both the referee and player should exercise restraint at first, starting small, then working their way up as they understand how to cope with the game.

The players, especially, must be concerned with going slowly, at least in the beginning. Remember that the referee must create material on a dozen or so planets (at least); in any given adventure, he or she has to decide, at least in general, what he or she intends to do next. Players who press him or her to go forward when he or she is unprepared to continue run the risk of pushing him or her into a corner — the resulting game will be only a shadow of what it might have been with only a little more preparation.

One suggestion that will show how a referee might be given time to prepare might be to divide the adventure into at least two sessions of play. In the first, the characters are created for everyone concerned (if this is not part of an on-going campaign); this can take a fair amount of time, so allow plenty. The referee should have an idea of where he or she wants to go with the adventure they will play, but needn't have every detail down pat. The remainder of the first session should be spent in leading up to the adventure; meeting the patron, getting into the situation from which the adventure will come, or whatever. At that point, however, the first session ends. Then, before the next one, the referee can put together the things he or she has to have - encounter tables, die rolls, maps, or whatever. The second session will then be ample to allow the

continued on p. 33

GALACTIC ENCOUNTERS

Published by Federal Data Bureau (div. Galactic Information Service)

Lavishly illustrated with full color artwork



ALIENS: *An Illustrated Guide to the Inhabited Galaxy*— Catalog of bizarre creatures and humanoid life-forms that populated the outer planets of the 23rd Century Galactic Federation. \$5.99 postpaid.

THE FANTASTIC PLANET- Crew's diary of a forced landing on the planet *Mystery*— a world of fantastic magic, and the momentous events they are swept up in. \$5.99 postpaid.

SETTLERS IN SPACE— A journey into the vast realms of interstellar space to record the triumphs and disasters of Federation colonists and their fight for survival on the perimeter worlds. \$5.99 postpaid.

SPACE PATROL— An introduction to the *Federal Security Force*, commonly known as the *Space Patrol*, describing its nature and functions. Also includes detailed information on its equipment and techniques. \$5.99 postpaid.

STAR QUEST— The account of an epic journey by the *Venturer* and its highly trained crew towards the very heart of the Galaxy in its search for new and unknown species. \$5.99 postpaid.

WORLDS AT WAR- Records of the three major wars of the last 150 years of Federation History— the *Hyperwave War*, the *Marauders of Pherkard*, and the *Phalan War*— and their reasons, causes, and outcomes. \$5.99 postpaid.

About the Author: Steven Caldwell retired from the Federation Security Force with the rank of Group 1 Battleforce Commander. During active duty he travelled to all parts of the Federation and was awarded the Andromeda Star for his part in the settlement of the Perimeter Worlds. Caldwell is now a belter, running his own company headquartered in Juno.

SAVE 10% ON THE COMPLETE 6 VOLUME SET.

ALL 6 VOLUMES FOR ONLY \$29.95 postpaid.

Illinois residents please add 6% sales tax.

MEDIA RESOURCES, 1024 W. WASHINGTON BLVD. CHICAGO, IL 60607

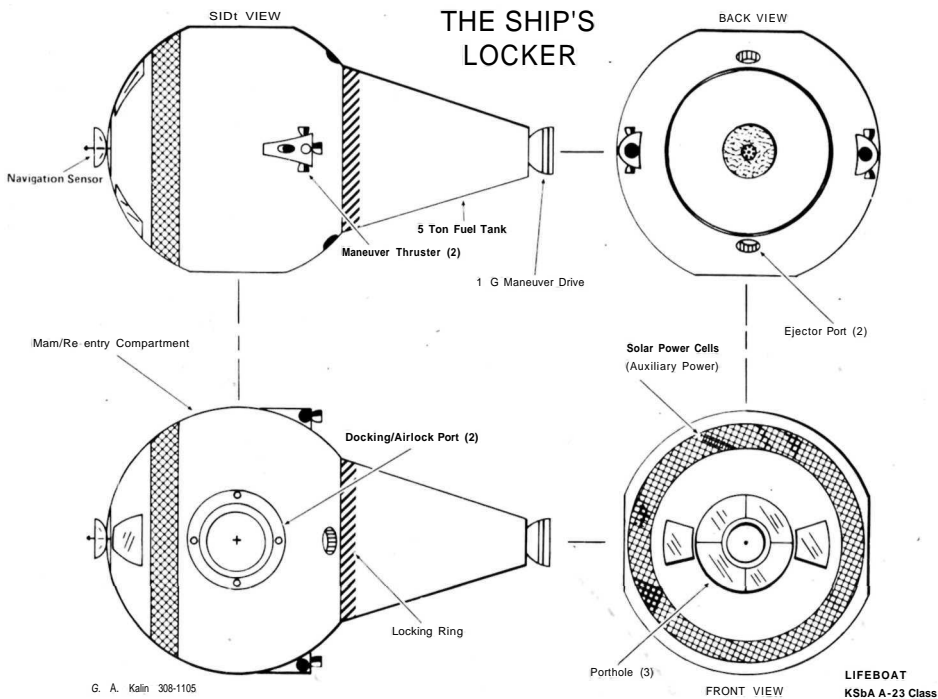

LIFEBOATS

Lifeboats of many designs are in use on larger vessels throughout the Imperium. The above illustration shows one in common use in many regions, the KSbA Model A-23, manufactured by Kaufmann Sternschiffbau Amt.

The craft masses 19.6 metric tons and is capable of carrying three conscious passengers (including the pilot) and an additional twenty in five cold sleep berths, for a total of twenty-three passengers.

Thfi Model A-23 incorporates an ablative heat shield and a simple retro-rocket for atmospheric entry under most conditions. In addition, fuel sufficient for a soft landing under all but the most extreme gravities and a parasail landing parachute permit a reasonable last minute choice of landing sites. A combination of extremely simple controls and a small onboard auto-pilot allow even the most inexperienced small

craft pilots a good chance of a safe planetfall. (Base chance 2D for 8+, with DM's of +1 per level of ship's boat skill).
20 tons TL 8 Cr 14000000

RESCUE BALL

This item is standard on all Imperial military vessels and on most private ships as well. When folded, the rescue ball is a cylinder about 5 cm in diameter and about 10 cm long. When deployed, it forms a sphere slightly over one meter in diameter which contains air sufficient to last one person for from one to two hours. In the event of explosive decompression or other loss of air, rescue balls allow individuals not in the possession of vacc suits or those without time to don vacc suits to survive long enough for aid to reach them. The user pulls a lanyard, climbs inside and seals the zip closure. The ball is made of a metal-coated plastic film for ease of location by radar and contains a small bottle of

compressed air, a small first aid kit, and a transparent window through which the occupant may observe conditions outside the ball. Rescue balls provide some protection from stellar radiation and from corrosive and insidious atmospheres for a five to seven hours.
5 kg. TL 7 Cr 150

HOSTILE ENVIRONMENT KIT (Individual)

Imperial safety regulations require that one of these kits be carried for each crewmember and passenger aboard all starships. Additionally they are often found on board non-starships, ATVs, and other vehicles. Their value in case of accident is obvious.

Contents:

Filter/Respirator Combination: One per kit, as per book 3.

Water: 8 x 1/2 liter cans of distilled water.

Food: 30 days supply of dietary supplements and concentrates for one person.

Cold-light Sticks: 30 hollow plastic tubes which, when flexed, give a soft light for 24 hours.

CommLink/Beacon: A combination medium range radio and signaling transponder. One per kit.

Flares: 4 per kit. Signaling devices which when activated, emit a colored smoke and bright light for 15 minutes.

Rifle, survival: A light-weight rifle which disassembles into three basic components, barrel, action and hollow stock, into which the other two may be stored. The weapon comes with 400 rounds of standard 100 rounds of shotshell. It is treated as rifle minus 2.

(201)
744-6622

Tarpaulin: As described in book 3.
Cord: 5mm diameter x 300m length. Stout cord suitable for snares, etc.
Rope: 1 cm diameter x 50 m length. Suitable for climbing, and so on.
First Aid kit: A small package of bandages, splints, and other equipment for treatment of minor injuries.

Grappling Hook: Used in climbing, attached to rope.

Climbing spikes and hammer: Metal spikes used in climbing steep rock faces.

Machete: Equivalent to blade, as in book 1. Used in cutting vegetation to clear a path, campsite, etc.

Binoculars: As in book 3.

Sheltersuit: A loose-fitting garment with facemask, gloves, and hood which can be used in conjunction with a battery operated heat pump to provide protection from most extreme conditions of hot and cold.

Heat pump: Used with the above. When activated, battery is good for an average 30 days continuous operation.

Raft, 1 person: An inflatable raft capable of keeping one person afloat in water.

Miscellaneous: Fishhooks and line, matches, etc.

Survival Manual: A hand-held portable microfilm reader with self contained instructions for survival under many adverse conditions.

Carrying case: 50 x 40 x 15 cm.
15 kg TL 7 Cr 300

(201)
744-6622



*Fantasy Game Center
War Game Headquarters
for North New Jersey*

TUES.-SAT. 11:00 A.M. TO 7:00 P.M.
THURS.-OPEN TILL 9:00 P.M.

209 CLENRIDGE AVENUE
MONTCLAIR, N.J. 07042



THE WEREWOLF DISEASE

The planet Taldor (C-866413-8) is owned by Kitzen, Ltd, a company specializing in biochemistry. The population of the world is concentrated about the capital and starport, Port Stagbuck, situated on the island of Bekain.

In port Stagbuck the adventurers are contacted by a representative of the government/company. She offers them a Cr 100000 success only contract for a mission. She is rather secretive of the exact nature of the mission, saying only that she wants the players to catch alive an armed man roaming the wilderness on Bekain. When the players have accepted the mission, she will explain more thoroughly.

A week ago a young lab technician was accidentally infected with an experimental virus. He was kept in isolation in a high security hospital. Two days local (34h) ago he suddenly turned very

ill. In a terrible rage he broke out of the hospital, causing great damage in the process. He managed to steal an advanced combat rifle and was later seen running out of Port Stagbuck at extremely high speed.

The group's task is very simple, she says. They are to find, catch, and bring this man back alive to Port Stagbuck. Kitzen, Ltd will supply the adventurers with gas grenades, combat snub pistols and crossbows with gas and tranquilizer ammunition. The adventurers can also borrow non-military vehicles, but will have any costs of repair deducted from their pay.

Amber Zone

Referee's Information:

The referee will have to prepare a map of Bekain. The island is roughly

circular, with a diameter of approximately 300 km. Port Stagbuck is located on the northeastern coast. The city is the only settlement on Bekain. Most terrain types possible in a temperate climate can be included.

To track the technician recon or perhaps survival skill should be necessary, but it should not be impossible for the average person to follow him since he has killed a great many animals. The man has had his UPP modified by the disease to FFFCCA. His metabolism has been speeded up and he acts as if he had taken slow drug. His senses have also been improved, which makes it difficult to surprise him. He has turned wildly paranoid and will consider all animals and humans as a threat to his life, observe that he is capable of very intelligent planning.

He has approximately fifty rounds of DS ammunition for the ACR. For protection he uses cloth armor which he took from a security guard during his escape. In close combat he fights with a cudgel which he has made from a tree limb.

The technician is slightly agoraphobic and because of that his hut or lair will be in an area with a dense terrain, e.g. mountain or forest.

Available gases are sleep gas, blind gas (which temporarily paralyzes the optic nerve) and teargas. The tranq darts for the snub pistols and the crossbows are the typical sleep inducing type. The effect of the sleep gas is that the dexterity and endurance of the man are reduced to 3 in four rounds. The effect will last about 15 minutes. This reduction will

not affect the capability of taking wounds. No one knows anything about the ability of the man to stay awake in his current condition, which could cause a nasty surprise for the players. The effect of the tranquilizers and of the tear gas should also be unknown to the players. If the technician is blinded, he would still be surprisingly efficient, using his improved senses of hearing and smell.

Anders Blixt

continued from p. 28

adventure to be played out without rushing the referee.

By doing this, players insure that there are no hasty decisions, no short cuts — because, in Traveller, "getting there is half the fun".

To sum it all up, then, Traveller is a game that must be approached with confidence, imagination, and the determination to have a good time. The game may not be fun for everyone — it demands much more than most other games, and cannot be played by rote. But, on the other hand, the game has so much more to offer than other games, too . . . and the more you put into it, the more you get out of it.

J. Andrew Keith

305
961-1660

THE
COMPLEAT
STRATEGIST

305
961-5660

*Fantasy Game Center
Wargame Headquarters
for Southeast Florida*

TUES.-SAT. 11:00 A.M. TO 7:00 P.M. THURS.-TILL 9:00 P.M.
5406-8 STIRLING ROAD FLORIDA 33314

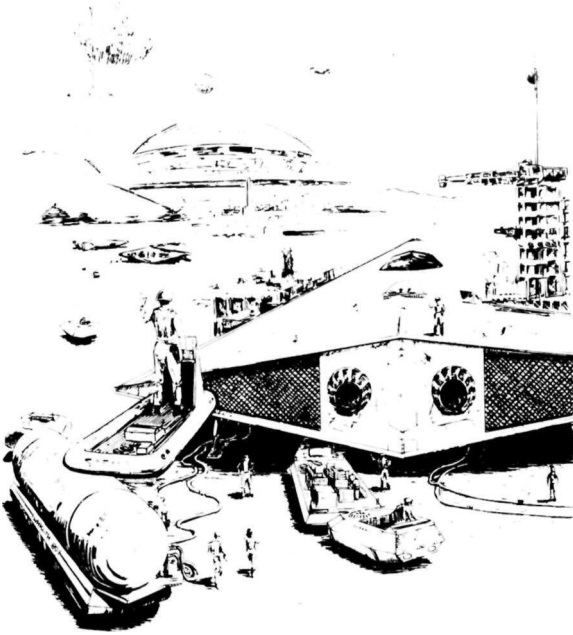

Speculation Without a Starship

Engaging in speculative trade by buying cargoes at low prices, transporting them to another market and selling them at a higher price can be very lucrative for a player with the proper skills and adequate capital. The procedure outlined below allows players not in possession of a starship to engage in trade by buying goods and chartering transport to a specified market.

BUYING THE GOODS

Players purchase goods according to the procedure described in book 2, pp 42-44. A character searching for goods to purchase may consult the trade and speculation table three times per week, provided he or she does not perform any other major activity that week. If a character does something else during that week, (another job, searching for a proper ship, and so on) the referee should reduce the number of times the player may consult the table. DMs for

Bribery and Admin skills apply, as per book 1.

SEEKING A CARRIER

Once a player has purchased a consignment of goods, he or she must decide where it is to be shipped. The player need not ship the same week the goods are purchased; they may be warehoused. The referee should work out a proper fee for such storage, such as .01% of the base price of the goods per week.

Each week a player seeks a carrier, the referee should roll 2D, DM-1 if in a B class starport, -2 if C, -4 if D, -6 if E and -8 if X. There is no DM for A class. The resulting number is the number of ships looking for cargo in that port that week. The referee then determines the types of ships by consulting the type of ship table. Military vessels are not considered on the table, as they do not carry cargo.

Starport Type:	Type of Ship Table DIE ROLL				
	A	2	3-4	5-6	7-9
B	2	3-5	6-8	9-10	11-12
C	2-3	4-6	7-10	11	12
D	2-3	4-5	6-10	11-12	
E	2-4	5-10	11-12	—	
X	2-7	8-11	12	—	—
	<i>Scout</i>	<i>Yacht</i>	<i>Free Trader</i>	<i>Ft Class Subsidized Merchant</i>	<i>M Class Subsidized Merchant</i>

Example: If a player is in a B starport seeking a carrier, the referee rolls two dice and an 8 is the result. $8-1=7$: there are seven ships in port that week looking for cargo. Rolling two dice seven times (once for each ship) gives results of 10, 8, 3, 12, 9, 7, and 8. Comparing these results with the table shows that there are one yacht, three free traders, two R type subsidized merchants and one M class subsidized merchant in port that week.

After finding the number and type of ships in port, the referee must determine the cargo space available on each ship, and the willingness of the ship's captain to go to the destination the player desires. (a player must designate one destination per consignment of goods). The player informs the referee what cargoes are being shipped and where they are to go. The referee then rolls 2D for each ship in port. DM's of -2 if scout, -9 if yacht, -4 if free trader, -8 if R or M class subsidized merchant. If the modified result is zero or less, the ship has all cargo space filled up. If the modified result is 1 or more, roll to determine if the ship's captain is willing to travel to the desired destination. The player must equal or exceed the number of the cargo determination determined above in order for the ship

to be bound for the desired destination.

If the modified result is 1 or more, and the ship's captain is willing to travel where the player desires, that number multiplied by 10 is the percentage of the total cargo space on that ship available for use.

In the example cited above, for instance, if a player has a 12 ton consignment and wishes to ship it to a specific destination, the following occurs:

Yacht: A 10 is rolled. $10-9 = 1$. A second roll is made with 2D and a 6 is rolled. As 6 is greater than 1, the yacht will go to the desired destination. As $1 \times 10 = 10\%$, and 10% of 13 = 1.3, the available space on the yacht is 1.3 tons.

Free Trader A: A 9 is rolled. $9-4 = 5$, on the second roll a 7 is rolled. As $5 \times 10 = 50\%$, and 50% of 82 = 41, the available space on free trader A is 41 tons.

Free Trader B: A 7 is rolled. $7-4 = 3$, the second roll is 4. As $3 \times 10 = 30\%$, and 30% of 82 = 24.6, the available space on free trader B is 24.6 tons.

Free Trader C: An 8 is rolled. $8-4 = 4$, the second roll is 2. As 2 is less than 4, the captain of free trader C is not willing to travel to the destination the player wants.

M Class Subsidized Merchant: A 4 is

rolled. 4-8 = -4, no available cargo space.

R Class Subsidized Merchant A: A 6 is rolled. 6-8 = -2, no available cargo space.

R Class Subsidized Merchant B: A 9 is rolled, 9-8 = 1. The second roll is a 9. As $1 \times 10 = 10\%$ and 10% of $200 = 20$, the available space on R Class Subsidized merchant B is 20 tons.

The player could ship the consignment on any of the free traders, or one of the R subsidized merchants. The yacht is too small to contain the entire shipment, but the player could split the shipment if the nature of the cargo permits. The other two subsidized merchants are either full up or are headed for a different destination than that which the player desires. (Subsidized merchants run set routes, and are less likely to go to the destination desired unless it happens to be on their regular run).

The cost of shipping the cargo is Cr 1000 per ton or 1% of the base price of the goods per ton, whichever is greater. Thus, the cost of shipping 12 tons of textiles would be Cr 12000, while the cost of shipping 2 tons of cybernetics parts would be Cr 5000 ($250000 \times .01 = 2500 \times 2 = \text{Cr } 5000$).

SELLING THE GOODS

Selling is accomplished as per book 2, pp 42-44. When goods are sold, someone must be present to conduct the sale for the owner of the goods. This may be a player (either the speculator or his authorized agent) or a non-player (such as a broker, see book 2, p 43.) hired for the purpose.

Example: A player is on Reston, (B starport, non-industrial) and engages in trade. As the week is spent looking for goods and searching for a ship to

transport them, the player may only consult the Trade and Speculation Table twice. The goods available are two ATV's and three tons of pharmaceuticals. The ATV's have a favorable resale DM on agricultural planets, and the nearest planet (Capon) is agricultural. The player purchases the two ATV's. The base price of ATV's is Cr 300000 each, but the player obtains them for 80% or Cr 240000 (a roll of 5 on the actual value table, book 2, p 42).

The referee determines that there are four ships in port, a scout and three free traders. Free trader I has 16.4 tons available, free trader II 24.6 tons free trader III 8.2 tons and the scout 1.2 tons. Since the player cannot split the two ATV's into less than two parts, and an ATV weighs 10 tons, the scout cannot be used, even for a split shipment. For the same reason, neither can free traders I or II. Freetrader III is the only choice that week.

The shipping cost is Cr 1000 per ton ($300000 \times .01/10 = 300$ per ton, which is less than 1000 per ton) or Cr 2000 total. At the destination, the buyer employs a +3 broker to handle the sale and receives a price of 130% (a roll of 7 on the actual value table, plus the brokers DM of 3, for a final result of 10 or 130%) or Cr 390000 (the brokers fee is 15% of the final sale price, or Cr 58500).

To sum up, the player buys two ATV's at Cr 240000 each, spends Cr 2000 transporting them to market, and spends Cr 58500 for a broker who sells the ATV's for Cr 390000 each. The player ends up with Cr 239500 more than he or she started with.

Additional complications, such as exchange rates, customs duties, black markets, and so on may be added at the referee's option.

Loren K. Wiseman

GDW

FLASH!

Game Designers' Workshop received the following Awards at Origins '80, held in Chester Pennsylvania:

Game Designers' Guild Select Awards

Double Star
Bloodtree Rebellion
White Death
Road to the Rhine

H.G. Wells Awards

Best Magazine Covering Role-playing
Journal of the Travellers' Aid Society

Best Miniatures Line
System 7 Napoleonics

Best Miniatures Rules
Special edition, Fire and Steel rules, For Use with System 7

Best Adventure
The Kinunir

Game Designers' Workshop and the Journal of the Travellers' Aid Society would like to thank the loyal fans whose votes made these awards ours.

GEN CON

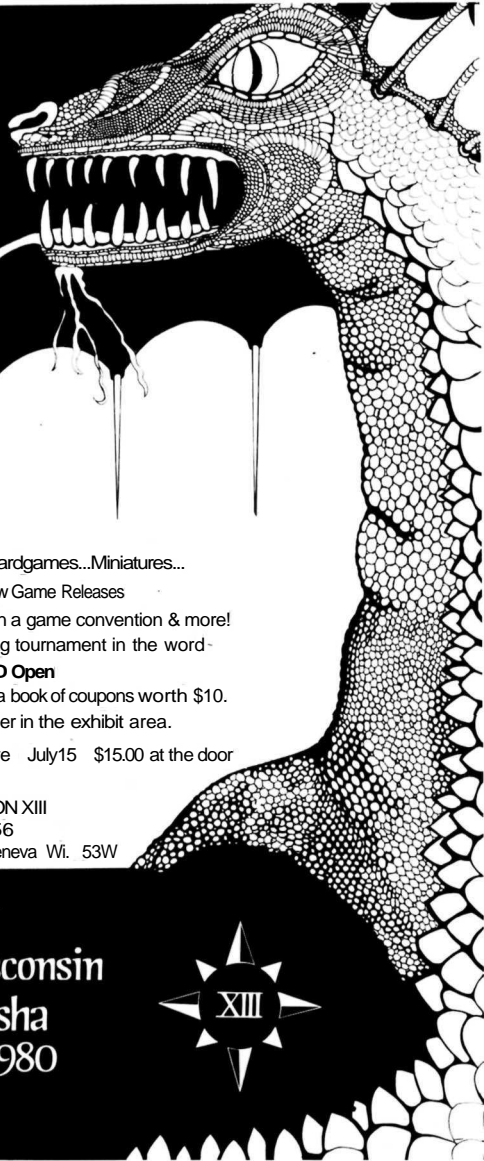

Dealers... Seminars... Boardgames... Miniatures...

Role Playing... New Game Releases

Everything you've ever wanted in a game convention & more!

The largest fantasy role playing tournament in the world-

The AD&D Open

Each conventioneer will receive a book of coupons worth \$10.

Redeemable with any dealer in the exhibit area.

\$10.00 pre-registration fee before July 15 \$15.00 at the door

For more information contact:

GEN CON XIII
POB 756
Lake Geneva Wi. 53W

University of Wisconsin
Parkside - Kenosha
August 21-24, 1980



Starships and Spacecraft

Three 22" x 34" sheets, 25mm scale three-color deck plans of all standard. TRAVELLER Starships and Auxiliaries, complete technical data, ship's papers and layout grid for your own Starship design.

No. 89.....\$5.50

Traveller Referee Screen

Approved for use with "TRAVELLER". Four piece referee screen. Many combat tables and other useful data reprinted thereon. All weapons from 'MERCENARY' are included also.

No. 75.....\$2.50

Traveller Logbook

Approved as a TRAVELLER gaming aid. Many charts on personal development and starship maintenance and combat character sheets and ship's papers are included. Illustrated.

No. 78.....\$3.00

STARSHIPS And SPACECRAFT



No Be

\$ 5.50

JUDGES GUILD
1165 N. University Ave. (J-1)
Decatur, IL 62526
Phone: (217) 422-1930

Approved For Use With
TRAVELLER



SCOUTS & ASSASSINS

This booklet provides players with an expanded character generation system for the Scout Service and a new generation system for a unique class of character, the Assassin. A special insert is included with complete technical data (including specifications and dispositions) on the Serpent Class Scoutships and 11" x 17" deck plans suitable for use with **Snapshot** or 25mm figures. Approved for use with **Traveller** by GDW and available for \$3.00 post-paid from:

PARANOIA PRESS

1207 Scott Avenue. Fort Wayne, IN 46807

Dealer's rates available.

DIFFERENT WORLDS



Magazine of Game Role-Playing

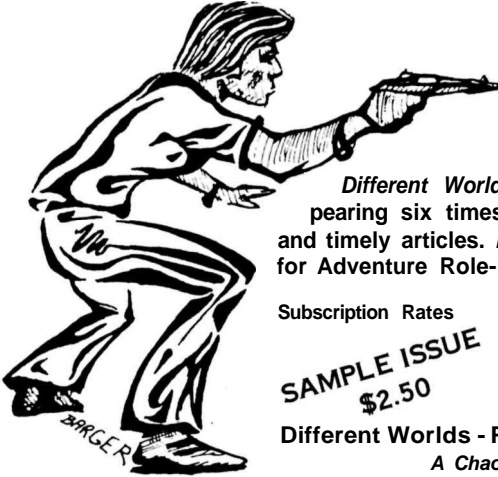

An authoritative journal that no dedicated Game Master should do without! Collect *Different Worlds* ... treasure each issue! Appearing six times a year, it features informative and timely articles. *Different Worlds* is The Magazine for Adventure Role-Playing Gamers! Subscribe now!

Subscription Rates

U.S.	\$10.50/1 year (6 issues)
Canada and Mexico	\$14.50
Rest of world surface	\$14.50
Rest of world air	\$21

Payment must be in \$US.

SAMPLE ISSUE
\$2.50

Different Worlds - PO Box 6302 -Albany, CA 94706

A Chaosium, Inc. publication



Next Issue:

Fleshing Out The Belt: A Belter variant by Roberto Camino.

The Scout Service: A closer look at scouts, by Marc Miller.

A Traveller Stock Exchange: by Stan Mullins. A look at a great way to lose your shirt.

Plus two *Amber Zones*, the *Bestiary*, *Ship's Locker* and more!

NOW WE'RE MONTHLY!

CLIMB ABOARD

THE

SPACE GAMER



for a mission that covers:

ALL THE PUBLISHERS! TSG is now the only magazine of its kind unaffiliated with any game publisher. TSG covers the *entire sf/fantasy game hobby* without bias.

ALL THE GAMES! TSG will review **EVERY** game, game supplement, or gaming product it receives ... and as many historical and modern games as possible! No other magazine even tries to do this. We're committed to it.

ALL THE NEWS! Conventions, upcoming products, tournaments, personalities, and, *yes, computer games*—everything you want to know about the wargaming hobby.

plus —

Designer's articles. Variant games. Play reports. Fact articles. Art and graphics. Letters. Cartoons. And fiction.

Name _____

Address _____

City _____ State _____ Zip _____

Check here if this is a subscription renewal.

Enclosed is my check for

- \$21 (one year -12 issues)
 \$39 (two years-24 issues)
 \$250 (lifetime subscription)

Canadian subscribers please add \$3 per year. Other foreign subscribers please add \$20 per year. We are sorry about these surcharges—but thanks to the Postal Service, we have to charge that much or refuse foreign subscriptions entirely!

A note on lifetime subscriptions: It's just what it sounds like. In exchange for one \$250 payment, you get *The Space Gamer* as long as it and you are both operational. We hope that will be a LONG time.

All subscriptions start with the next issue published.

THE SPACE GAMER / Box 18805-D / Austin, TX 78760

Hello, Earthlings!

Game Designers' Workshop had a whole galaxy to choose from when they picked the company to make the miniatures for their best-selling science fiction game. But they didn't have to go far. Just to Mars . . .

Now available from Martian Metals ... the licensed miniatures for *Traveller*.™ Incredibly detailed 15mm adventure sets of heroes . . . thugs and ruffians . . . aliens . . . robots . . . Imperial Marines . . . animals and creatures . . . and many more.

Drop by Mars and pick them up — or ask at your closest Earth hobby shop.

And remember: they may *look* lifelike . . . hut they're only metal. Really.



Martian Metals

MANUFACTURERS OF DRAGONSLAYERS™ MINIATURES

Box 338-TA

Cedar Park, TX 78613

512-258-9470