

US \$2.50  
Australia \$3.45  
UK £1.50

the

No. 11, \$2.50

# JOURNAL

of the Travellers' Aid Society

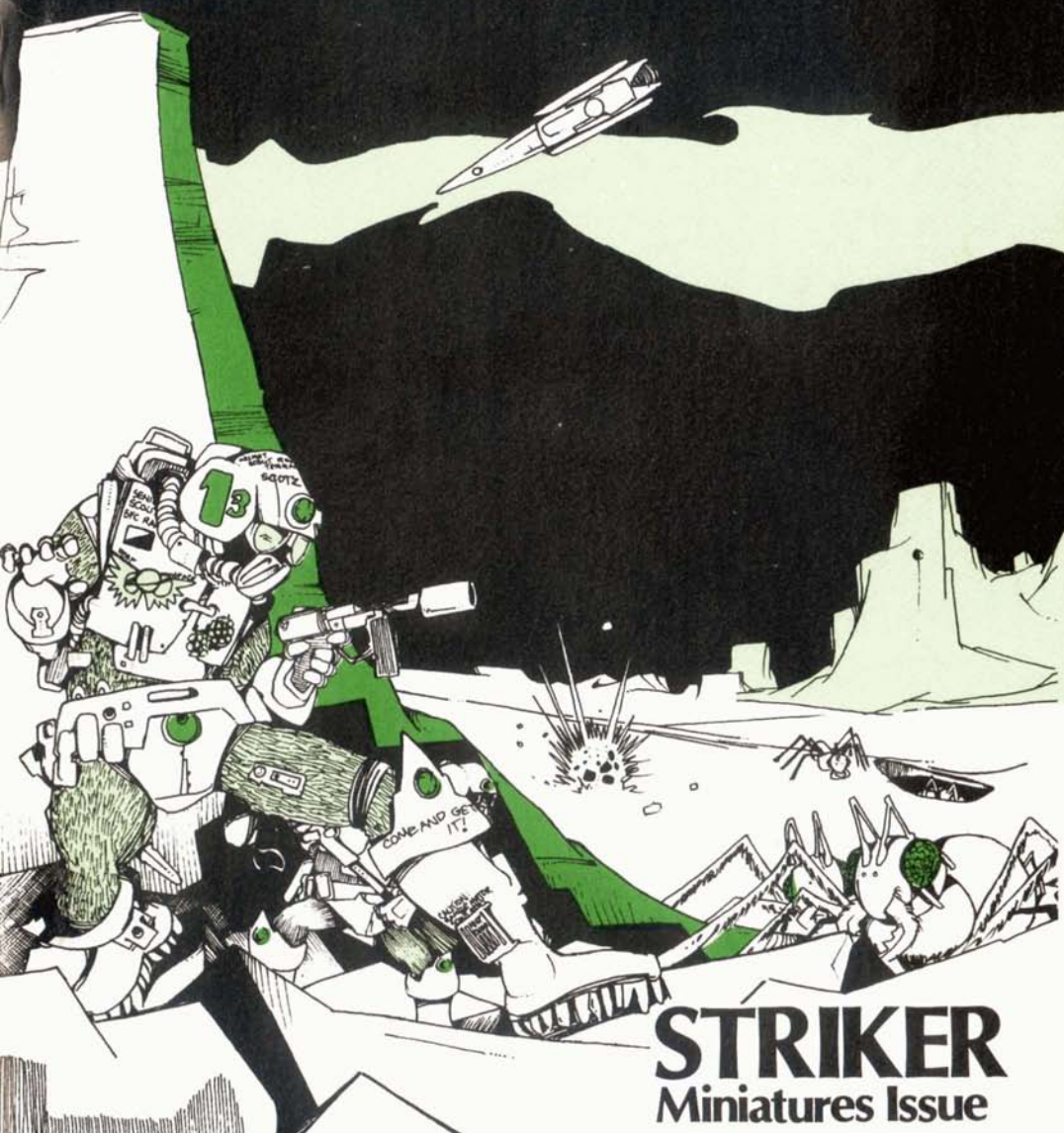

**STRIKER**  
Miniatures Issue

# NOW AVAILABLE

# STRIKER

Rules for 15mm  
Traveller Miniatures

704

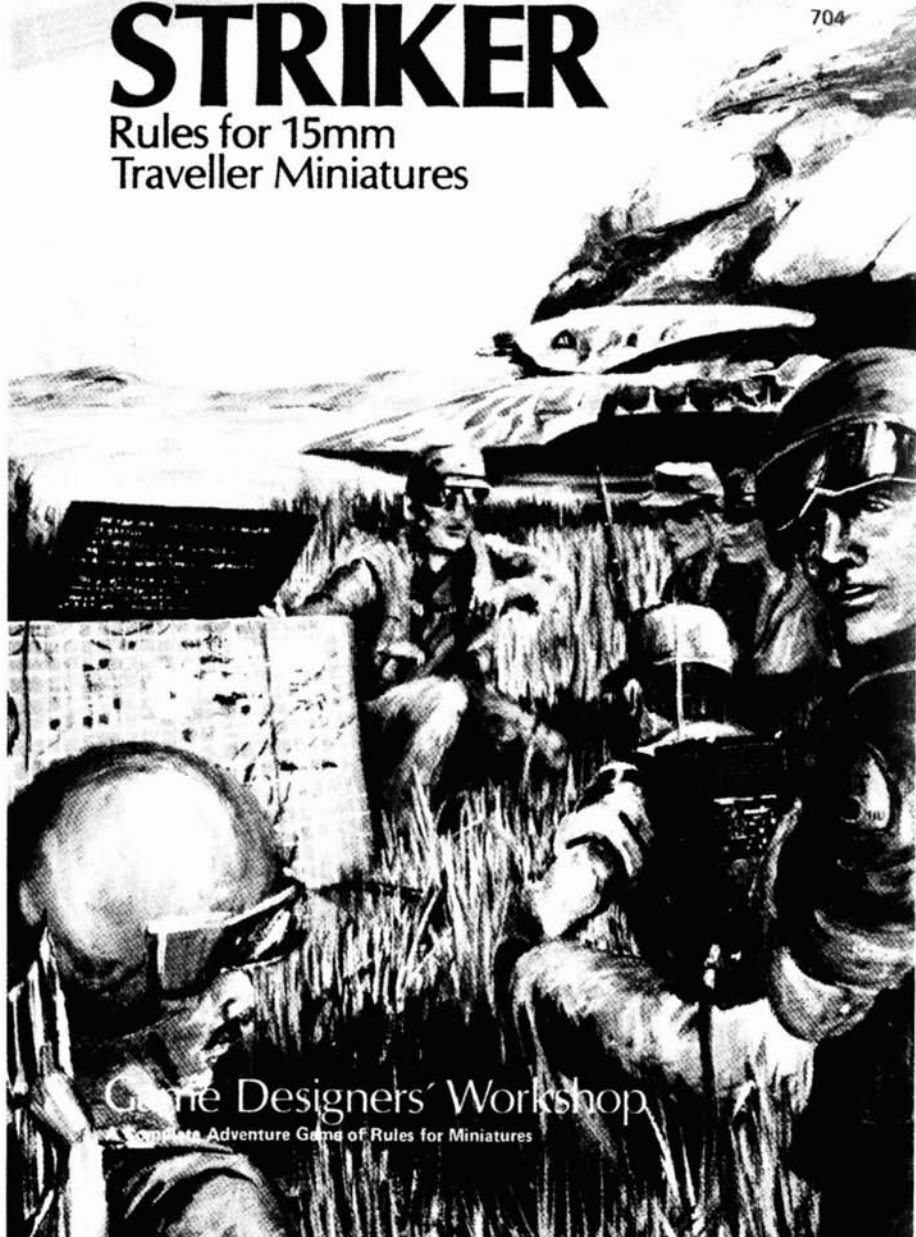

Game Designers' Workshop

A Complete Adventure Game of Rules for Miniatures

Striker, \$11.98, is available from  
better hobby shops around the world.

*Free catalog on request.*

the No. 12, \$2.50  
**JOURNAL**  
of the Travellers' Aid Society

**Cover Articles**

- Zhodani Military Organization, by Frank Chadwick and Loren Wiseman . . . . 26  
Archaic Missile Weapons, by Frank Chadwick . . . . . 44

**Amber Zone**

- Thunder on Zyra, by Roger Moore . . . . . 6  
Work of Art, by Loren Wiseman . . . . . 33

**Contact!**

- Newts, by Loren Wiseman and William Keith . . . . . 12

**Feature Articles**

- Planet-building, a Referee's Guide, Part II, by Andrew and William Keith . . . 37  
The Atmospheric Re-entry Kit, by John Colbert . . . . . 16  
Medical Treatment in Traveller, by Terry McInnes and Marc Desmond . . . . . 22

**Features**

- From the Management . . . . . 2  
Just Detected . . . . . 4  
Traveller News Service . . . . . 5  
The Bestiary . . . . . 9

Dates in this issue of the *Journal* are given in accordance with an arbitrary Imperial calendar of 365 days. The expression of date consists of a three-digit day number (showing the current day of the year) followed by a dash and a four-digit year number (showing the current year since the founding of the Imperium).

The date of this issue is **334-1107** or the 334th day of the 1107th year of the Imperium.

The *Journal of the Travellers' Aid Society* is a science-fiction gaming magazine dedicated to **Traveller**, GDW's role-playing game set in the far future.

**Editor:** Loren K. Wiseman

**Spiritual Advisor:** Marc W. Miller

**Publisher:** Game Designers' Workshop

**Artists in this issue:** William H. Keith—pages 9, 10, 12, 14, 37, 40; Jeanette Spencer—page 33; D. J. Barr—pages 22, 25; David R. Deitrick—pages 6, 16, 26; Darlene Pekul—page 46.

**WINNER— H. G. WELLS AWARD: BEST MAGAZINE COVERING ROLE-PLAYING, 1980**

The *Journal of the Travellers' Aid Society* is copyright 1981 by Game Designers' Workshop. Printed in the USA. All rights reserved. ISSN: 0193-3124. All editorial and general mail should be sent to the *Journal*, PO Box 1646, Bloomington, IL 61701.

The *Journal of the Travellers' Aid Society* is published quarterly with an individual issue price of \$2.50. One year subscriptions are \$9.00 in the United States and Canada. Foreign subscriptions (outside the USA or Canada, but not to APO or FPO addresses) are \$18 per year, which includes airmail postage. Please make all payments in US funds drawn on a US bank. Advertisers should inquire for an advertising rate card.

**Submissions:** We welcome articles and illustrations for the *Journal*. Please inquire before submitting manuscripts, enclosing a stamped, self-addressed envelope; we will send manuscript guideline and format sheets.

The underlying theme for this issue is the long-awaited publication of *Striker*, GDW's science fiction miniatures rules. We believe these to be the most comprehensive treatment of the subject available anywhere. Consider the size of the task we set ourselves: to create a set of miniatures rules covering tactical combat with equipment from tech levels 5 through 15. This is roughly from WWI to about 5600 AD! Few sets of miniatures rules cover this span of years, and none cover the radically different technologies involved. *Striker* was a staggering project, for our design staff, but we feel the end product will prove worth the wait.

The most useful item in this issue for the prospective *Striker* player, in light of the outbreak of the Fifth Frontier War, is the Zhodani organization article. The first unit examined, the Zhodani commandos, is perhaps the most dangerous infantry unit ever to appear on a tabletop. The other, the lift infantry battalion, is the unit most likely to be encountered by Imperial forces during the war.

In future issues, we will deal with other units from both sides, including Imperial, Sword Worlds, and Vargr forces, as well as other Zhodani units and the mercenary forces employed by both sides. Later, we will deal with the forces of the Solomani Rim region, and those of other major and minor races.

In addition, the military Amber Zone for this issue is *Striker* oriented, and we have included an article on archaic missile weapons for those who wish to take *Striker* back even more tech levels (or for the referee who thinks a war against myriads of primitives might keep the players entertained for a while).

Not directly related to *Striker*, but of some military utility nevertheless, is the article by John W. Colbert on the foamed ablative re-entry package. Also, Terry McInnes and Marc Desmond have combined their efforts to give us a short essay on medical treatment for wounds, which all *Traveller* referees should find of great utility, but will be of particular value to those running a military-oriented campaign. Finally, we have the second of the two Referee's Guide to Planetbuilding articles by Andy and Bill Keith.

This month also sees the start of another regular feature for the Journal, called Casual Encounters. We have long felt that there was a void which needed to be filled between the player character, with a fully developed background, and the simple, shallowly developed non-player character from sources such as supplement 1, *1001 Characters* or supplement 6, *76 Patrons*. We feel we have come up with a feature which will fill this void. Casual Encounters are descriptions of unusual and interesting non-player characters, with many potential uses. Each description will include the character's UPP, some short biographical

notes and any unusual drives or motivations. In addition, each encounter will give a number of adventure ideas, places where the character is usually found, and what the character will want of the players. A referee can use a Casual Encounter as the start of an evening's scenario, as a jumping off place for a series of interconnected scenarios, or add excitement to an existing campaign. Of course, not all Casual Encounters will be financially rewarding for the players, and many will do more harm than good, but every one will contain the potential to keep a group going through several scenarios. It is even possible that a player might want to make one the the subjects of a Casual Encounter his or her regular character! We hope that Casual Encounters will prove to be one of our most popular features in the years to come.

The publication of *Striker* brings up a few questions we here at the Journal would like to pose to the readers. How many of you buy miniatures and use them in the course of your campaigns? Would you like to see more articles devoted to this subject in future issues? Would you like to see articles for advanced miniatures players, for beginners, or a mixture of both types? Possible subjects for articles of this type include a series on how to build terrain for the tabletop, how to scratch-build and convert scale model vehicles of your own design, how to construct alien-looking buildings and fauna, uniform and equipment painting guides for the various military personnel and equipment of the **Traveller** universe. Some of the articles (such as the organizations of the various military units, or expansions of various rules) would be usable by non-miniatures users, but many would not be.

Subscribers will note that we now include a feedback response form on the

mailing label, which they may use to respond to the above questions. This form will be appearing regularly in each issue from now on, and we urge every reader to make use of them where possible. The form will ask the readers of the Journal to rate the issue overall, and each article and regular feature on a scale of 1 to 5, 1 equaling extreme dissatisfaction, 5 indicating great satisfaction. Additionally, the form will ask what area you would like to see the Journal handle that either is not handled now or should be handled in more depth. Non-subscribers are asked to respond to the same questions, but it will be necessary for them to use their own sheet of paper.

To encourage responses, each year we will draw one response at random, and award the lucky person a one year subscription, or extension to their current subscription. Only one response per issue per reader, please.

We hope these response forms will enable us to tailor our article content to suit the interests of our readers.

— Loren K. Wiseman

**Traveller** is available overseas through GDW distributors in the UK and Australia. We recommend that our readers in these countries obtain copies through their respective distributors.

**United Kingdom:** **Traveller** (and its additional booklets, adventures and supplements) is printed under license from GDW by Games Workshop, 27-29 Sunbeam Rd, Park Royal, London, NW10. GW import the Journal and other GDW products.

**Australia:** **Traveller** products are imported and distributed by Jedko Games, 18 Fonceca St, Mordialloc, Vic.

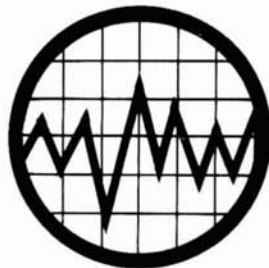

# JUST DETECTED

One 8½ x 11" book and a 22 x 34" map. \$5.98.

*Design:* Dave Sering

*Publisher:* Judges Guild, Inc, RR 8, Box 9, 1221 N. Sunnyside Rd, Decatur, IL 62522.

## Play Aids:

### *Amycus Probe*

The first in a series of interconnected adventures by Judges Guild, this one deals with the remains of a mysterious installation in the Gateway Quadrant. The illustrated booklet contains tables, charts, and a subsector map. Approved for use with **Traveller**.

One 8½ x 11", 32 page booklet, \$5.98.

*Design:* Dave Sering

*Publisher:* Judges Guild, Inc, RR 8, Box 9, 1221 N. Sunnyside Rd, Decatur, IL 62522.

### *Rogue Moon of Spinstorme*

Second in the series started by Amycus Probe, this adventure also deals with a mysterious installation, this time in the Spinstorme system. The booklet contains tables, charts, and a subsector map, as well as diagrams of the installation. Approved for use with **Traveller**.

One 8½ x 11", 32 page book. \$5.98.

*Design:* Dave Sering

*Publisher:* Judges Guild, Inc, RR 8, Box 9, 1221 N. Sunnyside Rd, Decatur, IL 62522.

### *Simba Safari*

A collection of adventure scenarios set aboard the Simba Safari, a safari ship. Included are capsule descriptions of the passengers and crew, as well as deck plans of the safari ship, surface maps of the various worlds along the ship's itinerary, and a subsector map. Approved for use with **Traveller**.

### *Marooned on Ghostring*

An adventure set on the world of Ghostring, in the Midomega subsector. Ghostring is a previously uncontacted and unexplored world (or at least not in the data banks) Included are tables, charts, and maps of the world's surface, as well as details of the inhabitants and the local fauna. Approved for use with **Traveller**.

One 8½ x 11", 30 page booklet with illustrations. \$5.98.

*Design:* Walter and Dorothy Bledsaw

*Publisher:* Judges Guild, Inc, RR 8, Box 9, 1221 N. Sunnyside Rd, Decatur, IL 62522.

### *Action Aboard*

Designed for use with their King Richard starship deck plans, Action Aboard is a series of scenarios for conducting adventures on that luxury liner. Included are capsule biographies of the crew and possible passengers, and suggestions for a variety of adventures ranging from simple murder through kidnapping, hijacking, boarding actions, and even a salvage scenario after the ship has crashed. Although designed for use with the King Richard plans, it is not necessary to own them in order to use Action Aboard, as a miniature version of those plans is provided. Approved for use with **Traveller**.

One 5½ x 8½", 46 page booklet and an 11 x 17" map, \$6.00.

*Design:* Bill Paley

*continued on page 11*



# TRAVELLER NEWS SERVICE

## ☐ RHYLANOR/RHYLANOR (0306-A434934-F)

Date: 243-1107

☐ Long quiescent, the Ine Givar terrorist organization seems to be taking advantage of the dislocation caused by the current war to increase their activities. In addition to reports of activity throughout the war zone, in recent months the Ine Givar have been implicated in numerous acts of destruction and sabotage, including (most recently) the disappearance of the merchant ship Harun-al-Rashid, now six weeks overdue from Equus (Lanth 0807), an explosion and fire in scout base facilities at Meleto (Mora 0407), and the release of a deadly viral toxin into the water supply of the Imperial naval installation at Bendor (Glisten 0706).

☐ Spokesmen for Naval intelligence refused to comment on speculation that the Ine Givar might be receiving support from the Zhodani or their allies. A high placed source, however, said that the possibility of Zhodani or Sword World financial support cannot be discounted.

☐ The most famous pre-war act of terrorism attributed to the Ine Givar took place on Efate (Regina early in 1105. Until now, no acts have taken place which could be directly attributed to the Ine Givar with the possible exception of the explosion in General Shipyard's Pixie Facility (Regina 0303) later in that same year. Ω

## ☐ TUREDED/LANTH (0804-C465540-9)

Date: 251:1107

☐ Authorities on this agricultural world have announced the discovery and arrest of a number of "sleeper" agents in high places in the planetary government. A press release issued by Naval Intelligence did not to reveal names, but said that the agents were citizens of the Sword Worlds, disguised as locals, who had apparently spent years (in one case decades) working their way unobtrusively into the highest councils of the planetary government.

☐ According to the press release, the agents were to break the vital jump-1 route to Regina and the war zone by turning the world against the Imperium and destroying or inpounding supply vessels on their way to the front.

☐ No information is available on how the "sleepers" were discovered. The press release explains that Naval intelligence does not wish to compromise Imperial agents in Zhodani or Sword Worlds territory. Ω

## ☐ REGINA/REGINA (0310-A78889-9)

Date: 268-1107

☐ OFFICIAL RELEASE 46-268-1107: Notwithstanding current military conditions, landing operations or other activity not specifically sanctioned by the Imperial Naval Department will not be tolerated at the following worlds: Pscias (Regina 0506), Shionthy (Regina 0706), Algine (Regina 0708), Victoria (Lanth 0207), Ylaven (Lanth 0306), Sontherth (Lanth 0308), Djinni (Lanth 0501), and Grant (Jewell 0807).

☐ Subordinate authority for such landings or operations is delegated to fleet commanders when there is incontrovertible evidence that enemy forces have landed on such worlds or intend to do so.

☐ Violations of this directive will be severely dealt with.

☐ By order Santanocheev, Sector Admiral. Ω



*Players' Information:*

Zyra (B5554487) is one of the youngest colonies in the Trin's Veil subsector. Located on a small world orbiting the largest gas giant of that system (Bellus), Zyra's sixty-thousand inhabitants are concentrated around

## Amber Zone

two harbor cities on the eastern coast of the largest continent. The original survey report showed only low levels of potentially exploitable minerals, and the Zyrans, lacking the equipment and knowhow to economically mine these deposits, sought outside help. In return for a significant share of any profits, the interstellar firm of Telneskian Mines and Refining agreed to provide training for the locals.

Information has recently come to

light that the original report was inaccurate, and the lesser continents contain a large number of rich and readily exploitable metallic lodes. The Zyran confederacy believes that the company will soon make moves to take over control of the government of Zyra in order to drain the world of its resources.

The Zyran confederacy is seeking a battalion-sized strike force to overpower the TM&R security forces and assist Zyra in nationalizing the company's assets. Upon landing, the mercenaries will be required to make immediate assaults upon the Telneskian Industrial regions. The confederacy offers triple standard salaries plus a Cr3,000,000 success only bonus. The Zyran government, unfortunately, is cash poor, and can only offer Cr750,000 up-front money. The Zyrans are prepared to pay immediately in grants of land on Zrya, or in bonds payable in one year (with

# Thunder on Zyra



appropriate interest) backed by the world's mineral resources.

### *Referee's Information:*

As soon as the mercenaries arrive on planet, the unit's commander will be contacted by the Zyran government. In the last two days, the government has learned that the company has obtained two illegal thermonuclear devices (called thunderballs in mercenary jargon), which it has hidden at the main camp. Further, the government has learned that the company plans to use the devices to hold the Zyran people for ransom. In the case of a nationalization attempt. The devices were landed several weeks ago, but the technical personnel needed to arm them either have not yet arrived, or have only just landed. It is imperative that the mercenaries capture the devices before they can be armed.

Ordinarily, no company would dare undertake any venture using thunderballs. TM&R obviously feel that the current war will keep Imperial attentions elsewhere long enough for the company's plans to become a fait accompli, and for the incident to be properly hushed up.

The Zryans have determined that TM&R has beefed up its normal security forces (normally about four-hundred personnel, armed to tech 9) with a company sized unit of mercenaries. Zyran intelligence has learned that this unit is under strength, and equipped to tech 11).

The TM&R security patrols (of which six are assigned to the camp) are basically platoon-sized units. A patrol contains five squads, each with 10 security specialists (two fireteams of four each, a squad leader and an assistant squad leader). Each squad has a VRF gauss gun for support, each soldier is armed with an advanced combat rifle

and 4 cm RAM grenades. Several dozen individually carried tac missiles are available, but are not usually issued. 75% of the 4 cm RAM grenades available are various sorts of riot control gasses (the exact effects of these must be determined by the referee). Each squad is transported in two lightly armored, wheeled ATVs, each equipped with a Ram auto-grenade launcher.

The mercenary team in TM&R's employ is a company-sized unit. The company consists of a 6 man command element, 3 infantry platoons, a weapons platoon and a transport platoon.

Each infantry platoon has 5 squads, each of three fireteams and a lightly armored 12 passenger grav vehicle. In practice, each squad contains only two fireteams, due to heavy casualties suffered during the unit's last ticket. Each grav vehicle is equipped with a VRF gauss gun and RAM auto grenade launcher as the squad support weapons, and each soldier is equipped with combat armor and armed with a gauss rifle and 4 cm RAM grenades. A small number (one or two per squad) of individually carried tac missiles are available.

The weapons platoon consists of 2 mortar squads and 2 tac missile squads. The mortar squads contain two mortars and eight personnel. The missile squads contain one tac missile launcher, one 4 cm Ram auto grenade launcher, and eight personnel. Transportation is provided by the vehicles of the transport platoon.

The transport platoon contains 5 cargo grav sleds, each lightly armored and armed with a VRF gauss gun. Each grav sled has a crew of two, a driver and a gunner.

The camp where the nuclear devices are stored is a collection of prefabricated buildings, surrounded by an electric

*continued on page 15*

# HALT!

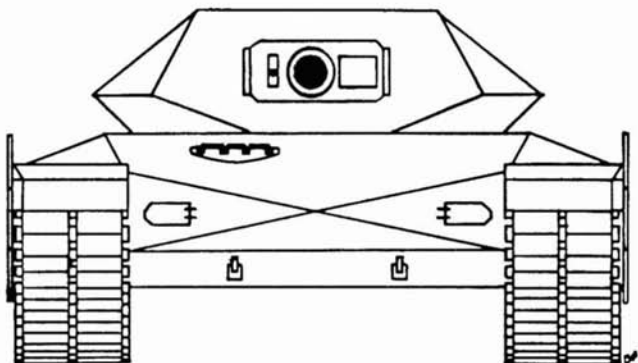

## **YOUR COMMAND AWAITS YOU IN: OPERATION: SKYBOLT**

**OPERATION: SKYBOLT**, Computer War Game Corporation's NEW Play-by-Mail (PBM) wargame, portrays one of the major battles of a great civil war occurring on the homeworld of an alien solar system. The invading lunar colonists and defending off-worlders, using conventional weapons and forces remarkably similar to those of modern day earth, attempt to wrest or maintain control of one of the few habitable regions untouched by the nuclear devastation caused by a recent World war.

### **FEATURING:**

- A Chain of Command: The Army/Corps Commander directing the movements, support, and supply for the powerful Divisions under his command. The 9 Division Commanders control the actual cutting edge of this awesome force; the deadly armor and infantry battalions.
- New Computer generated maps each turn showing current locations of all known units, the roads, rivers, railroads, cities, airfields, and terrain.
- Complete casualty and status reports each turn for all your units.
- No codes and few abbreviations to decipher.
- We handle all the math and record keeping so that you can concentrate on strategy and tactics as you fight your way to victory.

Games will start in December and for the months of October and November ONLY we are offering FREE setup to new players. Turns are \$4.00 for Division Commanders and \$5.00 for Army/Corps Commanders. Turns are every 21 days. Rules are \$1.00. We guarantee your money back if you don't like the game after the first turn.

To join a game, just send a check or money order for \$10.00 to: *Computer War Games Corp., Dept J1, 93 Hill Street, San Francisco, CA, 94110.*

# The Bestiary



## Ragfish

(*Trineroposopon enteronophagus*)

Sometimes known as the bletch, this handsome piscine creature is native to several freshwater bodies on Onicrom. Most humans find them unusually, disgustingly ugly in appearance and repulsive in their habits. Though quite rare, they have become popular as novelties with wealthy aquarists, and have been known to sell for as much as Cr15,000.

They are also known for their lethal poison, which is injected into their prey through a telescoping hollow anterior spine. In their natural habitat, small fish are attracted to feed on ragged strips of mucus-covered skin which float from the ragfish's body (and from which the name is derived). These small fish attract larger animals, which fall prey to the creature's poison spine. While the prey is still dying, the ragfish disgorges a number of intestinal tubes with sucker heads, which attach to the prey, secrete digestive juices, and inject liquid and semi-liquid tissue.

Besides being much sought-after by fish collectors, they have been used occasionally as assassin's weapons.

The fish will attempt to inject anything that disturbs it. Crime boss

Joseph "Slimey Joe" Siskovitch was found dead in a Regina hotel penthouse in 1106, victim of a ragfish hidden beneath the bubbles of his whirlpool bath. Ragfish can survive for long periods under adverse conditions, even in chlorinated swimming pools and the like. The animal's mantle will keep it moist and alive for as much as eight hours out of water.

The ragfish averages 40 cm in length and masses about .5 kg. The anterior spine, which is less than 10 cm long when collapsed, snaps out to 25 cm when triggered by nearby motion or physical contact. The venom inflicts 4D of damage immediately. A human stung by a ragfish and not killed outright will take 12 endurance-weeks (i.e. a character with an endurance of 6 would take two weeks, one with an endurance of 12 would take one week, etc) to recover completely.

Antivenom is not commonly available because of the animal's rarity, but a single dose can be prepared from the body of a ragfish (or, more properly, from the poison glands, but in any case, the fish must be killed) by a hospital or medical research lab on any world of

tech level 5 or higher. Use of the antivenom will shorten the victim's recovery time by half. Any collector wealthy enough to afford to keep ragfish will undoubtedly keep a frozen supply of the antivenom on hand.

Ragfish are most commonly found in pet stores catering to wealthy or exotic pet-owning clients. They are occasionally encountered as special cargo on board freighters or starliners, sealed in transport aquaria. They are easy to care for, and eat anything longer than 2 cm as long as it is alive. They will not eat dead meat.

Little is known of the ragfish's reproductive habits or life-cycle. It is known that they are egg-layers and bisexual, but paired ragfish in captivity kill one another more often than not, and breeding is difficult. Commercial pet houses increase their stocks by artificial insemination, but this is difficult (and dangerous) which accounts, in part, for the animal's high cost.



## Bloodvark

(*Megalorhinos osmichnilatis claudii*)

Bloodvarks — also called walking noses and Hoovers, for reasons unknown, are four-limbed mammal-like creatures native to Lantoli. They have been introduced as trade items to worlds throughout the Imperium; they are often purchased by the law enforcement agencies of planets of tech level 5 through 9.

These strong, hairy animals mass between 50 and 70 kg when full grown, stand .8 meter high at the shoulder and average 2.3 meters long, including the bushy tail. They are omnivores, preferring small, burrowing animals or hive insects, which they dig up with their foreclaws, but can subsist on berries and sweet grasses. This adaptability has let them adjust to and thrive on a number of planets and a variety of climates.

Bloodvarks are best known for their uncanny sense of smell. Once put on the trail of a fugitive or animal prey (by letting them smell an article of clothing or recently-handled item, for instance), they will follow it relentlessly and without stopping for days at a time. They can follow trails a week old in good weather, though they will lose a trail after about 4 hours of steady hard rain or snow. They have been known to follow fresh trails — less than 6 hours old — across streams or along the ground UNDER the branches used by an escaping prisoner, probably picking up traces of scent still hanging in the air. They do not tire easily; they are worked on leashes day and night by handlers working in relays. The animals used by local police forces are trained for their tasks, usually by the agency which raises them, a process which takes 3 months.

Bloodvarks have extremely poor eyesight, and

only fair hearing. Normally gentle, they attack if wounded, cornered or provoked, with powerful swipes of their long claws.

Their usefulness as trackers makes them valuable trade items. Trained bloodvarks can fetch as much as Cr800 on the world where they are purchased; untrained animals bring about Cr100 each. Their size and single-mindedness makes them unattractive as pets, but because of their intelligence and fierce

loyalty, human handlers frequently become quite attached to their charges.

Bloodvarks are oviparous and bisexual. The female digs a den in soft earth under a fallen tree or a large boulder, buries two or three 15 cm eggs under loosely packed soil, and lays over them until they hatch. The young dig themselves out and cling to the mother's abdominal hair, where they hang and nurse for about 5 months.

— William H. Keith, jr

---

*continued from page 4*

*Publisher:* FASA, PO Box 6930, Chicago, IL 60680.

### *Uraqyad'n of the Seven Pillars*

An adventure set in the Cabala sub-sector, chronicling the actions of a group of adventurers stranded on Skela, a low tech level world in the grips of a ruthless dictatorship. The players rapidly become involved in the local guerilla movement as their only way off planet. Approved for use with **Traveller**.

One 5½ x 8½" 46 page booklet, and a 8½ x 17" map. \$6.00.

*Design:* William and Andrew Keith

*Publisher:* FASA, PO Box 6930, Chicago, IL 60680.

### *The Legend of the Sky Raiders*

On Mirayn in the Jungleblut sub-sector, the adventures help an archeologist's daughter search for artifacts which will vindicate her father's theories. The rumors of fantastic treasures are an additional spur. Approved for use with **Traveller**.

One 5½ x 8½" 48 page booklet and one 8½ x 17" map. \$6.00.

*Design:* Andrew and William Keith

*Publisher:* FASA, PO Box 6930, Chicago, IL 60680.

### *Adventure Class Ships, volume I*

Deck plans and descriptions for ten

ships in the 100 to 800 ton range, drawn to 15mm scale. Several Imperial and Zhodani vessels are included, as well as a private yacht, a 500 ton merchant vessel, and a commerce raider. Both the booklet cover and the plans contain illustrations by William H. Keith. Approved for use with **Traveller**.

Five 17 x 22" maps, printed on both sides, and a 16 page booklet, packaged in a protective cardboard sleeve. \$9.00.

*Design:* Jordan Weisman, Craig Johnson, Scott Walschlager, Ross Babcock.

*Publisher:* FASA, PO Box 6930, Chicago, IL 60680.

### **Magazines:**

#### *The Space Gamer*

Issue number 46, the latest to hand, is another special **Traveller** issue, by popular demand. As a special feature, there is a complete folio adventure by the prolific Keith brothers (approved for use with **Traveller**), an article on terrorists, and page after page of reviews of **Traveller** material, including *Library Data*, *Marooned/Marooned Alone*, *Trillion Credit Squadron*, and others, as well as a detailed look at *Fifth Frontier War*. A must for **Traveller** fans.

Single issues are \$2.50, subscriptions are \$21 for one year, \$39 for two.

*Publisher:* The Space Gamer, PO Box 18805, Austin, TX 78760.

# CONTACT! Newts



Also known as Bwaps or Wabs, (from their name for themselves, *Bawapakerwa-a-a-awapawab*), the newts originated on Marhaban, in the Lentuli subsector.

## GENERAL

Newts average 1.4 meters in height and weigh between 30 and 50 kilograms. They are upright, bipedal, homeothermic and bi-sexual. The skeleton is internal, and their circulatory system is closed. Their hemoglobin is copper-

based, and a deep blue in color. Because of this, their skin shows as a faint greenish-blue in areas where pigmentation is absent. Body markings vary tremendously from clan ("tree") to clan, each one having a distinctive pattern. The pattern is determined by genetic factors and the color determined by careful manipulation of the mother's diet during the formation of the egg. Greens, browns, yellows and blues are most common, usually in patterns of

darker colors over a lighter basic color.

Because their skin must be kept constantly moist, Newts are uncomfortable in humidity of less than 98%. With special clothing, they can exist indefinitely in humidities as low as 25%, provided they have adequate water. This clothing normally consists of a loosely fitting kaftan-like garment and a hood covering the head (giving rise to another nickname, "towel-heads"). The cloth of these garments is permeated with a network of fine tubes, through which water flows and keeps the cloth moist. In occupations where they must handle papers, or other items which would suffer from moisture, Newts wear thin water-proof gloves. In humidities of less than 25%, they must use sealed environment suits. All clothing is colored with a stylized representation of their body coloring, since recognition of body pattern is an important part of their greeting ritual.

Newts are oviparous, each female incubating a single, non-amniotic egg in a special pouch on her lower abdomen. After hatching, the young remain in this pouch for several weeks, occasionally coming out to be fed, until they are strong enough to survive outside. The young reach maturity after 14 years.

## HISTORY

Before attaining civilization, the newts lived in densely wooded, mangrove like swamps, burrowing under and among the root-systems of large trees to form dens for the communal protection of their young. Their culture and ritual interactions began at this time.

A shift in weather patterns on Marhaban caused the marshy areas which formed their home to shrink, forcing them into increased competition with other animals in the region. The discovery of tools, and agriculture permitted the Newts to gain a tremendous advan-

tage over their competition, and put them on the road to civilization. Although the Newts discovered tool use and agriculture early, they did not discover fire until late in their development, because of their environment.

For this reason, the Newts have always lagged behind in metal-working and similar pursuits. When discovered by the Vilani, their tech level had reached tech level 7, and seemed to have stabilized there. Their introduction to advanced technologies such as the jump drive had no major effect on their culture, and the newts have prospered greatly in the intervening centuries.

Newts can be found throughout the Imperium, but their numbers are greatest in the region trailing and coreward of capital. Fewer than a dozen worlds are completely controlled by Newts, and most of these are inside the Imperium. Newt merchants and administrators can be found throughout known space, although they are less common outside the Imperium.

## SOCIETY

The Newt world view (which is not really a religion, but nevertheless dominates every part of their life), holds that each individual has a place in his *wapawab* or tree — a term stemming from their species' habitat, but including phratry, bloodlines, country, and place of duty. The literal tree is intricately tied into the planetary ecology, sheltering hundreds of species, providing oxygen, converting water and minerals into food, and so on. The figurative tree is much harder to define, but is roughly equivalent to clan or tribal groups in other races. A tree can vary in number from a few individuals to thousands. Both sorts of trees are part of a planet, which is part of a solar system, which is part of a cluster, which is part of a galaxy which is part of the

cosmos. Everything the Newts do reflects this complex, wheels-within-wheels, patterns-within-patterns outlook. Each individual takes great pride in being one small, functional and unique cog in a vast, ever-living, ever-changing universe of interlinked patterns and cogs. Their ritual of greeting, for instance, seems like meaningless formality and windy chit-chat to non-Newts, but reflects a communication of "I am in this place, and doing my part. Where are you and what are you doing?"

From the human point of view, the Newts are obsessed with minutiae, patterns, and the order of things. Driven by this internal desire to see everything in its proper place, the Newts make excellent bureaucrats, officials, mathematicians, bookkeepers, scientists, and historians.

Their obsession with ritual and proper conduct often makes them difficult to deal with. Those who violate the ritual will be lectured on the proprieties of the situation, often at great length. Dealing with Newts takes time, but trying to speed things up only takes more time.

Criminal behavior is extremely rare, and is considered the worst form of mental disorder among the Newts, since it is disruptive of the proper order of things. Their definition of crime, however, can sometimes be at variance with Imperial norms. The elimination of a greatly disruptive influence is considered good, even if it involves the death of an intelligent being to restore the proper order to things. Fortunately, most Newt courts of law consider exile to be sufficient, especially in the case of humans.

## GOVERNMENT

The few worlds which are completely controlled by the Newts are classed as



a religious dictatorship. Law levels are usually very restrictive, representing the Newts obsession with proper behavior.

## REFEREEING NEWTS

As NPCs, Newts can be an interesting and valuable addition to a campaign. Few players will find Newts desirable as player-characters, however.

*Character Generation:* Newts in the Imperium can be generated in the normal manner, with the following exceptions. Strength and endurance are determined with a throw of 2D-4 rather than the normal 2D. Enlistment DMs, in addition to all others which may be applicable are -3 for marines, -1 for the army, +1 for the scouts and other and +2 for the merchants. The first level of admin skill received counts as two (i.e. a newt with admin cannot have admin-1), each subsequent level received counting normally. Newts may not receive gambling, forgery, or street-wise (roll again if one of these skills occurs). Newts receive a -1 DM when attempting to use tools or weapons not specially constructed to fit their hands (likewise, other races receive the same DM when using Newt tools or weapons). Newts receive normal mustering out



benefits (any weapon received is suited to their hands).

Newts may eat human food and live under human life-support without difficulty (except for humidity, as noted above). Newt style tools and weapons may be purchased at normal prices, but must be specified as such at purchase. Availability is up to the referee.

Psionics are rare (DM -3 in addition to all others) but not unknown. Psionic talents are suppressed in Newts, as in the rest of the Imperial population.

*Playing Newts:* Players who wish to be Newts should bear in mind that there are certain activities from which they are prohibited. Newts will not lie (although they may withhold the truth if protocol requires it. Newts will not break the law unless by doing so they can restore the balance of the universe. Newts will not obey orders which are disruptive, in their view. Disorder and disorganization make them nervous and they will have a very difficult time resisting the urge to order and organize their surroundings.

Players who have no experience dealing with Newts have a DM of -3 on the reaction table whenever encountering one. The referee may wish to allow reductions of this DM for knowledge of Newt rituals. Players may gain knowledge of Newt ways by study in a library, or by association with Newts. Referees should make learning the more

**save our  
coupons for  
FREE  
traveller supplements**

**We Sell  
Games**

**Days of Yore** **10-20% off!**  
P.O. Box 814-H  
Doylestown, PA 18901

SEND SASE FOR DETAILS

advanced rituals more tedious, of course. To learn the proper method of greeting may take several weeks, to be able to deal with an official quickly a month or two, to learn the details of trial procedure, or of contract negotiation will take months or years.

*Military:* Newt military forces are usually restricted to the defense of their homeworlds. Newts are occasionally found in mercenary units, but because of the logistical problems involved are usually segregated from other races.

— Loren Wiseman and Bill Keith

---

*continued from page 7*

fied fence and a cleared free-fire zone 300 meters across. The camp contains about 1600 unarmed workers (in addition to the mercenaries and the security troops) who will take cover once shooting starts. Several guard towers line the perimeter and the mercenaries and security forces are on constant patrol out to about twenty km away from the camp. About eight minor camps (each with a security squadron permanently stationed) are positioned between one and six days journey away from the main camp.

The equipment of the security forces and the mercenary company may be changed by the referee according to the size and armament of the players' forces.

— Roger Moore

#### FASA ERRATA

On page 30 of *Uraqqad'n of the Seven Pillars*, the column headings for the *Morale Effects Table* were inadvertently omitted. The columns should be labelled (left to right) 1) *Talaki*, 2) *The Grey Death Legion*, and 3) *N'baqah*.

We apologize to any of our customers who may be inconvenienced by this omission.

## The Atmospheric Re-entry Kit

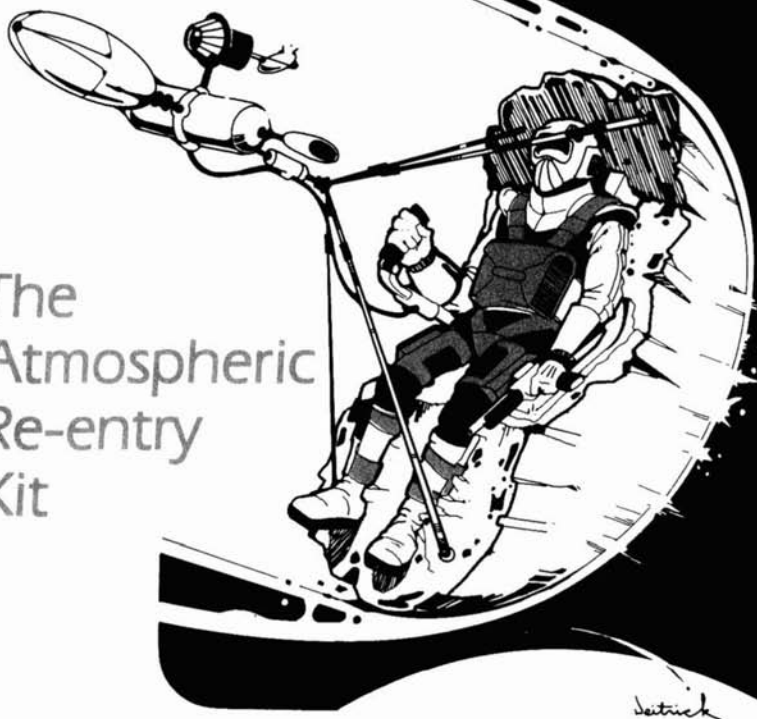

The individual atmospheric re-entry kit is a foamed ablative shield that protects an individual while re-entering an atmosphere, provided that his velocity while re-entering does not exceed 14 km/sec. This kit may only be used to land on planets with atmospheres of type 4+ because the device relies on parachutes for the final stage of the descent. (Note: the de-orbit thruster is capable of landing on size 0 planets regardless of the planet's atmosphere type. This is because the surface gravity is so small that the thruster has no problem achieving a soft-landing.)

The vacc-suited user bails out of his spacecraft, straps on the shield's plastic inflation mold, connects the foam dispenser to the mold's inlet valve if it is not already connected, and inflates the foam shield. It takes about 15 minutes for inflation and for the foam to harden to optimum consistency.

A chemically-fueled rocket thruster is used to control attitude and to provide the thrust necessary to successfully de-orbit. An optical sighting device/computer is used to insure that the attitude of the shield and the transfer orbit produced by the retro-burn are both correct for re-entry. When

the retro-burn has been accomplished, the rocket thruster may be jettisoned if it is empty. The elliptical transfer orbit produced by the retro-burn will take the shield and its occupant 180° around the planet from where the ship was abandoned. The perigee of the transfer orbit will be at the top of the planet's atmosphere at an altitude of approximately 350 km. Atmospheric braking will occur at this point if the shield was de-orbited correctly. If the de-orbit maneuver was not performed correctly, the shield will either burn up as it ploughs at too steep an angle into the planet's atmosphere or will miss the upper reaches of the planet's atmosphere and swing back towards apogee. The shield's occupant may be able to achieve re-entry on a second orbit if he has sufficient fuel remaining in the de-orbit thruster.

Time spent in the transfer orbit prior to ablative re-entry may be calculated according to the following formula: Time in orbit (minutes)=60 minutes/Planet size code x 2D.

The ablative foam of the shield is designed to slough off when exposed to the hot gasses of re-entry. This insures that the occupant is never exposed to the high temperatures of re-entry.

About 10-15 minutes is spent in the ablative portion of re-entry. After the ablative portion of re-entry is finished, the remains of the shield will be falling freely at a high rate of speed.

At an altitude of approximately 35 km, the drogue chute will be deployed. This parachute will reduce the rate of descent so that the main parachute may be deployed without damaging it.

The main chute will deploy at an altitude of about 5 km. This allows the shield's occupant plenty of time to pick a landing spot.

Total time spent in atmospheric descent (from the time that ablative

re-entry is finished to the time the shield touches down on the planet's surface) may be computed by the following formula: Time in descent (minutes)= 30 minutes x Atmosphere modifier. The atmosphere modifiers are as follows: .5 if type 4 or 5 atmosphere (very thin), 1.0 if type 6 or 7 atmosphere (standard), 2.0 if type 8 or 9 atmosphere (dense). Note: If the shield is re-entering a type 10+ atmosphere, the referee must decide which atmospheric density to use: very thin, standard or dense.

The speed of descent after the main chute has deployed may be computed using either of the following: Descent rate (m/sec)= .625 m/sec x planet size code x atmosphere modifier, or Descent rate=5m/sec x surface gravity of planet (Gs) x atmosphere modifier. Atmosphere modifiers are as listed above.

The descent rate computed will be the speed at which the shield and its occupant strike the ground at the end of the parachute descent.

**Survival roll:** Even if the character has sufficient life-support capability in his vacc suit and performs the de-orbit maneuver correctly, there is still a possibility for a fatal accident to occur. Some of the more common accidents are: the orbit may be too high to achieve re-entry from, the foam in the kit may be faulty and burn through on re-entry, the shield might tumble during re-entry, the character might vomit in his helmet and suffocate before he reached the ground, the main parachute might not deploy, etc. Roll 9+ on 2D to survive re-entry and the descent to the planet's surface. Before applying DMs, check the number showing on the dice: a roll of 2 is always fatal, regardless of any positive DMs. DMS: +½ per level of vacc suit or battle dress skill, +1 per level of computer expertise, +1 per navigation or pilot skill, +½ zero-G

# Adventure Class Ships

## Vol. 1

Ten Ships in the 100 to 800 ton range, each drawn in 15mm scale on 22 X 17 inch sheets.

Descriptions of use and interiors, plus *High Guard* statistics are contained in a 16 page booklet also included. . . \$9.00

Also out in the same format is

*Star Port Module Number One : The Hotel Complex.*

FASA P.O. Box 6930 Chicago IL 60680-6930



# fasa



combat skill, +1 if planet is size 1 or 2, -1 if planet has type B (corrosive) atmosphere, -2 if the planet has a type C (insidious) atmosphere.

After adding all DMs together, round up to the nearest whole number. All DMs are cumulative.

**Note:** There is no easier way to kill off a character than to force him to abandon ship and attempt re-entry of a type 3 atmosphere.

**Power pack usage:** Each power pack contains 96 points of power. This point contained in each unit and is used to determine how much energy that each unit contains. For each hour that the power packs are in use, subtract the hourly cost of the device being powered from the point total of the power pack. If the device was in use for less than 1 hour, determine the portion of the hourly cost that was used and subtract that portion from the power pack's point total. The minimum hourly

cost is one point. Points costs of  $\frac{1}{2}$  are not permitted. If in doubt, round up.

There are many re-entry clubs in the Imperium, organized similarly to the parachute clubs that existed on old Terra. Most clubs are part of the Imperium-wide Inter-Sector Re-entry Association. Judges are assigned by the ISRA to preside over the various meets held by the clubs. The type and quality of re-entry kits used by these meets is also regulated by the ISRA.

### KITS AND ASSOCIATED EQUIPMENT

The standard re-entry kit measures 50 x 50 x 125 cm. The carrying case is equipped with several handles. The standard kit contains the following items:

- A carrying case (1.5 kg, Cr30)
- A flexible plastic mold (1 kg, Cr 15)
- A foam dispenser (24 kg filled, Cr100)

A chemically fueled attitude/de-orbit thruster (35 kg, Cr400)  
A sighting device/computer (4 kg, Cr 400)  
A parachute pack (13 kg, Cr300)  
A survival kit (23 kg, Cr400)  
A packet of recovery aids (5 kg, Cr 290)

The military version, occasionally issued to specialist units in place of the more expensive jump capsule, measures 50 x 50 x 80 cm. The main difference between the standard civilian model and the military model is the lack of the big de-orbit thruster, the survival kit and the packet of recovery aids. It is assumed that a soldier using the military kit will carry his own survival and recovery gear.

Usually, the soldier will be dropped from a ship maintaining an orbit which will intersect the top of the planet's atmosphere. The drop point will be as close to the planet as the ship may safely come. Because of this, the thruster is needed only for attitude correction prior to re-entry. The military thruster contains 8 kg of fuel, and is capable of 3,200 kg of thrust. Its two rocket motors will develop a maximum thrust of 10 kg per second. Its sole purpose is to control the attitude of the shield. It is not used to provide enough thrust to de-orbit with; that is the job of the troop ship which inserts the soldier into the proper re-entry trajectory.

The drogue parachute is usually deployed at an altitude of about 10 to 15 km and the main chute is deployed at an altitude of about .2 to 1 km. The foam shield makes fair armor against small arms fire, but is easily destroyed by larger weapons. The main chute is 14 m in diameter.

The first price listed for a re-entry kit is if the kit is purchased as a unit. The price in parentheses is the total price of the kit if each part of the kit is pur-

chased separately. The price given for each individual item is the price of that item if purchased separately. Obviously, buying the re-entry kit as a complete package is cheaper than buying each of its component parts separately.

To purchase a portion of a re-entry kit, use the following procedure: subtract the price of the item(s) you do not wish to purchase from the price of the full kit in parentheses. No discount is allowed on this purchase because you are not buying a standard kit. You will pay the full price of all units purchased.

All items described below are for the standard re-entry kit. The military version contains similar devices.

**Foam Dispenser:** A cannister filled with ablative foam which is used to inflate the mold of the re-entry shield. It takes fifteen minutes to fill the mold, and for the foam to harden to optimum consistency. The inflated foam shield masses 20 kg, is two meters in diameter, one meter deep, and 10 cm thick. The foam shield will float if it lands in water.

The foam of the shield is not capable of withstanding Corrosive or Insidious atmospheres for more than a few hours. It will be completely destroyed at the end of 2 hours.

*20 cm dia x 50 cm 24 kg TL8 CR100*

**De-orbit Thruster:** The de-orbit thruster is an unusual type of rocket device in that it is a tractor design rather than a pusher. This means that it pulls the shield rather than pushing it, a more stable design. Three rocket nozzles are set into the end of the thruster's casing and point backwards toward the shield, angled to disperse their exhaust safely. A heavy tether secures the thruster to the shield, and allows the thruster to run at maximum thrust for prolonged periods of time without the operator becoming fatigued from holding the thruster in position. The tether also

prevents the loss of the thruster in the event of clumsiness or misjudgement.

The unit consists of a cylindrical casing containing a rudimentary control panel, three rocket motors capable of a total maximum thrust of 20 kg per second, and 30 kg of liquid fuel. Each kg of fuel will yield 400 kg of thrust when burned, for a total of 12,000 kg of thrust for the 30 kg in the tank. This works out to a total change in velocity of about 500 m/sec for a character massing 100 kg (fully suited) and the 102.5 kg of the re-entry kit (202.5 kg total). The 30 kg of fuel will yield a 10 minute burn at maximum thrust.  
*45 cm dia x 70 cm 35 kg TL8 Cr300*

**Sighting Device/Computer:** This device is used to determine the thrust and correct attitude needed to achieve re-entry. The unit consists of a sextant-like mechanism connected by a data cord to a pocket-sized computer. The computer contains a number of hard-

wired routines to simplify the calculations needed for re-entry (and consequently can be used for nothing else). The sighting device is used to determine orbit speed and altitude (should these not be known to the shield's user when he bails out). The sighting device contains a number of electronic circuits which simplify computing orbital characteristics and velocity. This allows accurate plots to be more easily recorded, computed, and used.

The sighting device measures 30 cm in diameter, and 1 cm wide. The computer measures 15 x 8 x 3 cm. They are connected by a data cord 40 cm in length.

Having computer, pilot, or navigation skills count as positive DMs in the survival roll. It is assumed that a character with these skills will find it easier to manage the sighting device/computer than would a character without them.  
*4 kg TL8 Cr400*



## ORIGINS '82

JULY 23-24-25, 1982

The National Adventure Gaming Show is returning to its birthplace in Baltimore, MD bigger and grander than ever before. ORIGINS '82 promises to be the biggest extravaganza yet staged in the burgeoning Adventure Gaming hobby. Never before have so many Adventure Gaming manufacturers exhibited their wares in one show. Consumers will be treated to the largest exhibition ever of sophisticated gaming materials; role playing, wargames, sports games, miniatures, computer games and much more will all be on exhibition with many companies unveiling brand new products for the first time.

ORIGINS '82 will also feature hundreds of events ranging from big money tournaments, to free demonstrations and seminars by hobby personalities; all in the most comfortable and impressive sight yet chosen for ORIGINS.

For pre-registration information, send a stamped, self-addressed envelope to: ORIGINS '82, P. O. Box 15405, Baltimore, MD 21220.

**Parachute Pack:** This consists of three separate parachutes, the pilot chute, the drogue chute, and the main chute.

The pilot chute is a small parachute which pulls the drogue chute out into the airstream. Once this occurs, the pilot chute is jettisoned.

The drogue chute is a small parachute which is used to stabilize and decelerate the shield so that the main chute may be deployed without destroying it. The drogue chute is equipped with ring-slots to allow it to endure greater stress than a non-slotted chute. Once the main chute is deployed, the drogue chute is jettisoned. The drogue chute is approximately 3 m in diameter x 1.5 m tall.

The main chute serves to lower the shield and its occupant safely to the surface of the planet. The chute is equipped with a 'sleeve' to reduce the jerk experienced initially upon opening. The material of the parachute is relatively water-proof, and may be used as a tent, or cut up for use as bandages, clothing, etc.

The canopy is 12 m in diameter x 5 m tall with a .5 m vent at its apex and has a total area of 295 square meters. It is equipped with thirty-six 19.8 meter-long shrouds, each consisting of a 12 meter long suspension line connecting the foam shield to the skirt of the parachute and a 7.8 meter long support line which is sewn to the canopy. A total of 712 m of .5 cm diameter braided cord is available from these parachute shrouds.

The main chute is somewhat steerable. It may be maneuvered about 1 meter in any direction (except up) for every 50 meters it descends (this is a glide rate of 50:1).

Each chute is colored orange and white in alternating stripes and is highly visible in all types of terrain. The

material of the chutes is not capable of withstanding corrosive or insidious atmospheres for more than a few hours. It will begin to degrade within one hour after re-entry in these atmospheres, and will be completely destroyed at the end of eight hours.

13 kg TL7 Cr300

**Radar Altimeter:** A device which is used to deploy the various parachutes at the proper altitudes. The altimeter consumes power at a rate of 8 points per hour.

5 x 10 x 20 cm TL9Cr200

**Survival kit:** This kit can be one of the player's or the referee's invention, or the one mentioned in *Marooned/Marooned Alone*.

**Recovery Aids Package:** This contains the following items.

**ADS Radio Beacon:** A 500 km range Auto-Distress Signal radio beacon and signal transponder. This device has no capability for transmission of voice communications. The beacon consumes power at a rate of 2 points per hour. It measures 5 cm in diameter x 15 cm long and masses 1.5 kg.

**Flares:** Signaling devices which emit colored smoke and a bright light for 15 minutes. There are 6 flares per kit, each flare measures 2.5 cm in diameter x 20 cm long and masses .3 kg.

**Dye Markers:** Devices which emit a brightly colored dye when dropped into water, facilitating detection by searchers. There are 6 markers per kit, each marker measures 4 cm in diameter x 10 cm long and masses .2 kg.

— John W. Colbert



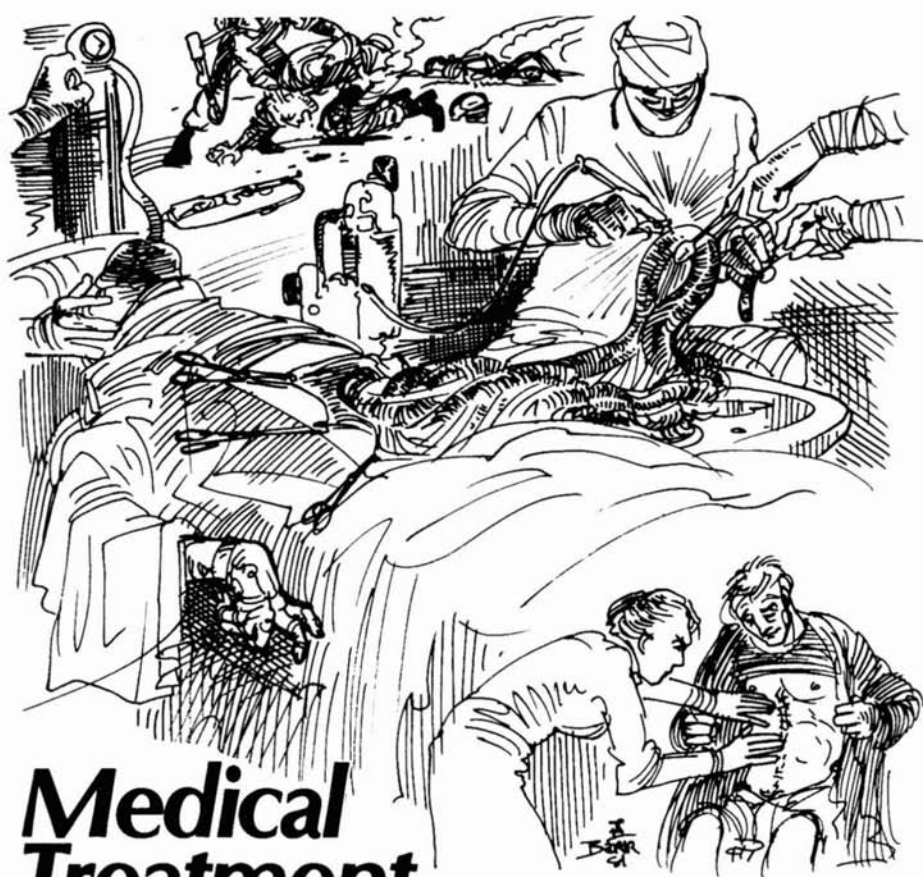

# Medical Treatment For TRAVELLER

Adventuring in the universe of the far distant future is a dangerous business. Characters die and wounds are often suffered.

While certain drugs and their effects on wounds have already been described in Book 2, and some thought to the effects of wounds on characters has been given in the personal combat system of Book 1, these are relatively simple systems designed for speed of play. Referees and players who wish to have a more sophisticated system of dealing with wounds — one that brings the various levels of Medical skill into use — may use these rules as an alterna-

tive to the wound and healing rules presented in Book 1.

## WOUNDS

Characters are most likely to suffer injury from wounds acquired in combat or from trauma caused by such events as falls. These injuries may consist of gunshot wounds, slash, cut, stab and puncture wounds, multiple fragment wounds, concussion, and burns from fire or energy weapons. In many cases (signalled by the reduction of at least one characteristic to zero) the character will need prompt medical attention to function again, or even to survive.



There are three basic wound or trauma categories — light, moderate, and severe. Light wounds include those that do not reduce any physical characteristic to zero. Moderate wounds are those which reduce one characteristic to zero from shock, resulting in temporary unconsciousness for about ten minutes. Severe wounds are those which reduce two characteristics to zero and possibly effect the remaining physical characteristic, resulting in severe shock, and coma from loss of blood, and injury.

It should be noted here that wounds which do not receive prompt medical attention may become more serious or kill the victim with the passage of time. Because of infection, blood loss, or other progressive deterioration of a patient's condition, light wounds may become moderate wounds. These in turn may become severe wounds, and untreated severe wounds may eventually kill a patient.

#### **ADDITIONAL WOUND EFFECTS**

If a light or moderately wounded character does not receive medical treatment from a medic-1 within 1D x 10 minutes, there is a possibility the character's wound will become more severe. Roll 2D for 7+ for the character's condition to deteriorate an additional 1D wound points. If, on this roll, 12 is rolled exactly, a catastrophic trauma has occurred, and the character dies immediately. This reflects the fact that trauma patients may sometimes seem okay, but suddenly die when a critical blood vessel ruptures or some other hidden damage takes full effect. Repeat the deterioration and additional wound roll once for each hour after the first deterioration roll until the character receives medical care or dies.

If a severely wounded character does not receive first aid within 1D minutes, the wounded character will die. If

first aid is received, but no further medical attention is received within the next hour, the severely wounded character's condition will automatically begin deteriorating at a rate of 1D wound points per hour until major medical treatment is received or the character dies.

#### **MEDICAL TREATMENT**

The treatment of most wounded characters is primarily surgical in nature, supported by drug therapy and nursing care. However, some types of wounds, such as laser and other energy weapon burns can only be healed with drug therapy and rest. The skill levels of medical personnel, the local tech level, and the quality of local medical facilities all have an effect on how well the wounded character recovers from his or her wounds. Even the dexterity of the attending surgeon has a bearing on the success of the treatment. Price is also a consideration.

Therefore, a wealthy character wounded in a robbery attempt near a major medical facility on a tech 15 world will stand a much greater chance of a full recovery than a mercenary private wounded in combat on a tech 5 world with only a field medic in attendance.

In order to fully recover from moderate wounds, a character must be attended by a doctor (medic-3). Severely wounded characters require a surgeon (dexterity 8+ and medic-3+) for treatment. Light wounds can be treated by a medic-2 nurse or medical technician (these wounds are assumed to be superficial, and require only stitching and/or bandaging).

Doctors in surgery must be assisted by at least one surgical technician (medic-2+) and at least one anesthetist.

Surgery is required with all moderate and severe gunshot, fragment, blade,

and puncture wounds. In the case of the former two, slugs and fragments must be removed. In all cases, tissue damage must be repaired. Wounds from energy weapons will often require extensive surgery because their great heat will usually cause a steam explosion from the water in the tissues, and considerable damage to adjacent tissues from radiated heat.

Because recovery from surgery is by no means certain, a wounded character undergoing an operation must throw a surgical survival and recovery roll. The patient must throw 2D for 6+ for a normal recovery. A 2 means death on the table, and a 3, 4, or 5 means an impaired recovery. As outlined on the table below, the tech level of surgical facilities and the surgeon's training affect the outcome, as do the surgeon's medical skill and dexterity level.

Surgery survival roll DMs: +2 if TL14+ world; +1 if TL12+ world; -1 if TL6 world, -2 if TL5 world; -6 if TL5- world; +1 if surgeon's dext 8+; +2 if surgeon's dext 10+; +1 for each medic skill level higher than 3; +1 if anesthetist is medic 3+; +1 if surgical technician is medic 3+.

## HEALING

A wounded character will be restored to full physical capacity if he or she passes the modified surgical survival roll with a roll of 6+ and if he or she receives proper post operative care. This involves spending time recovering from surgery in a hospital and an additional period of reduced activity in convalescence. A character who has suffered moderate wounds can expect to spend 2D days in hospital while a character who was severely wounded must spend 1D x 10 days in hospital. When released from the hospital, the patient's physical characteristics will be halfway between their full value and their wounded value.

Moderately wounded characters may leave the hospital in half the above rolled time provided they remain bed patients in the care of a medic-2 nurse for the balance of their recovery period (this is often done to save money. See below).

After leaving the hospital or completing the initial recovery period, the wounded character will regain his or her physical characteristics (beginning at the half-way level mentioned above) at a rate of one point per week for each of the three characteristics. Lightly wounded characters do not require hospitalization, merely convalescence, and recover at the rate described.

Characters who have an impaired recovery because of a low surgical survival and recovery throw will suffer 2D points of permanent physical damage. These permanent damage points may be distributed in any manner among the three characteristics. However, if any one characteristic is reduced to zero, the character will remain in a permanent coma.

## DEATH

When all three of a character's attributes are reduced to zero, death normally results. Death, however, is not instantaneous, and a character with medical-2+ will be able to preserve the character in suspended animation for later treatment, providing that suitable hospital facilities (tech level 9+) or a low berth or equivalent is available. Fast drug alone will not be enough, as the patient will need extensive life supports during this period. His attributes will remain at zero, and he will be vulnerable to any influence that interferes with his life supports, such as a severe jolt or the depletion of needed supplies.

If the dead character is tended by a surgeon or other specialist (medic-4+), he may be sustained in this condition

indefinitely or until his life supports are threatened. Otherwise, he can only be held in suspended animation for 2-12 months. To have a chance at reanimation, he must be delivered within that time to a hospital on a world with a tech level of 13+. There is a base chance of recovery, which is accomplished on a roll of 11+ with a DM of 1+ for every tech level over 13. If the roll is missed, the character dies. If the roll is made, the character recovers to a comatose state with one point in each physical attribute. Subsequent treatment will restore one point per week on a roll of 2D for 9+ , DM +1 per tech level over 12. The player must decide before each week's roll which attribute is to be restored that week; if the character misses a week's recovery roll, the chosen attribute is reduced permanently by one point. This sort of treatment is not only rare, but expensive (see costs, below). A patient may be restored to life on an advanced planet and then removed to some other location for further recovery provided that a character with medical-4+ is in attendance; if this is done, he may resume limited activity as soon as all of his characteristics have been restored to four or their normal value, whichever is less. This may include performance of ordinary professions such as navigation or admin, but



not to more demanding ones such as pilot or hunting. The referee should impose on a character recovering from near-death the rule that fighting may only be done in self-defense until the patient is nearly or completely recovered.

The above treatment may not be applied in cases where the brain has been destroyed, severely damaged, or severed from the body, or in other cases of major trauma such as a crushed torso, etc. In addition, the referee may designate certain conditions or diseases as incurable if desired.

### COSTS

Unless they are members of a mercenary organization that provides medical care free of charge, or have made other arrangements, such as insurance, adventurers will find that medical care is expensive.

An ordinary visit to a physician costs Cr20, while out-patient treatment of a light wound will cost Cr10 x 2D. A moderately wounded adventurer will pay Cr500 x 1D for surgical treatment, while a severely wounded adventurer will pay 2D x Cr1000 for surgery.

A patient being revived from near death (all three characteristics reduced to zero) costs a minimum of Cr250,000 per day, plus Cr500 per day of recovery time (the referee may add additional charges as he or she sees fit).

Hospital care will cost Cr500 per day during the first 1D-3 days after surgery, and Cr100 per day after that. Moderately wounded characters can hire Medic-2 home care nurses at Cr50 per day.

Physicians in private practice receive 50% of the surgical fee with the balance going to the hospital and to the assistants. Doctors receive all of the office call and minor surgery fees.

— Terry McInnes and Marc Desmond



## Zhodani Military Organization

All material in this article has been gathered from unclassified sources, and is cleared for reading by the general public. Zhodani organizational terms have been translated into their nearest Imperial equivalent (battalion, regiment, etc), except for those referring to psionic units, which have been rendered idiomatically (groupment, detachment, etc).

### COMMANDO GROUPMENT

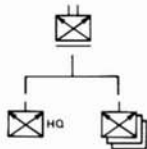

The Zhodani commando forces are considered by some experts to be the most dangerous troops opposing the Imperium in the current war. Even though the 95 groupments (battalion-sized units) known to be in the Spinward Marches represent only 2% of Zhodani combat battalions in the sector, the commandoes cause disruption and morale deterioration greatly out of proportion to their actual numbers.

In Consular Guard formations, one

commando groupment is part of each lift infantry regiment and mechanized infantry regiment of those respective divisions, and of the grav tank regiment of the lift mechanized division. Two jump commando groupments are part of each jump regiment of a jump division, and one jump commando groupment is attached directly to each lift infantry and lift mechanized division. Three groupments (two jump) are attached directly to a Consular Guard corps as part of the corps troops. In the regular army formations, one groupment is attached to each corps.

Unlike other Zhodani units, which have only a small detachment of psionic specialists attached to each battalion headquarters, most of the personnel in a commando groupment (422 out of 531) are psi talents. Of these, 36 are clairvoyant/telepaths and 384 are teleports. The teleport talents are all of psi level 9 or higher. All psi talents in the Zhodani armed forces are issued autoinjectors of psi-double drugs, which increase their abilities.

A commando groupment will seldom make more than two jumps per day, and never more than three. Distances travelled rarely exceed very distant

range (5 to 50 km), because of the disorientation involved, and the effects of energy and momentum differences.

A point of minor interest is the fact that the unit consists largely of officer-equivalents. In the Zhodani military, those with psionic talents cannot hold enlisted rank. The lowest rank held by a psionic talent is that of commissioned specialist, roughly equivalent to the lowest officer grade in the Imperial military. Commissioned specialists are officers by virtue of their special talents, however, and though they hold officer-equivalent rank, they are not in the chain of command and do not give orders (an example in the Imperial military is that of doctor, who holds a commission and officer-equivalent rank, but is not in the chain of command). In addition, some positions require both psi talent and command responsibilities, such as the commander of a groupment. The reason for this is that any Zhodani with psi talent is automatically made a member of the upper classes (the Intendants or the Nobles). Of course, the technicians, drivers, gunners, non-commissioned officers (NCOs) and so on are proles.

It should be noted that not all officers in the Zhodani military have useful psionic talents. Positions noted below in italic type indicate that a special talent or talents are required to fill that position. It is possible for an officer to have talents not required by his position. Equivalent ranks of key officers in the groupment are also indicated.

## ORGANIZATION

A commando groupment is organized into a headquarters & headquarters squadron and three commando squadrons. Jump commando groupments are organized identically, the only difference is that all personnel are jump

trained. The commando groupment contains a total of 531 personnel and 59 vehicles.

## HEADQUARTERS & HEADQUARTERS SQUADRON

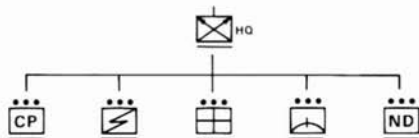

The headquarters contains a command post detachment (platoon) and comms, medical, nuclear damper, and point defense detachments.

The command post detachment contains an intelligence group, a communications group, a computer group, an electronic warfare (EW) group, and a headquarters. The intelligence group contains two *officer/interrogators* (telepaths able to probe) and three other ranks, one of which drives the group's grav sled. The communications group contains one driver, three communications technicians and a laser/maser/radio (LMR) sled. The computer group contains one driver, three computer technicians and a grav sled containing a battle computer. The electronic warfare group contains one driver, one gunner, one vehicle commander, one EW technician and an EW grav sled. The headquarters group contains the *groupment commander* (colonel) and *assistant commander* (lt. colonel), one NCO, two drivers, two gunners, two vehicle commanders and two command grav sleds. The command post detachment contains a total of 26 personnel and 6 vehicles.

The communications detachment contains three drivers, six communications technicians, one officer, one NCO, a meson communicator sled, and an LMR communications sled; a total of 11

personnel and 3 vehicles.

The medical detachment contains four drivers, eight medics, one doctor, three grav ambulances and one surgical van grav sled; a total of 13 personnel and 4 vehicles.

The nuclear damper detachment contains three drivers, two vehicle commanders, two damper technicians, one NCO, two nuclear damper projector sleds and a light utility sled; a total of 8 personnel and 3 vehicles.

The point defense detachment contains four drivers, four gunners, four vehicle commanders, one officer, one NCO, and four point defense grav sleds; a total of 14 personnel and 4 vehicles.

## COMMANDO SQUADRON

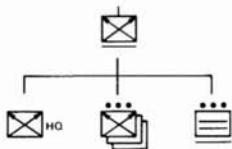

The commando squadron contains the *squadron commander* (lt. colonel), the *squadron vice-commander* (major), both teleports, a transport detachment and three commando detachments.

The transport detachment has thirteen drivers and thirteen 12-passenger grav APCs. These are used for the transport of the unit during non-teleport operations.

Each commando detachment consists of a *detachment commander* (major), a *detachment vice-commander* (captain), both teleports, and four commando groups. Each group contains a *group leader* (captain), an *assistant group leader* (lieutenant), both teleports, a *group director* (lieutenant) a clairvoyant/telepath, and eight *commissioned specialists*, all teleports.

## EQUIPMENT

Zhodani commandos are equipped

to the highest possible standard, because only a limited amount of equipment can be carried in a teleportation. The combatants are all equipped with battle dress and grav belts and armed with PGMP-13s. In jump commando units, all personnel are issued jump capsules when expected action may require them. One member of each group is armed with a FGMP-14 as a support weapon. Individually-carried tac-missiles are issued to combatants according to the demands of the individual tactical situation. Occasionally, a unit may be armed with other weapons (grenades, gauss rifles, and so on), or support units such as artillery may be temporarily attached for special missions. Non-combatants in commando units are equipped with combat armor and armed with gauss rifles. Ram grenade launchers and a variety of individually-carried tac-missiles are issued to the non-combatants of the headquarters squadron for its defense.

## TACTICAL EMPLOYMENT

The principal difficulty of most commando operations lies with inserting the commando force behind the enemy lines in close proximity to its target. Zhodani commandos accomplish this by psionic teleportation, and recruits for commando units are chosen solely on the basis of their talent in this field. Thus, Zhodani commandos do not occupy the role of elite combat troops, unlike most other armies.

In long-range penetration situations, where teleport disorientation is to be expected, commandos jump to previously reconnoitered safe areas (such as small clearings in woods) where they can recover from teleport and then move out against their objective. In short range teleports, commandos are sometimes inserted directly onto the battlefield and open fire almost immed-

ately. In this regard, they are often used in retrograde operations to disrupt an enemy advance, being inserted immediately behind advancing enemy spearheads to ambush follow-up forces or even attack spearhead forces from behind.

Another problem encountered in commando operations is that of recovering the troops after the mission is conducted. Zhodani commandos usually accomplish this by teleportation also.

The best defense against commando raids is to mine or carefully watch every possible assembly point, a task which is nearly impossible, and which draws great numbers of troops away from the forward lines.

### LIFT INFANTRY BN

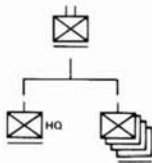

The lift infantry battalion is one of the most common ground formations of the Zhodani military. These units comprise 32% of the Zhodani combat battalions known to be in the Spinward Marches. In Consular Guard formations, two lift infantry battalions are found in the lift infantry regiments and lift mechanized regiments of those respective divisions. One lift infantry battalion is assigned to the tank regiment of the Guard lift mechanized division. In the regular army formations, there are three lift infantry battalions in the lift infantry regiments of a lift infantry division, two in the lift mechanized regiments of a lift mechanized division and lift cavalry division, two in the grav tank regiment of a grav tank division, and one in the grav tank regiment of a lift cavalry division.

### ORGANIZATION

The lift infantry battalion is organized along fairly standard lines. Each consists of a headquarters company and four rifle companies, for a total of 799 personnel and 127 vehicles. The same organization is used in both lift infantry and lift mechanized regiments (the difference between the two is in the number and type of other battalions in the regiment).

### HEADQUARTERS COMPANY

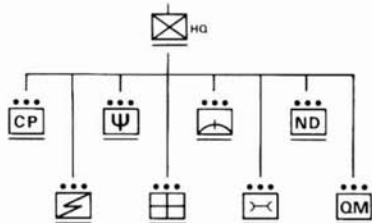

The headquarters company contains a point defense platoon, a nuclear damper section, a maintenance platoon, a quartermaster platoon, a medical platoon, a communications platoon, a psion detachment and a command post platoon, for a total of 167 personnel and 46 vehicles.

The point defense platoon contains four drivers, four gunners, four vehicle commanders, one officer, one NCO, and four point defense grav sleds; a total of 14 personnel and four vehicles.

The nuclear damper section contains three drivers, two vehicle commanders, two damper technicians, one NCO, two nuclear damper projector grav sleds, and a light utility sled; a total of 8 personnel and 3 vehicles.

The maintenance platoon contains six drivers, fifteen mechanics, 3 squad leaders, one officer, one NCO, two repair van grav sleds, two recovery grav sleds, and two utility grav sleds; a total of 26 personnel and 6 vehicles.

The quartermaster platoon contains seven drivers, three squad leaders, one platoon commander, one platoon NCO, one light utility grav sled, and twelve utility grav sleds; a total of 12 personnel and 7 vehicles.

The medical platoon contains four drivers, eight medics, one doctor, three grav ambulances, and one surgical van grav sled for a total of 13 personnel and 4 vehicles.

The communications platoon contains three drivers, six communications technicians, one officer, one NCO, a meson communicator sled, and two LMR communications sleds; a total of 11 personnel and 3 vehicles.

The psion detachment consists of a scout group, a recon group, and an assault group. The scout group contains four drivers, four gunners, four scout grav sleds, four vehicle commanders and four assistant vehicle commanders. Each *vehicle commander* and *assistant commander* are psi talents, with telepathy and/or clairvoyance. Additionally, the recon group contains eighteen *commissioned specialists*, all psi talents, with clairvoyance. The assault group consists of six assault teams. Each team has two *scramblers* and one *director*. Scramblers have telekinetic ability, the director has clairvoyance and telepathy. The command group consists of one officer (major) three drivers, two utility grav sleds and one light utility grav sled.

The command post platoon contains an intelligence section, a communications team, a computer team, an electronic warfare team, and a headquarters group. The intelligence team consists of two *officer/interrogators*, each a telepath, three soldiers (one a driver), and a command sled. The communications team contains one driver, three communications technicians and an LMR communications sled. The computer team contains a driver, three computer

technicians, and a battle computer sled. The electronic warfare team contains one driver, one gunner, one vehicle commander, one EW technician, and one EW sled. The headquarters group contains the battalion commander, the assistant commander, one NCO, two drivers, two gunners, two vehicle commanders, and two command sleds. The command post platoon contains a total of 26 men and 6 vehicles.

## RIFLE COMPANY (LIFT)

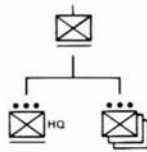

Each rifle company contains a headquarters & weapons platoon and three line platoons.

The headquarters & weapons platoon contains an electronic warfare team, a recovery team, a fire direction center (FDC) team, an indirect fire team, a direct fire team, and a headquarters team. The EW team contains one driver, one gunner, one EW technician, one vehicle commander, and one EW grav sled. The recovery team contains one driver, one gunner, one vehicle commander, one mechanic and one recovery grav sled. The FDC team contains one driver, one team leader, three technicians and one FDC grav sled. The indirect fire team contains one driver, one vehicle commander, one multiple rocket launcher (MRL) technician, and one MRL drop sled. The direct fire team contains one driver, one gunner, one team commander, and one gun sled. The headquarters team contains one driver, one gunner, one vehicle commander, the company commander, the company NCO, one forward observer, one medic and one command sled.

Each line platoon consists of one



headquarters team, one point defense team and three rifle squads. The headquarters team contains one driver, one gunner, one vehicle commander, the platoon commander, the platoon NCO, and one command sled. The point defense team contains one driver, one gunner, one vehicle commander, and one point defense sled. Each rifle squad contains one NCO, one gunner, one vehicle commander, eight infantry and one grav APC. Each rifle company contains 158 personnel and 15 vehicles.

## EQUIPMENT

With the exceptions noted below, all lift infantry battalions in a lift infantry division are equipped with combat armor and armed with gauss rifles and 4cm RAM grenades (shoot-through). Each squad of a rifle company has one PGMP-14 as a support weapon. Individually-carried tac-missiles are issued as the tactical situation may warrant.

Lift infantry battalions in grav tank, mechanized infantry and lift cavalry regiments are equipped with battledress, and armed with PGMP-13s, with FGMP-14s as the squad support weapon. Plans to equip all lift infantry with battle dress were not completed before the onset of the current war, but it is known that one lift infantry battalion per lift infantry division is equipped in this fashion.

The battalion's vehicles are armed and equipped as follows:

**Armored Personnel Carrier (APC):** 36 per battalion, 39 per groupment. A twelve-passenger armored grav vehicle armed with a VRF gauss gun and tac-missiles.

**Command Sled:** 19 per battalion, 3 per groupment. An armored grav vehicle equipped as a mobile command post, and armed with a VRF gauss gun.

**Point Defense Sled:** 16 per battalion, 4 per groupment. A lightly armored grav

vehicle armed with a large fusion gun and equipped with target acquisition and counter-battery radar, usually employed to destroy incoming artillery rounds.

**Utility Sled:** 13 per battalion, 0 per groupment. A lightly armored and unarmed utility transport grav vehicle.

**Light Utility Sled:** 3 per battalion, 1 per groupment. A smaller version of the utility sled.

**Nuclear Damper Sled:** 2 per battalion, 2 per groupment. A lightly armored, unarmed grav vehicle equipped with a nuclear damper projector unit. Usually employed to neutralize nuclear weapons on the battlefield, these vehicles must be deployed in pairs.

**Scout Sled:** 4 per battalion, 0 per groupment. A small, lightly armored, high speed grav vehicle usually employed for scouting and reconnaissance purposes. They are usually armed with VRF gauss guns or tac-missiles.

**LMR Communications Sled:** 3 per battalion, 2 per groupment. An unarmored, unarmed grav vehicle containing laser, maser and radio communications equipment. Provision can be made for wire hook-ups if the situation demands.

**Meson Communications Sled:** 1 per battalion, 1 per groupment. As the LMR sled, but containing meson communications equipment instead of the LMR equipment.

**Shop Van Sled:** 2 per battalion, none per groupment. An unarmored, unarmed grav vehicle containing tools and spares for the maintenance and repair of the battalion's vehicles, equipment and weapons.

**Surgical Van Sled:** 1 per battalion, 1 per groupment. An unarmed and unarmored grav vehicle containing a mobile field surgical unit.

**Ambulance:** 3 per battalion, 3 per groupment. A small, unarmed and lightly armored grav vehicle equipped with

emergency medical equipment. Ambulances normally carry one driver, two medics, and four stretcher-borne or six ambulatory wounded.

**Recovery Sled:** 6 per battalion, 0 per groupment. A large, lightly armored grav vehicle armed with a VRF gauss gun. These are equipped with a large crane and tools and repair parts for repair of lightly damaged vehicles in the field. This vehicle is capable of picking up any severely damaged vehicle in the battalion, and transporting it to a rear area for repair.

**Electronic Warfare Sled:** 5 per battalion, 1 per groupment. A lightly armored grav vehicle armed with a VRF gauss gun and equipped with jammers, message security devices and other electronic-countermeasure equipment.

**Computer Sled:** 1 per battalion, 1 per groupment. An unarmored and unarmed grav vehicle equipped with a battle computer and other intelligence gathering and processing equipment.

**Fire Direction Center Sled:** 4 per battalion, 0 per groupment. A lightly armored and unarmed grav vehicle equipped for receiving corrections from forward observers and transmitting them to the appropriate artillery unit. This vehicle must also keep track of the locations and condition of the unit's artillery.

**MRL Drop Sled:** 4 per battalion, 0 per groupment. A lightly armored grav vehicle armed with a VRF gauss gun, and equipped to emplace and remove remote multiple rocket launchers (MRLs).

**Gun Sled:** 4 per battalion, 0 per groupment. An armored grav vehi-

cle armed with a heavy, direct fire fusion gun for close support of attacking infantry.

## TACTICAL EMPLOYMENT

Zhodani doctrine for the employment of lift infantry is almost identical to Imperial doctrine, and only the use of the psion detachment will be dealt with here.

The scramblers of the assault teams are most often used in conjunction with attacks on enemy fortified positions which, for one reason or another, cannot be neutralized by firepower. Immediately prior to the infantry assault on the position, scramblers will disrupt the defense by telekinetically pulling pins on grenades, squeezing triggers on defender's weapons, activating safetys, etc. Troops experienced in combat with Zhodani troops are accustomed to such tactics, and take steps to minimize the effects. Fortified positions are generally provided with grenade sumps and troops are careful to either keep weapons pointed out embrasures or unloaded. Nevertheless, the actual scambler assault will clearly mark the position to non-psionic assault troops and suppress the defender's ability to fire for several seconds. Properly exploited, this is often a critical advantage for the attackers.

— Frank Chadwick & Loren Wiseman

305  
961-5660

THE  
COMPLEAT  
STRATEGIST

305  
961-5660

*Fantasy Game Center  
Wargame Headquarters  
for Southeast Florida*

TUES-SAT. 11:00 A.M. TO 7:00 P.M. THURS-TILL 9:00 PM  
5406-S STIRLING ROAD DAVIE, FLORIDA 33314

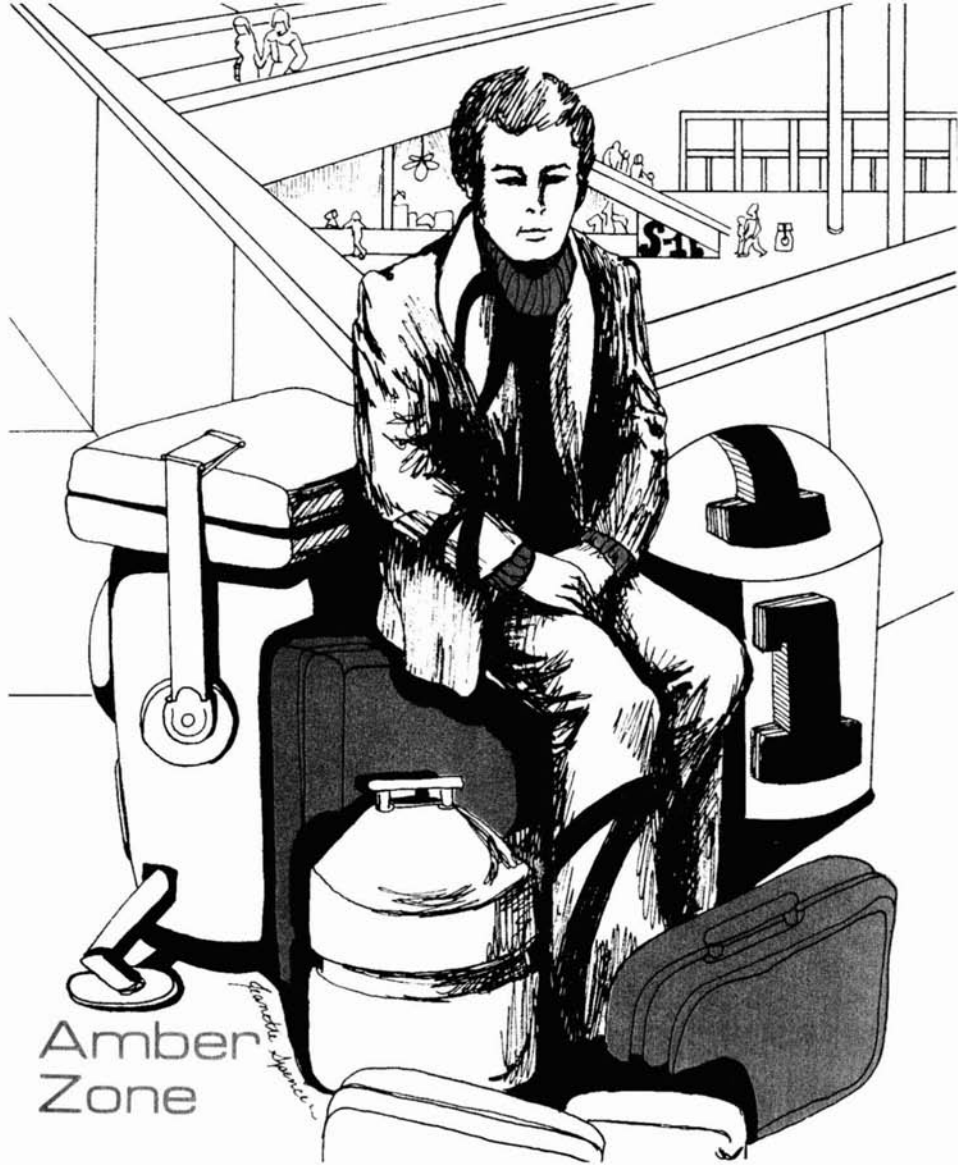

## Amber Zone

### Players' Information:

While searching for gainful employment on Fornice (A-354A87-6), the players' group is approached by a representative of an association of local merchants. Your band, she says, has been recommended to her as trustworthy, and she has a job offer.

A K'kree trade delegation has entered into negotiations with a number of worlds in the Spinward for carrier and distribution contracts for K'kree products in the Spinward. The Fornice Merchant's Association has entered a bid, but is in competition with several other similar organizations on other worlds. The chief of the K'kree delega-

tion in the Spinward is currently on Fornice, and is enjoying the hospitality of the local merchants while he evaluates the potential contract.

The Fornice merchants have learned that the head of the K'kree delegation is a connoisseur of the K'kree multimedia art forms. The Fornice merchants had gone to great expense to obtain a piece by an artist familiar with the K'kree tastes in art, titled Gak'knak (which the artist translates as Whispers of Summer). It arrived several weeks ago, and was placed in a warehouse, cases unopened.

Unfortunately, Gak'knak was stolen yesterday, three days before it was to be presented to the K'kree delegation.

The Fornice Merchant's Association was able to determine that the art has been stolen by the Andros organization, a little known criminal group with chapters on several worlds in the subsector. The association suspects that Andros plans to deliver the art to the merchants of Mora (who are also in competition for the contract), which plan to present the art as their own gift.

The Fornice Merchants Association will pay Cr750,000 for the recovery of Gak'knak undamaged, with an additional bonus of Cr250,000 if it can be recovered within 24 hours.

#### Referee's Information:

Gnak'kak consists of a series of holographic projectors, which create a three-dimensional image of native K'kree plants waving in the wind, a sound projector which produces about fifteen minutes worth of (to human ears) dis-

cordant cacaphony, and a large number of waxy crescents. These crescents are the main part of the art, all the rest being roughly equivalent to the frame of a painting or the pedestal of a sculpture. To appreciate Gnak'kak, a K'kree sets up the other parts of it, and places one of the crescents in the palm of his hand, seating it against the thumb and curling the fingers gently around it. The crescents are made of a mixture of waxes which melt at slightly different temperatures. As the K'kree's hand warms the wax, each different type melts in turn, releasing a series of odors, which, to the K'kree, are the most important part of any artwork. The crescents are stored in a small case, which is insulated from the effects of extreme temperature.

The cases and bags holding Gnak'kak are currently inside Fornice starport, where they await transfer to the agent of Mora, and loading aboard a merchant vessel, for smuggling off-planet.

The players can locate Gnak'kak in several ways, the best of which is to attempt to find and question members of the Andros organization. DMs for streetwise and bribery will be useful to the players in this endeavor.

Naturally, once the players find the art, they must still overpower the guards without damaging it, and see to its delivery to the Fornice merchants.

— Loren Wiseman

685-3880

THE  
COMPLEAT  
STRATEGIST

685-3881

*War Game Headquarters  
for Greater New York*

*10:30 A.M. TO 6 P.M. DAILY 11 EAST 33rd STREET  
OPEN TIL 9:00 ON THURSDAYS N. Y. C., N. Y. 10016*

*We Pay Shipping On All Mail Orders - Sorry No C.O.D.'s*

# New for TRAVELLER

**thieves' world** ROBERT L. ASPRIN'S awaits you. Based on the immensely popular anthologies **THIEVES' WORLD** and **TALES FROM THE VULGAR UNICORN**, this adventure pack opens up a new world for exploration. Marc Miller provided the statistics for all of the major characters from the stories, developed a world designation and subsector location, and even derived a magic system for Traveller players. The pack includes two 16-page Players' Guides, a 64-page Gamemasters' Guide, and a 64-page Personalities book, plus three maps of the city of Sanctuary. All this boxed for \$15.95.



## Chaosium Inc.

BOX 6302-JT, Albany, CA 94706. Add \$1 for postage when ordering. Catalogue available free upon request.

# HIGH PASSAGE

Issue Three Includes :

Featured Adventure :	The Edge
Starship Files :	The Armored Merchant
Special Feature :	Marc Miller Interview, Part Two
The Port Authority Handbook :	Arrival In System

And much, much more !!!!!

Issue One – Sold Out ! Issue Two – Limited Quantities Left.

Available at stores or direct from FASA, \$4.50

FASA P.O. Box 6930 Chicago IL 60680-6930

MilConSimuSystems  
PO Box 1139  
Smithfield, North Carolina, 27577

## SPECIAL OPENING SALE PRICES

	<i>Retail:</i>	<i>Sale:</i>
Deluxe Traveller	\$19.98	
Mercenary, Book 4	\$5.98	
High Guard, Book 5	\$5.98	
	\$31.94	\$25.98
Fifth Frontier War	\$14.98	\$12.98
Azhanti High Lighting	\$21.98	\$17.98
Universe (Boxed) (SPI)	\$20.00	\$17.98
Sword & the Stars (SPI)	\$12.00	\$9.98

### WRITE FOR OUR COMPLETE LISTING OF GAMES

Dealer Inquiries welcome Phone (919) 934-5958

N. C. Residents Add 4% Sales Tax

Long before role-playing games were even thought of, weird and exotic creatures were a major part of many science fiction stories. Some were intelligent aliens, many were almost identical to humans, the best were unusual (to say the least) by human

standards, but all could be placed in one of two simple categories: those that were believable and those that weren't. Believability has nothing to do with size, shape, color, or number of legs/arms/tentacles/eyes/scales or whatever. Believability is based on only two points: 1) does the creature fit into its environment? and 2) do the creature's behavior and motivations make sense in that environment? We often lose track of these precepts for believability in role-playing games. All too often, our horrible beasts will leap for no apparent reason on unsuspecting adventurers, there to rend, maul, and otherwise inconvenience everyone in sight. Perhaps we have been corrupted by fantasy games, where beasts of every description can live in a totally unsuitable environment, living as wayfarer (who must be few and far between), with no way of justifying their continued survival except through some form of "magic."

of two simple categories: those that were believable and those that weren't.

Believability has nothing to do with size, shape, color, or number of legs/arms/tentacles/eyes/scales or whatever. Believability is based on only two points: 1) does the creature fit into its environment? and 2) do the creature's behavior and motivations make sense in that environment?

We often lose track of these precepts for believability in role-playing games. All too often, our horrible beasts will

leap for no apparent reason on unsuspecting adventurers, there to rend, maul, and otherwise inconvenience everyone in sight. Perhaps we have been corrupted by fantasy games, where beasts of every description can live in a totally unsuitable environment, living as wayfarer (who must be few and far between), with no way of justifying their continued survival except through some form of "magic."

But science fiction, or at least the kind of SF elevated to prominence by the likes of Anderson, Niven, and Clement requires more than an airy and oversimplified dismissal of reality. We must learn to put our creations in the proper perspective, make them fit reasonable biological and ecological laws, in order to make our **Traveller**

# A Referee's Guide to Planet-Building

PART II

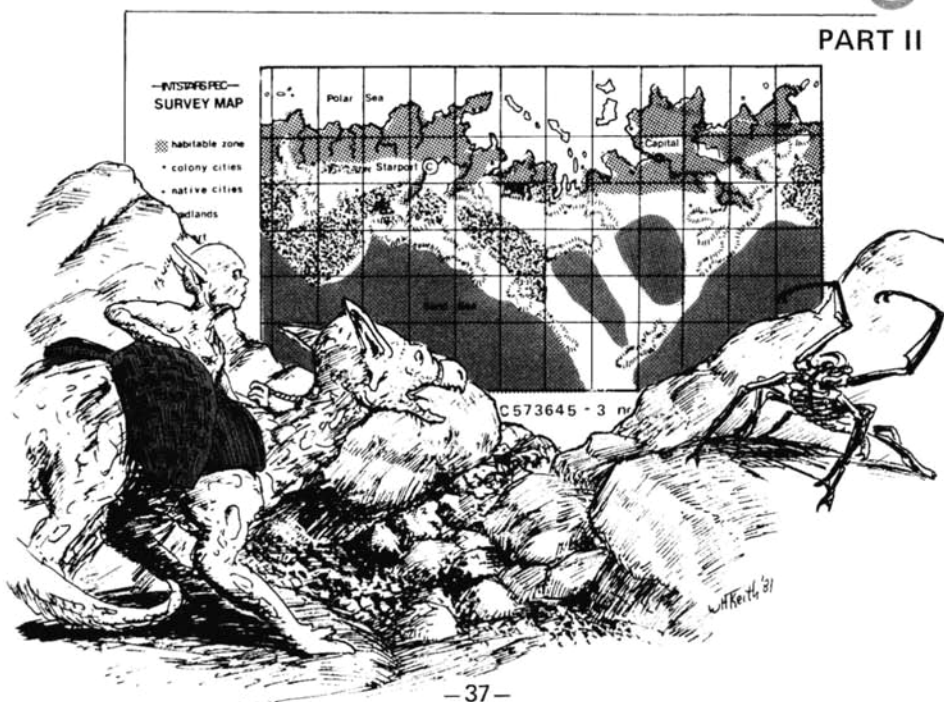

adventure something more sophisticated than a Captain Video space opera.

Let's return to *Craw*, that lovely vacation spot in the Glisten Subsector of the Spinward Marches, for a look at how alien beasties can be made to fit a given environment. *Craw*, as you may remember, is a medium sized world with a roughly earthlike gravity and a standard density, oxygen poor atmosphere. The planet is hot and arid, with a narrow habitable zone circling a small polar sea; beyond that zone lies a variety of unpleasant terrain, including desert, badlands, and other uninviting real estate that humans will find less than accommodating. But life will exist out there; life evolved to fit *Craw's* exacting conditions. To this life, *Craw* will not be inhospitable, will not be barely tolerable, it will be home.

Where do we start in our analysis of life on *Craw*? Animals can be created in accordance with book 3, or drawn from the encounter tables of supplement 3, *Animal Encounters*. But because the creatures created by the **Traveller** system must be able to fit any of the hundreds of worlds adventurers might travel to, the entries we derive from these sources will be strings of numbers and characteristics, much like the planetary statistics we analyzed in previous articles. Once again we are faced with the task of translating raw data into a fleshed-out, well-rounded whole. In order to create a believable beastie, to have it take on a real form instead of a vague and shadowy hinted image, we must examine the creature in terms of the environment and ecology which lies behind and around it. By doing this, we will find our encounters far more interesting than they ever were before.

Now the first life form we analyze won't be from an animal encounter table. We have already postulated a

native, intelligent life form which is used by human settlers as slave labor, or found wandering the outback as nomadic tribesmen. From this dominant species, we can envision many of the basic characteristics of all life on *Craw*, since creatures evolved from the same basic conditions and stock should have at least a few points in common.

We made the natives humanoid during our first brief sketch of them, mostly out of a desire for speed; it is also amusing to picture them as native sepoys, officered by humans, forced to adopt ill-tailored uniforms but basically looking human. Now we can fill in some more facts about them. We will allow the same basic biochemistry as humans, again for speed and simplicity, and also to avoid little incompatibilities such as lack of trace elements or reversed amino acids that would prove deadly to humans trying to live within the native ecosphere. They'll have the same need for air and water as their off-world masters; making them leathery-skinned and rather short to help conserve body water. Tough skin also protects them from desert sun, wind-blown sand, and hot, sharp rocks underfoot. Note that many other adaptations are possible, but these particular features seem to fit our mental image of this particular race rather nicely. In creating for *Traveller*, a feeling for what fits is the referee's most useful tool.

*Craw's* atmosphere is short on oxygen, giving it a "taint" that most off-worlders will find hard to cope with. The natives won't have technological assistance to help them breathe, therefore they must be adapted to this low oxygen content and like it. They will have barrel chests to hold the large lungs necessary to extract oxygen from the atmosphere in the quantities they need. When competing with a human with an adequate oxygen supply, they



will have a lower endurance, though on their own terms, when both a human and a native are breathing the air unassisted, the natives will last longer every time.

Here's another twist: oxygen, to our natives, is a powerful intoxicant. A whiff from an off-worlder's supply will fog their minds and produce a drunken condition; an overdose of oxygen can kill. This is a nice touch of "chrome" that gives these natives some extra character.

Our natives are not strictly nocturnal, as this would make it too hard to fit them in with the settlers, but they no doubt do move and hunt by night when they can, to avoid the heat of the desert outback. They will have large eyes, with two eyelids: one a nictitating membrane to shield out strong light reflected from open desert plains, the other is tougher, more leathery, to keep out particles of sand whipped up by desert storms. Hearing and smell will both be better than a human's. They will be able to sniff out hidden pockets of water, for example. For this reason alone, adventurers in the outback will want a sturdy native guide to help them survive.

Finally, we give our friends short, thick, flexible tails, for balance as they scramble across rocks and cliff faces; and fingers and toes equipped with roughened, knobby tips. They can't climb a sheer vertical wall, but they'll be able to get to places where no player would expect them to reach!

Cultural details have little place here, and so are to be developed as we discussed in our last article. One aspect of the environment, however, which will have an impact on our natives is the absence of wood on Craw. Don't give them wooden buildings, don't arm them with spears or other polearms, give them some other material, such as a long,

flexible weed grown in the habitable zone, which can be woven into clothes, used as a building material, and used to produce slings or bolas, a major weapon for these people. Don't have these natives using tools or other items which don't fit the native ecology.

Now we've pretty well described one life form on Craw. What about others?

We'll use supplement 2, *Animal Encounters*, for our beasts. The planet is a "medium world, standard atmosphere" despite all the peculiarities we've developed. In the clear terrain section, which corresponds to the habitable plains around the sea, entry number six reads: Grazer, 400kg, 21/8, none, 10, teeth, F8 A9 S2

Here's a prime candidate for Craw's main beast of burden. The natives will use it, as will the Tech 3 humans. Even the more advanced off-worlders we find will probably use this sturdy little beast, as it is certainly easier to fuel and replace than expensive, complicated, imported machinery. Don't forget, a backwater like Craw will rarely have a lot of sophisticated gear floating around for anyone to use.

Four hundred kilograms makes this animal smaller than a terran horse, but about the size of a large pony. It has moderate speed, and no armor to speak of. This will probably be a highly developed animal, and fairly closely related to the natives, just as the horse is not all that different, biologically speaking, from a human. Note that we will not attempt to classify our animals as mammalian, reptilian, or whatever. They may have features in common with earth species, but they are not the same!

As a close relative of our native, the beast of burden will have the leathery skin, enormous lungs and chest capacity, and other adaptations we developed for the natives. The feet will be similar

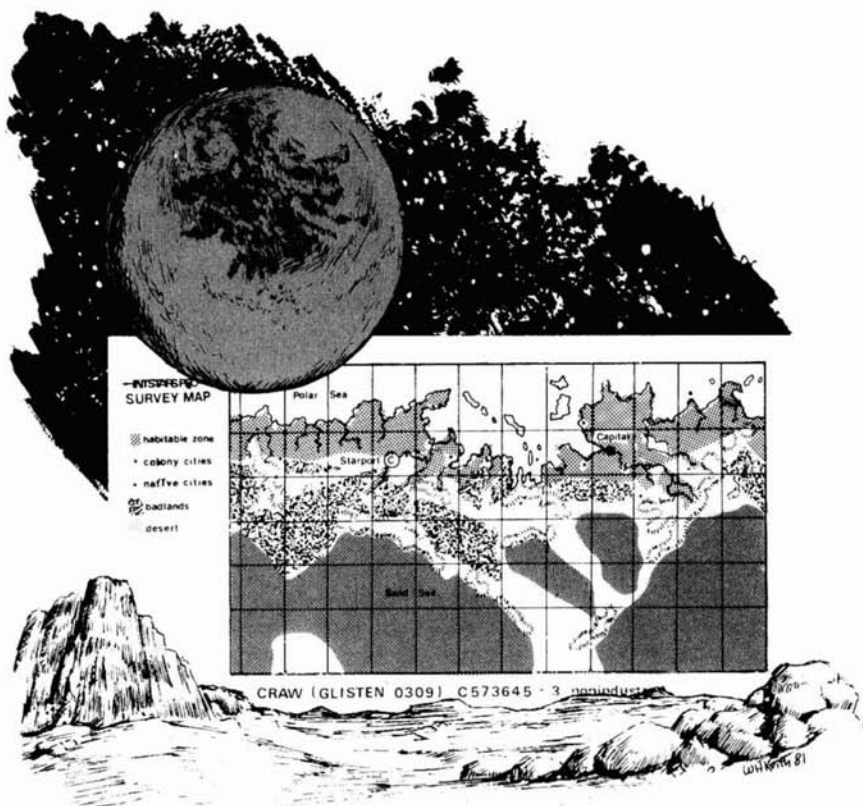

to the knobby, rough-ended digits of the natives, but splayed to carry weight on soft sand. The legs are short in relation to the body. Remember that the beast and native are closely related, which means the number of limbs will stay consistent from one life form to another. Multi-legged creatures (more than four, that is) are fun, but they must fit into the ecology you're creating.

These animals use their teeth in combat, as do terrestrial horses; but we're going to make these creatures omnivorous, an adaptation that will increase their chances of survival in the outback. This also allows us to see a nicely curved and gleaming set of canine teeth protruding from the upper and lower jaws.

There's our first beast, now fully

described for the players. If you're artistically inclined, a quick sketch such as the one we have shown will help immeasurably. Give it a name, and your beastie is ready to play its part in the adventures to come.

How about a predator? Number 3 of the desert encounter table is listed as: Hunter, 6 kg, 6/9, jack-1, 3, as blade, A5 F7 S1.

Six kilograms is the size of a small dog. The creature is rather hard to kill, considering this, and the armor is nearly as effective as jack. It is rather slow, which suggests that it may capture its prey by a stealthy approach and a sudden pounce.

For the rocky wastes of Craw, we've developed this data into a small animal called a rock spider by the human settlers. It is not, of course, a spider, but

it does have a superficial resemblance to the large hunting spiders of earth. This can be a much lower form of life than previous specimens, which means we can give it a long, squat body with ten jointed legs. It, too, has a leathery hide, thickened over its back into a flexible carapace. The hide is colored and textured to blend in among rocks, and we can expect to find it in crevices among loose boulders.

These little hunters won't have the barrel-chested physiology of the higher forms; exaggerated breathing movements would give them away as they sneak up on prey. Nor can we give them spiracles or book lungs, as they are too large. We'll give them instead, breathing organs on either side of the abdomen, protected by the posterior sets of legs and by loose flaps of skin. Forced air circulates freely across a convoluted blood-rich membrane suggestive of the gills of a terrestrial fish. The organs will be sensitive, and hence well-protected. Heat sensitivity will make necessary for the beast to be a nocturnal hunter, keeping to shaded nooks and crannies in the heat of the day.

Its forward set of legs have inner surfaces hardened and shaped into natural weapons very like curved blades. The rock spider attacks its prey by throwing the anterior legs over the victim, slashing down, and drawing it against its sucking beak. When threatened, the creature raises its front legs over its back, and will slash viciously at anything that moves.

Normal prey for the rock spider would be small animals the size of rats or squirrels; it wouldn't normally want to eat people! The specs show us, though, that no one is safe from possible attack; it is a testy animal, more likely to attack than to flee. It is not poisonous, but the slash wounds it inflicts are long deep and prone to

infection. The bite would be an extremely painful puncture wound. Boots or other protection would be useful, of course.

Here, then, we have three typical life forms found on Craw, changed from vague pictures and stats into really well-rounded beasts. But, referring back to our prerequisites on believability, we find we've filled only the first part of the requirements. What about behavior for these, or any other, animals?

Animals — all animals — have reasons behind their actions. Of all life on Earth, only humans will attack irrationally. Other animals may kill for food, territory, defense, or whatever, but they have a reason! This is extended to our exotic beasties too. Before you have something try to devour the adventurers, stop and stop and think: what does it eat when it can't get wayfarers? Are humans really going to be tasty to this predator? What other, possibly more interesting, reason might underlie the thing's actions?

Animal behavior can offer diverting (or deadly) moments of adventure that have nothing to do with between-meal snacks. For example, an encounter with 63 grazers could be a stampede requiring quick thinking on the part of the players. Particular behavior patterns (a tyrannosaurian male defending his harem and young, or a predatory bird defending territory) can be brought into play to give reason to a sudden and unprovoked animal attack. Those Crawan rock spiders, for example, probably pose the greatest threat to people scrambling over rocks, putting feet or hands into hiding places or threatening the beast. Another possibility is for a sleeping adventurer to awaken to find a 13 pound rock spider on his chest, slashers ready; the poor thing was just out hunting, and now finds the ground moving! Animals will threaten or attack

for good reasons, even if those reasons are not immediately visible to the attackees.

We hope you've enjoyed your visit with us to *Craw*, and come away with a better idea of the myriad ways you can round out your adventures through some carefully considered expansions of the basic stats on a planet, or a creature, or whatever. The process takes a little extra time, we admit. One reason why you might want to buy some of the supplements is to help with this time factor; supplements save you the mechanical, time-consuming process of rolling up characteristics, leaving you more time for the more important creative work that goes on in your mind.

At first, it might seem a waste of effort to detail a world that your players will land on, look at, and leave in a few days, but you will find that the more detail a world has, the more player interest it will generate.

So, put your knowledge and creativity to work. Everyone involved will enjoy a "real" world much more than the dry, sketchy work of a hasty referee.

— J. Andrew Keith

(201)  
744-6622

THE  
COMPLEAT  
STRATEGIST

(201)  
744-6622

*Fantasy Game Center  
War Game Headquarters  
for North New Jersey*

TUES.-SAT. 11:00 A.M. TO 7:00 P.M.  
THURS.-OPEN TILL 9:00 P.M.

209 GLENRIDGE AVENUE  
MONTCLAIR, N.J. 07042

**Uraqyad'n of the Seven Pillars . .**

Leading nomad tribes in the fight against a planets Dictator.

**Legend of the Sky Raiders . .**

Mystery, while searching for ancient treasure.

Both from the team that brought you *Ordeal By Eshaar*.  
Both include 11 X 17 maps. \$6.00

FASA P.O. Box 6930 Chicago IL 60680-6930

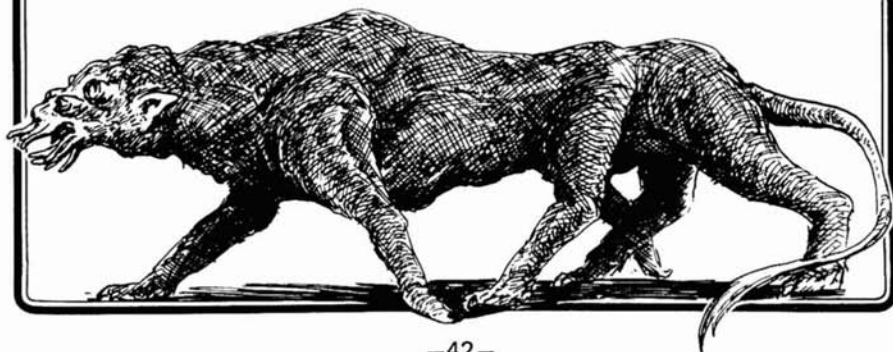

# ARE YOU RICH?



Really wealthy? Rolling in it? Are you SO RICH that you can afford to buy every new game that comes out? If you're that rich, turn the page. Otherwise keep reading.

The game hobby is growing by leaps and bounds. Publishers print more new games every month. Not just games . . . game supplements, game scenarios, computer software, miniatures, rulebooks . . . LOTS OF THEM.

That sounds great. But *how do you choose?* With inflation eating your dollars, you can't afford to waste money on a game you'll play once and forget.

That's where THE SPACE GAMER comes in. We run reviews of every new game and game product in the science fiction and fantasy world. We cover every game publisher fairly, without bias. (We review a lot of historical games, too.)

Are you into computer games? Again — SPACE GAMER to the rescue! We review new game software — all kinds. With tapes costing \$15 to \$20 (and up) you can't afford to waste your money on a dog. Read the reviews before you buy!

Of course, we carry more than reviews. We've got articles on strategy. Variants and scenarios for your favorite games. Letters, cartoons, art. Fiction (and every piece of fiction is followed by a game scenario or variant for that story). We even have complete games in some issues.

If you're NOT a millionaire, your subscription to TSG may be the best game buy you ever make. Don't buy games for the closets. Read the reviews first. Your game budget will go a lot farther.

Name \_\_\_\_\_

Address \_\_\_\_\_ State \_\_\_\_\_ Zip \_\_\_\_\_

Check here if this is a subscription renewal.

Enclosed is my check for

\$21 (one year - 12 issues)

\$39 (two years - 24 issues)

\$2.50 (sample copy)

Canadian subscribers add \$3 per year. Overseas subscribers add \$20 per year (airmail). All payments should be in U.S. funds, please.

**THE SPACE GAMER / Box 18805-D / Austin, TX 78760**

# Archaic Missile Weapons

The weapons listed below are usable with both *Striker* and *Azhanti High Lightning*.

**Sling:** This is the typical David-and-Goliath type, not the Y-shaped stick.

**Short Bow:** A small bow, usually between 50 and 75 cm in length. All three bow types shoot identical arrows.

**Long Bow:** The 1.4 to 1.7 m bow of Robin Hood fame.

**Composite Bow:** A short bow, made of wood laminated between strips of horn or sinew for added power.

**Light Crossbow:** A bow mounted at right angles to a stock, with a mechanism to hold and release the string. Both types of crossbows use shorter projectiles (bolts). Bolts may not be shot from bows. Projectiles are not interchangeable.

**Heavy Crossbow:** A larger, more powerful crossbow.

**Arquebus:** A crude firearm, set off by a glowing match held in the hand.

**Matchlock Musket:** A heavier version of the arquebus, set off by a match in a trigger-operated clamp.

**Wheellock Pistol:** A crude pistol set off by a complex and fragile trigger-operated sparking mechanism.

**Flintlock Smoothbore Pistol:** A pistol set off by an improved sparking mechanism, and with an unrifled barrel.

**Flintlock Musket:** A shoulder fired weapon set off by flintlock.

**Flintlock Rifle and Rifled Pistol:** Identical to the flintlock musket and smoothbore pistol, but with the addition of spiral grooves inside the barrel for increased accuracy.

**Percussion Pistol and Rifle:** Identical to the rifled versions (sometimes multi-shot), but set off by percussion caps.

Archaic Missile Weapons, Table 1

Weapon/tech level:	Shots:	Range		
		Effective(8+):	Long(10+):	Extreme(12+):
Sling/1	1 stone	4 (1)	8 (6)	15 (0)
Short Bow/1	1 arrow	2.5 (1)	5 (0)	30 (0)
Long Bow/1	1 arrow	5 (2)	20 (1)	40 (0)
Composite Bow/1	1 arrow	5 (2)	20 (1)	50 (0)
Light Crossbow/1	1 bolt	5 (2)	10 (1)	30 (0)
Heavy Crossbow/1	1 bolt	5 (3)	10 (2)	40 (0)
Arquebus/2	1 ball	2.5 (2)	8 (2)	25 (0)
WL Pistol/2	1 ball	1 (1)	2 (1)	5 (0)
ML Musket/2	1 ball	5 (3)	10 (2)	30 (0)
FL SB Pistol/3	1 ball	1 (1)	2 (1)	5 (0)
FL Musket/3	1 ball	5 (2)	15 (2)	30 (0)
FL Rifled Pistol/3	1 ball	1 (1)	2 (1)	5 (0)
FL Rifle/3	1 ball	20 (3)	40 (1)	60 (0)
Percussion Pistol/4	6 balls	2 (2)	3 (1)	6 (0)
Percussion Rifle/4	1 ball	20 (3)	40 (1)	80 (0)

**Notes:** Heavy crossbow and matchlock musket may only be fired in enemy fire phase and only if firing soldier is stationary. Same for flintlock rifle. No weapon listed may achieve multiple hits on a stand. All bows and slings have a signature DM of 0, all others have a signature DM of +1.

Archaic Missile Weapons, Table 2

Weapon:	Data			
	Weight (gm):	Price(Cr):	Targets:	Dex. Mods:
Sling	0 (100)	1 (0)	1	6 (-2) 10 (+1)
Short Bow	500 (100)	15 (.1)	1	5 (-2) 10 (+1)†
Long Bow	1000 (300)	30 (.1)	1	7 (-2) 11 (+2)†
Composite Bow	1000 (150)	100 (.1)	1	8 (-2) 11 (+1)†
Light Crossbow	3000 (100)	45 (.1)	1	4 (-2) 9 (+1)†
Heavy Crossbow	9000 (100)	65 (.1)	1	6 (-2) 11 (+1)†
Arquebus	5000 (25)	50 (.5)	1	6 (-2) 11 (+1)
WL Pistol	1500 (20)	300 (.1)	1	6 (-2) 10 (+1)
ML Musket	9000 (30)	100 (.1)	1	6 (-2) 11 (+1)
FL SB Pistol	900 (20)	40 (.1)	1	6 (-2) 10 (+1)
FL Musket	6000 (30)	60 (.1)	1	6 (-2) 10 (+1)
FL Rifled Pistol	1250 (20)	150 (.1)	1	6 (-2) 10 (+1)
FL Rifle	7000 (30)	100 (.1)	1	6 (-2) 10 (+1)
Percussion Pistol	1250 (20)	150 (.1)	1	6 (-2) 10 (+1)
Percussion Rifle	6000 (30)	100 (.1)	1	6 (-2) 10 (+1)

**Notes:** Weight in parenthesis is that of a single unit of ammunition. Cost in parenthesis is that of a single unit of ammunition. Weapons noted with a † have the DM required to both dexterity and strength. Ammunition for slings usually consists of small stones, which can be found almost anywhere and thus have no cost.

Abbreviations: WL=wheellock, ML=matchlock, FL=flintlock, SB=smoothbore.

## BLAZE NEW TRAILS TO ADVENTURE! WITH *Judges Guild*

### 50 STARBASES

A new playing aid for *Traveller* campaigns, this 96 page book provides the essential Starbases necessary to any spacelaring culture. Extensive Tables are provided to detail the facilities of each Starbase as well as the services available to Startravellers in the nearby area. Created and Approved for use with *Traveller* tm. \$5.98

### NAVIGATOR'S STARCHARTS

A new mapping aid for *Traveller* campaigns, this 112 page book provides all the special grids for plotting six complete sectors. Each of the 96 Subsectors has a separate page with a map grid and planetary data blanks. Room for over three thousand stellar systems gives enough elbow room to get any campaign off to a Nova blast start. Created and Approved for use with *Traveller* tm. \$4.98

## *Judges Guild*

R. R. 8 Box 9  
1221 N. Sunnyside Road  
Decatur, IL. 62522  
Ph. (217) 422-1930

WRITE FOR FREE  
96 PAGE CATALOG

# Casual Encounters



## Noble/Heiress

Glorinna Firella

4A6AAF Age 26 2 terms Cr0 to ?

Leader-1, Liason-1, Dagger-1

Until recently, Glorinna was princess and sole heiress to the throne of a planetary government near the edge of the Imperium. The government was more or

less along the lines of a constitutional monarchy with a representational parliament. However, a popular front uprising, possibly inspired by off-planet



interests, deposed her father, the king, and erected a military junta in his stead. Glorinna managed to escape the rebels, but her father was taken and has not been heard of since. He is presumed either dead or imprisoned.

Now an exile, Glorinna is bending all her efforts towards engineering a return to her world and a counter-coup against the rebels. She is also driven to learn the fate of her father, and to rescue him if he is still alive. The particular object of her bitter hatred in General Kang Ladro, once head of the Royal Companions regiment, who betrayed her father and brought the Royalist army over to the rebels in order to gain power. Ladro is now part of the junta, and wants Glorinna dead or (preferably) married to him in order to secure his position. Ladro aspires to a re-establishment of the monarchy, with himself as king, and sees Glorinna's great popularity with the masses as his key to absolute power.

The rest of the junta is divided, the majority desiring a "popular dictatorship," a strong minority under Ladro's leadership looking towards the renewed monarchy. The populace itself is greatly dissatisfied with the junta, which has imposed repressive military control over all phases of daily life without doing anything to keep the promises of redistribution of wealth to the impoverished. They are strongly in favor of the return of the monarchy (though much too afraid of the junta to show it), and will support the return of Glorinna, who has always (unlike her father) been a popular and charismatic figure.

Glorinna is beautiful and regal, but talented in winning the loyalty and devotion of others and in no way snobbish. She is brave, and keeps a cool head in a crisis; but her strong ingrained sense of honor makes it certain that she will handsomely reward those who aid

her. Her greatest weakness is a romantic, sentimental streak; there is a chance, to be determined by the referee, that she will fall in love with one of the adventurers, or possibly some other individual, whom she believes shares her devotion to the cause. This chance is especially improved if she meets the individual under dangerous or "romantic" circumstances, such as being rescued from some hazardous situation in the course of her adventures. Her impulsive heart often makes her easy prey for fortune-hunters.

Should Glorinna fall in with a party of adventurers, she will be patient and willing to go out of her way if she feels some benefit would be won from the diversion. She will not, however, lose sight of her own goals, and if need be will part company as readily as she joined. Her ultimate goal is, of course, to raise funds and troops enough to oust the junta; she will tend to assume that others attach the same degree of importance to this goal as she does. Under no circumstances will she be turned from her course, either by arguments or by knowledge of danger; she may postpone her plans for the sake of expediency, but will never abandon them, and she will regard any who tries to persuade her against the enterprise as a coward or worse.

Glorinna is accompanied in her travels by Ek, a 2.2 meter mute utterly devoted to her. He is suspicious of outsiders, and will take orders from no one except the princess. Ek is particularly suspicious of anyone showing a romantic interest in her. Glorinna will not dismiss Ek; he is kept on as her personal servant and bodyguard, because "he's been in the family for years."

Glorinna Firella may come to the attention of the adventurers in one of many ways. They might, for example,

actually be involved in the coup on her homeworld, and be approached for help in escaping the planet aboard their ship. There is a good chance she will approach adventurers later, recruiting them as bodyguards, or hiring travellers with military experience as advisors or officers for the army she is putting together. She may also hire mercenary units to assist in raising her army, on cadre, striker or commando missions in connection with her attempt to return, or in other capacities. There is also an excellent chance that she would hire a band of adventurers to learn the whereabouts of her father, and then to rescue him.

The party might also be approached by Ladro's agents, who would offer an exorbitant reward for them to kidnap or kill her. The adventurers would find, however, that Ladro is not entirely trustworthy when it comes to honoring agreements. Other adventures could well

revolve around the divisions within the junta, with other factions seeking to hold the princess as a bargaining counter against Ladro, for example.

Finally, the referee might involve the adventurers in the situation by having Glorinna turn up as a fellow passenger aboard a starship, a chance acquaintance met at a hotel or bar on some planet, or as the victim of one or more assailants in the street. In this case, the adventurers might be caught in the middle and shoved into one or more adventures without real freedom of action.

Glorinna's finances are subject to considerable fluctuation; the referee should determine how much money she has available according to the nature of the situation. She may be able to pay well for services rendered, or the adventurers might have to rely on the promise of money tied in with her own success in reaching her goal.

— J. Andrew Keith

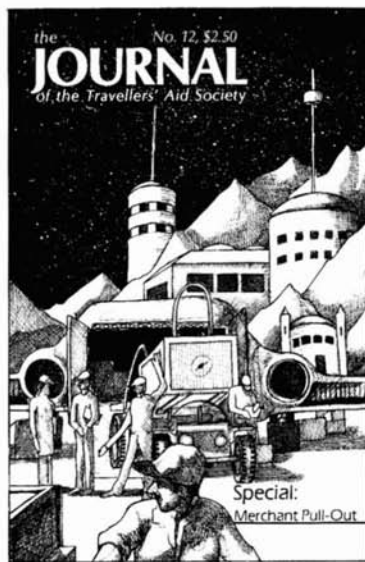

## Next Issue:

**Special Merchant Pull-out:** A 16 page pullout supplement on the Merchant service by J. Andrew Keith.

**Imperial Organization:** More units for use with Striker.

**PLUS:** Another Casual Encounter, the Bestiary, Amber Zones, our regular features and More!

# Deluxe Traveller

Traveller Books 1,2,3  
Book 0, Introduction to Traveller  
Introductory Adventure, The Imperial Fringe  
Map of the Spinward Marches  
2 dice  
... everything you need to play!

This is Free Trader Beowulf,  
calling anyone. . .  
Mayday, Mayday. . . we are under  
attack. . . main drive is gone. . .  
turret number one not responding . . .  
Mayday. . . losing cabin pressure  
fast. . . calling anyone. . . please help. . .  
This is Free Trader Beowulf. . .  
Mayday. . .

Deluxe  
Edition

**TRAVELLER™**  
*Science-Fiction Adventure  
in the Far Future*

Game Designers' Workshop

For the science fiction fan who wants to experience the ultimate gaming adventure, there is **Traveller**.

For the novice gamer who is unfamiliar with the wide range of **Traveller** material and who wants the **Traveller** universe explained thoroughly and systematically, there is **Deluxe Traveller**.

**Deluxe Traveller** contains everything the novice needs to begin play, and everything needed to establish a firm foundation for expanding the boundaries of science fiction role-playing. The traditional **Traveller** books 1, 2, and 3 have been revised to explain more clearly and precisely the fundamental rules of **Traveller**. Book 0 has been added to take new players on a step-by-step excursion of role-playing in general and **Traveller** in particular. A special introductory adventure, *The Imperial Fringe*, allows players to begin adventuring at once, and a special four-color map allows them to chart their progress through the Spinward Marches.

**Deluxe Traveller** is now available in a new, larger box to permit greater storage capacity for the many **Traveller** books, supplements, and adventures that can be used to expand the game system. **Deluxe Traveller**. Boxed. \$19.98.

## Game Designers' Workshop

P.O. Box 1646, Bloomington, IL 61701

Traveller is available from  
fine hobby shops around the world.  
*Free catalog on request.*

# BEYOND THE STELLAR EMPIRE

*Are you looking for a science fiction role-playing game where luck takes a back seat to skill and where excitement never gives way to tedium? If so, your search has ended, for you have found **Beyond the Stellar Empire**. Developed and playtested for over 3 years, a game of this detail could only have been designed as a correspondence game. You begin as a starship commander for one of the companies and services operating in the barbarous Capellan Periphery, located at the edge of the Stellar Empire.*

## BEYOND THE STELLAR EMPIRE features:

3 rules manuals (Captain's, Governor's, and Mercenary's — describing background and starship, colony, and ground party information, respectively.)

Capellan Periphery Times (a newspaper written by the participants about the events in the game.)

\* \* \* \*

Adventures By Mail moderates this game using a computer system and a full time staff of Gamemasters. As a player, you choose your objectives, interact with an unlimited number of players, and control your destiny.

Players fill out their turn sheets and mail them to Adventures By Mail, who evaluate their actions and returns a computer printout and other turn related information. Turns cost \$3.50 each, and the Capellan Periphery Times is free.

## To enter **BEYOND THE STELLAR EMPIRE**:

Send \$11.00 for the Starter Package which includes the 3 rules manuals, set-up turn and two turns.

The 3 rules manuals with set-up turn may be purchased seperately for only \$5.00.

Make checks or money orders payable to:

ADVENTURES BY MAIL, P. O. BOX 424-J, COHOES, NY 12047