

The Sarafand File

Paul Vernon & Sean Masterson

Source Files

Central Records, Cartographical Service
Ship of Strangers, Bob Shaw

All the sections of this **TRAVELLER** and **STAR FRONTIERS**® game adventure file, except the **Mission Profiles**, may be given to players at the start of play in addition to any normal referee's briefing. The information in these sections is readily available to the player characters. **IMAGINE**™ magazine grants permission for referees to photocopy the relevant sections for their personal use only.

THE CARTOGRAPHICAL SERVICE

Beyond the volume of explored and colonised space — the Bubble — preliminary surveys by unmanned probes are continuously carried out. The diplomatic and military arms of government are given responsibility for those systems and worlds which apparently support intelligent life. The vast majority of systems have no planets within their star's ecosphere or have not yet evolved intelligent life. Mapping these systems for later exploitation is the purpose of the Cartographical Service.

To perform this task, the Cartographical Service utilises specially designed exploration vessels, of which the **Sarafand** is a typical example. Although the ships have a crew of 12 to 15 members, command of the ship and the survey missions are the responsibility of **AESOP**. The Sarafand's crews have always thought **AESOP** to be Advanced Electronic Spaceship Operator and Pilot. Crew duties are confined to piloting individual Survey Modules — not-so-small go-anywhere exploration vehicles — as it has been found practical to have a human element within the system to cope with the unexpected.

The Cartographical Service and RPGs

Survey vessels such as the **Sarafand** make an ideal base for adventurers. The crew roster is small enough for player characters to be influential, while even smaller groups can adventure as the crews of Survey Modules. However, a few modifications do need to be made to Bob Shaw's technological background to suit the needs of role-playing games, and the technological backgrounds of the game systems.

AESOP, the ship's computer and master, is by far the most influential character in the *Ship of Strangers* stories. Although this makes the book interesting, as a part of the game it is likely to be very unsuccessful, as player interest is almost certain to be diminished by being ordered about by a computer. The responsibility for decision-making has to be returned to the players, and this entails giving **AESOP** an advisory, rather than controlling, role in the **Sarafand's** command structure. In *Ship of Strangers* there are only 12 crew members plus **AESOP** as mission commander. In this file there are 15 members, the extra humans being command staff.

A final problem with the missions undertaken by a Sarafand class explorer is that many of them are boringly routine, which does not aid in making the game exciting. One way to avoid this is to run the player characters' very first survey as a dull, routine affair to 'show them the ropes' and then use the out-of-the-ordinary mission profiles, stressing how many dull surveys there have been between moments of interest and excitement. There might be 10-60 dull missions between specially profiled occurrences.

TRAVELLER

The Scout Service of the Imperium (see **Scouts**, Book 6) includes, among its offices and branches, the External and Internal Mapping Branches of the Imperial Grand Survey. These two parts of the Grand Survey have roughly the same responsibilities as the Cartographical Service of *Ship of Strangers*. Simply renaming the Cartographical Survey as the Imperial Grand Survey (or vice versa) is all that is required.

The Imperium of the official **GDW Traveller** universe leaves scouts with very little mapping to do, as the Imperium is a mature state which has expanded to fill much of the available surrounding real estate. If the suggestions in **Uncharted Stars** (see **IMAGINE** magazine, #19) are followed, they will provide numerous locations for potential adventures for members of the Cartographical Service.

The STAR FRONTIERS game

The **Knight Hawks Campaign Book** includes an option for characters to become officers in the UPF Spacefleet (p48-50), but this may not be entirely suitable for many campaigns. The Cartographical Service gives referees a chance to provide a consistent backdrop for adventures together with a chance for player characters to see a bit more of the universe than is normally possible.

The Cartographical Service of the UPF is an entirely independent arm of government (although it was once part of Star Law), with its own command structure, bases, ships, training academy, budget and operational commitments. It exists solely to survey planetary systems, collate such information from the corporations and maintain and issue maps, star catalogues and geological data.

Safax Institute

The headquarters of the Cartographical Service is at Triad in Cassadine, part of the main UPF facilities in that system. It is here, at the Safax Training Institute on Triad's moon, that the future crews of exploration vessels are given their initial training.

Applicants for the Cartographical Service are 'stable, well adjusted and intelligent' but do not require any relevant skills. INT/LOG and PER/LDR must be above 45, and non-human applicants have a 75% chance of being rejected regardless of their qualifications (single species ships make long periods of confinement while on survey missions easier to bear).

Training in the use of the Survey Modules (the equivalent of Technician 4 subskill Operate Machinery) is provided by the Cartographical Service. Computer 2, Technician 2, Medical 2 or Environmental 2 and a level 1 Military PSA skill are also taught to the character at Safax. This training procedure supercedes the normal starting skill allowance if the entrant characters are newly created.

Advancement

After training at Safax, characters are expected to serve at least two years aboard one of the Cartographical Service's exploration vessels (obviously, administrators and support personnel are required, but these are non-adventuring posts filled by NPCs). The two year minimum requirement is mandatory; hospital time, for example, is not counted towards service time or paid as such (although the Cartographical Service does pay for treatment).

In-service training is considered worthwhile, and is often one of the few ways to pass the time during missions. Characters may continue to spend experience points and acquire new skills through hypno-training, practice or training while on missions. Length of service and skills both contribute towards character advancement within the pay structure of the Cartographical Service. Leadership of teams usually falls upon the shoulders of the most experienced crew members or the natural leaders of the group. As long as the job gets done, the Cartographical Service does not mind how individual ships are organised.

Qualifications	Daily Pay
Up to 2 years	100
Up to 6 years or at least 40 experience points worth of skills	300
Up to 12 years or at least 80 experience points worth of skills	500
More than 12 years or at least 150 experience points worth of skills	650

The Service provides no retirement benefits for employees.

CREW

The ship's crew of a typical Sarafand class vessel is usually a mixed bag, with only one or two long term members. The rest are short assignment, limited contract personnel.

Most crew members serve for two two-year periods before leaving to pursue projects of their own with the money that they have earned. There are, however, one or two veteran crew members aboard most ships, providing a valuable steadying influence. The Cartographical Service is seen more as a stepping stone to other things than as a profession — though the work itself is monotonous and unsocial, the pay is excellent (at least double the rates paid by commercial corporations for people with the same skills), even though the opportunities for spending it are somewhat limited.

When surveying a planet, the team leader, computer operator and one other crew member stay aboard the Sarafand in order to monitor data as it is received from the Survey Modules. The remaining 12 crew members provide crews for the Survey Modules.

TRAVELLER

1. Pilot/Team Leader, UPP 5A78C9, Terms 5, Pilot-4, Leader-2, Nav-2, J-o-T-1, Veh*-1, Gun Cbt-1.
 2. Navigator, UPP 4867C6, Terms 5, Pilot-1, Nav-3, Elec-2, Comp-1, Gun Cbt-1.
 3. Medic, UPP 3877B5, Terms 5, Medic-3, Vacc-2, Gun Cbt-2, J-o-T-1, Veh*-1.
 4. Computer Operator, UPP 685988, Terms 4, Comp-4, J-o-T-2, Gun Cbt-1, Pilot-1.
 5. Leading Engineer, UPP 9A8967, Terms 4, Engrg-3, J-o-T-2, Gun Cbt-2, Veh*-1.
 6. Engineer, UPP C79778, Terms 3, Engrg-2, Gun Cbt-1, Elec-1, Mech-1, Veh*-1.
 7. Engineer, UPP AB9C98, Terms 3, Engrg-2, Pilot-1, Veh*-1, Mech-1.
 8. Engineer UPP 687DB7 Terms 5 Pilot-1, Gun Cbt-2, Medic-1, Mech-3, Veh*-2, J-o-T-2.
 9. Engineer UPP 788A96 Terms 2 Engrg-1, Veh*-1, Gun Cbt-1, Elec-1.
 10. Engineer UPP 9838B5 Terms 2 Engrg-1, Veh*-1, Mech-1, Gun Cbt-2.
 11. Leading Gunner UPP 79DA77 Terms 5 Gunnery-4, Gun Cbt-2, Veh*-1, Comp-1, Elec-1.
 12. Gunner UPP 59385A Terms 2 Gunnery-1, Veh*-1, J-o-T-1, Gun Cbt-1.
 13. Gunner UPP A97468 Terms 4 Gunnery-3, Vacc-2, Mech-1, Veh*-1.
 14. Gunner UPP 5A9767 Terms 3 Gunnery-2, J-o-T-1, Veh*-1, Elec-1, Gun Cbt-1.
 15. Gunner UPP CA8569 Terms 2 Veh*-2, Gunnery-1, Vacc-1, Gun Cbt-1.
- * Vehicle skills (Veh) pertain to driving the Sarafand Survey Modules.

The STAR FRONTIERS game

The crewing policy of the Cartographical Service in the **STAR FRONTIERS** game reflects the fact that *Ship of Strangers* is set in a human universe. Mixed species crew are not usually employed aboard Sarafand class vessels, and few non-humans ever bother to apply for this type of repetitive and boring work, even though it is highly paid.

The 15 crew members, other than the two or three 'oldtimers' aboard most ships, are only expected to have enough skills to operate the vessel under normal conditions, while relying on **AESOP's** self programming ability for major problems. Typically, Computer 2, Technician 2, Medical 2 or Environmental 2 and some military PSA skills are required by short term crew members. Training in the use of Survey Modules (the equivalent Technician 4 subskill Operate Machinery) is provided by the Cartographical Service. Characters can then fully operate the Survey Modules in normal circumstances. Success rolls (at the referee's discretion) may be needed under exceptional conditions.

Long term crew members usually have spaceship skills and appropriate foundation skills as well. The 'captain' of a Sarafand class vessel usually has minimum skills of Technician 6, Computer 6, Piloting 4, Astrogation 2 (or System Navigation 3) and Weapon 3, while the other 'oldtimers' are similarly skilful in their areas of competence, including the new Astronomy skill detailed below. One of the long term crew members will usually be designated as the ship's weaponry officer in addition to any other duties, and will have Gunnery (Energy Weapons) 3, although this character need not have the relevant Beam Weapons 6 skill (this is an exception to the normal foundation skills requirement for this NPC only).

The description of the Cartographical Service at the beginning of this file outlines its use as an alternative career to the UPF SpaceFleet (see **Knight Hawks Campaign Book**).

New Skills for STAR FRONTIERS characters

	Cost					
Level:	1	2	3	4	5	6
System Navigation	6	12	20	30	50	75
Astronomy	As other Technological skills					

ASTRONOMY (Technological)

The study of stars, galaxies, planets, moons, asteroids, comets and meteors, their conditions and origins.

This skill has two sub-skills: Identify and Calculate. Astronomers must make observations to perform either subskill, using telescopes, radar, energy sensors, cameras and computers. Each type of equipment astronomers use to make their observations adds 10% to their chance of success.

Identify

Success Rate: 10 x skill level + equipment

Astronomers can identify objects in space, from planets to spaceships. Identifying takes half an hour for objects closer than 10,000 kilometres. Objects further away take 1 hour to identify.

Calculate

Success Rate: 10 x skill level + equipment

Astronomers can calculate the age, speed, mass or orbit (course) of any object in space. Astronomers can only make one calculation at a time. Each calculation takes half an hour.

SYSTEM NAVIGATION (Spaceship)

This skill is used to guide a ship (usually one incapable of interstellar travel) within a star system. As such, it is a partial replacement for the Astrogation skill given in the **Knight Hawks Campaign Book**. System Navigation requires foundation skill of Computer 2.

Plot Course

Success Rate: 40% + 10% x skill level — 10% per hour less than required plotting time

Navigators make the complicated calculations required to plot a safe and accurate course for a spaceship. The time needed for course calculations increases for longer trips, because even small errors become very serious as the distance increases. The required plotting time is one hour per 100,000 kilometres that will be travelled. Navigators can cut the required plotting time in half by using computers to aid them (typically with Analysis programs).

If the navigator spends less than the required plotting time, his success rate is reduced. Every hour of the required plotting time the navigator does not spend reduces his success rate by 10%.

If a navigator fails the plot course roll, an error has been made, and all the calculations must be made again.

MISSION PROFILES

Cartographical survey missions are supposed to follow the same, invariable pattern. On arrival in a target system, the plane of the elliptic is determined and the first planet for scanning is chosen. The exploration ship orbits the planet, deploying three communications satellites into geo-synchronous orbits above the equator, and then lands at one of the poles. The Survey Modules are launched, and they fly (or drive) over preset courses which are plotted to allow the entire surface of the planet to be scanned by the Module sensors. Data is transmitted to the ship via the satellites.

Meanwhile, the ship takes off and lands at the opposite pole to await the arrival of the Survey Modules. Once all the modules have been recovered, the ship then leaves for the next target world. Work for the Cartographical Service is, for the most part, very boring....

The following scenario outlines are given in **TRAVELLER-style 76 Patrons** format, which will be unfamiliar to **STAR FRONTIERS** referees. An outline of the situation is presented, but the specific details are left largely to the referee to determine, based on the experience and temperament of the players involved. If the scenarios are used as a basis for a campaign, Mission Profiles 1 & 2 should be run consecutively, for reasons that will become apparent.

1. THE OUTCAST

During the routine survey of Helat 4, a particularly worthless world, the NPC crew of one of the Modules, Straker and Kaminsky, pick up readings of a large concentration of metal and a power source. **AESOP** advises an investigation, and all the other Modules are halted while Straker and Kaminsky head for the source of the enigmatic readings.

The other crews watch on their video screens as the investigators cross a ridge line and discover, half hidden in drifting dust, the skeleton of a starship. Kaminsky suits up and heads into the wreck on foot, his shoulder camera carrying the view to the rest of the Sarafand's crew....

Inside the ship is a wreck, skewered by a meteorite before it crashed. The bridge area is relatively intact, and Kaminsky manages to struggle to the pilot's position and extract the log tapes. He also finds the remains of the pilot, with a jagged hole in his helmet and skull and a corroded automatic pistol clutched in his hand.

When transmitted to **AESOP**, the log tapes prove to be from the commercial explorer Outcast, lost ten years ago. A comparison with **AESOP's** library data reveals the ship's last position was 10 light years away.

The rest of the survey is as boring as usual, and all the Modules reach the Sarafand at Helat's North pole without further incident. In the meantime, **AESOP** has analysed the log tape, and discovered that the crew of the Outcast fell victim to a terminally debilitating spinal infection. Only the navigator, who had a prosthetic pelvis and spinal column, was immune, and he purposely brought the ship to Helat 4, well away from any inhabited worlds. Kaminsky and Straker are sent to the sickbay, but both are perfectly healthy. Kaminsky is very upset by the scenes he saw aboard the wreck of the Outcast, and cannot even talk about it. He begins to withdraw from conversation, and to brood.

The Sarafand boosts out of the Helat system towards its next target, and as the last calculations before the Jump are being made, the subject of the Outcast comes up in conversation. Kaminsky lashes out at the nearest person (one of the player characters) and then retreats to his room, locking himself in and everybody out.

Next morning, Kaminsky does not appear at breakfast, and when somebody is sent to his room the door is open and Kaminsky is lying in his bed, dead. Something has gnawed its way out of his stomach....

Referee's Information

Kaminsky has fallen victim to the same 'disease' as killed the crew of the Outcast. In fact, the creature that killed him was roughly the size and shape of a Terran woodlouse, although infinitely more dangerous. The creature has used Kaminsky as a nest, and its young (2-12 specimens) are now at large.

The creature (the player characters may have the privilege of naming it) attacks warm-blooded creatures in order to feed and reproduce. It climbs to a point on the victim where nerve impulses are particularly strong (the base of the neck hidden under the hair on a human) and there inserts its proboscis into the central nervous system, deadening all sensation with a powerful natural anaesthetic. Once established, it suborns its victim's nervous system to protect itself and in the process produces changes in behaviour, until ready to reproduce. The creature then paralyses its victim and migrates to a suitable nest — the stomach or chest cavity are nearly perfect. There it lays its eggs (the creature is asexual) and dies, killing the host as it does so. Six hours later the eggs hatch and the young eat their way out, looking for new nest sites....

Once the takeover has begun, the resources of the Sarafand are not sufficient to halt the process in a 'nest' person. However, the creatures can be stopped by systematically decompressing the ship. If the adventurers follow this course of action, the referee should judge how successful their measures are, and may choose to give hints that the PCs should not necessarily assume there is more than one creature. The referee should also feel free to have another crew member (preferably an NPC) fall victim to the creatures, producing another 2-12 young.

If the adventurers succeed only in containing the creatures, it will be covered that the life support system is overloading, despite the death of Kaminsky (and any others). Despite their small size, the creatures consume as much oxygen as a man....

Traveller:

2-12 Eaters Weight 0.01kg; Hits 1/0; Wounds/Weapon Special; Armour Jack (DM-3 to hit), A0, F9, S1

The STAR FRONTIERS game

2-12 Tiny Carnivores MV Slow; IM/RS 2/16; STA 18; ATT 90; DAM Special; NATIVE WORLD: Unknown.

2. SABOTAGE

In this scenario, one of the NPCs or (more interestingly, perhaps) one of the player characters should be an agent for the Sathar or Zhodani....

The referee should roll 1d6.

1. The Sarafand has been assigned to survey the supposedly uninhabited world of Yazrin 3. In fact, the planet is an enemy supply dump for their long range spyships. The enemy agent aboard the Sarafand will stop the mapping if possible or, if the base is discovered, he or she will set about eliminating the crew.

2-3. While the ship is in hyperspace, the agent sabotages **AESOP**. With the computer partially disabled, the crew face the prospect of spending the rest of their (somewhat limited) future in the terrible void. **AESOP** must be repaired, but once this is done, the presence of a saboteur will be revealed. Obviously the agent must take steps to avoid discovery.

4. One of the player characters is implicated as a spy and assassin. The agent has planted incriminating documentation in the player character's possessions.... This particular line of adventure works well if the referee takes the accused player aside at any earlier point to impart some information of a trivial nature — but out of earshot of the other players.

5-6. If Mission 1 **The Outcast** (see above) has not been used, then roll again. If it has, the agent is a fanatic, unafraid to die for the cause, and has captured one of the creatures. Another outbreak of the creatures is the result, as the agent uses the creature to murder an NPC.

3. THE HAL SYNDROME

After entering the barren Quettyr system and surveying the planet Victoria II, **AESOP** malfunctions. During a meal time, instead of delivering the requested items, **AESOP** orders the galley to produce an endless stream of cold porridge. The computer's behaviour becomes more and more 'quirky' and starts to endanger crew lives, apparently intentionally.

For example: **AESOP** leaves the outer airlock door open and allows the inner door to be opened — only the emergency locks shut the hatch, but not before several crew members have suffered (mildly) from explosive decompression; **AESOP** locks the crew out of the engine room and bridge, and begins to broadcast an endless succession of ancient songs (in particular, *Oh, Mr Porter* and *I Like to go Swimming with Women*) over the ship's intercom system; and **AESOP** begins to refer to the Captain as 'Moriarty' and only speaks when addressed as 'Holmes'.

1-3. **AESOP's** central processor has been damaged by stray radiation. The computer must be stripped down and the damaged circuitry removed.

4-5. **AESOP's** errant behaviour is the result of a carelessly worded order to search the library banks. Instead of extracting information about the planet Victoria II, **AESOP** has accessed data about the Victorian Era and wrongly rewritten his main program. Purely by chance, the Victorian file marker was at the 'M's' — including Moriarty, Murder and Music Hall.

6. **AESOP's** behaviour is the result of manipulation by Cartographical Service headquarters. The crew are being subjected to a carefully controlled stress pattern to see how they react. **AESOP** is monitoring the crew and will terminate the exercise once they devise — and begin to implement — a strategy that he feels will remedy his 'madness', or earlier if he or the ship is in danger of destruction.

4. TANZIN 2

Tanzin is a K8 main sequence star with a planet positioned almost ideally in the ecosphere. After the initial probe report, a Contact mission was organised and despatched, but Tanzin 2 proved to be a great disappointment. As the Contact ship orbited the planet, it became clear that T2 was a barren and unpleasant world. Pausing only to skim the top of the oxygen-free atmosphere for samples, the Contact mission returned, the Tanzin file was given to the Cartographical Service, and the player characters' vessel was despatched to map the world — just so the files can be closed.

Although T2's gravity proves to be slightly weaker than standard, NOE flights and surveys prove to be impracticable due to the frequent and violent storms in the planet's atmosphere. All is apparently routine, despite some minor problems like wheel changes and a broken half-axle on one of the Survey Modules. The exploration of T2 proves to be as dull as it could possibly be, with no evidence of life, and no evidence as to why life never got started, despite the fact that it does not have the normal type of primeval atmosphere associated with lifeless worlds. The only moment of excitement is when one of the PC crews picks up readings of a cavern system in an inappropriate series of rock formations.

Tanzin's condition is due to the release of a potent biological weapon into the atmosphere of the planet over 5,000 years ago. The spores mutated as soon as they were out of the laboratory, and attacked all life, using up tremendous quantities of oxygen is the process. Eventually, the biosystem broke down completely and all life on Tanzin 2, from the bottom of the ocean to the tops of mountains was dead. The oxygen in the atmosphere was locked into complex chemical compounds. During the intervening millenia, the spores have been dormant, but now some have been revitalised by being carried into a Survey Module on the suits of the crew who repaired the half-axle.

The initial symptoms of infection by the spores, which appear after 12 hours, are tiredness, nausea and blurred vision. The infected crew are already suffering from these symptoms, although it is hardly surprising that they are tired after the drive from South pole to North pole. Twelve hours after that, the symptoms will grow progressively worse, with a general lassitude, muscular aches and complete loss of appetite overcoming the victim. The spores are infectious once the initial symptoms have appeared.

TRAVELLER characters undergo the equivalent of rapid ageing (though without obvious physical effects such as greying hair etc), treating 1 hour as 1 year for the purposes of the spores progression, and rolling on the ageing table every four hours once 'old' enough to do so. Characters who have a characteristic reduced to zero go into a coma; if a characteristic drops below zero, that character is dead. Medical skill gives a DM of +1 per level of skill to the ageing saving throw.

Characters in the **STAR FRONTIERS** game suffer an S8/D1000+ infection. Characters using the Medical Cure Infection subskill suffer a 30% chance of success and will only halt the progress of the spores for 10 hours. Another successful Cure Infection roll is required every 10 hours to stave off the effects of the spores.

The only chance of defeating the spores is to examine the strange cavern formations some 3,000 km from the pole. These caverns are a military research bunker from 5,000 years ago, the last attempt the Tanzinities made to defeat the spores.

Once there, the bunker is in remarkably good condition as it has been sealed since the disaster. If **AESOP** is given samples of the written language (transmitted to him via suit video cameras) found in the bunker, he can analyse and translate it in 1d6+6 hours. The Tanzinities were close to a breakthrough, but the spores eventually won....

Medical 2 will allow a character to understand the nature of the Tanzinite research into the spores, and a roll of 9+ (**TRAVELLER**, DMs +1 per 4 hour period spent in analysis, and this can be repeated every four hours, but no treatment can be administered to spore victims during this time) or a successful Cure Infection roll at -40% (+10% per ten hour period spent in research, and the roll can be repeated after a further 10 hours, although Cure Infection rolls on patients will not be possible during a period so spent) will provide the necessary antidote.

5. THE BONUS

While surveying the planetary system of Oula, the F8 star in a binary system, it is discovered that the F3 companion star also has a planet, one that the initial robot probe missed completely. This kind of discovery occurs all the time, so mission commanders have the authority to alter the mission profile and explore newly discovered worlds in addition to those already targetted for mapping. As such initiatives are approved of by headquarters, the crew often get the chance to 'enjoy' longer 'Bonus' missions and see another very boring world.

The survey of Oula 2/1 begins by following the usual routine. Soon after the ship lands at the second pole, however, the module crews (including the PCs) are contacted by the ship with the message that "We've just discovered..." before contact is lost completely.

1-2. The communications satellite linking the ship and the modules has been struck by a tiny piece of anti-matter and destroyed. Contact is re-established when (or if) the modules move into the zone covered by

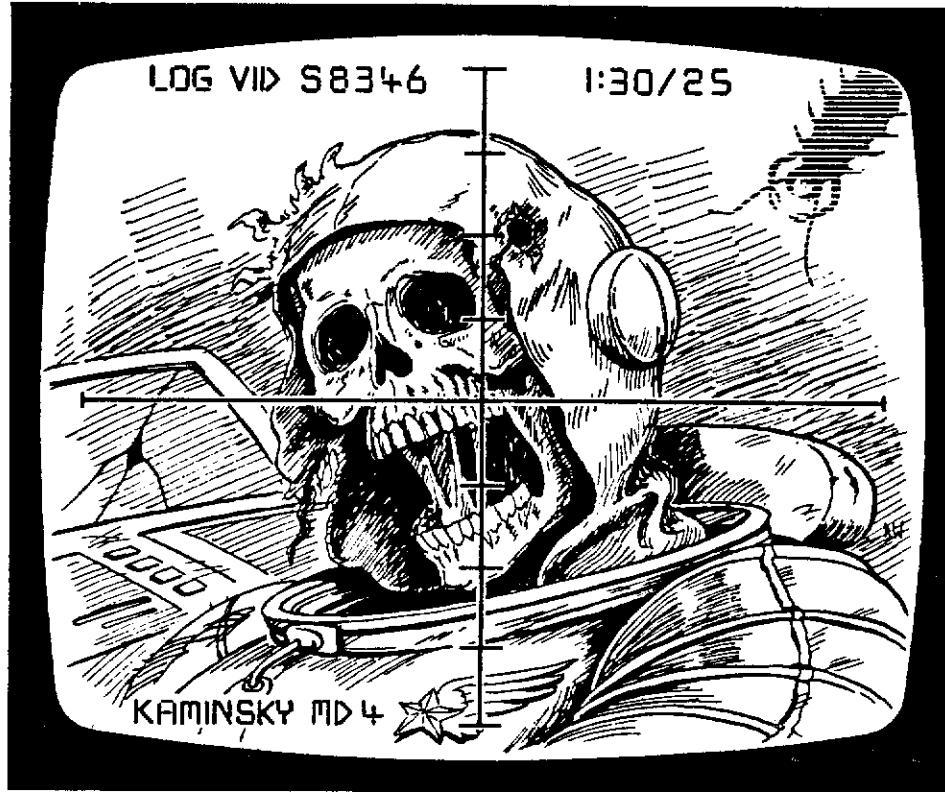

another satellite. There is a 1 in 6 chance that the one of the other satellites will suffer a similar fate, or that the ship will be damaged before it leaves orbit.

3-4. The planet is very rich in superdense elements, which are being mined by a large corporation without the knowledge of the authorities or any competitors. To protect their interests, the company have destroyed the satellites with a missile, and have stationed armed teams to make sure the Survey Modules do not return to the ship.

Although the ship itself is too strong for the corporation's men to handle, one of their own armed vessels will arrive in 2-12 days.

5-6. As in 3 above, except that the mining operation is being conducted by hostile aliens, Zhodani or Sathar, depending upon the game system.

CONCLUSION

Those seeking ideas for further adventures need look no further than *SHIP OF STRANGERS*, the novel of Bob Shaw from which the **Sarafand** and the Cartographical Service are taken.

The missions outlined above need not be the only use to which the **Sarafand** is put. The potential for continued use of the **Sarafand** in a campaign is enormous, as it allows the referee to introduce almost anything without too much disruption of what has gone before, and gives the player characters the feeling that they are exploring virgin territory and that they matter (in a small way) in the overall scheme of things.

The authors would like to thank Bob Shaw for his assistance in supplying the necessary background material which made this article possible.

CREDITS

Inspiration: Bob Shaw
 Original Design: Paul Vernon & Sean Masterson
 Development: Mike Brunton with Jim Bamba
 Art: Brian Williams

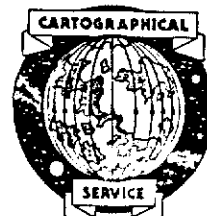

THE SURVEY MODULES

TRAVELLER

The Survey Module statistics for TRAVELLER are given below in STRIKER format.

Cartographical Service G-Carrier (TL13)

Height: 3m (plus communications turret, 1.2m)

Width: 3m

Length: 6m

Total volume: 51 m³ (useable volume 44.3m³).

Weight: 41.3 tons

Price: 883,888Cr

Max Road Speed: 265(+)^{kph}

Cross Country: 53(+)^{kph}

Water Speed: 13(+)^{kph}

Max Grav Speed: 540 kph

Cruise Grav Speed: 405 kph

NOE: 170 kph

Armour: 11

Target Size DMs: +1 high, +2 low

Equipment: searchlight and image enhancement output to view-screen; 5000 power radio; 500 power radar sensing equipment; geological sound ranging gear; battle computer programmed to handle geophysical data.

Power: 6 megawatt fusion powerplant (consumes 9 litres of fuel per hour, fuel capacity of 7560 litres gives 840 hours of operation). Grav generators produce 1.453g.

Survey Modules see service in a wide range of planetary variations and are designed with this in mind. In addition to being capable of both surface and grav movement, they are built to travel over or under water where necessary.

The maximum awareness radius of the sensors carried is 500 kilometres, and they are sensitive enough to register all necessary data when the vehicle is travelling at speeds up to 170kph (NOE speed in grav mode).

On a planet with a gravity in excess of 1.453g, grav mode is impossible and the grav generators are used to improve the power to weight ratios for ground movement (hence the + signs after the figures given for ground speeds). When grav mode is not feasible for any reason (eg atmospheric disturbance), the grav generators are often used to keep the survey modules on the ground. They are also used to provide the required buoyancy during marine travel. While on surveys, the average speeds achieved are 80 kph (ground movement) or 160 kph (NOE).

As the crews (driver and co-driver) are often confined to the vehicles for days at a time, their living accommodation is quite extensive. Three tons of cargo capacity is taken up by the supplies and spares necessary during long treks in the wilderness.

The STAR FRONTIERS game

Cost: Cr 100,000 (rental is inapplicable)

Top/cruise speed: 90/50 kph

Water/NOE speed: 10/100 kph

Turn speed: 40 m/turn

Passengers: 2

Cargo: 10,000kg or 40 cubic metres (3,000kg of spares and equipment, the rest is allocated to crew quarters).

The Cartographical Service Survey Module is a heavy, long range version of the standard Explorer van, hardened (100 + d100 structure points) against a wide variety of external conditions and capable of a rocketed-assisted Nap of the Earth (NOE) flight. The Survey Module is powered by a type 4 hydrogen fusion generator with 850 hours of fuel in reserve, giving a range of operation of 80,000 +km. Life support for the crew of two (driver and co-driver) is also provided for this length of time.

The Survey module carries a long range detector system (500km range) which includes radar, energy sensors (see the Knight Hawks Campaign book) and geological sensors, a camera system with IR enhancers, a video radiophone including a computer data transfer system, two spacesuits (for hostile environments) and a level 3 computer (powered by the module's generator). The computer runs Analysis 4, Information Storage 4, Communications 2, Robot Management 3 (to run the sensor packages) and Life Support 1 programs.

A civilian version, lacking the geological survey sensors and flight capability, is manufactured and sold for Cr 85,000.

APPROVAL

372/399/4	<i>[Signature]</i>
05732A7	<i>[Signature]</i>

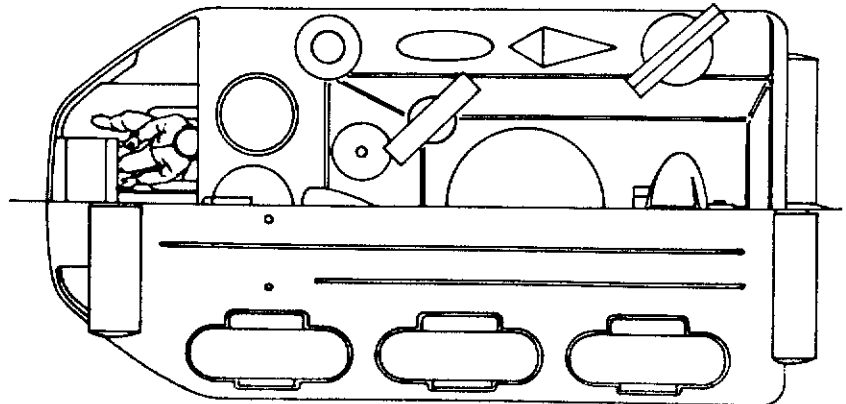
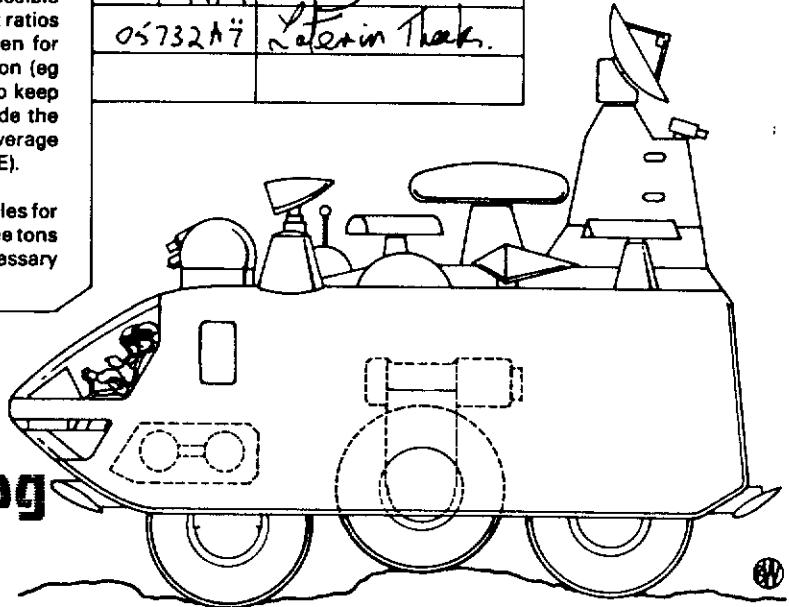

DUPLICATE

Williams Engineering

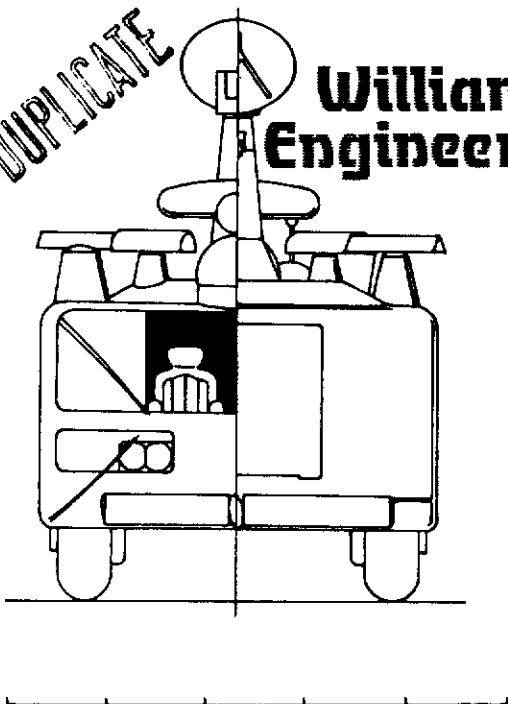

SARAFAND (Cartographical Service Mark 6 Exploration Ship)



Williams
Engineering

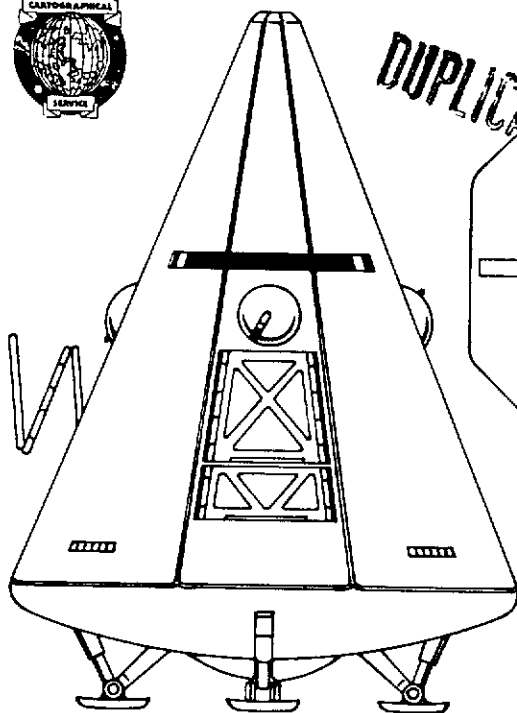

DUPLICATE

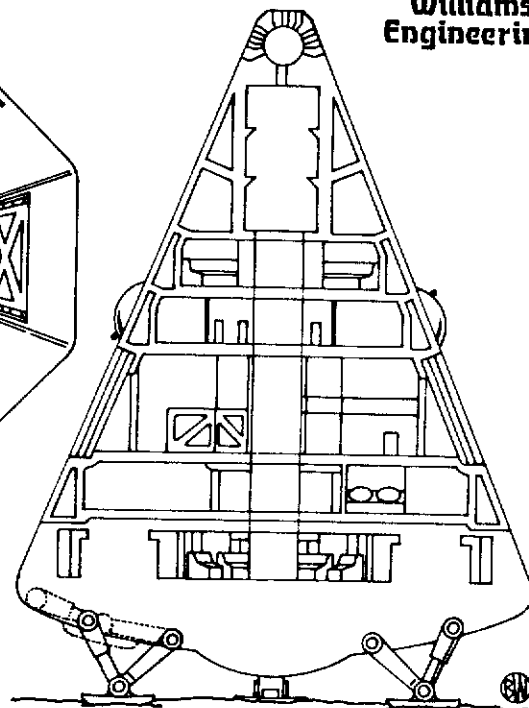
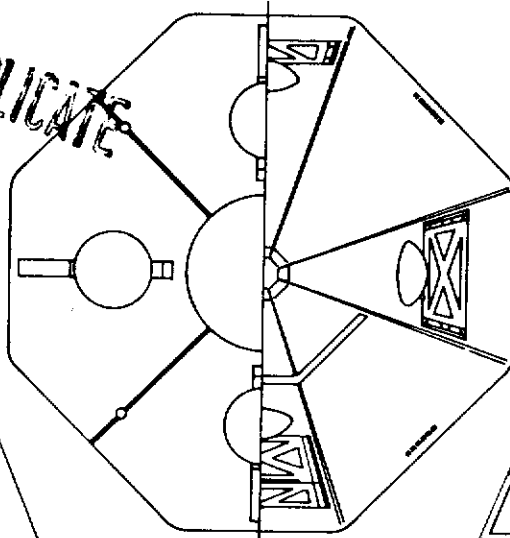

02/3/5	W. J. ...
3323	Thoorika

TRAVELLER

The Sarafand class is built on an 800 ton hull and used to carry a survey team and their survey modules to previously unmapped planetary systems. Its jump drive-4, manoeuvre drive-4 and power plant-4, give jump-4 and 4-g acceleration (Book 5, 2nd Edition design), and the fuel tankage of 352 tons supports 4 weeks of power plant operation and one jump-4. An onboard purification plant is carried. The hull is streamlined for wilderness refuelling and planetary landings.

The computer system, installed adjacent to the bridge, is a model/7 fib. Eight turrets are installed at launch, four carrying a pair of fusion guns each and four with two missile racks and a sandcaster each.

On a large hangar deck, the ship carries six survey modules for planetary scanning, each displacing 10 tons. The cargo capacity of 78 tons is used to carry the supplies and comprehensive range of spares required for deep-space operations away from maintenance facilities.

The crew of fifteen (pilot/team leader, navigator, medic, computer operator, six engineers and five gunners) have their own staterooms. All except the pilot and computer operator act as survey module crews in addition to their ship-board duties.

The Mark 6 Exploration ship takes 25 months to build and costs 660.156Mcr (fully equipped); 20 months and 528.124Mcr if constructed in bulk.

High Guard Statistics (2nd Edition)

SJ-374 SARAFAND

SJ-81444G2-030000-05003-0	Mcr 660.156	800 tons
Batty Bearing 4 2 2	Crew = 15	TL = 13
Passengers = 0 Low = 0 Cargo = 78	Fuel = 352 EP = 32	Agility = 1

The STAR FRONTIERS game

SHIP'S NAME: Sarafand (class)
OWNER: UPF Cartographical Service
CAPTAIN ABOARD: Team Leader (with *AESOP*)

HULL SIZE: 3
ENGINES: 2 x A Atomics — De-rated UPF Triad Shipyards Type 42's
FUEL: 3 pellets/engine
COST: Cr 1,502,300
CREW: 15
CREW SALARIES: Variable

LIFE SUPPORT CAPACITY
MAIN: 18
BACKUP: 0

PASSENGER ACCOMMODATION:
FIRST: 1
JOURNEY: 14
STORAGE: 0

COMMUNICATION EQUIPMENT: Videocom, intercom, subspace radio

OTHER EQUIPMENT: Radar, full camera system, energy sensors, skin sensors, 6 x survey module

ADF: 3
MR: 4
DCR: 29
HULL POINTS: 15
WEAPONS: 2 x Laser battery
DEFENCES: Reflective hull

The Mark 6 Exploration ship does not quite fall within the standard rules of ship design for the **STAR FRONTIERS** game.

The Sarafand class carries an extra laser battery without penalty because it is built to military, rather than civilian, specifications.

The deck plans also show that a great deal of internal space is devoted to special compartments for fuel storage. This is because starships carry a great deal of fuel within the hull in the **TRAVELLER** game. Furthermore, the engines are built directly into the hull but they are heavily shielded and can be jettisoned in an emergency. The crew is not exposed to an increased level of radiation.

Referees may also notice that the Survey Modules carry out many of the functions performed by landing drones (*Knight Hawks Campaign Book* p22). Union pressures have forced the Cartographical Service to maintain its fleet of Mark 6 Exploration Ships, although the Marks 7 & 8 do exist (and are equipped with advanced automated landing drones).

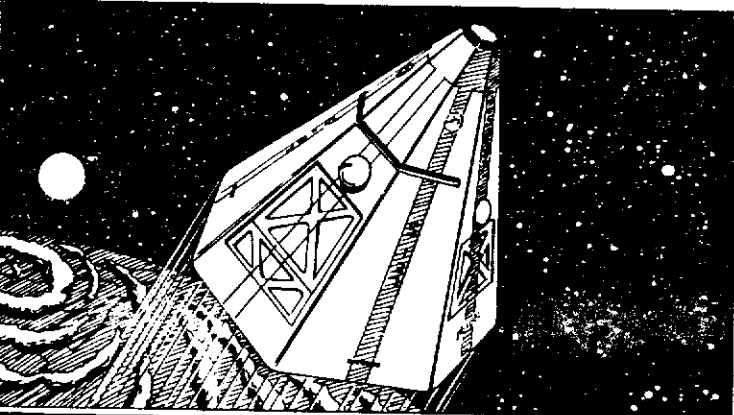

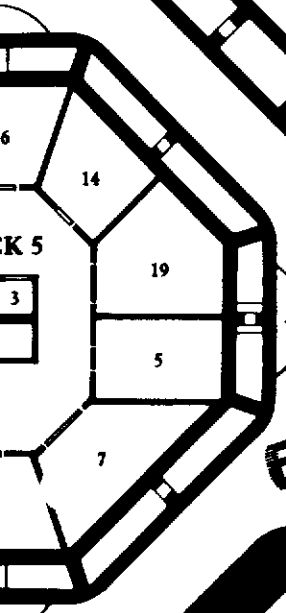
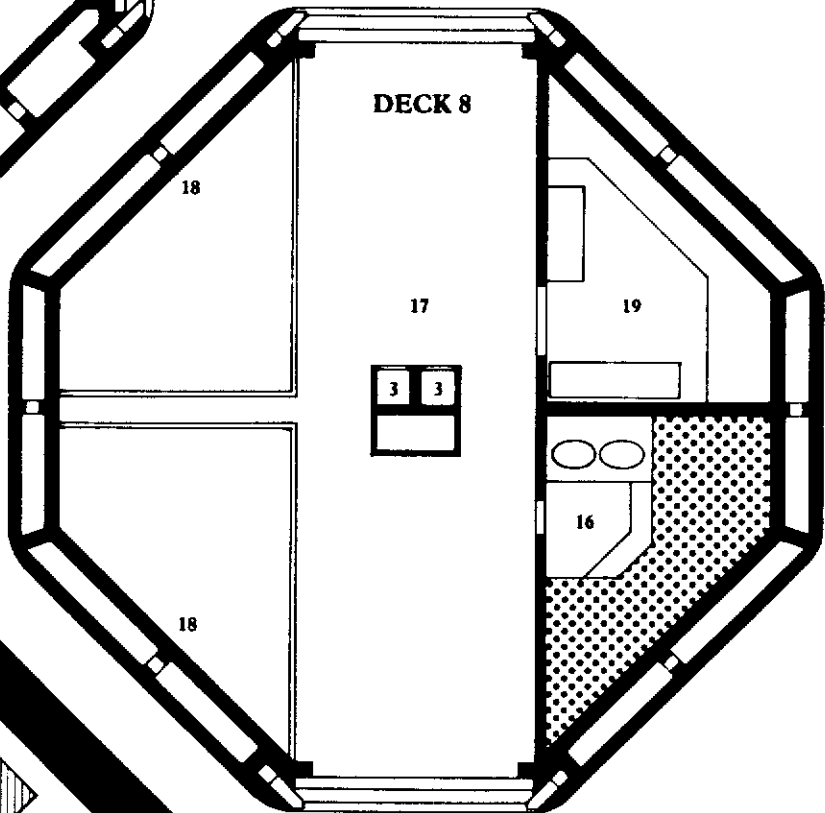
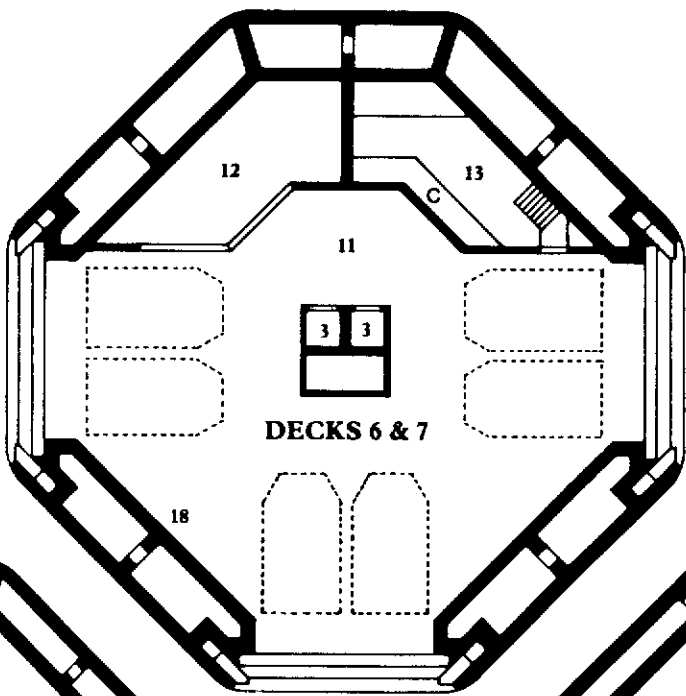
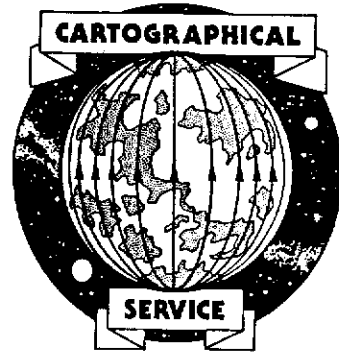

**Williams
Engineering**

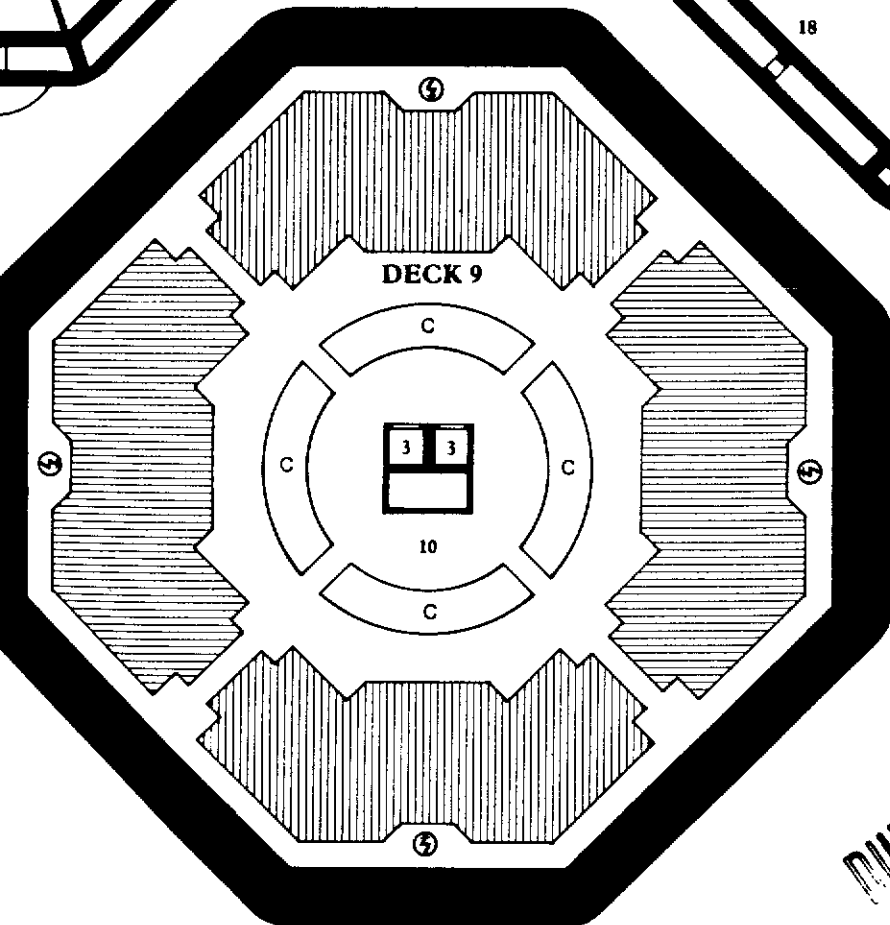

APPROVAL	
001/3	<i>[Signature]</i>
001/7	<i>[Signature]</i>
3Y1A/1	<i>[Signature]</i>
	<i>[Signature]</i>
<i>[Signature]</i>	292/8

DUPLICATE