

214  
Oktober  
£3.50

# WARHAMMER ORUK!

PATH OF  
THE ELDAR

Special pointy eared feature

# GORKAMORKA™

STONKIN' ARE YOU LOOKIN'  
NEW GAME! FER A BASHIN'?

GAMES  
WORKSHOP

ISSN 0265-8712



9 770265 871059



**CUVVA  
STORY**

# WHITE DWARF **ORK!**

DA NEW GAME  
IS 'ERE...™

## GORKAMORKA™

Free card  
tower

... SO YOO 'AD  
BETTER PAY  
ATTENTION  
IF YOO  
WANNA  
SURVIVE  
DIS ISSUE.  
NOW, GET  
READIN'!

**STUFF WOT'S IN DA  
MAGAZINE DIS MUNFF**

**GAMES WORKSHOP NEWS**

**2**

Da Orks 'ave booted out da White Dwarf.

**GORKAMORKA  
GORKAMORKA  
GORKAMORKA  
GORKAMORKA™**

**DA FUTURVERSE IS GREEN**

**9**

Dis is wot it's all about.

**WE WUZ 'ERE FURST**

**20**

Wanna see how it works? Turn to the world's first Gorkamorka game report.

**ALL ALONG THE WATCHTOWER**

**32**

You'll be needin' a big 'ammer and some scrap to put your tower together.

**COLLECTING A MOB**

**34**

Andy Kettlewell knocks a couple of sprues into a well 'ard Gorkamorka mob over one weekend.





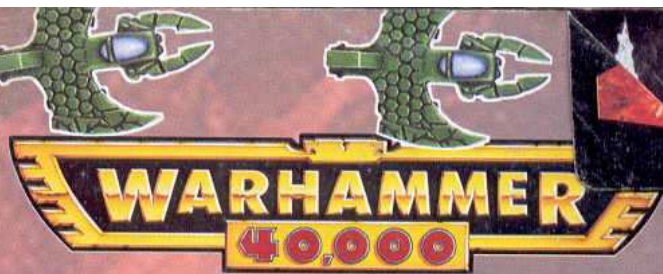

# WARHAMMER EPIC 40,000

## PATH OF THE ELДАР 50

We aren't talking crazy paving on Craftworlds here. We're talking tactics to defeat the galaxy's less sophisticated types.

## THE HAND OF FATE 64

Fate Cards for Epic and how to use them.



## AIR SUPERIORITY 94

Strap on yer goggles and put a coat hanger in yer scarf as we take off with a whole cargo of new stuff for flyers.

# WARHAMMER

## THORSKINSON'S ISLAND (PART 4) 39

Sunshine, palm trees and wholesale carnage in Return to Thorskinson's Island (Part 4).

## DIARY OF A COLD HEARTED SLAUGHTERER 85

Dark Elf shenanigans on Thorskinson's Island, by Iain Compton, aged 3 and a bit.

## MIGHT OF THE IMPERIUM 70

TAAANKS!!! Oh, and some infantry too as we showcase some cracking Imperial Guard armies.



## MAIL ORDER 102

Who's got all the gamey things you could possibly desire, including subscriptions, special deals and limited edition models? The Mail Order Trolls, that's who's got 'em.

**CORRESPONDENCE** We welcome comments about White Dwarf, Games Workshop games and Citadel miniatures. All letters except subscriptions and Mail Order should be addressed to: The White Dwarf, Games Workshop, Howard House, 16 Castle Boulevard, Nottingham NG7 1FL.

Please mark your envelope clearly with the name of the game you are writing to us about. If you want a reply you *must* enclose a self-addressed stamped envelope (overseas readers should include IRCs). We receive an enormous amount of mail. We do read every letter, but it may take a little time for us to reply to you, so please be patient!

You can find Games Workshop on the World Wide Web at the following internet address: <http://www.games-workshop.com>

**SUBMISSIONS** All material submitted to us

for publication is only accepted on the assumption that the copyright in it is, by the very act of submission, unconditionally assigned by the author as beneficial owner and with full title guaranteed to Games Workshop Limited. We also retain the right to edit and/or amend all material as we see fit. So, if you do not wish to assign copyright in this way, please do not send us your submission. We're afraid we cannot work in any other way!

**COPYRIGHTS AND TRADEMARKS**  
All subject matter in White Dwarf is © Copyright Games Workshop Ltd 1997.  
All artwork in all Games Workshop products, and all images contained therein have been produced either in-house or as work for hire. The exclusive copyright in the artwork and the images it depicts is the property of Games Workshop Ltd. © Copyright Games Workshop Ltd 1997. All rights reserved.

**REGISTERED TRADEMARKS**  
The following are all registered trademarks of Games Workshop Ltd.

Armageddon, Blood Bowl, Chivalry, Citadel, the Citadel logo, Dark Angels, Dark Future, Deathwing, Dungeonquest, Eldar, Eldar Attack, Epic, the Games Workshop logo, Games Workshop, the GW logo, The GW Flame logo, Genestealer, Slottabase, Space-Fleet, Space Marine, Talisman, Tyranid, Warhammer and Warmaster. Marauder is a registered trademark of Marauder Miniatures Ltd. Used with permission.

**TRADEMARKS**  
The following are all trademarks of Games Workshop Ltd.  
Aspect Warrior, Attila, Avatar, Blood Angels, Bloodletter, Bloodthirster, Cadian, Catachan, Codex, Daemoneer, Dark Reaper, Death Zone, Digga, Digganob, 'Eavy Metal, Exo Armour, Exarch, Eye of Terror, Farseer, Fire Dragon, Flesh Hound, Gargant, Gobbo, Gorkamorka, Great Unclean One, Gretchin, Grey Knight, Grot, Hunter Slayer, Keeper of Secrets, Khorne, Knights Panther, Leman Russ, Lichemaster, Lightning Claw, Lord of Change, Madboy, Man O' War, Mekboy, Mighty Empires, Mordian, Necromunda, Nob, Nurgle, Nurgling, Ogryn, Old World, Ork, Painboy, Plaguebearer, Plague Fleet, Psyker, Ratling, Ravenwing, Sea of

Blood, Skaven, Slaanesh, Slann, Snotling, Space Hulk, Space Wolves, Spanner, Squat, Squig, Swooping Hawk, Striking Scorpion, Tallarn, Terminator, Thunder Hammer, Troll Slayer, Tzeentch, Ultramarines, Valhalla, Warhammer Quest, Weirdboy, White Dwarf and the White Dwarf figure, Knights of the White Wolf, World eater, Yool. The Citadel paint pot is UK registered design No. 2032326  
Scatter dice are UK registered design No. 2017484.

Product Code: 6024999214  
  
5 011921 977130 >



# NEWS

Oi, humies! Lis'n up!





# Da Orks 'as taken over!

Do not adjust yer seats. We control da verticool, and we control da other thing too. Me, Snagdbitz, and my faithful mob of gallant Ork Boyz have leapt through da tellyporta (thanks to Mek Zakwiz for doing da business wiv da worky bitz) ter mount a daring and totally unexpected surprise raid on White Dwarf. After da pathetic resistance dat one expects from humies, we pulled 'em out from under da tables and tied 'em up with da grey plastic string wot comes out of da grey boxes. After all, da Boyz might get peckish later on!

Da barricades round White Dwarf are utterly feeble, so da Snots are building 'em up good and strong ter protect da gallant leader (ME - dat is!) while I make my broadcast ter da world. Snotpik? Snotpik, yer lazy grot, come 'ere and comb me hair squig. Now, hold da microphone up higher, dat's better. Ahem... Harrumf... Unaccustomed as I am ter public speaking...

**LIS'N UP, HUMIES! WE IS ORKS  
AND WE IS COMING TER GET YER!**

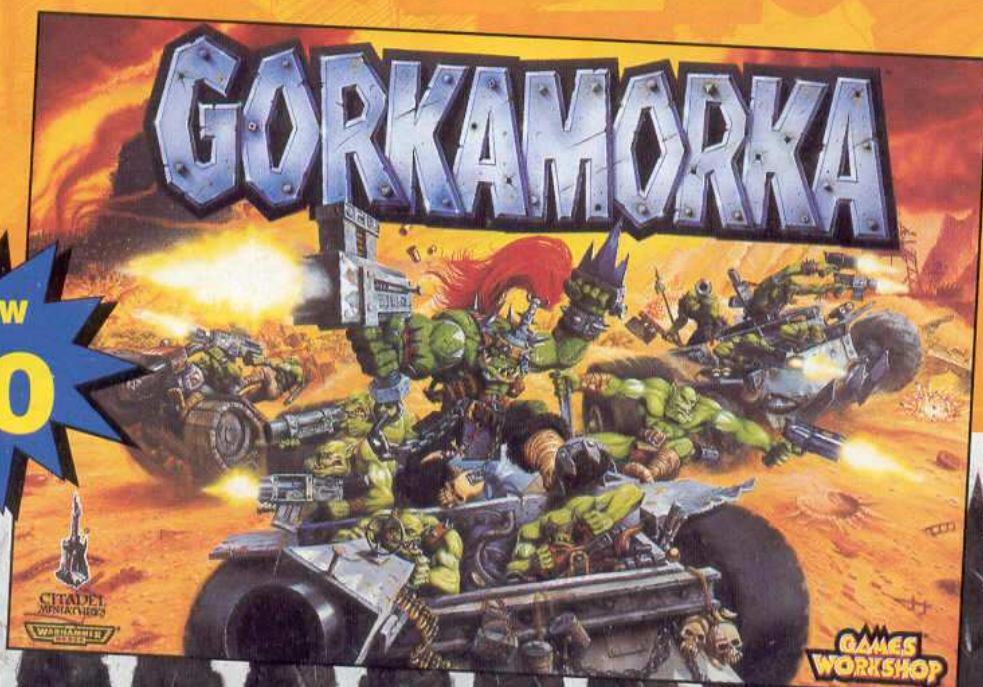

OUT NOW

**£40**



# NEWS

## MORE SCOUTS!

Question: When is a Space Marine not a Space Marine. Answer: When he's a Scout! New this month, hot on the heels of the Scouts boxed set, come Scouts in blisters! As all Imperial players know, with their special *Infiltration* skill Scouts are great for lightning raids on the enemy.

If you equip them with needle sniper rifles, you don't have to roll to wound, which makes them especially good against opponents with a high Toughness. Beautifully designed by Jes Goodwin, the new models include Scouts armed with needle sniper rifles, heavy bolters, and a Scout Sergeant. If you've just bought Storm of Vengeance, these new Scouts are just what you need for Veteran Sergeant Naaman and his squad of brave Dark Angels Scouts. Depending on how you paint them, these Scouts can be used for any Space Marine Chapter, and who knows, in a couple of years' time, your Scouts might grow into Space Marines!



## WARHAMMER 40,000

This month's Warhammer 40,000 releases

### SPACE MARINES

Space Marine Scouts with Needle Sniper Rifles (Three models per blister)	£5.00
Scout with heavy bolter (One model per blister)	£4.00
Scout Sergeant (One model per blister)	£4.00
Space Marine Scouts (Three models per blister)	£5.00

### This Month's Gorkamorka releases

Gorkamorka (boxed game)	£40
Rokkit Buggy (boxed set of one model)	£12.00
Wrecker Trukk (boxed set of one model)	£12.00
Ork Biker (boxed set of one model)	£7.00
Ork Nob (One model per blister)	£5.00
Spanner Boy (One model per blister)	£3.00
Boyz with Shootas (Three models per blister)	£5.00
Ork Weapons	£5.00
Gubbinz Bag	£5.00

Da Gubbinz bag is a great way ter get hold of all those extra bits and pieces for yer buggy. If yer can't squash da bits inside da engine, yer can glue 'em on da outside for extra protection. And if a zoggin' Grot nicks da bits for some ear-danglies, glue him ter da buggy instead!

### INDEPENDENT RETAILER IN MOSCOW

Games Workshop spreads out across the globe further than ever with the opening of our special first independent retailer in Russia, in the city centre of Moscow. Mr Sinyatkin's shop

opened in June, and business is brisk, big boxed games like Warhammer being particularly popular. We wish Mr Sinyatkin the very best of luck and hope that Games Workshop games prove as popular in Russia as they have everywhere else in the world.

*"Don't forget - when yer go ter da store always buy some green paint and some red paint - green fer da Boyz and red fer da buggies. And if yer mix 'em together yer get a really useful mud colour for da*

*gunz and da trousers."*





R

es

5.00

4.00

4.00

5.00

es

£40

2.00

2.00

7.00

5.00

3.00

5.00

5.00

5.00

hold of

99y. If

ie, yer

action.

ie ear-



Questing Knight Hero



Knight of the Realm

# SWORDS OF JUSTICE LANCES AND MORNING STARS TOO

We've tried, we really have, but we just can't stop Alan & Michael Perry making their wonderful Bretonnian models. First we have two foot models – a Questing Knight Hero and a Knight of the Realm Hero. An unmounted Knightly Hero is ideal for leading a regiment of commoners – because they're not riding a horse they can't be targeted by missile fire, and they bolster the unit's Leadership. And, by not forcing your Hero to ride a horse (some people are allergic to them), you save a whole 3 points which you could – er – spend on 3/5 of a Squire! Also new this month are some more special characters from Warhammer Armies Bretonnia. Tristran le

Troubadour and his faithful companion Jules le Jongleur come packed together in one blister. In addition to his Knightly virtues, Tristran has a choice of three ballads he can sing while fighting which have similar effects to magic spells (+1 combat score, 3+ magic dispel or Ld10 for unit he accompanies). Baron Odo d'Outremer and Suliman le Saracen come blistered individually. Odo's magic weapon, the Morning Star of Fracasse, gives him +2S in the first turn of any combat, while Suliman's warcry so terrifies his opponents that he can sometimes strike first in hand-to-hand combat.

# WARHAMMER

This month's Warhammer releases

## BRETONNIANS

Questing Knight Hero on foot (One model per blister)	£3.00
Knight of the Realm Hero on foot (One model per blister)	£3.00
Tristran le Troubadour & Jules le Jongleur (Two models per blister)	£8.00
Baron Odo d'Outremer (One model per blister)	£6.00
Suliman le Saracen (One model per blister)	£6.00

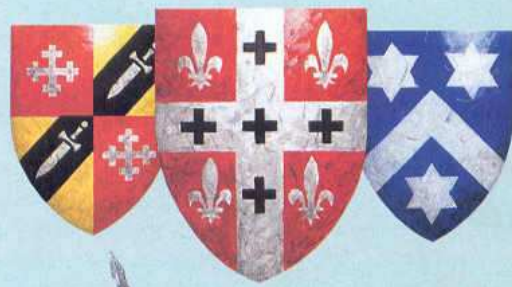

Left you can see Tristran le Troubadour and above, Jules le Jongleur.



Baron Odo d'Outremer



Suliman le Saracen

"A few good shoota shells should see 'em off!"





# NEWS



Above: A massive game of 40k at the French Games Day.

Right: The tables groan under the weight of Golden Demon entries at the US Games Day.



## GAMES DAY ON YER JOLLIES

"At Games Day play and make good cheer, for Games Day comes but once a year!" Or more than once if you happen to be a bit of a jet-setting

globetrotter. If you're feeling European, why not hop over to French Games Day in Paris, a city of untold delights – Notre Dame, the Louvre, the palace of Versailles and now... Games Workshop! We have three stores in Paris, all easy to get to on the Metro. If you're

feeling more adventurous, and are fond of hot weather, visit beautiful downtown Baltimore for Games Day US. This two-day event takes place in June, and incorporates the Golden Demon awards. Now's just the time to start thinking about next year's holidays!

## GAMES DAY & GOLDEN DEMON 97

As I write, Games Day (26th September, Birmingham NEC) is galloping closer and closer at the speed of – er – a great, big galloping thing. In fact, by the time you read this the galloping sound may already be receding into the

distance, but we thought we'd mention it anyway, because we're nice that way. There are some important things to remember about Games Day. Firstly, this is a ticket only event, and tickets must be bought in advance from a

Games Workshop store or by post from Mail Order. You can't just turn up on the day and get in, so please don't come along on the off chance! Games Day is also the venue for the UK's premier model painting championship – Golden Demon – so if you're planning to enter you don't have much time to finish off your regiment of badger-riding Goblins (or whatever you've dreamed up).

You may remember that two years ago we featured the complete Ultramarines chapter. Last year we had the Battle for Antoch Plains between the Bretonnians and Lizardmen. Those of you who have tickets to Games Day this year will be treated to another massive display. We'll have a feature on this diorama in a special Games Day edition of White Dwarf.

This red jeep was spotted by Andy Chambers when he was passing through San Francisco earlier this summer.

While everyone knows that "red wunz go fasta in 40K", only an Ork player could believe it was really true!



## ANDY'S NEW HAIR SQUIG

Style icon of the Studio, Andy Chambers, surprised everyone (including himself) by turning up for work recently shorn of his famous flowing locks. Now that Andy looks so smart, will Gav and Warwick follow his example? (No, I'm sure they're not man enough to rise to the challenge – Ed)



"Taking yer buggy out on da road without armour plating, let alone an 'eavy shoota is very foolish indeed. No wonder this Ork has had his new buggy nicked by Diggas."



"It's a good idea ter trim da hair squig once in a while ter stop it falling over yer eyes while you is firing da shoota."

Look out for Andy and Gav in this issue's Gorkamorka game report!

EL  
Cob  
Dre  
Eld  
Fire  
Nigh  
Nigh  
Pho  
Scor  
Supp  
Vamp  
War





"Hang on, where did this lot come from? Well I always enjoy bashing 'em on their pointy heads."

# FAST, FURIOUS AND DEADLY



Eldar Vyper Jetbikes

Eldar Falcon Grav tank

Eldar Night Spinner

Eldar Dreadnought

Eldar War Walker

We did it with the Space Marines, we did it with the Orks and last issue we did it with the Tyranids! Now its time to unleash the mighty Eldar upon you! The Epic 40,000 Eldar army is now ready to attack and the Space Marines, Orks and Tyranids had just better watch out, these guys are dangerous. The Eldar are more than a match for any enemy force.

We take a closer look at the deadly troops as well as the exotic weaponry of the Eldar race in **Path of the Eldar**, later in this issue.



This month's Epic 40,000 releases

## ELDAR

Cobra Super Heavy Grav Tank (One model per blister)	£6.00
Dreadnoughts (Four models per blister)	£4.00
Eldar Command (Three models per blister)	£5.00
Fire Prisms (Three models per blister)	£5.00
Night Spinners (Two model per blister)	£5.00
Night Wing Interceptors (Five models per blister)	£5.00
Phoenix Bombers (Three models per blister)	£5.00
Scorpion Super Heavy Grav Tank (One model per blister)	£6.00
Support Weapons on Grav Platforms (Five models per blister)	£4.00
Vampire Raider (One model per blister)	£7.00
War Walkers (Four models per blister)	£4.00



## IT'S ONLY A GAME, BOYZ!

From left to right, Gerritt and Marcus from White Dwarf Germany and Oriol and Jordi from White Dwarf Spain try out Gorkamorka for the first time, during their recent UK studio visit. Whilst Gerritt and Jordi enjoy with their game, Marcus congratulates Oriol for his victory in typically Orky fashion!

## GAMING CLUBS ON LINE

The first official Games Workshop Club opened in Lincoln on September 11th. This is the first of many official-clubs that will be opening around the country. All the clubs will have a large supply of gaming tables and terrain for you to use, as well as a painting area.

The second club will open in Watford at the end of September, and we'll be opening more clubs every month. More news will follow soon, but if you'd like to know more now please write to: **GW Clubs, Games Workshop, Chewton Street, Hilltop, Eastwood, Notts, NG17 3HY.**

Now, on wiv da mag...



# GORKKA





# WARROCKA





GORKAMORKA

GORKAMORKA

GORKAMORKA

GORKAMORKA

GORKAMORKA

GORKAMORKA

## TRAKS 'N' TRUKKS

Spinning and skidding, trukks and traks carry the Boyz into battle.

## BITZ

The battlefield is strewn with barrels, fuel cans and barricades, to smash, crash and crunch into!

It's finally here! Gorkamorka has arrived and we're going to introduce you to this crazy game of high speed buggies and green skinned monsters!



## ORK MOBS

Brutal Nobs lead their mobs of savage Boyz into combat.

## TEEF

Orks fight to recover scrap and trade in for huge piles of teef!

## 'ARD BOYZ

The more you fight the harder you get, the harder you get the more teef you can earn – it's a grand life!

## A WHOLE NEW WORLD

The Gorkamorka box has everything you need to get started, with enough models for two mobs. And that's not all – take a look at the Rokkit Buggy, Wrecker Trukk, Spannerz and Nobz later in this article to see just some of what's in store for Gorkamorka.

## DA FORT

In the desert Ork mobs build huge forts in the desert out of scrap.

with  
to





# GORKAMORK G

## SHOOTING: TO HIT

Use the shooter's BS to find the D6 roll needed to hit the target. A roll of 1 always misses.

BS	1	2	3	4	5	6	7	8	9	10
D6	6+	2+	3+	3+	2+	1+	5	-1	-2	-3

### HIT MODIFIERS CHART

- 1 Target in partial cover
- 2 Target in cover
- 1 Appearing/disappearing or changing target (Overwatch only)
- 1 Firing from a vehicle which used its thrusters
- 1 Target used its thrusters
- +1 Large target (All vehicles except bikes)
- 1 Small target
- +/- Weapon to hit modifiers for range

## SHOOTING: TO WOUND

Compare the hit's Strength with the target's Toughness. The result is the D6 score needed to inflict a wound.

STRENGTH OF HIT	Toughness									
	1	2	3	4	5	6	7	8	9	10
1	4	3	2	1	0	0	0	0	0	0
2	3	2	1	0	0	0	0	0	0	0
3	2	1	0	0	0	0	0	0	0	0
4	1	0	0	0	0	0	0	0	0	0
5	0	0	0	0	0	0	0	0	0	0
6	0	0	0	0	0	0	0	0	0	0
7	0	0	0	0	0	0	0	0	0	0
8	0	0	0	0	0	0	0	0	0	0
9	0	0	0	0	0	0	0	0	0	0
10	0	0	0	0	0	0	0	0	0	0

Biggest vehicles roll for hit location at the back of D6 Rows, then equal or best armour by rolling D6+ the weapon's Strength.

WEAPON SUMMARY	RANGE	BS	STRENGTH	WOUND	DAMAGE	ARMOUR	NOTES
Bow	12 18	-1	3	+1	1	4+	Move or fire
Crossbow	12 18	-1	3	0	1	4+	Knockback
Shoots	6 18	-1	4	0	1	4+	
Kannoh	6	+3	3	0	1	4+	
Blunderbuss	6	+3	3	0	1	4+	Double handed. Opponent wins if
Bludge	6 12	+1	3	0	1	4+	
Uge club/Choppe			user +2	varies	1		Opponent can't block. Fortifies
Club/Choppe			user +1	varies	1		+1 Initiative. Throw once per ga
Knife/Ruckles			user +1	varies	1		+1 Initiative. Throw once per ga
Chain/Flail			user	varies	1		+1 Initiative. Throw once per ga
Spear	6	+1	3	0	1	4+	3 Shots
Six Shoots	6 12	+1	5	-2	1	4+	3 Shots
Eight Shoots	20	40	-1	5	-3	0+	8+
Rokkil Launcher	12 18	-1	D6+2	-2	0+	4+	3 Shots
Harpoon Gun	12 18	+1	4	-1	1	4+	3 Shots
Speay Gun	12 18	+1	4	-2	1	4+	3 Shots
Scorchie			template				









## ORK MOBZ

Each Ork mob has its own distinctive markings and mob colours which are used to distinguish its vehicles and warriors from those of other mobs. These markings and colours are decided by the mob's Nob. If he really likes big glyph tattoos then you can be sure all his Boyz and Yoofs will have these on their arms and faces. Because of this there are no hard and fast rules about how to paint your mob but there are lots of ways to make your models look dead Orky.

*This trak has been painted using only black, white and bolt gun metal. Limiting yourself to a small range of colours when painting your models will help you to paint them quicker and also gives your mob a very strong and striking colour scheme.*



## ORK NOBZ

Since the traditional enemies of the Orks (Space Marines, Eldar, etc) aren't around, the Orks will happily fight each other! A mob's allegiance is to its leader, the Nob, who "shows 'em 'ow ta give da enemy a good kickin'!"



*Below: This mob's main distinguishing marks are the lightning bolt glyph and the black and white check pattern. As well as using these to decorate the trak, they also appear on the Boyz. The checks have been used on their clothing, whilst the lightning bolt is used as a tattoo.*



*Painting different designs transfer sheets or splendid with ham noting the artistic ab*

## ORK BIKES

Every Ork Nob likes to have a bike or two in his mob. These are the fastest vehicles in the Skid, the Ork riders driving far ahead of the rest of the mob to attack the enemy as quickly as possible.





## “ROKKIT BUGGY”

This is an example of a typical Ork buggy. It's been fitted with a huge ram and has an impressive rokkit launcher mounted on it. The rokkit launcher will blow apart a vehicle or the gate of a fort with no problems. OK, the crew may be deafened for a few days after a battle, but it's worth it because every mob for miles can hear each time they blow something up!



Painting designs and patterns on your Ork vehicles can be done in a number of different ways. If you have a steady hand you can simply paint your chosen designs straight onto your model. We've included some handy waterslide transfer sheets in the box. These can be very useful as the sheets contain many different glyphs and patterns. Some splendid results can be achieved by combining the transfers with hand painted motifs and patterns. It's worth noting that Orks are not renowned for their artistic abilities!



Above and right: Side and front detail shots of the Ork driver and gunner.





## “WRECKER TRUKK”

Any truck or buggy fitted with a wrecker ball is dangerous opposition. Whatever the wrecker ball hits, it smashes to bits. A wrecker ball is just a massive iron ball on the end of a crane, so it's really easy for the Spannerz to knock together out of scrap.

Of course, it's a bit risky having a huge iron weight swinging about on the back of a speeding truckk, but the Boyz still think it's great because it's simply the best thing for bashing in enemy vehicles! This truckk has a big ram bolted to the front for extra bashing power.



Right: With this mob we've used bolt gun metal as a base colour. For patterning and Orky glyphs we've chosen a bold, bright yellow.



Below: When choosing a colour scheme for your Orks, remember that Orks are a savage, brutal race. Their clothing is simple and practical, being made from leathers, furs and animal hides, whilst the tattoos they bear are meant to be intimidating, depicting skulls, fangs, lightning flashes and so on.



Above: If you're going to use very bright colours when painting your models, then one good tip to bear in mind is that bright colours always stand out more if the rest of the model is painted in neutral colours. The clothing of the Orks pictured above has been painted using neutral browns, which makes the bright yellow of their patterning and tattoos look really vibrant.





*This Nob likes to slug it out up close and personal.*



*The Spannerz have the Know-wots to keep the mob's vehicles up an' runnin'!*



*Orks just love their shootas!*

*This truk has been decorated with lots of bright, flashy patterns and Orky glyphs. Orks take great pride in their vehicles and constantly try to outdo rival mobs by making their buggies and traks the snazziest vehicles around.*



*One way of making your vehicles look distinctive is to make them appear beaten up and battle-worn. The truk shown here has been made to look as if it has been in a few battles by painting the glyphs and other decoration so they seem chipped and worn.*





## DA MEKBOY WORKSHOP

One of the best things about the Gorkamorka game is that you can approach building up your vehicles just like a Mekboy. Orks bash their vehicles together out of bits of scrap so you can just dive in and glue yours together with a cheerful disregard for the usual niceties of painstakingly assembling your models.

This also means that converting your vehicles by changing guns and adding on extra gubbins like wrecker balls is really easy. Building Ork vehicles like this gives your mob that really personal touch and means that no two models will ever look the same.

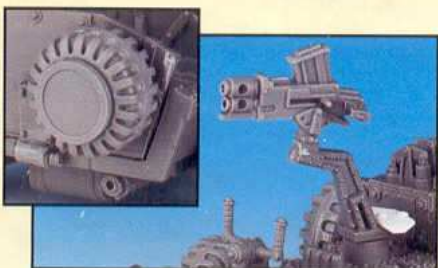

Converting a model is really just the process of adding bits to or taking bits away from the original kit. Many keen modellers find they start to acquire lots of spare bits of scrap which can be kept in a 'bits box' and used for all kinds of modelling projects.

The pictures above show what can be done by just using a craft knife to scrape away bits of plastic and make your vehicles look battle damaged and riddled with bullet holes.

## CONVERTING YOUR MODELS

As you fight more battles you can add extra warriors and vehicles to your mob. You'll soon need kustomised weapons, gubbins for your vehicles, and then you can start getting into da pinnerkal of the Mekboyz' art by converting your weapons and vehicles.

*Below: This model has been made using parts from a standard Gorkamorka truck kit, with additional parts like the wheelguards and the front armour plating taken from a Warhammer 40,000 Ork Warbuggy kit.*



*This buggy is a stripped down Warhammer 40,000 Ork warbuggy, with a few bits from a Gorkamorka truck added to it.*





# KRUKSKUL'S KRIMS

This is an example of a fairly experienced Gorkamorka mob. All of the vehicles and Boyz have been heavily converted by Mike McVey using all manner of materials and spare bits of Citadel miniatures.



Above: The roll cage on this truck has been made using brass tubing, whilst the tip of the harpoon gun is actually the speartip of a Warhammer Orc Boarboy. Notice also the amount of extra canisters, sacks and boxes that have been added to the truck.



The crossed choppas is the mob symbol of Krukskul's Krims, and features prominently on all their vehicles.



Nob Krukskul, like all of the Boyz in this mob, has been converted using the upper body of a Warhammer 40,000 Boarboy, and the legs of a normal plastic Gorkamorka boy.



Ork Boy Skinna



Ork Boy Grizlob



## IN THE BEGINNING

So that you can get a better idea of just how much conversion work has gone into the vehicles on this page, the pictures below show you exactly how they looked before they were painted.



White areas on the vehicles have been made using plasticard cut to the right shapes.



The heavy shoota turret on this trak has been repositioned closer to the driver, and armour plating made from small squares of plasticard has been added over each trak.











# GORKAMORKA®

## TURN I

**Gav:** Da Leg Snappas arrive at the battlefield first and move on from the dunes near the mining shaft. Gazgrim's Danger Boyz arrive shortly after near the fort, and Badgutz, the Morka Boss, immediately shouts to his boyz to attack.

The Morka truk (Skumsmasha) races towards the abandoned watchtower but is going so fast that Snazmek skids out of control just in front of the tower and narrowly avoids all the barricades around it! The Morka trak speeds towards the mine shaft and the scrap hidden in the rocks, but just as it reaches top speed the engines splutter sending the trak skidding across the desert as well.

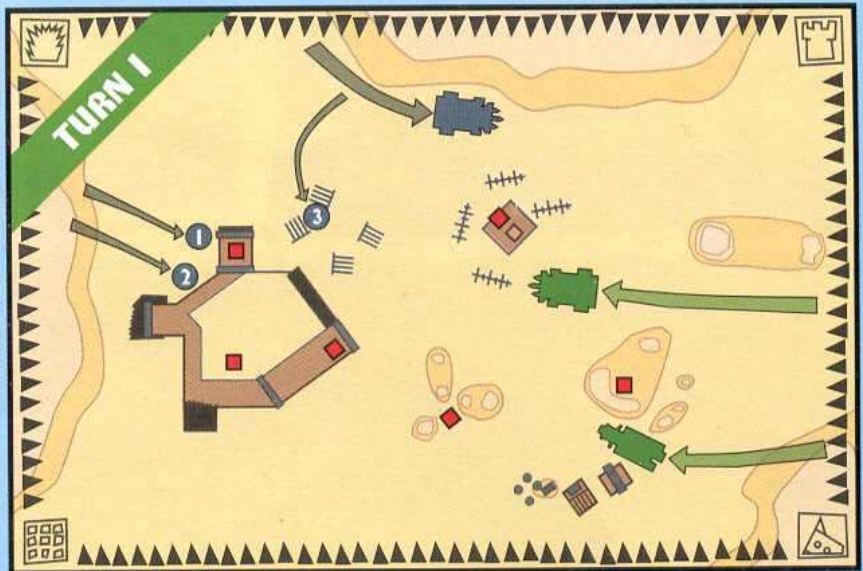

**Andy:** Seeing the Morka mob bearing down on him, Gazgrim orders his Danger Boyz to attack. Rukfang and Morgskull run towards the fort and the rest of the Gorka mob race at top speed on their truk (Da Krusha) towards the Morkas! As they pass the fort Blagrot, the Gorka Spanner, jumps off Da Krusha and runs off towards the fort eager to get his hands on some scrap. Gazgrim ignores Blagrot and shouts at Snograt to drive as fast as he can. Time after time Snograt hits the injector button, until the thrusters malfunction and Da Krusha skids out of control on the opposite side of the watchtower from the Morkas!



### ANDY'S MOB - GAZGRIM'Z DANGER BOYZ

-  Trukk "Da Krusha" carrying Gazgrim, Snograt, Skabsnik, Tuffgit and Grog.
- 1** Morgskull
- 2** Rukfang
- 3** Blagrot

### GAU'S MOB - DA LEG SNAPPAS

-  Trukk "Skumsmasha" carrying Badgutz, Snazmek, Wazzgrond and Krumpslug.
-  Trak "Skumdakka" carrying Mekgrub, Snikdreg and Dakkasnik
-  Scrap

## TRUKKS 'N' TRAKS

All vehicles on Gorkamorka have two types of engine – gas and thrusters. Gas engines are slow, and allow the vehicle to move up to 6" per turn. They are mainly used to turn tight corners and get out of tricky situations.

Orks love thrusters. When an Ork driver presses that big red button, the trak or truk thrusts forward and, until something goes wrong, the Ork will just keep pressing da button! When you are playing Gorkamorka, every time a vehicle uses its thrusters it moves up to 6" straight ahead but you must test to see if the thrusters malfunction. The first time you use thrusters they malfunction on a D6 roll of a 1, the second time on a roll of a 1 or a 2 and on the third and subsequent times they fail on a 1-3. You don't have to thrust but once you start you can't really stop yourself from thrusting, you just have to press that button (just like an Ork!). If the thrusters malfunction then the vehicle will do something wild and unpredictable like spinning out of control or skidding across the desert! Turning while thrusting is also very difficult and drivers must pass a Leadership test to turn. If they fail their vehicle will be sent skidding out of control.

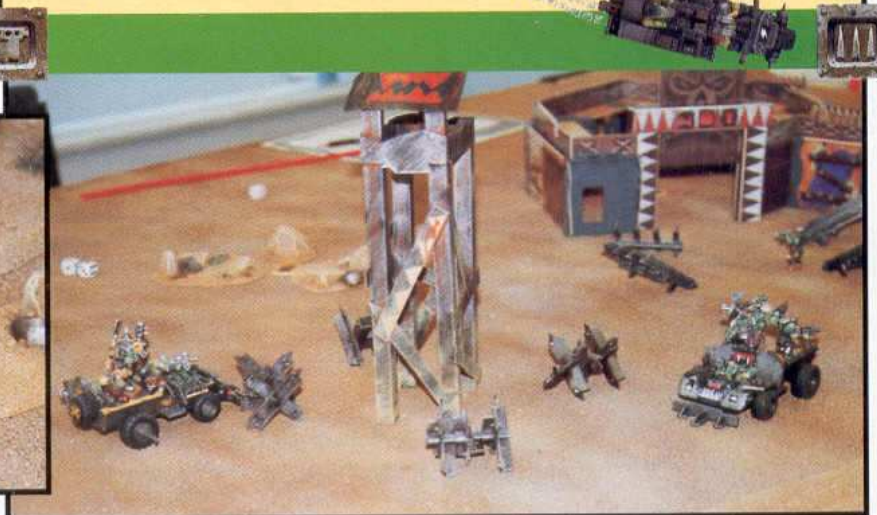



### TURN 2

**Gav:** Realising there is a chance to ram the Gorkas, Snazmek skilfully controls Skumsmasha's skid and manoeuvres around the dangerous barricades and hits the thrusters. Seeing even more barricades rapidly looming in front of him, Snazmek attempts to turn but instead skids out of control again in front of even more barricades.

**Andy:** After the Morkas stopped shooting Gazgrim and his boyz bellow a mighty Waaagh and Snograt continues to drive Da Krusha around the watchtower. Unfortunately, the thrusters malfunction as soon as he hits the big red button and sends the truck skidding out of control, rather messing up the Gorkas' glorious getaway! Attempting to salvage some self respect from the situation Gazgrim shoots at the Morkas behind him but his shot is deflected harmlessly off the truck's side.

### DAKKA! DAKKA!!

Orks love guns with plenty of 'dakka', such as machine gun type weapons and the best way get the loudest noise out of these weapons is to hold the trigger down longer! This is called firing on full auto. If an Ork is firing a sustained fire weapon you first roll the sustained fire dice to see how many shots you get, and then roll to hit for each shot!

Completely ignoring all the action around the watchtower, Morgskull and Rukfang start to climb the fort walls to get closer to the scrap. Blagrot, however, ignores

Meanwhile Mekgrub had driven his trak (Skumdakka) around the densely packed rocks and Dakkasnik leapt off to collect some scrap. Still fuming with anger, Badgutz orders his whole mob to shoot at the Gorka truck and immediately a rain of bullets flies at the Gorkas, but all go wide and Badgutz howls in frustration.

the scrap altogether and chooses instead to try out a new weapon bought in Mektown - da stikkbomb! Crouching behind the barricades he lobs a stikkbomb towards the Morka truck, but the bomb misses and explodes right in front of the vehicle.

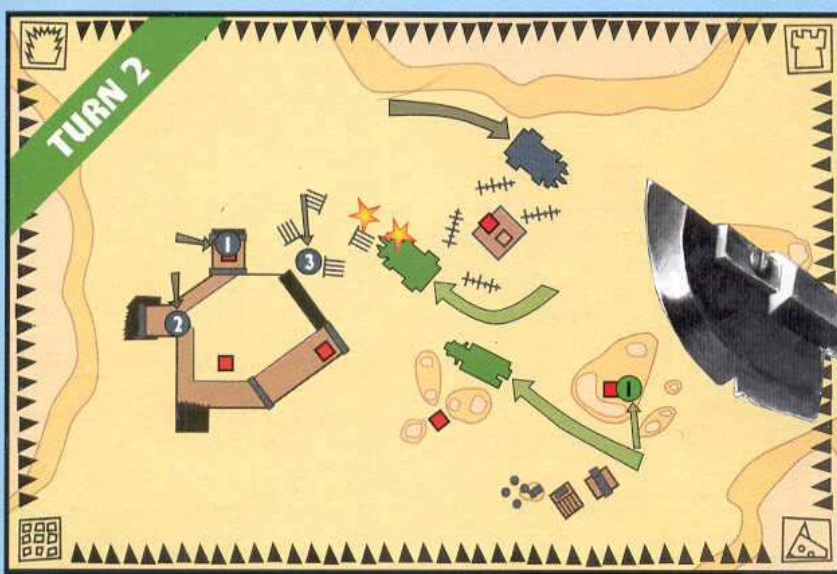

#### ANDY'S MOB - GAZGRIM'Z DANGER BOYZ



Truk "Da Krusha" carrying Gazgrim, Snograt, Skabsnik, Tuffgit and Grog.



Morgskull



Rukfang



Blagrot

#### CAU'S MOB - DA LEG SNAPPAS

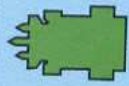

Truk "Skumsmasha" carrying Badgutz, Snazmek, Wazzgrond and Krumpslug.

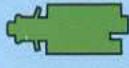

Trak "Skumdakka" carrying Mekgrub and Snikdreg

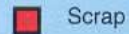

Scrap



Dakkasnik





# GORKAMORKA®



## TURN 3



**Gav:** Further angered by the stikkbomb, Badgut leaps from Skumsmasha and charges Blagrot. Seeing their Boss charging, the rest of Da Leg Snappas start chanting MORKA, MORKA, MORKA as loud as they can. To get a better view Snazmek slowly manoeuvres Skumsmasha out of the brutal array of barricades and Mekgrub races Skumdakka past the watchtower. At the last moment Mekgrub realises that he has missed the action and attempts to turn, but is going too fast and skids into a huge sand dune.

Badgut is completely oblivious of the chaos behind him as he charges and swings his massive choppa at the Gorka Spanner. Unfortunately Blagrot is ready for him and, using a stikkbomb as a club, he knocks the Morka Boss out cold! GORKA, GORKA, GORKA!



### ANDY'S MOB - GAZGRIM'Z DANGER BOYZ



**Trukk "Da Krusha"** carrying Snograt, Skabsnik, Tuffgit and Grog.



1 Morgskull



2 Rukfang



3 Blagrot



Gazgrim

### GAU'S MOB - DA LEG SNAPPAS



**Trukk "Skumsmasha"** carrying Snazmek, Wazzgrond and Krumpslug.

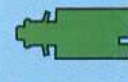

**Trak "Skumdakka"** carrying Mekgrub and Snikdreg



Scrap



Dakkasnik



Badgut

## CHARGIN'

In Gorkamorka models may charge at any time during the movement phase so warriors can race towards the enemy mob on their trukks and still charge off them in the same turn. If warriors jump off vehicles while they are thrusting, however, they may get hurt but that doesn't seem to stop most Orks!



**Andy:** Gazgrim's face contorts into a hideous grin as he sees the Morka Boss fall and be carried away by Snograt and Da Krusha. As they move round the watchtower Dakkasnik, who has been waiting for a bit of the action, opens fire on the vehicle with his six-shoota but misses. Outraged by the Morkas' attempt to hit him, Gazgrim waits until Da Krusha is near enough and then charges at Dakkasnik while the truck is thrusting! Obviously ready for the charge Dakkasnik hits and wounds Gazgrim, but the huge Gorka Boss howls with rage and refuses to go down (only suffering a flesh wound).

Meanwhile, back at the fort, Rukfang and Morgskull have reached the scrap and Blagrot readies himself to throw another stikkbomb. This time the stikkbomb hits the Morka truck but explodes around the engines! Shrapnel ricochets off the thick armour plates protecting them.





### TURN 4

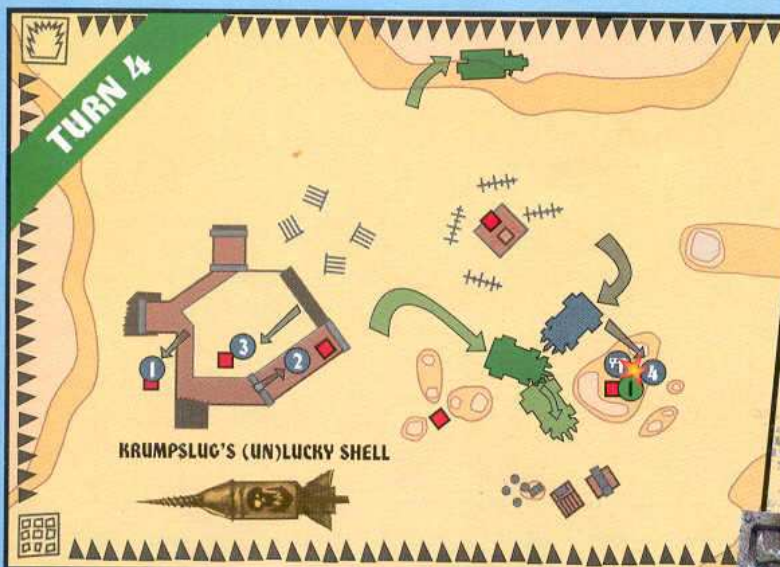

### RAMMIN'

As you can well imagine, ramming is very destructive in Gorkamorka, not only to the vehicle being rammed, but the vehicle ramming too! Gav's Morka mob luckily avoided all the rams this turn by his drivers passing Leadership tests to swerve out of the way. If he had failed these tests both mobs' vehicles would have suffered automatic damage! Some rams are more destructive than others, shunting for example (ramming from behind) only causes 1 damage to the vehicle being rammed, while head on rams cause D6 damage to both vehicles and may immobilise them too!



#### ANDY'S MOB - GAZGRIM'Z DANGER BOYZ



Trukk "Da Krusha" carrying Snograt, Skabsnik and Tuffgit

1

Morgskull

2

Rukfang

3

Blagrot

4

Grog.

Gazgrim

#### GAU'S MOB - DA LEG SNAPPAS

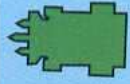

Trukk "Skumsmasha" carrying Snazmek, Wazzgrond and Krumpslug.

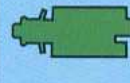

Trak "Skumdakka" carrying Mekgrub and Snikdreg



Scrap

1

Dakkasnik

### TURN 4

**Gav:** In obvious difficulties, Mekgrub carefully steers Skumdakka off the sand dune but the Trak's thrusters malfunction at the last moment and he finds himself skidding across the dune again. Snazmek has more luck with Skumsmasha and turns away from the barricades with some impressive skill, ready to thrust towards Dakkasnik and give him a hand. Again the thrusters malfunction and the truck skids right in front of the rocks. Seeing their chance, the crew of Skumsmasha shoot at the Gorka truck. Krumpslug hits the Gorka driver with his Kannon, but his shot is deflected off the truck's armour. Eager for another shot Krumpslug looks around, but can't find any more bullets. He has used his one and only lucky shell!



Encouraged by his mob racing to help him, Dakkasnik fights the Gorka Boss again and is wounded, but battles on!

**Andy:** Wanting to prove his fighting prowess, Grog charges off Da Krusha after his Boss, and attacks the wounded Dakkasnik in close combat. Snograt, realising there is a chance to ram something, puts his foot down on the accelerator and aims towards the Morka truck. At the last moment Snazmek swerves to avoid the ram but only manages to swerve in front of Da Krusha and instead of having another go Snograt stays behind the Morkas and starts a chase. As the Morka truck swerves into his firing line, Skabsnik lets loose with his heavy shoota on full auto. Shells glance off the truck's wheels and its crew compartment but no-one is hit! Tuffgit has a go with his six-shoota as well but his shots glance off the engines.



Grog's charge surprises both his Boss and Dakkamek, but he fails to hurt the Morka. While Dakkamek is distracted however, Gazgrim falls the Morka with his choppa. Seeing his opponent defeated he shouts a mighty Waaagh and picks up the Morka's scrap.



# GORKAMORKA

## TURN 5

**Gav:** The chase is on! Snazmek tries desperately to shake the Gorka truck off his tail and heads towards a rock face, but just as the two trucks come to the rocks, Skumsmasha's thrusters malfunction sending the vehicle spinning out of control! Behind them, Snograt manages to avoid the Morkas and steer Da Krusha around the spinning truck. As he goes past Skabsnik lets loose with another salvo from his heavy shooter and damages the Morka truck's wheels, slowing it down. The Morkas on the truck return fire but are too preoccupied with hanging on to the spinning vehicle to hit! Near the watchtower Mekgrub finally gets his trak yet again off the sand dune but as he hits the thruster button the engines malfunction, and the trak spins wildly towards some barricades!

**Andy:** Laughing at the Morkas, Snograt tries to ram their truck again but Snazmek swerves to avoid it and ends up nearly crashing into the rock face. Hearing Gazgrim shouting, Snograt races over towards his Boss, and Grog and Gazgrim jump back on to Da Krusha as he goes past. Now the chase has finished Rukfang, Blagrot and Morgskull stop watching the action and start to drag their scrap away from the fort.

### ANDY'S MOB - GAZGRIM'Z DANGER BOYZ



Trukk "Da Krusha" carrying Snograt, Skabsnik and Tuffgit



1 Morgskull



2 Rukfang



3 Blagrot



4 Grog



Gazgrim



Trukk "Skumsmasha" carrying Snazmek, Wazzgrond and Krumpslug.



Trak "Skumdakka" carrying Mekgrub and Snikdreg

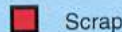

Scrap



## CHASIN'

Just like movies, most good Gorkamorka games have a chase scene in them. If a vehicle ends its movement within 2" behind an opposing mob's vehicle then they can choose to chase. In a chase when the vehicle in front moves in its turn the chasing vehicle is automatically moved with it and may shoot in its shooting phase. The only way to shake off a chasing vehicle is to keep thrusting and turning and hope that the chasing vehicle fails its thruster tests before you do!

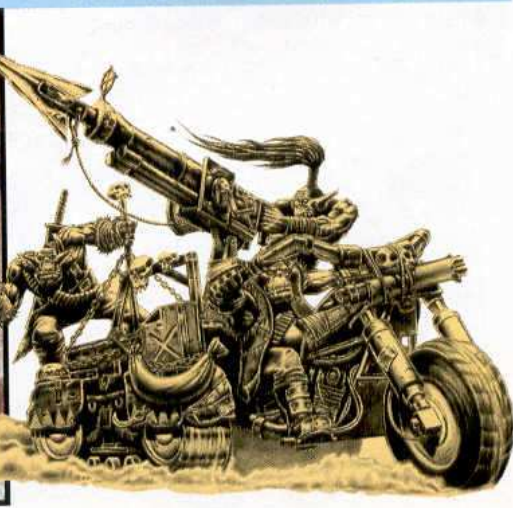



### TURN 6

**Gav:** Cursing the Gorkas, Snazmek reverses Skumsmasha out from the rocks and Wazzgrond shoots at the Gorka trukkk with his shoota but misses. When Mekgrub sees that he has got a chance to ram the Gorka trukkk he hits the red thrusta button but again the engines malfunction and the vehicle spins! As Mekgrub and Snikdreg hang on they curse the name of the Mekboy who built Skumdakka.

**Andy:** Not believing his luck, Snograt races Da Krusha forward towards the spinning Morka trak. Unfortunately just before the two vehicles hit each other Da Krusha spins out of control and gives the Morkas just enough time to regain control and swerve out the way! With all the spinning vehicles around him Gazgrim

decides to take matters into his own hands. Leaping from Da Krusha, Gazgrim boards the Morka trak, swiftly followed by his new apprentice Grog! As the two Gorkas land on the trak Tuffgit, the Gorka Yoof, shoots his six-shoota at it as well, narrowly missing his own Boss. Gazgrim makes a mental note to 'talk' to Tuffgit after the fight. On the trak Grog attacked Mekgrub while his boss Gazgrim fought with Snikdreg.



### CARRYIN' SCRAP

Scrap is very important to Gorkamorka mobz, but it is also very heavy and slows warriors down while they try and run around the desert and hit other mobz.

The best way to carry scrap is to throw it on a vehicle and let it carry the scrap round while the warriors get stuck in!

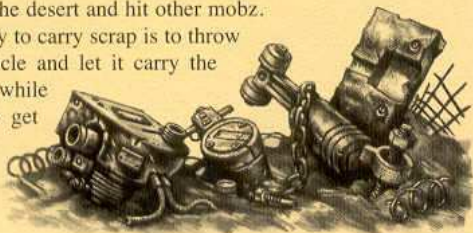

#### ANDY'S MOB - GAZGRIM'Z DANGER BOYZ



Trukkk "Da Krusha" carrying Gazgrim, Grog, Snograt, Skabsnik and Tuffgit



Morgskull



Rukfang



Blagrot

#### CAU'S MOB - DA LEG SNAPPAS



Trukkk "Skumsmasha" carrying Snazmek, Wazzgrond and Krumpslug.

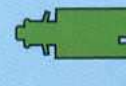

Trak "Skumdakka" carrying Mekgrub and Snikdreg



Scrap





# GORKAMORKA

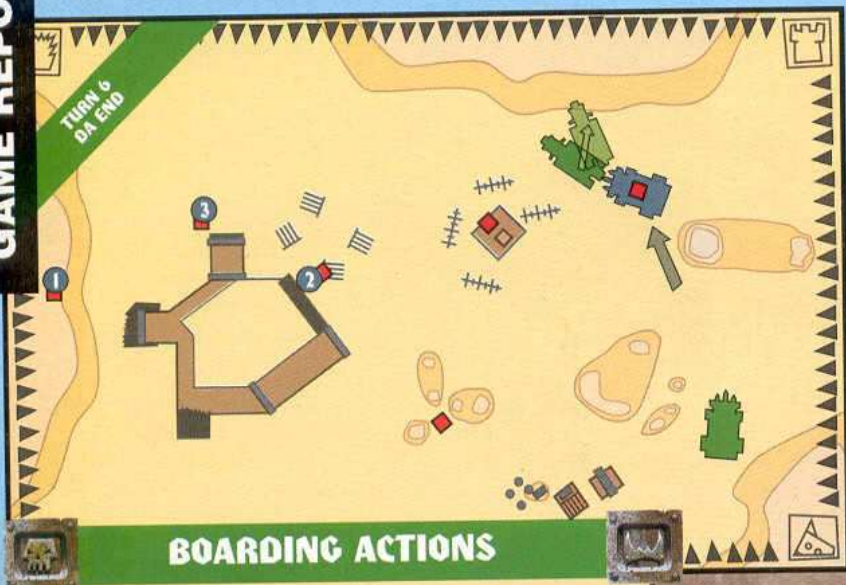

**Andy K:** I've focused in on the combat between *Da Krusha* and *Skumdakka* during Andy's sixth (and as it happens final) turn. It demonstrates how fast things can happen in Gorkamorka and was one of the turning points of the game.

The Morka trak thrusts off the dune but the thrusters malfunction sending the vehicle spinning across the desert. The Gorka trukks attempt to ram the trak but its thrusters also malfunction and the trukks skids forwards and spins. The trukks skids so far that it comes into contact with the trak and collides with it! The Morka driver passes his Leadership test to swerve out of the way and then Andy charges his Nob and one of his Yoofs off his trukks and onto the Morka trak. Amazingly both warriors pass their Initiative test to leap on board the trak and each attacks one member of the crew. In the one-on-one close combat that follows Andy's Yoof is hit, wounded and thrown off the vehicle by the driver, but Andy's Boss does the same to the Morka gunner! WAAAGH GORKA!

One of the most exciting parts of Gorkamorka are boarding actions. Warriors may board opposing mob's vehicles by charging them if they are on foot or, if they are riding on a vehicle, they are within 2" of an opposing vehicle. To successfully leap aboard, warriors must pass an Initiative test. If the warriors manage to get on they fight a round of hand-to-hand combat with one member of the crew. If they manage to win then they move onto the next member of the crew and so on until they have wounded all the crew, or the crew throws them off!



The more experienced Mekgrub gets the better of Grog and wounds him, throwing the Gorka Yoof off the trak. Gazgrim is far more successful and casually knocks Snikdreg off the vehicle.

**Gav:** After losing their Boss and two of their boyz, the sight of the Gorka Boss

boarding one of their vehicles was all too much for Da Leg Snappas (Gav unfortunately fails his bottle roll for the mob and the game finishes, as it would do in Necromunda). They decide to get

back to Mektown while they still have a chance. These Gorkas are 'ard, and besides, there is a certain Mekboy they want to talk to about their trak's dreadful thruster engines!

## DA END

**Andy K:** Trukks and traks skidding and spinning across the desert, brutal hand-to-hand combat, merciless shooting, dangerous chases and pirate boarding actions — sounds like a typical game of Gorkamorka to me!

For all their efforts Da Leg Snappas just couldn't do any damage to Gazgrim's Danger Boyz, but the Gorkas did what Gorkas do best, they hit people... hard. The turning points of the battle have to be the loss of the Morka Nob, the brilliantly

named Badgutz, and the Gorkas' boarding action on the last turn of the game. Boarding is normally very hard because warriors have to pass an Initiative test to leap on safely, but Andy managed it quite comfortably and once his Boss was on the trak there was no stopping him.

So here ends a day in the life of two Ork mobz... well, not quite. Fighting battles with your mob is only part of the game. Gorkamorka can be played as one-off battles as Andy and Gav did here, but it can also be played as a campaign where

players use the same mob in many battles. During games their warriors earn more experience and learn new skills which they can use in the next game.

There are plenty of places you and your mob can visit in Mektown between games to increase the size of your mob and make it 'arder. Da Mekboyz Workshop, Da Doc's Serjery and Da Job Pole are just a few such places, but as with everything in Mektown they are all very unreliable, so don't expect to get what you pay for when you visit! OK, now you've seen just how exciting Gorkamorka is...

# LET'S START FIGHTIN'!





Call in to your local store if you think you're 'ard enough and tell the staff that **YOU** are ready to **RUMBLE!**

# LE!





# ALL ALONG THE

Wow! Not only is there a huge feature about Gorkamorka, a step-by-step guide to collecting and painting an Ork Mob *and* a Game Report between Andy C and Gav in this issue, but we've also given you a **bonus building as well!** The watchtower is a great piece of tabletop terrain and it's simple to assemble. As the tower is printed on pre-punched card, the only equipment you'll need is some Citadel superglue. Just be careful that you don't get glue on your fingers: superglue bonds really fast and very strong! You can see the completed watchtower in *I Wuz 'Ere Furst*, the Gorkamorka Game Report.

## 1. THE TOWER LEGS

As you can see in diagram 1, fold each of the tower legs (1a,1b,1c,1d and 1e) round to make a rectangular tube. Apply a little glue to the tabs and fold the tower legs together (If you want, use some paper clips to hold them together until they are dry). Fold in the ends (1c,1d and 1e) and glue them into position.

Diagram 1

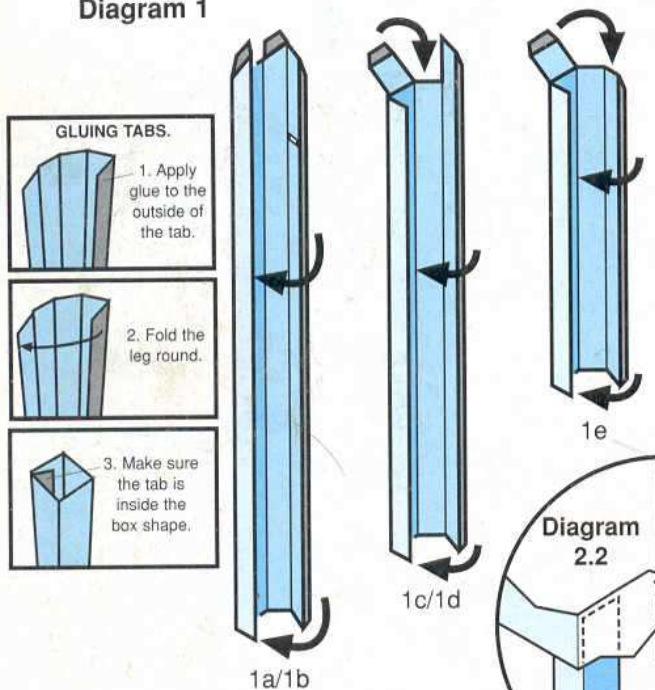

## 3. ROOF CONSTRUCTION

Fold down the edges of the roof (3a) and glue into position. Glue roof onto the tower legs as shown in diagram 2.1.

Fold the tabs on the roof supports (3b) and glue into position as illustrated.

Diagram 2.1

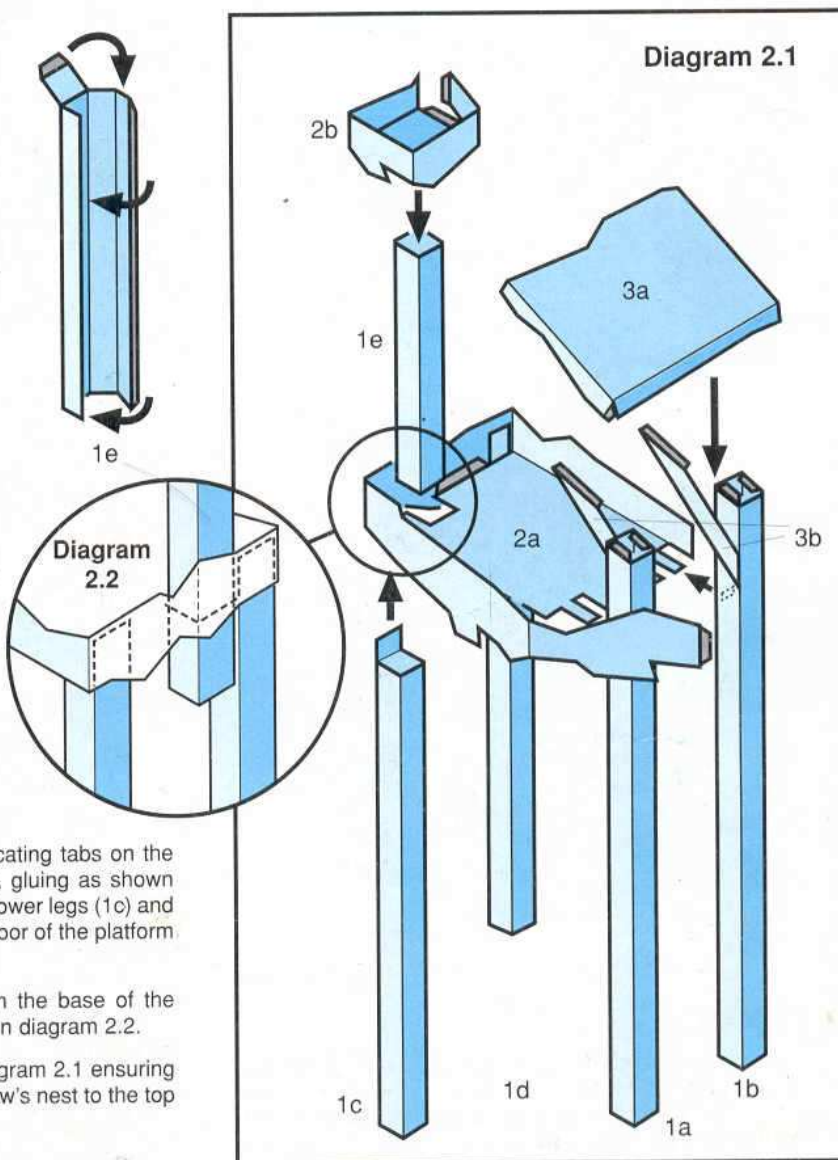

## 2. TOWER CONSTRUCTION

Push the tower legs (1a and 1b) into the locating tabs on the platform (2a). Fold round the platform walls, gluing as shown ensuring the tabs are on the inside. Slot the tower legs (1c) and (1d) into the gaps between the wall and the floor of the platform as shown in diagram 2.2.

Slot tower leg (1e) into the gap provided in the base of the platform and glue into position as illustrated in diagram 2.2.

Fold the crow's nest (2b) as illustrated in diagram 2.1 ensuring the tabs are glued on the inside. Glue the crow's nest to the top of tower leg (1e).



# WATCHTOWER

## FINAL STAGE

Finish the tower you need to add the support struts as shown in diagram 3. These can be positioned more or less as you like. Bear in mind, however, that the struts provide support to the tower itself so we've used two or three on each side, well spread out from the top to the bottom of the tower.

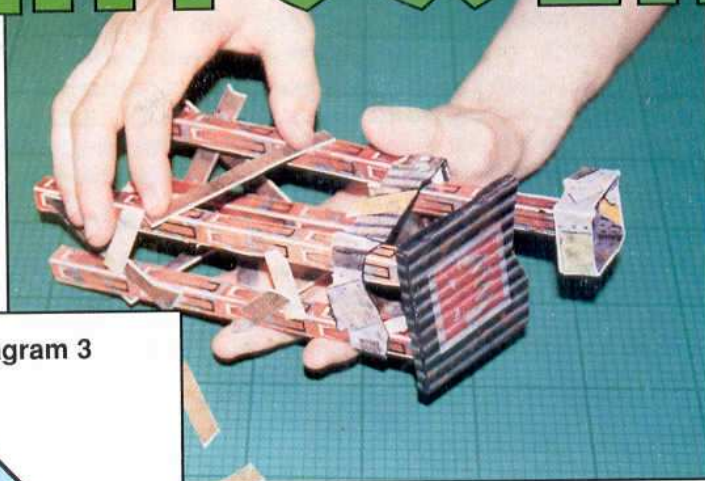
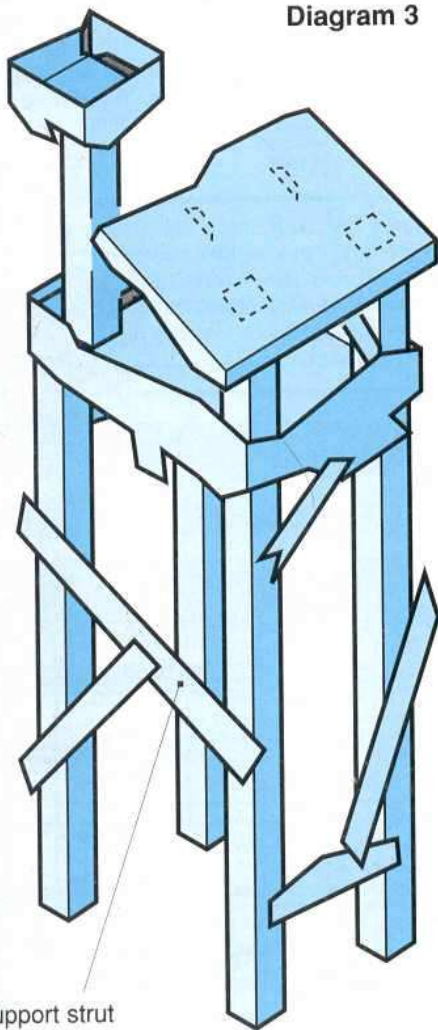

Diagram 3



Support strut

## 5. PAINTING

You'll notice that after folding all the card and gluing the watchtower together there is some bare card showing. If you want to really finish off your tower, paint the edges with an appropriate colour Citadel paint and also stick it to a sturdy card base.

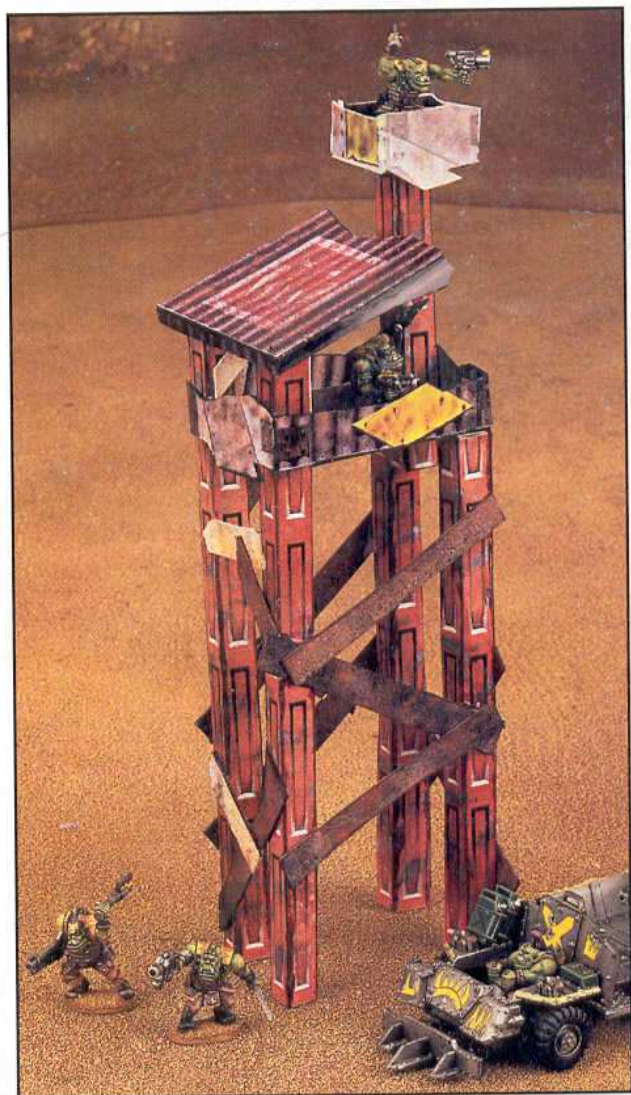



# COLLECTING A MOB

By Andy Kettlewell



Before you can start carving out a niche for yourself as a battle hardened Ork Nob you need to have a Mob to order around!

I'm going to show you how to choose you mob, step by step. I already have an Ork mob, Da Skull Splitterz, who have been quite successful but I really want another one as well. Having played Gorkamorka quite a bit now I have a good idea which Orks to choose to put together a Mob that suits my fighting style.

To hire my starting mob I get 100 teef to spend. The only other way I can earn any teef after this is to search for scrap in the desert so I'd better spend them wisely.

## Step 1 - Gorker or Morker?

Orks are either Morkers (cunningly brutal), or Gorkers (brutally cunning), so the first thing that I have to do is decide which one my mob is. Remember that the difference between Gorkers and Morkers is the skills they can have so I've decided on a Morker mob because Morkers have better driving and mechanical skills.

## Step 2 - Da Boss

First of all every mob has to have a Nob to be da boss. He's the toughest of the tough so he needs the best weapons in the whole mob. I give him some frag stikkbombz to throw, a kannon to shoot with and a choppa

Da Nob and da Spannerz have the best equipment because they are the hardest warriors in the mob.

to bash his enemies, as well as studded armour to give him bit of protection.

Teef cost so far - 20 teef

## Step 3 - Da Spannerz

Spannerz are Orks who specialise in maintaining vehicles and weapons and you need one for each vehicle in your mob. I want two vehicles in my mob, a Trukk and a Trak, so I am definitely going to need two Spannerz. Like the Nob, Spannerz start with a large amount of experience which, along with their mechanical skills, makes them quite valuable. They get a selection of armour, choppas and shootas between them.

Teef cost so far - 38 teef

The name of the mob is really important so I took a long time deciding what it should be. In the end I thought that Da Badskars sounded suitably 'ard and impressive.

# GORKAMORKA

MOB NAME: DA BADSKARS

MOB RATING: 127

TEEF HOARD: 0 TEEF

NAME	CHARACTERISTICS										WEAPONS, SKILLS AND INJURIES	WEAPONS SUMMARY						COST	EXP.			
	M	WS	BS	S	T	W	I	A	Ld	Short Range		Long Range	To Hit Short	To Hit Long	Str.	Save Mod.	Dam.			Ammo	Notes	
(Boss) BARKDREG	4	4	4	3	4	1	3	1	7	KANNON, CHOPPA, STUDDED ARMOUR, FRAG BOMBZ			4"	18"	-1	4		1	4+	KANNON CLOSE COMBAT KNOLK BACK	20	63
(SPANNER) BOSSKART	4	3	3	3	4	1	2	1	7	SHOOTA, CHOPPA			12"	18"	+1	3		1	4+	SHOOTA	9	65
(Boy) GAR GRUB	4	3	3	3	4	1	2	1	7	KNIFE											5	26
(Boy) GOFFIT	4	3	3	3	4	1	2	1	7	SIX-SHOOTA, KNIFE			6"	12"	+1	3		1	4+	SIX-SHOOTA CLOSE COMBAT 1 SUS. DCE	7	24
(YOOF) LUGUL	4	2	2	3	3	1	2	1	7	SIX-SHOOTA, KNIFE			6"	12"	+1	3		1	4+	SIX-SHOOTA CLOSE COMBAT 1 SUS. DCE	5	0
(Boy) GORSNIK	4	3	3	3	4	1	2	1	7	KNIFE											5	21
(SPANNER) NOSHMEK	4	3	3	3	4	1	2	1	7	SHOOTA, KNIFE, STUDDED ARMOUR			12"	18"	+1	3		1	4+	SHOOTA	9	62
(YOOF) SNAGIT	4	2	2	3	3	1	2	1	7	SLUGGA, KNIFE			6"	12"	+1	3		1	4+	SLUGGA CLOSE COMBAT	5	0
											<b>TOTAL POINTS COST AND EXPERIENCE</b>						100	261				

All the Yoofs are armed with knives and pistols because they aren't important enough to have a proper gun. They'll probably miss with them anyway!



#### Step 4 – Da Vehicles

Now I have bought my Spannerz I can buy some vehicles! A Trukk and a Trak will give me lots of room for da Boyz. These two turn out to be very expensive so I decide not to mount any Big Gunz on them. This means that my mob won't be very shooty so I think that I will specialise in close range shooting and close combat instead.

*Teef cost so far – 73 teef*

#### Step 5 – Da Slavers

Slavers look after Grotz and Slaves, but I don't really want any Grotz in my mob ("dere good for fetchin' but not fer fightin") so I decide not to have any.

#### Step 6 – Da Boyz

Every mob must have at least three Ork warriors, other than the Nob. I already have two Spannerz so I need at least one more Ork to make up the numbers! Boyz are important to the mob because they are the best at digging for teef after a battle. I decide to have three Boyz, two of which will be drivers. I am starting to run out of teef now so I won't give the drivers any gunz and the boy on foot just gets a six-shoota.

*Teef cost so far – 90 teef*



I have chosen the Boyz as drivers because they are fairly good fighters and can gain driving skills.

#### Step 7 – Da Yoofs

I have a few teef left so I decide to buy some Yoofs. Although Yoofs are not as good as Boyz at fighting, they do get skills faster and they are a good long term investment for a mob. I buy two Yoofs and give them a pistol each.

*Teef cost so far - 100 teef*

#### Step 8 – Da Grotz

Not in my mob! Pesky little things, you can't trust them. Grotz are good at boarding vehicles and searching for scrap so I will eventually buy some, but only after I have bought a Slaver to keep them under control.

#### Step 9 – Rolling for Starting Experience

Most warriors start with some initial battle experience and, now I have completed my mob I can roll a D6 for each of the Orks. The Nob and Spannerz start with 60 plus D6 experience each. The Orks start with 20 plus D6 but the Yoofs, who obviously have no battle experience, don't get any at all. This doesn't really matter, all my warriors will gain experience and skills fast enough once they start fighting some battles. Now I've chosen my Mob, I'd better start modelling them up!

To give my mob as much transport capacity as possible I chose a Trukk and a Trak. It was a hard choice not to have any Big Gunz but they will be one of the first things I will spend teef on after my first victories.

VEHICLE TYPE: TRUKK			NAME: GOKKART			COST: 20			FIXED WEAPON TYPE:			GUNNER:		
DRIVER: GARGRUB			SPANNER: BOSSKART											
Score	Armour	Location/Damage	Score	Armour	Location/Damage	Short Range	Long Range	To Hit Short	To Hit Long	Strength	Save Modifiers	Damage	Ammo	Notes
1	8	CREW	4	8	WHEEL									
2	8	CREW	5	8	DRIVER									
3	10	ENGINES	6	10	ENGINES									
KUSTOM JOBS, GUBBINS AND PERMANENT DAMAGE:														

VEHICLE TYPE: TRAKK			NAME: BAKKART			COST: 15			FIXED WEAPON TYPE:			GUNNER:		
DRIVER: GORSNIK			SPANNER: NOSHMEK											
Score	Armour	Location/Damage	Score	Armour	Location/Damage	Short Range	Long Range	To Hit Short	To Hit Long	Strength	Save Modifiers	Damage	Ammo	Notes
1	8	CREW	4	8	TRAK									
2	8	CREW	5	8	DRIVER									
3	10	ENGINES	6	10	ENGINES									
RUSKUM JOBS, GUBBINS AND PERMANENT DAMAGE:														

VEHICLE TYPE:			NAME:			COST:			FIXED WEAPON TYPE:			GUNNER:		
DRIVER:			SPANNER:											
Score	Armour	Location/Damage	Score	Armour	Location/Damage	Short Range	Long Range	To Hit Short	To Hit Long	Strength	Save Modifiers	Damage	Ammo	Notes
1			4											
2			5											
3			6											
RUSKUM JOBS, GUBBINS AND PERMANENT DAMAGE:														

As I've said before, names are very important and the Gorkamorka game has a section to help you invent Orky names for your warriors and vehicles using Ork glyphs. A few of my favourite's are Barkdreg and Gorsnik.

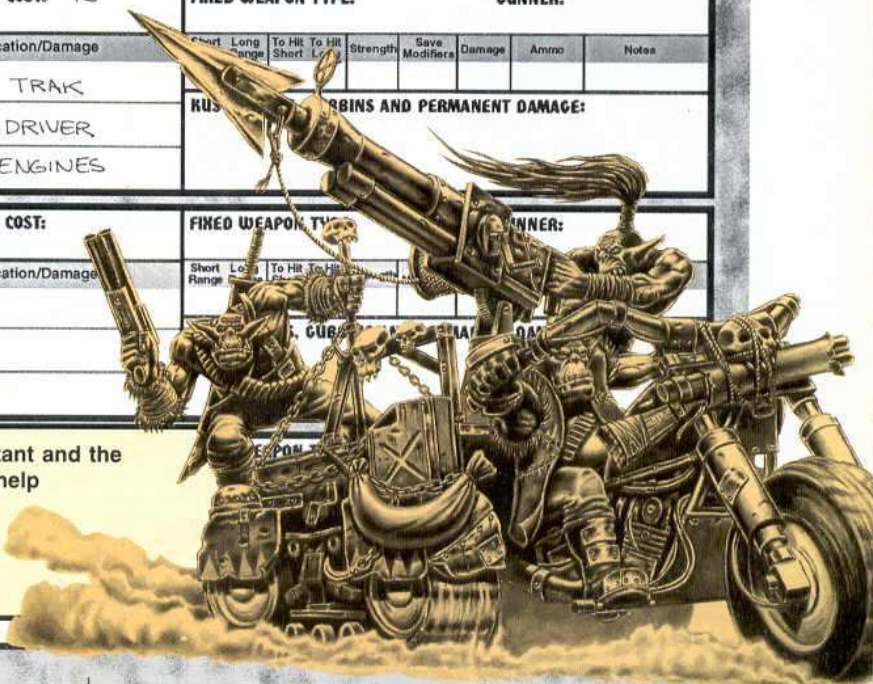



# PAINTING MY MOB IN A WEEKEND!

On the next two pages is a step by step guide to painting a Gorkamorka mob in a weekend. I only used the models from the Gorkamorka box, but Nob, Spanner and Yoof models are now available for you to buy.

## 1. DA SPRUE

I cut my models from the sprue with a modelling knife, carefully cleaning off all the mould lines with the knife and glue all the correct weapons to my Orks. I know it sounds silly but I have made this mistake in the past. It is very annoying having to change them again.

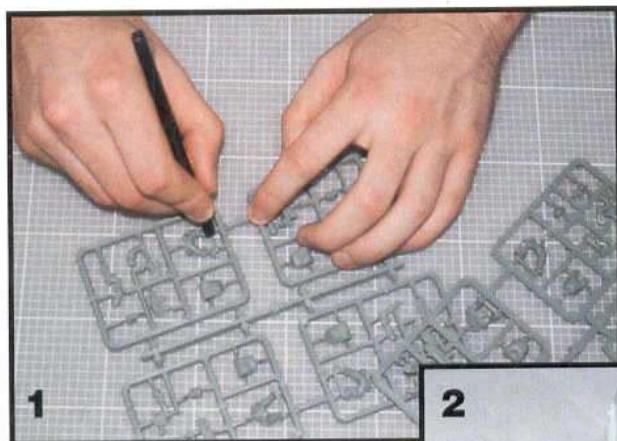

## 2. DA CONVERSIONZ

I want my Nob to look more impressive than da ladz so I've given him some shoulder pads from my bitz box.



## 3. DA UNDERCOAT

I've found it much easier to paint Ork flesh and metal over a black undercoat.



## PAINTING ORK FLESH

The older an Ork is, the darker his skin, so I paint my warriors different colours depending on their age:



1. Yoofs have the lightest skin. Give them a base coat of Goblin Green and then highlight with Scorpion Green.



2. Boyz are older so they have darker skin. Use a base coat of Snot Green and then highlight with Goblin Green.



3. Da Nob and da Spannerz have the darkest skin so basecoat with Dark Angels Green and highlight with Snot Green.

## 4. DA BASIC COLOURS

I've painted all the leather and fur in Snakebite Leather. All the metal is painted in Bolt Gun Metal and the Ork skin was painted depending on how old the Ork is (see above).



## 5. DA HIGHLIGHTS AND DA DRYBRUSHING

I've used Bubonic Brown to drybrush the fur and Bleached Bone for the leather. The Ork skin is highlighted with the next lightest shade of green.



## 6. DETAIL

Using a fine brush I've picked out the teeth, sun glasses and mob markings. Da Badskar's are a

Morka mob so they have brightly coloured markings and warpaint.



## 7. DA BASE

Finally I've stuck sand to the base with PVA glue, then painted the whole base Snakebite Leather and drybrushed it with Bubonic Brown.

## HIGHLIGHTING

Highlights are raised areas where light catches and brightens a colour. They can be produced by using a lighter shade of the original colour or, if you're using a very pale colour, with white. Mix up a lighter colour using the original base colour and some white. Carefully pick out the raised details with the highlight colour using a fine brush.

There is a really fast way of highlighting areas of fur and metal which have lots of texture on them. It is called 'drybrushing'.

## DRYBRUSHING

Drybrushing is a process that is easy to get the hang of and quickly brings out the detail of your models. It is similar to highlighting but using a drybrushing brush. Dip it in to the lighter shade of the original base colour you want to drybrush. Then wipe off the paint until the bristles appear dry. Lightly draw the brush back and forth over the area and paint will begin to build up on the raised areas of detail. Continue brushing until you are happy with the colour. Dip your brush back in the lighter colour and repeat the process when the colour runs out.



# PAINTING DA VEHICLES

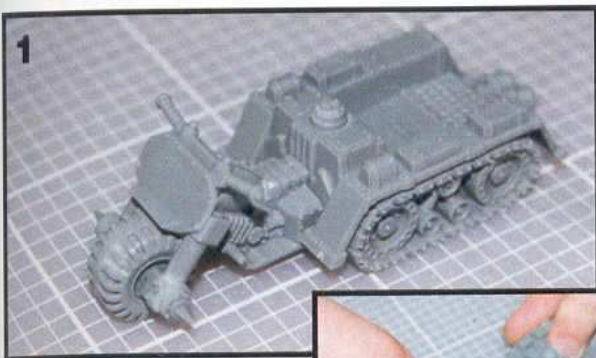

## 1. DA SPRUE

I've stuck the vehicles together in the same way as the Ork models, scraping off all the mould lines with a knife.

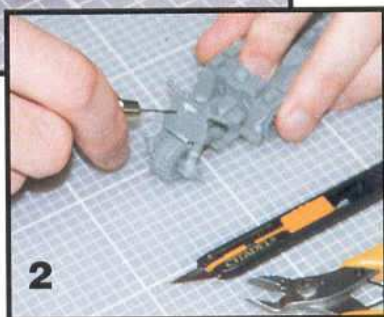

## 2. DA CONVERSION

Converting vehicles couldn't be simpler. I've used a knife to cut bits off the model and made bullet holes here and there until the models looked wrecked!

*When you use a modelling knife please take special care. Although it seems to be obvious to us that they are sharp, every year someone, somewhere slices off a piece of their finger with one - don't let it be you!*



## 3. DA UNDERCOAT

I've sprayed the whole vehicle with black and red spray. This made the model look really rusty.



## 4. DA METAL

I've drybrushed the entire miniature with Tin Bitz and then with Bolt Gun Metal.

## 5. DA MOB MARKINGS

Red and white teef (or triangles) are my main mob markings so I've painted these onto the model together with lots of other glyphs.



## 6. DA DIRT AND MUD

Ork's never clean their vehicles, it's just so un-Orky. Using a big drybrush and a pot of Bubonic Brown I've drybrushed most of the model.

## JOBS A GOOD 'UN

All finished in one weekend with a bit of hard, but fun, work. I am quite pleased with how Da Badskars have turned out and I can't wait to play a few games with them.

Next month see how Andy's mob gets on in battle on Gorkamorka...





# RETURN TO

# THORSKINSON'S

# ISLAND PART 4

Our summer Warhammer campaign has reached its fourth month of play and the island is starting to look pleasantly battle-ravaged. The top players have now established a commanding lead, with three front runners all occupying the maximum of twelve territories. This month I'll be dividing the objective groups into the top players and the rest. The idea behind this is to allow the leading players to start the climb to final victory whilst giving the rest a chance to catch up by fighting each other.

## THIRD ROUND RESULTS

Last time in White Dwarf 213 I presented players three reports to follow up: the Search for the Fabled City of Xhezeuotzit, Mysterious Caves, and the Sea Elf Wreck.

As in previous rounds the top two players in each group must fight a deciding battle to determine which of them wins the special territory. To work out which players qualify I used the basic scoring system with a few tweaks just to keep people on their toes. As you will doubtless recall, players can play as many games as they wish against other players who are pursuing the same objective earning points as follows:



By Rick Priestley

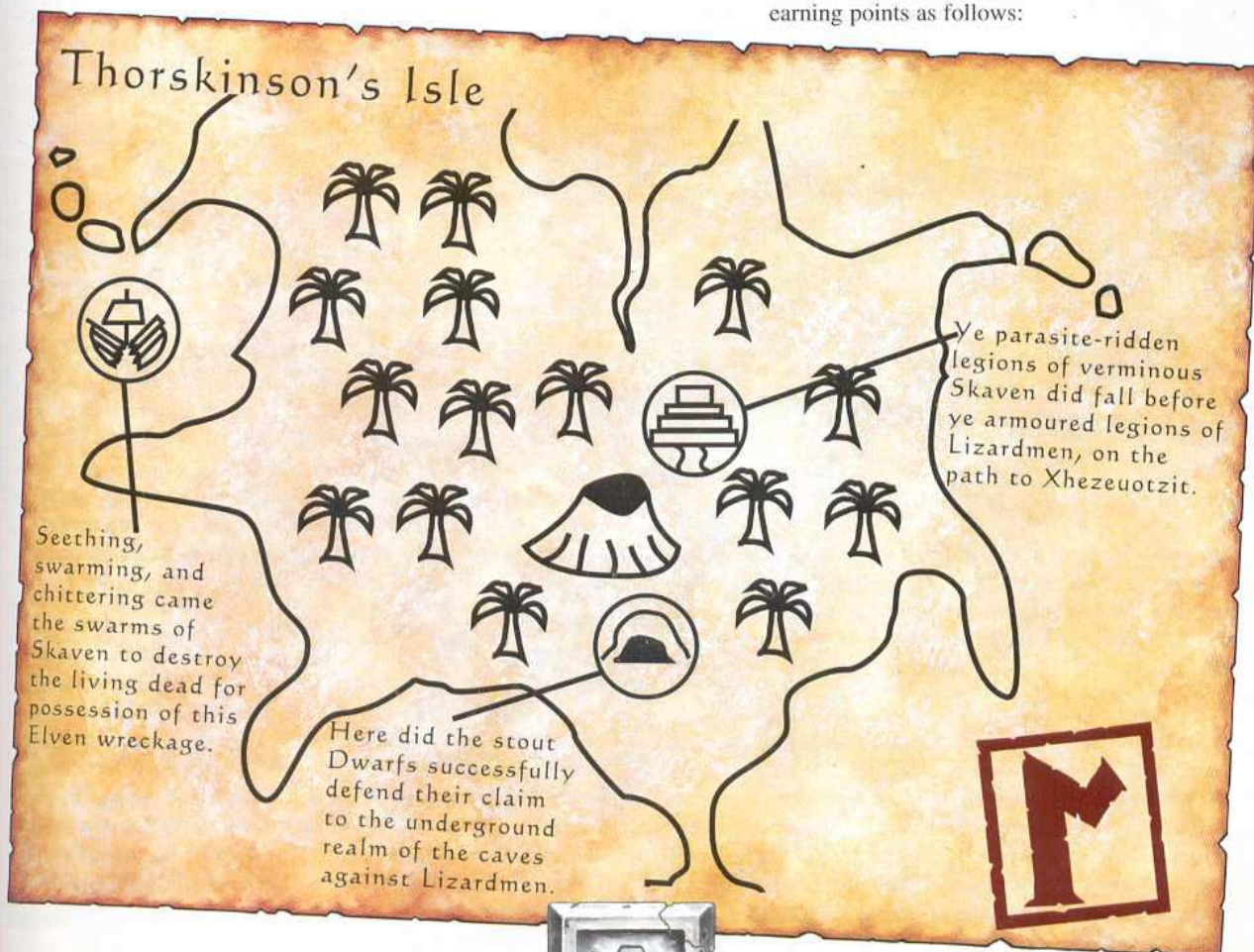



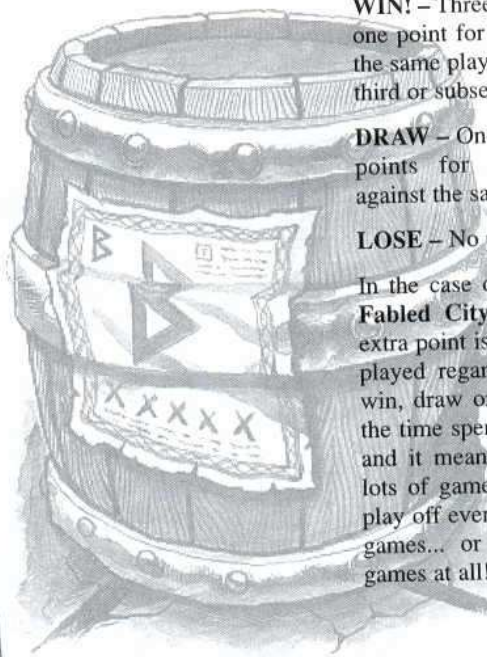
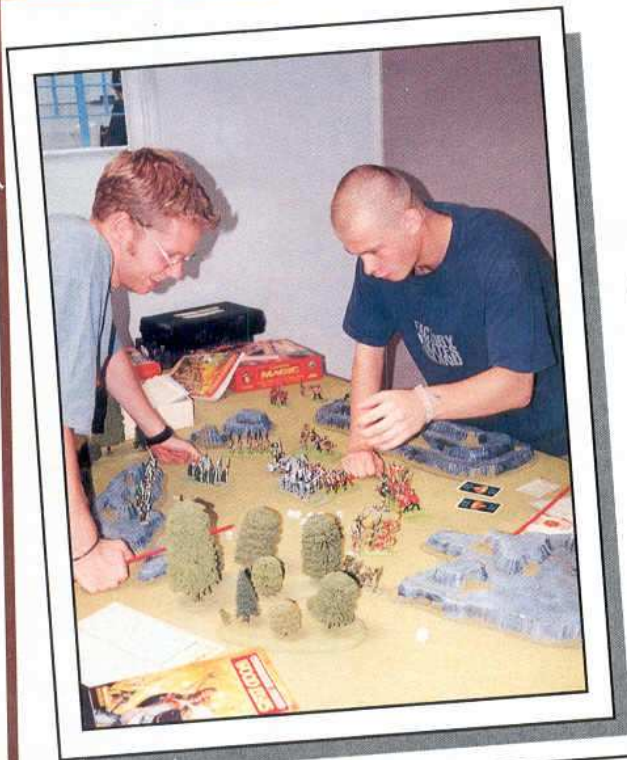

**WIN!** – Three points for a first win, one point for a second win against the same player, half a point for the third or subsequent win.

**DRAW** – One point for a draw. No points for a subsequent draw against the same player.

**LOSE** – No points.

In the case of the Search for the Fabled City of Xhezeutzit one extra point is earned for each game played regardless of whether you win, draw or lose. This represents the time spent searching the jungle and it means a player who fights lots of games may qualify for the play off even if he wins only a few games... or even if he wins no games at all!

**Entrance to the Fabled City of Xhezeutzit.** Once a player has possession of this territory he can move his armies freely into the great city of Xhezeutzit. This adds +100 points to the army's value in the same way as a bridge/pass etc. At the same time it means the player can avoid having to pay the usual penalties for entering the city as described later in this month's Island Chronicle.

**GROUP 2 - Mysterious Caves**

After many miles the tunnel complex eventually leads to a vast, cylindrical cavern. The cavern was hewn from the stone in ages past. At its centre there is a circular pit, dark and seemingly bottomless, its edges encrusted with runes stained with ancient blood. Around the inside edge of the cavern a staircase winds upwards into the darkness.

Fight a battle to decide who takes the Cavern of Sotek as part of their territory. The battle is fought in the cavern itself, which is flat and featureless apart from a massive pit in the middle – a black hole approximately 6" in diameter. All the restrictions previously described for cave fighting apply (check last month's issue for details). In addition any troops who are forced into the pit are destroyed (eg fleeing or pursuing into it, or randomly moving into the pit in the case of troops such as Gobbo Fanatics).

**The Cavern of Sotek.** The cavern lies directly under the City of Xhezeutzit and its winding stairway leads directly into the city from below. In ages past this was where the inhabitants of the city would sacrifice victims to the great and terrible serpent god Sotek. Of his mighty slithering majesty nothing appears to remain. The player who controls the cavern can use it to ascend into the city of Xhezeutzit and avoid paying the usual penalties for entering in the same way as the Entrance to the Fabled City of Xhezeutzit. In addition, the tunnels allow troops to spring into the city as if from nowhere. In any games fought inside the city the player may therefore deploy his entire army after the enemy.



**GROUP 1 - The Fabled City of Xhezeutzit**

The two rivals hack their way through the jungles to reach the towering ruins of an ancient city. Its walls are still high and impenetrable, though encrusted with undergrowth, but its vast gateway lies open, its massive gates cast down upon the ground. Through the gateway lies the ruined city itself and who knows what treasures lie within!

Fight a battle to decide which player takes control of the Gate of Xhezeutzit. The gate itself lies on one side edge and the rest of that edge is occupied by the city wall which is impassable. The two armies face each other across a stone paved square, ruined, but still free of jungle such is the amazing strength of its construction. The player who wins the game takes the Gate of Xhezeutzit territory. No territories are staked in this battle.



**G**  
A sha  
Thors  
treasu  
and th  
table i  
dunes)  
short  
other s  
if you  
  
Whoev  
Wreck  
items.  
for pur  
rolling  
magic  
charac  
charac  
carry  
allocat  
bring t  
the ma  
  
**1. SV**  
This  
gains  
lasts.  
  
**2. SW**  
This  
in ba  
has i  
is des  
  
**3. W**  
The V  
a nor  
requi  
Tough  
fashio  
  
**4. OR**  
The G  
to red  
by 2D  
cast th  
  
**5. ME**  
The M  
Total  
killed  
anythi  
  
**6. AW**  
The Aw  
normal  
is requ  
enemy



**GROUP 3 – The Sea Elf Wreck**

A shattered hulk has been thrown upon the shores of Thorskinson's Island – the place is awash with dead Elves, treasure chests, flotsam, jetsam, discarded tins of spam, and that kind of thing. Fight a battle on the beach. The table is basically flat but can include up to two hills (sand dunes) on each side of the table. The sea lies off one short edge and is impassable. The jungle lies off the other short edge and can be represented by a line of trees if you wish.

Whoever wins the game takes possession of the Sea Elf Wreck. Searching the wreck will uncover 3 magic items. These are special magic items, invented purely for purposes of the campaign, and they are generated by rolling a dice three times – re-roll any duplicates. These magic items must be assigned to specific named characters in your army. They cost no points. A character can only have one of these items, he cannot carry two or more of these specific items. Once allocated to a character the character must always bring that item to every battle. If the character is killed the magic item is lost forever.

The Sea Elf Wreck is a territory and can be staked like any other. If captured the new owner generates three random items afresh. If a player loses the wreck any remaining items in his possession are destroyed.



**RANDOM MAGIC ITEMS TABLE  
(Make three D6 rolls on this table)**

**1. SWORD OF IMPROBABLE GROWTH (Magic Weapon)**

*This mighty magic weapon adds +1 Strength to the wielder. Furthermore, if a combat lasts for more than 1 combat round, then the wielder gains +1 Strength in each round as he grows ever bigger and more powerful. This applies in both players' turns for as long as the combat lasts. Once combat is over the bonus reverts to +1 and starts over again.*

**2. SWORD OF ROBBERY (Magic Weapon)**

*This sword attracts the power of magic, robbing an enemy's magic of power, and feeding it into the wielder. The weapon affects enemy models in base contact with the bearer, and only works if the enemy model has at least 1 magic item. The highest value magic item the enemy model has is nullified whilst in base contact, and if the model suffers 1 or more wounds inflicted by the Sword of Robbery the nullified magic item is destroyed. If a magic item is destroyed by the Sword of Robbery the bearer gains +1 Strength for the remainder of the game.*

**3. WAND OF ENFEEBLEMENT (Wizard Arcana)**

*The Wand of Enfeeblement can be used to cast a spell of Enfeeblement once per magic phase of the player's turn. This is exactly like casting a normal spell, except no power is required to make it work. After each use the wand is exhausted on a D6 roll of a 1 or 2. Line of Sight is required and the spell can be cast upon a single model within 24". The enfeebled target loses D3 Toughness and any model reduced to 0 Toughness is dead. The reduction in Toughness lasts for the remainder of the game – so although a victim might be 'reincarnated' in some fashion during the game he still has Toughness 0, and so just dies again.*

**4. ORB OF ANTI-POWER (Enchanted Item)**

*The Orb of Anti-Power reduces all Winds of Magic rolls by D6, 2D6 or 3D6. Roll the Winds of Magic first, as normal, then decide how much to reduce it by. You must reduce the Winds of Magic by at least D6 each time... you have no choice in this. If you reduce the Winds of Magic by 2D6 or 3D6 any roll of a double means the Orb shatters and is destroyed, but the cataclysmic release of power means no spells can be cast that turn and all spells in play are dispelled. Once destroyed the Orb is gone forever and cannot be used in subsequent battles.*

**5. MIRROR OF DARKNESS (Enchanted Item)**

*The Mirror of Darkness weirdly turns back magic power sucking wizards into the nether regions of magic. If either side attempts to use the Total Power card the caster is immediately sucked out of the real world with a curious slurping noise. Only his hat is left. The caster is not killed but is lost in the magical regions and will reappear only after the battle is over. You earn no victory points for this... you don't get anything quite that easily!*

**6. AWESOME GALE HORN (Enchanted Item)**

*The Awesome Gale Horn can be blown to summon a sorcerous gale once per magic phase of the player's turn. This is exactly like casting a normal spell, except no power is required to make the horn work. After each use the horn is exhausted on a D6 roll of a 1 or 2. Line of Sight is required and the spell can be cast upon a single unit within 12". The target unit is blown back 3D6" directly away from the horn. If other enemy lie within the path of the blown-back troops then they are blown back also.*





# The Thorskinson's Island Chronicle

Being a report of the rumours and discoveries made upon the island, compiled for the benefit of adventurous lords in their search for wealth, sorcerous devices, and worldly power. Price one shilling.

This month the players are divided into two groups – those who have reached the plateau and the rest. In either case choose one report to follow-up this month. For those in the first group there is the chance to explore the ruins of Xhezeuotzit. For the rest there is the choice either to indulge in a bit of general raiding and pillaging or to search for the Idols of Wotnobizquet. I've given the extended Controllers Notes a miss this month. If you want to know more about how to organise and run your own

campaign refer to White Dwarf issues 211, 212 and 213.

## Report 1 – Explore Xhezeuotzit

This option is open only to players who have one of the following special territories: *Phantom Gorge*, the *Jungle Trail to Zapitquic*, the *Valley of Bones*, the *Entrance to the Fabled City of Xhezeuotzit*, or the *Cavern of Sotek*. Any players with at least one of these territories **must** explore Xhezeuotzit this



round or they will **automatically lose** any and all of these named territories they have. Any special territories lost in this way will be occupied by players who do explore the city (I'll explain how to do this in the next installment).

notice, scrawled in Dwarf Runes. This reads, 'Private Property. Keep Out or Else. Beware the Baboon. By Order Thurkin Thorskinson.' The sign is old and faded. Under it is a smaller, more recent note which reads, '2 pints please' along with two copper coins.

Xhezeuotzit is an ancient ruinous Lizardman city. Rubble and debris lie scattered over many square miles. Here and there buildings stand almost intact. Many buildings lie over vast underground store houses, dungeons, tombs and who knows what treasures! At the centre of the city a great pyramid rises into the sky – no doubt the main treasure house is beneath it. At the entrance to the city there is a crude

Any games fought in the city are assumed to take place over a layer of debris. Battlefields can include hills, areas of ruin, and buildings but no other scenery. At least two buildings should be included to give the flavour of the thing. Because of the debris the movement of all wheeled machines is halved, including chariots, wheeled cannons, and so on. In addition the charge speed of all cavalry is halved to normal rate (ie not doubled as usual!).

There is a penalty for entering the city – this represents the fact that whilst you are preoccupied with

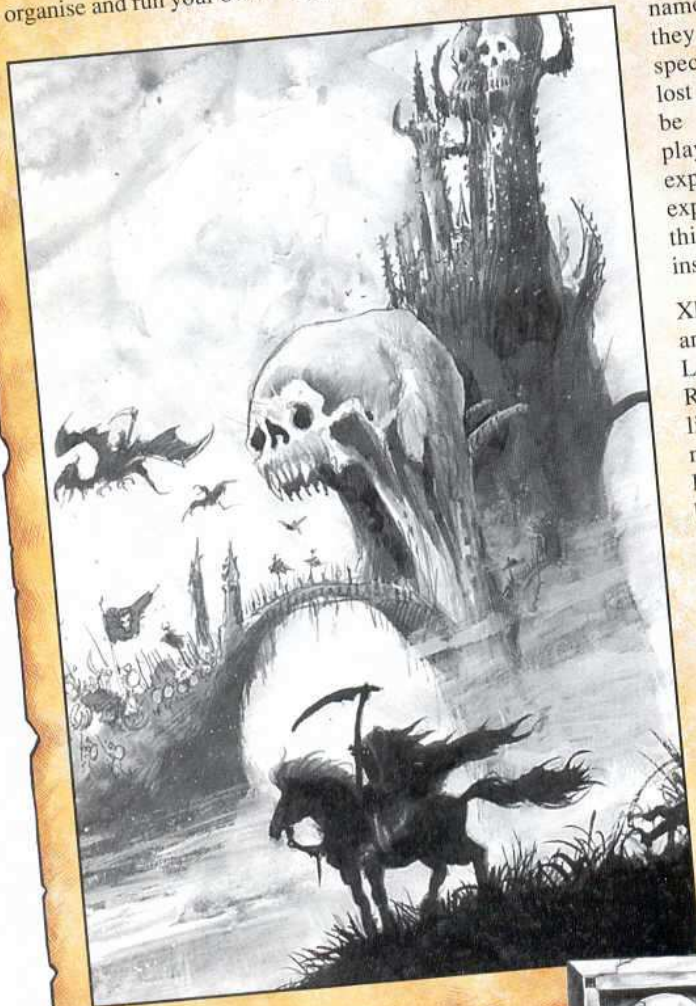



exploring the city, your coastal areas are vulnerable to attack, internal strife, and what have you. The penalty works as follows. After each battle is over and territory has been worked out, if you have 10 or more territories nominate 1 territory, if you have 11 or more nominate 2, and if you have 12 nominate 3. Roll a D6 for each nominated territory. On a roll of 6 the territory is lost, destroyed by raiders, ravaged by pirates, or despoiled by rebels. If the player has either the Fabled Entrance to the Fabled City of Xhezeuotzit or the Cavern of Sotek then only nominate 1 territory regardless of how many you have (because it's easier for you to get back to protect all of your possessions).

**Report 2 - Raiding and Pillaging**

With the harvest about ready now is a great time

to indulge in a bit of honest raiding and pillaging. If you go for



this option you must stake 2 territories for each battle instead of the usual 1. Two territories are generated randomly after the game. Whichever side wins the battle retains his staked territories and can chose any 2 of the remaining territories. In other words it's exactly like a normal campaign battle except double the territory stake and gain. In addition, at the end of the round all players who take part in the raiding and pillaging will be allowed an extra randomly generated territory for free. It's a time of abundance for all... so get fighting.

**Report 3 - The Idols of Wotnobizquet.**

A merchant convoy has come across a strange arrangement of standing stones in the jungle.

Mysterious flashing lights were seen. Strange smells were smelled. The merchant left the stones well alone, but is keen to organise an armed expedition to explore them further. A trek through the jungle is in order for those brave enough to try.

Games fought in search of the Idols of Wotnobizquet are played deep in the jungle, so you must include at least four woods in any battle. Hills, rivers, marshes and such-like are all permitted, but no buildings or other constructions are allowed.





# WARHAMMER



The Bretonnian army in combat with their arch enemies the Lizardmen. The photograph above features metal miniatures not available in the Warhammer boxed game.

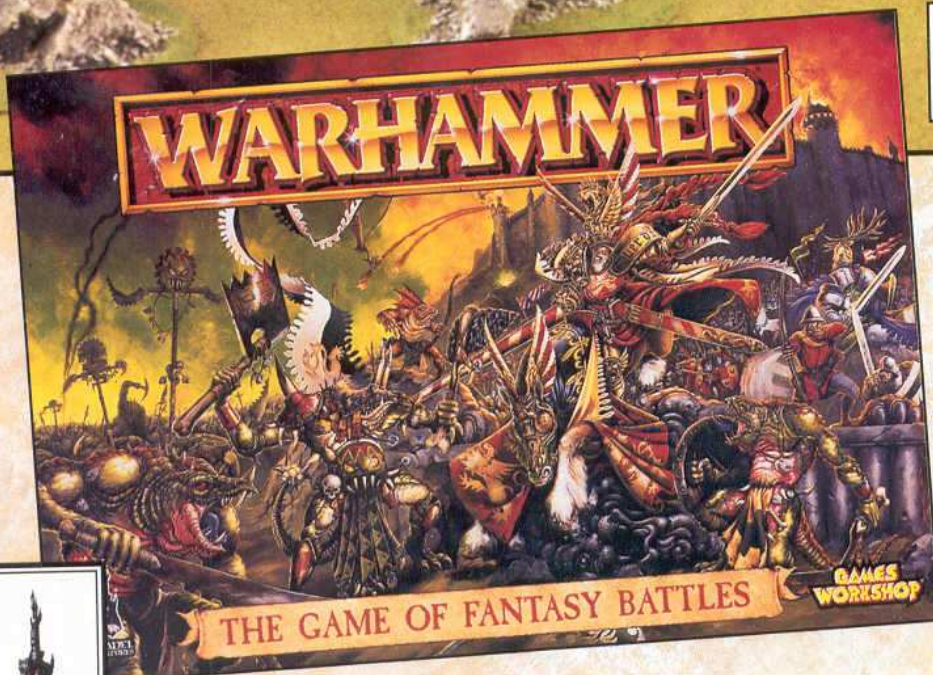

In Warhammer you become a fearless commander, painting and assembling mighty fantasy armies to do battle on the tabletop. Warhammer provides you with the core regiments of two armies – the knightly Bretonnians and the reptilian Lizardmen – and all the information you need to collect and paint your forces ready for battle.



Citadel, the Citadel Castle, Games Workshop, the Games Workshop logo and Warhammer are registered trademarks of Games Workshop Ltd. © Games Workshop Ltd. 1997. All rights reserved.

**GAMES  
WORKSHOP**



their arch  
h above  
e in the

ome a  
inting  
ighty  
tle on  
ammer  
e core  
nies -  
ans and  
men -  
on you  
l paint  
battle.

S  
HOP



Models supplied unpainted and unassembled. Contents and components may vary from those illustrated.

The Warhammer boxed game contains everything you need to get started including Citadel miniatures, buildings, rulebooks, dice, range rulers and much, much more.



# WARHAMMER ROSTER SHEET

DAVIDE COSTA'S LIZARDMEN

Models/Unit	M	WS	BS	S	T	W	I	A	Ld	Save	Notes	Points Val
SLANN MASTER MAGE PRIEST SWORD OF COCACIWA, PALANQUIN	4	5	4	6	5	6	5	6	9	4+	ANY UNIT WITHIN 12" TESTS AGAINST SLANN'S Ld. COLD BLOODED 4+ UNMODIFIED SAVE	550
SKINK SHAMAN HAND WEAPON, ADDITIONAL HAND WEAPON	6	2	3	3	3	1	5	1	6	6+	6+ UNMODIFIED SAVE COLD BLOODED	57
SKINK SHAMAN SHORT BOW (BISON ARROWS) HAND WEAPON, SPEAR DISPEL SCROLL	6	2	3	3	3	1	5	1	6	6+	6+ UNMODIFIED SAVE COLD BLOODED	84
SKINK HERO HAND WEAPON, HALBERD SHIELD, COAK OF FEATHERS COLD ONE	6	4	5	4	3	2	6	3	7	3+	6+ UNMODIFIED SAVE COLD BLOODED	90
SKINK HERO HAND WEAPON, SHIELD LIGHT ARMOUR, SHORT BOW (POISON ARROWS) CROWN OF COMMAND	8	3	0	4	4	1	1	2	3	N/A		
SKINK HERO HAND WEAPON, SHIELD LIGHT ARMOUR, SHORT BOW (POISON ARROWS) CROWN OF COMMAND	6	4	5	4	3	2	6	3	7	4	6+ UNMODIFIED SAVE COLD BLOODED	107
11 SAURUS WARRIORS HAND WEAPON, SPEAR, SHIELD, STANDARD BEARER	4	3	0	4	4	1	1	2	8	4+	6+ UNMODIFIED SAVE COLD BLOODED	192
14 SKINKS HAND WEAPON, SHIELD JAVELIN (POISON TIPPED)	6	2	3	3	2	1	4	1	6	5+	6+ UNMODIFIED SAVE COLD BLOODED	84
14 SKINKS HAND WEAPON, SHIELD JAVELIN (POISON TIPPED)	6	2	3	3	2	1	4	1	6	5+	6+ UNMODIFIED SAVE COLD BLOODED	84
5 COLD ONE RIDERS GREAT CRESTED SKINK HAND WEAPON, SPEAR, SHIELD COLD ONE	6	2	3	4	2	1	4	1	6	3+	6+ UNMODIFIED SAVE COLD BLOODED	125
2 TERRADONS SKINK RIDER HAND WEAPON, SHIELD, SPEAR SHORT BOW (POISON ARROWS) JAVELIN (POISON TIPPED) TERRADON	8	3	0	4	4	1	1	2	3	N/A		
2 TERRADONS SKINK RIDER HAND WEAPON, SHIELD, SPEAR SHORT BOW (POISON ARROWS) JAVELIN (POISON TIPPED) TERRADON	6	2	3	3	2	1	4	1	6	4+	6+ UNMODIFIED SAVE COLD BLOODED	89
STEGADON 8 SKINK CREW HAND WEAPON, SHIELD SPEAR, SHORT BOW (POISON ARROWS) JAVELIN (POISON TIPPED) BANNER OF NIGHT STEGADON	2	3	0	4	4	1	2	1	3	N/A		
STEGADON 8 SKINK CREW HAND WEAPON, SHIELD SPEAR, SHORT BOW (POISON ARROWS) JAVELIN (POISON TIPPED) BANNER OF NIGHT STEGADON	6	2	3	3	2	1	4	1	6	5+	6+ UNMODIFIED SAVE COLD BLOODED	29
STEGADON 8 SKINK CREW HAND WEAPON, SHIELD SPEAR, SHORT BOW (POISON ARROWS) JAVELIN (POISON TIPPED) BANNER OF NIGHT STEGADON	6	2	0	7	6	6	2	5	6	4+	IMPACT HITS COLD BLOODED	

The more eagle readers may have that the Character allowance for this an points over the ma Tut-tut Davide!



# WHEN LIZARDMEN RULED THE ISLAND...

## DAVIDE'S DOMINIONS

Davide's sprawling empire now extends to 12 territories, including the special Black Thunder Mine and Jungle Trails won during previous rounds:

TREASURE HORDE	Army may take five extra magic items at no points limit.
TEMPLE	Army may take a level 4 wizard and one extra magic item worth up to 75 points.
TRADE ROUTE	May take one extra magic item worth up to 50 points.
2 SACRED GROVES	Army may include two level 2 wizards.
2 VILLAGES	Army may include two Champions.
BLACK THUNDER MINE	Army may include one magic item worth up to 100 points.
TOWN	Army may include three Characters.
ROAD	Additional 230 points of troops.
JUNGLE TRAIL	Additional 80 points of troops.
PASS	Additional 80 points of troops.

Left: Davide finishes his last two Cold Ones in readiness for the next battle.

Currently at the top of the Thorskinson's Island league is Davide Costa, one of the chaps responsible for translating our games into Italian.

You can see from the territories accrued that his position is a commanding one, but there are swarms of ambitious Skaven, ruled by Warlords Baker and Cavatore, not far behind him.



Davide Costa



THIS ARMY IS AVAILABLE THROUGH MAIL ORDER, TURN TO THE BACK OF THE MAGAZINE FOR DETAILS.

Value

6

7

4

0

7

12

4

4

25

88

99

le eyed

e spotted

ter Point

army is 8

maximum



EPIC, 00

# PATRI THE L



WD50

By  
T  
d  
T  
m  
e  
r  
o  
b  
u



WAR  
C 000

WARHAMMER  
EPIC 40,000

# TIO OF ELDAR



By Andy Kettlewell and Steve Anastasoff

**The Eldar are the most ancient of the dominant races throughout the galaxy. Their civilisation spans countless millennia and their technology is without equal. However, they are a dwindling race, scattered through the cold depths of space on their massive Craftworlds, battling against the eternal threat of utter extinction.**

WD51



# THE ART OF WAR

*To the Eldar, war is an art. This attitude comes not from arrogance or from any strange sense of style, it comes from necessity. The Eldar are a dying race, so to truly win a battle they must destroy the enemy and suffer minimal losses. A battle won by attrition is a battle lost. For the Eldar, armour and numbers are replaced by speed and firepower. Eldar generals must use the manoeuvrability of their units to the maximum to achieve total victory.*



## BIEL-TAN CRAFTWORLD



For the people of the Craftworld of Biel-Tan the way of the warrior is considered the first and most important step upon the Eldar path. Their vehicles are ornamented with intricate twisting thorn patterns, designs of the Eldar craftsmen who take pleasure in the construction and decoration of everything in their culture, even their machines of war.

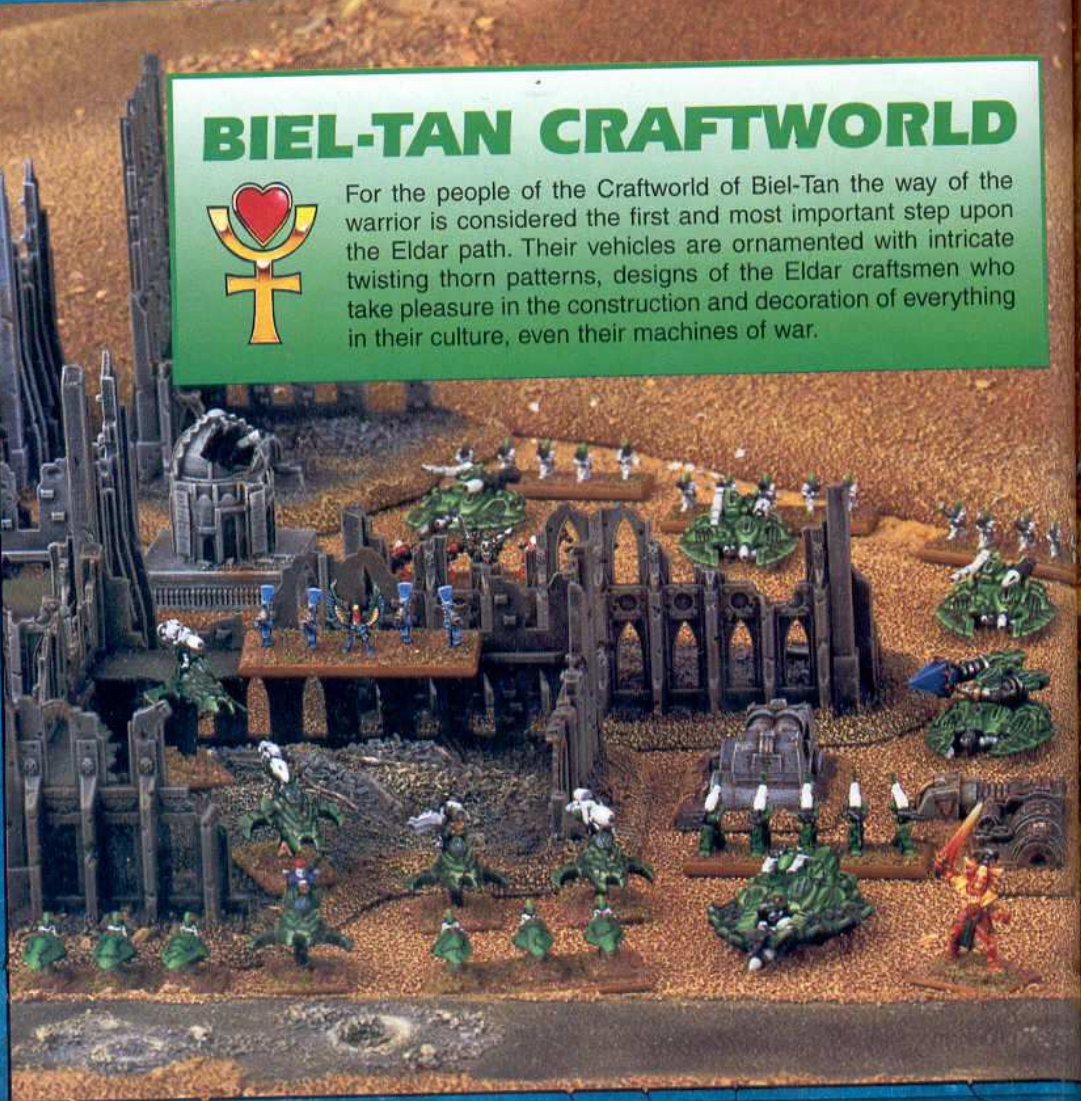



# ULTHWÉ CRAFTWORLD



The Craftworld of Ulthwé lies in close proximity to the Eye of Terror, and must constantly guard against incursions from this domain of the Chaos powers. Their distinctive black vehicles are a sight known throughout the Imperium, emblazoned with golden yellow designs that are believed to signify their position within the military organisation of the Craftworld.



## THE ARMY COMMANDER

When Eldar go to war, deep inside the heart of their Craftworld an awesome figure awakens to lead them into battle – an Avatar of the Bloody-handed god, Kaela Mensha Khaine. The most powerful of the Eldar Warlocks, the Farseers, also join battle, using their skills in predicting the future to direct the Eldar forces about the battlefield.

The Avatar is an awesome close combat opponent, and with a suitable bodyguard makes a very effective close combat detachment. The Farseer is equally useful, partly because of his psychic powers, but also due to his high manoeuvrability when mounted in a Falcon. This allows him to move quickly to wherever he is most needed.







## SAIM-HANN CRAFTWORLD



The wild, almost barbaric warriors of the Saim-Hann Craftworld favour a stark, violent red with which to colour their machines of war. Their savage Wild Riders and other vehicle crews paint symbols of the ancient Eldar pantheon of gods onto their swift tanks and Jetbikes, in the hope that the deity depicted will watch over them in battle.



## BIKES

The swiftest of the Eldar vehicles are the small but deadly Jetbikes, and their heavier cousins the Vypers. Armed with lethal shuriken catapults and shuriken cannons they can cut down their foes in swathes, with the Vypers lending a heavier punch to the squadrons.



*These Jetbike stands have been converted by raising them up on small pieces of wire to give the impression they are flying above ground.*







Eldar Jetbikes and Vypers are the fastest units in the game and possibly the most useful in the Eldar army. Vypers and Jetbikes are great for ambushing isolated enemy units and speeding around flanks after objectives. As with other Eldar units, Jetbike and Vyper detachments should form part of your mobile battle line.







# ENGINES OF VAUL

The huge war machines of other races are crude and ungainly when compared to the smooth grace of the Engines of Vaul, the super heavy grav-tanks of the Eldar. Both versions are designed mainly to destroy vehicles and war engines. The Cobra is equipped with a Distort Cannon, which has the potential to destroy any war engine (shields or no shields) with a single shot, while the Scorpion is armed with a Pulsar. Against

enemy infantry both will do damage, but will find themselves quickly swept away in firefights and close combats. Use them when there is a specific need in the battle. If you find yourself having problems with large Imperial tank detachments, or Titans, then a few Scorpions or Cobras are always welcome.



*Eldar Scorpion Super Heavy Grav Tank*



*Eldar Cobra Super Heavy Grav Tank*



*Thundering across the narrow causeway, the Land Raiders were protected by the swamp all around them. No doubt the humans believed themselves safe from attack as the skies were clear in all directions and ground vehicles could not easily penetrate the lagoons. Delairial, watching the human tanks smiled to himself, their complacency would be punished. The powerful grav tanks under his command would make short work of the ungainly human machines. He allowed his mind to slip into the soul-circuit and felt the readiness of his crews. Sensing the moment, the grav engines hummed and all three of the mighty Scorpion tanks rocketed upward, out of the swamp. Water cascaded off the smooth curves of the vast war engines as light stabbed from the slender barrels of their pulsars. The thick armour of the Land Raiders buckled and flowed under the relentless laser bombardment, smoke belched from one, then another and within seconds nothing remained of the column but a line of blazing wrecks.*



TH  
 pl  
 ph  
 sc  
 pr  
 th  
 hu  
 sn  
 ou  
 pil  
 pa



# FLYERS

With their unequalled grasp of anti-gravitic technology, it is unsurprising that Eldar craft are the most swift and agile to fly over the battlefields of the 41st millennium.

Squadrons of Night Wings make excellent interceptors and, if the enemy is foolish enough to have no fliers, they can do considerable damage when they attack ground targets as well.



Phoenix bombers have the potential to make devastating ground attacks. When using ground attack missions try to concentrate your fire power against one detachment. War Engines are particularly at risk from flyer attacks, especially when they have no shields, so try and target damaged titans and super heavy tanks before hitting infantry.

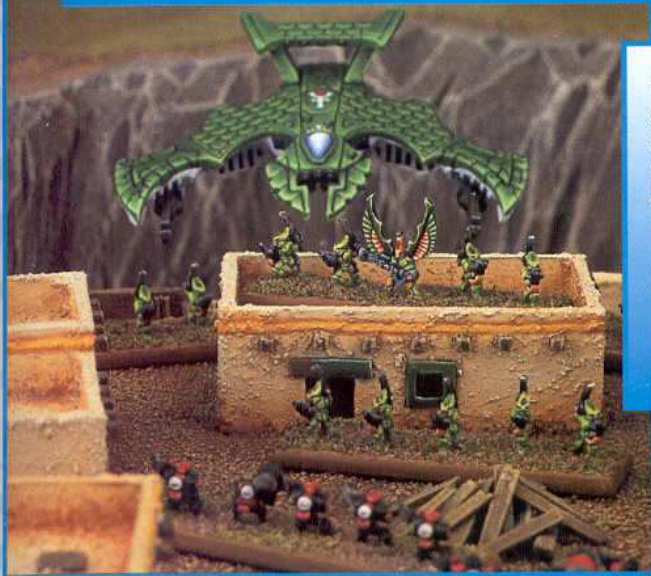

Vampires have the advantage of being able to transport units, but they are expensive and if they are carrying units as well it means a lot of points are concentrated in one, fragile model. Use your transport fliers to reinforce an attack, not to spearhead it.



*The ground rushed upwards at an impossible rate as Ceruithar plummeted to avoid the Thunderbolt fighters on his tail. The wraithbone frame of his Night Wing groaned under the phenomenal stress. Autocannon shells streaked past his cockpit in a fiery line as Ceruithar flattened into a wide roll. A soft chime sounded in the cockpit, his seer-crystal had analysed the fighter's attack pattern and was showing their projected flight paths. He sent his craft into a slow spin, then yanked it round into a sharp, banking climb. For less than a second a Thunderbolt was in his sights, he fired twice and it broke up in mid air. Explosions rang through the hull as the second Thunderbolt opened fire. Rolling to avoid it, he allowed the Night Wing to stall and enter a spine-snapping tail spin. The Thunderbolt followed him down trying to track his erratic progress. At the last second he pulled out and opened the throttles wide. The interceptor leapt skywards with laser fire stabbing from its wingtips. The human pilot tried to turn away but was not fast enough. Ceruithar swept upward through the expanding fireball as wreckage pattered off the hull. The danger over, he pulled a final wingover and resumed his attack run.*





# INFANTRY

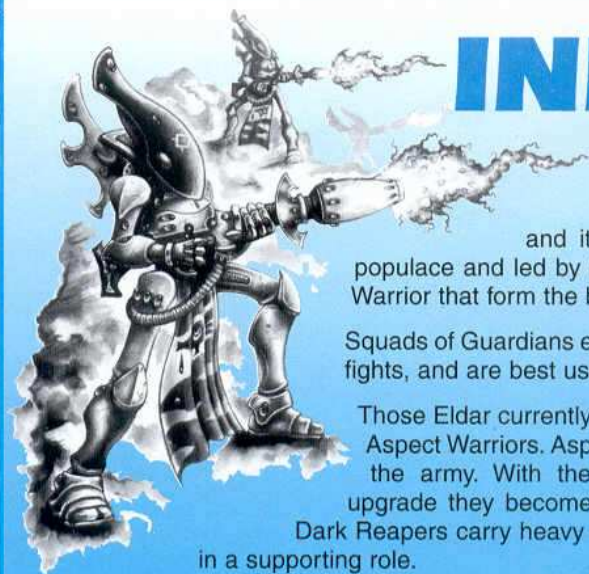

Guardians are the most numerous of the Eldar infantry. Every Eldar is trained and ready to fight if need be, and it is these squads, assembled from the populace and led by those who have trodden the Path of the Warrior that form the bulk of the Eldar forces.

Squads of Guardians excel in supporting close combats and fire fights, and are best used alongside other unit types.

Those Eldar currently on the path of the Warrior are known as Aspect Warriors. Aspect Warriors are the most flexible units in the army. With the assault upgrade and the jump pack upgrade they become very fast and deadly in close combat.

Dark Reapers carry heavy weapons which makes them very useful in a supporting role.

The Wraithguard are armoured shells bearing Spirit stones taken from the Craftworld's infinity matrix. They are most useful in assaults and for destroying tanks.

Harlequins are followers of the mysterious deity known as the Laughing God. They are great in close combat, in much the same way as Aspect Warriors.



*Swooping Hawk Aspect Warriors*

Support weapon batteries are most useful if your opponent has lots of tanks or

Scout detachments are useful for harassing enemy flanks and their infiltrate movement allows them to advance in front of your main detachments to uncover hidden counters and capture objectives ahead of the main force.



*Howling Banshee Aspect Warriors with Exarch*



*Dark Reaper Aspect Warriors with Exarch*



*Eldar Support Platforms*



*Eldar Wraithguard with Warlock*







Eldar War Walker



Eldar Fire Prism



Eldar Dreadnought



Eldar Wave Serpent

## VEHICLES



Eldar Falcon Grav Tank

Eldar vehicles, with their powerful anti-gravitic motors, combine speed with deadly firepower. Falcon grav-tanks are the most versatile of all the Eldar vehicles. They can carry troop stands, have good fire power, good speed and fairly good armour. They are generally best used in a supporting role as their range, fire power and ability to pop up attacks makes them excellent in both defence and attack. One final note about Falcons is if they are used in a supporting role they shouldn't remain stationary for very long. The Eldar battle line works best when it is mobile, constantly exploiting the opponent's mistakes and reacting to disrupt his plans.

Wave Serpents are the best vehicles to use in planned assaults and for transporting units. Their armour can protect them from the worst of the enemy fire and their weapons can lay blast markers on enemy units before you launch your assault.

Vehicles such as Prism Cannons and Night Spinners are best used in a supporting role with Falcons. Night Spinners have a huge range so they can support any assault by disrupting the enemy, while Prism Cannons can protect units from flier attacks and help destroy enemy armoured vehicles.

Relative to the rest of the army Dreadnoughts and War Walkers are slow. This means they are best used in support and for defending important objectives. Dreadnoughts also have a high assault value which helps if the enemy gets too close.



Eldar Night Spinner





The Eldar forces you can see in action across these two pages are all taken from figure painter Jonas Ekestam's very own army. Jonas has been collecting his Eldar ever since the latest edition of Epic was released, and has now amassed a full 4000 points. But not content with that he intends to keep on going until he has no less than 8000 points! Jonas also plays with Eldar in Warhammer 40,000, and has a 40K army painted up in exactly the same colour scheme.

*The key to using an Eldar army well is making the various diverse elements work together. Here we give you some hints and tips on how you can best do this...*

*...fast moving detachments of bikes can perform rescues with arrogant ease.*

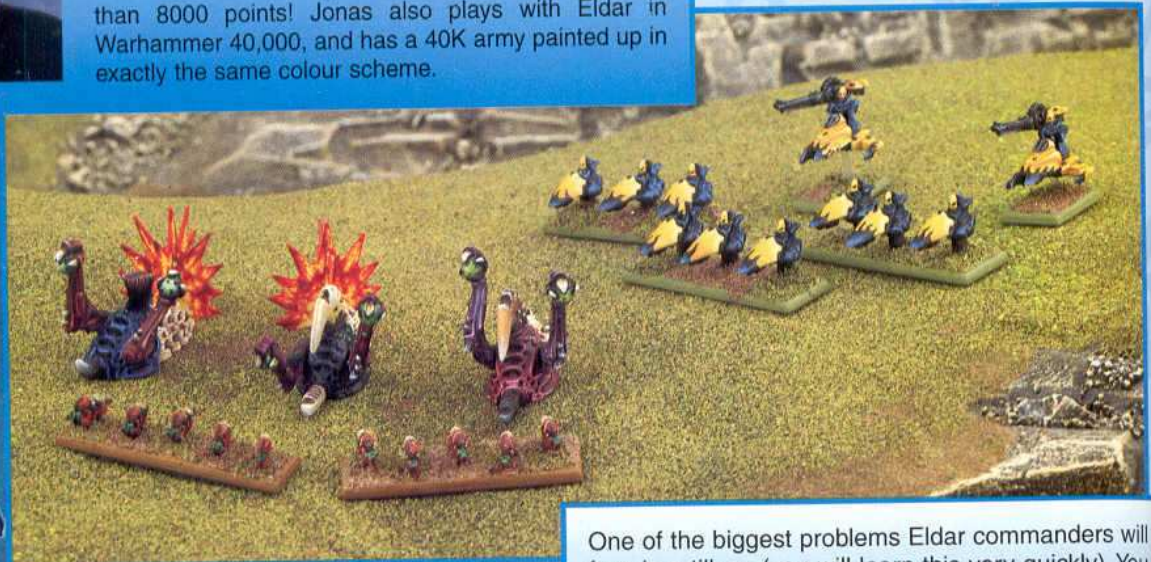

One of the biggest problems Eldar commanders will face is artillery, (you will learn this very quickly). You must find a way of neutralising the effect of your opponents' artillery detachments. Flier attacks, Bikes, Pulsars, and Night Spinners are all good solutions to the problem, but you are going to have to accept that you are going to take casualties. On the bright side artillery is very expensive so if you do manage to break an artillery detachment then it will be worth the effort.

Bunker and Rescue objectives are perfectly suited for the Eldar. Pulsars and D-cannon can destroy bunkers from long range and fast moving detachments of bikes can perform rescues with arrogant ease.

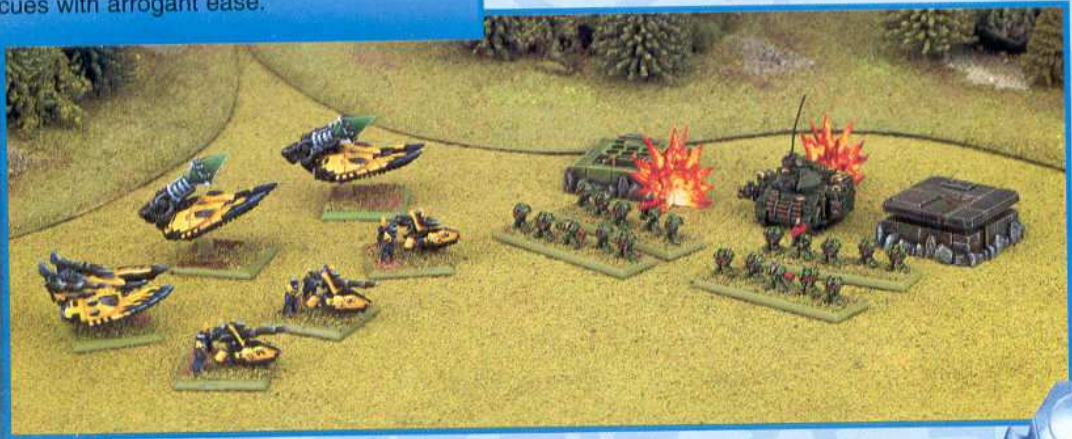

## IYANDEN CRAFTWORLD



Iyanden has suffered greatly over the millennia. This once great Craftworld is now partly ruinous due to a devastating Tyranid attack. They field large numbers of Wraithguard and Dreadhoughts, relying on the spirits of the dead to help the depleted ranks of the living. Their vehicles are most often yellow and blue, identifiable by the flaming designs used as decoration.





## ALAITOC CRAFTWORLD



The blue and yellow colours of the Alaitoc Craftworld are a familiar sight on the battlefields of the Eastern Fringe. Out in the depths of the frontier, Alaitoc warriors are taught to be self-reliant and are experts at surviving in the wild. Their huge number of Scouts gives them immense strategic advantages over lesser foes.



Super heavy tanks are excellent at long range against heavily armoured targets but can be easily pushed back in close combats and fire fights. Aspect Warrior units are the exact opposite being ideally suited for close combat, so it is a good idea to use Aspect Warriors to support your super heavy tanks.

The necessity for the Eldar player to use the speed of his units to the maximum can't be stressed enough. This does not mean however that you should be whizzing around the board in a random fashion just because you can, you should be using your speed to bring detachments together to launch a surprise attack on one part of the enemy line. Other forces simply cannot react to your quick attacks because their forces haven't the manoeuvrability. It will take your opponent a couple of turns to re-deploy and by this time you will have gone.



*Other forces simply cannot react to your quick attacks because their forces haven't got the manoeuvrability.*





**Jonas Ekestam** – Jonas' two detachments shown here are both excellent for taking out enemy armour. The Support Platforms, which are usually carried in the Falcons, Fire Prisms and Scorpions combine to deal out a frightening number of anti-tank shots each turn.

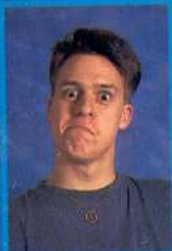

ELDAR DETACHMENT CARD																																				
DETACHMENT NAME: Ferra Sarxan	POINT COST: 25																																			
DETACHMENT TYPE: Eider Warhost	RESERVE SPEED: 30																																			
PSYKER: Ferra Sarxan	HALF STRENGTH: 6																																			
COMMANDER: Ferra Sarxan	MORALE VALUE: 7																																			
	TOTAL POINT COST: 222																																			
<table border="1"> <thead> <tr> <th colspan="2">ELDAR DETACHMENT MAIN FORCE</th> <th colspan="2">ELDAR DETACHMENT SUPPORT</th> </tr> <tr> <th>UNIT</th> <th>POINTS</th> <th>UNIT</th> <th>POINTS</th> </tr> </thead> <tbody> <tr> <td>1 2 Jutikes</td> <td>30</td> <td>1 1 Support Platform</td> <td>45</td> </tr> <tr> <td>2 2 Jutikes</td> <td>30</td> <td>2 1 Fire Prism</td> <td>35</td> </tr> <tr> <td>3 1 Falcon Gravtank</td> <td>28</td> <td>3 1 Fire Prism</td> <td>35</td> </tr> <tr> <td>4 1 Falcon Gravtank</td> <td>28</td> <td>4 1 Fire Prism</td> <td>35</td> </tr> <tr> <td>5 1 Falcon Gravtank</td> <td>28</td> <td>5</td> <td>0</td> </tr> </tbody> </table>		ELDAR DETACHMENT MAIN FORCE		ELDAR DETACHMENT SUPPORT		UNIT	POINTS	UNIT	POINTS	1 2 Jutikes	30	1 1 Support Platform	45	2 2 Jutikes	30	2 1 Fire Prism	35	3 1 Falcon Gravtank	28	3 1 Fire Prism	35	4 1 Falcon Gravtank	28	4 1 Fire Prism	35	5 1 Falcon Gravtank	28	5	0							
ELDAR DETACHMENT MAIN FORCE		ELDAR DETACHMENT SUPPORT																																		
UNIT	POINTS	UNIT	POINTS																																	
1 2 Jutikes	30	1 1 Support Platform	45																																	
2 2 Jutikes	30	2 1 Fire Prism	35																																	
3 1 Falcon Gravtank	28	3 1 Fire Prism	35																																	
4 1 Falcon Gravtank	28	4 1 Fire Prism	35																																	
5 1 Falcon Gravtank	28	5	0																																	
<table border="1"> <thead> <tr> <th>UNIT</th> <th>SPEED</th> <th>MOVES</th> <th>ARMOUR</th> <th>WEAPON</th> <th>PSYKER</th> <th>NOTES</th> </tr> </thead> <tbody> <tr> <td>Falcon</td> <td>30</td> <td>45</td> <td>2</td> <td>1 5*</td> <td>Slimec Transport (I)</td> <td></td> </tr> <tr> <td>Fire Prism</td> <td>30</td> <td>45</td> <td>1</td> <td>1 5*</td> <td>Slimec Transport (I)</td> <td></td> </tr> <tr> <td>Support Platform</td> <td>10</td> <td></td> <td></td> <td></td> <td></td> <td></td> </tr> <tr> <td>Jutike</td> <td>40</td> <td></td> <td></td> <td></td> <td></td> <td></td> </tr> </tbody> </table>		UNIT	SPEED	MOVES	ARMOUR	WEAPON	PSYKER	NOTES	Falcon	30	45	2	1 5*	Slimec Transport (I)		Fire Prism	30	45	1	1 5*	Slimec Transport (I)		Support Platform	10						Jutike	40					
UNIT	SPEED	MOVES	ARMOUR	WEAPON	PSYKER	NOTES																														
Falcon	30	45	2	1 5*	Slimec Transport (I)																															
Fire Prism	30	45	1	1 5*	Slimec Transport (I)																															
Support Platform	10																																			
Jutike	40																																			

ELDAR DETACHMENT CARD																													
DETACHMENT NAME: Ferra Sarxan	POINT COST: 25																												
DETACHMENT TYPE: Eider Warhost	RESERVE SPEED: 30																												
PSYKER: Ferra Sarxan	HALF STRENGTH: 6																												
COMMANDER: Ferra Sarxan	MORALE VALUE: 7																												
	TOTAL POINT COST: 222																												
<table border="1"> <thead> <tr> <th colspan="2">ELDAR DETACHMENT MAIN FORCE</th> <th colspan="2">ELDAR DETACHMENT SUPPORT</th> </tr> <tr> <th>UNIT</th> <th>POINTS</th> <th>UNIT</th> <th>POINTS</th> </tr> </thead> <tbody> <tr> <td>1 1 Scorpion</td> <td>110</td> <td>1</td> <td></td> </tr> <tr> <td>2 1 Scorpion</td> <td>110</td> <td>2</td> <td></td> </tr> <tr> <td>3</td> <td></td> <td>3</td> <td></td> </tr> <tr> <td>4</td> <td></td> <td>4</td> <td></td> </tr> <tr> <td>5</td> <td></td> <td>5</td> <td></td> </tr> </tbody> </table>		ELDAR DETACHMENT MAIN FORCE		ELDAR DETACHMENT SUPPORT		UNIT	POINTS	UNIT	POINTS	1 1 Scorpion	110	1		2 1 Scorpion	110	2		3		3		4		4		5		5	
ELDAR DETACHMENT MAIN FORCE		ELDAR DETACHMENT SUPPORT																											
UNIT	POINTS	UNIT	POINTS																										
1 1 Scorpion	110	1																											
2 1 Scorpion	110	2																											
3		3																											
4		4																											
5		5																											
<table border="1"> <thead> <tr> <th>UNIT</th> <th>SPEED</th> <th>MOVES</th> <th>ARMOUR</th> <th>WEAPON</th> <th>PSYKER</th> <th>NOTES</th> </tr> </thead> <tbody> <tr> <td>Scorpion</td> <td>20</td> <td>60</td> <td>0</td> <td>4</td> <td>5*</td> <td>Slimec Transport (I)</td> </tr> </tbody> </table>		UNIT	SPEED	MOVES	ARMOUR	WEAPON	PSYKER	NOTES	Scorpion	20	60	0	4	5*	Slimec Transport (I)														
UNIT	SPEED	MOVES	ARMOUR	WEAPON	PSYKER	NOTES																							
Scorpion	20	60	0	4	5*	Slimec Transport (I)																							



**Andy Kettlewell** – This is Andy's Supreme Commander detachment. The Farseer's bodyguard of Guardians riding in Falcons makes the detachment extremely fast and flexible.

ELDAR DETACHMENT CARD																																				
DETACHMENT NAME: Asp's Avengers	POINT COST: 78																																			
DETACHMENT TYPE: Eider Commander	RESERVE SPEED: 30																																			
PSYKER: Farseer	HALF STRENGTH: 6																																			
COMMANDER: Asp	MORALE VALUE: 7																																			
	TOTAL POINT COST: 321																																			
<table border="1"> <thead> <tr> <th colspan="2">ELDAR DETACHMENT MAIN FORCE</th> <th colspan="2">ELDAR DETACHMENT SUPPORT</th> </tr> <tr> <th>UNIT</th> <th>POINTS</th> <th>UNIT</th> <th>POINTS</th> </tr> </thead> <tbody> <tr> <td>1 Guardian Squad (2 Units) + 3 Falcons</td> <td>74</td> <td>1</td> <td></td> </tr> <tr> <td>2 Guardian Squad (2 Units) + 2 Falcons</td> <td>74</td> <td>2</td> <td></td> </tr> <tr> <td>3 Guardian Squad (2 Units) + 2 Falcons + 1 Unit with Warlock</td> <td>84</td> <td>3</td> <td></td> </tr> <tr> <td>4 Aspoet Warrior Squad + Exarch</td> <td>71</td> <td>4</td> <td></td> </tr> <tr> <td>5</td> <td></td> <td>5</td> <td></td> </tr> </tbody> </table>		ELDAR DETACHMENT MAIN FORCE		ELDAR DETACHMENT SUPPORT		UNIT	POINTS	UNIT	POINTS	1 Guardian Squad (2 Units) + 3 Falcons	74	1		2 Guardian Squad (2 Units) + 2 Falcons	74	2		3 Guardian Squad (2 Units) + 2 Falcons + 1 Unit with Warlock	84	3		4 Aspoet Warrior Squad + Exarch	71	4		5		5								
ELDAR DETACHMENT MAIN FORCE		ELDAR DETACHMENT SUPPORT																																		
UNIT	POINTS	UNIT	POINTS																																	
1 Guardian Squad (2 Units) + 3 Falcons	74	1																																		
2 Guardian Squad (2 Units) + 2 Falcons	74	2																																		
3 Guardian Squad (2 Units) + 2 Falcons + 1 Unit with Warlock	84	3																																		
4 Aspoet Warrior Squad + Exarch	71	4																																		
5		5																																		
<table border="1"> <thead> <tr> <th>UNIT</th> <th>SPEED</th> <th>MOVES</th> <th>ARMOUR</th> <th>WEAPON</th> <th>PSYKER</th> <th>NOTES</th> </tr> </thead> <tbody> <tr> <td>Farseer</td> <td>15</td> <td>15</td> <td>2</td> <td>1 3*</td> <td>*Non-Psychic Commander</td> <td></td> </tr> <tr> <td>Guardian</td> <td>15</td> <td>15</td> <td>2</td> <td>1 3*</td> <td></td> <td></td> </tr> <tr> <td>Warlock</td> <td>15</td> <td>15</td> <td>2</td> <td>1 3*</td> <td>*Psychic</td> <td></td> </tr> <tr> <td>Exarch</td> <td>15</td> <td>15</td> <td>1</td> <td>4 4*</td> <td>*Assault</td> <td></td> </tr> </tbody> </table>		UNIT	SPEED	MOVES	ARMOUR	WEAPON	PSYKER	NOTES	Farseer	15	15	2	1 3*	*Non-Psychic Commander		Guardian	15	15	2	1 3*			Warlock	15	15	2	1 3*	*Psychic		Exarch	15	15	1	4 4*	*Assault	
UNIT	SPEED	MOVES	ARMOUR	WEAPON	PSYKER	NOTES																														
Farseer	15	15	2	1 3*	*Non-Psychic Commander																															
Guardian	15	15	2	1 3*																																
Warlock	15	15	2	1 3*	*Psychic																															
Exarch	15	15	1	4 4*	*Assault																															







**Iain Compton** – No Eldar army is complete without a detachment of Jetbikes. They are the fastest vehicles in the game, making them excellent for skimming around and surrounding enemy detachments.

### ELDAR DETACHMENT CARD

DETACHMENT NAME: Caradhrivl's Storm Raiders DETACHMENT TYPE: Eldar Warhost PSYKER: Caradhrivl - Farseer on Vyper COMMANDER: As Above		POINT COST: 90 RESERVE SPEED: 40 HALF STRENGTH: 8 MORALE VALUE: 8 TOTAL POINT COST: 170	
<b>ELDAR DETACHMENT MAIN FORCE</b>		<b>ELDAR DETACHMENT SUPPORT</b>	
1	Jetbikes - 2 units, one with Warlock	1	Vyper
2	Jetbikes - 2 units, one with Warlock	2	Vyper
3	Jetbikes - 2 units	3	Vyper
4	Jetbikes - 2 units	4	Vyper
5	Jetbikes - 2 units	5	Vyper

UNIT	PSY	STR	MOV	ARM	ASST	ARMOR	NOTES
Farseer Vyper	40	30	2	1	4+	Skimmer, Psyker	
Vyper	40	30	2	1	4+	Skimmer	
Jetbike Warlock	40	15	2	1	4+	Skimmer, Psyker	
Jetbike	40	15	2	1	4+	Skimmer	

### ELDAR DETACHMENT CARD

DETACHMENT NAME: Eldar Warhost DETACHMENT TYPE: Eldar Warhost PSYKER: Detachment HQ - Warlock unit COMMANDER: As Above		POINT COST: +25 RESERVE SPEED: 30 HALF STRENGTH: 7 MORALE VALUE: 7 TOTAL POINT COST: 320	
<b>ELDAR DETACHMENT MAIN FORCE</b>		<b>ELDAR DETACHMENT SUPPORT</b>	
1	Guardians - 1 Unit in Falcon	1	Vyper
2	Guardians - 1 Unit in Falcon	2	Vyper
3	Guardians - 1 Unit in Falcon	3	Vyper
4	Guardians - 1 Unit in Falcon	4	Vyper
5	Guardians - 1 Unit in Falcon	5	Vyper
6	Guardians - 1 Unit in Wave Serpent with Warlock	6	Vyper

UNIT	PSY	STR	MOV	ARM	ASST	ARMOR	NOTES
Guardians	15	15	2	1	3+	Psyker	
Warlock	15	15	2	1	3+	Skimmer, Transport (I)	
Falcon	30	45	2	1	5+	Skimmer, Transport (I)	
Vyper	40	30	2	1	4+	Skimmer	
Wave Serpent	30	30	2	2	8+	Skimmer, Transport (I)	



**Chris Harbor** – Chris' Eldar Warhost is again designed with speed in mind. Chris says that speed is the key to using an Eldar force well. Trying to use your army like an Ork or Imperial force is a recipe for disaster. You have to use your speed to surround and destroy your foes, rather than trying to bludgeon your way through in a head-on charge.



**Dave Owen-Meller** – Although Eldar detachments tend to be smaller than those of other armies, Dave has tried to pack as much into this detachment as possible. The high Assault factor of the Wraithguard, supported by the Guardians and Wave Serpents, make this an excellent assault force.



### ELDAR DETACHMENT CARD

DETACHMENT NAME: Talons of Retribution DETACHMENT TYPE: Eldar Warhost PSYKER: Karl - Fars COMMANDER: As Above		POINT COST: 10 RESERVE SPEED: 30 HALF STRENGTH: 13 MORALE VALUE: 6 TOTAL POINT COST: 495	
<b>ELDAR DETACHMENT MAIN FORCE</b>		<b>ELDAR DETACHMENT SUPPORT</b>	
1	Guardians - 2 units in Wave Serpent	1	Wraithguard - 1 unit, with Warlock in Falcon, Ork (I)
2	Guardians - 2 units in Wave Serpent	2	Wraithguard - 1 unit in Falcon
3	Guardians - 2 units in Wave Serpent	3	Wraithguard - 1 unit in Falcon
4	Guardians - 2 units in Wave Serpent	4	Wraithguard - 1 unit in Falcon
5	Guardians - 2 units in Wave Serpent	5	Wraithguard - 1 unit in Falcon

UNIT	PSY	STR	MOV	ARM	ASST	ARMOR	NOTES
Wave Serpent	30	30	2	2	8+	Skimmer, Transport (I)	
Guardians	15	15	2	1	3+	Skimmer, Transport (I)	
Falcon	30	45	2	1	5+	Skimmer, Transport (I)	
Wraithguard	30	15	2	3	8+	Skimmer	



# The Hand of Fate!

*This month White Dwarf includes some special Fate cards for Epic 40,000 which have been specifically created for Eldar, Ork, Tyranid and Chaos players. Now the forces of Chaos can summon infernal magics against their enemies, Tyranids can terrorise their helpless prey, Eldar Farseers can confound their foes with their runic powers and Ork Warlords can unleash the ferocious energy of the Waaagh! Robin Dews tells us all about them...*

## Slings and Arrows

When we started to develop the Epic 40,000 game system one of the things we wanted to capture was the sense of a whole game of Warhammer 40,000 condensed down into a single Assault phase in Epic. Games of 40K normally start with the opposing armies about 24" inches apart (bolter range) and generally end with one or both of the forces being badly mauled but with one player victorious. In Epic 40,000, we recreated this sense of a decisive engagement by the resolving of combat with a single competitive dice roll (with the addition of a number of bonus factors to reflect the combat status of the troops) that makes the assaults a knife edge part of each battle.

However, whenever you decide things in a game with a single D6 roll the vagaries of chance can come into play. Despite stacking the odds in your favour by outnumbering your opponent, covering him with blast markers, and having psykers on your side, the fickle finger of fate can always turn against you and when your opponent rolls a

'6' and you roll a '1' there is nothing you can do but howl in fury! Thus the Epic 40,000 Fate cards were born.

Initially, the cards were designed as simple re-rolls to help iron out some of the slings and arrows of fortune. However, as we began to develop the system we saw the opportunity to include other events in the deck such as 'Orbital Barrages' and 'Forced Marches' to give players the opportunity for an extra edge at critical moments in the battle. We also saw how the Fate cards would give us the opportunity to further develop the characteristics of the different warring races in the 40K universe by giving the Orks some Orky Fate cards and the Eldar their own set and so on.

In the Epic 40,000 game, we included a deck of 12 Fate cards that are used by both players regardless of the armies involved in the battle. This often means that in an average 2000 point game, one side has four cards and the other player has five. This means that there are only three 'dead' cards left in the deck giving



you a fair chance of guessing your opponent's hand. I normally work on the assumption that if I'm not holding the 'Orbital Barrage' (a 3D6 firepower attack anywhere on the battlefield!) then the chances are that my opponent has it in his hand and I try to avoid making March moves too early in the game as this is usually one of the first cards to be played. However, if I'm holding 'Curses Foiled Again' then I know that whatever he throws at me, I can turn the tables and play his card back against his own force.

We always intended to increase the size of the basic Fate deck, and a few months ago we published the 'Emperor's Tarot' in White Dwarf issue 210. This is a special deck of 16 cards that can only be used by Imperial players.

Now it's the turn of the Ork, Tyranid, Eldar and Chaos players! On the card sections of this issue of White Dwarf you'll find four sets

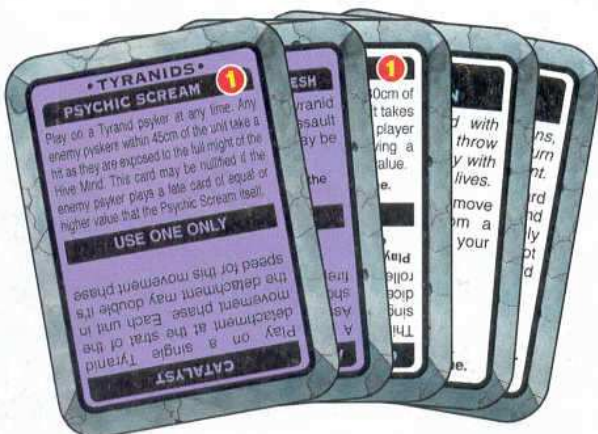

of  
cre  
Ea  
ea  
the  
sta  
nev  
car  
gre  
har  
wha  
  
In g  
givi  
Epic  
we c  
use  
way  
inv  
two  
here  
othe  
gam  
alter  
them  
know  
princ  
oppo  
meth  
draw  
  
How  
nev  
Epic  
  
Meth  
Imper  
Imper  
player  
either  
stand  
the 'Im  
oppon  
race sp  
stand  
new cu  
then dr



of four new cards specifically created for each of these armies. Each of the four new cards for each race are used together with the twelve cards from the standard fate deck to create a new 'custom' deck of sixteen cards. This larger deck generates greater fog of war and makes it far harder for your opponent to guess what cards you hold in your hand!

In generating the new cards and giving them to some of the big Epic fans in the Studio to playtest, we discovered that they can be used in a number of different ways depending upon the armies involved in the battle. We've listed two of the most obvious ways here, together with a handful of other ideas, but if you or your gaming group come up with alternate suggestions, then give them a try and write in to let us know. The most important principle is that you and your opponent should agree on which method to use *before* you start to draw any cards.

### How to include the new Fate cards in Epic 40,000

**Method 1:** If the battle involves an Imperial player against any non-Imperial army, then the Imperial player can choose to pick from either the 'Imperial Tarot' or the standard Fate deck. If he chooses the 'Imperial Tarot' then his opponent simply shuffles his four race specific cards into the standard Fate deck to create a new custom deck of 16 cards and then draws his cards normally.

If you don't have a copy of the 'Imperial Tarot' or the Imperial player chooses to draw from the standard deck, then simply mix in the race specific cards for the other player and deal them out in the normal fashion (usually one card for each 500 points in your army, with an extra card going to the player who's army points total was the lowest!).

If the Imperial player receives any of his opponent's army cards, then he simply puts them to one side and draws new Fate cards until he has the correct number of cards in his hand. The non-Imperial player can of course use either standard Fate cards or the new race specific ones.

**Method 2:** If no Imperial forces are involved in the battle, then both players should shuffle their four race specific cards in with the standard Fate deck to create an expanded super-deck of twenty cards. Cards are then dealt as normal, and if either player receives cards from their opponent's set, they place them to one side as before and draw new cards until their hand is full.

*In addition to the above, we've decided to list some of the wilder suggestions from the Studio staff. Please be aware that these have not been extensively tested and could lead to some unpredictable results!*

**Method 3:** Ignore the normal method of drawing Fate cards. Instead each player draws D3 cards from both the standard deck and their new set of race specific cards, so that each player will have a random number of cards ranging from 2 to 6!

**Method 4:** Mix the new set of Fate cards for each player into the standard deck before dealing out Fate cards as normal. Imperial players can draw four random Emperor's Tarot cards to add to the deck. Players who receive Fate cards they cannot use are allowed to redraw them (or not if you prefer).

**Method 5:** Each player is allowed to choose six cards to make up the Fate card deck. Cards can be chosen from the standard Fate deck or the players' special four card sets (or up to four from the Emperor's Tarot for Imperial commanders). Once the deck has been chosen, shuffle it and deal out Fate cards as normal. If either player is dealt a card they cannot use then the card is discarded and another one dealt to replace it. If there are no cards left the player doesn't get a replacement at all!

### Nullifying Psychic Attacks

The new Fate cards include many different kinds of psychic attack that players can use to blast their enemies. However, the method for nullifying these attacks remains the same regardless of what they are called. Any fate card that has a number value printed on it is counted as a Psychic Blast for the purposes of nullifying. Hence any psychic attack can be nullified by the opposing player if he can play a card with a *higher* value on it before the attack is resolved.

Well that's about it for now. Let us know how you get on with the new cards, but most of all just have fun!





# GAMES WORKSHOP

## 1st/2nd November 1997

# GRAND RE-OPENING



**Get £15 OFF  
GORKAMORKA!**



**MEADOWHALL STORE**  
91B High Street, Upper Mall  
Meadowhall Centre

Come off the M1 at junction 33. Follow signs for MEADOWHALL SHOPPING AND LEISURE. Go into the RED car park and Games Workshop is just inside the entrance near Boots chemist.

For more information, call the store on:

**0114 256 9836**

Offers subject to availability and only available on 1/2 November 1997 at Games Workshops Meadowhall, Portsmouth & Worcester.



# MEADOWHALL, PORTSMOUTH & WORCESTER

# WINGS

**DOORS OPEN  
9AM SATURDAY  
& 10AM  
SUNDAY**



Buy three blister packs and  
get the one with the lowest  
price FREE!



Buy three boxed sets and  
get the one with the lowest  
price FREE!

**£15  
OFF**

**GORKAMORKA or  
WARHAMMER or  
WARHAMMER 40,000 or  
NECROMUNDA or  
SPACE HULK or  
WARHAMMER QUEST**

Redeemable at Games Workshops  
**Meadowhall, Portsmouth &  
Worcester** on the 1/2 November 1997.

ONLY ONE VOUCHER PER PRODUCT. NOT TO BE USED  
WITH ANY OTHER OFFER.

**£5  
OFF**

**ANY 1  
Codex!**

Redeemable at Games Workshops  
**Meadowhall, Portsmouth &  
Worcester** on the 1/2 November 1997.

ONLY ONE VOUCHER PER PRODUCT. NOT TO BE USED  
WITH ANY OTHER OFFER.

**£5  
OFF**

**ANY 1  
Army book!**

Redeemable at Games Workshops  
**Meadowhall, Portsmouth &  
Worcester** on the 1/2 November 1997.

ONLY ONE VOUCHER PER PRODUCT. NOT TO BE USED  
WITH ANY OTHER OFFER.

## PORTSMOUTH STORE

34 Arundel Street, Portsmouth

Come out of Portsmouth and Southsea railway station. Cross the road and walk up Slindon Street. At the junction with Arundel Street, turn right and Games Workshop is approximately 20m up on the right hand side.

For more information, call the store  
on:

**01705 876266**

## WORCESTER STORE

4 Charles Street, Worcester

Walk up High Street towards the Cathedral. Once you reach the BT telephone shop, turn left and Games Workshop is approximately 200m down on the right.

For more information, call the store  
on:

**01905 616707**







# GAMES WORKSHOP

## MANCHESTER GRAND RE-OPENING 25/26 October 1997

DOORS OPEN  
9AM SATURDAY  
& 10AM  
SUNDAY

Get £15 OFF  
GORKAMORKA!

Buy three blister packs and  
get the one with the lowest  
price FREE!

Buy three boxed sets and  
get the one with the lowest  
price FREE!

£15  
OFF

GORKAMORKA or  
WARHAMMER or  
WARHAMMER 40,000 or  
NECROMUNDA or  
SPACE HULK or  
WARHAMMER QUEST

Redeemable at Games Workshop  
MANCHESTER on the 25/26 October 1997.  
ONLY ONE VOUCHER PER PRODUCT. NOT TO BE USED  
WITH ANY OTHER OFFER.

£5 ANY 1  
OFF Army book!

Redeemable at Games Workshop  
MANCHESTER on the 25/26 October 1997.  
ONLY ONE VOUCHER PER PRODUCT. NOT TO BE USED  
WITH ANY OTHER OFFER.

£5 ANY 1  
OFF Codex!

Redeemable at Games Workshop  
MANCHESTER on the 25/26 October 1997.  
ONLY ONE VOUCHER PER PRODUCT. NOT TO BE USED  
WITH ANY OTHER OFFER.

### MANCHESTER STORE

69/70 Marsden Court Arndale Centre  
Manchester

Walk down Market Street to the Arndale Centre entrance opposite Boots. Go to the escalator up to the first floor, then walk across to the escalator which goes down into Marsden Court. At the bottom turn right, Games Workshop is the 2nd on the right.

For more information, call the store on:  
**0161-834-6871**

Offers subject to availability and only available on 25/26 October 1997 at Games Workshop Manchester.



# WARHAMMER

## 40,000



Commissar Yarrick

Working on White Dwarf we get to see loads of photos of different armies sent in by our readers. This month was no exception and we were particularly impressed by Paul Thomas' brilliantly painted Warhammer 40,000 Imperial Guard army. Paul loves to collect and paint new armies (and when he's finished, he often sells them to finance his next project!) and so we asked him to bring his models into





# THE MIGHT OF THE IMPERIUM

the Studio. No sooner had we started to open the miniature cases, than a crowd gathered to take a closer look. The sight of all those tanks and Imperial Guardsmen prompted shouts of "ere, I've got one of those too!" and in the end we had people bringing in Imperial Guard armies left, right and centre. In a huge Imperial Guard fest we decided to photograph and show some of our favourites.



Captain Chenkov of Valhalla







Paul Thomas

## PAUL THOMAS

Paul paints loads of Citadel models and does it very well. His Imperial Guard army is one of many that he has collected: this one taking about two years to complete.

The basic squads are all painted in regimental colours of his own design. For example, Paul wanted an urban look for his Catachan Jungle Fighters instead of their traditional green so he painted them grey. The Storm Troopers are painted with red berets which, along with his Cadian Shock Troops, are his favourite squads in the army.

A tank lover through and through, Paul's original idea was to have a whole platoon of each type of Imperial Guard vehicle (that's ten Leman Russ', ten Chimeras etc, etc!). But you know how it goes, there's always something else to paint. Paul told us that he hadn't really painted any vehicles before he started on the Imperial Guard so he used the same highlighting techniques as he did on his infantry squads rather than just using a big brush to drybrush them with.

Griffons are Paul's favourite vehicles at the moment and he's come up with an interesting tactic for using them in battle. He keeps three of them in reserve for two turns or so and then brings them on to deal with any enemy troops who have strayed too close to Imperial Guard lines. In fact he quite likes to keep his reserves for later on in the battle rather than bring them on in the first turn like many players seem to do. As far as army selection goes, Paul would like to have less Hellhounds and more Griffons. He would also like to include a lot more basic 100 point infantry squads to bulk out his forces. Keep dipping your brush Paul!

### Catachan Jungle Fighters



### Mordian Iron Guard



### Imperial Storm Troopers

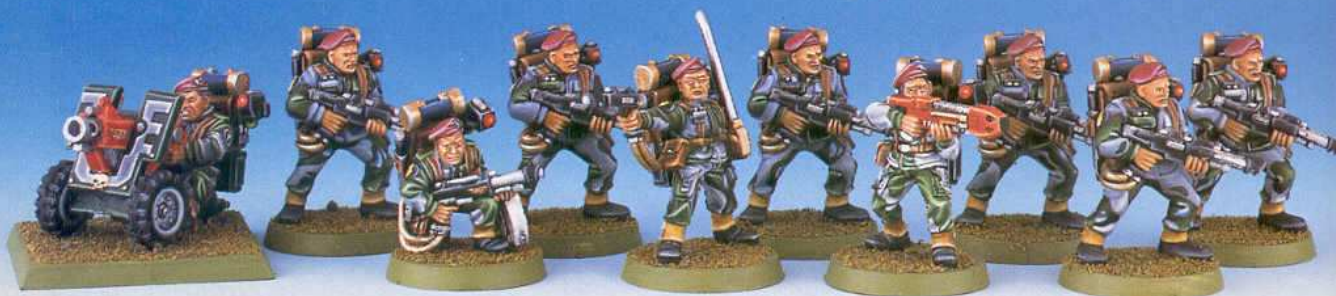

most of n  
tank and  
the follow  
causing  
specially  
one, it's t  
blade. Ne  
chances

The Chim  
any enem  
you'll fin  
begins. Y  
from hitt  
to start w  
"DAKKA  
miss! Now  
Chimera's



## Rough Riders of Attila

WARHAMMER  
60000



## Cadian Shock Troops



## Imperial Guard Ogryn Squad



### A WINNING IMPERIAL GUARD TACTIC BY LONNIE MULLINS FROM THE USA

I can hear it now, "Imperial Guard? How can you possibly win with the Imperial Guard?" Let me say, I've never lost a game with my army once I found the key ingredient for success: Ogryns!

A little lesson I learned some time back as I collected my Imperial Guard army was no one really expects you to be on the offensive. The Imperial Guard make great offensive troops, and

most of my opponents (and yours for that matter) will build their armies for anti-tank and assault if they're fighting against an Imperial Guard army. If you use the following tactic this will be their downfall. First take one squad of fear-causing Ogryn from your additional units allotment. Place them in your specially constructed Chimera (also from your additional units, you know the one, it's the one with the supercharged engine, ablative armour and bulldozer blade. Next add a Commissar as a turret gunner (his BS of 5 will improve your chances to hit). Mix well and employ as reserves. The following should ensue.

The Chimera comes screaming across the battlefield on turn two, ramming into any enemy troops or bikes foolish enough to get in the way. If you're lucky, you'll find yourself in or near your enemy's deployment zone. Now the fun begins. Your Ogryns jump from your Chimera, probably taking one wound each from hitting the ground at such high speed (so what, they have three wounds to start with - just a flesh wound!). Now you open fire with your Ogryns' "DAKKA DAKKA DAKKA!" And guess what? Ogryns at close range never ever miss! Now your Commissar opens fire along with the gunner manning the Chimera's heavy bolter. Do you have any idea how many Sustained Fire dice

that is? Two each for the Ogryns, two for the heavy bolter and three more from the scatter laser for a grand total of 15! Eat hot death alien scum! If anything survives, it's probably broken and running (if it's smart). Other units find it difficult to charge those fear-causing behemoths in hand-to-hand. Left to their own devices, the Ogryns will happily go skipping through your enemy's deployment zone dispensing a taste of boot and hot lead to anything in range.

The reason this tactic is so successful is that I have found there are only two types of opponent. The majority are those who play angry, "Oh you killed my Exarch! I'm gonna pound that unit into the dirt." These are the types of players who, when something goes wrong take their revenge on the unit that caused the problem. The minority fall into the category of those who play cold (me, for example), "Oh, you killed my Commissar, I guess I'll just have to continue my battle plan without him". This opponent has a set plan and will not bend (or bends very little). Both types of opponent will fall victim to this tactic as no one can afford to have 12 foot tall monsters that cause fear rampaging through their deployment zone. Most small arms won't stop them, so your opponent uses his heavy weapons to stop these beasts, allowing your tanks and infantry to move forward and sweep all that is before them!

While no plan ever survives contact with the enemy, I think you'll find no enemy will survive contact with this plan. Cheers to you all and good luck in your next game!

If you have any other great tactical ideas, send them in to White Dwarf. Don't write pages of stuff, though. Please be brief!



Paul has done some conversion work on all his tanks, and has come up with some great painting ideas too. These include diagonal colour stripes and camouflage painted in unusual patterns.

### Chimera

We like the way that this camouflage pattern starts with narrow bands extending out from the turret, getting broader as they move down the tank.



### Basilisk



### Chimera



Commissar



pattern starts  
of the turret,  
the tank.

### Leman Russ

Paul has used the spotter from the Griffon model kit as a Tank commander on this Leman Russ.



WARHAMMER  
40,000



Primaris Psyker

### Hellhound



Captain Al'rahem of Tallarn

### Leman Russ

Paul has replaced the lascannon on the front of this Leman Russ with a heavy plasma gun.



Commissar



# REINFORCEMENTS ARRIVING...



## Ian Strickland – White Dwarf

Ian has recently joined the White Dwarf team. He loves old photographs showing huge columns of Second World War tanks advancing across the landscape, supported by thousands of foot troops.







### Mark Bedford – GW Model Maker

Mark Bedford has some great looking painted armies including this Imperial Guard force. Take a look at the sand bags and camouflage netting Mark has added to all his tanks and artillery.

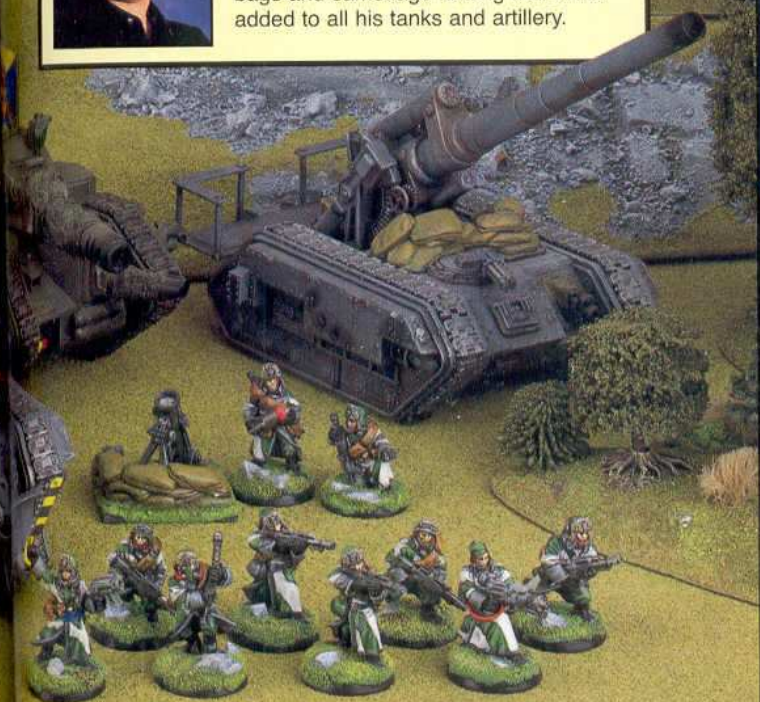

Check out Mark's models in White Dwarf 204, Treadheads.

## WARHAMMER EPIC 40,000

When we started work on the new Epic 40,000 model range, we wanted to invest the miniatures with as much variety, character and detail as their 40K counterparts. The Imperial Guard were no exception as you can see from the Epic 40,000 Basilisk, Leman Russ and Chimera models shown here



### John Wigley – GW illustrator

You'll recognise John from last month's illuminations article. He loves the Valhallan Imperial Guard and has lots of infantry squads instead of tanks.







## SIMON 'TREADHEAD'\* TIFT'S NECROMUNDA 9th

When we talked to Simon about his Imperial Guard army he started ranting. Rather than try to remember everything he said, we got him to write it all down...

"I never meant to collect an Imperial Guard army, it's one of those things that just kind of happened. I have a Blood Angels Space Marine army that has become so enormous (9000 points, including a 20-man Death Company!) that I can't stand painting red any more. Being a staunch defender of the Imperium and wanting to make my army even bigger, I decided to use a few Imperial Guard squads as allies for my Blood Angels. The Imperial Guard are a great looking army with some fantastic Tank kits. They would be great in battle, but most important of all, I wouldn't have to paint them red!

After painting my first few squads of Catachans, I decided to collect my own Imperial Guard army. It is based around my very own regiment with the models named after members of my Necromunda gang, 'the Grabbers'. I've also created my own regimental colour scheme and cammo patterns for this regiment. So, the Necromunda 9th (or Battle Grabbers) were born, with my old gang leader "General Grabber" as their wily commander. I am still adding to my army, even though it has now exceeded the size of my Blood Angels!

I wanted to give the impression of a massive army with regiments pulled from throughout the galaxy to fight alongside my Blood Angels. For this reason I decided to include squads and platoons from lots of different regiments rather than choose just one. I can also field a smaller force of just the Necromunda 9th as you can see above, which makes a great 1600 point army for smaller games.

### FAVOURITE TACTICS

The size of my army allows for great tactical flexibility. For example, I love using my Imperial Guard as a completely mechanised army by fielding loads more tanks than shown above. It's really intimidating for your opponent when you bring

your whole army onto the games table in your first movement phase, after they've had to set up on the table as normal. This can make the Imperial Guard an unpredictable army to play against and can often throw your enemy's plan completely off balance.

I have one particularly favourite unit in my army. The Catachan Lascannon weapon team have the veteran ability Dead Eye Shots. This unit was great when I played against White Dwarfers Adrian Wood's Ork army. They annihilated his Evil Sunz warbikes in two turns (that's not how I remember it – Adrian). Ratling Snipers are always great, (except when you play against Tyranids) I just love the way they bravely stick it out in the middle of the battlefield. Deploying Ratling Snipers is always fun, your opponent has to do something about them or risk losing entire units to their deadly fire.

### WHAT ELSE DO I HAVE? WHAT AM I PLANNING TO ADD?

I love tanks! I have included them at every possibility in my army, nearly every auxiliary unit I have is a tank. There is such variety in the Imperial Guard models that I'll just continue to collect more for a long time. At the moment I am working on a second platoon for my Necromundans and a completely converted platoon for a new regiment. I want to include some Ogryns and Storm Troopers and I still haven't got round to painting all the characters I want. There just isn't enough time, and to make things even worse I just started painting my first Sisters of Battle Squads as allies for my Imperial Guard. Oh no, here we go again..."

\*Treadhead – a person completely and utterly obsessed by anything remotely to do with tanks





Simon "Treadhead" Tift

Necromunda IX Yellow Company Red Platoon												
	M	WS	BS	S	T	W	I	A	Ld	Save	PTS	
<b>Colonel Grabber</b> Necromunda IX, Commander sword, bolt pistol, shotgun, frag grenades, refractor field, carapace armour	4	6	6	4	4	3	6	3	9	4+/5+ (unmodified)	137	
<b>Regimental HQ</b> 4 Troopers frag grenades, 2 flamer, 2 meltas guns, flak armour	4	3	3	3	3	1	3	1	7	Save 6+/5+		
<b>Squad 1</b> 10 Troopers frag grenades, lasguns, meltas gun, heavy bolter, bolt pistol	4	3	3	3	3	1	3	1	7	Save 6+/5+	118	
<b>Squad 2</b> 10 Troopers frag grenades, lasguns, flamer, heavy bolter, bolt pistol	4	3	3	3	3	1	3	1	7	Save 6+/5+	119	
<b>Heavy Weapon Squad 3</b> 6 Troopers frag grenades, 3 autocannons Dead Eye Shots	4	3	3	3	3	1	3	1	7	Save 6+/5+	133	
<b>Chimera/Command</b> 3 Crew bull dozer, hunter killer missiles, storm bolter, searchlight	4	3	3	3	3	1	3	1	7	Save 6+/5+	165	
<b>Chimera/Squad 1</b> 3 Crew bull dozer, storm bolter	4	3	3	3	3	1	3	1	7	Save 6+/5+	145	
<b>Chimera/Squad 2</b> 3 Crew auto launchers, storm bolter	4	3	3	3	3	1	3	1	7	Save 6+/5+	145	
<b>Chimera/Squad 3</b> 3 Crew auto launchers, storm bolter	4	3	3	3	3	1	3	1	7	Save 6+/5+	145	
Catachan IV Black Company White Platoon												
<b>Command Squad</b> Captain Flanley sword, bolt pistol, frag grenades, refractor field, carapace armour	4	5	5	4	4	2	5	2	8	Save 4+/5+ (unmodified)	94	
4 Troopers frag grenades, heavy bolter, flak armour	4	3	3	3	3	1	3	1	7	Save 6+/5+		
<b>Squad 1</b> 10 Troopers frag grenades, lasguns, meltas gun, missile launcher, bolt pistol	4	3	3	3	3	1	3	1	7	Save 6+/5+	138	
<b>Heavy Weapon Squad 3</b> 6 Troopers frag grenades, 3 lascannons Dead Eye Shots	4	3	3	3	3	1	3	1	7	Save 6+/5+	175	
<b>Ratling Snipers</b> 5 Ratling Snipers needle sniper rifles, flak armour	4	2	4	2	2	1	5	1	6	Save 6+/5+	80	
											Total points, 1593	

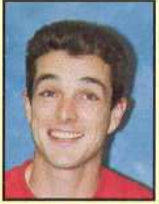

**Fred Reed – Area Manager**

One of our favourite Imperial Guard armies from past White Dwarfs is Fred Reed's force featured in WD 203. When asked about his painting scheme he said, "I like to keep it simple, choose one or two colours that go well and stick to them."







### Nick Davis – GW Studio

Nick works in the GW Studio and is a complete gaming addict. The word humongous seems to best describe Nick's army. Nick used the army in the first Warhammer 40,000 staff tournament where, he says, he got really thrashed!



### Richard Wilson – GW Leeds store

Richard is the manager of the Leeds store. He gave himself only six weeks to paint his force of Tallarn Desert Raiders (we don't believe it). He used the same uniform colour on all the models as well as a fast

but effective painting style. Although he says he's not lost a game yet, he admits to having played only five! One of Richard's favourite tricks is to give the Hardened Fighter veteran ability to his squads of Rough Riders and Ogryns. They become unstoppable in close combat and it only costs an extra 10 points!



### Anthony Bath – GW Photographer

GW photographer, Anthony always wanted a Tallarn Imperial Guard force when they first came out. More specifically, the Tallarn Guardsman with missile launcher was the figure that really attracted Anthony to the Tallarn army. Have a look at those Chimeras. Amazingly he painted all three in a single evening!

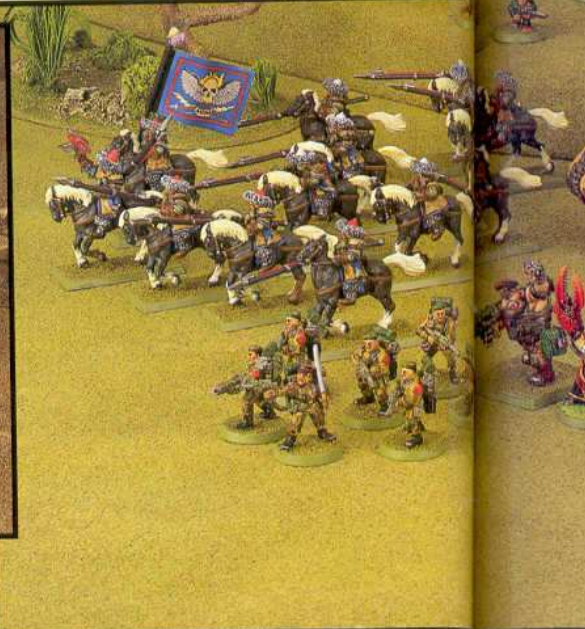



**95th Cadia Rifles Imperial Guard Regiment – (The Revenants)**

The 95th Cadia Rifles was raised for a campaign on Galthomer III which was under Ork domination. As the world has a mix of climates several additional regiments joined the 95th. The initial planet fall was a disaster, the Orks were able to destroy several troop transporters. With his original command almost destroyed, Colonel Fiess joined with the remnants of the other surviving regiments. He renamed them the "Revenants" and, with the help of additional reinforcements in the shape of the mighty Space Marines from the Star Eagles chapter, they reclaimed Galthomer III for the Imperium.

**Regimental Command HQ** – Colonel J. Fiess, Commissar Yarrick & Primaris Psyker Lord  
**(Regimental Command in green dress uniforms)**  
**Colour Sergeant A. Bull, Medical Officer D. Kildurn**

**Company 1 Command HQ** – Cadian Captain J. Tarrant, Commissar Byron & Primas Psyker Master  
**Commissar Heiss & Primaris Psyker Master**

**Platoon 1 – Cadian Rifles**  
 Command Squad – Lieutenant N. Pike  
 Tactical Squad  
 Tactical Squad  
 Tactical Squad – Chimera  
**Additional Units**  
 Demolisher  
 Ratling Snipers  
 Sentinel Squad

**Platoon 2 – Cadian Heavy Rifles**  
 Command Squad – Lieutenant S. Green  
 Tactical Squad  
 Heavy Weapons Squad  
 Heavy Weapons Squad  
**Additional Units**  
 Basilisk  
 Griffon  
 Valhalla Heavy Weapons Squad

**Platoon 3 - Mordian Grenadiers**  
 Command Squad – Lieutenant F. Lawrence  
 Tactical Squad – Chimera  
 Tactical Squad  
 Heavy Weapons Squad

**Additional Units**  
 Ratling Snipers  
 Storm Troopers  
 Leman Russ 1

**Platoon 1 – Catachan Rangers**  
 Command Squad – Lieutenant T. Savallis  
 Tactical Squad  
 Tactical Squad  
 Heavy Weapons Squad  
**Additional Units**  
 Ogryns  
 Leman Russ 2  
 Hellhound

**Platoon 2 – Tallarn Pathfinders**  
 Command Squad – Lieutenant A. Akbar  
 Tactical Squad  
 Tactical Squad – Chimera  
 Heavy Weapons Squad  
**Additional Units**  
 Leman Russ 3  
 Storm Troopers – Chimera

**Platoon 3 – Attilan Light Lancers**  
 Command Squad – Lieutenant G. Khan  
 Rough Riders

**Army Points Value: 7463**

Nick has also kindly supplied us with his 7463 point (WOW!) army list, or should I say essay!

needs  
arn  
eeve  
colour  
fast  
not  
ve!  
ened  
ers  
ombat





# WARHAMMER

## 40,000

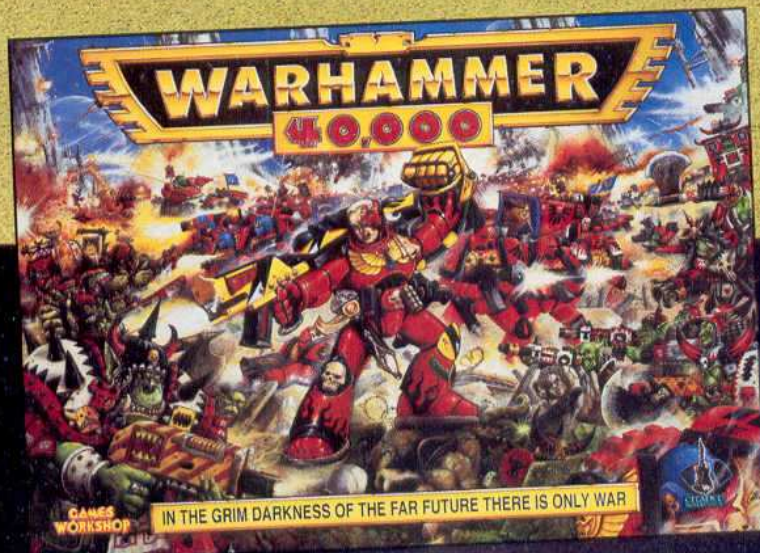

The Blood Angels defend an Imperial Firebase against a Tyranid swarm. This photograph features Space Marine and Tyranids from the extensive range of models for Warhammer 40,000 game.



Warhammer 40,000 and some of the many supplements available



WARHAMMER

# DIARY OF A COLD HEARTED SLAUGHTERER



The Warhammer 40,000 boxed game contains everything you need to get started including Citadel miniatures, buildings, rulebooks, dice and much, much, more.



## From the personal journal of Balinarch Chi'hl, Prince of Malthalion.

Translator's note -Only fragments of this journal have been translated. This is often due to Balinarch's eccentric handwriting or ominous stains obscuring parts of the text, occasionally however it is simply that the sentiments expressed within are not suitable for translation.

*It has been three days now since we landed on this rock. So far no amusements have presented themselves. Perhaps I shall have to order some random executions to test the loyalty of my troops. I may even be forced to uncover a plot or stage some kind of mutiny simply to prevent myself from going quite mad with boredom.*

*Today we fought the Skaven. Treachery prevented me from achieving the victory that was rightfully mine. I have been forced to execute almost a third of my scouts to eliminate the traitors. Now I am confident that I shall not suffer such ignominy again.*

*My mood was lifted somewhat today by a pleasant afternoon spent killing Chaos Warriors. The smell of these infernal creations is particularly disturbing to one of such refined sensitivities as myself, so exterminating them is almost a chore rather than a pleasure. I was gratified to see that casualties upon my own side were fairly heavy, hopefully I shall not see any more of the complacency that has characterised the household of late. I must ensure that Damroth's attention is firmly fixed on the task at hand in future. I couldn't help noticing that his heart did not seem to be in the battle today. I shall have to speak to him and make my feelings on this clear, painfully clear....*

*Wonderful news, after nearly a week in which I have not killed anything it seems that some of the wood scum have scampered from their dingy holes and dare to show their faces in open country. The perverted tree-hugging fools will be taught not to show such temerity again.*

*My plan was a masterstroke, the plant lovers stumbled forwards blindly and were crushed between the steel and fangs of the Knights of house Chi'hl. I personally slew the Tree-Daemon and all heart seemed to leave the unwashed barbarians - indeed some hearts of the wood scum were forcibly made to leave by the Brides of Khaine (ah yes, I am as much a master of comedy as I am a master of strategy).*

mine, allowing me to scuttle there and lick my wounds. The world will hear from Balinarch Chi'hl again.

**May 9th:** It's amazing what a good nights sleep can do for your confidence, I have arranged another game, this time against the servants of dread Khorne commanded by Stephen Averill. The game is set for Monday so I begin my preparations. After a lot of thought the only real change is that my unit of Crossbowmen is replaced by a legion of the dread Black Guard. As Crossbowmen will find it hard to damage tough, heavily armoured Chaos Warriors, the Black Guard should hopefully make more of an impression against the twisted legions.

**May 12th:** This is more like it! Exactly as I planned, the warped and ungainly children of Chaos fell like stalks before the scythe of my glorious

host. Not a single hideous creation survived to offend my sensitivities with its presence. Damroth Chi'hl, however, managed only the slaying of a single Beastman in the entirety of the battle - and that was in hand-to-hand combat! He has been warned that such a feeble performance will not be tolerated twice.... Intoxicated with success, the fell host captured another silver mine. Balinarch and Damroth now have magic items coming out of their pointy ears. Incidentally my cunning tactical use of Black Guard was a complete failure, they were wiped out to a man without striking a blow when



BATTLE 2: Take that! Chaos scum. A win against Steve's warband.

they were charged by Chaos Knights led by a Lord of Khorne. Well, you can't be right every time.

**May 13th:** Another game has been arranged, I am to face a second Skaven horde, this time commanded by Alessio Cavatore. Despite my previous poor showing against the Skaven, I am convinced that my basic army is fine, with this in mind I decide to return to my original army list for this battle. Alessio is a highly skilled player so this promises to be a tough game. I am going to spend my evening reading the Skaven Army Book, I shall exterminate the flea-bitten, verminous hordes of Ratmen for good.

### May 14th:

Evidently the 'chat' between Damroth and Balinarch worked as Damroth pretty much won the battle by himself.

Determined not to risk another poor performance he summoned a Spell Familiar and this magical double-act blasted the Skaven force into submission. Alessio suffered the most appalling luck, while I was fortunate beyond mere jamminess. At the end of the battle, a ragged half-dozen or so Skaven were huddled behind the concealing contours of a hill, afraid to venture out for fear of crossbows, bolt-throwers and Arnizapal's Black Horror. None dared oppose Balinarch's triumphant advance into the village that had previously been in thrall to the Skaven. The only piece of ill-fortune that I suffered was the death of my spy. For the first two games I had forgotten all about him, evidently he was busy infiltrating the Skaven lair - a difficult task at the best of times. As soon as I asked him to report, I must have blown his cover because he was instantly unmasked and

executed as an object lesson in counter-espionage. The adepts of Clan Eshin obviously never relax their guard for a moment.

**May 16th:** Today I am to play a Wood Elf army commanded by Paul Smith, one of our artists. I watched his army in action against Steve's Chaos force yesterday and I am pretty confident that I can beat it with my standard army and a very cunning plan. After a good, hard think, I have made only two significant changes to my army; the first is that after a distinctly substandard effort by the Cold One Knights, Balinarch has summoned his personal steed and will lead the regiment himself by way of an example. Secondly, in recognition of his continued success, the temple



of Khaine has released a Witch Elf champion. This fanatical killer will provide a deadly sting to the Sisters of No Mercy. Now for the cunning plan....

### May 16th - Later:

Hooray! An overwhelming victory over Balinarch's barbarian kin. I must admit to being slightly worried when the Treeman showed up, but Balinarch dealt with him personally and with commendable efficiency. The remainder of the Wood Elf army was simply swept away by the lethal onslaught of the berserk Witch Elves, or fell pierced by dark-fletched bolts as the crossbowmen of the Thorn Company decimated them from afar. As a result of their defeat, the Wood Elves were forced to abandon the forest that had been their home, leaving the foul servants of darkness to cut down the mighty trees for their evil machineries. I have now played everyone in my group once, and I think I am leading so far with three wins out of four games. There is still a long way to go before the fate of Thorskinson's Isle is finally



decided however and the second part of the campaign will begin shortly.

**May 22nd:** Rick announced the results of the first round today. I have the most points from my group and Rich Baker is second so we must fight a battle to decide who will be the winner. This 'play-off' battle will be slightly unusual in that we do not have to stake one of our territories for the game, instead the winner will gain a special territory which allows you to take extra points for your force and swap any territory you like for another, randomly generated one after every battle. This is an immensely handy territory to have, and Rich is the only player so far to have beaten me so I will have to come up with my most cunning plan yet if I want to win it. I have no fear however. My revenge will be mighty, Skaven blood will flow like mountain streams after the thaw, ahaha, AHAHAHA!

**May 27th:** OK, a temporary setback has occurred. I would like to think that Rich only beat me due to the fact that he had over three hundred points more than I did, however honesty forces me to accept that he simply had a better army and fought particularly well with it. His two Doomwheels in particular proved to be hugely successful, evidently the rats had been hand-reared on the finest Warpstone as both war machines managed a truly impressive turn of speed throughout the battle. My cunning plan consisted of having a very focused army. I took a two large units, one of Cold One Knights, the other of Witch Elves, a smaller unit of crossbowmen, two repeating bolt-throwers and a few scouts. I hoped to be able to crush his units one at a time between the Cold Ones and the Witch Elves while the Crossbowmen and Bolt throwers dealt with nuisances like Doomwheels and Plague Censer Bearers. That was the plan anyway. Unfortunately it all fell apart when the Doomwheels started to crash into the flanks of my force. The Witch Elves were completely demolished by one Doomwheel while the Bolt Throwers and Crossbowmen were crushed by the other. Balinarch, leading the Cold One Knights held out the

longest and almost destroyed both the Stormvermin and the Rat Ogres simultaneously in a heroic last stand, but the inevitable was only being postponed and he too fell when the Doom wheels managed to manoeuvre into a charge from the rear. Damroth was the only Dark Elf standing at the end of the battle - his Cloak of Mist and Shadows protected him from everything the Skaven could muster.

The next stage begins on Monday, this time there are two groups. One is exploring a haunted gorge reputed to contain a potent magical secret, while the other will explore the jungle trails and try to reach the volcanic plateau at the island's centre. Despite my recent misfortune, I really think that exploring is the best occupation for a Naggarothi noble. This time, this time...

**June 2nd:** The second stage of Rick's campaign has now begun so I have arranged a load of games. I find that if I arrange all of my games at once then I won't get so dispirited if I lose a couple because I always have

## 'Oh dear, and it was all going so well. Davide's Lizardmen crushed me utterly.'

the next game to look forward to. First I am going to play Luca Miselli, his Undead army will be a fresh challenge for me. After that, I am playing Owen Crisp who fields a Chaos army and then Rich Baker's Skaven for a third time (This time I'll show him!).

**June 3rd:** I have just finished fighting against Luca and this has been my most efficient demolition yet. On my first turn Damroth killed the Vampire Lord who was the dark will behind the Undead horde. Although the power of the Carstein Ring subsequently resurrected him, the entire army with the exception of a unit of Skeletons led by a Necromancer dissolved. As my blood-thirsty hosts surged forwards, he was forced to hide this last unit in a wood to keep it out of the way of the Cold One Knights. For four turns the Vampire dodged and evaded but to no avail. On the

last turn, he was charged by the Witch Elves and the Cold One Knights. He routed and was caught, the Necromancer panicked, victory was mine!

Balinarch now controls another trade route, this brings the current territory roster to: Two trade routes; two silver mines; a forest allowing three extra war machines; a sacred grove and a village. What I really need now is a territory that allows me extra points such as a road. Hopefully I shall be lucky when I play Owen's Chaos force tomorrow.

**June 4th:** Doh! Several people - including Tuomas our resident God of Warhammer - have pointed out to me that if a Vampire is killed wearing the Carstein Ring, then he is resurrected without the army being destroyed. Lesson for today; always read the description properly! Luca and I have agreed not to count yesterday's game and refight it next week. At least my battle against Owen brought me some cheer. Although I lost, I thoroughly enjoyed the game and I firmly believe that I could easily have won. The

next time that we meet, it should be a very close fought game. The only thing that really worried me was the Great Unclean One which he squeezed into his army.

After the weekend I have a few more games to play, I have the rematch with Luca, a game against Davide who has a Lizardman army and hopefully I will have time to play Owen again. Before all this however, I have to try and recover some sort of honour from the Skaven. I am playing Rich Baker for the third time tomorrow. An exceptionally cunning plan is needed.

**June 9th:** Oh dear, and it was all going so well. Davide's Lizardmen crushed me utterly. Damroth spent almost the entire battle frozen by the Black Gem of Gnar and Balinarch was ensnared by the spell Net. Meanwhile, a tide of scaly death swept across my force demolishing



**BATTLE 8:** Blast those Lizardmen! Davide denies my rightful victory.

units with impunity. To add insult to injury, on the very last turn of the game when Damroth finally broke free of the Black Gem, he steamed into the injured Slann Mage Priest hoping to finish him off with a Dark Hand of Destruction spell and the Staff of Lightning - only to find that Davide had the Drain Magic card - aaargh! My final attempt at glory denied. I have arranged a rematch for Wednesday so there is still some hope of redemption,

My army was pretty standard for this battle, it has remained essentially unchanged since my last game against Rich a couple of weeks back. Overall, I don't think that I need to modify it very much - in fact I want to keep it as

unchanging as possible so that it has more continuity. A lot of the players are simply writing their armies from scratch after each game, only the narrative of the campaign itself is providing any real link. I don't think that this is really within the spirit of the campaign so I shall make my stand for continuity over winning. It is after all a campaign, not a tournament.

**June 10th:** It's all going horribly wrong! I played Luca's Undead force again and it was a disaster. As fast as I advanced towards him, he retreated, and all the while a Liche, a Vampire count and a Necromancer were systematically dissecting my army. Unable to get to grips in combat, not able to see anything to shoot at and completely overwhelmed in the magic phase I could only watch helplessly as my force fell apart. Again my army was exactly the same as before,



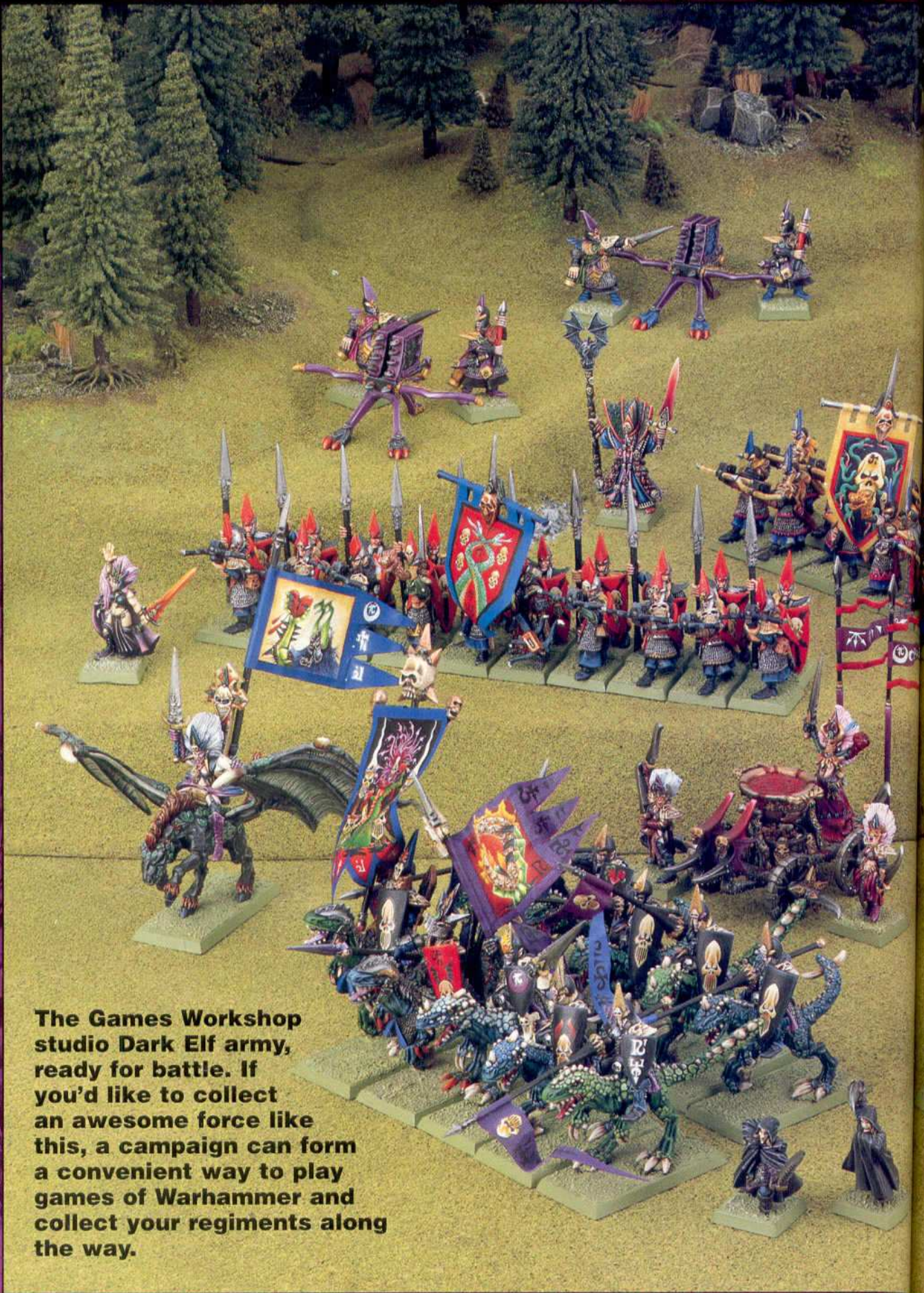

**The Games Workshop studio Dark Elf army, ready for battle. If you'd like to collect an awesome force like this, a campaign can form a convenient way to play games of Warhammer and collect your regiments along the way.**







perhaps it should change but I shall persevere for now.

Tomorrow I have a rematch versus Davide's Lizardmen. Although my confidence is at a bit of a low ebb at the moment, I shall be optimistic about it. He doesn't actually have anything that I can't take care of - bar his Stegadon, but I can work around this. As long as I don't get careless, I feel that I have a good chance of winning.

**June 11th:** OK, OK. Rethink required. Davide's victory was not as crushing as last time - but it was comfortable nonetheless. I started quite well, decimating his Skink regiments - both the javeliners and the Cold One riders but, as I predicted, the Stegadon proved to be unstoppable. After a brief detour over the Dark Riders, it stomped across the Witch Elves who were too busy fighting off the last of the Cold-One riders to get out of its way. Aside from the Stegadon, combats were generally very close, usually only one point separating the combatants. Unfortunately, Dark Elves are far more likely

more involving than picking them off at a range. There will be plenty of thumping tomorrow, as I am playing against Owen's Chaos force once more. It is time for my run of ill-fortune to end.

**June 17th:** At last! I am playing Owen tomorrow. I have come up with a basic plan using my standard army. The Dark Riders have been replaced by a Laurathe Chi'hl, a level one Sorceress with a Spell Familiar while Damroth's Cloak of Mist and Shadows will be replaced with a Potion of Knowledge to make the most of my magical superiority. Aside from that I shall rely on Cold Ones, Witch Elves and bolt throwers to break up his ranks. Hopefully, I will be able to sort out his Great Unclean One with a spell - Soul Drain, Arnizapal's Black Horror or Blade Wind could do it if I am lucky.

**June 18th:** Result! This has to be my fastest victory ever. Owen changed his force radically and took an entire army of Beastmen. Even so, my original plan worked beautifully. I crashed into his largest unit with the Cold One

(Whoop! Whoop! Hurrah!) which gives me an extra 60 points for my army. Another good result from the battle is that Balinarch, Laurathe, the Cold One Knights and the Witch Elves are all elite troops. This means that they can re-roll all of their 'to hit' dice once each per game. With the Cold One Knights especially, this is a particularly useful ability as a fluke set of rolls often means disaster. Because the Witch Elves roll so many dice, their luck tends to average out more than the Cold Ones who only get one dice each.

What to do with my extra points? I think that I shall give the Scouts another airing, five of them cost only 65 points so I won't need to refigure my army too drastically to accommodate them.

**June 20th:** Just as I was going home, Rich reminded me that we were supposed to be playing a game today. Luckily I hadn't forgotten....erm. As my army is held in a state of perpetual readiness at the Studio, we were still able to play despite my absent mindedness. This

last day of the second part of Rick's campaign, and I managed to squeeze in one more game against Rich. This time, the game was infuriatingly close. The only things left to him were a dozen or so Plague Monks and a Grey Seer. Both of his Doomwheels had been reduced to shattered wrecks, Balinarch had demolished the Stormvermin all by himself and the Skaven Warlord had been killed by a Manticore (Damroth under the influence of the spell Transformation of Kadon). To be fair my own army was seriously depleted, but I still had quite a lot still fighting. Next time...

So, the end of another month and the end of another campaign turn. I didn't do nearly as well this time as I



BATTLE 13: Skaven, Shmaven! Richard destroys me yet again.

## 'A shooty army is definitely the way to go against Skaven...'

to run away than Lizardmen so I tended to come off worse. A big cheer must go to Davide for leaving the Black Gem of Gnar behind on the grounds that it made the game boring, it's good to see that players are still concerned with an entertaining game over an easy victory. I am going to have to reorganise my army a little bit before I play Rich tomorrow. A plan of exceptional cunning is required, there is no way that I am going to lose three times to the same opponent.

**June 12th:** Rich isn't very well today so I have even more time to hatch my nefarious plans against him. Perhaps I should just take lots of missile troops and hope that everything dies before it gets to me. The only problem with this strategy is that it is SO BORING! I hate just standing there and rolling dice. I love big, swirly combats and desperate charges. Thumping people in close combat is so much

Knights and the Witch Elves simultaneously, broke them and while the Cold One Knights finished them off, the Witch Elves crashed into his second unit. That combat also went my way and the game was over as Owen didn't actually have any figures left. To be fair, I was quite lucky on two occasions - both times when I was in combat with his main unit. Firstly, Balinarch challenged the Chaos general and narrowly avoided death from his Frost Blade, secondly the Beastmen had a Battle Banner and he only rolled a '1' for it's effect!

The best news is that the territory I gained was a road



BATTLE 11: Ha! Chaos falls again. This time Owen is the victim.

was the closest game that I have played against Rich, but he still won convincingly. Quite a lot of this was due to his Vermin Lord. I really wasn't expecting this and it threw me somewhat. I actually managed to break it in hand-to-hand combat with Balinarch and the Cold One Knights but, as I couldn't pursue it rallied in the next turn. Even though the Vermin lord didn't perform particularly well in combat, it's Curse of the Horned One spell managed to do for most of the Cold One Knights and a large number of Witch Elves.

Although, Rich has now beaten me three times, I think that I have a very good chance of beating him, if we play again. Every time that I play him, I learn a great deal about how his army works and how my army works against it. A shooty army is definitely the way to go against Skaven. A second bolt thrower is under construction.

**June 26th:** Today is the

did in the first month, only one win from seven games. Not a great performance but, them's your breaks. In the third round there will be three objectives to fight over, an Elven shipwreck, some mysterious caves or searching for the fabled lost city of Xhezeuotzit. My interest in exploring has been momentarily eclipsed by the desire to despoil the scum of Ulthuan so I shall be investigating the shipwreck. Vengeance is eternal.

Well, it's that time again, or rather it was that time again some time ago - does that make sense? Never mind, due to my being a) on holiday and b) immensely busy for the last couple of weeks, I have managed to miss the first half of the third campaign turn. However I am planning to catch up with my adversaries and give them a good, solid dose of fine Naggaroth steel!

My Dark Elf army has remained entirely unchanged since the last turn, my views on changing armies around in the middle of a campaign are becoming increasingly hard-line. Just to recap, here is a brief run down of my army:



Balinarch Chi'hl is my general who rides a Cold One, wears Armour of Protection and carries an Ogre Blade. He leads House Chi'hl, a unit of seven Cold One Knights, with the Standard of Shielding. A Sorceress called Laurathe Chi'hl with a Spell Familiar normally fights alongside the Sisters of No Mercy, a unit of thirteen Witch Elves carrying the Standard of Might. I have a unit of nine Crossbowmen called the Thorn Company and they are usually accompanied by Damroth Chi'hl, a Sorcerer Champion with a Spell Familiar and a Potion of Knowledge. Five Scouts form the Shadow Company and the whole army is topped off with two repeating bolt throwers. This has turned out to be a surprisingly flexible army and I have done pretty well with it so far. On to battle!

**July 21st:** My first game of the turn is to be against Alessio who commands a Skaven horde which I have learned to respect. Those of you who have been following my progress over the past couple of months may recall that we clashed in the first turn and I came out on top. Alessio remembers...

**Later:** So close! That was the hardest fought game of Warhammer that I have had for a long time. Only a single victory point separated Alessio's victory from my defeat! Both armies were seriously mauled at the end of the battle with very little left to fight with on either side. Alessio had all the luck early in the game, but the favour of the Horned Rat left him once his general had fallen (or more likely, just before...) and I was unusually jammy later in the game. Magic played almost as big a part in this game as it did in our last battle - unfortunately it was all coming from Alessio's side this time. His Warlock Engineer and Warlock Champion kept up a constant hail of sorcerous power throughout the battle, Poison Winds, Putrefies and even

Cracks Call spells all took their toll on my depleted legions. My own wizards achieved very little. Damroth was killed early in the game by a Poison Wind spell, while Laurathe lost her life in a Mental Duel shortly after

At least the Skaven army fled wholesale when the general fell. It's so annoying to kill a general, only to see the enemy remain completely unfazed by this feat of arms. Large Skaven regiments look so much better from behind!

Alessio forced me to abandon my trade route so I have taken over another village instead, this means that I now have two villages, two silver mines, a forest, a road worth sixty extra points and a sacred grove. I am quite happy with these territories, the only thing that I really want is more points. There is nothing for it but to stake my road a couple of times.

My next battle will be tomorrow against Luca and his Undead army. We have met twice before, once we had to discount the game because I messed up the rules about the Carstein Ring and the second time he beat me hands down. I will make him pay for this.

**July 22nd:** Complete disaster! Luca won by using the sneaky and underhand tactic of hiding his entire army behind a wood so that I couldn't shoot at it. It was

## 'This has turned out to be a surprisingly flexible army...'

pretty much a replay of our last game where his three wizards - Vampire Count, Necromancer and Liche - blasted my army to bits from a distance with very little hand-to-hand combat involved in the game at all. The only real combat occurred on the last turn of the game when his Skeleton cavalry led by the Vampire charged the Cold One Knights. Needless to say the Vampire with his Hydra Sword carved them up utterly and, coupled with a rash of

### From the personal journal of Balinarch Chi'hl, Prince of Malthalion.

*Today we were ambushed by the scaly ones. My fury knew no bounds as I was forced to watch my household being cut down around me. By foul sorceries I was held immobile and unable to participate in the battle. I shall speak to Damroth and convey my displeasure at being made to suffer so. He shall not dare to stand by and allow me to suffer such ignominy in future.*

*Damroth claims that he was just as helpless as I. This sounds too convenient to be easily credible, but for now I will allow him to believe that I am taken in by his cowardice.*

*An amusing interlude occurred today. I had ordered the force to advance through a village and the men were of course taking their sport with the natives, when all at once we surprised a band of twisted Beastmen. Before they could array themselves for battle, we had overrun them and were thus able to spend a quiet afternoon cutting bits off of them. (translators note - here the text becomes particularly hard to decipher) I had his head... bits went everywhere... the blood... cooked with potatoes...*

*NO! NO! NO! I gave explicit instructions concerning battle with Skaven. My plans were meticulously detailed and absolutely bound to succeed. Instead, however my incompetent band of officers managed to misconstrue my orders in the most disastrously inept way possible. In some ways I bitterly regret executing them all instantly, as I have missed a sterling opportunity to deliver a lesson in tactics to the troops. However, I feel that a lesson in obedience is perhaps more appropriate at this time.*

appallingly bad saving throws on my part, this effectively finished the game.

**Iain's Handy Home Hint:** No.1 in an irregular series. Never cast a power three spell that will not achieve anything on the last turn of the game just for something to do. You never know when your opponent will have Reflection card and a Curse of Years spell in his hand!

killed two of the Cold One Knights with a Curse of Years spell causing a Panic test. As the unit contained my general, they needed a ten or less to pass. Naturally, they failed and fled. The next turn, they failed to rally and proceeded to run straight off the table. With my general gone I had to take Panic tests for everything else in my army. Every single unit failed their test with the exception of the Witch Elves

who were Frenzied and didn't have to test. Just to add insult to injury, Luca's Liche, who was armed with a bow, took advantage of the fact that Laurathe was temporarily separated from the Witch Elves and shot her dead!

Luca decided to take the village that I had staked leaving me to retreat to the dubious safety of a mountain. This means that I can include another monster in my army. Unfortunately, I tend not to

I did have one stroke of luck in the game. Right at the beginning, I forgot to stake my road and put up a village instead. I have arranged another game with Luca for Thursday, so I have two days to plot my revenge.

**July 24th:** If the last game was a complete disaster, then this game must rank as a truly apocalyptic cataclysm. At no point in the game was I even remotely in with a chance. Here is an example. Luca



BATTLE 15: Luca's Undead romp to another victory over me.



Each month, the players in the campaign are given a choice of objectives to fight over. The two most successful generals fighting over any particular objective get to fight in a special playoff with the winner gaining a unique and powerful territory. This month, my Dark Elf horde has learned of an Elven Shipwreck. Their interest piqued by tales of vast wealth being washed ashore along with dead High Elves, they have trekked back to the coast.

**From the personal journal of Balinarch Chi'hl, Prince of Malthalion.**

*The Skaven have pushed me too far. Even after they had obviously lost the battle, the ragged, flea-infested scum kept on advancing. Evidently they are too stupid to understand the magnitude of the glorious victory that I won over them. I shall see that the prisoners are given personal tuition in my greatness...*

*I have given the most explicit orders, that on no account is anyone to mention any details concerning our recent encounter with the unliving. Just thinking about it makes me want to shout rude things and kick people (Translators note. This is not a strictly accurate translation of the original text which runs to considerable length).*

*I find it hard sometimes to recognise the sheer incompetence of the average city guard officer. I led the army on to the field to eradicate once and for all the legions of the walking dead. Having seen that things were proceeding according to plan, I generously retreated to allow my regiments to sate their thirst for glory. The fools however mistook my magnanimity for cowardice, and, thinking that all was lost fled the field. Never have I been so humiliated. I have enjoyed the cut and thrust of lively debate over this with selected officers. The emphasis being firmly on 'cut' and 'thrust'. Alas my officers were only able to contribute opinions such as 'aargh' and 'scream' with 'gurgle' proving a popular counter-argument.*

use monsters in my games as I prefer to win or lose with my regiments. I believe monsters are for big games, games like these battles should be about units and low level heroes.

**July 28th:** At very short notice I arranged to play Alessio once more. I hoped that the game would be as close as our last joust and that I could bring about a reversal of my recent fortunes. How wrong I was. I got absolutely stuffed by Alessio's vermin legions. Balinarch pulled off his famous running away trick yet again. My crossbowmen proved unable to hit anything at all, and I failed all but one of my Cold One Knight's two plus saving throws when they finally got into combat. Still all credit to Alessio, he manoeuvred his army flawlessly and exploited his good fortune to the hilt. I am going to a dark room to have a long lie down now and when I return, the world will tremble because I will have come up with a plan so cunning that people on horses will want to chase it across fields

**July 31st:** My plan will have to wait for another time. Turn three of Rick's campaign is over and people are signing up for

round four. Not surprisingly I have failed to even remotely approach the Elven shipwreck that I was supposed to be investigating. Some unkind people have pointed out the seemingly downward trend of my performances over the last three turns - winning all but one game in the first round, only winning one game in the second round and not winning a single game in the third round - but these people just don't realise that tactical genius ebbs and flows, you can't just turn it on and off like some tap. Obviously these callous denigrators of have absolutely no personal experience of the pinnacles of such strategic brilliance....

Still, never mind. As before, there are three objectives to strive for in the next round. The first is only available to people who have won a previous round. A second is to go on a wild rampage of destruction, looting and slaying at random (sounds good to me!). The last option is to investigate the ruined city of Wotnobisquit. I think that a spot of good, honest, senseless violence will be just the tonic to lift Balinarch out of his black mood (not that he has any other kind) so I will sign up for the second objective. Ready or not world, here I come!

*The army of House Chi'hl*



My Dark Elf force was almost ready before the campaign was announced. Just a few bases to finish and I can start another regiment



If you're thinking of getting started  
in the GW hobby, then get down to  
your local Games Workshop store

# NOW!

**£12  
HOBBY  
STARTER  
DEALS**

For a limited period, all  
Games Workshop Stores  
are running some truly  
amazing offers for  
newcomers to the hobby...

**HOBBY STARTER DEAL INCLUDES:**

- Starter Paint set
- Back issue of White Dwarf
- 2x£5 plastic model sets

**OR** £10 worth of blisters

**OR** £10 combination of two

Call in at your store for more details

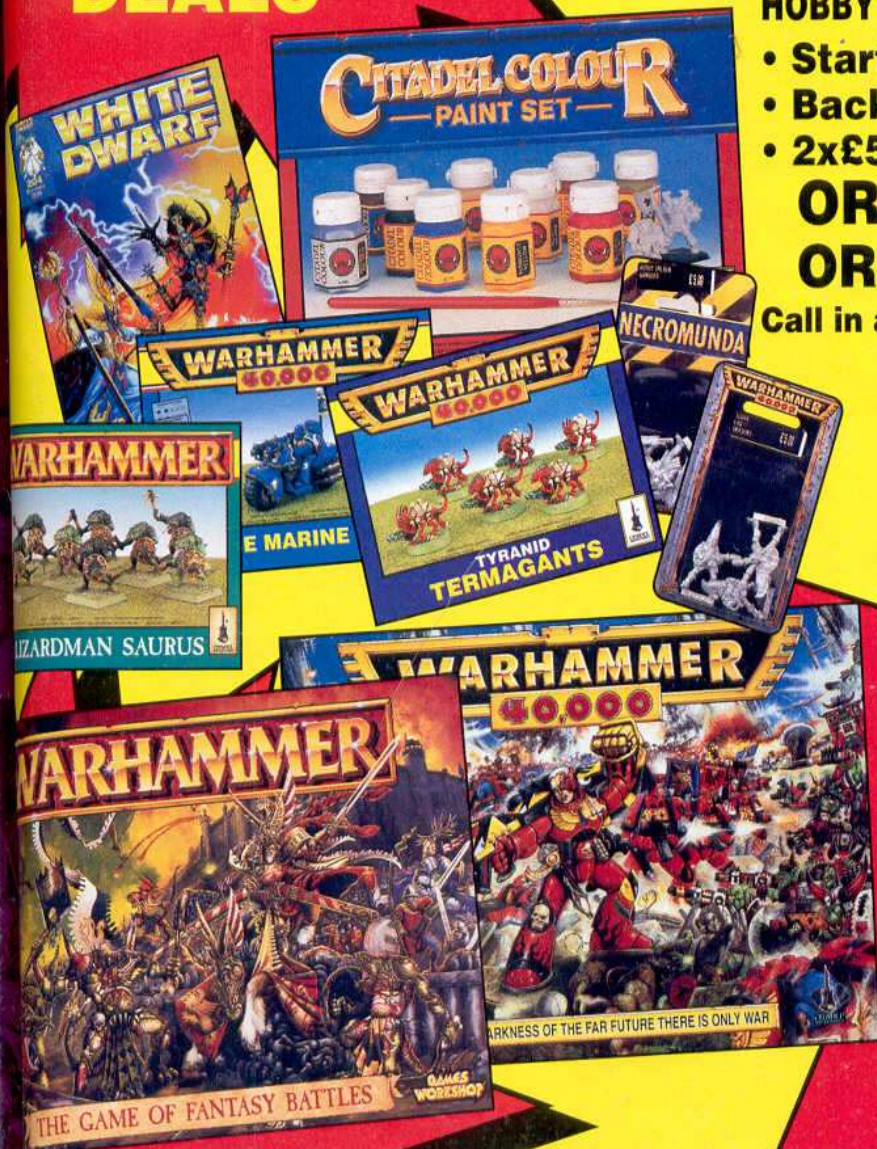

**FREE £10  
VOUCHER  
WHEN YOU  
BUY  
WARHAMMER  
40,000 OR  
WARHAMMER**



## EPIC 40,000

Get ready to start your attack run because we've got loads of new stuff to mess around with for Epic flyers, all penned by Gav Thorpe. There are ideas on how to carry non-infantry units on larger transport vehicles, more on Gargoyles and Swooping Hawks plus a couple of historical re-fights. To kick off though we've got two brand new flyer missions.

## EVAC! EVAC!

As well as rapidly deploying troops into key areas of the battlefield, another use of transport flyers is to airlift troops out of danger or swiftly relocate them from one part of the war zone to another. This introduces the possibility of another flyer mission – Evac (short for evacuation, if you hadn't already guessed). You can only use Evac missions if you have first agreed to do so with your opponent – this is an optional rule, not a sovereign right!

1. Flyers on Evac are placed and moved just like flyers performing a transport mission. They may also shoot in the same way – their

firepower is halved and any super heavy weapons require a 4+ to lock-on and fire.

2. After shooting the flyer must remain where it is until the end of the movement phase. The troops being evacuated are allowed to make a 20cm retreat move, just as if they were broken. This means they can move even if they are marked by lots of blast markers. As usual, the troops must sacrifice 5cm of their movement to board the flyers. Flyers which are attacked while on the ground (by a preparatory bombardment, for example) are treated like normal vehicles – there is no

chance they will be driven off, a hit is a kill.

3. At the end of the movement phase the flyer takes off and zooms back to its base, taking any evacuated units with it.

4. When the last unit in a detachment is evacuated it loses any blast markers (removing these does not affect army morale). From the next turn onwards the detachment counts as being a flyer detachment in reserve and you should roll to see if it is combat-ready in subsequent turns. When it becomes available it may be returned to the battlefield using a standard transport mission. The evacuating flyers must refuel and re-arm for a turn as normal.





# COUNTERSTRIKE

Achieving supremacy in the skies is a key part to winning a battle. If your flyers can ground attack the enemy without risk of interception they will cause your opponent untold amounts of grief. Air superiority can be achieved in a number of ways. Some commanders put their faith in the ability of their interceptors to shoot the enemy out of the sky in a dogfight. Some armies rely on their superior batteries of anti-aircraft guns. Other army leaders prefer to hit the enemy when they are most vulnerable – while they are on the ground! The new counter-strike mission detailed below allows you to send your flyers on a ground attack on the enemy airbase. You can only use counter-strike missions if you have first agreed to do so with your opponent (though I'd recommend them as they can be very entertaining...).

1. Flyers performing a counter-strike may be intercepted by enemy flyers, just like a ground attack or transport mission.

2. The defender may roll one snap fire attack at each attacking flyer to represent the anti-aircraft defenses around their base.

3. Any enemy flyers performing a mission this turn are not affected by the counter-strike – they are already in the air. Enemy flyers that are re-arming can attempt to scramble. Roll a D6 for each flyer, if the score is equal to or less than the flyer's dogfighting value it has managed to scramble and flies clear before the strike hits home. Any models which roll over their dogfight value or are being repaired are potential targets.

4. Work out the attack of the counter-strike just as if the flyers were performing a ground attack, treating all the enemy flyers on the ground as a single vehicle detachment in the open. The attackers are assumed to be in range and the player performing the counter-strike mission can allocate hits to any enemy models. Attackers with a

barrage count as having a firepower of 2 each (heavy barrages as 4) when performing a counter-strike. Flyers on the ground are destroyed if they are hit - there is no chance of them being driven off. This attack does not place blast markers.

5. Flyers that have performed a counter-strike must re-arm and refuel as normal next turn.



Author of the article, 'Barnstormer' Thorpe.

Top hole aerial prank from Iain 'Biggles' Compton:

**'Dropping an Avatar, and a load of Exarchs on to enemy Land Raiders is an absolute winner.'**





# CARRYING NON-INFANTRY UNITS



In Epic 40,000 transport vehicles are assumed to be only capable of carrying infantry units. However, as mentioned briefly in the Battles Book, it is not entirely unreasonable to assume that larger transports such as Leviathans and Nurgle Plague Towers can carry larger cargoes, like Dreadnoughts or Imperial Guard Sentinels. The same applies to flyers with a sufficient transport capacity (Space Marine Thunderhawks for the moment). There is actually no reason why you can't extend this idea to enable you to transport other vehicles which aren't walkers, both for flyers and ordinary transports. This only applies to transports with a capacity of 6 or more (you can't fit a Rhino into a Land Raider!). Of course, this is only a house rule and you'll have to agree with your opponent if you want to transport non-infantry units.

For instance, the Space Marines have several different operational loads for their Thunderhawks. As well as being able to carry troops to the planet's surface, Thunderhawks are quite capable of carrying vehicles and even unassembled fortifications such as bunkers and Imperial bastions. Here are just a few of the different loads a Thunderhawk may carry as part of its duties.

The standard transport is 3 squads of ten Space Marines each. The Thunderhawk contains an on-board medi-centre, plus a small workshop and armoury so that an Apothecary or Tech-Marine can have access to more sophisticated equipment and fulfil their roles to the best of their abilities.

The Formido payload replaces one unit of Space Marines with a Dreadnought (so if you are carrying ten-man squads, one can be left behind in favour of two Dreadnoughts). The Space Marines use this kind of load for reinforcing defensive positions or delivering the killing blow to broken troops. It is a great advantage for the Space Marines to deploy their Dreadnoughts from Thunderhawks, as they may otherwise be left behind as the Space Marines roar forwards in their Rhinos and Land Raiders.

Although Thunderhawks can drop their cargoes almost anywhere, there are still areas which are closed to them – zones defended by intense anti-aircraft fire, for example. However, these places are not invulnerable to the Space Marines' lightning assaults. A Thunderhawk can perform an Intrepid landing, carrying a single squad of Space Marines within its armoured shell and also transporting a Rhino slung beneath its hull. This allows the Thunderhawk to deploy the Space Marines as close as possible to the target, who then use their Rhino to complete the journey, striking where the enemy thought themselves safe. When four or five Thunderhawks act in concert this can deliver a sizeable force deep into the foe's territory, ready to assault his rear lines.

Following on with this principle, the storage bays of a Thunderhawk are easily capable of accommodating disassembled vehicles such as Rhinos and Whirlwinds. In this situation, the Thunderhawks operate in pairs, with one ship transporting three disassembled vehicles while the other carries three squads of Space Marines. Other variations are used too. If one Thunderhawk is carrying two Rhinos and a Vindicator, this is only enough ground transport for two squads, so the other Thunderhawk may well transport two squads and two Dreadnoughts instead of three squads. It is the flexibility of the Thunderhawk that make them such a powerful weapon.

There are other possibilities too, such as carrying a disassembled Land Raider, or perhaps transporting support weapons such as Tarantulas and Rapiers to forward positions to hold off the enemy while the rest of the army deploys.

If you like, a good house rule for transporting disassembled vehicles is to say that the vehicles must give up all of their movement phase while they are being assembled. However, this does not stop them moving in the assault phase if the detachment has appropriate orders. Of course, with the skill of the Space Marines, you could just say that having to assemble their Rhino hardly slows them down at all, and there's no penalty whatsoever! It's up to you to agree with your opponent what you think is suitable for your games.

These changes don't just apply to Thunderhawk Gunships. Other large transports should be able to accommodate different payloads too. The best guide for this is to look at the size of the models in relation to each other – if you think a Hellhound could comfortably fit into the back of a Leviathan, then you should discuss this with your regular opponents. In the end, allowing a vehicle with a large transport capacity to carry non-infantry units adds to the colour of your battles and doesn't affect game balance very drastically.



**Fancy bagging a couple of troop carriers before breakfast? Here's a rum do from Warwick 'Bomber' Kinrade:**

**'Mind your ranges with the Fighta-Bommer, because getting two shot down by a Rhino is somewhat of an embarrassment.'**

**(It's true! A single sharpshooting Rhino snap-fired and brought down two Fighta-Bommerz in one go! – Gav)**







## TYRANID GARGOYLES

The strangest flyers in Epic 40,000 are the Tyranid Gargoyles, which are a kind of flying infantry. Gargoyles are not fast-moving aircraft like Imperial Marauders and Eldar Nightwings but instead swoop down from their perches on the skin of a Harridan, which enables them to traverse the vast distances a flyer can. However, Gargoyles can also operate much like standard infantry, occupying objectives and assaulting the enemy. The following **optional** rules enable you to represent the particular way they can operate on the battlefield.

Gargoyles can, in effect, perform their own transport missions (and Evac if you are using those rules). What this actually means is the Gargoyles can fly in, open fire at half firepower and then

'land' (they actually have no legs so they're really hovering just above the ground). When they have landed the Gargoyles are treated as having a speed of 15cm and the jump packs ability (which doubles their move to 30cm and allows them to charge 45cm in the assault phase).

Their assault value is

1, and they move and fight just like other infantry with jump packs (their Range and Firepower is unchanged). If they wish to leave the battlefield they must perform an Evac mission, following the rules given earlier. You will find this makes Gargoyles more useful and so we advise you either limit their numbers in some way or increase their points value by two or three points each (probably at least three points).



## SWOOPING HAWKS

Swooping Hawks are one of the most specialised of the Eldar Aspect Warriors. With their sophisticated flight packs Swooping Hawks are able to traverse the battlefield with astonishing speed, bounding across the warzone with graceful leaps. This is represented in Epic 40,000 by having Aspect Warriors with the jump packs upgrade.

However, the winged flight-packs of the Swooping Hawks also gives them the ability to drop down from the skies to almost anywhere on the battlefield. Although Swooping Hawks don't have the speed to act like real flyers you can enhance their abilities by using the following optional rule.

Swooping Hawks can start the battle high in the atmosphere, waiting to drop down and deliver a swift and telling blow to the enemy. To represent this, any detachment that consists solely of Swooping Hawks units (they can include Exarchs if you wish) can use the drop pod rules described in the Epic 40,000 Battles Book. They can do this in any scenario, not just a Planetary Assault.



I say, here's a funny sort of thing from David 'Blue Max' Owen Meffer:  
 '3 Phoenix Boppers+ 2 Vampire Raiders = Dead Garganti!'





**Sage advice from Gary 'Red Baron' Morley for chaps who want to excel.**

*If you are using a lot of flyers in a game, then commit them to missions in waves. By splitting your flyers into at least three waves, then you can be sure of doing a Flyer mission on every turn of the game*

**No quarter is given to the fiendish Andy 'Rommel' Chambers:**

*'Facing flyers can be hideous. I've lost count of the number of Gargants I've had flattened.'*

The feral planet Laqueus was one of the first worlds which the Imperium had to defend against the onslaught of the Tyranids of Hive Fleet Kraken. Early on in the second Tyrannic War, the Imperium was still mobilising its forces to counter the threat. On Laqueus, Space Marines of the Ultramarines Chapter were deployed to stem the Tyranid advance. They had no hope of defeating the vast horde in the open field, but had to buy time; time for the Imperial Guard to lay miles of razorwire and construct bunkers and trench lines with which to hold back the bio-engineered monstrosities. What little study of the Tyranids existed showed that Lictors form an important part of the attack, leading the main Tyranid force to the enemy. The Ultramarines' commander devised a plan that would distract the Tyranids from assaulting the main defenses before they were complete. A small force of Ultramarines deliberately allowed themselves to be tracked by the Lictors and sure enough, the Tyranid swarm was soon assaulting their defensive perimeter. All the Space Marines could do now was hope the Thunderhawks arrived in time to extricate them from the Tyranid horde...

### THE RE-FIGHT

This battle uses the following special rules: Hidden Set-up, Razorwire, Fortifications, Reserves and Army Morale.

### FORCES

Decide a total points value for the battle. One player picks a Tyranid force to this total, the other chooses up to 75% of this total from the Army of the Imperium list. However, the Imperial player is only allowed to take Space Marine detachments (there are no massed artillery waiting in the wings for the alien swarm!).

### SET-UP AND SPECIAL RULES

1. The players set-up the terrain in some mutually agreeable manner.
2. The Space Marines deploy first using the Hidden Set-up rules from the Battles Book, and may set up razorwire and fortifications as they wish. Their whole force, except flyers, are deployed at the start of the game. Any flyers in the Space Marine army are in reserve at the start of the battle.
3. The Tyranids move on in the first turn. At the start of the movement phase the Tyranid player places each detachment HQ on any table edge. This indicates where the detachments will move on. If you wish several detachments to arrive at the same point (along a road, for example) then place each HQ in a row, one in front of the other. Each detachment measures its first move from the rearmost HQ.
4. The Evac flyer mission is used in this Re-fight (and if you like you can also use the transporting vehicles and Gargoyle special rules).

### GAME LENGTH AND VICTORY CONDITIONS

There are no objectives in this battle, instead for every Space Marine ground detachment that leaves the table before being reduced to half strength (either by moving off a table edge or being evacuated by Thunderhawks) the Space Marines add the morale value of the detachment to their Army Morale.

If one army's Army Morale is reduced to zero or less it has lost the battle. If this has not happened by the end of the sixth turn the force with the highest Army Morale wins a marginal victory.





# THE PURGATION OF XCV-78

XCV-78 was a primeval world discovered at the end of the 39th millennium. After the Adeptus Mechanicus Explorators had finished their surveys, huge mines were delved deep into the planet's crust, stripping it of its rich mineral wealth. However, as the work progressed there were increasing numbers of setbacks. Mine heads collapsed, whole work teams, hundreds of men strong, went missing and the populace was gripped by panic. Three regiments of Imperial Guard were raised and brought in to instill more confidence and to police the restless miners. Work began again, burrowing deeper and deeper in the ceaseless quest for yet more resources.

The Eldar attacked without warning. The single station orbiting the planet was destroyed in the first attack, its shattered remnants crashing through the atmosphere to rain debris on the planet's capital. The Eldar poured from their ships, sending wave after wave of fighters and bombers screaming through the sky, while the Ghostships bombarded the mines from space. The lightning strike took a heavy toll on the Imperial defenders, but they managed to muster a defence around the mining province of Diablos. Here they would make their last desperate defence to save the planet from certain destruction.

## THE RE-FIGHT

This battle uses all the normal rules for the Blitzkrieg scenario, unless otherwise stated below.

## FORCES

Both players pick a force to an agreed points value. The Eldar player must spend at least 25%-50% of his points on flyer detachments.

## SET-UP AND SPECIAL RULES

Both armies and objectives are set up as detailed in the Blitzkrieg scenario description.

The Eldar player is allowed to make D3 orbital barrages during the battle. These are resolved as detailed on the Orbital Barrage Fate card. Remember that these can place blast markers on troops who are hidden at the start of the battle.

The Imperial player may add +1 to all of his rolls for reserves to represent the fact that his army is concentrated in the vicinity of Diablos.

## GAME LENGTH AND VICTORY CONDITIONS

Normal victory conditions for a Blitzkrieg apply.



## AND EVERYTHING ELSE...

The open nature of the Epic 40,000 system gives you lots of room to invent special rules, scenarios and tactics for all kinds of troops, including flyers. The two historical re-fights presented in this article show just two ways that you can use flyers to add character to a battle. The ideas I've discussed are just the start though, and as you play more games I'm sure that you'll have many more of your own. There are many possibilities for other scenarios. Why not come up with a re-fight that has a convoy trying to escape an ambush, heavily outnumbered on the ground but backed up with some serious amounts of air cover. How about special flyer objectives, such as bombing enemy emplacements, flying recon missions over dangerous territory and so on. You can play battles where one side has lots of flyers while the other has really good prepared defenses, including massed batteries of flak units – can the flyers penetrate the curtain of death to deliver a killing blow to the enemy stronghold (backed up by a small ground force which can hopefully clear a path to their objective)? The list goes on, limited only by your imagination and willingness to try things out...

**Dashed unsporing anti-flying chap propaganda from Adrian 'Bofors' Wood:**

*'The irritating ability of flyers to skulk just beyond your snap-fire range makes flak absolutely vital.'*

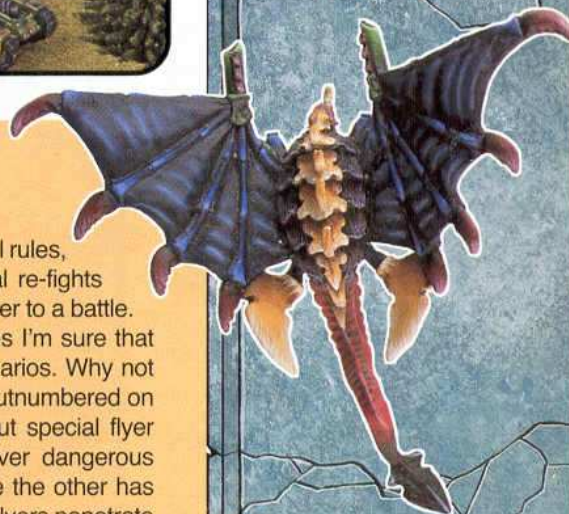



# BRETONNIA™

## MOUNTED SQUIRES COMMAND



**MOUNTED SQUIRE CHAMPION**  
020303401



**MOUNTED SQUIRE HORN BLOWER**  
020303601



**MOUNTED SQUIRE STANDARD BEARER**  
020303501



**MOUNTED SQUIRE CHAMPION**

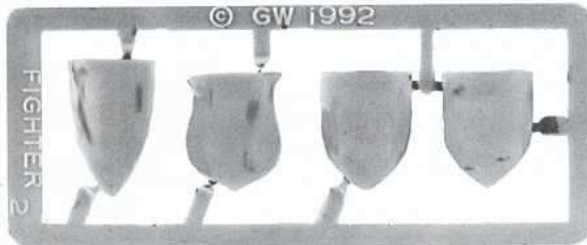

**FIGHTER SHIELD SPRUE**  
101635

A COMPLETE MOUNTED SQUIRE COMMAND CONSISTS OF:  
1 x MOUNTED SQUIRE COMMAND  
1 x PLASTIC HORSE  
1 x FIGHTER SHIELD SPRUE

## GRAIL KNIGHT HERO ON FOOT



**GRAIL KNIGHT HERO**  
020303201



**GRAIL KNIGHT HERO SHIELD**  
020303202

A COMPLETE GRAIL KNIGHT HERO ON FOOT CONSISTS OF:  
1 x GRAIL KNIGHT HERO  
1 x GRAIL KNIGHT HERO SHIELD



**GRAIL KNIGHT HERO**

Michael originally designed this model to represent The Holy Knight from the Circle of Blood Campaign Pack, however it can equally well be used as a Grail Knight Hero in any Bretonnian army.

## QUESTING KNIGHT HERO ON FOOT



**QUESTING KNIGHT HERO ON FOOT**  
020304001

A COMPLETE QUESTING KNIGHT HERO ON FOOT CONSISTS OF:  
1 x QUESTING KNIGHT HERO  
1 x FIGHTER SHIELD SPRUE



## KNIGHT OF THE REALM HERO ON FOOT



**KNIGHT OF THE REALM HERO ON FOOT**  
020304101

A COMPLETE KNIGHT OF THE REALM HERO ON FOOT CONSISTS OF:  
1 x QUESTING KNIGHT HERO  
1 x FIGHTER SHIELD SPRUE



Designed by Alan and Michael Perry

Not suitable for children under 36 months due to small parts and essential pointed components. All models supplied unpainted.  
© Copyright Games Workshop Ltd., 1997. All rights reserved.



# BRETONNIA™

## TRISTAN LE TROUBADOUR AND JULES LE JONGLEUR



TRISTAN'S BODY  
020304201



TRISTAN'S LANCE  
020304202



JULES LE JONGLEUR  
020304205



TRISTAN'S LUTE  
020304204



TRISTAN'S SHIELD  
020304203

### A COMPLETE TRISTAN LE TROUBADOUR CONSISTS OF:

- 1 x TRISTAN'S BODY
- 1 x TRISTAN'S LANCE
- 1 x TRISTAN'S LUTE
- 1 x TRISTAN'S SHIELD
- 1 x BRETONIAN HORSE SPRUE
- 1 x JULES LE JONGLEUR



TRISTAN LE TROUBADOUR

## BARON ODO D'OUTREMER



ODO D'OUTREMER'S BODY  
020304301

### A COMPLETE BARON ODO D'OUTREMER CONSISTS OF:

- 1 x ODO D'OUTREMER'S BODY
- 1 x ODO D'OUTREMER'S SHIELD
- 1 x BRETONIAN HORSE SPRUE



ODO D'OUTREMER'S SHIELD  
020304302



BARON ODO D'OUTREMER

## SULIMAN LE SARACEN



SULIMAN'S BODY  
020304401

### A COMPLETE SULIMAN LE SARACEN CONSISTS OF:

- 1 x SULIMAN'S BODY
- 1 x SULIMAN'S SHIELD
- 1 x PLASTIC HORSE



SULIMAN'S SHIELD  
020304302



SULIMAN LE SARACEN



# IMPERIAL GUARD<sup>®</sup>

## JUNGLE FIGHTERS OF CATACHAN



JUNGLE FIGHTER  
WITH LASGUN 1  
010504801



JUNGLE FIGHTER  
WITH LASGUN 2  
010504802



JUNGLE FIGHTER  
WITH LASGUN 3  
010504803



JUNGLE FIGHTER  
SERGEANT 1  
010504804



JUNGLE FIGHTER  
WITH LASGUN 4  
010504805



JUNGLE FIGHTER  
WITH MELTA-GUN  
010504806



JUNGLE FIGHTER  
WITH FLAMER  
010505612



JUNGLE FIGHTER  
WITH PLASMA GUN  
010505613

## JUNGLE FIGHTER MISSILE LAUNCHER



JUNGLE FIGHTER  
MISSILE LAUNCHER  
010504809



MISSILE  
LAUNCHER STAND  
010504810



JUNGLE FIGHTER  
LOADER  
010504807



JUNGLE FIGHTER  
MISSILE FIRER  
010504808

THE COMPLETE  
JUNGLE FIGHTERS OF CATACHAN  
MISSILE LAUNCHER  
CONSISTS OF:  
1 x CATACHAN JUNGLE FIGHTER  
MISSILE FIRER  
1 x MISSILE LAUNCHER  
1 x MISSILE LAUNCHER STAND  
1 x CATACHAN JUNGLE FIGHTER  
LOADER

## JUNGLE FIGHTER LIEUTENANT



JUNGLE FIGHTER  
LIEUTENANT  
010504701



JUNGLE FIGHTER WITH MISSILE LAUNCHER



Designed by Michael Perry

Not suitable for children under 36 months due to small parts and essential pointed components. All models supplied unpainted.  
© Copyright Games Workshop Ltd., 1997. All rights reserved.



# IMPERIAL GUARD<sup>®</sup>

## JUNGLE FIGHTERS OF CATACHAN



JUNGLE FIGHTER  
SERGEANT 2  
010503711



JUNGLE FIGHTER  
WITH LASGUN 5  
010504626



JUNGLE FIGHTER  
WITH LASGUN 6  
010504627



JUNGLE FIGHTER  
WITH LASGUN 7  
010504628



JUNGLE FIGHTER  
WITH LASGUN 8  
010504629

## JUNGLE FIGHTER LASCANNON



CATACHAN JUNGLE FIGHTER  
LASCANNON GUNNER  
010502322



CATACHAN JUNGLE FIGHTER  
LASCANNON LOADER  
010502321

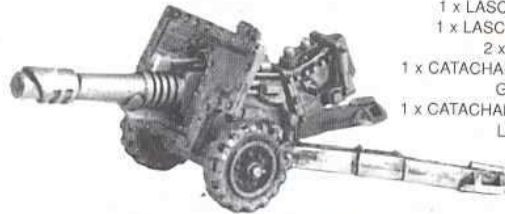

CATACHAN JUNGLE FIGHTER LASCANNON

A COMPLETE JUNGLE FIGHTER  
LASCANNON CONSISTS OF:  
1 x LASCANNON  
1 x LASCANNON STAND  
1 x LASCANNON SHIELD  
2 x WHEELS  
1 x CATACHAN JUNGLE FIGHTER  
GUNNER  
1 x CATACHAN JUNGLE FIGHTER  
LOADER



LASCANNON  
010500409



LASCANNON SHIELD  
010500410



WHEEL  
010504913

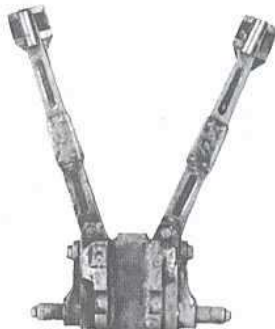

LASCANNON STAND  
010500411

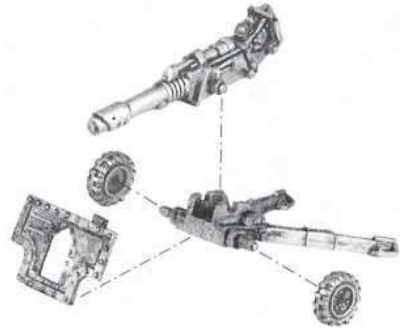

## JUNGLE FIGHTER HEAVY BOLTER



CATACHAN JUNGLE  
FIGHTER  
GUNNER BODY  
010502214



CATACHAN JUNGLE FIGHTER  
HEAVY BOLTER LOADER  
010502216



HEAVY BOLTER  
010504912



HEAVY BOLTER TRAIL  
010504911



CATACHAN JUNGLE FIGHTER HEAVY BOLTER



CATACHAN JUNGLE  
FIGHTER  
GUNNER LEGS  
010502215



WHEEL  
010504913



HEAVY BOLTER SHIELD  
010504910

A COMPLETE JUNGLE FIGHTER  
HEAVY BOLTER CONSISTS OF:  
1 x CATACHAN JUNGLE FIGHTER  
GUNNER BODY  
1 x CATACHAN JUNGLE FIGHTER  
GUNNER LEGS  
1 x HEAVY BOLTER  
1 x TRAIL  
1 x SHIELD  
2 x WHEELS  
1 x JUNGLE FIGHTER LOADER

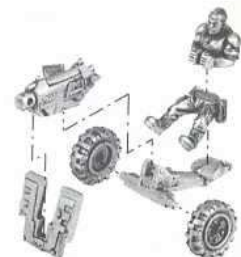

Jungle Fighters designed by Michael Perry, Heavy weapons designed by Norman Swales

Not suitable for children under 36 months due to small parts and essential pointed components. All models supplied unpainted.  
© Copyright Games Workshop Ltd., 1997. All rights reserved.



# SPACE MARINES®

## SPACE MARINE SCOUT SERGEANT



SPACE MARINE SCOUT SERGEANT  
010108802

## SPACE MARINE SCOUT WITH HEAVY BOLTER



SPACE MARINE SCOUT WITH HEAVY BOLTER BODY  
010109101



SPACE MARINE SCOUT HEAVY BOLTER  
010109102



SPACE MARINE SCOUT HEAVY BOLTER BIPOD  
010109103



SPACE MARINE SCOUT WITH HEAVY BOLTER

### A COMPLETE SPACE MARINE SCOUT WITH HEAVY BOLTER CONSISTS OF:

- 1 x SPACE MARINE SCOUT WITH HEAVY BOLTER BODY
- 1 x SPACE MARINE SCOUT HEAVY BOLTER
- 1 x SPACE MARINE SCOUT HEAVY BOLTER BIPOD

## SPACE MARINE SCOUTS



SPACE MARINE SCOUT 1  
010108801



SPACE MARINE SCOUT 2  
010108803



SPACE MARINE SCOUT 3  
010108804



SPACE MARINE SCOUT 4  
010108805

## SPACE MARINE SCOUTS WITH NEEDLE SNIPER RIFLE



SPACE MARINE SCOUT WITH NEEDLE SNIPER RIFLE 1  
010109001



SPACE MARINE SCOUT WITH NEEDLE SNIPER RIFLE 2  
010109002



SPACE MARINE SCOUT 5  
010109306



SPACE MARINE SCOUT 6  
010109307



Designed by Jes Goodwin

Not suitable for children under 36 months due to small parts and essential pointed components. All models supplied unpainted.

© Copyright Games Workshop Ltd., 1997. All rights reserved.



# EPIC® 40,000

## ELDAR SUPREME COMMANDERS

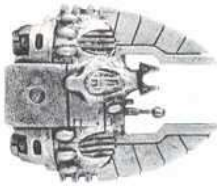

FALCON HULL 1  
030400102

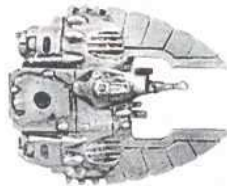

FALCON HULL 2  
030400103

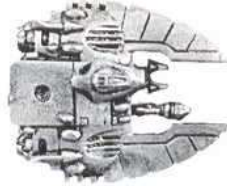

FALCON HULL 3  
030400104

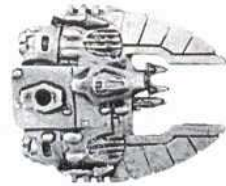

FALCON HULL 4  
030400105

FARSEER FALCON  
TURRET WING SPRUE  
030400507



FARSEER  
FALCON LEFT  
TURRET WING



FARSEER  
FALCON RIGHT  
TURRET WING



FARSEER FALCON TURRET  
030400506

A COMPLETE ELDAR FARSEER  
FALCON CONSISTS OF:

- 1 x FALCON HULL
- 1 x FARSEER FALCON TURRET
- 1 x FARSEER FALCON TURRET WING SPRUE



ELDAR FARSEER FALCON



VYPER JET BIKE HULL  
030400809



FARSEER VYPER PLATFORM  
030400510

FARSEER VYPER BASE SPRUE 1  
030100601



ELDAR AVATAR  
030400508

A COMPLETE ELDAR  
FARSEER VYPER  
CONSISTS OF:

- 1 x VYPER JETBIKE HULL
- 1 x FARSEER VYPER PLATFORM
- 1 x FARSEER VYPER BASE SPRUE



ELDAR FARSEER VYPER

FARSEER VYPER BASE SPRUE 2  
030100603



ELDAR AVATAR

## ELDAR WAR WALKER



WAR WALKER LEGS 1  
030400606



WAR WALKER LEGS 2  
030400607



WAR WALKER LEGS 3  
030400608



WAR WALKER LEGS 4  
030400609



WAR WALKER TURRET 1  
030400601



WAR WALKER TURRET 2  
030400602



WAR WALKER WING  
030400605



WAR WALKER TURRET 3  
030400603



WAR WALKER TURRET 4  
030400604

A COMPLETE ELDAR WAR  
WALKER CONSISTS OF:

- 1 x WAR WALKER LEGS
- 1 x WAR WALKER TURRET
- 1 x WAR WALKER WING



ELDAR WAR WALKERS



Designed by Tim Adcock

Not suitable for children under 36 months due to small parts and essential pointed components. All models supplied unpainted.  
© Copyright Games Workshop Ltd., 1997. All rights reserved.



# EPIC® 40,000

## ELDAR NIGHT SPINNER

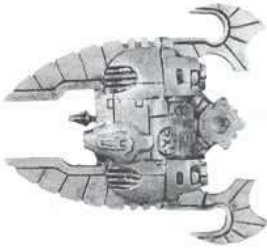

NIGHT SPINNER HULL 1  
030401201

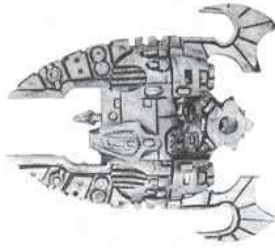

NIGHT SPINNER HULL 2  
030401206

### NIGHT SPINNER GUN SPRUE 1 030401204



NIGHT SPINNER LEFT CANNON



NIGHT SPINNER RIGHT CANNON

### NIGHT SPINNER GUN SPRUE 2 030401205



NIGHT SPINNER LEFT CANNON



NIGHT SPINNER RIGHT CANNON



NIGHT SPINNER CANNON MOUNT  
030401202



NIGHT SPINNER TURRET 1  
030401203



NIGHT SPINNER TURRET 2  
030401207

### A COMPLETE NIGHT SPINNER CONSISTS OF:

- 1 x NIGHT SPINNER HULL
- 1 x NIGHT SPINNER GUN SPRUE
- 1 x NIGHT SPINNER CANNON MOUNT
- 1 x NIGHT SPINNER TURRET



ELDAR NIGHT SPINNER

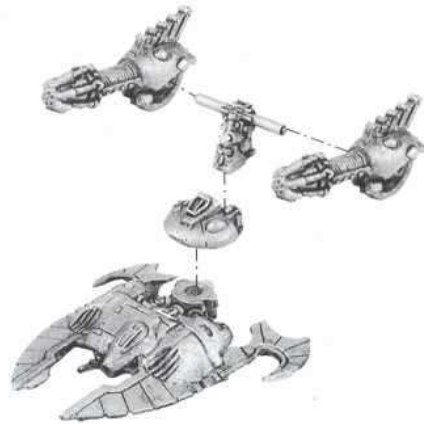

## ELDAR FIRE PRISM

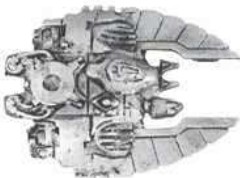

FIRE PRISM HULL 1  
030400501

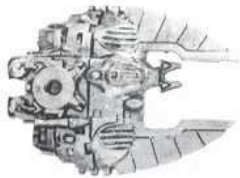

FIRE PRISM HULL 2  
030400502

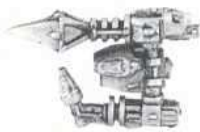

FIRE PRISM TURRET  
030401306



ELDAR FIRE PRISM

### A COMPLETE FIRE PRISM CONSISTS OF:

- 1 x FIRE PRISM HULL
- 1 x FIRE PRISM TURRET

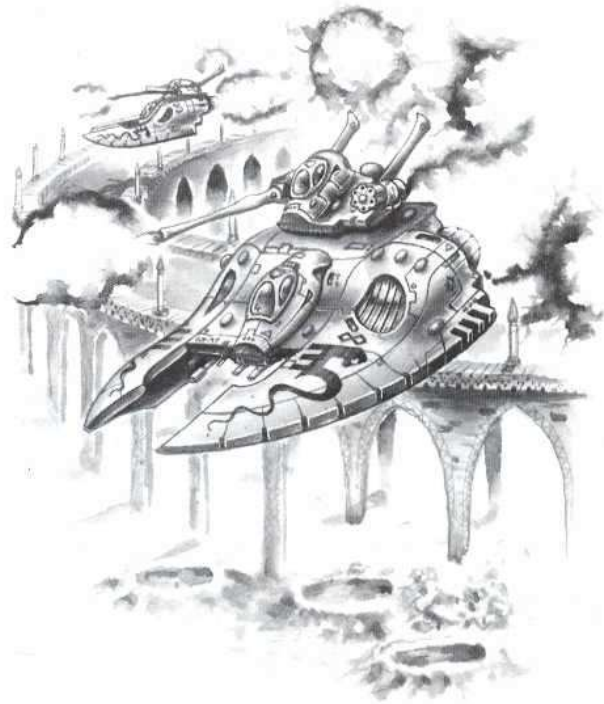

CITADEL  
MINIATURES



CITADEL  
MINIATURES



CITADEL  
MINIATURES

Designed by Tim Adcock

Not suitable for children under 36 months due to small parts and essential pointed components. All models supplied unpainted.  
© Copyright Games Workshop Ltd., 1997. All rights reserved.



# EPIC® 40,000

## ELDAR SCORPION

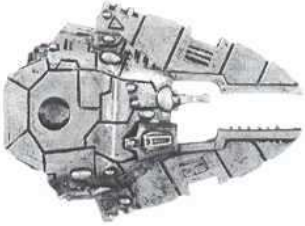

SCORPION HULL 1  
030401101



SCORPION PULSAR 1  
030401102



SCORPION SHURIKEN CANNON TURRET  
030401103

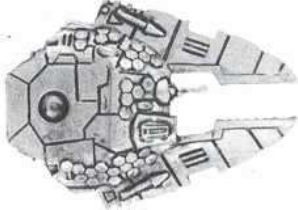

SCORPION HULL 2  
030401104

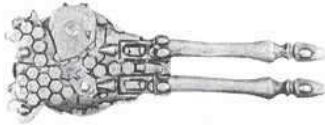

SCORPION PULSAR 2  
030401105



SCORPION LASCANNON TURRET  
030401106



ELDAR SCORPION

A COMPLETE ELDAR  
SCORPION CONSISTS OF:  
1 x SCORPION HULL  
1 x SCORPION PULSAR  
1 x SCORPION TURRET

## ELDAR COBRA

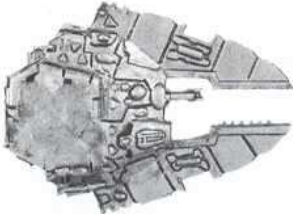

COBRA HULL 1  
030401001

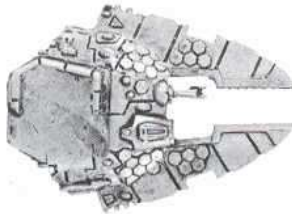

COBRA HULL 2  
030401002



COBRA DISTORT CANNON  
030401003



ELDAR COBRA

A COMPLETE ELDAR COBRA  
CONSISTS OF:  
1 x COBRA HULL  
1 x COBRA DISTORT CANNON



CITADEL  
MINIATURES

Designed by Tim Adcock

Not suitable for children under 36 months due to small parts and essential pointed components. All models supplied unpainted.  
© Copyright Games Workshop Ltd., 1997. All rights reserved.



# EPIC® 40,000

## ELDAR VYPER JETBIKE



VYPER JETBIKE  
HULL  
030400809



VYPER JETBIKE  
TURRET 1  
MISSILE LAUNCHER  
030400801



VYPER JETBIKE  
TURRET 2  
SCATTER LASER  
030400802



VYPER JETBIKE  
TURRET 3  
D-CANNON  
030400803



VYPER JETBIKE  
TURRET 4  
HEAVY PLASMA GUN  
030400804



VYPER JETBIKE  
TURRET 5  
SHURIKEN CANNON  
030400805

VYPER JETBIKE BASE SPRUE 1  
030100601



VYPER JETBIKE BASE SPRUE 2  
030100603



A COMPLETE ELDAR VYPER  
JETBIKE CONSISTS OF:  
1 x VYPER JETBIKE HULL  
1 x VYPER JETBIKE TURRET  
1 x VYPER JETBIKE BASE  
SPRUE



ELDAR VYPER JETBIKE

## ELDAR HEAVY WEAPON SUPPORT PLATFORM



SUPPORT PLATFORM  
HULL  
030400901



SUPPORT PLATFORM  
HEAVY WEAPON 1  
SCATTER LASER  
030400902



SUPPORT PLATFORM  
HEAVY WEAPON 2  
HEAVY PLASMA GUN  
030400903



SUPPORT PLATFORM  
HEAVY WEAPON 3  
LAS CANNON  
030400904



SUPPORT PLATFORM  
HEAVY WEAPON 4  
D-CANNON  
030400905



SUPPORT PLATFORM  
HEAVY WEAPON 5  
MISSILE LAUNCHER  
030400906

A COMPLETE ELDAR HEAVY WEAPON  
SUPPORT PLATFORM CONSISTS OF:  
1 x SUPPORT PLATFORM HULL  
1 x SUPPORT PLATFORM HEAVY WEAPON



ELDAR HEAVY WEAPON SUPPORT PLATFORM

## ELDAR DREADNOUGHT



DREADNOUGHT  
BODY  
030400701



DREADNOUGHT HEAD  
AND WEAPON  
030400702

A COMPLETE ELDAR DREADNOUGHT  
CONSISTS OF:  
1 x DREADNOUGHT BODY  
1 x DREADNOUGHT HEAD AND WEAPON



DREADNOUGHTS



CITADEL  
MINIATURES



CITADEL  
MINIATURES



CITADEL  
MINIATURES

Designed by Tim Adcock

Not suitable for children under 36 months due to small parts and essential pointed components. All models supplied unpainted.  
© Copyright Games Workshop Ltd., 1997. All rights reserved.



# EPIC® 40,000

## ELDAR VAMPIRE RAIDER

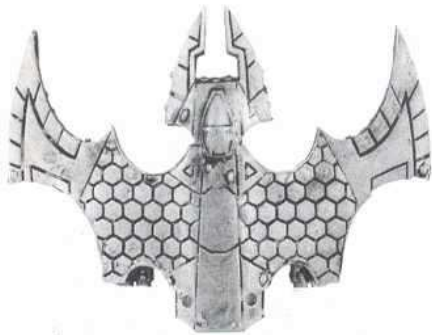

VAMPIRE RAIDER HULL  
030401401



VAMPIRE RAIDER FOIL  
030401404



VAMPIRE RAIDER LEFT FOIL SUPPORT  
VAMPIRE RAIDER RIGHT FOIL SUPPORT



ELDAR FLYER LEFT GUN  
ELDAR FLYER RIGHT GUN



VAMPIRE RAIDER

- A COMPLETE ELDAR VAMPIRE RAIDER CONSISTS OF:
- 1 x VAMPIRE RAIDER HULL
  - 1 x VAMPIRE RAIDER FOIL
  - 1 x ELDAR FLYER GUN SPRUE
  - 1 x VAMPIRE RAIDER FOIL SUPPORT SPRUE

## ELDAR PHOENIX BOMBER



PHOENIX BOMBER HULL  
030401501



ELDAR FLYER LEFT GUN  
ELDAR FLYER RIGHT GUN



PHOENIX BOMBER

- A COMPLETE ELDAR PHOENIX BOMBER CONSISTS OF:
- 1 x PHOENIX BOMBER HULL
  - 1 x ELDAR FLYER GUN SPRUE

## ELDAR NIGHTWING INTERCEPTOR



ELDAR NIGHTWING INTERCEPTOR  
030401601



ELDAR NIGHTWING INTERCEPTOR





# GORKAMORKA™

## NOBZ



NOB BODY 1  
040300401



NOB BODY 2  
040300402



NOB BODY 3  
040300403



NOB RIGHT SLUGGA ARM 1  
040300404



NOB RIGHT SLUGGA ARM 2  
040300414



NOB RIGHT AXE ARM  
040300405

### A COMPLETE ORK NOB CONSISTS OF:

- 1 x NOB BODY
- 1 x NOB HEAD
- 1 x NOB RIGHT ARM
- 1 x NOB BACK BANNER, NOB AXE OR NOB KANNON



NOB BACK BANNER  
040300408



NOB AXE  
040300407



NOB SHOOTA  
040300406



NOB HEAD 1  
040300409



NOB HEAD 2  
040300410



NOB HEAD 3  
040300412



ORK NOB



Designed by Brian Nelson

Not suitable for children under 36 months due to small parts and essential pointed components. All models supplied unpainted.  
© Copyright Games Workshop Ltd., 1997. All rights reserved.



# GORKAMORKA™

## ORK BOYZ WITH SHOOTAS



ORK BOY WITH  
PICK AND SHOOTA  
040300601



ORK BOY WITH  
AXE AND SHOOTA  
040300602



ORK BOY WITH  
KNUCKLES AND SHOOTA  
040300603



ORK BOY WITH  
STIKKBOMB AND SHOOTA  
040300605



ORK BOY WITH SHOOTA 1  
040300606



ORK BOY WITH SHOOTA 2  
040300607



ORK BOY WITH SHOOTA 3  
040300608



ORK BOY WITH SHOOTA 4  
040300609

## ORK WEAPONS

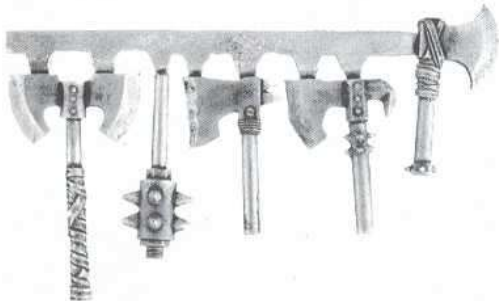

ORK HAND WEAPON SPRUE  
040300801

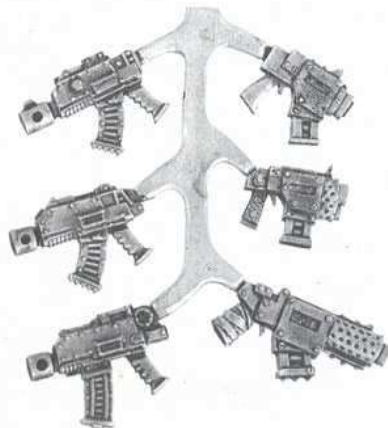

ORK GUN SPRUE  
040300802



Ork Boyz with Shootas designed by Colin Dixon, Ork Weapons designed by Brian Nelson and Colin Dixon

Not suitable for children under 36 months due to small parts and essential pointed components. All models supplied unpainted.

© Copyright Games Workshop Ltd., 1997. All rights reserved.



# GORKAMORKA™

## SPANNERZ



SPANNER WITH WRENCH  
040300501



SPANNER WITH MALLET  
040300502



SPANNER BACKPACK 1  
040300503



SPANNER BACKPACK 2  
040300504



SPANNER RIGHT ARM  
WITH SIX-SHOOTA  
040300505



SPANNER RIGHT ARM  
WITH SLUGGA  
040300506

A COMPLETE ORK SPANNER  
CONSISTS OF:  
1 x SPANNER  
1 x SPANNER RIGHT ARM  
1 x SPANNER BACKPACK



SPANNERZ

Designed by Brian Nelson



Not suitable for children under 36 months due to small parts and essential pointed components. All models supplied unpainted.  
© Copyright Games Workshop Ltd., 1997. All rights reserved.





# GORKAMORKA™

## ORK WAR TRUKK

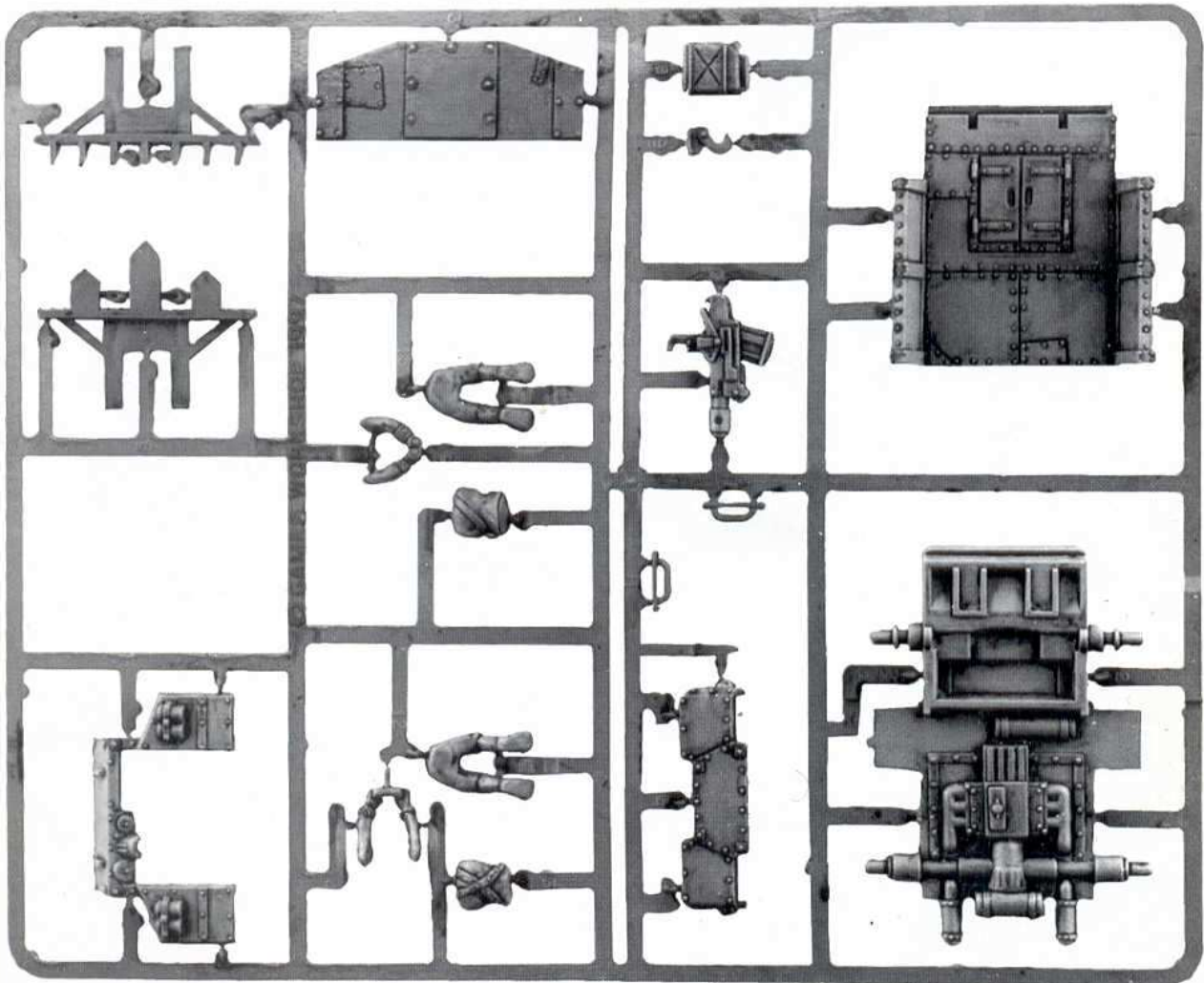

WAR TRUKK SPRUE (SHOWN AT 65% OF ACTUAL SIZE)  
0403002



WAR TRUKK





# GORKAMORKA™

## WRECKER TRUKK



WRECKER TRUKK  
FRONT PLATE  
040301601

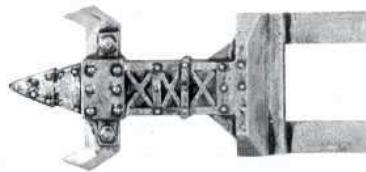

WRECKER TRUKK  
BATTERING RAM  
040301602



WRECKER TRUKK  
WRECKER BASE  
040301513



WRECKER TRUKK  
WRECKER MAIN SUPPORT  
040301603



WRECKER TRUKK  
WRECKER BALL AND CHAIN  
040301604



WRECKER TRUKK  
AMMO BOX  
040301614



WRECKER TRUKK  
WRECKER BALL  
040301605

WRECKER TRUKK  
GLYPH SPRUE  
040301607



WRECKER TRUKK  
DRIVER  
040301610



WRECKER TRUKK  
GUNNER  
040301611

WRECKER TRUKK  
WRECKER HANDLE  
040301606



WRECKER TRUKK  
WRECKER PEDAL  
040301608



WRECKER TRUKK  
SKULL SPIKE  
040301612



WRECKER TRUKK  
KANNON  
040301609

### WRECKER



### A COMPLETE WRECKER TRUKK CONSISTS OF:

- |                                  |  |
|----------------------------------|--|
| 1 x WRECKER TRUKK FRONT PLATE    | 1 x WRECKER TRUKK WRECKER BASE           |
| 1 x WRECKER TRUKK BATTERING RAM  | 1 x WRECKER TRUKK WRECKER MAIN SUPPORT   |
| 1 x WRECKER TRUKK AMMO BOX       | 1 x WRECKER TRUKK WRECKER BALL AND CHAIN |
| 1 x WRECKER TRUKK SKULL SPIKE    | 1 x WRECKER TRUKK WRECKER HANDLE         |
| 1 x WRECKER TRUKK KANNON         | 1 x WRECKER TRUKK WRECKER BALL           |
| 1 x WRECKER TRUKK GLYPH SPRUE    | 1 x WRECKER TRUKK WRECKER PEDAL          |
| 1 x WRECKER TRUKK DRIVER         | 1 x PLASTIC WAR TRUKK SPRUE              |
| 1 x WRECKER TRUKK GUNNER         | 1 x GORKAMORKA TRANSFER SHEET            |
| 1 x WRECKER TRUKK WRECKER HANDLE | 2 x LARGE PLASTIC WHEELS                 |
| 1 x WRECKER TRUKK WRECKER BALL   | 2 x SMALL PLASTIC WHEELS                 |



WRECKER TRUKK



CITADEL  
MINIATURES



CITADEL  
MINIATURES

Designed by Norman Swales and Brian Nelson

Not suitable for children under 36 months due to small parts and essential pointed components. All models supplied unpainted.  
© Copyright Games Workshop Ltd., 1997. All rights reserved.



# GORKAMORKA™

## ROKKIT BUGGY

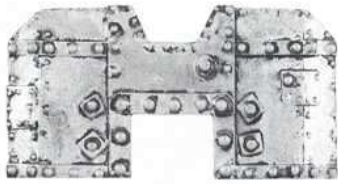

ROKKIT BUGGY  
FRONT PLATE  
040301401



ROKKIT BUGGY  
ROKKIT LAUNCHER  
040301403



ROKKIT BUGGY  
BATTERING RAM  
040301402



ROKKIT BUGGY  
PINTLE  
040301411



ROKKIT BUGGY  
GUNNER  
040301405



ROKKIT BUGGY



ROKKIT BUGGY  
LEFT SUPPORT  
040301407



ROKKIT BUGGY  
RIGHT SUPPORT  
040301406



ROKKIT BUGGY  
SPARE ROKKITS  
040301409



ROKKIT BUGGY  
GUNNERS PLATFORM  
040301404



ROKKIT BUGGY  
MAIN SUPPORT  
040301410



ROKKIT BUGGY  
BANNER TOP  
040301408

### A COMPLETE ROKKIT BUGGY CONSISTS OF:

- 1 x ROKKIT BUGGY FRONT PLATE
- 1 x ROKKIT BUGGY ROKKIT LAUNCHER
- 1 x ROKKIT BUGGY BATTERING RAM
- 1 x ROKKIT BUGGY PINTLE
- 1 x ROKKIT BUGGY GUNNER
- 1 x ROKKIT BUGGY SPARE ROKKITS
- 1 x ROKKIT BUGGY RIGHT SUPPORT
- 1 x ROKKIT BUGGY LEFT SUPPORT
- 1 x ROKKIT BUGGY MAIN SUPPORT
- 1 x ROKKIT BUGGY GUNNERS PLATFORM
- 1 x ROKKIT BUGGY BANNER TOP
- 1 x WAR BUGGY SPRUE
- 2 x SMALL ORK WAR BUGGY WHEEL SPRUES
- 2 x LARGE ORK WAR BUGGY WHEEL SPRUES



Designed by Norman Swales and Brian Nelson

Not suitable for children under 36 months due to small parts and essential pointed components. All models supplied unpainted.  
© Copyright Games Workshop Ltd., 1997. All rights reserved.



# GORKAMORKA™

## ORK BIKER



ORK BIKER

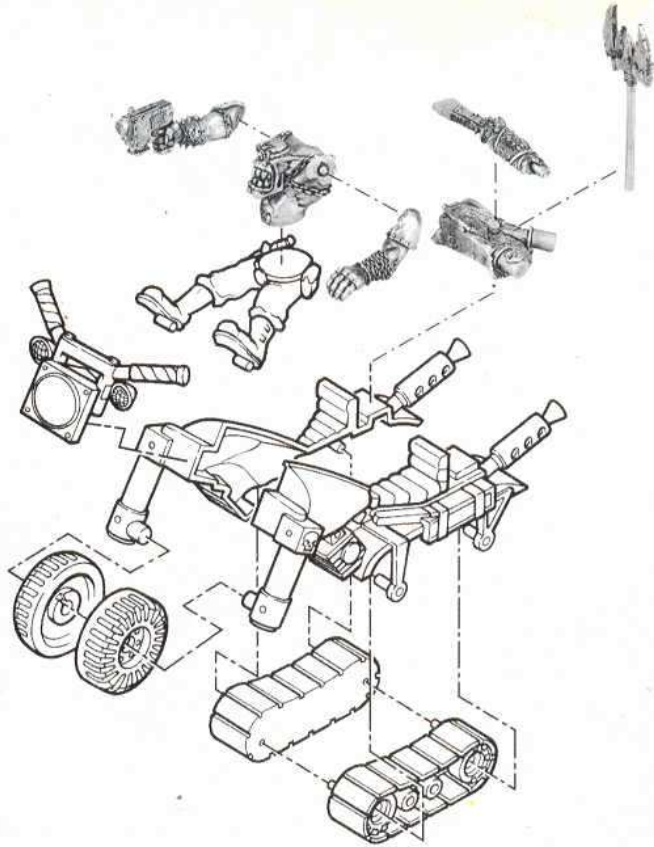

ORK BIKER RIGHT ARM  
040302002



ORK BIKER LEFT ARM  
040302003



ORK BIKER UPPER BODY  
040302001

### A COMPLETE ORK BIKER CONSISTS OF:

- 1 x ORK BIKER UPPER BODY
- 1 x ORK BIKER BACK PACK
- 1 x ORK BIKER KANNON
- 1 x ORK BIKER RIGHT ARM
- 1 x ORK BIKER LEFT ARM
- 1 x ORK BIKER ICON
- 1 x WAR BIKE PLASTIC SPRUE
- 1 x SMALL PLASTIC WHEEL



ORK BIKER ICON  
040302005



ORK BIKER KANNON  
040302006



ORK BIKER BACKPACK  
040302004



Designed by Brian Nelson

Not suitable for children under 36 months due to small parts and essential pointed components. All models supplied unpainted.  
© Copyright Games Workshop Ltd., 1997. All rights reserved.



# HE

g and painting  
i you a **bonus**  
emble. As the  
rglue. Just be  
ou can see the

lue into position.  
agram 2.1.  
re into position as

Diagram 2.1

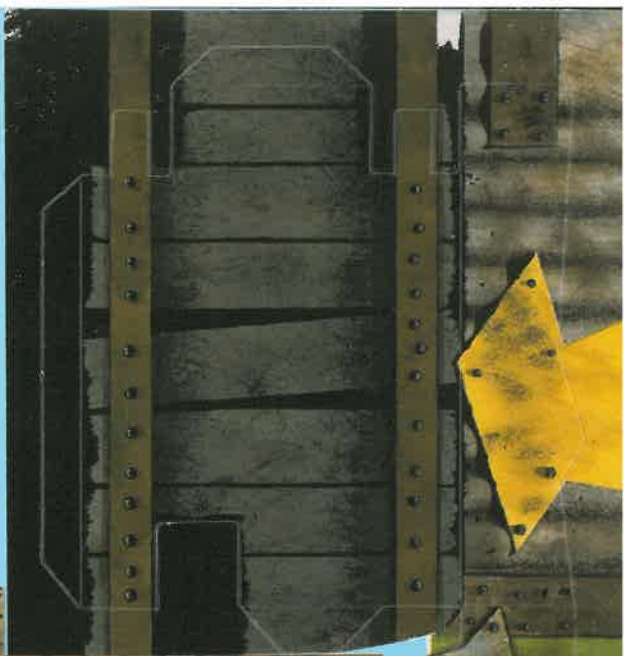



2a



3a



2b



1d



3b



1e







1a

1b

1e

1c









te!  
0,000 which  
ayers. Now  
es, Tyranids  
r foes with  
ergy of the



of guessing you  
I normally work  
n that if I'm not  
ul Barrage' (a  
ack anywhere on  
en the chances  
ent has it in his  
avoid making  
early in the  
ually one of the  
ayed. However,  
ses Foiled Again  
whatever he  
n turn the tables  
back against his

ed to increase  
sic Fate deck,  
ago we  
peror's Tarot' in  
e 210. This is a  
i cards that can  
mperial players.  
of the Ork,  
d Chaos players  
ons of this issue  
u'll find four sets

**COUNTER ATTACK**  
This card allows you to re-roll a single firefight or close combat dice roll. No dice may be re-rolled more than once.  
Play this card after dice roll a close combat or firefight.

**USE ONE ONLY**

**•ORKS•**  
**DUR**  
Each Ork detachment that has its HQ within 15cm of a Gargant becomes stubborn for the rest of the turn.  
Play this card at any time.

**COUNTER ATTACK**  
This card allows you to re-roll a single firefight or close combat dice roll. No dice may be re-rolled more than once.  
Play this card after dice roll a close combat or firefight.

**USE ONE ONLY**

**•ORKS•**  
**DAKKA**  
This card allows you to double the firepower of any Buzz units (not Shocky Buzz) in an Ork detachment for one turn. If the Ork detachment is shot at later in the shooting phase your opponent uses the Matching column on the Firepower chart.  
Play this card at the start of the Shooting phase.

**STOMP**  
Place the Barrage template on an enemy detachment within 30cm of one of your Warbossz. Roll once to hit any units touching the template unless the opposing player nullifies the stomp by playing it next with a higher value.  
Play this card at any time.

**USE ONE ONLY**

**•ORKS•**  
**BLITZ**  
This card allows you to re-roll failed reserve rolls for any Ork detachments for one turn.  
Play this card before rolling for your reserves.

**STOMP**  
Place the Barrage template on an enemy detachment within 30cm of one of your Warbossz. Roll once to hit any units touching the template unless the opposing player nullifies the stomp by playing it next with a higher value.  
Play this card at any time.

**USE ONE ONLY**

**•ORKS•**  
**WAAA**  
When this card is played all the units in the detachment add one to their assault value, for the rest of the turn.  
Play this card at any time on an Ork detachment on assault orders.

**TERRORISE**  
Such is the domination of the Hive Mind over the battlefield that it weakens the resolve of even the hardiest foe.  
Play this card on an enemy detachment. The detachment must pass a immediate leadership test or become broken.

**USE ONE ONLY**

**•TYRANIDS•**  
**PSYCHIC SCREAM** 2

Play on a Tyranid psyker at any time. Any enemy psykers within 45cm of the unit take a hit as they are exposed to the full might of the Hive Mind. This card may be nullified if the enemy psyker plays a fate card of equal or higher value than the Psychic Scream itself.

**CATALYST**  
Play on a single Tyranid detachment at the start of the movement phase. Each unit in the detachment may double it's speed for this movement phase.

**USE ONE ONLY**

**•TYRANIDS•**  
**PSYCHIC SCREAM** 1

Play on a Tyranid psyker at any time. Any enemy psykers within 45cm of the unit take a hit as they are exposed to the full might of the Hive Mind. This card may be nullified if the enemy psyker plays a fate card of equal or higher value than the Psychic Scream itself.

**ADRENALINE SACS**  
A Tyranid detachment on Assault orders may fire in the shooting phase using their full firepower value.  
Play this card in the movement phase.

**USE ONE ONLY**

**•TYRANIDS•**  
**DESTROY THE WEAK FLESH**  
This card allows the Tyranid player to reroll a single assault or firefight dice. No dice may be rerolled more than once.  
Play this card after rolling the dice for the first time.

**DRIFTING SPORE MINES**  
An enemy detachment has run into a swarm of drifting spore mines. The detachment takes 1D3 blast markers as Spore mines begin to detonate.  
Play this card on an enemy detachment at any time.

**USE ONE ONLY**

**•TYRANIDS•**  
**DESTROY THE WEAK FLESH**  
This card allows the Tyranid player to reroll a single assault or firefight dice. No dice may be rerolled more than once.  
Play this card after rolling the dice for the first time.







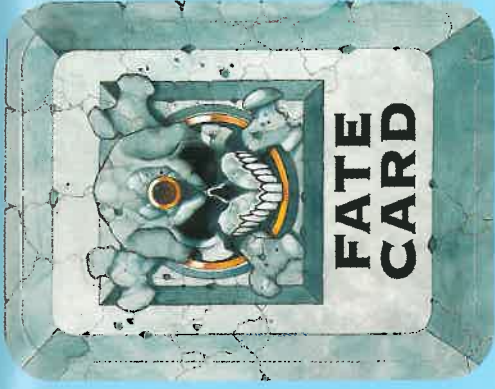



**•CHAOS•**  
**WITHERING GAZE** (2)

One of your psykers may make D3 anti-tank shots with a range of 30cm unless your opponent plays a psychic Fate card of a higher value.  
Play this card at any time.

**USE ONE ONLY**

**COUNTER ATTACK**

This card allows you to re-roll a single firefight or close combat dice roll. No dice may be re-rolled more than once.  
Play this card after dice roll a close combat or firefight.

**•CHAOS•**  
**PLAGUE WIND**

Nominate an enemy unit and roll one die to hit. If this hit nominates another unit in the same detachment and roll to hit again. Continue to nominate units and roll to hit until you roll a miss. A hit causes critical damage on war engines (see Eldar Trans).

**USE ONE ONLY**

**PSYCHIC BLAST** (1)

Pick any unit within 30cm of one of your psykers. The unit takes a hit unless the opposing player nullifies the attack by playing a Psychic Blast with a higher value.  
Play this card at any time.

**•CHAOS•**  
**HAND OF WAR**

This card automatically nullifies a psychic Fate card such as Psychic Blast and inflicts a hit on the Psyker using the card.  
Play when your opponent plays a psychic Fate card.

**USE ONE ONLY**

**COUNTER ATTACK**

This card allows you to re-roll a single firefight or close combat dice roll. No dice may be re-rolled more than once.  
Play this card after dice roll a close combat or firefight.

**•CHAOS•**  
**WARP FRENZY**

The affected detachment may roll two dice for its close combat score and choose the best. If the detachment re-rolls its dice, it may re-roll both dice.  
Play this card on a Chaos detachment before rolling the dice to resolve an assault.

**USE ONE ONLY**

**PSYCHIC BLAST** (3)

Pick any unit within 30cm of one of your psykers. The unit takes a hit unless the opposing player nullifies the attack by playing a Psychic Blast with a higher value.  
Play this card at any time.

**•ELDAR•**  
**BATTLE FORTUNE**

This card may be played when your opponent declares he is shooting at an Eldar detachment. The target Eldar detachment shifts a column to the right on the firepower table for the rest of the turn.

**USE ONE ONLY**

**PSYCHIC BLAST** (1)

Pick any unit within 30cm of one of your psykers. The unit takes a hit unless the opposing player nullifies the attack by playing a Psychic Blast with a higher value.  
Play this card at any time.

**•ELDAR•**  
**THE RUNES OF TRUTH**

This card forces your opponent to keep his hand of fate cards visible to you throughout the game.  
This card must be played at the start of the battle.

**USE ONE ONLY**

**PSYCHIC BLAST** (3)

Pick any unit within 30cm of one of your psykers. The unit takes a hit unless the opposing player nullifies the attack by playing a Psychic Blast with a higher value.  
Play this card at any time.

**•ELDAR•**  
**CONFUSE**

This card may be played at any time. One enemy detachment takes D3 blast markers.

**USE ONE ONLY**

**SUSTAIN ATTACK**

This card allows you to re-roll a single firefight or close combat dice roll. No dice may be re-rolled more than once.  
Play this card after dice roll for a close combat or firefight.

**•ELDAR•**  
**TEMPORAL DISTORT**

When this card is played the Eldar player may choose to re-draw the initiative in each phase for the remainder of the turn. Initiative counters are put back into the cup and re-drawn again. Initiative counters may only be re-drawn once per phase.

**USE ONE ONLY**

**SUSTAIN ATTACK**

This card allows you to re-roll a single firefight or close combat dice roll. No dice may be re-rolled more than once.  
Play this card after dice roll for a close combat or firefight.