

**GAMES WORKSHOP**™

PRESENTS

£1.25  
USA  
\$2.50  
Australia  
\$4.95  
WEST GERMANY  
DM 6.80

99 **WHITE DWARF**™

009148

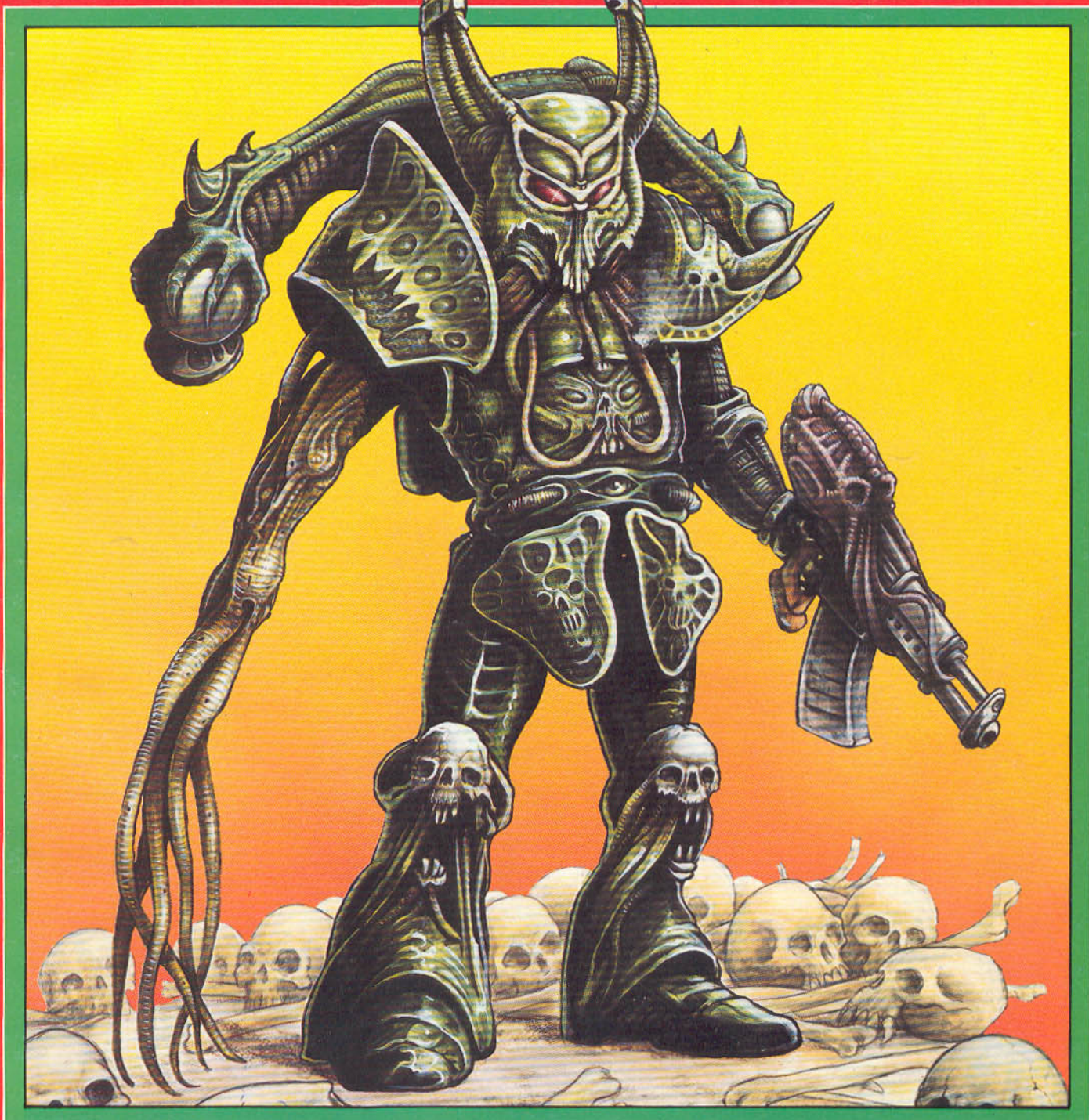

GAMES WORKSHOP'S MONTHLY GAMES MAGAZINE

# WARHAMMER 40,000

## ROGUE TRIBE



## ELDAR COMMAND GROUP



### +++ INQUISITION DIRECTIVE +++

Eldar Command Groups identified +++ leading Eldar mercenaries and/or craft world forces +++ standard config 4 Eldar +++ leader +++ champion +++ musician +++ standard bearer +++

+++ Action directive +++ priority one +++ seek out these groups +++

Citadel Miniatures proudly presents Jes Goodwin's Eldar Command Group figures, sculpted to the highest standards and approved by the Inquisition for use with WARHAMMER 40,000. And through the expertise of Games Workshop Mail Order, they cost far less than the average human rebel would pay for Eldar mercenaries - simply choose one model of each type from the picture, and place your order!

RT402  
**£2.50**  
 FOR STANDARD BEARER & 3 OTHER MODELS

● BANNER'S NOT INCLUDED



Available from all good games and hobby stockists, or in case of difficulty direct from: Citadel Miniatures, Chewton Street, Hilltop, Eastwood, Nottingham, NG16 3HY. US customers contact: Games Workshop US, 1220 Key Highway, Baltimore, Maryland, 21230. Please note Postage and Packing charges when ordering direct - UK, BFPO & Eire: Minimum order £5.00, add £1.00 P&P. Orders over £15.00 POST FREE. Overseas: Minimum order £10.00, add 33% P&P. Overseas Airmail: Minimum order £10.00, add 40% P&P.



For Access and Visa orders, ring the mail order hotlines on (0773) 713213/760462

All Figures Painted By Citadel Figure Painters ● Miniatures Supplied Unpainted ● Designed by Jes Goodwin  
 Copyright ©1988 Games Workshop Ltd. All Rights Reserved.

WARNING! This product contains lead which may be harmful if chewed or swallowed. Citadel Miniatures are not recommended for children under 12 years of age

# WHITE DWARF

ISSUE 99 MARCH 1988

**EDITOR:** Sean Masterson  
**EDITORIAL MANAGER:** Phil Gallagher  
**WRITERS:** Graeme Davis, Rick Priestley  
**GRAPHIC DESIGN:** Mark Craven, Brian George and Bil Sedgwick  
**ART EDITORS:** John Blanche and Ian Cooke  
**PRODUCTION:** Chris Colston, Nick Ord, Adrian Udall, Richard Wright, H and Graham Verity  
**COVER:** *In The Eye Of Terror* Collective Creativity Inc.  
**ILLUSTRATION:** Tony Ackland, Dave Andrews, Colin Dixon, Jes Goodwin, H, Tony Hough, Russ Nicholson  
**MINIATURES PAINTERS:** Mike McVey, Richard Wright and Sid  
**PHOTOGRAPHY:** Phil Lewis  
**TYPESETTING:** Lindsey D Le Doux Paton and Dawn Duffy  
**INVALUABLE TYPING:** Mary Anne Naismith  
**ADVERTISING:** Tim Pollard  
**PUBLISHER:** Games Workshop Limited  
**PRINT BUYER:** Bob Malin  
**PRODUCTION MANAGER:** Alan Merrett  
**ASSISTANT PRODUCTION MANAGER:** Steve Bruce  
**STUDIO MANAGER:** Tom Kirby  
**BIG CHEESE:** Bryan Ansell  
Printed by ThamesMouth Web Offset, Basildon, UK.

All correspondence except subscriptions should be addressed to: *White Dwarf*, Games Workshop Design Studio, Enfield Chambers, 14-16 Low Pavement, Nottingham NG1 7DL.

The **Realm of Chaos** swirls around our feet as we trip over ourselves trying to get this issue out. Malignant forces seem to ooze from the pages, and seep back into the mind of whoever happens to be working on them.

The effects are very strange indeed. No-one has escaped them. Articles shrink or grow fat and spiky. Artwork squeezes into awkward spaces and refuses to move. Pigments get thick and sludgy or so thin as to acquire superfluidity. And time flies faster.

Wouldn't mind if I could just get another pair of arms out of all this...

Sean Masterson

## CONTENTS

<b>Marginalia</b> Berserk ninja unleashes kitchen roll shock!	2
<b>Culture Shock Special</b> Something Happened.	4
<b>Cruisin' For A Bruisin'</b> Pedal to the metal with the Ork War Buggy.	6
<b>Letters</b> Mutants' musings	8
<b>Critical Mass</b> Spines creased by <i>Dave Langford</i> .	11
<b>Book Of The Second Earth Competition</b> Signed copies of <i>Patrick Woodroffe's</i> new book to be won!	13
<b>Thrud</b> How to get served in The Hobbit's Armpit.	14
<b>Illuminations</b> Blanche's Babies?	19
<b>The Ritual</b> A new beginning for <i>WFRP</i> adventurers - or an early demise?	23
<b>Eeyaaaargh!</b> A brief course in <i>RuneQuest</i> martial arts.	36
<b>Index Astartes</b> The Legion of the Damned.	39
<b>Spirit of the Mountain</b> Graeme Davis hears the <i>Call of Cthulhu</i> from Arizona.	43
<b>'Eavy Metal</b> Goes step by step...	55
<b>Blanchitsu</b> Agony aunt <i>John Blanche</i> extrapolates.	58
<b>Chapter Approved</b> <i>Rick Priestley</i> peeps into the cosmic cupboard.	61
<b>On The Boil Special</b> We've been playing with warpstone again.	66

### SUBSCRIPTIONS

Please send and make remittance to: *Games Workshop*, *Chewton Street, Hilltop, Eastwood, Notts NG16 3HY*, Telephone (0773) 789731. *White Dwarf* is published monthly. Annual subscription rates are: UK - £15.00; Europe £30.00; other overseas surface - £39.00; other overseas airmail - £45.00. Please make all payments in Pounds Sterling. NB: USA - contact *Games Workshop US*, 8920 Route 108, Columbia, MD 21045, USA.

### SUBSCRIPTION NOTICE

When you want to inform us of a change of address or subscription renewal, or if you have a query, please write to *Games Workshop*, *Chewton Street, Hilltop, Eastwood, Notts, NG16 3HY* and make sure that you tell us your present name and address (and your old address if you are moving). When you subscribe, please tell us whether you are renewing an old subscription or starting a new one.

ISSN 0265-8712

### OVERSEAS DISTRIBUTORS

France: Citadel France, 5 Rue des Fêtes, 75019 Paris. Italy: Pacific Enterprises Italia SRL, Via R. Di Lauria 15, 20149 Milan. Japan: Shinwa Corporation, Yamoto Building, 2-6-2 Iwamotocho, Tokyo. Australia & New Zealand: Ventura International, 3rd Floor, Shorter House, 193 Clarence Street, Sydney NSW 2000, Australia. USA: *Games Workshop US*, 8920 Route 108, Columbia, MD 21045, USA. West Germany: Citadel GmbH, Muhlendamm 41-43, 2000 Hamburg.

The publishers of *White Dwarf* regret they cannot accept responsibility for financial transactions between readers and advertisers.

*White Dwarf* reserves the right to amend or reject any material submitted for publication as an advertisement.

### CONTRIBUTIONS

The editor will be pleased to accept any previously unpublished articles or artwork for inclusion in *White Dwarf*. Article submissions should

be typed, double-spaced, on one side of A4 paper only. Artwork should be sent in copy form only. Please write for our submissions guidelines, enclosing a large SASE or IRCs.

All subject matter in *White Dwarf* is copyright *Games Workshop Limited*.

All rights on the contents of this publication are reserved. Nothing may be reproduced in part or in whole without the prior written consent of the publishers.

© *Games Workshop Limited 1988*

*Warhammer Fantasy Roleplay*, *Warhammer 40,000* and *Warhammer Fantasy Battle, Third Edition* are trademarks of *Games Workshop Limited*.

*RuneQuest* is the *Avalon Hill Game Company's* trademark for its fantasy roleplaying game.

*Call of Cthulhu* is *Chaosium Inc's* roleplaying adventure game based on the works of H P Lovecraft, and is their trademark.

# CRUISIN' FOR A BRUISIN

Citadel's new Ork War Buggy has got Warlords everywhere donning goggles in preparation for a swift entry onto the battlefield. We take this welded wonder for a test drive and see what it's really made of.

## ORK WAR BUGGIES

Orks are responsible for some of the ugliest technology ever to see the light of day. The extensive range of vehicles known as War Buggies are a prime example of how much importance the Ork masters of "know-wots" place on aesthetic appeal; ie, none whatsoever. Despite their cobbled-together appearance, however, these vehicles are effective enough and often put to good use by the Warlords.

The buggies are all constructed in a similar way and incorporate similar features - even though two seen side-by-side may bear little resemblance to each other. Each buggy is assembled around a basic, highly robust chassis to which are bolted various modules such as power plants and weapons mounts. Occasionally, enclosed cabins are used to provide protection for the driver or other crew members. But more often, the crew are left exposed, simply jangling on to any convenient bits of the buggy's superstructure while they operate the drive system or guns as best they can.

The most common form of Buggy can only hold two Ork crew, but there are larger versions which can carry a tactical unit (5 models), albeit in great discomfort.

LAND		AIR			TRR	Cp	T	D	Sv	Eq	W
Max	Acc/ Dec	Max	Min	Acc/ Dec							
24	6				½	2	7	15	6	2	2

**Equipment:** Communicator, Targeter.

**Weapons:** Twin Bolt guns, swivel mounted (180° traverse).

Each buggy is crewed by two Orks wearing Flak armour and carrying Knives and Bolt Pistols. The crew will have standard Ork profiles. They are included in the points cost of the buggy.

**PV:** 148 each

### Optional Upgrades for Ork Battle Buggy

1. Substitute **Multi-Melta** for Twin Bolt Guns

**Additional points cost:** 46 per Buggy.

2. Substitute **Heavy Plasma Gun** for Twin Bolt Guns.

**Additional points cost:** 71 per Buggy.

3. Arm driver with **Plasma Pistol** in place of Bolt Pistol.

**Additional points cost:** 3 per driver.

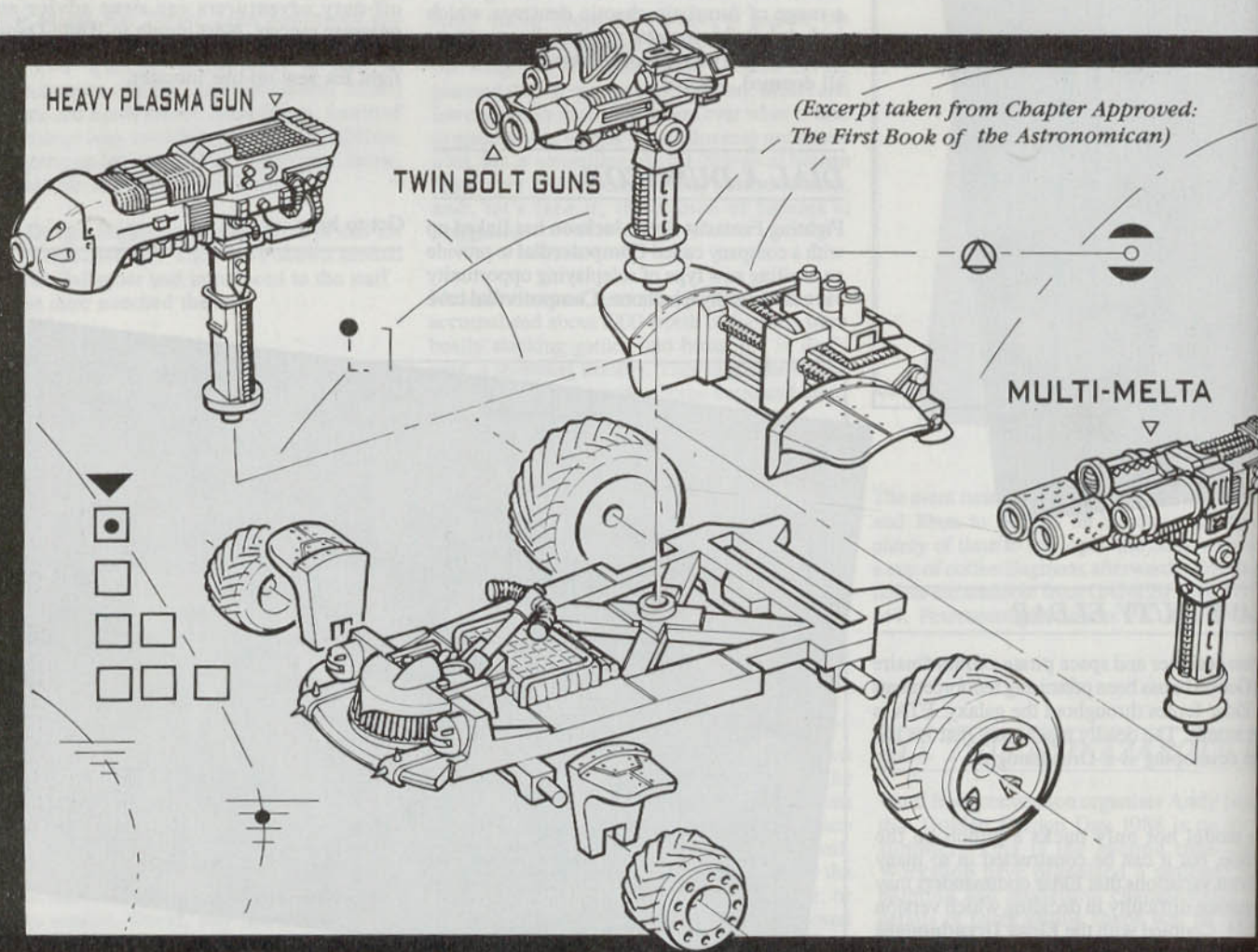

# ADVENTURERS



FEMALE  
WARRIOR JAYNE

PSYKER

OFFICIAL

PIRATE  
CAPTAIN

IMPERIAL  
SCOUT

TECH-PRIEST  
SCHILAN

SQUAT  
ENGINEER

BANDIT

SQUAT  
MINER

SPACE  
PIRATE

PUNK

NAVIGATOR

TECH-PRIEST  
ZON

SHIPS  
OFFICER

TESTBED  
SLAVE

EXTECH

SCUM

ASTROPATH  
KORM

OLD PIRATE

ASTROPATH  
YERL

HALFLING  
COOK

PILOT  
LORCAR

PILOT  
RAV

FEMALE  
WARRIOR  
GABS

MAD  
PUNK

CYBORG

IMPERIAL  
ASSASSIN

VENTOLIN  
PIRATE

SPACE  
AMAZON

HERO

ELDAR  
TRADER

HIVE  
WORDER

RT601  
£2.50  
FOR 5

Available from all good games and hobby stockists, or in case of difficulty direct from: Citadel Miniatures, Chewton Street, Hilltop, Eastwood, Nottingham, NG16 3HY. US customers contact: Games Workshop US, 1220 Key Highway, Baltimore, Maryland, 21230. Please note Postage and Packing charges when ordering direct - UK, BFPO & Eire: Minimum order £5.00, add £1.00 P&P. Orders over £15.00 POST FREE. Overseas: Minimum order £10.00, add 33% P&P. Overseas Airmail: Minimum order £10.00, add 40% P&P.



For Access and Visa orders, ring the mail order hotlines on (0773) 713213/760462

All Figures Painted By Citadel Figure Painters • Miniatures Supplied Unpainted • Designed By Trish and Aly Morrison, Bob Naismith and Mark Copplestone.

Copyright ©1988 Games Workshop Ltd. All Rights Reserved.

WARNING! This product contains lead which may be harmful if chewed or swallowed. Citadel Miniatures are not recommended for children under 12 years of age

# THRU THE BARBARIAN

## -THE RETURN OF-

# LYMARA-

## THE NEW WIDE BEAST

ART - CARL CRITCHLOW  
 SCRIPT - EVAN SMITH

WITH APOLOGIES TO LENNY



FULL RULES  
 APPEARING  
 IN  
 WHITE DWARF  
 100

# PROG 40,000 TRADER

## SPACE ORK DREADNOUGHT



RT206

£2.50

EXPANSION  
 SET

RT206 IS NOT A COMPLETE MODEL NEEDS  
 RT204 ORK DREADNOUGHT

RT204

£3.50

BASIC  
 SET

RT206 ORK DREADNOUGHT EXPANSION SET (£2.50) is not a complete model, but when added to the Basic set (RT204) you can build a bigger and more impressive Dreadnought. It consists of an 1) Ork Operator, 2) middle section, 3) Back-standard pole, 4) 2 short legs a choice of 5) one bent or, 6) one straight arm and a stub arm which can be fitted with your choice of one of the following: 7) Grenade launcher, 8) Heavy Plasma Gun, 9) Laser Cannon or 10) Heavy Bolter.

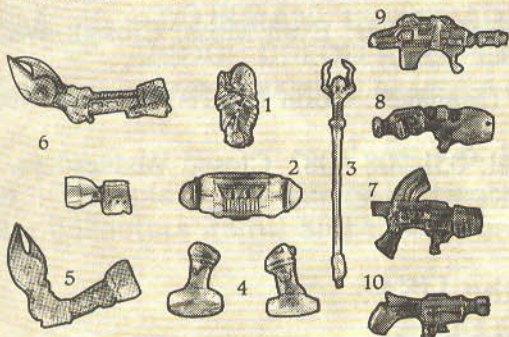

## DREADNOUGHT

RT204 ORK DREADNOUGHT ARMOUR (£3.50) consists of a 1) lid section, 2) top section, 3) leg section, 4) two long legs, a choice of 5) one bent or 6) one straight claw arm and a stub arm which can be fitted with your choice of one of the following: 7) Grenade launcher, 8) Heavy Plasma Gun, 9) Laser Cannon or 10) Heavy Bolter.

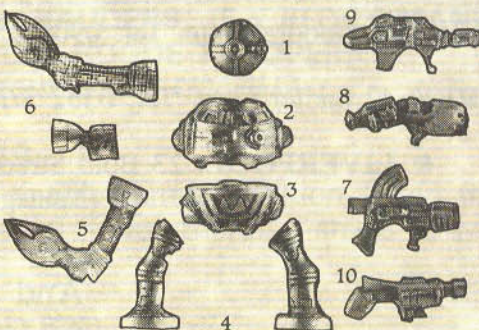

CITADEL  
 MINIATURES

Available from all good games and hobby stockists, or in case of difficulty direct from: Citadel Miniatures, Chewton Street, Hilltop, Eastwood, Nottingham, NG16 3HY. US customers contact Games Workshop US, 1220 Key Highway, Baltimore, Maryland, 21230. Please note Postage and Packing charges when ordering direct - UK, BFPO & Eire. Minimum order £5.00, add £1.00 P&P. Orders over £15.00 POST FREE. Overseas: Minimum order £10.00, add 33% P&P. Overseas Airmail: Minimum order £10.00, add 40% P&P.



For Access and Visa orders, ring the mail order hotlines on (0773) 713213/760462

All Figures Painted By Citadel Figure Painters • Miniatures Supplied Unpainted • Designed by Kevin Adams

Copyright ©1988 Games Workshop Ltd. All Rights Reserved.

WARNING! This product contains lead which may be harmful if chewed or swallowed. Citadel Miniatures are not recommended for children under 12 years of age

# EXPERT

## PAINT SET

BRILLIANT INKS FOR SHADING AND WASHES

**T**he Citadel Expert Paint Set is designed to compliment the Citadel Colour range of acrylic paints. They can be used by expert painters to give that special 'Citadel' look that you see in the pages of White Dwarf, or by the beginner to make a simple paint job look really special. Used over a base coat of Citadel Colour, a wash can pick out detail and add depth, while a glaze gives a richer and more brilliant finish.



CHAOS KNIGHT WITH INK WASHES OVER BARE METAL

COMPLETED CHAOS KNIGHT

INTRODUCING THE SPECIALLY FORMULATED RANGE OF INKS.

- 1 - RED - Shading red tunics, banners etc - subtle shading on flesh - chaos armour.
- 2 - ORANGE - To enrich, red cloth, neutral coloured cloths, fur, leather, wood.
- 3 - YELLOW - To glaze reds, greens - tunics, banners, orc flesh, dragon skin, - for brilliance and depth of colour.
- 4 - GREEN - To shade and glaze orc/monster flesh, tunics, chaos armour, bases.
- 5 - BLUE - Tunics and banners, dragon skin.
- 6 - PURPLE - Tunics, banner, chaos armour and flesh shading on red and zombie flesh.
- 7 - BROWN - Shading tunics, flesh, equipment, fur and weathering and rust effects, skeletons.
- 8 - CHESTNUT BROWN - As above but a richer and warmer tone good for fur and beasts, Horses.
- 9 - BLACK - Steel armour & equipment - lining and detailing.



PLASTIC SKELETON WITH WHITE UNDERCOAT

PLASTIC SKELETON WITH INK WASH

COMPLETED PLASTIC SKELETON



FIGHTER WITH BASE COLOUR

FIGHTER WITH INK WASHES

FIGHTER COMPLETED

**£5.99**

BOX SET OF 9 COLOURS  
RELEASE APRIL

Available from all good games and hobby stockists, or in case of difficulty direct from: Citadel Miniatures, Chewton Street, Hilltop, Eastwood, Nottingham, NG16 3HY. US customers contact: Games Workshop US, 1220 Key Highway, Baltimore, Maryland, 21230. Please note Postage and Packing charges when ordering direct. UK, BFPO & Eire: Minimum order £5.00, add £1.00 P&P. Orders over £15.00 POST FREE. Overseas: Minimum order £10.00, add 33% P&P. Overseas Airmail: Minimum order £10.00, add 40% P&P.

For Access and Visa orders, ring the mail order hotlines on (0773) 713213/760462

CITADEL  
MINIATURES



**GAMES WORKSHOP**

Copyright ©1988 Games Workshop Ltd. All Rights Reserved.



## BLANCHE'S BABIES

We often use *Illuminations* to bring you glimpses of work by artists and illustrators far from the constraints and environment of the Design Studio. We keep our own team of artists, illustrators, graphic designers and figure designers constantly busy with the latest projects to distract their attention from the fact that their companions are edible.

Yet the Studio is a flexible place - dynamic, to use my favourite adjective - and these bio-degradable Art Marines mutate from time to time. For instance, every reader knows that BiL Sedgwick draws Gobbledigook, but very few people realise that most of the time, BiL designs such gems as the *Dungeonquest* Sun Track, or the mausoleum effect for *Fury of Dracula*. Likewise, Jes Goodwin is respected for his work as a figure designer, but his sombre illustrations for *White Dwarf* and various GW hardbacks can send a chill down your spine.

How many of you thought wee Bobby Naismith spent all his time and talent on co-ordinating the figure designers? Bob's talents extend far beyond his managerial role. And some of you have been curious as to *what H* is. So are we.

The people who create the visual imagery for our games are a creative team; each has specific skills and talents but they all work together, building from ideas to final concrete forms and styles. And it's great to watch them do it. For now we can look at their rich black and white illustrations - next month we'll see what happens when you let them loose with colour.

John Blanche



CHAOS MUTATION

T.A.

BEASTMEN OF KHORNE



A.M.

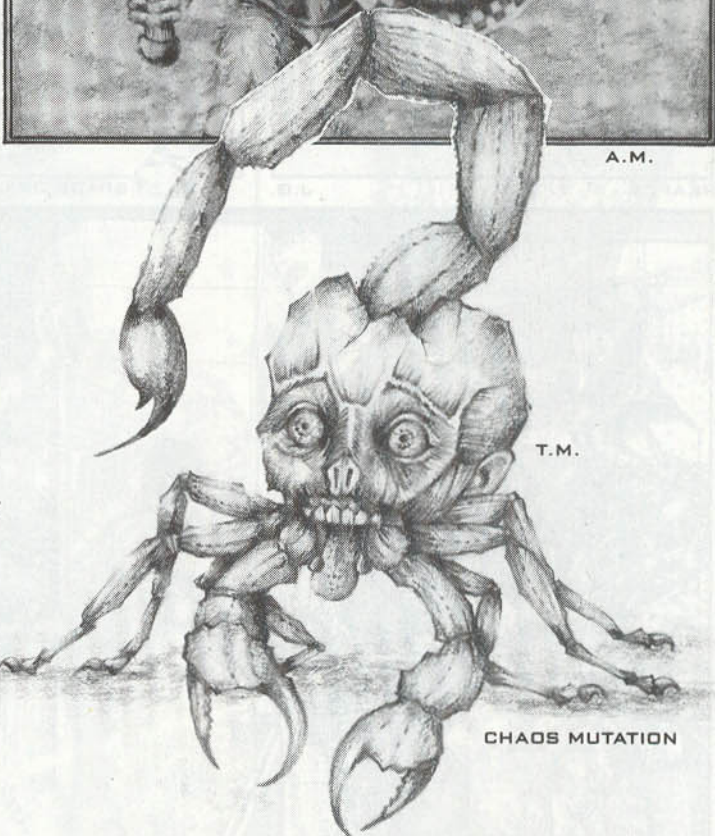

T.M.

CHAOS MUTATION



WARRIORS OF CHAOS

A.M.



REAPER

J.G.



T.A.

CHAOS WARRIOR MUTATION



SPACE ORK

A.M.



'NIGHT WINGS'

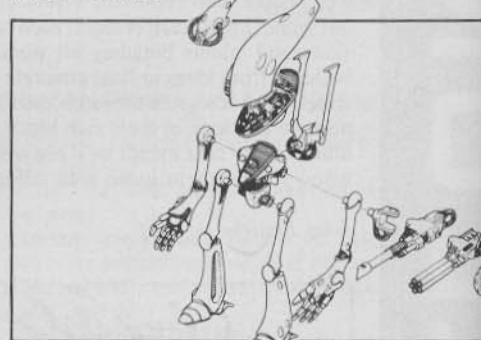

ELDAR DREADNAUGHT



40K SIEGE

A.M.

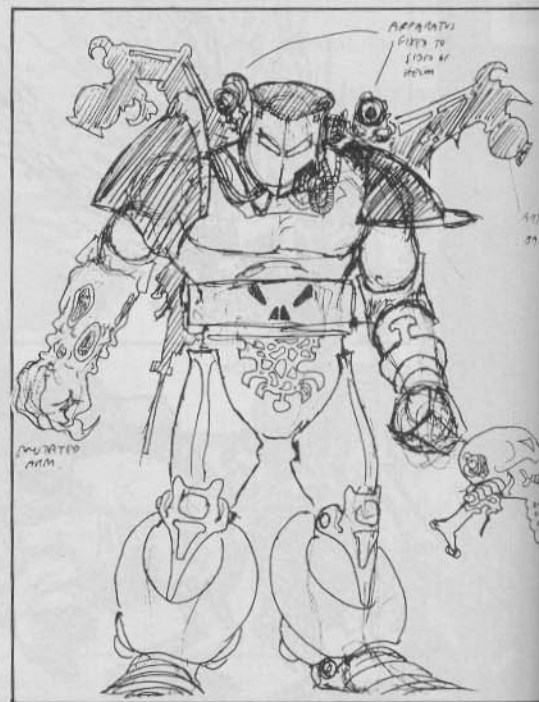

CONCEPT SKETCH FOR 40K



CHAOS BEASTMAN

C.D.

FAERIE KNIGHT

J.G.



OLD WORLD NOBLE

D.A.



THE ONE HORSEMAN OF THE APOCALYPSE

SID



CHAOS MUTATIONS



T.A.



CHAOTIC COLUMN

T.A.



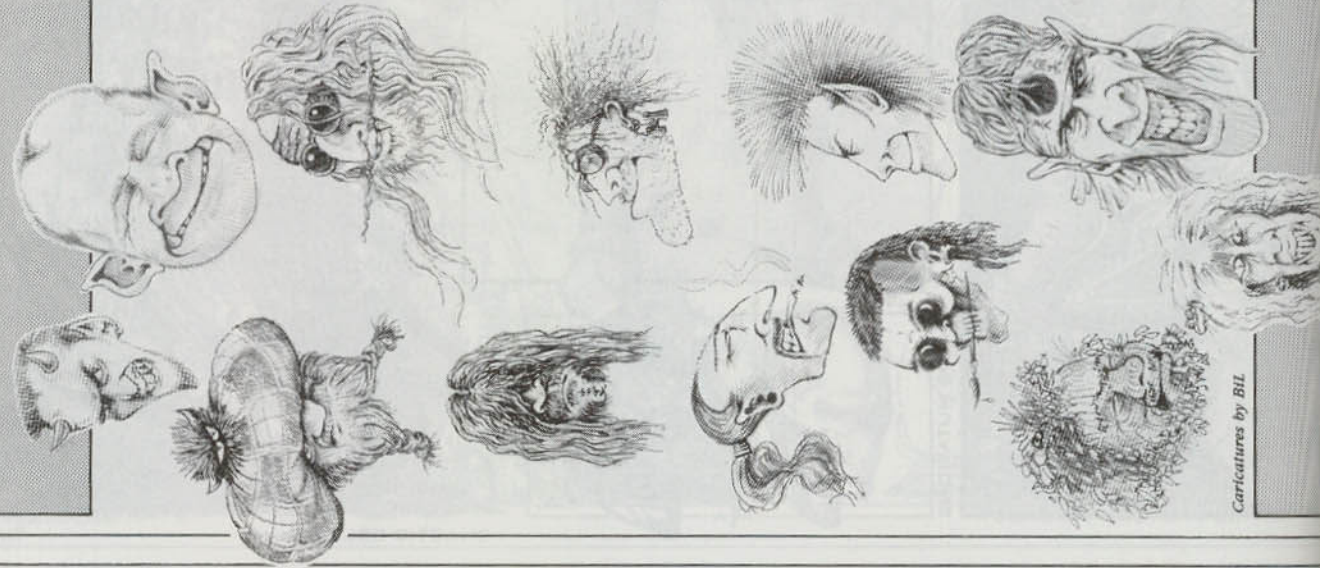

FAVOURITE THINGS AND OTHER STRANGENESS

NAME	AGE	JOB	TRAINING	ART MEDIUM	ARTIST	MUSIC OR BAND	BOOK OR AUTHOR	FILM	FOOD	AMBITION
<b>ALY</b> <i>Taurus</i>	30	Figure Designer	Self	Pen & Ink	Miller, Blanche, Dali	Eurythmics, New Order	2000AD, Any Marvel comic with 'X' in it	Terminator, Aliens	Jap	Bop till drop
<b>BIL</b> <i>Happy</i>	7½	Graphic Designer	BA Hons Architecture	Pen & Ink	Uderzo (Asterix), Sergio Aragones	Motorhead to Mozart	Richard Scary's Biggest Word Book Ever	Star Wars	Lots of everything	None
<b>BOB</b> <i>Scottish</i>	31	Figure Designer Manager	Dip AD Design	Citadel Colour	Patrick Woodroffe	Furys	Bladerunner	Star Wars	Chicken Tandoori	(He just laughed)
<b>COLIN</b> <i>Sagittarius</i>	23	Artist	Art College drop out	Citadel Colours & Crayons	William Blake	New Model Army	Lord of the Rings	Star Wars	Mushrooms	To be able to draw
<b>DAVE</b> <i>Artes</i>	22	Artist	Art college	Acrylits	Breughal	Noisy		Excalibur, Alexander Nevsky		To be rich
<b>H</b> <i>Aquarius-Capricorn Cusp</i>	9½ weeks	Designer & Tech Illustrator	Electronics Engineer	Ink via a nib	Michael Whelan	Sisters	Dot-to-Dot Painting by Numbers	Aliens		To grow up
<b>IAN</b> <i>Labrador</i>	35	Assistant Art Manager	BA Fine Arts	Screen Printing	Victor Moscoso, Vaun Bod	Zappa, Dead	Ubik, P.K. Dick	Apocalypse Now	Hot buttered chilli dogs	Sail around the world
<b>JES</b> <i>Leo</i>	27	Figure Designer	3 years sentence in Fine Arts	Pencil	Froud, Blanche	Jesus & Mary Chain	Gene Wolfe's New Sun series	Time Bandits	Veggy	To watch the world end
<b>SID</b> <i>Scorpio</i>	23	Figure Painter	Self	Doris Stoakes	Bosch	Hendrix	Black Easter, Blish	Easy Rider	Garlic pizza	Has achieved - got his Harley
<b>TIM</b> <i>Armadillo</i>	23	Studio Assistant	Art College drop out	Pen & Ink	Pre Raphaelites	Marillion	Star Trek	Aliens	Jap	To be Captain of the Enterprise
<b>TONY</b> <i>Artes</i>	Silurian	Artist	Self	Variograph	EC comics, Durer	Blues	Collector, Horror & any	Sci-Fi, Horror	Less than it used to be	To train trilobites
<b>TRISH</b> <i>Virgo</i>	21	Figure Designer	Degree Jewellery Design	Red Gold	Pre Raphaelites	T'Pau, David Cassidy	Amanda Pranita, Angela Carter	Rocky Horror, Co. of Wolves	Carob coated raisins	To be a dolphin

Caricatures by **BIL**



# THE RITUAL



The corpse twitched again. The Skaven's eyes were fixed on the table. The gaunt, robed figure in the shadows moved his arm across an invisible line, and as the twisted fingers uncoiled, the corpse rose to a sitting position.

'Seesee!' cried Skretth, salivating. He was suddenly aware of the curtain of silence he had disturbed. The necromancer seemed not to notice. Skretth returned his gaze to the corpse as it climbed down from the bench. Before it let go, there was a soft tearing sound and the rotting remains of the unfortunate corpse's internal organs splattered across the floor. Unbalanced, the monster collapsed in its own offal.

'I need something better,' hissed the robed figure before turning to leave the chamber.

Skretth was alone. He scurried across the room and pulled a jar down from the shelf. Clawing it open, he pulled out a small clump of leaves and ate them. His whiskers twitched wildly as he returned the jar and its diminished contents to the shelf.

The Black Lotus almost made him forget the putrid mess on the floor. Walking back around the room, he leaned over the corrupted body and began to sniff. He would find something better. He had an idea that would bring him something much better. He left to tell the others...

## INTRODUCTION

This **Warhammer Fantasy Roleplay** adventure provides GMs with an alternative introduction to *The Enemy Within* campaign. It is set in Delberz, and so occurs prior to any of the events in *Mistaken Identity*. Alternatively, new GMs may locate the adventure as they see fit (any reasonably large town or city) and use it as the introductory game in their campaign, or simply as a one-off adventure. (If you have just created some new adventurers with the **WFRP Character Pack** and don't know what to do with them yet, here's your answer!)

If you intend to play this adventure, stop reading now! Knowledge of what lies ahead will spoil the fun for all concerned.

## GM'S BACKGROUND

Skretth is insane: a renegade Skaven with an impossible goal. He controls a small group of loyal but misguided Clan Skryre warriors. Recently, he and his patrol have exited from the web of tunnels that riddle the Empire into the sewers beneath Delberz. The map said no such exit existed. Skretth looks upon it as fate.

His last mission involved close association with a necromancer. Skretth became too heavily involved. Constantly hallucinating from the effects of *Black Lotus* (**WFRP** p82), the young Skaven became fascinated by experiments he could not have hoped to understand. For bodies to be re-animated, there would have to be warpstone present. It was the stuff that sparked life into everything. If it was there, it could be extracted. And if he found a way to extract it, he would be able to return to his clan and take control. So went his warped reasoning.

The Delberz sewer network has provided him with an opportunity to collect specimens and practise rituals for his flawed quest. Human cultists in the town, members of the Horned Rat worshipping Poison Claw cult, have been made aware of the group's arrival and are aiding Skretth in his unofficial mission.

This adventure leads the players into the maze of sewers which riddle the ground beneath the city. They will discover that a band of Skaven have recently taken up residence down there, and, with the aid of their human servitors, are carrying out bizarre rituals and sacrifices to their deity, the Horned Rat. The players must try to eradicate (or at least drive out) the Skaven, whilst attempting to save a wealthy citizen from their clutches in the process. As the Skaven presence is significant, the players will need to have their wits about them. Repeatedly choosing to fight will lead to a swift and bloody demise...

## CLAW MARK

The following encounter should occur as the PCs are walking back from a late-night drink one evening at their local tavern. Note, however, that they should have a good deal of their equipment with them, certainly a weapon at least, as they will not have time to pick up anything if they left it behind at their place of lodging. If they have *Handout 1* from *Mistaken Identity*, they could be preparing to leave the town for Altdorf and adventure. How are they to know that adventure may be closer than they realise?

As they are strolling through a particularly dark and quiet street, a door suddenly bursts open from one of the expensive houses lining the road. A young man, dressed only in nightclothes, rushes out yelling, 'Help me, someone, please!' As he catches sight of the characters, he turns and races towards them. A large bruise covers one side of his face. As he races over, gasping for air, a dark shape appears, silhouetted in the doorway of the house. The man gasps one last sentence, 'They've got my father... Don't let them take him... Hurry...' before an audible twang comes from the doorway, followed by a much closer thud. The unfortunate young man collapse into the arms of one of the characters, choking and coughing up blood. A crossbow bolt is buried his back. He is dead.

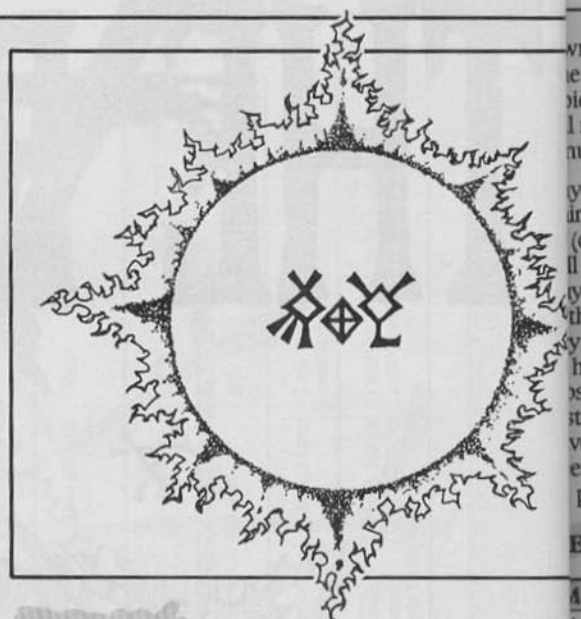

## GM's Notes

The crossbow quarrel landed in the back of Ernest Dralst, Klaus Dralst, a wealthy townsman. Both lived in the rather house from which Ernest just emerged. Ernest was asleep upstairs bedroom when he was awakened by a sound of something moving about below. After waking his father, the two of them went to investigate, but were leapt upon by three intruders in the cellar. Klaus was swiftly overpowered. Ernest, however, being quick and fitter, managed to break free and rush out into the street.

Peter Tavelli (a Poison Claw cultist), raced after Ernest in an attempt to prevent him from alerting anyone, after having first ordered his companions to take Klaus back to Skretth by way of a secret information away, he will immediately seize a capsule of Manbane from around his neck and bite into it. This Manbane capsule is carried by all the humans serving the Skaven, and contains the equivalent of 4 very powerful doses of the drug - the Poison Claw cultists resist its effects is made at a -20% penalty for each dose. It is possible that a capsule may not kill, but the GM should make it clear that this does not happen very often. The use of the capsules is accepted by all the human servitors, and even if the poison does not work, torture will be necessary to extract any information from them, such as their loyalty to Skretth.

As soon as Tavelli fires the bolt, he retreats back inside the house and waits to see the adventurers' reaction through the hallway. If they decide to pursue him, he will lead them into a trap set in the house before trying to get back to the cellar and into the secret passage. If he is caught or cornered, rather than giving up information away, he will immediately seize a capsule of Manbane from around his neck and bite into it. This Manbane capsule is carried by all the humans serving the Skaven, and contains the equivalent of 4 very powerful doses of the drug - the Poison Claw cultists resist its effects is made at a -20% penalty for each dose. It is possible that a capsule may not kill, but the GM should make it clear that this does not happen very often. The use of the capsules is accepted by all the human servitors, and even if the poison does not work, torture will be necessary to extract any information from them, such as their loyalty to Skretth.

The adventurers will probably decide to chase Tavelli into the house and try to apprehend him. However, should they hesitate for whatever reason, you should remind them that in his last moments Tavelli's murder victim expressed the need for speed. If they still refuse to enter the house at once, and insist on returning to their place of lodging, then the adventure can still be brought on line. The Skaven will be very interested in capturing the PCs as they are the only (living) people who know what happened to Klaus. They may be grabbed during their sleep and thrown into the cells in the sewers (see *Into the Sewers* below) to await sacrifice. The players will then have to escape - Klaus will have been sacrificed by then, so they won't have to worry about rescuing any more.

## UPSTAIRS, DOWNSTAIRS

If he sees he is being followed, Tavelli will race up the stairs to the hall, making sure the PCs have seen him. If they pursue him up the stairs, he will manoeuvre a decorative wine barrel over the stands on the landing to the top of the stairs and send it crashing down.

down towards his pursuers. Any characters on the stairs at the time must make a successful *Initiative* test at a -10% penalty to avoid the barrel. Anyone standing at the foot of the stairs must still make a successful *Initiative* test, but this time there is a +10% bonus to the roll.

Anyone hit by the barrel will take one **S 3** hit, and anyone on the stairs will be knocked down, taking falling damage as the GM judges fit (depending on how far up the stairs the character got). Tavelli will then come back down the stairs, leaping over the banister half way down (a distance of 3 yards). From there he will rush back to the cellar and enter the sewers via the secret passage. Should any characters have avoided the barrel and be able to go in pursuit of him, he will turn and fire a couple of bolts from his repeating crossbow. If they start to get too close for comfort, he will just make a straight run for it, abandoning any attempt to kill the characters. Tavelli's actions, should he be caught or cornered, have already been dealt with - don't forget that he will use the Manbane capsule in preference to being captured. His profile is as follows:

#### PETER TAVELLI, FOOTPAD, CULTIST

M	WS	BS	S	T	W	I	A	Dex	Ld	Int	Cl	WP	Fel
4	32	29	3	3	6	36	1	36	29	32	33	32	28

**Skills:** Silent Move Rural, Silent Move Urban, Strike to Stun.

**Trappings:** Club, Repeating Crossbow (9 quarrels), Face Mask.

Tavelli is a tall (6'3"), angular man, with a hooked nose, small beady eyes, and black hair. He is wearing a black, wide-brimmed hat that covers most of his face (though he wears a dark blue neckerchief as a mask as well), and his flowing midnight blue cloak is fastened by a cloak clasp identical to the one lying in the kitchen (room 3 - see below). His dark grey trousers are neatly tucked into a pair of leather boots. He is also wearing a pale blue tunic and black gloves. Most of the other humans serving the Skaven dress similarly when involved in night missions, but are indistinguishable from any other upright citizen when going about their business during the daytime.

#### The House

Only brief descriptions of the rooms in the house are given below as it is not anticipated that the players will be spending much of their time there. All the rooms may be illuminated by lanterns hanging from the ceiling, but only the ones in rooms 1, 7, 11 and 12 are currently burning.

**1. Hallway.** The hallway is opulently furnished with hunting trophies and tapestries which hang from the walls. A plush blue carpet covers the floor. An elaborate staircase spirals upwards to a balcony overlooking the hall in the south-eastern corner. There are three tapestries in all, each worth 25GC, but you should discourage the players from taking them, reminding them of where they are and what they are supposed to be doing. The hunting trophies are not especially valuable.

**2. Dining Room.** This room is currently in a total mess. Two bodies are sprawled across on the floor. The table is upturned and shattered glass lies everywhere. What must have been an expensive wooden cabinet has been smashed in along its front, and the drawers, together with their contents, have been scattered across the room. The two bodies are those of the servants who tried to oppose Tavelli when he was pursuing Ernest. The ensuing fight succeeded in completely devastating the whole room, leaving nothing of value unbroken.

**3. Lounge.** This is where Klauss used to entertain his guests while they relaxed after a meal. The room hasn't suffered the same fate as the dining room. Several luxurious armchairs, a large decorative fireplace and an elaborate sideboard provide grand furnishing. Four paintings hang on the walls, each worth 40GC, but again, looting should be discouraged.

**4. Kitchen.** This large room has a flight of stone stairs leading down into the cellar in one corner. Two clubs rest in a puddle of

blood, evident to anyone entering the room. Any character making a successful *Observe* test or searching the room will also find a ornamental cloak clasp with the Horned Rat's symbol on it - three crossed bones forming the shape of an inverted triangle in the middle. All the items were dropped during the scuffle between Klauss, Ernest and the men, and the clasp may serve to tell the players just what they are really up against. Any Cleric or Initiate in the party will immediately recognise the symbol as the Horned Rat's - if the player does not know, you should inform him of the fact together with the associated knowledge of his connection with the Skaven.

**5. Corridor.** This corridor connects the hall to the kitchen. As it is part of the house that guests do not normally see, it is merely stone flagged, showing none of the splendor seen elsewhere in the house.

**6. Storeroom.** This is where all the food and other domestic requirements of the household are kept, under lock and key. However, when Klauss and Ernest went to investigate the sounds, they armed themselves each with clubs kept here, and Klauss forgot to lock the door in his hurry. Thus the door is slightly ajar, the keys still in the lock.

Inside are several sacks of grain, stacked neatly against one wall along with many other items of food - you may add specific items at your discretion. Also kept in this room is what amounts to a small armoury - a wooden crate marked 'DANGER! EXPLOSIVES', sits innocently in the corner (it contains four bombs - *WFRP* p129). There are usually two more clubs, but as mentioned above, Klauss and Ernest each took one, and both are now lying in the kitchen where they were dropped in the scuffle. In addition, there are two lanterns here, three spare flasks of oil, and a tinderbox. The bombs will be very useful to the players in the latter part of the adventure, should they decide to take them now.

**7. Balcony.** The stairs from the hallway spiral upwards onto this balcony which overlooks the hall below. The floor here is also



# TALISMAN

## TIMESCAPE

Those who seek the Crown of Command face a new set of perils. Flung through space and time, they may find themselves in alien realms, faced with foes and dangers beyond their imaginings.

This fourth expansion set for the world's most popular fantasy boardgame takes you to new worlds, with an add-on board depicting the fantastic worlds of the Timescape, 40 Timescape cards, 12 Timescape Purchase cards, and eight new characters who start from the Timescape itself.

Brave the perils of space and time through the Timescape.

Will it take you nearer your goal? There's only one way to find out ...



£7.99



FOR ACCESS & VISA ORDERS RING THE MAIL-ORDER HOTLINES ON (0773) 713213/760462

Available from all good games and hobby stockists, or in case of difficulty, direct from: Games Workshop Ltd, Chewton Street, Hilltop, Eastwood, Nottingham, NG16 3HY. US customers please contact: Games Workshop US, 8920 Route 108, COLUMBIA, MD21045, USA.

**GAMES WORKSHOP**



covered with the blue carpet, but there are no adornments on the walls except for a large, decorative wine barrel situated in a small alcove at the top of the stairs.

**8. Guest Chamber.** Visitors to the house are normally accommodated here. A large four-poster bed set against one wall, a set of teak drawers and a large wardrobe provide the main furnishings. There is nothing of real value here, however.

**9. Servants Quarters.** This large room contains four beds, only two of which have been occupied recently (by the servants now lying dead in the dining room). The room is not as well furnished as the rest of the house, but still represents very good servants' accommodation.

**10. Corridor.** This corridor separates Klaus and Ernest's bedrooms off from the rest of the house, providing them with more privacy. As with the hall and balcony, the floor is covered with blue carpet. Two paintings also hang on the walls, worth approximately 70GC each.

**11. Master Bedroom.** This is the largest bedroom in the house, and is where Klaus usually sleeps. An ornate rosewood cabinet is set against the wall opposite the four poster bed, together with an equally ornate set of drawers and a spacious wardrobe. The drawers are all filled with personal belongings and clothes, but the wardrobe has a false bottom, concealing a secret compartment which contains 200 Crowns, 67 shillings and 300 brass pennies.

**12. Ernest's Bedroom.** This isn't quite as luxurious as the master bedroom. It's relatively sparsely furnished with a single bed, a wardrobe and drawers.

**13. The Cellar.** This stone flagged room is filled with barrels and casks containing a wide variety of fine wines and ales. A flight of stairs leads up into the kitchen in one corner, whilst in another corner, concealed beneath one of the flagstones is the entrance to an old, long-forgotten tunnel. This tunnel leads into the sewer

system, and is the way Tavelli and company gained entrance to the house. Neither Klaus nor Ernest knew of the existence of the passage. The flagstone has not yet been replaced over the hole, as Tavelli has not yet rejoined his companions. When (or if) he manages to do so, he will pull the flagstone back into place behind him, time permitting.

## INTO THE SEWERS

Beneath the hole, a rusty, iron-rungged ladder leads down a narrow shaft for 10 yards or so, finally emerging in a rough-hewn stone corridor. The course of the adventure from this point depends very much on what has happened to Tavelli. If he has successfully managed to escape down the shaft he will return to Skreth immediately and report what has happened. However, he will only mention the PCs if they are pursuing him. Thus, the Skaven will be ready for the characters and will step up their guard around the sacrificial chamber, so that when the time for the ritual sacrifice comes (at midnight), it will be much harder for the players to stop it from going ahead, as if it isn't going to be difficult enough as it is!

If Tavelli was killed by the characters (or if he killed himself), then he will not be missed for some time, as the Skaven have more important things to worry about with the impending sacrifice. Skreth's experiments have not been going well. He really has no idea of how to achieve his goal and is increasingly worried that his followers will soon lose patience. Apart from anything else, he is constantly under the influence of Black Lotus and the capacity for rational thought (if such can ever be truly grasped by Skaven) is far beyond him.

The guard around the sacrificial chamber will not be stepped up, and consequently the players' task will be made a little easier. Any attempt to impersonate Tavelli (by wearing his clothes) will probably be successful (make a *Bluff* test each time a character makes the attempt), but remember that there are several areas of the complex where humans are not permitted, and trying to gain access to these areas will arouse suspicion. The cultists know where they can and can't go.



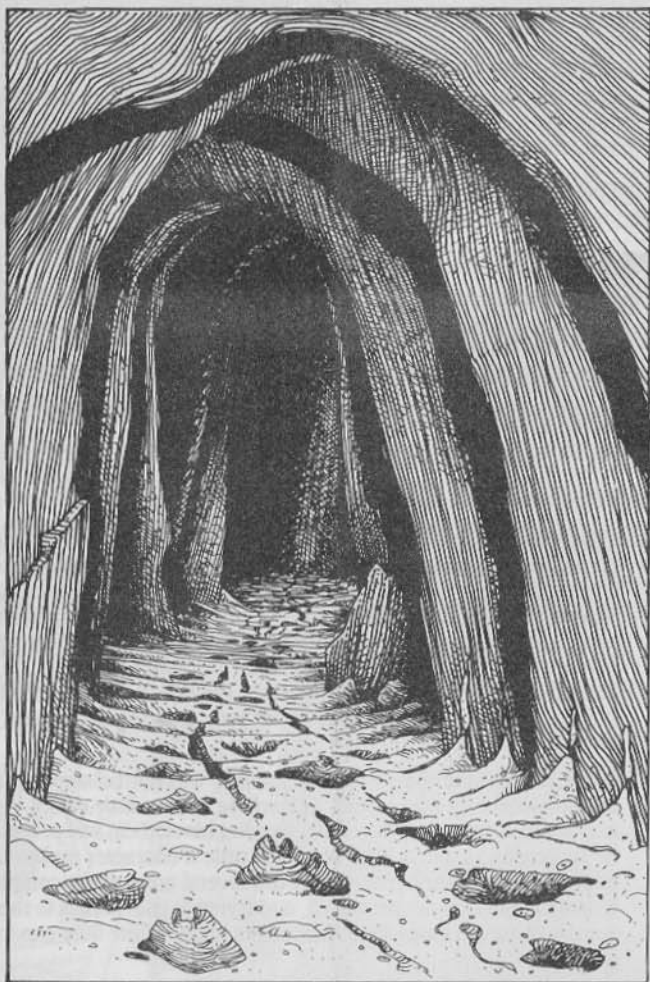

From this point onwards, the action is totally dependent on where the players go, but don't forget they are racing against the clock, so keep a careful record of elapsed game time.

The rock corridor in which the players are now standing is pitch dark. Characters must provide some means of illumination to see anything at all. *Night Vision* (except that possessed by Elves or Dwarfs) is useless. The corridor is also quite low (about 6' high), so some members of the party might find themselves having to duck down to avoid hitting their heads against the ceiling. The floor is covered with a shallow layer of mud (any character moving faster than *Cautious* rate should make an *I* test or slip and fall over), and footprints clearly mark the path taken by the cultists. The PCs needn't possess *Follow Trail* skill to see which way they have gone. In all the branches leading off from the corridor, the mud is undisturbed. However, a character who does have the skill will be able to identify two continuous, roughly parallel tracks as being made by Klaus's heels as he was dragged through here.

The corridor and branching passages are rather frightening, as the players will be able to hear strange, far-off noises and grunts echoing down them. The walls glisten with moisture - a greenish slime being evident in places - and the air is distinctly cool. GMs should try to create an atmosphere of foreboding down here.

Should the party decide to take any of the side passageways, they will soon get lost, as each leads gradually downwards into a terrifying, twisting maze which works its way for miles in every direction. No further details of the side branches have been given - if the players really do wish to investigate them, you should create the details yourself. The further into the tunnels they get, the more dangerous they become: all manner of pitfalls and wandering, mutated creatures could await the unwary... The party could wander endlessly, slowly dying of starvation, lack of water, and their wounds.

The tracks eventually lead to a dead end - a wall of moist, smooth stonework. Any character with *Secret Signs - Thieves* will notice

a marked stone on a successful *Observe* test. Otherwise, a successful *Search* test will reveal the mark. Pushing the marked stone against the wall to swing outwards, providing an entrance to the sewer. The door may be closed by pushing the stone as it protrudes from the other side (the stone merely repositions the counterweight which operates the door mechanism).

The major encounter areas in the sewers and the branching passageways are keyed on the map, and the corresponding descriptions given below. As the whole area below the cellars has been taken over by the Skaven and their servitors, there is a 10% chance per turn of the characters encountering something. If an encounter is indicated, roll a D4 and consult the following table. Note, however, that if, during combat, a Critical is scored, the victim should make an *Initiative* test immediately. Failure means he has been knocked from the walkway and will fall into the effluent as described below.

#### Die Roll Encounter

- One of the cultists on a routine errand for the Skaven. Use Tavelli's profile if a fight develops, but remember that raising the alarm will be the cultist's main priority.
- A patrol of D3+1 cultists armed with swords. Use the following profile for each of them:

M	WS	BS	S	T	W	I	A	Dex	Ld	Int	Cl	WF
4	36	32	3	3	5	32	1	29	24	25	31	30

- A single Skaven, going about its business. It will carry a combat knife (*WFRP* p226) in combat, and has the following profile:

M	WS	BS	S	T	W	I	A	Dex	Ld	Int	Cl	WF
5	33	25	3	3	7	40	1	24	24	24	18	29

- A small band of two (or more, at your discretion) returning from a routine reconnaissance patrol elsewhere in the sewers. Each may be treated as identical to the profile detailed above.

## DAMP, DARK AND DEADLY LOCATIONS

**1. Entrance To The Sewers.** The secret door in the wall leads into the sewers proper. The walls are made of dull grey stone, glisten with moisture (although there is no slime). Rules for adventuring in sewers are given in *Shadows over Bögenhafen*; a brief summary of them is necessary here. The sewers, like the corridor that leads to them, are pitch dark, and even characters with *Night Vision* (except Elves and Dwarfs) cannot see unless a source of light is carried. The portion of the sewer network explored by the PCs is classed as a Major Sewer, and as such the passages are roughly 10 feet wide in their entirety, including the stone walkways about 2½ feet wide on each side of the central channel, which is 5 feet deep, and filled to a depth of D3

feet. The walkways are only wide enough to permit movement in a single file, and, as they are also wet and slippery, anyone attempting to move faster than *Cautious* rate must make an *Initiative* test or round or fall into the effluent. The effluent, not surprisingly, has a terrible stench, and anyone falling in will lose half their *Feeling* until they have the opportunity to clean up. Additionally, any Elf or Halfling falling in must make a successful *Risk* test, or drown after a period of time equal to their *Toughness* in rounds. After this period, drowning characters lose 1 Wound per round until they reach 0 Wounds (in which case they die), or they are rescued by their companions. If the character is swept 'underground' by the points on the map where the channel disappears into the effluent channel will only have room for the 2 yard run-up character runs diagonally across the channel - a leap of faith (*WFRP* p75). If the test is failed, the character falls into the effluent. Wading characters must make a successful *Initiative* test every round to avoid slipping and falling over.

An unpleasant and unsettling atmosphere pervades the sewer system, and as a result all characters lose half their *Cool* and *Will Power* scores whilst they are in them. However, it should be noted that *Magic* tests are still taken on the character's normal *Will Power* score. As they are a dirty and generally unsanitary environment, all wounds suffered whilst in the sewers, apart from those gained by falling, have a 10% chance of becoming infected. Sound also carries for twice as far than normal, and there is a +10 modifier to all *Listen* tests.

The characters should realise that, although it is possible to leap or wade the 2 yard (5 feet) gap across the channel, for two men dragging an unconscious person, this would be practically impossible. Thus, it is highly likely that their quarry has kept to this side of the sewer. As the channel goes deeper 'underground' after a short distance to the left, the only possible way onwards (barring the existence of further secret doors, of course) is to follow the walkway round to the right. If, after much pondering, they still haven't figured this out, you should drop a few subtle hints.

2. **Ghoul.** At the point indicated on the map, the adventurers can see a humanoid body slumped face down over the walkway, one arm dangling over the edge. When they first see the figure, only the fact that it is dressed in rags and lies unmoving will be evident. The figure is, in fact, a Ghoul (*WFRP* p248), who could smell the far off stench of dead human flesh (see below). It began to explore but came across a Skaven patrol who attacked immediately.

The Skaven soon overpowered the miserable creature and have left it for dead. However, it has merely been reduced to a single wound and is currently on the verge of regaining consciousness. It will not come to unless one of the characters tries to turn it over or lift it, when it will lash out in dazed panic (*WS* -10). It will fight until either a character kills it, or moves out of range - it is too badly wounded to follow up any attack.

3. **Entrance to the Skaven Den.** At this point a secret door opens into a rock corridor branching off to the right. This corridor is inclined upwards at a steep angle (evident to anyone entering it), levelling out when it reaches room 4. Half way along, just before the bend in the passage, is a trip wire (normal chance of being triggered - *WFRP* p79 - but any character making a successful *Observe* test will see the wire immediately). If the wire is not seen or avoided, and is triggered by one of the PCs, two things happen. Firstly, a bell rings in room 4, alerting the guards there to the presence of intruders, and secondly, a yellowish gas seeps through concealed vents in the roof. From the bend, it floods a two yard radius, spreading down the corridor at the rate of 1 yard per round for D4 rounds. Anyone caught in the gas must make a successful *Toughness* test each round at a -20% penalty or collapse unconscious for 2D6 turns.

After the gas has dispersed (this takes as many rounds as it took for it to fully spread out, ie 2-5 more rounds) the guards from room 4 will take any unconscious characters and throw them in the cells in room 6. If any characters have managed to shrug off the effects of the gas, the guards will try to beat them into unconsciousness with their clubs, using their *Strike To Stun* skill. They will not want

to kill the characters because of Skreth's intentions (see below). If the PCs end up being subdued by the guards, refer to *Captured!* below.

4. **Cultists' common room/guard chamber.** This roughly-hewn cavern serves as both the common room and guard chamber for the cultist servitors of the Skaven. There are a couple of tables and some chairs in the north-eastern area of the room, two sets of bone dice, and a pack of cards lying on the tables. Illumination is provided by four torches mounted on the walls. Should Tavelli have escaped, this is where he will be now (unless the adventurers were hot on his trail, in which case he would not have had time to complete his report to Skreth and would therefore be in Skreth's chamber - room 9). At any time there are 2D4 off duty guards in the room, each with the following profile:

M	WS	BS	S	T	W	I	A	Dex	Ld	Int	Cl	WP	Fel
4	34	34	4	4	3	33	1	35	23	28	37	31	30

**Skills:** Consume Alcohol, Strike to Stun, Concealment Urban

**Trappings:** Leather Jack (0/1 AP - body & arms), Sword, 1-6 GC each

The guards' actions are dependent upon whether the party triggers the trap wire or not in room 3. If they don't, the guards will be sitting at the tables having a game of cards, and the players are either going to have to think up a convincing story and try to *Bluff* their way through (these guards are naturally suspicious, so any test is made at a -10% penalty), or they will have to fight. These guards knew Tavelli: if one of the PCs has donned the cultist's outfit, they will immediately recognise the character as an imposter. Note also that the noise of fighting will alert the Skaven sentries at location 7, who will attempt to ambush and capture any intruders into their area as described under the entry for room 7.

5. **Armoury and Storeroom.** This small cave serves as a makeshift armoury and storeroom for the guards in room 4. It contains 5 swords, 6 daggers, 3 hand axes, 2 flasks of oil, 2 tinderboxes and 11 torches. The weapons are all arranged in wooden weapon racks set against the walls, and the torches, oil, and tinderboxes are stacked neatly in another corner.

6. **Corridor and Cells.** This long, dismal corridor is accessible from the guard room by a sturdy oak door. There are a total of nine cells in the corridor. Each has a wooden door with a small barred window in it (*Toughness* 3, *Damage* 9, *Lock Rating* 30%). Only seven of these cells are actually used as such, though. The western-most cell will be used to store any possessions captured characters may have had, and will always be locked if there is no-one inside. The easternmost cell is the jailer's 'den' - the current incumbent being Tigrati Parvisch. He is about 5'10" tall, and wears a permanent layer of stinking sweat and dirt. He is dressed in a filthy white, sweat-soaked vest, and equally disgusting black trousers. He always carries the ring of keys to the cells around his belt, making them difficult to get hold of, but he is immensely stupid and easy to trick (making him eminently qualified for the job).



THE RITUAL

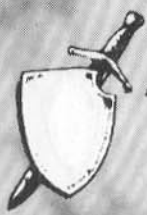

# WARHAMMER

## Towns-Folk



BODYGUARD



GOOD OL' BOY



THESBLAN



GATE-KEEPER



PEASANT



TRAINER



JESTER



HIGHWAYMAN



DANDY



STRONGARM



BOXER



SHEPHERDESS



STUDENT



WINO



PRIEST



ROGUE



SCRIBE



LORD



MLADY



SCHOLAR



WILDMAN



SIDEKICK



MONK



GYPSY



DRUMMER



BASKETMAID



DRUNKEN DWARF



CASUALTY

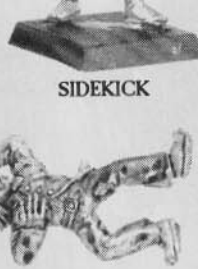

GENTLEMAN



MONGREL



TABLEMAID



COWARD



KNIFE-THROWER

C46  
£2.50  
for 5



Available from all good games and hobby stockists, or in case of difficulty direct from: Citadel Miniatures, Chewton Street, Hilltop, Eastwood, Nottingham, NG16 3HY. US customers contact: Games Workshop US, 1220 Key Highway, Baltimore, Maryland, 21230. Please note Postage and Packing charges when ordering direct - UK, BFPO & Eire: Minimum order £5.00, add £1.00 P&P. Orders over £15.00 POST FREE. Overseas: Minimum order £10.00, add 33% P&P. Overseas Airmail: Minimum order £10.00, add 40% P&P.



For Access and Visa orders, ring the mail order hotlines on (0773) 713213/760462

All Figures Painted By Citadel Figure Painters • Miniatures Supplied Unpainted • Designed by Trish Morrison & Mark Copplestone

Copyright ©1988 Games Workshop Ltd. All Rights Reserved.

WARNING! This product contains lead which may be harmful if chewed or swallowed. Citadel Miniatures are not recommended for children under 12 years of age

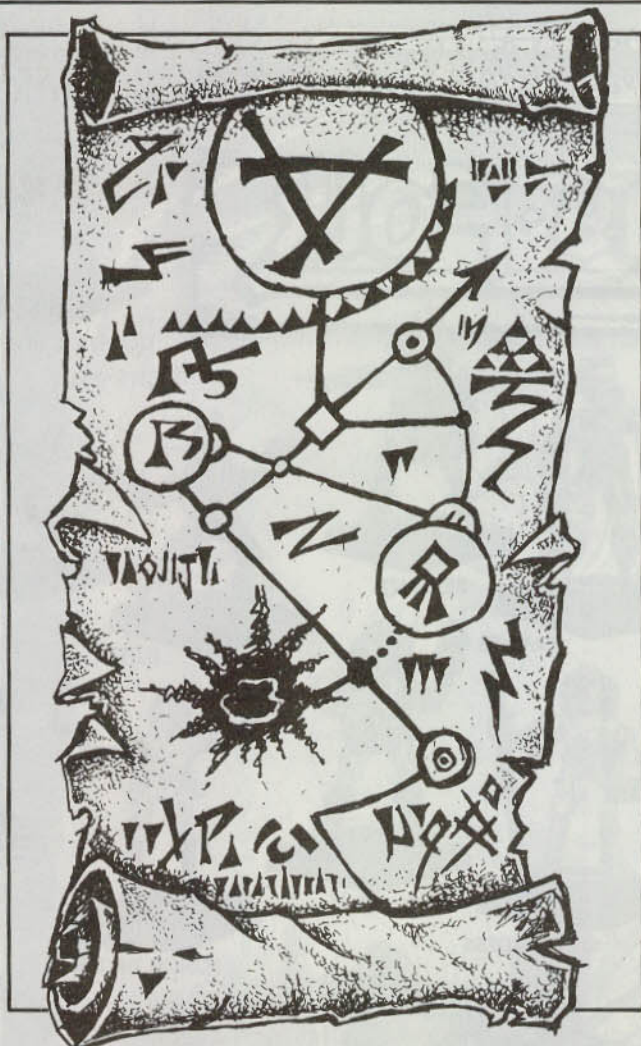

TIGRATI 'HEAD' PARVISCH

M	WS	BS	S	T	W	I	A	Dex	Ld	Int	Cl	WP	Fel
4	33	32	4	4*	6	29	1	37	26	22	25	36	22

**Skills:** Immunity to Disease, Immunity to Poison, Palm Object, Silent Move Urban, Very Resilient (\*).

**Trappings:** Club, Ring of heavy keys, Fleas

Tigrati's room is crudely furnished with a makeshift table and chair, a bottle of cheap Estalian wine standing on the former. The cells are rat-infested hell holes with damp straw on the floor and not even a bed to sit or sleep on. They are poorly illuminated too, the only light coming from a single lantern in the corridor.

**7. Junction.** The north-running passageway from the guard room splits into two at this point. Standing at the junction, in the positions marked on the map, are two brown-furred Skaven sentries. Humans are only allowed past them if they have been sent for by Skrethth, so again, the players will either have to *Bluff* or fight their way past them. However, yet again, fighting will only serve to alert Skrethth if he is in his chamber.

If profiles for the guards are required, use the same profile for the Skaven patrol listed earlier.

**8. Shrine.** Skrethth turned this chamber from a rough-hewn cave into a shrine for worship of the Horned Rat. It consists of an altar flanked on either side by two large (8' tall) statues representing the Horned Rat (these are crudely sculpted and may not be recognisable for what they represent). A large representation of his symbol - the three bones forming the inverted triangle in the middle - has also been chiselled into the rock wall opposite the altar. The roof is supported by four plain stone columns, and there is a small pit in the altar where any offerings to the deity are thrown by his worshippers. This pit is natural - a narrow shaft about 3' in diameter

which disappears downwards out of sight, and is effectively bottomless.

**9. Skrethth's Chamber.** Two brown-furred Skaven guards profile as above except knives are also envenomed with Black Lotus guard the entrance. Unless the PCs arrive during the ritual the victim will be Klauss Drast), Skrethth will be here. The contents of the room are scattered all across the floor. Skrethth's mental health has deteriorated through his addiction to Black Lotus and the failure of his experiments. He spends more and more time in the room from the rest of the group in 'thinkthink time'. The only contents of the room are some foodstuffs, a jar of Black Lotus leaves, and a shield.

## SKRETHTH

Skrethth leads the small band of renegade Skaven in a search for power. His leadership is unquestioned but his drug-taking habits have led to increasing paranoia concerning his position. He is now plagued with self-doubt. If sacrificing Klauss fails, he intends to quieten the scene.

His most powerful possession (indeed, the only one of note) is a ring that he 'obtained' from his old necromantic colleague. It is a spell ring for which Skrethth knows the trigger word. With it, he can cast *Summon Skeletons* (WFRP p176) twice. After the ring will have run out of magic points. If his life is in danger, he will use the ring on the corpses in the Sacrificial Chamber. They will be animated as *Zombies* (WFRP p251) and will be ordered to attack anyone representing a threat (ie: the characters). Skrethth will try and make his escape while the group are engaged in eliminating the Zombies.

SKRETHTH, SKAVEN LEADER

M	WS	BS	S	T	W	I	A	Dex	Ld	Int	Cl	WP	Fel
5	43	25	3	3	6	40	1	24	34	34	18	28	28



# ELF CAVALRY

DOLFAR  
SILVERHELM



LAEVAS  
SKYHELM



LINTHIN  
GREENWOOD



TORUVIEL  
LONGSTRIDE



IMRANDEL  
STARBRIGHT



AESINAL  
FARSIGHT



ERRDIL  
FLAMEYE



CLAGRAN  
BRIGHTHAND



FILAVANDEL  
COPPERHEAD



EDRIAN  
FLEETFOOT



GALARR  
REDLANCE



MALRIEL  
WINDSWORD



FANCORAN  
PROUDBROW



HALANEL  
GOLDMANE



IOANDAR  
DARKBROW



GILAREL  
LIGHTHORSE



**ELF6 CAVALRY £2.50 for 1 Horse, Rider & Infantry (+ bases & plastic spear)**

**CITADEL**  
MINIATURES

Available from all good games and hobby stockists, or in case of difficulty direct from: Citadel Miniatures, Chewton Street, Hilltop, Eastwood, Nottingham, NG16 3HY. US customers contact: Games Workshop US, 1220 Key Highway, Baltimore, Maryland, 21230. Please note Postage and Packing charges when ordering direct - UK, BFPO & Eire: Minimum order £10.00, add £1.00 P&P. Overseas: Minimum order £10.00, add 33% P&P. Overseas Airmail: Minimum order £10.00, add 40% P&P.



For Access and Visa orders, ring the mail order hotlines on (0773) 713213/760462

All Figures Painted By Citadel Figure Painters • Miniatures Supplied Unpainted • Designed by Jes Goodwin  
Copyright ©1988 Games Workshop Ltd. All Rights Reserved.

**WARNING!** This product contains lead which may be harmful if chewed or swallowed. Citadel Miniatures are not recommended for children under 12 years of age

# THE RITUAL

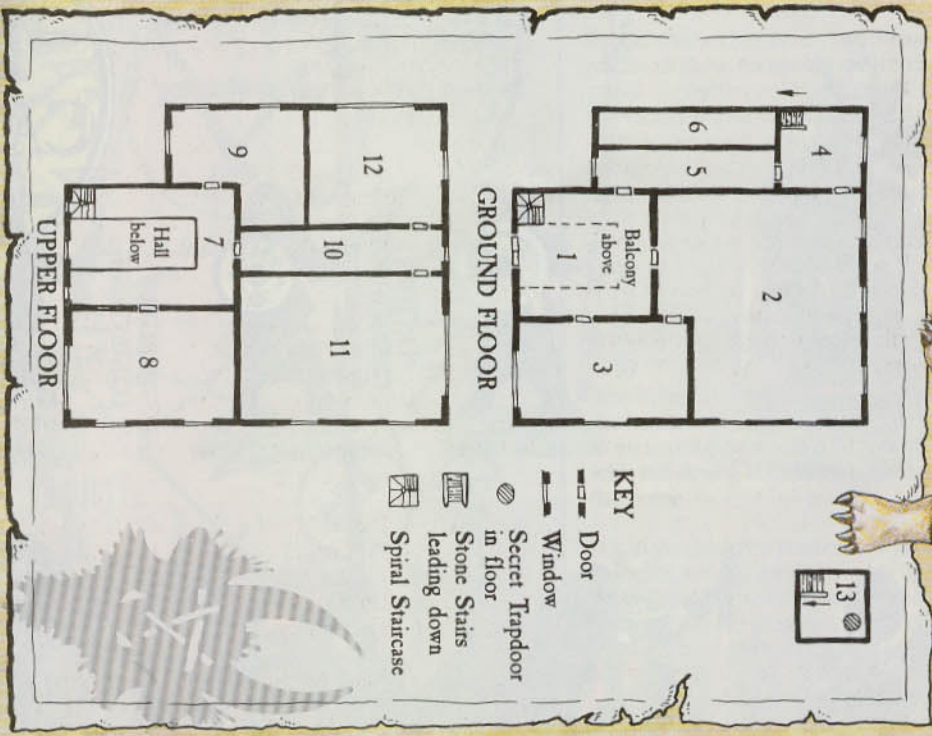

- KEY**
- Door
  - Window
  - Secret Tapdoor in floor
  - Stone Stairs leading down
  - Spiral Staircase

# THE HOUSE

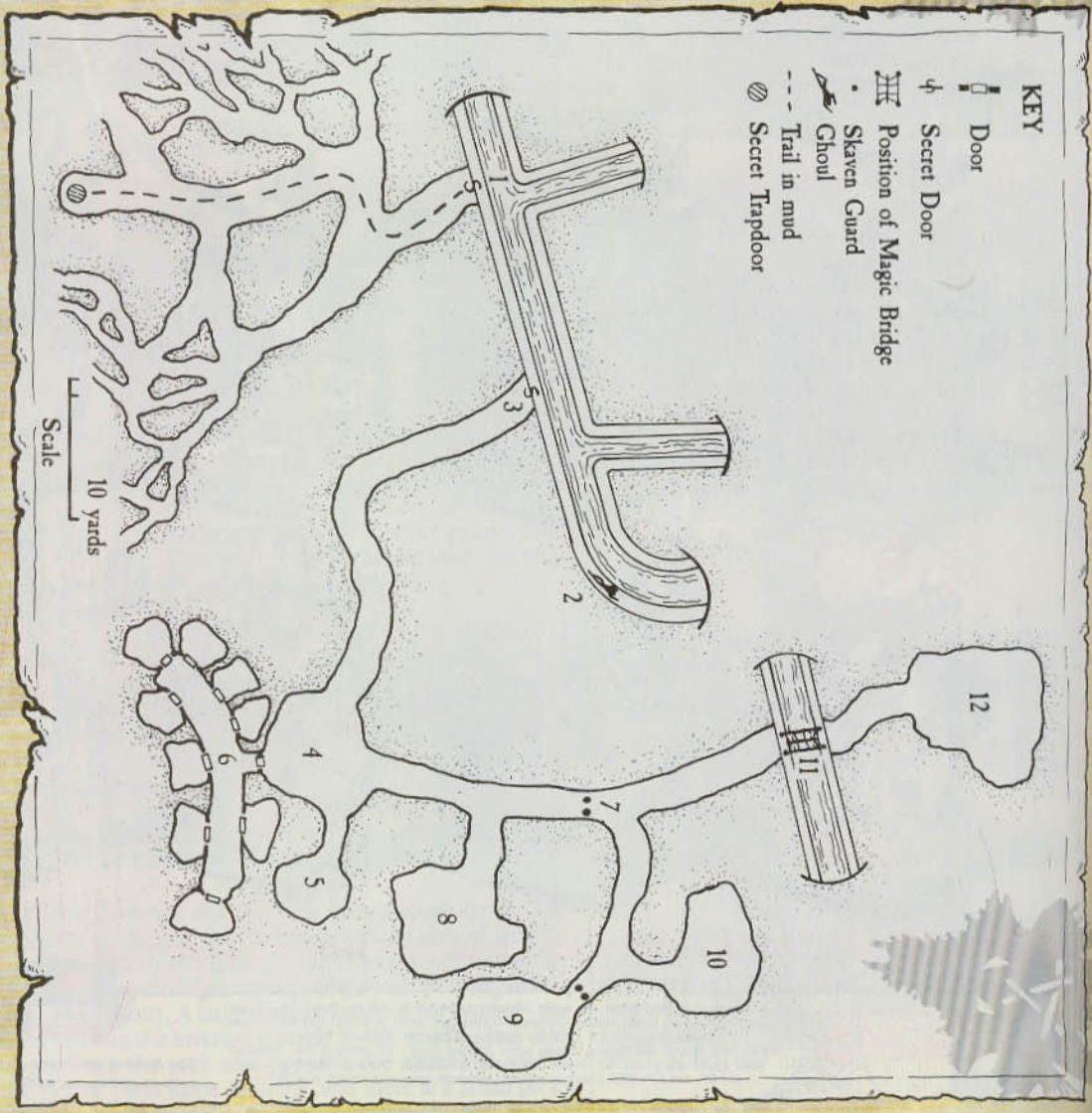

- KEY**
- Door
  - Secret Door
  - III Position of Magic Bridge
  - Skaven Guard
  - ☠ Ghoul
  - Trail in mud
  - Secret Tapdoor

# THE SEWERS





Notes: Insane. Skrethth suffers from *Dementia* and *Drug Addiction* (WFRP pp84-85).

10. **Robing Chamber.** Skrethth uses this room to prepare himself for the rituals. Two robes hang from pegs which have been driven into the stone walls. One is black with red lining. This is the robe worn by Skrethth when he conducts his futile warpstone extraction ritual. The other is white, torn and bloodstained. Victims are dressed in this just prior to the ceremony. A sacrificial dagger is left on a natural shelf in the cave wall (unless a ceremony is underway).

11. **End Of The Tunnel.** The tunnel ends at this point, dropping away to the sewer roughly 7 yards below. A rope bridge spans the chasm, ending in another tunnel mouth which leads away into the darkness. A rough staircase has been carved into the rock on the southern side of the gap, to allow the Skaven to get into the sewer system by their own route (they prefer to avoid contact with the humans whenever they can).

12. **The Sacrificial Chamber.** This huge natural cavern is dominated by a carving of the visage of the Horned Rat that has been chiselled out of the stone in the north wall. At the northern end of the cavern is a solid granite, bloodstained block with an iron ring set into it. The southern portion of the chamber is bare, except for two pillars supporting the entrance from the tunnel. This is where all the Skaven attending the ritual assemble. Torches in wall brackets provide illumination.

When everyone is in place (all the Skaven attend rituals), Skrethth stands at the head of the block and leads the group into a chant (a noise so loud it can be heard as far away as room 3). This lasts for about a minute, increasing in volume and speed until the Skaven are worked up into a frenzy. Victims are killed at this point. Immediately afterwards, the Skaven fall into silence, waiting for something (they're not quite sure what) to happen. Invariably, it doesn't, and the body is dragged away to a corner (the six most recent victims of Skrethth's horrific rituals still lie here).

If the adventurers arrive at the chamber before the ritual has begun (at midnight), Klausss will be bound to the block by a piece of rope tied around his wrists at one end, and to the ring at the other. He will be dressed only in the white robe from room 10, and too exhausted to cry for help. He will be unguarded.

If the PCs have to interrupt a ritual to save Klausss, they are likely to find the odds set against them. First of all, there may be as many as a dozen Skaven in the cavern, more than enough to overpower the characters. If the party have to deal with half a dozen Zombies (and possibly pursuing cultists) as well, they face certain defeat.

Unless... Remember the bombs? Exactly how the PCs use these devices is up to them to figure out and you to adjudicate. They could end up killing everything and everyone in the cavern, including themselves. At the very least, sensible characters should be able to use the explosive devices to aid their retreat if they find themselves outclassed.

**CAPTURED!**

At some point during the adventure, the PCs may be captured by either Poison Claw cultists or Skaven. In either case, they will be stripped of their possessions (which will be put in the westernmost cell of room 6) and tossed into different cells until Skrethth is ready to use them as ingredients in his latest experiments.

Characters will be allowed to shout to each other from their cells and the players may use this opportunity to discuss a number of wild and unlikely escape plans. However, as the jailer is dim-witted to the extreme, all they have to do is think up a *remotely* convincing story (and the *Bluff* test is made at a +30%) and Tigrati will simply open the doors and let them out (smiling, grunting and salivating in the process). After getting him to unlock the door, a swift grab for his keys and well-placed kick could leave him in the cell and the character outside with the keys. It is then an easy matter for the PC to unlock the doors of the cells holding his comrades. If the players come up with another idea, use your common sense to judge whether it works or not, and proceed as normal.

**CONCLUSION**

This is a fairly difficult adventure for the players to complete with total success - and the EP awards to the players should reflect that fact. A base 30 EPs should be awarded to each player for role-playing, modified at your discretion. In addition, each player should gain 20 EPs if they managed to rescue Klausss, and a further 30 EPs if they managed to eliminate the Skaven threat one way or another. Successfully escaping with Klausss will also bring them further rewards. He will be immensely grateful to the party, paying 80 Crowns to each character as a reward (should the adventurers *Haggle*, Klausss will go no higher than 100GC per person, and he will take offence they refuse his offer).

If the characters are careful and sensible, you should make sure they reach Klausss before the ceremony is due to take place. This gives them a reasonable opportunity to get him out safely. Remember that Skrethth is an incoherent maniac who could be a far more powerful adversary were it not for his weakness (Black Lotus). If the party rush blindly into combat in every encounter, they deserve to find the going very tough indeed.

If the adventure is successfully completed, the characters can proceed to Altdorf (see *TEW*) or wherever your own campaign may lead them. They should not be encouraged to get sidetracked by another expedition to the tunnels - all those explosions are bound to result in considerable structural damage...

Escaping Skaven need not be a problem. If they retreat into the tunnels, they will never bother the characters again (Skrethth is effectively finished anyway). If they actually manage to reach the streets of Delberz, the Watch will be able to take care of them. The Poison Claw cultists, should any of them escape, are likely to either disband, or flee the town. They were only a small outfit and have no contacts to help them re-organise in Delberz. At best, they will seek to join similar groups elsewhere in the Empire.

Failure has no future, though - for anybody.

Phillip Wells



ILLUSTRATED BY TONY HOUGH AND JES GOODWIN



## INTRODUCTION

In the year 963 of the current millennium, Space Marine chapter 'Fire Hawks' was ordered into the Crows World sub-sector. Crows World and adjacent planetary systems had fallen into anarchy following heavy raiding by Eldar Pirates. The 'Fire Hawks' intervention would drive the Eldar from the human worlds, restoring Imperial rule and teaching the alien invaders an important lesson. The entire chapter-fleet, including the chapter's mobile space-fortress, made a successful warp jump from the Piraeus system a mere 120 light years from Crows World. The five ships, over eight hundred brethren, and two thousand other personnel expected to reach Crows World within no more than 12 hours. They never arrived. Twenty years after the event the chapter was officially declared *lost in the warp* and presumed destroyed. The great Bell of Lost Souls tolled a thousand times, and it said that the Emperor himself ordered a Black Candle to be lit in the Adeptus Chapel of Fallen Heroes.

On 9667986.M41 a routine Imperial patrol passed through the Ork held system of Jakor-tal. The squadron uncovered altogether unexpected scenes of devastation. The limited facilities available to the patrol could uncover no clue to the identity of the attacking forces. The incident was noted and passed into the everlasting record of the Administratum.

A rash of similar incidents within the same and adjoining sectors soon began to arouse the interest of the Inquisition. Squadron commanders throughout these sectors were reinforced and ordered to double their routine patrols. The incidents continued apace, increasing rather than declining in frequency and destructiveness. Even so, no sign of the intruders was discovered for almost a year. Then, on 3628987.M41, a patrol ship in the Maran sub-sector narrowly avoided a collision with a space-craft at the Cift jump-point. The patrol ship was entering the Cift system as the unidentified craft was leaving. Alerted by the close encounter, the patrol crew scanned the entire jump-area and discovered two long cylindrical objects within the intruder's projected flight-path. These were hauled aboard and proved to be standard space-coffins without identification markings.

The coffins were shipped back to earth and opened by the Adeptus Mechanicus. The coffins themselves were identified as belonging to the *Absolute*, one of the spacecraft from the vanished Fire Hawk fleet. Inside were the armoured remains of two Space Marines. The unconventional armour colours and unofficial insignia puzzled the investigators, but serial numbers tallied with equipment made by or issued to the Fire Hawks. The armoured suits were expected to house members of the lost chapter, and were carefully broken open. The bodies within were human, but further identification proved impossible due to their advanced state of decay.

The full truth would not emerge until almost a year later when a besieged Imperial research station received unexpected help. The garrison had been attacked suddenly by Ork pirates. After three hours of fighting the situation looked hopeless. Then, without warning, the Orks found themselves attacked in the rear. The ferocity of the fighting appalled even the station's defenders. Within half an hour, several hundred Orks had fallen to the mysterious, power-armoured figures. Then, as suddenly as they had appeared, the warriors vanished. This time they left behind a banner - the gnarled chapter flag of the Fire Hawks - and inscribed upon it was the motto *In dedicato imperatum ultra articulo mortis* (For the Emperor beyond the point of death). As well as the banner there was a recorder and sundry other sealed items. These were immediately shipped to Earth.

From the data contained in the recorder the Administratum was able to determine exactly what had happened to the lost chapter. Following their warp-jump the entire fleet had been caught within a warp-storm of terrific intensity. Stunned by the power of the warp, the chapter was forced to endure the attacks of powerful warp entities. Ship after ship was destroyed and absorbed into the fabric of the warp. Soon only one craft remained. By a daring warp-exit manoeuvre the craft burst



LEGION OF THE  
IDAMNED

out of warp-space, emerging far in the galactic east, thousands of light years off-course and beyond even the psychic light of the Emperor.

The original survivors numbered two hundred brethren. All gene-seed had been lost, all initiates killed, and most of the chapter's masters were gone. None of the ordinary human staff have survived at all. To make matters worse the brethren had *changed*. This change became more obvious over the next few months. Skins began to blacken and blister, flesh began to fester and putrify. Slowly they began to die. Within days of the transition into normal space it became obvious that the chapter had been exposed to some form of dangerous mutation or disease. It took many years to navigate a way back into the Imperium, during which time almost half the brethren succumbed to the malady. Those who remained were no longer sane. Pain and despair had driven even their hardened minds beyond the point of rationality. Doomed to agonising deaths, they gradually became obsessed with their fate. Now they only wanted to die. But they were still marines, still loyal to the Emperor and humanity. They would not die without purpose.

So began the unstoppable war of the Legion of the Damned! The marines elected to remove all insignia from their armour. Instead their armour would be black, decorated by each brother with whatever emblems of death he chose (the accompanying illustrations show some typical variations). Most brothers employed a similar theme - skeletons, bones and skulls.

All ranks and companies were abolished, most of the chapter's officers were already dead and the remaining warriors were too few to make up a fully functional chapter hierarchy. All brothers were to be equal before death - levelled by the certainty of their assured extinction. The warriors decided to expend their lives attacking enemies wherever they could be found. The disease had robbed them of their sanity, but not their loyalty! And their condition gave them powers - powers that endow them with incredible fighting abilities.



## GAMING WITH THE LEGION OF THE DAMNED

The rules that follow reflect the unique nature of the Legion of the Damned. The legion is not a part of any Imperial force, and employs an unusual *modus operandi*. Apart from driving them insane, the contagion heightens their psychic awareness considerably. One result of this is the way in which the legion selects and attacks its targets. These matters are left entirely to the process of divination provided by the mystic *Tarot of the Emperor*. This tarot is supposedly bound within the psychic will of the Emperor and is used throughout the Imperium as both a pastime and a form of divination. It is an undeniable fact that attacks always seem to fall in 'the right place at the right time'. The Legion of the Damned certainly believe themselves to be directed by the Emperor - and who is to argue!



# LEGION OF THE DAMNED INSIGNIA



BERSERKER



BORN TO DIE

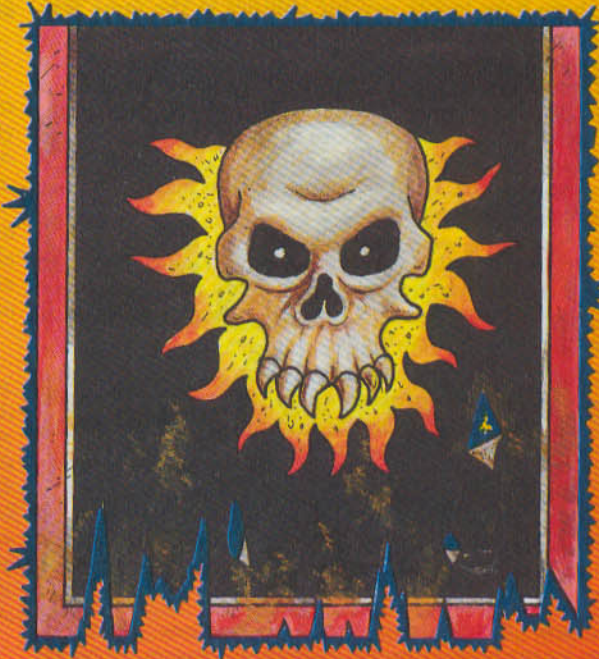

INSIGNIA BY DAVID ANDREWS AND COLIN DIXON



IN DEDICATO IMPERATUM ULTRA ARTICULO MORTIS

MINIATURES PAINTED BY MIKE MCVEY AND DAVID ANDREWS



As the fatal malady takes a firm hold, the victim begins to degenerate and putrify. However, even as his body decays, he grows in supernatural vigour. Even though the marine's limbs become rotten and twisted he gains strength far beyond that of a normal marine. These powers heighten as the disease rages through the victim's body. At the moment of death, each brother reaches a peak in power, at which point the raw energies of the warp transmute the death throes of the doomed marine into a berserk orgy of destruction. These changes are reflected by the profile and special rules given later. Make no mistake - the Legion of the Damned may be few in numbers, but their powers are awesome!

Just as their bodies are changed by contact with the warp, so their minds are hardened too. Brethren are completely immune to all forms of psychic attack or interference. They cannot be affected by the special psychic attacks of warp-creatures - although they may be harmed physically by physical attacks that such creatures may have. Astral spectres and other immaterial creatures cannot harm them in any way.

The brethren have innate psychic abilities in the same way as a normal psyker. These are *psychic sense* and *psychic awareness* as described on p48 of the rule book. These abilities enable them to seek out psychic foes and destroy them. In addition, the pall of death around each marine is so strong, it is manifested as an *aura of doom*. This affects any creature within 6" of the model, reducing all firing and combat dice rolls by -1, and adding +1 to all *rout* tests (thus making it more likely an enemy unit will rout).

Such is their resolve that the Legion of the Damned cannot be affected by any psychological test. They never take *rout* tests and so cannot be routed. Weapons causing psychological effects are useless against them.

## ORGANISATION

The Legion has no formal organisation - it fights as a single body of troops on the tabletop. Each model must remain within 2" of at least one other model at all times. The whole force is, in effect, one big unit! The only tactic possible to such a formation is to steam-roller over the enemy by a steady advance.

Facing death - the final equalizer - the marines' command decisions are made by collective divination. Devices, emblems and personal badges are applied over the armour by individuals; they are not indicative of rank or function.

### Profile

M	WS	BS	S	T	W	I	A	Ld	Int	CI	WP
4	5	5	4	4	1	6	3	10	10	10	10

The most notable aspects of the Legion brethren's profile are the disease enhanced characteristic values. Both *WS* and *BS* are boosted to heroic levels, whilst *I* and *A* are sufficient to ensure they win almost any hand-to-hand combat. The psychological values are given as 10, but these are not used because troops are immune to psychology and routing. They have been included anyway and may need to be used occasionally - for example to establish technical level accomplishment.

## EQUIPMENT

The vast stocks of weaponry available to the Fire Hawks were destroyed along with the rest of the fleet. The surviving brothers have only a limited range of weapons, and most are armed identically as shown below. Powered armour and weapons are of standard type.

Power Armour  
Bolt Gun with combat accessory  
Knife  
Bolt pistol

1 in every full 10 models fielded may substitute the main bolter armament for either a missile launcher firing crack and frag shells, or a plasma gun.

## BERSERK DEATH SPASM

The marines are rapidly approaching the moment when they will be claimed by the warp contagion. No-one knows when this be. The rigours of combat tend to initiate the final stages of the disease, warping more and more raw energy into the marine during his final moments.

This is represented by a test made for each marine model everytime it charges into hand-to-hand combat. The controlling player should roll a D6. If the score is a 6 the moment has finally come. The marine enters a berserk death spasm culminating in his automatic demise at the end of the hand-to-hand combat phase. However, until the end of hand-to-hand combat the following rules apply.

- 1 The model may double its speed. It may charge up to four times its movement allowance rather than the normal two times. This gives a charge of 16". As soon as the model charges it is treated as an independent model and is not bound to remain within 2" of another marine.
- 2 The model enters hand-to-hand combat and fights as normal except that it doubles the number of *attacks* to 6. Its *strength* is increased from 5 to 8 for the duration of hand-to-hand combat.
- 3 If the model wins the round of hand-to-hand combat and is left facing no foes, it may immediately charge another foe within 4". This is an exception to the normal move sequence. Another round of hand-to-hand combat is initiated upon contact. Due to the warp-frenzied state of the attacker, the target is not permitted to run-away or stand-and-fire. This extra round of combat is adjudicated immediately.
- 4 Following a second round of hand-to-hand combat as described above, a model may initiate further hand-to-hand combat in the same way. So long as the marine destroys all of his opponents in each round, the model may continue charging new foes. The only limitation is that the marine may not charge more than 4" at a time.
- 5 Once the berserker marine has completed his spasm of destruction the model is removed as dead. The normal turn sequence is resumed.

## POINTS VALUE

Due to their array of special powers it is very difficult to give a completely fair points value. Powers which are useless against one foe might be pivotal in defeating another. No points have therefore been allowed for these factors. It is assumed that the limited range of equipment and the restriction of operating as a single unit compensates for this. The points costs have been taken from the modified list given in *The Book of the Astronomican* - the only difference with the printed rule-book is the increase in the cost of crack shells from 4 to 20.

Points value. Basic Marine including standard weapons: 73

Extra to substitute bolter for missile launcher + shells: 49

Extra to substitute bolter for plasma gun: 3½

Rick Priestley

# WARHAMMER

PROGUE 40,000 TRADER

## AMBULL



FULL GAMING RULES CAN BE FOUND ON PAGE 64



SLAVE

RT602  
£2.50

DESIGNED BY MICHAEL PERRY

## VINCENT BLACK SHADOW

BIKE AND SIDECAR SUPPLIED RIDERLESS. DESIGNED TO FIT PLASTIC SPACE MARINES



RT106  
£2.50

DESIGNED BY ALAN PERRY

# IMPERIAL SPACE



**BROTHER WARD**  
(BOLT PISTOL)



**BROTHER WEST**  
(BOLTER/  
COMBAT BLADE)



**BROTHER GORSHIN**  
(NEEDLE GUN)



**BROTHER MEREDITH**  
(BOLTER)



**CAPTAIN ROMERO**  
(BOLTER/  
CHAINWORD)



**BROTHER KITT**  
(POWERFAZE)



**BROTHER HAMILTON**  
(BOLTER)



**BROTHER REPP**  
(MELTA-GUN)



**BROTHER BLAKE**  
(AUTOGUN)



**BROTHER CRAIG**  
(BOLTER)



**CAPTAIN NEWMAR**  
(BOLT PISTOL)



**BROTHER NAPIER**  
(BOLT PISTOL/  
POWER FIST)



**BROTHER BASEHART**  
(POWERFAZE)



**BROTHER HARRIS**  
(BOLTER)



**BROTHER REEVES**  
(BOLTER)



**CAPTAIN CRABB**  
(BOLT PISTOL/  
HAND FLAMER)



**CAPTAIN DOZIER**  
(POWER FIST/  
CHAINWORD)



**WOUNDED MARINE**



RT101  
£2.50  
FOR 3

# MARINES

DESIGNED BY ALY MORRISON AND MARK COPPLESTONE

**CITADEL**  
MINIATURES

Available from all good games and hobby stockists, or in case of difficulty direct from: Citadel Miniatures, Chewton Street, Hilltop, Eastwood, Nottingham, NG16 3HY. US customers contact: Games Workshop US, 1220 Key Highway, Baltimore, Maryland, 21230. Please note Postage and Packing charges when ordering direct - UK, BIFFO & Eire: Minimum order £5.00, add £1.00 P&P. Orders over £15.00 POST FREE. Overseas: Minimum order £10.00, add 33% P&P. Overseas Airmail: Minimum order £10.00, add 40% P&P.



For Access and Visa orders, ring the mail order hotlines on (0773) 713213/760462

All Figures Painted By Citadel Figure Painters • Miniatures Supplied Unpainted

Copyright ©1988 Games Workshop Ltd. All Rights Reserved.

WARNING! This product contains lead which may be harmful if chewed or swallowed. Citadel Miniatures are not recommended for children under 12 years of age.

# EAVY METAL

As promised, this month we're giving you a step-by-step guide to painting a typical miniature to show you the kind of results almost anybody can achieve - the famous (or is that notorious?) GW look. If you have never attempted miniature painting before, and you follow this guide, we think you'll be pleasantly surprised by your own efforts. On the other hand, if you have been following recent 'Eavy Metals but have nevertheless experienced problems when trying to apply the techniques described, here is the ideal opportunity to pinpoint where you're going wrong and see the error of your ways...



There are a variety of ways to undercoat a figure. The simplest method is to use a diluted mixture of Citadel white. It doesn't want to be so thick that it obliterates any detail, and it shouldn't be so thin that the paint shrinks on the surface of the model or fails to provide a clear white surface.

Remember that white makes the figure cleaner and brighter looking and provides a good surface to actually paint on. Enamel white or black undercoats provide alternatives but they will invariably make your task more difficult - just take our word for it for now. Acrylic white is the way to go! Make sure that the paint is applied evenly across the whole of the figure. Blobs or puddles of paint should be avoided at all costs (if extra paint does build up on the model, use an old brush to clean it up before the coat has a chance to dry).

Now for some fun. Slowly and carefully, apply base colours. A thin wash (paint diluted a little with water) of black to the mail, sword and helmet. Allow this to dry.

## STEP BY STEP...

You can apply the following treatment to any figure you like. We chose this Dwarf because it provided the opportunity to show you a variety of textures; metal, hair, flesh and cloth.

So give this guide a try and don't be afraid to start again if you feel unhappy with the results. You need to build up experience to fully understand why the techniques work the way they do. Once you get the knack, you won't want to stop. You could even leave some of the later stages out until you're more familiar with the basics. You may even decide to experiment with a couple of the stages on older figures - drybrushing and face painting, for example. This provides a good way of honing your skills. From the letters that arrive in the *Blanchitsu* pigeonhole, many of you seem to want to paint to the standard you see in *White Dwarf* the minute you start collecting. But even the most talented figure painters have to train themselves first. So don't be put off. Patience and perseverance will yield astonishing results sooner than you might think!

You need two small brushes (see photo), and one larger, older brush, your Citadel paints, a tube of superglue, a modelling knife, a jar of water, an old rag, a palette and some matt (or gloss) varnish. Wherever you decide to construct and paint your miniature, make sure it's not on an

unprotected piece of good furniture, such as a dining room table. The last thing we want to see is a claim from distraught mother, wife (husband!) invoicing us for a new table. Right then - off we go.

Clean the figure up with a sharp modelling knife (blunt blades are dangerous). Pay particular attention to small bits of flash and mould lines. The quality of Citadel miniatures is such that this process is minimal. The Dwarf used here was chosen randomly from stock, and only the helmet showed a thin mould line. Drawing the blade firmly over the line smooths the surface quickly and easily. The sword edges can be shaved down to give a clean, sharp line as well. This isn't actually necessary (there was no fault in the casting), but blades have to be made fairly thick to accommodate the casting process. Shaving the blade makes it look that little bit more authentic.

Next, cut out the slot on the rear of the plastic base so the figure faces directly to the front. It makes for a better position if the figure is going to be part of a regiment (but the choice is yours). Leave the shield for now. We'll come back to that later. Fit the figure into the slot. Then, holding the miniature upside down, squeeze a little super glue into the underside of the slot. Lay the figure down for 10 minutes while the glue dries (don't leave the thing standing upright or you may find the figure gets stuck to your work surface).

Paint flesh on the hands and face next. Then, paint a mixture of orange and yellow/Spearstaff brown to the boots. These will end up tan brown. Now paint the tunic orange. This is, in fact, going

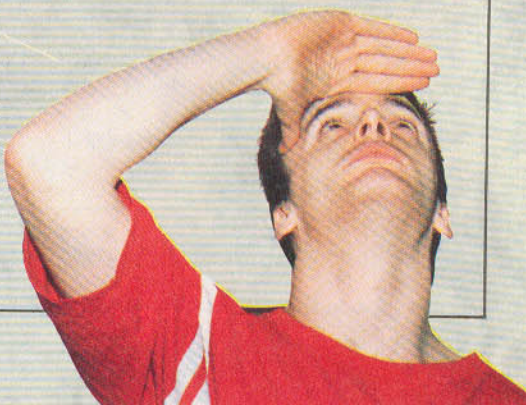



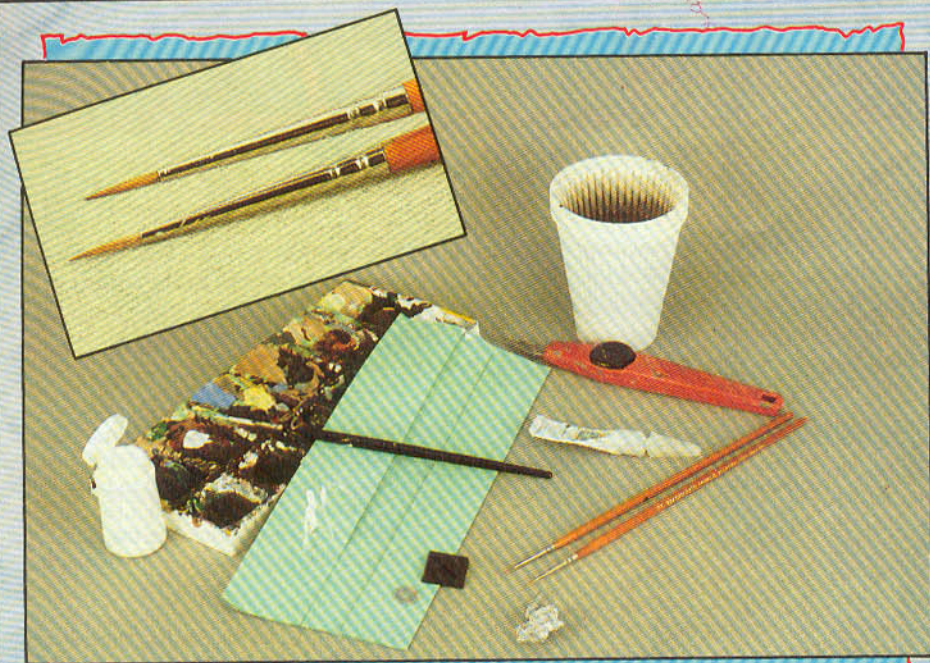

to end up red. Don't be concerned if the orange is a little thin.

Now we have the largest areas of the figure covered, it's time for a little shading and highlighting. First, we're going to give the black metal areas a burnished steel effect. Load a small quantity of silver paint onto the tip of the old brush tip. Gently rub most of this off against the rag. Then quickly draw the bristles across the black paint so that some of the remaining silver paint adheres to the area. Gradually repeat this process until you have the desired effect. You'll notice that some of the black remains. Dot in helmet rivets with silver. If you have been wondering what drybrushing is all about, that was it!

Now mix some red paint with water so that the solution is quite thin. Using the good brush, cover the tunic with the mix. Be careful not to let the paint flow onto any other areas you have already painted. Notice how the thin paint settles in the folds and recesses, and the orange paint shows through the raised areas, creating a highlight. Some of you may want to leave the tunic as it is at this stage. Make a similar wash of Bestial brown and paint this over the boots and flesh areas.

Right, now let's put some colour onto the hair and beard. Apply a base colour of Spearstaff brown. The sword handle and pommel are painted gold. A mix of red and Bestial brown

is applied as a wash over the hair and beard, and to the belt and pouch.



By adding white to these colours, you can carefully paint in highlights on the top part of the belt, the boot toe-caps and face. The nose can be finished off with an extra, fine line of white. The mix of white and Spearstaff brown can be used to highlight the hair and beard, drawing the brush lightly across the flow of the hair sideways.

To bring out those raised folds on the tunic, use a tiny amount of orange/Spearstaff brown mix to touch up the highest areas. Notice that white isn't used to highlight the tunic. This would only make the thing look pink, which isn't the effect we want. This is painted carefully. It isn't blended as such, but as the colours graduate upwards towards the final highlight, it looks blended anyway. Note that these smooth areas are not drybrushed. Drybrushing is quick and effective if you're painting the figure as part of a wargames army, but more subtle use of the brush results in a cleaner figure. Save drybrushing for when you want to paint a textured surface.

Next, add a little silver to the belt buckle. Then use a mix of black and Bestial brown to shadow the eye sockets. Oops! Notice that the right eye was painted wrongly. It looks a little lower than its counterpart. It could be re-painted but - well.

So far so good. It's starting to look a bit of a mess though, isn't it? This is the stage that seems to be putting some of you off. You get all this way, following the guidelines - and your figure still looks tatty! But don't worry. This is a stage that all figures go through. So let's start cleaning it up.

Take the fine brush and load it with flesh. Paint the raised flesh areas again. Leave the gaps between the fingers, the recesses underneath (and on each side of) the nose, the eye sockets and the edge of the face. Next, with Spearstaff brown, do the same to the beard, hair, belt, pouch and boots, but this time, use a careful combination of painting and drybrushing. Painting follows the line of the model, whereas drybrushing runs across it.



## HEAVY METAL

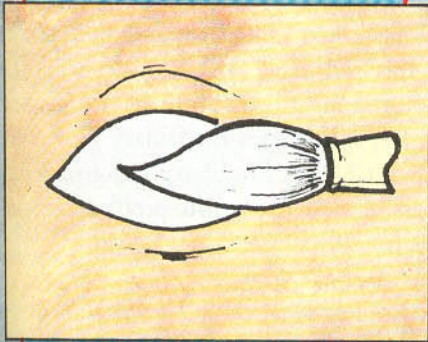

it actually adds character to our weather-beaten warrior. So it stays.

Very carefully, add the whites of the eyes. Use the angled tip of the fine brush to make the eye shape (see diagram). If you're right handed, the right eye can be painted fairly easily. Turn the figure upside down to paint the left one (reverse the process if you're left handed).

By the way, always hold the figure by the base (picking it up gently by the sword).

Adding the pupils is tricky, but with a little patience, a steady hand and some thinned black paint, anybody can do it. Just use the very tip of the brush, slightly angled (see diagram). If you slip, it won't take too long to retouch the area and try again. Anyway, practise makes perfect.

Mix some red and black to produce a very 'reddy-brown' - not too thick - and line all the edges, ie: helmet rim against hair and face, under the nose, the edge of the beard, tunic bottom and arm edges, belt edge, buckle, sword handle and hilt joint to sword, pouch, mail sleeve edge and shield boss.

Now, while holding the figure by the sword, paint

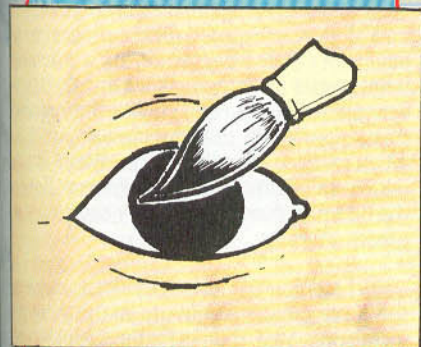

the base black. Looks good now, dunnit!

Let's take a look at the shield. Push the shield onto a matchstick so you can hold it. Paint the back and the rim of the shield black, then paint the centre white. What about the pattern then? Well, you could use transfers (*Arcane Armoriales*), or a pictorial design would look pretty spectacular. However, as this article is about minimal expenditure, time and expertise, the best answer is a geometric pattern painted in a colour which contrasts with the rest of the figure.

Being unashamedly derivative, the pattern you see here is stolen from the Bayeux Tapestry - it just looks suitable for a Dwarf. It's painted in green, with a small dab of green/white mix for



the highlights. Drybrush the black rim with silver, making sure to pick out the rivets around the edge. Superglue the shield to the boss and, when the glue is dry, pick out the boss in silver.

Using a matchstick, coat the base with superglue and sprinkle sand, flock or soil over the top (flock was used on this figure). Leave it to dry. Then make a green wash and flood the top of the base. Again, leave it to dry before highlighting it with Spearstaff brown.

When it's all dry, varnish to taste. Da, dah! Finito! Celebrations all round. Feast and merriment. Jump up and down a lot. Invested time? A couple of hours and use of a hair drier (to persuade the paint to dry more quickly).

Isn't the result worth it?

*John Blanche and Sean Masterson*

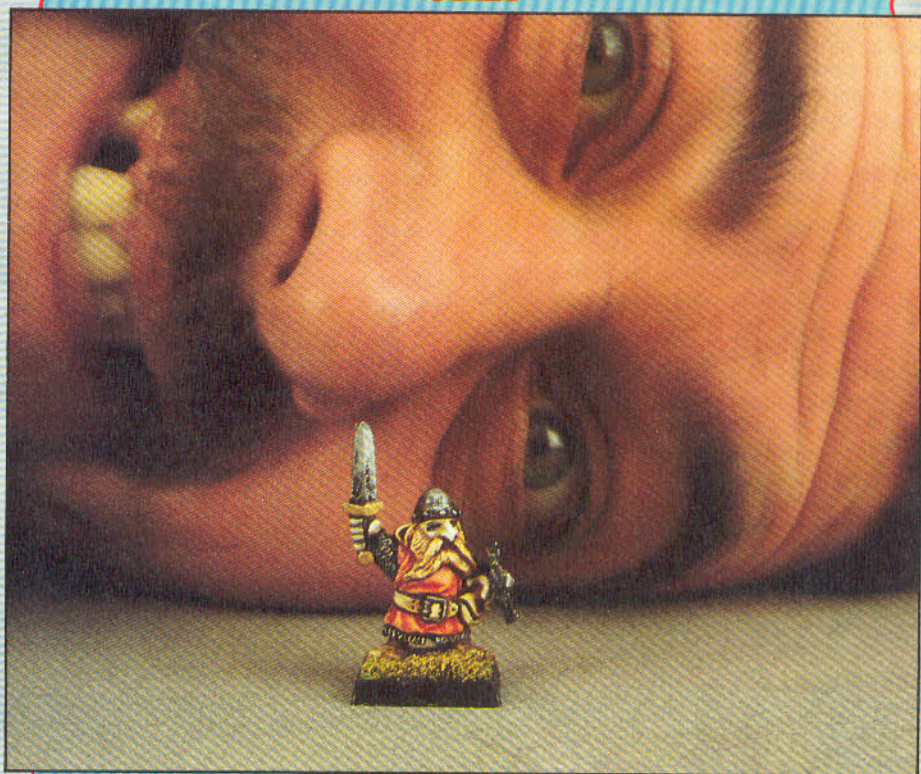
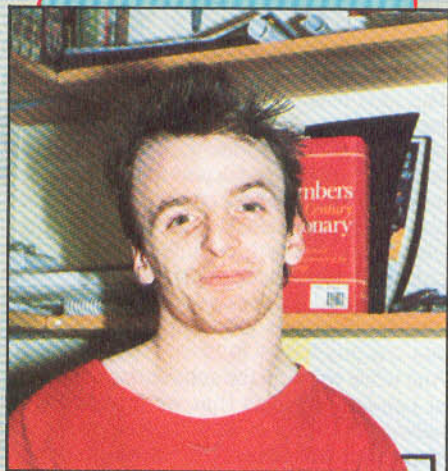



Welcome one and all to *White Dwarf's* forum for miniatures painters. The difference between this and *Eavy Metal* is that while EM will continue to explore new avenues, techniques and subjects for the fantasy gamers who wish to bring colour to their tabletop, *Blanchitsu* will give you the opportunity to ask us questions about specific problems, suggest new techniques that you have discovered, and so on.

The number of such letters now received at the Studio, prevent us from replying in person to each and every one. That's why these pages have become available. So let's hear from you now!

Alan A D Hamilton of West Lothian buys 1:76 scale tank decals produced for fighting vehicle kit enthusiasts. Alan suggests people use these for insignia on their 40K vehicles and figures. The kind of symbols found on these decals include a white eye, a white rhino, plumed helmet, mailed fist, a desert rat, pendar, a black bull, a red stag's head, a white armoured horse head, a white mailed fist and mace. That sounds like a really good idea. He also mentions Panzer Division badges such as skulls, and skulls with crossed bones. You can find these decals in model shops. Friends may also have spare transfers from kits they've bought.

And while we're on the subject, Mr Gary Short of London suggests that we buy fine scale railway alphabets to stick little numbers onto Marines and 40K Orks. The lettering adds good detail and makes models easier to paint. Actually, if 40K fans check model railway shops, and look at the range of goods you can get, there are all sorts of little metal accessories you can buy. You can get small spanners, shovels, hammers - all sorts of things.

Andrew Hodgson from East Sussex wishes to purchase a can of the often-mentioned matt spray varnish that people in *Eavy Metal* refer to every now and then. A product produced by Letraset, designed to varnish the Letraset instant lettering, is ideal. It's called Letracoat 102 and is usually available from graphic suppliers.

P Foster John of Hampshire suggests that when painting camouflage schemes on 40K vehicles, you ought to stipple the two colours of the camouflage scheme together along where they meet, blending them in to make the joints a bit fuzzy. He says that this creates the appearance of very delicate airbrush work and goes on to state that most modern aircraft are airbrushed anyway.

Mancunian Gareth Elms says he is struggling with making a diorama, in fact he can't even start it because he's not quite sure how to make the scenic base for the figures. Well this is how you do it.

First of all you need some polystyrene; the sort you find in packaging will suffice. You can break

the polystyrene up or sandpaper it into any shape you want. Then cover it with a layer of plaster of Paris and set your figures on top of that. Cover the bases with a mixture of plaster of Paris, PVA glue and flock. None of the components are expensive so it shouldn't be too difficult to experiment.

Hamish Gray of Argyll writes to tell us that, having filed and prepared his figure, he brushes it with a very soft copper wire brush (before undercoating it). This removes any particles of dust and white powder that appears in figures' armpits and orifices. He says that this makes the undercoat adhere better. The brush has to be soft or it will rip the figure to shreds. He got his tip from his local ironmonger.

His second tip concerns scenic bases. As he's not very good at modelling in Milliput, he has found a novel way of producing a pretty hip base! After painting the figure, he spreads superglue thinly over the base, and then pours Schwartz spices over it. Ground pepper makes a good neutral brown base, or red chilli powder for Martian soil. If only the texture is wanted, you can wash the spice with watered down black, and when it is dry, drybrush with green and brown over the surface. As well as producing effective scenery, it also smells fairly appetising. Hamish also obtains diamond tipped drills from his dentist, which he finds a lot sharper for drilling holes into his figures. Well, that's one good reason for going to a dentist.

Anthony McEwan from Scotland offers some sticky tips. Prior to assembling multi-part figures, Anthony cleans any joints with a lump of blu-tak which removes all the dust, dirt, grease and bits of odd metal that might prevent good bonding. He also utilizes blu-tak when he paints individual shields. He puts blu-tak on a matchstick and sticks the shield to it.

Stephen Squires of Liverpool and Damien 'slap'n'dab' Reynolds of Northampton simply put the tab base of a figure firmly held in a bulldog clip when they're painting. Anything convenient, which stops you from handling painted areas before they have been varnished, is a good idea. Damien also suggests using cut lengths of cotton as tassels on banners.

Here's one from Jonathan Tass of Herts who uses dry transfer lettering such as Letraset to put the name of the figure on the chamfered edge of the base. Now, this is something I've done as well, except that I usually paint it on with white paint and a very fine brush. Not only does the figure's name look good, but you can have other information; slogans, graffiti, unit numbers etc.

Matthew Pedder of Herts wants to know what drybrushing is. It's quite simply a brush with a very small amount of paint on it. In fact, most of it is rubbed off onto a cloth or a piece of newspaper. Then it's lightly but briskly brushed across the raised areas on any part of the figure. The paint very slowly adheres to those surfaces, and gradually builds up quite a subtle highlight. This does ruin brushes however, so always use an old one.

Chris Collins of Suffolk complains that when he adds washes to a figure, it ends up looking dirty and blotchy. He's tried different consistencies but hasn't succeeded at all. It's a question of what comes after the washes and trying to be very subtle with them. I still get the impression (from your mail) that people are putting too much pigment onto the figure. 'Wash' is a term which really indicates that paint must flow over the figure, rather than actually covering it with a bath of paint.

Daniel Monk of Sidcup sticks small shields onto the large plastic shields to make them more interesting. Well, thanks for the samples Daniel. I'll give it a try sometime.

The next tip is from Matthew Davis of Cleveland who discovered that when one of his pots of black paint dried up and he added a bit of white spirit, the resulting mix was far too thin to paint a figure. He did however, discover that if you painted chainmail with this mix, straight onto the bare metal, it made perfect looking chainmail without having to paint it black first and then dry brush it silver. It's one of the methods we use at the Studio. You want a very, very thin wash of paint to make mail look good.

Peter Marston of Worcester says he's having trouble sticking the wings on the Great Fire Dragon he got for Christmas. The problem lies in the fact that he's using superglue. It's no good

supergluing heavy wings onto Dragons. They'll just fall off or snap off. They should be pinned in the same method that we described before, and then epoxy glued for extra strength. He could just use epoxy glue on its own, but he should make sure that the two parts are held together while the glue dries.

Going on a step, somebody called Legless of Laurien wants to know how to drill straight holes in the joints of a figure (such as a Dragon wing to a Dragon body). Most experienced modellers would actually hold the bit in a pin-vice, otherwise it's down to having a steady hand and a careful technique. But I don't suppose it matters a great deal if the hole doesn't go in exactly straight because if you use a soft enough metal wire to actually stick the two joints together, you can actually bend it and push the two parts in line with each other.

Legless also says that when he dry brushes a figure, he usually ends up with a sort of rough and powdery effect. This sounds like he's actually using too much paint on the brush, or it's drying too quickly after he's put it on the brush. I suggest he actually thins the paint down slightly.

OK, this one's from Adrian Williams of Lancashire who wants to know whether Phil Lewis will eventually write an *'Eavy Metal'* as he thinks Phil's figures are absolutely ace, particularly the Eternal Champion Melnibonians. He's not quite sure what Phil meant in the *Blanchitsu* tip by saying you layer each colour until a highlight is reached. Well, it's just a question of adding lighter tones, usually with white, to the base colour until you work up to the lightest colour. A Lewis-style *'Eavy Metal'* is currently in the works, by the way.

Thomas Oliver of Edgham Surrey suggests that after undercoating a figure with white, you should give it a complete thin wash of black all over, darkening all the areas of shadow. Quite an interesting one that. Seems to combine two different ways of painting a figure. I'll have to give that one a try sometime, too.

Robin Morrison of Aberdeen has a lot of trouble painting horses. Now, that's one thing we've never covered yet, and we ought to. I think one of the best ways to paint a horse is to look at photographs of them, and examine the way the different colours on a horse provide contrast. For instance, you quite often get black on the lower half of the legs, black manes, tails and muzzles, which contrast against a tan/brown coloured coat. Horses with white 'stockings' or

dappled coats often look very effective. They are very difficult to paint, and we'll cover the subject in a future *'Eavy Metal'*.

Lee Barker of Nottingham, who's just started painting figures, can only achieve a horrible mess that he wants to throw in the dustbin. Now, Lee's told me how he paints his figures, and what I think he's doing wrong is putting an ink wash on last. Ink washes should be applied to put the shading in. Highlights and detail still have to be added on top of that. But it does take a long time to be able to paint a figure effectively, and he shouldn't be discouraged at his first results. Perhaps his very first attempt should be to paint a blank colour onto each part of the figure in the colour he requires, and then take it from there.

Lee also wants to know how to mix skin colours. Well, it's quite easy, you just use the flesh colour. You shade it with an orangy brown and you highlight it with white. If you want to mix flesh, you use white, put in a spot of red, a little bit of yellow, and a tiny smidgin of green. Lee also wants to know how you make bone colour. All you have to do is put a brown wash on the area of bone, drybrush it with a yellowy white colour, and then highlight it with white.

Adam Tinsley of South Yorkshire has got a problem. He's having trouble shading and highlighting. The colours he uses don't blend into the base colour very well. If he really wants it to blend properly the base colour still has to be wet, or at least damp, when he puts on the other colours, and he needs to work these colours together very carefully with a fine brush until they mix and make a gradation. If he's not blending the actual mix of colours together, and he's just laying highlights and shading onto the base colour, then the colours he uses need to be very very close to each other. Adding a couple more layers of shading and highlighting so that the finished result will actually form a closer gradation is probably the best solution.

Mr J Enoch of Devon wants to know how to paint an Orc Command Group; what washes do you

use; what colours would you use; what highlighting would you use; in other words, how do you paint them? Well, if he wants to know what colours to use, all he's got to do is look at the photographs in *White Dwarf*, and to follow the *'Eavy Metal'* articles and *Blanchitsu* column. The **Chapter Approved** book provides specific colour guides for painting 40K figures.

This one's from Carl Roberts from Swansea. 'Do you have to put washes on figures if you're already happy with the result you've got?' No, if you're happy with the look of the figure, stop painting it! The weathered effect on marine armour Carl wants to know about is simply a delicately drybrushed highlight.

Geoff Whittacker of Cheshire offers several suggestions. Firstly, he suggests that people should make scrapbooks of all the painting articles, photographs, and pictures of miniatures from magazines in order to build up a reference pack, and also suggests that people who are not very good at painting banners or shields cut pictures out of comics etc, stick them onto the shield or flag, and then colour them in. That's a good one.

He's got a good tip for making lengths of rope too. Take three or four pieces of thin copper wire and twist them together into lengths. Then paint them light brown. He uses bristles off old shaving brushes for dead grass on bases, and he uses a mapping pen bought from art shops to draw on details like tatoos or scars. Is there no stopping this man?

Of course there is. We've run out of space. I'll be back next month with another bundle of suggestions, tips and advice (keep sending them in). Until then, here's the address to write to if you have any questions on modelling and painting miniatures:

*Blanchitsu*,  
*White Dwarf*,  
*Enfield Chambers*,  
*14-16 Low Pavement*,  
*Nottingham NG1 7DL.*

May your bristles never bend.

*John Blanche*



# CHAPTER APPROVED

Thought for the day

The Cosmos cries out for salvation

Imperial record WD 01/004  
Cross file to: Imperial Armouries IA/12  
Office of the Inquisition OI  
Planetary ref Earth A3 Sol System  
Input ref Inquisition Investigation Team  
32/968 ES327  
Input dated 9985987.M2.

This time we look at the new **Devastators** boxed set from the Citadel Designers - featuring the Land Speeder two-man hover vehicle, the fiendish mole-mortar and the 'Tarantula' mobile weapon system. But first a selection of rule ideas for discussion - comments gratefully accepted.

One of the most common questions about the *WH40K* rules concerns the procedure for area fire, especially with regard to deviation. In my *Marginalia* article for *WH40K*, I confessed that even I wasn't entirely happy with the system. To summarise briefly - the procedure as given in the book is: 1) place your area marker; 2) roll for deviation using the area marker size deviation number; 3) roll 'to hit' each target within the area using the firer's BS; 4) roll 'to wound/damage' on any hits; 5) take saving throws.

*WH40K* was designed as an adaptable game which could accommodate new systems where necessary. An alternative system for area fire is as follows.

## REVISED AREA FIRE PROCEDURE

1. Place area marker over target as normal.
2. Roll to see if the shot lands on target or 'deviates'. The chance of a shot deviating is now based on *BS*, not the size of the template. This directly reflects the chance of the firer landing his grenade or mortar bomb on target.

BS	Deviates on D6 score of
1	1 or more (always deviates)
2	2 or more
3	3 or more
4	4 or more
5	5 or more
6+	6 or more (minimum chance of deviation)

Any weapon 'to hit' modifier may be added to the *BS* of the firer. No other modifiers apply. Shots which don't deviate are worked out with the area marker remaining as placed. If a shot deviates, the missile, grenades etc, land slightly off-target. The procedure for establishing deviation remains the same: roll a D12 for direction and an appropriate dice for distance.

3. Models within the area marker may be hit by the blast of the weapon. Any model will be hit on a D6 score of 3 or more. Basic 'to hit' dice modifiers apply (see p20 of the *WH40K* rule book). Weapon modifiers do not apply. Note that some weapons still hit automatically as defined in the rules.

4. Establish whether hits cause *wound/damage*, take any *saves*, roll for the number of wounds/damage where appropriate and remove casualties as normal.

## VITAL HITS

This idea was sent in by Paul Quinn and it's ideally suited to small games. I'm certainly going to use it for our *WH40K* improvised role-play games where combat is usually short and bloody.

*Hits scored with a 'to hit' dice roll exceeding the required score by 2 or more are deemed to have been particularly accurate or lucky. Either the whole burst strikes the target or a shot hits a vital spot. The following rules then apply.*

1. The firer may add +1 to the **strength** of the weapon or
2. The firer may instead make **three 'to damage' rolls at the basic strength**, each damaging hit causing wounds/damage as normal.

Paul goes on to say that this rule doesn't really work with *following fire* weapons. I'd agree. Perhaps the best solution is to say that *following fire* weapons can only cause a vital hit on their original target, and then have the choice of causing either a vital hit or using their *following fire* ability. Players wishing to try out this rule should note that only a single *saving throw* applies in case 2.

## DEVELOPING PSI-POWERS

Several players have asked me about the development of psi-powers in campaigns. Psi-powers can certainly be increased in theory - although there are no rules for this in the *WH40K* book. I would suggest that the GM awards psykers 1 point every time a psi-ability is used successfully under battle conditions. When the psyker has 10 points (presumably accrued over a few games) the player trades them in for an extra ability.

If the psyker already has the maximum number of abilities, it is not possible to gain more. Instead, any ability may be 'swapped' for another ability of a higher level.

When a new ability is earned the psyker also gains a 10% chance of going to the next highest mastery. The player should make the dice roll. The player may not choose a new ability from the higher mastery during that 'advance'. When the mastery goes up the psi-level also goes up by 3D6.



If a psyker reaches mastery level 4, he has attained the highest grade. However, the psyker may still gain in power, and may continue to swap spells once 10 points have been accumulated. Although the psyker cannot advance in mastery, there is still a 10% chance of gaining an extra D6 psi-level. Because this gives a theoretically unlimited psi-level, GMs should place a practical maximum as they see fit.

## THE TARANTULA

The Tarantula has three basic components, a mobile gravitic-powered base, a body including auto-aim and targeter systems, and armament. It is, in effect, a robotic weapon mount controlled by a crewman who can move the Tarantula from place to place and select targets. The crewman and Tarantula must remain within 12" or control becomes ineffective and the Tarantula is then *uncontrolled* as described below.

A crewman may not use weapons or engage in close combat whilst controlling a Tarantula. If the crewman moves out of control range, fires a weapon, becomes engaged in close combat, or is slain, the Tarantula comes to an immediate halt and is said to be 'uncontrolled'. Once the weapon becomes uncontrolled, the player must first nominate its targets during the *shooting phase*, and must then fire on the nominated target/s in the side's following *shooting phase*. If a nominated target is no longer visible, the weapon cannot fire at all. This rule only applies to uncontrolled Tarantulas. Controlled Tarantulas may fire at any visible target within range just like a normal trooper. Any Tarantula crewman can take control of any Tarantula, but may only control one at a time.

### Tarantula profile:

M	BS	S	T	D	I
6	5	5	5	5	5



Note that Tarantulas have no *Ld*, *Int*, *Cl* or *WP*, and have no *A* and therefore no *WS* (they are struck automatically in hand-to-hand combat). They cannot fight in close combat and take special damage in the same way as robots (see *WH40K*, p43).

The mobile weapon platform may be equipped with any two heavy weapons (4 weapon points) plus two auto-aim systems and two targeters (4 equipment points). A Tarantula may either move or fire during its turn - but not both. If the Tarantula remains stationary it may fire either or both weapons. Both weapons have a 360° arc and may be fired at separate targets - a Tarantula therefore normally fires twice during the shooting phase, once with each weapon.

PV = 20 + weapons, equipment and crewman.

## THE MOLE MORTAR

The mole mortar employs an inverted mortar launcher and special ammunition to launch a subterranean shell or 'tunnel-torpedo' which burrows its way underneath the battlefield. The mole mortar was actually developed to attack tunnelling vehicles, but was so successful it is now used as a short range assault weapon in its own right.

It has a restricted range of between 6" and 48". It has a normal fire-arc of 90°. The firer must first secretly nominate a target point within the range and fire-arc of the weapon. During following turns the firer may adjust the weapon to establish a fresh target point, but the weapon may only be adjusted enough each turn to move the target point by 4". The weapon may not be adjusted and fired in the same turn.

When used against normal targets the firer should position his area marker and roll for deviation as usual. Then roll a D6.

- 1-2 The shell spins out of the ground at a terrific rate, leaping into the air and exploding. Work out damage as for a normal shell burst.

- 3-4 The shell barely breaks the surface before exploding in a hail of earth. Work out damage normally. In addition, any low wall, hedge or other scenery within the burst area is levelled and destroyed. Buildings may be damaged as normal.

- 5-6 The shell bursts under the ground, lessening its effect but levelling any scenic items as for 3-4 above. All building sections in the burst area take 1 point of automatic damage for every point of *strength* of the exploding shell. In the case of the tunnel torpedo, this is a 6. Any models within the burst area may be hit and damaged as normal. Once casualties have been removed, the area indicated by the marker sinks and forms a crater. This can be represented by marking the crater rim with small stones, cork chips or similar material.

The mole mortar can be used to attack tunnelling vehicles. The weapon has a 360° arc of fire when firing in this way. This works as follows. The firer declares he is firing speculatively against tunnelling vehicles he suspects may be near. The GM checks the position of enemy tunnelling vehicles, and if a vehicle lies within the weapon's range he must test for a hit. To do this, the GM secretly rolls a D6. If the score is 6 the shot has hit. The GM works out all results in secret, neither player should be informed about what is happening. If a vehicle is destroyed it simply fails to appear, neither player is told of its loss.

Short range	Long range	Shooting to Hit		Strength	Damage	Save Modifier	Type				Area	T
		Short	Long				C	H	S	F		
6-24	24-48	-1	-2	6	1		2"	X		3"	6	

The mole mortar is designed to fire its own special tunnel torpedo with strength and details as shown on the weapon profile. It may also fire any other standard shell type. The mole mortar is normally crewed by two models.

PV = 50 + crew.

Additional ammo types must be paid for as normal. The tunnel torpedo is included in the cost.

## LAND SPEEDER

The land speeder is a patrol and light battlefield attack vehicle. It is used by the Imperial army as well as by marine chapters. It is also a common civilian vehicle, and has found its way into the personal retinues of many Imperial commanders. It is a hoverer, and rules 1 to 3 apply as given on p105 of *WH40K*. This ubiquitous vehicle can be easily modified to perform a variety of roles in many different environments. The profiles for three versions are given below as standard, fast attack and support variants.

	Land		TRR	Cp	T	D	Sv	Eq	W
	Max speed	Acc/dec							
Standard	24	8	1	2	7	15	6	4	3
Fast att	24	6	1	2	7	15	6	3	4
Support	20	4	1	2	7	15	6	5	4

Weapons and equipment variants are:

- Standard** Equipment: Communicator, Auto-drive, Auto-aim and targeter for main armament. Armament: Multi-melta (main), Melta-gun.
- Fast attack** Equipment: 3 auto-aim units. Armament: 4 independently firing bolt-guns.
- Support** Equipment: Communicator, Auto-drive, 2 targeters, Auto-systems. Armament: 2 las-cannon.

Individual commanders may elect to vary these weapons in any way. All weapons and equipment are bolt-on/bolt-off to facilitate speedy replacement.

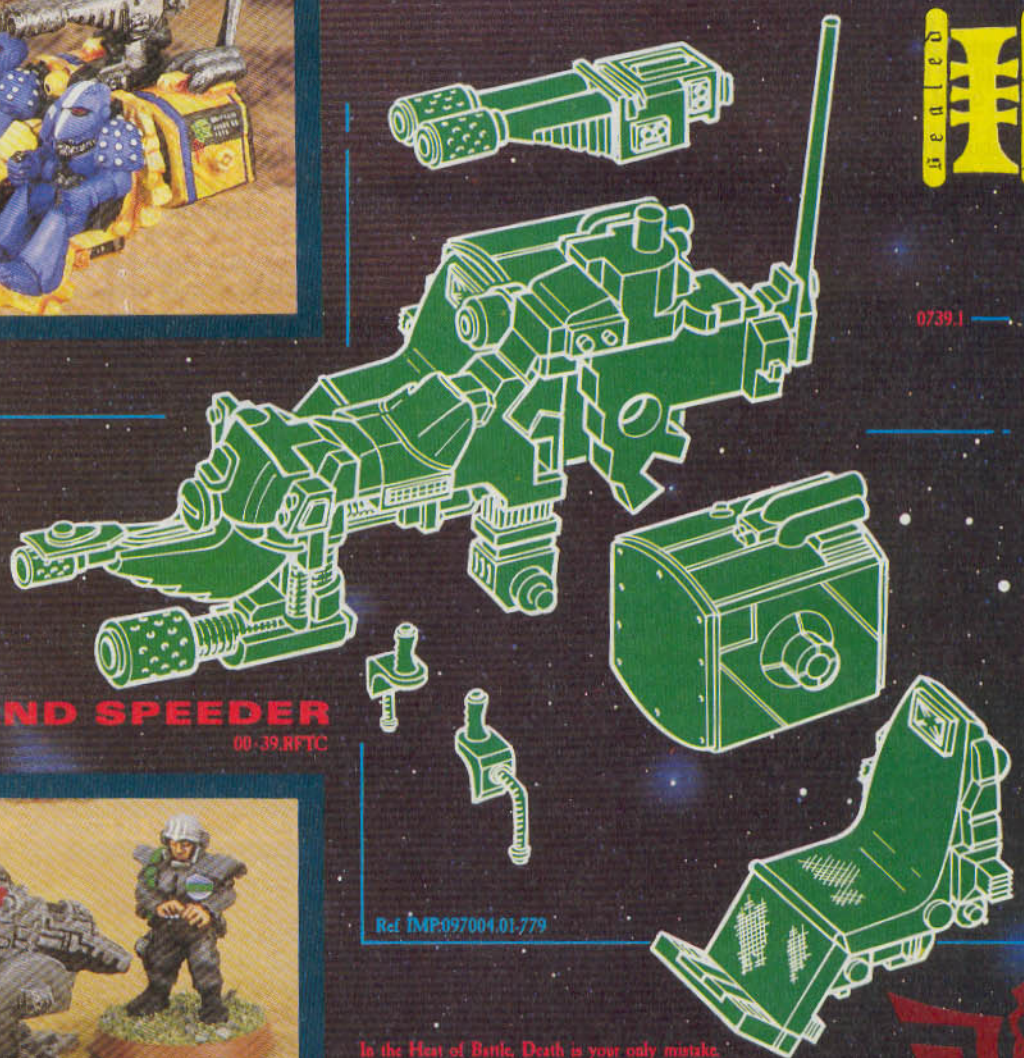

0739.1

### LAND SPEEDER

00-39.RFTC

Ref IMP:097004.01.779

In the Heat of Battle, Death is your only mistake.



### THE TARANTULA

TECH DRAWING H



0739.2

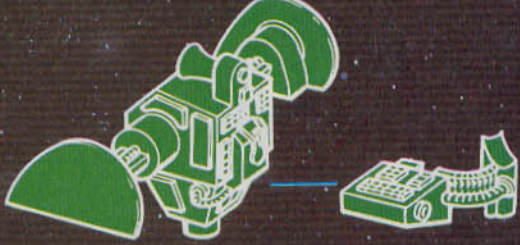

Ref. Imperial Records. Clearance level BRAVO

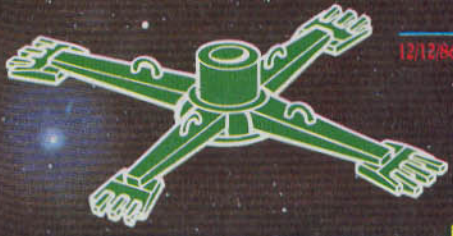

12/12/66



### THE MOLE MORTAR

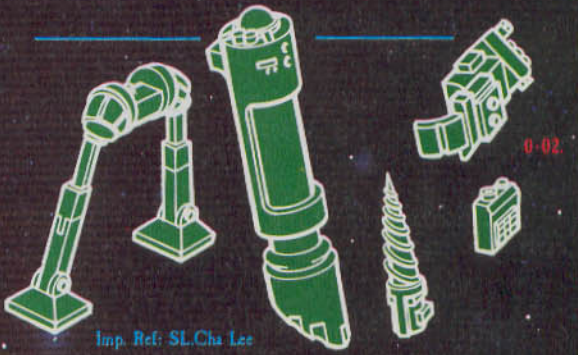

0-02

Imp. Ref: SL.Chu Lee

# DEVASTATORS



## AMBULLING OVER

I have always considered the most enjoyable feature of *WH40K* to be the variety of huge, horrible alien creatures. I was therefore quite pleased to see the Perry twins working away at a new model of an Ambull, on of *Warhammer 40,000's* resident alien creatures.

The Ambull originates from the hot desert death-world of Luther McIntyre IX. Thanks to misguided attempts to domesticate the species it is now common throughout human space. Ambulls thrive only on arid worlds and prefer to live in huge underground burrows which they dig from the soft rock. These burrows can be quite extensive, forming a whole underground complex. It is not unknown for human groups to take over Ambull tunnels. They are favoured by smugglers and pirates who sometimes use tunnels as a storehouse or base. Of course, it is a good idea to make sure the tunnels are uninhabited first!

I always use Ambulls and other large monsters as GM controlled creatures. No indication should be given to the players that Ambulls are in the area. The GM should mentally note one or more positions in the centre of the table where an Ambull burrow might conceivably lie. A set number of turns should be played, say 2 or 3, and then the GM can start making random D6 rolls at the beginning of each player's turn. On the role of a 6, a predetermined number of Ambulls appear at the burrow entrance wondering what all the noise is about. Ambulls are naturally rather bad tempered creatures, and will move towards and attack the nearest troops from either side. Otherwise they move randomly. The GM should tailor the number of Ambulls appearing to the number of models available. For example, if you have three Ambull models then you can say D3 Ambulls appear. You can keep re-rolling for 6's each turn until all of your available models have been placed on the table.

Another idea is to allow a player to use Ambulls as part of his attack force. Imagine that a group of marines, Imperial agents, pirates, Orks - or whatever faction you wish - has succeeded in capturing one or more Ambulls. The attack force perhaps has a ship in orbit, and is ready to use its teleporters to deliver troops straight into the midst of battle. Now what would your cunning commander decide to teleport first? Yup - the Ambull! Teleport it down into the middle of the tabletop and let it rip apart the defenders for a few turns before landing your main force. The standard teleport rules can be used. Before teleporting an Ambull the attackers implant an explosive device into its spine. This can be triggered by a communicator signal from any unit leader or character model on the attacking side. The range of the signal is 12". Naturally, success isn't guaranteed! Roll a D6 when attempting to activate the explosive. The result may be rolled in secret by the GM if he wishes.

- 1 No effect - explosive has become dislodged or is defective. No further attempts may be made.
- 2 No effect - the signal is too weak. Further attempts may be made in following turns.
- 3-5 Boom! The Ambull takes D6 automatic wounds.
- 6 Ooops! Yes, you used too much explosive again. Roll a D6 to indicate the radius of the resulting burst area in inches. All models within the area are hit once with a *strength* of 8. Damaging hits cause D3 *wounds*. All saving throws suffer a -3 penalty. The Ambull is scattered all over the table and may be considered to be dead.

M	WS	BS	S	T	W	I	A	Ld	Cl	Int	WP	Points
6	5	0	5	5	3	5	3	8	4	8	8	78/100

If you wish to include an Ambull in a game of your own, but you don't have a GM, then follow this procedure. Ambulls are only available to a side landing troops with teleporters. Teleported Ambulls must be paid for at the increased cost of 100 points. The player must note down how many Ambulls are being teleported each turn, and must also note down when combat units are being teleported. The player is not permitted to wait until the Ambulls are through before deciding to teleport other troops - the decision has to be made right at the start. The random movement of Ambulls can be handled by either player. Use a D12 'clock-face' for direction and D6 for distance in inches. Any models within charge range (12" over normal terrain) will be charged automatically. If several targets present themselves, the closest will be chosen. Targets can be randomised if equally close. Ambulls will not normally attack each other - although they will attack vehicles and fixed weapon systems (such as a stationary Tarantula for example).

## SAVE MODIFIER MODIFIERS

Given the high strengths of some of the larger creatures, many players feel it is appropriate to give them a modifier that affects the saving throw of their hand-to-hand combat opponents. For example, if a Space Marine is hit by an Ambull, his armour is far more likely to be crushed than if he was hit by an Ork or Gretchin. This is also true of Dreadnought suits, which currently have no save modifier. The following table gives accurate results.

Read the creature's *strength* in the left hand column against the saving modifier in the middle column. If the attacker is a Dreadnought or robot use the right hand column instead.



MARINES OF THE BLOOD ANGEL CHAPTER BEING CHARGED BY A PAIR OF AMBULLS





Strength	Saving Throw Modifier	
	Creature	Dreadnought
4	none	-1
5	-1	-2
6	-2	-3
7	-3	-4
8	-4	-5
9	-5	-6
10	-6	-7

This chart can be modified further if you wish, reflecting the greater or lesser armour penetrating power of individual creatures.

## THE BLACK SHADOW SIDE-CAR COMBINATION

The Vincent Black Shadow bike is widely used in the Imperial forces. Its armoured side-car unit is a popular modification, offering additional crew capacity with little loss in power. Bikes based on this design appear in all types of human forces, from planetary police to galactic pirate raiders.

The bike's profile is slightly modified to allow for the additional weight and some up-armouring. The side-car seats one warrior together with his specially mounted, forward firing weapon. Any heavy weapon may be mounted, but the Multi-melta in this example is

generally favoured. The bike also carries the standard armament of two forward-firing bolt guns. These fire in unison at the same target.

Normal bike rules apply but with the following modifications. An additional pillion passenger may still be carried, adding a further +1 to the TRR. Note that randomised hits should be allocated as follows. Roll a D6. 1-2 = bike hit, 3-4 = driver hit, 5-6 passenger hit. Even if one or more crew are killed the bike may still continue to fight using its own auto-systems. If the bike is destroyed, the crew are assumed to be killed and are removed automatically.

LAND		AIR			TRR	Cp	T	D	Sv	Eq	W
Max speed	Acc/Dec	Max speed	Min	Acc/Dec							
24	12				1	2	5	2	5-6	3	4

Weapon: Multi-melta, twin bolt guns (must be fired at same target)

Equipment: Auto-drive, auto-aim for the twin bolt guns, targeter for the Multi-melta.

The bike has a Points Value of 66 (not including weapons and equipment).

PV including equipment and listed weapons = 145 (plus crew).

Rick Priestley

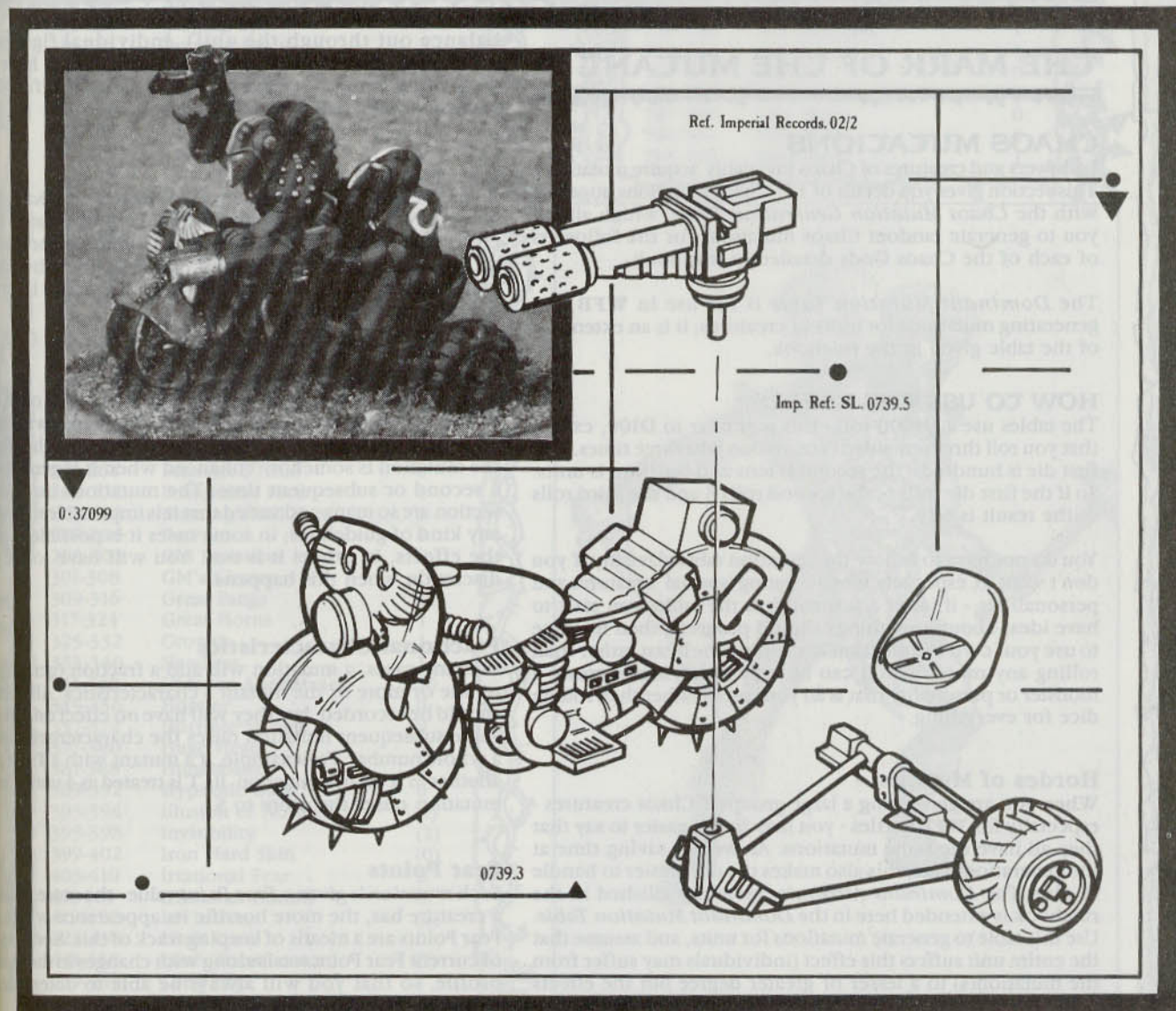

# REALM OF CHAOS

## \*SLAVES TO DARKNESS\*

This month's *On The Boil* is a little different, and somewhat more massive, than usual. Though *Realm of Chaos* lumbers slowly towards its release date, the rules are still in a volatile state, as playtesting continues to weed out bad ideas, strengthen good ones, and clarify weird ones. The idea of showing you some of the development work was tossed around in the office, and after plunging through piles of manuscripts, we selected the following excerpt on the grounds that, apart from being a colourful taster, you can actually use it.

You're not seeing something 'as is', but something that will undoubtedly mutate again. GMs of *WFRP* will find the material ideally suited to their needs. However, GMs of *WFB* and *WH40K* can make use of it if they're prepared to do a little work on putting the results into the right context. We recommend only experienced GMs having a bash at it. Sometimes characteristics and other details are separated by an oblique (/). Values expressed in this way refer to *WFB/WFRP* respectively. Finally, as the excerpt itself reveals much about mutants' physiology, we would be interested to hear from anyone who generates interesting mutants for their games (whichever one they play). Indeed, any views on the generation system and the ideas contained therein are welcome.

## THE MARK OF THE MUTANT

### CHAOS MUTATIONS

Followers and creatures of Chaos invariably acquire mutations. This section gives you details of 127 Chaos mutations, together with the *Chaos Mutation Generation Table*, which allows you to generate random Chaos mutations for the followers of each of the Chaos Gods detailed in this book.

The *Dominant Mutation Table* is for use in *WFB*, for generating mutations for units of creatures; it is an extension of the table given in the rulebook.

### HOW TO USE THE TABLES

The tables use a D1000 roll - this is similar to D100, except that you roll three ten-sided dice, or one D10 three times. The first die is hundreds, the second is tens and the third is units. So if the first die rolls 6, the second rolls 3 and the third rolls 9, the result is 639.

You do not have to follow the mutation table slavishly if you don't want to, especially when creating 'special' creatures and personalities - if, after a few rolls on the table, you start to have ideas about how things should progress, then feel free to use your own imagination in creating the beast rather than rolling any more dice. It can be very satisfying to create a monster or personality that is all your own, rather than rolling dice for everything.

### Hordes of Mutants

When you are generating a large group of Chaos creatures - especially for *WFB* battles - you may find it easier to say that they all have the same mutations. As well as saving time at the generation stage, this also makes the unit easier to handle in play. The *Dominant Attributes* system published in the rulebook is extended here in the *Dominant Mutation Table*. Use this table to generate mutations for units, and assume that the entire unit suffers this effect (individuals may suffer from the mutation(s) to a lesser or greater degree but the effects

balance out through the unit). Individual figures, like champions, heroes and wizards, should still have their mutations generated individually, using the full *Chaos Mutation Generation Table*.

### Creatures of Chaos

Some creatures are described as *Creatures of Chaos*. These beasts have a particular affinity with Chaos, and have a higher chance of mutation than other races. Mutations for *Creatures of Chaos* are always generated individually - they do not generally fight in units, and even when they do, it is very rare for two creatures to be alike.

### Duplicate Results

If a mutant receives the same mutation more than once, there are several things that you could do. You can always ignore the roll and roll again, or you might decide that the effect of the mutation is somehow enhanced when it is generated for a second or subsequent time. The mutations listed in this section are so many and varied that it is impossible to lay down any kind of guidelines; in some cases it is possible to 'stack' the effects, in others it is not. You will have to use your discretion when this happens.

### Fractional Characteristics

In many cases, a mutation will add a fraction (generally  $\frac{1}{2}$ ) to one or more of the mutant's characteristics. All fractions should be recorded, but they will have no effect on play until some subsequent mutation raises the characteristic score to a whole number. For example, if a mutant with a T of 4 gains another  $\frac{1}{2}$  T from a mutation, its T is treated as 4 until a further mutation raises the score to 5.

### Fear Points

Each mutation is given a *Fear Point* value - the more mutations a creature has, the more horrific its appearance will be, and Fear Points are a means of keeping track of this. Keep a record of current Fear Point totals along with changes in the mutant's profile, so that you will always be able to determine the

psychological effects it has on those who encounter it. The effects of Fear Points are as follows:

Fear Points	Effects
0-4	No effect
5-10	The mutant causes <i>fear</i> in all living creatures less than 10' tall.
11-15	The mutant causes <i>fear</i> +1/ <i>terror</i> in all living creatures less than 10' tall, and <i>fear</i> in all other living creatures.
16+	The mutant causes <i>fear</i> +2/ <i>terror</i> in all creatures other than Demons and deities.

**CHAOS MUTATION GENERATION TABLE**

D1000 ROLL	MUTATION	FP
001-016	Acid Excretion	1
017-024	Additional Eye	1
025-028	Albino	0
9-036	Atrophy	0
037-040	Beaked	1
041-048	Bestial Face	1
049-052	Bewapenoned Extremities	1
053-056	Big Ears	0
057-060	Bird's Feet	0
061-068	Black Skin	1
069-072	Blood Rage	0
073-088	Blood Substitution	(3)
089-096	Breathes Fire	1
097-104	Brightly Patterned Skin	0
105-112	Bulging Eyes	0
114-116	Burning Body	3
117-118	Chaos Lord *	150
119-120	Chaos Spawn	*
121-136	Chaos Were	2
137-152	Cloud of Flies	0
153-160	Cloven Hooves	0
161-168	Cowardice	0
169-176	Crest	0
177-184	Cross Breed	1
185-188	Crystalline Body	2
189-192	Dimensional Instability	0
193-196	Duplication	x2
197-204	Elastic Limbs	0
205-220	Enormously Fat	0
221-228	Enormous Noise	0
229-232	Evil Eye	1
233-240	Extra Joints	0
241-248	Extremely Thin	0
249-256	Eyestalks	1
257-260	Fear of Blood	0
261-264	Feathered Hide	0
265-272	Featureless Face	1
273-276	Flaming Skull Face	1
277-284	Furry	0
285-300	Gas Emission	0
301-308	GM's Choice	*
309-316	Great Fangs	1
317-324	Great Horns	1
325-332	Growth	1-3
333-340	Headless	1
341-348	Hideous Appearance	10
349-356	Hopper	0
357-372	Horrible Stench	0
377-380	Huge Head	½
381-388	Hunchback	1
389-392	Hypnotic Gaze	0
393-394	Illusion of Normality	(1)
395-398	Invisibility	(2)
399-402	Iron Hard Skin	(0)
403-410	Irrational Fear	0
411-418	Irrational Hatred	0
419-422	Levitation	(2)
423-430	Limb Loss	0
431-438	Limb Transference	(1)
439-442	Long Legs	1

443-450	Long Neck	0
451-458	Long Nose	0
459-462	Long Spines	15
463-466	Mace Tail	0
467-474	Magic Immune	0
475-482	Magic Resistant	0
483-486	Magician	0
487-490	Mane of Hair	0
491-498	Manic Fighter	0
499-502	Manikin	2
503-506	Massive Intellect	0
507-510	Mechanoid	2
511-515	Mercreature	1
516-520	Metal Body	3
511-526	Mindless	0
527-542	Moronic	0
543-558	Multiple Arms	0
559-574	Multiple Heads	1
575-576	Multiplication	(3)
577-584	One Eye	0
585-600	Overgrown Body Part	1
601-608	Pin Head	1
609-640	Plague Bearer	0
641-644	Pointed Head	0
645-652	Poisonous Bite	0
653-660	Powerful Legs	0
661-668	Prehensile Tail	0
669-670	Pseudo Demonhood	5
671-678	Puny	0
679-686	Quadruped/Biped	0
687-690	Rapid Regeneration	0
691-694	Razor Sharp Claws	0
696-710	Rearranged Face	1
711-718	Regeneration	0
719-750	Rotting Flesh	1
751-758	Scaly Skin	1
759-762	Scorpion Tail	1
763-766	Short Legs	0
767-770	Shrink	0
771-786	Siamese Twin	1
787-790	Silly Voice	0
791-794	Silly Walk	0
795-798	Skull Face	1





799-802	Snake Tail	1
803-810	Spits Acid	10
811-818	Subject to Alcoholism	0
819-834	Subject to Fits	0
835-840	Suckers	1
841-848	Tail	0
849-858	Technology	0
859-862	Telekinesis	0
863-866	Teleport	0
867-870	Temporal Instability	0
871-886	Tentacles	1
887-894	Transparent Skin	2
895-898	Uncanny Resemblance	0
899-900	Vampire	2
901-908	Very Agile	0
909-912	Very Fast	0
913-920	Very Resilient	0
921-928	Very Strong	0
929-944	Very Warty Skin	0
945-952	Vividly Coloured Skin	0
953-960	Walking Head	1
961-964	Warp Frenzy	(5)
965-966	Weapon Master	0
967-974	Wings	1
975-992	Zoological Mutation	*
993-000	Invent Your Own	*

**Notes**

FP is the Fear Point value of the mutation; values in brackets only come into play when the effect is used. Where the FP value is given as a multiplier (eg x2), the mutant's Fear Points total is multiplied by that number when the effect is used.

\* indicates that the value is variable, according to the degree of mutation. This is explained in the individual mutation description.

**DOMINANT MUTATION TABLE**

This table is used to determine mutations for units. Every creature in the unit is deemed to have the same mutation or mutations, for ease of handling. Mutations for personalities should be generated individually, using the full *Chaos Mutation Generation Table*.

**D1000**

ROLL	MUTATION	FP
001-010	Atrophy	0
011-020	Beaked	1
021-041	Bestial Face	1
042-051	Beweaponed Extremities	1
052-061	Bird's Feet	0
062-071	Blood Rage	0
072-080	Chaos Spawn	*
081-122	Cloud of Flies	0
123-143	Cowardice	0
144-153	Dimensional Instability	0
154-194	Enormously Fat	0
195-204	Fear of Blood	0
205-224	Great Fangs	1
225-245	Great Horns	1
246-266	Headless	1
267-287	Hideous Appearance	10
288-307	Hopper	0
308-348	Horrible Stench	0
349-358	Iron Hard Skin	(0)
359-378	Irrational Fear	0
378-398	Irrational Hatred	0
399-408	Long Legs	1
409-418	Long Spines	1
419-428	Mace Tail	0
429-449	Magic Resistant	0
450-459	Manic Fighter	0
460-469	Metal Body	3
470-510	Multiple Arms	0
511-531	One Eye	0
532-552	Pin Head	1
553-634	Plague Bearer	0
635-654	Poisonous Bite	0
655-674	Powerful Legs	0
675-695	Prehensile Tail	0
696-710	Puny	0
711-720	Razor Sharp Claws	0
721-740	Regeneration	0
741-760	Scaly Skin	1
761-780	Scorpion Tail	1
781-800	Short Legs	0
801-820	Silly Walk	0
821-840	Snake Tail	1
841-860	Tail	0
861-880	Tentacles	1
881-900	Very Agile	0
901-910	Very Fast	0
911-930	Very Resilient	0
931-950	Very Strong	0
951-000	Very Warty Skin	0

Notes - See above.

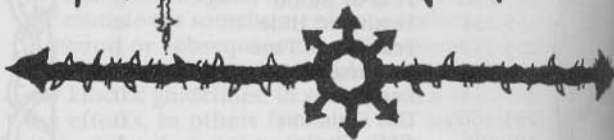

**Mutation Descriptions**

**Acid Excretion**

The creature sweats an extremely potent acid. Any creature in combat with it suffers 1 S5 hit from the acid in every turn/round when it fails to hit the mutant. **WHB**: calculate the total number of failed hits against the mutant and resolve all the acid attacks at once.

Non-magical weapons striking the mutant cause normal damage on the first wounding blow, but are then destroyed. Non-magical armour and shields will give normal protection against one attack from the mutant, but are then destroyed. Magical weapons and armour are unaffected by the acid. The mutant may not wear non-magical armour or use non-magical weapons. T + ½.

**Additional Eye**

The mutant grows an extra eye. A helmet which is part of a set of Chaos Armour will change to accommodate this, other helmets will have to be adapted or specially made.

**Albino**

The creature has dead white skin and glowing red eyes. T -½.

**Atrophy**  
One or more parts of the mutant's body are shrivelled and atrophied. Roll D6 to determine how many:

1-3	one
4-5	two
6	three

Roll D6 again to determine which areas are affected:

1-4	Head	See <i>Pin Head</i>
4	Arm	Arm becomes useless (equal chance of shield or weapon arm).
5-6	Leg	One leg - creature may move at half its normal movement allowance with a crutch, or hop at one-third of its normal movement allowance. Both legs - <b>M</b> = 0.

When rolling for a unit, determine the affected area(s) once, and assume that all creatures in the unit are identical. **I** -1/2/-5, **T** -1/2 per area affected.

**Beaked**  
The mutant is armed with a beak, which may be that of a bird, octopus or platypus (GM's choice). The mutant has an additional *peck* attack. It may not wear a closed helmet. **A** +1.

**Bestial Face**  
The creature has a face like that of a beast. Select from the following list or roll D20:

D20	Type	Special Effects
1	Ant	<b>A</b> +1, <i>bite</i> attack.
2	Ape	None.
3	Bat	<b>A</b> +1, <i>bite</i> attack. 'Sonar' Night Vision, 10"/20 yards.
4	Bear	None.
5	Boar	<b>A</b> +1, <i>gore</i> attack.
6	Bull	<b>A</b> +1, <i>gore</i> attack.
7	Deer	<b>A</b> +1, <i>gore</i> attack.
8	Dog/Wolf	<b>A</b> +1, <i>bite</i> attack.
9	Dragon	<b>A</b> +1, <i>bite</i> attack. <i>Night Vision</i> 10"/20 yards. Mutant may Breathe Fire once per turn instead of biting.
10	Eagle	<b>A</b> +1, <i>bite</i> attack. <i>Excellent Vision</i> ( <b>WFRP</b> only).
11	Horse	None.
12	Lion	<b>A</b> +1, <i>bite</i> attack.
13	Rabbit	<i>Acute Hearing</i> ( <b>WFRP</b> only). <i>Night Vision</i> 10"/20 yards.
14	Rat	<b>A</b> +1, <i>bite</i> attack. <i>Night Vision</i> 10"/20 yards.
15	Raven	<b>A</b> +1, <i>bite</i> attack. <i>Excellent Vision</i> ( <b>WFRP</b> only).
16	Sheep/Goat	<b>A</b> +1, <i>gore</i> attack.
17	Snake	<b>A</b> +1, <i>bite</i> attack. Bite is <i>poisonous</i> as normal snake.
18	Spider	<b>A</b> +1, <i>bite</i> attack. Bite is <i>poisonous</i> as Giant Spider.
19	Tiger	<b>A</b> +1, <i>bite</i> attack. <i>Night Vision</i> 10"/20 yards.
20	Weasel	<b>A</b> +1, <i>bite</i> attack.

When rolling for a unit, determine head type once, and assume that all creatures in the unit are identical.

**Beweaponed Extremities**  
The mutant's hands/paws are turned into weapons: roll D6 to determine type:

1-3	Blades
4-6	Maces

All attacks now count as weapon attacks. The mutant cannot be disarmed.

**Big Ears**  
The mutant has enormous ears, either large versions of its original ears or like those of an elephant, bat or rabbit (GM's choice). **WFRP**: *Acute Hearing*.

**Bird's Feet**  
The mutant's legs and feet become birdlike. If the mutant has wings, it gains 2 *claw* attacks. **T** +1/2.

**Black Skin**  
The mutant's skin becomes completely black, while its eyes turn milk-white. **WFRP**: +20 to *Hide* tests at night or in dark surroundings.

**Blood Rage**  
The mutant becomes subject to *frenzy* whenever it sees blood - when it is within 12'/24 yards of a wounded creature, including itself. The effects last for 2D6 turns after there is no more blood to be seen. If no enemies are in sight while the mutant is in *frenzy*, it will attack

friends unless it makes a successful *Cool* test. The test is repeated every time the frenzied mutant is looking for a foe.

**WFB**: for units, you may prefer to use the definition of this mutation given in the rulebook, and simply rule that the unit is subject to *frenzy*. **T** +1.

**Blood Substitution**

The nature of the mutant's blood changes radically; roll D6 to determine the nature of the change:

1	Leeches
2	Maggots
3	Acid
4	Protoplasm
5	Molten Metal
6	Electricity

**Leeches/Maggots**: whenever the mutant is wounded, a stream of squirming things pours out of the wound. The mutant's opponent must make a successful **I** test to avoid the stream, which penetrates armour and clothing, causing 1 **S** 1 hit every turn/round for 2D6 turns/rounds or until the victim can strip off and get rid of them. **WFB**: The opponent is automatically hit on a D6 roll of 6.

**Acid**: whenever the mutant is wounded, a powerful acid will spray out of the wound; the mutant's opponent takes 1 **S** 3 hit, and must make a successful **I** test (+2/+20 modifier for closed helmet) in order to avoid being blinded.

**Protoplasm**: a translucent slime oozes from the mutant's wounds. When the mutant is reduced to zero **W**, the slime coalesces to fight on in its own right; its profile is as follows:

**WFB**

M	WS	BS	S	T	W	I	A	Id	Int	Cl	WP
4	3	0	3	5	3	3	3	0	0	0	0

**WFRP**: treat as *Amoeba*, p231).

The slime is immune to all psychological effects.

**Molten Metal**: whenever the mutant is wounded, molten metal sprays from the wound; the mutant's opponent takes 1 **S** 3 hit. The stream of molten metal will ignite any flammable substances within a 2"/4 yard radius of the mutant. When the mutant is killed, it will explode, causing one **S** 4 hit to all creatures in a radius of 5"/10 yards.

**Electricity**: whenever the mutant is wounded by a sword or other all-metal weapon, the electricity in its bloodstream pours through



the weapon to cause one S3 hit. The damage is doubled if the victim is wearing metal armour. **T** + ½.

**Breathes Fire**

The mutant is able to breathe fire once per turn. The area of effect is cone-shaped, and all creatures within the area of effect are automatically affected by the fire, with no need to roll to hit. The size of the cone and the amount of damage caused vary with the size of the creature, as follows:

Size	Length	Width at End	No. of Hits
Larger than man-sized	12"/24 yds	4"/8 yds	3
Man-sized	6"/12 yds	2"/4 yds	2
Smaller than man-sized	3"/6 yds	1"/2 yds	1

All hits are at the mutant's S.

The mutant may never breathe fire and *bite* at the same time.

**Brightly Patterned Skin**

The mutant's skin becomes brightly-coloured, with clashing or contrasting stripes, spots, or other patterns.

**Bulging Eyes**

The mutant's eyes become large and frog-like. This presents a bizarre appearance, but has no effect on the mutant's profile.

**Burning Body**

The mutant's body is eternally wreathed in hellish flames, and burns with an unearthly light.

The heat of the fire may drive back hand-to-hand opponents; subtract -2/-20 from their 'to hit' throws. When an opponent hits the mutant, there is a 50% chance that the opponent will suffer one S2 hit from the flames; when the mutant strikes an opponent, the opponent suffers a S4 hit from the flames, in addition to normal damage.

The mutant may only carry equipment which is magical and/or a Chaos Gift; all other objects the creature touches will be destroyed by the flames. **T** +1.

**Chaos Lord**

The mutant has been favoured by the Gods of Chaos, and is chosen to lead its fellows. It gains 2D6 randomly-generated Beastmen as followers, and there is a 50% chance of being granted each of the following (throw for each).

1. A complete suit of Chaos Armour
2. 2D6 spells, and the ability to cast them
3. D6 extra mutations;
4. A Demon Weapon

**WFB:**

M	WS	BS	S	T	W	I	A	Ld	Int	CI	WP
-	+D4	+D4	+2	+1	+D3	+D4	+D3	+D3	+D3	+D3	+D3

**Chaos Spawn**

The mutant gains D6 additional mutations (**WFB**: units receive D3, rolled on the *Dominant Mutation Table*), and becomes one of the *Chaos Spawn*. Any creature becoming *Chaos Spawn* becomes subject to *stupidity*.

**Chaos Were**

The mutant becomes a Chaos Were. You will need two different models to represent it. Generate a random Chaos Beast with D6 mutations - this is the mutant's were-form, and you should keep a separate record of it.

The mutant is subject to *frenzy*. When it goes into *frenzy*, it must make a successful **WP** test or change to its were-form, and when the *frenzy* subsides it must make another successful **WP** test or be unable to change back until the next time it comes out of *frenzy*. The mutant gains 2 *Fear Points* when it changes into its were-form.

Each time the mutant gains a new mutation, the were-form gains a different mutation, which is diced randomly on the appropriate column of the *Chaos Mutation Generation Table*.

Chaos Armour will change shape to fit both 'normal' and 'were' forms. Chaos Weres may not wear armour other than Chaos Armour.

**Cloud Of Flies**

The mutant is permanently surrounded by a great swirling mass of flies. Any hand-to-hand opponent attacks at a -1/-10 penalty as the flies block vision, buzz into mouths and noses, and so on.

**Cloven Hooves**

The mutant has cloven hooves instead of feet. It may not use any magical boots, but otherwise its profile and abilities are unaffected.

**Cowardice**

The mutant becomes extremely cowardly. A successful **CI** test is required before it will charge. It also *fears* any attacker with greater numerical strength. **WFB**: character models with this mutation may not charge an enemy character model or an enemy unit containing a character model. **CI** x ½.

**Crest**

The mutant's head is adorned with a crest; either a wattled or feathered crest like a bird, or a membranous crest like a reptile.

**Cross Breed**

The mutant becomes a blend of its original species and an animal species. Select from the list below or dice randomly:

D20	Type
1	Ant
2	Ape
3	Bat
4	Bear
5	Boar
6	Bull
7	Deer
8	Dog/Wolf
9	Dragon
10	Eagle
11	Horse
12	Lion
13	Rabbit
14	Rat
15	Raven
16	Sheep/Goat
17	Snake
18	Spider
19	Tiger
20	Weasel

Roll D6 to determine how many body areas are affected, and roll for each one on the following table. Reroll any duplicate results.

D6	Body Area
1	Head
2	Left Arm/Shoulder
3	Right Arm/Shoulder
4	Torso
5	Left Leg/Foot
6	Right Leg/Foot

You will have to develop your own rules for the resulting hybrid, guided by common sense. A mutant who gains the head of a beast will have any sensory abilities and *bite* or *gore* attacks of the original beast, for example, while a mutant who gains clawed hands and/or feet will gain the appropriate attack forms.

If the mutant was previously a Warrior of Chaos or Chaos Sorcerer, it becomes a Beastman immediately, and any future character development is carried out on this basis.

**Crystalline Body**

The mutant's body becomes a living crystal form. It is tough, but easily shattered. **T** becomes 6, **W** becomes 1. Neither score is altered by subsequent character development, or by mutations unless they change the mutant's structure from crystal to something else.

**Dimensional Instability**

The mutant becomes subject to *instability*, as set down in the rulebooks.

**Duplication**

The mutant splits into two entirely separate and identical beings. From this point onward, each duplicate is a separate entity, gaining additional mutations and gifts independently of its twin.

**Elastic Arms**

The creature's limbs stretch out at will to allow it to strike at ranges of up to 1+D6"/2 + 2D6 yards. Its victim may only strike back on a successful *Initiative* test. **WFB**: Opponents may only strike back on a score of 4, 5 or 6 on a D6.

Chaos Armour will stretch with the limb to give protection against injury; other armour will not stretch, and the mutant is treated as unarmoured when the opponent strikes back.

**Enormously Fat**

The mutant is enormously fat and bloated. **M** x ½, **T** +1, **I** -1/-10.

**Enormous Noise**

The mutant periodically makes a deafening sound. This could be a wild, manic laugh, a mighty breaking of wind, a crazed scream or wail, or any other noise that you may care to devise. Each turn/round, roll D6; a result of 6 indicates that the mutant has produced its sound.

The mutant's companions will, of course, be entirely accustomed to this sound, but all others within 6"/12 yards will be sufficiently startled to make all dice rolls that turn/round with a penalty of -1/-10.

**Evil Eye**

The mutant's gaze can place a curse on any creature which meets it. Any creature coming within 4"/8 yards of the mutant must make a successful magic saving throw test or be unable to avoid meeting the mutant's gaze. Creatures which meet its gaze have a -1/-10 modifier to all dice rolls for as long as the mutant lives.

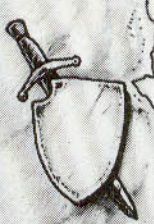

**Extra Joints**

The mutant develops extra joints in one or more of its limbs. Roll D6 to determine which limbs are affected:

1-3	Arms	I +1/+10.
4-5	Legs	M +1.
6	Arms and Legs	I +1/+10, M +1.

**Extremely Thin**

The mutant is as thin as a stick drawing; a matchstick figure. T x ½.

**Eyestalks**

The mutant has stalked eyes, like a crab. **WFRP**: 10% of all head hits will sever an eyestalk, but cause no further damage. Helmets provide no protection to the eyestalks.

**Fear Of Blood**

If any appreciable amount of blood (1 W or more) is spilt within 6"/12 yards, the mutant must make a successful **WP** test or faint for D6 turns. **WFRP**: While it is unconscious, it counts as a *prone* target.

**Feathered Hide**

The mutant's hide is covered in feathers, often including vestigial (and useless) wing membranes between arms and body.

**Featureless Face**

The mutant's facial features disappear, leaving an entirely smooth head. Despite the lack of features, the mutant's senses are unimpaired.

**Flaming Skull Face**

The mutant's head becomes a fleshless skull, surrounded by hellish flames (**WFRP**). Any unprotected flesh coming into contact with the flaming skull takes one S 1 hit from the flames, and any flammable substance coming into contact with the skull is ignited.

**Furry**

The mutant's body grows a covering of long, dense fur. If the mutant is naturally furry then it becomes even more so: its features and even its shape are obscured by the mass of hair. **WFRP**: at the GM's option, the dense fur may give 0/1 Armour Points on all locations.

**Gas Emission**

One of the mutant's bodily orifices emits clouds of gas. These clouds

are hemispherical, D4"/D4 x 2 yards in diameter, and the mutant releases D6 clouds per day. Roll at the beginning of the day or battle to determine how many clouds the mutant can emit, then roll a D6 every turn/round; on a roll of 5 or 6 on a D6, the mutant emits a cloud of gas.

The size and frequency of the gas emission may be varied at the GM's whim, according to the mutant's size or other factors.

The gas clouds will last for the same time as the second level Battle Magic spell *Mystic Mist*. At the GM's option, they may be moved across the battlefield by the wind, travelling at a speed of D6"/D6 x 2 yards per turn; wind direction may be determined using a D8, where 1 = north, 2 = north-east, and so on.

Roll D6 to determine the type of gas produced by the mutant, or select one. The type of gas does not change once it has been determined.

D6 Roll	Type	Effects
1-2	Poison	T test or die.
3	Paralysing	T test every turn/round spent in the cloud; failure indicates paralysis until a successful test is made.
4	Noxious	T test or become nauseous for D20 - T turns, -1/-10 penalty on all dice rolls during that time.
5	Oily Smoke	Same effect as <i>Mystic Mist</i> spell.
6	Crazy Gas	T test every turn/round spent in the cloud; failure indicates that the victim goes into <i>frenzy</i> until a successful test is made.

**WFB**: Resolve damage effect with a *strength* of 3 against the creatures *toughness*.

All individuals caught in the gas cloud are affected unless they have specific immunities or other abilities which protect them. For example, *Crazy Gas* will not affect creatures which are immune to all psychology rules. All effects last until the affected creatures leave the cloud, unless the table states otherwise.

**GM's Choice**

The mutant receives a mutation of the GM's choice.

**Great Fangs**

The mutant grows huge fangs, gaining a *bite* attack if it does not already have one. *Bite* attacks are made with a +1/+10 bonus to hit. **WFB**:

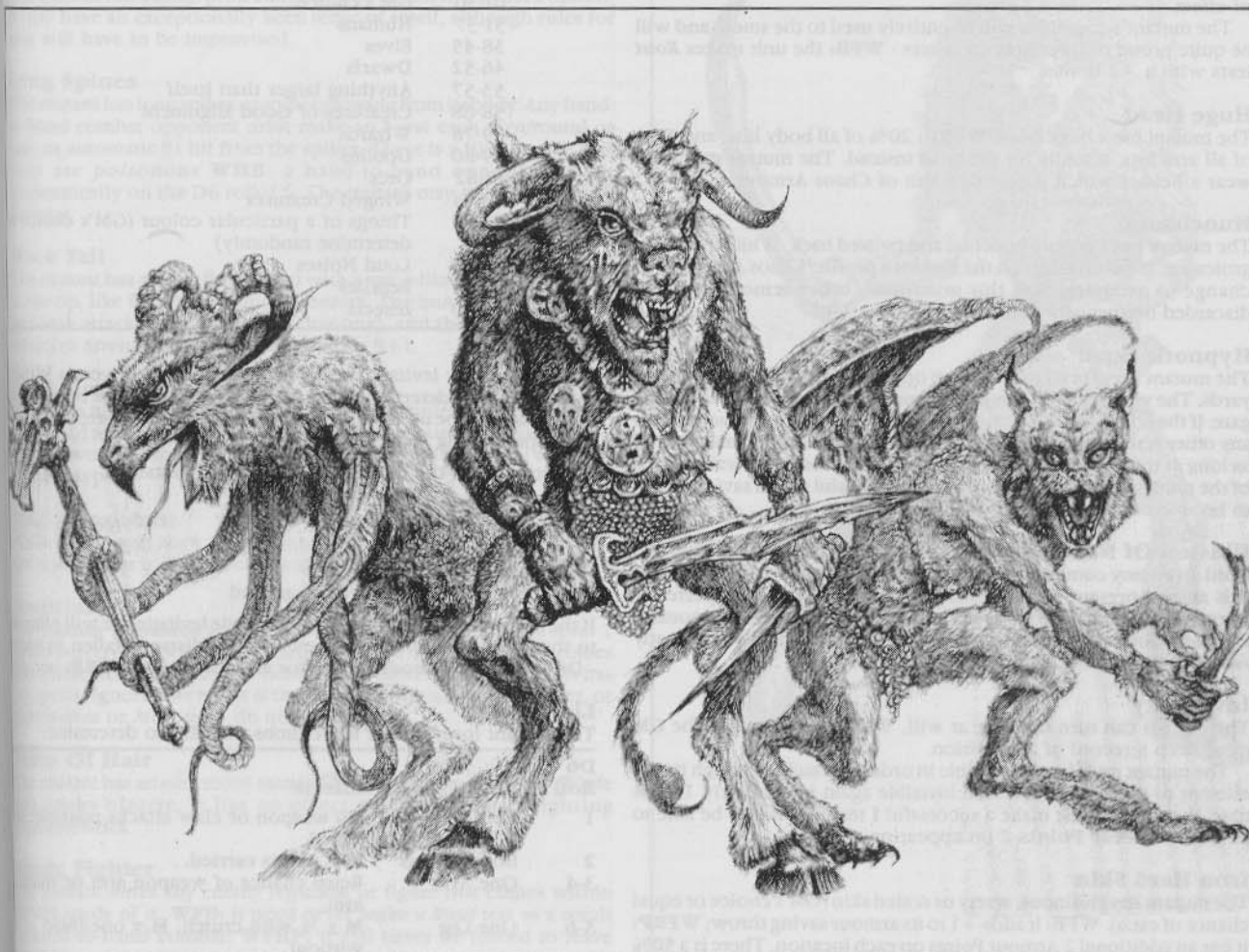

in the case of units, the extra attack is available to every second model fighting.

### Great Horns

The mutant's head grows horns, and it gains a *gore* attack if it does not already have one. *Gore* attacks are made with a +1/+10 bonus to hit. A helmet which is part of a suit of Chaos Armour will change to accommodate this mutation; all other headgear must be discarded. **WFB:** in the case of units, the extra attack is available to every second model fighting.

### Growth

The mutant grows to D3+1 times its natural size. The profile is affected as follows:

Growth	M	WS	S	T	W	I	FP
x2	x1 1/2	-	+2	+1	x1 1/2	-1/-10	1
x3	x2	-1/+10	+3	+2	x2	-3/-30	2
x4	x2 1/2	-2/+20	+4	+3	x2 1/2	-5/-50	3

Chaos Armour will change to accommodate this mutation; other armour must be discarded and new equipment of appropriate size acquired.

### Headless

The mutant is headless, having its face situated on its chest. It may not wear body armour other than Chaos Armour. **WFRP:** all head hits should be treated as body hits.

### Hideous Appearance

The mutant's appearance becomes indescribably hideous. It causes *fear +2/terror* in creatures smaller than itself, and *fear* in others.

### Hopper

One leg becomes huge and powerful, while the other or others waste away to nothing. The mutant may only move by hopping.

**M** x one-third, rounding fractions to the nearest whole number.

### Horrible Stench

The mutant smells very, very bad. Roll D6/D6 x 2 to discover the range of the stench in inches/yards. The stench affects all non-Chaos creatures within this range; creatures which do not have a sense of smell are immune. Creatures affected by the stench make all dice rolls at a -1/-10 penalty until they move out of range - even when the mutant has been killed. Elves must make a **Ld** test or refuse to move within the area of effect.

The mutant's comrades will be entirely used to the smell, and will be quite proud of its effects on others - **WFB:** the unit makes *Rout* tests with a +2 bonus.

### Huge Head

The mutant has a huge head. **WFRP:** 20% of all body hits, and 10% of all arm hits, actually hit the head instead. The mutant may only wear a helmet which is part of a suit of Chaos Armour.

### Hunchback

The mutant has a grossly hunched and twisted back. While this looks grotesque, it has no effect on the mutant's profile. Chaos Armour will change to accommodate this mutation - other armour must be discarded or specially made.

### Hypnotic Gaze

The mutant may fix its gaze on one opponent at a time within 6"/12 yards. The victim may attempt a test magic saving throw to avoid the gaze. If the test is failed, the victim is fixated, and may not move or perform any other actions (**WFRP:** static target). The victim will remain fixated as long as the mutant's gaze remains upon it. Once the victim is free of the mutants gaze, it needs to make a successful magic saving throw to be able to act again.

### Illusion Of Normality

Until an enemy comes into actual physical contact with the mutant, it is able to present an illusionary appearance of being a perfectly normal individual of its original species. Once hand-to-hand combat is joined, however, the mutant is visible for what it really is, and any *fear* and *terror* effects come into play.

### Invisibility

The mutant can turn invisible at will. While it is invisible, the GM must keep a record of its position.

The mutant must become visible in order to attack, although it may attempt to strike and then turn invisible again immediately. In this case, the victim must make a successful **I** test in order to be able to strike back. **Fear Points** 2 on appearing.

### Iron Hard Skin

The mutant has chitinous, warty or scaled skin (GM's choice or equal chance of each). **WFB:** it adds +1 to its armour saving throw; **WFRP:** it has an additional 2 Armour Points on each location. There is a 50%

chance that any non-magical weapon which strikes the mutant but does not cause damage will break.

### Irrational Fear

The mutant has an irrational fear of one or more things, and is subject to the appropriate psychological effects whenever it encounters such things. Roll D6 to determine how many things the mutant is frightened or terrified of:

1-3	1
4-5	D4
6	D6

Next, roll D6 for each one to determine the extent of the mutant's fear:

1-4	Fear
5-6	Fear +2/Terror

Finally, roll D100 to determine the object of the fear:

01-30	GM's choice
31-37	Humans
38-45	Elves
46-52	Dwarfs
53-57	Anything larger than itself
58-68	Creatures of Good alignment
69-78	Wizards
79-80	Goblins
81-82	Orcs
83-84	Winged Creatures
85-94	Things of a particular colour (GM's choice or determine randomly)
95-96	Loud Noises
97-98	Reptiles
99-00	Insects

### Irrational Hatred

The mutant *bates* one or more things, and is subject to the appropriate psychological effects whenever it encounters such things. Roll D6 to determine how many things the mutant *bates*:

1-3	1
4-5	D4
6	D6

Then roll D100 for each to determine the object of its hatred:

01-30	GM's choice
31-37	Humans
38-45	Elves
46-52	Dwarfs
53-57	Anything larger than itself
58-68	Creatures of Good alignment
69-78	Wizards
79-80	Goblins
81-82	Orcs
83-84	Winged Creatures
85-94	Things of a particular colour (GM's choice or determine randomly)
95-96	Loud Noises
97-98	Reptiles
99-00	Insects

### Levitation

The mutant may levitate, using Magic Points as if it were a Wizard. Throw 2D10 to determine how many Magic Points the mutant has; these may only be used for levitation, and should be noted separately from spellcasting Magic Points.

Levitating costs the mutant the following points:

Rising 1 1/2 yards	1
Falling up to 3 5/6 yards	Free
Each 3 5/6-yard fall thereafter	2
Moving horizontally 1 1/2 yards	3
Remaining stationary above the ground	1

If the mutant runs out of Magic Points while levitating, it will plummet to the ground. **WFB:** the mutant loses 1/2 (distance fallen in inches - D6) **W**, with no modification for armour and **T**; **WFRP:** see p75.

### Limb Loss

The mutant loses one or more limbs. Roll D6 to determine:

D6 Roll	Limb(s) Lost	Effects
1	Both/all Arms	No weapon or claw attacks possible; no shield.
2	Both/all Legs	<b>M</b> 0 unless carried.
3-4	One Arm	Equal chance of weapon arm or shield arm.
5-6	One Leg	<b>M</b> x 1/2 with crutch, <b>M</b> x one-third without.



**WFRP:** Losing one or both arms will affect **Dex** and manual skills; losing one or both legs will affect movement skills. The GM should impose penalties as appropriate, taking into account the number of remaining limbs (loss of one arm will affect a four-armed character less radically than a two-armed character), and any other relevant points.

### Limb Transference

One or more parts of the mutant's anatomy have been moved about. Roll D6 to determine how many parts have been moved:

1-4	1 Part
5	2 Parts
6	D4 Parts

Roll D10 to determine which parts are affected:

1-2	Head
3	Eyes
4	Mouth
5-7	Arm/Hand
8-0	Leg/Foot

Roll D10 again to determine where they are moved to:

1	Head
2	Chest
3	Back
4	Stomach
5	Hip
6	Groin
7	Elbow
8	Knee
9	Hand
0	Foot

### Long Legs

The mutant has exceptionally long legs: **M** +1.

### Long Neck

The mutant has a long giraffe-like neck. **WFRP:** any Critical Hit to the head has a 25% chance of severing the neck.

### Long Nose

The mutant has a long, protruding nose or snout. At the GM's option, it may have an exceptionally keen sense of smell, although rules for this will have to be improvised.

### Long Spines

The mutant has long spikes or spines growing from its body. Any hand-to-hand combat opponent must make an **I** test each turn/round or take an automatic **S1** hit from the spikes. There is a 10% chance that they are *poisonous* **WHB:** a hand-to-hand opponent is hit automatically on the D6 rolloff 6. The mutant may only wear Chaos Armour.

### Mace Tail

The mutant has a long, flexible tail with a mace-like bony excrecence at the tip, like Fimir and some dinosaurs. The mutant gains an extra *tail-lash* attack (unless it already has one), and the *tail-lash* has an effective **Strength** equal to the mutant's **S**+1.

### Magic Immune

Magic has no effect upon this mutant. It is completely immune to all spells, and to all magical effects generated by creatures and magic items. Magical weapons may still harm it, but are treated as normal weapons of their type.

### Magic Resistant

**WFB:** the mutant has a +2 bonus to any magic saving throw; **WFRP:** the mutant has a +20 bonus to all *Magic* tests.

### Magician

The mutant is granted magical powers. **WFB:** it becomes a level 1 Chaos Sorcerer or Beastman Wizard as appropriate; **WFRP:** it becomes an Initiate Chaos Sorcerer or Beastman Wizard as appropriate. It has D3 spells. Ignore this result if the mutant is already a spellcaster, or is *Mindless* or *Moronic* - do not reroll.

### Mane Of Hair

The mutant has an enormous mane of hair, like a lion or a horse. While this looks bizarre, it has no effect on its profile or fighting characteristics.

### Manic Fighter

The mutant *bates* any enemy regiment or figure that comes within 12"/24 yards of it. **WFB:** it need never make a *Rout* test as a result of hand-to-hand combat; **WFRP:** it can never be forced to leave combat.



**Manikin**

This unusual Chaos mutation causes the facial features of the mutant to atrophy, until only the mouth is functional. Meanwhile, a miniature upper body, complete with arms and head, grows from the top of the redundant forehead. **WFRP**: 25% of head hits are on the manikin, which has 10% of the mutant's **W** points; the mutant cannot survive the destruction of the manikin.

**Massive Intellect**

The mutant's intelligence is enhanced: **Int** +2/+20.

**Mechanoid**

The mutant has metallic mechanical parts substituted for some or all of its natural limbs and organs. Roll D6 to determine the extent of the mutation:

- 1-3 Completely mechanical - the mutant is a 'Robot'; roll D6 again for mode of locomotion:
  - 1-4 'Normal' limbs
  - 5 Wheels
  - 6 Tracks

You should decide for yourself what the effects of this will be. For example, a mutant with wheels will not be able to climb stairs, whereas a mutant with tracks might, although neither will be able to climb over a wall.

- 4-6 Partially Mechanical - D4 bodily parts are mechanical: roll D10 to determine which:

1	Head	<b>A</b> +1, <i>bite</i> attack.
2	Body	<b>T</b> +2.
3-5	Arm	Equal chance of either. <b>S</b> +2, <b>WS</b> +1/+10, affected arm only.
6-7	Hand	Equal chance of either. <b>S</b> +2, <b>Dex</b> +20, affected hand only.
8-0	Legs	<b>M</b> +1. Optionally, roll D6 on the table above to determine if the mutant is wheeled or tracked.

Metal parts count as armour. **WFB**: if the mutant is completely mechanical, it has an armour saving throw of 4, 5 or 6; if it is partly mechanical, it has an armour saving throw of 5 or 6. **WFRP**: the mutant has 2 Armour Points on each mechanical location, and may only be killed by a blow to the head or body - critical hits to other locations are not fatal, and the critical effect descriptions may have to be amended accordingly.

**Mercreature**

Instead of legs/rear legs the mutant has a fish-like tail. It is also equipped to breathe underwater if necessary. The mutant is able to move through water at its normal movement rate.

**Metal Body**

The mutant is made up of living metal. It is immune to non-magical weapons, and there is a 50% chance that any non-magical edged weapon striking it will shatter. It is also immune to the effects of heat and cold, and takes no damage from attacks based on fire or cold. Electricity-based attacks cause double normal damage.

**WS** x ½, **BS** x ½, **S** +3, **T** = 7.

**Mindless**

The mutant becomes a total automaton, doing no more than obeying the commands of whoever currently holds sway over it. It is immune to all psychology rules, and cannot be forced to leave combat. When this mutation is gained, the mutant can no longer lead a group, and command passes to the next most able individual. **Int** = 0.

**Moronic**

The mutant is subject to *stupidity*, and must make a **CI** test whenever trying to do anything that requires the least thought; fighting, running, going through a doorway, etc. **Int** -2/-20.

**Multiple Arms**

The mutant grows extra arms. Roll D6 to determine how many:

1	One
2-4	Two
5	Three
6	Four

**A** +1 per extra arm. An arm may be used to carry a shield or a weapon - no mutant may carry more than two shields. **WFB**: each shield reduces the mutant's armour saving throw by 1; **WFRP**: a shield counts as 1 Armour Point on each body area, as explained on p121 of the rulebook - a mutant carrying two shields has 2 AP on all body areas, in addition to any armour worn.

**T** +½ per extra arm.

**Multiple Heads**

The mutant grows one or more extra heads. Roll D6 to determine how many:

1-5	One
6	Two

Roll D6 again for each new head to determine species:

1-3	Mutant's original species
4-5	Other Humanoid (Dwarf, Elf, Goblin, Orc, etc.)
6	Animal (see <i>Bestial Face</i> above)

If two or more heads are subject to *animosity* against each other, or if one or more heads are subject to *stupidity*, the mutant must make a **WP** test at the start of any combat or in any other stressful situation; failure indicates that the mutant will stop and argue with itself until a successful **WP** test is made to bring the heads back into accord with each other. It may perform no other action during this time, but may attempt the test every turn/round until successful. At the GM's option, a particularly serious failure of the test may result in two or more heads attacking each other.

When the heads are working together, the mutant will have at least as many weapon attacks as it has heads. **T** +½

**Multiplication**

The mutant may duplicate itself by splitting into two or more entities for a limited time. This will only occur during periods of stress; when the mutant is within 12"/24 yards of an enemy, if it rolls 6 on a D6 it will split into D6 smaller beings.

Each duplicate will be proportionately smaller than the original mutant, with its *Strength* and *Wounds* proportionately divided, subject to a minimum score of 1. The rest of the profile remains the same. For example, a mutant with **S**3 and **W**3 splits into three; each duplicate will have a profile identical to the mutant's original profile, except that **S** and **W** will both be 1.

The duplication lasts for D6xD6 turns; at the end of this time the replicas are re-united at a point equidistant, as far as possible, for all of them. As long as at least one replica survives, the mutant will be restored to its original size and health.

**One Eye**

The mutant has a single huge eye, like a cyclops. **BS** x ½, owing to lack of depth perception.



**Overgrown Body Part**

One or more parts of the mutant's body become overgrown. Roll D10 to determine which part is affected, then roll D3 + 1 to determine the extent of the growth.

The following table lists the changes to the mutant's profile. Note that no characteristic may drop below 1.

D10	Part	Growth	M	WS	S	T	W	I	A
1	One Arm	x2	-	+1/+10	+1	+½	+½/+3	-	-
		x3	-	-	+1	+½	+½/+3	-1/-10	-1
		x4	-1	-1/-10	+1	+1	+½/+3	-2/-20	-1
2	All Arms	x2	-	+1/+10	+1	+½	+½/+3	-1/-10	-
		x3	-1	-	+1	+1	+½/+3	-2/-20	-1
		x4	-1	-1/-10	+2	+1	+1/+6	-4/-40	-1
3	One Leg	x2	x½	-1/-10	-	+½	+½/+3	-2/-20	-
		x3	x½	-2/-20	-	+½	+½/+3	-4/-40	-
		x4	x½	-2/-20	-	+1	+½/+3	-5/-50	-
4	All Legs	x2	x1½	-	-	+1	+½/+3	+1/+10	-
		x3	x2	-	-	+1	+1/+6	+2/+20	-
		x4	x3	-	-	+1	+1/+6	+2/+20	-
5	Head	x2	-	-	-	-	-	-	-
		x3	-	-	-	-	+½/+3	-2/-20	-
		x4	x½	-1/-10	-	+½	+1/+6	-4/-40	-
6	Hand	x2	-	-	-	-	-	-	-
		x3	-	-	-	-	-	-	-
		x4	-	-1/-10	+1	+½	+½/+3	-½/-5	-
7	All Hands	x2	-	-	-	-	-	-	-
		x3	-	-	+½	-	+½/+3	-	-
		x4	-	-1/-10	+1	+½	+1/+6	-	-
8	Foot	x2	-½	-	-	-	-	-2/-20	-
		x3	-1	-	-	-	-	-4/-40	-
		x4	-2	-	-	+½	+½/+3	-5/-50	-
9	All Feet	x2	-	-	-	-	-	-1/-10	-
		x3	-½	-	-	+½	+½/+3	-2/-20	-
		x4	-1	-	-	+1	+½/+3	-3/-30	-
10	Torso	x2	x½	-	-	+½	+½/+3	-	-
		x3	*	-	-	+½	+1/+6	-1/-10	-
		x4	*	-1/-10	-	+½	+1/+6	-3/-30	-

**Notes:**

Where one arm or hand is affected, **WS** and **S** adjustments apply to that arm only, and **A** adjustments apply only if it is the mutant's normal weapon arm.

Mutants with one overgrown leg hop at half their normal movement allowance, and may not charge.

\* Mutants with a heavily overgrown torso (x3 or x4) may only move on all fours, at three-quarters of their normal movement allowance.

**Pin Head**

The mutant has a tiny head, out of all proportion to the size of its body. It becomes *Moronic* (qv).

**Plague Bearer**

The mutant carries a vile disease - *Nurgle's Rot* in the case of followers of Nurgle, otherwise the GM should determine its characteristics. **WFB**: It might require an infected character or unit to make a **T** test at the beginning of each turn/round, losing 1 **T** or 1 **W** on each failed test, or have some other effect of your own devising; **WFRP**: you might select one of the diseases detailed on pp 82-3 of the rulebook, or design your own.

The chances of infecting a hand-to-hand combat opponent are as follows:

Bite attack:	80%
Claw attack:	60%
Weapon attack:	40%
Other close combat:	20%
Coming within 2¼ yards:	5%

Once it has been determined that a victim has been infected, it is allowed a **T/Disease** test to resist the infection. The mutant's companions will normally be immune to the disease.

**Pointed Head**

The mutant's head rises to a sharp point. A helmet which is part of a set of Chaos Armour will change to accommodate this; other helmets must be made specially. **Int** -1/-10.

**Poisonous Bite**

The mutant's bite is *poisonous*, and should be treated as the bite of a Giant Snake. If the mutant did not previously have a *bite* attack, it gains one, at **S1**.

**Powerful Legs**

The mutant is equipped with powerful legs, like those of a kangaroo or rabbit. It may make normal move, and then leap half as far again. It may leap over man-size or smaller troops and obstacles.

**Prehensil Tail**

The mutant grows a prehensile tail, capable of wielding an additional hand weapon or shield. **A** +1

**Pseudo-Demonhood**

The mutant gains all the physical advantages of Demonhood, but none of the magical abilities.

**Puny**

The mutant shrivels to one-quarter of its original weight, and its muscles wither almost to nothing.

**S** and **T** are reduced to one-quarter of their original values, rounding fractions down, subject to a minimum score of 1 in each characteristic.

**Quadruped/Biped**

If the mutant is a biped, it becomes a quadruped. If it is a quadruped, it becomes a biped. If a biped has more than two arms, there is a 50% chance that only two of them will become legs, leaving one or more arms free to manipulate weapons and tools. A quadruped's forelegs become arms with manipulative hands. This will affect the mutant's **A** and **Dex** scores; the extent to which they are affected is up to the individual GM. For example, a mutant with no arms can have no **Dex** score, and may not make weapon attacks.

**Rapid Regeneration**

The mutant has regenerative powers (see *Regeneration* below) at greater than normal rate. **WFB**: roll twice to regenerate; **WFRP**: regain 2 **W** per turn.

**Razor Sharp Claws**

The mutant grows long, sharp claws, which count as hand weapons for combat and strike at the mutant's **S** +1. It may not be disarmed.

**Rearranged Face**

The mutant's face is completely rearranged. Possibilities include: mouth and eyes change places; mouth in forehead; whole face upside-down; mouth vertical with one eye and one nostril on either side.

**Regeneration**

The mutant has the same regenerative powers as a Troll. See the respective rulebooks for details.

**Rotting Flesh**

The mutant's flesh hangs from its body in rotting and putrescent fronds. While this looks horrific, the mutant's profile is not affected.

**Scaly Skin**

The mutant has reptilian scales instead of normal skin. **WFB**: +1 to armour saving throws; **WFRP**: 0/1 AP on all locations, as leather armour.

**Scorpion Tail**

The mutant grows a scorpion tail, allowing it an extra attack to the front and sides only. Roll D6:

1-2	Non-Poisonous	Counts as additional <i>weapon</i> attack;
4-6	Poisonous	<i>Tail</i> attack, <i>poisonous</i> , front only, as Manticore.

**A** +1

**Short Legs**

The mutant's legs shrink to half their normal size. **M** x ½

**Shrink**

The mutant shrinks; roll D6 to determine the extent of the size reduction:

1-2	half original size
3-4	one-third original size
5-6	one-quarter original size

The effect on the mutant's profile is as follows:

Shrinkage	M	S	T	W	I
Half	x2/3	x2/3	-	x2/3	+1/+10
One-third	x½	x½	-	x½	+2/+20
One-quarter	x1/3	x1/3	-1	x1/3	+3/+30

No characteristic may fall below 1.

**Siamese Twin**

The mutant becomes two joined entities. Each has its own profile, and subsequent mutations are rolled for each independently. If either twin is killed, both will die. If either twin gains the mutation *Duplication* there is a 50% chance that the twins will be separated, becoming fully independent of each other.

Roll D6 to determine how the twins are attached:

1-3	Back to back	Mutant cannot be attacked from the rear. No <i>tail</i> attacks possible.
4-6	Side by side	Twins have only the same number of arms as the original mutant.

**M** x ½ for both types of mutant.

**Silly Voice**

The mutant's voice changes, becoming squeaky, stuttering, trumpeting, honking or otherwise unusual and open to ridicule. This has no effect on its profile or abilities.

**Silly Walk**

An extreme mannerism in the mutant's perambulatory technique endows it with a ridiculous gait. **M** -1.

**Skull Face**

The flesh of the mutant's face dissolves, leaving a skull. While this mutation presents a horrifying appearance, it has no effect on the mutant's profile.

**Snake Tail**

The mutant grows a tail which ends in a snake's head. The mutant gains a *tail* attack (**S** 1). There is a 50% chance that the snake's bite is *poisonous*, like that of a Giant Snake.

**Spits Acid**

The mutant may *spit acid* at any time rather than making a *bite* attack. It may spit acid up to 5/10 yards, using **BS** to determine whether the acid has hit. If successful, the attack causes one **S3** hit, and the victim

must make a successful **I** test (+2/+20 bonus for a closed helmet) or be blinded. **WFB**: Victims are blinded on a D6 roll of 4, 5 or 6.

**Subject To Alcoholism**

The mutant becomes subject to *alcoholism* - **WFRP** only.

**Subject To Fits**

The mutant becomes subject to *fits* brought on by stressful situations. Whenever it is in melee and is fired upon, or is within 12"/24 yards of anything it *fears*, there is a 10% chance of a seizure taking place. While the mutant is suffering from a fit, it can do nothing but lie on the ground twitching and frothing (**WFRP**: *prone* target). Roll D100 to see how long the fit lasts:

01-50	1 turn
51-75	2 turns
76-85	D3 turns
86-95	D6 turns
96-00	D10 turns

**Suckers**

The mutant's limbs and body become covered in powerful suckers. In any round where a hand-to-hand combat opponent fails to hit it (regardless of whether or not it is wounded), the mutant may attach itself by making a normal attack roll. Once attached, it has a bonus of +2/+20 to its **WS**, and its opponent suffers a similar penalty. The mutant will be detached by any wounding hit.

**Tail**

The mutant grows a long tail. Chaos Armour will change to accommodate this; other armour must be adapted or specially made. The tail has no effect on the mutant's profile and abilities.



**Technology**

The mutant's **Int** is increased by +2/+20, subject to a maximum of 10/100 and a minimum of 6/21, and it gains a strange, obsessive aptitude as a mechanic. Given the nature of a Chaos Creature's lifestyle, this gift will inevitably be directed towards the manufacture of weaponry.

Roll D6 to determine the level of technology available to the mutant:

D6	Level	Typical Weapons
1-2	Black Powder	Musket, Pistol, Blunderbuss, Bombard.
3	Early Metal	Revolver, Breech loading rifle, Cartridge Shotgun, Cased-shell field gun.
4	Late 20th Century	Machine gun/sub-machine gun, missile launcher, grenade, flame thrower, automatic pistol.
5-6	Future	Bolter, Laser and Blast weapons, etc.

The mutant and any followers will be suitably armed and equipped. The exact nature of any weapons may be determined by the GM. Rules for black-powder weapons can be found in the respective rulebooks. Rules for futuristic weaponry can be found in the **Warhammer 40,000** battle rules.

**Telekinesis**

This power permits the mutant to move small, inanimate objects by force of will alone. The mutant may perform no other action while using telekinesis.

The range of the effect is  $D4 \times D6''/D4 \times D6 \times 2$  yards, and this power is most commonly used for the remote control of weapons. The telekinetic mutant may do nothing else (even walk) while operating a weapon, and the weapon fights with half the mutant's **WS** and with a **S** calculated as follows:

**WFB:** Mutant's **Int** minus twice the range in inches;

**WFRP:** Mutant's **Int** minus range in yards.

Mutants larger than man-size may use telekinesis to pick up rocks and drop them on victims, using the rules for stone throwing machines in **WFB**. Any Telekinetic may drop sharp objects on victims, counting as a long bow firing at *short* range, and using half the mutant's **BS**.

**Teleport**

The mutant has a teleport ability; roll D6 to determine its nature:

1-4	Teleport Self
5	Teleport Others
6	Teleport Self and Others

**Teleport Self:** allows the mutant to teleport itself and anything it is holding/carrying up to  $D6 \times D6''/D6 \times D6 \times 2$  yards at will. It may not teleport any other living creature, except a familiar.

**Teleport Other:** allows the mutant to teleport any single creature or object within  $D3''/D3 \times 2$  yards up to a distance of  $D6 \times D6''/D6 \times D6 \times 2$  yards. Creatures who do not wish to be teleported may make a **WP** test to resist the effect. The victim may not be teleported into mid-air or into a solid object.

The mutant may not perform any other action while using its teleport ability.

The mutant must make a successful **Int** test while using the ability; failure indicates a degree of inaccuracy. Roll D8 to determine the direction from the intended spot (1 = north, 2 = north-east, and so on), then calculate the distance as follows:

Failed by	Result
01-10	$D3''/D6$ yards out
11-20	$D6''/2 \times D6$ yards out
21-40	$2D6''/2 \times 2D6$ yards out
41 or more	$4D6''/2 \times 4D6$ yards out

**Tentacles**

The mutant's arms turn into tentacles. Roll D6 to determine how many are affected:

1	One arm
2-3	D3 arms
4-6	All arms

The tentacles may grip weapons normally, but do not permit the fine manipulation of objects (**WFRP:** **Dex** = 0).

**Temporal Instability**

The mutant becomes unstable in the dimension of time, and may 'skip' the time line. This may happen in one of two ways:

**Involuntary** Roll D6 every turn/round. On a roll of 6, the mutant disappears for D6 turns.

**Voluntary** Roll D6 every turn/round. On a roll of 6, the mutant disappears for D6 turns. The mutant may modify this roll by 1 point either way.

In both cases the mutant will reappear in the spot from which it disappeared. No time will have passed for it subjectively.

**Transparent Skin**

The mutant's skin becomes completely transparent, revealing its inner workings for all to see. While this looks bizarre, it has no effect on the mutant's profile or fighting ability.

**Uncanny Resemblance**

The mutant's facial features and, to whatever extent is practical, the rest of its physical characteristics resemble a member of your gaming group, or some other friend or associate (Mum, Dad, Wife, Boss - whatever), or anyone you like. This has no effect on its profile or abilities, unless the GM rules otherwise.



**Vampire**

The mutant becomes a kind of Vampire, requiring meals of human blood in order to survive. It starts its vampiric existence with 6D6 Magic Points, and must expend 10 points per day in order to remain active. Each **W** point of blood taken from a victim replenishes 1 Magic Point. The mutant does not have any of the other special powers or weaknesses of a Vampire.

**Very Agile**

The mutant becomes extraordinarily agile - **I** +1/+10.

**Very Fast**

The mutant becomes very quick on its feet, or wheels, or tentacles, or... **M** +1.

**Very Resilient**

The mutant is very resilient. **T** +1.

**Very Strong**

The mutant is very strong. **S** +1.

**Very Warty Skin**

Every inch of the mutant's body is covered in warts. **WFB:** +1 to armour saving throws; **WFRP:** 0/1 AP on all locations, as leather armour.

**Vividly Coloured Skin**

The mutant's skin or pelt is coloured in some exceptionally vivid shade, such as bright purple, pink, orange, or electric blue.

**Walking Head**

The mutant has no body; its limbs being attached instead to its oversize head. **WFB**: this does not alter the mutant's profile or fighting ability; **WFRP**: treat all body hits as head hits. Chaos Armour will change to accommodate this mutation; other types of armour must be adapted or specially made.

**Warp Frenzy**

*Fear Points* 5 when warped.

The mutant is subject to *frenzy*. When it goes into *frenzy*, roll 5 + D6 extra mutations - the mutant will warp into this new form, reverting to its usual form when the frenzy ends.

**Weapon Master**

The mutant develops a high degree of skill with one favourite weapon. **WS** or **BS** +6/+6D8 with *one* weapon, subject to a maximum of 10/100.

**Wings**

The mutant grows a pair of wings - equal chance of feathered or membranous.

Roll D6 to determine the size of the wings:

1-2	Small
3-4	Medium
5-6	Large

Small wings cannot be used to fly.

Medium wings allow the mutant to fly - with a minimum speed of 0" maximum of 24" for membranous wings, and with a minimum speed of 6" maximum speed of 32" for feathered wings.

Large wings allow normal flight, as above, but are cumbersome on the ground; they trail in the dirt, get clogged with mud and can trip the mutant up. **M** x ½ for ground movement; movement through woods becomes impossible, and **M** = 1 for movement in buildings or other confined spaces.

**Zoological Mutation**

One or more parts of the mutant's body become bestial; roll D6 to determine how many:

1-4	1 Part
5	2 Parts
6	D6 Parts

Next, roll D100 to decide which part or parts are affected:

01-07	Head	47-49	Pair of Arms
08-10	Torso and Arms	50-56	One Arm
11-13	Torso and Head	57-63	Hand
14-16	Torso, Head and Arms	64-66	Finger
17-23	Face	67-73	Mouth
24-26	Lower body and Legs	74-76	Nose
27-29	Pair of Legs	77-83	Eye
30-36	One Leg	84-90	Pair of Eyes
37-43	Foot	91-93	Ear
44-46	Toe	94-00	Tail

Finally, roll D100 again for each part to determine the 'donor' species:

01	Ant	56-57	Lizard
02-05	Ape	58-59	Octopus
06-10	Bat	60-61	Owl
11-15	Bear	62-65	Rabbit
16	Beetle	66-75	Rat
17-20	Boar	76-77	Raven
21-25	Bull	78	Scorpion
26-27	Deer	79-90	Sheep/Goat
28-35	Dog/Wolf	91	Snake
36-37	Dragon	92	Spider
38-40	Eagle	93-97	Tiger
41-42	Frog	98	Toad
43-50	Horse	99-00	Weasel
51-55	Lion		

*Fear Points* 1 per mutated part.

You will have to develop your own rules and profile modifications for the resulting hybrid, taking into account the body areas affected and the species involved. Some of the other mutations, such as *Bestial Face*, *Bird's Feet*, *Feathered Hide*, *Furry*, *Mace Tail*, *Powerful Legs*, *Prehensile Tail*, *Razor Sharp Claws*, *Scaly Skin*, *Scorpion Tail*, *Suckers*, *Tail*, *Tentacles* and *Wings* may be useful for reference when doing so.

**Invent Your Own**

This space has been left for you to fit mutations of your own design into the table. If you do not wish to design any mutations of your own, ignore this result and roll again.



**CHAOS IN THE FORTY-FIRST MILLENNIUM**

During the thirty-first millennium, ten thousand years ago, the Emperor faced and defeated the forces of Warmaster Horus after a long and bloody conflict referred to by historians as the Inter-legionary Wars. Space Marine battled Space Marine for control of the human occupied galaxy. In the end the Emperor won, although he was so severely weakened that he was rendered physically immobile. Warmaster Horus, once the most trusted of all the Emperor's servants, was banished together with his rebel legions (now termed the *Treachers Legions*).

Horus and his followers were forced to flee into a volatile region of the galaxy known as the Eye of Terror. In this zone the forces of Chaos swirled in constant warp-storms light years across: energies battling energies in an eternal struggle for dominance. Although star systems do exist within the Eye of Terror, travel between them is almost impossible. Only once every few hundred years do the forces of Chaos subside sufficiently to allow spacecraft to move within, into and out from the zone. This hellish region seemed an appropriate place in which to exile Horus and his minions.

But just as the Eye of Terror held the Treacher Legions, so it protected them from the wrath of the Emperor. Exposed to the full wrath of Chaos, the descendants of Horus's followers became horribly twisted. When renegades from human space fled to the Eye of Terror, braving the warp-storms in search of sanctuary. What they found was a realm of writhing madness, where the Chaos-nurtured flaws of humanity had become elevated into a heinous ideal.

Today the Eye of Terror harbours many horrible secrets. The Treacher Legions have been extinct for millennia, but they have spawned other legions of imitators: warriors whose appearance apes that of the Legionnaires Astartes, but whose armour masks a corruption of the body no less disgusting than that of their sickening minds. Just like the original Treacher Legions, these Chaos renegades nurture a deathless hatred of the Emperor and humanity. They look forward to nothing less than the destruction of mankind, and especially of the Space Marines, and to occasions when the warp-storms temporarily abate, allowing the filth of Chaos to spill upon the galaxy.

Just to remind you, we'd like to hear your thoughts on all of this (and see your mutants). The address to write to is: *On The Boil*, White Dwarf, Games Workshop Design Studio, Enfield Chambers, 14-16 Low Pavement, Nottingham NG1 7DL. Next month, OTB will be back in its usual format - as if by magic...

# WARHAMMER

## CHAPTER 40,000 APPROVED

WELCOME TO THE FIRST COMPANION VOLUME TO THE WARHAMMER 40,000 GAME - GUARANTEED MORALLY PURE BY THE IMPERIAL INQUISITION! CHAPTER APPROVED - THE BOOK OF THE ASTRONOMICAN CONTAINS 96 PAGES PACKED WITH NEW INFORMATION, RULES, MODEL UPDATES AND A COMPLETE SCENARIO FOR WH40K, THE WOLF TIME. WHITE SCAR MARINES, DRK DROP LEGION, THE IMPERIAL ARMY AND ELDRITCH RAIDER ELДАР PIRATES ALL FEATURE IN OUR OFFICIAL WH40K ARMY LISTS TOGETHER WITH FULL DETAILS OF THEIR EQUIPMENT AND POINTS VALUES. JOIN IN OUR FREE-TO-ENTER WH40K COMPETITION AND WIN A VERY SPECIAL PRIZE! (NOT FOUR DAYS IN A SAUNA WITH THE GAMES WORKSHOP SALES TROLLS...HONEST). PLUS, CHAPTER APPROVED HAS A COMPLETE ILLUSTRATED LISTING OF EVERY MODEL MADE FOR THE WH40K GAME, INCLUDING MANY NEW ONES.

REJOICE FOR THE EMPEROR IS GENEROUS!



£6.99

## BOOK OF THE ASTRONOMICAN

**GAMES WORKSHOP**

Available from all good games and hobby stockists, or in case of difficulty direct from: Citadel Miniatures, Chewton Street, Hilltop, Eastwood, Nottingham, NG16 3HY.  
US customers please contact: Games Workshop US, 1220 Key Highway, Baltimore, Maryland, 21230.

FOR ACCESS & VISA ORDERS RING THE MAIL-ORDER HOTLINES ON (0773) 713213/760462



# CURSE OF THE MUMMYS TOMB

Hidden within the labyrinthine passageways and rooms of the deadly Pyramid of Khonsu is a fabulous treasure - the Elixir of Life. Whoever can find it is sure of ever-lasting youth and health. But for the many who attempt its discovery, there is death and terror to be encountered, for Khonsu was never one to leave his secrets unguarded.

In this fast-playing, tense and visually compelling game, one to four players can pit their wits against the fiendish Pyramid. Just moving towards your goal is difficult enough, for you can never be sure about heading in the right direction, thanks to a dastardly sneaky card-based movement system. And, as you explore, you will encounter the defenses of the Pyramid - deadly traps and awesome monsters.

And, most dangerous of all, there is the Mummy! Slowly it will hunt you down, stalking its victims relentlessly through the passageways.

Can you reach the Elixir of Life? Look out for the special sarcophagus bearing the words CURSE OF THE MUMMY'S TOMB in your local games shop, and prepare to step inside...

## Contents

- 3D playing board (to be assembled - the work of a few seconds)
- Over 100 playing cards in glorious Egypto-colour.
- 5 metal miniatures - Four for the players, and one for He-Who-Stumbles-Around-in-Bandages.
- A4 sheet of playing counters.
- 2 booklets; the simple rules and the MUMMY'S TOME which shows how the Special Cards work.

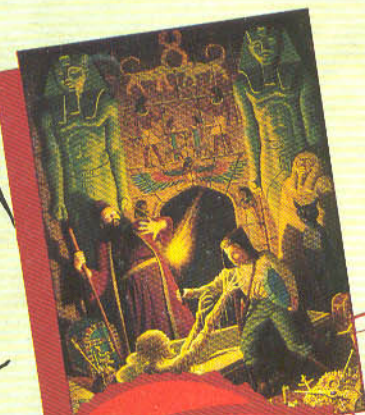

**£14.99**  
AVAILABLE  
LATE MARCH



**GAMES WORKSHOP** <sup>TM</sup>

Available from all good games and hobby stockists, or in case of difficulty, direct from: Games Workshop, Chewton Street, Hilltop, Eastwood, Nottingham, NG16 3HY. US customers please contact: Games Workshop US, 1220 Key Highway, Maryland, Baltimore, 21230, USA. Please note postage and packing charges when ordering direct: UK, BFPO & EIRE: Minimum order £5.00. Order value under £15 please add £1.00 P&P. Order value £15 and over, post free. Overseas (surface): Minimum order £10, add 33% P&P. Overseas (airmail): Minimum order £10, add 40% P&P.

For Access and Visa orders, ring the Mail Order Hotlines on (0773) 713213/760462

