

**GAMES
WORKSHOP**

NEW WARHAMMER 40,000 SPACE MARINE RHINO!

WHITE DWARF

- INDEX ASTARTES:
BLACK LEGION
- THE HORUS HERESY
- SKAVEN VS EMPIRE
WARHAMMER
BATTLE REPORT

FEATURING

THE
**LORD
OF THE
RINGS**

THE FELLOWSHIP
OF THE RING

WD268 APRIL £3.50

GAMES WORKSHOP'S MONTHLY GAMING
SUPPLEMENT & CITADEL MINIATURES® CATALOGUE



WWW.GAMES-WORKSHOP.COM

WHITE DWARF

268 April 2002

Printed at Artisan Press, England

EDITORIAL

Editor: Paul Sawyer

Contributors: Gavin Thorpe, Andy Chambers, Pete Haines, Graham McNeill, Phil Kelly, Graham Davey, William King, Kevin J. Coleman, Alessio Cavatore, Space McQuirk, Dan Abnett, Anthony Reynolds and Andy Hoare.

PRODUCTION

Production Editor: Graham Davey

Designer: Matthew Hutson

Design Team: Paul Rudge, Tom Hibberd and Gary Roach.

ARTWORK

John Blanche, Adrian Smith, Alex Boyd, David Gallagher, Nuala Kennedy, Paul Dainton, Neil Hodgson, Karl Kopinski and Stefan Kopinski.

CITADEL DESIGN TEAM

Jes Goodwin, Brian Nelson, Juan Diaz, Colin Dixon, Aly Morrison, Alan Perry, Michael Perry, Trish Morrison, Mark Harrison, Alex Hedström, Colin Grayson, Dave Andrews, Tim Adcock, Gary Morley, Adam Clarke, Mark Bedford and Martin Footitt.

'EAVY METAL TEAM

Chris Smart, Neil Green, Mark Jones, Keith Robertson, Kirsten Mickleburgh, Tammy Haye, Darren Latham and Sebastian Perbert.

GAMES WORKSHOP MAIL ORDER

Webstore: www.games-workshop.com

Tel: 0115 91 40000

Fax: 0115 916 8002

E-mail: motroll@games-workshop.co.uk

GAMES WORKSHOP ON-LINE

www.games-workshop.com

GAMING CLUB NETWORK

www.gamingclub.org.uk

Email: clubguy@games-workshop.co.uk

FORGE WORLD

www.forgeworld.co.uk

Tel: 0115 916 8177

Fax: 0115 916 8044

THE BLACK LIBRARY

www.blacklibrary.co.uk

SPECIALIST GAMES

www.specialist-games.com

GAMES WORKSHOP

Willow Road, Lenton, Nottingham, NG7 2WS

CONTENTS

REGULARS

- 2 New Releases**
All the latest goodies released this month.
- 6 Games Workshop News**
The world according to Games Workshop.
- 26 'Eavy Metal Masterclass: Thanquol and Boneripper**
How we painted this Skaven character.
- 48 Warhammer Chronicles (Warhammer)**
Discussing some of the many breeds of Goblin found in the Warhammer world.
- 58 Tactica Chaos Space Marines (Warhammer 40,000)**
Tactics for playing with Chaos Space Marines.
- 74 Index Astartes: Sons of Horus (Warhammer 40,000)**
The Black Legion Chaos Space Marines.



Iron Warriors Warsmith



The new Space Marine Rhino is unleashed on the battlefields of the 41st Millennium.

FEATURES

- 10 Rhino Assault (Warhammer 40,000)**
The new Space Marine Rhino rumbles in.
- 12 Rhino Concepts (Warhammer 40,000)**
How the new Rhino was brought into being.
- 18 Deathly Silence (Warhammer)**
A tale of the sinister Skaven.
- 22 Night Runners (Warhammer)**
How to prepare your Night Runners for war.
- 28 Assault on Holy Terra**
The battle for the Emperor's Palace.
- 36 Bitter and Twisted (Warhammer 40,000)**
The new Iron Warriors miniatures.
- 38 Abaddon the Despoiler (Warhammer 40,000)**
Scourge of the Imperium.
- 60 Ancient Threat (Warhammer 40,000)**
New Codex preview.
- 66 Specialist Games Range**
Games for the dedicated hobbyist.
- 68 The Dark Master (Warhammer)**
Who or what is this terrible being?



THE LORD OF THE RINGS

THE FELLOWSHIP OF THE RING

Starting on page 102, we put the new battlefield that we built last month to good use as the Fellowship are ambushed at Amon Hen.

Also in this issue is an expert guide to painting Isildur, Elendil, Gil-Galad and Elrond.



BATTLE REPORT

84 An Empire army is surrounded and outnumbered by an enormous horde of Skaven. Alessio Cavatore takes on Graham McNeill in this Last Stand battle.



REGISTERED TRADEMARKS The following are all registered trademarks of Games Workshop Ltd: Armageddon, Blood Bowl, Chivalry, Citadel, the Citadel logo, Codex, Dark Angels, Dark Future, Deathwing, Dungeonquest, Eavy Metal, Eldar, Eldar Attack, Epic, the Games Workshop logo, Games Workshop, the GW logo, The GW Flame logo, GamesTealer, Necron, Slottabase, SpacePleat, Space Hulk, Space Marine, Talisman, Tyrant, Warhammer and Warmaster.

TRADEMARKS A full list of Games Workshop trademarks can be found at the following Internet address:

<http://www.games-workshop.com/Legal/legal.htm>

COPYRIGHTS All subject matter in White Dwarf is © Copyright Games Workshop Ltd 2002. All artwork in all Games Workshop products, and all images contained therein have been produced either in-house or as work for hire. The exclusive copyright in the artwork and the images it depicts is the property of Games Workshop Ltd. © Copyright Games Workshop Ltd 2002. All rights reserved.

The Lord of the Rings, The Fellowship of the Ring and the characters and places therein, TM The Saul Zaentz Company d/b/a Tolkien Enterprises under license to New Line Productions, Inc. All Rights Reserved.

SUBMISSIONS All material submitted to us for publication is only accepted on the assumption that the copyright in it is, by the very act of submission, unconditionally assigned by the author as beneficial owner and with full title guarantee to Games Workshop Limited. We also retain the right to edit and/or amend all material as we see fit. So, if you do not wish to assign copyright in this way, please do not send us your submission. We're afraid we cannot work in any other way!

CORRESPONDENCE We welcome comments about White Dwarf, Games Workshop games and Citadel miniatures. All letters except subscriptions and Mail Order should be addressed to: The White Dwarf, Games Workshop, Willow Road, Lenton, Nottingham NG7 2WS.

Please mark your envelope clearly with the name of the game you are writing to us about. If you want a reply you must enclose a self-addressed stamped envelope (overseas readers should include IRCs). We receive an enormous amount of mail. We do read every letter but it may take a little time for us to reply to you, so please be patient!

You can find Games Workshop on the World Wide Web at the following Internet address:

<http://www.games-workshop.com>

EDITORIAL

THE RHINO IS DEAD, LONG LIVE THE RHINO!

This month sees the end of the line for one of the stalwarts of the Games Workshop hobby. For many years, the Space Marine Rhino has served the Imperium well and there can't be many hobbyists who haven't built and painted at least one of these tireless workhorses. However, the time has come for it to slip into the great STC graveyard in the sky.

Fear not! Wipe away those tears of nostalgia and rejoice! A brand new Rhino kit is here. Jes Goodwin and Tim Adcock have lovingly overhauled the look of the Imperium's most numerous Space Marine APC. The new model has been brought up to date and more in line with the Space Marine Land Raider. These two models have plenty in common – the Rhino mimics the Land Raider with an opening access door at the rear and a detailed interior. It also uses several of the same components making it very flexible for those who like to convert their vehicles.

Of course, this stunning new model has implications for the rest of the

Space Marine range too. As a standard template for many Imperial vehicles, the Rhino's makeover means you should keep your eyes peeled for a new Predator, Razorback, etc. Tim and Jes have already been working on these two variants and I can tell you they look fantastic! I've been lucky enough to get my hands on a Razorback which I'm painting up in White Scars livery...

Of course this month isn't solely the preserve of the new Rhino model.

The Imperium's nemesis also plays a starring role this issue. We have a feature on the Horus Heresy – the cataclysmic schism that tore the Imperium of Mankind apart. Prime participants in this rebellion were Abaddon and the Black Legion Chaos Space Marines and they also feature heavily this issue. Dreaded Chaos Space Marine player Graham Davey also gives some sound tactical advice for those tempted to forsake their heritage...

We also have TWO battle reports! The new Skaven in their inaugural battle report – a massive furry horde descends upon the remnants of an Empire army. And we also have a game set at Amon Hen as the Fellowship race against time and their Uruk-Hai ambushers in our latest battle report for The Lord of The Rings.

Believe me, this White Dwarf is packed so full that by the time you finish it, next month's will be on the shelves!

Paul Sawyer
Editor



Product Code: 60249999268
ISSN: 0265-8712 04

GREY SEER THANQUOL AND BONERIPPER £12.00

Gray Seer Thanquol and Boneripper are special characters and count as a single Lord choice, but will use up one of your Hero choices as well.

This boxed set contains both Grey Seer Thanquol and his guardian, Boneripper.

Designed by Jes Goodwin and Mark Harrison. These models require assembly.

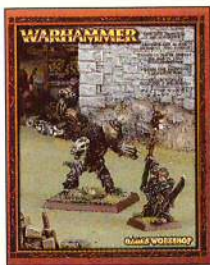

SKAVEN RATTLING GUN TEAMS £6.00

Stormvermin and Clanrat units may have one attached Rattling Gun team as an upgrade.

The blister pack contains one Rattling Gun team.

Designed by Colin Grayson. These models require assembly.



WARHAMMER MONTHLY 54 £2.50

Comic published by the Black Library.

In this issue of the all-action monthly... Bloodquest! With only the daemon-mark to guide them, Blood Angels Cloten and Lysander are going back into the Eye of Terror. Darkblade makes his play for the throne of Hag Graef. Meanwhile, the Vampire Helmar is reunited with an old love and Kal Jerico has a close encounter of an altogether more homicidal nature!

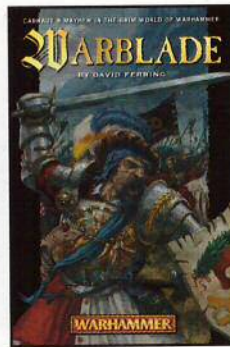

WARBLADE

£5.99

The concluding novel in the Konrad trilogy, by David Ferring.

Published by the Black Library.

Konrad is a man of destiny, linked to the eternal schemings of the Chaos Powers in ways he can neither understand nor escape. The mystery of his destiny plunges him into a new set of deadly adventures, aided by the Warblade, a mystical sword forged especially for his hand.

SKAVEN RAT OGRES

£8.00

Skaven Rat Ogres are a Special choice. A minimum unit consists of one Rat Ogre and one Packmaster.

The blister pack contains one Packmaster and one Rat Ogre model.

Designed by Mark Bedford and Jes Goodwin. These models require assembly.



SKAVEN WARLOCK ENGINEER £5.00

Warlock Engineers are a Hero choice.

This blister pack contains one Warlock Engineer model.

Designed by Colin Grayson.
This model requires assembly.

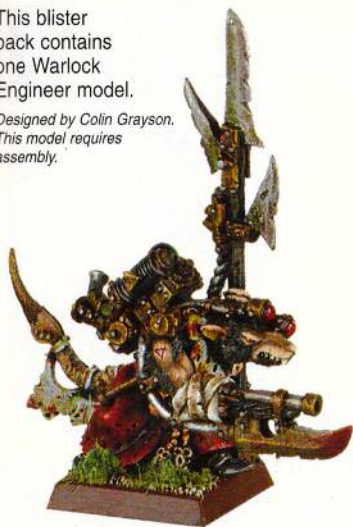

SKAVEN GIANT RATS £5.00

Skaven Giant Rat packs are a Core choice. A minimum unit consists of six Giant Rats and one Packmaster.

This blister pack contains six Giant Rats and one Packmaster model.

Designed by Colin Grayson and Jes Goodwin.



SKAVEN SCREAMING BELL £20.00

A Screaming Bell is an upgrade which may be taken by a Grey Seer.

This boxed set contains one Screaming Bell, with one crewman and one Grey Seer.

Designed by Colin Grayson and Dave Andrews.
This model requires assembly.

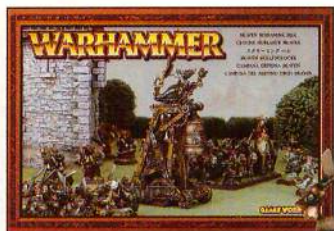

SKAVEN WARPLOCK JEZZAILS £6.00

Skaven Warplock Jezzails are a Special choice, with between three and ten models in a unit.

This blister pack contains one Warplock Jezzail team.

Designed by Colin Grayson. These models require assembly.



OR VISIT OUR ONLINE STORE AT WWW.GAMES-WORKSHOP.COM



SPACE MARINE RHINO £15.00

Space Marine Rhinos may be bought as an upgrade for Space Marine squads.

This boxed set contains parts to make one plastic Space Marine Rhino.

Designed by Tim Adcock and Jes Goodwin.
This model requires assembly.



CITADEL COLOUR SPRAY CANS

To help you get your new Space Marine Rhino ready for battle, we have re-released the following coloured sprays.

- | | |
|---|-------|
| 250ml Shadow Grey (for painting Space Wolves) | £4.00 |
| 250ml Dark Angels Green | £4.00 |
| 250ml Ultramarine Blue | £4.00 |
| 250ml Blood Angels Red | £4.00 |

IRON WARRIORS WARSMITH £6.00

Iron Warriors Warsmiths are independent characters and use up an HQ choice.

The blister pack contains one Iron Warriors Warsmith model.

Designed by Aly Morrison.
This model requires assembly.



IRON WARRIORS SQUAD £15.00

Iron Warriors Chaos Space Marine squads are a Troops choice, with five to ten models in a unit.

This boxed set contains enough parts to make eight Iron Warriors, including an Aspiring Champion, a meltagun and a lascannon-armed Chaos Space Marine.

Designed by Aly Morrison, Alex Hedström, Mark Harrison, Juan Diaz and Jes Goodwin. These models require assembly.



BATTLE GEAR

These items are available from Mail Order or the www.Battlegear.co.uk website, which also offers mouse mats, wallets, CD holders and paperweights.

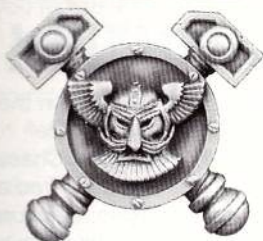

DWARF SHIELD

(Antique Pewter)

Megabadge A1531P £5.00

Keyring K1055P £5.50

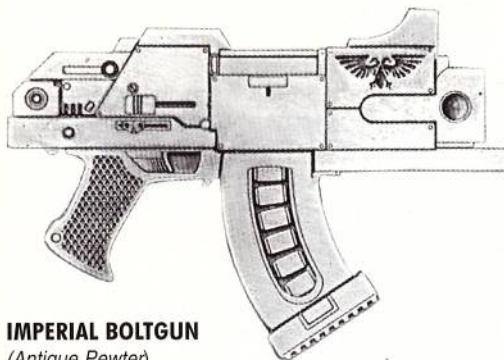

IMPERIAL BOLTGUN

(Antique Pewter)

Belt Buckle B1575P £13.50



SKAVEN SCREAMING BELL

(Antique Pewter)

Megabadge A1530P £5.00

Keyring K1055P £5.50

WARMASTER

WARMASTER DAEMON PRINCES £7.00

The complete rules for using Daemon armies in Warmaster are available in Warmaster Magazine issue 10.

This blister pack contains one Daemon Prince model.

Designed by Mark Bedford.
This model requires assembly.



The Daemon models shown here are only two of a fantastic new range of Warmaster Daemons available from Fanatic. Both these blister packs are available from Mail Order or through the Online Store on our website.

WARMASTER CHAOS SPAWN £7.00

The complete rules for using Daemon armies in Warmaster are available in Warmaster Magazine issue 10.

This blister pack contains two Chaos Spawn models.

Designed by Mark Bedford.
This model requires assembly.

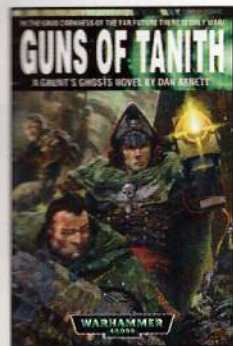

THE GUNS OF TANITH £5.99

The fifth explosive novel in the Gaunt's Ghosts series by Dan Abnett.
Published by the Black Library

Gaunt's Ghosts must take to the air in an all-out airborne attack on the Chaos-infested cities of Phantine. Yet in the midst of the carnage, one atrocity does not go unnoticed. Troopers are being murdered and the finger of guilt points squarely at one of Gaunt's own men.

INFERNO! 30

£5.00

All Gaunt special!
Published by the Black Library

The Month of Gaunt continues in Inferno! This is an essential issue for all fans of Commissar Gaunt and the Tanith Ghosts and will include all-new fiction from Dan Abnett, a brand-new Ghost comic strip, an in-depth guide to the Tanith First-and-Only and their campaigns in the Sabbat Crusade.

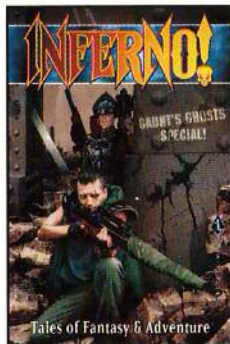

INQUISITOR

KAL JERICO

£15.00

This model allows you to use the legendary character Kal Jerico in your games of Inquisitor. The complete rules for using Kal Jerico in Inquisitor are available in the Exterminatus 2 magazine.

This boxed set contains enough parts to make one Kal Jerico model.

Designed by Alex Hedström.
This model requires assembly.



OR VISIT OUR ONLINE STORE AT WWW.GAMES-WORKSHOP.COM

AN ANCIENT ENEMY RETURNS

It's looking bleak for the Imperium as yet another threat begins to muster on the fringes of the galaxy! The forces of the Necrons are once again rising from their long-silent tombs.

The next Warhammer 40,000 book to be released will be **Codex Necrons**. The mysterious aliens are returning in force and are a bigger threat than ever.

Accompanying the Codex is a brand new miniatures range which has been sculpted with a more sleek and sinister look. The

Necron war machine is very different from anything that has gone before and really has to be seen to be believed.

As you can see from the piece shown here, the artwork really captures the feel of an ancient and deadly enemy returning to retake a galaxy that was once theirs!

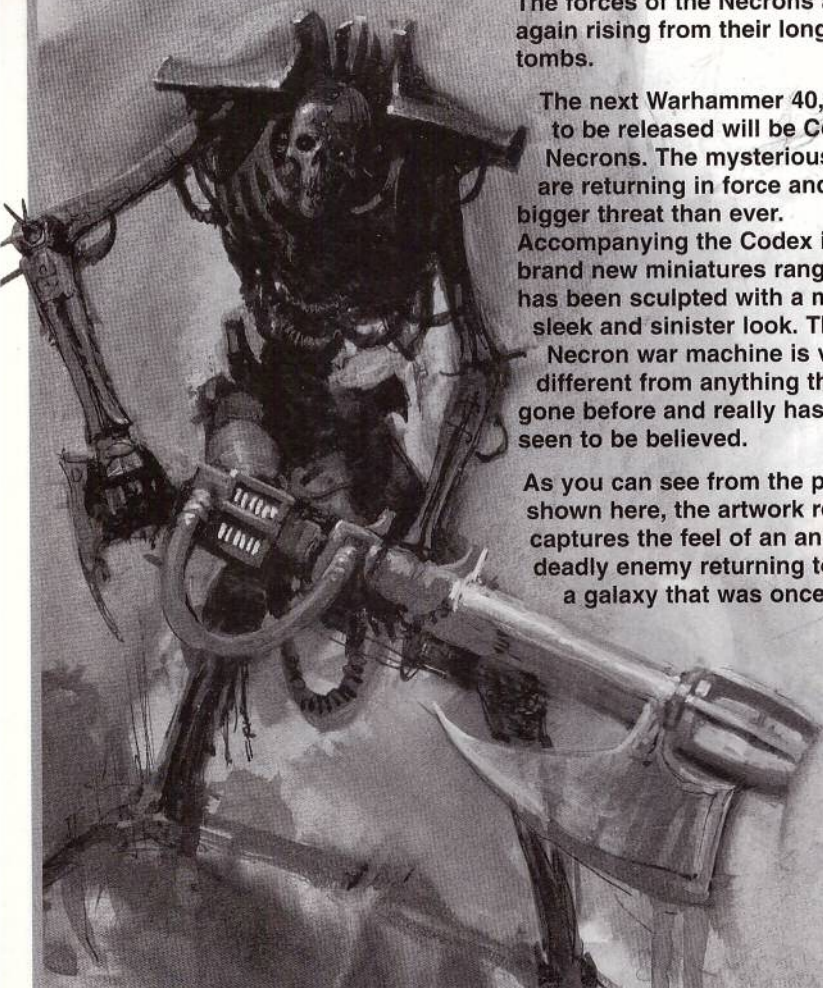

MARAUDERS SIGHTED!

Last month we reported on the progress of the Warhammer Armies Book, Hordes of Chaos. This month we can bring you a taste of the incredible miniatures range. The 'Eavy Metal team have been slaving away on the new Marauders of Chaos plastics in order to choose a colour scheme for the army. We've managed to prise a couple of the miniatures away from them.



GAUNT'S INFERNO

Artist Paul Jeacock has recently been working on a special project 'The Emperor Protects', an 8 page Gaunt's Ghosts comic strip written by Dan Abnett. The strip will appear in issue 30 of *Inferno!* which is a must for all Gaunt's Ghosts fans as the issue is dedicated to these heroes of the Imperium. In addition, after a long wait and a couple of false starts, the crazy Ork Fighta-Bomma pilots of Deff Skwadron will finally be returning to the pages of *Inferno!* in issue 31 – due out in July in the promisingly titled strip 'Catch the Squigeon'!



'Catch the Squigeon'

DEEP IN THE FOREST SOMETHING STIRS

Well, you asked for it and now it's almost here. In next month's White Dwarf Warhammer Chronicles we will be bringing you the Wood Elves preview army list. Written by Alessio Cavatore, the army list replaces the one in the Ravening Hordes booklet. As ever these preview lists are 'work in progress' and we'd like to hear what you think.

To the Wood Elves, their forest home of Loren is a sacred place. They guard it with all their strength and cunning, leading invaders to their doom in the darkest tangles of the thickest woods.

The Wood Elves of Loren are masters of the bow, and it is said that an Elven marksman can hit the eye of a Goblin in the dark.



Glade Riders react quickly to an Undead invasion.

PAGES FROM THE PORTAL

SKAVENTASTIC!

The Web team have been busy supporting the Skaven release. New on the website is a set of Skaven magic cards that, once printed, can be cut out and used as reference. Gareth Hamilton, a Skaven general of some renown, gives advice on sneaky underhand tactics, and there's also a feature on modelling Skaven terrain.

NECRON ART

To coincide with the Necron release, an art and concept gallery will soon be available to browse.

SPACE MARINE GALLERY

The Space Marine Gallery will soon be up and running. This will focus on the background of specific Chapters, rules and inspirational modelling ideas. The team are currently working on adding pages that focus on vehicles in particular.

www.games-workshop.com

ALL THINGS GREAT AND SMALL

It seems that there is no stopping the Forge World design team at the moment, as they are set to deliver some fantastic new additions to their already mammoth range. The sculpting of the new Tyranid Harridan has recently been finished and the proportions are quoted as being 'really big!' In contrast the new range of Epic Tau miniatures have just been finished by Will Hayes. The level of minute detail is awesome, even right down to the drones.



Epic Tau Battlesuits

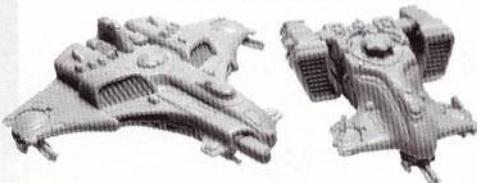

Epic Tau Barracuda and Devliffish

BULLET POINTS

- Warhammer generals in the Studio are currently busy plotting, scheming and creating treacherous alliances as a new map-based campaign gets under way. The strategies, various armies and general progress of this massive campaign will be followed up on the website. White Dwarf's Matt Hutson has won his first two games with his Dark Elf army, and is currently playing a third against Graham McNeill's Empire.
- Artist Paul Dainton is currently sketching some early Khemri designs. Meanwhile, Undead chariots can regularly be seen racing across the Games Development playtest table.
- The 'Eavy Metal team has just started painting a new Black Legion Chaos Space Marines army.
- After putting the finishing touches to Codex Necrons, the Warhammer 40,000 Games Development team have just started work on their next project, the promisingly titled Codex Daemonhunters.
- Designer Colin Grayson has been sculpting the new Skeleton plastic regiment sets for Khemri. Rumour has it that he's finished and is about to move on to other models in the Khemri range.
- Anthony Reynolds' Chaos Warband campaign has started in the Studio. It's early days yet but numerous warbands have already been battling it out at lunchtimes and after work. We'll bring you more on this in future issues . . .

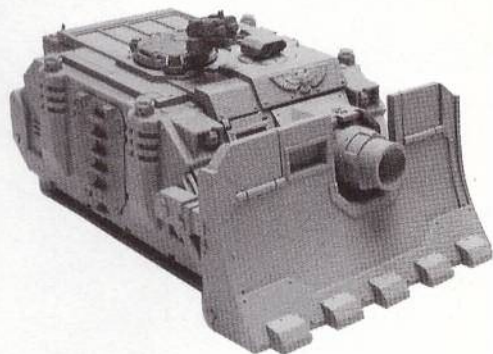

As you might have guessed by now, this month we are releasing a new version of the Space Marine Rhino. But what about the variants? Well, already in production are the Predator and Razorback. Whilst the Whirlwind and Vindicator will follow in a year or so. In the meantime, Forge World are gearing up to produce Rhino conversion kits for these two variants. The Whirlwind is ready, and we managed to get hold of some early pictures of the very scary looking Vindicator.

SPACE MARINE RHINO





WARHAMMER
40,000

Here in all its glory is the new Space Marine Rhino, released this issue. It comes complete with a host of exciting features such as moving doors and a fully detailed interior.

RHINO ASSAULT!

The new Space Marine Rhino rumbles in

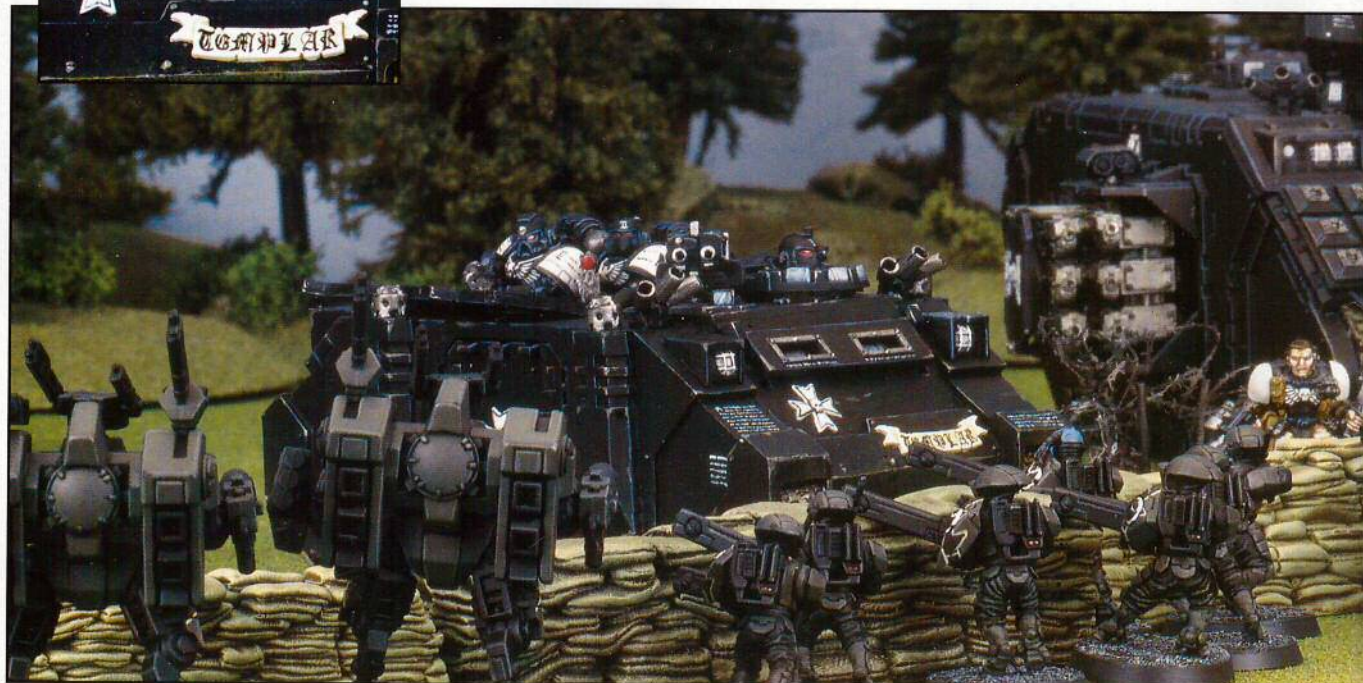
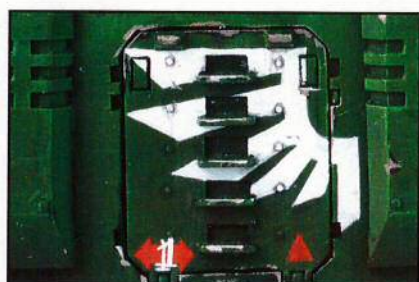

Matt Hutson's Rhino delivers its deadly cargo into the heart of the Tau defences.



Tank Shock! The Blood Angels follow their Rhino over the top.

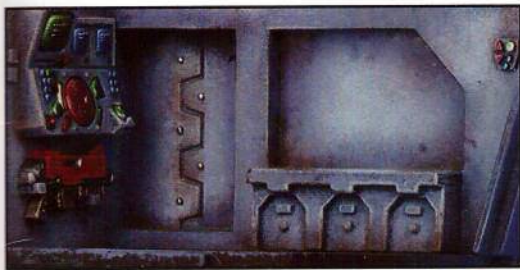

The new Rhino has a fully detailed rear compartment like the Land Raider's!



The interior features some amazing details such as control panels and a boltgun.



RHINO

CONCEPTS

How the new Rhino was brought into being

Tim Adcock recently embarked on a massive project to bring the ubiquitous Space Marine Rhino up to date. Space McQuirk caught up with Tim to get an insight into the creation of the Rhino.

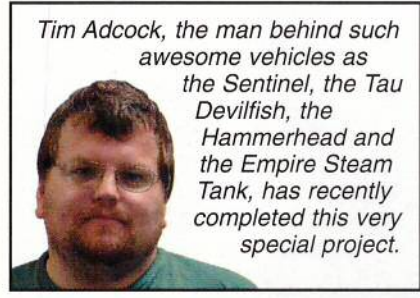

Tim Adcock, the man behind such awesome vehicles as the Sentinel, the Tau Devilfish, the Hammerhead and the Empire Steam Tank, has recently completed this very special project.

benefit from a similar overhaul. This project was no small undertaking. The Rhino forms one of the core transport vehicles of the Space Marines, the most popular Warhammer 40,000 army, and they are a strong favourite of many gamers. Working alongside Jes, Tim was given the job of making the new Rhino.

Over the fifteen years that the Rhino has been in service for the armies of the Imperium, the Studio has spent considerable time and effort working

The previous version of the Rhino – now retired from service.



Over the last few years, Jes Goodwin has been very purposefully designing the new Space Marines plastic range so that each kit integrates with the others. The results have been clearly evident with the Land Speeder, Space Marine Bike, Dreadnought and the Land Raider. Last, but by no means least, it was felt that the long-serving Rhino could

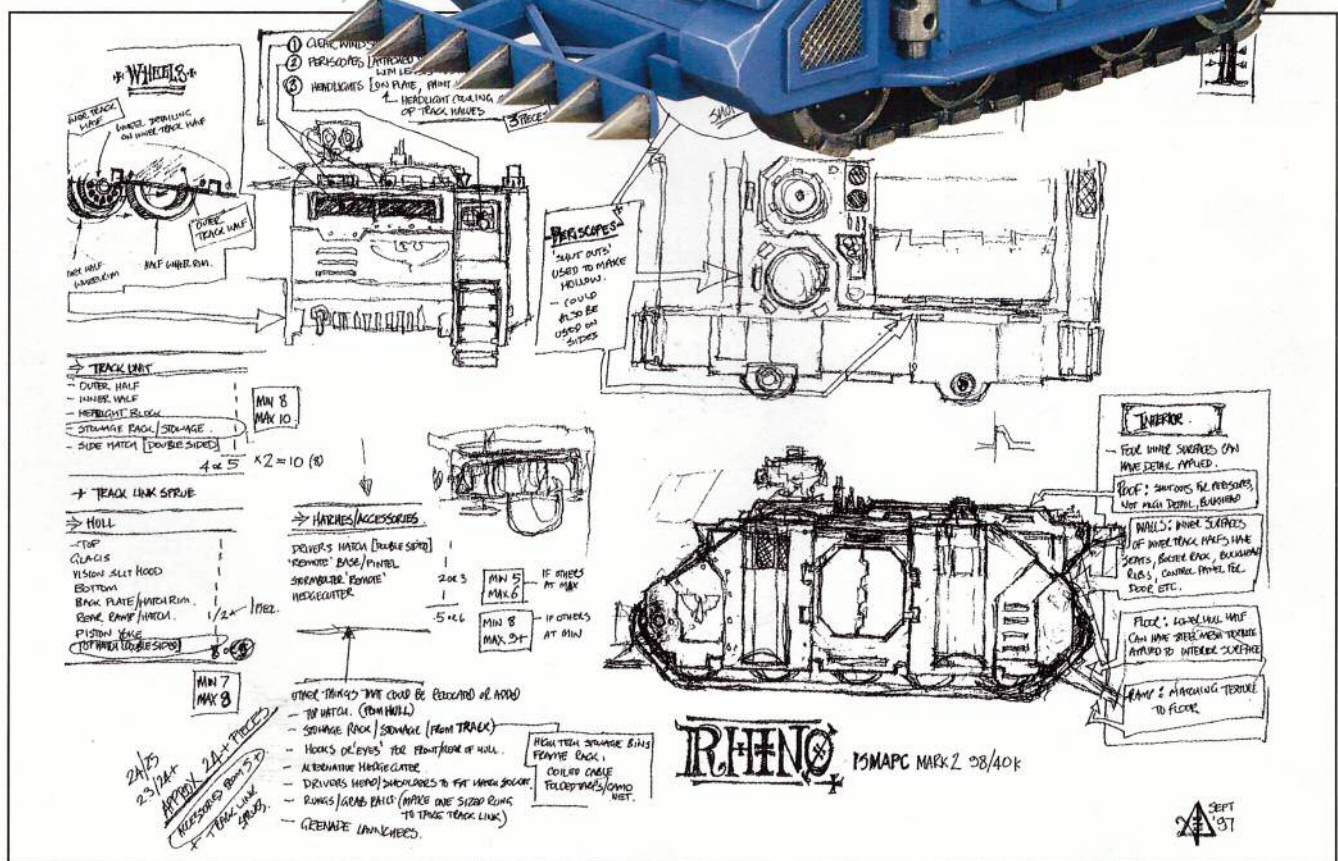

Some of Jes Goodwin's concept sketches for the Rhino.



A Space Marine squad deploys for battle from its Rhino.

out exactly how it should function and appear on the battlefield. In many ways, far from simplifying Tim's job this put extra constraints on his work. He would have to keep his project bound within the commonly accepted ideals.

Tim took a lot of inspiration from Jes Goodwin's Land Raider. Jes had succeeded in improving upon an old design, allowing a great deal of flexibility and versatility within a single model. The new Rhino design would also give us the opportunity to make new plastic kits for the Predator and the Razorback and later the Whirlwind

and Vindicator. These elements would have to be taken into account when Tim designed the model.

At the same time that Jes started his concept designs for the Land Raider back in 1997, he had also worked up sketches for the Rhino. Tim took these concept plans and used them as the blueprint design for the new Rhino. While retaining some of the elements of the old Rhino such as the four exhausts and familiar sloped front,

Tim also wanted to keep the design themed to Space Marines by adding small points of detail that appeared on the Land Raider. He used the same layered armour panels, headlights, aerial and door hatch design, and an a detailed interior like that used on its larger brother. These small details add a significant themed element to the model, encapsulating the idea of Standard Template Construct design that fits in with the background of the Space Marines.



The first cardboard mock-up.



The 1:1 scale mock-up was made from plasticard and existing parts from other vehicles.

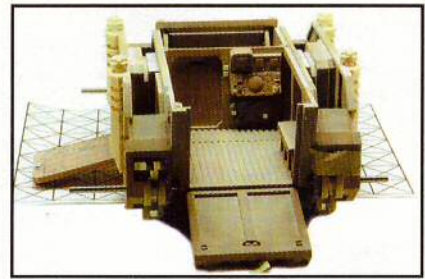
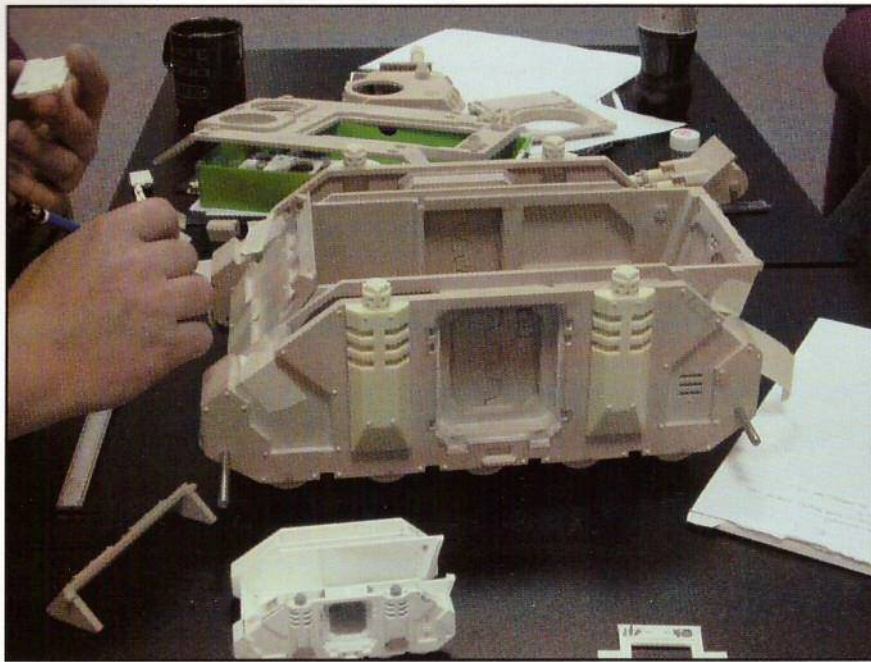

When the 1:1 scale mock-up is finished it is then sent to the pattern makers. This is so they can make a 3:1 scale version, known as a three-up.

When the three-up comes back, it has to be checked to see if all the parts are correct and everything fits together. Additional detail is often sculpted on at this stage.

Once that's done, resin casts of the three-up can be made, and the final mould (called the tool) can be cut using the resin casts and a pantograph machine to reduce the scale back down to 1:1.

One important factor in the design of the new Rhino was that it was to be simple to construct. This allows for gamers to use the kit easily, but lets the more experienced modeller concentrate on adding fine detail to the model.

There is one very special feature of the kit. On the Rhino frames you also get the reversible turret ring for the Razorback and Predator variants. Remember not to throw these out, as they could come in very useful later on. In fact you should never throw components away – add them to your bits box for later conversions!

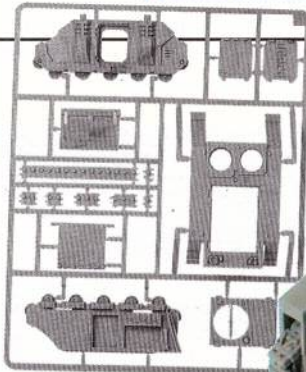
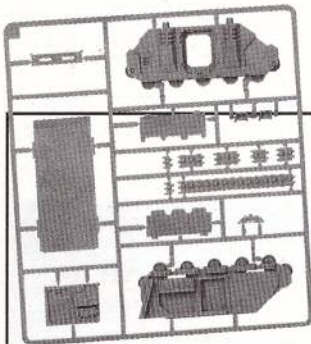

Above: The component frames from the Rhino plastic kit.

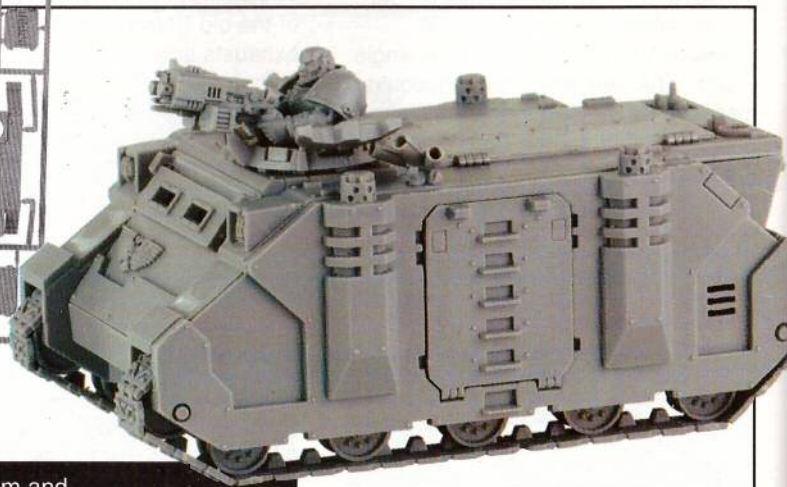

The finished product ready for painting.

Of course, this is not the end of the Rhino story. Tim and Jes have also been working on the Predator and Razorback variants. We will keep you informed, so keep your eyes peeled.

Letting filthy black smoke, the six Ultramarine Rhino APCs rumbled throatily along the rubble-choked street, the blue of their armoured hulls a stark contrast to the uniform greyness around them. The distant rumble of artillery echoed in the canyons of the city and flames licked from the windows of bombed-out buildings. Techmarine Harkus expertly guided the lead APC around a gaping crater in the road as they converged on the building that was their objective. The eight Space Marine Devastators carried within his Rhino prayed or ministered to the spirits of their weapons, attending to the rites of battle as was only right and proper. Harkus gunned the engines, feeling the vehicle shudder as the locally refined fuel angered the engine's spirit with its impurities. A lucky artillery round had taken out their already rationed stocks of fuel the previous night and the only substitute was a thick, tarry oil used by this planet's drilling Leviathans. The machine was angry and Harkus would need to make supplications to it after the battle in order to maintain its performance.

Harkus caught sight of scurrying figures in scarlet uniforms through the Rhino's vision blocks and yelled a warning to the following vehicles as he saw several enemy soldiers carrying missile launchers amongst them.

"Enemy heavy weapons! Right flank!"

The vox clicked in acknowledgement as the first volley of lasfire spat from the rubble of the buildings on their right flank. Harkus was not worried by such pinpricks; the blessed armour of his vehicle was proof against such weapons. Even as he formed the thought, a pair of missiles speared from the rubble, slashing a bright path towards him. He hauled back on the control column, slewing the Rhino into a screeching skid. One missile flashed past the Rhino's frontal armour, but the second slammed into its flank. Harkus fought to control the APC's motion, waiting for the inevitable detonation. When it didn't come, he glanced over his shoulder, gasping in astonishment as he saw the missile protruding a full foot into the crew compartment, its battered warhead sparking and smoking. Muttering a brief prayer to the Blessed Guilliman and the spirit of the Rhino, Harkus shouted,

"Everybody out! Quickly, before it detonates!"

The Ultramarines needed no prompting and dispersed from the rear hatch, making short dashes into cover. Harkus followed them out, snatching his bolter from the interior wall of the Rhino as more lasfire flashed around him. Heavier weapon fire joined in the fusillade and he saw they were still several hundred yards from their objective. He sprinted into cover and watched as the missile finally detonated within his Rhino with a ringing blast. Harkus could see that one other Rhino had been stopped, bright flames burning inside and bolter rounds spraying in

random directions as its ammunition cooked off. Its passengers were in cover in the slope of a nearby crater, answering the rebels' fire with their own expertly-aimed shots. The Rhinos carrying the assault troops had made it through the initial volley to the objective, but without the support of their brethren equipped with heavy weapons they would be unable to hold the position. The ground between them was wide open and without

protection the Devastators would be cut to pieces by massed gunfire as they ran the gauntlet. Harkus knew that he had to get his charges to their destination and risked a glance around the corner of the building to see how badly his Rhino had been hit. Tendrils of smoke boiled from the interior, but much of the explosion's force had vented through the open hatch. Fumes sputtered from the exhausts, which meant the engine was still running...

Harkus shouted over to the sergeant of the Devastators.

"The Machine Spirit invests the Rhino still, brother-sergeant. With the benefit of some covering fire from your men, I believe it will yet serve us."

The sergeant nodded and barked his orders. Within seconds, disciplined volleys of heavy bolter fire and lascannon bursts tore through the ranks of the enemy troops in a rippling series of explosions and shell impacts. Harkus sprinted towards the Rhino, clambering through the open ramp at the rear and vaulting into the armoured bucket seat at the front. He offered a brief prayer to the spirit of the vehicle and slammed open the throttle. The Rhino responded instantly, throwing great spurts of grey dust into the air as Harkus pulled it in a tight turn towards the Devastators. Driving parallel to their position, Harkus eased up as much as he dared, bolts of lasfire leaping out to meet him from the rebel lines.

The Devastators burst from their cover and leapt into the moving Rhino through the hole blown by the missile. Their sergeant shouted, "Go!" and Harkus pushed the APC to its maximum speed while chanting the Litany of Appeasement to the vehicle's spirit. More shots flashed past them as the Rhino crossed the plaza, but none troubled the armoured vehicle; the Devastators' volley having taken out the enemy's heavy weapon teams. Harkus guided the Rhino into the cover of the objective building and watched with pride as the Devastators disembarked and moved to occupy commanding positions throughout the structure. Harkus leaned back and brought the engines down to idle.

"Thank you, my friend," he whispered.



CITADEL MODELLING



Mega Paint Set

£100

The Mega Paint Set is far more than a normal paint set; it contains every colour paint produced by Games Workshop, including all of the metallic paints and the inks. It also includes Smelly Primer to undercoat your models before painting them, seven paint brushes, a painting guide and PVA glue, as well as modelling flock and sand to base your models with, and varnish to protect your finished models. This is the ultimate paint set for the serious hobbyist!

Citadel Colour Paints

£1.50 each

| | | |
|-------------------|-------------------|-------------------|
| Skull White | Nauseating Blue | Fortress Grey |
| Chaos Black | Imperial Purple | Shadow Grey |
| Scab Red | Liche Purple | Space Wolves Grey |
| Red Gore | Warlock Purple | Ghostly Grey |
| Blood Red | Tentacle Pink | Metallics |
| Blazing Orange | Midnight Blue | Boltgun Metal |
| Fiery Orange | Storm Blue | Chainmail |
| Golden Yellow | Regal Blue | Mithril Silver |
| Sunburst Yellow | Ultramarines Blue | Tin Bitz |
| Bad Moon Yellow | Enchanted Blue | Shining Gold |
| Scorched Brown | Lightning Blue | Burnished Gold |
| Bestial Brown | Ice Blue | Beaten Copper |
| Snakebite Leather | Hawk Turquoise | Brazen Brass |
| Bubonic Brown | Dark Angels Green | Dwarf Bronze |
| Vomit Brown | Snot Green | Inks |
| Bleached Bone | Scorpion Green | Black |
| Dark Flesh | Bilious Green | Yellow |
| Vermin Brown | Scaly Green | Flesh Wash |
| Leprous Brown | Jade Green | Red |
| Dwarf Flesh | Vile Green | Purple |
| Bronzed Flesh | Camo Green | Sky Blue |
| Elf Flesh | Rotting Flesh | Green |
| Pallid Flesh | Codex Grey | Orange |
| | | Chestnut |
| | | Magenta |
| | | Blue |
| | | Dark Green |
| | | Brown |

Citadel Colour Spray Cans

| | |
|--------------------|----|
| 400ml Skull White | £5 |
| 400ml Chaos Black | £5 |
| 400ml Matt Varnish | £5 |

There is also a range of 250ml spray cans available. With colours ranging from Dark Angels Green to Space Wolves Grey, these are ideal for the expert and beginner alike. Phone Mail Order for more details.



Hobby Starter Set

£20

The Hobby Starter Set is a great way to begin painting your models. It includes everything a beginner will need – eight Citadel paints, a starter paintbrush, two types of glue, clippers, modelling flock, and a simple guide on how to paint your miniatures.





Pin Vice £8



Curved Pliers £6



Model Files £5



Tweezers £4



Sculpting Tool £3



Clippers £6



Terrain Cutter £12



Model Saw £10



PVA Glue £3



Tank Brush £3



Paint Brush Set £6

Fine Detail Brush, Standard Brush, Small Drybrush



Superglue £3



Paint Station £18

Self assembly modelling area



Polystyrene Liquid Cement Glue £3

**AVAILABLE FROM YOUR LOCAL GAMES WORKSHOP STORE,
INDEPENDENT STOCKIST, MAIL ORDER (0115 91 40000)
OR www.games-workshop.com**

A thin line of red traced the path of the blade, and a trickle of blood ran down the length of the fat human's exposed neck. The Skaven Assassin released his tight grip on his victim and let the body of the cellarman slump to the floor. He dragged the corpse away from the foot of the stairs, hiding it beneath a large frame that supported an immense barrel. Dozens of such barrels filled the long thin chamber. The palace of Middenheim was well stocked, but the black robed Skaven had not come here to assess the man-things' supplies of brew.

He ran down the length of the chamber, counting the barrels as he passed them. Instinctively he kept in the shadows, his movements silent and swift. At the thirteenth barrel from the end he stopped. The Assassin tapped three times on the wooden lid with the base of his dagger. His signal was met with a similar reply. Running his thin clawed hands across the metal rim he found a small niche and pressed on it. A dull click told him he had found what he sought, and he stepped back as the front of the barrel slowly swung forward. He stared into the dark barrel and hissed.

"Come-come. Quickly."

A pair of red eyes appeared in the dark gloom of the barrel, followed by a second, then a third. A Skaven jumped from the large barrel, quickly followed by more of

its kindred. They were dressed in the same black robes as the Assassin, with sharp, talon-like blades strapped to their hands. In all a dozen of the creatures emerged, examining their surroundings as each of them awaited their master's command.

"Go now, up steps." The Assassin addressed his underlings. "Above us, a tavern, full it is. Man-things, not warriors, drunk. Will die easily." The group headed towards the entrance moving as one, like ghostly shadows down the length of the vault.

"Gunther!" yelled the tavern keeper. "What's keeping you? There's good customers waiting up here." The palace workers' inn was full tonight. Angestag was always a busy night. The nobles of the palace would often let their servants have the day off whilst they slept off their overindulgence on the weekend. Most of the servants took the opportunity to unwind and relax with some good food and an ale or two with which to swill it down.

The cellar door creaked open. Without looking up from the pint he was pulling, Brostow the innkeeper shouted at what he thought was his cellarman.

"Bout time! Now be a good 'un and come an' help me here." He finished pouring the ale - it had a fine, creamy-white head on it, just about the best ale he had pulled that night. He relished the thought of closing time when he would be able to relax and have a drink or two himself. Putting the tankard on the bar, he wiped his hands on his apron and was about to pour another when a high pitched scream caused him to look up.

"Ulric save us!" he stammered as he surveyed his bar. With a speed the likes of which he had never seen, a number of small black creatures leapt from table

to table. Blades were darting left and right, ripping out the throats of his patrons. They looked like small shadows, flitting across the room. In the noise and commotion of the pub, the invaders had already caused a bloodbath before any of the customers had realised what was afoot. Only now did it dawn on the few remaining tables that something was terribly wrong.

Brostow watched as a young couple tried to flee to the door. They had only gone a few steps before one of the black robed figures dropped down from a roof beam onto the back of the girl. It closed a furry arm around her head twisting it and snapping her neck, whilst at the same time thrusting the blade held in its tail into the lower spine of her partner.

A couple of off-duty guardsmen had drawn their swords and fought off the flurry of blows from one of the dark creatures. Slowly, the two of them forced it back into a corner of the tavern, but the creature reached into the folds of its robes. From here the innkeeper could not quite tell what it was the foul creature grasped in its taloned fingers. He watched in horror as it launched two projectiles at its assailants. Both men fell to the floor writhing in death spasms, dark green stars, glowing unnaturally, protruding from their chests.

Within moments the once teeming inn had descended into total silence. As Brostow, rigid with fear, cast his eyes around the room he saw that few had even managed to escape from their tables before they had been brutally slain. The black robed ones pulled their blades from the corpses of their victims, wiping the blood on their cloaks. Thirteen pairs of eyes turned towards him and as one they advanced.

Brostow stared at the man-sized creatures. They had the visages of rats beneath the cowls of their robes; rows of razor sharp teeth were bared as they slowly crept towards him.

"No, no!" he screamed as he tried to flee, but his legs would not respond. "You're not real! You're just a story told at bedtime to frighten naughty children."

The largest of the creatures leapt onto the bar and drew a wicked looking blade. Green toxin dripped from it, causing wisps of smoke to rise as it struck the polished wooden surface. The Skaven hissed, bringing its blade down in a vicious arc.

As a dark cloud covered the moons, the Skaven crept out from the tavern into the crisp, cold night air of Middenheim. The trees in the palace ground had already shed their leaves and only the noise of frost covered leaves, quietly crunching underfoot, betrayed the presence of the dark robed Gutter Runners as they made their way through the grounds.

They followed the Assassin as he pressed himself against the cover of the ancient stone walls of the city. Soon he disappeared into the shadows of a small alcove facing the main palace quarters.

"The Dark ones are coming. Already they march from the north. Soon first of man-things' cities fall. Here, our time draws near. Already clans gather in strength and..." It hissed for the others to stay silent. The sound of a sentry's footsteps on the cobbled stones echoed across the square. They grew louder as the sentry approached their hiding place. One of the Gutter Runners drew his blade in readiness to dispatch the guard. The man-thing paused, scant metres away from the alcove. The Skaven could smell the strong odour of his pipe. After a few seconds he resumed his patrol and walked away.

"Tower," the Assassin continued, pointing to a building before them. "Must get inside."

"Why master?" One of the Gutter Runners ventured a question. The Assassin turned, suddenly baring a set of sharp yellow fangs.

"Your's is not to ask why." With the tip of his dagger he scratched a rough map in the dirt beneath the alcove. Soon every Skaven in the group knew his task, and they set off on their mission.

Kurt Thersmite felt the warmth of the fire against his cold face as he stepped into the guardroom. He took one last suck on his pipe before tapping the ashes out onto the floor. The rest of the nightshift were sat around the fire warming themselves. He walked up to the guardsman nearest the fire and stood before him.

"Move over lad, it's deadly cold out there and I'm needing to thaw my fingers." The young lad looked up and for a moment seemed ready to argue but one look from the elder guardsman's face told him it wasn't worth it. Kurt sat down on the stool and placed his hands close to the fire. As he did so he heard something scurry across the roof of the barracks.

"Damned rats," he muttered. "Somebody kick that fat, lazy cat outside to do her job."

DEATHLY SILENCE

Penned by Scribe Space McQuirk





A young guard walked over to the cat but it hissed at him, its fur standing on end.

The guard backed away from the feline, preferring to avoid a mauling at the sharp claws of the terrified animal.

"I dunno what's got into her tonight, she's petrified of going out." He said, sitting back down.

Kurt glared at the cat with disdain before returning his gaze back to the hypnotic glow of the red-hot embers.

Suddenly he jumped back, tipping off the stool as a glass sphere fell from the chimney and landed in the heart of the fire. The old warrior got back up onto his knees, leaning forward to examine the strange glass ball. It glowed an eerie shade of green against the red heat of the coals. A loud crack was followed by Kurt's screams as the ball shattered and exploded in his face. The shards of glass, which had pierced his eyes, blinded him to the thick green noxious gas that poured from the ball and quickly enveloped the room.

"Quick! Get out." The young guard screamed, the gas already causing a strong burning sensation at the back of his throat. One by one the guards poured out from the barracks, their eyes streaming. One by one they fell to the floor, clutching at their throats as their blood spilled onto the frost covered cobbles. One by one the Skaven Gutter Runners sheathed their weapons and slipped back into the shadows.

The Assassin had slipped away from the main group, taking two of their number with him. He pointed towards the foot of a tall tower, where two guardsmen stood at the entrance.

"There, lair of one I seek."

The building rose high into the night sky. It dwarfed a tower next to it and at the top of the building was a metallic dome. Copper pipes extended out from the top quarter of the tower and ran up the length before burrowing back into the walls.

"Kill guards, master?" One of the Gutter Runners asked, drawing out a throwing star as he spoke. The Assassin motioned for him to put back the weapon.

"Not yet. Must reach target first. Kill guards now risks alerting victim." The Assassin looked at the alleyway between the two towers.

"Wait. Inside tower I must be, then strike," he instructed his apprentices.

Sprinting across the courtyard, he clenched his fists, on each hand two blades sprang forth from the

sleeves of his robes. Running into the dark alleyway, the Assassin leapt onto a pile of crates to gain some height. From the top crate he launched himself upward at the far wall, driving the tips of his blades into the stonework. Plaster from the wall fell to the floor. Had he hoped to gain a solid purchase then the Assassin would have failed and tumbled to the ground below.

Instead, in that fraction of a second's purchase that the crumbling stonework lent him, he pushed himself off the wall with his clawed feet, launching upward towards the opposite side of the alley, again driving in his blades for a brief hold. In a short space of time the Assassin had managed to climb to the top of the lowest tower, leaping from one wall to the other. His black robes, silhouetted against the night sky, lent him the appearance of a bat in flight.

Once on the roof of the smaller tower the Assassin paused for a moment. He could spy an open window at the top of the tower but, even with his acrobatic abilities, it would be too high for him to reach in a single jump. A movement at the window caught his attention. He snarled as a figure drew the shutters and locked them.

Undaunted by the setback, he crouched for a moment focusing his energy on the jump and then bounded upward. For a brief moment it looked as though it was a suicidal leap and the Skaven found himself falling downwards. As he did so his blades scraped on the copper piping, causing a shower of sparks to fall down into the alley. The tip of one blade caught on a bend in the piping leaving the Assassin hanging suspended over the hundred foot drop.

He swung himself upwards, reaching out with his fingertips to grasp the piping. It was hot and burned his hands but the alternative was far less appealing. Climbing up the pipe he reached the window ledge and pulled himself up. He pulled out a small pin secreted in his thick, dark grey fur. With his long nimble fingers he made short work of the shutter lock on the window and leapt inside the tower.

Engineer Freidrich Holst sat down at his desk and picked up his quill. He turned a switch and the dim lights in the room glowed bright as the burners were fed more gas. He was glad for the integrated flow system that he had recently installed into the tower, it ensured that on the cold winter nights in Middenheim he would remain warm. Since his arrival in the palace

Freidrich had been making quite a name for himself.

Now though he had been granted a bursary to begin studies on a far grander project.

During his short time in the city he had been allowed access to a wide range of ancient artefacts. It was here that he had discovered a strange stone. Dated at over five hundred years old it was simply entitled Wyrdstone. All attempts to locate its source had met with failure but Freidrich was not concerned with such details. He was more interested in harnessing the energy of the stone.

In recent months, and after many near disastrous experiments, Freidrich had managed to safely use the stone as a power conduit. Unfortunately, the single shard he had found had been virtually drained of energy and so he had sent word across the Empire for more samples. He stared at the dark green shard on his desk; this simple piece of stone would change his life forever. With it he would achieve recognition beyond his wildest dreams.

A sudden draft of cold air caused him to turn round. The shutters were wide open. 'Strange', he mused to himself, he was sure he had locked them. The engineer refastened the lock and sat back down at his desk. His eyes widened in shock. The stone was gone. He looked under the desk, perhaps it had fallen, but his quick search revealed nothing.

"Lost something?" A sharp voice spoke behind him. Freidrich turned and his heart almost stopped at what he beheld.

The Assassin grinned, revealing his razor sharp teeth. In his hand he casually tossed the green shard. The engineer slowly stepped back, his mouth wide open whilst his eyes betrayed a look of bewilderment and horror at the creature before him. He backed himself up against the wall, shuffling slowly step by step, sideways towards the door.

"I knew it!" He stammered, pointing at the Assassin. "All the evidence pointed towards it, I knew you were real. The skulls were too precise to be fakes." The human continued to back away from the Skaven. As he reached the door, he slowly turned to open the handle. No sooner had he averted his gaze than the Skaven leapt towards him with lightning speed. The blades attached to the Skaven's wrists thudded into the thick oak, pinning the engineer to the door. One blade on either side of the man's neck trapped him. The engineer turned slowly back round to face

his attacker, a trickle of blood ran down his neck as the blades nicked him, whilst at his feet a small puddle of another liquid formed.

"Warpstone you are wanting yes? Think you to harness its power?" the Assassin pressed his snout close to the engineer's face, staring deep into his eyes.

"W...w... warpstone?" the engineer stammered again, a puzzled and desperate tone creeping into his speech. He looked down at the shard of stone the Skaven held in his menacing clawed hands. "Y...y...you mean Wyrdstone!"

"We know you harness energy. Give me plans I give you quick death." The Skaven turned his blades, cutting slightly deeper into the engineer's neck.

"You will get nothing from me, you verminous filth." Freidrich retorted, wincing at the pain. "All the results of my experiments are contained safely within my mind. There is nothing for you here, it is all in my head."

The Skaven snarled for a second and pulled his blades away from the engineer's neck, reaching into the folds of his robe. He turned his back to the engineer for a moment, whispering, "Good, good."

In one fell move he whirled back around, the sword held in his hand sliced cleanly through the engineer's neck, severing his head.

At the foot of the tower the two Gutter Runners pulled their throwing stars from the bodies of the guards. The door opened and they quickly lowered their daggers from a striking position as they spied their master.

"Success master?" one whispered as they skulked into the shadows.

"Yes." The Assassin spoke. In his hand he held a small sack. Blood dripped from the seams, leaving a trail behind it. But by the time the guards discovered the gruesome murder, the Skaven would have long since vanished.

"Hurry we must. Clan Skryre need this one's brains before they grow cold. Even after death they have the means with which to retrieve his secrets." As the Assassin spoke the other Gutter Runners emerged from the shadows. Three of them lifted the heavy grating of a manhole cover and the small band of infiltrators vanished as swiftly as they had appeared.

Night Runners form the basis of Clan Eshin's forces. With the versatile Night Runners boxed set, sculpted by Aly Morrison, you can field full packs of speeding skirmishers ready to harry your enemy's troops and wreak havoc throughout their ranks.

NIGHT RUNNERS

How to get your Night Runners ready for war

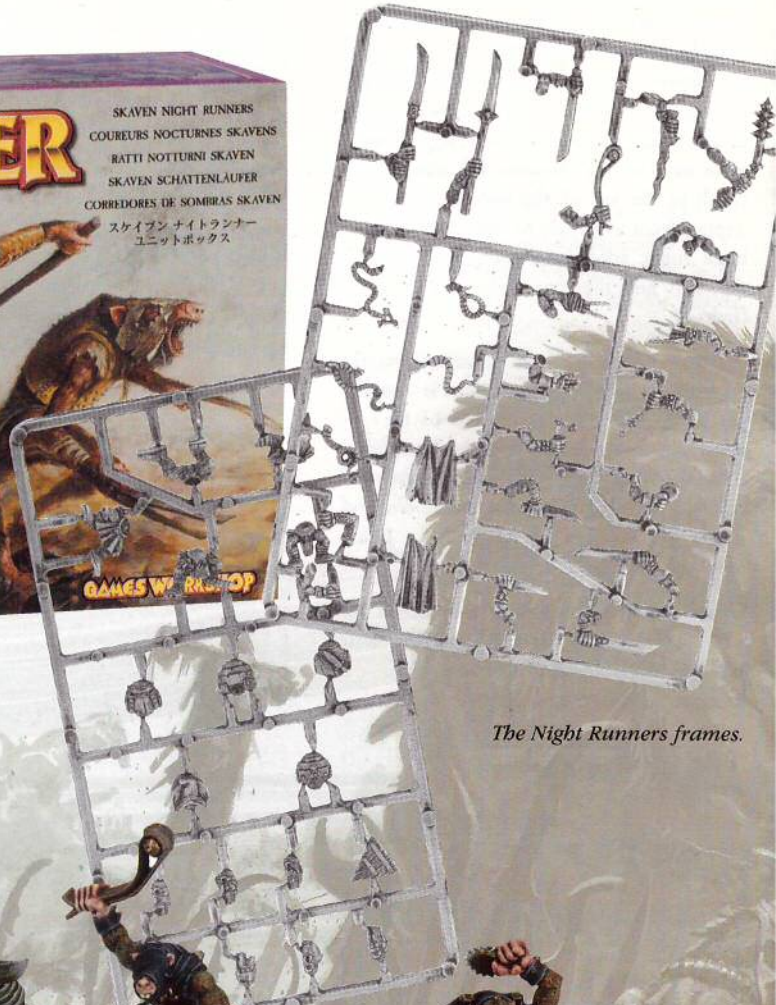
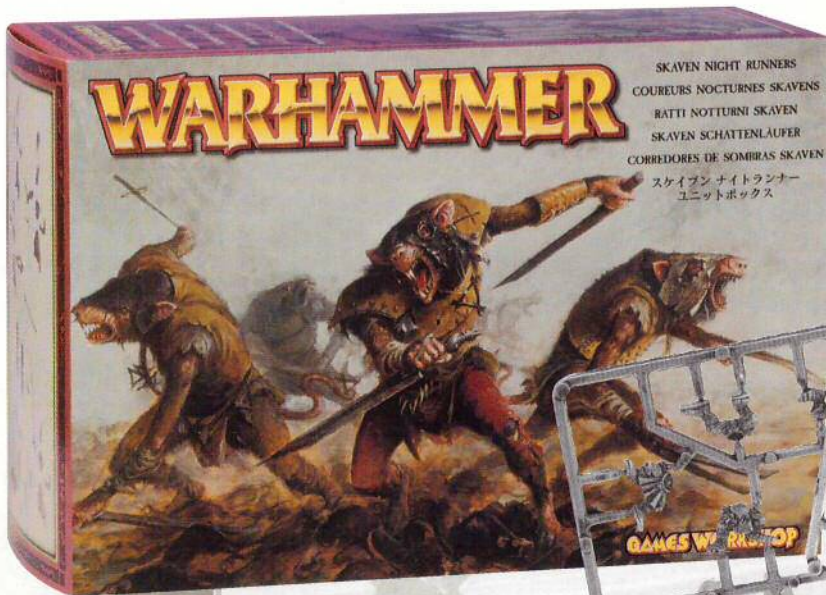

The Night Runners frames.

SKAVEN NIGHT RUNNERS REGIMENT

Skaven Night Runners are a Core choice, with 5-20 models in a unit. The boxed set contains enough parts to make 20 Night Runners.



Painting your Skaven Night Runners

Phil Kelly has been plaguing the Studio with massed ranks of ratmen for a couple of years now. We tracked him down to give us some tips on painting Night Runners.

1 I started by spraying the model Chaos Black and drybrushing the Skaven's fur with Scorched Brown.

Because these guys are from Clan Eshin, the assassins of Skaven culture, I decided to leave the majority of the Skaven's clothing black.



2 I then highlighted the brown by drybrushing with Vermin Fur, adding a little Skull White for successive highlights. You can be as scrappy as you like here – the great thing about drybrushing a colour when the remainder of the model is black is that

it's very easy to clean up any mistakes with Chaos Black when you have finished. The claws and tail-mace were painted in Chainmail, and the bindings in Snakebite Leather.

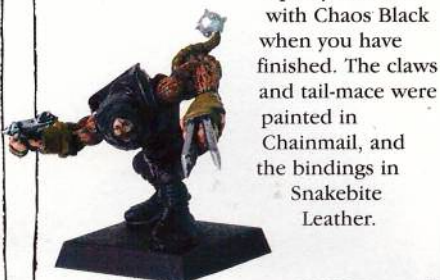

3 The next stage was a little more delicate. I painted the tail and picked out the Skaven's buck teeth with Vomit Brown, again adding Skull White for the highlights. The clothing was highlighted by mixing a little Skull White into Chaos Black and carefully lining areas that stood out. Be careful not to overdo this, as less is definitely more!



4 Finally, I covered the metallic areas with a thinned down wash of Chestnut Ink. I finished off the highlights on the bindings with Skull White and Snakebite Leather. Although I think weapons dripping with gore looks cheesy, I did mix a little Chestnut Ink and Scab Red for the blood and dirt spattered across the cloth. Finally I based the model.



GETTING THE MOST OUT OF YOUR NIGHT RUNNERS

Phil: The way I see it, there are two ways to use Night Runners in the Skaven army. You can either tool them up and use them to harass the enemy's flanks, or you can use them as an expendable but incredibly mobile skirmish screen. Luckily, because you get a healthy twenty in the boxed set, provided you have two units of Clanrats, you can split them into two units of ten Night Runners and do both.

The main strength of the Night Runners is their incredible mobility. Because they are skirmishers, they can always move at double pace – a highly respectable 12". This means they can nip round the enemy's flank with ease. Try equipping a large unit with slings and getting round the side of an enemy unit, but staying within 9" of it. This allows you to chuck out a potential forty sling shots per Shooting phase! On the other hand, if you intend to use them for a well-timed flank or rear charge, tool them up with additional hand weapons.

Alternatively, they can be used as a skirmish screen to protect more valuable units such as Plague Monks. One of the best things about this tactic is the fact that Night Runners are gloriously cheap, a mere 5 points per model! Better get painting...



Using stealth and speed, the Skaven Night Runners prepare to give the defenders a nasty surprise.

WARHAMMER SKAVEN

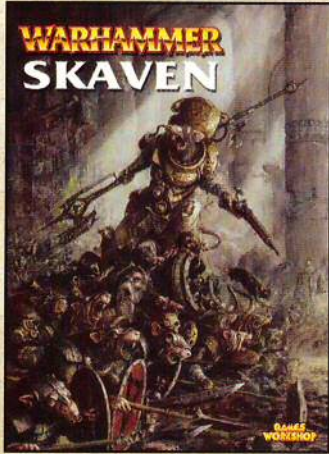

Warhammer Armies: Skaven £10

This 80 page Army book contains all the rules needed to field an army of vicious Skaven. Included are rules for the major Skaven Clans, fearsome magical items, destructive warpstone-fuelled war machines, and special characters. This book is essential for any Skaven general!



Skaven Warlord £6 each

The most cunning and vicious warrior in the Skaven army, the Warlord leads from the rear orchestrating his diabolical plans. While more than capable of matching a foe in close combat, the wary Skaven general is more comfortable sending his warriors to fight for him.



Skaven Grey Seer £6 each

The master of Skaven magic, a Grey Seer will often lead a Skaven army to battle. Guiding the Skaven warriors into position from a safe place, the Grey Seer uses nuggets of pure warpstone to call forth devastating magic, blasting their foes with warpstone-fuelled spells.

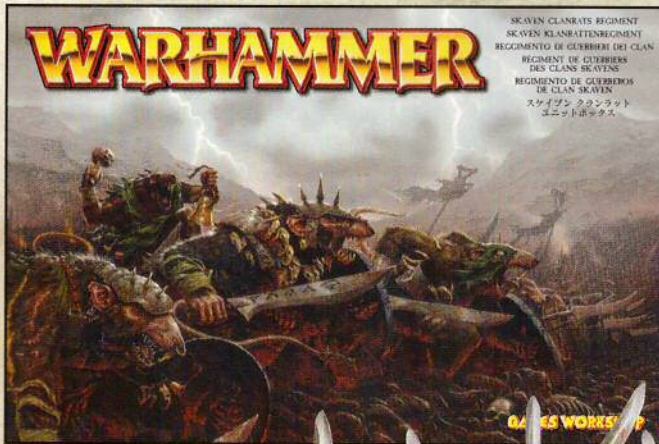

Skaven Warriors Regiment

£15 boxed set

The Skaven Warriors regiment can be used to make units of Clanrat Warriors or Slaves. Clanrat warriors form the bulk of every Skaven army. On their own, they are not exceptional fighters, lacking discipline and determination, but in large groups they are fearsome opponents. Masses of slaves are often pushed at the head of Skaven armies as a screen against missile fire or to test the strength of the enemy. Skaven generals send them to be butchered without hesitation, and other Skaven do not care about their fate at all.



(left) This regiment of Clanrat Warriors has been built with the basic parts available in the Skaven Warriors boxed set. They are armed with spears and shields, and we have used the shield icon available in the boxed set to give the unit a unified appearance.

WARHAMMER

SKAVEN NIGHT RUNNERS
COUREURS NOCTURNES SKAVENS
BATTI NOTTURNI SKAVEN
SKAVEN SCHATTENLAUFER
CORBEDORES DE SOMBRAS SKAVEN
スカイブシナイトランナー
ユニットボックス



GAMES WORKSHOP

Skaven Night Runners Regiment

£15 boxed set

Night Runners scuttle ahead of the main Skaven army, picking off poorly defended units and war machines. These units of fast skirmishers are notorious for the low survivability of their troops. This is the Eshin way, to ensure that only the worthy make it to the ranks of the Gutter Runners.



WARHAMMER

SKAVEN WARP-LIGHTNING CANNON
CANNON A MALLECOURRE SKAVEN
ワープライニングキャノン
SKAVEN WARPBLITZKANONE
L'ANZILLAMAS DE DISFORMIDAD
CANNONE A FULMINE WARP DEGLI SKAVEN

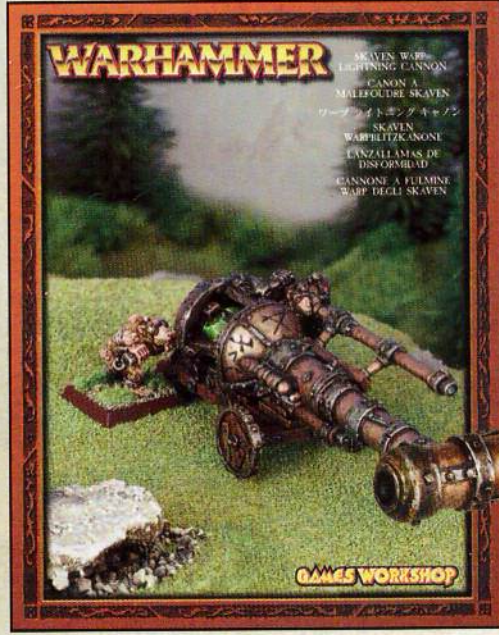

GAMES WORKSHOP

Warp-Lightning Cannon

£15 boxed set

The deadly Warp-Lightning Cannon is crewed by two slaves, who provide the muscular power needed to move the gun around the battlefield. A Clan Skryre adept orders the slaves around and fires the gun, sending bolts of warp-lightning searing across the battlefield, annihilating everything in its path. The magical energy of the warpstone powering the gun is also used by the Skryre adept to strengthen the slaves, giving them enough muscle to move and spin around the heavy machine with ease. The unfortunate side effect of this exposure to raw warpstone energy means that the slaves normally survive for less than a day. Just long enough...



AVAILABLE FROM YOUR LOCAL GAMES WORKSHOP STORE, INDEPENDENT STOCKIST, GAMES WORKSHOP MAIL ORDER (0115 91 40000) OR www.games-workshop.com

'EAVY METAL MASTERCLASS

This month sees the release of **Thanquol** and **Boneripper**, two great miniatures for the Skaven army, designed by **Jes Goodwin** and **Mark Harrison**. What better excuse could we have to find out how they were painted.

Models Painted by Tammy Haye



THANQUOL

PAINTING THE MODEL

Thanquol was first given an undercoat of Chaos Black. A basecoat mix of equal parts Codex Grey and Chaos Black was applied first to the fur areas. Bleached Bone was then added to the basecoat mix in small amounts for each successive highlight

stage, finishing off the highlights by adding Skull White and Bleached Bone to the mix together.



A basecoat of Scorched Brown was applied to the skin. An equal quantity of Dwarf Flesh was then added to this for the first highlights, adding more Dwarf Flesh and Fortress Grey for successive highlights. Bleached Bone was then added to the mix for the final highlight stage.



The cloak was painted with an equal parts mix of Codex Grey and Chaos Black. Once this had dried



a Glaze of watered-down Black ink was applied and a second coat of the original mix was painted on as a highlight. The final highlights were an equal parts mix of Codex Grey and Fortress Grey.

FINE DETAIL

Scorched Brown was painted on as the basecoat for the staff. This was drybrushed with Bestial



Brown followed by Bubonic Brown. To finish the wood effect, a thin glaze of Flesh Wash and Brown Ink was then applied.



The copper armour and top of the staff were painted with a basecoat of Tin Bitz. This was highlighted with an equal parts mix of Tin Bitz and

Brazen Brass. The next highlight stage was to use Brazen Brass on its own, followed by a final highlight of Brazen Brass and Mithril Silver in an equal parts mix. To finish these sections they were given a wash with an equal parts mix of watered-down Chestnut Ink, Brown Ink and Black Ink.



The pouches and the rope were painted with a Basecoat of Scorched Brown. Bleached Bone was added to this for each successive highlight, adding extra highlight stages when finishing the ropes.

FINISHING TOUCHES

Tin Bitz was first painted on as the basecoat for the sword and chain, followed by Boltgun Metal for the first highlight. Mithril Silver was



used for the final highlight stage. The central part of the sword just above the hilt was given a glaze of thinned-down Brown Ink and Black Ink.



To paint the horns, a basecoat mix of Bestial Brown and Codex Grey, with a small

amount of Chaos Black, was applied. Bleached Bone was then added to this for successive highlight stages, which were painted on moving from the base to the tip. As the highlight stages reached the very tips of the horns small amounts of Skull White were added to the mix.

Finally, a glaze of Brown Ink and Black Ink, which had been greatly watered-down was applied at the base of the horns.

BONERIPPER

ASSEMBLING THE MODEL

The model was put together in a dry run assembly before the torso was double pinned to the legs for extra support. The rest of the model was then glued together before giving it an undercoat of Chaos Black.

PAINTING THE MODEL

The skin was painted with a basecoat of equal parts Chaos

Black and Scorched Brown. This was highlighted with Scorched Brown. A mix of Scorched Brown and Snakebite Leather was used for the next highlight stage with Bleached Bone being added to this for each successive highlight. The final highlight was made by adding more Bleached Bone and Fortress Grey to the highlight mix, followed by a glaze of equal parts Brown Ink Black Ink and Yellow Ink.

The bone was painted with a basecoat of Bestial Brown, Codex Grey and a small amount of Chaos Black. This was highlighted by the addition of small amounts of Bleached Bone to the mix for successive highlights, with the final addition of Bleached Bone and Skull White.

A basecoat mix of equal parts Codex Grey and Chaos Black was painted onto the bandage wrappings. This was then highlighted with



Codex Grey, followed by an equal parts mix of Codex Grey and Fortress Grey.

FINE DETAIL

The exposed muscle was painted with a basecoat of Bleached Bone. A thinned mix of Red Ink with a small amount of Scab Red was

then painted onto the edges of the muscle. In doing it this way the ink runs down into the recesses creating the sinew effect.



The fur was painted with a drybrush of Codex Grey.



To create the metal effect a basecoat of Tin Bitz was highlighted with Boltgun Metal. A thinned-down mix of Flesh Wash, Brown Ink and some Green Ink was applied to these areas, leaving out the protruding



edges. This same mix was also applied to some patches on the skin.

Texture was added to the base of the model by gluing on sand with PVA glue. This was then painted with Bestial Brown and drybrushed with Bubonic Brown. It was given a final drybrush with Bleached Bone and finally static grass was applied.



PAINTING WARPSTONE

Both models, and many others in the Skaven range, feature warpstone. There is a simple but effective method to paint this.

Starting with a basecoat of Dark Angels Green the warpstone is

highlighted with Snot Green.

Scorpion Green can then be painted on in patches as the final highlight.



Boneripper's glass bulb was given a coat of gloss varnish to create a glassy effect.



Over recent months our Index Astartes series has been chronicling the First Founding Space Marine legions. Here, William King recounts the Battle for the Emperor's Palace – a cataclysmic event that almost brought an end to the Imperium and forever altered the First Founding legions...

On the thirteenth of Secundus, the bombardment began. From orbit, the Warmaster's ships laid down an unrelenting barrage of missiles and deadly energy beams. The aim was to cripple the defences around the Emperor's Palace and make possible a massive invasion of Earth. The lunar bases had already fallen, and the defending Battlefleet Solar had been scattered. On Mars, as across the entire vast Imperium, bitter civil war raged.

On countless worlds, blood-mad warriors clashed. Those who had pledged loyalty to the Emperor fought those who had sworn fealty to Warmaster Horus and, through him, to the dark powers of Chaos. The Emperor's realm was in turmoil and some of the greatest battles in human history were being fought. On the hive-world of Thranx over a million warriors died in a single day on the killing fields of Perdagor. On the blazing deserts of Tallarn, at the Ka'an Salient, fifty thousand tanks clashed in the greatest armoured action of all time. During the space drop on Vanaheim, three hive-cities were depopulated by rebel forces as a warning against resistance, yet still the defenders fought to the last man.

Like a cancer, the Heresy infected the entire structure of the Imperium. Everywhere brave men gave up their lives to try to excise that cancer.

It was on Earth, at the very heart of the Emperor's realm, that the fate of the galaxy was to be decided. In those last days, the sky was black with dust clouds and the earth split by gigantic fissures. Tectonic plates shifted under the stress of the bombardment. Mountain chains shivered and seas evaporated and became barren deserts. Rains of blood and ash dripped from the dark sky. Astropathic choirs sang of evil portents and men went mad with fear. Hideously twisted ships full of the lost and the damned hung in orbit over the ravaged world. Shielded from the devastation by the cunningly wrought defences of the Adeptus Mechanicus, a pitiful few stood ready to repel the invaders.

The embattled remnants of the Emperor's army were desperately trying to hold out until reinforcements arrived. The Emperor himself oversaw the defence of his fortress-palace,

ASSAULT ON HOLY TERRA

THE BATTLE FOR THE EMPEROR'S PALACE



personally commanding the Adeptus Custodes, his elite guard. He was accompanied by Sanguinius, white-pinioned Primarch of the Blood Angels and his legion of Space Marines. In the palace grounds stood the stalwart Adeptus Arbites. The palace was not the only bastion of resistance; there were others, each an awesome fortified city filled with dauntless soldiers. Beneath

the ruins of the Imperial Basilica, grim-visaged Rogal Dorn led the stern Imperial Fists in final prayers. Within the armoured factory complexes of the Adeptus Mechanicus, tech-priests put aside their tools and girded themselves with the fearsome weapons of their order. In the rubble of burned-out hab-areas, Primarch Jaghatai Khan mustered the White Scars, the Chapter of Space Marines which he had

personally instructed in the art of lightning warfare. Three full Titan legions stood ready to defend their Emperor.

As the earth shuddered under the bombardment, tank divisions roared across the tortured landscape to take up their position against the coming invasion. Brave men checked their weapons and offered up last prayers. Defence lasers swivelled to face the



turbulent threatening sky. Suddenly, the night was streaked by the plasma contrails of drop-pods. Within the Emperor's halls even the Space Marines shuddered, knowing that they would soon confront their lost and damned brethren. The terrifying prospect of facing these corrupt Primarchs who had sold their souls to Chaos filled every man's mind with indescribable horror and dread.

The pods touched ground and from them erupted the mightiest champions of Chaos, the renegade Space Marines of the lost legions. These were no longer the fine human warriors of legend but twisted creatures, bodies warped by the energies of Chaos, minds twisted by their devotion to the dark powers. If what had happened to the Space Marines was bad then what had happened to their Primarchs was worse. They had been created higher in the Emperor's esteem and had fallen further. None of their former comrades would have recognised them – they had been transformed into creatures both daemonic and exultant.

Mighty Angron bellowed orders to his blood-drinking followers, the World Eaters. Brandishing his great runesword

he led them against the defenders of Eternity Wall Spaceport. Around his red-armoured followers bolter shots whined. Unflinchingly they advanced, determined to spill blood for the Blood God.

At Mortarion's rasping command, the Death Guard emerged silently from the festering cocoons of their drop-pods and advanced on their terror-stricken foes. The dread runes on Mortarion's scythe glittered eerily in the night as he gestured for them to advance.

Magnus the Red glared triumphantly about him with his one watchful eye before ordering the mage-warriors of the Thousand Sons to cast their spells of doom.

A hail of deadly bolter shells cut down dozens of the Emperor's Children. Undeterred, the wounded howled with pleasure at the experience and chanted the praises of their Primarch, Fulgrim. The renegade Space Marines surged forward to carve a path through their foes.

Perhaps some defenders went mad with fear. Perhaps the corruption of Chaos ran deeper than anyone suspected. Perhaps some were foolish enough to think that they could negotiate with the

ultimate enemy. Whatever the reason, one last vile treachery was to take place. Many units of the Imperial army that had pledged loyalty to the Emperor turned blasphemers even as the Traitor Space Marines made their drop. It was almost as if it were a pre-arranged signal. In one of the basest acts of betrayal in Humanity's history, they turned their weapons on their brother warriors and cut them down like dogs. Thus did the Lions Gate Spaceport fall to the rebels. As the heretics chanted and howled their mad prayers, the air shimmered and slaving daemons emerged from the warp to spread terror and dismay.

Then indeed did it seem to the defenders that they were living in the last days of Mankind. Huge bat-winged Bloodthirsters swept triumphantly across the weeping skies. Clawed Keepers of Secrets danced lasciviously on piles of corpses. Great Unclean Ones chuckled as they lumbered through the ruined streets spreading trails of filth and slime and disease. Enigmatic Lords of Change perched atop the towers and statues and supervised the coming of Chaos to the heart of the world. Mighty ships began the descent from orbit, hoping to overwhelm the defenders by sheer weight of numbers. Unlike the drop-

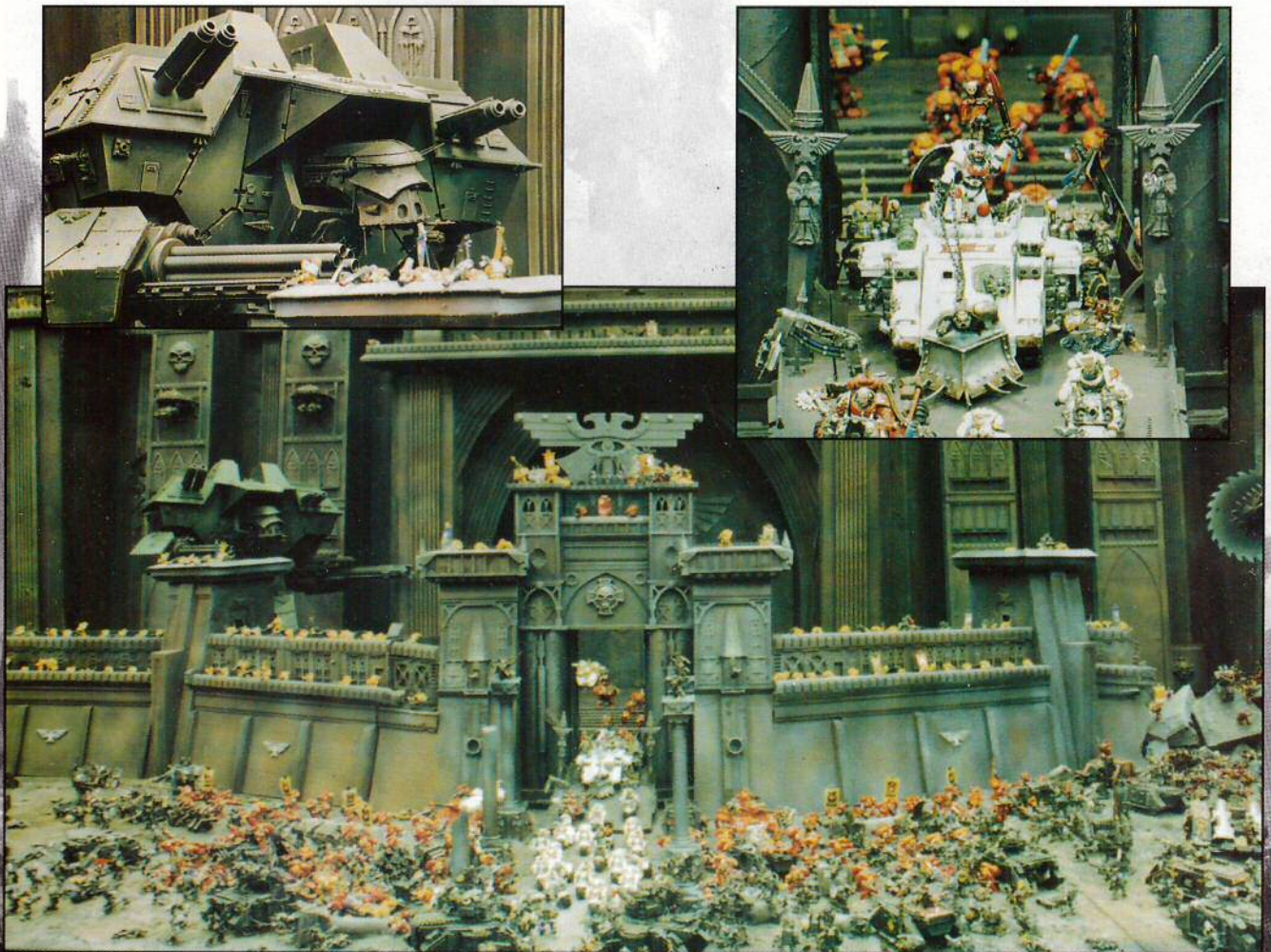

Pods, these presented fine targets for the weapons of the defenders. And thus did the battle for Earth begin in earnest.

Defence lasers blasted many renegade ships from the sky, sending thousands of tons of fused metal death raining down onto the ground below. One giant raft span out of control and crashed into a hab-unit, killing a hundred thousand people. Another was welded to the ground, disgorging its passengers into a lake of bubbling tar and plas-crete. The vessel of the Legio Damnatus was vaporised and that Titan Legion's name passed into history. As quickly as they disembarked, the traitors surged forth from the spaceports to besiege the bastions of the defenders. Their first objective was to silence the defence lasers inflicting such casualties on their comrades. The rebels were met by a wave of Imperial defenders, desperate men who knew that they were giving their lives for their home world and their Emperor.

In the tightly packed streets around the spaceports, the fighting was close and deadly. Bolters chattered and missile launchers delivered cargoes of death from building to nearby building. Traitor tanks rumbled through the avenues,

turrets swivelling to bring weapons to bear on the hastily improvised barricades of their former comrades.

Soon the defenders of Eternity Wall Spaceport had been swept aside by the merciless assault and the hordes of the Warmaster were in total possession of the space field. More and more intricately wrought drop-ships descended from orbit. They towered over the landing ground like nightmare skyscrapers, the dark runes on their sides glowing evilly in the gloom. Hundred-metre high doors opened in their kilometre-long sides. From their red depths, Titans emerged. They were warped giants; the armour of their carapace fused and moulded into new shapes by the power of Chaos. Within them were men melded to their machines. Some of the hideous Titans had strange and potent weapons, others were a bizarre hybrid of the organic and the machine. Metal tentacles lashed, spiked tails whipped back and forth. Engines roared like the voices of angry beasts. Banners fluttering, the Titans of the Storm Lords and the Flaming Skulls legions marched forth. At Lions Gate Spaceport, the traitors welcomed the towering black war engines of the Khornate host. Monsters, mutants and

cultists seethed like angry ants around their bases.

Reinforced by this fresh wave of troops, the hordes swept on, driving through the exhausted and demoralised Imperial troops to the very walls of the Emperor's palace. Khornate warriors howling their bestial war cries raced towards the marble and steel outer ring. Hordes of unstoppable Thousand Sons marched relentlessly forward, bolter fire raking the defenders. Slaaneshi Noise Marines swept aside the Imperial Guard infantry and reached the Saturnine Gate. Round the walls bitter fighting ensued as the Imperial soldiers sallied forth, trying to drive the attackers back before the main body of the assaulting troops arrived. Men died in their thousands. From pillbox emplacements in the palace walls Imperial gun crews rained death down on the relentless attackers. Again and again the streets outside the palace were swept clear of heretics. Again and again new foes stepped forward to take their place.

Now indeed it seemed that the tide of battle had turned against the Emperor. The spaceports were firmly in the grasp of the minions of the Warmaster. Hundreds of thousands of troops poured

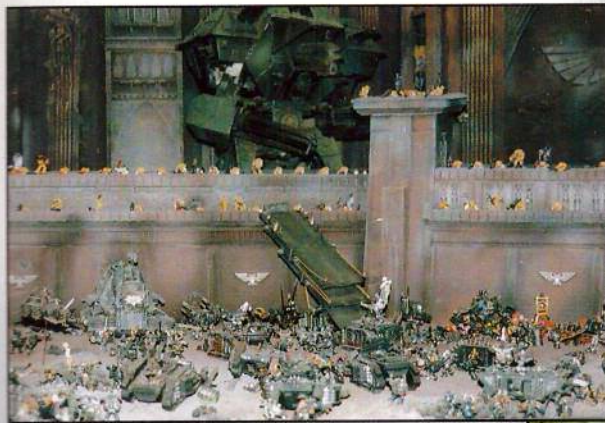

The Siege of the Emperor's Palace was Games Day 98's megadisplay. Months in the making, the diorama tells of the final, desperate struggle for control of the Emperor's Palace on ancient Terra. The finished piece stood over 6' tall and 12' wide and included both a Chaos and Imperial Warlord class Titan, an awesome scratch-built Chaos mole made by Tony Cottrell and even included the legendary Jaghatai Khan, Primarch of the White Scars, leading his Legion out for a lightning fast attack on the Chaos hordes as he speeds towards the Lions Gate spaceport.

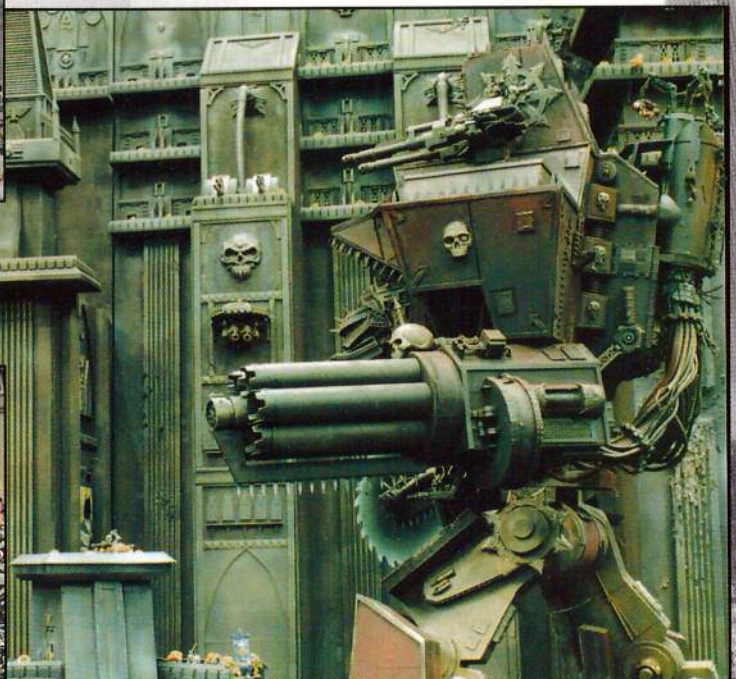

down from orbit. Gibbering mutants and hideous amorphous Chaos Spawn surged out of the dread ships. Under the banner of the great eye, the sign of Horus, the lackeys of the four great powers of Chaos marched united. Mounted in Rhinos, lurking within mighty behemoths and clinging to the sides of gigantic war-engines, they made their way en masse to the Emperor's palace.

Looking down on the seething sea of foulness, the defenders' hearts went cold. Mingling with the daemons and the mad-eyed cultists and the mutants, they could see heretical Space Marines and traitor Guardsmen. These were people they might have once fought alongside, who had once been as loyal to the Emperor as themselves. They looked upon a dark mirror of their souls. Down there they could see martial honour become berserk madness, human cleverness become sly treachery, hope become foulness and love become abominable lust. The brave men on the walls knew that there was no way out. Here they must stand and fight and die. There would be no mercy from those below.

This was a war where there could be no honourable peace. It was destroy or be destroyed. For a moment all was silence, then Angron strode forth. In his brazen voice he demanded that the loyalists surrender. He told them that their cause was hopeless, as they faced a foe which could not be defeated. They were cut off, outnumbered, and defending a ruler too weak to be worthy of their loyalty. In that moment the men on the walls felt their resolve weaken. Looking at the transformed face of the Primarch who had once been one of the

Emperor's finest warriors, they saw an invincible, relentless foe backed by a numberless horde and all the daemonic might of Chaos.

There was a clamour on the walls as Sanguinius and the Blood Angels arrived. Standing on the wall, the angel-winged Primarch glared on Angron with angry contempt. For long moments their gazes locked, each Primarch seemed to be measuring the other, searching for chinks in the armour, for any sign of weakness and lack of resolve. Who knows what they saw there? Perhaps they communicated telepathically, brother Primarch to brother Primarch. The truth will never be known. Eventually Angron turned and walked back to his lines. He told his troops that there would be no surrender; they should kill everyone they found within the palace. No stone should be left upon stone.

With a roar the horde advanced towards the walls. Great Lords of Battle lurched forward on iron wheels, crushing anything in their way, unloading racks of missiles and turning the area on the top of the walls into blazing storms of death. Doom Burners sent tongues of superheated metal licking out at the emplacements. Molten brass filtered through the windows and scalded those inside. Multi-tracked Cauldrons of Blood squirted jets of obscene daemonic ichor onto the defenders. Enormous Flesh Hounds of Khome loped forward in their wake. Titans armed with specially constructed siege weapons lumbered into position. Battle cruisers dropped megatons of explosive death onto the defenders.

Every loyal warrior knew that he was already dead, that there was no way he could survive the coming of the daemonic army. The soldiers fought with the desperate ferocity of hopeless men, firing until their weapons were empty, snatching up the bolters of the fallen, and facing monsters with the butts of their guns when all ammunition was exhausted. Three times the horde managed to scale the walls, and three times it was driven off by the valiant efforts of Sanguinius and the Blood Angels. Warily the Primarch marshalled the defenders, rallying the broken, speaking words of comfort to the mortally wounded, fighting with cold, implacable fury when he was called upon to do so. Slowly though, despite his efforts, the Chaos forces managed to erode the defence. They seemed numberless as the grains of sand on a sea shore and Horus spent their lives carelessly.

Outside the walls, Imperial forces frantically raced from their bastions to try to relieve the palace. Titan legions boldly cut their way towards the centre of the rebel army. The White Scars Space Marines harried its flanks. No attempt to break the rebel line succeeded. Breaking through that blood-mad horde was a near impossible task. All four of the daemonic Primarchs inspired their followers to feats of fiendish bravery. For every Chaos warrior who died it seemed that two more stood ready to take his place.

In orbit, the Warmaster watched approvingly. If the palace fell and the Emperor died, loyalist legions across the galaxy would lose heart and the war would be over. Without the psychic



shield of the Emperor's power, Humanity would swiftly fall prey to Chaos. Horus would stand triumphant amid the rubble of Humanity's greatest empire. He would become a new and angry god. If he did not win soon, reinforcements would filter in from the corners of the Imperium, and his attack would falter. For the Warmaster this was the desperate, ultimate gamble. Everything was staked on this attack. It had to succeed, and at that moment it looked as if it might.

Day by day the siege wore on, casualties rose from the thousands to tens of thousands to hundreds of thousands. Bodies had to be bulldozed from the access ways to the Saturnine Gate by war machines. Chaos Titans blazed at the walls, specially constructed missiles ripping great chunks from the masonry. The Titans of the Fire Wasps answered their fire with volcano cannons. The smell of burning flesh filled the air as the corpses of the dead were incinerated in funeral pyres a hundred foot high. Obscene ash parched the throats of the defenders. The World Eaters built a pyramid of scorched skulls sixty foot high in Temple Square. By night the chants of degenerate cultists echoed through the streets and daemons flitted among the ruins of Earth.

Slowly, foot by torturous foot, the defenders were forced back. The great walls of the palace were riddled with hundreds of kilometres of bulkheads and corridor. Within this maze, bitter hand-to-hand fighting ensued until entire sections of passage were filled with bloated corpses. Feeling that progress was too slow, Horus ordered the Titans of the Death's Head Legion to demolish

entire sections of the wall. Despite taking tremendous casualties, the great Warlord Titans broke through, and the forces of the Warmaster flooded into the palace grounds.

While all this was taking place, Jaghatai Khan of the White Scars had implemented a change of plan. Rather than throwing away his forces against the near invincible bulk of the main Chaos army, he launched a lightning raid against Lions Gate Spaceport. This night attack was spearheaded by the savage warriors of the White Scars, who led the remnants of the 1st Tank Division and elements of the surviving Guard armies against the surprised heretics. Khan threw a defensive perimeter around the spaceport and held it against all counter-attacks. The flow of men and materials towards the palace was halved at a stroke.

This success gave heart to the defenders. They swiftly attempted to seize Eternity Wall Spaceport, but here the forces of the Warmaster were better prepared. The attackers were ambushed and driven back by traitors. Horus knew it was imperative to keep his beachhead secure. The final push on the inner palace had begun.

The battle raged across the grounds of the Inner Gardens. What had once been a vast parkland was swiftly turned into a killing ground. Men used statues for cover and monuments for bunkers. Blood swirled in the waters of the ornamental lakes. Groves of ancient redwoods burned. The smell of the burning mingled with the acrid odours of weapons and engines and death. Red-eyed, snatching sleep when they could, both sides fought a total war. Trenches were hurriedly excavated in the meadows. Snipers killed men as they tried to sip brackish water from the ruined fountains.

Both sides fought with unimaginable naked ferocity. Both sides sensed that the end was near.

Eventually Sanguinius was forced to retreat to within the palace itself, personally holding the Ultimate Gate against the oncoming horde while the last of his wounded men was carried through. Just as the giant ceramite gate was about to close, a Bloodthirster of Khorne leapt upon him and the daemon's huge talons closed around Sanguinius' throat. The Primarch took to the air, angel and daemon wrestling over the warring armies. Both sides halted for a moment to watch the titanic struggle. It was a conflict such as has been rarely seen; two beings of awesome power wrestling above them.

Sanguinius was weary and near the end of his strength, and the daemon gouged great wounds in his flesh. The heretical throng roared its approval as the Primarch was cast to the ground, the

impact splintering the granite. For a moment the Primarch lay still and a groan rose from the Blood Angels as the daemon stood over him and howled in exultation. Then slowly and painfully the Blood Angels' Primarch rose and seized the creature, raised it high and broke its back across his knee. Then, with a halo of power playing round his head, he tossed its broken carcass back amid its followers. They beat their chests and rent their hair and wailed in dismay as the Ultimate Gate shut.

Above, the great Sky Fortress bore Rogal Dorn and the remnants of the Imperial Fists to the inner palace. The loyal Primarch was determined to stand and die with his Emperor in the final hour. The Sky Fortress then raced away from the palace in a desperate attempt to reach Jaghatai Khan and return him to the palace. It was destroyed by a blaze of fire from the Death's Head Titan Legion. Even in death its commander wrought havoc on the enemy, bringing the crippled vehicle down into the centre of the Chaos horde. It seemed as if a new sun was born on Earth as the plasma reactor exploded, blasting out a crater three kilometres across. Those within the palace knew they were cut off; now they were truly alone. Only a miracle could save them.

Now the final siege began. Through great breaches in the outer walls more and more armaments and reinforcements were brought to bear. The Warmaster himself prepared to teleport down to the surface and supervise the destruction of his former lord. Then a daemon from the Warp whispered to him the words that he had dreaded. A loyalist fleet under Leman Russ and Lion El'Johnson bearing a fresh army of Space Wolves and Dark Angels was only hours away. It would take days to break Humanity's last citadel, even with Horus leading his troops. It seemed that time had run out for the Warmaster, that his gamble had failed.

Horus was first among the fallen, with the power of a god and the cunning of a daemon. He resolved to try one final desperate gambit. He could still kill the Emperor. He ordered all comm-net communications blocked so that the defenders would get no word from their rescuers and then he used his psychic powers to the full to prevent the Emperor becoming aware of this. Finally he dropped the shields of his command ship. It was an invitation and a personal challenge that he knew the Emperor could not resist. He was being offered a chance finally to smite the foe who had harried him for so long.

The Emperor rose to the challenge, and he and his surviving Primarchs teleported aboard the Warmaster's battle barge. Horus used his powers to



separate the Emperor from his loyal followers. The loyalists were transported to different spots within his hideously altered ship. Sanguinius fought his way directly to Horus' throne room. In his evil cunning the Warmaster offered the Blood Angel a chance to switch sides, reasoning that the winged Primarch's followers would be useful when the Space Wolves and the Dark Angels arrived.

Sanguinius refused. Horus grew wrathful and attacked him. At the peak of his powers the Blood Angel would have been no match for the Warmaster and now, sorely wounded and weary, he had no chance at all. Horus strangled him with his bare hands before the throne which the powers of Chaos had gifted him with.

The Emperor found Horus shortly after this and what happened next is the subject of legend. The two mightiest beings in the history of Mankind clashed. They met blade to blade, power to power, mind to mind and tested sinew and psychic ability to the ultimate. Behind Horus was the massed power of the Chaos gods. The Emperor stood alone and still he triumphed, though he was terribly wounded in the process.

The psychic shock wave of the Warmaster's passing rippled outward through the warp. On Earth, daemons screamed and vanished, and the rebel Primarchs stood dumbfounded. It was their leader, not their enemy's, who was dead and they knew it. With the one who had raised the banner of rebellion dead, there was nothing to hold the rebels together. They were demoralised and dismayed. When word of the oncoming Imperial fleet reached them they knew that they must flee.

Within the perimeter of Lions Gate Spaceport, Jaghatai Khan and the handful of unwounded White Scars watched in amazement as the horde halted in confusion then retreated. Angron, Fulgrim, Magnus the Red and Mortarion led their men to their ships and departed, leaving the deluded, traitorous followers of Chaos to their fate. As he stepped aboard his ship, Angron turned and shook his fist at the glittering dome of the Imperial palace that had proved just out of his taloned reach.

Then he shrugged; he and his fellow rebels had all eternity to seek revenge. The Battle for Earth was effectively over. The Horus Heresy was ended. Rogal Dorn found the Emperor's broken body in the ruins of the Warmaster's throne room. Through mangled lips, the Emperor whispered instructions for the creation of his golden throne. Dorn smiled, for while the Emperor still lived there was still hope.

The veteran Primarch returned to Earth. There was much to be done.

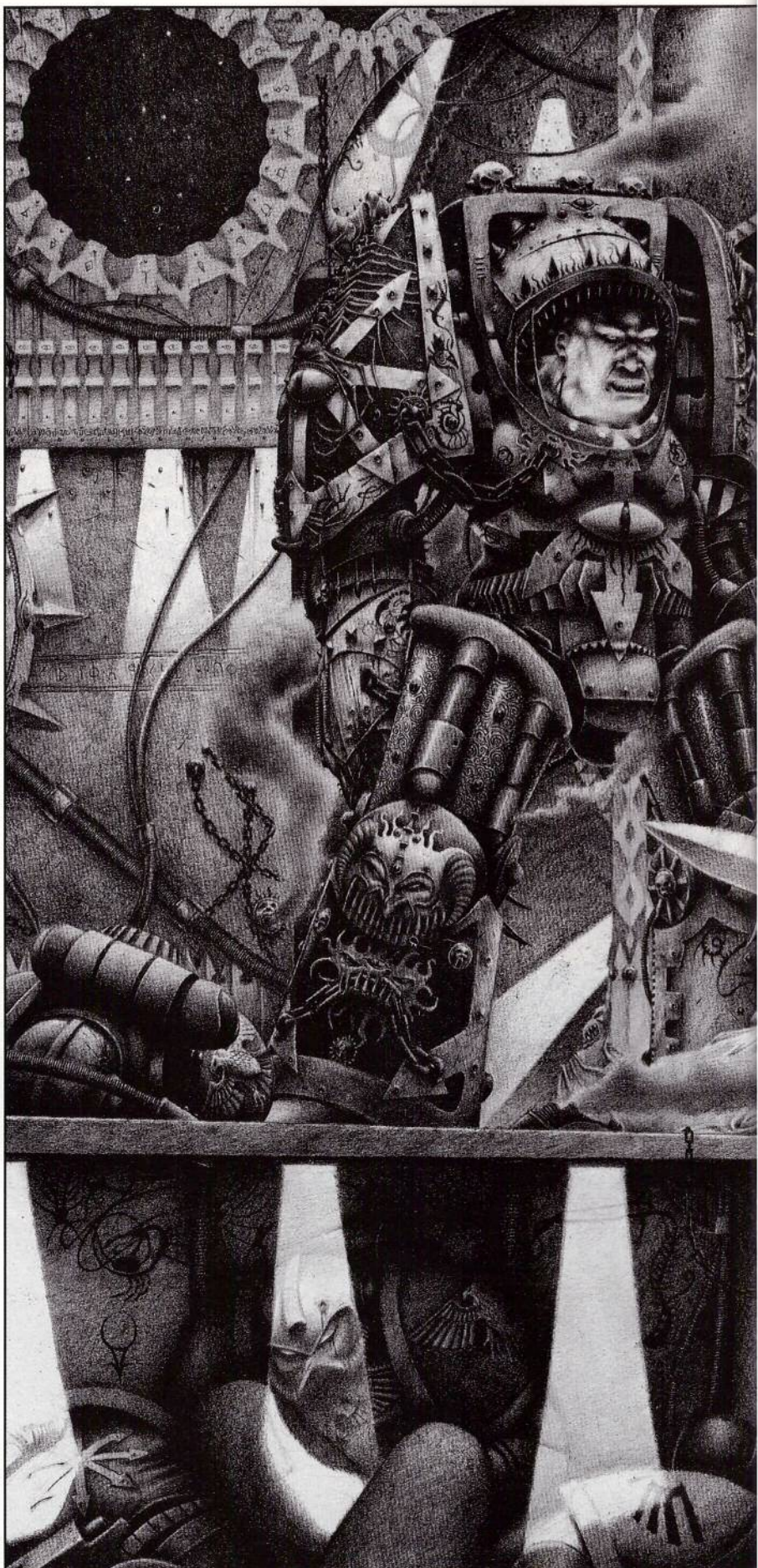

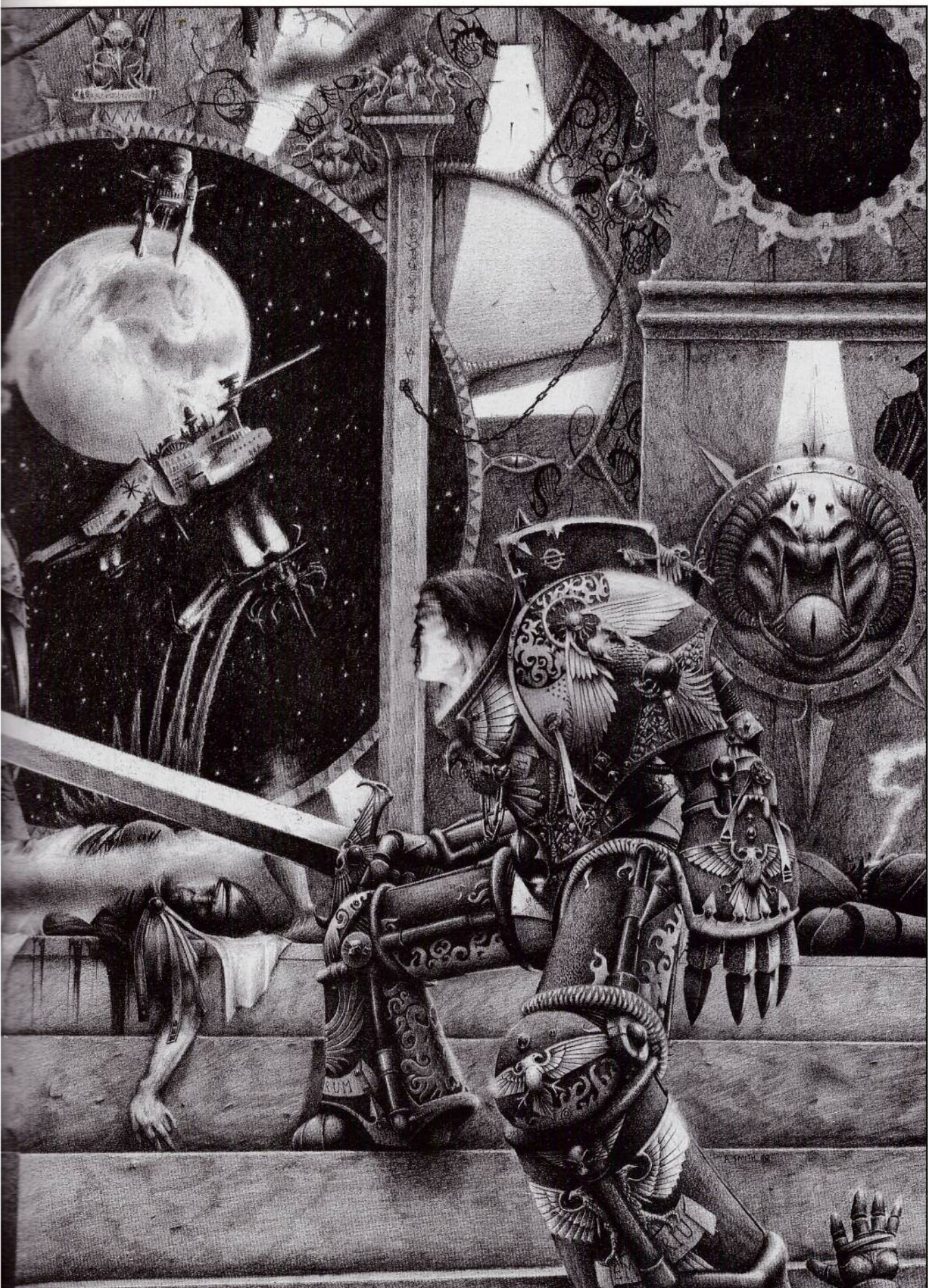

BITTER AND TWISTED

This month the Legions of Chaos are bolstered by the release of an Iron Warriors squad and an Iron Warriors Warsmith. You can find the rules for the Iron Warriors in the Index Astartes compilation.

The implacable Iron Warriors have landed!



An Iron Warriors Warsmith

An Iron Warriors squad, including an Aspiring Champion, plus Warriors with a lascannon and a meltagun.



| | | | |
|------------------|----------------------------------|--------------|---|
| COMMIT TO: | INQUISITION RECORD KW 93/03u4 | TRANSMITTED: | SPIRIT OF DOMINICA (INISCURI SYSTEM) |
| CROSSFILE TO: | IMPERIAL RECORD 03323/9302 | TRANSMITTER: | ASTROPATH PRIME SOLIS |
| INPUT DATE: | 4393597.M38 | RECEIVER: | ASTROPATH-TERMINUS GAIUS |
| INPUT CLEARANCE: | CLASSIFIED | THOUGHT: | FAITH IS THE STRONGEST OF ARMOUR. |
| AUTHOR: | INQUISITOR MAUL | | |

>>> My Lords,

It is with shock and anger that I must report to you that our fortress-archive at Auxesia has fallen. My team and I arrived here three days past, in response to our lay-brethren's pleas for aid, I have spent that time gathering what details I could so that you may formulate an appropriate and, I trust, timely response. My Lords, Auxesia and our most sacred library is now a blasted ruin, the sight of which has reduced many of my compatriots to tears.

The testimony that follows was compiled from the engrams of servitor TF/927, stationed aboard Inquisition Orbital Augur AUV-839/93.

The invaders were the traitors of the Iron Warriors legion, led, so far as we can deduce by Ferrous Ironclaw, the Warsmith of the Iron Warriors' second grand company. As you know, this bitter and sadistic creature has been responsible for numerous attacks on Imperial worlds since the time of the Heresy, and his presence in this sector fills me with dismay.

The attack came completely without warning. Before local forces could be mobilised, the traitor fleet arrived in high orbit and neutralised the majority of Auxesia's defence assets with a heavy and sustained orbital bombardment. Iron Warriors drop pods and Dreadclaw assault craft soon filled the sky, landing in the vicinity of the fortified city of Damia, where our archive was located. What little resistance the defenders could muster was destroyed in short order.

The traitors encircled the hastily prepared Imperial lines and established their fortifications, cutting off further relief or escape. Successive lines were constructed and fortified over the course of the next twelve days, with a Redan pattern continuous entrenchment constructed. The heavy weapons emplacements so characteristic of the Legion soon studded the lines, with the Iron Warriors' staple lascannons and heavy bolters much in evidence.

[In this deployment we see the Legion's reliance on heavy weaponry aptly demonstrated, and I am led to wonder what damage a well-equipped and motivated assault oriented force could wreak amongst such a tactically unbalanced deployment].

The traitors displayed the twisted cunning and ingenious logic we have come to expect in their construction of field fortifications +++Augur scan schematics attached+++ With the final (third parallel) line complete, the Iron Warriors commenced their bombardment of the city on the thirteenth day. Damia was equipped with an ancient void-shield array, and this held out for the first three days of the assault. The Iron Warriors threw thousands of tons of ordnance at the shield, including plasma torpedoes from orbit and Earthshaker and Doomblaster shells from the ground. They even utilised Doomstrike missile launchers evidently captured in earlier engagements.

The void-shield could not withstand such punishment, and eventually collapsed. With the protection of the shield lost, the defenders saw no alternative but to launch a desperate counter-attack. Twelve companies sallied forth through the city's main gate. Those who did not fall victim to the miles of razorwire, tank traps and mine fields were cut down in a brutal crossfire from concealed positions along the Iron Warriors' line.

The bombardment carried on for a further seven days, until one dawn the heavily fortified gatehouse collapsed under concentrated shelling. This was evidently the opening the Iron Warriors had awaited, and they now commenced their ground assault. From the length of the trench lines, Rhinos and Land Raiders swept forward, heading for the ruins of the gatehouse and other, smaller breaches in the wall. Termite tunnellers were used to transport the elite of the traitor force directly to targets beyond the walls, and Terminators were teleported from the fleet in orbit to points of resistance along the wall.

The remainder of the siege consisted of brutal street-to-street fighting, followed by the wholesale slaughter of the defenders as they attempted to escape the doomed city. In the following days, the invaders set about an orgy of destruction, and the Augur was rendered blind by the volumes of smoke released by the fires left in the traitors' wake.

We arrived two months after the Iron Warriors' fleet was first detected. Upon entering orbit we found a world shrouded in smoke and ruin. The Iron Warriors had left. Our first concern was for the sanctity of our archive-shrine, fearing as we did that the records held therein were the objective of the attack. It saddens me to report that our library is destroyed utterly, but it furthermore puzzles me that it did not appear to have been desecrated by the invaders.

In less than two months, the traitors had reduced an entire world to ruins. One hundred thousand Planetary Defence Force troopers lay dead, and Auxesia's capital and every major settlement was reduced to rubble. As far as I can see, the traitors had not even set about their siege with the intention of capturing land or assets - they appear to have fought simply for the sake of causing death and destruction in the names of their foul masters. As I have remarked in the past, it appears to me that the traitors of the Iron Warriors Legion will not suffer a fortress or redoubt to stand lest they themselves have constructed it. Any other structure is a blasphemy to them and they are compelled to cast it down.

My Lords, once again I submit my request that a survey mission be sanctioned to penetrate the Eye of Terror. For too long have we suffered the predations of these traitors and I beg that I be allowed to breach their realm.

You most obedient servant,
Inquisitor Tybalt Maul <<<

Transmission ends <<<

ABADDON THE DESPOILER

SCOURGE OF THE IMPERIUM

Leader of the apocalyptic Black Crusades and destroyer of worlds, Abaddon the Despoiler has caused the death of untold billions throughout the Gothic Sector and beyond. Graham McNeill uncovers the dark history of this evil Lord of Chaos.

It is said that the name of the Despoiler is a curse that blights the lips of those who speak it, bringing ill fortune and misery upon the poor unfortunate who gave voice to that damned name. It is not for nothing that Abaddon's name carries such power, for he was once a favoured servant of the Emperor before being cast down into the depths of madness and hatred. Once, Abaddon carried the Emperor's light to the darkest corners of the galaxy, bringing fire and steel to those who would not accept the manifest destiny of Mankind to rule the stars. Many thousands of years ago, Abaddon was a captain in the Luna Wolves, one of the greatest Legions of the Emperor's armies, but who treacherously betrayed their master and plunged Mankind into one of the most destructive wars ever to tear at the galaxy. Now that once-proud champion has sunk into an inescapable morass of bitterness, hatred and obsession.

The Luna Wolves fell under the command of the Primarch Horus, first among the Emperor's sons, and Abaddon commanded the First Company of the legion. Abaddon was a mighty hero and a warrior almost without peer. He marched at the forefront of the Emperor's Great Crusade, liberating world after world from alien oppression or the corruption of Chaos, and records of his feats of bravery and heroism filled entire halls of the legion's Librarius. He revered Horus as a god, venerating him above all others, and Horus, in turn, treated Abaddon as a favoured son, bestowing upon him all manner of honours and plaudits. It was even rumoured by some, perhaps jealous of Horus' favour, that Abaddon was in fact his clone-son, the result of the earliest primogenitor experiments. The truth of these rumours was never proven and whether even Abaddon himself knows is a secret kept only by him.

THE HORUS HERESY

As the Great Crusade continued, it seemed as though nothing could halt the expansion of the Emperor's realm and after the Luna Wolves' successes in the Ullanor Campaign, the Emperor declared it to be the greatest victory yet achieved by any of his Primarchs. He bestowed the title Warmaster upon Horus and renamed the legion the Sons of Horus, in honour of

its Primarch. He then bade him return to Terra to receive his battle honours. What happened next has been so clouded by myth and outright falsehood that the truth of the matter is unlikely ever to be known. For unknown reasons, the Warmaster Horus turned to Chaos and rebelled against the Emperor's rule while en route to Terra, beginning what historians have chosen to call the Horus Heresy. Whole swathes of the Imperial armed forces sided with Horus, from the Navy, divisions of the Collegia Titanica, factions of the Adeptus Mechanicus and entire regiments of the Imperial Guard. Even worse, a full nine Legions of Space Marines joined the Heresy, pitting brother against brother in a galaxy-wide civil war.

Abaddon was instrumental in the rebellion, tearing down what he had helped to build in the Great Crusade, smashing down the statues of the Emperor and defiling his temples in the name of his new masters, the gods of Chaos. The name of Abaddon became a byword for betrayal, second only to that of his Primarch, as the Sons of Horus advanced relentlessly towards Terra, defeating every foe that stood before them.

The fall of Horus is one of the greatest legends of the Imperium of Mankind and its telling would take many volumes of greater size than this. Suffice to say that the rebellion faltered at the cusp of victory when the Emperor took the fight to Horus on his own battle barge and, in a battle of such titanic proportions that only the most gifted storytellers may attempt its retelling, bested his once-favourite son. Fighting on another part of the mighty vessel, it is said that Abaddon felt the psychic backlash of his master's death and that the trauma of this calamitous event pushed Abaddon deeper into the pits of grief and madness than any mortal being should ever sink. Enraged with a deathly fury, Abaddon hacked and slaughtered his way to the bridge of the Warmaster's flagship, cutting down those Imperial warriors who yet remained on the vessel. He reclaimed the body of the fallen Horus, tearing the Warmaster's lightning claw from his wrist and taking it for his own as a symbol of Horus' legacy. His howl of anguish echoed through the Immaterium, and the forces fighting below on Terra suddenly knew that their cause was lost.

As the Chaos forces withdrew from Terra and their fleets fled into the depths of space, Abaddon took command of the Warmaster's battle barge and escaped to the Eye of Terror in the galactic northwest. The scale of Abaddon's fury knew no bounds and entire systems were ravaged in his bitter flight from Imperial forces. Before he could be stopped, Abaddon's ship vanished into the Eye of Terror and disappeared from Imperial space, and many hoped that this would be the last of him. But the powers of Chaos are mindful of those pawns that may yet serve them and Abaddon was to return, many years later, more powerful than ever, at the head of his first 'Black Crusade'.

THE DESPOILER

Abaddon returned at the head of a vast army, laying waste to entire regions of space around the Eye of Terror in a devastating crusade that almost managed to break through into Imperial space. The noble champion of Humanity that Abaddon had once been had vanished forever, swallowed by the dark powers of Chaos, and he destroyed without mercy, killing every living thing before him. Where Horus had failed, he vowed that he would one day succeed. He would see the galaxy burn. And but for the combined might of the Imperial Titan Legions and several Chapters of Space Marines, he would have succeeded. Abaddon was driven back to the Eye of Terror, bringing to an end the first of his Black Crusades, but it would not be long until he returned. Each time Abaddon brought death and destruction on a massive scale to the Imperium, he made unnumbered pacts with the diabolic entities of the warp in return for power beyond imagining. Led by a monstrous, golden messenger, Abaddon discovered the daemon weapon Drach'nyen beneath the Tower of Silence on Uralan and became nigh unstoppable.

The Chaos gods lavished unspeakable and inhuman strength upon their champion, investing him with powers beyond mortal ken, and he repaid them in blood. At El'Phanor, his forces assaulted the Citadel of the Kromarch; a fastness built with all the cunning its designers could muster. It was pierced with but a single portal, a mighty gate of adamantium, fully three metres thick, but Abaddon cared not. He boasted that he

would feast on the Kromgrch's kin and led the charge of the gate himself. The Citadel was a masterpiece of military engineering and barely one in ten of Abaddon's warriors survived to reach the gate. To either side, enemy weapons prevented their retreat, but Abaddon laughed, raising his sword wreathed in black flames high above his head and smote the gate a blow that smashed it to splinters and shook the very foundations of the citadel. As Abaddon had promised, he and his warriors feasted upon the Kromarch.

On the bloody fields of Mackan, Abaddon sought out the Blood Angels and repaid them for the part they played in the downfall of Horus. Leading a charge of berserk warriors towards the dug-in positions of the Sons of Sanguinius's heavy weapon squads, Abaddon and his warriors charged through a storm of gunfire that should surely have seen them all slain. But Abaddon clawed his way across the Blood Angels' barricades unharmed and he and his few surviving berserkers tore the beating hearts from their enemies' chests. When the inevitable counter-attack struck, the victorious Abaddon fought with such tenacity and ferocity that the Blood Angels were unable to reclaim the fallen bodies of their battle brothers. Abaddon had special reason to hate the Blood Angels – now they had one to hate him.

To date, Abaddon has led twelve Black Crusades into the Imperium, vast sector-wide campaigns and countless seemingly random raids, and though every one has thus far been defeated, the cost of holding them at bay has proved almost too much to bear. The one stable route through warp space that leads from the Eye of Terror is known as the Cadian Gate and the entire Cadian sector has become a military camp, its every resource dedicated to martial industry and holding the forces of Chaos at bay. Its manufactoria churn out millions of tons of ordnance every day, thousands of armoured fighting vehicles rumble from the assembly lines of its hangar forges and every man and woman is trained from birth as a soldier. The wars fought in this sector are without number, but perhaps the most destructive incursion which



Abaddon has made into Imperial space occurred in the early years of the second century of the Forty-First Millennium, and has since been dubbed the Gothic War.

THE GOTHIC WAR

The seeds of this devastating war had been sown some years earlier, in a series of seemingly unconnected raids on Imperial outposts across the Segmentum Obscurus. Warp storms built across the sector with growing fury, and zealots preached that the Emperor was displeased with his subjects' wickedness and was sending these storms as a sign of his displeasure. Despite all attempts by planetary officials, fanatic cults formed, hordes of flagellating doomsayers engulfing the Gothic Sector in violent upheavals. Secret cults and covens used the cover of these upheavals to insinuate their depraved members into positions of power and authority. After several naval vessels were lost to explosions in dock, widespread reports of suspected sabotage did nothing to calm an already volatile situation. With sightings of Chaos vessels in the sector increasing all the time, it was soon clear to even the most blinkered official that the forces of Chaos were planning a major incursion into the Gothic Sector.

Abaddon's fleet struck as the building warp storms swirling around the Gothic Sector surged into terrible life, cutting off the Imperial defenders from any help. Dozens of Imperial outposts were attacked simultaneously throughout the Gothic Sector, naval vessels were ambushed and orbital docks were bombed by saboteurs. Though taken by surprise, Imperial forces were able to hold on and prevent themselves from being totally overwhelmed. Of the seventeen naval bases in the Gothic Sector, six were based on what were known as the Blackstone Fortresses, ancient star citadels of unknown origin. Who had created them or what their original purpose had been was a mystery, but they made perfect bases of operation for the Imperial Navy. After extensive refitting by the Adeptus Mechanicus with primary power and weapons systems centuries before, each was the equal of Naval Command at Port Maw. The Navy prided itself that none of the Blackstones had ever fallen in battle, but after the battle of Blackstone IV, this was all to change.

As the Chaos fleet moved in to attack, Blackstone IV's power grid suddenly and inexplicably shut down, rendering the guns useless and the personnel on board defenceless. The battle was short and bloody and, after a hurried astropathic plea for aid, there were no more communications with Blackstone IV. But there was worse to come. Abaddon had not been idle in his time within the Eye of Terror, using millions of slaves, sorcerers

and polluted magicks to create a gargantuan vessel, simply dubbed the Planet Killer. The cardinal world of Savaven was the first to feel its wrath and was destroyed in a single night as the Planet Killer's unholy weapon split the planet's core apart. An impenetrable asteroid field is all that remains to even prove it existed at all and Imperial morale was hit catastrophically by this colossal act of destruction.

Sub-sector after sub-sector fell to the legions of Chaos, worlds surrendering wholesale rather than face the awesome power of the Planet Killer. Another Blackstone Fortress fell to Abaddon at Brinaga when it appeared that his minions had some way of activating the long-dormant weapon and power systems of the mighty fortress. With the power of two Blackstone Fortresses at his disposal, Abaddon attacked the defenders of Blackstone I at Fularis II, utilising the unknown power of the Blackstones to combine their energies in an unholy blast of warp-spawned power to annihilate the Imperial forces and capture the Fortress.

The war dragged on for many years, with Abaddon's fleets continuing to ravage the sector until the warp storms that had isolated the Gothic Sector for so long began, finally, to abate. At Tarantis, Abaddon demonstrated the fearsome power of the Blackstones once more. With the combined might of the three now at his disposal, he unleashed their energies into the core of the star at the heart of the Tarantis system before making a fighting withdrawal. The star seethed and boiled for many weeks, and those that could flee the system did so until, four weeks after the attack, Tarantis' star went nova, destroying everything for many thousands of billions of miles in all directions and rendering the system uninhabitable.

The climactic battle in the Gothic war was to take place at Shindlegeist, where Blackstone V orbited in the depths of space. Eldar forces that had chosen to ally with the Imperial forces, led by Lord Admiral Ravensburg, had discovered Abaddon's intent to attack Blackstone V and allowed the Imperial fleet to utilise their ancient warp portals in order that they might spring a trap on the Despoiler. As Abaddon began his attack, the allied forces fell upon him with all their might and there was little the traitorous captains could do except to die fighting. The battle was one of the most destructive and bloody of the war, lasting for fully three days. At the battle's climax, Abaddon ordered the three Blackstones under his command to drive for the system's star and inflict upon it the fate that had befallen Tarantis. But Captain Abridal aboard the Flame of Purity flew his ship into the path of the Blackstones and managed to disrupt their powerful beams. His ship was torn apart by the lethal energies, but his heroic

sacrifice saved the star from destruction. The Blackstones had expended their power and Abaddon had run out of time.

Abaddon fled into the warp with two of the Blackstone Fortresses, the third hotly pursued by the vengeful Imperial fleet. The Imperial ships hammered it with their weapons, to little effect, until Strike Cruisers from the Angels of Redemption and assault boats from the Divine Right were able to close and board the Fortress. They found the interior of the Blackstone Fortress changed beyond all recognition, the modifications made by the Adeptus Mechanicus vanished and the walls pulsing with a dark, internal light. No sooner had they boarded than the fortress began to break up around them, slowly cracking apart into thousands of fragments. And with Abaddon's defeat at Shindlegeist, the Gothic War was over.

Throughout the Gothic Sector, the remaining Blackstone Fortresses destroyed themselves in a similar fashion, though whether the two still under Abaddon's control also broke apart is not known as there have been reported sightings of the Despoiler, both with and without them in the years since the Gothic War. And as for the Planet Killer, unverifiable reports claim that it was destroyed by Omega Squadron at Kharlos II, but when Adeptus Mechanicus salvage teams led by Inquisitor Horst journeyed to the site of the battle, they could find no trace of the vessel.

Abaddon has been a constant threat to the Imperium ever since the end of the Gothic War, but thus far, has yet to raise as vast a force as he did during those dark days. The High Lords of Terra live in fear of the day that Abaddon is able to unite the various armies of the Eye of Terror, but the very fractious nature of its inhabitants may be the High Lords' greatest ally in preventing such an occurrence. There are a multitude of ruthless warlords within its anarchic depths and it is hoped that many would be unwilling to unite under a single banner, lest their own monstrous ambition be outshone by Abaddon's dark glory. However, many who are given to know such things speak of dark portents and dreadful omens that point to the rise of a great uniter within the depths of the Eye of Terror. The identity of this mysterious figure remains elusive but, knowing the force of Abaddon's leadership, it is difficult to see who else it could be. Currently there are the usual scattered reports of Chaos vessels probing Imperial picket lines, though perhaps on a more regular basis. A dire warning from the Eldar Farseer, Eldrad Ulthran, telling of Abaddon's return has caused alarm in some circles, but the words of such a manipulative xenos obviously cannot be trusted and his lies have been discounted.

Forge World

Abaddon is the Lord of the Black Legion of Chaos Space Marines and rumoured to be clone-son of Horus himself.

Not only is Abaddon a Warhammer 40,000 miniature sculpted by Jes Goodwin, it's also an imposing piece from Forge World. Abaddon is one of the most detailed and characterful models you can own.

Sculpted by Simon Egan (based on Jes Goodwin's original concept sketch below), this 18-part resin model stands some 11 inches/275mm tall when assembled.

You can find more information on this fantastic model and others like it at: www.forgeworld.co.uk



Painted by Darren Latham

USING ABADDON IN WARHAMMER 40,000



On the killing fields of Mackan, Abaddon takes his revenge against the Blood Angels.

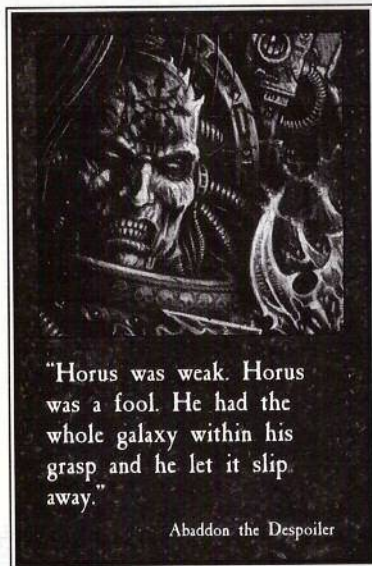

"Horus was weak. Horus was a fool. He had the whole galaxy within his grasp and he let it slip away."

Abaddon the Despoiler

A Chaos Space Marine army of 2,000 points or more may be led by Abaddon. If you decide to take him then he counts as one of the HQ choices for the army. He must be used exactly as described opposite and may not be given extra equipment from the Chaos Armoury. In addition he, may only be used in a battle where both players have agreed to the use of special characters.

| | Points | WS | BS | S | T | W | I | A | Ld | Sv |
|---------|--------|----|----|---|---|---|---|-------|----|----|
| Abaddon | 240 | 6 | 5 | 4 | 5 | 3 | 7 | 3(+1) | 10 | 2+ |

Wargear: Talon of Horus, Daemon Sword Drach'nuyen, Chaos Terminator armour, Mark of Chaos Undivided.

SPECIAL RULES

Talon of Horus: With this armoured claw, Horus fought the Emperor and strangled the Primarch Sanguinius. It was torn from Horus' armour by Abaddon and is now fused to his own. The Talon mounts an early version of the Imperial storm bolter on its back, (which Abaddon may shoot with in the Shooting phase) and is treated as a lightning claw in close combat. The Talon is an icon of evil incarnate to the Imperium, so all Imperial units with a model within 6" of Abaddon must subtract -1 from their Leadership. The only exception to this are Blood Angel Space Marines, who hate the Talon because it was used to slay their Primarch and therefore add +1 to their Leadership if they are within 6" of it.

Daemon Sword Drach'nuyen: This arcane blade contains the bound essence of Drach'nuyen, a writhing warp entity that can rend reality apart. In close combat, Abaddon can make one attack with Drach'nuyen in addition to his normal three attacks with the Talon of Horus. The sword may not make more than one attack per turn and no attack bonuses can increase this. Any hit inflicted will wound automatically with no saving throw allowed for armour, though invulnerable saves may be taken as normal. Vehicles struck by the blade are penetrated automatically. Any model wounded by the sword is slain outright no matter how many Wounds it has.

Chaos Terminator Armour: Blessed by the fickle powers of Chaos, Abaddon's Terminator armour not only has the abilities of normal Terminator armour but it also provides a 4+ invulnerable save against attacks that penetrate armour automatically. The armour will also nullify any psychic power used against Abaddon, or that includes him in its area of effect, on a D6 roll of 4+. Note that Abaddon may take either the Chaos Terminator armour's normal 2+ armour save or its 4+ invulnerable save, not both.

Independent Character: Unless accompanied by a Retinue, Abaddon follows the Independent Character special rules in the Warhammer 40,000 rulebook.

Retinue: Abaddon may be accompanied by a bodyguard of his finest warriors. See the Retinue entry in Codex Chaos Space Marines army list for details.

USING ABADDON IN BATTLEFLEET GOTHIC

Abaddon is known to be the driving force behind the Black Crusade which ravaged the Gothic Sector between 142.M41 and 160.M41. What means he used to bring together the fleets of so many different Chaos Lords and Warmasters is unknown, but even his unholy gift of leadership must have been stretched to the full when coordinating the attacks of such an anarchic coalition. Abaddon's own warfleet was the most powerful in the sector and one of the last to be defeated. This was in no small part due to the awesome power of the Planet Killer at his command, to say nothing of the Blackstone Fortresses he succeeded in corrupting to the service of the Dark Gods.

Abaddon was once a Space Marine, a captain of the Luna Wolves 1st Company during the Great Crusade, over ten thousand years ago, conquering distant stars in the name of the Emperor. The Luna Wolves battled across uncounted worlds to free them from alien tyranny or the taint of Chaos, and Abaddon was ever at the fore. But at the time of the Great Heresy, Abaddon chose to betray the Emperor and join with the forces of his Primarch, the Warmaster Horus, in his attack on Earth. Upon Horus' defeat, Abaddon rallied the remnants of the hordes which had fought on Earth and fled to the Eye of Terror, where the powers of Chaos welcomed him as their champion.

For ten millennia, Abaddon has continued to harry the Imperium at every opportunity, raining fire and destruction on the empire of Mankind that he helped to build. The Gothic War is one of the most recent of his terrible works, but his history of bloodshed extends as far back as the Imperium itself. During the Gothic War, Abaddon took personal command of the Planet Killer in many engagements, although he escaped its ramoured destruction at Kharlos II.

ABADDON AS FLEET COMMANDER

Abaddon can be chosen to act as fleet commander in any game in which the Chaos fleet is worth 1,000 points or more. You may not place a Chaos Lord on the same ship as Abaddon (you don't get to be a Chaos Lord by spending lots of time near a bloody-tempered maniac!). He has the following characteristics:

LEADERSHIP: 10

Abaddon is an exceptional commander in all respects. His crew and fleet live in mortal terror of arousing his anger and perform at peak efficiency when he is aboard. He is also aided by the prophecies of the Sorcerer Zarithon.

RE-ROLLS: 1 PER TURN

Abaddon's fleet is allowed to re-roll a single Command check or Leadership test each turn. Abaddon's awesome reputation and dogged determination ensure that there are seldom any failures in the chain of command. When there are, the consequences are likely to be dire.

SPECIAL RULES

Boarding Actions: Abaddon is accompanied by his company of Black Legion Traitor Marines aboard the ship he is commanding. This, combined with his own abilities, means that the ship doubles its value in boarding actions and gains an extra +1 boarding modifier.

Hit-and-Run Attacks:

Abaddon will have his own ship sealed tight against hit-and-run raiders (he knows every trick in the book). Therefore, hit-and-run raids deduct -1 from their dice roll against Abaddon's ship. If Abaddon's vessel makes any hit-and-run teleport attacks, add +1 to the dice roll for the

attack as it will be undertaken by elite Black Legion Terminators. Boarding torpedoes and assault boats from Abaddon's ship will be manned by more mundane minions and do not receive this modifier.

"You have failed me for the last time..."

Abaddon the Despoiler does not tolerate failure, as many of his followers have discovered to their cost. If Abaddon's re-roll is used for a Command check or Leadership test on another ship or squadron and the test is failed a second time, he will become angry – very, very angry! In the Chaos Shooting phase Abaddon will direct at least half the available firepower and lance strength of the ship he is commanding against the weaklings who have failed him (assuming the worthless scum are within range and fire arc). Resolve the attack as normal, just as if Abaddon's vessel were an enemy.

The victims of his wrath (assuming they survive) will be suitably chastised and gain a +1 Leadership increase for the remainder of the game. The Leadership bonus will only take effect once (after that the crews are working as hard as they can!). If the object of Abaddon's wrath is not in range and/or fire arc he will leave them to their fate – Abaddon's re-rolls may no longer be used on it. This means that no further Commander re-rolls may be used on the ship or squadron unless it is carrying its own Chaos Lord with a Mark of Tzeentch.

Should this dreadful failure occur on Abaddon's own ship, it will lose one damage point as the Black Legion massacre those who failed him. No Leadership increase is gained.



With the Planet Killer under Abaddon's command, no Imperial world is safe.

GAUNT'S GHOSTS

THE TANITH FIRST-&-ONLY ARE BACK AND THIS TIME IT'S TOTAL WAR!

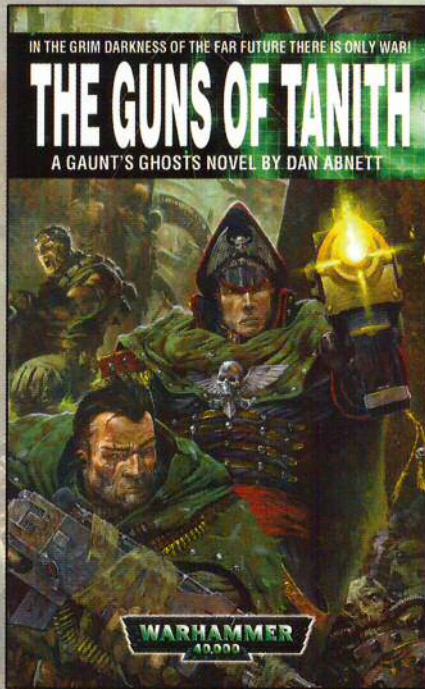

THE GUNS OF TANITH by Dan Abnett

Action! Treachery! Justice! Death! Gaunt's Ghosts storm back into action against the vile forces of Chaos in their latest adventure.

Coming Soon • £5.99

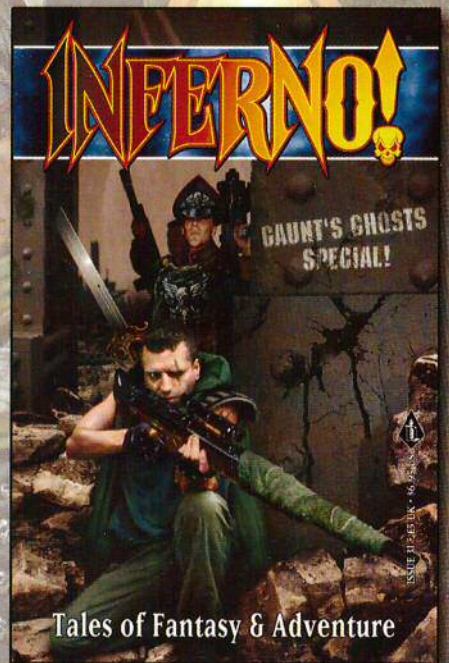

INFERNO! 30

Tales of Fantasy & Adventure

All-Gaunt special includes: New fiction from Dan Abnett! A brand-new Ghosts comic strip! An in-depth guide to the Tanith First-and-Only! The Gaunt story that never was! An interview with the Ghostwriter himself Dan Abnett and much more!

Coming Soon • £5.00

Read more about the Tanith First-&-Only in these carnage-filled novels from Dan Abnett! £5.99 each!

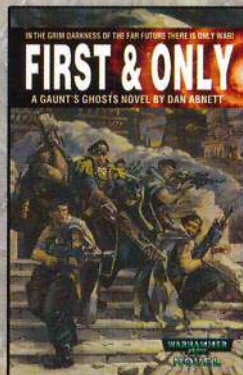

FIRST & ONLY

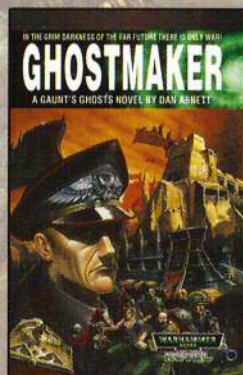

GHOSTMAKER

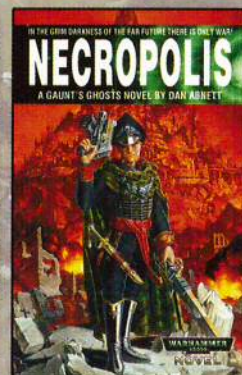

NECROPOLIS

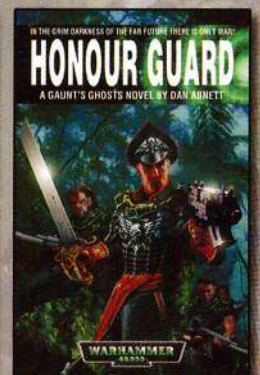

HONOUR GUARD



THE BLACK LIBRARY

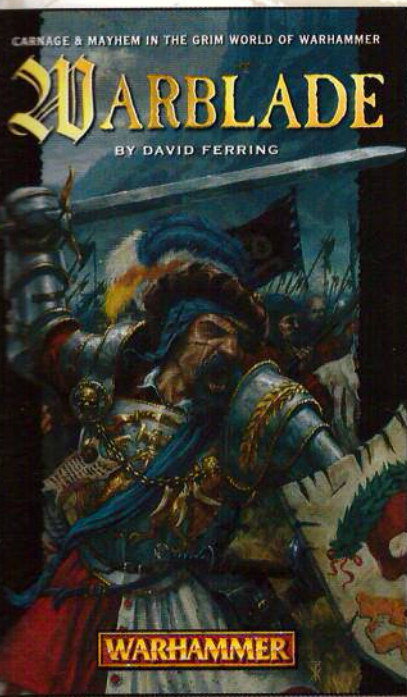

WARBLADE

by David Ferring

A magical sword and a perilous destiny confront the heroic Konrad in the earth-shattering final book in the trilogy of his adventures.

Coming Soon • £5.99

Follow the previous adventures of Konrad in these gore-splattered novels from David Ferring. £5.99 each!

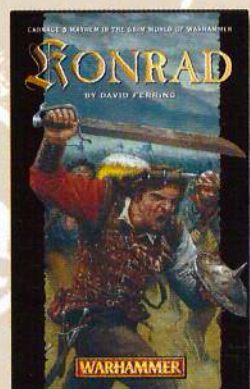

KONRAD

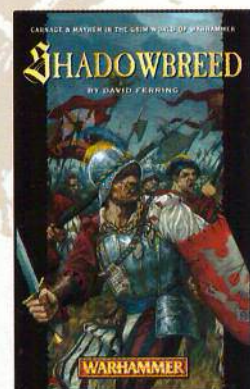

SHADOWBREED

For more details on all these products check out the New Releases pages at the beginning of this issue.

WARHAMMER MONTHLY 54

Warhammer Monthly is the Black Library's award-winning monthly comic book set in the savage worlds of Warhammer and Warhammer 40,000.

This month's collection of action-packed strips includes: Bloodquest – the Daemon-Mark! Darkblade – Throne of Blood! Kal Jerico – Killing Time! Ancient Blood and much, much more!

Coming Soon • £2.50

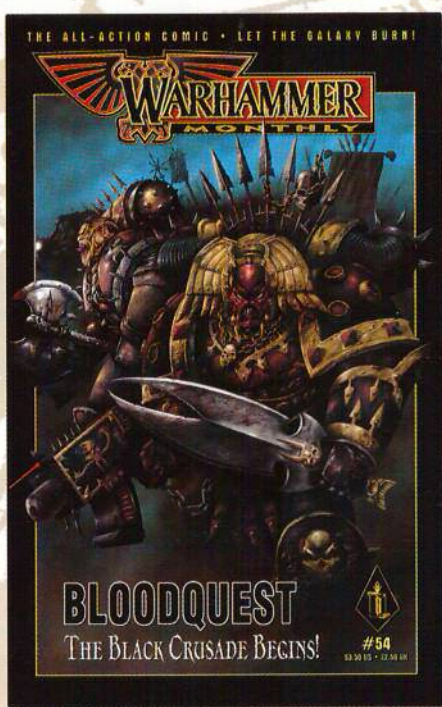

Available from all better bookshops, hobby shops & Games Workshop stores

Order direct on 0115 91 40000

Online store at: www.blacklibrary.co.uk/store



THE GAMING CLUB NETWORK

By Che Webster and Space McQuirk

All across the UK over one thousand gaming clubs are meeting each week to fight battles, share ideas and learn more about the Games Workshop hobby. Over the past few years these groups have begun to link up and share their enthusiasm. The Gaming Club Network is the organised face of this activity.



Finding a gaming club

For most people one of the greatest difficulties of the hobby is getting regular games. Gaming clubs offer the best environment in which to play games. They allow like minded people to arrange gaming times, and provide a gathering point where ideas and opinions can be shared. You can exchange painting and scenery building tips, and get different views on army building and tactics, but most importantly you can play regular games! The problem lies in knowing where these gaming clubs are meeting. The Gaming Club Network offers you a first place in which to get involved with the club community. Locating a club has never been easier – the online club lists provide a useful starting point. In addition, Games Workshop stores are able to point you in the direction of any of the groups they are in contact with.

Join the Club Network

If you're already running a gaming club, but haven't got around to registering yet, here's how:

- Either Log on to the Gaming Club website and fill in the on-line form
- Or drop into your local Games Workshop store and ask for a registration form.

Contact details

If you would like to send in your news and photos, ask a question, or just drop us a line, you can:

e-mail us at:

clubguy@games-workshop.co.uk

or write to:

UK Gaming Clubs,
Games Workshop HQ,
Willow Road,
Lenton,
Nottingham NG7 2WS.



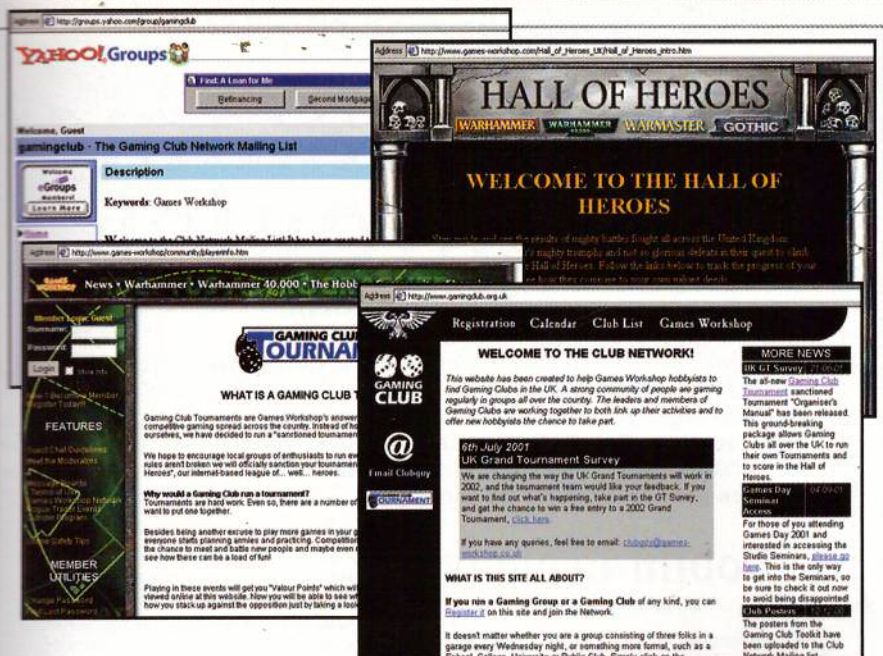

A whole community

The truth about our hobby is that it is far bigger than any of us on our own. There are countless enthusiasts all over the world who enjoy Games Workshop games, miniatures and all aspects of the hobby. In the UK the community has found its feet and is pulling together in ways that add

even more enjoyment to the experience. This is easiest to see on the internet but is not limited to those who own computers. Each gaming club is an exciting entry in the whole Games Workshop community and taking part will reap a rich reward: great games, new things to learn, and new people to get to know. Get connected online at www.gamingclub.org.uk



Creating a place of your own

Not everyone has a gaming club on their doorstep. If you find yourself without such a group, the answer is simple: start a club of your own. Setting up a gaming club and keeping it alive is not as hard as it might seem. It's fair to say that a gaming club only needs three things to get it going:

- Three or more people meeting regularly.
- Somewhere to meet.
- Something to do each meeting.

If you're thinking about getting a group together the toughest challenge is to find a suitable venue. If there are only a few of you to start with then various parts of the average home will do just fine – garages or dining rooms to mention just a few. The Gaming Club Toolkit is a useful guide to the things you will need to think about when setting up a group. It has a host of useful notes designed to give an aspiring club leader the knowledge and confidence to get things going. To get your Gaming Club Toolkit, call Mail Order (0115 91 40000).

Here are just a few of the gaming clubs who support the Gaming Club Network:

Tanelorn

St Gabriels Church Hall
Park Road, Wanstead, London E12
Contact Conrad – 0208 530 8462

Leeds Gaming Club

Headingley Community Centre
North Lane, Leeds
Contact Laurie – 01405 860653

Gobstyks

St Andrews Church Hall, Lincoln
Contact Gary – 01522 888016

Oxford Gaming Club

Wesley Memorial Church Hall
New Inn Hall Street, Oxford
Contact Mike – 01491 834060

Cheltenham Big Chiefs

St Mark's Community Centre
Cheltenham
Contact GW Cheltenham
01242 228419

Spiky Club

Post Office Social Club
(next to Brandon Tools)
Richfield Avenue, Reading
Contact Al – 07788 445906

Bad Company Wargaming Society

Castle Park Hall, Bangor
Northern Ireland
Contact Simon – 0776 119 4292

Cambridge Wargames Club

Cambridge Regional College
Kings Hedges Road, Cambridge
Contact Dave – 07900 543412

Falkirk District Wargames Society

Newlans Community Centre
Montgomery Street, Grangemouth
Contact Kenny – 01259 731091

To find your nearest gaming club talk to staff at your local Games Workshop store or log on to www.gamingclub.org.uk

Warhammer Chronicles takes a look at the Warhammer game, its rules, background and game mechanics, frequently stolen from in-progress developments here at the Studio. It also acts as a forum for dedicated Warhammer players who have produced inspired, well thought out and exciting additions to the game.

If you have got a good item for Warhammer Chronicles then write to:

*Gav Thorpe
(Warhammer Chronicles)
Games Workshop
Willow Road, Lenton
Nottingham, NG7 2WS*

Please note that any letters containing rules queries, requests for a Mercedes Benz, or cooking recipes etc. will be terminated with Extreme Prejudice. You have been warned!

Warhammer Chronicles

By Gav Thorpe

Welcome to this month's Warhammer Chronicles! This treatise by Kevin J. Coleman discusses some of the many breeds of Goblin that can be found at large in the Warhammer world, as well as the rules for including them in your Orc & Goblin armies. After reading the rules, Anthony Reynolds couldn't resist having a go at modelling the nasty little fellows. You can see the results of his endeavours as you browse the article.

Goblin Ecology

By Kevin J. Coleman

For as long as anyone can reckon, the nations of the Warhammer world have been threatened by marauding tribes of Orcs and Goblins, which inhabit nearly all regions and habitats of the known world. The two general terms, Orcs and Goblins, include several different sub-species such as the Night Goblins that dwell in the mountains, and the frenzied Savage Orcs that cover themselves with barbarous tattoos; collectively though, all Orcs and Goblins are known as Greenskins due to their broad range of greenish skin tones. In general, the enemies of the Greenskins do not give much thought to the distinction between different sub-species of Orcs and Goblins. After all, an Orc is just an Orc and a Goblin is just a Goblin. However, there are some scholars that find Greenskins fascinating and devote their entire lives to studying these Goblinoids, learning and collecting as much information as possible about these green monstrosities.

For ages, sceptics have shunned the research of Goblinoid ecology, insisting

that the information found by such 'ludicrous' scholars is completely pointless. However, in recent times the research of Goblinoid ecology has been used in effective ways, saving lives and is even responsible for winning battles.

Such is the variety of the Greenskins though that scholars will debate for hours on the most minute details of a particular Goblinoid. Arguments range from such broad topics as tribal relationships to small details such as the shape of a skull or colour pigments of a particular hide. In any event, the information gathered here contains facts about Goblinoid species that most Goblinoid scholars agree on. At least, to an extent!

NEW GREENSKINS

Unless otherwise noted, all the Greenskins found here count as Goblins for purposes of spell effects and any other special rules that have an effect on Goblins.

These are not 'official' rules, but we hope that Orc & Goblin players will try them out and give some feedback on how they work on the field of battle.

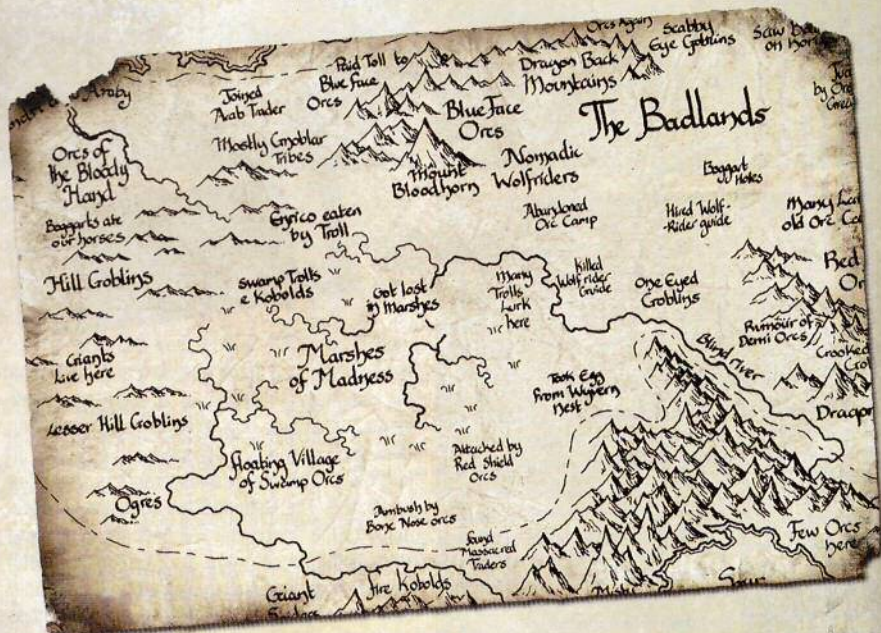

FIRE KOBOLDS

Kobolds are green-skinned Goblinoids that are almost completely identical to the common Goblin. Only an exceptional expert of Goblinoid studies can spot the distinction of their longer arm-span and smaller hip bones, which make a Kobold's movement somewhat irregular and crooked compared to that of a common Goblin. Fire Kobolds on the other hand are much more recognisable.

They are indigenous to the volcanic Red Cloud Mountains that lay south of the Badlands and other volcanic regions around the globe. Although Fire Kobolds have a greenish skin tone, they are covered in large patches of deep red or orange tones. In fact, at first glance they look like Goblins with some type of horrific skin disease, fungus infestation or who are perhaps covered with blotches of red war paint.

Reports have suggested that these Goblinoids spit small wads of fire as a brutal attack and natural defence mechanism, though others have reported that they simply favour the use of flaming arrows. At the same time, fire based weapons seem to have little or no effect at all on these Kobolds, which would suggest that their volcanic environment has had a profound effect on this species of Goblinoids.

FIRE KOBOLD (Core Unit)..... 3 points per model

| | M | WS | BS | S | T | W | I | A | Ld |
|-------------|---|----|----|---|---|---|---|---|----|
| Fire Kobold | 4 | 2 | 3 | 3 | 3 | 1 | 2 | 1 | 6 |
| Kobold Boss | 4 | 2 | 3 | 3 | 3 | 1 | 2 | 2 | 6 |

Unit Size: 20+

Weapons & Armour: Hand weapon and shield.

Options:

- Any unit may be equipped with spears for +1 pt/model.
- Any unit may be equipped with light armour for +1 pt/model.
- Upgrade one Fire Kobold to a Musician +4 pts.
- Upgrade one Fire Kobold to a Standard Bearer for +8 pts.
- Promote one Fire Kobold to a Kobold Boss for +8 pts.

Special Rules: Animosity; Fear Elves; Spit Fire; Fire Resistant.

- **Spit Fire:** Fire Kobolds may spit tiny streams of fire at enemies during the Shooting phase. This attack counts as a thrown weapon. All Spit Fire attacks count as Fire attacks, of course!

| Attack | Maximum Range | Strength |
|-----------|---------------|----------|
| Spit Fire | 8" | 4 |

- **Fire Resistant:** Fire Kobolds live in and along mountainous volcanoes and fire pits, this has affected their Goblinoid physiology with several fiery traits. All fire-based attacks (ie, fire balls, Skaven Warfire Throwers, Dragon Breath, etc) suffer a -1 Strength penalty when rolling to wound Fire Kobolds. For example, a fire ball (normally S4) would be lowered to S3 when rolling to wound a Fire Kobold.



This Fire Kobold has had no conversion work done to it at all, and was made using only the plastic Goblin frame. Its orange patterning was painted onto the skin using a basecoat of Scab Red, highlighting it up in patches using Fiery Orange.



TROGLAGOB

Troglagobs are by far one of the most unusual types of Goblins. They are Goblins that dwell in the sea, making coastal raids against the Empire, Tilea and even raiding the shores of Ulthuan and Lustria. Recently, many of these ocean-dwelling Goblins have been sighted on



For the Troglagob, the boots were cut off one of the plastic Goblins and replaced with bare feet taken from a Goblin Wolfriider. To make the javelin, a Goblin spear was cut to the right length and the tip sharpened. The Troglagob was then painted using Hawk Turquoise as the base colour to give it a sea-like colour.

Albion in great numbers, in the muddy southern tip of the island that has come to be known as Troglad. Troglagobs can have greenish skin like their Goblin cousins, though most tend to reflect a more seaish green such as turquoise or similar blue-green colour. The hands and feet of a Troglagob are webbed like that of a frog, making them excellent

swimmers with exceptional speed. Troglagobs actually have both gills and lungs, allowing them to breathe comfortably above and below water. However, Troglagobs will not venture too far from their aquatic habitat as they need to refresh themselves at least every few days or else they will dry up and die.

0-1 TROGLAGOB UNITS (Rare Unit) 5 points per model

| | M | WS | BS | S | T | W | I | A | Ld |
|-----------|---|----|----|---|---|---|---|---|----|
| Troglagob | 4 | 2 | 3 | 3 | 3 | 1 | 2 | 1 | 5 |
| Trog Boss | 4 | 2 | 3 | 3 | 3 | 1 | 2 | 2 | 5 |

Unit Size: 10-15

Weapons & Armour: Hand weapons and javelins.

Options:

- Troglagobs may exchange their javelins for short bows for +1 pt/model.
- Promote one Troglagob to a Trog Boss for +8 pts.

Special Rules: Animosity; Fear Elves; Aquatic; Skirmish; Troglagob arrows and javelins count as Poisonous Attacks.

- **Aquatic:** Troglagobs are sea dwelling Goblins, making them experts at swimming and moving speedily through aquatic features. Troglagobs may count marshes, rivers, streams, lakes and any other water terrain feature as open ground and so can move through water terrain without any of the normal penalties. Also, when in such terrain Troglagobs benefit from soft cover.
- **Skirmish:** Unlike most Goblinoids, Troglagobs always fight in loose formations. Troglagobs are *skirmishers* and follow all the rules governing skirmish troops as described on pages 115-116 of the Warhammer rulebook.
- **Poisoned Attacks:** Troglagobs coat their weapons with ichor from poisonous sea monsters. All shooting attacks made by Troglagob arrows and javelins count as poisoned attacks. See page 114 of the Warhammer rulebook for details. Note: Poisoned attacks wound targets automatically on a To Hit roll of 6. If you need a 7 or more to hit, the poison has no effect and cannot wound automatically.

HILL GOBLINS

South of the Empire, across the shores of Tilea and the Border Princes, lays a barren plain of hills and grasslands at the very edge of the Badlands. It is in this deserted region where the largest Goblins can be found. Generally reckoned as Hill Goblins, but also known

as Great Goblins, these Goblinoids are larger than ordinary Goblins, more aggressive and as strong as Orcs. The skin tone of a Hill Goblin is much darker than that of a common Goblin, with some shades even resembling that of a Black Orc's hide.

Being much more brutally ambitious than the average Goblin, Hill Goblins enjoy

fighting almost as much as Orcs do and will occasionally sell their services as mercenaries to armies that will put up with them. Wrestling and brawling are favoured leisure activities for these hulking Goblins and they enjoy nothing more than bullying around their smaller Goblinoid cousins.



The Hill Goblin was made with the legs and body of a plastic Night Goblin. The left arm had its bow removed and replaced with a sword, and the spiked helm was cut from a plastic Orc. A plastic Chaos shield with its design filed off was stuck to the model's back. The completed Hill Goblin was then painted a dark skin tone, using Dark Angels Green as a basecoat.

0-1 HILL GOBLINS (Core Unit) 4 points per model

| | M | WS | BS | S | T | W | I | A | Ld |
|-------------|---|----|----|---|---|---|---|---|----|
| Hill Goblin | 4 | 2 | 3 | 3 | 4 | 1 | 2 | 1 | 6 |
| Goblin Boss | 4 | 2 | 3 | 3 | 4 | 1 | 2 | 2 | 6 |

Unit Size: 20+

Weapons & Armour: Hand weapon.

Options:

- Any unit may be equipped with great weapons for +2 pt/model or additional hand weapons for +2 pt/model.
- Any unit may be equipped with light armour for +1 pt/model and/or shields for +1 pt/model.
- Upgrade one Hill Goblin to a Musician +4 pts.
- Upgrade one Hill Goblin to a Standard Bearer for +8 pts.
- Promote one Hill Goblin to a Goblin Boss for +8 pts.

Special Rules: Animosity; Fear Elves; Big Bullies

- **Big Bullies:** Hill Goblins are especially nasty and aggressive Goblins that love nothing better than showing off and bullying around smaller Goblinoids such as Kobolds and Night Goblins. To represent this, if your army includes any other types of Goblins (including Hobgoblins) then the Hill Goblins will fail their Animosity tests on a 1 or a 2 rather than just a 1 (see pages 8-9 of the Orc & Goblin army for details of Animosity). Note this rule only applies if your army does NOT include any Orc units. Even Hill Goblins know their place and will avoid getting into a brawl with an Orc!

DUST GOBLINS

In the deserts of Khemri, ancient Liche Priests raise mighty armies of Undead warriors for their mummified masters known as the Tomb Kings. In these cursed domains the dead do not rest easy and those that dare venture to the Land of the Dead are doomed to a life of Undeath. Occasionally, a teeming horde of Greenskins from the Badlands or the World's Edge Mountains make their way into this realm of death intent on slaughtering, plundering and conquering. None have ever succeeded, nor ever returned from the Land of the Dead... at least alive!

Once the armies of the Tomb Kings destroy the green-skinned interlopers, the Liche Priest summons the rotting Goblinoid carcasses back from the grave, adding them to their lord's horrific legions. However, some of these Undead Goblins somehow find their way back to their homelands.

Unlike Humans, Elves and Dwarfs, an Undead Goblin corpse retains a small part of its mischievous and unpleasant qualities from its previous malevolent life. These Undead Goblins, known as Dust Goblins, still bicker and taunt one another like spiteful children.



The Undead Dust Goblin was made by cutting a plastic Skeleton torso to fit onto plastic Goblin legs. A Goblin head was glued to this, and then Skeleton arms were attached. The blowpipe was a spear, cut to the right length and a small hole drilled in each end. The dart was made from the plastic arrow on the Skeleton frame, cut to the right size and glued into place.

DUST GOBLINS (Rare Unit) 8 points per model

| | M | WS | BS | S | T | W | I | A | Ld |
|-------------|---|----|----|---|---|---|---|---|----|
| Dust Goblin | 4 | 1 | 3 | 3 | 3 | 1 | 1 | 1 | 2 |
| Morbid | 4 | 1 | 3 | 3 | 3 | 1 | 1 | 2 | 2 |

Unit Size: 10-20

Weapons & Armour: Hand weapons and Blowpipe.

Options:

- Promote one Dust Goblin to a Morbid for +10 pts.

Special Rules: Animosity; Blowpipe; Dust Goblins are *Undead*, and as such the following rules apply to them, although as they retain some of their former psychological qualities, these rules are slightly different from usual.

- **Break Tests:** Dust Goblins are Unbreakable. If the Dust Goblins are beaten in combat, they suffer one extra wound for every point they lost the combat by, with no saves of any kind allowed.
- **Immune to Psychology:** Dust Goblins are immune to psychology.
- **Charge Reactions:** Dust Goblins are allowed to make charge reactions. Note that this is an exception to the normal Undead rules.
- **Marching:** Dust Goblins may make march moves. Note that this is an exception to the normal Undead rules.
- **Cause Fear:** Dust Goblins cause *fear*.
- **Dead:** Undead Goblins cannot be joined by characters.
- **Blowpipe:** Dust Goblins carry small blowpipes and coat their darts with scorpion venom. Blowpipes have a range of 12" and 2 x Multiple Shots. They suffer penalties for long range, moving and shootings, etc, as normal. All shots are resolved with a Strength of 3.

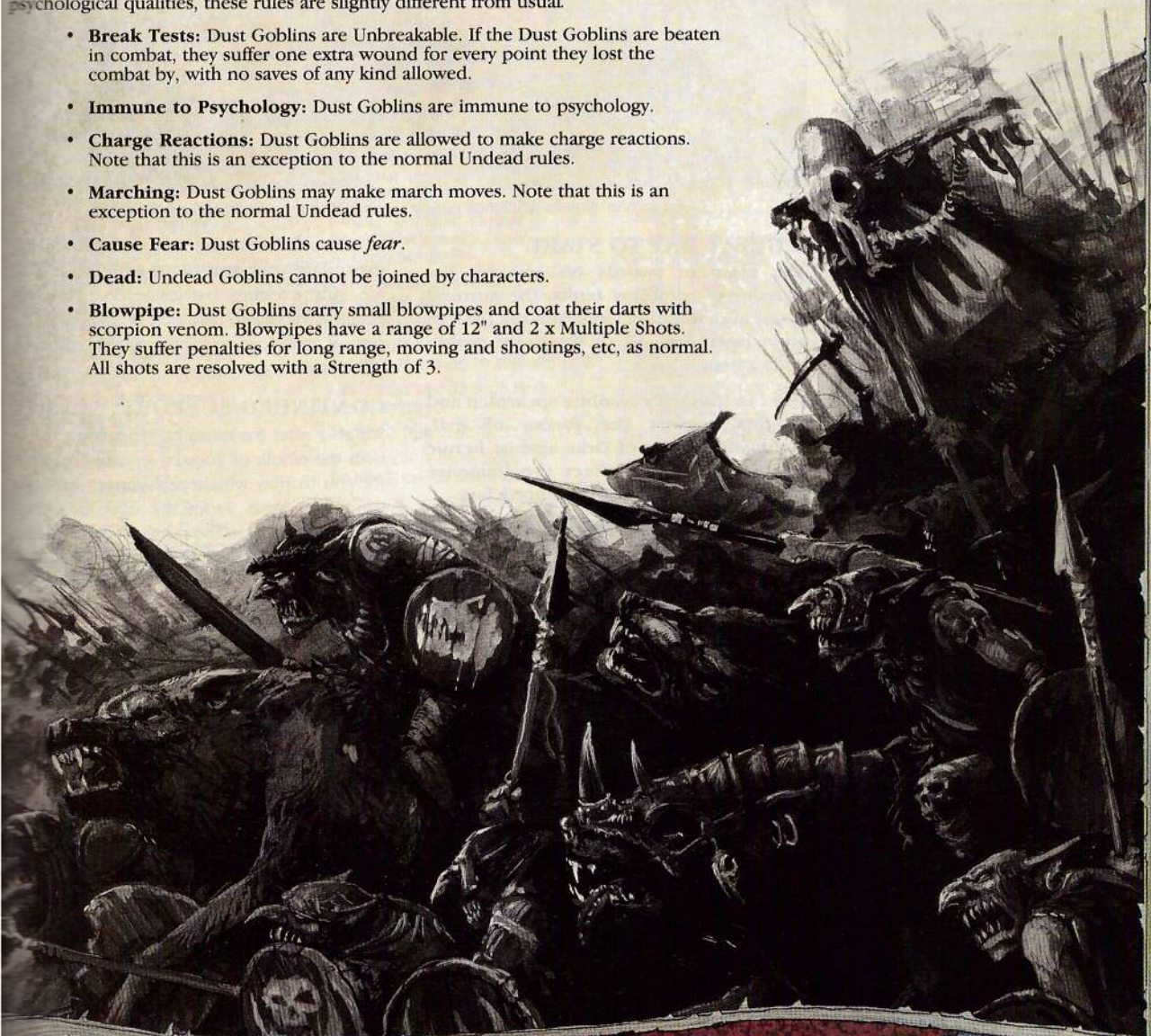

INTRO WEEKENDS

In April our stores are running special introductory weekends.

Designed for the beginner (and ideal if you've just got hold of one of our games), these weekends can teach you exactly how to assemble and paint your models, as well as how to play the games.

Each introductory weekend also features a mass participation game, allowing you to make the most of your new skills. So if you are new to the hobby, or have just received a copy of Warhammer, Warhammer 40,000 or The Lord of The Rings, come along to your local store on the dates below.

The Lord of The Rings

20th and 21st April



Warhammer

27th and 28th April

Warhammer 40,000

4th and 5th May



GAMES WORKSHOP STORES

Find out what's happening near you!

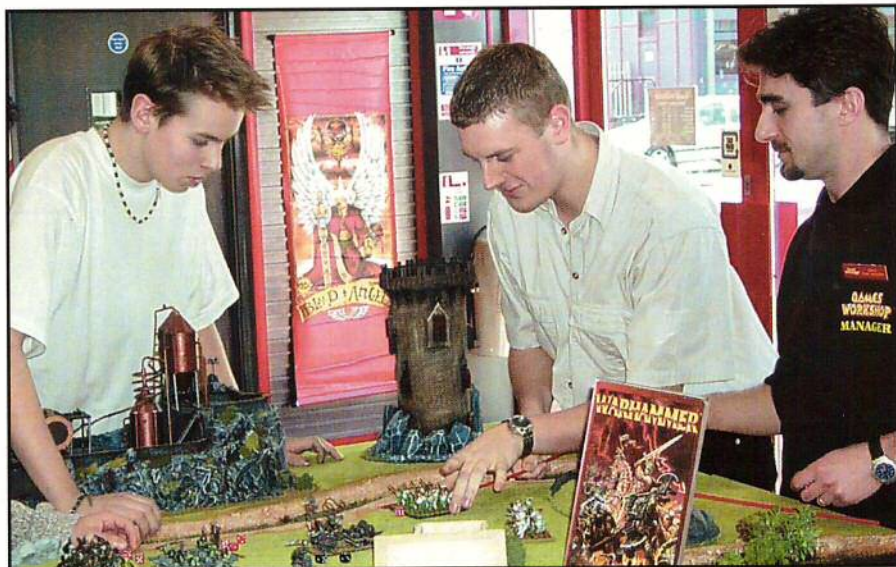

Learn to play Games Workshop games – our staff are ready to show you how!

A GREAT WAY TO START

The clash of swords on armour, the thunder of rumbling tanks, the guttural shout of marauding Orcs, and the flash of alien laser fire. All of these are within your grasp.

You can lead your resolute spearmen and knights against the forces of evil, command hordes of Orks against heroic Space Marines, or direct the immense firepower of the highly advanced Tau.

All Games Workshop stores offer a special introductory service for beginners. As well as offering advice on all aspects of the hobby, you can try out a game in the store. Don't worry, it's totally free to play! In addition we devote every Sunday to teaching newcomers the various aspects of the hobby. From painting advice and modelling tips, to special tutorials and scenarios designed to teach various aspects of playing the games, the beginner is fully catered for at our stores.

DEVELOPING THE HOBBY

Games Workshop stores are dedicated to a continued development of the hobby, and our commitment to you is displayed in our day-to-day store activities. We are always available for advice on different levels of the hobby, from rules and gaming queries, to hints and tips on painting and modelling your armies. We can give you ideas and

advice on converting your miniatures and expanding your armies. In addition to this, we run exciting battles every Thursday evening for you to take part in, as well as the special participation games that we run every Saturday.

CONTINUED SUPPORT

We also cater for more experienced gamers, with the whole of Tuesday evening set aside for you to play whichever Games Workshop game you wish. From the dark underhive of Necromunda, to the ravaged battlefields of Warmaster, you can pit your armies against gamers of similar standards to test your skills. We also provide an In-store Mail Order service, so you can order older models or specific parts for your conversions.

STANDARDS OF EXCELLENCE

As well as all of this, Games Workshop stores also provide a comprehensive range of Games Workshop games, miniatures and accessories. Every Saturday we have the newest releases, with the latest games and models available in the stores. We also showcase miniatures, armies and terrain pieces in our store cabinets, allowing you to see some great miniatures painted to superb standards. So what are you waiting for? Come along to your local Games Workshop store and join in!

This is a list of Games Workshop stores in the UK and Northern Europe. To find out what events are happening in the stores just give them a call. We also have Games Workshop stores in 16 different countries across the world (and independent stockists in even more). Call Mail Order on 0115 91 40000 to find out where they are. Most Games Workshop stores are open seven days a week and open late for gaming evenings, but please contact your local store for more details.

ENGLAND

ALTRINCHAM: Unit 1, 17 Grafton Street.
Tel: 0161 929 9896

BASINGSTOKE: 3 Potters Walk,
White Street. Tel: 01256 466 050

BATH: 30 Upper Borough Walls.
Tel: 01225 314 414

BEDFORD: 10 Greyfriars.
Tel: 01234 273 663

BIRMINGHAM: 116 Corporation Street.
Tel: 0121 236 7880

BLACKPOOL: 8 Birley Street.
Tel: 01253 752 056

BLUEWATER: Unit 052B,
Upper Thames Walk, Bluewater,
Greenhithe, Kent. Tel: 01322 427880

BOLTON: Unit 13, The Gate Centre.
Tel: 01204 362 131

BOURNEMOUTH: 24 Post Office Road.
Tel: 01202 319 292

BRADFORD: 4 Piccadilly, Bradford,
BD1 3LW. Tel: 01274 739 430

BRENT CROSS: Unit F9, Lower Mall
(near Fenwicks), Brent Cross Shopping
Centre. Tel: 0208 202 4979

BRIGHTON: 7 Nile Street.
Tel: 01273 203 333

BRISTOL (CENTRAL): 13 Broad Weir.
Tel: 0117 925 1533

BRISTOL (CRIBBS CAUSEWAY):
Unit 129 (next to M&S), Upper level,
The Mall at Cribbs Causeway.
Tel: 0117 959 2528

BROMLEY: Unit 8, The Mall, Bromley.
Tel: 0208 466 0678

CAMBRIDGE: 8 Bridge Street.
Tel: 01223 313 350

CANTERBURY: Unit 5, Iron Bar Lane.
Tel: 01227 452 880

CARLISLE: Unit 2, Earls Lane.
Tel: 01228 598 216

CHELMSFORD: Unit 4C, Phase 2,
The Meadows Centre. Tel: 01245 490 048

CHELTENHAM: 16 Pitville Street.
Tel: 01242 228 419

CHESTER: 112 Foregate Street.
Tel: 01244 311 967

COLCHESTER: 2 Short Wyre Street.
Tel: 01206 767 279

COVENTRY: Unit 39, Upper Level,
Cathedral Lanes Shopping Centre.
Tel: 02476 227 311

CROYDON: Unit 35, Drummond Centre
(outside the back of the centre),
Keeley Road. Tel: 0208 690 4600

CRAWLEY: 11 Broadway.
Tel: 01293 552 072

DARLINGTON: 78 Skinnergate.
Tel: 01325 382 463

DERBY: 42 Sadler Gate.
Tel: 01332 371 657

DONCASTER: Unit 10, The Colonnades.
Tel: 01302 320 535

DUDLEY: Unit 36, Merry Hill Centre,
Brierley Hill. Tel: 01384 481 818

EALING: 52D St Saviours Mall,
Ealing Broadway Centre.
Tel: 0208 840 0171

EASTBOURNE: 13 Terminus Road.
Tel: 01323 641 423

ENFIELD: 3/5 Genotin Road.
Tel: 0208 363 3238

EXETER: 12 Paris Street.
Tel: 01392 490305

GLOUCESTER: 35 Clarence Street.
Tel: 01452 505 033

GRIMSBY: 9 West St Mary's Gate.
Tel: 01472 347 757

GUILDFORD: Unit 1, 9/12 Tunsgate.
Tel: 01483 451 793

HAMMERSMITH: 161 King Street.
Tel: 0208 846 9744

HARROGATE: 29 Beulah Street.
Tel: 01423 564 310

HARROW: 296 Station Street.
Tel: 0208 861 2350

HEMEL HEMPSTEAD: 16 Bridge Street.
Tel: 01442 249 752

HIGH WYCOMBE: Unit 29,
The Octagon Centre. Tel: 01494 531 494

HULL: 30 Paragon Street.
Tel: 01482 589 576

IPSWICH: 2nd Floor, Debenhams,
Waterloo House. Tel: 01473 210 031

KENSINGTON: Shop 7, Lancer Square,
Kensington Church Street.
Tel: 0207 937 7011

KINGSTON ON THAMES: 33 Fife Road.
Tel: 0208 549 5224

LEAMINGTON: 22 Park Street.
Tel: 01926 435 771

LEEDS (CENTRAL): 12-16 Central Road.
Tel: 0113 242 0834

LEEDS (WHITE ROSE): Unit 28D,
White Rose Centre. Tel: 0113 272 3470

LEICESTER: Unit 2,16/20 Silver Street.
Tel: 0116 253 0510

LINCOLN: Unit SUA, Saltergate
(on outside of Waterside Centre).
Tel: 01522 548 027

LIVERPOOL: 47 Lord Street.
Tel: 0151 258 1404

LONDON (OXFORD ST): Unit F10,
The Plaza Shopping Centre, 1st floor,
116-128 Oxford Street. Tel: 0207 436 0839

LOUGHBOROUGH: 22 Biggin Street.
Tel: 01509 238 107

LUTON: 12 Park Street. Tel: 01582 417 474

MAIDENHEAD: 2 Blandy House,
3/5 King Street. Tel: 01628 621 854

MAIDSTONE: Unit 6, 1/9 Pudding Lane.
Tel: 01622 677 435

MANCHESTER (CENTRAL): Unit R35,
Mardens Way South, Arndale Centre.
Tel: 0161 834 6871

MANCHESTER (TRAFFORD CENTRE):
Unit H2, Festival Village, The Trafford
Centre, Trafford Park. Tel: 0161 747 2121

MIDDLESBROUGH: Unit 33,
39 Dundas Street. Tel: 01642 254 091

MILTON KEYNES: Unit 2, West End
Extension, 504 Silbury Boulevard,
Milton Keynes Shopping Centre.
Tel: 01908 690 477

NEWCASTLE (CENTRAL):
63 Clayton Street. Tel: 0191 232 2418

NEWCASTLE (METRO CENTRE): Unit B14,
First Floor (near the Mediterranean Village).
Tel: 0191 461 0950

NORTHAMPTON: 38 Princess Walk,
Grosvenor Centre. Tel: 01604 636 687

NORWICH: 12-14 Exchange Street.
Tel: 01603 767 656

NOTTINGHAM (CENTRAL): 34a Friar Lane.
Tel: 0115 948 0651

OXFORD: 1A Bush House, New Inn,
Hall Street. Tel: 01865 242 182

PETERBOROUGH: 3 Wentworth Street.
Tel: 01733 890 052

PLYMOUTH: 84 Cornwall Street.
Tel: 01752 254 121

POOLE: Unit 12 Towngate Centre,
High Street. Tel: 01202 685 634

PORTSMOUTH: 34 Arundel Street.
Tel: 02392 876 266

PRESTON: 15 Miller Arcade.
Tel: 01772 821 855

READING: 111 Broad Street Mall,
Tel: 0118 959 8693

RICHMOND: Unit 8, Westminster House,
Kew Road. Tel: 0208 948 6122

ROMFORD: 12 Quadrant Arcade.
Tel: 01708 742 140

ST ALBANS: 18 Heritage Close,
off High Street. Tel: 01727 861 193

SALISBURY: 1B Winchester Street.
Tel: 01722 330 955

SHEFFIELD (CENTRAL):
16 Fitzwilliam Gate. Tel: 0114 275 0114

SHEFFIELD (MEADOWHALL CENTRE):
Unit 91B, High Street, Upper Mall
(next to entrance near Boots).
Tel: 0114 256 9836

SHREWSBURY: Unit 1, 2 Bridge Street.
Tel: 01743 362 007

SLOUGH: 101 High Street.
Tel: 01753 575 675

SOLIHULL: 690 Warwick Road.
Tel: 0121 705 7997

SOUTHAMPTON: 23 East Street.
Tel: 02380 331 962

SOUTHEND: 12 Southchurch Road.
Tel: 01702 461 251

SOUTHPORT: Unit K2, Marble Place
Shopping Centre. Tel: 01704 501 255

STAINES: 52D Elmsleigh Centre
(at back of M&S). Tel: 01784 460 675

STOCKPORT: 32 Mersey Square.
Tel: 0161 474 1427

STOKE: 27 Stafford Street.
Tel: 01782 205 287

SUTTON: Unit 24, Times Square
Shopping Centre. Tel: 0208 770 9454

SWINDON: 50 Fleet Street.
Tel: 01793 436 036

THURROCK: Unit 415B, Level 3,
Lakeside Shopping Centre.
Tel: 01708 867 133

TORQUAY: 12 Market Street.
Tel: 01803 201 036

TRURO: Unit 1, Bridge House,
New Bridge Street. Tel: 01872 320 047

TUNBRIDGE WELLS: 4A Camden Road.
Tel: 01892 525 783

WALSALL: Unit 27, Old Square Shopping
Centre. Tel: 01922 725 207

WARHAMMER WORLD: Willow Road,
Lenton. Tel: 0115 916 8410

WARRINGTON: Unit 20, Time Square
(near Currys). Tel: 01925 651 984

WATFORD: Unit Q, 1A Queen Street,
Harlequin Centre. Tel: 01923 245 388

WINCHESTER: 6 St Georges Street.
Tel: 01962 860 199

WOKING: Unit 3 Cleary Court.
Tel: 01483 771675

WOLVERHAMPTON: Unit 98,
Mander Centre. Tel: 01902 310 466

WORCESTER: 4 Charles Street.
Tel: 01905 616 707

YORK: 13A Lendal. Tel: 01904 628 014

WALES

CARDIFF: 31 High Street.
Tel: 02920 644 917

NEWPORT: 25 Skinner Street.
Tel: 01633 256 295

SWANSEA: 45 Princess Way.
Tel: 01792 463 969

SCOTLAND

ABERDEEN: Unit 1, 30/40 Upper Kirkgate.
Tel: 01224 621 261

AYR: 10 Arran Mall,
(behind Hourstons dept. store).
Tel: 01292 610 673

BRAEHEAD: 115 Braehead Shopping
Centre, King Inch Road.
Tel: 0141 885 9440

DUNDEE: 110 Commercial Street.
Tel: 01382 202 382

EDINBURGH: 136 High Street.
Tel: 0131 220 6540

EAST KILBRIDE: 4 Righthead Gate
(at the back of M&S). Tel: 01355 224 680

FALKIRK: 12 Cow Wynd.
Tel: 01324 624 553

GLASGOW: 198/200 Hope Street.
Tel: 0141 332 5588

STIRLING: 14 Barnton Street.
Tel: 01786 448 263

NORTHERN IRELAND

BELFAST: 70A Castle Court
(towards back of the Centre).
Tel: 02890 23 3684

LISBURN: 3 Smithfields Square.
Tel: 02892 634 150

EIRE

BLANCHARDSTOWN: Unit 249a,
Blanchardstown Shopping Centre, Dublin.
Tel: 01822 3868

DUBLIN: Unit 3, Lower Liffey Street.
Tel: 01872 5791

NETHERLANDS

AMSTERDAM: Rokin 36.
Tel: 020 622 3863

HAARLEM: Gierstraat 29.
Tel: 023 551 7677

ROTTERDAM:
Van Oldenbarneveltplaats 452.
Tel: 010 280 0268

NORWAY

OSLO: Mollergata 5/9, 0179, Oslo.
Tel: 22332990

DENMARK

KØBENHAVN: Frederiksborggade 5 Kl.
Tel: 33122217

SWEDEN

STOCKHOLM: Regeringsgatan 30.
Tel: 8213840

LONDON

This is a list of Games Workshop stores and independent stockists within the M25. The Games Workshop stores are marked in **red**, while the independent stockists are marked in **blue**. Games Workshop stores stock the full range of Games Workshop products and offer activities and instore Mail Order. Independent stockists offer a variety of products and services, please call your local store for details.

- 1: GW BLUEWATER:** Unit 052B, Upper Thames Walk, Bluewater, Greenhithe, Kent. Tel: 01322 427880
- 2: GW BROMLEY:** Unit 8, The Mall, Bromley. Tel: 0208 466 0678
- 3: GW BRENT CROSS:** Unit F9, Lower Mall (near Fenwicks), Brent Cross Shopping Centre. Tel: 0208 202 4979
- 4: GW CROYDON:** Unit 35, Drummond Centre (outside the back of the centre), Keeley Road. Tel: 0208 690 4600
- 5: GW EALING:** 52D St Saviours Mall, Ealing Broadway Centre. Tel: 0208 840 0171
- 6: GW ENFIELD:** 3/5 Genotin Road. Tel: 0208 363 3238
- 7: GW HAMMERSMITH:** 161 King Street. Tel: 0208 846 9744
- 8: GW HARROW:** 296 Station Street. Tel: 0208 861 2350
- 9: GW KENSINGTON:** Shop 7, Lancer Square, Kensington Church Street. Tel: 0207 937 7011
- 10: GW KINGSTON ON THAMES:** 33 Fife Road. Tel: 0208 549 5224
- 11: GW OXFORD ST:** Unit F10, The Plaza Shopping Centre, 1st floor, 116-128 Oxford Street. Tel: 0207 436 0839
- 12: GW RICHMOND:** Unit 8, Westminster House, Kew Road. Tel: 0208 948 6122
- 13: GW ROMFORD:** 12 Quadrant Arcade. Tel: 01708 742 140
- 14: GW STAINES:** 52D Elmsleigh Centre (at back of M&S). Tel: 01784 460 675
- 15: GW SUTTON:** Unit 24, Times Square Shopping Centre. Tel 0208 770 9454
- 16: GW THURROCK:** Unit 415B, Level 3, Lakeside Shopping Centre. Tel: 01708 867 133
- 17: GW WATFORD:** Unit Q, 1A Queen Street, Harlequin Centre. Tel: 01923 245 388
- 18: BARNETTS NOVELTY HOUSE LTD:** 14 Elgin Crescent, Notting Hill. Tel: 0207 7277164
- 19: ELTHAM MODELS:** 54 Well Hall Road, Eltham. Tel: 0208 850 4324
- 20: ELYS:** 16 St Georges Road, Wimbledon. Tel: 0208 946 9191
- 21: FREDERICK BECK LTD:** 22-26 Camden Passage, Islington. Tel: 0207 2263403
- 22: HAPPICRAFT:** 144 The Centre, High Street, Feltham. Tel: 0208 890 4211
- 23: HAPPY RETURNS:** 36 Rosslyn Hill, Hampstead. Tel: 0207 435 2431
- 24: HARRODS:** Knightsbridge
- 25: HOWARD MARSHALL:** 5 Station Road, Gerards Cross. Tel: 01753 882 952
- 26: JOHN SANDERS:** 77-79 High Street, Ruislip. Tel: 01895 634 848
- 27: LEISURE GAMES:** 91 Ballards Lane, Finchley. Tel: 0208 346 2327
- 28: MURRAY & BRAND:** 8 Heddon Court Parade, Cockfosters. Tel: 0208 449 0827
- 29: PATRICK TOYS:** 107-111 Lillie Road, Fulham. Tel: 0207 3859864
- 30: ROSSIS OF LONDON:** 265 Chingford Mount Road, Chingford. Tel: 0208 529 1920
- 31: TAYLORS TOYS & SPORTS:** 10 Chipstead Valley Road, Coulsden. Tel: 0208 660 0710
- 32: TOY CITY LTD:** Unit 62, Wood Green Shopping Centre, Wood Green. Tel: 0208 881 0770
- 33: TOYMASTER KINGDOM:** 208 High Street, Sutton. Tel: 0208 7700216
- 34: TOYSTOP:** 377 Upper Richmond Road West, East Sheen. Tel: 0208 876 5229
- 35: TOYSTOP:** Unit D2, The Exchange, Putney High Street. Tel: 0208 785 9955
- 36: TOYSTOP:** 75 St Johns Road, Clapham Junction. Tel: 0207 228 9079



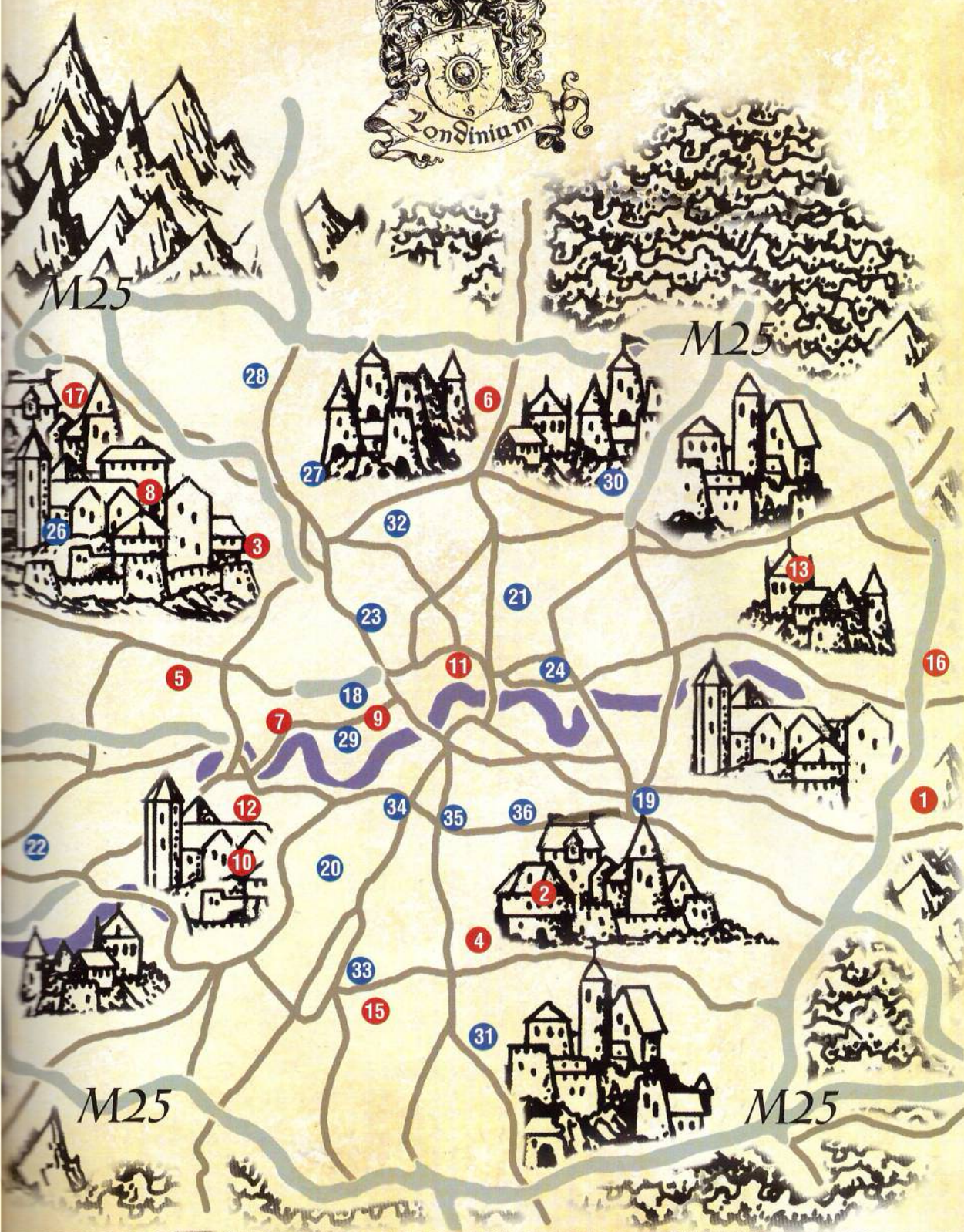

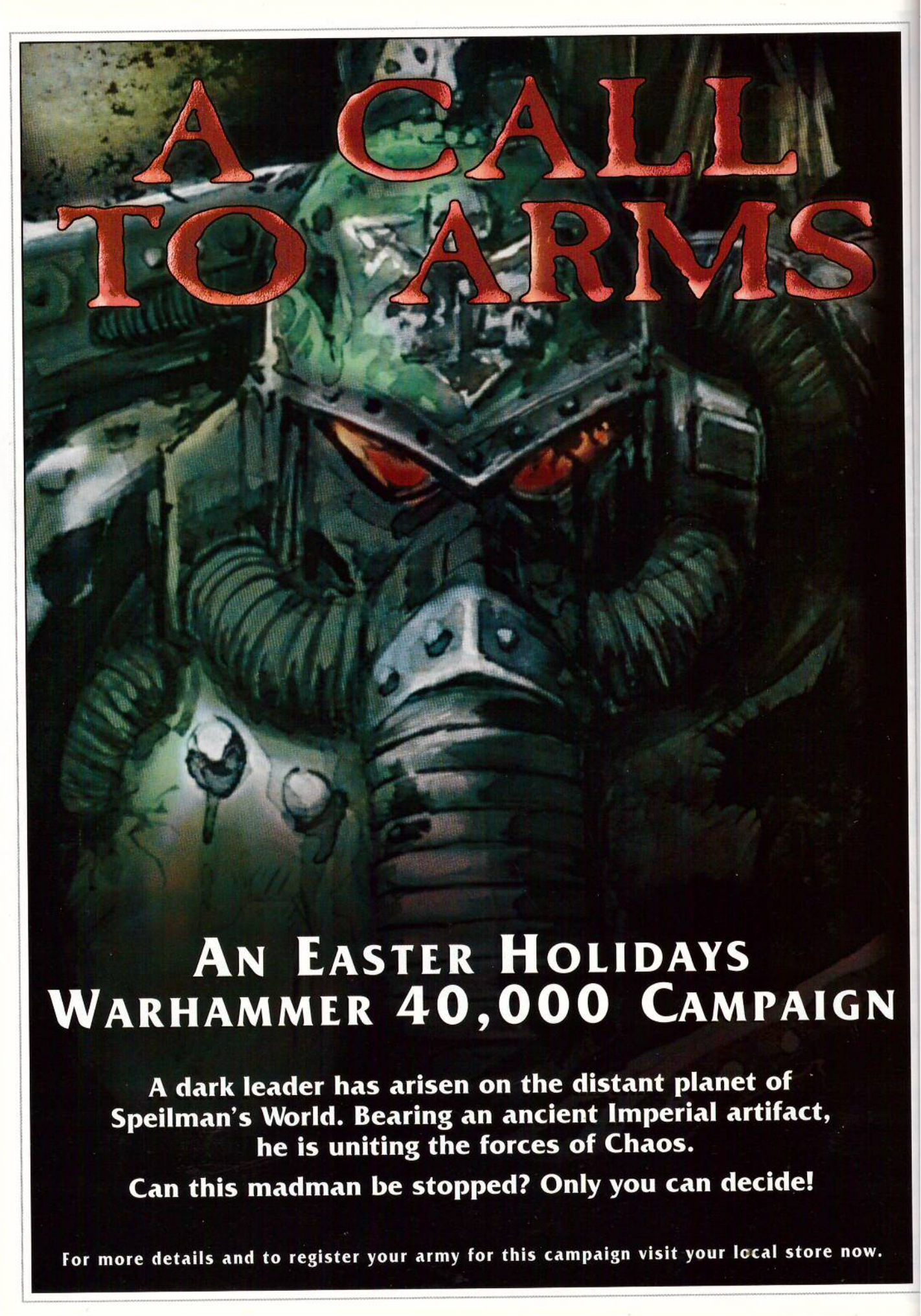

A CALL TO ARMS

AN EASTER HOLIDAYS WARHAMMER 40,000 CAMPAIGN

A dark leader has arisen on the distant planet of Speilman's World. Bearing an ancient Imperial artifact, he is uniting the forces of Chaos.

Can this madman be stopped? Only you can decide!

For more details and to register your army for this campaign visit your local store now.

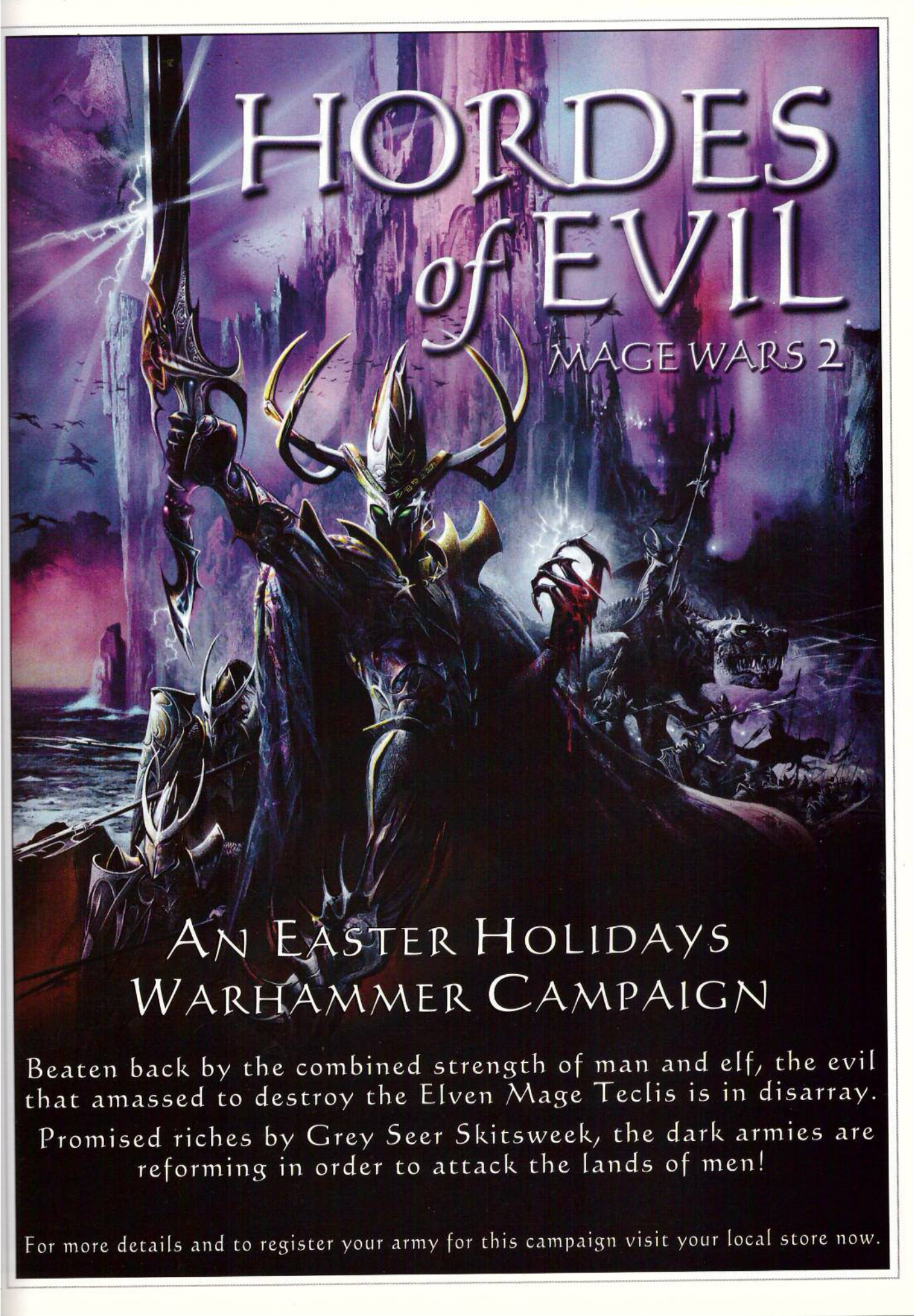

HORDES of EVIL

MAGE WARS 2

AN EASTER HOLIDAYS WARHAMMER CAMPAIGN

Beaten back by the combined strength of man and elf, the evil that amassed to destroy the Elven Mage Teclis is in disarray.

Promised riches by Grey Seer Skitsweek, the dark armies are reforming in order to attack the lands of men!

For more details and to register your army for this campaign visit your local store now.

TACTICA

CHAOS SPACE MARINES

TACTICA shines the spotlight on one particular army, with a veteran player taking you through some tactics and strategies for their favourite force. This month Graham Davey explains how he gets the best out of his Chaos Space Marines.

TACTICS FOR PLAYING WITH CHAOS SPACE MARINE ARMIES



Graham has been fighting with Chaos Space Marines for over five years and in this time has gathered together a vast warband of Black Legion Chaos Space Marines.

Of all the different Warhammer 40,000 armies available, the one with the most variety of units to choose from has to be Chaos Space Marines. You can have a full-on 'hack the enemy to pieces' close combat

army, a solid, defensive force stacked with massed firepower or even a mobile army designed to outmanoeuvre the enemy, all with a different selection of miniatures. Whatever your favoured playing style, the Chaos Space Marine army list probably has the troop types to accommodate it.

In gaming terms, the result of all this variety is that your opponents won't know what to expect when they turn up to play you. You also have the option of choosing your army specifically to beat one opponent. For example, if you know your mate's Tyranids always charge across the

battlefield at your lines, you could gain the upper hand by taking an entirely 'shooty' army to mow down the swarm before it reaches you. However, this approach usually leaves your army inflexible and vulnerable to a 'double bluff' – imagine the carnage if your mate suddenly announces he has decided to use a Seeding Swarm army for a change, and deep strikes into the midst of your troops!

A more challenging approach is to select a flexible, rounded army that can, if you play well, win against any enemy army with only a few minor adjustments. Tournament play is the ultimate test of this approach, where



you must play unknown opponents with no change to your army at all. This article will deal with choosing and using this sort of all-round Chaos army, simply because that is what I generally use. I mostly play against Matt Hutson's Black Templars or Tau, Paul Sawyer's White Scars, Rowland Cox's Imperial Guard, Alex Boyd's Orks, and Phil Kelly's Tyranids and Eldar – so my tactics are largely formulated from these games. Another effect of all the variety in the Chaos army is that, being rather a slow painter, I haven't got around to painting up all the possible choices – so if I don't mention your favourite troop type it just means that I haven't tried them yet. *(Not that it seems to matter; Graham is a very capable player – Ed.)*

BATTLEFIELD ROLES

I consider my Chaos army as a mixture of assault units and fire support units. The role of assault units is to get into close combat (preferably by assaulting, not getting assaulted) and to hack the enemy to bits. The

role of fire support units is to destroy anything that causes a real threat to the assault units, whether that threat be from shooting or something that is likely to beat my assault units in combat. For the army to function well (and hopefully win), as many units as possible must complete their roles successfully. This may seem like common sense but it really is the key to winning, so it's important to keep these roles in mind when choosing, deploying and playing with your army.

ASSAULT UNITS

Chaos Lord

Every Chaos army needs a Chaos Lord or a Daemon Prince to lead it, and, with the addition of some tasty wargear, these can become extremely destructive combat monsters. I take a Chaos Lord, riding a Jugger to get five or six attacks, normally accompanied by a Chaos Space Marine squad armed with pistols and close combat weapons, including a Champion with a power fist. I can rely on this lot to tear apart most things they assault.

Chaos Terminators

These are great. They are hard to kill, especially since they were given a 5+ invulnerable save in WD250's Chapter Approved, and, unlike Imperial Terminators, you do not have to choose between combat and firepower prowess – you can have both! Twin-linked bolters throw out lots of accurate shots and you can throw in a heavy weapon (I always take an autocannon for the long range) and a few meltaguns as well. However, it is their combat weapons that make Chaos Terminators really dangerous. Lightning claws are my favourite. Re-rolling the To Wound dice makes them extremely efficient even against Toughness 5 foes like Space Marine Bikers. I like to take a good-sized squad of seven or eight Terminators – if you take only five then a couple of early casualties severely reduces the unit's effectiveness. I expect to lose a few to shooting, so I leave two models with just the basic power weapons to be removed first, then give the rest lightning claws plus a chainfist to deal with tanks and Dreadnoughts.



Graham's Chaos horde rampages into the Tau lines.

Chaos Dreadnoughts

These are extremely dangerous assault units. They get one more Attack than their Imperial counterparts and may go into a Blood Rage, charging at the enemy with double Attacks. Don't forget to keep rolling for this when the Dreadnought is in combat – it is now even more likely to go into a Blood Rage! Obviously, this model can be very destructive, and most infantry models will not be able to cause damage back thanks to its heavy armour. Just watch out for huge squads of small creatures such as Gretchin or Termagants. Things like these can hold up a Dreadnought for most of the game as it will probably only kill two or three per turn – not much of a dent in a squad of thirty! It is much more useful attacking the enemy's expensive Elite units.

Chaos Bikers

Bikers can be very useful in an assault. Their speed means that they should get to charge, giving them three Attacks each in the first round thanks to the scythes and blades on their bikes. I always include an Aspiring Champion with a power weapon for extra bite, and the squad is very reliable at defeating an enemy's smaller units. They are great for speeding up a flank to take out heavy weapon teams or infiltrators.

Raptors

These guys cost a fair few points, so I generally take a small squad, that can nip around the flanks, jump out from behind terrain and attack. Keeping them hidden is important because they are a good prize for a starcannon crew or the like. Fortunately, staying out of sight is what jump packers excel at. Their Fearsome Charge ability means they can force quite powerful enemy units to fall back (as long as they're not Fearless) by simply winning combat, and have a good chance of chasing them down too. However, remember to look at

where your Raptors will end up – you may be sacrificing them for the chance to kill the enemy. Equally, if you decide to use the Hit and Run ability, remember it is your opponent's turn next and he will be gunning for them if they haven't run far enough. If the unit you charged has not fallen back (for whatever reason), consider the option of trying to survive another turn in combat and then using the Hit and Run when it is your turn next.

Possessed

Possessed get three random daemonic abilities, rolled up at the start of each game; so taking them is a bit of a gamble, but if you get lucky you'll end up with an awesome assault unit. Even if you get a poor roll, you'll still end up with a decent close combat squad. You'll have to adapt their exact role depending on what you get, so prepare to be flexible. A Rhino may be worth taking, to keep them safe and make sure they reach the enemy lines with minimal casualties.

Plague Marines

The best unit to receive an enemy charge and survive – Plague Marines have Toughness 5 and are Fearless, making them really hard to get rid of. More about that later...

Bloodthirster

In big games I use a Bloodthirster because it's just about the most dangerous and fear-inducing model you can get. In fact, all the Greater Daemons are fairly similar, but I think the two with wings are easiest to use as they are more likely to be able to assault in the turn they appear, and hence not get shot at. They will smash apart tanks and are good for disposing of Dreadnoughts, Terminators and other expensive units. Just try to keep them in combat so they cannot be targeted by shooting.

FIRE SUPPORT UNITS

Chaos Space Marines

Rather than using a Havoc squad, I like to take a couple of basic Chaos Space Marine squads armed with boltguns and one heavy weapon. The big guns are much cheaper this way – lascannons are 15 points instead of 35! It means my tank-busting weapons aren't all stuck in one place, making it harder for the enemy to stay out of sight as they advance. It also makes it much harder for enemy shooting to take out my heavy firepower, as they'll have to kill lots more men before I have to take off the lascannons. Another advantage is that these squads are Troops choices, and their main targets, enemy tanks, will usually be deployed first, being Heavy choices. This enables you to position the lascannons in the best possible place, often with a clear shot if you get the first turn.

Obliterators

Obliterators are extremely expensive models, and rightly so as they can morph a huge range of weapons to suit their target. You are allowed just one of each heavy weapon type at a time – against armoured targets you can use the lascannon, multi-melta and twin-linked meltagun, while against light targets you can use the assault cannon, heavy bolter and storm bolter. Any more than three Obliterators and you would have to use less suitable weapons, so for this reason I only ever take three in a squad. Note that only the heavy bolter and lascannon have ranges over 24" and that the heavy weapons can only be used if they do not move, making the effective range of Obliterators fairly short. This means that like Noise Marines they work best against armies that come towards your lines. Paul Sawyer's White Scars can vouch for this! (*Thanks for bringing that up again – Ed.*)

Chaos Dreadnoughts

As they are striding forward to attack the enemy, Chaos Dreadnoughts should also be acting as fire support units. Mine are armed with plasma cannons (the weapon of choice against Space Marines in particular) or autocannons (great for stopping armour 10 vehicles like Trukks, Land Speeders and Raiders).

Chaos Bikes

Chaos Bikes have twin-linked bolters and can always rapid fire, so they can

DREADNOUGHT FIRE FRENZY

As all Chaos commanders know, your Dreadnought is at risk of going into Fire Frenzy, shooting all its guns twice at the nearest models – friend or foe. Now, Andy Chambers has told me that some players moan bitterly about having their own troops mown down by their psychotic Dreads, but I think it is a really entertaining and characterful rule. Besides, if you go into a big sulk while everyone around you is laughing at the self-inflicted carnage, your opponent has got one up on you without doing anything! Just wait until the enemy is the closest target... it'll all seem worthwhile. Victims of my Dreadnoughts' Fire Frenzies range from Matt Hutson's Emperor's Champion and his entire squad, to another of my own Dreadnoughts!



Graham's Black Legion Chaos Space Marines launch an assault upon a squad of Matt Hutson's Black Templars.

deliver some very accurate firepower from a long distance away – 12" movement plus 24" range. Remember, if you move within 12" in order to get two shots each, your bikes may be assaulted by any enemies who survive the hail of bolt shells.

Noise Marines

These are armed with sonic blasters that can also throw out a serious amount of firepower, especially if they stand still. This makes them most cost effective in a defensive role, ideal against poorly armoured troops that are likely to advance towards you, such as Orks or Tyranids.

LOOK OUT FOR...

As with all armies there are certain enemy units that can really mess you up! These are some of the worst I have encountered...

Vindicators

I hate Vindicators, especially Matt Hutson's! That huge template tends to

kill every Space Marine under it, including most of your Terminators. Battle cannons from Lemman Russ tanks have a bigger range but at least Terminators get their armour save against them. Remedy? Keep your models well spaced out and shoot the tanks as soon as possible.

Incubi

Incubi accompany a killer Archon, come with a power weapon each and have a better Initiative than Chaos models. They will rip apart any of your squads without even working up a sweat, and tend to swoop in on a Raider so they invariably get to charge too. Solution? Take out their Raider early on so you can shoot them to bits as they trudge across the table. Alternatively, induce them to charge your Terminators while they are in cover so you get to go first for a change (this only worked once because the next time my opponent brought plasma grenades)!

Nobz mobs

These can cause problems because

their choppas reduce your armour saves, plus they'll probably fight first if they charge and they get a simply horrendous number of attacks. Again the key is to target their Trukk so you can whittle down their numbers before they assault, but Alex always has a number of ploys to stop me doing this!

Dark Reapers

Shooting from Dark Reapers is always damaging to Space Marines, and they hide away right at the far side of the table. Shoot back at them with autocannons!

Wraithlords

Wraithlords are as good as a Dreadnought at both combat and shooting. They have to be wounded three separate times to kill them and you can't shake or stun them. It simply takes lots of big guns to destroy these Eldar giants. Your best bet is probably a Chaos Predator equipped with all lascannons, but I don't have one of these yet (however, there's a tasty new model on the way)!

SUMMONING THE BLOODTHRISTER

To summon a Greater Daemon you go through each of your characters in turn and the first time you roll a 6, that model is possessed and replaced by the monster. If no 6 is rolled you have to wait and try again next turn. This means that the number of Aspiring Champions in your army will affect when the Daemon is likely to appear. If you only have your Chaos Lord and one or two Aspiring Champions then there is a good chance that your Daemon will not appear until late in the game – hardly a good use of this expensive model. There is also a good chance that your Chaos Lord will be the model you lose – a serious blow – my usual Lord costs 140 points, as much as the Bloodthirster itself! Worse still, if things are going badly you could lose all your characters before your Daemon has popped out at all!

To ensure this doesn't happen, you can buy your Lord a retinue that includes multiple Aspiring Champions. This way I can be pretty sure that the Daemon will arrive early on, and I will have to be much more unlucky to lose my Chaos Lord in the process. This method also makes the Lord and his retinue an awesome, if expensive, squad. The only problem now is that the Bloodthirster may appear too soon, before you have got into assault range, leaving him a great big target for all the enemy's guns.

A good compromise I have found is to take around three Aspiring Champions in total plus my Lord. With a bit of luck my Daemon will then appear around Turn 3, just in time to charge in and cause havoc.



TO BATTLE...

So far I have assigned battlefield roles to all my units and mentioned a few particular things to look out for and avoid. It is also useful, once you can see your opponent's army, to think about the roles enemy units will play and, as the game proceeds, try to prevent them doing so. But how do you achieve all this? In the midst of battle how do you get all your units to do what you want while preventing enemy units doing what your opponent wants? The answer is all about deployment and manoeuvring.

Deployment

The key to good deployment is thinking ahead. Fire support units obviously need a good line of sight, not necessarily to where enemy units are deployed, but also to where they are likely to advance. Assault troops benefit from keeping terrain that blocks line of sight between them and the enemy's fire support units, so deploy them accordingly, remembering how far they can move each turn. Troops that move only 6" each turn take a long time to get anywhere, so you can rarely afford to change your mind about where a unit is going halfway through the game. Faster units such as bikers or squads in transport vehicles are better suited to roving about the battlefield and I often deploy my Chaos bikes at the back in the middle, so they can move to add weight of numbers or to meet any new threats.

Manoeuvring

Once the battle is raging things get a lot more tricky, as both players try to get the best out of their own units and prevent their opponent from doing the same. My army always relies more on combat than shooting, and assaulting your enemy always gains you an advantage in combat, so manoeuvring my squads to 'get the charge' is very important. In fact assaulting potentially adds so much to a model's basic movement (adding on the assault move and possible sweep move) that it is crucial for victory in many a battle, whatever the armies involved. I'll finish off with some tips on manoeuvring to gain the upper hand in close combat...

KNOW THY DISTANCES

Your opponent cannot charge if you don't move to within his charge range in your turn. For normal foot troops the crucial measurement is 12"

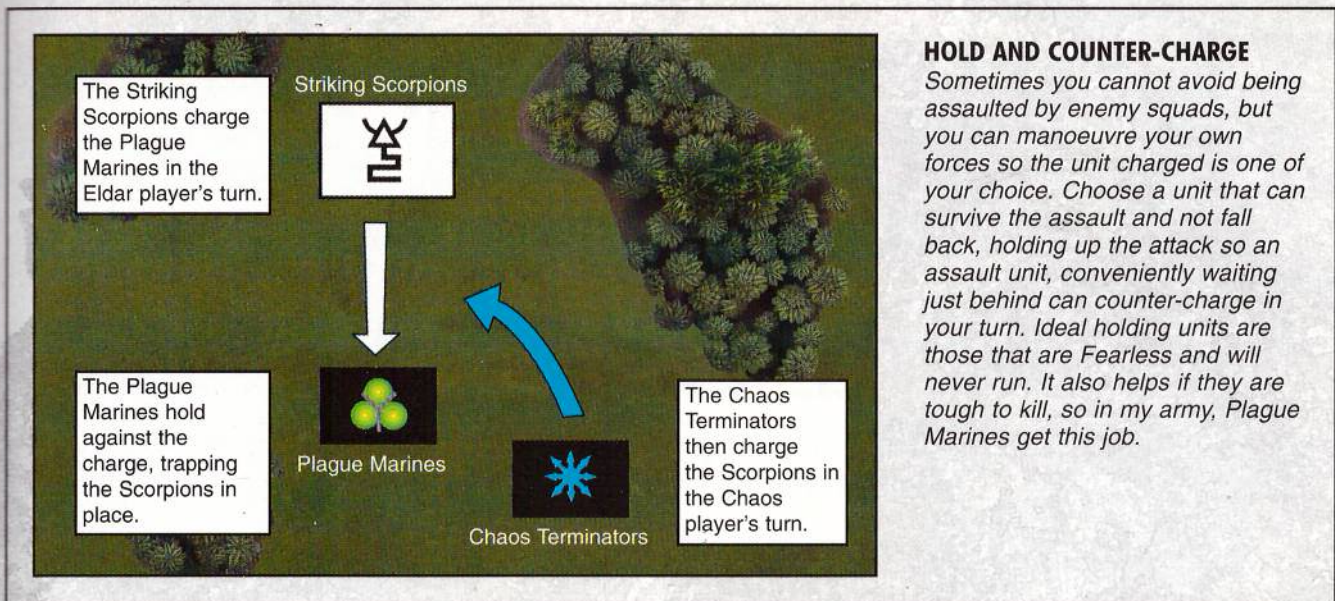

HOLD AND COUNTER-CHARGE

Sometimes you cannot avoid being assaulted by enemy squads, but you can manoeuvre your own forces so the unit charged is one of your choice. Choose a unit that can survive the assault and not fall back, holding up the attack so an assault unit, conveniently waiting just behind can counter-charge in your turn. Ideal holding units are those that are Fearless and will never run. It also helps if they are tough to kill, so in my army, Plague Marines get this job.

(6" basic move + 6" assault move). If you move within this distance you can, and probably will, be assaulted. Equally, it's handy to recognise when the enemy has come too close and your own troops are in range. Remember that some units have a longer range – troops who can Fleet of Foot have a maximum range of 18", while squads in transport vehicles can charge anyone within 20" (12" vehicle move + disembark within 2" + 6" assault move) – and note that certain vehicle upgrades can increase this even further. Of course, you cannot go around with a tape measure to check these ranges so you have to learn to estimate the distance on the tabletop.

DON'T SHOOT THE ONLY ONES YOU CAN REACH

A common tactic is to shoot at an enemy squad to soften it up before assaulting it in the same turn. However, always remember that your opponent is allowed to choose which of his models to remove as casualties, so he may remove the ones nearest to your troops, leaving none of your models in assault range. Of course this only works if you are at the limit of your charge range and there are enough casualties, but it can make the difference between the chance to wipe out the enemy or shooting just a handful, only for the survivors to assault you instead! It may be a better

idea to shoot at a different target to the one you want to assault, or even not shoot at all.

ANY CARNAGE IS GOOD CARNAGE

At the end of the day, when the chips are down, I try to remember that I am a Chaos player and my army is led by a Champion of Khorne. If everything is going wrong, then my final order will be to charge everything possible into the assault. And I always try to get my Lord into combat with the enemy commander. If he wins then it is a huge moral victory. If he loses, well, it's just more dramatic that way! Besides, Khorne doesn't really care whose blood is flowing...

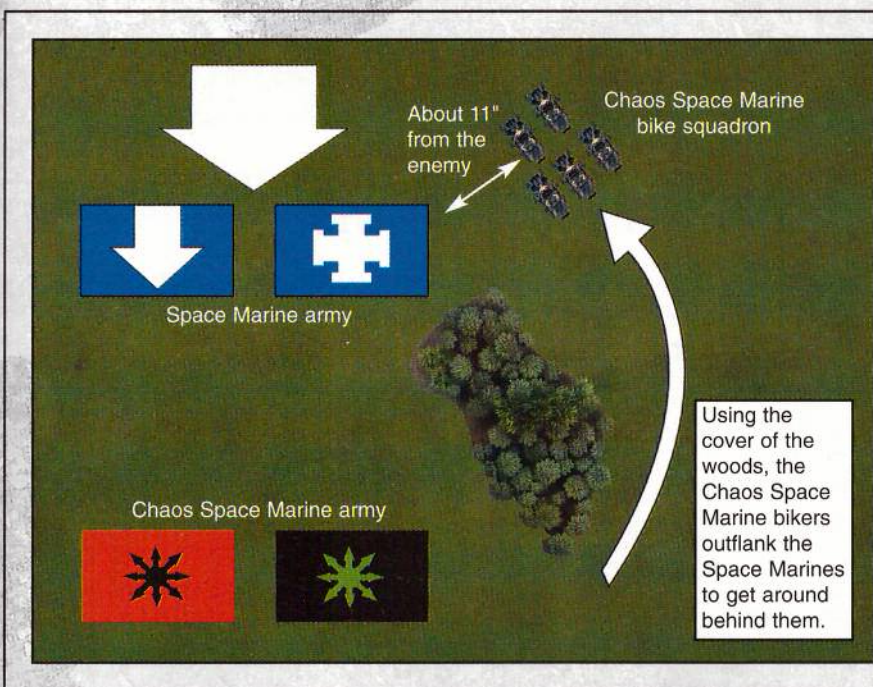

DISTRACTIONS AND SACRIFICES

It may be useful to let the enemy assault one of your squads if it will draw them out of position – sacrificing a unit to leave the enemy too close or too far away.

For example, if my Chaos bikers get behind or to the flank of an expensive enemy assault unit I would move them just within 12". If the unit ignores my bikers they can continue to pour in close range bolter fire. If the unit wants to charge the bikes then it must move nearly 12" back, away from the main thrust of the battle. I may lose a few bikes but if the enemy unit never manages to get back to where the real fighting is, it has been a useful distraction.

THE LORD OF THE RINGS

THE FELLOWSHIP OF THE RING



BATTLE GAMES DAY

14th April 2002 at Warhammer World, 10am to 4pm.
Tickets available from Mail Order. £10



This is your chance to re-enact the action and adventure from The Fellowship of The Ring in the newly re-opened Warhammer World. Throughout the day you'll also have the opportunity to learn both beginner and advanced modelling & painting skills from our team of experts.

Warhammer World, Willow Road, Lenton, Nottingham NG7 2WS.
For further information log on to www.games-workshop.com/ukevents

The Lord of The Rings, The Fellowship of The Ring and the characters and places therein, TM The Saul Zaentz Company d/b/a Tolkien Enterprises under licence to New Line Productions, Inc. All Rights Reserved.
© 2002 New Line Productions, Inc.

NEW LINE CINEMA
An AOL Time Warner Company



Visit: www.lordoftherings.net

America Online Keyword:
Lord of the Rings



Call To Arms

WARMASTER & MORDHEIM

12th May 2002 at Warhammer World, 10am to 4pm.
Tickets available from Mail Order. £10

Whether you are a seasoned veteran or a youngblood, come along to the newly re-opened Warhammer World and take part in a dedicated day of Warmaster and Mordheim gaming.

Bring along your own 1,500pts painted Warmaster army or starting Mordheim warband and do battle for the fate of the Warhammer World.

For those of you who don't have a Mordheim warband or Warmaster army yet, you can still join in the action with the many participation games which will be running throughout the day.

Warhammer World, Willow Road,
Lenton, Nottingham NG7 2WS.
For further information log on to
www.games-workshop.com/ukevents

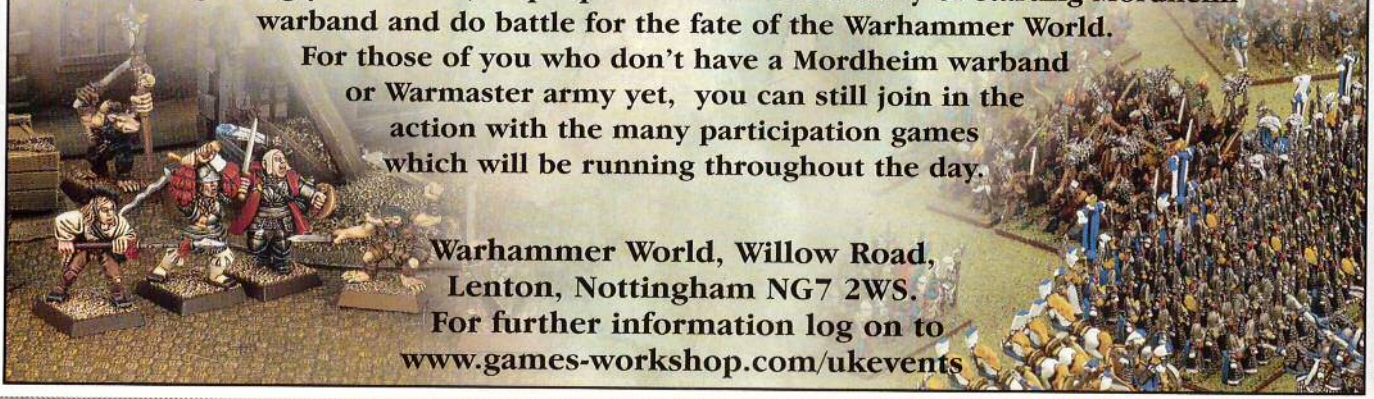

The background of the poster features a large, stylized sunburst or starburst pattern in the center. On the left side, there is a detailed illustration of a dark, heavily armored warrior, possibly a Space Marine, holding a chainsword. On the right side, there is an illustration of a character in ornate, golden armor with a helmet that has a rat-like or animal-like face. The text is overlaid on this background.

CONFLICT

LONDON
Regional Tournament

Saturday 30th March 2002

The Royal Horticultural Halls & Conference Centre,
80 Vincent Square, London SW1P 2PE.

CONFLICT

EDINBURGH
Regional Tournament

Sunday 19th May 2002

Royal Highland Exhibition Centre
Ingliston Road, Edinburgh

CONFLICT

BRISTOL
Regional Tournament

Saturday 22nd June 2002

The University of Bristol Union (UBU)
Queens Road, Clifton, Central Bristol.

ARE YOU THE GREATEST LEADER OF YOUR REGION?

Register your army for your regional tournament and prove your worth! The Conflict Tournaments will also feature participation games, Mail Order, Forge World, the chance to meet the Fanatic team and special guests.

To get your ticket, talk to your local Store staff now!

Full Tournament rules will be sent with your ticket.

Warhammer 40,000 Tournament - 1,500pts

Warhammer Tournament - 2,000pts

£25 in advance for each tournament.

£10 in advance for spectators.

Tournament tickets only available in advance.

Don't miss out, get your ticket today!

Check out www.games-workshop.com/ukevents for more details about these tournaments and other events.

SPECIALIST

GAMES RANGE

Games for the Dedicated Hobbyist



*Inquisitor:
Imperial Guard Veteran*

Warhammer and Warhammer 40,000 are not the only great games that Games Workshop has produced over the years. Up until now these games were only released for a limited period of time and then taken off sale. However, such has been the demand to keep these games in print, we've decided to make seven of them available permanently. We've called them the Games Workshop Specialist Games Range, and below we answer some of the more commonly asked questions about the range.

WHICH GAMES ARE IN THE SPECIALIST GAMES RANGE?

The range currently consists of Inquisitor, Warmaster, Mordheim, Battlefleet Gothic, Blood Bowl, Necromunda and Epic 40,000. If new specialist games are produced by Games Workshop then they will be added to the range as soon as they come out.

WHY ARE THEY CALLED SPECIALIST GAMES?

We've decided to use the term 'specialist games' to cover these titles as they tend to appeal to older and more experienced gamers who have 'cut their teeth' on either Warhammer or Warhammer 40,000 and are looking for something new to try out. Or, to

put it another way, we see the specialist games as primarily for veteran players with specialised tastes. In addition, the specialist games tend to cover more specialised subjects than Warhammer or Warhammer 40,000. Mordheim, for example, is set in one city in the Warhammer world in a specific period of the Warhammer world's history, while Battlefleet Gothic deals with spaceship combat in the Warhammer 40,000 Galaxy, and so on.

WILL THERE BE NEW STUFF FOR THESE GAMES?

Yes there will! We'll be bringing out magazines, annuals and new miniatures for

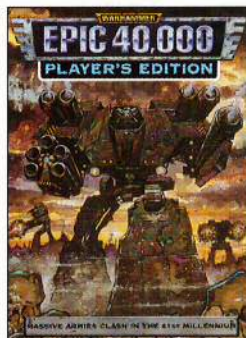

Control gigantic war machines or command massive armies with Epic 40,000.

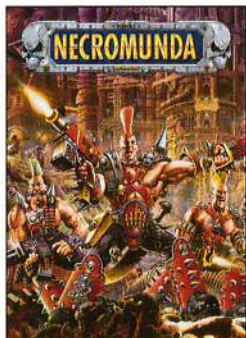

Fight vicious battles in the hives of Necromunda with this Warhammer 40,000 skirmish game.

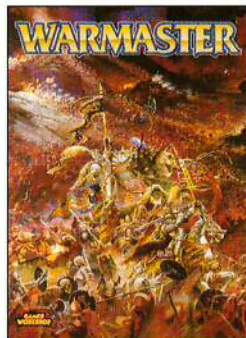

Command huge armies and lead them to victory to prove you are the greatest general of the Warhammer world!

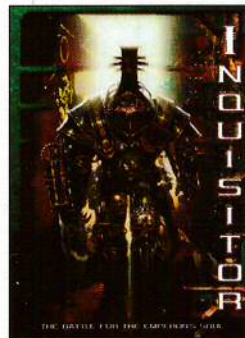

Take on the role of a powerful Inquisitor and do battle against rival factions in this super-detailed narrative wargame.



Lead your warband into the ruined city of Mordheim in this Warhammer skirmish game.



Fight huge battles between fleets of spacecraft with Battlefleet Gothic.

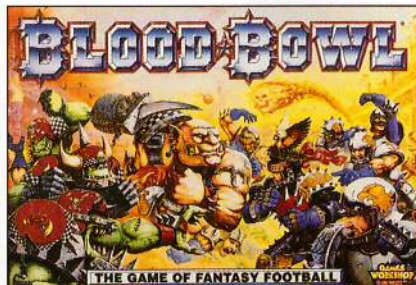

Lead your team to bloody victory in Blood Bowl, the game of fantasy football.

*Warmaster:
Knights of the White Wolf*



*Battlefleet Gothic:
Retaliator Class Grand Cruiser*



all of the games in the Specialist Games Range. This is already happening – all of the miniatures pictured on these pages were released within the last few months.

WILL YOU KEEP MAKING NEW STUFF FOR THESE GAMES FOREVER?

As long as the demand is there and you're playing the games then we'll keep on supporting them and bringing out new material for them. Watch out for details of new Specialist Games Range releases in each White Dwarf.

CAN YOU TELL US MORE ABOUT THE MAGAZINES?

Each of the games in the Specialist Games Range has its own magazine. The magazines provide new rules, articles, details of new releases, news and gossip, designer's notes, a gaming contact section and an events calendar. Our aim is to make the magazines a 'must-have' item for dedicated players of the game that the magazine covers. In addition, White Dwarf will also publish articles about the games in the range.

WHAT ARE THE ANNUALS?

Once a year we will bring out an annual for each game in the Specialist Games Range. These annuals will contain the rules for any new models released in the previous year, as well as official errata, Q&A and new rules for the game covered. Basically, as long as you have the game and the latest annual then you will know that you are completely up to date on the game rules.

DOES THE SPECIALIST GAMES RANGE HAVE A WEBSITE?

Yes indeed! You can find out about new releases and order on-line by visiting the Specialist Games Range page of the Games Workshop website

at www.fanatic-games.com. We're gradually adding community sites for each of the games in the range, which will include archives, chat rooms, links to cool fan sites and other bits and pieces.

HOW DO I GET HOLD OF THE GAMES AND MINIATURES IN THE SPECIALIST GAMES RANGE?

You should ask your local Games Workshop stockist if they carry the Specialist Games Range. If you can't get hold of the games from your local shop then the full range is carried by Games Workshop Mail Order, and can be ordered on-line from the Games Workshop website at www.games-workshop.com.



Epic 40,000: Leman Russ Executioners

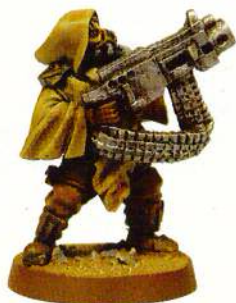

Necromunda: Ash Waste Nomad



Mordheim: Kislev Champion



Blood Bowl: Amazon

The Specialist Games Range is available from selected stockists and Games Workshop Mail Order. Visit the Specialist Games Range website at www.fanatic-games.com

Shadows whipped around his head, screaming and tireless. He swatted at the ghostly apparitions with his own insubstantial hands, hands that ended in blackened talons. The shadow-creatures taunted him always. They blurred and changed, and he felt that he should remember what these images meant. At times he thought that he did remember, but those moments slipped quickly out of his reach again, and he was left alone again within the darkness with his frustration and his anger.

Flashes of light burned deep into his very being, irritating and disorienting him. He saw a great, powerful figure, beautiful and awe-inspiring as it led an endless horde of gibbering daemonic creatures. Blood was shed, the blood of mortals, and it felt good. Was this himself he was seeing?

Again the images and sounds flickered out of his mind and were forgotten. Why was he so angry? Who had done him this wrong? Who was he? Be'lakor, he heard whispered, but that name was meaningless to him. Cackling laughter echoed through his being, and rage burned through him again. He screamed in torment, as he had screamed for thousands of years, though no sound was heard. The hideous laughter rebounded back to him, and he recoiled in loathing, hating indiscriminately and without focus. What was there to focus on?

Flames danced their way around him, and he drew back into the dark shell of himself. He saw himself sat upon a great throne, high upon a mountain. Thousands of souls circled around him, begging for his mercy, their spirits unable to move on to the next plane, bound by shining chains to the mighty throne. He saw himself, a glorious and radiant figure with everything he could ever wish for at his fingertips.

"You could have had all this..." came a taunting whisper in his mind, a voice he knew was his own. He screamed, trying to drown out the voice, but he could not. "It would all have been yours, if only, if only..."

Abruptly, his vision cleared, his mind became his own once more. Darkness was around him, but it was the crisp shadow of his own realm, not the gloom of madness. A flood of memories flowed through the being known as Be'lakor, as the Harbinger, as the Dark Master. With the memories came the hatred once more, for he remembered his tragic fall from the heights of power to insanity, condemned by the cursed Changer of the Ways.

As awareness filled him with clarity, Be'lakor vowed that he would never again fall into that horrid mad existence, that endless parade of inconceivable images and sounds.

"Not this time," vowed the Dark Master.

THE DARK MASTER

The Dark Master held the fate of the Warhammer world within his shadowy talon during last summer's worldwide campaign set on the mist-enshrouded isle of Albion. But who or what was this terrible being? Twisted scribe of forbidden lore, Anthony Reynolds, delves into the background of this dangerous and powerful creature of eternal darkness.

The powerful being called, in these times, the Dark Master has been known over the centuries by countless other titles and names, including the Harbinger, the Bearer and the Darkening. It is written in ancient tomes that the creature's original name was Be'lakor, but this is known only amongst a few scholars specialising in the forbidden texts, for this entity is thousands upon thousands of years old. A being of eternal despair and doom, the Dark Master was once a mortal being – indeed it is widely believed that he was the first earthly creature to achieve eternal life, being raised to the status of daemonhood by his infernal masters for countless deeds that attracted their attention and favour.

Reborn into his new body as a Daemon Prince, the Dark Master was a terrifying and overwhelming creature, and soon came to be worshipped as a deity in his own right. With unimaginable power at his fingertips, Be'lakor strode at the forefront of the armies of Chaos, leading endless legions of daemons in great wars that ravaged the land. No mortal could stand before him, and he slaughtered thousands at a whim.

As his powers grew stronger with each passing day, so too did his pride, which was to prove his downfall.

Swollen with arrogance and pride, Be'lakor eventually incited the anger of the Greater Gods of Chaos. It is written in the dark volumes that he saw himself as equal to the gods of Chaos rather than giving them their worthy respect, and that it was this act which caused his fall from grace. The Dark Master was cast down from his exalted position and cursed by Tzeentch, the Changer of the Ways. From being the favoured son of Chaos, he became a hate-filled and confused spirit-creature, denied physical form. His sanity was stripped from him, and he became a random and unpredictable entity that ruled a dark realm of his own madness. For thousands of years the Dark Master has existed in insanity, time dragging agonisingly slowly, each passing minute feeling to him like a month. The confines of his tortured mind is constantly awash with random thoughts and ideas, filled with frustration, anger and hatred.

As part of his curse, a destiny was placed upon this now insubstantial and random Chaos spirit. Over thousands of years, there have been many Chaos invasions of the world, led by all manner of fell daemons and mortal warriors. However, some of these leaders stand out from the others, mighty conquering champions particularly favoured by the Dark Gods. These powerful leaders have each united the followers of the dark gods of Chaos and led the great incursions of Chaos that have ravaged the world. Each one of these invasions could well have overtaken everything, but each has been pushed back at great cost. The mark of the Chaos gods' favour on the elevated warlord who leads the incursions is the dread Crown of Domination, a powerful symbol to the creatures of Chaos that the Greater Gods have marked out this mortal leading their armies.

Before each coming of these powerful incarnations of Chaos, Be'lakor wakes from his tortured insanity. It is his curse to lead these mighty warlords to the eternal resting place of the Crown of Domination, to guide them along the hidden paths where they must face a number of mortal challenges in order to prove themselves in the eyes of the gods. Once the crown has been retrieved, it is the Dark

Master who is compelled to complete the ceremony, and place the crown on the warlord's brow in a dark coronation, the fallen Daemon Prince filled with jealousy and hatred. Once the crown has been placed upon the warlord's brow, Be'lakor begins to fade back into his mad state of existence, no matter how much he struggles to resist the pull of insanity. Each time he witnesses the rise of the Uniter of Chaos he is painfully reminded that they take the place that is rightfully his own. Such is his curse, that he must aid them on their path to greatness, filled with the knowledge that it is they and not he who will lead the glorious incursions against the mortal world.

And so for a sixth time the Dark Master rose from his madness and regained his wits in order to fulfil this preordained fate. Be'lakor's memories of what occurred in his past resurfaced, and he once again recalled how he was hurled from his exalted status into darkness. Hatred towards the higher powers of Chaos filled his being, and he was determined not to let history repeat itself once more. Be'lakor set about on a desperate action that would

enable him to avoid fulfilling his pre-ordained destiny and regain what he had lost. Before the rising warlord was ready to receive the crown, the Dark Master swept unseen over Albion, recognising that this isle held the key to his

Domination out of his reach. If he could claim the Crown for himself, it would be he who could claim the mantle of the Uniting Warlord of Chaos, and it would be he who would lead the daemonic legions on their rampage into the mortal lands of the south. Be'lakor set about attracting servants, those he could corrupt and lure to his side, for he needed minions to do his bidding and focus the power into himself.

The Dark Master turned his attentions to the Truthsayers of Albion, the protectors of the Ogham stones, and set about weeding out those who he could turn against their brethren.

Promised great power and gifted with potent magic, these so-called Dark Emissaries began to abuse their ancient knowledge of the Ogham stones, turning their power towards feeding and fuelling the power of the Dark Master. A tremendous battle erupted between the Dark Emissaries and the Truthsayers, both groups seeking help from far shores, securing allies from all the corners of the Warhammer world, and the battles escalated. Thus the War of Albion was begun.

Albion was soon soaked in blood and devastation, and countless stone circles had been desecrated, their power turned to infernal, abhorrent uses. Be'lakor revelled in the bloodshed and horror. As they gained control of the stone circles, the Dark Emissaries used their corrupted powers to siphon off the wild energy of the land, sucking the vitality from the isle of Albion to feed their Dark Master. As his powers grew, the shadowy Daemon Prince grew increasingly more solid, and he gloried as he slowly began to regain his long lost physical form.

chance for escape, feeling the pulse of magical energy emanating from it. He alone knew the resting place of the Crown of Domination, although it is a part of his curse that he cannot touch the Crown until the hand of the chosen warrior has retrieved it. However, if the power of the Albion Ogham stones was focused into his being, Be'lakor realised he could regain his much coveted physical form and breach the defences that kept the Crown of





Goading his minions ever onwards, and greedy for the feel of material form, Be'lakor knew that his chance to escape his doomed fate had come. He began to exert his own power as it grew, and many on Albion could feel his dark shadow like an oppressive cloud hanging in the sky. To others, this feeling was more intense, and the Truthsayers themselves could feel the power of the Dark Master as a heavy pressure forcing itself into their minds. At the same time, Be'lakor began to probe the defences surrounding the Crown of Domination, feeling them begin to yield before him.

Meanwhile, the forces of the Truthsayers had been busy securing new allies, and the forces of darkness were ground to a halt. The Dark Master raged, for he knew that time was short. He could feel that far to the north, the time was nearing when the powerful warlord was ready to receive the Crown of Damnation. The Dark Master knew that he must have the powerful artefact within his grasp before then, for even his will could not resist the pull of fate that would require him to fulfil his hated destiny when the time of unholy coronation came.

As the forces of darkness faltered, they began to turn upon each other, and former allies killed many of the Dark Emissaries. The Truthsayers, united within the Bastion of the Old Ones, began to perform powerful

incantations, their magic converging to counter the assault of the Dark Master. In a fit of rage the Dark Master, now almost completely in solid, corporeal form, realised that his plans had been thwarted. He knew that with the advance of his forces halted, he could not filter enough power into himself in time. As his destiny began to pull at him, he knew that he could not resist.

His semi-formed, shadowy figure filled with power, the Dark Master rose to his full majesty and swept from the towering Citadel of Lead as his destiny tugged him unwittingly onwards, leaving his minions to continue their battle against the Truthsayers without him.

But with his new-found power, a number of realisations came to Be'lakor. He knew that the great incursions were becoming more frequent, and the time was nearing

when the world would be assailed by one almighty incursion that would last until the end of time. It did not matter how long this incursion would take to conquer the lands, centuries perhaps, for time is nothing to the gods of Chaos. Hatred burned through the Dark Master, for he knew that he would not be leading the forces of Chaos in these final, glorious battles.

With this hatred came another curious thought. Be'lakor realised that with the power he had gathered into himself during the war on Albion, he was able to resist descending back into madness. He was free of his cursed destiny. Though he had not achieved all that he had dreamed, the Dark Master was far from finished with his treacherous scheming. After the crowning of this new leader of

Chaos, this upstart known as Archaon, the Dark Master would retreat to the Realm of Chaos with new dreams filled with power and vengeance.

The rage-fuelled plans of the Dark Master are focused on seeking vengeance against the Greater Gods of Chaos. In darkness, the being known as Be'lakor concocts his final revenge, while the world becomes increasingly aware of the grim and bloody times rapidly approaching, when the lands shall once again feel the hellish grip of Chaos...





WORLD

Sea of Chaos

Argulle

Anden forest

Couronne

Wastebard

Guoreux

Bordeleaux

Britannia

Brionne

Quercelles

Zombie forest

Estalia

Magalla

Zombie Swamps

Miragles

The Great Ocean

Tilea Sea

Tilea

Remas

Lucany

The Black





Heretic

Empire

Here Be Dragons

Badland

Dark Van

Black Mountains

Sylvania

North

South

East

West

North

South

East

West

North

South

East

West

North

South

East

West

North

South

East

West



Index Astartes

First Founding



An in-depth look at
the First Founding
Legions of the
Adeptus Astartes

SONS OF HORUS

The Black Legion
Space Marine Chapter

by Graham Davey

The Primarch of the Luna Wolves was the infamous Horus, first and greatest of all the Primarchs. His Legion conquered countless worlds during the Great Crusade before Horus betrayed the Emperor and led a violent rebellion that devastated the Imperium. The Luna Wolves are the only Space Marine Legion to have changed their name, becoming the Sons of Horus and finally the Black Legion.

Origins

The early history of the First Founding Space Marine Legions is largely lost to the relentless march of time. Accounts and details of those Legions that rebelled (and especially of the Arch-Traitor Horus himself) were further expunged from Imperial records after the Horus Heresy, to deny any knowledge of those events from the vulnerable minds of Imperial citizens. Indeed, only a select handful of powerful individuals know any of the truth and it is likely that none know it all. Such information that does exist is sketchy and anecdotal, and lies in ancient heretical tomes closely guarded by certain Inquisitors or handed down within the secret orders of the original Legions that remained loyal.

These records suggest that the Space Marines of the Luna Wolves Legion were created using human stock taken from the violent hive gangs inhabiting a planet called Cthonia. This planet allegedly existed in one of Earth's closest neighbouring systems. Being within reach even for non-warp spacecraft, Cthonia had been colonised, built upon, tunnelled and mined probably since the dawn of space travel. As such, all natural resources had been stripped away and used up millennia before, and the ancient mining technology had long since been rediscovered and removed by the Adepts of Mars. The planet that remained was largely redundant and abandoned, completely riddled with catacombs, crumbling industrial plants and exhausted mine-workings.

Fierce gangs inhabited the lawless depths of Cthonia, enjoying freedom from the rigours of Imperial citizenship; but at the time of the First Founding they provided an easy source of Human specimens whom nobody would miss. One report talks of so-called 'recruitment squads' rounding up thousands of gangers and shipping them away, chained together in the holds of prison-shuttles, to genolaboratories on Luna. Here they were modified using the genetic code of the Primarch Horus. It is more common for Space Marine genetic stock to be gleaned from feral or primitive worlds,

however after the usual hypnopsychological indoctrination process, the Luna Wolves recruits emerged as excellent and ferociously loyal specimens.

Horus

Information about Horus himself is even harder to uncover. It is thought that he was the first of the Primarchs to be recovered by the Emperor, having been cast much closer to Terra than the others, and was found at a much younger age. As a result, Horus was for many years the Emperor's only son, and there was a great affinity between them. The Emperor spent much time with his protégé, teaching and encouraging him. Horus was soon placed in command of the Luna Wolves Legion – ten thousand Space Marines created from his own genetic code. With these warriors to lead, Horus accompanied the Emperor for the first thirty years of the Great Crusade, and together they forged the initial expansion of the young Imperium.

The two fought together on many occasions. At the fortified city of Reillis, a Human settlement unwilling to accept the Emperor's beneficent will, the defending army used secret tunnels to infiltrate behind the besieging Imperial army and hundreds of shock troops swamped the command encampment. Unprepared and unarmoured, the Emperor and Horus fought back to back until a plasma blast stunned Horus and sent him staggering to the floor. The Emperor stood over the Primarch and refused to give ground until reinforcements arrived to drive their attackers back. On the Ork-infested planet of Gorro, Horus repaid the debt by hacking the arm from a huge, frenzied Greenskin warlord as it struggled to choke the Emperor's life out of him.

Then came the day that the Emperor divined the presence of a second Primarch in their proximity and immediately set out to find him, leaving Horus in temporary command of the massed Legions of the Great Crusade. While he rejoiced at the discovery of one of his brothers, Horus was determined that the Emperor would

always remain most proud of him, his first son.

As other Primarchs were discovered, the Emperor's time was pulled more and more in other directions and, while many of the other Legions now had their destined leaders, Horus was often given overall strategic command. It was a position he relished, proving himself time and again a consummate general, winning praise and decorations from the Emperor for his achievements and conquests. He had the approval and admiration of all the Space Marine Legions, including their Primarchs.

It is said that as well as being a great warrior and strategist, Horus was fiercely intelligent. He was charismatic, persuasive and had an innate understanding of psychology. He could read men in order to use their strengths or exploit their weaknesses. These skills made him a well-loved leader, but also allowed him to find non-military solutions when others would simply have attacked. On many worlds, a blunt explanation of the destructive might at his disposal and a day's parley with the planetary leaders was enough to bring them into the Imperial fold without

bloodshed. Horus always took trouble to follow the local Human customs and modes of greeting if he thought it would lessen the chance of a hostile reaction to his arrival. His practice of taking part in local rituals to establish ties for later exploitation soon became Imperial policy.

Horus was also skilled in getting the best out of the other Primarchs and their respective Legions. Many of them excelled in a particular style of fighting, and Horus encouraged this diversity and endeavoured to deploy them to war zones that would suit them best.

Inquisition Access Level: 6 nine hundred and ninety-one

Luna Wolves, Progenitor Legion M31

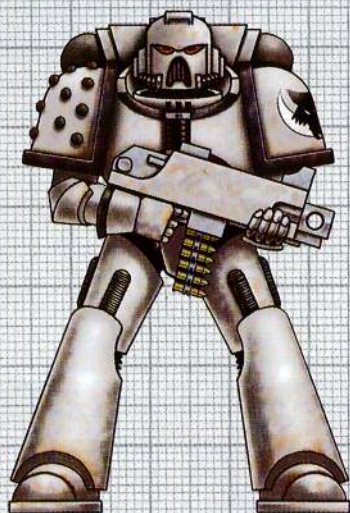

Pre-Heresy Luna Wolves colour scheme



Pre-Heresy Sons of Horus colour scheme
(renamed after Ullanor Crusade)



Luna Wolves Legion symbol

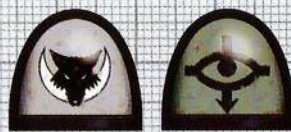

Pre-Heresy auto reactive shoulder plates
incorporating Legion iconography



Black Legion colour scheme
(Renamed for unknown reason)

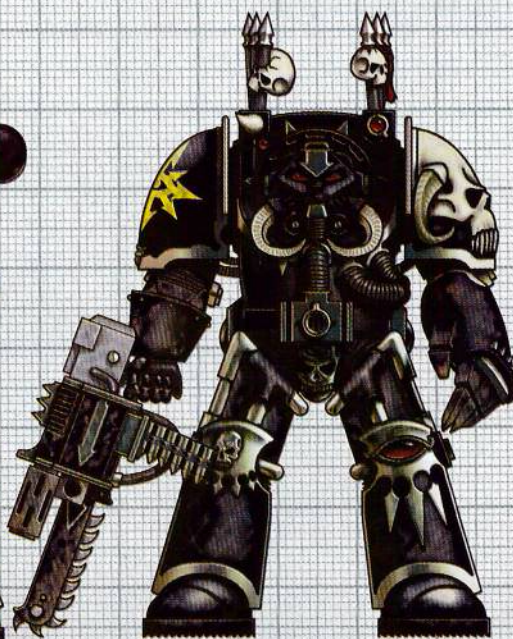

Black Legion Terminator

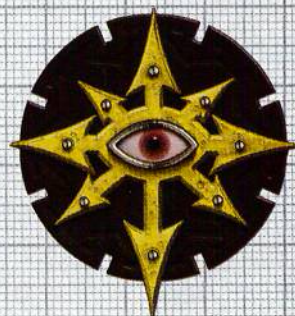

Traitor Black Legion symbol



Auto reactive shoulder plates
incorporating blasphemous iconography

Thought for the day: The weak shall fall, the strong shall prevail.

If a sudden strike was needed, he would send the White Scars or the Night Lords. If a protracted campaign was expected, then the Death Guard or the Salamanders were used. When precise timing or covert operations were required, the Alpha Legion were favoured, and if simple ferocity was called for, other Legions were brought to the fore. Horus wielded the Space Marine Legions as a lesser commander would wield the squads of his army, positioning them so that each could perform to their advantages and win glory for all. There is also evidence that he sent dispatches detailing the World Eaters' most ferocious victories to the Blood Angels Legion and vice versa, presumably to foster a competitive rivalry. Likewise, it can be assumed that Horus was well aware of the feud between the Space Wolves and the Dark Angels. These two Legions were repeatedly deployed in joint actions, spurring them both on to greater military feats in order to outdo each other.

His own Legion had all the glory of being the greatest Primarch's personal guard, and they shared Horus's credo of fighting to be the best. Under his inspiring command, the Luna Wolves were always at the forefront of the latest campaign, pushing the boundaries of the Imperium ever wider, driving further and further into the galaxy and striving to conquer and liberate more worlds than the other Legions. In the Aartuo, Keskastine and Androv Systems, the Luna Wolves are known to have moved swiftly on to planet after planet as soon as the local armies had been subdued. The Ultramarines and the Iron Warriors, who were fighting alongside Horus's Legion at this time, were repeatedly left to mop up any final pockets of resistance and establish garrisons on the conquered worlds. The Luna Wolves officers apparently refused point blank to assign any troops to these duties, insisting that every man was required for the ongoing crusade. Further rebellion flared up on a number of the planets after the Luna Wolves had left, and it is believed that the Ultramarines Primarch Roboute Guilliman subsequently had words with Horus on the matter. At the time it seems that Horus pacified the Primarch by admitting that Guilliman was much better at this sort of thing than he was, however in his great work, the Codex Astartes – completed much later – Guilliman prescribed a much more thorough tactical doctrine for the suppression of a planet.

Heresy

The Ullanor Crusade saw Horus battling a huge Ork empire. At its conclusion, the Emperor declared it the greatest victory yet for his mighty Imperium and was said to bestow much praise upon the Luna Wolves and Horus, for their part in the campaign. The most notable reward was the renaming of the Legion. The Emperor sent word that henceforth they would be known as the Sons of Horus, in honour of their Primarch. Horus himself was given the title Warmaster – now officially supreme commander of the Emperor's forces. Despite these great honours, there is some suggestion that Horus was less than content. The wording of the Emperor's proclamation clearly claimed the glory of Horus's victories as his own. This was the usual rhetoric for such announcements – after all, the Primarchs were the sworn vassals of him and his Imperium. And yet in the Primarch's eyes, the Emperor now spent his time in safety at his palace on Terra while Horus won his Imperium for him. It seems likely that a deeply-rooted resentment had surfaced.

Before he could return to Terra to be officially invested with his new title, Horus apparently fell ill on a small feral world called Davin. During his convalescence, he took part in the induction ceremony of a warrior lodge on the planet. This was the Primarch's well-tried practice to develop ties with local populations – feral natives were more easily recruited into the Imperial fold when the 'Warriors from the Stars' had become brothers. However, this time was different. In the days that followed, Horus's officers detected a change in his character. It is now presumed that the warrior lodge was in fact a Chaos coven, which somehow managed to ensorcel the Warmaster.

The Primarch proceeded to introduce similar 'warrior lodges' into his own Legion, and then others under his command. Horus's fealty had changed; his Legion believe that he was actually possessed by a Daemon. Whether or not this is true, it is certain that he was

now allied body and soul to the powers of Chaos, and he had a new vision for the Imperium with himself at its head. Whether the events on Davin were planned by the gods of Chaos or just the work of an isolated group is unsure. Certainly a Primarch becoming ill was almost unheard of, and it would surely have required a virulent and unique ailment to affect him, perhaps indicating a greater conspiracy.

The Sons of Horus, already fiercely loyal and proud of their Warmaster, had no hesitation. They quickly renounced their oaths to the Emperor and started to worship Horus and his new gods. The corruption spread to every organisation with which Horus had dealings, including a division of the Adeptus Mechanicus, and from there to the Collegia Titanica and the Legio Cybernetica. The other Primarchs, Horus knew like brothers, and was already well practiced at motivating them. Appealing to their pride, martial prowess and courage, while playing upon past grudges and favours, the Warmaster gained the loyalty of fully half the Primarchs. The war that followed was the most terrible in the history of the Imperium, and came close to shattering it forever. Space Marines fought Space Marines and Titans fought Titans as Earth was invaded, and the Emperor's palace itself was besieged and breached.

History records that on the 55th day of the battle, overwhelming Imperial





THE ULLANOR CRUSADE

The Ullanor Sector was the domain of Ork Overlord Urlakk Urg. His empire was founded on dozens of conquered and enslaved Human planets. Knowing the Orks' love for battle, the Warmaster's tactics were to lure the Greenskin forces away from his real targets. Other Space Marine Legions were tasked to retake the outlying planets, supported by newly-raised Imperial Guard regiments. As the Ork armadas moved out to resist this invasion, the Luna Wolves fleet drove straight for the central system.

Drop pods crashed to the ground all around Urlakk's fortress-palace. Heavy shuttles deployed Land Raiders and Predators and armoured Space Marines advanced on the defences. Then, as hundreds of Orks rushed to join the battle on the perimeter walls, Horus and the entire Terminator-armoured 1st Company teleported directly to the foot of the great central tower. As the Luna Wolves blasted away the guards, mobs from the walls raced back to protect Urlakk. Horus left most of the Terminators to hold back the Orks and pushed on up the tower with just ten Space Marines at his side. At the pinnacle of the tower they found Urlakk in a grand chamber, accompanied by forty of the biggest Orks in his empire. Horus charged straight into the midst of the Nobs, slicing apart the muscled, green bodies with the twin lightning claws of his battle armour. The Terminators with him would not fire into the mêlée for fear of hitting their beloved Primarch, so they too crashed into the combat. Slowly they hacked a path through the mob until Horus faced Urlakk himself. The Overlord was an enormous Ork, but he was simply no match for the Primarch's skill and unnatural power. First crippling his enemy, Horus hefted Urlakk's broken body out onto the roof and threw it screaming from the battlements to fall far below amongst the horde of Orks still assaulting the lower levels.

The sudden demise of their mighty leader sent a panic through the Greenskin forces, which started to fall back from the Terminators. But the fleeing mobs found they had nowhere to run, as the outer walls had been breached by the attacking Luna Wolves, and the day turned into a slaughter. Back in the Overlord's chamber, Horus found every Ork and Terminator dead, apart from the gore-drenched Captain of the 1st Company, Abaddon, surrounded by crushed and broken bodies.

As word of his death spread, the Overlord's empire fragmented. The Imperial forces were able to destroy or drive out the remaining Orks and free the quadrant for Imperial rule within a year (naturally, the Luna Wolves claimed to have liberated substantially more worlds than their allies).

reinforcements approached. In a bid to slay the Emperor before it was too late, Horus lowered the shields around his battle barge, daring his creator to teleport on board. But it was Horus who was slain, and with him died the rebellion. It was a traumatic and devastating blow for the Sons of Horus. Everything they had ever fought for was lost. The Legion fell back immediately from the attack on the palace and fought their way back to their shuttles. This action alone is thought to have secured the enmity of all the other Traitor Legions. On board the battle barge, the Captain of the 1st Company led a furious counter-attack to drive the Imperials from the vessel, then fled into space with the Warmaster's body.

Exile

Along with the other rebel Legions, the Sons of Horus found refuge in the Eye of Terror, where they established a base from which to continue the

campaign against the Imperium. They constructed a fortress-tomb for the body of the Warmaster and even in death still revered him as their commander. Nobody was appointed in his place and the Captains of the Legion would offer sacrifices and pray for guidance in his shrine. In the following centuries they were the most active of the Traitor Legions, possibly trying to maintain their tradition of achieving more than the others, or perhaps seeking to atone for their moment of weakness on Terra. During this time they offered their worship to each of the Chaos gods in turn, willingly giving their bodies to possession by Daemons in emulation of their dead Primarch. However, with every change in loyalty, the Daemons of the rejected god retreated into the warp leaving their Space Marine hosts nothing more than discarded husks. The Legion grew fewer and fewer until it was threatened with extinction. Desperate experimentation and research by the Legion's Sorcerer-

Librarians finally uncovered a method of possession that did not destroy the mortal host.

Saved, but still numerically inferior, the Sons of Horus fought a series of bloody wars against the other Traitor Legions, vying for resources, power and superiority within the Eye of Terror. The culmination of the conflict was the destruction of the Legion's fortress by a combined force of their erstwhile allies, including the Emperor's Children. Worse still, the Warmaster's corpse was taken and there were subsequent reports that a being calling himself the Primogenitor was working with the Emperor's Children to clone the body. With their Primarch taken from them and defiled by their enemies, the remains of the Legion finally swore fealty to a new leader – Abaddon, Captain of the 1st Company.

Abaddon knew that the memory of the Warmaster shackled his Legion to the failures of the past, so his first edicts renounced the name of Horus and the ancient title of the Legion. Taking their last surviving battle barge, he led them in a lightning raid that destroyed the Warmaster's body and the whole cloning laboratory complex. For this action and in every subsequent sighting, each Space Marine's armour was painted black. Since this time, Abaddon's 'Black Legion' has raided the Imperium, sowing havoc and misery on every world it attacks.

Home World

The Legion's home world of Cthonia no longer exists, having apparently lost geo-structural integrity and broken apart into asteroids and debris during the centuries following the Heresy. Certainly the once ore-rich planet was riddled with mine workings right through to its dead core (in fact the numerous gangers that formed the population may originally have been imported as work teams to maintain the crumbling tunnels), however there is much conjecture that Cthonia was destroyed deliberately.

Since the destruction of their fortress in the Eye of Terror, the Black Legion is no longer based on any particular planet, instead stationed permanently on various spacecraft. They possess a single ancient battle barge from their original fleet, as well as other vessels commandeered or captured over the years. In particular, many Imperial Navy ships that rebelled during the

Horus Heresy now seem to be under Abaddon's command, along with newer vessels he has ordered constructed.

Combat doctrine

The Legion is a flexible fighting force, that can perform well and adapt quickly to any combat situation. It was trained to respond sharply and decisively to the tactical orders of its Warmaster and consequently the

chain of command within the Legion was very efficient. This suffered significantly during the early years of exile when the Legion was leaderless, but Abaddon has done much to restore discipline, mainly through fear and horrendous violence inflicted on those that displease him. Horus's favoured doctrine of 'tearing the throat out of the enemy' by eliminating their high command in a swift strike, remains a well-used tactic.

ABADDON THE DESPOILER

Abaddon was Captain of the Luna Wolves 1st Company during the Great Crusade and followed Horus from ancient Terra to conquer the distant stars. He worshipped the Warmaster like a god and Horus treated him as his most favoured son. Indeed, some whispered that he was in truth the clone-son of the Primarch himself, product of the earliest geno-experimentation.

When the Heresy came it was clear that Abaddon's loyalty was to his Primarch and not the distant Emperor of Mankind. He led the Terminator armoured Sons of Horus in campaigns on Istvaan, Yaran and in the siege of the Imperial palace on Earth. His anguish at Horus's defeat in that final conflict drove him deeper into madness and hatred than any mortal should ever sink. He took Horus's lightning claw, tearing it from the Warmaster's armour with a howl of rage which echoed through the great ship.

Abaddon has fought to rebuild the pride and reputation of the Black Legion, always leading his forces into the most dangerous conflicts personally. At first, Abaddon won the grudging respect of the other Traitor Legions, but as his deeds have grown mightier he has succeeded in winning their support too. His impassioned words have rekindled the Traitor Legions' smouldering hatred of the Imperium and warriors of all the Legions have fought beneath his banner.

Abaddon has marshalled his strength with care and now commands the loyalty of champions from all of the other Traitor Legions. Those who oppose him are crushed. Those who join him add their strength to the greatest army ever assembled within the Eye of Terror. Abaddon has tested the strength of the Imperium many times, and with each victory his power grows.

When Abaddon first returned it was at the head of a diabolic horde which ravaged entire systems around the Eye of Terror before the Imperium could muster the strength to halt it. During this first 'Black Crusade', Abaddon made many bloody pacts with the infernal powers. In the crypts below the Tower of Silence on Uralan, Abaddon recovered a daemon sword of prodigious power. With the howling daemon blade in his fist, Abaddon became nigh on unstoppable. Whole cities were burned in sacrifice to the ever-hungry daemons of Chaos, and entire armies were torn apart by gibbering warp entities. Abaddon's power swelled to inhuman proportions as the gods of Chaos rewarded him lavishly and he undertook acts of fiendish bravery which horrified those who stood against him.

His most recent and most devastating incursion was the Gothic War, during which Abaddon almost brought an entire sector to its knees. His fleets were augmented with a newly constructed flagship, known for good reason as the Planet Killer. Alongside this he somehow activated and gained control of the Blackstone Fortresses, mysterious constructions allegedly pre-dating the Imperium itself, that combined to generate prodigious destructive firepower. Abaddon attacked while the Sector was cut off from reinforcements by warpstorms, and caused huge damage to the Imperial battlefleet, destroyed a number of planets and devastated many more. Only the intervention of the Eldar enabled Imperial forces to stop the Chaos fleet.

The High Lords of Terra live in fear of the day that Abaddon unites all of the Traitor Legions into an unstoppable horde and returns to play out the last acts of treachery begun by Horus ten thousand years ago.

Organisation

After the death of Horus, proper structure within the squads and companies disintegrated, and their later dispersal in various spacecraft further fragmented the Legion. Now warbands of virtually any size and composition can be found following Black Legion Champions – ranking officers from older times or newly emerged leaders who have won favour through their violent deeds. At times, such warbands rally together under the banner of a greater Champion or even Abaddon himself, for a major raid or incursion into the hated Imperium. However, loyalty to differing Chaos gods often leads to internal politics and conflict. Possession by Daemons is still considered highly favourable, and many members of the Legion have the honour of being hosts.

Beliefs

The overriding belief of the Legion prior to the Warmaster's demise was in the ultimate superiority of Horus and themselves. In continually seeking to prove themselves as the greatest Legion, they did indeed achieve most in terms of sheer numbers of worlds brought into the Imperial fold prior to the Heresy. Their defeat and exile was a crushing blow to the collective ego of the Legion. It has taken all the strength of character of their new commander, Abaddon, to restore the Legion's sense of pride and refocus on their ultimate goal – to overthrow everything which the false emperor of Mankind created.

Gene-seed

The Legion's gene-seed, prior to the incident on Davin, was reliably pure. However, following their corruption by Chaos, Space Marines started to exhibit random mutations, and it is likely that this taint goes right down to the gene-seed level. The regular practice of seeking Daemonic possession may also have accelerated the effect. However, such mutations are seen as a mark of favour from the Chaos deities and are generally displayed with pride.

Battle-cry

Up until the destruction of Horus's body: "For the Warmaster!"

Following this event, the various warbands each use their own battle-cries. Warbands fighting for Abaddon use: "We are returned!"

CHAOS SPACE MARINES

The forces of the Despoiler are gathering strength. Once again Abaddon prepares to bring the Imperium to its knees.



Abaddon the Despoiler £9

The leader of the Black Legion, Abaddon is the bane of the Imperium and the most powerful Chaos Lord to plague the universe since Horus.



Chaos Space Marine Lord £7

Mightiest of the Chaos Space Marines, Chaos Lords are rewarded by the foul Chaos gods for their countless vile deeds.



Chaos Space Marine Sorcerers £5 each

Using the perilous powers of the warp Chaos Space Marine Sorcerers stalk the battlefield, blasting apart their foes with bolts of eldritch force. These deadly psykers are perfect for leading small Chaos forces.



Chaos Space Marine Icon Bearer £4 each

The Icon Bearer carries the blasphemous icon of the dark lords of Chaos into battle.



Chaos Terminators £6 each

The most savage and worthy warriors amongst the Chaos Space Marines will sometimes be gifted with a suit of Terminator armour, turning them into even more awesome combatants. Protected by thick ceramite armour and armed with a variety of archaic weaponry, Chaos Terminators have been the bane of the galaxy for countless millennia.

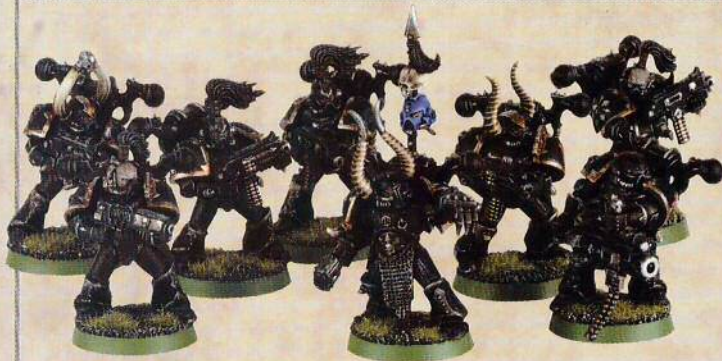

Chaos Space Marines £15 boxed set

Chaos Space Marines are deadly warriors, combining the skill and genetic engineering of a Space Marine with the bloodthirst and cruelty of Chaos.

They wage an unrelenting war against those who remain loyal to the Emperor, who they see as an undeserving usurper to the rulership of Humanity. Well armed and armoured, Chaos Space Marines are amongst the most deadly warriors in the galaxy.

This boxed set contains eight Chaos Space Marines, including heavy bolter, plasma gun, Aspiring Champion and Mutations frame.



Chaos Space Marine Bike Squadron £18 boxed set

Chaos Space Marine Bike Squadrons make an excellent fast attack flanking force for supporting your main units. With their special weapons a Chaos Space Marine Bike Squadron can tear through enemy units with contemptuous ease.

This boxed set contains three Chaos Space Marine Bikes, one Aspiring Champion, one plasma gun, and one meltagun.

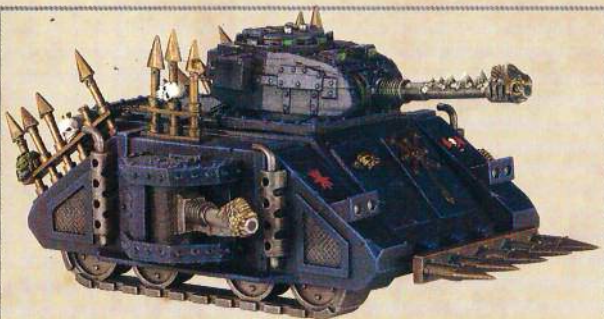

Chaos Predator

£18 boxed set

The Chaos Predator is a modified version of the Chaos Rhino transport vehicle, fitted with extra armour and upgraded to carry an assortment of heavy weapons. Some Chaos Predators have survived over thousands of years, their armoured hulls and weapons mutated beyond recognition.

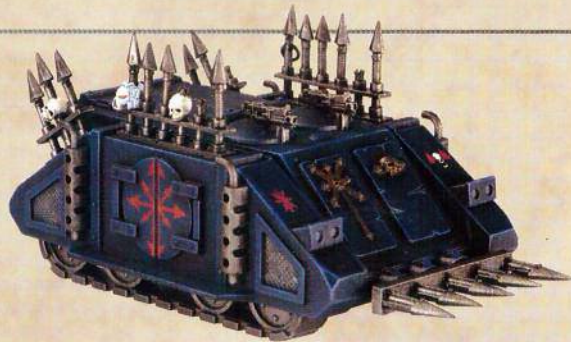

Chaos Rhino

£12 boxed set

The Rhino is one of the most common of all Chaos Space Marine vehicles. It has been in service since long before the Horus Heresy, and machines taken into the Eye of Terror by the Chaos Space Marines following Horus's defeat are still in use thousands of years later.



Chaos Land Raider

£30 boxed set

Many vehicles used by the Chaos Space Marines date back over 10,000 years to the founding of the Imperium. Of these, the Land Raider is the most deadly, able to transport a squad of Chaos Space Marines or Chaos Terminators into battle within its near-impenetrable hull.

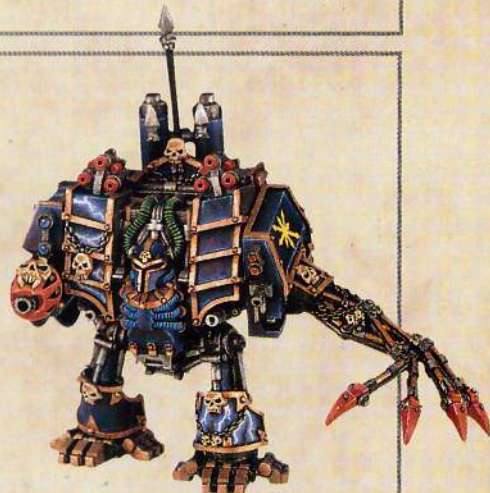

Chaos Dreadnought £25 boxed set

The Chaos Dreadnought is one of the most homicidal and dangerous foes to plague the Imperium.



Chaos Space Marine Battle Force £50

The Chaos Space Marine Battle Force contains:

- 10 Plastic Chaos Space Marines
- 12 Khorne Berserkers
- 4 Chaos Space Marine Bikes
- 1 Rhino
- 1 Chaos Spiky Bits frame
- 1 set of Gothic Ruins

Mail Order Exclusive: Chaos Space Marine Shoulder Pads

50p each

Mail Order has an extensive range of Chaos Space Marine shoulder pads. They are the perfect way to personalise your army, allowing you to create unique models. For more details on the entire range of shoulder pads available, give Mail Order a ring on 0115 91 40000.



Black Legion



Chaos Space Marine 3



Chaos Space Marine 4



Chaos Space Marine 5



Chaos Space Marine 6



Chaos Space Marine 7



Chaos Space Marine 8



Chaos Space Marine 9



Chaos Space Marine 10



Chaos Space Marine 11



Chaos Space Marine 12



Chaos Space Marine 13



Chaos Space Marine 14



Chaos Space Marine 15



Chaos Space Marine 16



Chaos Space Marine 17

ALL THE MODELS SHOWN ON THESE PAGES ARE AVAILABLE FROM YOUR LOCAL GAMES WORKSHOP STORE, INDEPENDENT STOCKIST, MAIL ORDER (0115 91 40000) OR AT www.games-workshop.com

Models not shown at actual size

BE PART OF

WARHAMMER

40,000

SCANDINAVIAN GRAND TOURNAMENT

27TH – 28TH APRIL 2002

REMISEN, TRIANGLEN IN COPENHAGEN, DENMARK

Tickets £30

On sale from 21st March. Tickets are strictly limited to competitors only. For further details phone Mail Order on 0044115 91 40000

Take part in the first ever Scandinavian Grand Tournament, in Copenhagen, Denmark. This tournament will feature the cream of Northern Europe's Warhammer 40,000 generals. Also featuring guest appearances from Warhammer 40,000 Overfiend Andy Chambers, and Games Development's Andy Hoare. Full details will follow with the registration pack, including hotel guides, and full army restrictions.

F HISTORY



**GAMES
WORKSHOP**

This month's battle report focuses on an epic confrontation between the Skaven and a vastly outnumbered Empire army.

VERMINTIDE!

Following last issue's release of the new Skaven army, it's only right and proper that they should take to the field of battle in their multitudinous hordes. The question was who would face off against them. There were many possibilities but we decided to tie this month's battle report to the 'Fall of Miragliano' story published in WD266. In the story a mercenary army is routed by the vile Skaven invaders. Miragliano is sacked and the remnants of the mercenary force is put to flight into the Blighted Marshes. So, with this in mind we decided to re-enact the last stand of the disgraced Elector Count Leopold von Stroheim as he flees with his rag-tag force through the Blighted Marshes pursued by a tide of fur, talon and tooth.

It was fitting that this shouldn't be a straight pitched battle. We wanted this to fit the background as closely as we could and to really set the scene. After some discussion we plumped for a Last Stand. This scenario pits hugely disproportionate armies against each other (the attackers have 4,000 points to the defenders 2,000...). The demise of the defending Empire troops is not in question – whether they can hold out long enough to inflict serious damage to the incoming Skaven horde is another matter however...

As with all White Dwarf battle reports the two players would play a practice game or two to become more familiar with their chosen force and so there were no nasty surprises from the opposing side. So, with the practice

game out of the way and a little fine-tuning by Alessio and Graham, the scene was set for a memorable battle report. We'd be fighting over the superbly dank and dismal new battlefield created by Dave Andrews and Mark Jones. This would not only be an evocative battle from a storyline point of view but it would really look the part too.

So, would Graham's beleaguered and heavily outnumbered Empire force die in vain, alone in the Blighted Marshes? Or could they salvage something from their inevitable annihilation by taking enough of the abominable rat-things with them as they sold their lives dearly?

Let battle commence!



It was fitting on his last day alive that rain would fall. Dawn spilled weak light over the Blighted Marshes and Leopold von Stroheim, former general of the Emperor Karl Franz, knew that his dreams of conquest were over. He no longer thought of himself as an Elector Count; he was now simply a sword for hire. Lord Ravenbrandt had seen to that when he had used his influence at court to have him recalled from the fledgling province of Neuland on Albion. Since then, his political star had plummeted. He was no longer welcome at the court of the Second House of Wilhelm, and his friends and allies had vanished like morning mist. Now the last act of his career would be played out in this godforsaken marshland in the rain.

He stopped to take a drink from his canteen, enjoying the fiery heat of the Tilcan brandy as it burned a path down his gullet. It was early to be drinking, but having heard the reports

of his scouts, he knew that it would only go to waste if he did not drink it now. The remnants of the men he had pulled from Prince Lorenzo's army after the disaster at Miragliano huddled, shivering around sputtering fires, casting nervous glances towards the horizon. Less than a hundred had survived the battles following the city's fall and they had been harried by the ratmen ever since, finally ending up in this bleak moorland on the edge of the Blighted Marshes. The warrior priests passed among the men, offering prayers and hearing confessions. Even they knew that this day was lost.

A shout was raised from his pickets and he stoppered his canteen, running for his armoured steed. Leopold clambered into the saddle and galloped towards his personal retinue of Knights of the White Wolf. His steed's ears were pressed flat against its skull in fear, and he could well understand its alarm. Until recently

he had not even believed that these rat-creatures could exist; perhaps the late 'Mad Baron of Averland' had not been so mad after all. His throat was dry and he washed down another mouthful of brandy, passing the canteen to the knights as he watched the foe emerge from the noxious fog before them. Tattered banners fluttered above a sea of mange-ridden fur, stretching as far as the eye could see. By Sigmar, was there no end to their number? The stench of the creatures reached him even here and their monstrous, chittering cries sent a shiver down his spine as the dolorous peals of a doom-laden bell rang out. Leopold drew his sword and shouted, "Men of the Empire, today we face our death, but we are men of courage and though they may take our lives, they will never defeat us! Onward!"

Leopold von Stroheim raked back his spurs and led the last charge.



GOING DOWN FIGHTING!

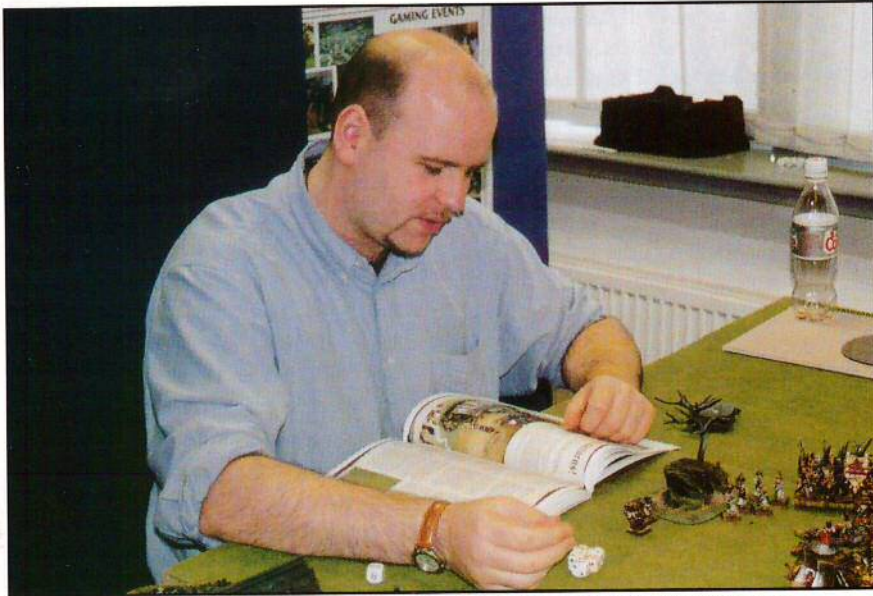

Graham refreshes his memory on the intricacies of the Steam Tank rules.

Graham: OK, let me get this right. My force is completely surrounded by a Skaven army twice the size of mine, there's no escape, and the game ends when all my men are dead... I think it's fair to say the situation is grim. This is perhaps the only game of Warhammer I'll play where I know for a fact that every single one of my men is going to die. Well, this week anyway.

My initial thoughts were to pick a shooty army and try to blast the Skaven apart as they charged towards me, but after looking at the scenario more closely, I realised I'd have (at best) perhaps three turns of shooting. And knowing my luck with Artillery dice, I wasn't going to stop 4,000 points of Skaven with that. So that left me with only one option: take the fight to the enemy!

I knew that fighting the more numerous Skaven across an equal front was a recipe for disaster, so I devised my army and battle plan around fighting one part of it at a time. I began with taking a Conqueror pattern Steam Tank and two units of Knights. These units can really hit hard and I hoped that if they could cause enough damage, I could break one part of Alessio's line while holding off the rest with solid blocks of infantry that would die horribly as they acted as 'speed bumps' for the Skaven army. Since I knew that my infantry units were in all likelihood going to be charged, I picked two that could best receive a charge and still hold. A unit of Spearmen with the Griffon Standard would be able to soak up casualties in the

initial attack, and still be able to strike back, and a unit of Swordsmen, with their good armour save (and a detachment of Free Company) would hopefully survive long enough for me to re-orientate my cavalry units and flank the Skaven. A Warrior Priest would ride with one of my units of Knights to take full advantage of his Righteous Fury rule that imparts his hatred of all things Skaven, and allows them to re-roll any misses in the first round of close combat. Nasty! I placed my Elector Count with the White Wolves to bolster their Leadership and make sure they hit with enough force.

Two Mortars and a unit of Handgunners should help thin the Skaven ranks before my cavalry charges hit home. Against a horde army like the Skaven, Mortars are essential due to the fact that even if they miss their intended target, they'll probably still hit something belonging to the enemy. I had no doubt that the Knights would eventually be surrounded and cut down, but I hoped to cause enough damage with them and the Steam Tank to claw enough Victory Points to snatch a draw at least.

And you never know, if it actually works, I might even get a victory...

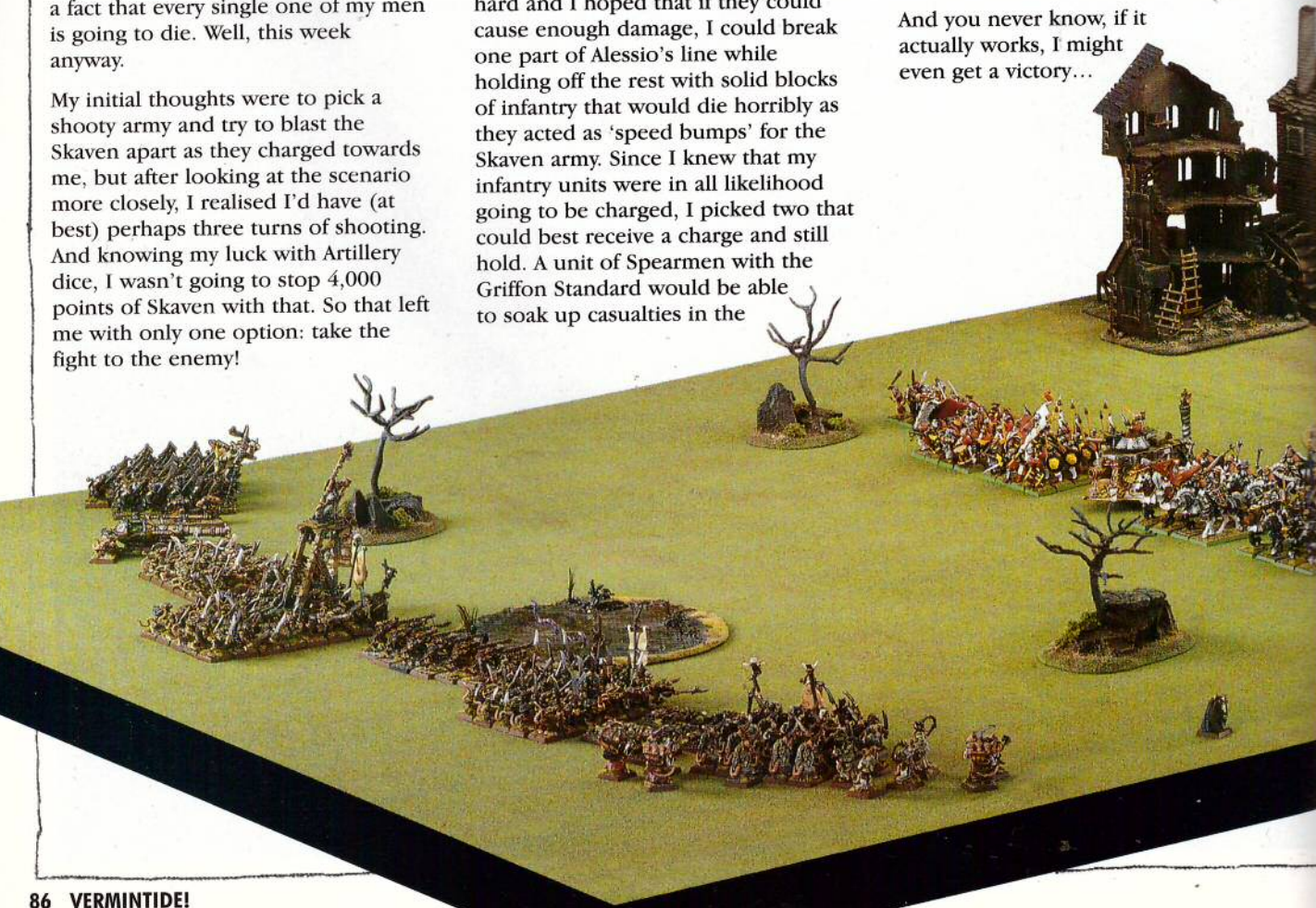

RATTACK!

Alessio: 4,000 points of Skaven? Wow!

To command so many ferocious ratmen is great, and since the scenario is a Last Stand, we'd be facing only a puny 2,000 points of Empire troops...

This time it would be as it should always be: an unstoppable avalanche of fur unleashed against a much outnumbered, desperate enemy.

The victory conditions are certainly interesting: to win you have to minimise casualties (how very un-Skaven!). If you suffer more than 2,000 points of casualties, the enemy wins. If you suffer less than 1,000 points of casualties, you win. Any other difference is a draw. I had to admit that it seemed quite likely that the game would end in a draw, but a lot depended on what kind of force the Empire came up with.

To start with I picked pretty much everything in the Studio army. I could have picked more than one Grey Seer, but that would have made for a quite boring game, where my army could have simply sat back and blasted away at my opponent with magic.

The prospect of using this tactic, although safer, was not very appealing to my bloodthirsty taste:

I wanted to get stuck in and bury them under a horde of claws and rusty blades!

Even with the massive Studio army, to reach 4,000 points I had to equip my characters with loads of powerful magic items (everybody knows that I would never do anything like this unless forced to... would I?). I picked many of the amusing deranged tools of destruction available to the evil Skaven and finally I couldn't resist to the temptation: I had to equip Warlord Quickpaw with a Fellblade!

I can just imagine Grey Seer Squelch giving the cursed blade to his rival for the command of the army: "Here, use this, make you invincible it will! Yes-

yes!" What a perfect plan: the Warlord was going to die for sure and quite likely he would take some enemies with him as well. This way the triumph would be Grey Seer Squelch's alone and he would shine brightly in the eyes of his masters!

The rest of The Plan™ was easy. I would have the advantage of seeing where the enemy deployed, so I'd be able to spread my forces into two detachments of appropriate size and strength. Then we'd jump on them from all sides and crush them utterly, devour their flesh and break open their bones to suck the marrow out!

Perfect-perfect!

DEPLOYMENT (FROM A SKAVEN POINT OF VIEW)

Seeing where the enemy troops were going was great! It allowed me to deploy my troops in the perfect starting positions. Graham had chosen to concentrate the attack on one half of the table: the plains where his knights could move best. He also left a unit of Handgunners behind, to slow down my advance in the marshes. Okay man-thing, I'll make sure that your attack on the plains is met with overwhelming force and I'll leave just a couple of fast units in the marshes! On the left of what was now to be my main battle line, all my armour-ignoring nastiness (Globadiers and Censer Bearers) were arrayed in front of the Empire Knights, together with the Rat Swarm that is perfect for stopping these hard-hitting units in their tracks. On my left the Stormvermin, Slaves and the Clanrat unit including the Screaming Bell were facing the enemy infantry. My fastest ranked-up units (Clan Moulder) were to advance at the back of the enemy on the good ground around the swamp. The Night Runners would use their skirmishing ability to easily negotiate the insidious marshy terrain and charge the Handgunners across the stream. It's good to have Movement 6, always being able to march and ignoring movement penalties for terrain! The two Assassins infiltrated the enemy lines, and the Tunnel Team started burrowing towards the Mortars.

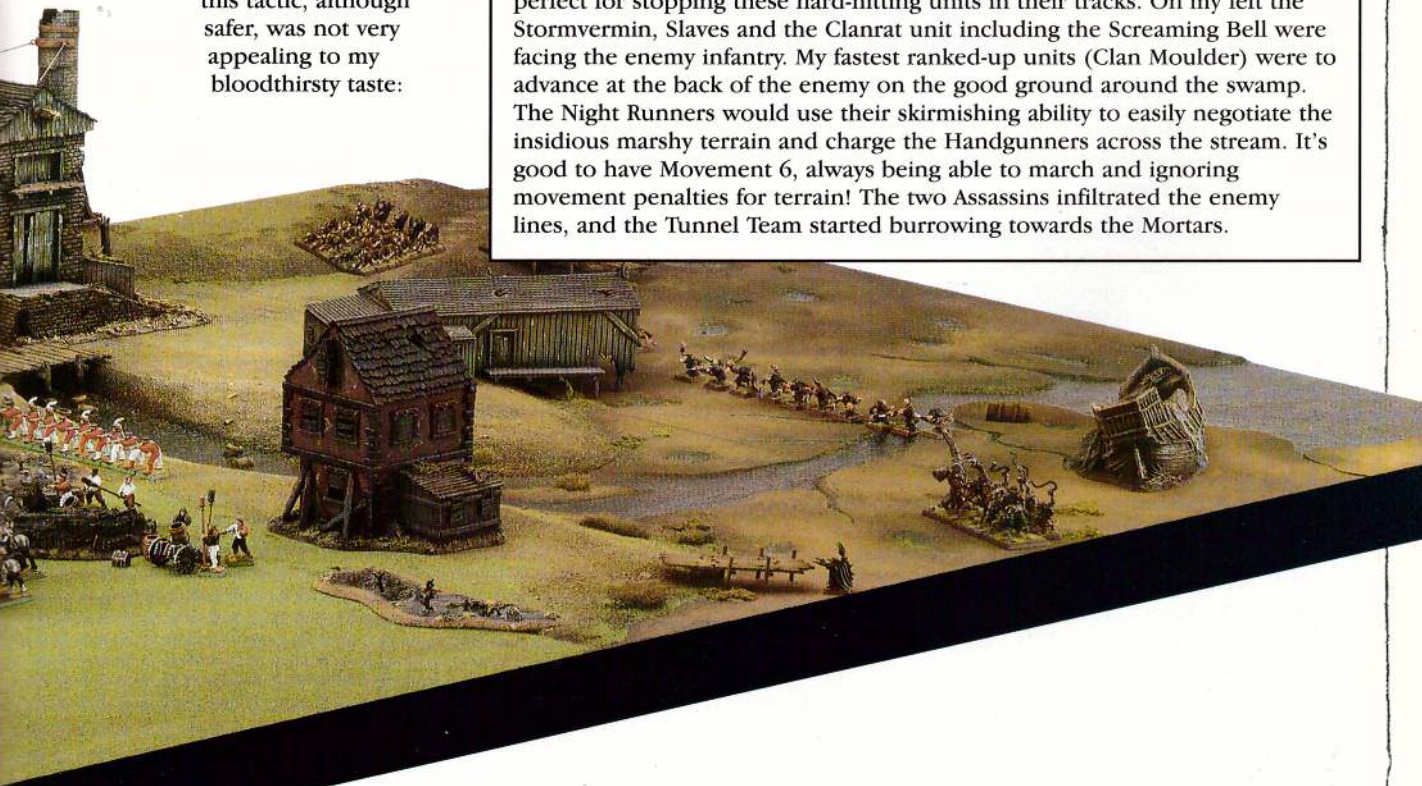



STROHEIM'S LAST STAND

CHARACTERS

LORD: Elector Count Leopold von Stroheim, hand weapon, shield, barded warhorse, Dawn Armour, Sword of Justice. **169 pts**
*Leads the Knights of the White Wolf.

HERO: Warrior Priest Robertus Krieger, heavy armour, two warhammers, barded warhorse. **117 pts**
*Assigned to the Knights Panther.

HERO: Warrior Priest Raynard Manzarek, heavy armour, great hammer. **103 pts**
*Assigned to the Spearman regiment.

HERO: Battle Wizard Adolphus von Stroheim, hand weapon, two Dispel Scrolls. **110 pts**
*Assigned to the Swordsmen regiment.

CORE

 **20 Swordsmen**, light armour, shields, swords, Standard Bearer, Duellist, Musician. **165 pts**

 **Detachment - 10 Free Company Fighters**, two hand weapons. **50 pts**

 **20 Spearmen**, light armour, spears, hand weapons, Standard Bearer, Sergeant, Musician, Griffon Standard. **195 pts**

 **10 Handgunners**, hand weapons, handguns, Marksman, brace of pistols. **89 pts**

 **8 Knights of the White Wolf**, Inner Circle, full plate armour, cavalry hammers, Standard Bearer, First Knight, Musician. **264 pts**

 **8 Knights Panther**, Inner Circle, full plate armour, shields, lances, hand weapons, Standard Bearer, First Knight, Musician, Standard of Arcane Warding. **288 pts**

SPECIAL

 **Mortar**, 3 crew, hand weapons. **75 pts**

 **Mortar**, 3 crew, hand weapons. **75 pts**

RARE

 **Conqueror Steam Tank**, main cannon, steam gun, tank commander with repeater pistol. **300 pts**

TOTAL

2,000 pts

CLAN QUICKPAW

CHARACTERS

LORD: Grey Seer Squelch, hand weapon, Screaming Bell, *Dispel Scroll*, two *Warpstone Tokens*, *Warpstone Charm*, *Warpstone Amulet*. **530 pts**
*Takes refuge in the Clanrat regiment.

LORD: Warlord Quickpaw, heavy armour, shield, *Fellblade*, *Talisman of Protection*. **199 pts**
*Leads the Clanrat regiment.

HERO: Chieftain Twitch, heavy armour, battle standard, *Sacred Standard of the Horned Rat*. **149 pts**
*Leads the Stormvermin regiment.

HERO: Assassin Skritch, two hand weapons, throwing stars, smoke bombs, *Cloak of Shadows*. **175 pts**

HERO: Assassin Stretch, two hand weapons, throwing stars, smoke bombs, *Brass Orb*. **175 pts**

HERO: Plague Priest Stinch, hand weapon, plague censer, *Liber Bubonicus*, *Warpstone Charm*. **136 pts**
*Leads the Plague Monk regiment.

HERO: Warlock Engineer Ritch, hand weapon, warlock pistol, warp-blades, upgraded warp-energy condenser, supercharged warp-power accumulator, *Storm Daemon*, *Dispel Scroll*. **145 pts**
*Leads the spear-armed Clanrat regiment.

HERO: Master Moulder Writch, light armour, whip, *Skavenbrew*. **123 pts**
*Leads the Rat Ogres

CORE

30 Clanrats, light armour, shield, hand weapons, Standard Bearer, Clawleader, Musician, Warpfire thrower team. **250 pts**

29 Clanrats, light armour, shields, hand weapons, spears, Standard Bearer, Clawleader, Musician, Ratling gun team. **259 pts**

25 Stormvermin, heavy armour, halberd, hand weapons, Standard Bearer, Clawleader, Musician, Ratling gun team, *Umbranner*. **320 pts**

2 Poisoned Wind Globadiers, hand weapons, poisoned wind globes. **20 pts**

3 Poisoned Wind Globadiers, hand weapons, poisoned wind globes. **30 pts**

5 Plague Rat swarms. **325pts**

10 Night Runners, hand weapons, Nightleader. **60 pts**

10 Night Runners, hand weapons, Nightleader. **60 pts**

4 Giant Rat Packs, Packmasters have light armour, hand weapons, whips. **120 pts**

22 Clanrat Slaves, hand weapons, Pawleader, Musician. **54 pts**

SPECIAL

9 Gutter Runners, tunnelling team, two poisoned hand weapons, Black Skaven. **165 pts**

6 Warplock Jezzails, hand weapon, jezzail, pavise. **120 pts**

25 Plague Monks, two hand weapons, Standard Bearer, Deacon, Musician, *Banner of Burning Hatred*. **250 pts**

3 Rat Ogre Packs, Packmasters have light armour, hand weapons, whips. **150 pts**

RARE

5 Plague Censer Bearers, Plague Censer. **85 pts**
Warp-lightning Cannon. **100 pts**

TOTAL **4,000 pts**



EMPIRE TURN 1

Graham: I began this Last Stand by ordering the majority of my regiments to advance towards the Skaven lines and be ready to receive the charge of the ratmen. The Steam Tank built up a full five Steam Points and rumbled forwards, angling its cannon towards the Screaming Bell. With a bit of luck, I could knock it out before its deadly peals rang out and nobbled my war machines. The Knights Panther angled their advance away from the flank and the Rat Swarm. I hoped that with some accurate mortar fire, I could cause enough casualties amongst the Clanrats ahead of the Knights Panther to panic them and keep the Knights' flank safe, leaving them free to charge the Screaming Bell unit. The Knights of the White Wolf, having been mauled in the practice game by Ratling Gun fire and magic, decided to redeploy onto the other flank, turning and moving behind the main body of the army as fast as they could. I just hoped they would manage to get into position quickly enough. The Handgunners about faced to train their guns upon the Night Runners, that were sure to be coming at the rear of my army across the marsh.

My Magic phase was pretty disastrous, with both my Warrior Priests' prayers and my Battle Wizard's spells being

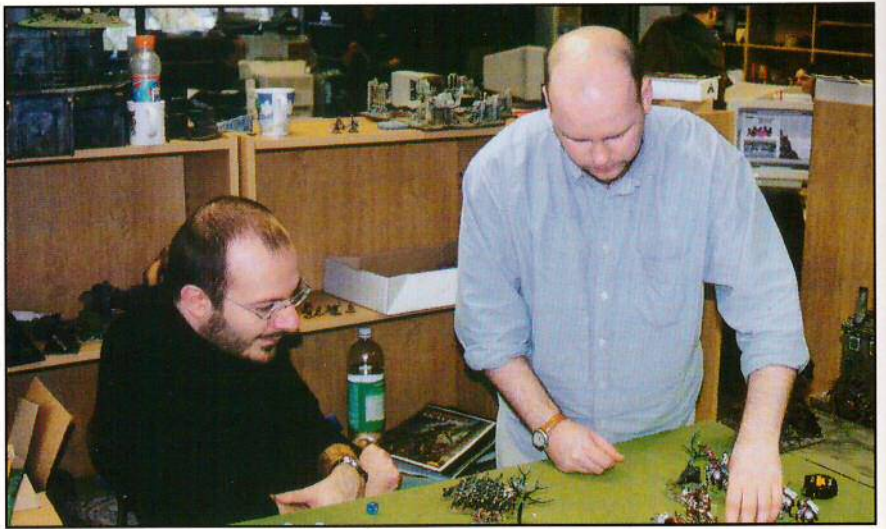

Graham tries to manoeuvre his army out of the Skaven trap.

dispelled. I wasn't that surprised by this, as I knew from the outset I'd be outclassed in the magic department. I'd figured the best I could manage against Skaven magic would be a half-hearted defence, so I chose to spend the points that I'd save on Wizards on something more useful instead – like a Steam Tank! When it came to the Shooting phase, I decided to target the units most threatening to my Knights, but fared little better, with the first shell landing just short of the Censer Bearers and failing to do any damage. The other shell was aimed at the Clanrats, but was slightly off target

and landed on the Jezzails and the Clanrats' Ratling Gun, killing the weapons team and two of the Jezzails. Not quite what I'd intended, but pretty satisfying anyway. The Steam Tank fired at the Screaming Bell, the ball landing nicely before the unit of Clanrats that was pushing it. I gleefully rolled the dice for the cannonball's bounce, then turned the air blue as the dice came up with a Misfire and the ball buried itself in the mud. With that, my turn was over and I waited to see what hideous nastiness Alessio would unleash on my army.

The Skaven army moves in for the kill!



SKAVEN TURN 1

Alessio: Ah! Shooting at Grey Seer Squelch, are you? I'll have to teach you a couple of things about firepower, man-thing, especially of the magical kind! My troops at the back of the Empire line advanced as quickly as possible, while the main line inched forward, with my Rat Swarm redeploying to follow the move of the Empire general's main unit of Knights. The Plague Monks, foaming at the mouth, had to move as fast as possible towards the other units of Knights, forced by their magical Banner of Burning Hatred. Pwah! Let the puny man-things charge the chosen of Clan Pestilens! I then moved the Censer Bearers in support, just in case...

In the Magic phase I started with the Warlock Engineer zapping the Tank. First his Storm Daemon caused one point of damage on the machine and then the Clan Skryre Skaven cast a 9+ Warp-lightning (for 2D6 Strength 5 hits!) and rolled a treble 1!

Fair enough, now the Grey Seer would show him how it's done! He cast the same spell and embarrassingly rolled too low for the spell to go off. In frustration he followed up with a Skitterleap on two dice – double one! I started to have a bad feeling about this and cast Plague at the Spearman –

another miscast! I was lucky (well, sort of...) that the results on the Miscast chart were not too bad. Surely the Shooting phase would be better! I rang the Bell with three dice and got the result that forces a Panic test for all enemy cavalry. Cool! Except that in this scenario the entire enemy army is immune to panic... The Bell also rolled a double, killing one Clanrat and wounding the Grey Seer, though this was saved by his Warpstone Amulet.

The Jezzails fired at the Steam Tank and their hits just bounced off its thick armour plating. Was anything going to work? I was getting more and more desperate when finally my luck turned. The Warlock Engineer operating the Warp-lightning Cannon aimed at the Steam Tank and lowered the lever. The

result was an impressive Strength 10 beam of light that streaked through the battlefield for 30", vapourising a Spearman and punching a big hole into the Empire's armoured pride. Eleven points of damage – things were starting to look better!

In the Shooting phase you can choose to ring the Screaming Bell with one, two or three dice. The more dice, the more powerful the effects of the Bell's sound and, of course, the same goes for its side effects! If you roll a double, both the unit pushing the Bell and the Grey Seer may suffer some damage, roll a treble however and you are in real trouble!



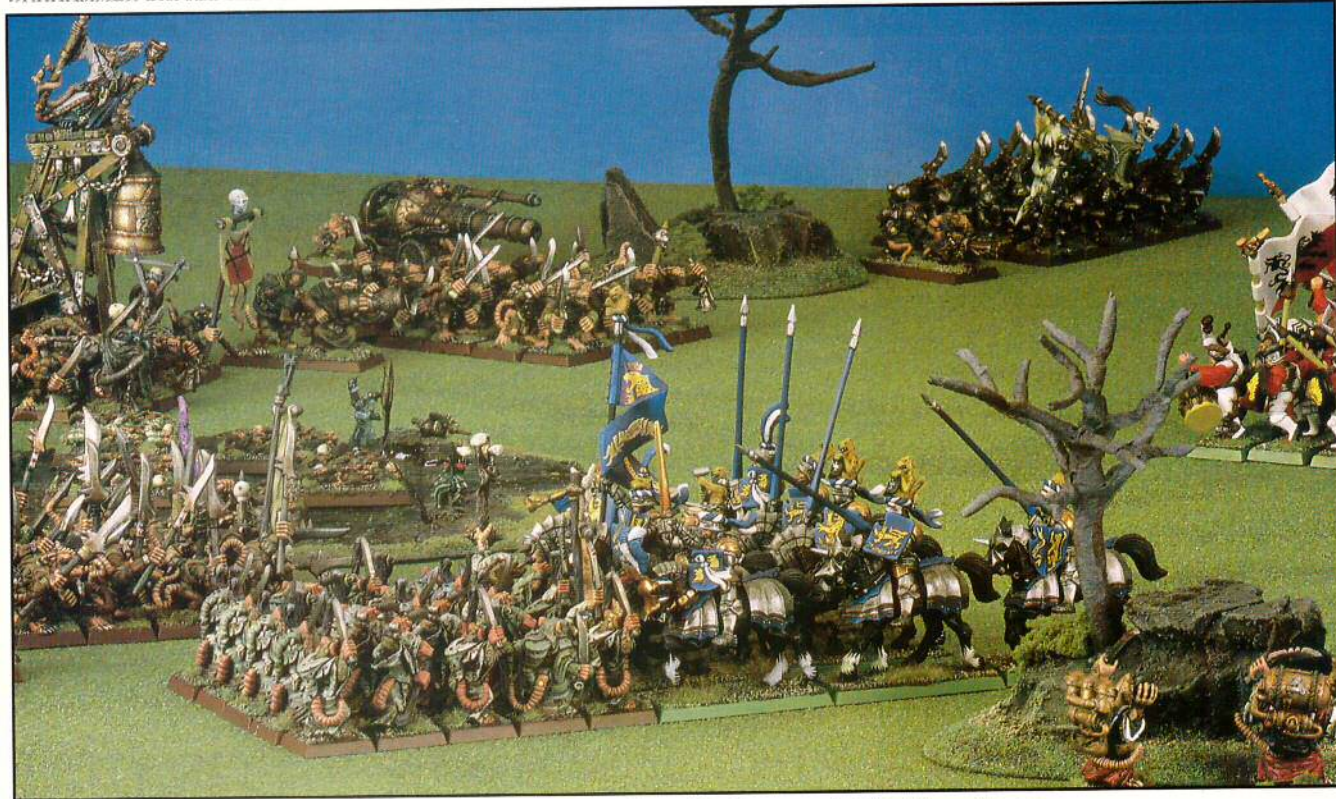

The Knights Panthers' desperate charge hits home against the Plague Monks.

EMPIRE TURN 2

Graham: Sigmar protect us! If ever I needed a demonstration of how horrendous Skaven weapons can be, that was it. Eleven points of structure gone from my Steam Tank, just like that... oh, and a Spearman dead. As Alessio's turn had progressed, I felt the faint flutterings of hope as his Magic phase sputtered and failed to achieve much. I was beginning to feel vindicated in my decision to eschew my magical defences. But then the Warp-lightning Cannon opened fire and everything suddenly looked a whole lot grimmer. Oh, well, it's not like I wasn't expecting this.

With the Assassin loitering suspiciously close to my Steam Tank I had the nasty feeling that he was carrying some wicked Skaven magic item that would turn it to junk. So with only 13 Hull Points left, I risked building 3 Steam Points and breathed a sigh of relief when I got them and was able to turn the tank to face the Assassin and ready its cannon. My infantry units wheeled to face the Slaves and Stormvermin. I hoped the Spearman could hold on their own with the Griffon Standard and that, with the help of their Free Company detachment, so too would the Swordsmen. The Knights Panther

were faced with a tricky choice of which enemy to charge since my plan of getting the Clanrats to panic had failed dismally. If I didn't break whichever unit I attacked, I'd be charged in the flank by the other one, so had to look at which one would hurt the most. A frontal charge against spears is never an appealing prospect, so I decided to charge the Plague Monks, hoping to break them quickly, but knowing that if I didn't, the Spearman would only be attacking with one rank of warriors when they charged. The Clanrats and Monks only have a Strength of 3, so I was pretty sure that my Knights' Armour save was up to the task.

This Magic phase was as ineffectual as the previous one, but I hoped to do some real damage to the Clanrats this turn with my Mortars. Unfortunately, one fired a dud shell, the other scattering to land on the Jezzails once again, killing another of them. It looked as though the Clanrats were living a charmed life as far as my Mortars were concerned. The Assassin in front of the Steam Tank was so close that I had to be very careful not to overshoot with my initial ranging guess for the hull cannon, so I declared 0" and rolled the dice. The

cannonball landed obligingly close to the Assassin, but as I rolled a 2 for the bounce, it rolled harmlessly along the ground, just failing to reach him. The Steam Tank was now officially 'In Trouble'. The Handgunners only managed to kill a single Night Runner and they were getting disturbingly close. At best, I'd get one more shot off at them before they were on top of my Handgunners.

In the all-important close combat between the Knights Panther and the Plague Monks, the Knights managed to kill four of the Plague Monks, but the maddened Plague Priest wreaked havoc in their ranks, slaughtering them where they stood. Some poor armour save rolls followed, which meant that they lost the combat by one. Promptly failing their Break test, the Knights decided that discretion was the better part of valour and fled the fight, the Plague Monks hot on their heels. This was a disaster for the Empire and left a gaping hole in my flank that Alessio was sure to exploit. At this point I wasn't sure how I could plug the gap. My only hope was that the Knights would be able to rally in time to come back to the fight. At least they were heading in the direction of the Elector Count and his high Leadership.

SKAVEN TURN 2

Alessio: As I rolled the Scatter dice and Artillery dice to see where my Tunnel Team would surface, I accidentally called the Artillery dice "the Misfire dice". Alas! As you all well know, that's the meanest, most touchy dice on the face of the planet and I promptly rolled a Misfire followed by a 1. The tunnel caved in, killing my expensive Tunnel Team!

My deranged Plague Monks followed their glorious, deranged leader in a charge against the fleeing Knights who fled again out of range, closely imitated by the Spearmen unit against which I had redirected my charge. The Monks failed their charge, but half the Empire army was now fleeing before them. Must be the smell! One Assassin charged a Mortar and the other moved in position half a foot from the damaged Steam Tank, readying his deadly Brass Orb with a wicked smile. The rest of the army advanced closer to the Empire line. Next turn we'll be upon them, I thought.

The Magic phase got slightly better, with Graham having to use up a Dispel Scroll, but unfortunately my Grey Seer also took a wound from a warpstone piece...

Skaven wizards can get extra dice to cast their spells by consuming pieces of warpstone. But be careful, power has its price!

Then the Bell rang again, and this time the vibrations caused several wounds on both Mortars and, more importantly, a hefty 6 points of damage on the Tank! The colossus was going down (I was really scared of the Tank since in the practice game it destroyed half my army). The rest of the Shooting phase was a farce. First the Warp-lightning Cannon fired a mighty Strength 2 bolt that fried two Slaves and did nothing to the Tank, then the Warfire thrower killed five Swordsmen and one Slave. The Slaves decided that they'd had enough of this 'friendly fire' and legged it. Then the Ratling Gun opened up. I rolled a 4, decided to continue firing, rolled another 4 (no, not a double so soon!) and the misfire resulted in the gun firing all eight shots in a random direction. Guess where? Directly into the Stormvermin, killing four!

The Jezzails damaged the Tank some more and finally the Assassin lobbed

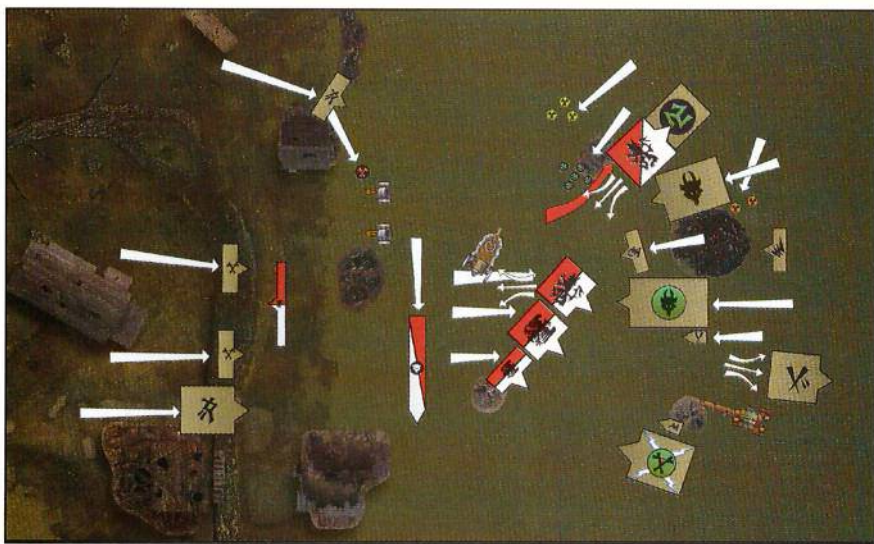

When firing a Ratling Gun the player rolls a D6, inflicting that many Strength 4 armour piercing bits on the target. Then he can choose to stop or roll another dice and add the result to the total of bits caused. Unfortunately, if you roll a double, the machine misfires!

his powerful Brass Orb at it. He watched in anticipation as the grenade described a slow arc in the air. The Assassins expression turned from one of wicked anticipation to one of cold dread when the deadly magic weapon bounced off the armoured hull and rolled right back to his feet, emitting a low-pitched buzz. I had rolled a scatter back and a perfect 6" right towards the Assassin... the template of

the blast touched his base and Graham promptly rolled the 4+ needed to hit him. With a confident smile the Assassin prepared to jump elegantly aside. After all he just needed to pass a test on his impressive Initiative value of 8 not to be sucked into the Realm of Chaos.

"Anything but a 6!" I said, while rolling the dice. Guess what I rolled?

That was the most amusing episode of my gaming career, especially because the same had happened during the practice game, when the Assassin rolled a Misfire followed by a 6...

Half an hour later, when we finally recovered from the hilarity, my second Assassin duly proceeded to cut down two of the Mortar crew, ending the turn.



The Skaven Assassin's attempt to destroy the Steam Tank goes horribly wrong.

EMPIRE TURN 3

Graham: Well, Alessio's turn swung wildly from hideously effective to utterly hilarious as the Assassin with the Brass Orb managed to kill himself and the Tunnel Team suffered a cave-in. My lines were now in utter disarray with a unit of Plague Monks rampaging in my rear and my Spearmen having fled from their charge. My Knights Panther had managed to flee all the way to the Elector Count and all I needed to roll was equal to or less than 10 to rally them. Of course this was the time I decided to roll a double 6 and off they went again, fleeing around the Knights of the White Wolf towards the marsh. However, I managed to rally the Spearmen, who reformed to face the incoming Plague Monks. Undaunted by their brother knights' abject cowardice, I turned the White Wolves and advanced them towards the enemy, threatening the flank of the Stormvermin unit, while the Free Company moved forward to protect the Swordsmen unit from being charged in the flank. I angled the Free Company's movement in such a way that if the Stormvermin charged them, their Pursuit move (I had no illusions about the Free Company's chances of holding against Stormvermin) would



carry them away from the Swordsmen. The Night Runners were right on top of the Handgunners and, given that there was a better chance of taking them down with close combat than shooting, I charged the Handgunners into the river to try to club the furry little blighters to death.

A combination of magic, Jezzails and the Screaming Bell had reduced my Steam Tank to a mere 3 Hull Points and I had no choice but to go for a death or glory attempt at generating Steam Points. I rolled the full five dice for Steam Points, hoping that I would be lucky when it came to rolling on the Malfunction chart. If Sigmar smiled upon me and I rolled a 6, then not only would I generate all my Steam Points, but I would in fact generate another one. Unfortunately that wasn't to be the case as I rolled a 1, the worst possible result on the Malfunction chart, which blew the boiler to kingdom come and broke the Steam Tank into a pile of steaming metal.

My Wizard and Warrior Priests were having no luck at all with their prayers and spells as once again the Grey Seer easily dispelled them. In close combat, the Skaven Assassin finally dispatched the last artilleryman from one of my Mortars but my brave Handgunners killed enough of the Night Runners to break them. The ratmen fled, but not quickly enough as the Handgunners pursued and clubbed them down. It was a small victory, but a victory nonetheless. As the Skaven readied themselves for the charge, it looked as though the final moments of the last stand were upon the men of the Empire.



Empire Handgunners bravely fight the Night Runners in hand-to-hand combat.



SKAVEN TURN 3

Alessio: "Charge-Charge!" The Giant Rats charged the fleeing Knights who fled some more. The Stormvermin charged the Free Company who also fled. More Night Runners charged the Handgunners' rear and they too fled. The Skavenbrew-frenzied Rat Ogres and the Assassin charged the remaining mortar crew, who fled. OK, was anybody going to stay and fight? Well, at least the Swordsmen took the Rat Swarm's charge and the Spearmen held their ground against the Plague Monks. With most of my army failing charges, the remainder moved in for the kill.

We went through what seemed another pretty uneventful Magic phase, and Graham's defences held at the price of his second and last Dispel Scroll, but then my final warpstone-powered Plague hit the White Wolves. Graham proceeded to fail all his Toughness tests but one, leaving him with a Standard Bearer and a wounded Elector Count where a knightly unit was standing a few seconds before. Way to go! Finally the Horned Rat had turned his benevolent gaze upon me! To add insult to injury, the Plague extended to the Free Company as well, killing four out of ten (proving that they're much tougher than the Knights, of course!).

The Shooting phase was quite good as well, with the Jezzails and the Globadiers maliciously concentrating their fire on the fleeing Knights Panther and killing all but one!

The Warp-lightning Cannon took careful aim at the wounded Empire general and with a Strength 8 bolt blasted him away (oh yeah, together with three Stormvermin...).

In the Close Combat phase, the frenzied, hate-filled Plague Priest had an interesting theological debate with

the Warrior Priest, which ended in the Plague Priest mashing him into a pulp. The Spearmen lost the fight but held their ground thanks to their Griffon Standard. They started looking nervously at the unit of Censer Bearers rushing towards their exposed flank...

The turn ended with Warlord Quickpaw suffering a wound from his Fellblade that he still hadn't had a chance to use. An evil grin appeared on the Grey Seer's snout.

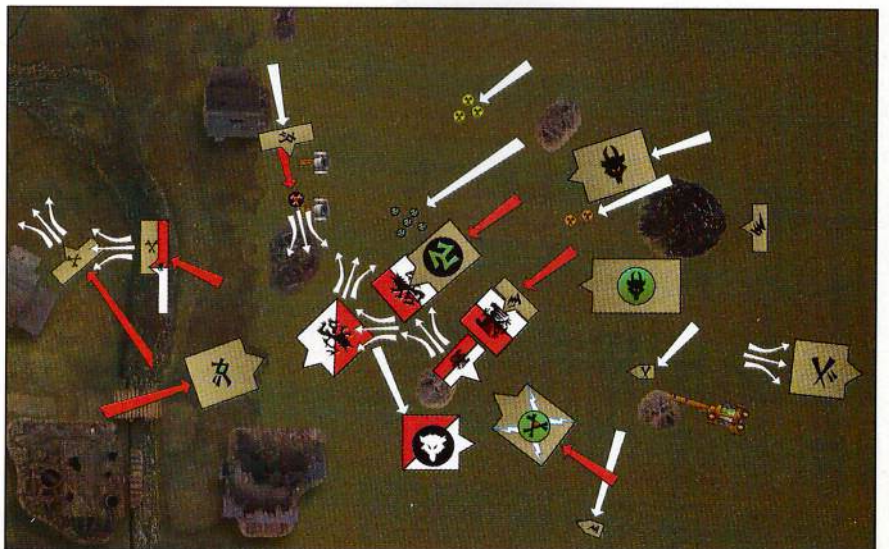



The Handgunners are eventually butchered by the second unit of Night Runners.

EMPIRE TURN 4

Graham: Could that turn have been any more devastating to the Empire army? Seven Knights dead to a single spell and my Elector Count blasted from the saddle by the Warp-lightning Cannon. While there might have been a chance of inflicting some damage on the Skaven-flank, that last turn put the final nail in the coffin of the Empire army. The Handgunners managed to rally and face the

Night Runners, leaving me with the hope that they could do enough damage in their Stand & Shoot charge reaction to blunt the Skaven attack that was sure to come. The Knights Panther were too few to rally and fled towards the table edge, as did the Free Company. My fleeing Mortar crew conveniently rallied with enemies all around them and no way of getting back to their war machine. Oops!

The Swordsmen were being swamped by Rat Swarms but managed to kill a single base, winning the combat. However due to the Swarm being unbreakable, they could do nothing to capitalise on their victory. Meanwhile the Spearmen were locked in a vicious fight to the death with the frenzied Plague Monks.

The front rank were cut down and it was only thanks to the magic of the Griffon Standard that they achieved a draw. The

last of the White Wolves, determined to avenge his brothers (and maybe earn some much needed Victory points), charged the Stormvermin and attacked the Skaven Battle Standard Bearer. Unfortunately, neither he nor his warhorse could fight their way out of a wet paper bag and failed to even hit their foe! The Knight's armour protected him from the return attacks, but it was in vain as he was forced to flee before the Stormvermin and, despite fleeing 12", was caught and killed when Alessio managed to roll a double 6 for his pursuit distance. Damn, these Skaven are quick!

SKAVEN TURN 4

Alessio: This was going to be the last turn, and the Censer Bearers slammed into the Spearmen's flank. The Night Runners assaulted the Handgunners in the swamp, the Giant Rats reached and devoured the fleeing mortar crew and Warlord Quickpaw left his unit and charged into the Swordsmen, eager to use his mighty sword.

Unseen, in a far corner of the field, the Clanrat Slaves unit kept running and abandoned the fight. Very appropriate.

The winds of magic ebbed once again, frustrating the attempts of the Grey Seer to 'help' the General by casting bolts of warp-lightning into the fight where his rival was engaged. The Warlock Engineer fared better and he wiped out the fleeing Free Company.

In the Shooting phase nothing much happened, except for Grey Seer Squelch ordering the near by Ratling Gun to 'help' the General (he was proving annoyingly resistant to the side-effects of the Fellblade for the Grey Seer's taste...) by shooting into the fight.

The machine performed very well this time, killing five Swordsmen and inflicting two wounds on the Rat Swarm and one on the Warlord! The plan was working, thought the Grey Seer at this point, the Warlord was almost gone. He only needed one of the man-things, or the Fellblade, to finish him off.

The combats were very successful, in fact too successful for the Grey Seer, those humans were too weak when he needed them to be strong! Warlord Quickpaw's lethal magic sword cut three Swordsmen in half and the rest turned tail and fled, only to be caught and eaten alive by the Rat Swarm. The Censer Bearers and Plague Priest made short work of the Spearmen and even the Night Runners broke the Handgunners and killed them all in the foetid swamp.

With the only model left in Graham's army being a wounded, fleeing Warrior Priest surrounded by Globadiers and locked in the sights of the Jezzails, the

game was over. We counted the points and despite it being close it was a Skaven victory! Glorious!

But then, as we started to pack up our armies, I suddenly remembered one minor detail: my Grey Seer was equipped with a Warpstone Amulet. This very useful item provides the wearer with a 4+ Ward save for a mere 25 points, but it might also have unpleasant side-effects. If the wearer rolls a 1 at the end of the game, he turns into a hideous blob of flesh and counts as slain. With a nonchalant laugh I said, "anything but a 1!" and rolled...

The game ended in a draw.



Perched on top of his mighty Screaming Bell, symbol of the power of the Horned Rat, Grey Seer Squelch was contemplating the complete destruction of the man-things army. The enemy had been utterly crushed. Squelch had only let the wounded priest of the hammer-god flee so that the terror of the Skaven would spread further among the man-things. What a brilliant victory! There was only one little flaw to ruin the total accomplishment of Squelch's master plan: Warlord Quickpaw was still alive.

Squelch tried to find his rival, scanning the mass of fur that was the victorious Skaven army. The rat-men were frantically busy, looting and devouring the fallen and wounded warriors, both enemy and kin.

And there he was. The large Warlord was slowly making his way towards the Grey Seer at the head of his Stormvermin bodyguard. He was visibly suffering from his wounds, his right arm swollen with blisters caused by the deadly Fellblade and his side bleeding where the bullets of the Ratling Gun had riddled his armour. Knowing himself to be more or less the direct source of those wounds, and seeing

the murderous light in Quickpaw's eyes, the Grey Seer felt a shiver run down his spine. Surely the Warlord had no proof to accuse him with? At a sign from the Warlord, Squelch climbed down from the Bell, into the middle of the Stormvermin that were now surrounding it.

"Greetings-greetings, Warlord Quickpaw. A most great victory, yes-yes?" began the Grey Seer in his most unctuous tone, his tail beating the ground nervously behind him.

"Thank you, Grey Seer Squelch. Thank you for the 'covering fire'. You ordered the Ratling Gun to shoot-shoot. They told me," grinned the Warlord, pointing at the dry blood staining the many holes in his armour. He continued, this time showing the blackening sores on his sword arm.

"Thanks-thanks for the powerful sword. I give it back to you. You keep it. You carry it back to Skavenblight. Too powerful for me. No problem for a mighty wizard like you. Yes-yes?"

A flash of horror crossed Grey Seer Squelch's eyes at the idea of touching the foul blade.

"Many thanks, Warlord Quickpaw. My slaves carry it for me. Too heavy for me," he tried.

"No, you carry it!" snarled Quickpaw, tossing the blade into the Grey Seer's arms.

The musk of fear filled the air as the terrified Seer caught the weapon. No sooner had his claws closed on the scabbard when an arc of powerful green energy flared, linking the sword's hilt with the amulet hanging on the Grey Seer's neck. The vast quantity of warpstone magic bound within the two artefacts was obviously too much to contain, even for a Grey Seer. Within a few seconds of screaming agony, Grey Seer Squelch had mutated into a horrible blob of flesh and grey fur.

As the Stormvermin hacked the monstrosity to pieces, Warlord Quickpaw turned his gaze on the smirking Warlock Engineer behind him. The two exchanged a brief look of understanding and then the Warlord walked away.

"Yes-yes, too heavy for you, Grey Seer Squelch."

IT'S A MAN'S LIFE IN THE SPEARMEN REGIMENT

Graham: Ouch! My army has been completely destroyed! Oh wait, that's what's supposed to happen in a Last Stand. Well, as things turned out, the brave warriors of the Empire managed to sell their lives dearly and kill enough of the Skaven to count this battle as a draw... but only just. Had it not been for Alessio's Grey Seer rolling a 1 for his Warpstone Amulet at the end of the game, it would have been more of a horrible massacre than it already was. In the end, it was the inherent Skaven randomness more than anything else that helped me limp towards the draw and make this one of the most exciting and amusing games of Warhammer I've played in a long time.

As any general will tell you, no plan survives contact with the enemy, and mine pretty much collapsed almost as soon as Alessio had deployed. Facing my mighty breakout force were

unbreakable Plague Rats that would stop my Knights as surely as if they had hit a brick wall and Clan Skryre Globadiers that could ignore the hefty 1+ Armour save of my Knights. Initially, things went reasonably well, with some of the more lethal units of Alessio's getting creamed by Mortar fire and everyone moving into position. But as soon as the Skaven Magic and Shooting phases began, things suddenly looked a lot dicier. The Warp-lightning Cannon blowing off 11 Hull Points from the Steam Tank with one shot really put a crimp in my plans. In the practice game we played beforehand, it ran amok in the Skaven ranks and did an impressive amount of damage (before the Warlord turned it into scrap metal with his Fellblade). After that there was little it could do except trundle about and take the odd, ineffectual cannon shot; one shot burying itself in the mud before the Screaming Bell

and another rolling to a gentle halt at the Assassin's feet.

My cavalry performed less than brilliantly; the Knights Panther running after losing the fight with the Plague Monks (then failing to rally while standing right next to the Elector Count) and seven of my White Wolves falling to a Plague spell. I must start feeding the Knights more vitamins in future. Having my Elector Count shot out of his saddle right after this by the Warp-lightning Cannon didn't help much either. But supreme honour has to go to the Spearmen unit, which attracted a horrendous amount of magic and firepower while the Swordsmen escaped relatively unscathed (until they were butchered in the final moments of the game). After the game ended, we pictured a recruiting sergeant touring the taverns of the Empire to replenish the local levy with the words, "It's a man's life in the spearmen regiments..."

Next time, Cavatore!



THE FUNNIEST GAME IN MY LIFE

Alessio: Well, it has been great. I don't remember laughing so much in a game ever before. The Skaven are just like that. When everything works they're lethal, unstoppable, but with

so many random elements, something is going to go wrong at some point (OK, admittedly I had more funny disasters than I should have...). The important thing is to learn to live with

the little mishaps of Skaven life and be ready to exploit the occasions when things go your way.

I also loved the ending, which inspired me to write the story on the previous page.

It's sooo fitting with the Skaven internecine malevolence that, if the Grey Seer hadn't ordered the Ratling to fire into combat, Graham wouldn't have scored any points for the Warlord. Instead, the wound caused by the gun brought my general below half his initial wounds, scoring a 100 Victory points to the Empire. Without those points the Skaven would have won by 50 points, even with the death of the Grey Seer. Instead they scored a draw by 50 points.

It really is true that if the Skaven would spend less time killing each other they could take over the world!



After uttering the immortal words, "Anything but a 1", the outcome is a foregone conclusion!



WARHAMMER



Warhammer Starter Set

£50

The game of fantasy battles, Warhammer is set in a fantasy world where you control a mighty army to crush your foes. Knights in shining armour crash into regiments of bloodthirsty warriors, while archers darken the sky with arrows. Powerful war machines belch forth death with earsplitting fury, while heroes on fantastic monsters sweep into combat, turning the tide of battle.

This boxed set contains:

- A 288 page rulebook,
- 38 Empire Soldiers
- 1 Empire Cannon
- 1 Empire General
- 1 Orc Warboss
- 35 Orc Warriors
- 1 Orc Boar Chariot
- 1 ruined building
- 3 weapon templates,
- 8 assorted dice
- 2 range rulers.

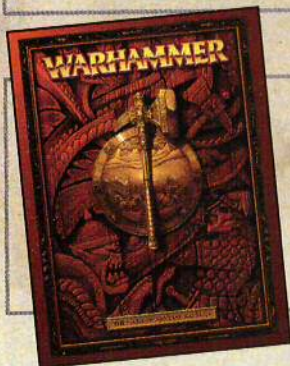

Warhammer Rulebook

£25

This 288 page rulebook contains all the rules you need to create exciting fantasy battles in the Warhammer world. In addition to the core rules of the game, the rulebook includes advanced rules for deadly war machines and powerful characters. The section on magic provides powerful spells to crush your enemies and enhance your own troops, turning the tide of battle at critical moments. The rulebook also includes background for all the races, a 32 page introduction to the hobby, scenarios and supplemental rules. In all, the Warhammer Rulebook is an essential purchase for any dedicated hobbyist interested in Warhammer.

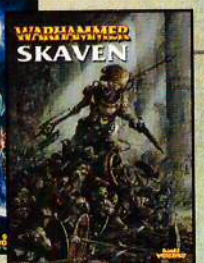
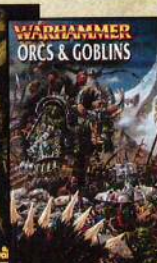
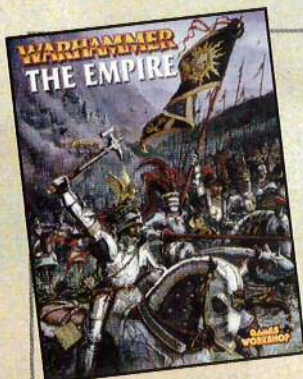

Warhammer Army Books

£10 each

The Warhammer Army books each contain the background, rules, army lists, painting guides, magic items and special characters for one race in the Warhammer world. They are an essential tool for starting an army, and an inexhaustible guide for further army building, painting and modelling.



Empire Militia Regiment

£15 boxed set

Broadly referred to as 'irregular troops', Militia units are called up as required. Having no formal training or discipline, these units are armed with their own equipment at their own expense. Filling gaps in the Empire line these troops form a vital part of the Empire army.



Empire Knightly Orders

£15 boxed set

Resplendent in their full plate armour, the Knightly Orders of the Empire are the amongst the most feared heavy cavalry in the Warhammer world. Their devastating charge can break even the most steadfast of foes.



Empire Soldier Regiment

£15 boxed set

The Soldiers of the Empire are the backbone of an Empire army. Professional soldiers to a man, they are trained in a variety of weapons. Forming the core units of the Empire army these disciplined warriors fight with great bravery in the defence of the Empire.



Empire Greatswords

£6 for a blister of three

Greatswords Command

£7 for a blister of three

Personally chosen from the bravest troops by the Elector Count himself, Greatswords form the Count's personal retinue. These stalwart troops will fight to the last man to protect their lord.

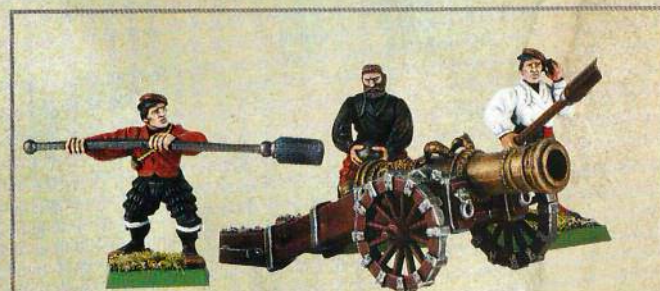

Empire Great Cannon

£10 boxed set

The Imperial Gunnery School of Nuln is the biggest cannon foundry in the world, and it is here that the Emperor's gunners receive their training. The Great Cannon is highly feared by the enemies of the Empire, as the destructive potential of this mighty artillery piece has been proven of the field of battle many times. This boxed set contains components to make either a Cannon or a Mortar.



Helblaster Volley Gun

£10 blister pack

Consisting of nine separate barrels mounted on a central circular crank, the Helblaster Volley Gun is capable of firing several shots at once in a devastating volley. A full volley will rip through the toughest regiment causing immense casualties in the blink of an eye. The disadvantage of the Helblaster is its inclination to misfire, jam or even explode in the midst of battle.

**AVAILABLE FROM YOUR LOCAL GAMES WORKSHOP STORE, INDEPENDENT STOCKIST,
GAMES WORKSHOP MAIL ORDER (0115 91 40000) OR www.games-workshop.com**

(models not shown at actual size)

THE LORD OF THE RINGS

THE FELLOWSHIP OF THE RING

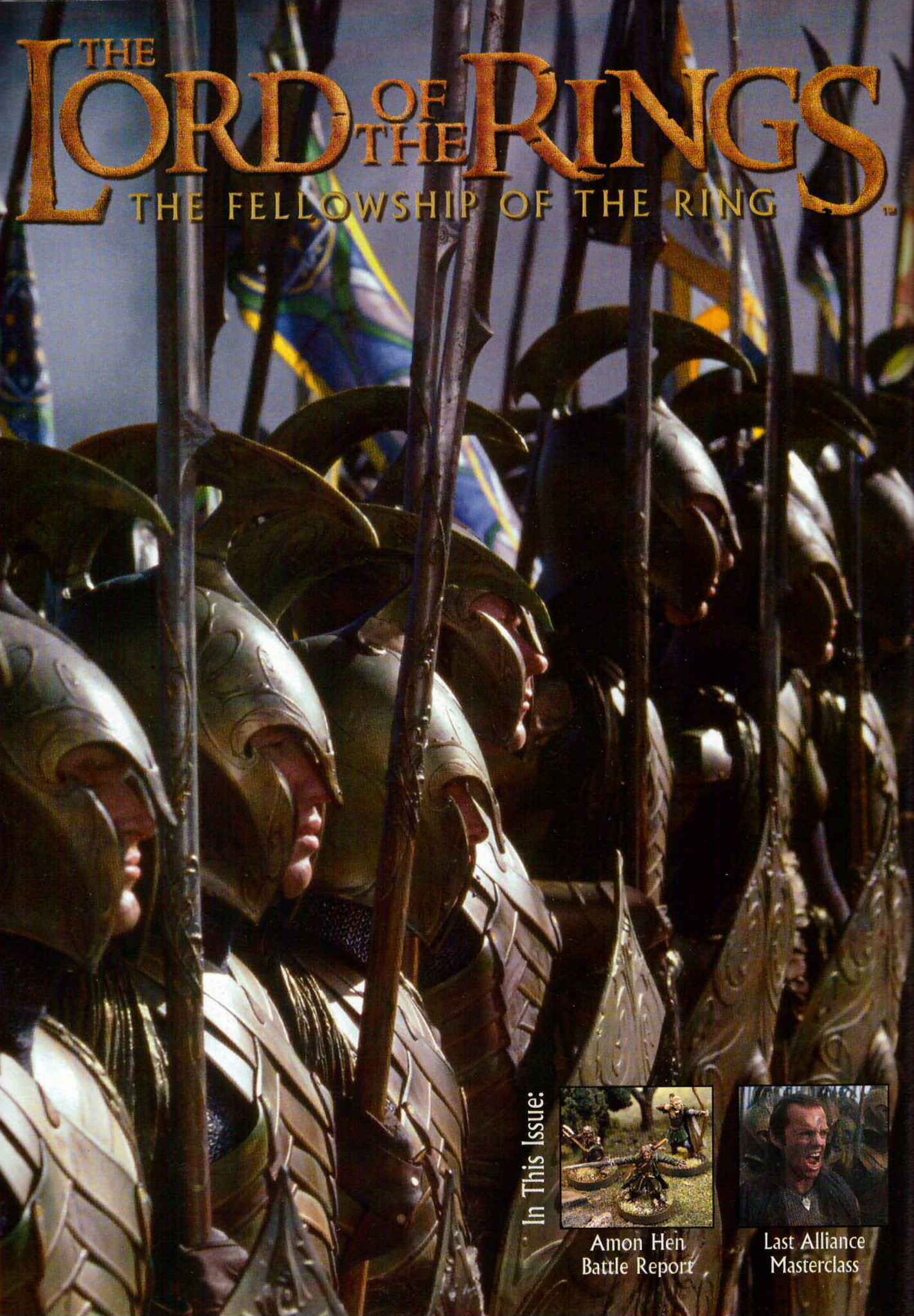

In This Issue:

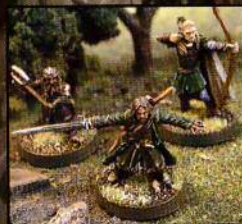

Amon Hen
Battle Report

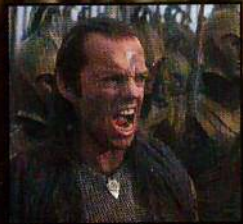

Last Alliance
Masterclass

THIS MONTH'S RELEASES FOR THE LORD OF THE RINGS

Elendil
£4.00



Isildur
£4.00



Available from Games Workshop stores, Mail Order and independent stockists, or visit our online store at www.games-workshop.com



The Last Alliance

THE LORD OF THE RINGS

THE FELLOWSHIP OF THE RING™

Relive the battles and adventures of *The Fellowship of The Ring* with *The Lord of The Rings* battle game – a tabletop strategy game for two or more players. In this box you'll find a rulebook, dice and 48 highly detailed plastic miniatures – the ideal start to your collection.



The Strategy Battle Game £40

The *Lord of The Rings* game contains a 128 page full colour rulebook, 48 highly detailed plastic miniatures (8 Men of Gondor, 16 Elves & 24 Moria Goblins), a ruined building and dice.



Paint Set £8

Contains 10 paint pots (4ml each), starter brush & painting guide.



Warriors of Middle-earth £12

The *Warriors of Middle-earth* boxed set contains 4 Men of Gondor, 8 Elves and 12 Moria Goblins.



Ambush at Amon Hen £20

The *Ambush at Amon Hen* boxed set contains Aragorn, Dying Boromir, Legolas, Gimli, Lurtz, an Uruk-Hai with Pippin, an Uruk-Hai with Merry and 3 Uruk-Hai.



Bridge at Khazad-Dûm £40

The Bridge at Khazad-Dûm boxed set contains Gandalf and the Balrog.

This is an expert modeller's set.



The Fellowship of the Ring £25

The Fellowship of the Ring boxed set contains Gandalf, Aragorn, Frodo, Sam, Merry, Pippin, Boromir, Legolas & Gimli.



Attack at Weathertop £20

The Attack at Weathertop boxed set contains Aragorn, Frodo, Sam, Merry, Pippin, the Witch King & 4 Ring Wraiths.



Escape from Orthanc £20

The Escape from Orthanc boxed set contains Gandalf, Saruman, Gwaihir and Saruman's plinth.



PAINTING MASTERCLASS

The Last Alliance

With the release of Elendil and Isildur this month we've dedicated a whole Masterclass to the good characters from the epic struggle between good and evil – the Last Alliance.

Painted by Martin Footitt

ELROND



The model was painted with an undercoat of Chaos Black. Any areas where the spray had failed to catch were then painted over with a thinned coat of Chaos Black.



To paint Elrond's face a basecoat of Bestial Brown was highlighted with Dwarf Flesh. Elf Flesh was then added to this for the final highlight before a mix of thinned Magenta and Red inks was applied as a wash.



Elrond's robes were painted with a basecoat of equal parts Chaos Black and Camo Green. These were then highlighted by adding more Camo Green to the mix. The final highlights were made with an equal parts mix of Goblin Green and Fortress Grey, which was then added to the original mix. To finish, the robes were then given a wash with thinned-down Blue ink.



A basecoat mix of Chaos Black and Regal Blue was used to paint the cloak. To highlight, Regal Blue and Shadow Grey were added to the mix, followed by a final highlight of Shadow Grey.

The chainmail was painted with a basecoat of Regal Blue, which was



followed by a highlight of Boltgun Metal. This was then highlighted with Chainmail, with a final highlight stage of Mithril Silver. The chainmail was then given a wash with thinned Blue Ink.



Goblin Green was painted in the recesses of the armour plates. The armour was then painted with a basecoat of Brazen Brass which was highlighted with Burnished Gold. A small amount of Mithril Silver was added to this for the final highlight before the armour was given a wash with Blue Ink.



Elrond's hair was painted with a basecoat of Scorched Brown, which was then highlighted with Dark Flesh. A small amount of Bleached Bone was mixed with Dark Flesh for the final highlight before the hair was given a wash with an equal parts mix of thinned Brown and Black inks.



The sword was painted with a

basecoat of Chainmail, which was highlighted with Mithril Silver. The base of the sword was then given a wash with thinned Blue Ink. The hilt was painted with a basecoat of Scorched Brown, which was highlighted with Dark Flesh, followed by Bestial Brown.



To paint the belt, small amounts of Bleached Bone were added to the basecoat of Dark Flesh for each successive highlight.



The scabbard was given a basecoat of Scab Red. Fortress Grey was added to this for successive highlight stages. The trim of the scabbard was painted with a basecoat of Brazen Brass, which was highlighted with Burnished Gold.



An equal parts mix of Chaos Black, Bestial Brown and Codex Grey was drybrushed onto the hem of the cloak to create a dirtied effect.

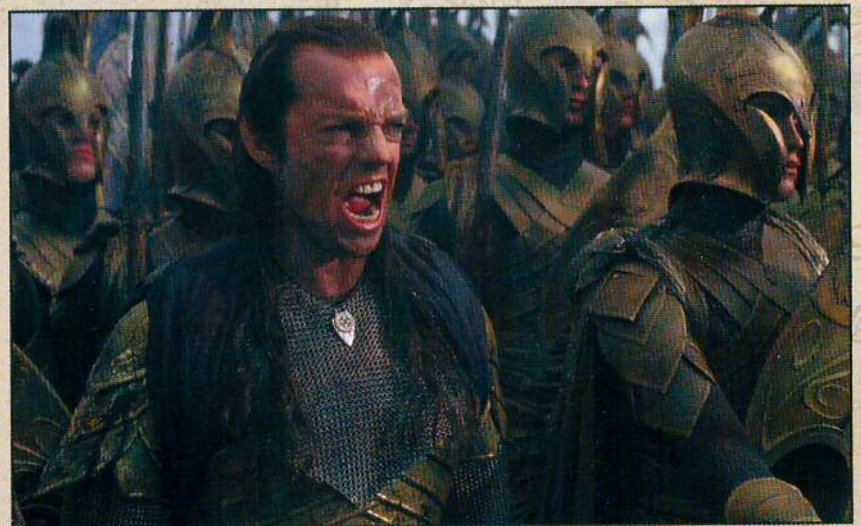

Elrond leads the Elves to battle.

ELENDIL & ISILDUR

Painted by Matt Parkes



Each of the models were painted with an undercoat of Chaos Black. Any areas where the spray had failed to catch were then painted over with a thinned coat of Chaos Black.



The faces were painted with a basecoat of Bestial Brown. This was then highlighted with

Dwarf Flesh, followed by adding Pallid Flesh for the final highlights.

Elendil's beard was painted with a basecoat of Codex Grey. A small amount of Bleached Bone was added to this for the highlight stages.

Isildur's beard was painted with a basecoat of Scorched Brown. Bestial Brown was used as the first highlight coat, then Bleached Bone was added for the final highlight stages.



A basecoat of Scab Red and Chaos Black mixed together in equal parts was used to paint the robes. Scab Red on its own was used to paint the next highlight stage followed by adding an equal



quantity of Blood Red to this. Fiery Orange was added to the mix for the final highlight stage and then the robes were given a wash with a thinned down Red Ink.



Elendil's cloak was painted with Chaos Black and highlighted with an equal parts mix of Chaos Black and Codex Grey. A small amount of Bleached Bone was then added to this for the final highlights. The



inner section was painted with a basecoat of Snakebite Leather, and Bleached Bone was then added to this for successive highlight stages.



All of the armour sections, helmets and swords on each of the models were painted with a basecoat of Boltgun Metal. These were then highlighted with Chainmail, followed by final highlights of Mithril Silver.



The gold trim of the armour and the decoration on the helms were painted with a basecoat of Tin Bitz. This was then highlighted with Shining Gold, followed by a final highlight of Burnished Gold.



The patterning on Isildur's robes started with a basecoat of Burnished Gold. The outer lines were painted on first and then the dashes and dots were painted down the centre. The basecoat was then painted over with an equal parts mix of Bleached Bone and Sunburst Yellow.

Chaos Black was used as the basecoat for the shoes, with an equal quantity of Codex Grey added to this for the highlights.

GIL-GALAD

Painted by Neil Green



A basecoat of Vermin Fur was used to paint the face. Increasing amounts of Bleached Bone was added to this for each successive highlight. A thinned wash of Brown Ink was then applied to the face before reapplying the last highlight mix.

The cloak and shoulder sections of Gil-Galad's armour were painted with an equal parts basecoat mix of Chaos Black and Regal Blue. Regal Blue was then



painted on for the first highlight stage with small amounts of Bleached Bone added for each highlight stage.



Equal parts Chaos Black, Goblin Green and Chainmail were mixed together to form the basecoat for the inner cloak, armour and pattern on the shoulder pads. Mithril Silver was then added to this for each successive highlight stage. A wash of one part Black Ink to three parts Green Ink, which had been thinned down greatly, was then applied. The inner cloak was then given a final highlight stage with the last highlight mix.



The speartip was painted with a basecoat of Chainmail and highlighted with Mithril Silver.



The staff of the weapon was painted with a basecoat of Scorched Brown. A small amount of Bleached Bone was added to this for a subtle highlight stage.



Chaos Black was used as the basecoat for the gloves and hair. Codex Grey was then added to this for the highlight stage.

BASING

Sand was glued onto the base with PVA and then, once dry, given a Brown Ink wash. This was drybrushed with a mix of Snakebite Leather and Fortress Grey, and was finally



flocked with static grass.

THE LORD OF THE RINGS

THE FELLOWSHIP OF THE RING



Exclusive Medallion Program

Sideshow / Weta is offering a unique collectible program to Lord of the Rings fans worldwide. A very special line of Lord of the Rings Medallions, 24 different pieces in all, have been created for this exclusive offering. The original Medallion sculptures were created at the Weta Workshop, the same group who helped realize Peter Jackson's vision of Tolkien's world.

These special Medallions, measuring approximately 6" (152 mm) in diameter, capture a moment of Middle-earth history in a beautifully handcrafted, low-relief scene, featuring the characters and creatures of this epic tale. Each Medallion in the series

has been meticulously sculpted to the highest standards, hand-finished to resemble antique bronze. Each Medallion release is limited to no more than ten thousand hand-numbered units and comes complete with a hand-numbered Certificate of Authenticity. These unique treasures will be released on a monthly basis over a two year period and are only available through the Sideshow / Weta Collectibles web site at www.sideshowweta.com. Each Medallion released will surely occupy a unique place in the collectible offerings surrounding the upcoming films. To learn more about the Medallion Program go to the Sideshow / Weta web site and reserve a piece of film-making history in your name.



The Orcs of Moria
Medallion No. 1 / Jan. '02 Release



Back of
Medallion No. 1



The Nazgûl
Medallion No. 2
Feb. '02 Release



The Industry of
Isengard
Medallion No. 3
Mar. '02 Release



The Last Alliance
Medallion No. 4
April '02 Release



The Birth of the Uruk-hai
Medallion No. 5
May '02 Release



The Soldiers of the White Hand
Medallion No. 6
June '02 Release



(800) 474-3746
www.sideshowweta.com

Distributed in the U.K. by
Amerang, Ltd., W. Sussex,
Tel: 01903-765496

Weta Workshop Ltd. is New Zealand's foremost special effects facility. The Lord of the Rings, Weta Workshop's latest project, has immersed the company for the past four years in the conceptualization, creation and on set operation of the creatures, miniatures, armor, weapons and special make-up effects for these epic films. Now Weta Workshop, in partnership with Sideshow Toy of the U.S., are proud to offer a wide range of collectible product that is an amazing representation of The Lord of the Rings motion pictures.

SERIES FOUR Figures



Aragorn, Son of
Arathorn
Item # 9314 14"H



Arwen Evenstar
Item # 9313 11.5"H



Moria Orc Archer
Item # 9316 9.25"H



Uruk-hai Scout
Swordsman
Item # 9320 9.5"H

Busts



Arwen Evenstar
Item # 9410 7"H



Ringwraith
Item # 9424 9"H



Moria Orc Archer
Item # 9425 6.75"H



Wounded Orc
Item # 9421 6.25"H



Dwarven Lord
Item # 9420 6.75"H

There will be six different series of products released over a 10 month period. Look for the upcoming additions in the next issue of *White Dwarf* or visit our web site. Series Four is scheduled to be in stores in April '02.



AOL Keyword: Lord of the Rings
www.lordoftherings.net

© 2001 New Line Productions, Inc. All rights reserved.
"The Lord of the Rings, The Fellowship of the Ring and the characters and the places therein, TM The Saul Zaentz Company d/b/a Tolkien Enterprises under license to New Line Productions, Inc. All rights reserved."
© 2001 Sideshow, Inc. and WETA Workshop, Ltd.
(Product specifications subject to change.)

The chance to put together a battle report using their newly built gaming table (see WD267) and an all-new scenario? Life doesn't get much better for our US White Dwarf team...

Quite some time ago, White Dwarf editor Paul Sawyer said he wanted to show off some of the terrain we'd been making in the US Promotions department. Even better, he wanted us to build a few specific pieces for our Lord of The Rings project. Better still, he slyly dangled the carrot that a battle report might be required. We were very pleased at how our Amon Hen terrain had turned out and were already playing lots of games on it anyway, so we'd had plenty of practice and felt really confident.

You might think we'd get tired of the same scenario – but you'd be wrong! In fact, it's really quite the opposite.

With each game you hone skills, improve strategies or come up with new twists. Both sides had nearly perfected their tactics playing the scenario from the rules manual, resulting in nearly every game being a nail-biter. It almost always came down to Uruk-Hai shooting from the riverbank or leaping from rocky outcroppings onto the boats as Frodo and Sam paddled to safety. We were pretty excited at the prospect of producing a full battle report at Amon Hen!

So, with our battle report date rapidly approaching, we got an e-mail from Paul containing a completely

AMBUSH AT AMON HEN

Battle Report based on the finale of The Fellowship of The Ring

new two-part Amon Hen scenario by Alessio Cavatore that would be used for the battle report. Aaaargh! Our beloved scenario had been snatched away – our preciousssss...

However, once we actually got the new scenario (featured in last month's issue) our perspective changed. It was going to be a bit tougher, but the scenario read fantastically. We thought that the suggestion of using four players to play out the two scenarios was great and the scene was now set...



Scenario description

This linked scenario revisits the final episode of *The Fellowship of The Ring*. Boromir has tried to take the Ring from Frodo, who flees, followed by his inseparable companion Sam. The other members of the Fellowship are scattered around the ancient hill of Amon Hen looking for the missing Hobbits when they are ambushed by the Uruk-Hai led by Lurtz. The minions of Saruman have orders to capture the Hobbits!

The first battle takes place with Aragorn, Legolas and Gimli trying to get across the table in order to find the rest of the Fellowship. If (more likely, when) they make it, they join the second scenario – Boromir's desperate attempt to save Merry and Pippin – already in progress.

If you missed last issue, you can find Alessio's two part scenario on the Games Workshop website at www.games-workshop.com.

Part 1 - TO THE RESCUE!

Participants

On the Good side are Aragorn, Legolas and Gimli, all wearing Elven cloaks.

On the Evil side there are 18 or more Uruk-Hai warriors (at least three must have bows), chosen from the total Evil force as detailed in the scenario rules in WD267.

Starting positions

Aragorn is deployed first, up to 12" away from the Good side's table edge. Six Uruk-Hai warriors are then deployed 4" away from Aragorn. Legolas and Gimli are then deployed anywhere at least 8" away from the Uruk-Hai and up to 12" from the Good side's table edge. The remaining Uruk-Hai are finally deployed within 12" of the Evil side's table edge.

Objectives

The heroes have to get off the opposite edge of the table. The evil side is merely trying to delay them and knock a few points of Might off the good guys, weakening them for the next episode.

Special rules

This is a race against time and we had to track the number of turns that had expired as this would determine when the successful heroes leaving Part 1 might appear on the table edge for Part 2! As the gamers playing the second episode were not privy to this information, they would not know when (or if) to expect help!



*Above: The 6' by 4' table that we built for the Amon Hen scenario in *The Fellowship of The Ring* rules manual. While it was not entirely perfect for the new scenario, the important parts (distances to travel and terrain features) were well matched, if not necessarily in the correct spot. This goes to show that improvising models and terrain is a situation that is sure to beset all tabletop battle gamers – from veteran clubs to novices, and even us here at Games Workshop!*

THE FELLOWSHIP (Drew Will and Jason Buyaki)

Drew: I would play the Fellowship for Part 1 of this scenario. My task sounds simple enough – get my three heroes (Aragorn, Legolas, and Gimli) off the far edge in as few game turns as possible. Before Jason (who would play the remaining Fellowship in Part 2) was

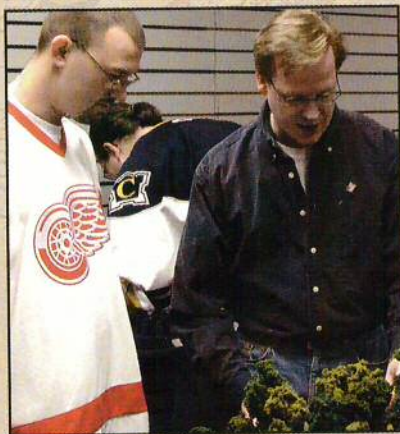

Jason and Drew discuss how to protect the Hobbits.

kicked out of the room so he couldn't observe Part 1, we got a chance to discuss a quick strategy. He's expecting me by turn 12, but I think I can do better!

I plan on leaving Aragorn on his own and teaming up the firepower of Legolas with the sturdy defence of Gimli. This will hopefully break up the Uruk-Hai defenders and help speed me on my way!

Jason: I had a quick minute to talk strategy with Drew before I got sent out of the battle room! Not getting to know what turn help will arrive in Part 2 is really cool and heightens the tension and drama of the game!

My battle plan is pretty solid – the objective for the good side is to keep the Hobbits alive whilst the Evil side try to capture them. With a Movement of only four inches, the Hobbits are eventually going to get caught – I just want to make sure they are caught as far away from the table edge as possible, giving Drew lots of time to rescue them!

THE MAGIC OF ELVEN CLOAKS

Before the Fellowship leave the magical Elven lands of Lothlorien, each hero is given a cloak woven by the Elves. These amazing cloaks allow their wearers to blend in perfectly with any type of terrain.

What this means in game terms, is that if a model wearing an Elven cloak is even partially concealed then he may NOT be targeted by an enemy archer unless that archer is within 6"! As all the Fellowship (save for Boromir) are wearing these cloaks, and our gaming board was loaded with terrain – it made shooting for the Evil side very difficult.



THE FIGHTING URUK-HAI (Rich Curren and William Stilwell)

William: First off, Rich Curren (who would take my place as Evil player in Part 2) and I had to split our forces up according to the scenario instructions. We were allowed to have a total of 36 Uruk-Hai, and for the first game I had to have at least 18 models, and at least three had to have bows. While I argued that I should get all the extra reserves because I'm bigger than Rich, in the end we decided to split the force evenly (18 Uruk-Hai for each game), but I took a few less of the archers in my force for

a total of thirteen Uruk-Hai warriors and five Uruk-Hai archers.

In this scenario, I have one job, and one job only, and that's to delay the members of the Fellowship that I'm facing as long as I possibly can. I've

played enough games against them to fear the combat prowess of Aragorn, Legolas, and Gimli. I think Alessio says pretty bluntly in the scenario that the bad guys won't win this battle – so I don't think I can let us down too badly!



Rich and William draw out their 'Capture Hobbits' plan.



Turn 1 – A RACE AGAINST TIME

THE EVIL STRATEGY!

William: Set-up was pretty much straightforward, as six of my Uruk-Hai were, by rule, to start 4" away from Aragorn. I chose to surround him, in order to slow him down right away. The rest of our minions were simply placed in a straight rank across my deployment line in an effort to create a 'wall of Orcs and steel'. We left one Uruk-Hai free to cover any good guy that managed to make it through.

Turn One Set-up



Fellowship Move

The scenario pretty much dictates how the Fellowship models can be set up, but the variables were how William had decided to place the Uruk-Hai. As the scenario states that the Fellowship wins priority for the first round, it was up to Drew to begin.

The already surrounded Aragorn charged forward into combat with the northernmost Uruk-Hai. Gimli ran forward, but Drew procrastinated about moving Legolas or firing his bow, as models cannot advance more than half of their movement rate and still fire. However, Legolas is allowed three shots per turn making it difficult to pass up any chance he has to fire at the enemy. Deciding in the end that the scenario would be won mostly by speed, Drew advanced Legolas his full move.

Uruk-Hai Move

William had a clear plan (see 'The Evil Strategy' above). When his move started, every Uruk-Hai that could reach Aragorn piled in to bring the hero down. Aragorn was quickly surrounded by three heavily armoured evil warriors, with three more directly behind!

The remaining Uruk-Hai on the top of the hill advanced in a line towards the action.

Shooting: None.

Combat: For this round of combat each side would be rolling three dice – Aragorn has three attacks versus one each from three Uruk-Hai. Aragorn rolled a 4, a 3 and a 2 while the Uruk-Hai came up with a high roll of 5. Trouble for the Fellowship already!

Deciding not to get bogged down early, Drew spent Aragorn's free Might point to make his score 5 (Aragorn's Mighty Hero skill gives him a point of Might that recharges every turn – in essence a 'free' point). This means that each side had a high roll of 5 and, since ties go to the combatant with the highest fighting skill, Aragorn was victorious.

Pushing back all three assailants, Aragorn then rolled his attack dice to wound. Needing 5s against the heavily armoured Uruk-Hai, Drew rolled a 4, 5 and a 1. One enemy was cut down and the other two were pushed back. As models can't manoeuvre within an inch of enemy models, Drew knew that he would need Aragorn to clear a wider path, and dispatching just one foe wasn't going to be enough. Using another point of Might, Drew 'bumped up' his roll of 4 to a killing 5 and cleared his path for the next turn as a second Uruk-Hai fell.



Drew moves Aragorn forward...



...and the Uruk-Hai close in...



...but soon regret it!

Turn 2 – AN UPHILL STRUGGLE

Fellowship Move

Winning the priority for this turn, Aragorn ran his full distance uphill. On the other side of the forest, Gimli followed suit. Legolas, however, advanced more slowly, taking time to ready his deadly Elven bow.

Uruk-Hai Move

William managed to get one Uruk-Hai back into base to base contact with Aragorn, while others trailed hot on his heels! The bulk of William's ambushing force advanced into position – too far away to fire due to the Fellowship's Elven cloaks (this prompted the first of many curses from William directed towards the Elven cloaks).

Shooting: The only archer that could fire this turn was Legolas, who loosed three shots towards the oncoming Uruk-Hai. Scoring hits isn't too difficult for the keen-eyed archer (who needs a mere 3 or better to hit). The trouble would be wounding the heavily armoured foe! Drew made a strategic choice to aim at the slightly less armoured Uruk-Hai armed with bows. This would both take out the archers and reduce the overall

numbers more quickly! With a roll of 5, Drew's choice proved a wise one, as an Uruk-Hai archer fell to the Elven arrow!

Combat: Aragorn made short work of his foe.



Legolas hits his mark!



Aragorn breaks away...



...but is caught up by one Uruk-Hai who is quickly sent to his doom!

Turn 3 – THE FELLOWSHIP'S WRATH



Aragorn proves his lineage as heir to the throne of Gondor

Uruk-Hai Move

Having won the priority roll, William took the opportunity to send the three Uruk-Hai that had dogged Aragorn each turn surging into combat with him!

Meanwhile, uphill, the defensive line split up into three distinct packs: one headed downhill to join the fray with Aragorn, one kept watch in the middle, and the third ran towards Legolas and Gimli. Two of the Uruk-Hai archers only moved 3", allowing them to get into position and still fire their bows.

Fellowship Move

Gimli charged 5" uphill, to bring the doughty Dwarf into contact with an Uruk-Hai! Nearby, Legolas advanced three inches, setting him up to pour point blank fire into the onrushing foe.

Shooting: The Uruk-Hai had priority so could fire first! One of William's two archers that could fire was exactly 6½" from Aragorn's combat, so Drew was saved by both his pesky Elven cloak and William's slight miscalculation! The other Bowman fared better, scoring a hit on Legolas even as he drew back his bowstring, but failed to wound!



In a whirling mêlée, three Uruk-Hai warriors charge in and are quickly dispatched!



Now it was Legolas's chance to return fire, and his Elven bow twanged three times, scoring hits on all three shots. Drew followed up with some more masterful dice rolling and two more Uruk-Hai archers dropped lifeless to the ground.

Combat: Using his regular axe (as opposed to his double-handed one) Gimli easily hacked down and slew his share of Uruk-Hai, but the real action was taking place on the other side of the copse of trees.

Three Uruk-Hai with their shields held high came crashing into Aragorn, but superior numbers didn't matter this time. Cleaving through their armour like it was butter, Aragorn took out all three of his combatants in a single swipe of his blade. Needing 5's, Drew rolled 6, 6, and 4 (which got bumped up using the rechargeable Might) to deliver the Orc-slaying hat-trick!

Between shooting and combat six Uruk-Hai fell this turn alone! The sheer carnage on the evil side meant that courage tests would have to be taken by the Uruk-Hai next turn!

COURAGE TESTS!

Courage tests are made in three specific circumstances:

- 1) Attempting to charge a terrifying enemy.
- 2) At the start of a move once half the force is destroyed.
- 3) At the start of a move if the model is on its own (can't see any friends) and near lots of enemies.

In this game it was definitely case two: half of the force was destroyed! This was a crucial turn, as not only were many Uruk-Hai destroyed, but now they must make Courage tests every round.



The path to rescue their friends is blocked...



...until Legolas sends two Uruk-Hai to their deaths!

THE FIGHTING URUK-HAI!

The Uruk-Hai are tough! To wound an Uruk-Hai with a shield (Defensive value 6) even a shot from Legolas's potent Elven bow would need to roll a 6! The Uruk-Hai archers have no shields but still boast a formidable Defensive value of 5. They're certainly not the weedy Moria Goblins, but an evil breed of Orcs that are heavily armed and armoured by the corrupt wizard Saruman!

Turn 4 – AN ERROR OF JUDGEMENT

Uruk-Hai Move

The Uruk-Hai won priority, but before William could commence with any movement, he had to take a Courage test for each model on the board (following last turn which left him with less than half of his starting force). Three of the Uruk-Hai failed and retreated their full move backwards, obviously taken aback by the ferocity of the attack against them! While his defensive line was broken, William made an attempt to shore it up with his remaining moves. Elsewhere, one archer advanced 3" downhill and into range to shoot Aragorn. With only two non-retreating Uruk-Hai in range to attack Gimli and Legolas, William decided to send one warrior into each, if only to slow them up for a turn.

Fellowship Move

Aragorn charged uphill, making contact with the advancing Uruk-Hai archer.

Shooting: None, as all archers were in combat or out of range!

Combat: With his heavy axe, Gimli easily won combat and killed his foe, as did Aragorn. The only hitch for the

Fellowship this turn was Legolas, who won his round of fighting but failed to wound, and had to settle for knocking the Uruk-Hai 1" back, rather than killing him.



WHOOPS!

William: What was I thinking? I tried to make up for last turn's mistakes, and in my excitement I totally forgot the turn sequence and moved my Uruk-Hai bowman into position to fire, forgetting that if I was within 6" to shoot at Aragorn's Elven cloak, then he was in charge range! In the end, it served as a great reminder of just how different The Lord of The Rings game is to play!

Turn 5 – CRESTING THE HILL

William was hoping to rebuild his momentum and was pleased to roll a 5 for priority, but Drew countered with a 6!

Fellowship Move

Gimli and Legolas made a full move uphill towards their objective. In charge range of one model (on a horizontal), Aragorn instead took the opportunity to head straight up towards the table edge.

Uruk-Hai Move

William passed every Courage test, but would it be too little too late? The Uruk-Hai that Legolas couldn't take out last turn could reach either Legolas or Gimli, and William reasoned that it should be Legolas as he was faster and easier to wound, so better to slow him down and hopefully make him spend his Might.

Casting caution to the wind, three Uruk-Hai again charged into combat with Aragorn. The remaining two models (which fled last turn) moved closer to return to the action. The last remaining archer lined up a shot.

Shooting: Even though he risked hitting his own side, just like a true Orc, William fired! Also just like an Orc, he missed entirely.

Combat: Legolas won combat, but again failed to wound (rolling a 3 when he needed a 5). However, as time was slipping away, Drew opted to spend two

Might points to take out that last stubborn foe! After all, time was of the essence and now the path was clear.

Aragorn carved through Saruman's minions with his whirling blade! Again, all three who dared to block his way fell (with a roll of 5, 5, 4 – that free Might coming in handy again!).



In the last three turns, Aragorn had whirled, parried, and hacked through a total of seven Uruk-Hai! Now that's a hero!

Turn 6 – THE LAST BATTLE

Adding insult to injury, Drew won the priority roll by one – again.

Fellowship Move

At this point the Fellowship outnumbered the Uruk-Hai three to two! Fearing nothing at this point in the game, Drew surged ahead full speed with all of his characters.

Uruk-Hai Move

With only two models left, William (to the amazement of all who watched) charged into combat with Aragorn. It appeared that both the Uruk-Hai and

William had passed their Courage tests! A bit disheartened by the carnage earlier, he opted to bank on the 'my luck *must* turn' theory and hoped against hope to beat the mighty hero.

Shooting: Only Legolas was left with a bow, and moved his full 6" distance.

Combat: Aragorn easily dispatched both foes (again), and the sounds of William's moaning protests could be heard throughout the building!

At this point, Drew had actually wiped out EVERY single enemy model and

now simply needed to 'leg it' off the enemy table edge as quickly as possible.



By this point Aragorn had slain an incredible dozen Uruk-Hai!

Turns 7 to 10 – THE FINAL SPRINT



The lack of opposing Uruk-Hai meant that there was no need to worry about priority, Shooting or Combat. There was, however, still a lot of ground left to cover. The far table edge the heroes had to escape off was 36" away at the start of the game. Now it was just a matter of time as the three members of the Fellowship sprinted their full movement to get off the board as quickly as possible. This was vitally important, as the turn they 'escaped' in would be the turn *before* they appeared during Part 2. Aragorn made it off the edge in turn nine, and Legolas and Gimli in turn ten!



CONCLUSION

Drew: I'm not going to lie – I was pretty discouraged when I looked at the numerical odds against me at the beginning of the game. All of my worries had vanished, however, by the time Aragorn tore through half-a-dozen Uruk-Hai warriors. Legolas's shooting and Gimli's axe provided ample protection for them, and they were able to make it off the table without facing that much peril. I thought I used my

Might points wisely, especially at the beginning when some players might have been tempted to save them for later, mostly because Aragorn had an entire game left to play with a completely new set of Uruk-Hai. It proved to be a smart move, as once the Uruk-Hai were out of the way, I could speed off the table without any worries. In the end, I clobbered William, and I was happy!

William: If I'd thought about it a little more as the game went on instead of getting wrapped up in the emotion of the scenario, I probably would have fared better. I should have sent the Orcs in one at a time to slow the Fellowship down more, and I shouldn't have moved my only shooter into range of the meanest warrior in the game!

Oh well, die and learn, I guess...

Part 2 – CAPTURE THE HALFLINGS!

Participants

On the Good side are Boromir, Merry and Pippin. The Hobbits have Elven cloaks. On the Evil side are Lurtz and the remaining Uruk-Hai warriors (in this case eleven with swords and shield and seven with bows).

Starting Positions

Merry and Pippin are deployed 15" away from the Evil side's table edges.

The same goes for Boromir, except he is closer to the enemy and must be within 12" of the Uruk-Hai. The Evil models can come on from their table edge.

Objectives

The Uruk-Hai must capture (not slay) the Hobbits and carry them off the table from their own starting lines. The Good side must stop this from happening.



Turns 1 to 3 – FIRST BLOOD!

As per the scenario instructions the Uruk-Hai went first.

TURN ONE

Uruk-Hai Move

Rich Curren would be taking over the Uruk-Hai side. Rich split his force in two: one group to cover each of his starting board edges. Each party had a separate mission – Lurtz and most of the archers came in from the right side (as seen below right) with the task of killing Boromir, while the top side force's objective was to grab the

Hobbits as soon as possible and then concern themselves with escaping.

With this plan in mind, Rich moved his models onto the board. The top group came running, and Lurtz and the archers moved 3" and notched arrows in unison to fire a volley at Boromir!

Fellowship Move

Jason moved the Hobbits diagonally away, as this kept maximum distance from both advancing parties! In order to play rearguard, Boromir hung back a little, being careful to shield himself from some of the incoming fire.

Shooting: Although five archers were in range, Jason's clever manoeuvring left only one archer and Lurtz with any shots. Only Lurtz hit, and he needed a 6 to cause a wound against the mighty Boromir, who was well protected with armour and shield. After the dice finally rolled to the bottom of our sloped terrain it stopped spinning on a wounding 6!

Taking an arrow this early was definitely not in Jason's game plan! Boromir has to drag the fight out long enough for the others to come on to the board and save everyone. Not a good start for the Fellowship!

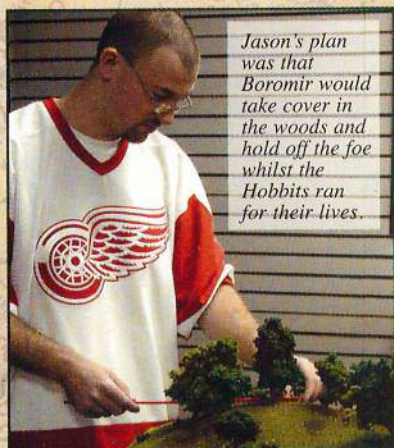

Jason's plan was that Boromir would take cover in the woods and hold off the foe whilst the Hobbits ran for their lives.

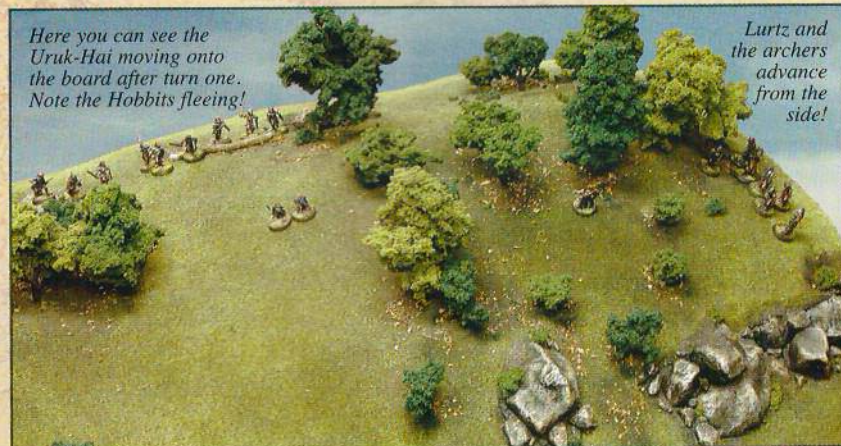

Here you can see the Uruk-Hai moving onto the board after turn one. Note the Hobbits fleeing!

Lurtz and the archers advance from the side!

TURN TWO

Fellowship Move

Jason really didn't want to win this priority – but trying to make the best of a bad situation, he scammed the Hobbits further away and moved Boromir mostly behind a rocky outcrop to intercept any Uruk-Hai advancing downhill. With a few more inches to move, Boromir could have been totally behind cover.

Uruk-Hai Move

Moving their full 6", the pursuing Uruk-Hai gained ground on the Hobbits.

Meanwhile, the pack that Lurtz led crept forward with each Bowman spreading out and trying to draw a bead on Boromir through the dense trees and forest undergrowth.

Shooting: Only Lurtz could get a shot off, and then with a cover save from the boulder for Boromir. Rich rolled a 3 (needing a 4) and surprised everyone by immediately bumping it up to hit with one of Lurtz's precious few Might points. Rich succeeded in avoiding

hitting the obstacle, then followed that with the required 6 to wound the proud Gondorian. A howl of dismay from Jason followed as soon as the die stopped rolling!

TURN THREE

Fellowship Move

Again, Jason raced the Hobbits away and worked the seriously wounded and

bleeding Boromir closer to the Uruk-Hai, all the while taking full advantage of the plentiful cover.

Uruk-Hai Move

After much pre-measuring and stooping to see the correct angles, Rich was quite frustrated to realise that no matter where his troops manoeuvred to, he could not get a single shot off, so every Uruk-Hai ran forward to set up next turn!

After a question arose over how many shots Rich was eligible to take, he took a 'model's eye view'. This time-honoured method of checking line of sight is used in almost all tabletop battle games, and it is even more crucial than normal on our realistic scenery with its sloping hills and dense skirmish terrain!



The Hobbits flee the pursuing Uruk-Hai whilst the archers close in on Boromir...

Turns 4 & 5 – CLOSING IN

Uruk-Hai Move

The Uruk-Hai charged forward howling for blood! One model slammed into Boromir. Even more menacingly, the remaining archers closed in! The surge towards the Hobbits came up 2" short!

Fellowship Move

Hairy feet scurry for their lives...

Shooting: Arrows flew into Boromir's combat, and two hit. No damage was done, but needing a 6, one came up 5! This was way too close for Jason, who was getting rather fearful of Rich's shooting prowess!



Seen here is the Fellowship's path from the heroic combat in Turn 4 to the out of sequence move at the start of Turn 5!

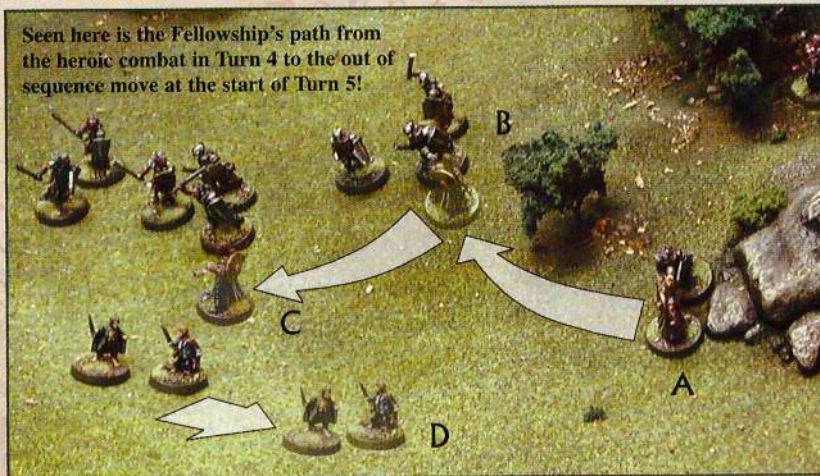

Combat: Jason yelled 'heroic combat', spending his first Might point (the spot marked A, above). Perhaps Boromir was slowed by the many arrows that must be sticking into his armour, shield, and flesh at this point, but more bad luck followed – needing a 5 (on three dice) the best Jason could muster was a 3. There went two more Might points to fell his foe!

Finally, completing his heroic combat (which he was allowed to do as he had killed his only foe), Boromir raced 6" to intercept one of the Uruk-Hai bearing down on the Halflings (this is at spot B in the picture above)! This time, the fight went Jason's way, and he slew the foul Orc with a single blow.

TURN FIVE

More dismay – Rich and the Uruk-Hai won priority and would've swept into

the Hobbits except for the timely called...

Heroic Move!

Jason spent Boromir's last Might point and called for a heroic move to place the Hero between the Orcs and their prey (at spot C). Jason also remembered the 'With me!' rule which allowed the Hobbits (who were within 6") to move further out of harm's way (point D)!

Uruk-Hai Move

Not to be denied any longer, Rich closed around Boromir!

Combat: In truly heroic fashion, Boromir sounded his awesome horn, driving away the Uruk-Hai (and killing one in the process!).

HEROIC COMBAT AND HEROIC MOVES

What really brings The Lord of The Rings gaming action into its own is the way that Heroes can spend points to perform 'extra actions'. For instance, a heroic combat allows a fighter to finish one battle and (so long as he slays his foe) move and fight again in the same round. A heroic move allows a Hero to move out of priority sequence. Both of these heroic actions can influence friendly models as well! Might points run out all too quickly, but used at the right time, they can win the game. However, keep in mind that the only thing worse than squandering your Might too early is dying with points unspent!

THE HORN OF GONDOR

When Boromir is outnumbered in combat he may sound his fearsome horn. The blast is so powerful that models in combat must pass a Courage test or flee at full speed away from him!



Turn 6 – REDEMPTION

With both sides desperate to win priority in turn six, the roll was a tie, giving the nod to the Fellowship.

Fellowship Move

Pre-measuring very carefully, Jason determined that only one Uruk-Hai could reach the Hobbits this turn, so that was where Boromir dashed to intercede! Merry and Pippin moved away – safe for one more turn at least!



Uruk-Hai Move

The bulk of Rich's force was now closing in! Tired of the interfering Boromir, three Uruk-Hai quickly surrounded the beleaguered human. Five more Uruk-Hai closed in menacingly on the Hobbits. Lurtz and his party of archers moved last to ensure that they would be able to pour fire into combat!

Shooting: All but one shot missed, but the one hit was from Lurtz. Jason winced as Rich had been constantly pointing out how Boromir had already taken two wounds – both inflicted by Lurtz! The roll to see whether friend or foe was hit came up in Rich's favour, and now he just needed a 6 to slay Boromir. The die came up a 5, but Jason's zeal quickly faded to despair as

Rich used Lurtz's last Might point to fell the mighty hero before he could blow his horn and mete out any punishment in combat! Pierced by many arrows, and bleeding from a score of wounds, the hero fell – brave to the last – trying to redeem himself and protect the two young Hobbits!

ALL MIGHT AND NO FATE ...

Boromir is a truly powerful hero who can turn the tide of battle even when the dice are against him. The combination of an awesome 6 Might points but no Fate at all can leave Boromir (especially when outnumbered) destined to die a hero's death!

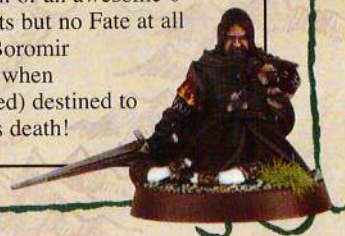

Turns 7 & 8 – SURROUNDED!

Uruk-Hai Move

Taking advantage of winning priority (and with no pesky Might points to get in the way!), the Uruk-Hai closed into combat. The Hobbits made their stand back-to-back against the brutal Orcs.

Combat: Using the scenario's special 'knock-out' rules, the Uruk-Hai attempted to batter the Hobbits into submission. After their long chase, the Uruk-Hai won both combats but rolled terribly to wound, causing none on Pippin, and only one on Merry (even with double dice for surrounding a foe). Jason declared he was using Merry's one and only Fate point. If Jason could manage a 4 or better, then Merry would

survive another round. If he failed, it would be off to the races, as the Uruk-Hai would grab his unconscious body and trek towards their table edge before any more of the Fellowship could turn up. Jason rolled a 5 and so Merry fought on!

TURN EIGHT

Uruk-Hai Move

Both Hobbits were well and truly surrounded now. Feeling confident in their imminent capture, the remaining Uruk-Hai began moving back towards their board edges to help set up a defence against the remaining Fellowship who could be entering the

fray at any time!

Combat: Jason rolled a 5 for Pippin's combat and felt a ray of hope, but that was quickly beaten out of him as Rich came up with a 6. After the first wound (with two more Uruk-Hai waiting to roll) Jason decided not to use Pippin's Fate point here, as it would not prevent the inevitable. Thus the plucky little Hobbit slipped into unconsciousness.

Merry, on the other hand, won his combat and with his short sword drove all three of his assailants back.

This being the case we replaced Pippin with the Amon Hen boxed set model – a fantastic miniature with a running Uruk-Hai carrying the dejected Hobbit.



Turns 9 & 10 – TO THE RESCUE!

TURN NINE

Fellowship Move

With only the surrounded Merry to move, it would be quite easy to give up, but Jason knew that help was on the way, and that he must delay the Uruk-Hai at any cost! With this in mind he charged Merry 2" into an Uruk-Hai, but not just any of the foes. Merry chose to attack the model that was carrying his companion Pippin. This was an especially cunning move as it not only got Merry a few inches further from the Uruk-Hai table edge, it also prevented the Orcs from getting a good start with one captured Hobbit! Best of all, it seemed like just the kind of brave thing an overwhelmed but loyal friend would do!

Uruk-Hai Move

The special rules for kidnapping say that you must drop your captive when confronted in close combat, so Pippin was unceremoniously dumped while the Uruk-Hai drew out his wicked blade. Further frustrated by the little whelp, Rich moved more Uruk-Hai to once again surround Merry. Elsewhere the remaining Uruk-Hai were placed behind cover (fearing Legolas' bow) and waited to ambush any returning heroes that might try to help.

Combat: Against five surrounding Uruk-Hai you'd think that Merry would have no chance but, heroically, Merry rolled a 6, and the once gloating Uruk-Hai came up with a 1, 2, 3, 5, 5 – Merry won! Although failing to wound

(needing a 6 against the well-armoured beasts!), Merry was single-handedly holding up the foe, and in addition he had freed Pippin! If he could win priority next turn, Merry could revive his fallen friend.



Merry to the rescue...

TURN TEN

Uruk-Hai Move

Winning priority and vowing that “no runt of a Hobbit will make a fool of me,” Rich once again closed ranks upon Merry. After the Hobbit was pinned, another Uruk-Hai came over to regain control of the knocked out Pippin.

Fellowship Move

Merry was pinned but, much to the Hobbit’s delight, Aragorn arrived to make a heroic dash to help. As he had left Part 1 of the scenario on Turn 9, he was allowed to enter this game from any enemy board edge on Turn 10.

Drew jumped back into the game with his Aragorn model – but where? (See below).

Shooting: None, as everyone either moved or was protected by an Elven cloak.

Combat: In a classic show of hopeless bravado, Jason bragged that Merry would once again beat back the ferocious Orc attack. He then promptly rolled a 1 for Merry, who was knocked out and slung over an Orc shoulder like a sack of potatoes...

ARAGORN

After some pondering and debate about where he should bring Aragorn onto the board, Drew finally decided. Choosing the eastern board edge made sense as it was closest to the beleaguered Hobbits, and it would cut off the easiest avenue of escape for the villains.



Turns 11 to 13 – REINFORCEMENTS

TURN ELEVEN

Fellowship Move

Although both Hobbits were captured, the glimmer of hope was that Drew and Jason had won priority, Aragorn was racing forwards to help, and Gimli and Legolas were due to arrive. In order to deny a free board edge for the evil-doers to slink off from, the Elf and Dwarf appeared on the northernmost board edge.

Uruk-Hai Move

The Uruk-Hai hoisted their living burdens and made towards the northern table edge in a diagonal path that would carry them further from the onrushing Aragorn. Meanwhile, Lurtz and his band of ambushing Orcs moved from behind cover to shoot – only remembering at the last minute that he couldn’t target anyone wearing an Elven cloak until within 6”, as the



Gimli and Legolas arrive to lend an axe and a bow!

outright, except for Fate points! Drew saved one – but was left with no Fate, one Wound, and one point of Might. Aragorn was hit, but passed his Fate roll.

Combat: Gimli cleaved his foe to the ground with ease.

TURN THIRTEEN

Fellowship Move

Realising that the Uruk-Hai were trying to delay him and bait him into a trap, Aragorn ignored them and rushed to help the Hobbits. Legolas moved 3” and prepared to fire, while Gimli charged into a nearby archer.

Uruk-Hai Move

More running and archers moving into position which would pay off next turn, as Aragorn would either be in combat or be forced to skirt around a wedge of Uruk-Hai warriors.

Shooting: Legolas took out two more enemy models although it cost him his last Might point! All the Orc shots missed the Fellowship!

Combat: With a clang of axe against armour, Gimli won his combat, but failed to wound.

RUN FOR IT

Rich: With clear instructions to grab the Hobbits and run, that’s what I was going to concentrate on. I was wary of getting too close to Aragorn, and I was willing to sacrifice all (even Lurtz) to achieve my objective!



model was in cover! The ambushers on the north end moved to confront the newcomers.

Shooting: Quick on the draw, Legolas hit and killed one Uruk-Hai archer before it could nock an arrow!

TURN TWELVE

Fellowship Move

The long chase continued for Aragorn, while, at the top of the hill, Gimli raised his axe and charged, and Legolas moved to cut off the escape routes.

Uruk-Hai Move

Rich knew his objectives, and teams of two Uruk-Hai concentrated on getting the captives off the board. The remaining Orcs were to delay Aragorn and harass Gimli and Legolas with archery.

Shooting: Legolas missed all three shots, and in return was hit three times by the Uruk-Hai. Rich rolled two wounds – enough to kill Legolas



Turns 14 & 15 – TENSION BUILDS

TURN FOURTEEN

Uruk-Hai Move

Winning priority on a tie, Rich started his turn by moving the last surviving Uruk-Hai on the northern edge to pin Legolas (because Gimli is slower!) while downhill, Lurtz and another warrior leapt into combat with Aragorn. The remaining bowmen crept and skulked into range to fire.

Fellowship Move

Only Gimli was free to move and, wanting to remove the last Uruk-Hai guarding the escape route, he charged in to bring his axe to Legolas's defence!

Shooting: After using the 'shoot into combat' tactic to kill Boromir, Rich finally killed one of his own troops and this cheered Jason up immediately.

Combat: Gimli and Legolas teamed up to destroy the only foe facing them. Aragorn took out his frustration over

the chase on Lurtz! Stunned by the fury of the blows, Lurtz lost combat and took a wound (failing his only Fate roll!). As Lurtz had two wounds to start, he was just injured and driven back!

and driving him to the ground. Fittingly enough, the death of their leader Lurtz was just enough to make all the Uruk-Hai take Courage tests at the start of their next turn!

TURN FIFTEEN

Fellowship Move

Gimli and Legolas moved to intercept the Uruk-Hai pack with the Hobbits that had been steadily working itself uphill. Aragorn charged into Lurtz.

Uruk-Hai Move

Sensing that Gimli and Legolas would cut off their escape, the two Uruk-Hai warriors that were not hauling Hobbits broke off from their course and made straight for the heroes.

Shooting: A few Orcs shot into Aragorn's combat but all missed!

Combat: Aragorn slaughtered Lurtz, hitting and wounding with all three attacks, smashing his armour asunder,



Turns 16 & 17 – THE HUNT IS ON

TURN SIXTEEN

Uruk-Hai Move

This pivotal priority roll went to the Evil side, but before movement came the Courage rolls! A few Uruk-Hai failed and scattered to the winds as they fled directly away from the closest enemy model in sight. Of the crucial tests, one pair of Uruk-Hai carrying Hobbits passed, the other failed. The team that found their courage continued to move away from the heroes and towards the (looming) table edge. As luck (or misfortune, depending on your point of view) would have it, the failing team was not in line of sight of any Good models as they were deemed to be just around the forest area. Failing to see an enemy model, they ran for the nearest board edge. Had the Fellowship moved first, the team would have

retreated backwards. The hunters had definitely become the hunted!

Fellowship Move

There was nothing but a sprint to close in on the enemy as Aragorn continued uphill, and Gimli and Legolas come around the wooded grove. There was no Shooting or Combat.

TURN SEVENTEEN

Fellowship Move

It was clear at this point that Aragorn was going to arrive on top of the hill just in time to miss the action! Win or lose, it would be up to Gimli and Legolas! Taking advantage of the failed Courage test, both Gimli and Legolas charged into combat to save Merry from the clutches of the Uruk-Hai! Hopefully Gimli, who still had Might left, could perform a heroic combat and then move into Pippin's captors as well.

Uruk-Hai Move

More Courage tests, but this time Rich passed the important one, and the Uruk-Hai carrying Pippin streaked towards the edge – falling short by about 2". Gimli was just within his 5" charge range, but he was locked in combat with an Uruk-Hai who stood between the Dwarf and his real quarry. This meant that Gimli not only had to win the Combat, but also wound his foe to clear a path!



Gimli and Legolas free Merry from the Orcs!

Combat: Legolas easily won his combat and slew his foe, but Gimli did not fare as well. First, Gimli needed to spend a Might point to declare a heroic combat. Then he spent his very last point of Might to tie the combat (and therefore win it with his higher Fight skill), but the roll to wound came up short as well. In order to crumple the Orc beneath his axe, the sturdy Dwarf would have needed to spend another point of Might, but had none left, leaving Drew unable to complete his heroic combat to move again and possibly free Pippin. While Merry was now free (although still unconscious until a friendly model could revive him), there was no chance to intercept Pippin. It would come down to priority!



THE FINAL TURN!

Uruk-Hai Move

Rich was overjoyed after winning the priority roll. It was then that the forces of Good reminded Rich to take a Courage test. Every single Uruk-Hai failed, including the team that was carrying Pippin! With Hobbit in tow, the pair of Uruk-Hai had to flee directly away from any visible Good models, and Gimli was certainly not only visible, but bearing down quickly! But such was the angle of their retreat that the pair still made it off the board with but an inch to spare!

Fellowship Move

Merry was revived and the last Uruk-Hai were hunted down or scurried off the board on their own. It was over...

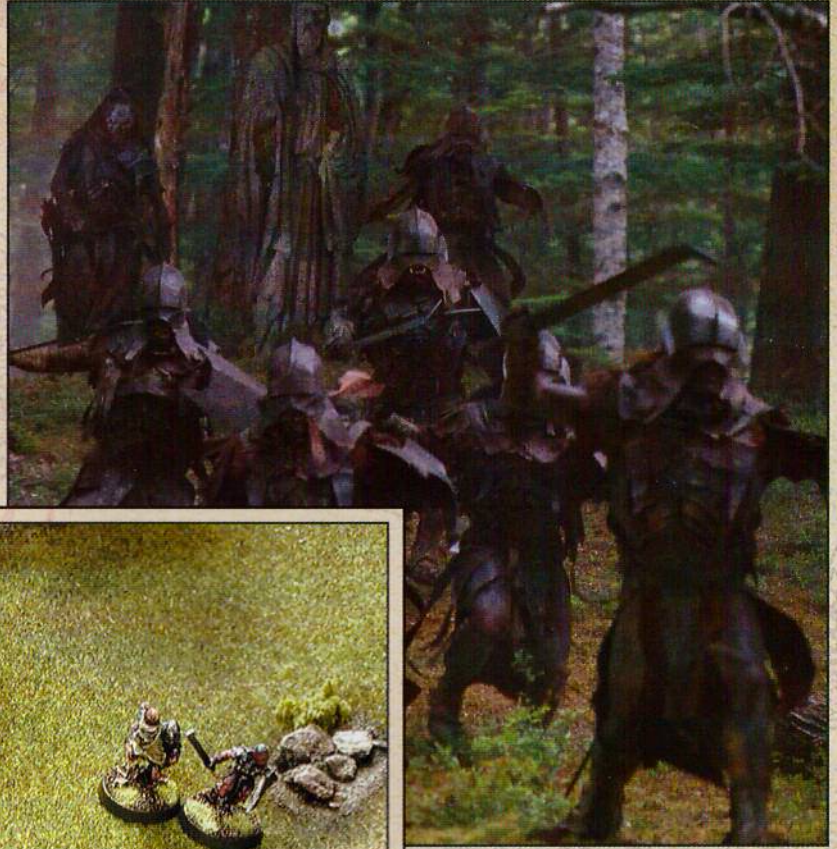

A TIE BY INCHES

Both sides could claim both good and bad moves as well as luck! In the end though, it was so closely contested that it came down to a few inches. The scenario states that both Hobbits captured means an Evil victory, both saved means a Good victory, and a split means a tie!

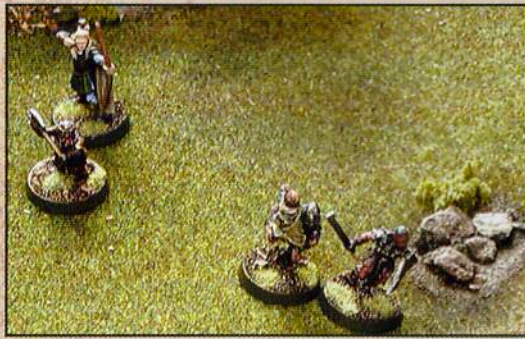

PLAYERS' CONCLUSIONS

Between both parts of this scenario, battle raged for a massive 28 turns, but it went so quickly that none of us realised just how long we'd been playing!

The Fellowship

Drew: I saved Merry, but was so close to saving Pippin too that it's hard to be completely happy. Aragorn was 'the man' in Part 1, but was too far away to make a difference in Part 2. Still at least he hacked down Lurtz in suitably heroic fashion!

Jason: Rich's shooting was monstrously lucky! Every time I looked up he was rolling a six to wound! Bad luck could've ruined me, but I'm very proud of Boromir's heroic combats and heroic moves. They saved several extra turns for the Good side!

The Uruk-Hai

William: What can I say? Part 2 was cool to watch. But the longer I watched the more guilty I felt for my performance in Part 1! After my pitiful showing, I'm relieved we managed to salvage a draw in the end.

Rich: Eighteen turns in Part 2 and it turns out to be a tie! A few Courage tests going my way and I would've won it all. Of course, that last priority roll going against me, and Gimli's axe could've taken it all from me, so perhaps a tie is OK. In the end it worked out sort of like the movie, but with a few cool differences! At least I captured Pippin!



Victory and defeat – a closely fought battle!

The Terrain Makes the Game!

We fought this linked battle on great terrain that we built ourselves. While it's true that the table is ideal for the Amon Hen scenario in the rulebook, it does not match up perfectly with the scenery set up for the two new linked scenarios. Important details like types of terrain and distances to travel were accurate – but some details were a bit altered (Aragorn is supposed to run downhill in the scenario; in ours he runs uphill). In the end, though, the feel of the woods, forest undergrowth and ancient ruins all added to the effect of putting us into the action! It was a treat to play on, and all that scenery-making work was absolutely worthwhile!

"Not only are Tolkien fanatics getting the first live-action movie based on Tolkien's world, but we are getting an incredible trading card game to help us relive that world...believe me, it is a winner in every sense of the word."

-Andrew Parks, longtime Tolkien gaming fan

"I truly believe it will go down as one of the best TCGs of all time... it will meet or surpass everyone's expectations."

-Nigel Jefferson, longtime Magic: The Gathering TCG player and high-level tournament judge

"GREAT GAME, SOLID MECHANICS, FANTASTIC PICTURES..."

-JAMES KIGHT, #1 RANKED MIDDLE EARTH CCG PLAYER AND FOUNDER OF MECCG NEWSLETTER

"...The Lord of the Rings TCG is the best new game I've seen in a long, long time. Like the One Ring itself, once you have experienced its power, you cannot let it go!"

-Tim Burall, 20-year gaming veteran

"...The Lord of the Rings TCG is a refreshingly creative game faithful to story and spirit of Tolkien's masterpiece. It is sure to put more than a few smiles on the faces of new and experienced gamers alike."

-David Akers, DeckTech.net





ARWEN
DAUGHTER OF ELROD

COMPANION • ELF

Range: While skirmishing a Nazgûl, Arwen is strength +3.
If she had been in the land of her mother's kin, she would have been a queen, and she has lately returned to Rivendell in her father's house.

ARAGORN
RANGER OF THE NORTH

COMPANION • MAN

Range: Whenever Frodo Aragorn to make him Defender +1 until the regroup phase.
"Early on, we see... heights of the wild, hunters... but hunters, eyes of the mountains of the Coerent..."

CONDITION

To play, exert a C -Cost. Plays on a companion.
Each time bearer is assigned to a skirmish, the Free Peoples Player chooses to either discard 3 cards from hand or add a burden.
The Company must defend the Ring in all cases.

GIMLI
SON OF GLIM

COMPANION • DWARF

Damage +1. Skirmish! Exert Gimli to make him strength +2.
"There was a stronger heart at Glóin's side than was Gimli's."

PHILOU'S BANE

Response: If bearer is about to take a wound, he swears. The One Ring until the regroup phase.
While wearing the One Ring, each time the Ring-bearer is about to take a wound, add 2 burdens instead.
"...the Ring slipped from his finger as he swears..."

CONDITION

Plays to your support area.
The twilight cost of your M events is -1. Skirmish! Discard this condition to make an Uruk-hai strength +2.
"We must have power, power in order things of us will for the Good which only the Wise can see."

EVENT

Skirmish! Make an Uruk-hai strength -1 and damage +1.
"Find the Halflings!"

FRODO
OLD BRASS' HEIR

COMPANION • HOBBIT

Ring-bearer (resistance 10).
At the start of each of your turns, you may heal a Hobbit ally.
"But he that as it were... He Frodo is as near a young hobbit as you could wish to meet."

CLAIRE ATTEA
KEEPER OF DOL GULDUR

MINION • NAZGÛL

Fierce. Skirmish! Remove C to make Claire Attea strength +1 (limit +5).
"More than any, the most power of kings were placed in particular ways for the Will of Sauron."

THE LORD OF THE RINGS
TRADING CARD GAME

MAIL ORDER



Chaos Space Marine Variants

The models on this page can be used to create Chaos Space Marines for a Black Legion army or any other Chaos Legion. From the ancient pre-Heresy suits of power armour, to the warped and corrupted suits of the Traitor Legions, the variety of armour types used by Chaos Space Marines is huge. These only represent a brief selection of all those available.

For more information please call Mail Order on 0115 91 40000.



**Chaos Space Marine
Champion 1** £4
010202701



**Chaos Space Marine
Champion 2** £4
010200403

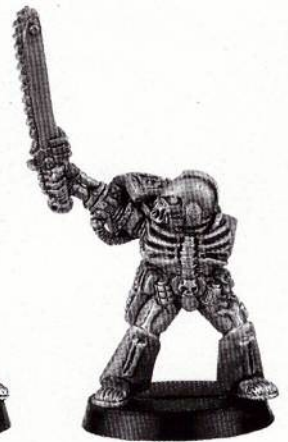

**Legion of the Damned
Sergeant 1** £2
010103601



**MK2 'Crusade'
Armour** £2
70106/45



**MK4 'Maximus'
Armour** £2
70106/47



**MK5 'Heresy'
Armour** £2
70106/46



**Legion of the
Damned 1** £2
010109605



**Legion of the
Damned 3** £2
010109667



**Legion of the
Damned 6** £2
010109610



**Legion of the
Damned 12** £2
010109732



**Legion of the
Damned 14** £2
010109734



**Chaos
Marine 1** £2
010202903



**Chaos
Marine 2** £2
010202904



**Chaos
Marine 3** £2
010202905



**Chaos
Marine 4** £2
010202906



**Chaos
Marine 5** £2
010202907

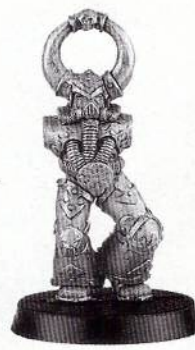

**Chaos
Marine 6** £2
010202908



**Chaos
Marine 7** £2
010200402



Chaos Space Marine
Arms Frame 1
102805A



Chaos Space Marine
Arms Frame 2
102805

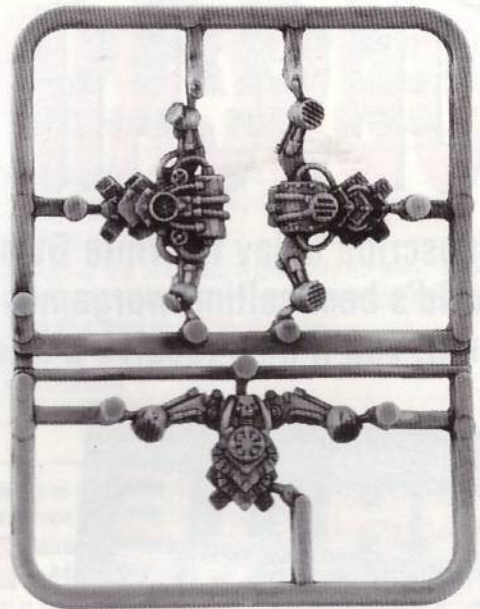

Chaos Space Marine Backpack Frame
102794



Chaos Space Marine Close
Combat Weapons Frame 1
102813/1



Chaos Space Marine Close
Combat Weapons Frame 2
102813/2

Chaos Accessory Frames £1 each

These plastic frames are the perfect way to add the finishing touches to your Chaos Space Marines. With two types of arms frames offering a variety of positions, along with a Chaos boltgun and bolt pistol, you can make your Chaos Space Marines totally unique. The Chaos Space Marine Close Combat frames allow you to equip your Chaos Space Marines for bloodthirsty close combat, while the Chaos Space Marine Backpack frame will complete your models. Phone Mail Order on 0115 91 40000 for more details on the variety of accessory frames available.

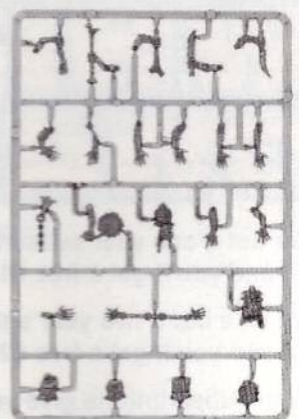
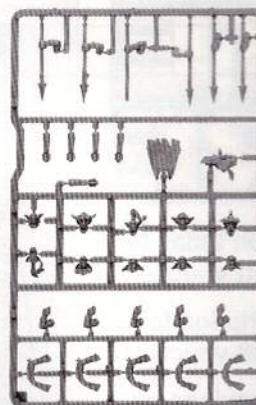
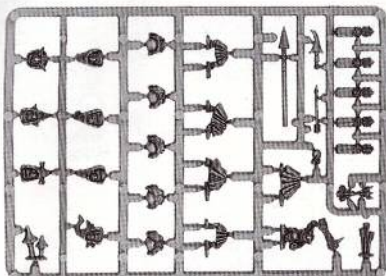

Build your own Goblins!

The Warhammer regiment frames are the perfect starting point for building your own Goblin variants. These plastic kits are cross compatible, enabling you to mix and match body parts to build your own specialist Goblins according to the new variants listed in Warhammer Chronicles this month. You can buy the Warhammer regiment frames separately from Mail Order; just give them a call on 0115 91 40000 for more details.



SUBSCRIPTION OFFER!

Subscribe today to White Dwarf magazine and you'll not only get the world's best selling wargames magazine delivered to your door every month, you'll also receive a free gift voucher and regular special offers!

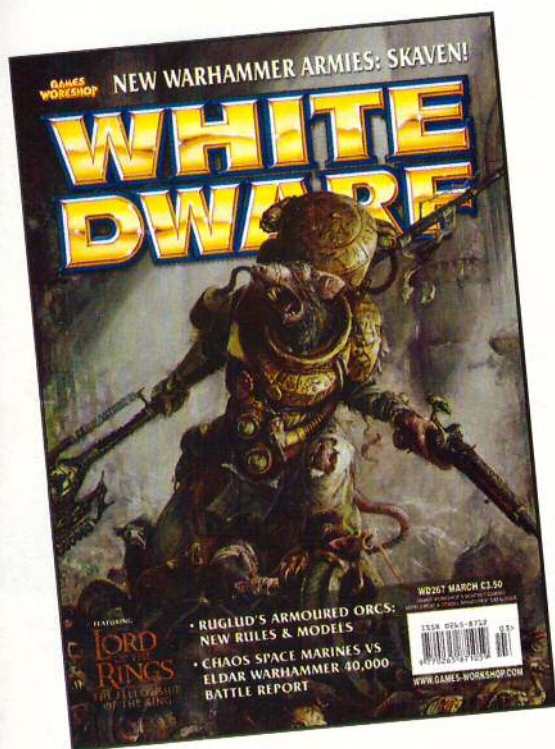

WHITE DWARF

Take out a one year subscription today for £40 and you'll get a free £10 gift voucher!

Or take out a two year subscription for £80 and you'll get a free £25 gift voucher!

Both subscriptions give you savings on the cover price, regular subscriber-only special offers and your magazine is delivered straight to your door!

Call now on 0115 91 40000
or visit our on-line store at
www.games-workshop.com
for more details!

GW MAIL ORDER

WILLOW ROAD, LENTON, NOTTINGHAM, NG7 2WS, UK

• Component part service

Mail Order has an extensive range of current and back catalogue miniatures.

• Delivered to your door

You can order and receive your miniatures in the comfort of your own home. Set postage rates no matter how much you order!

• Rules service and advice

If you have a gaming or hobby question, give us a call.

• Advance order

Why wait for that new release? If you like a product, place an advance order. You benefit from special postage rates and receive your order on the day of release!

• Open 7 days a week

8am to 10pm. Hours may vary on Bank Holidays.

Contacting us by phone

Mail Order have set up phone lines specifically for different European language speakers to make using Mail Order even simpler! These lines offer all of the great Mail Order services including the archive service, the rules & advice service and component part service.



UK
0115 9140000

We have a dedicated team ready and waiting to take your calls. Phone us now to place your order, and also find out the latest deals, special offers, and upcoming new releases.



Dutch
++44115 9168255

Deze telefoonlijn is speciaal opgezet voor onze Nederlandstalige klanten. Een Nederlandstalige telefoon operateur is ter beschikking voor al uw telefoontjes. Indien de lijn bezet is wordt u doorverbonden met een Engelstalige operateur.



Danish
++44115 9188506

Denne linie er specielt lavet til de danske kunder. En Dansk talende trold sidder klar og venter på dit opkald. Hvis linien er optaget vil du blive sendt videre til en Engelsktalende operatør.



Swedish
++44115 9188507

Denna linje är speciellt för svenska kunder. En svensk talande operatör väntar på ditt samtal. Om det är upptaget koplas samtalet till en engelskoperatör.

USING MAIL ORDER

Using Mail Order couldn't be easier. You're just four steps away from the miniatures or army that you've always wanted:

1: Choose your purchases

Choose the miniatures and products that you would like to order from these White Dwarf pages, the 2002 Catalogue or some of the many mailshots that we send to regular Mail Order customers.

2: Place your order

- You can contact us by phone on one of the numbers in the box above.
- You can FAX us on 0115 916 8002.
- Make your order in your local Games Workshop store.
- Or, if you prefer, you can use our on-line store at www.games-workshop.co.uk.
- You could also fill in the form below and pop it in the post to the address at the top of the page.

3: Postage & Packaging

- If you live in the UK you have three choices.
- For £7 your order will be picked and dispatched by Special Delivery, and will be delivered the next day (Mon-Thurs) if you place your order before 1pm.
 - For £4 your order will be picked and dispatched by First Class post, and should be with you within 3-4 working days.
 - For £3 your order will be picked and dispatched by Second Class post and should be with you within 7-10 working days.

Postage and packing on overseas orders is dealt with by weight. Please call one of our Phone operators for details. If you notify us within seven days of receipt that you wish to cancel your order, Mail Order will be pleased to offer you a credit note or refund your money as soon as you return the items in question.

4: Unpacking & Playing

All that remains now is to unpack your purchases and get them on the battlefield!

| DESCRIPTION/CODE | PUBLICATION/PAGE | PRICE | QTY | TOTAL |
|------------------|------------------|-------|-----|-------|
| | | | | |
| | | | | |
| | | | | |

Cheques to be made payable to *Games Workshop Ltd.*
Cheques over £100 must be guaranteed. Sterling only.

| | |
|----------------------|--|
| SUBTOTAL: | |
| POSTAGE & PACKAGING: | |
| GRAND TOTAL: | |

Name: Date of Birth:

Address:

Postcode: Country: Tel:

Email Address:

Method of Payment: Postal Order(UK only) Cheque Mastercard Visa Switch/Delta

Card No:

Expiry Date Switch/Delta Valid from: Switch/Delta Issue No:

Cardholder Name:

Cardholder Signature:

NEXT MONTH:

CHITTERING HORDES!

- Collecting a Skaven army
- Skaven 'Eavy Metal masterclass
- Throt the Unclean feature

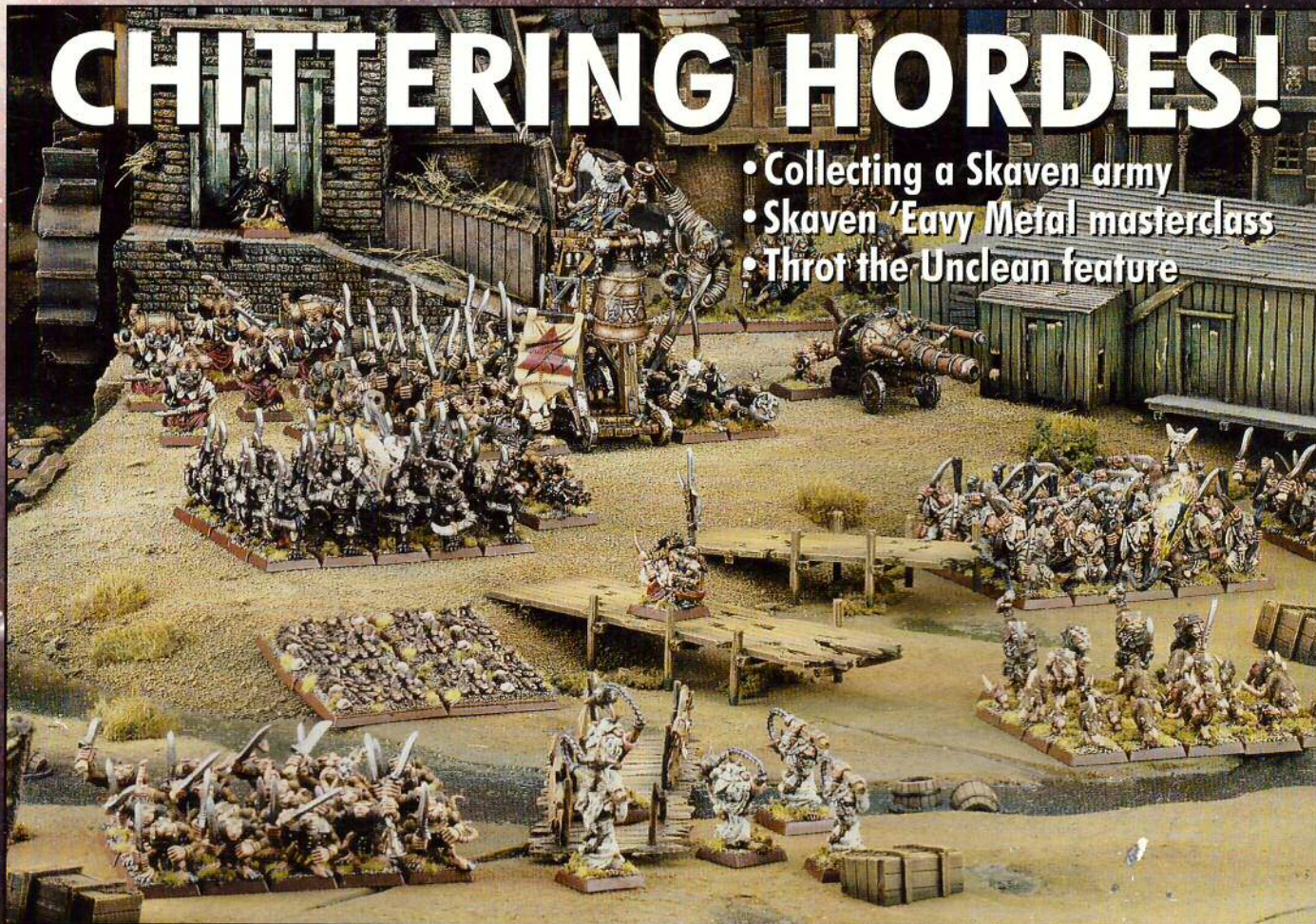

GAUNT'S GHOSTS

New Novel by Dan Abnett...

IN THE GRIM DARKNESS OF THE FAR FUTURE THERE IS ONLY WAR!
THE GUNS OF TANITH
A GAUNT'S GHOSTS NOVEL BY DAN ABNETT



...and New Rules & Models for Warhammer 40,000.



INQUISITOR

Battle Report

