

# GAMES WORKSHOP®

PRESENTS ITS MONTHLY HOBBY SUPPLEMENT AND MINIATURES CATALOGUE



CITADEL  
MINIATURES®

185  
£2.50

# WHITE DWARF



ISSN 0265-8712



9 770265 871035 05



THE MORDIAN IRON GUARD FIGHT OFF AN ORK ATTACK



PRINCE TYRION LEADS THE HIGH ELVES AGAINST A HORDE OF SKAVEN



AUDITED AT 60,968  
COPIES PER MONTH  
IN THE UK

# WHITE DWARF™

Issue 185  
May 1995  
Product Code: 0901  
Ref. No: 00901s  
ISSN: 0265-8712  
Editor: Robin Dews

## CONTENTS

### COVER: CODEX ULTRAMARINES – *Dave Gallagher*

#### GW AND CITADEL NEWS

All the latest news from Games Workshop and Citadel Miniatures.

2

#### SPACE MARINE WHIRLWIND – *Ian Pickstock*

The latest vehicle to reinforce the Imperial arsenal is the Space Marine Whirlwind. In this article, Ian provides the full rules for using this deadly new Rhino variant in your **Warhammer 40,000** games.

8

#### 'EAVY METAL – *Studio 'Eavy Metal Team*

Lord Macragge, Master of the Ultramarines.

12

Space Marine Company Standard Bearer.

13

Space Marine Librarians.

15

Epic Warlord Titan.

29

#### DEATH OR GLORY! – *Alan Richmond and Gavin Thorpe*

Following on from the cunning strategies of Old Weirde's Tacticus and similar articles, we explain how you can use your army like a *Castle* to win your **Warhammer** battles.

17

#### CHIMERA ASSAULT! – *Andy Chambers*

Andy takes a look at three new Chimera variants – the Chimerax, Chimedon and Chimerro, and provides the rules and army cards to include them in your **Epic** Imperial armies.

26

#### GAMES DAY AND GOLDEN DEMON '95

We list all the categories for the **1995 Golden Demon Awards**.

31

#### 'EAVY METAL – *Studio 'Eavy Metal Team*

Warhammer characters.

36

#### ASTRAGOTH, HIGH PRIEST OF HASHUT – *Rick Priestley*

Astragoth is the most ancient of the malevolent Chaos Dwarf Sorcerers. In this article Rick explains Astragoth's special rules so that you can include him in your **Warhammer** games.

37

#### TALLARN DESERT RAIDERS – *Rick Priestley*

The latest of the Imperial Guard regiments come from the vast sulphurous deserts of Tallarn. Here are the rules to include these warriors in your games of **Warhammer 40,000**.

41

#### MISSION IMPOSSIBLE! – *Gavin Thorpe*

After last month's release of the **Warhammer Quest** game, Gavin offers new challenges for your Warriors with the addition of three deadly Special Quests.

46

#### WOLVES OF FENRIS – *Kim Syberg*

Kim is one of the Studio 'Eavy Metal painters, and this month we feature his personal collection of **Warhammer 40,000** Space Wolves. This is a brilliant army which has to be seen to be believed!

51

#### HOW TO MAKE AN EASY WARHAMMER BUILDING – *Rick Priestley and Robin Dews*

Once again Rick and Robin show you how to make great scenery with little more than an old Cornflakes packet!

59

### ADVERTS

Warhammer 40,000 Battles .....	6	Warhammer Quest Pit Fighter .....	50	Citadel Miniatures Catalogue .....	73
Games Workshop Retail Stores .....	16	Space Marine Land Speeder .....	53		
Warhammer .....	20	Space Marine Razorback .....	54		
The Exterminatus Roadshow .....	25	The Battle for Bugman's Brewery .....	58		
Grand Opening – Carlisle .....	30	Grand Opening – Altrincham .....	62		
Grand Opening – Wolverhampton .....	35	Grand Opening – Harrogate .....	66		
Grand Opening – Swansea .....	39	Grand Opening – Northampton .....	67		
Games Workshop – Basingstoke .....	45	Games Workshop Mail Order .....	68		





# WHITE DWARF®

First of all, I'd like to say a big thanks to all of you! We've already had a massive response to last issue's Reader's Survey, and all your views and ideas will help us to ensure that White Dwarf remains the best gaming and miniatures magazine available. In a couple of issues time we'll be able to announce the Mega-prize winner who will be going home with nearly £3,000 worth of Games Workshop games and Citadel goodies!

Work is continuing on the first exciting Warhammer Quest Adventure pack. Your brave Warriors will soon be able to venture into the dangerous domain of an Orc Warlord with new board sections, Treasure cards and an entire deck of Orcy Event cards.

Jervis Johnson is currently writing and playtesting Warhammer Armies – Dark Elves. To illustrate this exciting new book, Simon Smith, our resident

cartographer, who has produced all the wonderful maps you see in the other Warhammer Armies books, is getting to grips with Naggaroth, the land of the Dark Elves.

Finally, our 'Eavy Metal team are furiously painting some of the new Dark Elf models, which will be available soon. A meaner looking bunch is hard to imagine (the Dark Elf army, not the figure painters!).

## STUDIO STAFF

We are currently looking to recruit the following staff to join the team at our busy Nottingham Design Studio

### 'Eavy Metal Painters

The Design Studio is the creative hub of games Workshop, with the Citadel miniature painters at the forefront of the Studio production process. As a Studio painter, you have the opportunity to paint the very latest miniatures months ahead of their official release, and contribute towards our ever expanding range of products.

If you think you have the talent and flair to paint to the standard you see in White Dwarf every month, then take a sample of you best models along to your nearest Games Workshop store and have a chat with the manager. If he's impressed, then he'll arrange for your models to be brought up to the Studio where we can take a closer look at your work.

Pass that test, and we'll invite you up for an interview to see if you have what it takes to join the ranks of the very best miniature painters in the world!



### Production Editor/Proofreader

We are looking for a bright, cheerful, self-motivated person who will enjoy working in our busy Studio. We need someone with a very high standard of English – ideally with a minimum of A-level, who will positively enjoy searching for and correcting mistakes. The other vital qualification for this job is a thorough knowledge of Warhammer 40,000, Warhammer and the Epic Game System as many errors are only obvious if you can tell Orcs from Orks!

The job entails assisting with the layout and checking of all written material before it goes to press. This includes magazine articles, adverts, mail order pages, rulebooks, product boxes and all game components which incorporate text. The work involves checking for grammar, spelling, punctuation, missing words, repeated words, and incomplete sentences (a particular problem with desktop publishing!).

If the successful applicant proves able, we would like to extend their duties to a higher level of editing. This would involve working closely with our existing editors, turning raw copy into good, clean English. As our editors also do all the layout work, this includes working on an Apple Mac and using Quark Xpress. Editing at this level involves checking for internal consistency, logic, paraphrasing and in some cases actually rewriting, making sure the level of English is appropriate to the subject and the intended audience, and (as far as possible) making sure game rules make sense.

If you feel that you are the right person for this challenging job, please apply with a full CV to:

Helen King, Office Manager, Games Workshop Ltd,  
Chewton Street, Hilltop, Eastwood, Nottingham, NG16 3HY



**THIS MONTH'S  
WARHAMMER RELEASES**

**Krell - Lord of the Undead** £4.99  
(One miniature per blister)

**Astragoth - High Priest of Hashut** £4.99  
(One miniature per blister)

**Skaven Warfire Thrower** £4.99  
(One team per blister)

**Chaos Knight** £3.99  
(One mounted miniature per blister)

**High Elf Dragon Prince of Caledor** £3.99  
(One mounted miniature per blister)

**High Elf Reaver Knight** £2.99  
(One mounted miniature per blister)

**CHARGE!**

This month, you can increase the size of your mounted regiments with the release of three Warhammer cavalry models in individual blister packs.

The **Dragon Princes of Caledor** are the most heavily armoured High Elf warriors. These proud and veteran soldiers charge into battle mounted on swift Elven Steeds. The Dragon Princes' highly stylised armour can turn aside the most savage blows, while their keen lances rarely miss their mark. The fast, some would say rash, **Reaver Knights** of Ulthuan are the youngest sons of the High Elven nobility. Speed and skill are paramount to the lightly armoured Reaver Knights.



Dragon Prince

**WARHAMMER**

Many Reaver Knights also carry bows and constantly harry the enemy while the rest of the High Elves' forces gather to meet the threat.

The merciless **Chaos Knights** are some of the most formidable opponents in the Warhammer world. Clad in ancient Chaos armour and riding bestial, mutated Chaos Steeds, Chaos Knights can crush all but the most determined opposition in a single devastating charge.



**WARHAMMER BOOKS**

Three new Warhammer books hit the shelves this month. Both **Wolf Riders**, and **Red Thirst** contains short stories, involving some of your favourite heroes and heroines, plus a few new faces. Also **Harlequin** by Ian Watson continues where **Inquisitor** left off. These Warhammer novels by Boxtree books are available from Games Workshop stores and good bookshops, costing £4.99 each.

Watch out for Hogshead Publishing's re-print of the original **Warhammer Fantasy Role-Play** book. Over the next few months they are also planning to re-print all the original supplements and some new material as well!

**WARHAMMER HEROES**

The Chaos Dwarf armies now have a new Sorcerer. **Astragoth - High Priest of Hashut** is encased in an ingenious mechanical frame, which allows him to fight even though his body has partially turned to stone! **Krell - Lord of the Undead** is a mighty Undead character who was raised to Undeath by the mighty Nagash himself.

**WAR MACHINE**

New **Skaven Warfire Throwers** trundle ahead of the Clan Skryre this month. You can see them in all their glory in an 'Eavy Metal later in this issue

**WHITE DWARF**

**FREE NEXT ISSUE!**

On the front cover of the next issue of White Dwarf you'll find one of 8 different Warhammer Wizards. These **FREE!** miniatures include a Dark Elf Sorceress, a Chaos Sorcerer and six different Imperial Wizards. This issue is bound to sell out so order your copy now!

One of the eight different Wizards. **FREE!** next month.



## EXPORT DIVISION AREA SALES MANAGERS

# GAMES WORKSHOP

This is the cutting edge. This is where we put our specialised crack-troops. This is where you jump on a plane in the morning to see customers in far away places!



We are looking for dynamic individuals with the personality and skills to help expand Games Workshop across the globe. You must be into the hobby and also able to speak a foreign language. We would prefer one or more of the following:

**Dutch, German, Italian, French  
Japanese or Cantonese**

But if you speak Swahili and think there's a market for Games Workshop games then get in touch!

For this full-time position you must be over 18 and have a love of adventure and excitement.

Please write with a full CV to:

Helen King, Games Workshop, Head Office,  
Chewton Street, Hilltop, Eastwood, Nottingham NG16 3HY

# GAMES WORKSHOP

## RETAIL STORES KEY-TIME STAFF

Are you a fanatical gamer with time at the weekend?



Then you should be working for Games Workshop as a key-time sales assistant!

Games Workshop is dedicated to providing the best hobby support and customer service in the world. Right now we need to recruit Key-Time Sales Staff for the following stores:

**Guildford, Brighton,  
Bournemouth, Portsmouth  
and Crawley**

Like all Games Workshop staff, you should be cheerful, polite and enthusiastic, probably aged between 18 and 30 with a good knowledge of Warhammer, and Warhammer 40,000. Key-time staff receive the same training and benefits as full-time sales assistants ie: same hourly rates of pay, staff uniform and generous staff discounts, the only difference is that you would work an average of 16-20 hours per week, mainly at weekends. These hours may be increased over the school holiday period.

These positions would probably suit students or applicants who have other responsibilities during the week.

### How to apply

In the first instance, pop into one of these Games Workshop stores and ask the manager for an application form. Alternatively, ring Janet in our personnel department on 01773 769731 and she'll send you one.

Post your completed application form quoting REF/TK1 to:

Rob Griffiths, Retail Operations Manager, Games Workshop, Head Office, Chewton Street, Hilltop, Eastwood, Nottingham NG16 3HY

**THIS MONTH'S  
WARHAMMER 40,000 RELEASES**

Warhammer 40,000 Battles	£9.99
Eldar Aspect Paint Set (Boxed set of six paints)	£5.99
Dark Angels Paint Set (Boxed set of six paints)	£5.99
Space Marine Whirlwind (One model per boxed set)	£14.99
Marneus Calgar Ultramarines Commander (One miniature per blister)	£4.99
Space Marine Company Standard Bearer (One miniature per blister)	£2.99
Space Marine Techmarines (One miniature per blister)	£2.99
Space Marine Epistolary Librarian (One miniature per blister)	£2.99
Imperial Guard Tallarn Desert Raiders (Boxed set of ten miniatures)	£12.99
Mordian Iron Guard Lieutenant (One miniature per blister)	£2.75

**WHIRLWIND**

The new **Space Marine Whirlwind** mounts a devastating multiple rocket launcher to fire tremendous salvos of missiles at the Imperium's enemies. The kit includes a plastic Space Marine Rhino chassis and the special lead parts of the Whirlwind, and also contains sets of waterslide transfers for the Imperium's four main Space Marine Chapters. The rules and datafax for this latest Warhammer 40,000 vehicle can be found later in this issue.

**WARHAMMER  
40,000**

**WARHAMMER 40,000 BATTLES**

In response to popular demand, we've now compiled all of the best Warhammer 40,000 articles published in White Dwarf over the last year or so into a single volume entitled **Warhammer 40,000 Battles**. This mammoth 128 page book contains battle reports, tactics articles and new rules for the Warhammer 40,000 game. We've also included full-colour card versions of the Space Marine Razorback datafax, new vehicle cards and mission cards and three Battle Bunkers for you to cut out and use in your Warhammer 40,000 games.



*Mordian Iron Guard Lieutenant*

**ULTRAMARINES**

Also released this month is Jes Goodwin's mighty **Marneus Calgar – Lord Macragge, Master of the Ultramarines** and general hard dude! Armed with the awesome *Gauntlets of Ultramar*, the powerful commander of the Ultramarines leads the finest Space Marine Chapter into the thick of battle. Striding beside him is the **Space Marine Company Standard Bearer**, proudly holding aloft the Space Marines' banner, proclaiming the company's honours.

**DESERT RAIDERS**

From a grim and forbidding world of rocks, dust and sand come the **Tallarn Desert Raiders**. These fearsome soldiers are amongst the most hardened regiments of the Imperium. Their full background is given later in this issue, together with an 'Eavy Metal page.

**Warhammer Quest**



*Gary Morley's splendid Warhammer Quest Pit Fighter miniature.*

**PIT FIGHTER**

The first in the brand new range of **Warhammer Quest** expansions is now available. The **Pit Fighter** is a brutal Warrior who has escaped from his master to seek fame and fortune in the hazardous dungeons and catacombs beneath the Old World. Written by Gavin Thorpe, this new Warhammer Quest Warrior pack contains everything you need to go adventuring with the Pit Fighter and includes: a 12-page rulebook, a full-colour Warrior card, together with new equipment cards and an absolutely stunning Pit Fighter miniature designed by Gary Morley.

**WARHAMMER QUEST  
RELEASES**

Pit Fighter Warrior Pack (Boxed set with one model, cards, counters and rulebook)	£9.99
Blank Event Cards	£3.99
New Treasure Cards	£4.99

**NEW CARD PACKS**

Also now available this month are two new packs of cards for Warhammer Quest. The first of these contains 54 new full-colour Treasure cards to add dozens of exciting new items to your existing deck.

We've also published a pack of extra blank Event cards. These enable you to include all the monsters from your miniature collection

# WARHAMMER

## 40,000



Warhammer 40,000 Battles is a compilation of the most sought after Warhammer 40,000 articles from White Dwarf magazine. This book contains four complete battle reports featuring the forces of the Ultramarines, Eldar, Blood Angels, Orks and Space Wolves. It features new rules and datafaxes for the Lemman Russ battle tank and the Space Marine Razorback plus special tactics for using these vehicles in your games. Also included are three card Battle Bunkers for you to assemble, a Battle Bunker datafax, two new mission cards and a bonus scenario for the Battle for Armageddon campaign!



**WARHAMMER 40,000 BATTLES IS NOT A COMPLETE GAME.  
YOU NEED A COPY OF WARHAMMER 40,000 AND DARK  
MILLENNIUM TO USE THE CONTENTS OF THIS BOOK.**

Citadel, the Citadel castle, Games Workshop, the Game Workshop logo, Warhammer and White Dwarf are registered trademarks of Games Workshop Ltd. Ultramarines is a trademark of Games Workshop Ltd.  
© Games Workshop Ltd, 1995. All rights reserved.



CITADEL<sup>®</sup>  
MINIATURES

GAMES<sup>®</sup>  
WORKSHOP





**FISTS OF DEATH!**

The ground trembles beneath the tread of the towering **Imperial Warlord Titan**. As this monolithic war machine strides into battle, its weapons rain death down upon the enemy. Whether the mighty machine battles alone or as part of an Imperial Titan battle group, the Warlord can more than hold its own against the enemies of humanity. The Titan comes equipped with the Gatling Blaster, potent Volcano Cannon, Chainfist and dreaded Vortex missile.

The new Warlord Titan model has been designed by Dave Andrews and really captures the sheer might and power of these towering war machines.

**CHIMERA ASSAULT!**

The Adeptus Miniature Designicus workshops on Mars have also been working overtime this month and have produced three new variants based on the Imperial Chimera troop carrier.

**THIS MONTH'S EPIC RELEASES**

- Imperial Warlord Titan** £9.99  
(One model per boxed set)
- Imperial Chimerro** £4.99  
(Three miniatures per blister)
- Imperial Chimedon** £4.99  
(Three miniatures per blister)
- Imperial Chimerax** £4.99  
(Three miniatures per blister)

**GAMES WORKSHOP**

**HARROGATE**

**NOW OPEN AT:**

**29 Beulah Street  
Tel: 01423 564310**



**GAMES WORKSHOP**

**RETAIL STAFF**

Throughout 1995, Games Workshop is planning to open dozens of new hobby stores throughout the UK. In order to staff this expansion, we need to recruit more enthusiastic and energetic people as Sales Staff and Retail Managers.



**Retail Managers**

As well as having a thorough knowledge and understanding of Warhammer, Warhammer 40,000 and the Epic game system, our ideal applicant will be bright, enthusiastic and have had some previous experience in a retail environment, preferably with some supervisory duties.

**Sales Staff**

If you are young, energetic and have a good knowledge of all our games, you should be working for Games Workshop!

**How to Apply**

First of all, you need to apply in writing on a Games Workshop staff application form. These are available from all Games Workshop stores, or by phoning Janet in personnel on: 01773-769731

Once you have completed your application form, send it to:

**Rob Griffiths, Retail Operations Manager  
Games Workshop Ltd, Chewton Street, Hilltop, Eastwood, Nottingham NG16 3HY**

## SPACE MARINE® WHIRLWIND™



Space Marines are trained to operate all manner of machines and more than any other warriors of the Imperium they can adapt to fulfil any combat role. All Space Marines are able to act as crew for the vehicles maintained in each Chapter's armoury. It is normally the Tactical squads which provide vehicle crews. When fighting in this role they replace their normal tactical markings with crew badges, but otherwise they retain their company colours and Chapter insignia as normal.

Whilst each company has its own Rhino carriers the remaining vehicles in a Chapter form a pool which is available as required. These vehicles are either deployed as massed formations, wholly independent from the companies, under command of a senior officer. Alternatively they may be allocated to an individual company under the command of its Captain.

In the latter case the vehicles are given appropriate company badges and are assigned a simple number: I, II, III, IV etc. This number is repeated on the crews' badges. It is perfectly possible that a company may have a large number of armoured vehicles allocated to it and under command of its Captain.

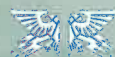
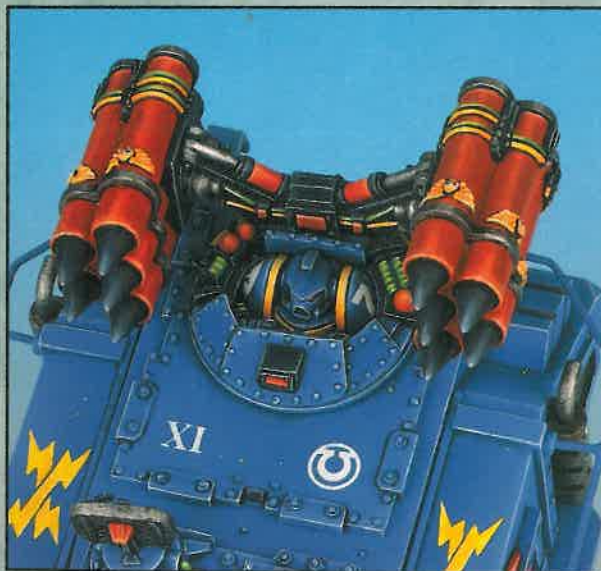

ARMoured VEHICLE INSIGNIA



WHIRLWIND DESIGNATION



COMPANY BADGE

This Whirlwind is part of the 2nd Company.



IDENTIFICATION NUMBER

This is the eleventh vehicle attached to the 2nd Company.

# WARHAMMER

## 40,000

## SPACE MARINE WHIRLWIND

by Ian Pickstock

Advancing just behind the first wave of the Space Marine attack, the Whirlwind showers the enemy with a barrage of deadly fragmentation missiles. There is no escape from these deadly strikes as the Whirlwind's sophisticated detection devices enable it to fire at targets even if they are hidden by terrain!

### FAST SUPPORT

The Whirlwind is one of the most common variants of the Rhino troop carrier and is used by both the Imperial Guard and Space Marines. However, as the Imperial Guard have many other types of artillery it is much more common amongst the armies of the Adeptus Astartes. The Space Marines' role as a mobile strike force also means that they can ill afford to be slowed down by ponderous artillery. The Whirlwind is the perfect solution to this need for fast, mobile support.

### LETHAL FIREPOWER

All Space Marine Commanders recognise the importance of good supporting fire, especially against numerous foes such as the Orks or the highly mobile forces of the Eldar. It is vital that swift retribution is delivered before they can take advantage of the Space Marines' lack of numbers. This is where the Whirlwind comes into its own by combining the manoeuvrability of the Rhino with the devastating punch of a multi-launcher.



*An Ultramarines Whirlwind supports the Space Marines' assault against a band of Orks.*



The Whirlwind's multi-launcher can hold up to ten rockets. Each rocket is propelled by solid fuel and carries a fragmentation warhead. The multi-launcher fires in programmed salvos of two rockets at a time, using sophisticated target acquisition systems to guide home the missiles and maximise the concentration of fire, creating a barrage far deadlier than that of a standard frag missile. This makes the Whirlwind the perfect choice for attacking heavily defended positions, with its ability to blast holes in enemy front lines and accompany a spearhead attack to exploit newly created weaknesses.



**WHIRLWIND MULTI-LAUNCHER**

The multi-launcher carries ten rockets, which are programmed to be fired in salvos of two. If you are playing a normal game you will have enough rockets to last the duration of the battle. However, if you are playing a longer battle of six turns or more, then you will have to keep track of your ammunition expenditure. Use counters or a dice placed next to the model, or make a note on a piece of paper, to keep track of the number of shots fired.

Short Range	Long Range	To hit Short	To hit Long	Strength	Damage	Save Modifier	Armour Penetration	Special
0-20	20-72	-	-	5	D4	-2	D6+D4+5	3" Blast marker, may fire indirectly

The two rockets are primed to explode together creating a devastating barrage. A multi-launcher uses the 3" blast marker from the Warhammer 40,000 boxed game. Place the blast marker and roll to hit as normal (the gunner has a Ballistic Skill of 4, and the multi-launcher is equipped with a targeter). If the multi-launcher misses then the shot scatters. Roll an Artillery and a Scatter dice together near the intended target and consult the following table.

**IF YOU MISS...**



If a HIT and a MISFIRE is rolled this indicates that a malfunction has occurred in the multi-launcher. Roll a D6 on the **Multi-launcher Malfunction Table** to determine exactly what has gone wrong.



If an 'Arrow' and a MISFIRE is rolled this indicates that the rockets were duds and the barrage has no effect at all.



If an 'Arrow' or HIT and a number is rolled move the blast marker a number of inches equal to the Artillery dice roll, in the direction indicated by the arrow (there is a small arrow over the 'I' in HIT).

**MULTI-LAUNCHER MALFUNCTION TABLE**

D6	Result
1-2	Faulty launch tubes cause the rockets to detonate inside the launcher. The Whirlwind is ripped to pieces in a blaze of destruction, destroying the Whirlwind and killing the crew. Any models within 3" suffer D6 Strength 10 hits with a -3 saving throw modifier.
3-4	The firing mechanism is fused and no barrage is fired this turn. The rockets are expended and should be marked on the ammo expenditure. In subsequent turns the multi-launcher may only be fired if you first roll a 4 or more on a D6.
5-6	The rockets are duds and fail to fire. The rockets are expended and should be marked on the ammo expenditure. The multi-launcher will be ready to fire as normal in your next turn.

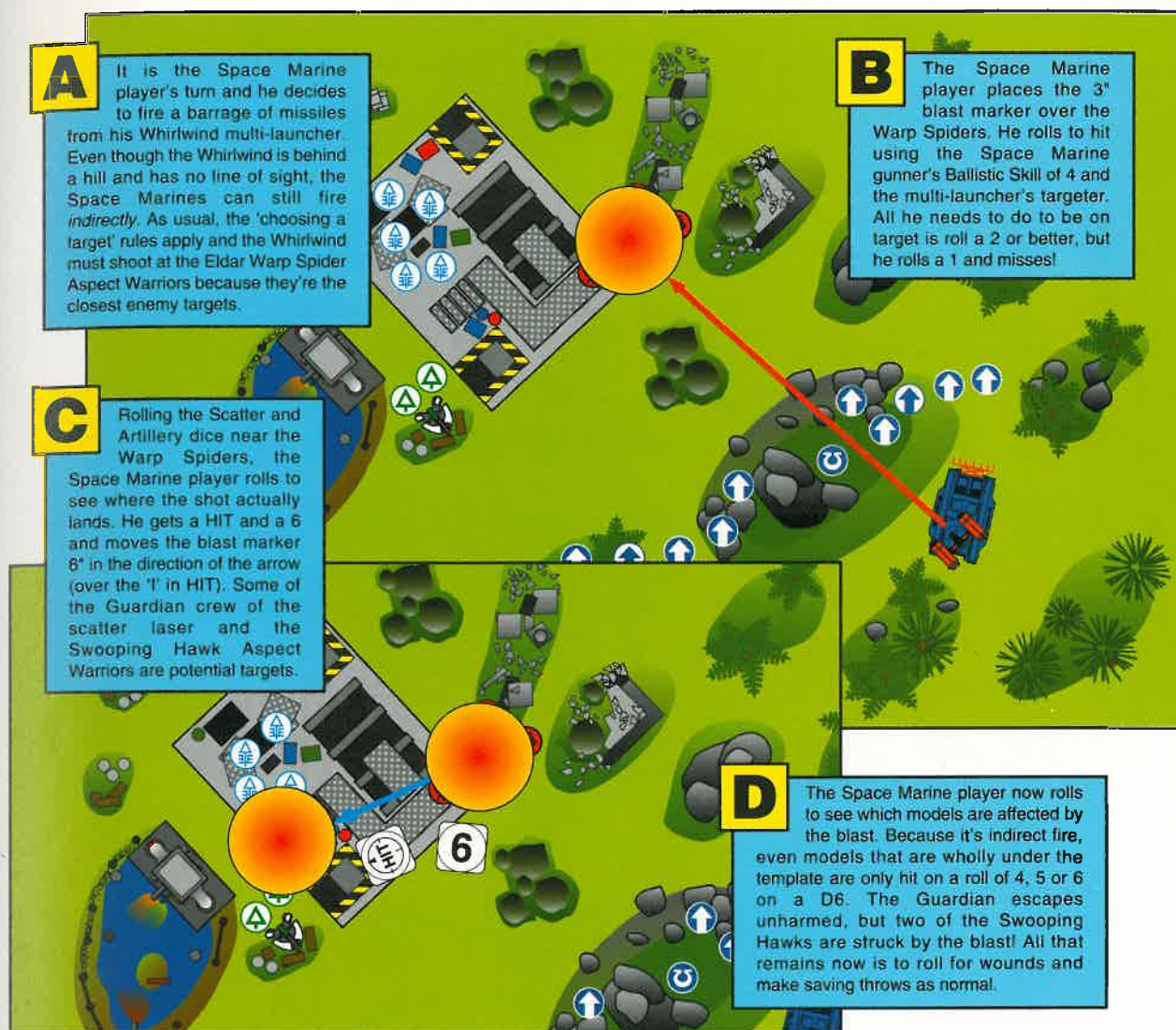

## INDIRECT FIRE

The Whirlwind is equipped with a sophisticated scanning device. This device employs a bio-scanner and an energy scanner enabling it to distinguish all enemy troops, vehicles and defended positions. The scanner sweeps the whole area locating enemy units and calculating their position on the battlefield. This information allows the Whirlwind crew to fire on enemy troops that they can't see. This procedure is known as indirect fire.

When firing indirectly you may shoot at any enemy models that are within range of the multi-launcher, even if a direct line of sight can't be drawn to the target from the Whirlwind (note that the 'Choosing a Target' rule on page 29 of the Warhammer 40,000 rulebook still applies). Place the 3" Blast marker where you want the shot to land and roll to hit as normal. If you miss, establish where the barrage lands using the scatter rules on the previous page. Normally, models completely under a blast marker are hit automatically, but as indirect fire is less accurate than direct fire, any models or vehicle locations wholly or partially under the blast are only hit on a D6 roll of 4, 5 or 6. Once you've worked out who has been hit, make damage rolls and saving throws as normal.

## ARMY LIST - SUPPORT SECTION

### SPACE MARINE WHIRLWIND ..... 150 points

The Space Marine army must include at least one Techmarine in order to have any Whirlwinds. The Whirlwind is a variant of the Rhino made by attaching a multiple missile launcher to its roof. The interior carries missiles and guidance equipment. In battle, the Whirlwind is used to provide medium range supporting fire for the advancing Space Marines.

PROFILE	M	WS	BS	S	T	W	I	A	Ld
Space Marine	4	4	4	4	4	1	4	1	8

**CREW:** A Space Marine driver and a Space Marine gunner.

**WEAPONS:** One multi-launcher. In addition the crew are armed with bolt pistols.

**ARMOUR:** All crew wear power armour (3+ save).

**OPTIONS:** The Whirlwind may be fitted with auto-launchers, loaded with either frag or blind grenades, at an additional cost of +5 points.



# LORD MACRAGGE

## MASTER OF THE ULTRAMARINES



PERSONAL BANNER

Marneus Calgar is the current Master of the Ultramarines Chapter. An imposing sight in his splendid armour, Calgar is a very formidable warrior. Hero of countless wars and innumerable battles, his expertise is almost unparalleled throughout the Imperium. He is especially effective when fighting against the Tyranids as personal, bitter experience has concentrated his attention on their strategies and hardened his will to defeat them. As the Lord of Macragge he wears the awesome Gauntlets of Ultramar. These ancient but powerful weapons are the badge of office for the Master of the Ultramarines Chapter and have been worn through the ages by each successive holder of that high rank.



MARNEUS CALGAR



THE GAUNTLETS OF ULTRAMAR

# TECHMARINES

The Techmarines of any Chapter stand apart from the rank and file of the fighting companies. As devotees of the Cult Mechanicus they provide the Chapter with technological competence and maintenance. Without them the Chapter's weapons and equipment would atrophy and fail.



TECHMARINE



Although their armour is highly modified it still resembles that of their Space Marine cousins. Shoulder insignia retains the heraldry of their parent Chapter and displays the badge of a Tech-Priest adept. Outside the Adeptus Mechanicus they are the only ones honoured in this fashion.



TECHMARINE



TECH-PRIEST BADGE



CHAPTER HERALDRY

## COMPANY STANDARD BEARER

The Company standards are possibly the most revered of all the Chapter's artefacts. Each standard has proudly flown over hundreds of battlefields and every Space Marine will understand the exact meaning of every nuance and reference that has been woven into their lavish designs. The standards are predominantly blue, the Chapter colour, with borders and decorations in the Company colour.

The Standard Bearer is a hand picked veteran chosen specifically for his bravery and steadfastness. He is also a more than capable warrior not to be discounted when assessing the Chapter's fighting strength.



ULTRAMARINES  
2nd Co. STANDARD



WREATH  
BADGE



CHAPTER  
SYMBOL



ULTRAMARINES 2nd COMPANY  
STANDARD BEARER



### 3rd COMPANY STANDARD

This banner is the youngest in the whole Chapter having only comparatively recently been presented to the 3rd Company. The Company earned great respect during the scouring of the polar fortresses of Macragge during the First Tyrannic War. The banner illustrates one of the many trophies won during the scouring.



### 4th COMPANY STANDARD

The 4th Company of the Ultramarines is known as the 'Defenders of Ultramar'. The banner incorporates several references to Ultramar, notably the steel gauntlet design and the star constellation. Again, there are references to the Tyrannic Wars on the honour scroll beneath the main banner design.



### 5th COMPANY STANDARD

The 5th Company standard displays the classic version of the Imperial eagle motif. All the Company banners display most of the elements seen here. The eagle, wreath, skull, scroll and Chapter icons are the very core of the Chapter's heraldry and are repeated throughout.

To assemble your datafax, first photocopy or cut the card from this page and fold it in half along the dotted line. Spread a thin layer of glue across the back of the card and press the two halves firmly together. If you want to make your datafax a little more hard-wearing, it's a good idea to insert a thin layer of card (cereal packet is ideal) between the two halves before you glue them together.

# SPACE MARINE WHIRLWIND



## VEHICLE DATA

### CREW:

- 1 SPACE MARINE DRIVER
- 1 SPACE MARINE GUNNER

### RAM VALUE:

- STRENGTH 7
- D12 DAMAGE
- 5 SAVE

### MOVEMENT:

- SLOW SPEED: 8"
- COMBAT SPEED: 18"
- FAST SPEED: 25"
- TYPE: TRACKED

### WEAPONS:

One Multi-launcher mounted in the turret. The Whirlwind is fitted with a targeter and has a 360° field of fire. The Whirlwind may be fitted with a set of auto-launchers carrying frag or blind grenades at an additional cost of +5 points.

## WEAPON DATA

WEAPONS	RANGE		TO HIT		DAM.	STR.	SAVE MOD.	ARMOUR PENE.	SPECIAL
	SHORT	LONG	SHORT	LONG					
Multi-launcher	0-20	20-72	-	-	D4	5	-2	D6+D4+5	3" Blast Marker
Auto-launcher	6	-	-	-	As Grenade	Type	-	-	-
Frag Grenade	-	-	-	-	3	1	-1	D6+4	2" Blast Marker
Blind Grenade	-	-	-	-	-	-	-	-	2" Blast Marker



**POINTS COST: 150 points**

D6	Location	Armour	
		Front	Side / Rear
1	Track*	15	15
2-4	Hull	20	18
5-6	Turret	20	18

### D6 Track Damage Table

- The track is damaged but keeps running. The Whirlwind may only move at slow speed for the rest of the game.
- 2-5 The track is blown off. The Whirlwind moves out of control next turn and comes to a permanent halt for the rest of the battle.
- A track is blown off and the resulting damage smashes the vehicle's drive shaft, causing it to flip over. The wreck comes to rest D6" away in a random direction. Any model it lands on takes D6 S7 hits with a -2 saving throw modifier. Roll a D6 for each model on board. They are killed in the crash on the D6 score of 4, 5 or 6. Surviving models may dismount using the normal rules.

### D6 Hull Damage Table

- The driver is killed. Unless his position is taken over the Whirlwind will move out of control for the rest of the game.
- 2-3 A large explosion tears through the crew compartment. Roll a D6 for each crew member. On a roll of 4, 5 or 6 they are hit and killed.
- The Whirlwind's engine explodes, killing the crew. The Whirlwind is spun round to face in a random direction by the force of the explosion and then comes to a permanent halt.
- A spark ignites the Whirlwind's fuel tanks and it bursts into flames, killing all the crew. The flaming wreck moves out of control next turn and then explodes. Anything within 3" of the point where it ends up is caught in the explosion, suffering damage exactly as if hit by a heavy flamer.
- The Whirlwind's ammunition explodes. The Whirlwind is destroyed and any models within 3" suffer D6 strength 10 hits with -3 saving throw modifier.

### D6 Turret Damage Table

- The Whirlwind multi-launcher mounted in the turret is damaged. It may not fire indirectly and may only be fired if you first roll 4 or more on a D6.
- The multi-launcher goes haywire and fires a barrage at a random target. Roll a Scatter dice to determine the direction of the barrage. Place the 3" blast marker on the first model (friend or foe) within range and in its path, and work out the effects of the barrage as normal. The rockets are expended and the multi-launcher may not fire next turn.
- The turret gunner is killed. Unless his position is taken over by another crewman the Whirlwind's multi-launcher may no longer be fired.
- 4-6 The ammunition stored in the turret explodes and the Whirlwind is destroyed. All the crew are killed and the turret is blown off, flying 2D6" in a random direction before it crashes to the ground. Anything under the spot where the turret lands takes D6 Strength 9 hits with a -6 saving throw modifier.





# SPACE MARINE LIBRARIANS



ULTRAMARINES EPISTOLARY



CHAPTER SYMBOL



EPISTOLARY BADGE



BLOOD ANGELS EPISTOLARY



CHAPTER SYMBOL



EPISTOLARY BADGE



A BLOOD ANGELS EPISTOLARY LEADS THE SPACE MARINE ASSAULT

# GAMES WORKSHOP®

## A WORLD OF FANTASY GAMING

The first thing you notice when entering a Games Workshop store is how different it is from nearly every other shop. Here you'll find not only all you need for the gaming hobby, but much more besides. With friendly, approachable staff and a vast range of Citadel Miniatures, you'll find everything you need to build up an army or team for Warhammer 40,000, Blood Bowl, Warhammer, or the Titan Legions/Space Marine Epic game system.

### STORE OPENING TIMES

10 am to 6pm Monday to Friday  
9.30am to 5.30pm Saturday

Every Thursday is **Games Night** when most of our stores stay open until 8pm. Whether you're an experienced gamer or a total novice our staff will be happy to see you, so why not come along and join in the fun!

### SUNDAY OPENING

The following stores are also now open every Sunday:

Edinburgh, Manchester, Dudley, Thurrock, Metrocentre and Meadowhall.



Bournemouth, Brighton, Crawley, Guildford and Portsmouth will be open on Sundays from 1st May 1995. Check local stores for details.

## GAMES WORKSHOP® UK STORES

ABERDEEN: Unit 1, 30/40 Kirkgate.  
Tel: 01224 621261

ALTRINCHAM: 19 Grafton Street.  
Tel: 01619 299896

BASINGSTOKE: 3 Potters Walk,  
Wote St. Tel: 01256 466050

BATH: 30 Upper Borough Walls. Tel: 01225 314414

BECKENHAM: 292-294 High Street.  
Tel: 0181 658 8102

BELFAST: 20A Castle Court. Tel: 01232 233684

BIRMINGHAM: 116 Corporation Street.  
Tel: 0121 236 7880

BLACKPOOL: 8 Birley St. Tel: 01253 752056

BOLTON: Unit 25, First Floor Gallery,  
Shippgates Centre. Tel: 01204 362131

BOURNEMOUTH: 24 Post Office Rd.  
Tel: 01202 319292

BRADFORD: 5 Broadway. Tel: 01274 739353

BRIGHTON: 7 Nile Pavilions, Nile St.  
Tel: 01273 203333

BRISTOL: 13 Broad Weir. Tel: 0117 9251533

BROMLEY: 8 Bromley Mall. Tel: 0181 466 0678

CAMBRIDGE: 4 Quayside. (Off Bridge St).  
Tel: 01223 313350

CARDIFF: 29-30 High Street. Tel: 01222 644917

CARLISLE: 2 Earls Lane, Lowther St  
Tel: 01228 598216

CHELMSFORD: Unit K5, The Gallery,  
The Meadows Centre. Tel: 01245 490048

CHELTERHAM: 16 Pitville St. Tel: 01242 228419

CHESTER: 112 Foregate St. Tel: 01244 311967

COLCHESTER: 2 Short Wyre St. Tel: 01206 767279

COVENTRY: 14 City Arcade. Tel: 01203 227311

CRAWLEY: 11 Broadway. Tel: 01293 552072

CROYDON: Unit 35, Drummond Centre,  
Keeley Road. Tel: 0181 680 4600

DERBY: 42 Sadler Gate. Tel: 01332 371657

DUDLEY: Kiosk U, Upper Level, Merry Hill Centre.  
Tel: 01384 481818

EALING: 52D St Saviours Mall,  
Ealing Broadway Centre. Tel: 0181 8400171

EDINBURGH: 136 High St. Tel: 0131 220 6540

EXETER: 37 Princess Hay. Tel: 01392 490305

GLASGOW: 66 Queen Street. Tel: 0141 226 3762

GLOUCESTER: 35 Clarence Street. Tel: 01452 505033

GUILDFORD: 12 Tunsgate. Tel: 01483 451793

HAMMERSMITH: 1 Dalling Road. Tel: 0181 741 3445

NEW STORE HARROGATE: 29 Beulah Street.  
Tel: 01423 564310

HARROW: 296 Station Road. Tel: 0181 861 2350

HIGH WYCOMBE: Unit 29, The Balcony,  
The Octagon Centre. Tel: 01494 531494

HULL: 30 Paragon Street. Tel: 01482 589576

IPSWICH: 2nd Floor, Debenhams, Westgate Street.  
Tel: 01473 210031

KINGSTON ON THAMES: 33, Fife Road.  
Tel: 0181 549 5224

LEEDS: 12-16 Central Road. Tel: 0113 2420834

LEICESTER: 16/20 Silver Street. Tel: 0116 2530510

LIVERPOOL: 47 Lord Street. Tel: 0151 258 1404

CENTRAL LONDON: Unit F10, The Plaza,  
116-128 Oxford Street. Tel: 0171 436 0839

LUTON: 12 Park Street. Tel: 01582 417474

MAIDENHEAD: 2 Blandy House, 3/5 King St.  
Tel: 01628 21854

MAIDSTONE: Unit 6, 1-9 Pudding Lane  
Tel: 01622 677435

MANCHESTER: 69/70 Marsden Court,  
Arndale Centre. Tel: 0161 834 6871

MEADOWHALL CENTRE SHEFFIELD:  
91B, High St, Upper Mall. Tel: 0114 2569836

METROCENTRE NEWCASTLE: Unit B14,  
First Floor. Tel: 0191 461 0950

MIDDLESBROUGH: 39 Dundas St.  
Tel: 01642 254091

NEWCASTLE: 63 Clayton Street. Tel: 0191 232 2418

NORTHAMPTON: 6/7 The Friary, Upper Level,  
Grovesnor Centre. Tel: 01604 36687

NORWICH: 12-14 Exchange St. Tel: 01603 767656

NOTTINGHAM: 34a Friar Lane. Tel: 0115 9480651

OXFORD: 1A New Inn Hall St. Tel: 01865 242182

PETERBOROUGH: 3 Wentworth Street.  
Tel: 01733 890052

PLYMOUTH: 84 Cornwall St. Tel: 01752 254121

PORTSMOUTH: 34 Arundel St. Tel: 01705 876266

PRESTON: 15 Miller Arcade. Tel: 01772 821855

READING: Unit 3, Cheapside. Tel: 01734 598693

ROMFORD: 12 Quadrant Arcade. Tel: 01708 742140

ST ALBANS: 18 Heritage Close, High Street.  
Tel: 01727 861193

SHEFFIELD: 16 Fitzwilliam Gate. Tel: 0114 2750114

SHREWSBURY: Unit 2, Bridge Street.  
Tel: 01743 362007

SOUTHAMPTON: 23 East Street. Tel: 01703 331962

SOUTHEND: 12 Southchurch Road.  
Tel: 01702 461251

STAINES: Elmsleigh Centre. Tel: 01784.460675

STOCKPORT: 32 Mersey Square. Tel: 0161 4741427

STOKE ON TRENT: 27 Stafford Street, Hanley.  
Tel: 01782 205287

SUTTON ON THAMES: Unit 26, Upper Mall,  
Times Square Shopping Centre. Tel: 0181 770 9454

SWANSEA: 45 Princess Way. Tel: 01792 463969

SWINDON: 17 Fleet Street. Tel: 01793 436036

THURROCK LAKESIDE: Unit 415, Level 3/Food  
Court, Thurrock Lakeside. Tel: 01708 867133

TORQUAY: 12 Market St. Tel: 01803 201036

WATFORD: Unit Q1A, Harlequin Centre,  
Queens Road. Tel: 01923 245388

WOLVERHAMPTON: Unit 98,  
Mander Centre. Tel: 01902 310466

WORCESTER: 4 Charles Street. Tel: 01905 616707

YORK: 26 Goodramgate. Tel: 01904 653575

# WARHAMMER

## DEATH OR GLORY!

By Alan Richmond and Gavin Thorpe

**“The greatest warriors a General can muster will fail if badly led. Conversely, a brilliant strategy can turn even the humblest soldier into a force to be reckoned with. Luckily for us I have a brilliant strategy.”**

*Attributed to Castellan de Ville before his defeat at Blood Peak*

### A WORLD AT WAR

Across the Warhammer world armies clash with relentless ferocity. Brave soldiers and fell beasts live and die by sword and fang. Cunning Generals use countless stratagems to outwit their foes, as their armies march across the blood-stained fields intent on victory. However, regardless of their skill in combat, battles can be won or lost even before a blow is struck!

Some of the biggest decisions you make during a game of Warhammer are when you choose your army and formulate your battleplan. Most of the Warhammer Armies books

contain a special tactics section for that particular race and we also publish similar articles in White Dwarf. Jake's *Charge!* article in White Dwarf 180, for example, gave an insight into using massed cavalry in your battles. If you like huge units of Knights, chariots and other high-speed troops then his advice can help you make some of the important decisions. Richard Halliwell's *Olde Wierde's Tacticus* in White Dwarf 177 demonstrates another possible method of fighting. His *Oblique Line* strategy shows how a simple principle can be applied to your battleplan. In this article I hope to shed some light on another strategy for battle – *The Castle*.



*Empire cavalry and a War Wagon sally out from the protection of the 'Castle' to counter the Undead attack.*

The basic *Castle* plan has a *Keep* of artillery (in yellow). This is surrounded by a *Wall* of foot troops (in red) who are in turn protected by the *Moat* of cavalry.

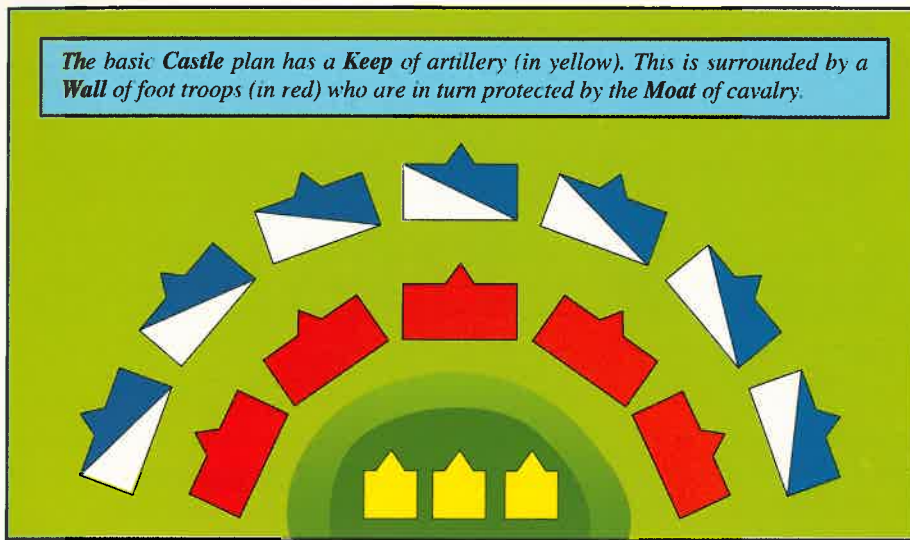

### THE CASTLE

The basic idea of the *Castle* plan is shown in the diagram above. Your cannons and artillery form a central *Keep* which is the strongpoint of your army. Surrounding and protecting your *Keep* is a *Wall* of foot soldiers. With a large enough army you can even have a *Moat* of cavalry to keep back the enemy!

Real castles don't move, and if you follow this battleplan then neither does the bulk of your army. You set up your troops in a strong position and pound the enemy with cannons or rock lobbers as they approach. When they get close enough, your missile troops open fire, cutting down the advancing foe in bloody swathes.

Whilst this is happening, your *Moat* of cavalry and other fast troops are causing confusion in the enemy ranks. They charge the weaker units and break them, causing panic tests among the rest. Even if your troops don't charge, they can still slow the enemy advance by being within 8" and stopping them making march moves.

If your opponent manages to get any troops past your *Moat* and up to your *Wall*, you can be sure that they will be in rather a



battered state. This is when your best infantry regiment steps in to finish them off.

Most armies can fight as a *Castle*, though some are better suited than others. Dwarfs and Chaos Dwarfs are past masters at the *Castle* tactic – mainly because they're so slow and couldn't advance quickly if they wanted to! The Empire forces are even better suited to the *Castle* tactic as they can include powerful cavalry to stall the enemy attack and provide even more time to bombard the advancing foe. Only the armies of Chaos and the Skaven have really big problems with this tactic, but

with the addition of allies, even they can use it to great effect. The exact choice of troops obviously depends on which army you have, but the following general guidelines hold true for most armies.

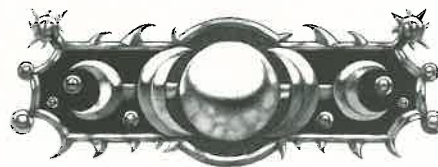

### THE KEEP

The *Keep* is the easiest part of the *Castle* to choose, because it simply consists of all of your deadliest war machines in one massive battery! The aim of the war machines in your *Keep* is to drop lots of large, painful objects on the other army as often as possible. Doom Divers, Mortars, Rock Lobbers, Cannon and all sorts of other artillery can fire tremendously long distances and should start pounding your adversaries from turn one. The dominant principle with the *Castle* plan is to destroy as much of your opponent's army as possible before he can reach you. In this way, you can stack the odds in your favour for the hand-to-hand fighting which only takes place when (if!) he reaches your *Wall*.

When you are deciding which of your foes to blast to bits, you should try to work out which regiments pose the biggest threat and kill them first. Since the bulk of your army will remain stationary throughout the battle, it becomes very vulnerable to the enemy war machines. Once your opponent starts getting the range of your units he will rain destruction down upon their heads. For this reason you should concentrate on removing the enemy's artillery before anything else.

Concentration of fire is the key to success with war machines. Pick an enemy unit and destroy it. This will cause panic tests, gain you victory points and is far better than lightly damaging several enemy regiments. This also holds true for any missile troops in your *Wall* who can add their firepower to that of your *Keep's* war machines. Only if you have really large amounts of missiles and war machines should you think about obliterating more than one target per turn.

After the enemy war machines, the next targets on your hit list should be opposing cavalry, chariots and flying creatures.



An Empire army deployed as a Castle.

Because the *Castle* plan tries to keep the enemy at arm's length for as long as possible while your war machines pound them to jelly, terror causing flying creatures and other fast enemy troops are potentially going to cause an upset. Cavalry units tend to be quite compact, and so artillery pieces that use a template, like a Rock Lobber or Mortar, are better for this task than those which may only affect a single model like a Bolt Thrower or a Cannon. Even so, you can sometimes plough through several ranks with a cannon ball if you're lucky!

Once you've dealt with the enemy cavalry and war machines it is time to move onto the most heavily armoured infantry. Although a Dwarf Iron Breaker in a unit with the *Standard of Shielding* may have a 2 or more saving throw, he still gets flattened when hit by a Doom Diver!

### BUILDING THE WALL

Now that you've constructed a *Keep* full of the most lethal war machines you've got, it's time to build a *Wall* to protect it. Unless the bombardment from your *Keep* and the forces of your *Moat* can completely halt the enemy, the regiments in your *Wall* will have to bear the brunt of the enemy charge.

Whatever happens, the opposing units should be much weaker when they arrive than when they started, and their attack shouldn't cause too much of a problem. However, your *Wall* is only as strong as its weakest part so build it carefully! Once a gap is opened up in your line the enemy can break through and surround the rest of the regiments. A fleeing unit also causes panic tests so if you don't want broken troops to disrupt your line it's essential that you invest in some characters and magic items to bolster your troops' Leadership.

When you start building your *Wall*, it's best to start with a core force. This should consist of a regiment which will bear the brunt of the fighting. For this reason the unit should be suitably large, twenty or more models is best (or forty plus for Skaven and Goblin units!). You don't want low quality cannon fodder, on the other hand, spending half your points on a single brick in your *Wall* will be equally disastrous. It's also a good idea to add a Hero and a standard bearer to make the unit even harder.

One unit on its own doesn't form a *Wall*, so the next thing to do is consider your supporting regiments. These units will stop the enemy surrounding your main unit and can attack the enemy in the flanks themselves. I often alternate missile troops and tough hand-to-hand fighters in my *Wall*. This variation allows you some flexibility and also adds to the damage you can cause to the enemy before they reach you.

### EMPIRE DETACHMENTS

If you have an Empire army, a really good way to aid your main fighting units is to use the detachment rule. This enables most Empire units to be supported by one or two small detachments which benefit from all the Leadership bonuses that apply to the main unit (such as a Hero leading it). When



# WARHAMMER

## RULES P...

### TURN SEQUENCE

- 1. MOVING
- 2. SHOOTING
- 3. HAND-TO-HAND
- 4. MAGIC

### MOVEMENT

The player whose turn it is may move his troops. Movement is controlled by the following rules:

- 1. SKILL AND CHARGE
- 2. RALLY FLEEING TROOPS
- 3. COMPLICATION MOVES
- 4. MOVE CHANGES
- 5. REMAINING MOVES

### CHARGE AND REACTIONS

Charge: A unit may charge a battle to some limit only. Movement is controlled by the following rules: Charge is only allowed if the unit is within a certain range of the intended opponent. Charge is only allowed if the unit is within a certain range of the intended opponent. Charge is only allowed if the unit is within a certain range of the intended opponent.

### MANOEUVERES

When a unit may when it moves from one place to another, it must be within the range of the opponent. When a unit may when it moves from one place to another, it must be within the range of the opponent.

# WARHAMMER



STIAR

THE GAM



MINIATURES SUPPLIED UNPAINTED. CONTENTS AND COLOURS MAY VARY FROM THOSE SHOWN.

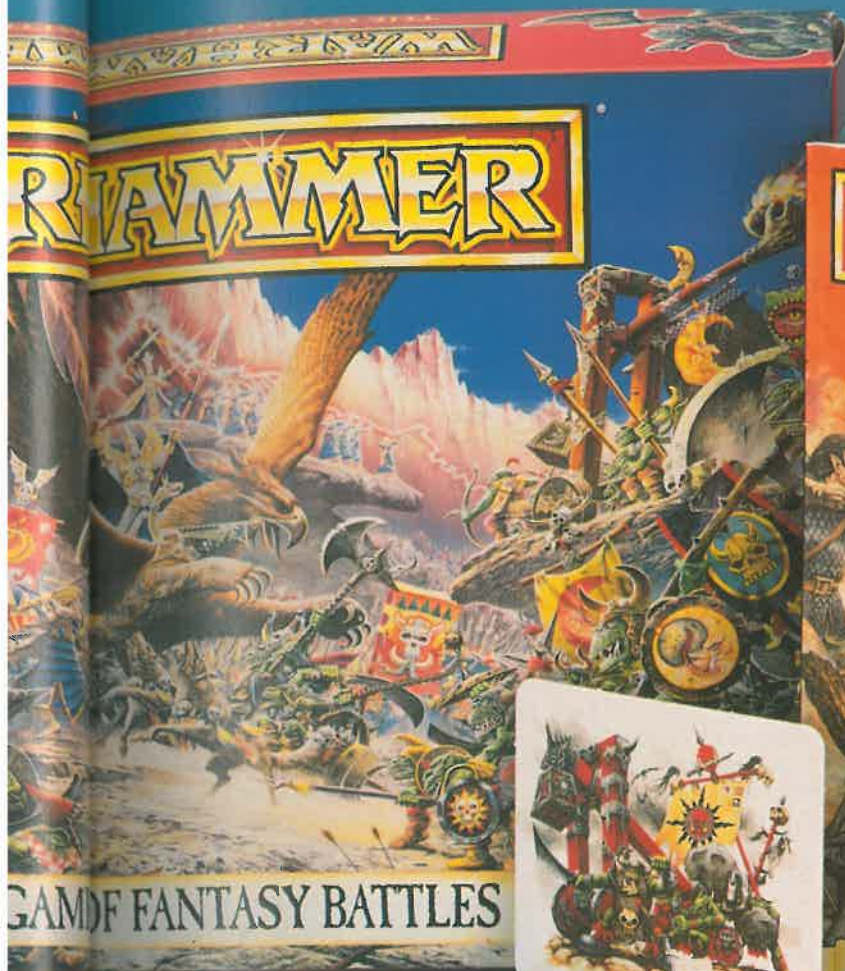



*Empire detachments are the ideal foot troops to form the Wall of your Castle.*

you give a Champion or Hero in the main unit a Magic Item like the *Crown of Command*, you get to affect three units for the price of one! Remember though, that only factors that actually affect the unit's Leadership value, like a character or the *Crown of Command*, count. Having a *Dread Banner*, for instance, doesn't mean the detachments cause *fear*.

Detachments of missile troops are especially useful. With a really tough main regiment, like Spearmen or Halberdiers, you can rely on it to survive quite well in combat. If you add hand gun or crossbow detachments to either side then it becomes even tougher! As the enemy advances you fire volleys of shots into their ranks and then, at the last minute, move your Spearmen into position to receive the charge. This gives you the best of both worlds. You don't suffer the penalty of being unable to move and fire because you don't want to move anyway. This means that you get the extra strength of the hand gun and crossbow's attack but without the drawbacks!

troops are best formed up in a thin line with few ranks so that most or all of them can fire at once. This means that they are quite vulnerable in hand-to-hand combat. To avoid this weakness, you should place your missile regiments slightly behind the others. This makes it harder for the enemy to charge your *Wall* without hitting one of your dedicated hand-to-hand regiments. There simply isn't enough room for the enemy to manoeuvre. The diagram below demonstrates this – you'll notice that your *Castle Wall* now has battlements!

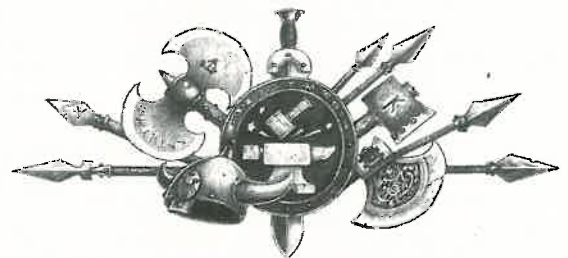

### BATTLEMENTS

The Empire forces are not the only ones who should include missile troops in their *Wall* – it's a good idea for everyone. These regiments need to be deployed differently from your main fighting units and are usually much smaller. Missile

When you're shooting at the enemy, always try to cause as many panic tests as possible. As I said before, concentrate the fire of your artillery and missile troops. If you can get some of the enemy running away, you have won half the battle as panic takes its toll and large gaps appear in the enemy line.

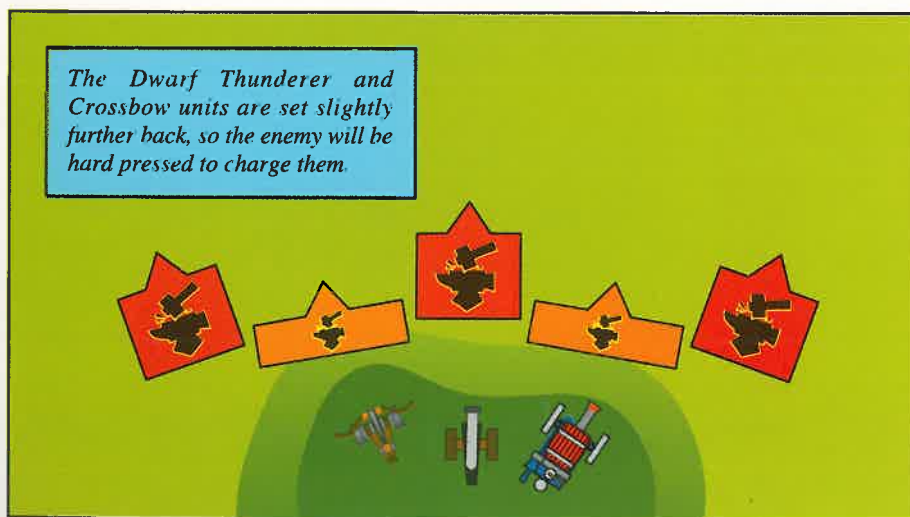

For missile troops to be really effective their initial set up is very important. They should be placed with the best field of fire possible, where they can hit the most enemy, even at long range. The ideal place for them to be deployed is on a hill where you can set up in two ranks and allow all of the troops to fire, the second rank shooting over the heads of the first. This set up also gives a rank bonus for hand-to-hand combat as well as allowing everyone to stand and fire at incoming chargers. Once the fighting gets close, and lots of



*Each end of the Wall is anchored.  
The left flank is protected by a  
Helblaster Volley Gun, while the  
right is next to some woods.*



units are in hand-to-hand combat, your Archers' main job is to fire at any unengaged targets, or perhaps charge units already in combat in the side or rear to cause more panic tests.

### SOLID FOUNDATIONS

Now that you've got your *Wall* lined up you have to get the enemy to move into it. If you don't take the proper steps, the opposing army will simply move around your hardest units and avoid them altogether. You don't want this at all, so it's necessary to 'persuade' your opponent to march into the teeth of your army. Another problem with the *Wall* is its flanks, which are very vulnerable and if your opponent attacks from the side will give you no end of difficulties. There is one answer to both these problems.

No matter what army or plan you are using, it's always a good idea to anchor your flanks. This means that you protect the ends of your battle line with either very good troops or a terrain feature. Rivers, for example, are a good place to anchor your flank because they are impassable to almost all types of enemy. You can even use a war machine or Monster to keep your flank safe. A Dwarf Flame Cannon or an Empire Volley gun, for instance, is enough of a deterrent to make the opposition think twice before walking straight into it. A Hydra, Manticore or other massive creature that causes *Terror* can have the same effect.

By taking these precautions you can channel the other army into your missile fire and specialist units. If your opponent doesn't want to co-operate he'll either get blasted (if he stays back) or he'll run into the troops protecting the flank. If you choose your flank troops wisely either of these options should spell certain defeat for the enemy.

### THE MOAT

The Warhammer World contains all sorts of mounted troops, from the magnificent splendour of the Dragon Princes of Caledor, to the wild Kislev Horse Archers. Each has its place in our *Castle* army. If you want to strike a few blows before the other army reaches your *Wall*, a unit or two of heavily armoured Knights will be useful. Not only can you hurt the enemy this way, but your units will also slow down their approach giving you even more time to rain cannon balls, Doom Divers, Hot Pots and Mortar shells onto their heads.

Another way to slow down the enemy advance is to distract them. This is why it's rare to find an Empire army that doesn't include some Kislev Horse Archers. Other races have similar troops, like Goblin or Hobgoblin Wolf Riders. These fast cavalry regiments can be really annoying for the enemy General, as they threaten his flanks, shoot at his war machine crews and generally get in the way. It's probably best to take lots of small units rather than a few large ones, so that the opposing General will have to spend more time trying to get rid of them all.

One of the most obvious uses of hard-hitting Knights is to counter-attack. This involves waiting for your enemy to get into contact with your *Wall* of infantry, and then charging them



*In the Battle for Talabheim from White Dwarf 183, Jake used a variation of the Castle plan to deploy his army. Instead of placing the Castle in the centre of his deployment area, he put the majority of his force on his left flank.*

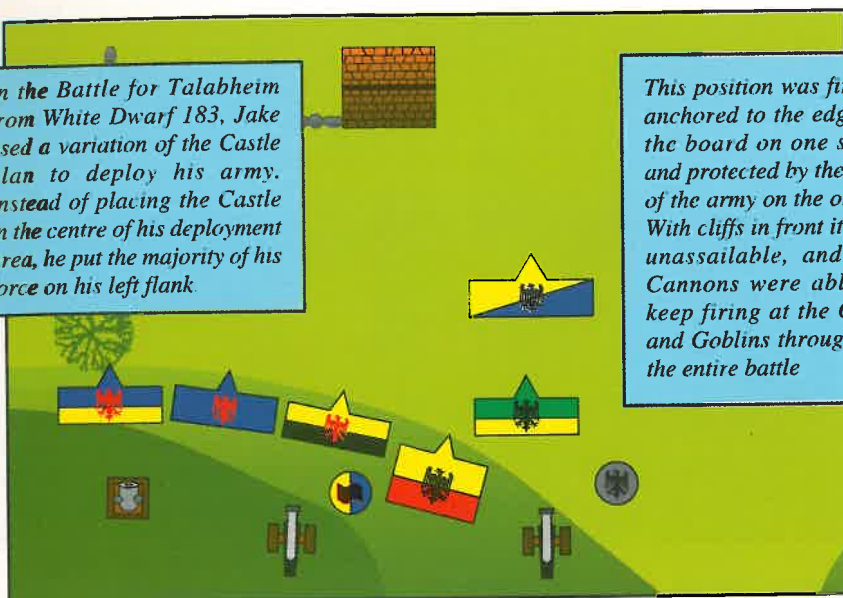

*This position was firmly anchored to the edge of the board on one side, and protected by the rest of the army on the other. With cliffs in front it was unassailable, and the Cannons were able to keep firing at the Orcs and Goblins throughout the entire battle*

Cannons, Bolt Throwers and Doom Divers safe in your *Keep*.

Whether you charge into the enemy ranks or simply close in to use your bows, your *Moat* should move forward as quickly as possible, to get within 8" of the enemy. This prevents the opposing units from making march moves, and increases the time you have to bombard them with your war machines before they get across the battlefield. Being far out in front of your *Wall* also means that your smaller regiments of cavalry won't cause panic in your own ranks if they are broken or destroyed.

in the flank or rear with your Knights. This move will crush most foes, no matter how tough they are, and it will certainly make your opponent nervous about charging with other units. On the other hand, why have such splendid troops sitting around for two or three turns when they could be out there causing some damage? If you pick on the enemy cavalry, you can stop them from attacking your *Wall* too early. Remember, the longer you keep the other side at arm's length the more time you have to pound them into submission with the ranks of

### AND THE REST..

This is just one of the many possible strategies you can try in your battles, and there are many variations on the *Castle* theme itself. Indeed, one of the most rewarding aspects of collecting a Warhammer army of any race is developing your own tactics and ideas about how the various troops can be used. What's covered here is only the tip of a tactical iceberg that's just waiting for you to explore!

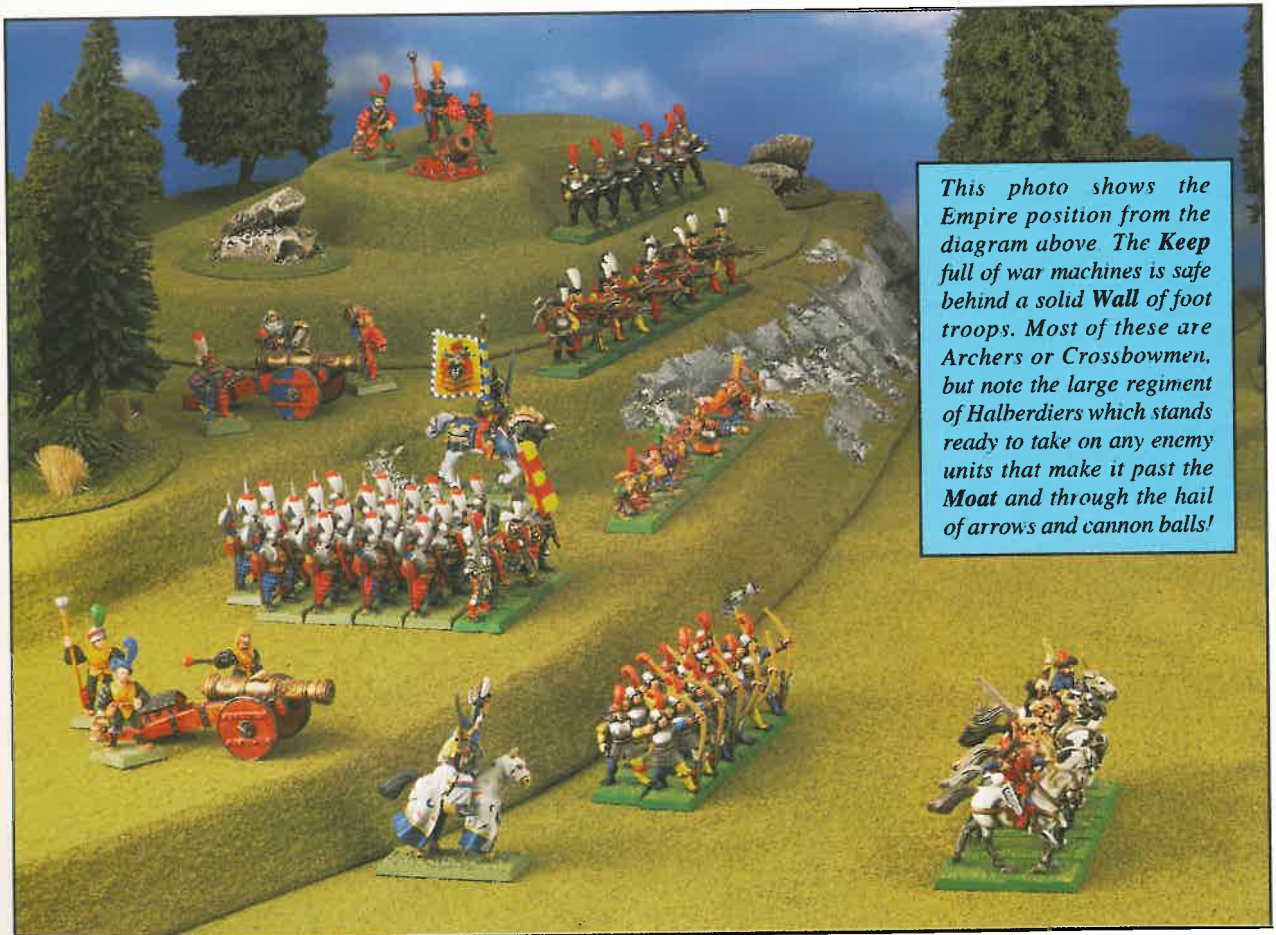

*This photo shows the Empire position from the diagram above. The Keep full of war machines is safe behind a solid Wall of foot troops. Most of these are Archers or Crossbowmen, but note the large regiment of Halberdiers which stands ready to take on any enemy units that make it past the Moat and through the hail of arrows and cannon balls!*

GAMES WORKSHOP®

Presents

EXTERMINATUS

WARHAMMER

40,000

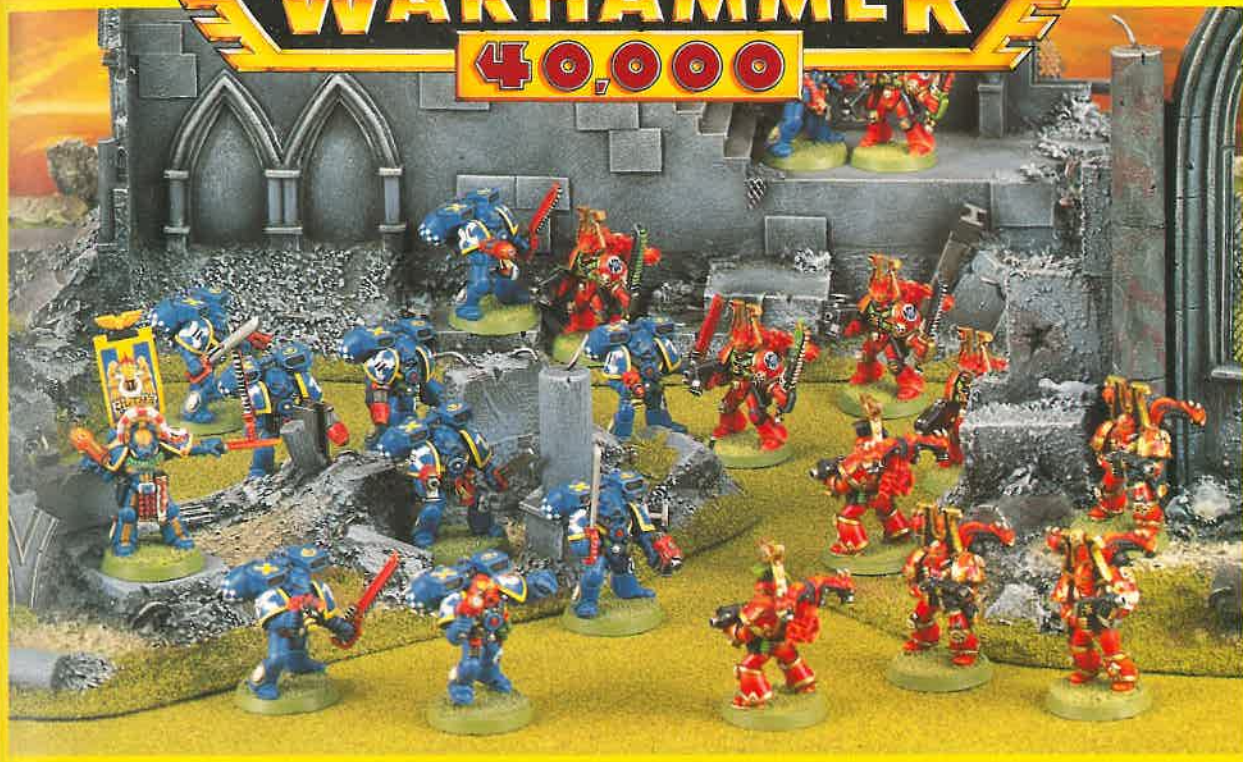

## THE WARHAMMER 40,000 EXTERMINATUS ROADSHOW

### APRIL

22nd Reading  
29th Kingston

### MAY

6th Derby  
13th Liverpool  
20th Cheltenham  
27th Croydon

### JUNE

3rd Bournemouth  
10th Brighton

With loads more  
dates to come...

The Imperial planet of Trantis IX has been overrun by the foul World Eaters Chaos Space Marines. Can the Ultramarines plant the Exterminatus device and destroy the infestation or will their efforts be crushed by the dark forces of Chaos?

At each Exterminatus Roadshow everything is provided. There's no need to bring miniatures, dice or rulebooks – you just turn up and play!

And, at every event, there will be special prizes of a brilliant limited edition **Exterminatus Poster** so see you there!

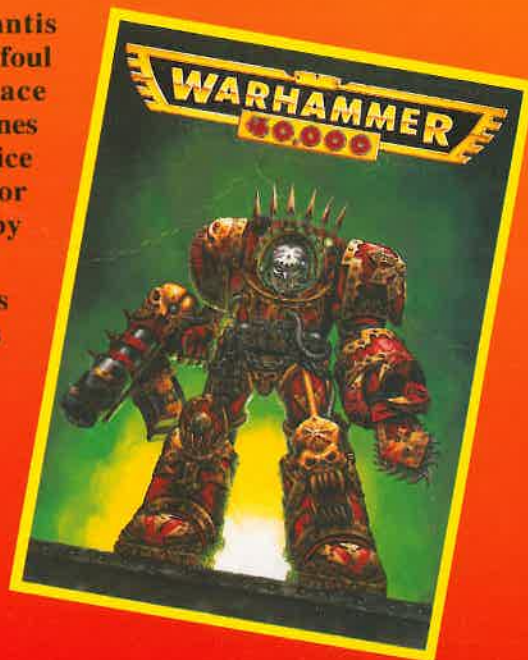

## CHIMERA ASSAULT TROOP CARRIERS



IMPERIAL CHIMERRO ASSAULT SQUADRON

The Chimerax is a more heavily modified assault version of the basic Chimera troop carrier. As the Imperial assault rolls forward, the Chimerax' four autocannons provide protection against enemy counterattacks from both flyers and troops.



IMPERIAL CHIMERAX ASSAULT SQUADRON



IMPERIAL CHIMEDON ASSAULT SQUADRON

The Chimera is a highly adaptable vehicle used by both Imperial Guard and Tech-Guard regiments across the Imperium. Of the many Chimera variants the Chimerro is the most basic, with a hunter missile system adding long-range firepower to its standard multi-laser.

With a huge battle cannon replacing its multi-laser, the Chimedon is the most heavily armed of the Chimera assault variants. After its troops have disembarked the Chimedon covers their advance, destroying any vehicles which stand in their way.



CHIMERRO, CHIMERAX AND CHIMEDON ASSAULT SQUADRONS PREPARE FOR BATTLE

# EPIC<sup>®</sup>

## CHIMERA ASSAULT!

By Andy Chambers

### CHIMERA ASSAULT TROOP CARRIERS

The highly adaptable Chimera troop carrier has spawned innumerable variant designs as a result of the constant modification and experimentation which takes place in the research weaponshops of the Adeptus Mechanicus. The most popular of these have been the Chimera assault variants which replace or upgrade the vehicle's turret mounted multi-laser armament with more powerful weaponry. In all cases the variants have retained their full troop carrying capacity so they can be used to replace ordinary Chimeras on a one for one basis in unit organisations. Assault Chimeras are used to attack strongly fortified positions, to aggressively seize vital objectives and to give heavy fire support to armoured attacks and their accompanying infantry. To date, three variants of the assault Chimera have been combat tested and approved by veteran regiments of the Imperial Guard and the Tech-Guard.

### CHIMERAX

Chimerax assault vehicles are easily recognisable because their turret has been upgraded to mount four light autocannon. These multiple autocannon allow the Chimerax to lay down a ferocious curtain of fire. This is highly effective for keeping enemy infantry, light skimmers and flyers at bay even though the Chimerax is not equipped with complex tracking and ranging sensors like its larger cousin, the Hydra self propelled anti-aircraft gun.

### CHIMEDON

Chimedon assault vehicles have had their turret strengthened to mount a short barrelled battle cannon similar to those carried by Stormhammer super-heavy tanks (though Stormhammers bristle with four such weapons). The battle cannon's powerful armour-piercing shells can easily smash opposing tanks and Titans at medium range, giving it tremendous tactical flexibility when combined with the Chimera's sturdy and manoeuvrable hull. The Chimedon's only real failing is its lack of bolters, which means that it can be vulnerable to infantry assaults. Because of this, Chimedons

are seldom used as tanks to spearhead attacks (though they can do so), instead they provide supporting fire for platoons of infantry which are facing enemy armour or dug-in infantry.

### CHIMERRO

Chimerro assault vehicles are the least modified of all the Chimera assault variants, mounting a standard hunter missile tube with an autoloader system on the side of the existing Chimera turret. The addition of this missile system gives the Chimerro a longer range weapon which is powerful enough to destroy enemy tanks or Titans. The multi-laser is still retained, enabling the Chimerro to mow down marauding enemy infantry and support its own disembodied troops.



### NEW ARMY CARDS

On the following page we've included army cards for you to use in your Epic battles. If you don't want to cut up your copy of White Dwarf, or need several copies of a single card, feel free to photocopy the army cards. To assemble them, first cut them out, taking care to keep the front and back of each one together. Then fold each one in half along the dotted line. Finally, spread a thin layer of glue across the back of the card and press the two halves firmly together. If you want to make your army cards a little more hard wearing, it's a good idea to insert a thin layer of cardboard (cereal packet is ideal) between the two halves before you glue them together.

Troop Type	Move	Saving Throw	CAF	Weapons	Range	Attack Dice	Roll to Hit	Target's Save Mod.	Notes
Chimerax	20cm	3+	+1	Autocannon	50cm	2	5+	0	Carries 2 troop stands
Chimedon	20cm	3+	+1	Battlecannon	50cm	1	4+	-2	Carries 2 troop stands
Chimerro	20cm	3+	+1	Multi-laser Hunter missile	25cm 50cm	1 1	4+ 5+	0 -2	Carries 2 troop stands

## TECH-GUARD MECHANISED ASSAULT COMPANY

Any combination of Chimerax, Chimedon and/or Chimerro assault vehicles may be chosen to transport the assault company.

**BREAK POINT 15:** The Tech-Guard mechanised assault company is broken once it has lost 15 models, either Guard stands, HQ stands or Chimera assault vehicles. Once the company is broken each platoon must take an individual morale check.

**MORALE VALUE 3:** Tech-Guard have a morale value of 3. They must roll 3 or more on a D6 to pass their morale check.

For a platoon to receive orders it must be within 25cm of a company HQ at the start of the Orders phase. The same also applies to any support units allocated to the company. If troops are unable to receive orders they cannot move but they may fire in the advance fire segment of the combat phase in the same way as other troops with no orders.

The company HQ is a command unit. It does not therefore need orders and there is no need for the unit to check morale.

### VICTORY POINTS 9

Your opponent gains 9 VPs when the unit is broken.

## TECH-GUARD MECHANISED ASSAULT COMPANY

A Tech-Guard mechanised assault company consists of one company HQ unit with a Chimera assault vehicle and three assault platoons in Chimera assault vehicles. Each assault platoon comprises six assault stands, including a section HQ, in Chimera assault vehicles.

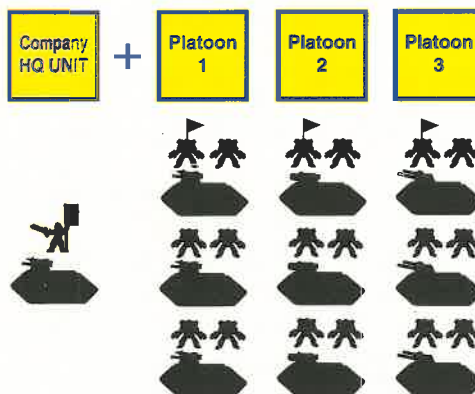

POINTS VALUE 850

## CHIMERAX ASSAULT SQUADRON

A Chimerax assault squadron is added to an infantry detachment to give it transport vehicles. The assault squadron becomes part of the infantry detachment and is subject to the same orders and command restrictions. The Chimerax squadron adds +2 to its parent detachment or company's break point, and +2 to the victory points awarded to your opponent for breaking the infantry detachment or company.

### VICTORY POINTS +2

Your opponent gains +2 VPs when the unit is broken.

## CHIMERAX ASSAULT SQUADRON

A Chimerax Assault Squadron consists of 3 Chimerax assault troop carriers.



POINTS VALUE 150



## CHIMEDON ASSAULT SQUADRON

A Chimedon assault squadron is added to an infantry detachment to give it transport vehicles. The assault squadron becomes part of the infantry detachment and is subject to the same orders and command restrictions. The Chimedon squadron adds +2 to its parent detachment or company's break point, and +2 to the victory points awarded to your opponent for breaking the infantry detachment or company.

### VICTORY POINTS +2

Your opponent gains +2 VPs when the unit is broken.

## CHIMEDON ASSAULT SQUADRON

A Chimedon Assault Squadron consists of 3 Chimedon assault troop carriers.



POINTS VALUE 150



## CHIMERRO ASSAULT SQUADRON

A Chimerro assault squadron is added to an infantry detachment to give it transport vehicles. The assault squadron becomes part of the infantry detachment and is subject to the same orders and command restrictions. The Chimerro squadron adds +2 to its parent detachment or company's break point, and +2 to the victory points awarded to your opponent for breaking the infantry detachment or company.

### VICTORY POINTS +2

Your opponent gains +2 VPs when the unit is broken.

## CHIMERRO ASSAULT SQUADRON

A Chimerro Assault Squadron consists of 3 Chimerro assault troop carriers.



POINTS VALUE 150



# IMPERIAL WARLORD TITAN™



VORTEX MISSILE



GATLING BLASTER



QUAKE CANNON



CHAIN FIST



A MIGHTY WARLORD TITAN LEADS THE ATTACK AGAINST AN ORK STRONGHOLD

# GAMES WORKSHOP



## CARLISLE GRAND OPENING



**SATURDAY 29th & SUNDAY 30th APRIL**  
**2 Earls Lane, Lowther Street. Tel: 01228 598216**

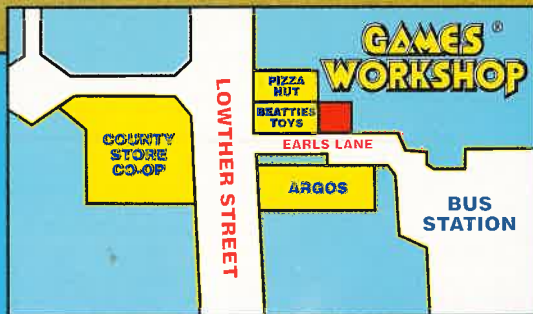
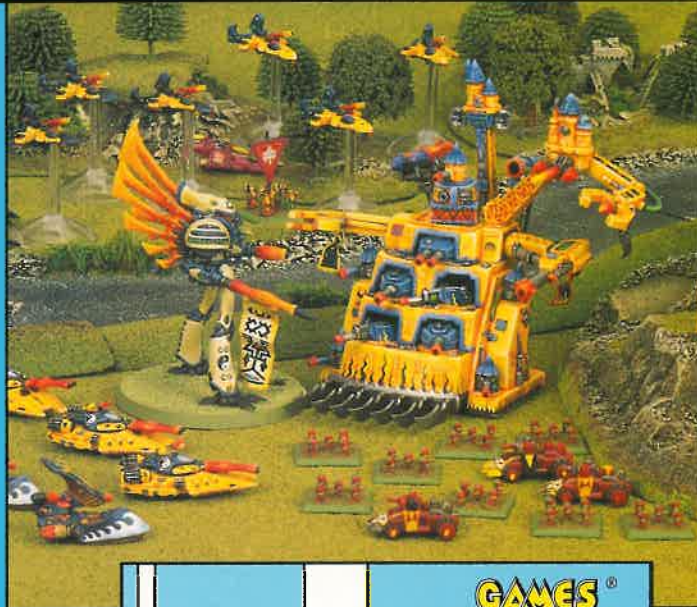

**BUY ANY THREE BLISTER PACKS AND  
GET THE CHEAPEST ONE FREE!**



### MASSIVE DEALS ALL DAY ONLY £48.50 EACH!

That's up to a 33% saving!  
 Don't miss these amazing offers and  
 massive discounts on a whole range of  
 exciting Games Workshop products.



**WARHAMMER  
plus!  
WARHAMMER  
BATTLE MAGIC  
plus! any one  
ARMIES BOOK  
Normal price  
£69.97**



**SPACE MARINE  
OR TITAN LEGIONS  
plus!  
SPACE MARINE  
BATTLES BOOK  
plus! any one  
BOXED SUPPLEMENT  
Normal price  
£64.97**



**BLOOD BOWL  
plus!  
DEATH  
ZONE  
plus! any one  
BOXED TEAM  
Normal price  
£59.97**



**WARHAMMER  
40,000  
plus!  
DARK MILLENNIUM  
plus! any one  
CODEX BOOK  
Normal price  
£69.97**

REDEEMABLE AT GAMES WORKSHOP  
CARLISLE 29TH & 30TH APRIL 1995

**25% OFF** GAMES WORKSHOP  
OR CITADEL PRODUCTS.

ONLY ONE VOUCHER PER PRODUCT. NOT  
TO BE USED WITH ANY OTHER OFFER.

REDEEMABLE AT GAMES WORKSHOP  
CARLISLE 29TH & 30TH APRIL 1995

**10% OFF** GAMES WORKSHOP  
OR CITADEL PRODUCTS.

ONLY ONE VOUCHER PER PRODUCT. NOT  
TO BE USED WITH ANY OTHER OFFER.

REDEEMABLE AT GAMES WORKSHOP  
CARLISLE 29TH & 30TH APRIL 1995

**10% OFF** GAMES WORKSHOP  
OR CITADEL PRODUCTS.

ONLY ONE VOUCHER PER PRODUCT. NOT  
TO BE USED WITH ANY OTHER OFFER.

REDEEMABLE AT GAMES WORKSHOP  
CARLISLE 29TH & 30TH APRIL 1995

**10% OFF** GAMES WORKSHOP  
OR CITADEL PRODUCTS.

ONLY ONE VOUCHER PER PRODUCT. NOT  
TO BE USED WITH ANY OTHER OFFER.

REDEEMABLE AT GAMES WORKSHOP  
CARLISLE 29TH & 30TH APRIL 1995

**25% OFF** GAMES WORKSHOP  
OR CITADEL PRODUCTS.

ONLY ONE VOUCHER PER PRODUCT. NOT  
TO BE USED WITH ANY OTHER OFFER.

REDEEMABLE AT GAMES WORKSHOP  
CARLISLE 29TH & 30TH APRIL 1995

**10% OFF** GAMES WORKSHOP  
OR CITADEL PRODUCTS.

ONLY ONE VOUCHER PER PRODUCT. NOT  
TO BE USED WITH ANY OTHER OFFER.

REDEEMABLE AT GAMES WORKSHOP  
CARLISLE 29TH & 30TH APRIL 1995

**10% OFF** GAMES WORKSHOP  
OR CITADEL PRODUCTS.

ONLY ONE VOUCHER PER PRODUCT. NOT  
TO BE USED WITH ANY OTHER OFFER.

REDEEMABLE AT GAMES WORKSHOP  
CARLISLE 29TH & 30TH APRIL 1995

**10% OFF** GAMES WORKSHOP  
OR CITADEL PRODUCTS.

ONLY ONE VOUCHER PER PRODUCT. NOT  
TO BE USED WITH ANY OTHER OFFER.

PLEASE NOTE: NONE OF THE VOUCHERS ON THIS PAGE MAY BE USED IN COMBINATION WITH ANY OTHER OFFER  
 NOR MAY THEY BE USED ON BOXTREE BOOKS, WARHAMMER NOVELS, OR ELECTRONIC ARTS' SPACE HULK COMPUTER GAME.



**GAMES WORKSHOP®**

**PRESENTS**

# **GAMES DAY™** **and** **GOLDEN '95™** **DEMON**

**THE 8TH INTERNATIONAL  
CITADEL MINIATURES PAINTING COMPETITION**



*The magnificent bronze Space Marine Trophy. This year it will be awarded by the Studio 'Eavy Metal Team to the Games Workshop store that produces the finest painted Warhammer Command group.*

## **GAMES DAY 1995 AND THE GOLDEN DEMON AWARDS**

On the 15th October 1995, the Birmingham National Indoor Arena will play host to **Games Day '95** and the **1995 Golden Demon Awards**. Thousands of Games Workshop hobbyists will get together for a dazzling day of exciting games and special events.

The **Golden Demon Awards** is the showcase for the finest painted miniatures in the world. Hundreds of Citadel miniature painters and modellers come together to display their talents and compete for the title of Golden Demon Master Painter and the coveted Golden Demon Slayer Sword.

# THE 1995 GOLDEN DEMON AWARD CATEGORIES



## 1. Best Warhammer 40,000 Miniature

Any single Warhammer 40,000 miniature on a standard round slottabase.

## 2. Best Warhammer 40,000 Squad

This category is for Warhammer 40,000 squads chosen from the Squads section of the Codex army lists. Note: Space Marine squads must be full ten-man squads and not five-man combat squads. Other races may be chosen within the army list parameters (eg: Striking Scorpions 3-7 models, Dark Reapers 3-7 models, Deathskulls Mob 3-10 models, Snotling Herd 2-10 bases plus a Runtherd, Genestealers 5 models etc). All models must be presented on standard slottabases.

## 3. Best Warhammer 40,000 Vehicle

This category is open to single Warhammer 40,000 vehicle, Dreadnought or War Walker models.



NEIL THOMANSON - 1994 1ST PLACE  
WARHAMMER 40,000 SINGLE MINIATURE



GARY TAYLOR - 1994 1ST PLACE WARHAMMER 40,000 SQUAD



ROBIN HEMPSALL - 1994 1ST PLACE  
WARHAMMER SINGLE MINIATURE



## 4. Best Warhammer Single Miniature

This category is open to single Warhammer miniatures on standard gaming slottabases up to 25mm x 50mm maximum size (cavalry base). Models on 40mm x 40mm bases should be entered into the Monsters and Creatures category.

## 5. Best Warhammer Command Group

Entries for this category consist of any four Warhammer miniatures on their standard slottabases (25mm x 50mm maximum size as for single miniatures). Your entry must include **four** of the following five models for any one army: an Army General, an Army Standard Bearer, a Regimental Musician, a Regimental Champion or a Wizard.



AKIO MENISTER - 1994 2ND PLACE WARHAMMER 40,000 CREATURE



AND



### 6. Best Warhammer Monster or Warhammer 40,000 Creature

This category is open to all Warhammer or Warhammer 40,000 monsters on 40mm x 40mm standard bases. This covers Avatars, Ogryns and Tyranids and you may include a rider if you wish eg: Orc Wyvern, Chaos Dwarf Bull Taurus, etc.



### 7. Best Epic Titan

This category is for a single model of a Titan of any class, or any type of Gargant.

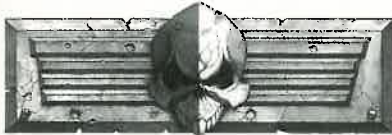

### 8. Best Epic Battleforce

Entries to this category should be made up of an Epic force consisting of the miniatures representing a **Company Card**, with a Titan/Gargant or Gigantic Vehicle as a **Special Card**, plus three **Support Cards**.



ROY SCORER - 1994 2ND PLACE EPIC TITAN



MARK WALTHAM - 1993 COMMENDED BATTLE SCENE

### 9. Battle Scene

Entries for this category consist of a Battle Scene from either Warhammer 40,000, Warhammer or the Epic game system. The display must not be larger than 30cm x 30cm and the maximum permitted height is 30cm. The Battle Scene should have at least two miniatures arranged in a combat pose, but otherwise there is no restriction on the model's theme or content.

# THE GOLDEN DEMON COMPETITIONS

In addition to the nine main Golden Demon Award categories, this year we will also be running two Golden Demon Painting and Modelling Competitions.



## The Young Bloods Competition

The Young Bloods painting competition is open to any competitors aged 14 years or under.

Your entry should consist of any single plastic Citadel miniature on its standard gaming slottabase.

## The Golden Demon Open Competition

The Golden Demon Open Competition is literally what it says – an open opportunity for you to let your imagination run riot. There are no restrictions on your entry so it could range from a single miniature to a sweeping diorama. Anyone can enter the Open Competition, including Games Workshop staff, but remember that no matter how wild your entry, the judges will be looking for well-painted miniatures that adhere to the imagery and ethos of Games Workshop's fantasy universes. Conversions are allowed, but should also be consistent with the atmosphere of the game world and spirit of the miniatures.



ROY SCORER – 1994 2ND PLACE BATTLE SCENE

## 1995 COMPETITORS GUIDELINES

All entries to the Golden Demon Awards must be painted Citadel or Marauder miniatures.

All single miniatures must be mounted on the appropriate gaming bases. To help the judges compare the entries, we prefer these to be painted green.

Conversions are allowed, but should be consistent with the atmosphere of the game world and spirit of the miniatures.

Overall, the judges will be looking for well-painted miniatures that adhere to the imagery and ethos of Games Workshop's fantasy universes.

All entries to the 1995 Golden Demon Awards must be personally handed in and registered at the National Indoor Arena Birmingham on the 15th October 1995. Full details

on the entry and booking-in procedure will appear in White Dwarf issues 188, 189 and 190.

Competitors will be fully responsible for the transport of their own entries to and from the competition and for storing their own transport and packing materials on the day.

Once they have been booked in, Games Workshop undertakes to treat all entries with the greatest care, but we can accept no responsibility for loss or damage to individual entries. Entry to the competition is entirely at the competitor's risk.

Entry into the competition gives Games Workshop the right to display, photograph and publish any entry as they see fit. The judges' decision is final and no correspondence will be entered into.

# GAMES WORKSHOP®

## WOLVERHAMPTON GRAND OPENING

**SATURDAY 29th & SUNDAY 30th APRIL**  
Unit 98, Mander Centre. TEL: 01902 310466

**DOORS OPEN  
9.00AM  
SATURDAY  
AND 10.00AM  
SUNDAY**



**BUY ANY THREE BLISTER PACKS AND  
GET THE CHEAPEST ONE FREE!**



**MASSIVE DEALS ALL DAY  
ONLY £48.50 EACH!**

That's up to a 33% saving!  
Don't miss these amazing offers and  
massive discounts on a whole range of  
exciting Games Workshop products.



**WARHAMMER  
plus!  
WARHAMMER  
BATTLE MAGIC  
plus! any one  
ARMIES BOOK  
Normal price  
£69.97**



**TITAN LEGIONS OR  
SPACE MARINE  
plus!  
SPACE MARINE  
BATTLES BOOK  
plus! any one  
BOXED SUPPLEMENT  
Normal price  
£64.97**



**BLOOD BOWL  
plus!  
DEATH  
ZONE  
plus! any one  
BOXED TEAM  
Normal price  
£59.97**



**WARHAMMER  
40,000  
plus!  
DARK MILLENNIUM  
plus! any one  
CODEX BOOK  
Normal price  
£69.97**

REDEEMABLE AT GAMES WORKSHOP  
WOLVERHAMPTON 29TH & 30TH APRIL 1995

**25% OFF** GAMES WORKSHOP  
OR CITADEL PRODUCTS.  
ONLY ONE VOUCHER PER PRODUCT. NOT  
TO BE USED WITH ANY OTHER OFFER.

REDEEMABLE AT GAMES WORKSHOP  
WOLVERHAMPTON 29TH & 30TH APRIL 1995

**10% OFF** GAMES WORKSHOP  
OR CITADEL PRODUCTS.  
ONLY ONE VOUCHER PER PRODUCT. NOT  
TO BE USED WITH ANY OTHER OFFER.

REDEEMABLE AT GAMES WORKSHOP  
WOLVERHAMPTON 29TH & 30TH APRIL 1995

**10% OFF** GAMES WORKSHOP  
OR CITADEL PRODUCTS.  
ONLY ONE VOUCHER PER PRODUCT. NOT  
TO BE USED WITH ANY OTHER OFFER.

REDEEMABLE AT GAMES WORKSHOP  
WOLVERHAMPTON 29TH & 30TH APRIL 1995

**10% OFF** GAMES WORKSHOP  
OR CITADEL PRODUCTS.  
ONLY ONE VOUCHER PER PRODUCT. NOT  
TO BE USED WITH ANY OTHER OFFER.

REDEEMABLE AT GAMES WORKSHOP  
WOLVERHAMPTON 29TH & 30TH APRIL 1995

**25% OFF** GAMES WORKSHOP  
OR CITADEL PRODUCTS.  
ONLY ONE VOUCHER PER PRODUCT. NOT  
TO BE USED WITH ANY OTHER OFFER.

REDEEMABLE AT GAMES WORKSHOP  
WOLVERHAMPTON 29TH & 30TH APRIL 1995

**10% OFF** GAMES WORKSHOP  
OR CITADEL PRODUCTS.  
ONLY ONE VOUCHER PER PRODUCT. NOT  
TO BE USED WITH ANY OTHER OFFER.

REDEEMABLE AT GAMES WORKSHOP  
WOLVERHAMPTON 29TH & 30TH APRIL 1995

**10% OFF** GAMES WORKSHOP  
OR CITADEL PRODUCTS.  
ONLY ONE VOUCHER PER PRODUCT. NOT  
TO BE USED WITH ANY OTHER OFFER.

REDEEMABLE AT GAMES WORKSHOP  
WOLVERHAMPTON 29TH & 30TH APRIL 1995

**10% OFF** GAMES WORKSHOP  
OR CITADEL PRODUCTS.  
ONLY ONE VOUCHER PER PRODUCT. NOT  
TO BE USED WITH ANY OTHER OFFER.

PLEASE NOTE: NONE OF THE VOUCHERS ON THIS PAGE MAY BE USED IN COMBINATION WITH  
ANY OTHER OFFER NOR MAY THEY BE USED ON 'HOT TREE ROCKS' WARHAMMER NOVELS

## WARHAMMER® CHARACTERS

### KRELL – LORD OF THE UNDEAD

Legends speak of the mighty Krell – dreaded Lord of the Undead, raised to undeath by Nagash himself and a powerful enemy of the Old World. In battle he wields the Black Axe of Krell, carved out of obsidian rock and enchanted with deadly magic.

### ASTRAGOTH – HIGH PRIEST OF HASHUT

Astragoth is the oldest and most powerful of the mighty Sorcerers of the Chaos Dwarfs. Encased in his cunning mechanical harness, Astragoth hurls potent magic at the enemy ranks, scattering them before him.



KRELL  
LORD OF THE UNDEAD



ASTRAGOTH  
HIGH PRIEST OF HASHUT

## SKAVEN™ WARPFIRE THROWER TEAM



CLAN SKRYRE WARPFIRE THROWER TEAM

# WARHAMMER®

## ASTRAGOTH HIGH PRIEST OF HASHUT

By Rick Priestley

From the dark, forbidding lands of the Chaos Dwarfs comes their oldest living sorcerer and High Priest of Hashut – Astragoth. Although he has been partly turned to stone, he still leads the malevolent forces of the Chaos Dwarfs to battle, striding at their head in the semi-mechanical shell which encases his petrified limbs.

### CHAOS DWARFS

The Chaos Dwarf Sorcerers rule over the Tower of Zharr-Naggrund as the lords and masters of the Chaos Dwarfs and high priests of Hashut. Their lore is deep and ancient, the study of machines and magic combined to produce arcane engines of power and destruction. It was the Chaos Dwarf Sorcerers who constructed the city in past ages, who carved its shape from

obsidian, raised its dark towers and fashioned its massive gateways. They are few in number, probably no more than a few hundred amongst the whole Chaos Dwarf race.

In the Temple of Hashut the Chaos Dwarf Sorcerers meet in a conclave of evil to make their plans of domination. There is no leader nor formal hierarchy amongst them, but the strongest voice belongs to the oldest and most powerful, for Chaos





Dwarfs respect age and knowledge just as much as other Dwarfs. Each Chaos Dwarf Sorcerer controls part of the city, with its workshops and forges, slaves and warriors, as his personal dominion.

Chaos Dwarfs are resistant to magic, as are all Dwarfs after a fashion, but they are not immune to its effects. As Chaos Dwarf Sorcerers use magic it gradually seeps into their bodies, evoking changes in them which are both unique and horrific. After many centuries of labour a Chaos Dwarf Sorcerer begins to change – the pace of change is slow, but once it begins, his fate is sealed.



Starting with his feet, the Chaos Dwarf Sorcerer slowly begins to turn to immobile stone. At first his legs turn grey and solid so that he is unable to move, and his followers are obliged to carry him around or else he has them construct a mechanical engine to move him about. Then his lower body and torso turn to stone, making him extraordinarily tough. Once his arms become stone he is entirely dependant upon his followers to perform his magic, as all he can do is speak and watch their progress. After a while his entire body turns to stone and he becomes a statue.

For miles around the Tower of Zharr-Naggrund at the heart of the Chaos Dwarf Empire the roadways are lined with these stern grey statues. The Chaos Dwarf Sorcerers form rank upon rank of dark stones, watching over the approaches to their city and their sacred Temple of Hashut.

**ASTRAGOTH ..... 358 points**  
**HIGH PRIEST OF HASHUT**

Astragoth is the oldest living Chaos Dwarf Sorcerer. When he was at the height of his powers he was the most potent sorcerer to walk the Plain of Zharr in a thousand years. Now his powers have begun to wane and his body is slowly succumbing to petrification. A decade ago he constructed a mechanical device by which he is transported from place to place. His legs have long ceased to work and even his hands have now turned to stone. To an extent these have been replaced by the machinery grafted onto his body. This engine was constructed by his slaves to plans created by Astragoth himself, and combines the undoubted skills of the Chaos Dwarf race with twisted, dark and malevolent science.

PROFILE	M	WS	BS	S	T	W	I	A	Ld
Astragoth	6	6	3	5	5	4	5	3	10

**WEAPONS/ARMOUR:** Astragoth is encased within a machine that enables him to walk and which powers his petrified limbs. This machine combined with armour gives him an armour saving throw of 3+.

**MAY RIDE:** Because of his elaborate semi-mechanical body, Astragoth may **not** ride any kind of creature.



**MAGIC ITEMS:** Astragoth is a Sorcerer Lord and may carry up to four magic items.

**MAGIC SPELLS:** Astragoth is a Sorcerer Lord and may have up to four Chaos Dwarf magic spells. These are randomly dealt before the battle begins as described in the Warhammer Battle Magic supplement. The Chaos Dwarf magic spells are included in the **White Dwarf presents: Chaos Dwarfs** book and the **Arcane Magic** supplement.

**SPECIAL RULES**

**MOVEMENT:** Astragoth can move faster than an ordinary Chaos Dwarf because of his remarkable semi-mechanical body. However, his machine enables him to move no faster than this rate. Consequently Astragoth can only charge up to 6" and he cannot make a faster march move. The exception to this limitation is that he will still pursue and flee at the normal rate of 2D6".

**DEATH BLOW:** The steam-driven pistons that have replaced Astragoth's muscles and sinews allow him to strike his enemy with mechanical force. As well as boosting his strength as shown by his characteristics, he can also make a Death Blow special attack. If Astragoth successfully hits the same target with all three of his attacks, then his mechanised arm goes into overdrive, pounding, smashing and stabbing faster than flesh and bone would permit. He can immediately strike all his blows once again against the same target.



# GAMES WORKSHOP



## SWANSEA GRAND OPENING



**SATURDAY 6th & SUNDAY 7th MAY**  
45 Princess Way. TEL: 01792 463969

**DOORS OPEN**  
9.00AM  
SATURDAY  
AND 10.00AM  
SUNDAY



**BUY ANY THREE BLISTER PACKS AND  
GET THE CHEAPEST ONE FREE!**



**MASSIVE DEALS ALL DAY  
ONLY £48.50 EACH!**

That's up to a 33% saving!  
Don't miss these amazing offers and  
massive discounts on a whole range of  
exciting Games Workshop products.

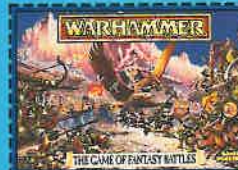

**WARHAMMER**  
plus!  
**WARHAMMER  
BATTLE MAGIC**  
plus! any one  
**ARMIES BOOK**  
Normal price  
**£69.97**



**TITAN LEGIONS**  
plus!  
**SPACE MARINE  
BATTLES BOOK**  
plus! any one  
**BOXED SUPPLEMENT**  
Normal price  
**£64.97**



**BLOOD BOWL**  
plus!  
**DEATH  
ZONE**  
plus! any one  
**BOXED TEAM**  
Normal price  
**£59.97**



**WARHAMMER  
40,000**  
plus!  
**DARK MILLENNIUM**  
plus! any one  
**CODEX BOOK**  
Normal price  
**£69.97**

REDEEMABLE AT GAMES WORKSHOP  
SWANSEA 6TH & 7TH MAY 1995

**25% OFF** GAMES WORKSHOP  
OR CITADEL PRODUCTS.

ONLY ONE VOUCHER PER PRODUCT. NOT  
TO BE USED WITH ANY OTHER OFFER.

REDEEMABLE AT GAMES WORKSHOP  
SWANSEA 6TH & 7TH MAY 1995

**10% OFF** GAMES WORKSHOP  
OR CITADEL PRODUCTS.

ONLY ONE VOUCHER PER PRODUCT. NOT  
TO BE USED WITH ANY OTHER OFFER.

REDEEMABLE AT GAMES WORKSHOP  
SWANSEA 6TH & 7TH MAY 1995

**10% OFF** GAMES WORKSHOP  
OR CITADEL PRODUCTS.

ONLY ONE VOUCHER PER PRODUCT. NOT  
TO BE USED WITH ANY OTHER OFFER.

REDEEMABLE AT GAMES WORKSHOP  
SWANSEA 6TH & 7TH MAY 1995

**10% OFF** GAMES WORKSHOP  
OR CITADEL PRODUCTS.

ONLY ONE VOUCHER PER PRODUCT. NOT  
TO BE USED WITH ANY OTHER OFFER.

REDEEMABLE AT GAMES WORKSHOP  
SWANSEA 6TH & 7TH MAY 1995

**25% OFF** GAMES WORKSHOP  
OR CITADEL PRODUCTS.

ONLY ONE VOUCHER PER PRODUCT. NOT  
TO BE USED WITH ANY OTHER OFFER.

REDEEMABLE AT GAMES WORKSHOP  
SWANSEA 6TH & 7TH MAY 1995

**10% OFF** GAMES WORKSHOP  
OR CITADEL PRODUCTS.

ONLY ONE VOUCHER PER PRODUCT. NOT  
TO BE USED WITH ANY OTHER OFFER.

REDEEMABLE AT GAMES WORKSHOP  
SWANSEA 6TH & 7TH MAY 1995

**10% OFF** GAMES WORKSHOP  
OR CITADEL PRODUCTS.

ONLY ONE VOUCHER PER PRODUCT. NOT  
TO BE USED WITH ANY OTHER OFFER.

REDEEMABLE AT GAMES WORKSHOP  
SWANSEA 6TH & 7TH MAY 1995

**10% OFF** GAMES WORKSHOP  
OR CITADEL PRODUCTS.

ONLY ONE VOUCHER PER PRODUCT. NOT  
TO BE USED WITH ANY OTHER OFFER.

PLEASE NOTE: NONE OF THE VOUCHERS ON THIS PAGE MAY BE USED IN COMBINATION WITH  
ANY OTHER OFFER NOR MAY THEY BE USED ON BOXTREE BOOKS' WARHAMMER NOVELS

# TALLARN DESERT RAIDERS



TALLARN DESERT RAIDERS WITH LASGUNS

MELTA GUN



SERGEANT



TALLARN DESERT RAIDERS AUTOCANNON AND WEAPONS TEAM



THE TALLARN DESERT RAIDERS DEPLOY FOR BATTLE

# WARHAMMER

## 40,000

# TALLARN DESERT RAIDERS

By Rick Priestley

Tallarn is a harsh planet, with endless sulphurous deserts and constant raging sandstorms. It was the site of the largest tank battle fought during the Horus Heresy, the grave of thousands of Chaos heretics, and the home of some of the hardest warriors in the Imperial Guard – the Tallarn Desert Raiders.

### TALLARN

The world of Tallarn was once a fertile planet bathed in the gentle orange light of its twin suns. Oceans, plains and lush jungles covered its surface, and its people prospered. All of this ended during the Horus Heresy.



### CHAOS ATTACK!

In a devastating surprise attack, the Iron Warriors Chaos Space Marines struck the planet. Thousands of virus bombs rained down on Tallarn and all who could ran to the enviro-shelters deep beneath the surface. As they hid, safe from the devastating bio-infestation, the deadly coils of DNA mutated as they were programmed to do. Animals, plants, even insects died as the virus did its work, destroying the planet's ecosystem and leaving an empty shell.

After seven weeks of isolation the virus had run its course and the remaining people of Tallarn emerged upon the surface. They found a world covered with the acrid slime of plants and corpses not yet decayed – for the world was still sterile without even bacteria to aid the decomposition of its dead. The Iron Warriors sent their task force to repossess the world for the Dark Gods of Chaos. From underground bunkers the Tallarn forces emerged to do battle with the invaders. Soon, reinforcements from both sides arrived, rival space fleets bringing vast armies to fight over the worthless remnants of the dead planet.

The Battle of Tallarn raged for many months and was the largest armoured conflict of the Horus Heresy. Outbreaks of viral infection from rogue DNA residue made it almost

impossible for infantry to operate outside of their protective shelters. The battle was finally decided by armies of tanks. When the fighting ended the empty, putrid wastes of Tallarn were littered with the wreckage of more than a million shattered vehicles.

### A HOLLOW VICTORY

Chaos was driven from Tallarn at great cost, yet for all the millions that died there seemed little gained from the fight. The planet was destroyed and rendered useless for large scale habitation, industry or agriculture. The armies of the Imperium might well have given up Tallarn had their commanders realised the extent of the devastation, but once the armies were in motion there was no going back.





At the time the Chaos attack made little sense. It seemed insane that even the fickle Gods of Chaos should expend such energy fighting over a devastated world of no particular strategic significance. But in the aftermath of the Horus Heresy their were few left to ponder such questions. Amongst the evils of the time it was just another demonstration of the random destruction of Chaos.

### TALLARN SURVIVES

Within a thousand years of the Horus Heresy Tallarn evolved into a very different world from the prosperous planet of former times. Deserts of sulphurous sand stretched from pole to pole and all water disappeared except for a thin residue in the atmosphere. No vegetation remained on the surface exposed to the blistering, wind-blown sands. All that grew was the carefully husbanded crops of the Tallarn themselves, sheltered in their protective horticultural domes.

The surviving Tallarn now lived in domed towns or in natural caverns hollowed out in the planet's rock. Fierce winds drove the Tallarn into their shelters, corrosive sulphur storms made all travel risky, and eventually a system of tunnels was built to facilitate travel beneath the surface.

Above their settlements the Tallarn built vapour traps to catch water from the thin atmosphere. These tall towers still stand above their domes to this day, and all the water they use is caught by these cunning devices and channelled into subterranean holding tanks.

### A SECRET UNCOVERED

During the construction of an arterial tunnel, Tallarn miners struck an outcrop of hard black rock. They were unable to penetrate through this strange substance which was quite unlike any other they had encountered. After some days they decided to divert their tunnel to go around it. As they did so they discovered something very strange. At first it seemed like a natural formation, but soon they realised they had uncovered a deliberate construction.

The initial excavations revealed a huge wall of the strange black rock carved over its entire surface with weird entwined figures. The figures were human sized yet not entirely human, possessing a grace and beauty which rendered their grotesquely inscribed cavorting all the more perverse. Giant earth movers were brought in to dig out the layer of sulphur sand in which the wall was buried, and bit by bit it was slowly and painstakingly exposed to the daylight.

The Tallarn soon discovered the wall was not straight but curved, in fact part of a huge circle. Carefully their most skilled technicians worked to uncover the entire thing, a huge ring-shaped mound almost half a mile across.

### THE DANGER AWAKES

It was not until the whole circle was exposed that the disaster happened. With a blast of power the circle screamed and writhed, its inert form turned suddenly to moaning flesh. Where before there had been carvings now there were the creatures themselves, Eldar creatures, yet twisted with an uncanny evil, locked together by some sorcerous bond into a sickening embrace of depraved passion.

Within the circle itself, blackness boiled and stars wheeled – stars that belonged in another part of the galaxy altogether.

### THE DARK LIBRARY

In the Dark Library of the Eldar a custodian shivered as he felt an unaccustomed surge of power. Adrift from time and space his mind searched the endless strands of probabilities and found the thread that led to Tallarn. After so long it had been discovered: the Cursus of Alganar, legend of evil from before the Fall, vortex of unimaginable power, one of the three mythical Gateways of the Gods.

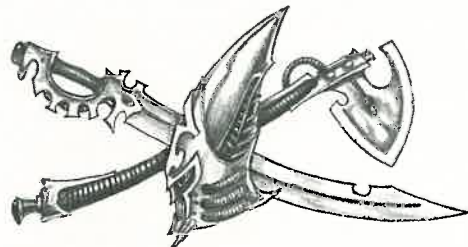

His mind shifted into synchronicity with the Farseers of his race, tracing the paths that linked his mind to the Craftworlds of the Eldar. When that knowledge touched the Farseers the Avatars of Khaine would wake. And Khaine would recognise the work of his ancient destroyer Slaanesh – Bane of the Eldar, Prince of the Chaos Gods.



*The Tallarn Desert Raiders and their Eldar allies battle against the foul forces of Chaos.*

## ELDAR ATTACK

The Eldar struck from the skies without warning or explanation. To the Tallarn it was an unwarranted act of aggression. Little could they imagine that the fate of the entire Eldar race was bound up with their strange discovery. To the Eldar there was no time for explanation or discussion. They couldn't know whether the Tallarn were in league with Chaos or whether the fierce desert people were unwitting pawns in the Dark Gods' game. As far as they were concerned the only option was to attack, to destroy the Cursus if they could before it was too late.

The Tallarn fought back with characteristic ferocity. Years of living upon the burning sulphur deserts had honed them into resilient fighters. To the Eldar the deserts were an unknown quantity. Even the hardy Aspect Warriors died under the heat of the sun, whilst the Eldar Guardians fell to the lightning raids of the human fighters. But the Eldar did not give up. They could not afford to abandon their attack. The survival of the galaxy depended on it.

## THE DARK GODS AWAKE

But it was already too late. The gateway that was the Cursus grew in power by the minute. Its screams and wails filled the desert as the dark light brightened and fluxed within its core. Lights and stars swirled and clashed, fountains of spinning incandescence spat into the night sky. The laughter of gods

rebounded across the sulphur dunes and Eldar and humans alike shuddered in terror.

From the Cursus poured the minions of Chaos. There were things indescribable to men. Things that awakened primal terrors in Eldar hearts – horrors of slime and flame that cackled and bounded into battle, transparent bodies of pure energy dividing and reuniting in a cascade of colours, vile fleshy things that pulsed with inner power and sucked at the air with poisonous lips, long-legged abominations that bore slender and elegant creatures upon their backs, beautiful and yet sickening to look upon. It was as if all the daemons of hell had fallen upon Tallarn. They had.

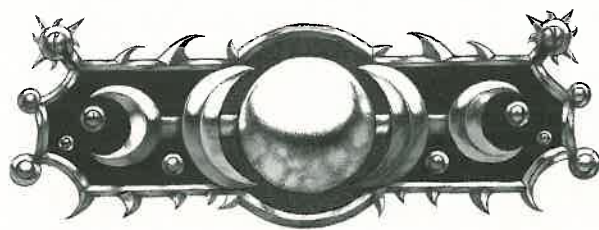

## THE BATTLE FOR THE CURSUS

The human commander called a truce and hurried to the Eldar lines where the alien Seers sat waiting. Knowledge had finally opened their eyes. The Runestones lay cast upon the desert floor. Hope in union was predicted. Division would lead to



damnation, darkness and death. With their fates so clearly predicted, the Eldar and Tallarn joined forces.

The two races fell back before the Chaos onslaught. Many were caught and destroyed in the early confusion, but the Chaos advance was slowed by the merciless hit and run tactics of the desert raiders. Humans led Eldar jet-bike riders into the attack, and soon the Tallarn and Eldar were able to regroup.



As the daemon hordes advanced beyond the Cursus their power waned, as if they were dependant upon its proximity for their power. And so it was, for the tendrils of Chaos though long are very tenuous, and only blood-letting and victory can sustain the link between the Dark Gods and their minions.

### CHAOS DEFEATED

With skill and cunning the Tallarn drew out the Chaos battle lines. Choosing their targets carefully the Tallarn launched one attack after another, always retreating before the Chaos hordes could turn to meet their fire. It was a tactic calculated to drain the power of the horde, and it worked better than even the wily sons of the sulphur desert could have hoped.

The Eldar Seers saw the runes change, saw the opportunity develop. The daemons were fading fast, their glittering bodies growing ever more transparent, their cries ever weaker. Now was the time to hit them hard.

With a furious charge the Eldar and Tallarn threw their remaining strength against the gibbering horde. It was a last effort that would result in absolute victory or utter defeat. The Chaos hordes shuddered and the bodies of the daemons seemed to fade and dull. The crackle of energy died and the spark of life vapourised into the oily air.

Many lay dead, human and Eldar, gored by monstrous claws, crushed by the sensual caress of a poisoned tongue, or torn apart by razor sharp teeth. Many Eldar waystones were collected from the field, and many Tallarn taken back to their domes to surrender the water from their bodies to the hydro-tanks. But it was victory nonetheless.

### THE CURSUS

Once the Eldar had departed in peace, and the people of both races had exchanged their promises of friendship, the Tallarn returned to the Cursus. They found the black stone cold and lifeless once more, just as it was when they had first uncovered it. However, they knew now that the stone was not dead but merely sleeping, awaiting its time again, waiting for the call of its evil masters.

The Tallarn buried the Cursus beneath the sulphur sands once more and placed within its circle the mysterious devices that the Eldar had given them for that purpose. Then they sealed the surface with plascrete and turned their backs upon it.

### TALLARN DESERT RAIDERS

For every Command Section in your Imperial Guard army you may include up to three squads of Imperial Guard. These squads could be Tallarn Desert Raiders, Mordian Iron Guard, Ice Warriors of Valhalla, Cadian Shock Troops, Rough Riders of Attila or any other Imperial Guard regiment.

#### TALLARN DESERT RAIDER SQUADS ..... 127 points

A Tallarn Desert Raider squad consists of 1 Sergeant and 9 Imperial Guard troopers armed with lasgun, frag grenades and wearing flak armour (6+ save). The Sergeant is armed with a plasma pistol, sword, frag grenades and is wearing flak armour (6+ save). One Imperial Guard trooper is equipped with a melta-gun, and the squad includes a two man weapons team armed with an Imperial Guard autocannon (See White Dwarf issues 180 or 182 for the weapons team rules).

PROFILE	M	WS	BS	S	T	W	I	A	Ld
Imperial Guard	4	3	3	3	3	1	3	1	7

# GAMES WORKSHOP

## BASINGSTOKE GRAND OPENING

**SATURDAY 27th & SUNDAY 28th MAY**  
3 Potters Walk, Wote Street. TEL: 01256 466050

**DOORS OPEN  
9.00AM  
SATURDAY  
AND 10.00AM  
SUNDAY**



**BUY ANY THREE BLISTER PACKS AND  
GET THE CHEAPEST ONE FREE!**



**MASSIVE DEALS ALL DAY  
ONLY £48.50 EACH!**

That's up to a 33% saving!  
Don't miss these amazing offers and  
massive discounts on a whole range of  
exciting Games Workshop products.



**WARHAMMER  
plus!  
WARHAMMER  
BATTLE MAGIC  
plus! any one  
ARMIES BOOK  
Normal price  
£69.97**



**TITAN LEGIONS OR  
SPACE MARINE  
plus!  
SPACE MARINE  
BATTLES BOOK  
plus! any one  
BOXED SUPPLEMENT  
Normal price  
£64.97**



**BLOOD BOWL  
plus!  
DEATH  
ZONE  
plus! any one  
BOXED TEAM  
Normal price  
£59.97**



**WARHAMMER  
40,000  
plus!  
DARK MILLENNIUM  
plus! any one  
CODEX BOOK  
Normal price  
£69.97**

REDEEMABLE AT GAMES WORKSHOP  
BASINGSTOKE 27TH & 28TH MAY 1995

**25% OFF** GAMES WORKSHOP  
OR CITADEL PRODUCTS.

ONLY ONE VOUCHER PER PRODUCT. NOT  
TO BE USED WITH ANY OTHER OFFER.

REDEEMABLE AT GAMES WORKSHOP  
BASINGSTOKE 27TH & 28TH MAY 1995

**10% OFF** GAMES WORKSHOP  
OR CITADEL PRODUCTS.

ONLY ONE VOUCHER PER PRODUCT. NOT  
TO BE USED WITH ANY OTHER OFFER.

REDEEMABLE AT GAMES WORKSHOP  
BASINGSTOKE 27TH & 28TH MAY 1995

**10% OFF** GAMES WORKSHOP  
OR CITADEL PRODUCTS.

ONLY ONE VOUCHER PER PRODUCT. NOT  
TO BE USED WITH ANY OTHER OFFER.

REDEEMABLE AT GAMES WORKSHOP  
BASINGSTOKE 27TH & 28TH MAY 1995

**10% OFF** GAMES WORKSHOP  
OR CITADEL PRODUCTS.

ONLY ONE VOUCHER PER PRODUCT. NOT  
TO BE USED WITH ANY OTHER OFFER.

REDEEMABLE AT GAMES WORKSHOP  
BASINGSTOKE 27TH & 28TH MAY 1995

**25% OFF** GAMES WORKSHOP  
OR CITADEL PRODUCTS.

ONLY ONE VOUCHER PER PRODUCT. NOT  
TO BE USED WITH ANY OTHER OFFER.

REDEEMABLE AT GAMES WORKSHOP  
BASINGSTOKE 27TH & 28TH MAY 1995

**10% OFF** GAMES WORKSHOP  
OR CITADEL PRODUCTS.

ONLY ONE VOUCHER PER PRODUCT. NOT  
TO BE USED WITH ANY OTHER OFFER.

REDEEMABLE AT GAMES WORKSHOP  
BASINGSTOKE 27TH & 28TH MAY 1995

**10% OFF** GAMES WORKSHOP  
OR CITADEL PRODUCTS.

ONLY ONE VOUCHER PER PRODUCT. NOT  
TO BE USED WITH ANY OTHER OFFER.

REDEEMABLE AT GAMES WORKSHOP  
BASINGSTOKE 27TH & 28TH MAY 1995

**10% OFF** GAMES WORKSHOP  
OR CITADEL PRODUCTS.

ONLY ONE VOUCHER PER PRODUCT. NOT  
TO BE USED WITH ANY OTHER OFFER.

PLEASE NOTE: NONE OF THE VOUCHERS ON THIS PAGE MAY BE USED IN COMBINATION WITH  
ANY OTHER OFFER NOR MAY THEY BE USED ON BOX TREE BOOKS' WARHAMMER NOVELS

# Warhammer Quest

DUNGEON ADVENTURES IN THE WARHAMMER WORLD

## MISSION IMPOSSIBLE!

By Gavin Thorpe

Occasionally, among their perilous adventures and heroic deeds, a party of Warriors will be caught up in a really unusual series of events. They may get lost or imprisoned – anything could happen. To represent these possibilities, Gavin has written the following rules to allow your brave Warriors to venture forth on a Special Quest.

### SPECIAL QUESTS

Sometimes a straightforward adventure gets a bit more complex than it first seemed. Warriors may get lost or be ambushed and captured before they reach the dungeon. The Warriors may even decide to go on a quest which they know will be more perilous than normal. The rewards for such bravery are great, and because of this some Warriors make a special effort to seek out impossible odds to face (these parties often include a large number of Dwarf Troll Slayers!).



The Special Quest card and floorplan at the end of this article, together with the three new Special Quests, can be used to introduce an unexpected twist to your games. In future issues we will feature more Special Quests, Objective rooms and other expansions for your Warhammer Quest adventures.

### DUNGEON CARDS

To use the Special Quest card simply shuffle it in with your Objective room cards when you are starting your adventure. If you draw the Special Quest card, roll to see which mishap or special circumstance has affected your heroic Warriors. This is just like finding out which adventure you are playing with a normal Objective room.

Alternatively, you can choose to set out on a Special Quest, eager for the greater rewards to be gained. If you decide to do this, simply roll a dice and consult the following pages to find out what the Warriors have found themselves embroiled in.

*Leaning on his gnarled oak staff, Fizantan the Marvellous waited patiently for the young warriors to recover from the shock of meeting such a fabled enchanter. Once their gasps of astonishment had subsided, he reached into the recesses of his voluminous robe and drew out the legendary Amulet of Vanhels.*

*"This talisman" he said, "contains the power of one of the mightiest sorcerers ever to walk the world. If it were to fall into evil hands there's no telling what would happen! You must ensure that it is safely returned to its resting place before others find out that it is loose once more."*

*Handing the blood-red pendant to the leader of the warriors, Fizantan the Marvellous stepped backwards.*

*"This won't hurt" began Fizantan, as smoke started to seep from the ground around the warriors. "At least it's not supposed to..."*

*His last words were cut off by a massive explosion and a brilliant flash of white light.*

*Rubbing their eyes, the warriors blinked at their new surroundings. Everything had changed. They weren't in the woods any more and Fizantan was nowhere to be seen. As their eyesight returned to normal they noticed the strange runes and carvings on the walls.*

*They had obviously been magically transported to the temple of Dagnatz, deep inside the Worlds Edge Mountains! All they had to do to complete their quest was to place the Amulet of Vanhels on the Shrine of Sigmar and return to collect their well earned payment.*

*Of course, it would be easier if Fizantan the Marvellous had transported them into the Shrine itself instead of this dank, dark, smelly prison cell...*



If you are performing a Special Quest you must also find out which adventure you were on when circumstances changed. This is done as normal by drawing an Objective room card, rolling a dice, and looking up the result in the Warhammer Quest Adventure Book. For example, you may be playing the Firechasm adventure number 4 – *Destroy the bridge*, when you become mixed up in Special Quest 5-6 – *The Slavers*.



## COMPLETING A SPECIAL QUEST

Unless otherwise noted in the Special Quest description, the Warriors play out their adventure exactly as written in the Adventure Book. The main difference is the bonus rewards that you get for completing the Special Quest. This may be extra gold or additional Treasure cards – the details are noted in each Special Quest description.

### HIDDEN PASSAGES

Sometimes the dungeon may contain a secret door or concealed corridor. If the Warriors finish their adventure (either by completing it, or by being cut off in a dead end) they may look for a Hidden Passage. Only if the adventure description says that the Warriors have to escape immediately, can they not search for a Hidden Passage.

Searching for Hidden Passages is simple. First, decide which board section(s) you want to search. Searching is the Warrior's action for that turn, and each Warrior may only search a particular board section once per adventure. At the end of the Warriors' phase roll a dice for each Warrior searching and consult the table below.

### HIDDEN PASSAGE TABLE

D6 Roll	Result
1	<b>Collapse!</b> The Warrior's searching causes a part of the dungeon ceiling to fall down. The dungeon isn't blocked, but each Warrior on the same board section suffers 1D6 Wounds (with no deductions) from the falling rocks.
2, 3, 4	<b>Solid Rock!</b> The Warrior cannot find any secret doors on this board section.
5, 6	<b>Found it!</b> Attach a Doorway to the board section and place the remaining Dungeon deck behind it to be explored as normal. Each dungeon will only ever have one Hidden Passage so there is no point searching again once one has been found.

## THE GAOL



*The Gaol is a very small and dark dungeon cell. A noxious smell rises from the open drain and the straw is infested with all kinds of unpleasant life. It is used by the Monsters for imprisoning people they want to forget about...*

At some point during each of the Gaol Special Quests, the Warriors will probably want to get into or out of the Gaol. Unfortunately, the thick iron gates of the Gaol are locked and cannot be passed until they have been opened. Hand-to-hand attacks may not be made through the gates but missile attacks will pass through the bars without hindrance. The Warriors may either try to smash the gates with brute force and ignorance, or attempt to pick the lock with stealth and cunning. Whichever method they choose, a Warrior must be standing adjacent to the gates to try to open them. Only one Warrior may attempt to open the gates each turn, and he may not move or attack while he does so.

To see if the Warrior is successful roll a D6. On a roll of 1 the unfortunate Warrior has set off a hidden trap which springs a poisoned spike into his arm or causes a guillotine blade to drop from the ceiling. As a result of this wound, the Warrior will remain at -1 Strength for the rest of the adventure. Otherwise add either the Warrior's Strength (for brute force) or Initiative (for picking the lock) to your dice roll. On a total of 7 or more the Warrior has overcome the locks and the gates have swung open. Any other result means that the gates stay firmly shut.





## CHOOSING A QUEST

Roll a dice to see which of the Gaol Special Quests the Warriors find themselves involved in. Because there are three adventures instead of the normal six, a roll of 1 or 2 indicates *The Mad Beast* Special Quest, a roll of 3 or 4 is *The Guards*, and a 5 or 6 is *The Slavers*.

### 1-2 THE MAD BEAST

The Goblins in this dungeon have trapped a mad Minotaur. The Chaos Gods have tainted the beast's mind and it is now totally insane. When the Warriors first enter the dungeon the Minotaur is safely under lock and key inside the Gaol, but the Minotaur is trying very hard to escape...

#### Special Rules

Create the dungeon as normal, but as well as the Objective room, shuffle the Gaol Dungeon card into the bottom portion of the Dungeon deck. The mad beast itself is represented by the single Minotaur Event card (not the 1D3 Minotaurs Event card). You should ignore instructions on the card to draw another Event card, the insane Minotaur is always alone when the Warriors encounter it.

There are two different circumstances in which the Warriors will meet the Minotaur. If the Minotaur card is turned over before the Gaol has been discovered the mad beast has already escaped. The Warriors hear a fearsome roar and the crash of twisted metal echoes down the corridors. Suddenly a massive shape hurtles out of the darkness! The Minotaur is placed on the board as normal and fights like any other Monster.

The second way that the Warriors can meet the Minotaur is if

they discover the Gaol before the Event card is turned over. In this case you should place the Minotaur inside the Gaol. The Warriors will be able to attack him with spells and missile fire (or hand-to-hand attacks if they're foolhardy enough to try and open the gates to let him out!). If the Minotaur is on the board and in the Gaol when the Minotaur Event card is turned over, then the beast lets out a tremendous bellow and smashes the gates aside! From that point on, the Minotaur will move towards and attack the Warriors just like any other Monster. Also, like other Monsters, the Minotaur is removed from play if he is cut off from the Warriors by a Cave-in, Portcullis or similar obstruction.

Wherever he is met, the Minotaur is so crazed that he can ignore wounds which would normally kill other creatures. To represent this, roll a dice each time the Minotaur is hit. On a roll of 1, 2 or 3 resolve the damage as normal, but on a roll of 4, 5 or 6 the Minotaur simply shrugs off the blow and takes no damage at all! If the Warriors manage to kill the crazed Minotaur it is worth 750 gold instead of the normal 440.



### 3-4 THE GUARDS

The Warriors were caught in a trap last night, and have found themselves the prisoners of the Night Goblins! The Warriors have been locked in the Gaol until the Night Goblin Warlord returns from his raid. Standing guard outside the Gaol are six cruel Night Goblin Archers.

#### THE GUARDS SET-UP

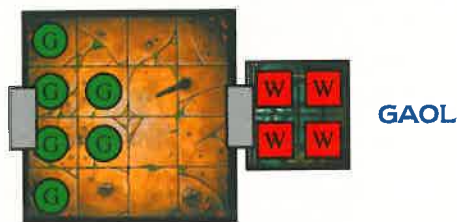

#### Special Rules

To start the adventure, set up the board sections as shown above. The Warriors start the adventure in the Gaol and you should place six Night Goblin Archers as shown on the diagram. The Night Goblin Archers will start shooting in the first Monsters' phase after one of the Warriors tries to open the gates, cast a spell or make any type of attack! However, until the Warriors have opened the gates of the Gaol, a roll of 1 in the Power Phase *does not* trigger an Unexpected Event.

Instead of gaining a single Treasure card for killing all the Night Goblin Archers, the Warriors find the guards' stash of loot and each one of them gets a Treasure card.

## 5-6 THE SLAVERS

The Monsters in this dungeon are raiding the local area for slaves, who they hope to take back to their powerful masters. An unlucky Warrior may find himself dragged off into the darkness and imprisoned.

### Special Rules

Shuffle the Gaol Dungeon card into the dungeon deck (remember to make sure that the Objective room stays within the bottom seven cards).

Any Warrior who is reduced to zero Wounds while there are Monsters on the board must immediately roll a dice. On a roll of 1, 2 or 3 the Warrior is dragged off by the Monsters (if he was carrying the Lantern, he drops it as he disappears into the darkness!). All of the Monsters on the board are removed from play, together with the unconscious Warrior. The players do not get any Gold for Monsters that slink off in this fashion. Any captured Warriors should be placed inside the Gaol when it is found, and will have D6 Wounds left. Each captured Warrior will also have had one randomly determined item of Treasure stolen from him if he was carrying any.

In this adventure, the Warriors must find the key to open the Gaol, they cannot try to pick the lock or force open the gates. The key is held by one of the Monsters in the dungeon, but the Warriors do not know which one. To find the key, roll a dice every time the Warriors finish an Event involving Monsters. On a roll of 6, one of the Monsters was carrying the key. Give the Dungeon Gaol Key Equipment card (below) to one of the Warriors. The party can start searching for the key even if a Warrior hasn't been enslaved yet.

The Warriors must return to the Gaol if they want free any prisoners. It takes a Warrior one turn to open the lock, during which time he may do nothing else while he sorts out the keys. Although he cannot attack, the Warrior can still defend himself as normal. The Warriors must leave the dungeon as explained in the Adventure Book (usually they will have to exit through the Objective room).

Luckily for the Warriors, the Monsters' slaving parties have been very successful and their hoard of stolen treasure is growing rapidly. Every time the Warriors get a Treasure card from an Event, roll a dice. On a roll of a 4, 5 or 6 the Warriors get two Treasure cards instead.

### HOW TO ASSEMBLE YOUR DUNGEON CARD, FLOORPLAN AND EQUIPMENT CARD

To assemble your new Dungeon card carefully cut it out (remembering to keep the two halves together). Fold your Dungeon card along the dotted line. Glue the back of each half (Citadel PVA glue is ideal) and press together firmly. It's a good idea to insert a piece of thin card between the two halves to make your Dungeon card a bit more durable. Trim off any excess so that your Gaol card doesn't stand out from the rest of your Dungeon deck.

To make your board section, cut around the outside of the floorplan and glue it to some card. The card needs to be quite thick so that your plastic doorways will hold the Gaol floorplan tightly. You may need to use several layers of card to make the Gaol floorplan the right thickness.

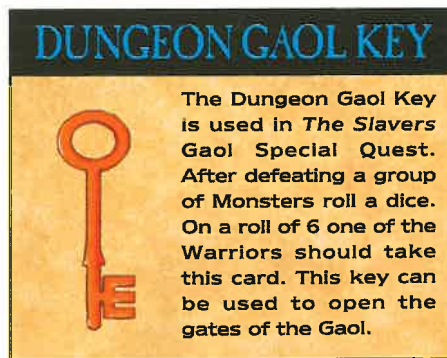

To make your Dungeon Gaol Key more durable, it's probably best to stick it to some thin card after you have cut it out.

# Warhammer Quest

## PIT FIGHTER



**A COMPLETE WARRIOR EXPANSION SET FOR THE WARHAMMER QUEST GAME**

Pit Fighters are brutal Warriors, trained by many years of bitter and bloody fighting for their lords and masters. The Pit Fighter is a trained killing machine whose battle-honed reflexes allow him to spring into action with lightning-fast speed. Armed with a deadly fist spike and an awesome pit flail he can take on any opponent, from a horde of Night Goblins to a huge, raging Minotaur.

In this pack you will find everything you need to play a Pit Fighter in the Warhammer Quest game. The boxed set includes a 12 page rulebook, full colour cards and counters, and a finely-sculpted Pit Fighter Citadel miniature.



Contents and components may vary from those illustrated



Model supplied unpainted



**This is not a complete game.  
You need a copy of Warhammer Quest to use the contents of this box.**

Citadel, the Citadel castle, Games Workshop, the Games workshop logo and Warhammer are registered trademarks of Games Workshop Ltd. Warhammer Quest is a trademark of Games Workshop Ltd. © Games Workshop Ltd. 1995. All rights reserved.

**GAMES WORKSHOP**

# WARHAMMER

40,000

## WOLVES OF FENRIS

By Kim Syberg

Kim is one of the highly-skilled painters from our 'Eavy Metal team. He spends all day painting Citadel miniatures, then goes home to work on his brilliant Space Wolves army in the evenings!



### SPACE WOLVES

Of all the different Space Marine Chapters in the Warhammer 40,000 universe I think the Space Wolves are the most exciting. With their nordic imagery and ferocious battle tactics, they are the ultimate close combat warriors. This combination of

distinctive imagery and battle-winning skills makes the Space Wolves my favourite Chapter by far.

Within a squad or pack, each of the Space Wolves is an individual who adorns his armour with wolf pelts, fangs and other totems to celebrate his victories. These decorations form his own personal iconography which sets him apart from his battle-brothers. These simple variations between troopers give me the opportunity to endlessly convert models!

The Space Wolves are organised slightly differently to other Space Marine Chapters. Each battle pack is trained and equipped for lightning fast raids into enemy territory and fulfils a specialised battlefield role. For example, the battle-hardened Long Fangs all carry heavy weapons. Grey Hunters are quite similar to Tactical Space Marines but they can all



Kim's army of Space Wolves assembled for battle.



One of the minor conversions in this Grey Hunters battle pack is the grenade in the hand of the second trooper.

carry close combat weapons to slaughter their foes. In the same vein, the Blood Claws have a *Berserk Charge* ability which allows them to roll an extra attack dice when they charge into hand-to-hand combat. These special rules make the individual troop types in the army really fun to use in battle and also are an endless source of modelling ideas.

### COLLECTING THE ARMY

I don't worry too much about having a battle-winning army, I much prefer to buy models which appeal to me as a modeller. Having said that, when I originally planned my army the first squad I bought were the Wolf Guard Terminators! These veteran troopers are not only great models to paint but are really powerful in battle! Each Wolf Guard is free to fight using whatever weapons he favours, so I equipped my pack with storm bolters, two assault cannons, a heavy flamer and a variety of close combat weapons. This variety gives them flexibility in the game, and was also more interesting to paint!

At the same time I bought the Terminators, I chose Wolf Lord Ragnar Blackmane to lead my army. He is a magnificently sculpted model with lots of detail on his armour and a huge wolf skin hanging from his shoulder. In battle Ragnar is a courageous leader and a formidable close combat opponent.

Although I had now created the backbone of a mighty Space Wolf army, I still only had seven models to fight with! I needed some more troops to bolster my forces and the plastic Space Marines from the Warhammer 40,000 boxed set were the answer. They can easily be used as Grey Hunters as all you have to do is paint them the right colour! With these extra troops my army began to look much more formidable.

I then realised that I didn't have any vehicles in my army, so I decided to paint up a Predator. I had great fun adding detail to this model and find the destructive power of its lascannons and autocannon very useful in battle. Over the next few months I added more vehicles as well as battle packs of Long Fangs and Blood Claws. Finally, after almost a year, I had assembled the army you see on these pages.



There are lots of small conversions on these Long Fangs Pack, like the trooper giving the 'thumbs-up' signal, but the really big job in making this squad was building a multi-melta from scratch!

# WARHAMMER

40,000

## SPACE MARINES<sup>®</sup> LAND SPEEDER



Miniatures designed by Jes Goodwin.



Model supplied unpainted

The Space Marine Land Speeder is a lightning fast weapon of war. Crewed by two Space Marines, the Land Speeder is armed with a heavy flamer and the awesome multi-melta. Soaring across the deadly battlefields of the 41st Millenium, the Land Speeder destroys the enemy with lightning fast attacks and deep strikes behind the enemy lines.

**WARNING!** This model contains lead which may be harmful if chewed or swallowed. Citadel Miniatures are not recommended for children under 14 years of age.

These models require assembly. We recommend that the parts are cleaned and trimmed with a modelling knife before being painted with Citadel paints.

Citadel, the Citadel castle, Space Marine, Games Workshop and Warhammer are registered trademarks of Games Workshop Ltd. Blood Angels, Space Wolves and Ultramarines are trademarks of Games Workshop Ltd. © Games Workshop Ltd, 1995. All rights reserved.



**EACH BOXED SET  
CONTAINS THREE  
SPACE MARINE<sup>®</sup>  
LAND SPEEDER  
TRANSFER  
SHEETS**

# WARHAMMER

## 40,000

# SPACE MARINE®

# RAZORBACK™



Model supplied unpainted.

### THE SPACE MARINE RAZORBACK BOXED SET CONTAINS:

One complete Space Marine Razorback model kit consisting of:

1 plastic Rhino kit.

1 blister pack containing all the metal components needed to assemble the Razorback's turret.



CITADEL  
MINIATURES

Blood Angels,  
Dark Angels,  
Ultramarines,  
Space Wolves  
and Razorback  
transfer sheets.

The Razorback is one of the Space Marines' most deadly support vehicles. With its powerful lascannon to destroy enemy tanks, and twin plasma guns to cut down enemy troops, this Rhino variant provides heavy covering fire for the Space Marines it transports into battle.

This kit contains all you need to make one complete Space Marine Razorback including transfer sheets for the Ultramarines, Blood Angels, Space Wolves and Dark Angels Chapters.

WARNING! This kit includes parts which contain lead and may be harmful if chewed or swallowed. Citadel Miniatures are not recommended for children under 14 years of age.

This is a multi part kit which contains both plastic and lead components and requires a degree of modelling skill to assemble.

Citadel, the Citadel Castle, Dark Angels, Warhammer, Space Marine and Games Workshop are registered trademarks of Games Workshop Ltd. Razorback, Rhino, Blood Angels, Ultramarines and Space Wolves are trademarks of Games Workshop Ltd.  
© Copyright Games Workshop Ltd 1994.  
All rights reserved.

GAMES  
WORKSHOP



★ SPACE MARINE RAZORBACK ★

**THIS BOXED SET  
CONTAINS A RAZORBACK  
TRANSFER SHEET AND  
FOUR SPACE MARINE  
TRANSFER SHEETS**





The sergeant and the veteran of this Blood Claws pack have been given metal arms cut from other models, rather than plastic arms.

## WOLF PACKS

When I began the army I decided to really individualise my Space Wolves by adding extra little details to each model. Nearly all of my miniatures are converted in some way, from a simple addition of a half-empty weapon magazine to more complex head or weapon swaps. Personalising your basic troops doesn't take long, and makes them far more interesting.

Jes Goodwin's brilliant Long Fang models stand implacable and unmoving like great oaks, and this fits their character perfectly. Nevertheless, I was still tempted to add some little bits and pieces of my own to make my models unique. Simple details like the Long Fang giving the 'thumbs-up' sign, or removing a missile from a missile launcher are great fun to do. However, the real challenge was to create a complete multi-melta! There isn't a Imperial version of this immensely destructive weapon available yet but I still wanted one in my army. I pieced it together using parts gleaned from a variety of sources including the Orks' chunky multi-melta! I adorned it with skulls cut from plastic Space Marine models and scoured my bits box for other interesting details like Imperial eagle badges. In the end I think you'll agree that it looks pretty good!

You'll notice that both my Grey Hunters and Blood Claws include troopers with their arms raised. This kind of dynamic pose is quite difficult to model with normal plastic arms, so I simply cut up some sergeant models and pinned their arms into place on my ordinary troopers. A few adjustments with a file and some modelling putty and the jobs a good 'un! This type of simple conversion is discussed in Mike McVey's 'Eavy Metal Modelling Guide which is full of interesting tips and ideas.

On this page you can see my savage Blood Claws battle pack. This is my latest squad and as you can see it's not complete yet. I prefer to model and paint a single battle pack at a time, converting all the miniatures in the squad in one go as I assemble them. In this way, if an idea comes to mind for a conversion I can follow it through on the whole squad. These conversions take many hours of careful work and are not for the faint-hearted. Sometimes it feels like they're never going to be finished, but the weeks of work are worth the effort. If you want to have a go at converting some of your own models, it's best to start with a simple weapon or head swap, and work up gradually to more complex conversions as your skills improve.

When all of the conversion work is complete I paint up the whole pack to a good basic standard. At this stage I can game with them, but I don't think they're really finished until I've been through and added the fine details. On my Blood Claws, for example, I've given them a really feral look by adding war paint and pack markings.



From the start I had decided to paint my army as part of Ragnar Blackmane's company, indicated by the yellow shoulder pad with a black wolf's head. I did this for two reasons. Not only was Ragnar the first Wolf Lord I painted, but I find his company the most evocative of the Space Wolves Chapter. Later, when I added a second Wolf Lord to my collection, I made his company badge very similar to Ragnar's in order that he would fit in with the rest of the army.



Extra wolf tails, grenades and other small details really personalise these Space Wolves Scouts.



My second Wolf Lord – a conversion based the Ragnar model.

## CHARACTERS

You may think I put a lot of work into painting the battle packs in my army, but I lavish even more time on the characters! Much of this work has been in converting models to represent the personalities in the army list who aren't available yet.



Space wolf Dreadnought Ragon.



Wolf Guard Ranulf and battle-brother in Terminator armour.

The first major conversion I tried was a second Wolf Lord. Based on Ragnar Blackmane's body, this heroic leader of the Space Wolves was built up from 57 different bits! With the addition of a few lumps of modelling putty I succeeded in creating a completely unique model. As you can see, the extra time and effort it takes to make such an important character isn't the sort of thing that you want to try for every trooper, but for a Wolf Lord I think that it's well worthwhile.

It wasn't long before I set myself a real challenge. One of the most unusual characters in the Space Wolf Army list is Wolf Guard Ranulf, a legendary giant of a Marine who defeated a horde of Orks in hand-to-hand combat. I began to model him by cutting up several different Space Marine and Wolf Guard Terminator models which I pinned together for extra strength. I stuck layers of plasticard onto his body and shoulder pads, to make him much broader than a regular Space Marine. After I'd finished this, I covered all the armour plates and the eagle on Ranulf's chest with modelling putty, blending it into the model to make him even more bulky. Finally I was able to add some details from other models: the storm bolter, power fist, and the head of the Blood Bowl Star Player – the Mighty Zug. Have a look at the finished model in the photo, he's huge!

I think Ranulf is my best conversion yet, so when I'd finished constructing it I took particular care when it came to painting. It's important to remember when you're painting characters, to really take your time to make sure that you get a good result. If you rush the paint job on your characters it really shows and can bring down the overall look of your whole army.

## VEHICLES

My Dreadnoughts, both Bjorn the Fell-handed and Ragon, took a lot of time to paint. This was partly deliberate as their immense size and tactical importance make them the centrepieces of my army and I didn't want to rush myself into making mistakes. Like the Land Speeder, both Dreadnoughts are painted in a bright and clean finish with only minor battle damage to the larger armour plates. Too much dirt and damage



*My finished Space Wolves Predator complete with kill markings and severed Ork heads.*

tends to make this sort of model look a bit messy and so I apply the maxim – less is more! Tanks are a different story as they have lots of flat areas which can be covered with all manner of details without obscuring the model. I usually carve a fair amount of scratches and damage from enemy fire onto the plastic hull with a scalpel before painting the model.

You will notice that my Predator is adorned with several trophies from its many victorious battles. The reason for all these severed Ork heads is simply the countless battles I have fought against the Orks! I like adding honour badges to vehicles to commemorate heroic engagements and victories. This gives the army a life of its own as games are won or lost and battle honours are added to the company standard.

### HAVE FUN!

Collecting and especially painting this army has taken me quite some time but it's been great fun. I find it very satisfying to see my army grow larger and larger, and it's hard to stop adding more packs all the time!

When I've finished my Blood Claws pack, I'm going to get some new Wolf Scouts to add to the pack I've already done. I've already started one, but it will take me some time to get all four Space Marines finished. After that I want to fill up my character collection a lot more. I don't think that an army ever really gets finished, There's always something new to add to it and, after all, that's the charm of collecting and gaming with a Warhammer 40,000 army.



**GAMES WORKSHOP®**

Presents

# THE BATTLE FOR BUGMAN'S BREWERY

**WARHAMMER**

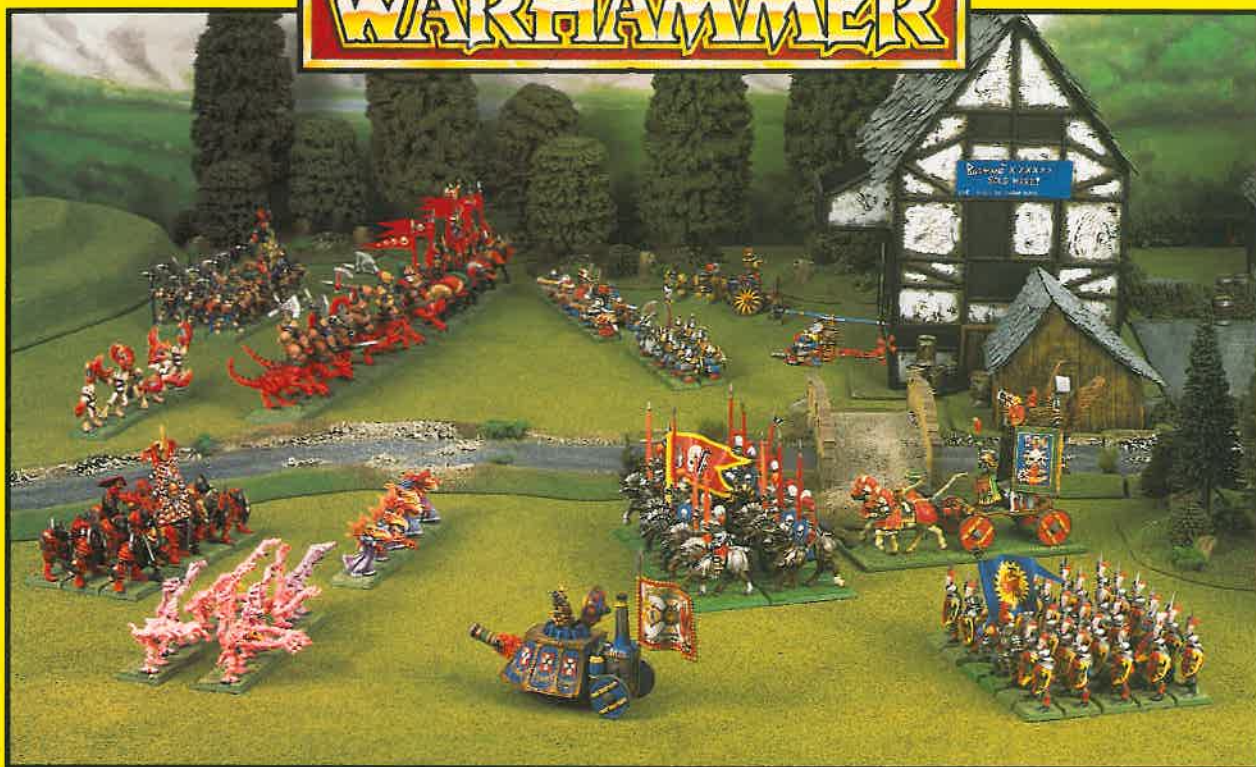

Come along and join in our massive battle at the



## EMPIRE IN FLAMES ROADSHOW



### APRIL

22nd Glasgow  
29th Bath

### MAY

6th Chelmsford  
13th Worcester  
20th Leicester  
27th Manchester

### JUNE

3rd Torquay  
10th Bristol

with loads more dates to come...

The Brewery of Josef Bugman is under siege. Will the Imperial army defeat the foul Chaos horde or will the forces of darkness smash the walls asunder and drink the legendary Bugman's Brew?

At each Empire in Flames Roadshow everything is provided. There's no need to bring miniatures, dice or rulebooks – you just turn up and play!



And, at every event, there will be special prizes of a limited edition **Bugman's Baseball Cap** so see you there!

# MODELLING WORKSHOP

## HOW TO MAKE AN EASY WARHAMMER BUILDING

By Rick Priestley and Robin Dews

**Modelling scenery and terrain for your battles is entertaining, challenging and fun say Robin and Rick. To make their point, in this month's Modelling Workshop they explain how you can make a great looking Warhammer building with nothing more than an old cornflakes packet!**

### OFF WE GO!

In last month's issue Rick and Robin showed you how to make a simple model of a Warhammer 40,000 Strongpoint, using nothing more complicated than a packet of cornflakes, a pair of scissors and some glue. This month, our cereal architects have turned their attention to the Warhammer World and the typical rustic dwellings found in the cities and towns of the Empire.

In this article we'll show you how to make a simple Warhammer building (looks more like a hovel to me – Ed) using the sorts of bits and pieces you'll find around the house. All the templates are provided so let's get started!



*Above: You'll be able to make this model with just the few simple items shown above.*

*Left: This model was neatly assembled by Owen Branham at the Studio.*

*Below: The rough prototype Robin made while watching TV!*



## EQUIPMENT AND MATERIALS

In the same way as for the Strongpoint, all you need to make this model is a large cereal packet, a pair of scissors and some glue – Citadel PVA, UHU, Evostick, Bostick or any other similar adhesive is perfect. You might find that some sellotape and a modelling knife also come in handy but they are not essential. The chimney pot you can see on our model was cut from a plastic drinking straw.

## USING THE TEMPLATES

If you had a go at the Strongpoint model we published last month, you'll already know how to make use of the templates printed on the following pages. If not, I'll give a quick summary here.

The templates provide you with the exact shapes for all the pieces of card you need to make your model. In order to use them, you'll need to remove the pages from your copy of White Dwarf or photocopy them before you start. You don't need to cut out the individual pieces as you are simply going to transfer the shapes onto your cereal packet or card.

Once you've photocopied or removed the templates, lie the whole sheet on top of your flattened out cornflake box. Next, use a compass or similarly pointed object – a drawing pin would do but is a bit clumsy to handle – to prick holes through the template at all of the positions marked by a red circle. Once

you've marked out all of the corners and fold lines in this way, lift off the template sheet and simply join up all the pin holes with a pen or pencil and you'll have a perfect copy. It's a bit like doing a dot-to-dot puzzle really, except the dots don't have any numbers. If you're not sure where some of the lines connect, then a quick glance at the template should solve the problem. When you've done all of this, simply cut out the card copies with your scissors and you'll be ready to start assembling your model building.

## ASSEMBLING THE WALLS

Cut out the two wall sections and gently score along the dotted fold lines with the point of your scissors (of course on your card copy you'll have drawn the lines in yourself so check against the template to see where the folds are). Once you've got the two pieces in front of you, simply glue the two wall sections together and hold them in place until the glue begins to set (see Diagram 1). The roof can then be added by spreading some glue along the tabs located on top of the walls, and pressing the roof down onto these. You might find that you need to stick a piece of sellotape across the back of each of the tabs, just to hold things firm until the glue sets.

*Diagram 1: Fold the two wall sections and then glue them together along the tabs to make a box shape. Once the glue has started to set, you can add the roof by sticking it down onto the tabs located on the top of the walls.*

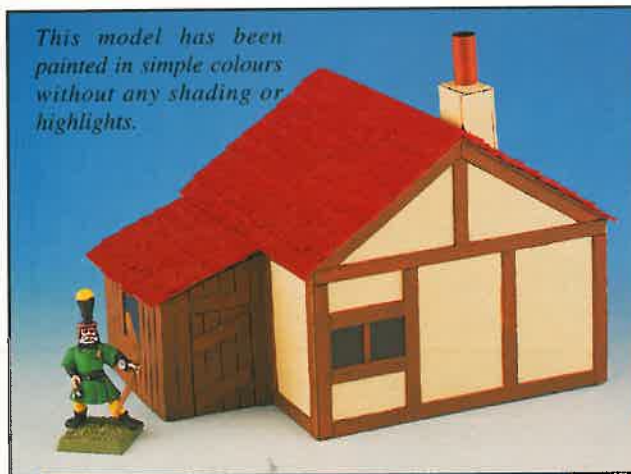
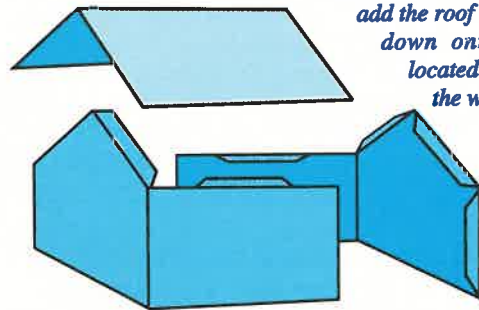

*This model has been painted in simple colours without any shading or highlights.*

*The fully assembled model, is now ready for painting.*



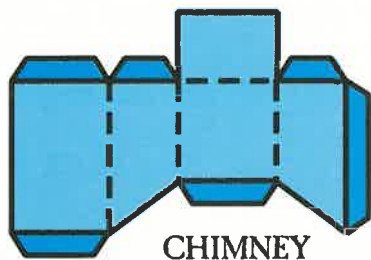
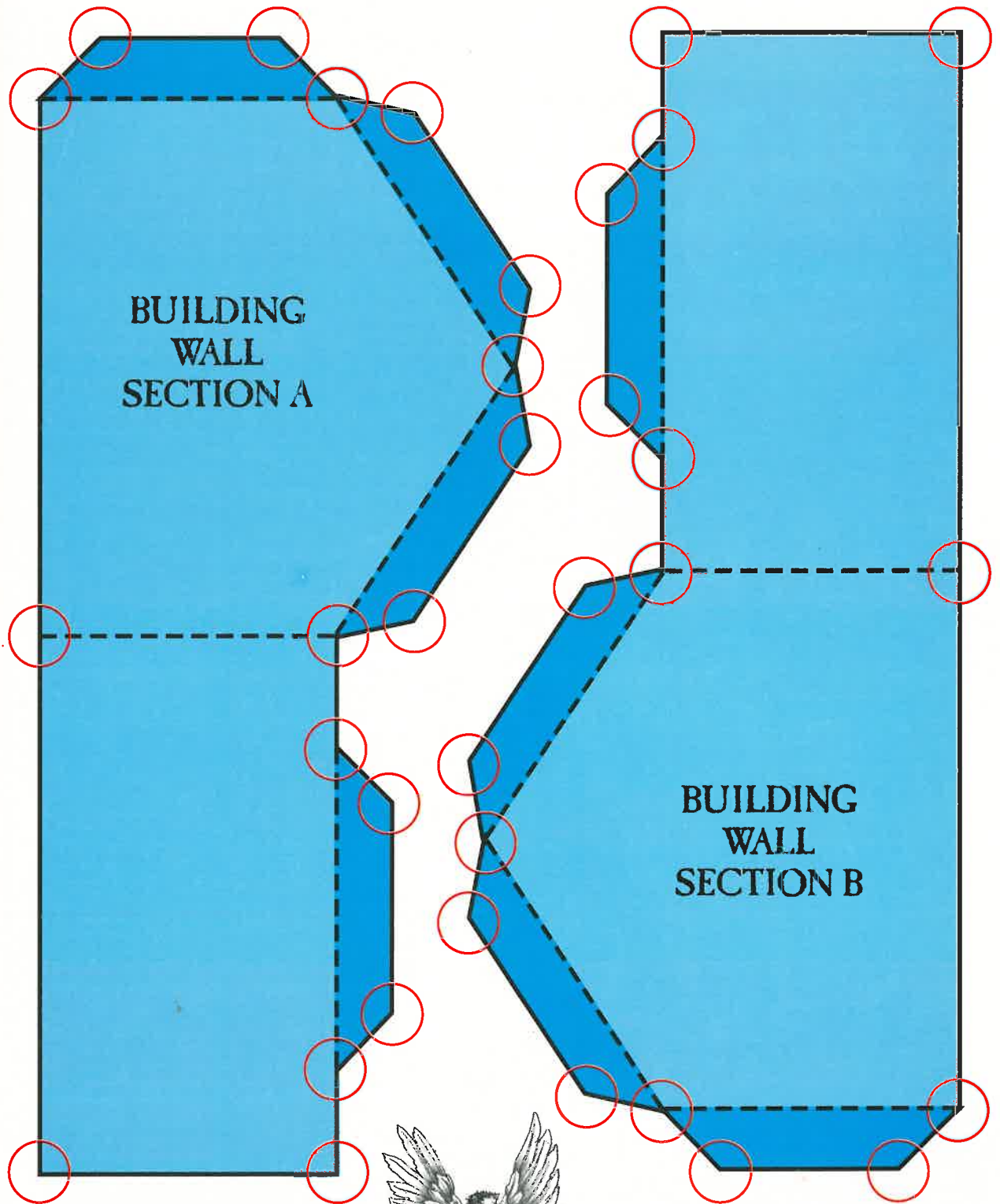

CHIMNEY

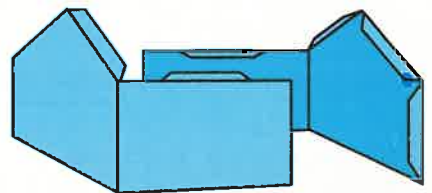

*Fold the two wall sections to make two right angled pieces and then simply glue the two halves of the building together.*

# GAMES WORKSHOP

## ALTRINCHAM GRAND OPENING

**SATURDAY 6th & SUNDAY 7th MAY**  
Unit 1, 17 Grafton Street. TEL: 0161 9299896

**DOORS OPEN  
9.00AM  
SATURDAY  
AND 10.00AM  
SUNDAY**

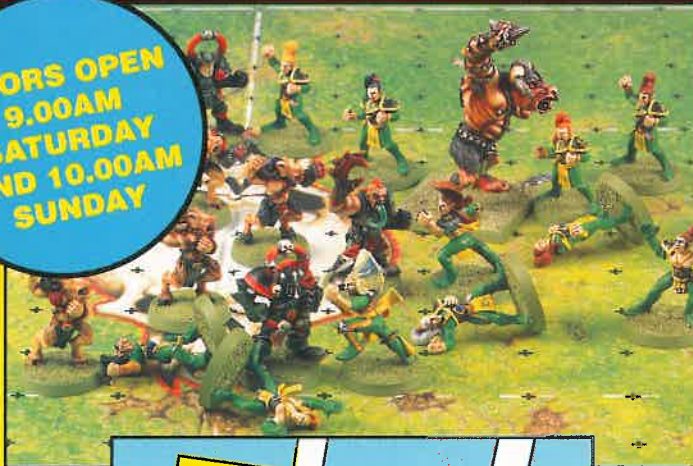

**BUY ANY THREE BLISTER PACKS AND  
GET THE CHEAPEST ONE FREE!**



**MASSIVE DEALS ALL DAY  
ONLY £48.50 EACH!**

That's up to a 33% saving!  
Don't miss these amazing offers and  
massive discounts on a whole range of  
exciting Games Workshop products.



**WARHAMMER  
plus!  
WARHAMMER  
BATTLE MAGIC  
plus! any one  
ARMIES BOOK  
Normal price  
£69.97**



**TITAN LEGIONS OR  
SPACE MARINE  
plus!  
SPACE MARINE  
BATTLES BOOK  
plus! any one  
BOXED SUPPLEMENT  
Normal price  
£64.97**



**BLOOD BOWL  
plus!  
DEATH  
ZONE  
plus! any one  
BOXED TEAM  
Normal price  
£59.97**



**WARHAMMER  
40,000  
plus!  
DARK MILLENNIUM  
plus! any one  
CODEX BOOK  
Normal price  
£69.97**

REDEEMABLE AT GAMES WORKSHOP  
ALTRINCHAM 6TH & 7TH MAY 1995

**25% OFF** GAMES WORKSHOP  
OR CITADEL PRODUCTS.

ONLY ONE VOUCHER PER PRODUCT. NOT  
TO BE USED WITH ANY OTHER OFFER.

REDEEMABLE AT GAMES WORKSHOP  
ALTRINCHAM 6TH & 7TH MAY 1995

**10% OFF** GAMES WORKSHOP  
OR CITADEL PRODUCTS.

ONLY ONE VOUCHER PER PRODUCT. NOT  
TO BE USED WITH ANY OTHER OFFER.

REDEEMABLE AT GAMES WORKSHOP  
ALTRINCHAM 6TH & 7TH MAY 1995

**10% OFF** GAMES WORKSHOP  
OR CITADEL PRODUCTS.

ONLY ONE VOUCHER PER PRODUCT. NOT  
TO BE USED WITH ANY OTHER OFFER.

REDEEMABLE AT GAMES WORKSHOP  
ALTRINCHAM 6TH & 7TH MAY 1995

**10% OFF** GAMES WORKSHOP  
OR CITADEL PRODUCTS.

ONLY ONE VOUCHER PER PRODUCT. NOT  
TO BE USED WITH ANY OTHER OFFER.

REDEEMABLE AT GAMES WORKSHOP  
ALTRINCHAM 6TH & 7TH MAY 1995

**25% OFF** GAMES WORKSHOP  
OR CITADEL PRODUCTS.

ONLY ONE VOUCHER PER PRODUCT. NOT  
TO BE USED WITH ANY OTHER OFFER.

REDEEMABLE AT GAMES WORKSHOP  
ALTRINCHAM 6TH & 7TH MAY 1995

**10% OFF** GAMES WORKSHOP  
OR CITADEL PRODUCTS.

ONLY ONE VOUCHER PER PRODUCT. NOT  
TO BE USED WITH ANY OTHER OFFER.

REDEEMABLE AT GAMES WORKSHOP  
ALTRINCHAM 6TH & 7TH MAY 1995

**10% OFF** GAMES WORKSHOP  
OR CITADEL PRODUCTS.

ONLY ONE VOUCHER PER PRODUCT. NOT  
TO BE USED WITH ANY OTHER OFFER.

REDEEMABLE AT GAMES WORKSHOP  
ALTRINCHAM 6TH & 7TH MAY 1995

**10% OFF** GAMES WORKSHOP  
OR CITADEL PRODUCTS.

ONLY ONE VOUCHER PER PRODUCT. NOT  
TO BE USED WITH ANY OTHER OFFER.

PLEASE NOTE: NONE OF THE VOUCHERS ON THIS PAGE MAY BE USED IN COMBINATION WITH  
ANY OTHER OFFER NOR MAY THEY BE USED ON BOXTREE BOOKS' WARHAMMER NOVELS.



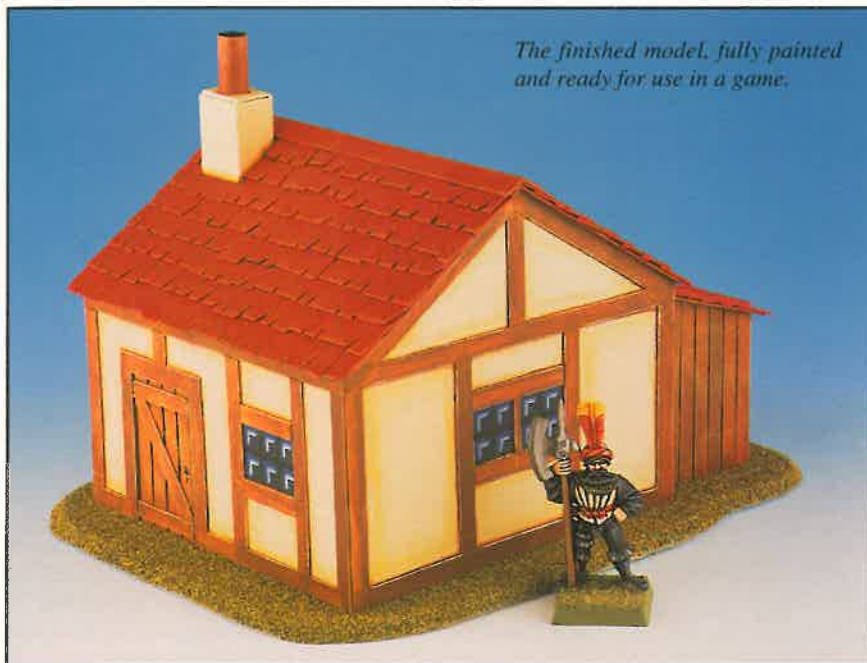

*The finished model, fully painted and ready for use in a game.*

### ADDING A CHIMNEY

In a moment, you're going to tile the roof of your building. Before you do that, you might want to add a chimney pot to your model like the one you can see in the photo.

You'll find a template for the chimney on the previous page. We didn't bother marking on all of the red circles, because by now you should have got the hang of how this works. In this case, the template is so small the circles would have just looked really messy and confusing.

Mark out the template in the normal way, fold it into a box and glue it onto the roof of your model. As a final touch, we stuck a piece of plastic drinking straw to the top of the chimney on our building, but this is entirely up to you.

Well that's it! You should now have in front of you a simple model building. Everything else we're now going to do just adds extra detail to this basic structure.

### THE OUTHOUSE

We decided to add a simple timbered outhouse to our building using the templates provided on the opposite page. First of all mark out the template onto your cereal packet card in the same way as before. On our model we attached the outhouse to one of the long sides, but where you place yours is entirely up to you! Once you've glued it into place, you can simply stick the flat roof down onto the tabs

### DETAILING YOUR MODEL

Once you've finished assembling the basic shape, you can begin to add more detail to your model. First of all we cut out some thin strips of card and glued them to the sides of the model to build up a timber frame. We also used this technique to mark out the door and window frames.

The door was then filled in with four more strips of card that made it look like rough-hewn planks of wood.

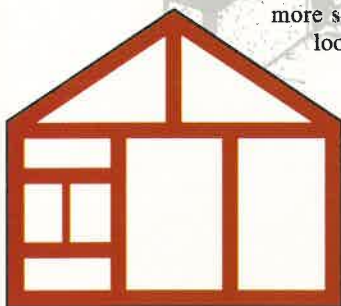

These two diagrams should give you some idea as to how to do this, but feel free to vary the pattern to suit your own model.

Once we'd finished working on the main building, the whole outer surface of the outhouse was covered with more strips of card to give it the appearance of a rough wooden structure.

### TILING THE ROOF

Adding tiles to the roof of a model makes it look really good and is very simple to do. It's true! Don't be misled by appearances. Tiling is dead straight forward.

First of all, cut yourself some strips of card about 10mm wide and the same length as the roof section. Then with your scissors, make a series of snips and cuts along one of the edges of each strip. Starting at the bottom of the roof, glue the tiling strips into place, with each one overlapping the strip below it. Although this is a bit complicated to explain, it's actually very simple to do, as Diagram 2 below makes quite clear. When you've finished tiling one side of the roof, turn the model round and do the same to the other side. To complete the job, you'll need to add a special 'capping strip' to the apex of the roof. This is just a strip of card that's twice as wide as the normal ones (20-25mm should be fine). Fold this down its centre line before snipping the edges and gluing it firmly into place.

*Diagram 2: On his model, Owen cut each roof strip into smaller sections before gluing them down. This takes a little longer to do but gives the roof a more varied look.*

*When you come to the bit of the roof where you attached the chimney, simply trim your strip a little shorter or cut a notch to make it fit.*

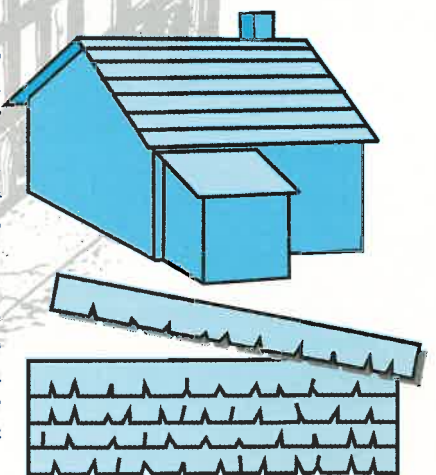

Once you've finished adding these extra details, you'll find your model is much more rigid. And, when the glue has all completely dried, your building is ready for painting.

## PAINTING YOUR MODEL

Well that's about it. When we'd finished fiddling about, we sprayed our model with Citadel black undercoat and gave it a simple, clean paint job. All the techniques that you normally use when painting a miniature – base coat, colour washes and drybrushing, etc – work fine on model buildings. In fact it's probably much easier to get a decent looking result because of the larger surfaces. Drybrushing is particularly effective on the roof and wooden outhouse, where the tile edges and planks really pick up the highlights and come to life.

Finally, we also attached our model to a cardboard base to make it a little more durable. The base was painted green and then coated with PVA glue before being dipped into green Citadel modelling flock.

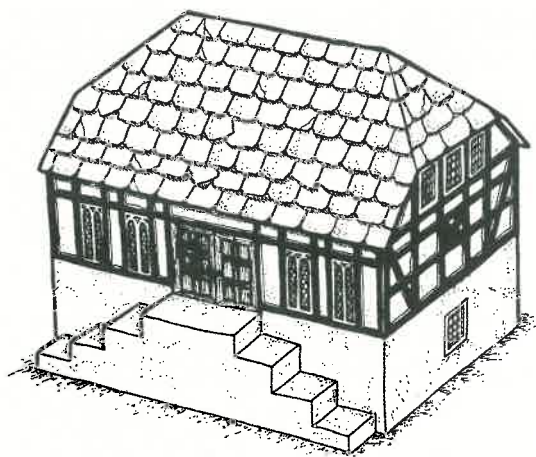

## GETTING MORE AMBITIOUS

Once you've made your first building, there's no reason to sit back on your laurels. Modelling is a whole hobby in itself and we've hopefully demonstrated just how easy it is to turn a few simple materials into a perfectly good building. On these pages we've illustrated just a few ways in which you could vary the basic shapes to create almost a limitless range of models for your games.

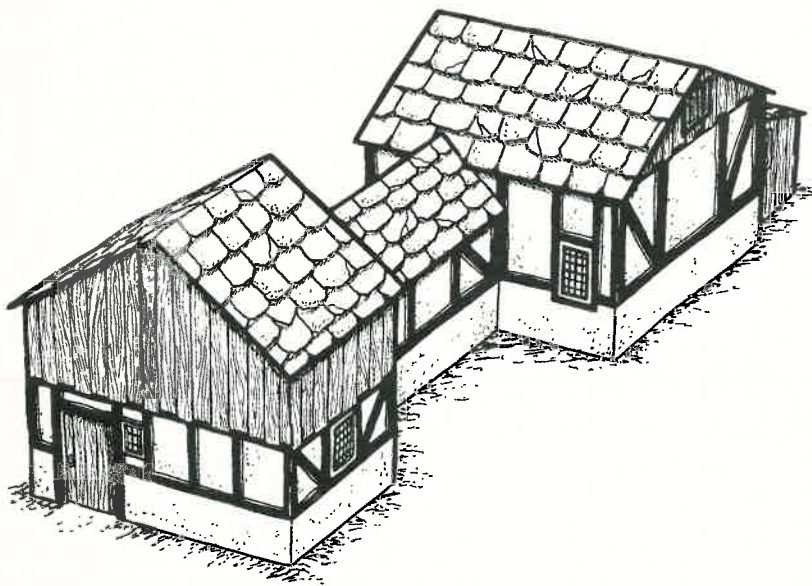

The thing to remember is that all buildings are basically a square or rectangular box with a few bells and whistles added. The farmhouse shown above is simply three buildings joined together to make a more complex shape. The model on the right has been modified to make a tall thin building with a balcony added. The large building at the top of the page has a slightly more complicated roof shape, but this really shouldn't cause you any difficulties.

Designing a flight of stairs might take a little more thought, but the only thing you really have to remember when adding features like stairs and balconies is to make sure that your models fit on them!

## AND EVEN MORE...

By now, you should have either turned the page or started to scoff several bowls of cornflakes! In previous Modelling Workshop articles, we've made reference to whole lists of model making materials and equipment such as foamcard, lineboard, balsa wood, etc. All of these are useful materials that you can use to enhance the look of your models, however none of them are essential. The buildings and other terrain we make at the Studio are constructed by our expert model maker Owen Branham. They all have to be designed and built to stand up to the rigours of almost daily use in the various games and playtests that go on in the Games Workshop Studio. They are also built and painted to a standard that enables us to take close-up photographs of them for White Dwarf and other books and publications.

For most games, all you really need is a reasonable collection of different buildings that you can use to vary your gaming terrain and so create different tactical challenges for your Warhammer battles.

For this purpose, these simple buildings are just great. So what are you waiting for... get to it!

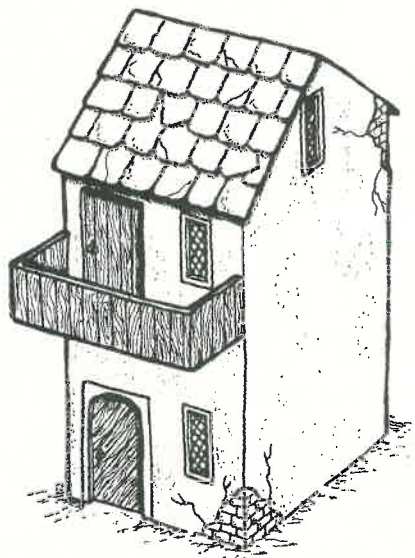

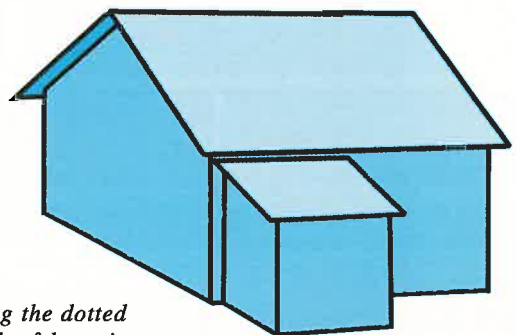
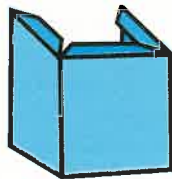
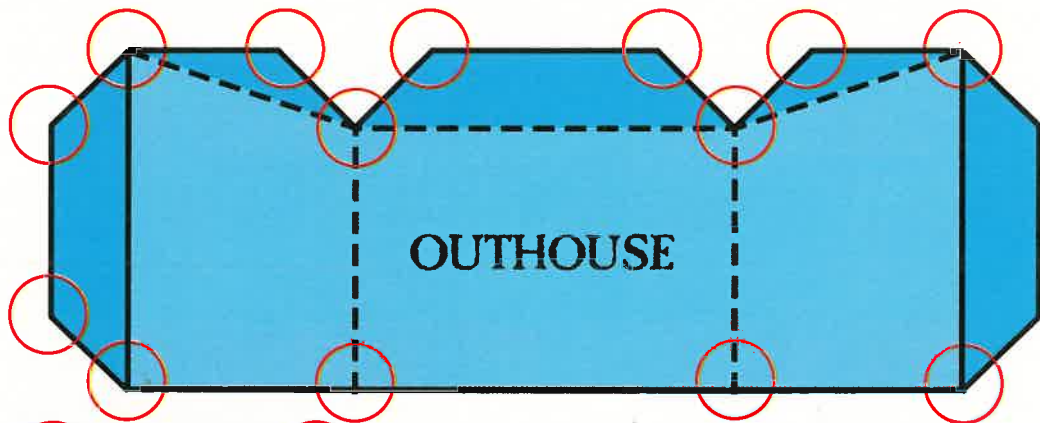
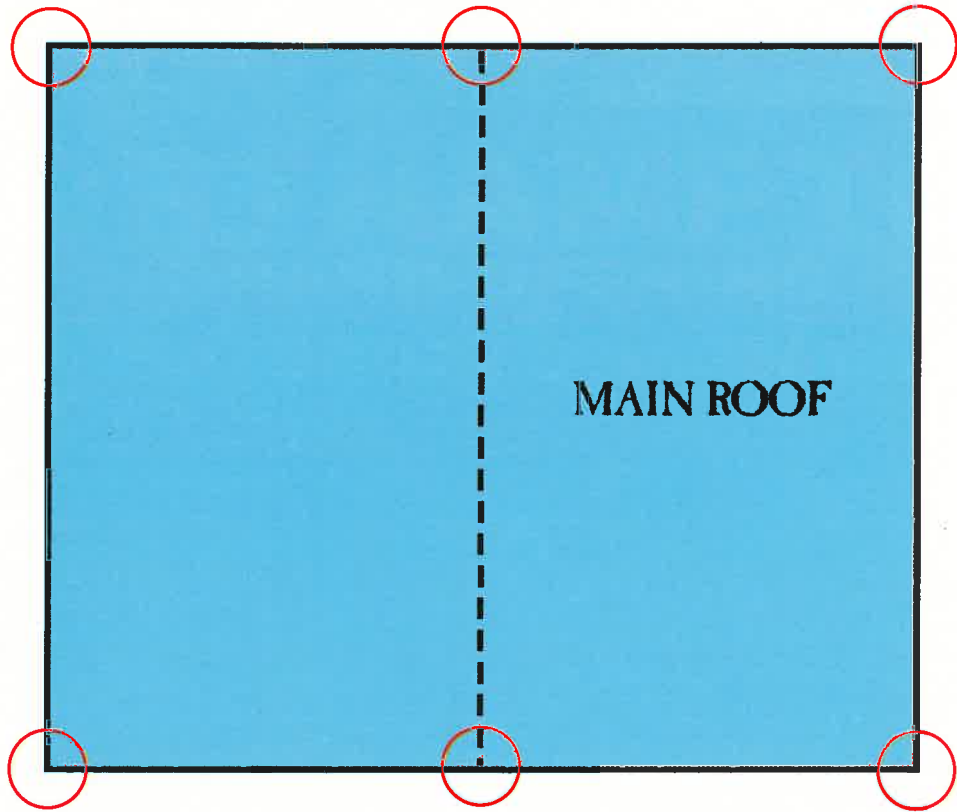

*Fold the outhouse along the dotted lines and glue it to the side of the main building. Once it's in position, you can add the flat roof.*

# GAMES WORKSHOP



## HARROGATE GRAND OPENING



**SATURDAY 27th & SUNDAY 28th MAY**  
29 Beulah Street. TEL: 01423 564310

**DOORS OPEN  
9.00AM  
SATURDAY  
AND 10.00AM  
SUNDAY**



**BUY ANY THREE BLISTER PACKS AND  
GET THE CHEAPEST ONE FREE!**



**MASSIVE DEALS ALL DAY  
ONLY £48.50 EACH!**

That's up to a 33% saving!  
Don't miss these amazing offers and  
massive discounts on a whole range of  
exciting Games Workshop products.



**WARHAMMER  
plus!  
WARHAMMER  
BATTLE MAGIC  
plus! any one  
ARMIES BOOK**  
Normal price  
£69.97



**TITAN LEGIONS OR  
SPACE MARINE  
plus!  
SPACE MARINE  
BATTLES BOOK  
plus! any one  
BOXED SUPPLEMENT**  
Normal price  
£64.97



**BLOOD BOWL  
plus!  
DEATH  
ZONE  
plus! any one  
BOXED TEAM**  
Normal price  
£59.97



**WARHAMMER  
40,000  
plus!  
DARK MILLENNIUM  
plus! any one  
CODEX BOOK**  
Normal price  
£69.97

REDEEMABLE AT GAMES WORKSHOP  
HARROGATE 27TH & 28TH MAY 1995  
**25% OFF** GAMES WORKSHOP  
OR CITADEL PRODUCTS.  
ONLY ONE VOUCHER PER PRODUCT. NOT  
TO BE USED WITH ANY OTHER OFFER.

REDEEMABLE AT GAMES WORKSHOP  
HARROGATE 27TH & 28TH MAY 1995  
**10% OFF** GAMES WORKSHOP  
OR CITADEL PRODUCTS.  
ONLY ONE VOUCHER PER PRODUCT. NOT  
TO BE USED WITH ANY OTHER OFFER.

REDEEMABLE AT GAMES WORKSHOP  
HARROGATE 27TH & 28TH MAY 1995  
**10% OFF** GAMES WORKSHOP  
OR CITADEL PRODUCTS.  
ONLY ONE VOUCHER PER PRODUCT. NOT  
TO BE USED WITH ANY OTHER OFFER.

REDEEMABLE AT GAMES WORKSHOP  
HARROGATE 27TH & 28TH MAY 1995  
**10% OFF** GAMES WORKSHOP  
OR CITADEL PRODUCTS.  
ONLY ONE VOUCHER PER PRODUCT. NOT  
TO BE USED WITH ANY OTHER OFFER.

PLEASE NOTE: NONE OF THE VOUCHERS ON THIS PAGE MAY BE USED IN COMBINATION WITH  
ANY OTHER OFFER NOR MAY THEY BE USED ON BOXTREE BOOKS' WARHAMMER NOVELS

# GAMES WORKSHOP

## NORTHAMPTON GRAND OPENING SATURDAY 27th MAY

6/7 the Friary, Upper Level, Grosvenor Centre. TEL: 01604 36687

**DOORS OPEN  
9.00AM  
SATURDAY**

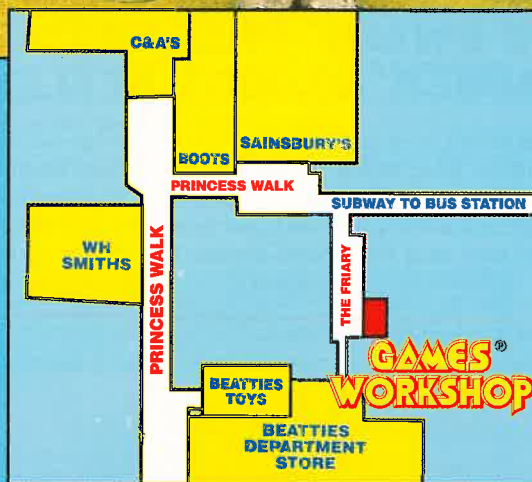

**BUY ANY THREE BLISTER PACKS AND  
GET THE CHEAPEST ONE FREE!**



**MASSIVE DEALS ALL DAY  
ONLY £48.50 EACH!**

That's up to a 33% saving!  
Don't miss these amazing offers and  
massive discounts on a whole range of  
exciting Games Workshop products.



**WARHAMMER  
plus!  
WARHAMMER  
BATTLE MAGIC  
plus! any one  
ARMIES BOOK  
Normal price  
£69.97**



**TITAN LEGIONS OR  
SPACE MARINE  
plus!  
SPACE MARINE  
BATTLES BOOK  
plus! any one  
BOXED SUPPLEMENT  
Normal price  
£64.97**



**BLOOD BOWL  
plus!  
DEATH  
ZONE  
plus! any one  
BOXED TEAM  
Normal price  
£59.97**



**WARHAMMER  
40,000  
plus!  
DARK MILLENNIUM  
plus! any one  
CODEX BOOK  
Normal price  
£69.97**

REDEEMABLE AT GAMES WORKSHOP  
NORTHAMPTON 27TH MAY 1995

**25% OFF** GAMES WORKSHOP  
OR CITADEL PRODUCTS.

ONLY ONE VOUCHER PER PRODUCT. NOT  
TO BE USED WITH ANY OTHER OFFER.

REDEEMABLE AT GAMES WORKSHOP  
NORTHAMPTON 27TH MAY 1995

**10% OFF** GAMES WORKSHOP  
OR CITADEL PRODUCTS.

ONLY ONE VOUCHER PER PRODUCT. NOT  
TO BE USED WITH ANY OTHER OFFER.

REDEEMABLE AT GAMES WORKSHOP  
NORTHAMPTON 27TH MAY 1995

**10% OFF** GAMES WORKSHOP  
OR CITADEL PRODUCTS.

ONLY ONE VOUCHER PER PRODUCT. NOT  
TO BE USED WITH ANY OTHER OFFER.

REDEEMABLE AT GAMES WORKSHOP  
NORTHAMPTON 27TH MAY 1995

**10% OFF** GAMES WORKSHOP  
OR CITADEL PRODUCTS.

ONLY ONE VOUCHER PER PRODUCT. NOT  
TO BE USED WITH ANY OTHER OFFER.

REDEEMABLE AT GAMES WORKSHOP  
NORTHAMPTON 27TH MAY 1995

**25% OFF** GAMES WORKSHOP  
OR CITADEL PRODUCTS.

ONLY ONE VOUCHER PER PRODUCT. NOT  
TO BE USED WITH ANY OTHER OFFER.

REDEEMABLE AT GAMES WORKSHOP  
NORTHAMPTON 27TH MAY 1995

**10% OFF** GAMES WORKSHOP  
OR CITADEL PRODUCTS.

ONLY ONE VOUCHER PER PRODUCT. NOT  
TO BE USED WITH ANY OTHER OFFER.

REDEEMABLE AT GAMES WORKSHOP  
NORTHAMPTON 27TH MAY 1995

**10% OFF** GAMES WORKSHOP  
OR CITADEL PRODUCTS.

ONLY ONE VOUCHER PER PRODUCT. NOT  
TO BE USED WITH ANY OTHER OFFER.

REDEEMABLE AT GAMES WORKSHOP  
NORTHAMPTON 27TH MAY 1995

**10% OFF** GAMES WORKSHOP  
OR CITADEL PRODUCTS.

ONLY ONE VOUCHER PER PRODUCT. NOT  
TO BE USED WITH ANY OTHER OFFER.

PLEASE NOTE: NONE OF THE VOUCHERS ON THIS PAGE MAY BE USED IN COMBINATION WITH  
ANY OTHER OFFER NOR MAY THEY BE USED ON BOXSET BOOKS, WARHAMMER NOVELS.

# GAMES WORKSHOP®

## MAIL ORDER

Games Workshop Mail Order is a great way to purchase all the latest releases from Games Workshop and Citadel Miniatures. Our Mail Order staff are all Games Workshop enthusiasts and will be more than happy to advise you on any special character miniatures or other models that you might need for your armies.

**OUR MAIL ORDER TELEPHONE LINES ARE OPEN:  
8am – 10pm SEVEN DAYS A WEEK!**

If you are posting your order, please send it to:

**GAMES WORKSHOP MAIL ORDER SERVICE, CHEWTON STREET,  
HILLTOP, EASTWOOD, NOTTINGHAM NG16 3HY**  
Or you can fax your order through on: (01773) 533453



### WHITE DWARF™ PRESENTS WARHAMMER® 40,000 BATTLES

Warhammer 40,000 Battles is a compilation of the most sought after Warhammer 40,000 articles from White Dwarf magazine. This book contains four complete battle reports featuring the forces of the Ultramarines, Eldar, Blood Angels, Orks and Space Wolves. It features new rules and datafaxes for the Lemman Russ battle tank and the Space Marine Razorback plus special tactics for using these vehicles in your games.

Also included are three Warhammer 40,000 Battle Bunkers printed on heavy card, a Battle Bunker datafax, two new mission cards and a bonus scenario for the Battle for Armageddon campaign!

### SPACE WOLVES™ ARMY BOX

New from Citadel Miniatures, the Space Wolves Army box contains a complete 2000 point Space Marine army. The box includes the following models from the Citadel Miniatures range: Wolf Lord Ragnar Blackmane, Wolf Priest Ulrik the Slayer, Rune Priest Njal Stormcaller, complete Blood Claws, Grey Hunters, Long Fangs and Scout squads together with Space Marine Dreadnought Bjorn the Fell-handed. The box also contains a complete force list booklet which details points values and characteristics for all the models included.



# GAMES WORKSHOP MAIL ORDER IS



Tony hand-picks an order ready for despatch.

## THE FULL RANGE OF PRODUCTS!

Our Mail Order service can supply the full range of Games Workshop games and Citadel Miniatures, and we don't stop there! We can also supply any individual game component or miniature. So if the dog's chewed your **Warhammer 40,000** buildings, we can supply a brand new set! If you want the rulebook from **Warhammer**, we can provide it! If you want the dice from **Space Marine** all you need to do is ask!

If the models you want for your army aren't in your local store, or you are looking for an out of stock or hard to find range of miniatures, give us a call. Because we're based at the factory, our staff can arrange to cast up any number of miniatures especially for you, from the original moulds.

We can also supply any component from any multi-part model for those of you who like to customise or convert your miniatures.



Scott grabs a brand new copy of *Talisman* for a Mail Order customer.

## PLUS!

No queues! No parking! No bus fare! And it's really great fun using the catalogues to choose **exactly** the models you want for your army. We've found that many gamers get together with their friends to place an order so that the £2.50 UK and BFPO postage is applied to the whole order and the money saved buys them all a few extra miniatures.

## CONVENIENT!

Mail Order is convenient, with the entire range of Citadel Miniatures and Games Workshop games, just a phone call away.

## FAST!

Mail Order is fast. Most customers receive their orders within 2 days in the UK. (Some second class orders, or packages over 1Kg may take a day or so longer). Plus, on any telephone orders received before 1.00pm, our **Special Delivery Service** guarantees you'll receive your order the very next day.

We also have a special Troll who ensures that all **First Class** telephone orders received before 1.00pm are dispatched the same day!

Most overseas orders are delivered within 8 days.



Chas and Ash check miniatures in the Citadel foundry.

## FRIENDLY KNOWLEDGEABLE STAFF!

Our Mail Order service is staffed by enthusiastic hobbyists like yourself, who will be more than happy to tell you about all the latest releases for your particular army or favourite game.

## ACCURATE!

Every order is hand-checked against the catalogues to ensure that every model is perfectly cast and that your order is exactly what you want.



Andy, Steve, Ed and Gordon, man the Mail Order hotlines.



## CITADEL JOURNAL 8

**Citadel Journal 8** is available now! This issue is packed with great rules and modelling ideas to use in your games with Norse special characters for **Warhammer**, Eldar walkers and Ork Gobsmashas for **Warhammer 40,000**. Also included are rules for Daemons in your **Blood Bowl** Chaos teams, and much more besides.

**Issue 8** of the **Citadel Journal** is available now from Mail Order priced only £3.99 with FREE P&P within the UK and BFPO. Overseas add £1 P&P.

### SUBSCRIPTIONS

Issue 1 and 2 of the **Citadel Journal** are now completely sold out and stocks of Issues other back copies are very limited. To be certain of your copy please place an early order. We now also offer a special five-issue subscription.

**Price: UK/BFPO – £20.00 Overseas – £30.00**

With every UK and BFPO subscription we'll send your sixth issue absolutely FREE! Each subscription to the Journal will begin with the next issue to be published – unfortunately we are not able to include back copies in subscriptions as they are in such limited supply.

## BOXED ARMIES

These complete boxed armies contain everything you need to put together a powerful new army, including a complete force list and full-colour banners.



### WARHAMMER 40,000

2000 POINT SPACE WOLVES ARMY (Boxed Set)	£95.00
2000 POINT ULTRAMARINES ARMY (Boxed Set)	£95.00
1000 POINT SPACE ORK ARMY (Boxed Set)	£110.00
2000 POINT ELДАР ARMY (Boxed Set)	£100.00
2000 POINT SPACE MARINE ARMY (Boxed Set)	£90.00

### WARHAMMER

2000 POINT ORC AND GOBLIN ARMY (Boxed Set)	£115.00
2000 POINT UNDEAD ARMY (Boxed Set)	£105.00
2000 POINT HIGH ELF ARMY (Boxed Set)	£115.00

### EPIC®

TITAN LEGIONS BOXED GAME	£39.99
SPACE MARINE BOXED GAME	£39.99
SPACE MARINE BATTLES (BOOK)	£9.99
ARMIES OF THE IMPERIUM	£14.99
RENEGADES (Chaos and Eldar armies)	£14.99
ORK & SQUAT WARLORDS	£14.99
HIVE WAR	£14.99
EPIC TRANSFERS	£3.50
Each pack contains 10 sheets of transfers (Available for Space Marines and Imperial forces)	

### IMPERIAL

<b>NEW!</b> IMPERIAL WARLORD TITAN (Boxed set)	£9.99 each
<b>NEW!</b> CHIMERA VARIANTS	£1.75 each

### ORKS

MEGA-GARGANT (Boxed set)	£12.99
--------------------------	--------

## WARHAMMER® 40,000



WARHAMMER 40,000 BOXED GAME	£39.99
DARK MILLENNIUM	£19.99
<b>NEW!</b> WHITE DWARF PRESENTS: WARHAMMER 40,000 BATTLES	£9.99
CODEX ULTRAMARINES	£9.99
CODEX SPACE WOLVES	£9.99
CODEX ELДАР	£9.99
CODEX ORKS	£9.99
SUSTAINED FIRE DICE	£0.49 each
SELF ADHESIVE BANNERS	£3.50
Each pack contains 5 banners. (Available for Space Wolves and Space Orks)	

### IMPERIAL GUARD

<b>NEW!</b> TALLARN DESERT RAIDERS	£12.99
Boxed set contains 10 Desert Raiders	
MORDIAN IRON GUARD LIEUTENANT	£2.75 each
MORDIAN IRON GUARD	£12.99
Boxed set contains 10 Iron Guard	

### SPACE MARINES

<b>NEW!</b> IMPERIAL WHIRLWIND	£14.99 each
<b>NEW!</b> MARNEUS CALGAR ULTRAMARINES COMMANDER	£4.99
<b>NEW!</b> TECHMARINES	£2.99 each
<b>NEW!</b> COMPANY STANDARD BEARER	£2.99 each
<b>NEW!</b> EPISTOLARY LIBRARIAN	£2.99 each
VETERAN SERGEANTS	£2.99 each
LEXICANIUM LIBRARIAN	£2.99 each
CODICIER LIBRARIAN	£2.99 each
SERVITORS	£2.50 each

## WARHAMMER QUEST™

WARHAMMER QUEST BOXED GAME	£39.99
<b>NEW!</b> PIT FIGHTER WARRIOR PACK	£9.99



**WARHAMMER®**



WARHAMMER BOXED GAME	£39.99
WARHAMMER BATTLE MAGIC	£19.99
WARHAMMER – ARCANIC MAGIC	£14.99
WARHAMMER ARMIES – CHAOS	£14.99
WHITE DWARF PRESENTS: CHAOS DWARFS	£9.99
SELF ADHESIVE BANNERS Each pack contains 5 sheets of banners. (Available for Orcs, Goblins, High Elves, Dwarfs and Undead.)	£3.50

**CHAOS DWARFS**

<b>NEW!</b> ASTRAGOTH HIGH PRIEST OF HASHUT	£4.99 each
BLUNDERBUSSES	£1.75 each

**SKAVEN**

<b>NEW!</b> WARFFIRE THROWER TEAM (2 MODELS)	£4.99 each
JEZZAIL TEAM (2 MODELS)	£4.99 each
CLAN SKRYRE GLOBADIERS	£2.99 each

**HIGH ELVES**

DRAGON PRINCE OF CALEDOR	£3.99 each
REAVIER KNIGHT	£2.99 each
REAVIER KNIGHT COMMAND	£2.99 each
WHITE LIONS OF CHRACE	£1.75 each

**CHAOS**

MOUNTED CHAOS KNIGHT	£3.99
MOUNTED CHAOS KNIGHT COMMAND	£3.99

**UNDEAD**

<b>NEW!</b> KRELL LORD OF THE UNDEAD	£4.99 each
ISABELLA VON CARSTEIN	£4.99 each
VLAD VON CARSTEIN	£4.99 each
HEINRICH KEMMLER – THE LICHEMASTER	£4.99 each
GHOST	£2.75 each
VAMPIRE	£4.99 each

**CITADEL® COLOUR**

<b>NEW!</b> ELДАР ASPECT PAINT SET	£5.99
<b>NEW!</b> DARK ANGELS PAINT SET	£5.99
CITADEL STARTER PAINT SET	£9.99
CITADEL PAINT BRUSH SET	£5.99
'EAVY METAL PAINTING GUIDE	£7.99

**BLOOD BOWL®**

BLOOD BOWL BOXED GAME	£29.99
DEATH ZONE	£14.99

**WHITE DWARF SUBSCRIPTIONS**

**UK, EUROPE, & THE REST OF THE WORLD**

**UK & BFPO:** £27.50 for one year (12 issues).  
**EUROPE:** £35 for one year. (12 issues)

**REST OF THE WORLD:** £60 for one year. (12 issues)

Please send payments to Games Workshop Mail Order, Chewton St, Hilltop, Eastwood, NOTTINGHAM, NG16 3HY. All payments should be in pounds sterling. Please make cheques payable to Games Workshop Ltd.

If you have a Visa, Access, Mastercard or Switch you may place your subscription by phoning our Mail Order department on 01773 713213.

**USA & CANADA**

Please contact: White Dwarf Subscriptions, 3431 C Benson Avenue, Baltimore, Maryland 21227-1072.

For VISA and Mastercard orders, please telephone our Mail Order hotline on (410) 644 5699, Monday to Friday, 9am - 5pm EST.

Please state which issue you would like your subscription to start with.

**CORRESPONDENCE**

We welcome comments about White Dwarf, Games Workshop games and Citadel Miniatures. All letters except subscriptions and Mail Order should be addressed to: The Editor, White Dwarf, Games Workshop, Howard House, 16 Castle Boulevard, Nottingham NG7 1FL.

Clearly mark your envelope with the name of the game you are writing to us about. If you want a reply you *must* enclose a self-addressed stamped envelope (overseas readers should include IRCs). We receive an enormous amount of mail. We do read every letter, but it may take a little time for us to reply to you, so please be patient!

**COPYRIGHTS AND TRADEMARKS**

All subject matter in White Dwarf is © Copyright Games Workshop Ltd 1995. All artwork in all Games Workshop products, and all images contained therein have been produced either in-house or as work for hire. The exclusive copyright in the artwork and the images it depicts is the property of Games Workshop Ltd. © Copyright Games Workshop Ltd 1995. All rights reserved.

**Registered Trademarks**

The following are all registered trademarks of Games Workshop Ltd.

Armageddon, Blood Bowl, Chivalry, Citadel, the Citadel logo, Confrontation, Dark Angels, Dark Future, Deathwing, Eldar, Eldar Attack, Epic, the Games Workshop logo, Games Workshop, the GW logo, Genestealer, Realm of Chaos, Slottabase, Space Fleet, Space Marine, Talisman, Tyrannid, Warhammer, Warmaster, White Dwarf and the White Dwarf figure. Marauder is a registered trade mark of Marauder Miniatures Ltd. Used with permission.

**Trademarks**

The following are all trademarks of Games Workshop Ltd.

Aspect Warrior, Avatar, Blood Angels, Bloodletter, Bloodthirster, Daemonette, Dark Reaper, Death Zone, Dragonmasters, Dungeonquest, 'Eavy Metal, Exo Armour, Exarch, Eye of Terror, Farseer, Fire Dragon, Flesh Hound, Gargant, Gobbo, Great Unclean One, Gretchin, Grey Knight, Hunter Slayer, Keeper of Secrets, Khorne, Knights Panther, Leman Russ, Lichemaster, Lightning Claw, Lord of Change, Madboy, Man O' War, Mekboy, Mighty Empires, Necromunda, Nurgle, Nurgling, Ogryn, Old World, Ork, Painboy, Plaguebearer, Plague Fleet, Psyker, Ratling, Ravenwing, Sea of Blood, Skaven, Slaanesh, Slann, Snotling, Space Hulk, Space Wolves, Squat, Squig, Swooping Hawk, Striking Scorpion, Terminator, Thunder Hammer, Troll Slayer, Tzeentch, Ultramarines, Warhammer Quest, Weirdboy, Knights of the White Wolf, World eater.

The GW Flame logo is a registered trademark of Games Workshop Ltd.

The Citadel paint pot is UK registered design No. 2033236

Scatter dice are UK registered design No. 2017484.



# SPACE MARINE WHIRLWIND<sup>®</sup>

## WHIRLWIND

### THE COMPLETE SPACE MARINE WHIRLWIND CONSISTS OF:

- 2 x RHINO CHASSIS SPRUE
- 2 x RHINO TRACK SPRUE
- 1 x WHIRLWIND TURRET
- 1 x SCANNER
- 1 x SCANNER BASE
- 1 x WHIRLWIND TOP PLATE
- 1 x ROCKET SUPPORT ARMS
- 2 x WARHEADS
- 2 x ROCKET TUBES
- 2 x EXHAUST VENTS



EXAMPLE OF AN ASSEMBLED SPACE MARINE WHIRLWIND PAINTED IN THE COLOURS OF THE ULTRAMARINES CHAPTER



EXHAUST VENTS  
0448/8

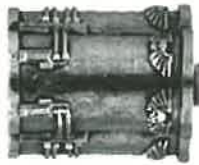

ROCKET TUBES  
0448/4



WARHEADS  
0448/7

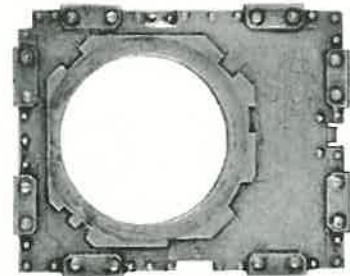

WHIRLWIND TOP PLATE  
0448/6



ROCKET SUPPORT ARMS  
0448/5



SCANNER  
0448/3



WHIRLWIND TURRET  
0448/1



SCANNER BASE  
0448/2

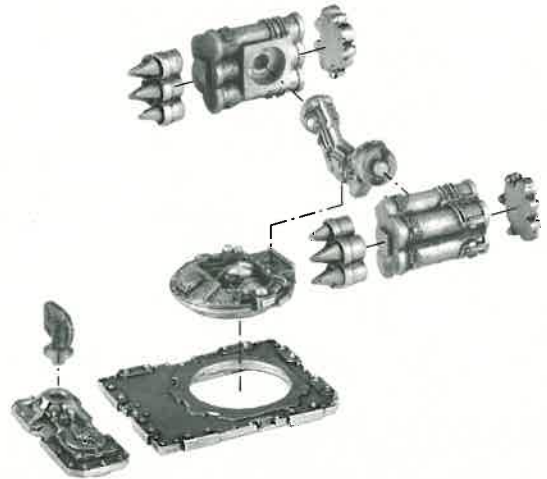

THIS BOXED SET INCLUDES A DETAILED CONSTRUCTION SHEET AND FIVE CITADEL TRANSFER SHEETS WHICH INCLUDE ALL THE MARKINGS NEEDED FOR THE DARK ANGELS, ULTRAMARINES, SPACE WOLVES AND BLOOD ANGELS SPACE MARINE CHAPTERS.

© Copyright Games Workshop Ltd 1995. All rights reserved.

Miniatures supplied unpainted. WARNING: This product contains lead which may be harmful if chewed or swallowed. Citadel Miniatures are not recommended for children under 14 years of age.



Designed by Norman Swales and Jes Goodwin

# IMPERIAL GUARD™

## MORDIAN IRON GUARD



IRON GUARD  
WITH LASGUN 1  
0445/3



IRON GUARD  
WITH LASGUN 2  
0445/1



IRON GUARD  
SERGEANT  
0445/6



IRON GUARD  
WITH GRENADE LAUNCHER  
0445/5



IRON GUARD  
WITH LASGUN 3  
0445/4



IRON GUARD  
WITH LASGUN 4  
0445/2

## IRON GUARD LIEUTENANT



IRON GUARD  
LIEUTENANT  
72208/1

## MORDIAN IRON GUARD LASCANNON



IRON GUARD  
LASCANNON LOADER  
0445/8



IRON GUARD  
LASCANNON OPERATOR  
0445/7



LASCANNON  
0445/9



LASCANNON STAND  
0445/11

### A COMPLETED MORDIAN IRON GUARD LASCANNON CONSISTS OF:

- 1 x LASCANNON
- 1 x LASCANNON SHIELD
- 1 x LASCANNON STAND
- 2 x WHEELS

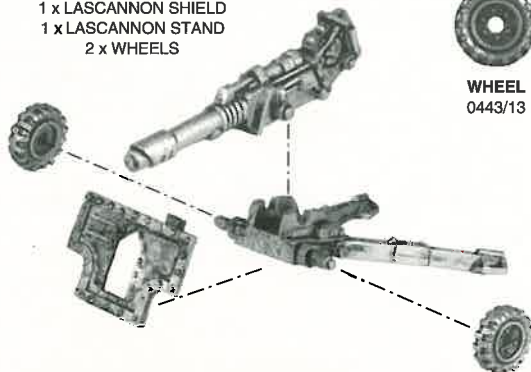

WHEEL  
0443/13



LASCANNON SHIELD  
0445/10



COMPLETED LASCANNON

Miniatures supplied unpainted. **WARNING:** This product contains lead which may be harmful if chewed or swallowed. Citadel Miniatures are not recommended for children under 14 years of age.  
 © Copyright Games Workshop Ltd 1995. All rights reserved.



Designed by Michael Perry and Norman Swales

# IMPERIAL GUARD

## TALLARN DESERT RAIDERS



DESERT RAIDER  
SERGEANT  
0446/6



DESERT RAIDER  
WITH LASGUN 1  
0446/4



DESERT RAIDER  
WITH LASGUN 2  
0446/5



DESERT RAIDER  
WITH LASGUN 3  
0446/2



DESERT RAIDER  
WITH MELTA-GUN  
0446/1



DESERT RAIDER  
WITH LASGUN 4  
0446/3

## TALLARN DESERT RAIDER AUTOCANNON



DESERT RAIDER  
GUNNER BODY  
0446/8



DESERT RAIDER  
LOADER  
0446/7

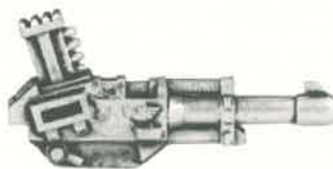

AUTOCANNON  
0446/12



SHIELD  
0443/10



DESERT RAIDER  
GUNNER LEGS  
0446/9



TRAIL  
0443/11



WHEEL  
0443/13

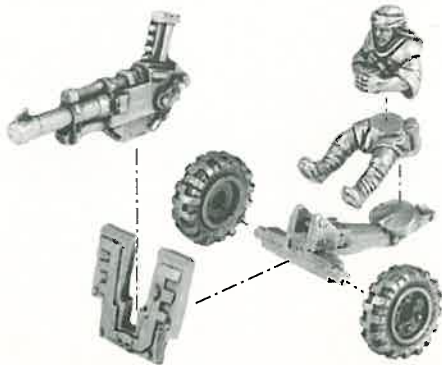

A COMPLETE  
TALLARN DESERT RAIDER  
AUTOCANNON CONSISTS OF:  
1 x DESERT RAIDER GUNNER BODY  
1 x DESERT RAIDER GUNNER LEGS  
1 x AUTOCANNON  
1 x TRAIL  
1 x SHIELD  
2 x WHEELS

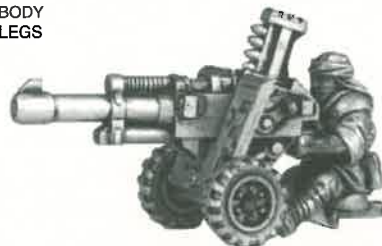

A COMPLETED TALLARN DESERT RAIDER AUTOCANNON

Minatures supplied unpainted. WARNING: This product contains lead which may be harmful if chewed or swallowed. Citadel Miniatures are not recommended for children under 14 years of age.

Minatures supplied unpainted. WARNING: This product contains lead which may be harmful if chewed or swallowed. Citadel Miniatures are not recommended for children under 14 years of age.

© Copyright Games Workshop Ltd 1995. All rights reserved.



Designed by Michael Perry and Norman Swales

# SPACE MARINES<sup>®</sup>

## SPACE MARINE LAND SPEEDER

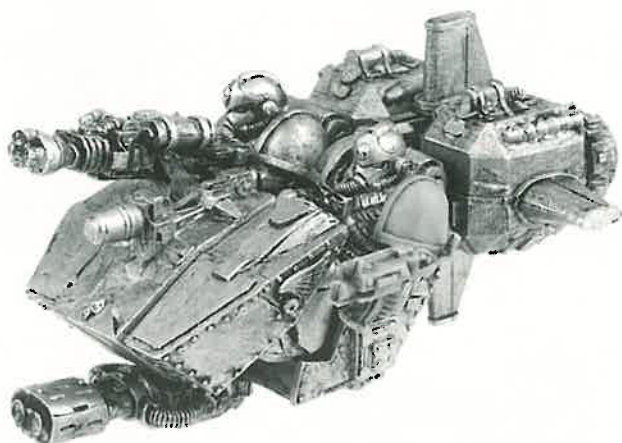

EXAMPLE OF A COMPLETED SPACE MARINE LAND SPEEDER

### THE COMPLETED SPACE MARINE LAND SPEEDER CONSISTS OF

- 1 x SPACE MARINE PILOT
- 1 x SPACE MARINE GUNNER
- 1 x HEAVY FLAMER
- 1 x MULTIMELTA
- 1 x LAND SPEEDER CHASSIS
- 1 x LAND SPEEDER FOOT REST
- 1 x STABILISER FIN
- 1 x LEFT FAIRING
- 1 x RIGHT FAIRING
- 2 x ENGINE NOZZLES
- 2 x LAND SPEEDER SEATS
- 2 x LAND SPEEDER BACK RESTS
- 1 x PLASTIC CHARACTER ARM SPRUE
- 1 x ENGINE POD TOP
- 1 x ENGINE POD BOTTOM
- 1 x PLASTIC FLYING BASE



MULTI - MELTA  
00439/13

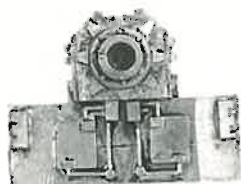

LAND SPEEDER FOOT REST  
00439/8



RIGHT FAIRING  
00439/7



LEFT FAIRING  
00439/6

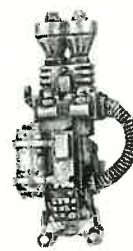

HEAVY FLAMER  
00439/14



ENGINE POD BOTTOM  
00439/4



SPACE MARINE PILOT  
00439/2



SPACE MARINE GUNNER  
00439/1



ENGINE POD TOP  
00439/5



BACK REST  
00439/11



STABILISER FIN  
00439/9

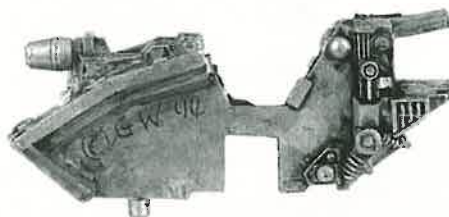

CHASSIS  
00439/3



SEAT  
00439/10



ENGINE NOZZLE  
00439/12

Minatures supplied unpainted. WARNING: This product contains lead which may be harmful if chewed or swallowed. Citadel Miniatures are not recommended for children under 14 years of age.

© Copyright Games Workshop Ltd 1995. All rights reserved.



Designed by Norman Swales and Jes Goodwin

# SPACE MARINES®

## ASSEMBLY STAGE 1

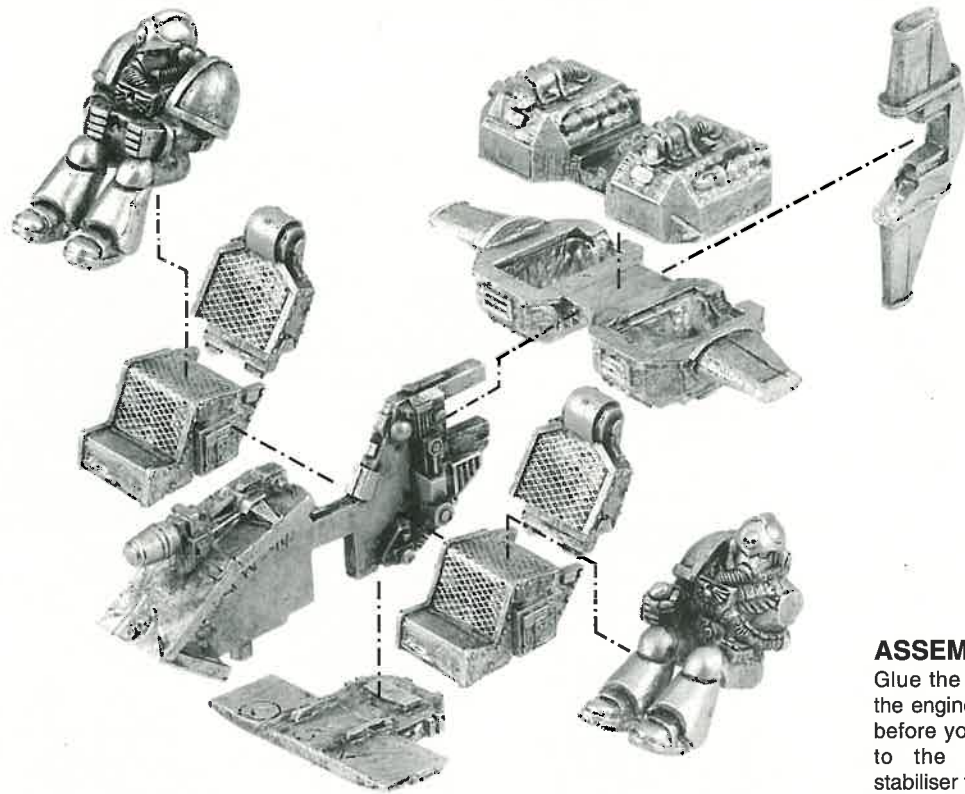

### ASSEMBLY NOTE

Glue the two halves of the engine pod together before you attach them to the chassis and stabiliser fin.

## ASSEMBLY STAGE 2

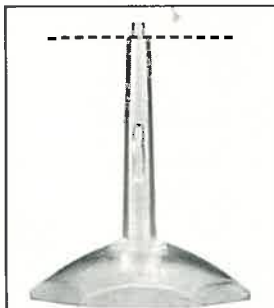

### ASSEMBLY NOTE

To ensure that your model remains stable, carefully remove the pin at the top of the flying base with a sharp modelling knife, as shown above. Then glue your finished model to the base.

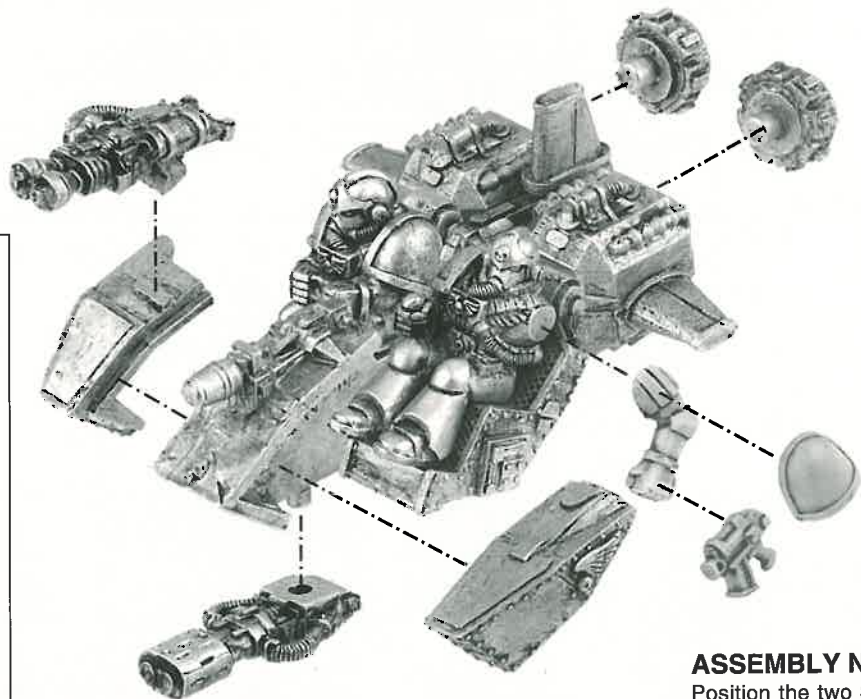

### ASSEMBLY NOTE

Position the two Space Marine crew members onto your Land Speeder before you attach the fairings to your model.

Designed by Norman Swales and Jes Goodwin

Minatures supplied unpainted. **WARNING:** This product contains lead which may be harmful if chewed or swallowed. Citadel Miniatures are not recommended for children under 14 years of age.  
© Copyright Games Workshop Ltd 1995. All rights reserved.



# SPACE MARINES®

## MARNEUS CALGAR MASTER OF THE ULTRAMARINES



MARNEUS CALGAR  
70084/1



CALGAR'S  
BANNER POLE TOP  
70084/4



CALGAR'S  
RIGHT GAUNTLET  
70084/2



CALGAR'S  
BANNER POLE  
70084/3

A COMPLETE  
MARNEUS CALGAR  
CONSISTS OF:  
1 x MARNEUS CALGAR  
1 x GAUNTLET  
1 x BANNER POLE  
1 x BANNER POLE TOP

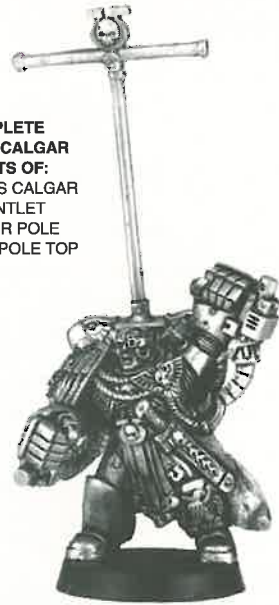

## VETERAN SERGEANTS



VETERAN SERGEANT 1  
WITH BIONIC EYE  
70081/2



VETERAN SERGEANT 2  
WITH CUSTOMISED  
BOLT PISTOL  
70081/4



VETERAN SERGEANT 3  
WITH BIONIC ARM  
70081/1



VETERAN SERGEANT 4  
WITH AUXILIARY  
GRENADE LAUNCHER  
70081/3

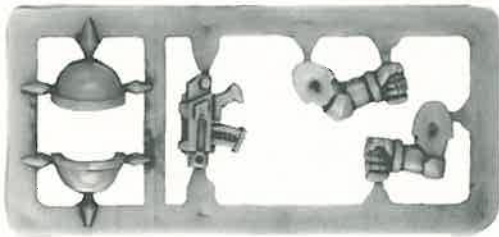

CHARACTER ARM SPRUE 102533

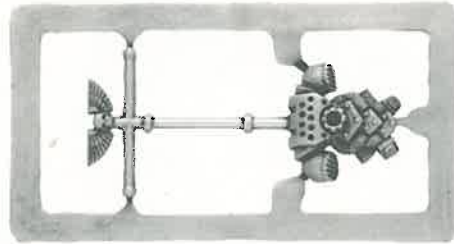

CHARACTER BACKPACK SPRUE 102532

EACH OF THESE MINIATURES IS SUPPLIED WITH A PLASTIC CHARACTER ARM SPRUE AND A PLASTIC CHARACTER BACKPACK SPRUE



EXAMPLES OF COMPLETED SPACE MARINE VETERAN SERGEANTS

Minatures supplied unpainted. WARNING: This product contains lead which may be harmful if chewed or swallowed. Citadel Miniatures are not recommended for children under 14 years of age.  
© Copyright Games Workshop Ltd 1995. All rights reserved.



Designed by Jes Goodwin



# SPACE MARINES®

## LIBRARIANS



LEXICANIUM 1  
70080/1



LEXICANIUM 2  
70080/2



EPISTOLARY 1  
70087/1



EPISTOLARY 2  
70087/2



CODICIER 1  
70083/2



CODICIER 2  
70083/1

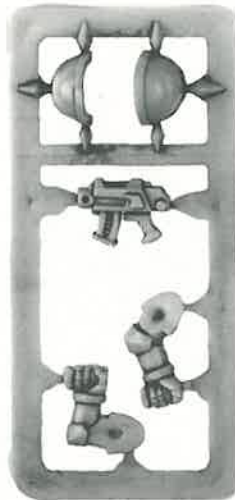

CHARACTER ARM SPRUE  
102533

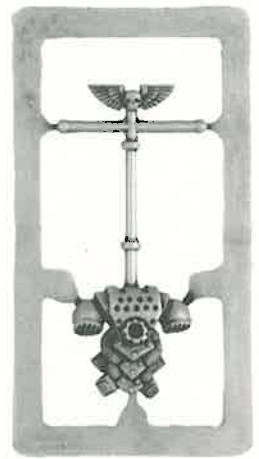

CHARACTER BACKPACK SPRUE  
102532



EACH OF THESE MINIATURES IS SUPPLIED WITH A PLASTIC CHARACTER ARM SPRUE AND A PLASTIC CHARACTER BACKPACK SPRUE



EXAMPLES OF COMPLETED SPACE MARINE LIBRARIANS

Miniatures supplied unpainted. **WARNING:** This product contains lead which may be harmful if chewed or swallowed. Citadel Miniatures are not recommended for children under 14 years of age.  
 © Copyright Games Workshop Ltd 1995. All rights reserved.



Designed by Jes Goodwin

# SPACE MARINES®

## COMPANY STANDARD BEARER



COMPANY STANDARD BEARER  
70086/1

A COMPLETE COMPANY  
STANDARD BEARER  
CONSISTS OF:  
1 x STANDARD BEARER  
1 x COMPANY STANDARD TOP  
1 x PLASTIC BACKPACK SPRUE  
1 x CHARACTER ARM SPRUE



COMPANY STANDARD TOP  
70086/2



A COMPLETED  
COMPANY STANDARD BEARER

## TECHMARINES

A COMPLETE TECHMARINE  
CONSISTS OF:  
1 x TECHMARINE BODY  
1 x SERVO-ARM BACK PACK  
1 x CHARACTER ARM SPRUE



TECHMARINE 1  
70085/1



SERVO - ARM  
BACKPACK  
70085/3



TECHMARINE 2  
70085/2



EXAMPLE OF A COMPLETED TECHMARINE

## SERVITORS



SERVITOR 1  
72000/1



SERVITOR 2  
72000/2

Minatures supplied unpainted. **WARNING:** This product contains lead which may be harmful if chewed or swallowed. Citadel Miniatures are not recommended for children under 14 years of age.  
© Copyright Games Workshop Ltd 1995. All rights reserved.



Designed by Jes Goodwin

# CHAOS

## CHAOS KNIGHTS



**CHAOS CHAMPION**  
73004/2



**CHAOS KNIGHT 1**  
0525/4



**CHAOS KNIGHT 2**  
0525/3



**CHAOS KNIGHT 3**  
0525/2



**CHAOS KNIGHT  
STANDARD BEARER**  
73004/3



**CHAOS KNIGHT LEGS**  
0525/1

**A COMPLETED CHAOS KNIGHT  
CONSISTS OF:**  
1 x CHAOS KNIGHT  
1 x CHAOS KNIGHT LEGS  
1 x CHAOS STEED HEAD  
1 x PLASTIC ARMoured HORSE SPRUE



**CHAOS KNIGHT BANNER TOP**  
73004/4



**CHAOS STEED HEAD 1**  
0525/5



**CHAOS STEED HEAD 2**  
0525/6



**CHAOS STEED HEAD 3**  
0525/7



**CHAOS STEED HEAD 4**  
73004/5



**CHAOS STEED HEAD 5**  
73004/6



THESE MODELS ARE SUPPLIED WITH A PLASTIC ARMoured HORSE SPRUE AND APPROPRIATE PLASTIC SHIELDS AS STANDARD

Designed by Michael Perry

Minatures supplied unpainted. WARNING: This product contains lead which may be harmful if chewed or swallowed. Citadel Miniatures are not recommended for children under 14 years of age.

© Copyright Games Workshop Ltd 1995. All rights reserved.

© Copyright Games Workshop Ltd 1994. All rights reserved.



CITADEL  
MINIATURES

# HIGH ELVES

## REAYER KNIGHTS

THESE MINIATURES ARE SUPPLIED WITH PLASTIC UNARMoured HORSE AS STANDARD



REAYER KNIGHT  
CHAMPION  
88790/1



REAYER KNIGHT  
STANDARD BEARER  
88790/2



REAYER KNIGHT 1  
0816/4



REAYER KNIGHT 2  
0816/3



REAYER KNIGHT  
LEGS 2  
0816/5



REAYER KNIGHT  
LEGS 1  
0816/6



EXAMPLES OF COMPLETED HIGH ELF REAYER KNIGHTS

## WHITE LIONS OF CHRACE



WHITE LION WITH  
DOUBLE HANDED AXE 1  
88750/1



WHITE LION WITH  
DOUBLE HANDED AXE 2  
88750/2



WHITE LION WITH  
DOUBLE HANDED AXE 3  
88750/3



WHITE LION WITH  
DOUBLE HANDED AXE 4  
88750/4

Designed by Aly Morrison

Minatures supplied unpainted. WARNING: This product contains lead which may be harmful if chewed or swallowed. Citadel Minatures are not recommended for children under 14 years of age.  
© Copyright Games Workshop Ltd 1995. All rights reserved.



# HIGH ELVES

## DRAGON PRINCES OF CALEDOR



**DRAGON PRINCE 1**  
0841/4



**STANDARD BEARER**  
75675/4



**HERO WITH SWORD**  
75675/5



**DRAGON PRINCE 2**  
0841/5



**DRAGON PRINCE 3**  
0841/6

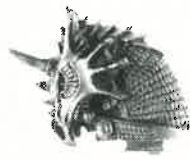

**DRAGON PRINCE HORSE HEAD 1**  
0841/2



**DRAGON PRINCE HORSE HEAD 2**  
0841/3



**DRAGON PRINCE LEGS**  
0841/1



EXAMPLES OF COMPLETED DRAGON PRINCES OF CALEDOR

THESE MINIATURES ARE SUPPLIED WITH THE APPROPRIATE PLASTIC SHIELDS AND PLASTIC ARMOURD HORSES AS STANDARD

Minatures supplied unpainted. **WARNING:** This product contains lead which may be harmful if chewed or swallowed. Citadel Miniatures are not recommended for children under 14 years of age.

Minatures supplied unpainted. **WARNING:** This product contains lead which may be harmful if chewed or swallowed. Citadel Miniatures are not recommended for children under 14 years of age.  
© Copyright Games Workshop Ltd 1993. All rights reserved.



**CITADEL**  
MINIATURES

Designed by Jes Goodwin

# SKAVEN™

## SKAVEN WARPFIRE THROWER



WARPFIRE THROWER  
FUEL CARRIER  
74470/2



WARPFIRE THROWER  
GUNNER  
74470/1



A COMPLETED WARPFIRE THROWER TEAM

THE COMPLETED SKAVEN  
WARPFIRE THROWER TEAM CONSISTS OF:  
1 x WARPFIRE THROWER GUNNER  
1 x WARPFIRE THROWER FUEL CARRIER

## SKAVEN JEZZAIL



JEZZAIL 1  
74469/1



JEZZAIL REST 1  
74469/2



JEZZAIL 2  
74469/3



JEZZAIL REST 2  
74469/4

THE COMPLETED SKAVEN JEZZAIL  
TEAM CONSISTS OF:  
1 x JEZZAIL  
1 x JEZZAIL REST



A COMPLETED SKAVEN JEZZAIL TEAM

## CLAN SKRYRE POISON WIND GLOBADIERS



GLOBADIER 1  
74458/2



GLOBADIER 2  
74458/3

THE COMPLETED POISON WIND  
GLOBADIERS CONSIST OF:  
1 x GLOBADIER  
1 x GLOBADIER BACKPACK



GLOBADIER BACKPACK  
74458/4



COMPLETED POISON WIND GLOBADIERS

Minatures supplied unpainted. WARNING: This product contains lead which may be harmful if chewed or swallowed. Citadel Miniatures are not recommended for children under 14 years of age. © Copyright Games Workshop Ltd 1995. All rights reserved.



# CHAOS DWARFS

## ASTRAGOTH HIGH PRIEST OF HASHUT

A COMPLETE ASTRAGOTH  
CONSISTS OF:  
1 x ASTRAGOTH BODY  
1 x ASTRAGOTH RIGHT ARM  
1 x ASTRAGOTH LEFT ARM  
1 x EXHAUST AND BANNER POLES



ASTRAGOTH BODY  
75885/1



ASTRAGOTH RIGHT ARM  
75885/2



ASTRAGOTH LEFT ARM  
75885/3



EXHAUST AND  
BANNER POLES  
75885/4



A COMPLETED ASTRAGOTH  
HIGH PRIEST OF HASHUT

## CHAOS DWARFS WITH BLUNDERBUSS



BLUNDERBUSS 1  
75810/2



BLUNDERBUSS 2  
75810/4



BLUNDERBUSS 3  
75810/1



BLUNDERBUSS 4  
75810/3



BLUNDERBUSS 5  
75810/6



BLUNDERBUSS 6  
75810/7



BLUNDERBUSS 7  
75810/5



Designed by Alan Perry

Miniatures supplied unpainted. WARNING: This product contains lead which may be harmful if chewed or swallowed. Citadel Miniatures are not recommended for children under 14 years of age.  
 © Copyright Games Workshop Ltd 1995. All rights reserved.



# UNDEAD

## KRELL LORD OF THE UNDEAD

THE COMPLETE KRELL  
CONSISTS OF:  
1 x KRELL BODY  
1 x KRELL'S BANNER POLE



KRELL BODY  
74540/1



KRELL'S BANNER POLE  
74540/2



A COMPLETED KRELL

## VAMPIRE

A COMPLETE VAMPIRE  
CONSISTS OF:  
1 x VAMPIRE BODY  
1 x VAMPIRE CLOAK



VAMPIRE BODY  
74520/1



VAMPIRE CLOAK  
74520/2



A COMPLETED VAMPIRE

## GHOST



GHOST  
74534/1

## HEINRICH KEMMLER, THE LICHEMASTER



HEINRICH KEMMLER, THE  
LICHEMASTER  
74527/1

## ISABELLA VON CARSTEIN



ISABELLA VON CARSTEIN  
74525/1

## COUNT VON CARSTEIN



COUNT VON CARSTEIN  
74526/1

Miniatures supplied unpainted. WARNING: This product contains lead which may be harmful if chewed or swallowed. Citadel Miniatures are not recommended for children under 14 years of age.  
© Copyright Games Workshop Ltd 1995. All rights reserved.



Designed by Gary Morley



# IMPERIAL TITANS

## IMPERIAL WARLORD TITAN

### A COMPLETED WARLORD TITAN CONSISTS OF :

- 1 x WARLORD TITAN CARAPACE FRONT
- 1 x WARLORD TITAN CARAPACE REAR
- 1 x WARLORD TITAN CARAPACE MIDDLE
- 1 x WARLORD TITAN TORSO
- 1 x WARLORD TITAN HEAD
- 1 x WARLORD TITAN LEGS
- 1 x WARLORD TITAN BANNER POLE
- 1 x WARLORD TITAN VORTEX MISSILE
- 1 x WARLORD TITAN GATLING BLASTER
- 1 x WARLORD TITAN QUAKE CANNON
- 1 x WARLORD TITAN CHAIN FIST
- 2 x WARLORD TITAN FOOT
- 1 x WARLORD TITAN JOINT PLATE

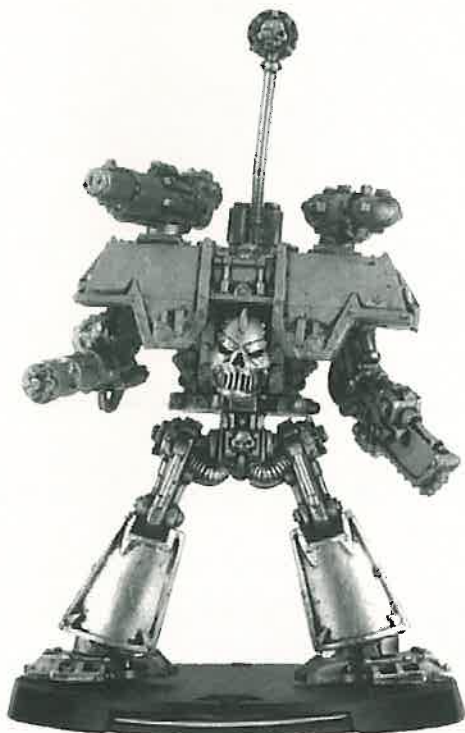

A COMPLETED WARLORD TITAN



BANNER POLE  
00490/12



WARLORD TITAN  
REAR CARAPACE  
00490/2



WARLORD TITAN  
MIDDLE CARAPACE  
00490/1



VORTEX MISSILE  
00490/9



WARLORD TITAN  
FRONT CARAPACE  
00490/3



WARLORD TITAN  
TORSO  
00490/4



QUAKE CANNON  
00490/8

WARLORD TITAN  
HEAD  
00490/7



WARLORD TITAN  
JOINT PLATE  
00490/5



GATLING BLASTER  
00490/10



WARLORD TITAN  
LEGS  
00490/6



CHAIN FIST  
00490/11

WARLORD TITAN FOOT  
00490/13



WARLORD TITAN  
FOOT  
00490/13



Miniatures supplied unpainted. WARNING: This product contains lead which may be harmful if chewed or swallowed. Citadel Miniatures are not recommended for children under 14 years of age.

© Copyright Games Workshop Ltd 1995. All rights reserved.



Designed by Dave Andrews

# IMPERIAL TANKS

## CHIMERA



COMPLETED CHIMERA

A COMPLETE CHIMERA  
CONSISTS OF:  
1 x CHIMERA CHASSIS  
1 x CHIMERA TURRET



CHIMERA TURRET  
76020/2



CHIMERA CHASSIS  
76020/1

## CHIMERRO

CHIMERRO TURRET  
76023/5



CHIMERA CHASSIS  
76020/1

A COMPLETE CHIMERRO  
CONSISTS OF:  
1 x CHIMERA CHASSIS  
1 x CHIMERRO TURRET



COMPLETED CHIMERRO

## CHIMERAX



COMPLETED CHIMERAX

A COMPLETE CHIMERAX  
CONSISTS OF:  
1 x CHIMERA CHASSIS  
1 x CHIMERAX TURRET



CHIMERAX TURRET  
76021/3



CHIMERA CHASSIS  
76020/1

## CHIMEDON

CHIMEDON TURRET  
76022/4



CHIMERA CHASSIS  
76020/1

A COMPLETE CHIMEDON  
CONSISTS OF:  
1 x CHIMERA CHASSIS  
1 x CHIMEDON TURRET



COMPLETED CHIMEDON

Minatures supplied unpainted. WARNING: This product contains lead which may be harmful if chewed or swallowed. Citadel Miniatures are not recommended for children under 14 years of age.  
© Copyright Games Workshop Ltd 1995. All rights reserved.



# Warhammer Quest



Contents and components may vary from those illustrated

Models supplied unpainted

## DUNGEON ADVENTURES IN THE WARHAMMER® WORLD



The Warhammer world is a dark and brooding place filled with hideous monsters and deadly evil. In Warhammer Quest you are a heroic Warrior, journeying deep into the danger-ridden catacombs beneath the Old World. As you triumph over terrifying monsters and lethal traps, you will be rewarded with gold, treasure and powerful magical artefacts. Warhammer Quest is an exciting tabletop board-game that contains full colour card floorplans, 3 rulebooks, dice, counters and over 90 finely-detailed Citadel Miniatures.

The game utilises an innovative card-based system which ensures that each quest provides a unique and exciting series of challenges for your Warriors to overcome. As each Dungeon card is turned over, new passageways and caverns are revealed for you to explore until a sudden Event card pitches you into deadly combat.

Also included is a complete bestiary, detailing the many monstrous foes you can face, which enables you to use the entire range of Citadel Miniatures in your Warhammer Quest games.

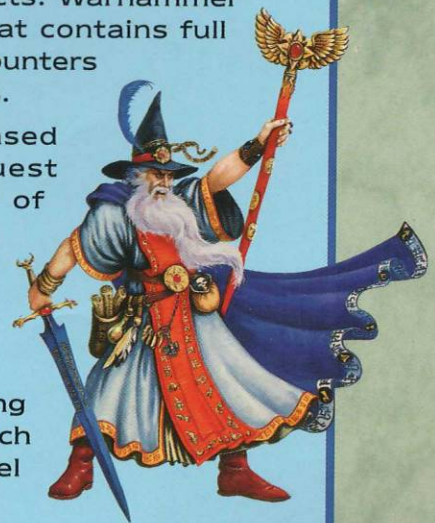

Citadel, the Citadel castle, Games Workshop, the Games Workshop logo and Warhammer are registered trademarks of Games Workshop Ltd. Warhammer Quest is a trademark of Games Workshop Ltd.  
© Games Workshop Ltd, 1995. All rights reserved.

**GAMES®  
WORKSHOP**



THE ELECTOR COUNTS OF MIDDENLAND, OSTLAND, AVERLAND AND HOCHLAND LEAD AN EMPIRE ARMY AGAINST THE CHAOS DWARFS