

GAMES WORKSHOP

PRESENTS ITS MONTHLY HOBBY SUPPLEMENT AND MINIATURES CATALOGUE



WHITE DWARF



CITADEL
MINIATURES

180

£2.25

FREE!

WARHAMMER
40,000



CITADEL® MINIATURE



Conforms to European Toy
Safety Regulation.

Retain cover for future reference. Not suitable for children under
36 months due to small parts and essential pointed components.

ISSN 0265-8712



9 770265 871028



A CHAPLAIN LEADS A TACTICAL SQUAD OF SPACE MARINES OF THE ULTRAMARINES CHAPTER



WORLD EATERS CHAOS SPACE MARINES OF KHORNE ATTACK A DARK ANGELS' POSITION

CONTENTS

COVER: FISTS OF DEATH – *Gerry Grace*

GW AND CITADEL NEWS

All the latest news from Games Workshop and Citadel Miniatures.

2

'EAVY METAL – PAINTING YOUR FREE MINIATURE – *Neil Hodgson*

Neil explains the best way to paint your free Citadel miniature.

8

'EAVY METAL – *Studio 'Eavy Metal Team*

Catachan Jungle Fighters.

10

CATACHAN JUNGLE FIGHTERS – *Rick Priestley*

The first of the new Imperial Guard regiments for **Warhammer 40,000** are released this month. In this article, Rick takes a look at these deadly warriors from the Death World of Catachan.

11

'EAVY METAL – *Studio 'Eavy Metal Team*

Space Marine Chaplains.

13

Space Marine Land Speeder.

14

Chaos Sorcerers.

18

CHARGE – *Jake Thornton*

Master tactician Jake Thornton considers how best to use cavalry in **Warhammer** games. Even if you fight with an army that has no 'obvious' cavalry there are still tricks you can try.

19

'EAVY METAL – *Studio 'Eavy Metal Team*

Imperial Knights.

26

Imperial and Squat forces.

31

Orks and Chaos.

34

FISTS OF DEATH – *Gavin Thorpe*

Gavin takes some time out from working on the Citadel Journal to look at different ways of arming your Titans. He also delves into the 'De Bellis Titanicus' to consider tactics for individual Titans and Titan Battle Groups in the **Epic Game System**.

27

GAMES DAY '94

It came, it saw, it conquered! The biggest Games Workshop gaming event ever.

38

'EAVY METAL – *Studio 'Eavy Metal Team*

Blood Bowl Halflings.

42

THE SMALL AND SHORT OF IT – *Jeremy Vetock*

US **Blood Bowl** Coach Vetock, cooks up some tasty victuals, and explains how to win with Halflings!

43

A BITTER HARVEST – *Adrian Wood and Fred Reed*

This month's battle report is a bloody **Warhammer 40,000** game between Orks and Space Marines

48

ADVERTS

Talisman – City of Adventure	5	Warhammer 40,000	56
Eldar Jetbikes	7	Games Workshop Mail Order	68
Games Workshop Retail Stores	16	Citadel Miniatures Catalogue	73
Apocalypse Titanicus	25	High Elf Lord of Dragons	75
Titan Legions	32	Warhammer Boxed Sets	76
Ork Stormboyz	37	Chaos Dwarfs	Inside Back
Chaos All-Stars	47		



5 011921 009954



WHITE DWARF®

THIS MONTH'S ISSUE

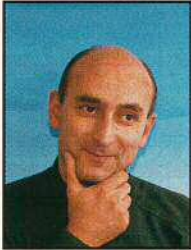

Welcome to this month's issue of White Dwarf. Well Games Day came and went leaving us all slightly dazed by the sheer enthusiasm of the thousands of gamers who crowded into the National Indoor Arena in Birmingham. A big thank you to everyone who made it along to the White Dwarf stand. Our only problem was that with so many people crowding the floor, it wasn't very easy to actually have a decent conversation! Jake and Adrian's "live" battle report attracted a lot of attention, although most of the questions were about how we made the scenery and terrain on the games table. It's pretty obvious that

we're going to have to run a few more Modelling Workshop articles in future Dwarfs.

Inside, we've put together some of the best photos of Games Day to give people who missed it a taste of what it was like. Maybe one year we should give away a prize to people who appear in the White Dwarf photos!

By the time you're reading this, you should already have your free Chaos Space Marine out of its bag and assembled in front of you. Elsewhere in this issue, you'll find an article by Neil Hodgson of the 'Eavy Metal team on how to paint this great miniature.

The battle report this month is a clash between the Space Marines of Fred Reed from Games Workshop Bristol and Adrian's Orks. Fred was the winner of the 1994 Golden Demon Space Marine Trophy and we showed the whole of his army on last month's

back cover. I won't give away the result of the game but it was a very closely fought battle.

Without a doubt, my favourite release this month are the Imperial Guard – Jungle Fighters of Catachan. Designed by Michael Perry, these are the first in a brand new series of releases for the too-long neglected Imperial Guard. Rick Priestley has provided the rules and I'm sure you'll agree that this is one of the most exciting Warhammer 40,000 releases since...the brand new Eldar Jetbike... no, that was only last month... uuuhm!... it seems like Warhammer 40,000 gamers have had a lot of excitement recently!

Ah well... Christmas is coming and I know what I'm going to spend my time painting. Enjoy your free model, and may your dice roll high!

GAMES WORKSHOP®

GIFT VOUCHERS

Fed up of receiving sensible socks and hankies for Christmas? Tired of the same old slippers and woollen hats that you get every year?

Why not ask your Granny to buy you Games Workshop Gift Vouchers instead?!

Games Workshop Gift Vouchers are available in £5.00 or £10.00 denominations from our Mail Order Trolls or from your local Games Workshop store NOW!



ASSISTANT GAMES DEVELOPERS



Last year we took the courageous step of employing three enthusiastic young gamers at the Games Workshop Studio. Their job was to play games and help to develop the Games Workshop Hobby. We had over 500 applicants and out of all of these we chose Ian, Gavin and Mark who you can see on the right, enjoying a game of Warhammer 40,000. After a year the three have been thoroughly potty-trained – you may have seen their Battle Reports, Warhammer



40,000 rules and of course the supposedly 'well-hoopy' Citadel Journal. Now we're going to do it again.

SO WHAT'S IT ALL ABOUT?

We want three more young bloods to join us at the Games Workshop Studio and learn how games are invented, developed and produced. This will mean making mock-ups of games, books and cards, working out and checking points values from army lists, and playing games along with our design teams. Yes, we do want you to play games for a living! The three successful applicants will be employed on a maximum two year contract specifically to assist our design teams to invent and produce new games and supplements. The work of the Assistant Games Developers will be assessed over this two year period, at the end of which we will offer permanent places to those who have proven sufficiently able.

WHAT DO I NEED TO APPLY?

There are few formal qualifications for this position although an unquenchable enthusiasm for Games Workshop is an absolute necessity. A good knowledge of Warhammer, Warhammer 40,000 and the Epic Game System is essential too. You must be between 18 and 25 years old with some post 'A' level education. We are looking for people with degrees or the equivalent, but if you dropped out of college, or are willing to do so to take up this position, we will consider you. You must be reasonably literate, with a good command and understanding of written English. You must also be keyboard literate, that is to say you need to know how to use a computer and you need to be comfortable about typing. We would require you to have at least 'O' level maths or comparable or better maths qualifications, as a lot of our work involves calculations or the manipulation of dice probabilities.

The three people we take on will be provided with lodgings at our expense, in a house owned by the company. We will also cover the cost of your travel to work and back. In addition you will receive a wage of £6,000 a year which you are free to spend in whatever depraved fashion takes your fancy.

Send us your full CV together with as many details as possible about your gaming experience, the armies you collect and your abilities as a miniature painter, to: **Assistant Games Designer, c/o Helen King, Games Workshop Limited, Chewton Street, Hilltop, Eastwood, Nottingham NG16 3HY.**

BLOOD BOWL®

HALFLINGS

The **Halflings** are back, and no, it isn't a joke! Gary Morley's latest gems for the excellent Blood Bowl range are six of the little chaps. With spoon at the ready (oh yes, and the football) they dodge and weave their way to the end zone through tall forests of legs, in the name of a larger helping of pudding.

But seriously, later in this issue we have a brilliant article on Halfling tactics which should have many a coach reaching for the fizzy pop. No

longer will their lack of height stand in their way on the path to glory!

SKAVEN MUTANTS

On a rather different note we have some new models for the chattering Skaven teams. Four miniatures are now available which include mutants with **Very Long Legs, Claw, Big Hand** and **Extra Arms**. These twisted creatures from the talented hands of Gary Morley are a must for any Blood Bowl coach lucky enough to have a Skaven team!

THIS MONTH'S BLOOD BOWL RELEASES

Halflings (Four miniatures per blister)	£4.50
Skaven Mutants (Four miniatures per blister)	£4.50

STOP PRESS

Since he wrote the article, Jeremy's Halfling team won the American Games Workshop League outright! The Southshire Stoutboys confounded all their opponents by romping to victory against a rather unfortunate team of Orcs!

TALISMAN[®]

CITY OF ADVENTURE

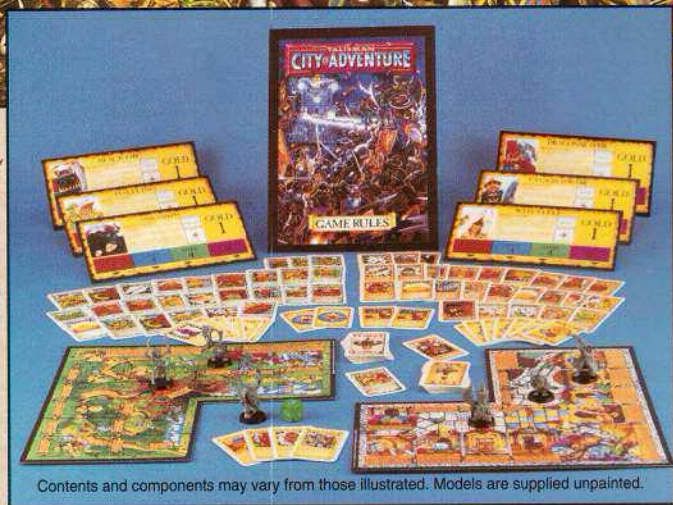

Contents and components may vary from those illustrated. Models are supplied unpainted.

NEW REALMS OF ADVENTURE

Talisman – City of Adventure contains two brand new board sections to expand your Talisman games. Enter the city realm of the Emperor and the forest realm of the Wraith Lord. With two brand new sets of adventure cards, you can pit yourself against fearsome new foes and uncover vast treasures including the prized Talisman itself!

Talisman – City of Adventure also contains six new characters, so now you can venture out as a Dragon Slayer, an Assassin, a Witch Elf, a Black Orc, a Chaos Dwarf or a Halfling, each represented by a superbly detailed plastic Citadel Miniature.

THE DUNGEON OF DOOM BOX CONTAINS

- 1 City board section • 1 Forest board section • 6 Citadel Miniatures
- 6 Character cards • 1 Rules sheet • 37 City cards • 40 Forest Cards
- 7 Purchase cards • 4 Adventure cards • 10 Special Cards • 1 Realm Dice



CITADEL
MINIATURES

The Citadel castle, the Games Workshop logo, and Talisman are registered trademarks of Games Workshop Ltd.
Citadel and Games Workshop are trademarks of Games Workshop Ltd.
© Games Workshop Ltd, 1994. All rights reserved.

GAMES[®]
WORKSHOP

EPIC[®]

TITAN LEGIONS

TM

THIS MONTH'S EPIC RELEASES

Knight Errants (Three miniatures per blister)	£4.50
Knight Crusaders (Three miniatures per blister)	£4.50
Knight Paladins (Seven miniatures per box)	£5.99
Imperial Leman Russ (Three miniatures per blister)	£4.50
Imperial Mole (One miniature per blister)	£4.50
Stormhammer (One miniature per blister)	£4.50
Leviathan (One miniature per blister)	£6.99
Squat Thunderfire Cannon (Two miniatures per blister)	£4.50
Ork Gobsmashas (Five miniatures per blister)	£6.50
Ork Lungburstas (Three miniatures per blister)	£4.50
Ork Spleenrippas (Three miniatures per blister)	£4.50
Ork Bonebreakas (Twelve miniatures per box)	£5.99
Brass Scorpion (One miniature per blister)	£2.99
Mortarion (One miniature per blister)	£2.50

EPIC VEHICLES

More and more Epic vehicles and tanks reach the battlezone this month with the release of a dozen or more models for the Epic System.

IMPERIAL KNIGHTS

The **Knight Paladins** boxed set enables you to increase the size of your escort, scout and strike forces in Titan Legions and Space Marine.

The Imperial **Knight Crusaders** and **Knight Errants** are the first new metal Knights to be released for the Epic Game System. All these models can be seen on the 'Eavy Metal pages in this issue, and will enable Epic gamers to field fully-mobile Knight detachments.

IMPERIAL ARMOUR

In addition to the forces of the Adeptus Mechanicus and the followers of the Titan Legions, we have a selection of heavily armoured vehicles for the Imperial Guard. The **Stormhammer** is the largest of these and is a formidable super heavy tank, equipped with an amazing fourteen bolters to provide close support for the infantry in the front line of an assault.

SQUAT FORCES

The Imperial allies are also reinforced this month with the massive **Leviathan**. This monstrous vehicle bristles with weapons and is protected by banks of void shields.

Above the battlefield the skies have been swept clear of the enemy by the new **Thunderfire Cannon**. Batteries of these great guns often accompany Squat forces to shoot down anything which might threaten the Brotherhood's advance.

ORK TANKS

Across the battlefield the hordes of Orks are mustering. New this month are **Gobsmashas**, **Lungburstas** and **Spleenrippas** as well as a boxed set of plastic **Bonebreakas** like those in the Titan Legions box. With this selection of extra armoured support, the Orks are ready to take on anyone.

CHAOS HORDES

Not to be forgotten are the deadly forces of Chaos. Re-released this month are the **Daemon Primarch of Nurgle Mortarion** as well as Khorne's deadly **Brass Scorpion**.

'EAVY METAL

MIKE MCVEY

Ace modeller and figure painter extraordinaire, Mike McVey has joined the team at White Dwarf and will be producing an irregular series of special Masterclasses for us.

EMPEROR AND HORUS

At the moment, Mike is working on the first of these projects – the final confrontation between the Emperor and Warmaster Horus, basing his diorama on the black and white illustration by Adrian Smith.

He has already completed all of the modelling and conversion work and has just started to paint the background.

We can't promise exactly when you'll see this masterpiece as we don't want to rush Mike into doing less than his best, but keep an eye on these pages for more information.

MORE MODELLING

As well as Mike, we now have a new modeller in the Studio. Owen Branham has joined us from Games Workshop

NEW MAIL ORDER FAX NUMBER

As these pages go out the door we are told that we have a new fax number for Mail Order. Anyone wanting to send their order through by fax should now use:

01773 533453.

USA and has already completed several splendid pieces of scenery.

He is currently busy on his most ambitious project to date – a massive landing pad for Warhammer 40,000. This too is nearing completion and will be sure to feature as the centrepiece of a battle report soon.

WARHAMMER

40,000

ELDAR® JETBIKE & SHRIEKER JETBIKE

The Jetbike is a deadly, lightning-fast weapon of war. Eldar Guardians riding Jetbikes streak across the battlefields of the 41st millennium to overrun heavily defended positions and strike deep into enemy territory.



Miniatures designed by Jes Goodwin.



Shrieker Jetbikes ride at the forefront of the Eldar attack. As the sleek machines dart across the battlefield, the shrieker cannon spits forth screaming missiles of lethal serum which twist and mutate the very flesh of their targets. Other troops flee in horror as the convulsing bodies of the shrieker's victims explode in bloody ruin.

The Eldar Jetbike boxed set contains a plastic Jetbike complete with an Eldar rider and a sheet of transfers. The Eldar Shrieker Jetbike boxed set contains a complete plastic Eldar Jetbike, a sheet of transfers, an additional metal shrieker cannon and metal Eldar rider.

WARNING! The Eldar Shrieker Jetbike boxed set contains some lead parts which may be harmful if chewed or swallowed. Citadel Miniatures are not recommended for children under 14 years of age.

These models require assembly. We recommend that the parts are cleaned and trimmed with a modelling knife before being painted with Citadel paints.

Citadel, the Citadel castle, Eldar, Games Workshop and Warhammer are registered trademarks of Games Workshop Ltd.
© Games Workshop Ltd, 1994. All rights reserved.



CITADEL
MINIATURES

GAMES
WORKSHOP



**EACH BOXED SET
CONTAINS AN
ELDAR® JETBIKE
TRANSFER SHEET**

'EAVY METAL™

PAINTING YOUR FREE MINIATURE

By Neil Hodgson

On the front cover of this issue of *White Dwarf*, you'll find a free World Eaters of Khorne – Chaos Space Marine. In this article, Neil Hodgson, one of the Games Workshop 'Eavy Metal team, explains how to paint up your free Citadel miniature.



Khorne is the great warrior of Chaos, the ferocious Blood God. The World Eaters of Khorne Chaos Space Marines are his ultimate warriors, steeped in martial honour and the ethic of war, chosen for the final conflict when Khorne awakes and the universe is drenched in blood

The World Eaters were one of the Space Marine chapters who joined the forces of Chaos during the infamous Horus Heresy. Even amongst the brotherhood of the Legiones Astartes, before the rebellion, the World Eaters were renowned for being amongst the toughest and most determined warriors, savage in battle and exultant in victory.

Angron, Primarch of the World Eaters, was a great warrior whose courage and sense of honour were recognised by



Khorne himself. His loyalty to the Emperor, once unswerving as any of the Primarchs was compromised. Angron became a champion of Khorne and began to tread the path toward daemonhood and ultimate power.

The World Eaters took part in some of the greatest and bloodiest battles of the Horus Heresy, including the assault on the Emperor's palace itself. They even claim that it was they not the Sons of Horus that first breached the walls of the outer palace during the battle for Earth. When Horus was finally slain, Angron and the World Eaters battled their way across the galaxy to the Eye of Terror from where they have raided the Imperium ever since.

STAGE 1 – ASSEMBLING YOUR MODEL

Before you pick up your paint brush you will first need to remove the miniature from its sprue using either a modelling knife or a pair of cutters. Using these tools prevents any damage to the model which can sometimes occur if you try to remove it by just snapping the model from the sprue.

The next thing to do is clean off the mould lines with a needle file or a modelling knife. Mould lines are created when the two halves of the model's mould are separated and are an inevitable result of the manufacturing process. Similar marks can also be found on all Citadel metal miniatures and it's a good idea to remove them so that the model looks clean and tidy when it's painted. Carefully trim or file away any excess material, until the surface of your miniature is clean and smooth. Take care not to press too hard, as it's easy to cut too deep into the plastic.

Once you've cleaned off the mould lines, you'll need to glue all of the parts together. Citadel produce a range of glues which have been perfectly formulated to suit the whole range of modelling tasks. In this case, the type of glue you'll need for your model is polystyrene cement.

First of all, glue the right arm onto the body of the miniature. You'll find that you can alter the angle of the arm, which will slightly vary the appearance of the model. In the stage-by-stage photos, you can see that when the bolter is slightly lowered, it looks as if the model is advancing forward into close combat. On the finished miniature, the right arm has been raised to give the impression that the Space Marine is standing and firing. The best thing to do is experiment with a few different positions, until you find one that pleases you. The poses on almost all plastic Citadel miniatures can be



STAGE 2

STAGE 3

STAGE 4

varied in this way and you soon get used to getting the pose just right. When you are ready, thinly coat both side of the join with polystyrene cement and gently press the parts together. Hold them tightly for a few moments and then set the pieces on one side to dry. The tab on the base of the miniature should be glued into the slot on the base in the same way.

STAGE 2 – APPLYING AN UNDERCOAT

Once the glue is dry you should give your model a white undercoat. There are two ways to do this. The easiest, particularly with a single model, is to simply paint the miniature all over with *Skull White* paint thinned with a little clean water. If you are painting more than one model at a time, it's best to use a spray paint such as *Citadel White* spray. Remember to follow the instructions and spray in a well-ventilated area. With either method, it's best to apply two thin coats rather than one thick one which might cover and obscure the detail on your model.



STAGE 3 – BASIC COLOURS

The next step is to apply an even layer of paint to the main areas on your model. As a rule, you'll get a better result and brighter colours by applying two thin coats of paint to your miniature rather than one thick one. You should therefore thin down some *Blood Red* paint with a little clean water and give all of the armoured areas a couple of coats, ensuring that the first coat is dry before the second is applied.

Next I painted the right kneepad, the edges of the armour and the edges of the helmet decoration in *Shining Gold*. Try not to spill paint into the red areas, but don't worry too much as you can always give the armour a final touch-up coat later on. Finally, the left knee pad, the spaces between the armour plates, the bolt gun, the handle of the chainsword and the pouches were all painted with *Chaos Black*. The chest straps and the blade of the chainsword were painted with *Jade Green*.

Like the *Blood Red* on the armoured areas, you may need to apply two thin coats in order to get a bright solid colour and touch up any mistakes at the end. Lastly pick out all of the big skulls on the model in *Bronzed Flesh*.

STAGE 4 – ADDING DETAIL

Many people paint their models to Stage 3 and then include them in their armies. How much more detail you want to add is a matter of personal choice and is really up to you. On the Stage 4 miniature, I began to pick out more of the detail on the model to give it a more three-dimensional look. I used *Shining Gold* to pick some of the details on the handle of the chainsword and the Khorne symbol on the Space Marine's chest plate. The Khorne symbol on the left knee pad was first painted in *Skull White* before being re-painted in *Blood Red*. If you try to paint a lighter shade on top of black, you just end up with a dirty looking colour. On the bolt-gun casing I used the same technique with *Mithril Silver* to pick out some of the metal areas such as the muzzle, the ammunition holder and the firing mechanism at the back.

The teeth on the chainsword and the rivets on the edges of the armour were all painted in *Chaos Black*. When this colour was dry, I then went over the rivets with *Mithril Silver* to create a strong relief. Finally, I painted the skulls on the belt buckle and chainsword with *Bronzed Flesh*. You should now have a finished World Eater Space Marine ready for your army, and the only thing that remains is to paint the base *Goblin Green*.

The photograph below shows one of these models painted by a member of the Games Workshop 'Eavy Metal team. This has been shaded and highlighted using simple techniques such as blending or drybrushing. Many of these methods of painting are described in Mike McVeys 'Eavy Metal series of books, and with patience and practice you too will be able to achieve similar results. Good luck!



THE JUNGLE FIGHTERS OF CATACHAN



JUNGLE FIGHTERS WITH LASGUNS



SERGEANT



JUNGLE FIGHTER WITH MELTAGUN

Imperial Guard Badges.

Every company of the Imperial Guard has its own badge, usually a simple disc divided into two or three colours. Over this, each squad displays its number, or letter in the case of the Command Section. These badges are then painted onto the weapons, equipment, vehicles and uniforms of the individual troopers.



MISSILE LAUNCHER



JUNGLE FIGHTER WITH MISSILE LAUNCHER AND LOADER



BADGE DETAIL



The Imperial world of Catachan is one of the most dangerous places in the entire galaxy. Its steaming tropical forests are a living hell filled with innumerable dangers. Vicious predators stalk through the undergrowth, killer insects swarm in the skies and even the plants are monstrously carnivorous. It is from this terrifying Deathworld that the Jungle Fighters regiment has been recruited into the Imperial Guard. Although few in number, the colonists of Catachan are hardy and tempered by their hostile environment to make excellent warriors. Their battledress is well suited to the rigours of jungle warfare and they make little use of flashy decorations. Company badges are restricted to a few pieces of equipment like the knife scabbards and heavy weapons. Metallic Imperial Guard icons are worn on neck chains and rivetted onto gun cases. In addition, individual jungle fighters tattoo the traditional Imperial Guard skull device onto their arms.



WARHAMMER

40,000

CATACHAN JUNGLE FIGHTERS

By Rick Priestley

Trained from birth to kill, the Catachan Jungle Fighters are one of the most famous and feared regiments in the service of the Emperor. In this first article on the Imperial Guard regiments, Rick takes a look at these battle-hardened warriors from the jungle swathed Death World of Catachan.

IMPERIAL GUARD

Our Imperial Guard project is well underway with many new models either awaiting release or in the design process. A short while ago we released the Leman Russ battle tank, our first new plastic kit for quite a while and certainly the most detailed to date. This month sees the launch of the first of our new Imperial Guard range in the form of the Catachan Jungle Fighter regiment. We have several more regimental sets to come, as well as special types such as deadly Ratling Snipers and some wild Rough Riders based on the John Blanche illustration on page 17 of the Warhammer 40,000 Rulebook.

Our intention is to produce a whole series of regiments, each from a different world with its own distinctive costume style. This gives Imperial Guard players the option of collecting an

army based on a particular regiment that they happen to like, or a varied army with squads drawn from as many different regiments as you wish. Each regiment will be available as a squad in a box, with extra models, commanders and special characters out later in blister packs. All the models have been designed by top-gun putty-pushers Mike and Alan Perry. The gruesome twosome have also produced an exciting range of vehicle crew models to accompany the Leman Russ tank.

As models come out we'll be adding new regiments to our collection and featuring them in future issues of White Dwarf. We'll also be publishing more new rules for the Imperial Guard where appropriate and we hope to bring you a battle report as soon as our army reaches a respectable size. In the meantime, our Imperial Guard forces will be fighting alongside our existing armies of Space Wolves, Ultramarines, Dark Angels and Blood Angels.



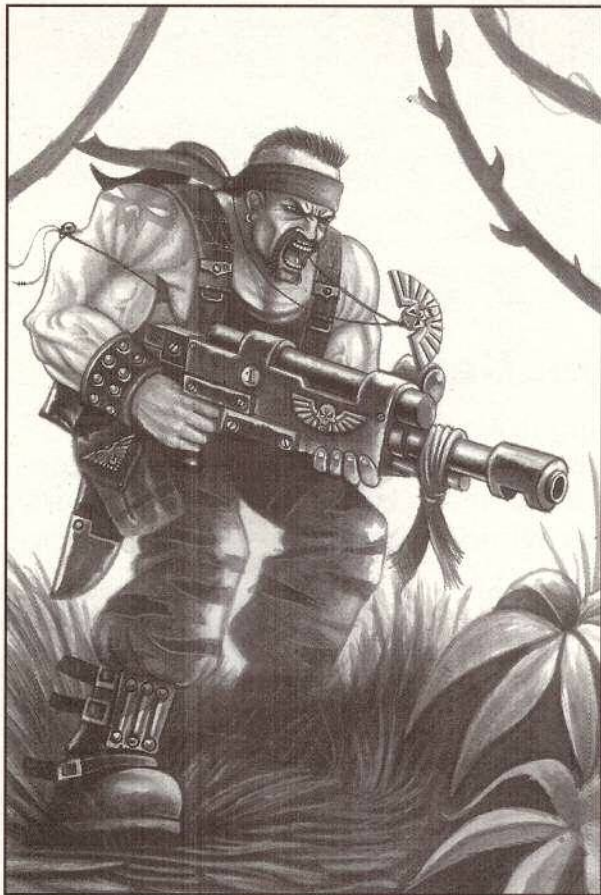

REGIMENTS OF THE IMPERIAL GUARD

The Imperial Guard is the military arm of the Imperium, the largest fighting force in the galaxy and the most powerful army of all time. Across the far-flung battlefields of the forty-first millennia the Imperial Guard struggles against alien invaders, rebellious planetary lords, and the savagery of nature. The Imperial Guard is not really a single army but many armies, each recruited for a specific campaign or war.

Each army is comprised of many regiments. Each regiment comes from a single world and is recruited by the Lord of that world as part of his Imperial obligations. When the Emperor calls the Imperium to war, every planet must provide a regiment to fight for the human cause. From all over the galaxy different regiments join together to fight side-by-side. An army often contains regiments from very different worlds: vast industrial hive worlds, arid sulphur deserts, and steaming jungles. Not all warriors are suited to every battlefield. Troopers from the claustrophobic hives of Necromunda would quickly perish amidst the jungles of Catachan, for example.

Wherever possible, regiments are raised from worlds similar to their intended theatre of operation. However, this is not always possible, and troops from quite different planets often find themselves mixed together on a battle front. During the course of a war, individual squads are often seconded to neighbouring regiments, thrown forwards amongst warriors from another world to bolster a weak spot in the defences or to reinforce an attack. Often regiments are so depleted by casualties that squads of different origin are reformed into a single regiment, forming a polyglot force from many different worlds.

CATACHAN

Man has lived upon Catachan longer than Imperial records can recall. The scout probes of the first colonists found a planet which looked deceptively green and fertile from the safety of orbit. When the giant colony ships crash landed the pioneers inside awoke from cryogenic slumber to find themselves marooned upon one of the most inhospitable places in the galaxy. Catachan is a Death World, perhaps the most notorious and dangerous of all the Death Worlds in the Imperium. Its jungles are home to some of the most predatory animals and plants ever encountered by man. The first settlers survived by the merest chance, holed-up inside the wreckage of their spacecraft, besieged by the living jungle around them. Undoubtedly many died. Only the hardest, quickest and luckiest ever survive on a Death World.

The planet's few scattered settlements are fortresses surrounded by barren bedrock where the soil has been blasted bare to provide clear lines of fire. Even so, buildings never last long on Catachan. Lichens soon take root upon any surface, secreting a potent acid which crumbles even the most solidly constructed defences. Strangle Vines creep a hundred metres in a single night, and their constricting grip can crush a plasteel bunker or smash a tank like an eggshell. The people of Catachan must constantly build and rebuild. Wherever they construct their settlements the jungles grow more densely and become increasingly aggressive. The wild creatures of Catachan gather to repel the invaders. It is as if the whole planet were determined to rid itself of human intrusion, just as the immune system of a man might react to some invasive virus. Sooner or later humans must abandon their homes and resettle on another site, beginning their struggle against the jungle afresh.

The people of this unique world are moulded by a life of constant battle. Children learn to shoot before they can walk. Only those who can shoot fast and straight ever reach adulthood. Outside the fragile domes a world wars against its human inhabitants, vicious creatures like the Catachan Devil lie waiting for the unwary. Every plant and every animal on Catachan is inimical to human life. Every creature is a carnivore. Every plant is poisonous. Some plants secrete a deadly pollen which saturates the air and invades filter systems. Other types of vegetation release sticky sap which holds a creature fast and slowly dissolves its flesh. A few large trees even emit poisons into the ground water, killing surrounding plants and creating a slimy acid bog which entraps anything foolish enough to venture near.



The native creatures are even more dangerous than the plants. The multi-legged Catachan Devil with its segmented body and snapping jaws is as big as a tank and capable of battling even the notorious Shambling Mamorphs of the volcano lands. Few humans grow old on Catachan, and those that survive the longest retain an instinct for self-preservation unrivalled anywhere in the galaxy.

SPACE MARINE® CHAPLAINS

The Space Marines' Codex stipulates that each one of the Company Chaplains should wear black armour.

On their right shoulder pad, all Chaplains display the skull badge of their rank, whilst the left shoulder pad bears their Chapter icon.

Each Chaplain carries a banner to identify him in battle. In its simplest form the banner shows the Chaplain's skull



badge in combination with the Chapter icon and a simple border in the Company colour. Chaplains mark their armour with the army badge as the first stage in its adoption by the Company for the subsequent campaign.

The Chaplains are revered veterans, and over the passage of time, as they accumulate many battle honours, their armour and heraldry become subject to many modifications. Each Chaplain's suit of armour is in itself a litany of bravery and endeavour, and is festooned with all manner of carefully sculpted embellishment to recall famous victories and heroic actions.

Banners are likewise adapted over time, often becoming lavish works of art recalling key events in the history of the Company and of the Chapter, or being emblazoned with glorious icons.



CHAPLAIN'S
BADGE



ARMY
BADGE



ULTRAMARINES, 3RD COMPANY



ULTRAMARINES, 2ND COMPANY



CHAPLAIN'S
BADGE



ULTRAMARINES'
ICON



IMPERIAL
FISTS'
ICON



IMPERIAL FISTS, 3RD COMPANY



WHITESCARS, 1ST COMPANY



CHAPLAIN'S
BADGE



WHITESCARS'
ICON



CHAPLAIN'S
BADGE

SPACE MARINE® LAND SPEEDER



CHAPTER ICON



ASSAULT SQUAD BADGE



SQUAD NUMBER



ARMY BADGE



Space Marines Assault squads are expected and trained to fight in a variety of ways. Whole squads are usually deployed as close combat specialists and as jump troops, but they can also be deployed as Bike squadrons or as individual Land Speeder crews. This particular example shows a Land Speeder crewed by two Space Marines of the VIII Squad, 2nd Company of the Ultramarines. The Land Speeder itself carries the relevant army and squad badges, and has the yellow trim of the 2nd Company, whilst the two Space Marines retain their normal squad uniform.



THE CATACHAN REGIMENT

Like all the worlds in the Imperium, Catachan is required to provide troops for the Imperial Guard. The people of Catachan live amongst dense and dangerous jungles which are altogether alien to most of the hive-dwelling citizens of the Imperium's larger planets. When it comes to jungle fighting the Catachan Regiment has no equal and the Imperial Guard recognises their supremacy in this type of warfare.

During the jungle wars on Epsilon Octarius, the Catachan Regiment survived for nearly forty days amidst Crotalid infested mangrove swamps before reaching the Ork Gargant construction site of Grubnak's Drops. On that occasion the savagery of the jungle fighters so impressed the Deathskull Ork Warlord that he ordered his Gargants to be painted in green jungle stripes with red bandanas, in imitation of the Catachan Jungle Fighter's uniform. Whether he did this out of respect for his enemies or in the hope that some of the Jungle Fighter's skills would rub off on his Gargant fighting machines is uncertain.

Jungle Fighters wear the green combat gear that is everyday costume for the people of Catachan. Their clothing is completely suited to fast moving warfare amidst steaming jungles. Combined with the red bandana, this rough but practical costume passes as the regiment's uniform.

THE WEAPONS TEAM RULE

The Catachan Jungle Fighters introduces a new idea for Warhammer 40,000. Their Missile Launcher has not one but two crew members, a firer and a loader. This is going to be the usual format for the Imperial Guard regiments. Future releases will include not only shoulder mounted heavy weaponry but also guns on heavy tripods and wheeled carriages. This gives the Imperial Guard a very military feel. It also gives us a chance to invent a new and entertaining rule for them!



A weapons team consists of two models, a firer who carries and operates the heavy weapon, and a loader whose job is to act as back up. The loader not only loads the weapon, but he carries extra ammunition, tools, and spare parts. What's more, he is trained to use the weapon just like his partner. The firer and loader must stay within 2" of each other wherever possible (normal coherency distance). The loader is also armed as a standard squad fighter, so he carries a lasgun and can shoot and fight in the same way as any other member of the squad. The presence of the loader makes no difference to the way that the heavy weapon shoots. However, if the trooper with the heavy weapon is killed the loader can take over. Instead of removing the model with the heavy weapon, take off the loader model

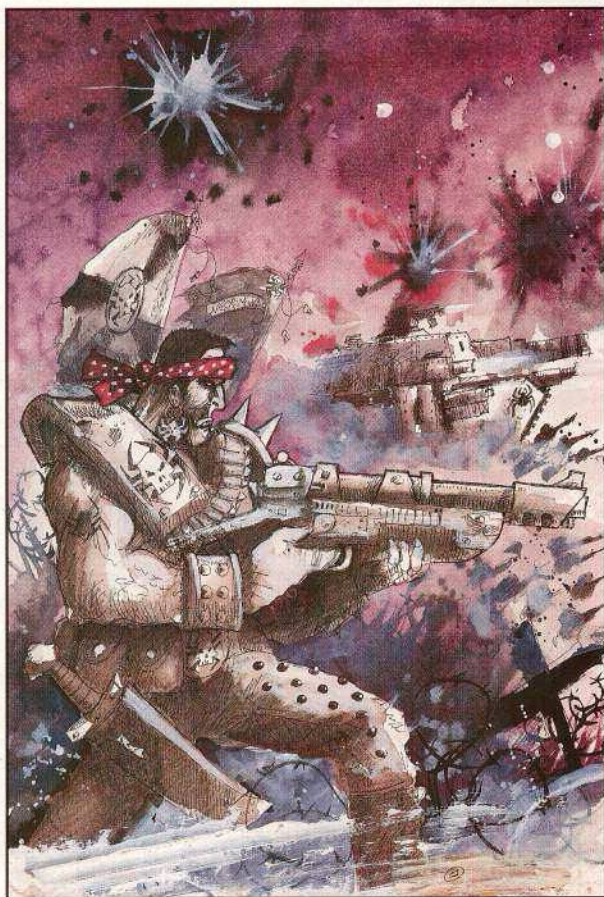

and move the firer to the loader's position. If the loader is not within 2" of the firer for some reason, then he cannot swap over in this way and the weapon is lost.

The weapons team rule is a straightforward way of representing the extra loader. It allows one of the squad to 'pick up' the heavy weapon when the firer is killed. This second chance gives the Imperial Guard a real advantage. Bear in mind that only the loader model can pick up the weapon, not any other member of the squad. Don't worry about whether the weapon might be destroyed, damaged or lost in some way – we will simply assume that the weapon miraculously escapes the lascannon shot, or is tossed aside from the vortex blast!

CATACHAN JUNGLE FIGHTERS

An Imperial Guard army may include up to three squads of Catachan Jungle Fighters for every Command Section it has.

SQUADS

140 points

Squad consists of 1 Sergeant and 9 Imperial Guard armed with lasgun, frag grenades and flak armour (6+ save). The Sergeant is armed with bolt pistol, chainsword, frag grenades and flak armour (6+ save). One trooper is equipped with a melta-gun, and the squad includes a two man weapons team armed with a missile launcher.

PROFILE	M	WS	BS	S	T	W	I	A	Ld
Imperial Guard	4	3	3	3	3	1	3	1	7

GAMES WORKSHOP®

A WORLD OF FANTASY GAMING

The first thing you notice when entering a Games Workshop store is how different it is from nearly every other shop.

Here you'll find not only all you need for the gaming hobby, but much more besides.

With friendly, approachable staff and a vast range of Citadel Miniatures, you'll find everything you need to build up an army or team for Warhammer 40,000, Blood Bowl, Warhammer, or the Titan Legions/Space Marine Epic game system.



Above: Every Thursday night your local store runs a Games Night where you can battle with your favourite armies. Here is an exciting game of Warhammer 40,000.

GAMES WORKSHOP

SUNDAY OPENING

The following stores are now open every Sunday:

Edinburgh, Manchester, Dudley, Thurrock, Metrocentre and Meadowhall.

These stores will also be opening on Sundays from this winter:

Birmingham, Blackpool, Brighton, Hull, Leicester, Watford, Croydon, Glasgow, Guildford, Kingston, Nottingham, Peterborough

GAMES WORKSHOP®

UK STORES

ABERDEEN: UNIT 1, 30/40 KIRKGATE,
TEL: 01224 621261

BATH: 30 UPPER BOROUGH WALLS, BA1 1RC
TEL: 01225 314414

BECKENHAM: 292-294 HIGH ST.
TEL: 0181 658 8102

BELFAST: 20A CASTLE COURT, TEL: 01232 233684

BIRMINGHAM: 116 CORPORATION STREET,
TEL: 0121 236 7880

BLACKPOOL: 8 BIRLEY STREET,
TEL: 01253 752056

BOLTON: UNIT 25, FIRST FLOOR GALLERY,
SHIPGATES CENTRE TEL: 01204 362131

BOURNEMOUTH: 24 POST OFFICE ROAD,
TEL: 01202 319292

BRIGHTON: 7 NILE PAVILIONS, NILE ST.
TEL: 01273 203333

BRISTOL: 13 BROAD WEIR, TEL: 0117 9251533

BROMLEY: 8 BROMLEY MALL TEL: 0181 466 0678

CAMBRIDGE: 4 QUAYSIDE, (OFF BRIDGE ST).
TEL: 01223 313350

CARDIFF: 29-30 HIGH STREET, TEL: 01222 644917

CHELMSFORD: UNIT K5, THE GALLERY,
THE MEADOWS CENTRE, TEL: 01245 490048

CHELTENHAM: 16 PITVILLE STREET,
TEL: 01242 228419

CHESTER: 112 FOREGATE STREET,
TEL: 01244 311967

COLCHESTER: 2 SHORT WYRE STREET,
TEL: 01206 767279

COVENTRY: 14 CITY ARCADE, TEL: 01203 227311

CRAWLEY: 11 BROADWAY, TEL: 01293 552072

CROYDON: UNIT 35, DRUMMOND CENTRE,
KEELEY RD, TEL: 0181 680 4600

DERBY: 42 SADLER GATE, TEL: 01332 371657

DUDLEY: KIOSK U, UPPER LEVEL, MERRY HILL
CENTRE, DUDLEY, TEL: 01384 481818

EALING: 52D ST SAVIOURS MALL, EALING
BROADWAY CENTRE, TEL: 0181 8400171

EDINBURGH: 136 HIGH ST. TEL: 0131 220 6540

EXETER: 37 PRINCESS HAY, TEL: 01392 490305

GLASGOW: 66 QUEEN ST. TEL: 0141 226 3762

GUILDFORD: 12 TUNSGATE, TEL: 01483 451793

HAMMERSMITH: 1 DALLING ROAD,
TEL: 0181 741 3445

HARROW: 296 STATION RD, TEL: 0181 861 2350

HIGH WYCOMBE: UNIT 29, THE BALCONY,
THE OCTAGON CENTRE, TEL: 01494 531494

HULL: 30 PARAGON STREET, TEL: 01482 589576

IPSWICH: 2ND FLOOR, DEBENHAMS,
WESTGATE STREET, TEL: 01473 210031

KINGSTON ON THAMES: 33, FIFE ROAD,
TEL: 0181 549 5224

LEEDS: 12-16 CENTRAL ROAD, TEL: 0113 2420834

LEICESTER: 16/20 SILVER ST, TEL: 0116 2530510

LIVERPOOL: 47 LORD STREET, TEL: 0151 258 1404

CENTRAL LONDON: UNIT F10, THE PLAZA,
116-128 OXFORD STREET, TEL: 0171 436 0839

LUTON: 12 PARK STREET, TEL: 01582 417474
MAIDSTONE: UNIT 6, 1-9 PUDDING LANE,
TEL: 01622 677435

MANCHESTER STORE BATTLE DAY



3rd December 1994



WARHAMMER 40,000 - TERROR AT MANCURIA XII

On Saturday the 3rd December, our Manchester Store will run a battle with a colossal difference. A vast Genestealer horde has landed the planet of Mancuria XII and taken over the Imperial Research Station. Squads of Space Marines from the Dark Angels, Blood Angels, Space Wolves and Ultramarines have been dispatched to isolate and destroy the infestation. The game will be played across a massive 20' by 20' cross shaped table with dozens of players on each side. We provide the superbly painted miniatures and terrain, all **YOU** have to do is turn up on the day! Phone the Manchester store now on 0161 8346871 for more details.

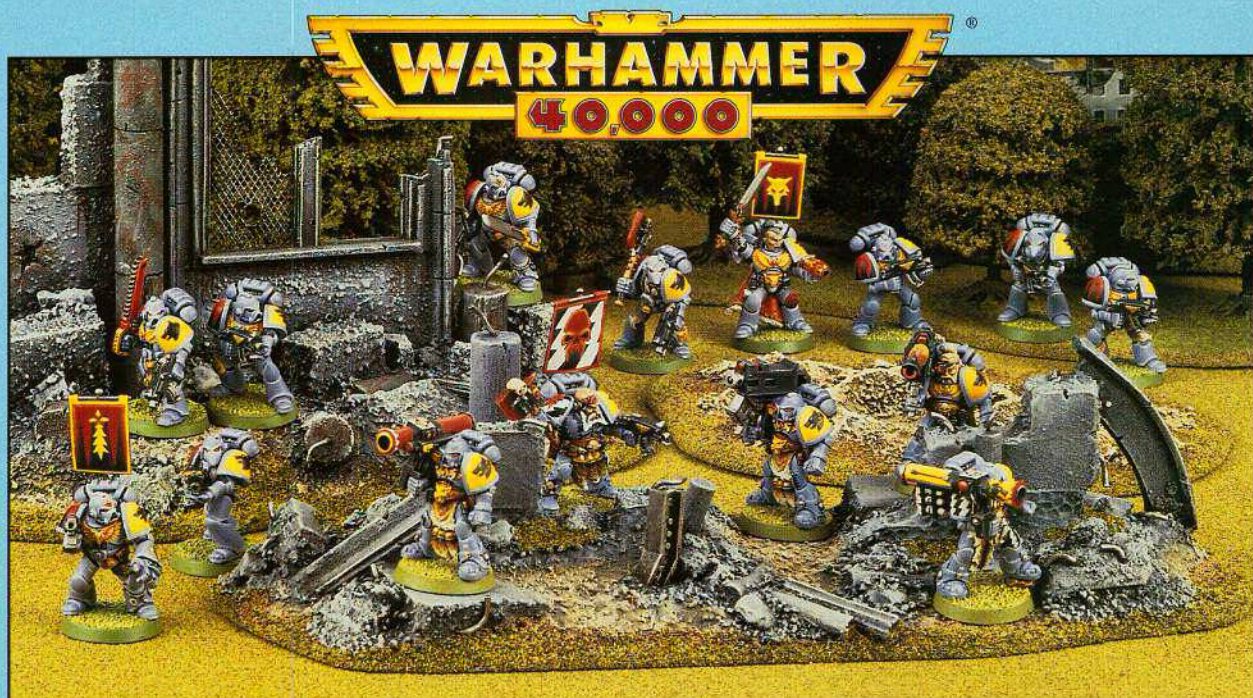

MAIDENHEAD: 2 BLANDY HSE, 3/5 KING ST.
TEL: 01628 21854

MANCHESTER: 69/70 MARSDEN COURT,
ARNDALE CENTRE, MANCHESTER.
TEL: 0161 834 6871

MEADOWHALL CENTRE SHEFFIELD:
91B, HIGH ST, UPPER MALL. TEL: 0114569836

METROCENTRE NEWCASTLE: UNIT B14,
FIRST FLOOR. TEL: 0191 461 0950

MIDDLESBROUGH: 39 DUNDAS ST.
TEL: 01642 254091

NEWCASTLE: 63 CLAYTON STREET.
TEL: 0191 232 2418

NORWICH: 12-14 EXCHANGE STREET.
TEL: 01603 767656

NOTTINGHAM: 34a FRIAR LANE.
TEL: 0115 9480651

OXFORD: 1A NEW INN HALL ST.
TEL: 01865 242182

PETERBOROUGH: 3 WENTWORTH STREET.
TEL: 01733 890052

PLYMOUTH: 84 CORNWALL STREET.
TEL: 01752 254121

PORTSMOUTH: 34 ARUNDEL STREET.
TEL: 01705 876266

PRESTON: 15 MILLER ARCADE. TEL: 01772 821855

READING: UNIT 3, CHEAPSIDE. TEL: 01734 598693

ROMFORD: 12 QUADRANT ARCADE.
TEL: 01708 742140

SHEFFIELD: 16 FITZWILLIAM GATE.
TEL: 0114 2750114

SHREWSBURY: UNIT 2, BRIDGE ST.
TEL: 01743 362007

SOUTHAMPTON: 23 EAST STREET.
TEL: 01703 331962

SOUTHEND: 12 SOUTHCHURCH RD.
TEL: 01702 461251

STAINES: ELMSLEIGH CENTRE. TEL: 01784.460675

STOCKPORT: 32 MERSEY SQUARE
TEL: 0161 4741427

STOKE ON TRENT: 27 STAFFORD ST, HANLEY.
TEL: 01782 205287

SUTTON ON THAMES: UNIT 26, UPPER MALL,
TIMES SQUARE SHOPPING CENTRE.
TEL: 0181 770 9454

SWINDON: 17 FLEET STREET. TEL: 01793 436036

THURROCK LAKESIDE: UNIT 415,
LEVEL 3/FOOD COURT, THURROCK LAKESIDE.
TEL: 01708 867133.

TORQUAY: 12 MARKET ST. TEL: 01803 201036.

WATFORD: UNIT Q1A,
HARLEQUIN CENTRE, QUEENS ROAD.
TEL: 01923 245388

WORCESTER: 4 CHARLES STREET.
TEL: 01905 616707

YORK: 26 GOODRAMGATE. TEL: 01904 653575

GAMES[®]
WORKSHOP
OPENING TIMES

Most Stores are open late at least one night a week. Please phone your local store for times of opening.



CHAOS SORCERERS

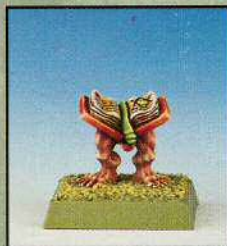

CHAOS FAMILIARS



A CHAOS SORCERER LEADS HIS FOUL WARBAND AGAINST A REGIMENT OF KNIGHTS PANTHER

WARHAMMER

CHARGE!

By Jake Thornton

With thundering hooves the cavalry charged, crashing into the enemy line and scattering their footsoldiers like chaff in a high wind. None could stand before the armoured might of the iron-clad lancers as they crushed all those foolish or unlucky enough to stand before them.



Of all the types of warriors in Warhammer, my favourite non-magical troops are the cavalry. Faster than the foot troops and more numerous than the heroes on their winged mounts, massed regiments of cavalry dominate the battlefields of the Old World. The *Gauntlet of Fear* in White Dwarf 178 shows just how devastating these troops can be...

My definition of cavalry is simple – they are any troops mounted on horses, boars, wolves or Chaos riding beasts. Chaos Dwarf's Bull Centaurs and the

more common Centaurs who serve Chaos also behave like cavalry, as do some daemons such as the Flamers of Tzeentch.

Dwarf Gyrocopters, Skaven Doomwheels and Chariots of any race are similar too. With a little adaptation for their different movement rules, these war machines can successfully use the following cavalry tactics to crush their enemies under their scythed wheels.

With this variety of troop types coming under the general heading of "cavalry" you can see that every army should be able to field some of these battle-winning troops. Even those few armies that don't have cavalry of their own are always able to take allies who have. Taking allied troops like this is also an ideal way to start collecting a new army.



TYPES OF CAVALRY

There are basically three sorts of cavalry in Warhammer: heavy cavalry like Chaos Knights, missile cavalry such as the famous Kislev Horse Archers of the Empire, and light cavalry like Skeleton Horsemen.

Heavy cavalry forms the main striking force of many Chaos, High Elf and Empire armies. They are easily distinguished from the other types by the huge amount of armour worn by the warriors (often a 2+ save or better!) and the fact that they are usually armed with lances. These are the perfect weapon for charging troops, adding +2 to the Strength of the attack in the first turn, but unlike double-handed weapons still allowing the charger to strike before their opponent. As the elite of the army, these fearsome warriors are often highly skilled and well led which further increases their killing potential. In fact, there are few units which can withstand the charge of a regiment of heavy cavalry.

At the other end of the scale we have missile cavalry. As the name suggests, the most important point about these troops is that they carry a missile weapon. Whether it is a bow, pistol or repeater hand gun, the object is to shower the enemy with arrows and shot in order to soften them up before a charge by the rest of the army. These warriors need to move quickly and so they wear little or no armour. The best missile cavalry only has a 5+ or 6+ save as they then count as *fast cavalry* as defined on page 22 of the Warhammer rulebook. This means that they can make any number of turns for free – even whilst marching – and allows them to continually outmanoeuvre their enemy and avoid being caught up in hand-to-hand combat.

The third type of cavalry is the most difficult to define and use. Light cavalry is really what you have left once you have taken

out the missile and heavy cavalry. These troops are sometimes almost as well protected, and nearly as well armed as the heavy cavalry, but never quite. They appear to be, and are usually used as, second rate heavy cavalry.

One final note about types of cavalry is that many of the army lists allow you to vary the equipment of your troops and this can change them from one class to another. It is worth thinking very carefully about your cavalry's weapons and armour before you add them to your army. Do you need to upgrade their armour? Will it slow them down? Will it stop them being *fast cavalry*? Would your Goblin Wolfboyz be more useful if you gave them spears? Or bows?

TASKS

Each sort of cavalry has a different task to perform on the battlefield. Understanding these varying skills is important as it helps you to get the most out of your troops by making sure that you use each regiment to do what they're best at. It's no good sending your Kislev Horse Archers to take on the Dwarf Slayers or to waste your Chaos Knights merely harassing an enemy flank. Pick the right troops for each job and you'll get the best value out of your points.

CHARGE!

Heavy cavalry are there to strike the enemy and strike them hard. They can move much faster than foot troops and are therefore usually in the position to charge rather than being charged. This is important if they are to do maximum damage with their lances. Being faster than your enemy also allows you to pick and choose your fights, avoiding the dangerous opponents until they've been softened up with missile fire or spells. It is usually best to charge units that you think you can

break easily as this will cause panic tests on the other enemy regiments as well as freeing your heavy cavalry to charge again before the battle is over. The example below is taken from the *Gauntlet of Fear* battle report from White Dwarf 178.

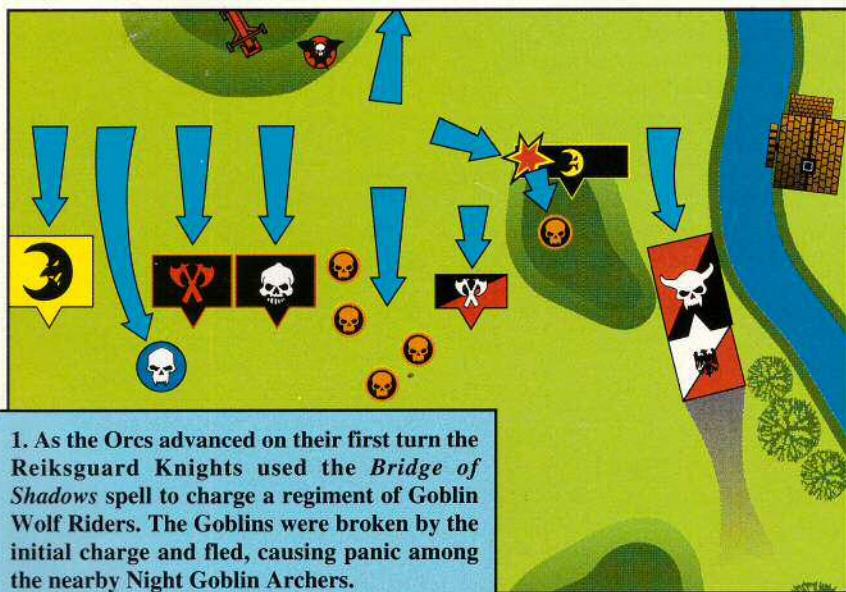

1. As the Orcs advanced on their first turn the Reiksguard Knights used the *Bridge of Shadows* spell to charge a regiment of Goblin Wolf Riders. The Goblins were broken by the initial charge and fled, causing panic among the nearby Night Goblin Archers.

Night Goblin Archers

Goblin Wolfboyz

Reiksguard Knights

3. ...leaving the Reiksguard free to look for new victims.

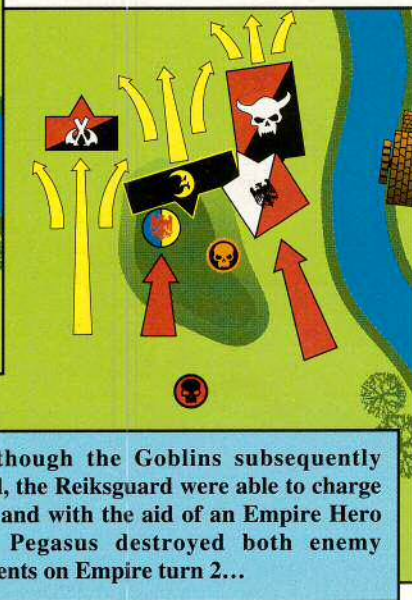

2. Although the Goblins subsequently rallied, the Reiksguard were able to charge again and with the aid of an Empire Hero on a Pegasus destroyed both enemy regiments on Empire turn 2...

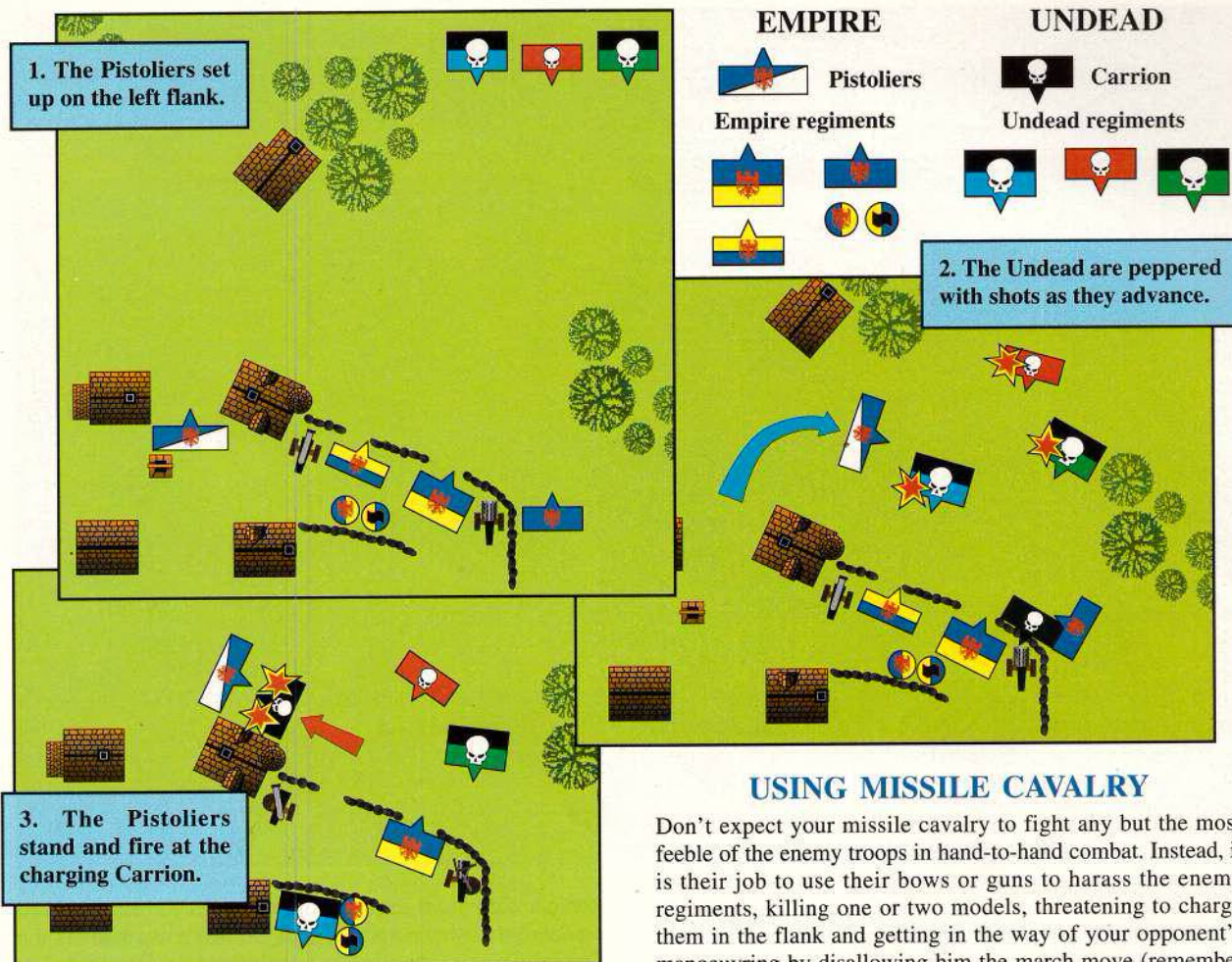

USING MISSILE CAVALRY

Don't expect your missile cavalry to fight any but the most feeble of the enemy troops in hand-to-hand combat. Instead, it is their job to use their bows or guns to harass the enemy regiments, killing one or two models, threatening to charge them in the flank and getting in the way of your opponent's manoeuvring by disallowing him the march move (remember that you cannot march move closer than 8" to an enemy model). Missile cavalry are also useful to pursue troops who have been broken by other friendly regiments such as your heavy cavalry, leaving them to charge someone else. The ideal formation for missile cavalry is rather different to heavy cavalry. Instead of wanting the greatest depth of unit to give maximum rank bonus, your aim should be to get the most troops firing. This means that missile cavalry regiments are better being quite small so that they can avoid wasting models in back ranks that cannot see to shoot.

Speed is the next essential and if your missile cavalry can skirmish then so much the better. If you aren't allowed to skirmish, then try to ensure that your regiments all qualify as *fast cavalry* instead.

A textbook use of missile cavalry was Mark's deployment of his Empire Pistoliers in the battle report in White Dwarf 174.

1. They began the battle covering the left wing of the Empire position which was defending the village of Beeckerhoven.
2. Mark initially advanced the Pistoliers to threaten the flank of any Undead regiment that dared to charge the Empire force. This also left them ideally placed to fire into the ranks of the Undead regiments as they approached.
3. As the combat raged in the village Mark repositioned the Pistoliers to threaten the rear of the Undead regiments. In an attempt to counter this, Gavin charged the Empire cavalry with his Carrion but the Pistoliers cut them to pieces in a hail of shot as they bravely stood to receive the charge.

In combat, heavy cavalry rely on the charge to beat much more numerous units, denying them the chance to fight back as their fighting rank is wiped out in the initial strike. To this end you need to think carefully about how you are going to form up your regiment. Ideally it should be several models deep and at least four wide to get a rank bonus in combat resolution. This costs rather a lot of points and so is not always possible to achieve but there are several ways around this. Firstly, always take a regimental standard. He costs as many points as two normal models but gives you an extra +1 just as if you had a whole extra rank! Not only this, but he is also gives you a great chance to show off your modelling and painting skills.

Secondly, remember the characters in your army. These also cost a lot of points as they are very powerful and often carry magic items. Where better to place them than at the cutting edge of your attack? Don't forget that these models also count towards your rank bonus and that half ranks are only wasted. Work out which characters will fight with each regiment whilst you are picking your army and try to make sure that you purchase whole ranks to get the most out of your points.

Finally, get the rules right! It is particularly important with smaller regiments, such as heavy cavalry, to remember that rank bonus is calculated *before* you remove that turn's casualties and that models which are lapping round count towards rank bonuses too. This means that the smaller units have a better chance of coming out on top against the large formations of Goblins and Skaven who always seem to get +3 for their ranks no matter how many you kill!

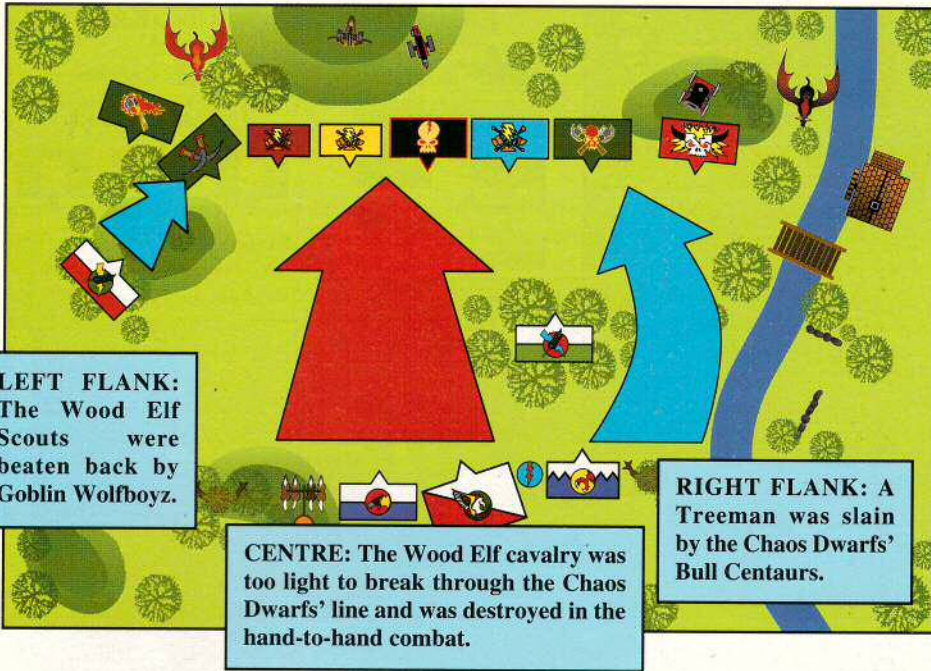

LIGHT CAVALRY

As I said before, these are the trickiest cavalry to use effectively. Sometimes your light cavalry can be used against average enemy regiments, charging in like the heavies. The success of this tactic relies almost completely on your careful choice of targets and timing. If you intend to use your light cavalry like heavy cavalry then follow the suggestions above about extra ranks and so on. This is the biggest danger with light cavalry – thinking they can do something they can't, and is best explained with an example.

In the example from White Dwarf 170 on the left, I

commanded a Chaos Dwarf army against Robin's Wood Elves. Robin had formed a bold plan to smash through the centre of the thin Chaos Dwarf line whilst his Treemen and Scouts harrassed the flanks. Robin is an experienced cavalry commander and has destroyed my armies with similar moves more times than I care to remember. However, this time he made a fatal mistake.

Robin usually leads the army of the Empire to battle and had assumed that the Wood Elf Knights were as tough as the Empire Knights, but this just wasn't the case. He charged in expecting to break the Chaos Dwarf line in one glorious blow but ended up stuck in a bloody struggle that he couldn't win and couldn't escape from. With the right sort of heavy cavalry this plan may well have punched a hole in the centre of the Chaos Dwarf line and left them scattered and in disarray. As it

All in all, the regiment greatly hampered the Undead advance, whittling down some of the regiments with their fire as they blocked the movement of others, finally wiping out the Carrion in a brave stand. And all this without ever getting bogged down in hand-to-hand combat!

One other very specific use of missile cavalry is against the dreaded Goblin Fanatics who are such a plague on heavy troops. Missile cavalry are fast enough to get close to the Night Goblin regiments first, forcing the Fanatics to emerge and then shooting them to pieces. Of course the Fanatics sometimes inflict such heavy losses on the unit that they flee, but this is still preferable to having the same losses inflicted on your better and more costly troops. This tactic also gets the Fanatics out in the open where they can be dealt with by the other missile troops and wizards in the army.



Two regiments of light cavalry in an evenly matched struggle – Kislev Winged Lancers fight against Skeleton Horsemen.



The Wood Elf attack approaches the Chaos Dwarf line.

was, he had used light cavalry to do a heavy cavalry job and was defeated for his mistake.

Light cavalry are much easier to use if you treat them more like missile cavalry and send them to protect the flanks of friendly regiments, or to threaten those of the enemy. However, once your regiment is in position it behaves rather differently. Instead of shooting at the enemy and avoiding hand-to-hand combat, you simply make sure that all the fights are on your own terms. By using your superior movement you should be able to dictate who fights who and gang up on enemy regiments with two or more of your own. Then, whilst the other enemy troops are still trying to get into position you can overwhelm the outnumbered foe. Manoeuvre and position are all important, and with fast troops such as cavalry you should be in control. Remember that units of enemy troops are not a threat if they cannot get to you and so you should leave some of them out on a limb while you massacre the others.

In fact, apart from their lack of ranged weapons, light cavalry can be employed to perform all the same tasks that your missile cavalry do – pursuing fleeing enemy regiments and blocking their reinforcements as your heavy cavalry destroy their main fighting strength.

CAVALRY FORCES IN BATTLE

Obviously, the different types of cavalry don't operate in a vacuum and each must be incorporated into your battle plan for the whole army.

Cavalry often work best as a mixture of different types. Because foot troops are too slow to support them, the various

types of light and heavy cavalry are best used to complement and support each other. At its most basic, this means using your missile and light cavalry to protect the flanks of the slower and less manoeuvrable heavy cavalry as they get into a position to charge. Once the heavy troops are engaged then their flanks still need to be protected and again this is best done by means of a threat.

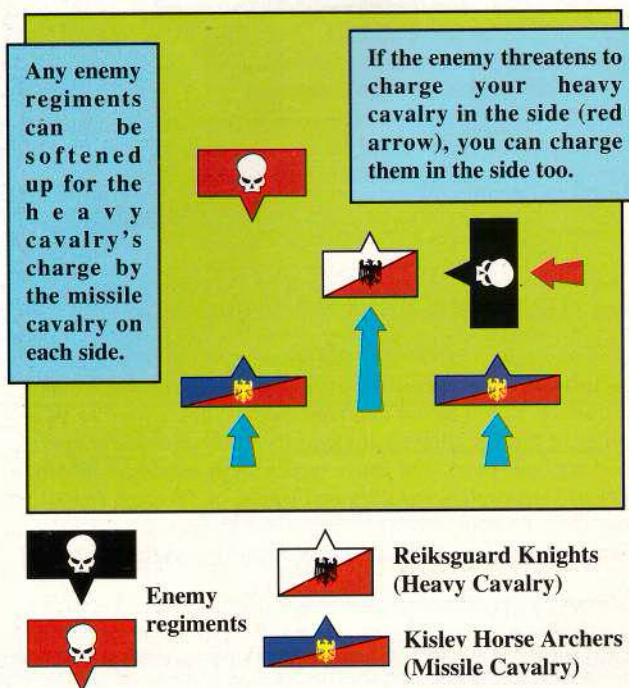

CHARGE!

This simple formation allows the heavy cavalry to advance whilst the flanks are covered by the missile cavalry. These troops can fire at any potential threat and if anyone was foolish enough to charge the heavy cavalry in the flank then they would be charged in turn. If you have made your original choice of victim for the heavy cavalry correctly, then this multiple combat should still be in your favour.

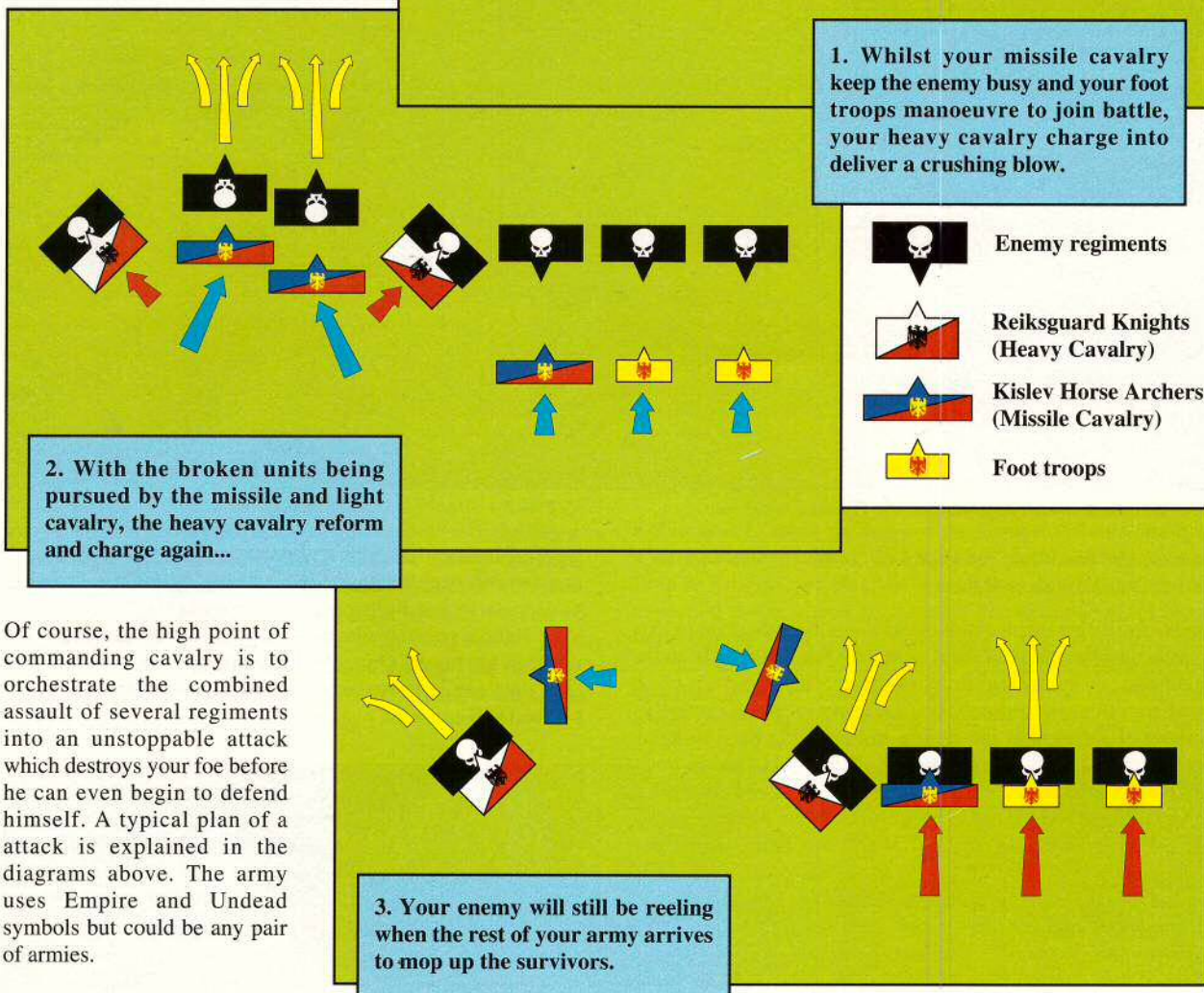

Of course, the high point of commanding cavalry is to orchestrate the combined assault of several regiments into an unstoppable attack which destroys your foe before he can even begin to defend himself. A typical plan of an attack is explained in the diagrams above. The army uses Empire and Undead symbols but could be any pair of armies.

WHAT IF YOU HAVEN'T GOT ANY CAVALRY?

As I said at the beginning of this article, every army has access to some cavalry, even if they have to resort to allied troops. However, if you haven't enough models, don't want to take allies or are not allowed any cavalry in the scenario you are playing, take heart. The above tactics apply equally well with Dwarf Gyrocopters and daemon Flamers of Tzeentch (missile cavalry), Chariots from any army, the Empire War Wagon, War Altar or the Skaven Doomwheel (heavy cavalry).

Magic can also replace cavalry, with many of the decks containing movement spells such as Waaagh magic's *Hand of Gork* or the *Bridge of Shadows* from the Grey magic deck.

These spells and many others like them can effectively transform your tougher foot troops into heavy cavalry by transporting them across the battlefield and into hand-to-hand combat. Imagine the effect of a large regiment of Black Orcs smashing into the enemy from the other side of the table – easy enough with the *Hand of Gork*, but what a shock for your opponent! Or you could charge your High Elf Phoenix Guard across the *Bridge of Shadows* and into the very heart of your foe's position.

Finally, know your own army. Learn what your regiments can expect to beat and what they should steer clear of. Remember that it is the General that really counts, and that any army can win if it is well led. Good luck!

EPIC[®]

TITAN LEGIONS

Apocalypse

TITANICUS

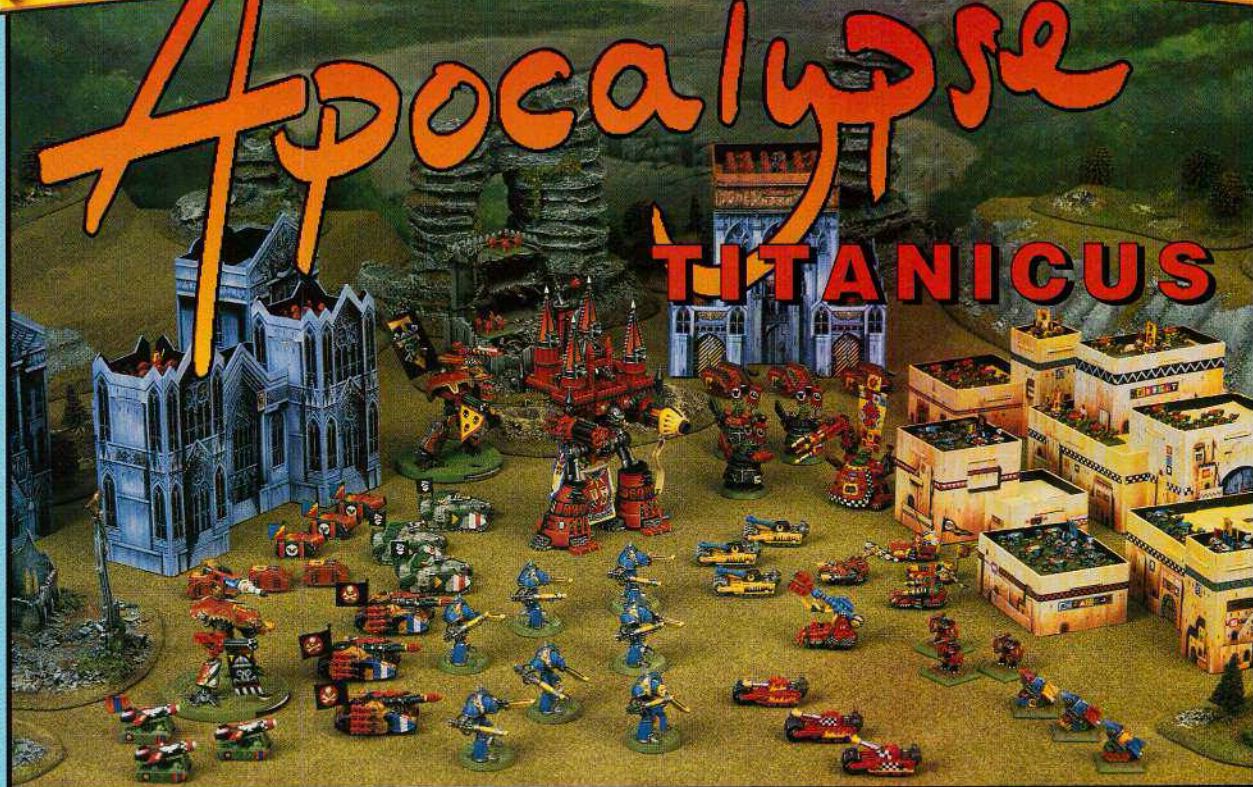

THE TITAN LEGIONS ROADSHOW

On the ancient Ork planet of Retallus IV, a massive Waa-Ork! is gathering pace. From a dozen neighbouring systems, thousands of Orks are travelling to the planet in preparation for the crusade. Hundreds of Mekboyz have directed the labour of thousands of human slaves, in order to raise the towering titanic forms of a score of Mega-Gargants over Retallus's now desolate plains.

But the Imperium is determined to strike back. Before the devastating green horde begins to spread, the Orks must be defeated and their totemic effigies destroyed.

By direct order of the Emperor, twelve Emperor Class Titans of the Legio Sinister have been dispatched to Retallus with orders to smash the Waa! before its tide of bloody destruction spreads across the galaxy. The stage is set for a titanic clash...

Throughout November and December we'll be playing **THIS** massive game of Titan Legions at these Games Workshop stores. All **YOU** need to do is turn up and play! All the miniatures will be provided as well as superbly-made terrain so just come along and join in the fun. And, at every event, we'll be giving away a limited number of special edition Titan Legions badges!

GAMES WORKSHOP[®]

NOVEMBER

**26th Games Workshop
Belfast**

DECEMBER

**3rd Games Workshop Birmingham
10th Games Workshop Chester**

IMPERIAL KNIGHTS

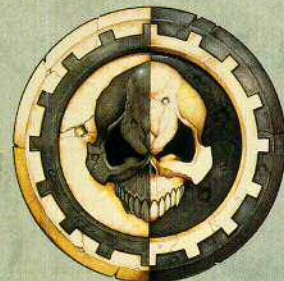

KNIGHT PALADIN DETACHMENT

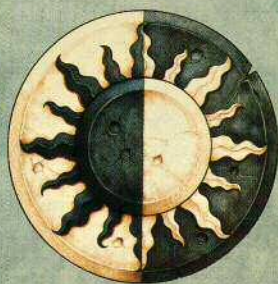

KNIGHT CRUSADER DETACHMENT

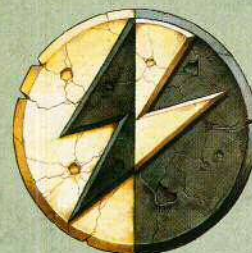

KNIGHT ERRANT DETACHMENT



IMPERIAL KNIGHTS SMASH THE ORK ADVANCE

EPIC[®] TITAN LEGIONS

FISTS OF DEATH By Gavin Thorpe

In the immortal words of Haran Jaxx, as laid down in the *De Bellis Titanicus* "The arming of Titans must, by necessity, always be a compromise". With Imperial Titans this is a paramount consideration as the sheer number of weapons to choose from when arming your Battle Titans can be daunting. This article aims to give you a few helpful insights.



With the release of Titan Legions, much attention has been drawn to developing new strategies and tactics for the Epic games system. The renewed importance of Titans in the game means that old battle plans are being thrown out or modified and new ones devised. Many gamers will want to add new

Titan models to their Epic armies and this will inevitably involve selecting the weapon combinations for their war

machines. "The right tools for the job" is probably the best summery of what Haran Jaxx was saying in the above quotation. What this means is that before you make your weapon selection you should consider carefully just exactly what you want your Titan to do on the battlefield.

For most gamers, myself included, a Titan model represents a significant investment of time, money and painting skill. These gargantuan machines form the centrepieces of an Epic army and the last thing you want is for your pride-of-place model to be destroyed in every game because of an ill-conceived or implemented weapon fit.



OVERALL STRATEGY

Titans are the most powerful and expensive units in the Epic game system and so the roles your Titans are going to play should be foremost in your mind when you choose your army.

On the whole, your main options are between a balanced force with equal proportions of assault, mid-range and long range troops and vehicles or an army that is biased towards only one or two of these elements in order to achieve a specific game task or tactical approach.

Some players like to choose their Titan Battle Groups before selecting infantry and other weapons, while others approach their army selection the other way round. Your choices will obviously also be determined by the selection of models in your army. Either way you should keep in mind the number of points you want to spend on Titans. If you have decided upon a broad, tactically balanced force, then a Battle Group of Warlord or Reaver Battle Titans is the obvious choice. If you prefer to get in much closer then you should definitely take two or three detachments of Warhound Titans. An Emperor Titan has a huge array of mid and long range weapons and is ideal for supporting a Battle Group of Reaver Titans laden with shorter ranged armaments. The idea is for everything in your force to dovetail together, with your Titans covering any weaknesses of the rest of your force, and your other units making up for any gaps left by your choice of Titan weapons.

IF THE WEAPON FITS...

Considering the awesome arsenal available to Titan Battle Groups, selecting the most appropriate weapon combination is not always easy. Try to keep foremost in your mind just exactly what you want your Titans to do. Are they there to hunt down opposing Titans? or to annihilate enemy infantry and tanks? With the introduction of Battle Groups this choice takes

on a further dimension, as each Titan in the group can be tailored to specific roles which can enhance the others' strengths and cover up their deficiencies. One way of narrowing down your range of choices is to consider that there are really only three basic possibilities for a Titan weapons fit. These are the Heavy Support Titan, Close Support Titan and Assault Titan varieties.

A Heavy Support Titan is mostly armed with long-range weapons, and perhaps some kind of one-shot missile system like a Vortex missile. It will also mount at least one 'Titan-killing' weapon, such as a Warp Missile, Plasma Destructor or Volcano Cannon.



A Close Support Titan is best armed with shorter-ranged weapons, with two to five attack dice and less potent saving throw modifiers such as Laser Blasters, Gatling Blasters, Plasma Blastguns or Turbo-Laser Destructors.

An Assault Titan bears the shortest ranged weapons, such as Vulcan Mega-Bolters, Inferno Guns and Melta-Cannon and as its name suggests is designed for assaulting enemy positions.

A common tactic is for a Battle Group to include a mix of a Heavy Support Titan, a Close support Titan and an Assault Titan. This is a flexible formation which allows the Battle Group to act and react, no matter what the enemy army consists of. However, some Imperial tacticians have found this mix of Titans to be a bit half-hearted and reactionary. The Titans can cope with many things, but performing a decisive action on the battlefield becomes a much harder task.

Consider for example a Battle Group of three Reaver Titans. One of them is armed with mid-range weapons, and the other two have Vulcan Mega-Bolters and Inferno Guns. The commander has chosen this group because he knows he is facing Orks, with their large Mobs of Boyz and squadrons of vehicles. Equipped in this way, the last two Reavers (with an assault mix of weapons) will be able to move forward quickly and eradicate vast swathes of the Ork army, breaking the Clans in perhaps one or two turns. The first Titan can keep position behind them, using its close support weapons to counter any threat posed by Giblet Grindas, Skullhammas, Lungburstas and other heavily armoured Ork tanks. As you can see, the 'even spread' Battle Group would find itself in less of an ideal position to deliver a truly killing blow to the Ork horde.

All Battle Groups should contain at least one weapon which can destroy buildings, such as a Quake Cannon or Multiple Rocket Launcher. This will enable the Battle Group to open up lines of sight to enemy Titans and tanks, and deny cover to the opposing infantry.

Another weapon, worth a mention to Space Marine players is the Quake Cannon which is allowed to target buildings even though it does not fire a barrage. If a building is hit it must make its saving throw, modified by -3, or be destroyed.



THE WEAPONS

Once you've settled on the battlefield role you want for your Titans, you can get down to the nitty-gritty of choosing the actual weapons. Take a look down the Battle Titans weapon summary listed below. Glancing down the profiles you will see the weapons mainly fall into four basic categories:

Heavy Support Weapons: These have one or two attack dice, a long range and a good to-hit roll often combined with a hefty saving throw modifier. This category also includes the one-shot missiles, and the barrage weapons.

Close Support Weapons: These weapons have a 50cm- 75cm range, between three and six attack dice, 4/5+ to hit rolls and saving throw modifiers that don't exceed -2.

Assault weapons: Assault weapons have a high rate of fire, or a template. They have a short range and a low saving throw modifier.

Close Combat weapons: This category is pretty obvious, but just as important. The smaller Titans can make a highly effective Titan hunting party if equipped with Chainfists or Laser Burners and the like. While a Warlord Battle Titan can protect itself from the enemy with a Powerfist or other close combat weapons.

There are some weapons, such as the Plasma Blastgun and Melta-Cannon, which don't easily slip into one of these types, but on the whole you can start to see which weapons go on which sort of Titan.

BATTLE TITAN WEAPONS SUMMARY

Weapon	Range	Attack Dice	To Hit Roll	Target's Sv. Mod	Notes
Barrage Missile Launcher	Unlimited	8 BP's	-	-2	Place D6 extra barrage templates when fired. One shot weapon.
Battle Claw	Close combat weapon. Roll off against opponent - causes maximum damage				
Carapace Landing Pad	Used as platform for Recon Land Speeder				
Carapace Multi-lasers	15cm	2	5+	0	Always shoots in First Fire.
Chain Fist	Close combat weapon. +D6 in close combat, +2 to damage				
Combat Head	Close combat weapon. Adds +3 to Titan's CAF.				
Corvus Assault Pod	Carries 4 Terminator stands. +D6 CAF in attack turn.				
Deathstrike Cannon	200cm	10 BP's	-	-2	Barrage weapon
Fire Control Centre	Adds +1 to all to hit rolls. Has save of 3+				
Gatling Blaster	75cm	4	5+	-1	
Harpoon Missile	Unlimited	-	Auto	-2	Takes over target Titan if save is failed. One shot weapon.
Inferno Gun	Special	Special	4+	0	Uses inferno template.
Laser Blaster	50 cm	6	5+	0	
Laser Burner	Close combat weapon. Hits D6 times.				
Melta-Cannon	25cm	4	3+	-3	
Multiple Rocket Launcher	100cm	8 Barrage points		0	Fires barrage.
Plasma Blastgun	50cm	2	3+	-4	Must recharge after use.
Plasma Cannon	75cm	6	4+	-3	May not fire other weapons.
Plasma Destructor	100cm	4	3+	-6	May not fire other weapons or move next turn.
Power Fist	Close combat weapon. Roll off against opponent - cause maximum damage.				
Power Ram	Close combat weapon. Opponent knocked over if you win by 6+ points.				
Power Saw	Close combat weapon. Adds D6 to close combat score. +2 to damage.				
Quake Cannon	100cm	1	3+	-3	May attack buildings.
Trident	25cm	1	3+	-	May pull bits off target.
Turbo-Laser Destructor	75cm	2	3+	-2	
Volcano Cannon	100cm	1	3+	-4	+3 damage roll against Titans.
Vortex Missile	One shot weapon				
Vulcan Mega-Bolter	25cm	8	4+	0	
Warp Missile	Unlimited	-	Auto/3+	-	To hit Titans/vehicles. Ignores shields. Roll twice on hit location template. One shot weapon.
Weapon Head	25cm	1	5+	-1	
Wrecker	Close combat weapon. Get free strike before combat is resolved				



Reaver Titan Battle Group. Titan 1 carries a Barrage Missile Launcher, a Chainfist and a Vulcan Mega-Bolter. Titan 2 is armed with a Multiple Rocket Launcher and two Turbo-Laser Destructors. Titan 3 is equipped with a Plasma Blastgun, an Inferno Gun and a Vulcan Mega-Bolter.

TITAN KILLING

One other important battlefield role is 'Titan killing'. This is most suited to an individual Titan rather than one within a Battle Group, as its greater flexibility allows it to stalk the battlefield with total freedom. Weapons that are 'Titan killers' are the Volcano cannon, Plasma Destructor and Warp Missile, although a close combat weapon like a Chainfist can be used as well, providing that you can guarantee the Titan will get close enough to use it. The usefulness of Titan killing weapons has greatly increased with the release of Titan legions. Since it is not uncommon to have five or more Titans in the opposing army, any weapon that seriously threatens Titans has a greater part to play.

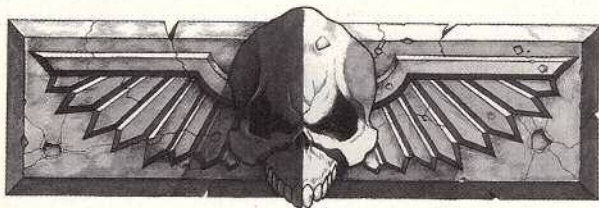

BATTLE GROUP VARIANTS

There are many standard variants of Battle Group armament, and the following examples demonstrate some of the different options open to an Imperial commander. They also give an analysis of the advantages and disadvantages of selecting that particular mix of weapons.

HISTORICAL BATTLE GROUPS

Armageddon campaign

Legio Metalica 'Hades IV' Battle Group

This Warlord Battle Group was deployed in the defence of the Hades Hive during Ghazghkull Thraka's invasion of Armageddon Prime. It consisted of the following three Warlord Titans:

Custodire Pius: armed with Barrage Missile Launcher, Volcano Cannon, Plasma Destructor and Multiple Rocket Launcher.

Custodire Invidia: armed with 2 Multiple Rocket Launchers, Fire Control Centre, Deathstrike Cannon and Quake Cannon.

Custodire Faex: armed with Turbo Laser Destructor, Warp Missile, Plasma Cannon and Gatling Blaster.

The Pius and Invidia are armed with support weapons, enabling them to pound their foes from the greatest possible distance. Since their main objective was to keep the Ork Gargants from piling shots into the structure of the Hades Hive, they were armed to keep the Gargants at arms length. Faex, with its shorter ranged weapons, was prepared to engage the Ork Gargants if any of them managed to survive the long-range wall of death set up by the other two Titans. This weapon format enabled the Battle Group to destroy many Gargants before any serious return fire started, but once several Gargants closed in their superior number of short ranged weapons smashed aside the Battle Group. Note that the Titans of 'Hades IV' were armed with a large number of weapons that can destroy buildings, ensuring that valuable cover was denied to the Orks and the Gargants were forced to advance in the open.

Thermopylae Scouring

Legio Destructor 'Redempta' Battle Group

The weapon fit of this Battle Group added to the worries that the Beasts of Steel were becoming more Orky with every battle, enjoying the prospect of battling close up to the enemy. The mixture of short ranged weapons and high rate of fire allowed the Battle Group to stave off a Chaos attack for thirteen days, allowing reinforcements to arrive and annihilate the Chaos horde.

Death Monger: armed with 2 Vulcan Mega-Bolters, Inferno Gun and Quake Cannon.

Doomlord: armed with 2 inferno Guns and 2 Las Blasters.

Deathfiend: armed with 2 Melta-Cannon, Barrage Missile Launcher and Chainfist.

The entire Battle Group also mounted Carapace Multi-lasers.

FORCES OF THE IMPERIUM



STORMHAMMER SUPER HEAVY TANK COMPANY



IMPERIAL MOLE

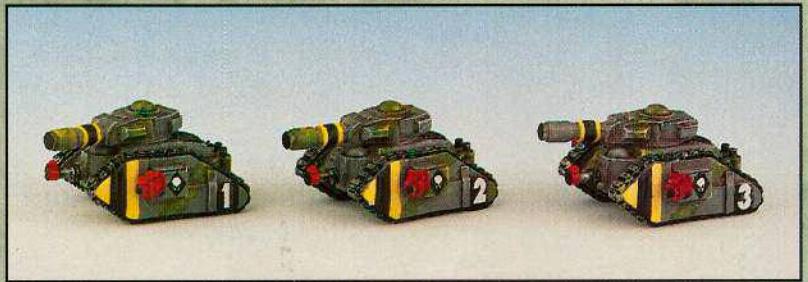

LEMAN RUSS BATTLE TANK SQUADRON

SQUAT FORCES

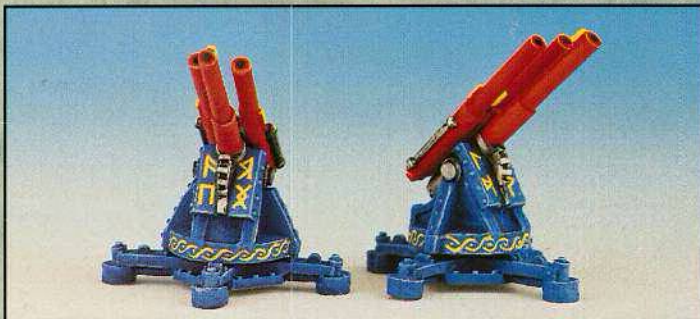

THUNDER-FIRE CANNON BATTERY



LEVIATHAN SUPER HEAVY VEHICLE



STORMHAMMERS LEAD AN ASSAULT AGAINST THE FORCES OF CHAOS

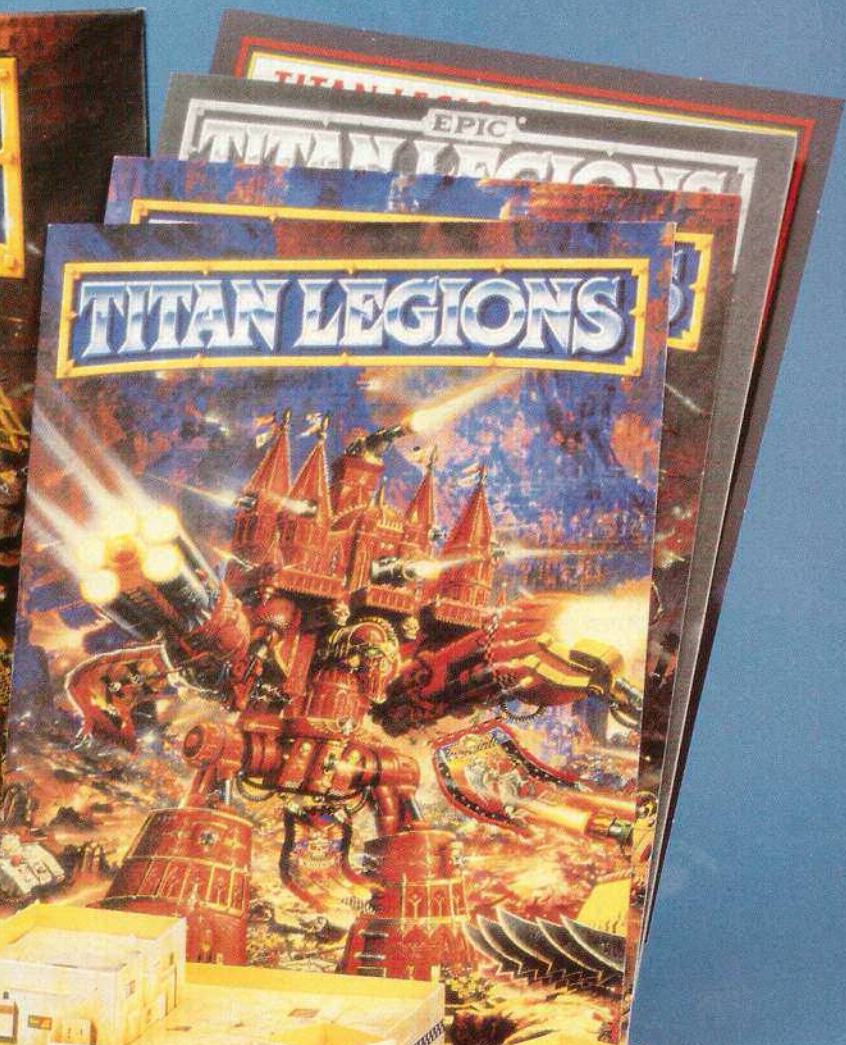
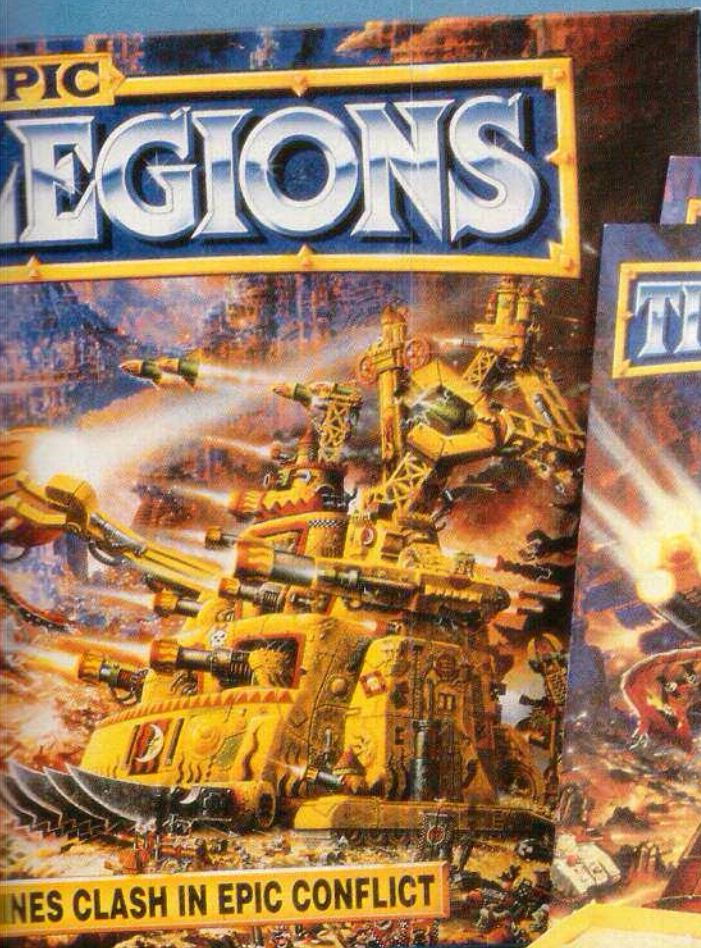

MINIATURES SUPPLIED UNPAINTED. CONTENTS AND COLOURS MAY VARY FROM THOSE SHOWN.



ORKS™



GOFF LUNGBURSTA SQUADRON



DEATHSKULLS BONEBREAKA SQUADRON



EVIL SUNZ SPLEENRIPPA SQUADRON



EVIL SUNZ GOBSMASHA SQUADRON



CHAOS



BRASS SCORPION
DAEMON ENGINE OF KHORNE



MORTARION - DAEMON
PRIMARCH OF THE DEATH GUARDS

The Battle Group commander, Princeps Leonidas, knew that the Chaos army had few long range weapons, and elected to hold a narrow pass where the horde would have to attack in a large mass. Since the bulk of a Chaos army consists of infantry and daemons, the Titans reaped a huge harvest with their weapons, while Deathfiend stalked out of cover to battle the Khorne Lords of Battle and Banelords, destroying them with Melta fire or besting them with its Chainfist. The Barrage Missile Launcher mounted on Deathfiend was used early on to destroy a swathe of troops before they could reach cover. Their Carapace Multi-lasers allowed the Battle Group to change their position, moving out occasionally into the midst of the enemy formations to seek out troops that were hidden amidst the rocks at the entrance to the pass.

Had the enemy laid hold of more weapons such as Cannon of Khorne, or the longer ranged Daemon Engines, the Battle Group may have been in serious trouble. If the Chaos army had been able to attack them at long range, then the Titans would have been forced to move out of the pass, where the enemy's greater numbers would have swamped them.

REAVER BATTLE GROUPS

This Battle Group was fielded by Jervis Johnson in the 'Inferno' battle report published in White Dwarf 179

Clavigera: armed with Chain Fist, Barrage Missile Launcher and Vulcan Mega-Bolter.

Carnivore: armed with Multiple Rocket Launcher and two Turbo-Laser Destructors

Castigator: armed with Turbo-Laser Destructor, Gatling Blaster and Warp Missile.

Jervis knew he was facing Orks and armed his Battle group accordingly. The Battle Group is fairly balanced, although a slight emphasis on shorter ranged weapons was possible since Orks are very much close-range fighters. Clavigera is an assault Titan in the purest sense. The Reaver Titan's Barrage Missile Launcher was fired off early in a battle, softening up the Ork formations before closing in and ripping into the Mobz with the Vulcan Mega-Bolter. The Chainfist is enough to ensure most Gargants would give it a wide berth.

Castigator is armed with a traditional Titan killing payload. The Warp Missile in particular is effective against Gargants, whose masses of power fields are completely negated. Because of their large silhouette, Gargants are easy to hit, even with this inaccurate weapon. Carnivore is a close support Titan, fielding the longer ranged weapons in this category. The Multiple Rocket Launcher is useful against the massed hordes of an Ork army, gouging great chunks out of their formations before they can get within range.

Jarix V Campaign

Legio Manus Flameaus 'Indomitus' Battle Group

This Battle Group led the attack against an Eldar force which had taken up a strongly defensive position. Needing to flush out the swift moving Eldar Skimmers, they mounted weapons with a moderate range and maximum rate of fire.

Indomitus Prime: armed with 2 Gatling Blasters and a Barrage Missile.

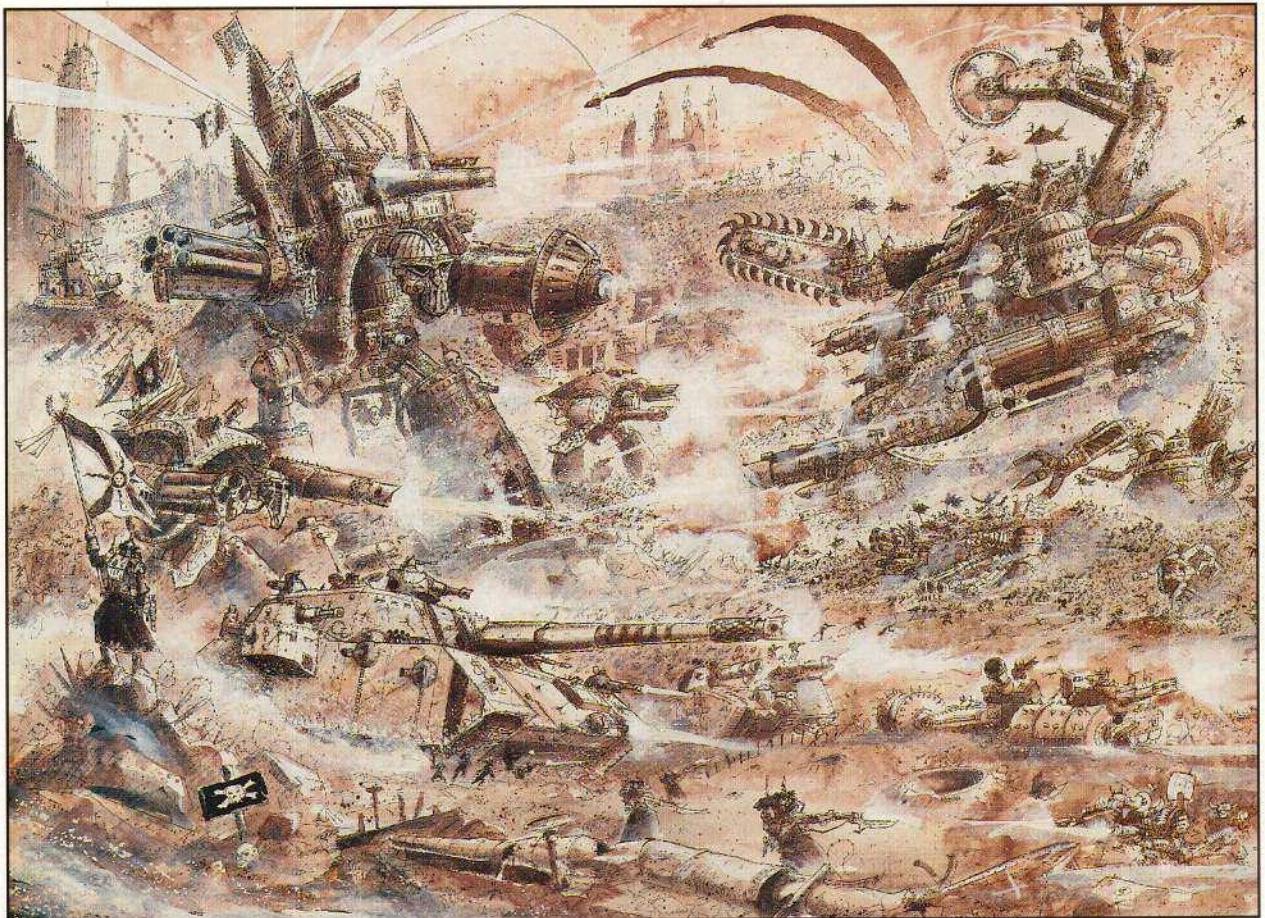

Indomitus Fautor: armed with 2 Laser Blasters and Vortex Missile.

Indomitus Ambitus: armed with a Multiple Rocket Launcher, Turbo-Laser Destructor and Gatling Blaster.

Armed with this array of weaponry the Battle Group fired off its Vortex and Barrage missiles as soon as they could, damaging the Holo-field Wings on some of the Phantom Titans. The Vortex field forced many of the Eldar skimmers to leave the safety of the ruins or be destroyed, denying them the cover they needed to make pop-up attacks. Once the Eldar were exposed, the Titans unleashed volleys from their other weapons. Indomitus Ambitus was equipped to attack the Eldar Phantom Titans. The barrages from its Multiple Rocket Launcher were able to destroy their Holo-field generators before it dealt killing blows with its Turbo-Laser Destructor and Gatling Blaster.

WARHOUND DETACHMENTS

The power and size limitations of a Warhound Titan greatly reduces the number of possible weapon variations. Warhounds are typically used in two roles when not acting as scouts or outriders. Their speed allows them to hit deep into enemy territory to capture Objectives and push back opposing infantry and light vehicles. Alternatively, their greater manoeuvrability allows them to make excellent Titan hunters, stalking the larger and more unwieldy Titans of an enemy force. This allows the Warhounds to fire upon the thinner armour of a Titan's sides and rear, attacking from an unexpected quarter and spreading fear and confusion.

WARHOUND 'HUNTER' DETACHMENT.

This detachment is fairly widespread throughout the Titan Legions. The Hunter detachment is outfitted for Titan hunting, allowing the Warhounds to stalk and destroy opponents many times their size and bearing up to twice their combined firepower.

Warhound Alpha: armed with 2 Turbo-Laser Destructors.

Warhound Beta: armed with Plasma Blastgun and Vulcan Mega-Bolter.

The Plasma Blast Gun and Turbo-Laser Destructors of the detachment are powerful enough to damage any Gargant or Battle Titan, especially if firing upon the side or rear armour of the target. The Vulcan Mega-Bolter of Warhound Beta is ideal for cutting into enemy troops, either as protection against a mass infantry assault or after the detachment's primary

mission is achieved. The Warhounds do not rely on their armour and void shields to protect them, instead they try to keep in cover and stay out of their target's weapon arcs.

INDIVIDUAL TITANS

Although the Battle Group is central to Imperial Tactics, individual Warlord and Reaver Titans can be assigned to a force to perform a specific mission or role. The most common occasion of this type is when a heavy support Warlord Titan accompanies a Battle Group of Reavers or two detachments of Warhounds. The Warlord can stay on first fire orders throughout the battle, while the other Titans move forward supported by the vehicles and infantry.

If one Titan of a Battle Group were to be designated in this heavy support role, the Battle Group formation rules would force it to either hold back the other two Titans, or move forward itself and thus lose its First Fire advantage.

As mentioned earlier, an individual Titan can also be used as a Titan hunter-killer in a similar way to Warhound detachments. Warlord Battle Titans are on the whole too slow for this task, but against Ork Gargants, which are even slower than Warlords, they can be quite effective. A Warlord mounting a Warp missile, Volcano Cannon, Gatling Blaster and a close combat weapon can deal out quite a lot of punishment.

Against Eldar and Traitor Titans, which are faster, and in the case of the Eldar highly manoeuvrable, a Reaver Titan is probably more suitable. If you are fighting against the Eldar, a Multiple Rocket launcher or Barrage Missile is essential, as these weapons can be used to destroy a Phantom or Warlock Titan's Holo field wings, leaving it very vulnerable to attacks from other weapons. These should typically be a Turbo-Laser Destructor and a Volcano Cannon or a Quake Cannon.

The Quake Cannon is also a very useful Titan hunting weapon. Its power to destroy buildings, denies the target the option of getting under cover, while its saving throw modifier of -3 will almost always penetrate the armour of a Titan.

EQUIPPING YOUR MODELS

Since a Titan's armaments must be represented on the model, it is sometimes difficult to achieve your ideal weapons fit. For example, the selection of weapons that come with the Reaver Titan may not be suitable for your intended role. This difficulty can be overcome in two ways. By far the easiest and most satisfactory method is to use the Games Workshop Mail

Order so that you order the exact weapon combination you require. Alternatively, each Titan boxed set contains more weapons than there are weapon mounts and so you should be able to swap between models or even with other members of your gaming group.

I hope that this article has inspired you to look again at how you equip your Titans and encourage you to maybe try out some new tactics. One thing to remember...although weapons alone won't win the day, a good gun always helps!



The Warhound on the left is armed with an Inferno Gun and a Turbo-Laser destructor. Its companion carries a Vulcan Mega-Bolter and a Plasma Blastgun.

WARHAMMER

40,000

ORK™ STORMBOYZ



Miniatures supplied unpainted.

Miniatures designed by Alan Perry.



THE ORK STORMBOYZ BOXED SET CONTAINS:

- 5 Stormboyz
- 5 Jump Packs
- 1 Plastic Ork weapons sprue
- 1 Plastic Ork Arms sprue
- 1 Stormboyz transfer sheet

Ork Mekaniaks invent all manner of strange and lethal wargear, including the highly dangerous and unpredictable Stormboy jump packs. Only Ork Stormboyz are brave or insane enough to use such devices. Normally, flying in any

form is shunned by the Orks, but Stormboyz think that disciplined 'soldiers' should be prepared to use any effective weapon, especially if it is noisy!

WARNING! This product contains lead and may be harmful if chewed or swallowed.

Citadel Miniatures are not recommended for children under 14 years of age.

These models require assembly. We recommend that the parts are cleaned and trimmed with a modelling knife before being painted with Citadel paints.

Citadel, the Citadel castle, Games Workshop and Warhammer are registered trademarks of Games Workshop Ltd. Ork is a trademark of Games Workshop Ltd. © Games Workshop Ltd, 1994. All rights reserved.



CITADEL
MINIATURES

GAMES
WORKSHOP



**THIS BOXED SET
CONTAINS AN
ORK™ STORMBOYZ
TRANSFER SHEET**

GAMES DAY '94

Games Day '94 was the biggest ever Games Workshop hobby convention, with over 8,000 gamers packing the National Indoor Arena for a day of games, fun, competitions and prizes. If you missed it, the following pages give you a taste of what it was like. If you were there, then you already know!



Top to bottom:

- Crowds pack the National Indoor Arena for Games Day '94
- An exciting game of Warhammer.

- Jervis Johnson.
- The crowds outside the Arena.
- Rick Priestley signs autographs and chats to a group of gamers.



Top to bottom:

- A group of young gamers enjoying a Warhammer 40,000 battle.
- Expert advice on the best way to assemble plastic kits.
- Tabletop action from the Games Day National Blood Bowl finals.
- Games Workshop Artist John Blanche chats about his paintings.
- Some gamers get to try out the new Warhammer Quest adventure game.
- A lucky winner makes off with a pile of prize games.





Above and right:

- Vast war machines battle for supremacy in Epic Titan Legions, while Simon Tift gives the lowdown on how the Epic game system works.

Right:

- Simon Smith chats about the new Talisman game.

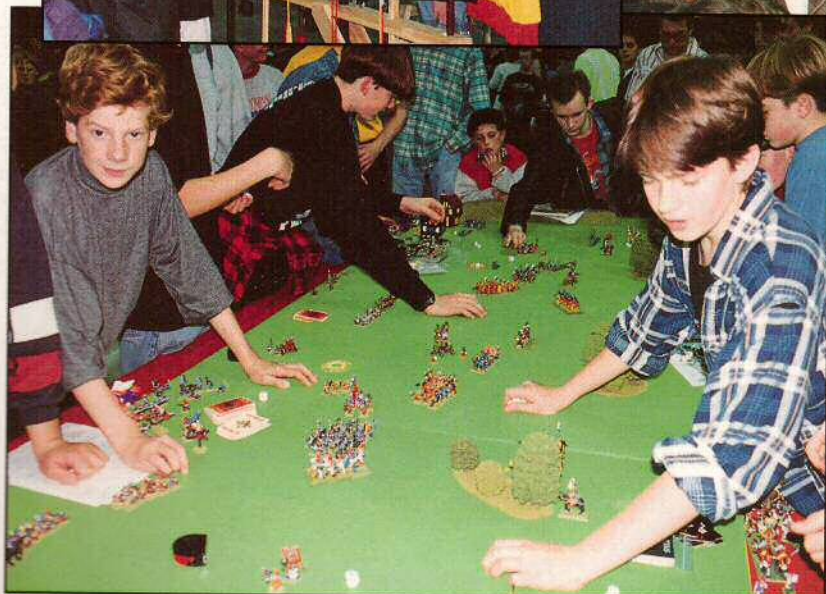

Above and left:

- Andy Jones answers questions about the new Warhammer Quest game.
- A few of the dozens of banners on display.

Left:

- A massive game of Warhammer.



Above and left:

- Artist Dave Gallagher.
- Waaagh! Warhammer!

Left:

- Jake and Adrian from the White Dwarf team, re-fight the "Witch Hunt".

Below:

- A group of gamers proudly display their store banner before the start of the parade.



Above top: • Jes Goodwin signs a few autographs.

Above: • Even before the doors had opened, the stunning Epic battle board attracted a lot of attention from the GW staff.

BLOOD BOWL® HALFLINGS



BLOOD BOWL® SKAVEN MUTANTS



VERY LONG LEGS



EXTRA ARMS



BIG HAND



CLAW



THE MOOT MIGHTIES' LINE IS BROKEN BY MUTATED MEMBERS OF THE SKAVENBLIGHT SCRAMBLERS

BLOOD BOWL®

THE SMALL AND SHORT OF IT!

By Jeremy Vetock

At first glance, Halfling Blood Bowl teams seem like a bad joke, but opponents who think that way are shortsighted. A skilled Halfling player can win against anybody, at least that's what Coach Vetock says. We needed more proof . . .

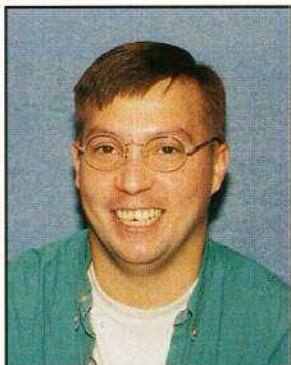

MEASURING UP

Since the new version of Blood Bowl was released, the staff at the American Games Workshop office in Baltimore have been running a very intense Blood Bowl League. In a frenzy of high-voltage gaming we have already completed two exciting Tournament Cups and are about to start on our third.

Although I had already been very successful with my overly pugnacious Orc team, even pulling off a miraculous win in the Spike Magazine Trophy final, for our next "Cup" season I decided to retire my Orcs for a while and see what it would be like to coach a team from one of the other Blood Bowl races.

A quick scan of our leader board (an ingenious poster with all the teams listed alongside their win-loss records) showed me which teams had already been entered. There was a plethora of Orc and Human teams and strong representation from many of the other races, but nobody was fielding a Halfling team. Since I wanted something different, I thought to give them a try and so I ran to check out their rules in Death Zone!

SHORTCOMINGS

It is true that Halflings run at half-pace compared to most other teams and it is also a fact that the better portion of a Halfling team can gang up to block an Ogre with little chance of success. Yes, I know Halflings are too small to properly throw the ball and therefore suffer range penalties and I have learned (through bitter experience) that any Halfling knocked over is likely to wind up in the Injury boxes or worse. Given these tremendous handicaps many people wonder why Halflings even bother playing Blood Bowl in the first place!



THE STUNTY AND DODGE SKILLS

I have to admit, that after looking at their stats I had some serious doubts about winning with Halflings, but there were a number of good points to them as well. The most important of these is that all Halflings come endowed with the twin skills of *Stunty* and *Dodge* – a wickedly effective combination.

In Blood Bowl, each player exerts a tackle zone on all of the squares adjacent to the model. As a result, whenever you attempt to move through an opposing player's tackle zone, you have to make a dodge roll. All Blood Bowl players may attempt to dodge, but some races, like Elves, are more graceful and adept at dodging than others. To counter a particularly agile player from sneaking through his lines, a cunning opponent will stack up his players in order to create multiple tackle zones. With more tackle zones come cumulative dodge penalties, but this is where Halflings excel!



The *Stunty* skill represents the fact that Halflings are too small to be easily grabbed – they just duck under arms and run between legs. In game terms this means that Halflings can ignore the multiple effects of tackle zones, and they always dodge at their basic roll of a 3+. To make things even better for the little guys, they also come with the *Dodge* skill which allows them to re-roll a failed dodge attempt once per move.

By making use of *Dodge* and *Stunty*, you can easily slip your ball-carrier or a receiver straight through your foe's best defence in an extremely effective, but nerve-wrackingly suspenseful play! In several of my games, the outcome has hinged on one of my Halflings making a last-ditch effort to score by dodging through a literal maze of opposing players, where each die roll could have meant certain doom...! Of course, when you do pull it off you also have every right to jump up and down, yell a lot, and mock the puny efforts of the opposing team.

PICKING YOUR TEAM

Every Blood Bowl coach starts off with 1,000,000 gold pieces with which to select their players, buy team re-rolls, purchase a fan factor, and add extra coaching staff, cheerleaders and a whole lot more. This is a critical stage for all teams, but especially so for Halflings.

First off, Halflings have never developed any but the most basic Blood Bowl skills. As a result you don't have to bother with Throwers, Catchers, or any of the specialty players that other teams may choose. Halflings are always Linemen. On the bright side, the low points cost (a mere 30,000) for a Halfling means that you can easily start off with a roster full of players. Given their fragile nature, I heartily recommend buying as many as possible. The following list shows how I started off my Halfling team – the Southshire Stoutboys:

13 Halfling Linemen	390,000
Treeman Star Player	180,000
3 Re-rolls	180,000
Fan Factor 5	50,000
Halfling Master Chef	150,000
Apothecary	50,000

TOTAL 1,000,000

A RECIPE FOR SUCCESS

Despite their obvious weaknesses, the fact that Halfling teams are allowed to recruit Treeman Star Players goes a long way towards rectifying the balance of power! These towering arboreal monsters can pile-drive opponents straight into the pitch with their *Mighty Blow* skill, and there is a fair chance that anyone a



Treeman can get close enough to block, will be carried off on a stretcher. I certainly jumped at the chance to recruit Star Player – Deeproot Strongbranch onto my team and I know of another Halfling team that managed to start league play with two of these awesome creatures.

The Master Chef is another nasty trick up the short sleeves of Halfling teams. Unable to purchase a wizard like most other races, the more culinary-minded Halflings may instead hire a Master Chef for their team. The fantastic food will inspire your team to the tune of one to three extra Re-roll counters per half. Even more diabolical, the delicious smells emanating from the Halfling dugout are so distracting, that other teams must reduce their team re-rolls in direct proportion to your bonus. By not allowing your opponents to re-roll any of their misfortunes you can often force them into crucial turn-ending mistakes. For an authentic looking Master Chef model I found the cleaver-bearing cook from the Halfling Hot-Pot crew to work especially well. The poised-to-fire Stewpot, crewed menacingly by my two assistant coaches, is equally brilliant.

In my practice games I quickly learned that a Halfling's armour value of six makes them very fragile. During the course of a normal game the Knocked Out and Injury Boxes saw a constant rotation of bruised and battered players. To counter this I started our League with the healing services of an Apothecary. You might want to take a risk and start without a healer, but I find confidence in knowing I can save my favourite players or (Sigmar save me!) the too-expensive-to replace Treeman, should they be seriously injured or killed!

Finally, in my experience, many Blood Bowl players ignore the importance of Fan Factor when starting up their team. After each game, depending on whether you won or lost (and influenced by subtle things like how many touchdowns you scored and the number of casualties inflicted!) your Fan Factor will rise or fall.

The importance of your Fan Factor is that it ultimately determines how much profit you receive from each game. High profits allow you to purchase new players, extra re-rolls, and more. Since you are bound to lose some of your Halflings to injury or (ulp!) even death, you will certainly want to make as much money as possible. The Southshire Stoutboys started out with a Fan Factor of 5 and I would've increased it even further. However, I also wanted to begin League play with as many re-rolls as possible and so I had to make a compromise. Halflings often need a second chance to pull off a block or thrown pass and so in addition to the Halfling Master Chef's constant supply, I purchased an additional three re-rolls because they are often simply too expensive to buy during the course of a season.

HALFLING STAR PLAYERS

In Blood Bowl, as your team advances, completes miraculous passes, and scores daring touchdowns, your players gain Star Player points. Once you have amassed enough points your player will enter into the lofty heights of exalted Star Player status. Star Players may then choose skills from the category appropriate to their position, which unfortunately leaves Halflings only selecting from the Agility Skills.

During my first few Halfling games I noticed that my players accumulated Star Player Points rapidly, but also that my players did not last too long afterwards! I was quick to learn that skills which work quite effectively with other teams were not as useful for Halflings. *Jump Up*, for example, is an excellent skill which allows you to stand up without paying the normal three movement points to do so. When this skill works for Halflings it often leads to spectacular results, but more often than not, a knocked over Halfling has no chance to *Jump Up* as he has already been carried to the injury boxes!

The skills I have found more reliable for my players are *Sprint* and *Sure Feet*. Halflings are not fast, so I find myself using the sometimes fatal "Going for it" rules to move extra squares. The *Sprint* skill will allow you to go for yet one more square and *Sure Feet* will let you re-roll any failed attempts. This combination can definitely get your furry feet moving out of even the most desperate of situations. Given the Halfling

tendency to make errant passes, the *Diving Catch* skill is extremely useful in making up for the fact that the ball often doesn't land where it is supposed to.

Anytime you roll doubles when selecting your Star Player Skills you may choose a skill outside that players normal repertoire. I haven't been lucky enough to do this yet, but I have my eyes on *Nerves of Steel*, *Sure Hands*, and any of the passing Skills. A warning though, Halflings can't rely too heavily on Star Players! With an armour value of a mere six, the harsh Blood Bowl environment often means that their playing days are often numbered.

TEAM TACTICS

The first thing to get into your head as a Halfling coach is that you don't necessarily have to block someone to score. A Halfling team is simply too fragile to absorb damage the way a Dwarf or Orc team can. A conservative running game formed up behind a closed formation just won't work for Halflings. In order to score or take a shot at blocking an opponent's ball-carrier, you will often find that you need your Halfling to dodge three times through heavy traffic and go for an extra square or two. Take the risk! It takes quite a bit of guts to run your Halfling ball-carrier straight into the teeth of an inspired defence, but as often as not, I've found that the Halfling will emerge safely on the opposite side! Not every outlandish play will work for you, and occasionally even a "sure-thing" will fail due to disastrous dice rolling, but the important lesson to learn with a Halfling team is to take the chance. You should be well-equipped with re-rolls and besides, if you stand still you'll find your team pulped to jelly. While no tactic will guarantee success, here are a few potential game-winners to get you started!

GOING BALLISTIC!

Treemen have the *Throw Team-mate* skill which allows them to pick up and hurl their fellow players. All Halflings have the *Right Stuff*, a skill which allows them to be picked up and flung. As you can see from the diagrams, the object of the play is to toss the Halfling with the ball over the heads of the defenders. Assuming you make the agility roll to for your player to land on his feet,

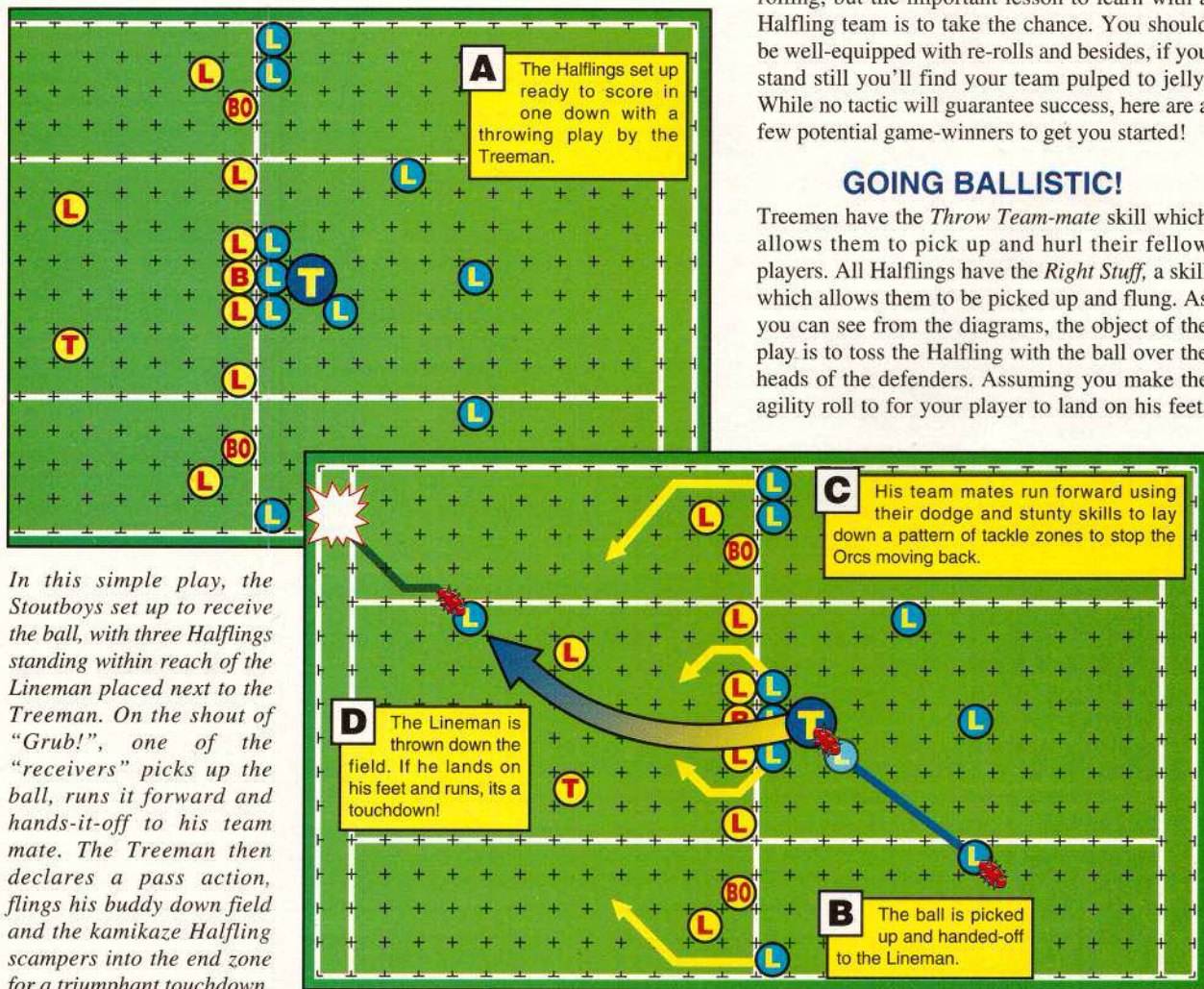

In this simple play, the Stoutboys set up to receive the ball, with three Halflings standing within reach of the Lineman placed next to the Treeman. On the shout of "Grub!", one of the "receivers" picks up the ball, runs it forward and hands-it-off to his team mate. The Treeman then declares a pass action, flings his buddy down field and the kamikaze Halfling scampers into the end zone for a triumphant touchdown.

he can then use his entire movement allowance to scamper into the end zone. I find throwing a player who's *not* holding the ball to be very effective on defence as well as offense. Not only can this play set up an open receiver deep in enemy territory, but it can also allow you to put pressure on your opponent's ball-carrier despite elaborate defensive formations. Note that your turn will NOT end if you fail to land feet first (so long as you weren't carrying the ball, that is). Even if you attempt this play and it fails it will alarm your opponent and help to accomplish the second part of my cunning plan.

SPREAD THE DEFENCE

Once your opponent realises that you are maniacal enough to fling your own team-mates into the heavens, then he will often spread his players across the field. By this time he will have noticed that the multiple tackle zones so effective against other teams are relatively ineffective against Halflings anyway. Halflings don't move very quickly and against a deep formation you will find it very hard to break out into open territory. This can still work to your advantage! With the opposition spread out deep downfield to prevent a projectile Halfling from sailing overhead, you can simply gang up on his players close at hand. Three-to-one odds for the Halflings will more often than not give you two blocking dice and a better than average shot at knocking down his players. Save Black Orcs, Chaos Warriors, and Star Players for the Treeman! Remember, a Halfling may have a lower strength than most players, but when it comes to assisting a block or fouling, a Halfling is every bit as effective as a Black Orc or an Ogre!

The majority of coaches I have played against panic at the sight of Halflings knocking over their players. To avoid this shame most coaches will collapse their reserves and charge, opening up a perfect slot to toss a Halfling. If the opposition is cautious and maintains his spread formation, advance down field with your three-to-one odds. When you get close enough to attempt it, send in the daring Halfling ball-carrier and hope *Dodge* and *Stunty* don't let you down.



SPECIAL PLAY CARDS

This is the perfect time to mention the Special Play cards from **Death Zone**. Divided into three decks, Magic Items, Random Events, and Dirty Tricks, the Special Play cards bring a fantastic range of variables into the game. Each coach starts the game with between one and three cards, randomly determined by a dice roll. The only exception is when one team greatly out-experiences the other. In this case, the handicap system should provide the underdog with enough extra cards to stand toe-to-toe with the toughest veterans. I've found this card system loads of fun and it can definitely save your hide when playing a game against a stronger team!

When it comes to picking Special Play cards for my Halflings, I always opt for a Magic Item card first. You are allowed to choose any combination of Magic Items, Random Events or Dirty Tricks, but due to the rarity of Magic Items, you may never select more than one. These potent relics can often be used to heal or resurrect dead and injured players (the *Healing Scroll* and *Magic Sponge* cards), and you'll have many of those! There are also plenty of excellent Magic Items that can put an absolute halt on your opponent's drive, such as the *Magic Hand of Jack Longarm* card which, to the dismay of your opponent, lets you automatically intercept a pass. If you only get to choose one card, make it a Magic Item.

When selecting additional cards, I switch between Random Events and the Dirty Tricks pile. All Blood Bowl coaches develop their own personal preference and every player has a favourite card that they hope for. Despite the fact that the Special Card drawing is random, I'm always hoping for either the Random Event card *Special Offer* (which would allow me to purchase a Star Player for half price – bringing the second Treeman into an affordable range!) or the risky, but effective Dirty Trick *Razzle Dazzle* (a stunning play which allows your team to go two uninterrupted turns in a row!).

Used in the right place at the right time, any of the Special Play cards can give your team that extra boost to stop a drive or score a much needed touchdown. If you get several cards don't worry too much about saving them for the perfect time. If I can pile all my cards into just one touchdown I'm always happy to do so. Remember though, that your opponent is sure to have a few tricks of his own and several cards are perfect for taking out the mainstay of your line, your Treeman!

SHORT BUT SWEET

At the start of our League there was a constant line of challengers, anxious to pulp my team before they were forced into early retirement. Now I have a constant line of challengers, eager to prove that my Halfling victories have all been a fluke. Winning with a Halfling team is never easy, but it can be done. Halfway through our current tournament the Southshire Stoutboys have won more than they've lost, and even the defeats have been by narrow margins. I have had both my share of good luck (my Halfling Bing O'Groten leads the League in scoring) and bad (in a single half against a Dark Elf team three of my Halflings were slain). Over the course of the season I have discovered a lot about playing Halfling teams and I'm still learning. Currently I'm trying to save money to purchase a second Treeman and I've even been working on a running play where the Treeman carries the ball! Although it is early in the season, I find myself thinking of the playoffs and the glory (and uneasy angst) I will gain for winning the tournament with a Halfling team!

Good luck and may your stew stay hot!

BLOOD BOWL



Models supplied unpainted.

Miniatures designed by Gary Morley

★ CHAOS ALL-STARS ★

Chaos teams are not noted for the subtlety of their game play. A simple drive up the centre of the field, maiming and injuring as many opposing players as possible, is about the limit of their game plan.

They rarely, if ever, worry about minor considerations such as picking up the ball and scoring touchdowns – not while there are any players left alive in the opposing team, anyway!

The Chaos All-Stars boxed set contains a complete Chaos Blood Bowl team consisting of 3 Chaos Warriors and 8 Beastmen together with a Chaos All-Stars transfer sheet to allow you to add numbers and symbols to your team.



CHAOS WARRIOR



CITADEL
MINIATURES

WARNING! This product contains lead and may be harmful if chewed or swallowed.
Citadel Miniatures are not recommended for children under 14 years of age.

Games Workshop, the Games Workshop logo, Blood Bowl, Citadel and the Citadel castle are registered trademarks of Games Workshop Ltd.

Chaos All-Stars is a trademark of Games Workshop Ltd.
© Copyright Games Workshop Ltd, 1994. All rights reserved.

GAMES
WORKSHOP

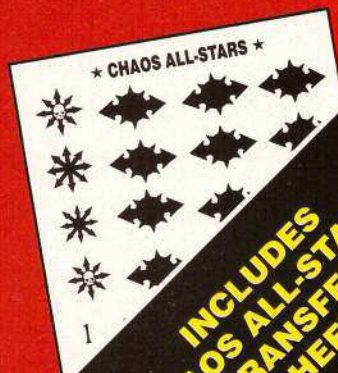

INCLUDES
CHAOS ALL-STARS
TRANSFER
SHEET



A BITTER HARVEST

By Fred Reed and Adrian Wood

For this exciting battle report Fred Reed, winner of the Golden Demon Space Marine Trophy, commanded his Howling Griffons Space Marines against the unstoppable horde of the Waaagh! Ork lead by Warboss Adrian Wood.

Procon Secundus had been a quiet place, simple colonists digging a bare living out of the unforgiving rock. Nothing ever happened there. Then the Orks came.

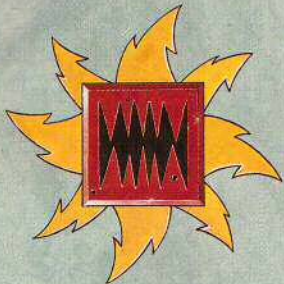

Without warning, the sledgehammer assault of the Waaagh! Ork descended on the colony, and before the Imperial forces could act most of their troops had been cut off and destroyed. As the capital fell and the Ork tanks rolled through the shattered streets, rumbling over the broken bodies of the defenders, a single Imperial Astropath managed a brief signal for help. A lone voice calling for the Emperor's mercy from across the depths of the warp.

Even as he did so, he was cut down by the raking bolterfire of the Orks who smashed into the inner chambers of his tower. The loyal guardians of the Imperium – the Adeptus Arbites, had sold their lives dearly protecting their one chance for aid but it had not been enough. There were too many Orks, and though a hundred fell for every man the Arbites lost they still came on. The aid would come but it would be too late for the brave Arbites.

To this embattled hellhole the Space Marines came. The Emperor's finest warriors, Space Marines of the Howling Griffons Chapter. But as they readied themselves for battle aboard their giant spacecraft, things were not all well.

Violent warpstorms delayed them at every turn as if the dark forces of Chaos had joined with the Orks to frustrate the Imperial reinforcements. Weeks passed and the Space Marine Commanders grew concerned at the lack of reports from Procon Secundus and could only assume the worst.

Back on the colony, the main Ork army had split into dozens of roving battlegroups, hunting down the scattered remnants of the Imperial Guard. Dozens of small, bitterly fought firefights raged across the entire continent. Battles for strategic outposts, important supplies or simply for survival. No quarter was asked and none expected from the rampaging hordes of Orks, but no matter how many were killed they still came on. Slowly, but surely, the final glimmers of resistance were being stamped out.

Just as everything looked hopeless, just as the Imperial defenders began to doubt their faith, the Space Marines landed. Cutting through the unprepared Orks they crushed each group as they found them. Orbital auguries pinpointed the concentrations of Ork forces and each was sought out and destroyed in turn as the cleansing of the colony began.



Typical of these small but brutal firefights was the battle fought through the smouldering ruins of the western suburbs of the capital. Detachments of Howling Griffons Space Marines were sent to intercept and destroy a powerful Ork psyker...



INTRODUCTION

On the back cover of last month's issue of White Dwarf, you might have seen the huge Howling Griffon army painted by Fred Reed from our Bristol store. Fred won the coveted Space Marine Trophy at this year's Golden Demon and we are sure to be seeing more of his excellent work in the future.

With well over six thousand points of models to choose from Fred had a bit of difficulty in deciding what to take to fight against Adrian's Orks. After much deliberation he settled on the army you see in the following pages.

If you want to see this impressive army for yourself then just pop down to the Bristol store and take a look! Fred will be more than happy to talk to you about painting Space Marines or any Citadel Miniatures, or about the different army tactics in Warhammer 40,000.

As usual with the games that we fight out at the Studio, Fred and Adrian played on an eight by four foot table with the scenery you see in the photographs. Adrian used the Studio's Ork army which isn't big enough to allow Fred to take his entire battle company and so the game was played with forces of 2000 points a side.

In Adrian's own army he uses a lot of bikes as he explained last month in his article on Speed Freaks. However, we decided to make the battle more of a challenge by only allowing him what we had in the miniatures cabinets at the Studio, forcing him to adapt to the equipment he had at hand in the way that a real commander would. Both armies were

chosen before they picked Mission cards so that they would have to consider all of the possible objectives they may be set. This meant that the armies had to be good at everything and not just a specialised force that could only do one thing.



The battle took place amongst the shattered ruins of the ravaged Imperial colony of Procon Secundus. Space Marines of the Howling Griffons Chapter had been alerted to a massive Ork assault but had been delayed by violent warp storms and by the time they arrived the planetary defences had been overrun. But even now small pockets of resistance fought bravely on and it was to one of these that the Howling Griffons had come. The beleaguered defenders had greeted the Space Marines with unsuppressed joy and had redoubled their efforts against the Ork invaders.

In this game we decided that a force of Howling Griffons had been dispatched from one of the surviving enclaves to remove the most powerful Warhead in the service of the Ork Warboss. The Orks, for their part, were simply intent on killing anything that moved...

WAAAGH THE ORKS!

By Adrian Wood



The last time I fought against Space Marines with the hordes of Ghazghkull Thraka was in White Dwarf 167. That particular conflict was a very small engagement which ended as a draw, and I was determined that this time would be different. My adversary for this battle was Golden Daemon winner Fred Reed from our Bristol store, commanding his superbly painted Howling Griffons army.

The first choice for my army was the Warboss – the infamous Ghazghkull Thraka himself with his sidekick and Battle Standard Bearer, Makari. Once I had taken his compulsory Wargear cards, the *Kustom Blasta* and *Adamantium Skull*, I added a *Sniffer Squig* to complete his equipment.

My next choice was a Painboy, equipped with the *Vaxxine Squig* to avoid the deadly effects of a *Virus Outbreak* or virus grenades. My Mekaniak had built a Shokk Attack Gun and a *Scanner*. I love Shokk Attack teams and took as many Snottlings as we had painted as ammunition! I also chose a Weirdboy Warhead together with a regular Weirdboy in order to increase the number of Ork psychic powers I would have. The Weirdboy also took a *Weirdboy Staff* to protect him from the unpleasant effects of the 'Edbangerz Table and stop his head exploding! These wargear cards are essential purchases as far as I am concerned and I seldom if ever go to battle without them.



As far as the mobs are concerned, my favourite Boyz are the Blood Axe Kommandos. When they are fully tooled up with power axes they are expensive at twenty points each, but they are well worth it. With their ability to infiltrate the battlefield they really tie up the enemy and can also slice up vehicles with their Power Axes. Stormboyz are endless fun and can really take the battle to the enemy with their jump packs. Also at twenty points the Stormboyz' Drillboss has a Leadership of nine, just like a normal Warboss. This gives Stormboyz real staying power, particularly as they often operate away from the Warboss and Battle Standard.

The third mob I took were the Deathskulls – heavy weapon specialists armed with a wide variety of lethal wargear. Last, but by no means least, came the Goffs. These fearsome Orks are renowned for their love of close combat and their single-minded strategy – charge!

With all the Orks ready for battle, the Gretchin refused to be left out of the fight so I took two mobs of ten models. Although

not individually as dangerous as the Orks, Gretchin can be battle winners, absorbing enemy fire meant for their Ork masters. If I advanced behind a screen of Gretchin this would enable my main force to reach the Space Marines' lines without taking too many casualties. Once in contact, the brutal tactics of the Goffs would carry them through.

To my mind, no Ork Army is complete without a Dreadnought. The Painboy and Mekaniak who had constructed mine had equipped it with both a lascannon to destroy enemy vehicles and heavy bolter to mow down the Space Marines themselves. With this deadly combination, my Dreadnought could stride across the battlefield laying waste to anything that stood in its way.

Before the battle began, I had been able to take a look at Fred's army so I had been able to marvel at the assembled might of an entire Space Marine Company! As we had set the size of the armies at 2000 points Fred wouldn't be able to take anything like an entire company, so although I would have to face lots of Space Marines I wouldn't have to fight against the wide variety of vehicles I knew he had painted up. I had to think of a way to counter this and my immediate thought was to take as many of Da Big Gunz as I could.

My first selection was a Smasha Gun to attack the Howling Griffons' Dreadnoughts and vehicles. The Traktor Kannon is great because you don't have to roll to hit! My last choice was the Splatta Gun which I decided to take for its unpredictability. You can never tell how far the shell will bounce as it careers madly about the battlefield, but I was sure that it would be fun to use and add some extra excitement to the Ork shooting!

Another essential purchase for my army was buggies and bikes and so I took everything I could get my hands on. As I explained in my article called **Speed Freaks** last month, my own Ork army has lots of vehicles. Unfortunately the Studio army is less well supplied with Wartraks and Warbikes but you can't always have what you want in a battle!

With my army chosen, I drew two Strategy cards – *Craven Cowardice* which would be of little use against the Space Marines, and the excellent *Crack Shot*.

DA PLAN

Engage and Destroy is one of my favourite missions but *Witch Hunt* is the one I dread facing the most. I nearly always have problems with it, as was shown in the battle report of the same name in White Dwarf 171. In order to protect my Warhead I decided to set up with a defensive wall of heavy weapons across the centre of the battlefield. This would dissuade the Space Marines from charging straight forwards and would hopefully form a curtain of fire behind which the Warhead could sit for the duration.

The rest of the army would split up to attack in a pincer movement along both flanks. This is a favourite tactic of mine, out-flanking the enemy and crushing them in a vice-like grip of Ork ferocity. This would prove a little harder as I had fewer Warbikes than I am used to but I could see how it could still work, even if the slower moving side only acted as a decoy.

All I had to do now was see how Fred would place his troops. It is possible for a good set-up to be wrecked by the enemy's careful deployment and as the Orks nearly always set up first you have to get used to altering your plans!

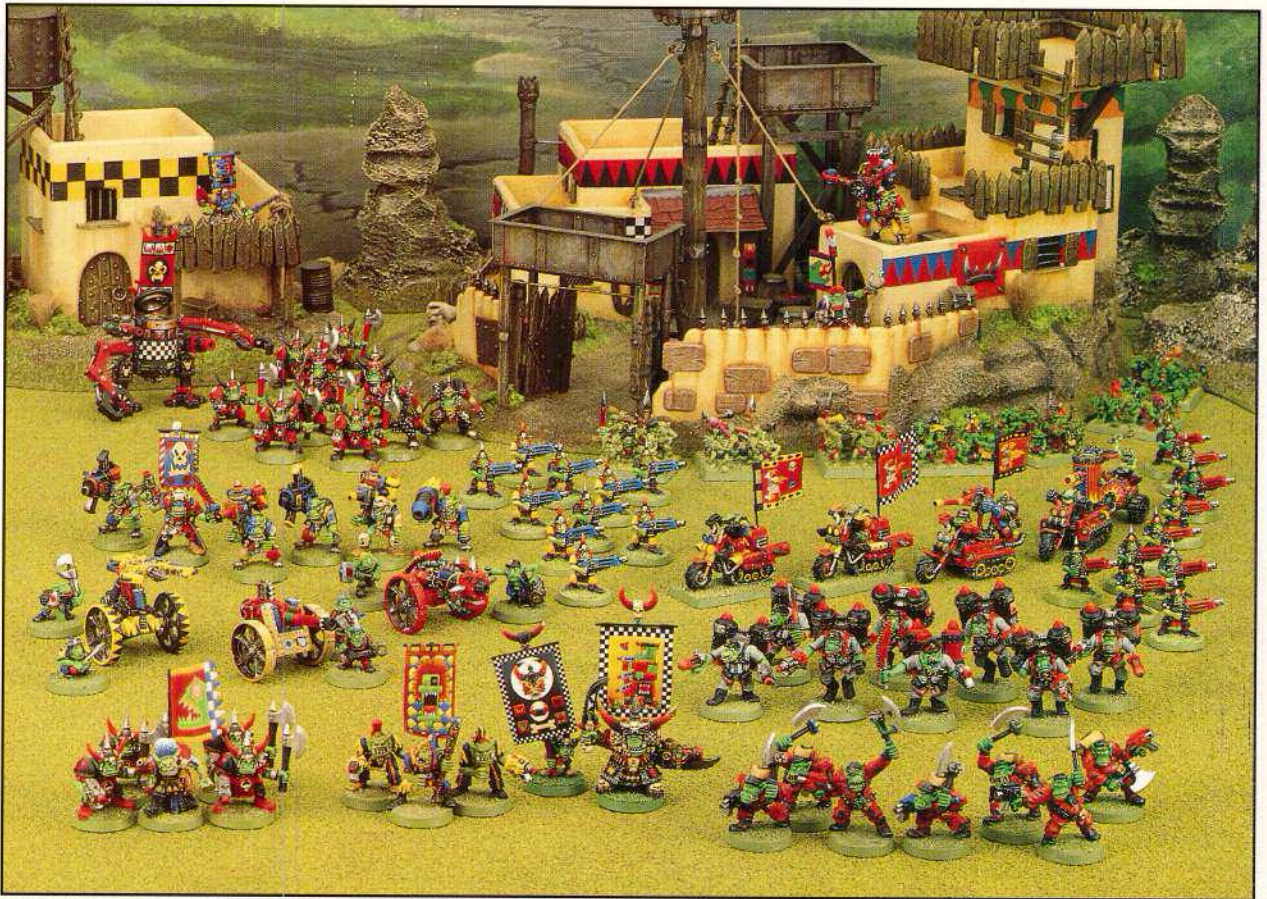

ORK ARMY (2000 points)

DA BOYZ



DREADNOUGHT
with a lascannon, heavy bolter and 2 power claws.



WARBOSS
Warboss Ghazghkull Thraka with his Gretchin Standard Bearer Makari.



WARHEAD
Weirdboy Warhead with an Aegis Suit and four Minderz.



WEIRDBOY
Weirdboy with two Minderz.



PAINBOY
Painboy with a Vaxxine Squig.



2 GRETCHIN MOBS
Each of 10 Gretchin with autoguns.



BLOOD AXE KOMMANDOS
7 Blood Axe Kommandos lead by a Kommando Kaptin.



STORMBOYZ MOB
8 Stormboyz lead by a Drillboss and all equipped with a jump packs.



GOFF MOB
6 Goff Boyz and 2 Skarboyz lead by 2 Goff Nobz in 'Eavy armour.

DA BUGGIES



WARTRAK
Wartrak with a lascannon.



SCORCHER
Scorcher with a heavy flamer.



WARBIKES
2 Warbikes with twin autocannons.

DA BIG GUNZ



DEATHSKULLS MOB
5 Deathskull Boyz equipped with 2 heavy bolters, 2 heavy stubbers and a heavy plasma gun. They are lead by a Nob.

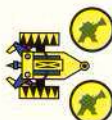

SMASHA GUN
with 2 Gretchin crew.



MEKANIAK
Mekaniak equipped with Shokk Attack Gun and Scanner.

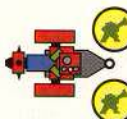

TRAKTOR KANNON
with 2 Gretchin crew.

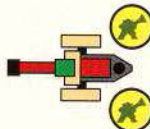

SPLATTA GUN
with 2 Gretchin crew.



RUNTHERD
Runtherd. with 7 Snotling bases.

SPACE MARINE BRIEFING

By Fred Reed



After painting an entire Battle Company of Howling Griffons Space Marines, I was really pleased to be invited up to the Studio to fight a battle with them. I nearly always command Imperial forces in my games of Warhammer 40,000 and I was happy to be facing the alien hordes of the Orks to prove once more who was mightiest – at least that was the plan!

As you can see from the photograph on the back of last issue, the Howling Griffon army I've painted is quite large. You can understand then, that I wasn't so pleased when I was told that I would have to take on the advancing Ork hordes with a very, very thin red and yellow line (you don't get many Space Marines for only 2000 points). It was a difficult task to whittle down my choices but in after much deliberation I managed to come up with a still balanced, but much smaller force.

When you are fighting Orks only one thing is certain: there are going to be loads of them, all hiding behind Gretchin. This single thought informed the majority of my choices. I was going to need lots of sustained fire weapons and weapons with large area effects.

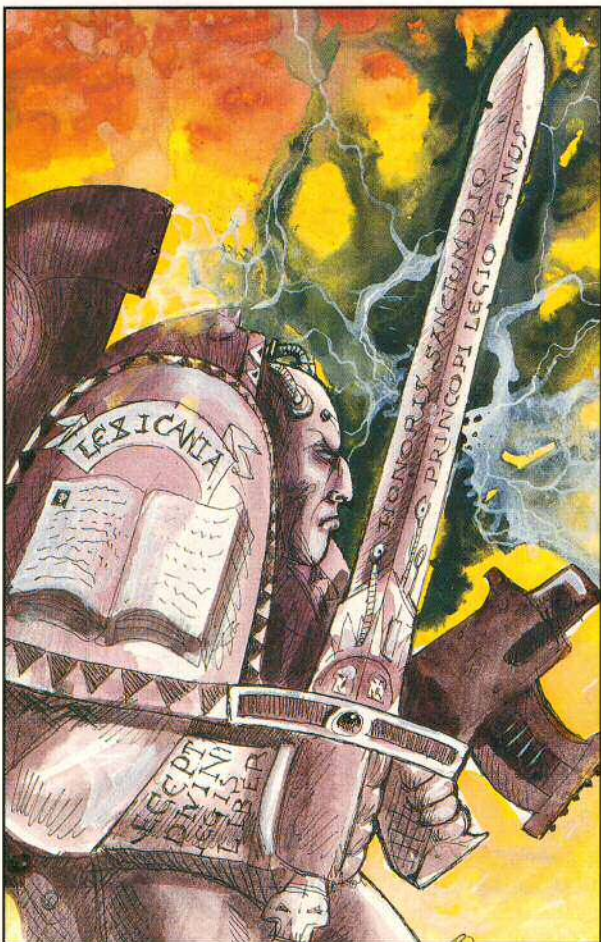

My first choice was a Tactical squad. This was equipped with a missile launcher and a plasma gun, and when split into two combat squads would be quite flexible. My next choice was a Devastator squad which was well equipped to slaughter Orks. Two heavy bolters would be able to slow down the advancing wave of Ork Boyz and my heavy plasma gun and lascannon should be able to destroy any troublesome Ork bikes. Even if Adrian was able to conceal his vehicles behind the terrain these weapons would serve equally well to cut down his charging Boyz.



In addition to these heavier troopers, I always take a squad or two of Space Marine Scouts. These warriors are not yet fully fledged Space Marines but with their ability to infiltrate the battlefield they form an important part of the Space Marine armies. I chose to equip each of my Scouts with chainswords to give them an edge in hand-to-hand combat, and gave one of them a heavy bolter to cover the rest as they advanced.

Armoured vehicles were next on the list and it took me some time to decide what to take. My army had a painted squadron of three Razorbacks and a Land Raider, but it was a Dreadnought and a Land Speeder that I decided on in the end. The Dreadnought carried an assault cannon and power fist – a fearsome combination which would be ideal against the massed hordes of lightly armoured Orks. The assault cannon rolled a massive three sustained fire dice with the potential of nine hits a turn! Even the power fist carried a storm bolter slung underneath which gave me a total of four sustained fire dice worth of shots with which to slaughter the foe.

My second vehicle was the latest addition to the armoured might of the Space Marines – the brand new Land Speeder. Not content with its already formidable armament I had converted one of mine to carry an assault cannon in addition to its multi-melta. This would add even more sustained fire dice with which I could destroy the advancing Orks and add to the huge destructive power of the multi-melta.

As vehicles tend to attract a great deal of attention I decided to equip mine to survive as much punishment as possible. With this in mind, I added auto-launchers loaded with blind grenades to the Dreadnought to give it some cover if it had to redeploy in the face of the Ork heavy weapons. I also added a *Null Shield* which I hoped would protect it from the worst Adrian's Weirdboyz could throw at it. For the Land Speeder I chose *Reinforced Armour* plus a *Supercharged Engine* in case it needed to get out of trouble quickly. The additional speed would also enable me to reposition the Land Speeder to counteract the biggest threat as the Ork attack unfolded, and make it harder for the Ork Boyz to hit the speeding target.

With most of my points spent, all I needed now was a few characters to lead the Howling Griffons into battle. My first choice had to be a Space Marine Commander who I equipped



HOWLING GRIFFONS SPACE MARINES ARMY (2000 points)

SPACE MARINE COMMANDER

Commander equipped with a power fist, power sword, *Displacer Field*, *Combi-weapon (Bolter-flamer)*, rad grenades and a *Bionic Eye*.



CHAPLAIN HERO

Chaplain Hero equipped with a bolt gun, chainsword, *Toxin Grenades*, and a *Scammer*.



LIBRARIAN

Lexicanian equipped with a *Force Sword*, refractor shield and *Master Crafted Bolt Pistol*.



LIBRARIAN

Chief Librarian equipped with a *Force Axe*, displacer field, Terminator armour and a *Psychic Hood*.



DREADNOUGHT

Dreadnought equipped with assault cannon, auto-launchers (loaded with blind grenades) and a *Null Shield*.



SCOUT SQUAD

4 Scouts equipped with chainswords and a heavy bolter. They are lead into battle by a **Veteran Sergeant**.



TACTICAL SQUAD

9 Space Marines equipped with bolters and power armour. One carries a missile launcher and another has a plasma gun.

They are lead by a **Veteran Sergeant** equipped with a power fist, chainsword and auxiliary grenade launcher.



DEVASTATOR SQUAD

9 Space Marines equipped with bolters and power armour. The squad is equipped with two heavy bolters, a lascannon and a heavy plasma gun.

They are lead by a **Veteran Sergeant** who is equipped with a power fist, chainsword and medi pack.



LAND SPEEDER

Land Speeder equipped with an extra assault cannon, *Reinforced Armour* and a *Supercharged Engine*.





with extra weapons and wargear to make him an even more awesome killing machine. This all made him a large investment in points which I protected with a *Displacer Field* – my favourite defence for valuable characters.

Next I chose one of my favourite models – a Chaplain, who I raised to Hero status and equipped with a *Toxin Grenade* and *Scanner*. With this mixture of wargear he would be able to prise out any Orks that were hidden in cover without having to fight their overwhelming numbers in hand-to-hand combat. His brave example would also inspire any Space Marine squads near him, allowing them to reroll any Leadership-based tests they might fail.



Last, but not least, I took both the company's Librarians. A level one Lexicanian would be useful as a back up, but the main psyker for my army would be the Chief Librarian. In order to protect this important character I gave him Terminator armour, a *Displacer Field* and a *Psychic Hood*.

After I had totalled up my points, I had just enough left to upgrade all the squad Sergeants to veteran status and buy them small amounts of extra wargear.

THE PLAN

Before we began the battle, Adrian and I each drew two Strategy and one Mission card for our armies. The first Strategy card I drew was *Traitor* which I used immediately to add two to my strategy rating. The second was *Look out Sir, AAARGH!* which might well save the life of one of my characters if I remembered to use it in the heat of battle!

When we drew missions, Adrian got *Engage and Destroy* – perfect for the Orks, and I got *Witch Hunt* which was going to cause me problems. As Adrian knew the one character I needed to kill, he was obviously going to hide his Weirdboy Warphead behind a wall of other troops and scenery. This would make it very hard for me to get close enough to target him, especially as I had made the difficult choice to exclude Assault squads equipped with jump packs when I picked my army. I would have to rely on either my vehicles being sufficiently manoeuvrable to get a line of sight to the Warphead, or my psykers being able to destroy him with a psychic power.

After Adrian had deployed his army I was able to set up in response to his positioning. I put the Devastator combat squad with all of the heavy weapons in the cover of some ruins overlooking the main concentration of Orks. Near them, on the far left of my position, I placed the Land Speeder and Lexicanian. The Land Speeder would be able to sweep down from the hill and engage any Ork forces that advanced into the open, or could wait in reserve, hidden amongst the debris on top of the hill.

The centre of my battleline was held by Space Marines armed mainly with bolt guns. These two combat squads would need to be supported if they were attacked by the Ork vehicles or Dreadnought, but would easily be able to hold their own against a mass of Orks or Gretchin on foot.

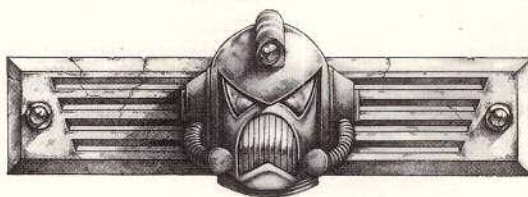

The Dreadnought and the last Tactical squad covered the right flank of my line facing the Ork vehicles. They were supported by the Chaplain Hero who would bolster their morale if they faltered in their devotion to the Emperor.

As we both had troops who were able to infiltrate the battlefield, we dived to see who would deploy them first. Adrian won, and placed his Kommandos amongst the rocks on the hill to the right of my line. I decided to ignore this new threat and put my Scouts far forward on my left. They would get in Adrian's way if he tried to advance with the Orks and Gretchin on that side, and slow up the Ork advance whilst my Devastators on the hill cut the greenskins to pieces with their heavy weapons.

Everything was ready. All I had to do now was pray to the Emperor, chant my battle liturgies in preparation and hope that the Orks would demonstrate their normal inability to hit a barn door from point-blank range whilst I sat back and shot them all to ribbons!

DEPLOYMENT MAP

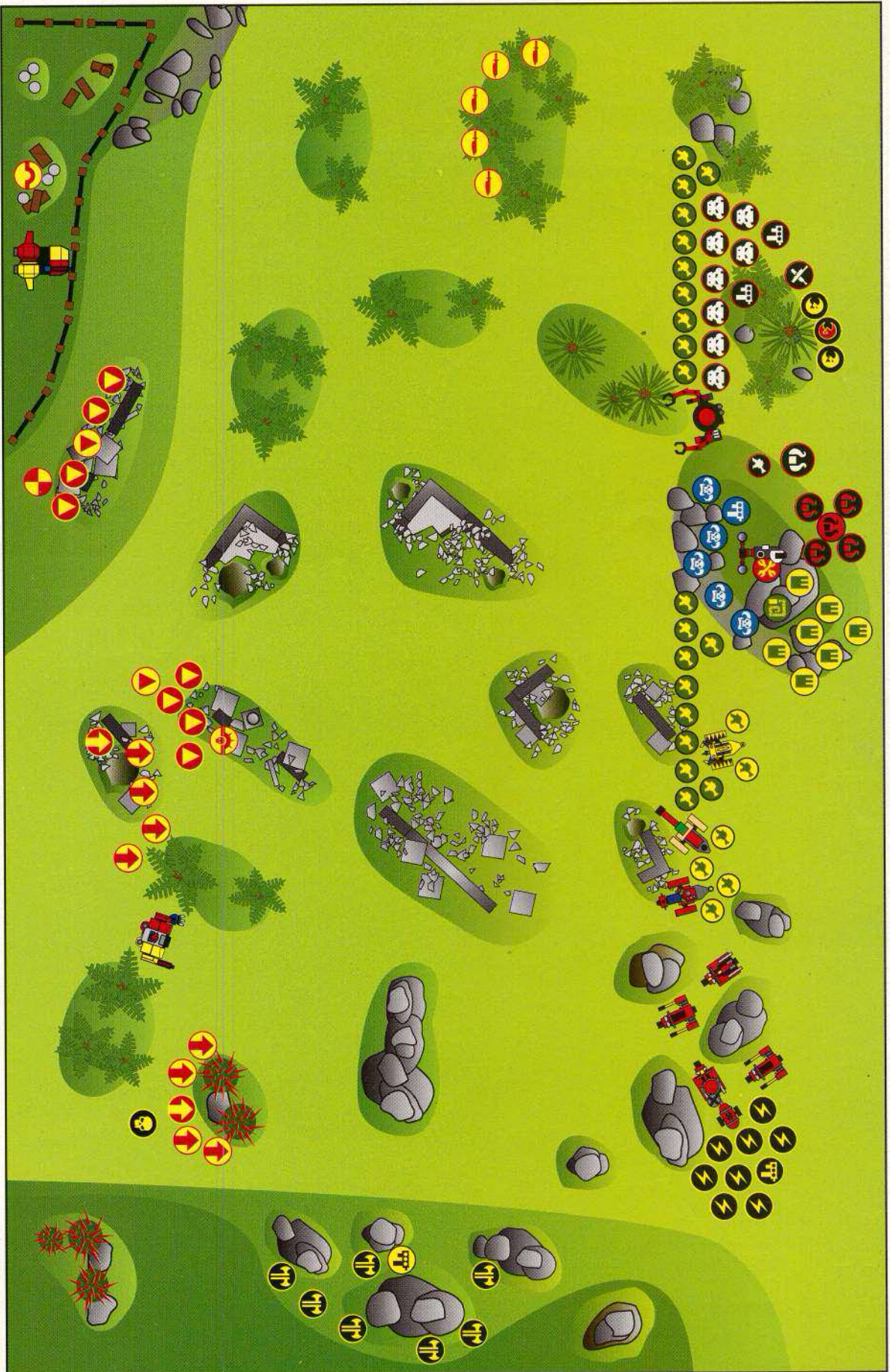





MINIATURES ARE SUPPLIED UNPAINTED. CONTENTS AND COLOURS MAY VARY FROM THOSE SHOWN.



The Land Speeder swoops down towards the attacking Orks and destroys the Dreadnought!

ORK TURN 1

As most of the troops on both sides of the battlefield began the game in hiding, Adrian found that his Deathskulls had nobody to shoot at. Placing them on overwatch, he decided to hold his fire until the Space Marine Devastators revealed themselves...

A few Orks advanced cautiously but most remained where they were, keenly aware that they had to protect their

Warhead and that their mission was simply to kill the enemy. There was no need to charge headlong onto the Howling Griffon's guns, they could let the Space Marines come to them. But Adrian had spotted a mistake in Fred's deployment and a single Warbike cautiously emerged from cover to catch the central Tactical Squad carelessly deployed in the open.

To draw out the rest of the Space Marines and to give them something to shoot at, both mobs of Gretchin advanced. Those on the right were followed by the Goffs who were spoiling for a fight and refused to sit on the back line and wait. In the centre of the Ork battleline, the second mob of Gretchin advanced, screening Da Big Gunz from enemy fire.

As the Warbike clattered forwards it opened fire on the foolhardy Space Marines in the open. Its heavy shells thudded into the hapless troopers, cutting down four of the Devastators and one of the Tactical squad. The last Devastator just passed his Break test and crouched behind the ruined walls out of sight.

Over on the hill, the Mekaniak braced himself as his Shokk Attack gun

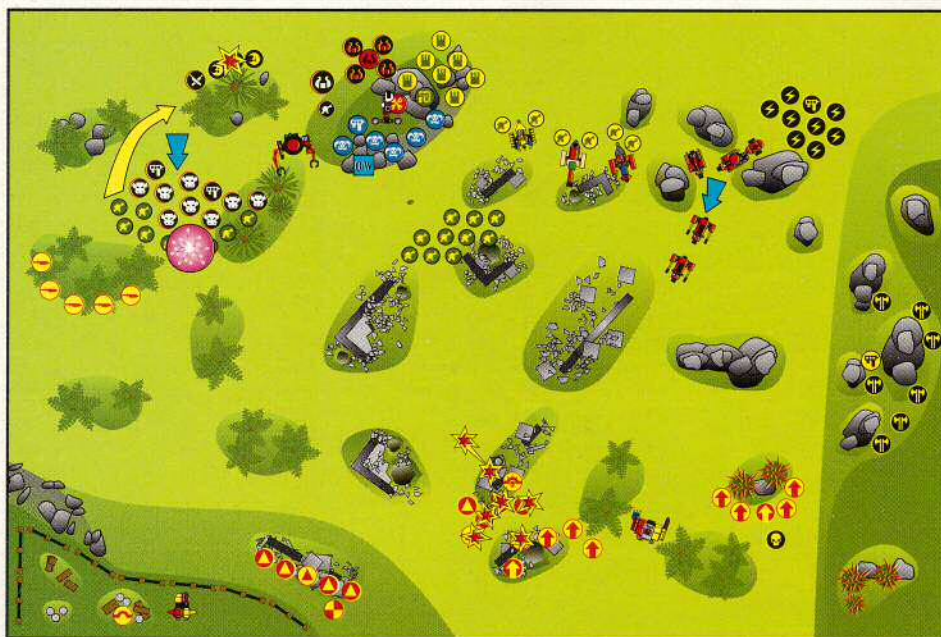

ORK TURN 1

opened a hole into the blackness of the warp and two scampering groups of Snotlings ran into the tunnel. Across the battlefield, two Space Marines from the second Tactical squad found themselves suddenly covered in terrified Snotlings, biting and clawing in their deranged frenzy. One trooper fought off the hordes of warp-maddened creatures but the other disappeared under their writhing mass.

With little to fire at, Da Big Gunz were silent except for the Splatta Kannon which could pick out the Chief Librarian amongst the rubble. With a mighty roar it launched a whirling splatter shell through the air but the spinning mass of rockets did nothing but ricochet off a wall and run out of steam.

Suddenly a terrified squeal split the air, accompanied by a brilliant flash of multi-coloured light. Two Minderz staggered from behind a tree, eyes blinking as they looked at the crumpled body of their charge. Even with his protective *Weirdboy Staff* the *Weirdboy's* head had exploded and the energy of the *Waaagh!* struck the Minderz. Although they survived the blast they were dazed by the death of the *Weirdboy* and *Adrian* too shook his head in disbelief.

Bellowing with rage the *Warphead* drew himself up to his full height and unleashed an *'Edbutz* of pure Orky power at the *Howling Griffons' Chief Librarian*. The Space Marine countered quickly, attempting to *Destroy Power* but the *Warphead* was more than able to defend himself and beat back the counterattack.

In return the *Warphead* tried to prevent the *Chief Librarian* placing the *Strength of Mind* on himself but failed to nullify the power. Then the *Warphead* tried to summon the power of the *Waaagh!* only to be nullified by the *Chief Librarian!* As the invisible struggle between the *Chief Librarian* and the *Warphead* reached its peak, *Fred* remembered the *Lexicanian* who lashed out with *Smite*, smashing four of the *Gretchin* who formed the skirmish screen in front of the *Goffz*. Despite the fact that they were being closely followed by their masters the *Gretchin* turned and fled.

SPACE MARINE TURN 1

Now it was the Space Marines turn to strike. Taking advantage of the Orks rather hesitant opening moves, *Fred* decided to waste no time and attack! The *Chaplain* activated his *Scanner* and detected the outlines of the *Blood Axe Kommandos* skulking behind the rocks to their right. Barking an order to the nearby *Tactical squad*, the Space Marines strode forward to flush them out.

Across the battlefield, the ground shook as the huge figure of the *Howling Griffons' Dreadnought* advanced into the open to



HOWLING GRIFFONS TURN 1

avenge his fallen comrades. To the right, the *Chaplain* was urging forward his battle brothers, and on the left the *Tactical Squad* stepped over the fallen bodies of their *Devastator* comrades to take cover in the rubble. The Orks would pay dearly for their blood.

The *Space Marine Commander* moved across to better direct the fire of the *Devastators* on the hill against the *Ork* position. As he moved, the *Land Speeder* roared overhead, diving down onto the battlefield to centre the *Ork Dreadnought* in its sights! To the far left of the *Space Marine* lines, the *Scouts* crept stealthily forward through the trees, closing in on the unsuspecting *Goffz*.

The *Dreadnought* stood resolutely, its weapons trained on the *Warbike* that had just gunned down five of the *Emperor's* finest. With vengeful fury it unleashed the deadly force of its weapons on the hapless *Ork bikers*, but instead of the sound of belt-fed rounds smashing into armour and flesh the Orks rode through the maelstrom without a scratch! Cursing his luck, *Fred* also fired the storm bolter, but this too ricocheted off the *Warbike's* feebly armoured hull. In mounting desperation the *Dreadnought* fired off a pattern of blind grenades to block any line of sight through which the Orks could return fire.

To the *Dreadnought's* right, the *Tactical squad* opened fire with their missile launcher at the only vehicle they could see and a *krak* missile flew across the battlefield, narrowly missing the *Scorcher*. The rest of the squad threw frag grenades into the concealing rocks to try and flush out the *Blood Axe Kommandos* Two Orks were caught in the multiple blasts whilst a third was saved as his flak armour absorbed the impact. Finally the *Chaplain* threw a *Toxin Grenade* for good measure and the lethal cloud engulfed two more *Kommandos*, killing them instantly. Amidst the explosions and deadly spinning fragments, the *Blood Axe Kaptin* steadied his *Boyz* and they passed their *Break* test and held their ground.

In the centre of the battlefield the *Devastators* tried to punch a hole through the thin screen of *Gretchin* in front of the *Ork's* support weapons, but without much luck. The heavy plasma gun missed the *Gretchin* completely and the heavy bolter only



ORK TURN 2

killed one of them. But just as Fred began to gnash his teeth in frustration at the number of 1's he was rolling, he noticed something that made up for his bad luck. The Space Marine carrying the lascannon could see nothing but a lone figure on the horizon... A shimmering, incandescent beam burned through the air and the Mekaniak carrying the Shokk Attack gun was knocked sprawling on the ground with a gaping hole in his chest.

With a hiss of super-heated air the Land Speeder opened fire on the Ork Dreadnought with its multi-melta. The shot struck the machine dead centre and its armoured chassis melted away, reducing the once proud Dreadnought to a heap of slag. On the left the Scouts opened fire on the Goffs whose Gretchin screen was now cowering behind them. In a highly accurate blaze of bolter fire the Scouts cut down eight of the Orks reducing the terrified mob to a single Skarboy and a Nob!

As the firing died down the Howling Griffons' Chief Librarian attempted to deliver the devastating power of a *Vortex*. However, instead of unleashing a swirling maelstrom of destructive energy he found himself under *Daemonic Attack*. Adrian's smile faded as the Space Marine fought off the malevolent force, but he had more tricks up his sleeve. Barely had the Librarian recovered when he was struck by an *'Edbutz* but he escaped this too with the aid of his *Strength of Mind*. After this concentrated onslaught the beleaguered Chief Librarian was unable to maintain his concentration and couldn't unleash any more power. Aware of the lapse in power the Warhead gambled on a *Psychic Duel*. Unfortunately for Adrian, the Chief Librarian had recovered enough to beat the Warhead and he was forced to discard *Power Vomit*.

TURN 1 VICTORY POINTS

ORKS: 1 POINT

SPACE MARINES: 5 POINTS

ORK TURN 2

Whilst Adrian pondered his next moves Fred rolled for the effects of the grenades he had thrown in the previous turn. The *Toxin Grenade* shrank to half its size and the clouds of blind smoke drifted apart, creating a fire corridor through which the Orks could see the Dreadnought.

Adrian's first action was to redeploy his vehicles. The lead Warbike remained in position whilst the second moved to target the Tactical squad near the Chaplain. The Wartrak pinpointed the Dreadnought through the gap in the blind clouds and the Scorcher remained

protected at the back. Bloodied but unbroken, the Kommandos advanced, steadying their aim on the nearest Tactical squad.

At the back of the Ork lines, the Stormboyz were getting ready. With as much discipline as they could muster, they fired up their jump packs and leapt towards the enemy. Unfortunately, one of the makeshift contraptions blew up in mid air and another jump pack exploded as the Stormboyz landed. Undaunted by their losses, the Stormboyz remained in good order and readied themselves to fire.



At the other end of the battleground the Weirdboy's Minderz abandoned his shattered body and moved forward into cover, whilst the Goffs quickly retreated from the killing ground they had blundered into. In the centre, the Gretchin rounded an outcrop of blasted rubble and took aim at the Land Speeder.

On the hill at the back, Makari moved forwards slightly. This would make him the nearest target to the Devastators rather than Ghazghkull who was standing behind him taking careful aim at the Scouts who'd mown down his brave Goffs. As Ghazghkull squeezed the trigger he found himself engulfed in smoke as a deafening explosion rocked the hill. Makari watched stunned as the billowing smoke cleared to reveal the enraged Warlord clutching the trigger and a few mangled wires. To his disgust his prized *Kustom Blasta* had misfired and blown itself apart.

Looking out over the battlefield, Adrian decided that the biggest threat to the Orks was the Land Speeder and the whole of his right flank now took great pains to eradicate the vehicle. The Gretchin and the Deathskull's heavy bolter opened fire on the skimmer in a fusillade of gunfire but every shot missed! In



The Blood Axe Kommandos lead the Ork attack.

a final effort to destroy the Imperial vehicle, the Deathskull armed with a heavy plasma gun took careful aim. The blast smashed through the vehicle's armour and the Land Speeder exploded spectacularly in mid air, trailing debris as the smoking hulk crashed into the jungle. The Orks let out a cheer and Adrian breathed a sigh of relief.

On the other flank the Ork vehicles fired in unison at the Space Marines facing them. Shot after shot bounced off the Dreadnought and chewed up the ground around the Space Marines but only one of the troopers with the Chaplain was killed. Three more Space Marines fell to the Stormboyz and Kommandos' fire but they passed their Break test. The Chaplain himself was struck by bolter shells but they all ricocheted off his ornate armour.

The energy released from the warp this turn was very weak and as the Warhead attempted to 'Edbutz' the Chief Librarian the power drifted away without effect. Finally the Gretchin in the cover of the trees passed their morale check and looked around to see if it was all over yet.

SPACE MARINE TURN 2

Much to Adrian's relief, the cloud of toxin drifted away from the Blood Axe Kommandos and out of harm's way.

The Howling Griffons advanced again, lead by their characters. Under the direction of the Chief Librarian, the Tactical squad in the centre of the battlefield readied itself to



HOWLING GRIFFONS TURN 2



The Space Marines Dreadnought advances menacingly towards the Orks.

fire at the centre of the Ork battleline spread out before them. On the left, the Lexicanian moved cautiously forward to the edge of the hill from where he could see the Scouts spread out below him as they stalked the remaining Orks through the dense jungle.

At the forefront of the Space Marine attack stood the Dreadnought. The mighty war machine strode through the billowing clouds from its own blind grenades and took careful aim at the Warbikes. Servos whirred and targeters clicked as the multi-barrelled weapon sought out its prey. The ancient warrior inside the armoured carapace was determined that none should escape the power of his assault cannon.

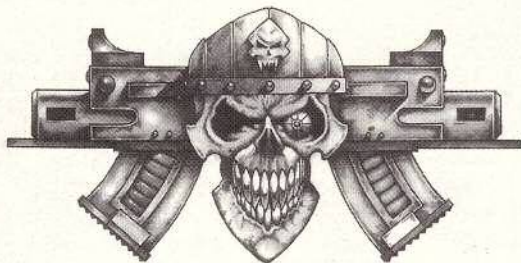

With a mighty roar the Dreadnought fired, killing one of the Warbike's drivers instantly and damaging the Wartrak's controls as the explosive shells ripped into the helpless Ork vehicles. The last Warbike escaped the fury of the Dreadnought only to be blasted by a krak missile from the last Tactical trooper accompanying the Chaplain.

The Chaplain Hero himself ignored the vehicles and continued to slaughter the Blood Axe Kommandos amongst the rocks. With deadly accuracy he threw another frag grenade which cut down one more of the concealed Orks.

In the centre of the battlefield, the Chief Librarian directed the fire against the Gretchin screen guarding the Orks' support weapons but missed them all. The Space Marines with him were more accurate killing three of the unfortunate greenskins. Following their lead, the Devastators on the hill also fired at the Gretchin and their two heavy bolters churned up the ground around the diminutive orkoids, killing another three and forcing a Break test on the mob. Adrian rolled double 6's and groaned as the remaining members of the mob turned to run for cover, leaving one lone Gretchin stranded in the open. Fred had carefully positioned the Devastators' heavy plasma gunner so that the Deathskulls were his nearest target and not the battered Gretchin. Before they knew what was happening two of the Orks were engulfed in a ball of incandescent plasma and went to join Mork and Gork. Finally, as if to balance the carnage the Space Marines had inflicted on the Orks' centre, the Scouts in the jungle missed everything they shot at!

After the devastation of the shooting phase there was a calm as both Adrian and Fred surveyed their warp cards for the forthcoming psychic conflict. Firstly, the Chief Librarian Teleported across the battlefield to join the Devastators. Then the Warphead spotted the Lexicanian who had walked right into range of 'Eadbutz. The unfortunate psyker was killed instantly, unable to defend himself against the raw energy of the Waaagh! Dismayed by this result, Fred played *Energy Drain* and ended the turn.

TURN 2 VICTORY POINTS

ORKS: 7 POINTS

SPACE MARINES: 6 POINTS

ORK TURN 3

Adrian's support weapons still had very few targets so he placed them on overwatch in case the Dreadnought or the Space Marines chose to advance. The riderless Warbike careered out of control and exploded whilst the second knocked down a Stormboy and crashed into some rocks. The lone Gretchin in the centre who had been standing in the open now took to his heels. He managed to join his companions in cover and they began to pull themselves together.

As the Warbikes skidded and crashed, the damaged Wartrak screeched to a halt, taking aim at the towering Dreadnought just in front of it. On the right flank, the surviving Orks and Gretchin ganged up on the Scouts whilst on the left the Stormboyz used their jump packs to leap over the last Tactical trooper and the Chaplain. One of the Stormboyz ended up being impaled on the spikes of a deadly cactus but the rest turned at the end of their jumps and surrounded the two Space Marines. From the hill on their left, the Blood Axe Kommandos moved out of the rocks to join the fray.

The ramshackle remains of the Orks' right flank concentrated their remaining fire on the Scouts. Amid the chattering of wildly aimed shots the Scout carrying the heavy bolter was felled by the Goff Nob.

From the hill the remaining Deathskulls opened fire at the Space Marines amidst the cover of the ruins. Most of their fire



ORKS TURN 3

went wide, but the heavy plasma gun was bang on target and slew one more of the Howling Griffons' troopers.

On the Orks' left, the Wartrak missed the Dreadnought from point blank range. The Stormboyz killed the last of the Tactical squad, cutting down the trooper with the missile launcher as revenge for their fallen comrades. The Kommandos' fire was just as accurate and wounded the Chaplain Hero.

Yet again the dice roll for warp flux was low and the psychic phase helped neither side as both the Warhead's 'Edbutz and the Chief Librarian's *Teleport* were each nullified in turn.

SPACE MARINE TURN 3

The lethal cloud from the toxin grenade finally disappeared whilst the blind grenade smoke also began to disperse. With both sides able to see each other again the scene was set for even greater slaughter this turn.

Fred seized the opportunity to charge the badly mauled Kommandos. Chanting his battle liturgies, the Chaplain leapt into close combat with two of the unfortunate Orks. To his left the Dreadnought advanced to attack the last two vehicles and walked straight into the sights of the overwatching Traktor Kannon. The bizarre Ork weapon fixed the giant Imperial machine with its traktor beam but failed to penetrate the massively thick armoured sides. Smoke poured from the Traktor Kannon's controls

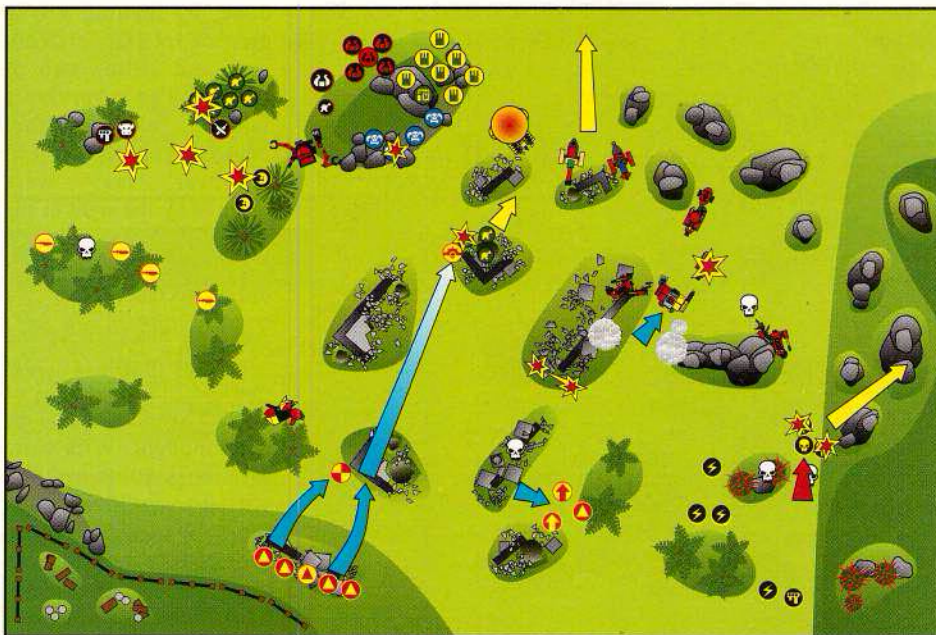

HOWLING GRIFFONS TURN 3



The Marines cheer as their Librarian kills the Orks' Warhead with a Vortex.

as it took up the strain, dragging the Dreadnought towards the Ork positions and almost, but not quite, into the sights of the other support weapons. With no clear line of sight to the Dreadnought, the Splatta Kannon fired at the central Tactical squad once more. Again its shell failed to bounce more than once and the Space Marines escaped without a scratch. Adrian began to think that the dead Mekaniak had got just about what he deserved! Having survived the Orks' fire, the Tactical squad in the centre began to move away from the cover of the ruins and close in on the exposed Stormboyz.

From the hill on the left of the Imperial battleline, both the Chief Librarian and the Space Marine Commander advanced to skirt around the ruins that the Devastators were using as cover. In front of them the Scouts were faced with a mass of Ork guns and readied themselves for combat.

Leading the squad, the Scout Sergeant ordered his men to use frag grenades to blast the Orks from their concealment in the jungle. Unfortunately, the young Scouts' lack of experience told and their grenades all failed to harm the Orks, knocking the Minderz off their feet but little else. Finally the Sergeant showed them how it was done, by lobbing a frag grenade into the Gretchin mob and killing two of them. The survivors faltered, rolling another double six as a Break test! However, they were inspired by the sight of the Battle Standard Makari close by, and passed their test the second time.

Amid the black smoke and scattered wreckage that marked the graveyard of the Ork Warbikes stood the Dreadnought. With calm efficiency it opened fire with its assault cannon at the Wartrak, which exploded spectacularly in a mushrooming ball of flame. The mighty war machine then fired its storm bolter at



ORKS TURN 4

the Scorcher but could barely make out its form amid the debris and its shots went wide. Fred was disgusted and Adrian delighted – he had plans for that Scorcher!

In the centre, the Devastators joined in the carnage. Their heavy plasma gun destroyed the crew of the Smasha Gun in a ball of incandescent energy and a wave of panic sent the rest of the crews running from the field! By careful positioning, Fred had placed both of the Devastators' heavy bolters and their lascannon so that they were able to chose the targets he wanted. An accurate lascannon shot cut down the Deathskull

carrying the heavy bolter and the rest of the heavy weapons pounded away at Makari. With his amazing luck, the little fellow escaped death every time, leaving Fred aghast!

In the bitter hand-to-hand combat against the Kommandos, the Chaplain killed one of the Boyz and as the other broke and ran he cut him down too. With only the Kaptin left, the broken mob was effectively destroyed and the model was removed.

Even with the extra energies of hand-to-hand combat this turn the Warphead managed to pass his Waaagh! test but the warp flux was still too small for him to use any of his powers. The Chief Librarian had just enough to *Teleport* himself forwards to attack the second mob of Gretchin who were covering in some ruins. As they fled, the Librarian butchered one of the cringing creatures and the last two Gretchin were also removed as they were beyond hope of rallying.

TURN 3 VICTORY POINTS

ORKS: 10 POINTS

SPACE MARINES: 11 POINTS

ORK TURN 4

This was it! Adrian had only one turn left and it was going to be close. With a mighty roar Ghazghkull called on the power of the Waaagh! and all across the battlefield the Orks felt a renewed sense of strength. There would be no more failures, the Orks would sweep the Space Marines before them!

Feeling the strength of their Warboss in the very air, the last two Goffs charged the Scouts whilst the rest of the Orks and Gretchin cheered wildly. The Goffs would show those Scouts a thing or two! The Warphead's Minderz clustered closer about him as they watched for any sign of a Space Marine attack. They had kept him alive so far and didn't want to lose the Warphead on the last turn of the game.



HOWLING GRIFFONS TURN 4

On the left flank the Scorcher accelerated to combat speed and bore down on the Chaplain, whilst the Stormboyz jump-packed towards the remains of the Tactical and Devastator squads positioned in the centre of the battlefield. With the force of the Waaagh! in them the Orks were really in control and only one of the Stormboyz span wildly off the board and into oblivion.

With a roaring whoosh of flame the Scorcher released its cargo of burning death completely engulfing the Chaplain who stood no chance of survival. The gunner on the Scorcher's laughed maniacally as he watched the last Howling Griffon on this flank die. Unfortunately the Ork attack in the centre came to nothing, for without their numbers to aid them the Orks were unable to inflict any damage at all. The Stormboyz were particularly disappointing as they failed to inflict the killing blow on two Space Marine squads worth a total of seven victory points. On the far flank, the Goffs fared only a little better killing a single Scout in their hand-to-hand combat. The Scouts were unworried by the assault and passed their Break test with ease.

Finally, to add injury to insult, the Chief Librarian used the *Ultimate Force* to unleash a *Vortex* at the Warphead. The *Aegis Suit* the Warphead was wearing fused and with nothing he could do to halt the awesome power, he just watched in horror as his carefully defended Warphead, Minderz and Deathskulls were consumed by the infinite power of the warp.

The end was nigh.

SPACE MARINE TURN 4

At either end of the battlefield the Space Marines were on the move once more. To the left, the remains of the Scouts charged the foolishly brave Goffs. At the other end of the battleground the Dreadnought pursued the Scorcher, eager to revenge the death of the howling Griffons' Chaplain.

As the flanks positioned themselves for the final attack, the centre of the Howling Griffons line let loose with a storm of

bolter fire. The surviving Tactical squad sprayed the last few Stormboyz with deadly accurate bolter shells, killing two and the mob finally broke and fled the battlefield. The Devastators on the hill above them opened up on Makari once again and to their disgust he shrugged off every shot! Only their heavy plasma gunner was positioned to fire at another target and his aim was perfect. The Painboy found himself engulfed in plasma and as his charred body crumpled to the floor, the doughty Scouts managed to finally defeat the Goffs, and wiping them out completely!

The Orks' right flank was in tatters but the slaughter wasn't over yet as the Space Marine's Chief Librarian cut down the surviving Minderz with a hail of bolter fire. Meanwhile, the Dreadnought had caught up with the Scorcher...

The heavy weapons of the ancient Imperial war machine fired one final time and the Scorcher's fuel detonated in a blinding explosion, utterly destroying the Ork vehicle in a plume of fire.

As the shattered remains of the Ork vehicles crackled and burned the Space Marines watched as the Orks retreated, the battle was over and victory was theirs.

TURN 4 VICTORY POINTS

ORKS: 13 POINT

SPACE MARINES: 24 POINTS



THE AFTERMATH

All praise to the Emperor! Mission accomplished and the Howling Griffons are fully blooded.

Although I won the battle it was a very closely fought game. For most of the time it was touch and go whether I would ever get anywhere near killing the Warhead it was just luck that I drew the *Ultimate Force* card which allowed me to do it so easily. By the end of turn three I was getting desperate and I thought that I would have to try and win on kills alone. In many ways the battle was all going horribly wrong – my right flank had virtually collapsed and the Land Speeder lay in a smouldering heap of wreckage, but in the end the legendary determination of the Space Marines saw them through and I was rewarded for my faith in the Emperor with the perfect weapon to complete my mission.



Overall my plan worked fairly well. I managed to keep most of my expensive units alive including the two major heroes. On my left, the Scouts and Land Speeder managed to heavily damage Adrian's forces, breaking the Gretchin, wiping out the Goffs and destroying his Dreadnought before it had fired a single shot.

On the right, my own Dreadnought obliterated the Ork vehicle squadron with a little help from the Tactical squad's missile launcher. By the end of the battle it stood alone in the middle of a sea of burning debris, dead and dying enemies scattered around him like the final scene from a film.

The Devastators performed admirably. They had duelled with his Deathskulls and won, killing the Orks with their heavy weapons and cutting down the Mekaniak carrying the Shokk Attack gun before he could cause much damage. In addition, they had also stalled the Gretchin mob in the centre which had tried in vain to cover the Orks' support weapons at the back of their lines. Finally, they had targeted the crews of the support weapons themselves and forced the few survivors to flee for their cowardly lives.

I did lose both the Lexicanian and Chaplain Hero which was all the more frustrating as I had the *Look out Sir, AAARGH!* in my hand all along. Each time one of my characters was slain he was much too far away from any other troopers for them to intervene and save him. Ah well... maybe next time.

In the end Adrian was a bit unlucky. I got the right card and having closed the range for *Vortex* there was nothing he could do to stop me using the power. Even so, he still failed to roll the save for his *Aegis Suit* and so lost the Warhead and his fate was sealed.

All in all, it was a great game that was close run until the end when fortune and a lot of sustained fire carried the day.

ABJECT HUMILIATION

Oh no! Defeated by *Witch Hunt* again! I truly dread fighting against an opponent with this mission and once again, no matter how much I tried to protect him, my Warhead was hunted down and slain.

What went wrong? Turn one saw what was probably my biggest mistake. In hindsight I can see that I should have attacked much harder on my left flank and played as if fighting an oblique line tactic in Warhammer. Fred had deployed his Dreadnought, two Tactical combat squads and a Devastator combat squad in quite a restricted area and I should have attacked more decisively.



If I had attacked the Tactical squad and Chaplain on the end of the line with the both the Kommandos and the Stormboyz at full strength I could have thrown the Space Marine battleline into confusion. Then, whilst they were still reeling, my vehicle squadron could have knocked them completely off balance and left Fred in disarray. If I had done this the Fred would have had to rethink his plans in the face of such a concerted attack and things might have been very different. In the event, I sat back and waited which just left the initiative with the enemy.

At the time I was a bit worried about the damage the Space Marines' Dreadnought could do and so didn't commit my forces as I should. Next time I'll try to remember to either avoid the really dangerous enemy units completely, or tackle them head on. Charging in against the Dreadnought sounds like a suicidal idea but even a devastating vehicle like that can only cause so much damage in one turn. The Boyz would have had to risk the wrath of the Dreadnought but it would have found itself with too many targets to shoot at once and so it would have been swamped.

In stark contrast to my left flank, the advance on my right was mistimed and I should have held back. My failure to recognise the threat to my Dreadnought from the Land Speeder cost me dear both in fire power and victory points. Once the Land Speeder's multi-melta had reduced my most powerful single model on the battlefield (next to Ghazghkull) to a heap of molten slag the whole advance stalled. If I had I only caught on to Fred's plan earlier I would have been much more defensive and overwatched against such an attack.

In the centre of the battlefield Fred managed to out-flank my artillery with his Dreadnought and rendered them useless for most of the game as they had nothing to shoot at. The only plus point (and believe me it was the *only* plus point) was that the Dreadnought wasn't in a position to threaten my centre either and spent the entire game trying to wipe out my vehicle squadron!

Once I could see the way the battle was heading I was able to counter Fred's attack and keep the victory points close until

turn four. Then, what was supposed to be my final hammer blow with the Stormboyz against the remainders of Tactical squad and the single surviving Devastator, ended instead with the Boyz in a rout. With this last embarrassing defeat yet another opportunity to gain victory points slipped away with a whimper. When the small pockets of surviving Orks and Gretchin on the right flank failed again to cut down the Scouts I knew the game was up.

After three turns of stalemate all it had taken was for one side to tip the scales in their favour and the other side collapsed. Unfortunately for the Orks, Space Marines are still able to strike hard with almost no troops, and once it had started there was nothing I could do to stop my downward plunge.

On the other side of the battlefield I have to say that Fred proved himself to be an adept Space Marine Commander and I hope to play him again someday. He managed to contain most of my attacks even when his squads had been badly shot up. After some careless initial deployment, he became much more careful with his troops and hung back, letting the awesome power of his Chief Librarian accomplish his mission.

It was an unusual battle in which neither of us made an all-out attack, both being content to probe the others' defences with a string of assaults by single mobs or vehicles. This meant that the casualties were concentrated on these aggressive units, many of which were completely wiped out! My squadron of four vehicles, Stormboyz, Blood Axe Kommandos and Goff mob were all destroyed utterly as were Fred's Land Speeder and one of his Tactical squads. It was my downfall that I couldn't finish off the other Tactical squad and the badly mauled Devastators. In the end, only the Space Marines' Dreadnought and Chief Librarian managed to attack vigorously and still escape unharmed.

The lesson that I learned from this battle is not to be half-hearted about attacking. Pick your targets and attack them without mercy and with everything you can throw at them. Weak and hesitant attacks only result in your own forces being obliterated. Next time will be different, next time I will triumph – Warlord Ghazghkull will be back!



GAMES WORKSHOP[®]

MAIL ORDER

Games Workshop Mail Order is a great way to purchase all the latest releases from Games Workshop and Citadel Miniatures. Our Mail Order staff are all Games Workshop enthusiasts and will be more than happy to advise you on any special character miniatures or other models that you might need for your armies.

**OUR MAIL ORDER TELEPHONE LINES ARE OPEN:
8am – 10pm SEVEN DAYS A WEEK!**

MAIL ORDER CHRISTMAS POST

To ensure that you receive your order in time for Christmas, we must receive it by the following dates:

The **14th December** if you wish it to be sent by 2nd Class Post – **Cost £2.50 per order**

The **19th December** if you wish it to be sent by 1st Class Post – **Cost £3.50 per order**

The **22nd December** if you wish it to be sent by Special Delivery – **Cost £6.20 per order**

PLEASE NOTE: If you are posting your order, you must allow four days for it to reach us. All orders received by phone on these dates will be despatched the same day.

Our Telephone Hotlines will be closed on the 24th, 25th and 26th December and the 1st January 1995.

Overseas customers please note that we are only able to guarantee delivery in time for Christmas on orders received before November 30th.

If you are posting your order, please send it to:

**GAMES WORKSHOP MAIL ORDER SERVICE, CHEWTON STREET,
HILLTOP, EASTWOOD, NOTTINGHAM NG16 3HY**

Or you can fax your order through on: **(01773) 530155**

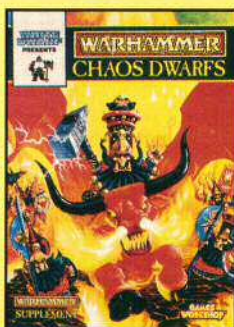

CHAOS DWARFS

This full-colour book is a compilation of all the Chaos Dwarf articles first printed in White Dwarf magazine plus additional unpublished material. These include rules for new Chaos Dwarf characters, the full range of Chaos Dwarf troops and war machines, a complete Chaos Dwarf army list and an exciting Warhammer battle report.



TITAN LEGIONS

Titan Legions is a complete game containing everything you need to fight out the epic clash of gigantic war machines. With dozens of models including the massive Imperator Titan and two of its most deadly foes – Mega-Gargants, Titan Legions is the ideal introduction to the Epic Game System.

GAMES WORKSHOP MAIL ORDER IS



Tony hand-picks an order ready for despatch.

CONVENIENT!

Mail Order is convenient, with the entire range of Citadel Miniatures and Games Workshop games, just a phone call away.

FAST!

Mail Order is fast. Most customers receive their orders within 2 days in the UK. (Some second class orders, or packages over 1Kg may take a day or so longer). Plus, on any telephone orders received before 1.00pm, our **Special Delivery Service** guarantees you'll receive your order the very next day.

We also have a special Troll who ensures that all **First Class** telephone orders received before 1.00pm are dispatched the same day!

Most overseas orders are delivered within 8 days.

THE FULL RANGE OF PRODUCTS!

Our Mail Order service can supply the full range of Games Workshop games and Citadel Miniatures, and we don't stop there! We can also supply any individual game component or miniature. So if the dog's chewed your **Warhammer 40,000** buildings, we can supply a brand new set! If you want the rulebook from **Warhammer**, we can provide it! If you want the dice from **Space Marine** all you need to do is ask!

If the models you want for your army aren't in your local store, or you are looking for an out of stock or hard to find range of miniatures, give us a call. Because we're based at the factory, our staff can arrange to cast up any number of miniatures especially for you, from the original moulds.

We can also supply any component from any multi-part model for those of you who like to customise or convert your miniatures.



Chas and Ash check miniatures in the Citadel foundry.



Scott grabs a brand new copy of Talisman for a Mail Order customer.

FRIENDLY KNOWLEDGEABLE STAFF!

Our Mail Order service is staffed by enthusiastic hobbyists like yourself, who will be more than happy to tell you about all the latest releases for your particular army or favourite game.

ACCURATE!

Every order is hand-checked against the catalogues to ensure that every model is perfectly cast and that your order is exactly what you want.

PLUS!

No queues! No parking! No bus fare! And it's really great fun using the catalogues to choose **exactly** the models you want for your army. We've found that many gamers get together with their friends to place an order so that the £2.50 UK and BFPO postage is applied to the whole order and the money saved buys them all a few extra miniatures.



Andy, Steve, Ed and Gordon, man the Mail Order hotlines.

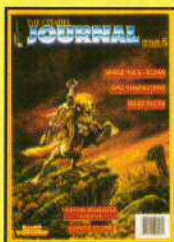

CITADEL JOURNAL

Citadel Journal 5 is out now! This exciting issue contains more great new rules and features to expand all your Games Workshop games. Issue 5 includes articles on Eldar in **Space Hulk**, siege warfare in **Warhammer**, Orc Waaagh! magic in **Man O' War** as well as all the regular features.

Issue 5 of the **Citadel Journal** is available now direct from Mail Order priced only £3.99 with FREE P&P within the UK and BFPO. Overseas add £1 P&P.

SUBSCRIPTIONS

Issue 1 and 2 of the **Citadel Journal** are now completely sold out and stocks of Issue 3 are very limited. To be certain of your copy please place an early order. We now also offer a special five-issue subscription.

Price: UK/BFPO – £20.00. Overseas – £30.00

With every subscription we'll send your sixth issue absolutely FREE! Each subscription to the Journal will begin with the next issue to be published – unfortunately we are not able to include back copies in subscriptions as they are in such limited supply.

BOXED ARMIES

These complete boxed armies make great value Christmas gifts! They contain everything you need to put together a powerful force to take on all comers including a complete force list and banners.

NEW! 2000 POINT UNDEAD ARMY (Boxed Set) £100.00

NEW! 2000 POINT ELДАР ARMY (Boxed Set) £100.00

2000 POINT SPACE MARINE ARMY (Boxed Set) £85.00

2000 POINT HIGH ELF ARMY (Boxed Set) £100.00



WARHAMMER

WARHAMMER BOXED GAME £34.99

WARHAMMER BATTLE MAGIC £19.99

WARHAMMER ARMIES – CHAOS £14.99

WARHAMMER ARMIES – DWARFS £9.99

WARHAMMER ARMIES – SKAVEN £9.99

WARHAMMER ARMIES – UNDEAD £9.99

NEW! WHITE DWARF PRESENTS: CHAOS DWARFS £9.99

SELF ADHESIVE BANNERS £3.50 per pack
Each pack contains 5 sheets of banners.
(Available for Orcs, Goblins, High Elves, Dwarfs and Undead.)

CHAOS DWARFS

NEW! CHAOS DWARFS £4.99
Boxed set contains 10 plastic Chaos Dwarfs

CHAOS

NEW! CHAOS SORCERERS £2.99 each

NEW! CHAOS FAMILIARS £0.75 each

CHAOS WARRIORS £4.99
Boxed set contains 10 plastic Chaos Warriors

CHAOS WARRIOR COMMAND £2.50 each

CHAOS WARRIORS £2.25 each

CHAOS KNIGHTS £9.99

Boxed set contains 3 Chaos Knights

CHAOS KNIGHT HEROES £3.99 each

EMPIRE

REIKSGUARD KNIGHTS £2.99

PISTOLIERS £2.99

KNIGHTS OF THE WHITE WOLF £2.99

KNIGHTS PANTHER £2.99

EPIC

TITAN LEGIONS BOXED GAME £34.99

SPACE MARINE BOXED GAME £34.99

SPACE MARINE BATTLES (BOOK) £9.99

ARMIES OF THE IMPERIUM £14.99

RENEGADES (Chaos and Eldar armies) £14.99

ORK & SQUAT WARLORDS £14.99

EPIC SPACE MARINE TRANSFERS £3.50 per pack
Each pack contains 10 sheets of transfers

EPIC IMPERIAL TRANSFERS £3.50 per pack
Each pack contains 10 sheets of transfers

IMPERIAL

NEW! KNIGHT ERRANT £1.50 each

NEW! KNIGHT CRUSADER £1.50 each

NEW! KNIGHT PALADINS £5.99

Boxed set contains 7 plastic Knight Paladins

NEW! LEMAN RUSS £1.50 each

REAVER TITAN (Boxed set) £9.99

WARHOUND TITAN (Boxed set of 2) £9.99

MOLE £4.50 each

STORMHAMMER £4.50 each

BANEBLADE £4.50 each

SHADOWSWORD £4.50 each

ORKS

NEW! BONEBREAKAS Boxed set contains 12 plastic Bonebreakas	£5.99
NEW! LUNGBURSTAS	£1.50 each
SPLEENRIPPAS	£1.50 each
GOBSMASHA	£1.30 each
GIBLETGRINDA	£4.50 each
SKULLHAMMA	£4.50 each

SQUATS

NEW! SQUAT THUNDERFIRE CANNON	£2.25 each
SQUAT LEVIATHAN	£6.99 each

CHAOS

MORTARION	£2.50
BRASS SCORPION	£2.99

WARHAMMER 40,000

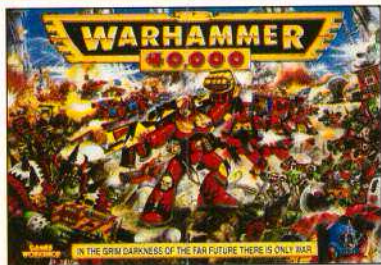

WARHAMMER 40,000 BOXED GAME	£34.99
DARK MILLENNIUM	£19.99
CODEX SPACE WOLVES	£9.99
CODEX ELДАР	£9.99
CODEX ORKS	£9.99
SUSTAINED FIRE DICE	£0.49 each
SPACE ORK BANNERS	£3.50

SPACE MARINES

NEW! SPACE MARINE CHAPLAINS	£2.99 each
NEW! SPACE MARINE LAND SPEEDER (Boxed Set)	£17.99 each
SPACE MARINES	£1.50 each

ELDAR

ELDAR SHRIEKER JETBIKE (Boxed Set)	£5.99
ELDAR JETBIKE (Boxed Set)	£4.99

IMPERIAL GUARD

NEW! CATACHAN JUNGLE FIGHTERS Boxed set contains 10 Catachan Jungle Fighters	£11.99
LEMAN RUSS (Boxed Set)	£14.99
ADEPTUS ARBITES	£1.50
ADEPTUS ARBITES CHAMPION	£2.25
ADEPTUS ARBITES GRENADE LAUNCHER	£2.25

ORKS

NOBZ WARBIKE	£4.50
ORK WARBIKE	£4.50

BLOOD BOWL

BLOOD BOWL BOXED GAME	£29.99
DEATH ZONE	£14.99
BLOCKING DICE	£0.49 each
NEW! HALFLINGS	£1.15 each
NEW! SKAVEN MUTANTS	£1.15 each

TALISMAN

TALISMAN BOXED GAME	£29.99
TALISMAN – CITY OF ADVENTURE	£14.99
TALISMAN – DUNGEON OF DOOM	£14.99

WHITE DWARF SUBSCRIPTIONS

UK, EUROPE, & THE REST OF THE WORLD

UK & BFPO: £27.50 for one year (12 issues).
EUROPE: £35.

REST OF THE WORLD: £45 for one year.

Please send payments to Games Workshop Mail Order, Chewton St, Hilltop, Eastwood, NOTTINGHAM, NG16 3HY. All payments should be in pounds sterling. Please make cheques payable to Games Workshop Ltd.

If you have a Visa, Access, Mastercard or Switch you may place your subscription by phoning our Mail Order department on 01773 713213.

USA & CANADA

Please contact: White Dwarf Subscriptions, 3431 C Benson Avenue, Baltimore, Maryland 21227-1072.

For VISA and Mastercard orders, please telephone our Mail Order hotline on (410) 644 5699, Monday to Friday, 9am - 5pm EST.

Please state which issue you would like your subscription to start with.

CORRESPONDENCE

We welcome comments about White Dwarf, Games Workshop games and Citadel Miniatures. All letters except subscriptions and Mail Order should be addressed to: The Editor, White Dwarf, Games Workshop, Howard House, 16 Castle Boulevard, Nottingham NG7 1FL.

Clearly mark your envelope with the name of the game you are writing to us about. If you want a reply you *must* enclose a self-addressed stamped envelope (overseas readers should include IRCs). We receive an enormous amount of mail. We do read every letter, but it may take a little time for us to reply to you, so please be patient!

COPYRIGHTS AND TRADEMARKS

All subject matter in White Dwarf is © Copyright Games Workshop Ltd 1994. All artwork in all Games Workshop products, and all images contained therein have been produced either in-house or as work for hire. The exclusive copyright in the artwork and the images it depicts is the property of Games Workshop Ltd. © Copyright Games Workshop Ltd 1994. All rights reserved.

Registered Trademarks

The following are all registered trademarks of Games Workshop Ltd.

Armageddon, Blood Bowl, Chivalry, Citadel, the Citadel logo, Confrontation, Dark Angels, Dark Future, Deathwing, Eldar, Eldar Attack, Epic, the Games Workshop logo, Games Workshop, the GW logo, Genestealer, Realm of Chaos, Slottabase, SpaceFleet, Space Marine, Talisman, Warhammer, Warmaster, White Dwarf and the White Dwarf figure. Marauder is a registered trade mark of Marauder Miniatures Ltd. Used with permission.

Trademarks

The following are all trademarks of Games Workshop Ltd.

Aspect Warrior, Avatar, Blood Angels, Bloodletter, Bloodthirster, Daemonette, Dark Reaper, Death Zone, Dragonmasters, Dungeonquest, Exo Armour, Exarch, Eye of Terror, Farseer, Fire Dragon, Flesh Hound, Gargant, Gobbo, Great Unclean One, Gretchin, Grey Knight, Hunter Slayer, Keeper of Secrets, Khorne, Knights Panther, Leman Russ, Lichemaster, Lightning Claw, Lord of Change, Madboy, Man O' War, Mekboy, Mighty Empires, Nurgle, Nurgling, Ogryn, Old World, Ork, Painboy, Plaguebearer, Plague Fleet, Psyker, Rattling, Ravenwing, Sea of Blood, Skaven, Slaanesh, Slann, Snottling, Space Hulk, Space Wolves, Squat, Squig, Swooping Hawk, Striking Scorpion, Terminator, Thunder Hammer, Troll Slayer, Tyrannids, Tzeentch, Ultramarines, Weirdboy, Knights of the White Wolf, Worddeater.

Flame is a trademark of Flame Publications Ltd. Used with permission.

Heroquest and Space Crusade are both trademarks of Milton Bradley Games. Used with permission.

Scatter dice are UK registered design No. 2017484.

CHAOS

CHAOS SORCERERS



CHAOS SORCERER 1
73009/1



CHAOS SORCERER 2
73009/2

THE COMPLETED CHAOS WARRIOR
STANDARD BEARER CONSISTS OF:
1 x CHAOS STANDARD BEARER BODY
1 x CHAOS STANDARD TOP



CHAOS STANDARD TOP
73005/3

CHAOS WARRIORS



CHAOS CHAMPION
73005/1



CHAOS DRUMMER
73005/4



CHAOS STANDARD BEARER
73005/2

THESE MINIATURES ARE SUPPLIED WITH PLASTIC SHIELDS AND BASES



CHAOS WARRIOR 3
73201/53



CHAOS WARRIOR 4
73201/54



EXAMPLE OF COMPLETED CHAOS STANDARD BEARER

Miniatures supplied unpainted. **WARNING:** This product contains lead which may be harmful if chewed or swallowed. Citadel Miniatures are not recommended for children under 14 years of age.
© Copyright Games Workshop Ltd 1994. All rights reserved.



CITADEL
MINIATURES

Designed by Aly Morrison

EMPIRE

KNIGHTS OF THE WHITE WOLF



EXAMPLE OF A COMPLETED KNIGHT OF THE WHITE WOLF



WHITE WOLF KNIGHT 2
073764/2



WHITE WOLF KNIGHT 1
073764/1



WHITE WOLF KNIGHT 3
073764/4



KNIGHT OF THE WHITE WOLF
STANDARD BEARER
073764/5



KNIGHT'S LEGS
073764/3

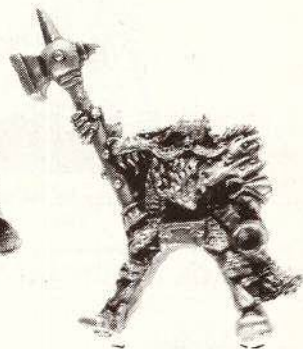

GRAND MASTER OF THE
KNIGHTS OF THE WHITE WOLF
073764/6

KNIGHTS PANTHER



EXAMPLE OF A COMPLETED KNIGHT PANTHER



KNIGHT PANTHER 1
073862/1



KNIGHT PANTHER 2
073862/2



KNIGHT PANTHER
STANDARD BEARER
073862/4



KNIGHT'S LEGS
073764/3

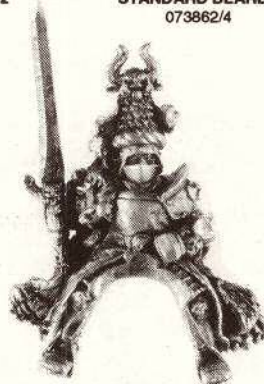

GRAND MASTER
KNIGHT PANTHER
073862/5

THESE MINIATURES ARE SUPPLIED WITH PLASTIC ARMoured HORSES AND THE APPROPRIATE PLASTIC SHIELD AS STANDARD

Minatures supplied unpainted. **WARNING.** This product contains lead which may be harmful if chewed or swallowed. Citadel Miniatures are not recommended for children under 14 years of age. © Copyright Games Workshop Ltd 1992. All rights reserved.



Designed by Alan and Michael Perry

WARHAMMER

INCLUDES
FULL-COLOUR
SELF-ADHESIVE
BANNERS

HIGH ELF LORD OF THE DRAGONS



Model supplied unpainted.



CITADEL
MINIATURES

Prince Imrik is the greatest High Elf warrior of the age. He leads his Dragon to the attack, plunging to the ground with the destructive fury of a lightning bolt. The great scaly beast seizes upon his victims and tears them limb from limb as Prince Imrik pierces the enemy ranks with his devastating Star Lance.

WARNING! This product contains lead and may be harmful if chewed or swallowed. Citadel Miniatures are not recommended for children under 14 years of age. This is a multi-part expert kit which requires a degree of modelling skill to assemble. We do not recommend this kit for young or inexperienced modellers.

Games Workshop, Citadel, Warhammer and the Citadel castle are registered trademarks of Games Workshop Ltd.

© Games Workshop Ltd, 1994. All rights reserved.

GAMES
WORKSHOP

WARHAMMER

NEW BOXED SETS

These two new boxed sets each contain ten highly detailed plastic Citadel Miniatures.



Models supplied unpainted.

Miniatures designed by Dave Andrews.

CHAOS WARRIORS



Models supplied unpainted.

Miniatures designed by Alan Perry.

CHAOS DWARFS

These models require assembly. We recommend that the models are carefully removed from the plastic sprue with a sharp modelling knife and that they are undercoated before painting with Citadel Paints. These Citadel miniatures are moulded in a hard styrene compound which is particularly suited for painting and modelling.

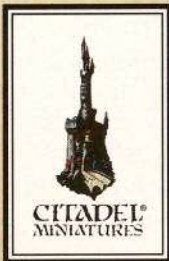

Citadel Miniatures are not recommended for Children under 14 years of age.
Games Workshop, the Games Workshop logo, Citadel, Warhammer and the Citadel castle are registered trademarks of Games Workshop Ltd.
© Games Workshop Ltd, 1994. All rights reserved.

**GAMES
WORKSHOP**

EPIC ORKS

LUNGBURSTA



LUNGBURSTA
76251

GIBLET GRINDA

THE COMPLETE GIBLET GRINDA CONSISTS OF

- 1 x GIBLET GRINDA CHASSIS
- 1 x GIBLET GRINDA TOWER
- 2 x GIBLET GRINDA TURRET



EXAMPLE OF A COMPLETED GIBLET GRINDA



GIBLET GRINDA
TOWER
76230/5



GIBLET GRINDA
TURRET
76230/6



GIBLET GRINDA
CHASSIS
76230/4



GIBLET GRINDA
TURRET
76230/6

SKULLHAMMA

THE COMPLETE SKULLHAMMA CONSISTS OF

- 1 x SKULLHAMMA CHASSIS
- 1 x SKULLHAMMA BOILER
- 2 x SKULLHAMMA TURRET

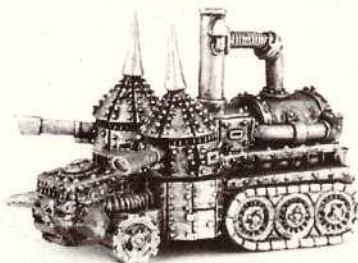

EXAMPLE OF A COMPLETED SKULLHAMMA



SKULLHAMMA
BOILER
76231/2



SKULLHAMMA
TURRET
76230/4



SKULLHAMMA
CHASSIS
76231/1



SKULLHAMMA
TURRET
76230/4

EPIC CHAOS

BRASS SCORPION

THE COMPLETE BRASS SCORPION CONSISTS OF

- 1 x BRASS SCORPION CHASSIS
- 1 x BRASS SCORPION CANNON
- 2 x POWER SAWS

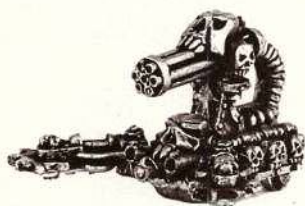

EXAMPLE OF A COMPLETED BRASS SCORPION



BRASS SCORPION
CANNON
76544/11



POWER
SAW
76544/12

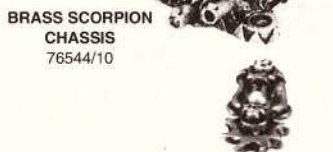

BRASS SCORPION
CHASSIS
76544/10



POWER
SAW
76544/12

MORTARION



MORTARION
76506/20

Miniatures supplied unpainted. WARNING: This product contains lead which may be harmful if chewed or swallowed. Citadel Miniatures are not recommended for children under 14 years of age. © Copyright Games Workshop Ltd 1994. All rights reserved.



CITADEL
MINIATURES

IMPERIAL TITANS

REAVER TITANS

A COMPLETE REAVER TITAN

CONSISTS OF:

- 1 x HEAD
- 2 x SHOULDER GUARD
- 1 x CARAPACE
- 2 x FEET
- 1 x LEGS
- 3 x WEAPONS



EXAMPLES OF COMPLETED REAVER TITANS

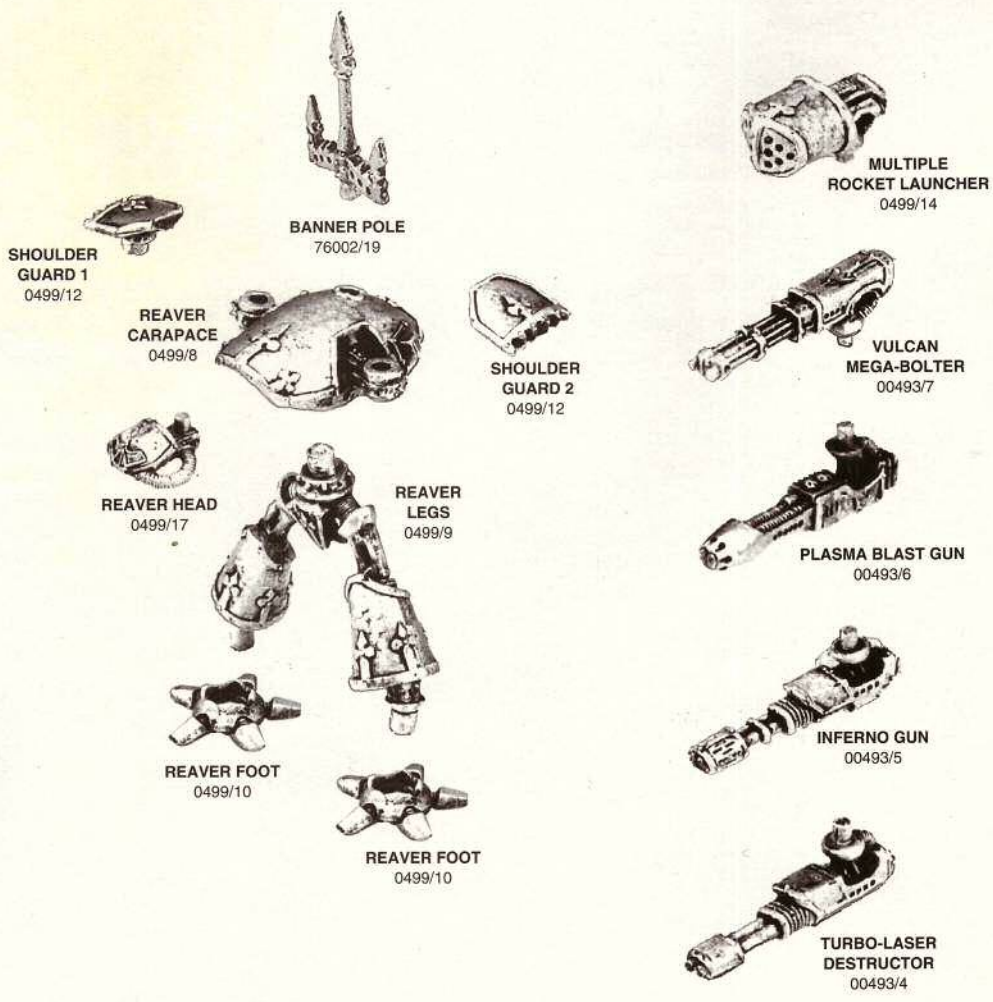

Miniatures supplied unpainted. **WARNING:** This product contains lead which may be harmful if chewed or swallowed. Citadel Miniatures are not recommended for children under 14 years of age.
 © Copyright Games Workshop Ltd 1994. All rights reserved.



EPIC® IMPERIAL

WARHOUND TITANS

A COMPLETE WARHOUND TITAN CONSISTS OF:
1 x HEAD AND TORSO
2 x WEAPONS
1 x LEGS
1 x CONNECTING RING



EXAMPLES OF COMPLETED WARHOUND TITANS

VULCAN MEGA-BOLTER
00493/7



TORSO AND HEAD
076015/2



PLASMA BLASTGUN
00493/6



INFERNO GUN
00493/5



CONNECTING RING
076015/3



TURBO-LASER DESTRUCTOR
00493/4

LEGS 1
076015/1



LEGS 2
00493/8



Designed by Jes Goodwin

KNIGHT ERRANT



EXAMPLE OF A COMPLETED KNIGHT ERRANT

A COMPLETE KNIGHT ERRANT CONSISTS OF:
1 x ERRANT BODY
1 x THERMAL CANNON
1 x POWER FIST

THERMAL CANNON
76008/2



POWER FIST
76008/3



ERRANT BODY
76008/1



KNIGHT CRUSADER



EXAMPLE OF A COMPLETED KNIGHT CRUSADER

A COMPLETE KNIGHT CRUSADER CONSISTS OF:
1 x CRUSADER BODY
1 x LASCANNON
1 x QUAKE CANNON

LASCANNON
76009/2



QUAKE CANNON
76008/3



CRUSADER BODY
76008/1

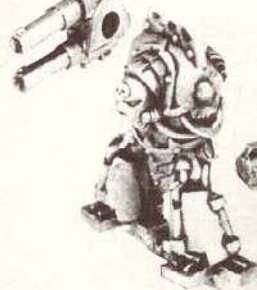

Designed by Dave Andrews

Miniatures supplied unpainted. WARNING: This product contains lead which may be harmful if chewed or swallowed. Citadel Miniatures are not recommended for children under 14 years of age.
© Copyright Games Workshop Ltd 1994. All rights reserved.



CITADEL
MINIATURES

EPIC® IMPERIAL

BANEBLADE

A COMPLETE BANEBLADE CONSISTS OF:
 1 x BANEBLADE TURRET
 1 x BANEBLADE CHASSIS
 2 x SPONSON TURRETS 1



EXAMPLE OF A COMPLETED BANEBLADE

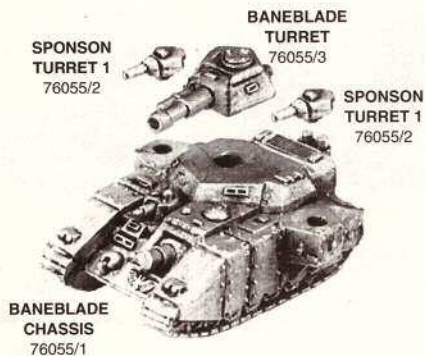

SHADOW SWORD

A COMPLETE SHADOW SWORD CONSISTS OF:
 1 x SHADOW SWORD CHASSIS
 1 x VOLCANO CANNON
 2 x SPONSON TURRETS 2



EXAMPLE OF A COMPLETED SHADOW SWORD

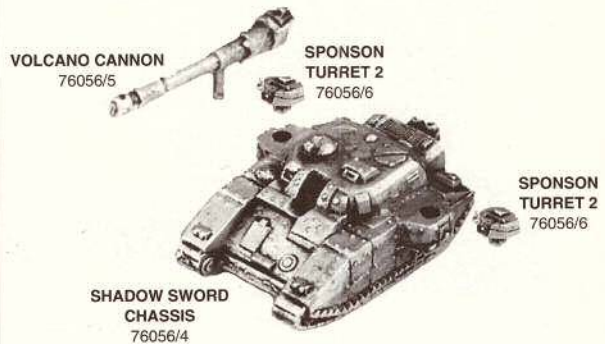

STORMHAMMER

THE COMPLETE STORMHAMMER CONSISTS OF
 2 x STORMHAMMER TURRETS
 4 x SPONSON TURRETS 2
 1 x STORMHAMMER CHASSIS



EXAMPLE OF A COMPLETED STORMHAMMER

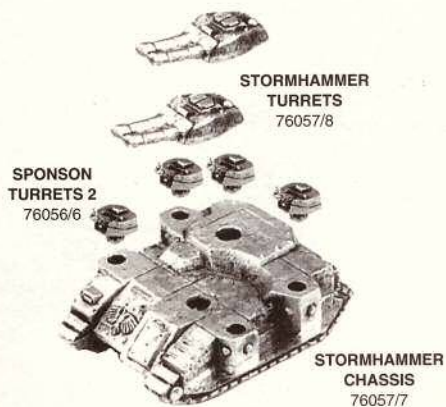

IMPERIAL MOLE

THE COMPLETE IMPERIAL MOLE CONSISTS OF
 1 x MOLE
 1 x TRANSPORTER
 1 x LAUNCH RAMP
 1 x HYDRAULIC PISTON

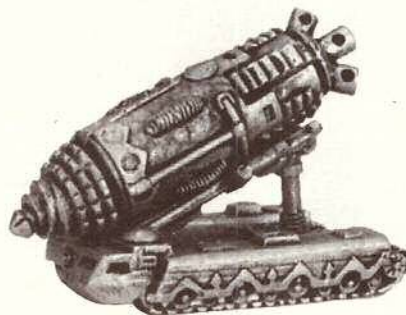

EXAMPLE OF A COMPLETED IMPERIAL MOLE

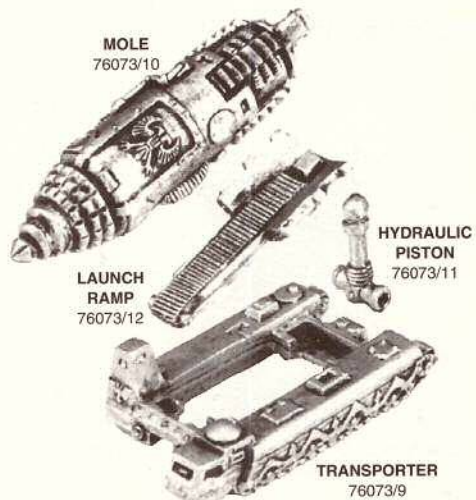

Miniatures supplied unpainted. **WARNING:** This product contains lead which may be harmful if chewed or swallowed. Citadel Miniatures are not recommended for children under 14 years of age.
 © Copyright Games Workshop Ltd 1994. All rights reserved.



IMPERIAL TANKS

LEMAN RUSS BATTLE TANK

A COMPLETE LEMAN RUSS
BATTLE TANK CONSISTS OF:
1 x TURRET
1 x CHASSIS



EXAMPLE OF A COMPLETED
LEMAN RUSS

COMMAND TURRET
0496/3



LEMAN RUSS CHASSIS
0496/1

RECOVERY TURRET
0496/5



LEMAN RUSS RECOVERY CHASSIS
0496/2

STANDARD TURRET
0496/4



LEMAN RUSS CHASSIS
0496/1

Designed by Norman Swales

EPIC® SQUATS

LEVIATHAN

THE COMPLETE LEVIATHAN CONSISTS OF:
1 x CHASSIS RIGHT
1 x CHASSIS LEFT
1 x BATTLE TOWER
1 x BATTLECANNON
1 x DOOMSDAY CANNON

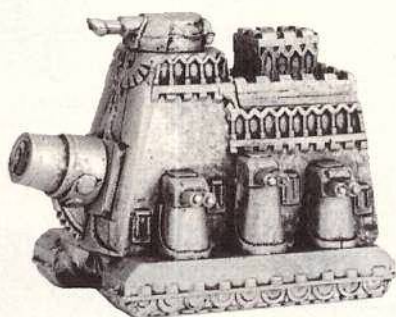

EXAMPLE OF A COMPLETED LEVIATHAN

BATTLECANNON
76113/4



DOOMSDAY
CANNON
76113/3

CHASSIS
RIGHT
76113/2



BATTLE
TOWER
76113/5

CHASSIS
LEFT
76113/1

THUNDERFIRE CANNON

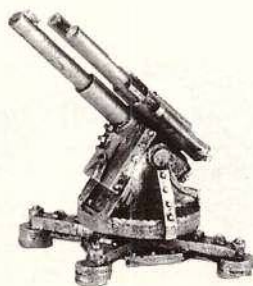

EXAMPLE OF A COMPLETED THUNDERFIRE CANNON

THE COMPLETE SQUAT THUNDERFIRE
CANNON CONSISTS OF
1 x CANNON BASE
1 x UPPER CANNON
1 x LOWER CANNON

UPPER
CANNON
76747/3



LOWER
CANNON
76747/2



CANNON
BASE
76747/1

Miniatures supplied unpainted. WARNING: This product contains lead which may be harmful if chewed or swallowed. Citadel Miniatures are not recommended for children under 14 years of age. © Copyright Games Workshop Ltd 1994. All rights reserved.



CITADEL
MINIATURES

Designed by Norman Swales

SPACE MARINES®

SPACE MARINE LAND SPEEDER

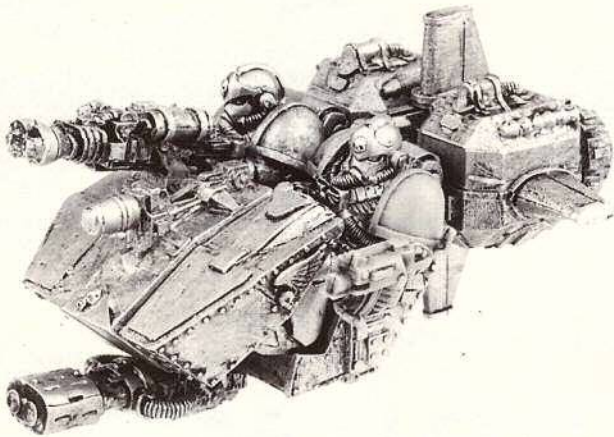

EXAMPLE OF A COMPLETED SPACE MARINE LAND SPEEDER

- THE COMPLETED SPACE MARINE LAND SPEEDER CONSISTS OF**
- 1 x SPACE MARINE PILOT
 - 1 x SPACE MARINE GUNNER
 - 1 x HEAVY FLAMER
 - 1 x MULTIMELTA
 - 1 x LAND SPEEDER CHASSIS
 - 1 x LAND SPEEDER FOOT REST
 - 1 x STABILISER FIN
 - 1 x LEFT FAIRING
 - 1 x RIGHT FAIRING
 - 2 x ENGINE NOZZLES
 - 2 x LAND SPEEDER SEATS
 - 2 x LAND SPEEDER BACK RESTS
 - 1 x PLASTIC CHARACTER EQUIPMENT SPRUE
 - 1 x ENGINE POD TOP
 - 1 x ENGINE POD BOTTOM
 - 1 x PLASTIC FLYING BASE

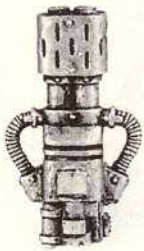

MULTIMELTA
00439/13

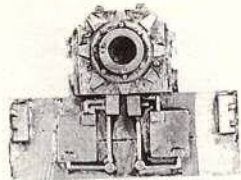

LAND SPEEDER FOOT REST
00439/8



RIGHT FAIRING
00439/7



LEFT FAIRING
00439/6



HEAVY FLAMER
00439/14



ENGINE POD BOTTOM
00439/4



SPACE MARINE PILOT
00439/2



SPACE MARINE GUNNER
00439/1



ENGINE POD TOP
00439/5



BACK REST
00439/11

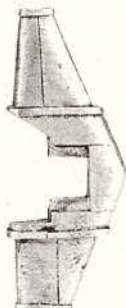

STABILISER FIN
00439/9

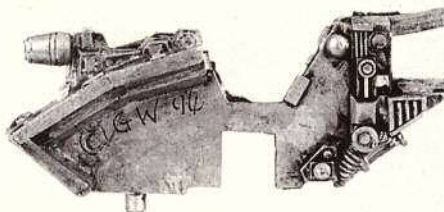

CHASSIS
00439/3



SEAT
00439/10



ENGINE NOZZLE
00439/12

Miniatures supplied unpainted. **WARNING:** This product contains lead which may be harmful if chewed or swallowed. Citadel Miniatures are not recommended for children under 14 years of age. © Copyright Games Workshop Ltd 1994. All rights reserved.



SPACE MARINES[®]

ASSEMBLY STAGE 1

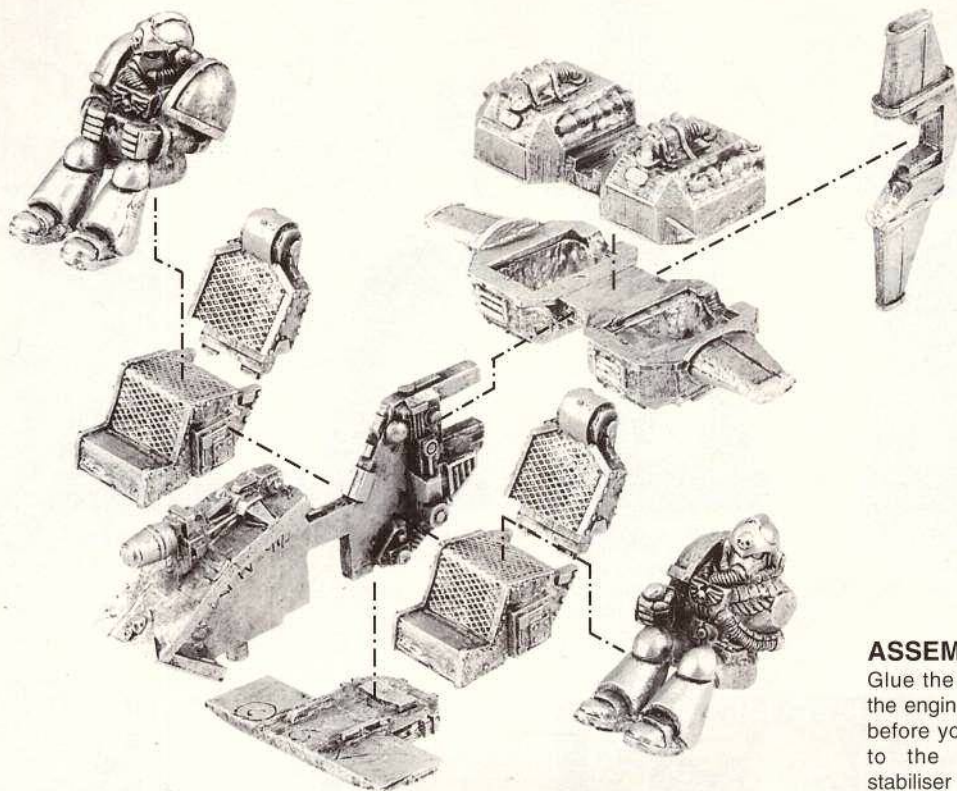

ASSEMBLY NOTE

Glue the two halves of the engine pod together before you attach them to the chassis and stabiliser fin.

ASSEMBLY STAGE 2

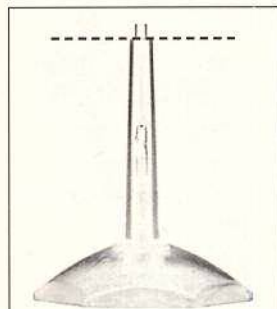

ASSEMBLY NOTE

To ensure that your model remains stable, carefully remove the pin at the top of the flying base with a sharp modelling knife, as shown above. Then glue your finished model to the base.

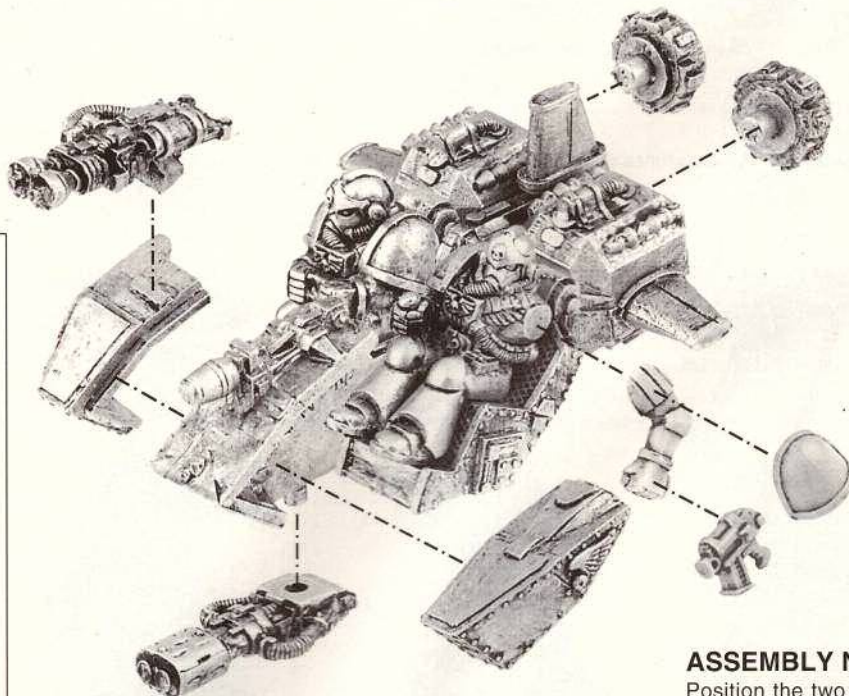

ASSEMBLY NOTE

Position the two Space Marine crew members onto your Land Speeder before you attach the fairings to your model.

Miniatures supplied unpainted. **WARNING:** This product contains lead which may be harmful if chewed or swallowed. Citadel Miniatures are not recommended for children under 14 years of age.
© Copyright Games Workshop Ltd 1994. All rights reserved.



CITADEL
MINIATURES

SPACE MARINES®

SPACE MARINE CHAPLAINS



CHAPLAIN 1
70701/3



CHAPLAIN 2
70101/2



CHAPLAIN 3
70101/1



CHAPLAIN 4
70101/4

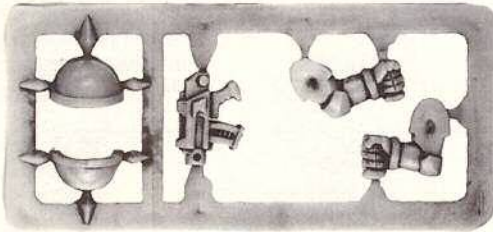

CHARACTER EQUIPMENT SPRUE
102533

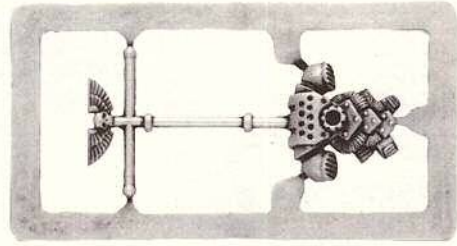

CHARACTER BACKPACK SPRUE
102532

EACH OF THESE MINIATURES IS SUPPLIED WITH A PLASTIC CHARACTER EQUIPMENT SPRUE AND A PLASTIC CHARACTER BACKPACK SPRUE ALLOWING A VARIETY OF POSES



EXAMPLES OF COMPLETED SPACE MARINE CHAPLAINS

Minatures supplied unpainted. **WARNING:** This product contains lead which may be harmful if chewed or swallowed. Citadel Miniatures are not recommended for children under 14 years of age. © Copyright Games Workshop Ltd 1994. All rights reserved.



CITADEL
MINIATURES

SPACE MARINES®



SPACE MARINE
MK2 'CRUSADE' ARMOUR
70106/45



SPACE MARINE
MK3 'IRON' ARMOUR
70106/44



SPACE MARINE
MK4 'MAXIMUS' ARMOUR
70106/47



SPACE MARINE
MK5 'HERESY' ARMOUR
70106/46



SPACE MARINE
MK6 ARMOUR 1
70106/48

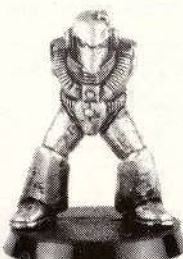

SPACE MARINE
MK6 ARMOUR 2
70106/49



SPACE MARINE
MK6 ARMOUR 3
70119/42



SPACE MARINE
MK6 ARMOUR 4
70119/43



SPACE MARINE
MK7 ARMOUR 1
70106/50



SPACE MARINE
MK7 ARMOUR 2
70106/51



SPACE MARINE
MK7 ARMOUR 3
0819/1



SPACE MARINE
MK7 ARMOUR 4
0819/2



SPACE MARINE
MK7 ARMOUR 5
70106/55



SPACE MARINE
MK7 ARMOUR 6
70106/56



SPACE MARINE
MK7 ARMOUR 7
70106/54



SPACE MARINE
MK8 'ERRANT' ARMOUR
70106/57

THESE MINIATURES ARE SUPPLIED WITH A SEPARATE PLASTIC SPACE MARINE ARM SPRUE AND A SPACE MARINE BOLTER AND BACKPACK SPRUE.



EXAMPLES OF COMPLETED MK7, MK6 AND MK3 SPACE MARINES.

Miniatures supplied unpainted. WARNING. This product contains lead which may be harmful if chewed or swallowed. Citadel Miniatures are not recommended for children under 14 years of age. © Copyright Games Workshop Ltd. 1994. All rights reserved.



IMPERIAL

ADEPTUS ARBITES



ADEPTUS ARBITES
WITH BOLTER
72400/2



ADEPTUS ARBITES
CHAMPION WITH SHOTGUN
72401/3



ADEPTUS ARBITES WITH
GRENADE LAUNCHER
74201/4



ADEPTUS ARBITES
WITH SHOTGUN
72400/1

Designed by Jes Goodwin

IMPERIAL GUARD

CATACHAN JUNGLE FIGHTERS



JUNGLE FIGHTER
WITH LASGUN 1
0437/2



JUNGLE FIGHTER
WITH LASGUN 2
0437/3



JUNGLE FIGHTER
SERGEANT 1
0437/4



JUNGLE FIGHTER
WITH MELTA-GUN
0437/6



JUNGLE FIGHTER
WITH LASGUN 3
0437/5



JUNGLE FIGHTER
WITH LASGUN 4
0437/1



JUNGLE FIGHTER
MISSILE LOADER
0437/7



JUNGLE FIGHTER
WITH MISSILE LAUNCHER
0437/8



MISSILE
LAUNCHER
STAND
0437/10



MISSILE LAUNCHER
0437/9

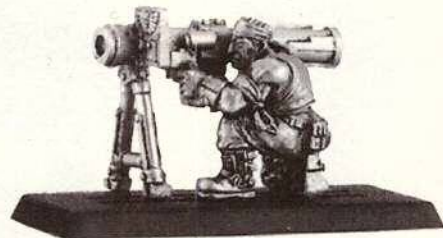

EXAMPLE OF COMPLETED JUNGLE FIGHTER WITH
MISSILE LAUNCHER

Minatures supplied unpainted. **WARNING:** This product contains lead which may be harmful if chewed or swallowed. Citadel Miniatures are not recommended for children under 14 years of age.
© Copyright Games Workshop Ltd 1994. All rights reserved.



Designed by Michael Perry

ORK WARBIKES



THE COMPLETE NOBZ WARBIKE

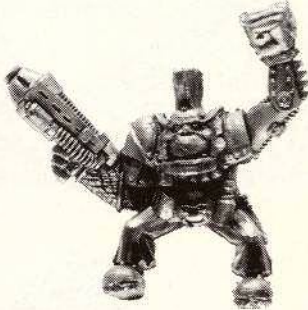

NOB PASSENGER WITH PLASMA GUN
070598/5



PASSENGER SEAT WITH BANNER POLE
070598/6

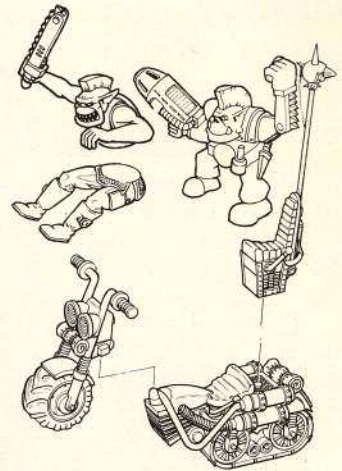

THE COMPLETE NOBZ WARBIKE CONSISTS OF:
 1 x BIKE CHASSIS
 1 x DRIVER
 1 x NOB PASSENGER WITH PLASMA GUN
 1 x PASSENGER SEAT WITH BANNER POLE
 PLEASE STATE WHICH DRIVER YOU REQUIRE WHEN ORDERING.

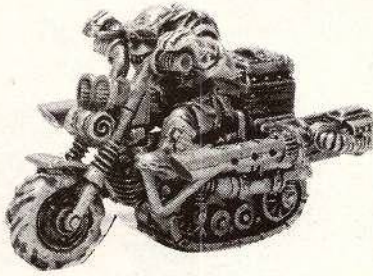

THE COMPLETE ORK WARBIKE

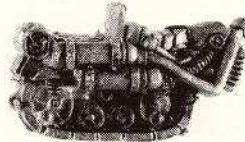

BIKE CHASSIS
070598/1



HANDLE BARS
070546/2



DRIVER WITH CHAINWORD
070598/4



DRIVER'S LEGS
070546/4

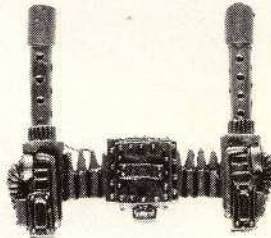

DUAL AUTO CANNONS
070598/2

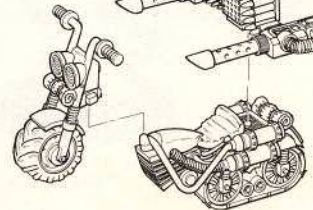
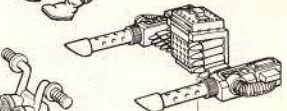

THE COMPLETE ORK WARBIKE CONSISTS OF:
 1 x BIKE CHASSIS
 1 x DRIVER
 1 x DUAL AUTO CANNONS
 PLEASE STATE WHICH DRIVER YOU REQUIRE WHEN ORDERING.



DRIVER 1
070598/3



DRIVER 2
070546/5



DRIVER 3
070546/1

Minatures supplied unpainted. WARNING. This product contains lead which may be harmful if chewed or swallowed. Citadel Miniatures are not recommended for children under 14 years of age.
 © Copyright Games Workshop Ltd 1994. All rights reserved.



CITADEL
MINIATURES

BLOOD BOWL®

HALFLINGS



HALFLING 1
73517/2

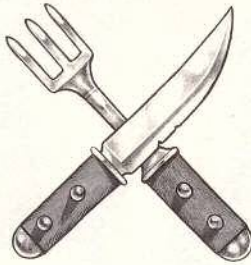

HALFLING 2
73517/1



HALFLING 3
73517/3



HALFLING 4
73517/5



HALFLING 5
73517/6



HALFLING 6
73517/4

SKAVEN MUTANTS



EXTRA ARMS
73518/2



BIG HAND
73518/4

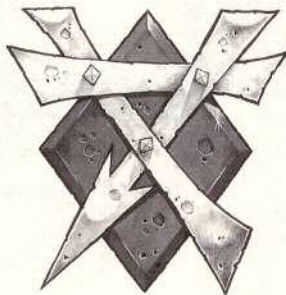

CLAW
73518/3



VERY LONG LEGS
73518/5

Minatures supplied unpainted. **WARNING:** This product contains lead which may be harmful if chewed or swallowed. Citadel Miniatures are not recommended for children under 14 years of age.
© Copyright Games Workshop Ltd 1994. All rights reserved.



WARHAMMER

WHITE
DWARF
PRESENTS



WARHAMMER CHAOS DWARFS



CHAOS DWARFS

The Chaos Dwarfs are a vile, black-hearted race, forever waging war in their relentless search for victims to enslave.



Shrouded by the smoke of a thousand forges, the foul empire of the Chaos Dwarfs lies deep inside the Dark Lands.

Far below the bitter earth, the tortured slaves labour in heavy chains, endlessly seeking out precious metals and minerals for their evil masters' plans and desires.

ARMY LIST

This full-colour book is a compilation of all the Chaos Dwarf articles first printed in White

Dwarf magazine plus additional unpublished material. These include rules for new Chaos Dwarf characters, the full range of Chaos Dwarf troops and war machines, a complete Chaos Dwarf army list and an exciting Warhammer battle report.



WARHAMMER CHAOS DWARFS IS NOT A COMPLETE GAME. YOU WILL NEED A COPY OF WARHAMMER TO USE THE CONTENTS OF THIS BOOK.

The Games Workshop logo and the Warhammer logo are registered trademarks of Games Workshop Ltd.

Citadel, Games Workshop and 'Eavy Metal are trademarks of Games Workshop Ltd.

© Games Workshop Ltd, 1994. All rights reserved.

**GAMES
WORKSHOP**



PRINCE IMRIK LEADS AN ATTACK BY AN ARMY OF HIGH ELVES AGAINST THE MALEVOLENT CHAOS DWARFS