

# GAMES WORKSHOP

PRESENTS ITS MONTHLY HOBBY SUPPLEMENT AND MINIATURES CATALOGUE



CITADEL  
MINIATURES

176  
£2.25

# WHITE DWARF



ISSN 0265-8712



08

9 770265 871028



THE IMPERIAL GUARD AND AN ELDAR WAR HOST CLASH AMONGST THE RUINS OF A CITY



A SKAVEN FORCE AMBUSH A HIGH ELF ARMY

## CONTENTS

### COVER: TALISMAN — *Geoff Taylor*

#### GW AND CITADEL NEWS

All the latest news from Games Workshop and Citadel Miniatures.

2

#### 'EAVY METAL — *Studio 'Eavy Metal Team*

The Skavenblight Scramblers Blood Bowl team.

8

#### THE KILLING FIELD — *Gavin Thorpe and Carl Brown*

The crunch of bone drowns out the roar of the crowds as we report on a recent **Blood Bowl** game between the Orcs of Da Deff Skwadd and the mighty Champions of Death.

9

#### 'EAVY METAL — *Studio 'Eavy Metal Team*

Chaos Beastmen

24

Chaos Knights

25

Undead Characters

32

#### MODELLING GUIDE — *Mike McVey*

With the release of the new **Warhammer Armies — Chaos** book, Mike takes a look at how to convert models with Chaos mutations and shows how he created his stunning Chaos Dragon.

26

#### GAMES DAY '94

Games Day '94 is going to be the largest ever Games Workshop convention. Here's everything you need to know about what's on and how to get there.

33

#### ORK CHARACTERS — *Jervis Johnson*

Jervis takes a detailed look at two infamous Ork characters — Zodgrod Wortsnagga and Ghazghkull Thraka — and provides special rules and wargear cards for including them in your **Warhammer 40,000** games.

38

#### 'EAVY METAL — *Studio 'Eavy Metal Team*

Ghazghkull Thraka and Zodgrod Wortsnagga

39

Blood Axe Kommandos

41

The new Ork Smasha Gun and the Evil Sunz

42

#### MODELLING WORKSHOP: ORK BUILDINGS — *Adrian Wild and Simon Tift*

Adrian and Simon give us the lowdown on the finer points of Orkitekture in this complete guide to modelling Ork buildings and settlements for your games of **Warhammer 40,000**.

47

#### A CHRONICLE OF BLOOD — *Jeremy Vetock and Richard Helliwell*

A brave force of Dwarfs stand firm in the face of a marauding Chaos horde in this exciting **Warhammer** battle report that showcases the new **Warhammer Armies — Chaos** rules and magic.

54

#### ADVERTS

Eldar Dreadnought.....3	Eldar War Walker.....37
Snakebite Ork Boarboyz.....7	Sun, Squigs and Stormbolters.....44
Champions of Death.....11	Grand Opening — Exeter.....46
Naggaroth Nightmares.....12	Games Workshop — Battle Days.....52
Games Workshop — Retail Stores.....22	Games Workshop Mail Order.....70
Games Day '94.....33	Citadel Miniatures Catalogue.....75



# WARHAMMER

Let the world beware! This month sees the release of the new Chaos Supplement for Warhammer.

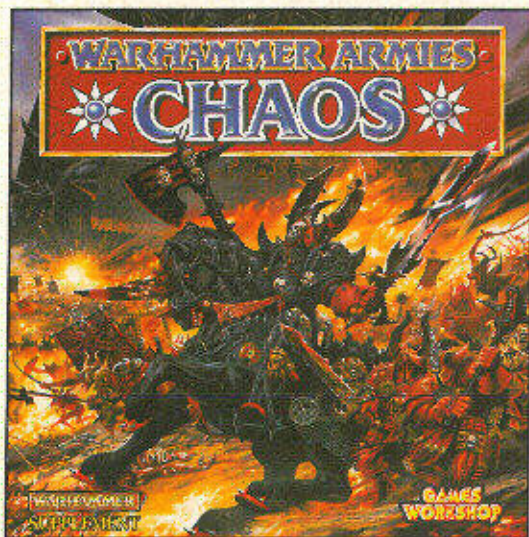

## CHAOS

The forces of Chaos are about to be unleashed across the battlefields of the Old World in the form of Warhammer Armies - Chaos. This boxed release not only contains a complete Warhammer Armies book but also dozens of full-colour cards and

counters. These include spell decks for three of the Chaos Powers, Chaos Gifts and Rewards and new Chaos Magic Items. The book contains a complete army list for the forces of Chaos together with a selection of special characters.

From Citadel Miniatures come the first in a whole series of Chaos models in the form of three new Chaos Knights, new Chaos Beastmen and a Beastmen command group. All of these miniatures are shown in the 'Eavy Metal pages in this White Dwarf.

Elsewhere in this issue, our battle report features a bitter struggle between a Chaos army and a stalwart Dwarf force, plus we have special feature from Mike McVey on modelling Chaos Spawn.

## THIS MONTH'S WARHAMMER RELEASES

Warhammer Armies - Chaos (Boxed set with Armies book)	£14.99
Chaos Knights (Three miniatures per box)	£9.99
Beastmen (10 miniatures per box)	£4.99
Beastmen Command Group (Three miniatures per blister)	£4.50
Beastman Shaman (One miniature per blister)	£2.50
Nagash (One miniature per box)	£9.99
Necromancer (One miniature per blister)	£2.50
Zombie Dragon (One miniature per box)	£14.99
Skaven Jezzail (One team per blister)	£4.50
Warhammer Combat Cards (Single Pack)	£1.99
Orc and Goblin Combat Cards (Single Pack)	£1.99

## UNDEAD

This month sees the release the Nagash Lord of the Undead, a great new Necromancer, and a fearsome Zombie Dragon ridden by a Wight Lord. Designed by Gary Morley, with the Zombie Dragon by Trish Morrison, rules for these powerful Undead creatures are in the Warhammer Armies - Undead. All these models are featured on 'Eavy Metal Pages elsewhere in this issue.

# GAMES WORKSHOP

## TELESALES OPPORTUNITIES

*Do you want an exciting career in Telesales? Are you young, articulate with a good knowledge of Games Workshop products?*

We are currently seeking to recruit ambitious, personable and enthusiastic young people to join our full-time Telesales team at our Head Office in Eastwood. Previous Telesales experience is not a pre-requisite, but applicants must be of 'A' level calibre, show initiative and be of a cheery disposition. A knowledge of Games Workshop's products is imperative!

If you feel you meet these requirements and you are ready for a new challenge and a new career then we would like to hear from you. Please write giving full details of your educational background, employment history and gaming knowledge to:

Helen King, REF: 009, Games Workshop Limited, Chewton Street, Hilltop, Eastwood, Nottingham NG16 3HY.  
Closing date: 25 July 1994.

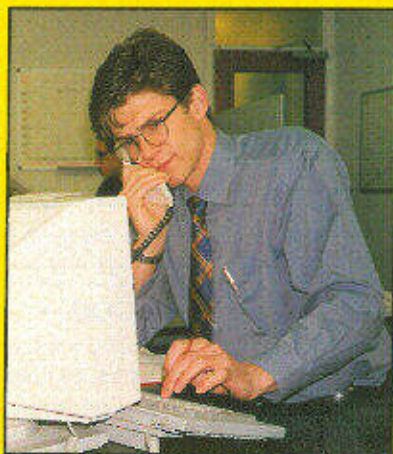

# WARHAMMER

## 40,000

# ELDAR® DREADNOUGHT™



Controlled by the spirit of a fallen Eldar warrior, and armed with a variety of deadly heavy weapons, Eldar Dreadnoughts are towering, mechanised engines of destruction.

Protected by their tough wraithbone armour, they stride over difficult terrain with ease, ready to strike deep at the heart of the enemy's force.



Miniature supplied unpainted

Miniature designed by Jes Goodwin

WARNING! This product contains lead and may be harmful if chewed or swallowed.

Citadel Miniatures are not recommended for children under 14 years of age.

This is a Citadel Miniatures Expert kit which requires a degree of modelling skill. We do not recommend this kit for young or inexperienced modellers.

This model requires assembly. We recommend that the parts are cleaned and trimmed with a modelling knife before being painted with Citadel paints.

Citadel, the Citadel castle, Eldar, Games Workshop and Warhammer are registered trademarks of Games Workshop Ltd. Dreadnought is a trademark of Games Workshop Ltd. © Games Workshop Ltd, 1994. All rights reserved.



**GAMES  
WORKSHOP**



THIS BOXED SET  
CONTAINS AN  
ELDAR  
TR  
MS

# WARHAMMER 40,000

Following last month's publication of the Codex - Orks, this month sees the release of the latest addition to the Ork army in the form of the Blood Axe Kommandos and the devastating Smasha Gun.

## KOMMANDOS

The Blood Axe clan are distrusted and despised by all other Orks clans due to the fact that they deal with 'filthy

humies' and trade with the Rogue Traders for weapons and equipment. However, this also means that they are a force to be reckoned with.

In keeping with their underhand methods, Blood Axes use special Kommando troops to infiltrate the enemy lines and make hit and run attacks against opposing troops. These deadly Ork Boyz are now available and are featured on an 'Eavy Metal page in

this issue together with the awesome new Ork Smasha Gun. We also have full rules for two Ork characters, Zogrod Wortsnaga and Ghazghkuff Thraka.

### THIS MONTH'S WARHAMMER 40,000 RELEASES

Zogrod Wortsnaga	£4.99
Snakebite Runmaster (One per blister)	
Blood Axe Kommandos (Three per blister)	£4.50
Ork Smasha Gun (One per blister)	£7.99
Assault Space Marines (One per blister)	£2.50

## TITAN LEGIONS NEARS COMPLETION

The lights are burning late in the Games Workshop to put the finishing touches to **Titan Legions**. Andy Chambers' long-awaited expansion to the **Epic** game system.

**Titan Legions** is a part of Games Workshop's **Epic** games system and is fully compatible with **Space Marine** and all of its supplements. The **Epic** system enables you to recreate the massive battles of the 41st Millennium with hundreds of model tanks and infantry and vast numbers of devastating war machines.

**Titan Legions** adds the awesomely destructive power of Emperor Titans and Ork Mega-Gargants to the already huge range of models available to **Epic** players.

The new Emperor Titans are massive fighting machines as tall as skyscrapers. Each one carries an arsenal of deadly weapons powered by the fury of its plasma reactor, and they are protected by energy shields and metres-thick armour. The ground trembles before these steel giants and whole cities are reduced to rubble by the earth-shattering energies of their weapons.

As well as the Emperor Titan, this exciting new game will contain two giant Ork Mega-Gargants, new Imperial Knights and Ork Bonebreaka tanks and 10 full-colour card buildings. These new **Epic** buildings have to be seen to be believed and we'll be bringing you a preview as soon as we have some colour proofs back from the printers.

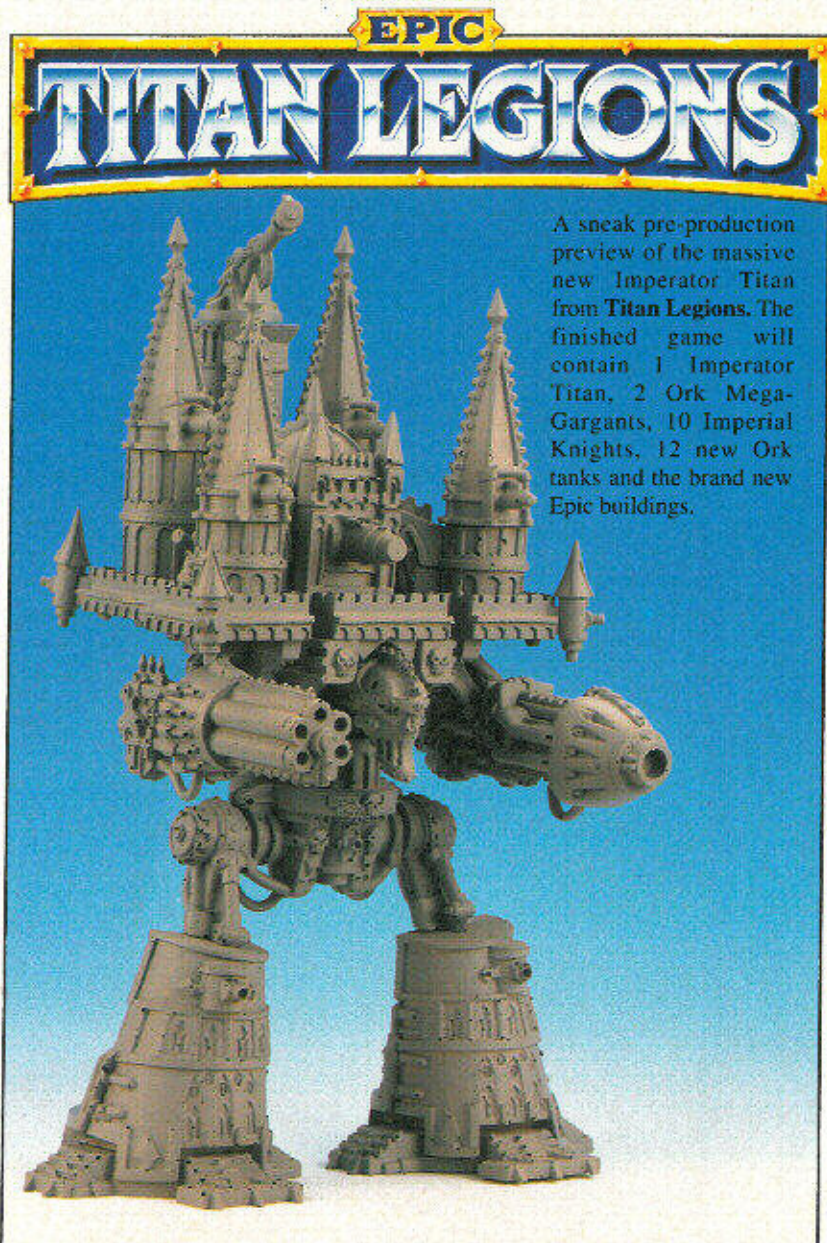

A sneak pre-production preview of the massive new Emperor Titan from **Titan Legions**. The finished game will contain 1 Emperor Titan, 2 Ork Mega-Gargants, 10 Imperial Knights, 12 new Ork tanks and the brand new **Epic** buildings.



# WHITE DWARF



## FREE 'EAVY METAL POSTER

Inside next month's issue of **White Dwarf** you'll find a great free **White Dwarf 'Eavy Metal** wall poster.

Games Workshop master painter **Mike McVey** has been working hard for months to update the entire Citadel range of acrylic paints. This has involved blending dozens of new colours and tints and extensively testing them on a whole range of plastic and metal miniatures. The results of his work are about to be released in the form of the brand new range of **Citadel Miniatures Paint Sets**.

These make up the most extensive range of specially-formulated acrylic

paints ever made available to miniature painters, gamers and hobbyists.

To accompany this release, Mike has created a full colour **White Dwarf 'Eavy Metal** poster that shows the complete new range of Citadel Colour.

The poster also explains with a simple table how to go about mixing the new colours in order to shade and highlight your miniatures.

Fully-illustrated with dozens of beautifully painted miniatures, the **White Dwarf 'Eavy Metal** poster is the **FREE!** only in next month's **White Dwarf** magazine, so order your copy now.



# BLOOD BOWL

## STUDIO BLOOD BOWL LEAGUE

In the Studio Blood Bowl league, Citadel designer Gary Morley's **Morley's Marauders** beat Simon Smith's **Dwarfs The Grudgebearers** 3-0 in the Blood Bowl final.



Gary's star squad of Humans has now obtained such a high team rating of 310 points that he is off the scale for handicap games against most of the other teams in the Studio. One result of this fame and fortune is that Gary is now very hard pressed to even get a friendly game. Not surprisingly, most of the other team coaches in the Studio

have no wish to have their own teams beaten to jelly and so avoid him at all costs!

Simon's comment after the match was...Uuuuugh!...We wuz robbed!

## NEW SKAVEN TEAM AND STAR PLAYER

From the caverns deep under the Blood Bowl Stadia of the Old World rise the Skavenblight Scramblers. The most famous of all Skaven teams, the Scramblers first rose to fame under the leadership of coach Andy Chambers and are the only Blood Bowl team to have won the Blood Bowl trophy two years running!

The new boxed set contains all the players you need to field this fast-moving Skaven team including two Stormvermin and three Gutter Runners, as well as six Linemen and a Thrower.

## THIS MONTH'S BLOOD BOWL RELEASES

<b>Rat Ogre - Headsplitter</b> (One miniature per blister)	<b>£5.99</b>
<b>Skavenblight Scramblers</b> (Twelve miniatures per box)	<b>£12.99</b>
<b>Blocking Dice</b> (Two dice per blister)	<b>£0.99</b>

## RAT OGRE - HEADSPLITTER

Huge and powerful, Headsplitter - the Rat Ogre Star Player is now available both as a miniature and on a Star Player card included in Death Zone. Headsplitter is a lethal addition to any Skaven Blood Bowl squad and an essential purchase for Skaven coaches.

Both the Skavenblight Scramblers and Rat Ogre Headsplitter were designed by Gary Morley and the painted miniatures can be seen on an 'Eavy Metal page elsewhere in this issue.

Also in this issue, we showcase the Death Zone rules in a special Undead vs Orcs game report.

**MORE WARHAMMER NOVELS**

Boxtree books have just released the latest titles in their collection of exciting Games Workshop fiction. Written by **Brian Craig**, the three books, **Zaragoz**, **Plague Daemon** and **Storm Warriors**, form a trilogy of macabre fantasies, recalled by the minstrel Orfeo, of the struggle against the Dark Powers that threaten the Warhammer World.

**Zaragoz** – the first in the series, tells the tale of the legendary castle of Zaragoz – a citadel that could never be taken but by treachery...

The second book **Plague Daemon** follows the adventures of Harmis Detz, a soldier of the Border Princes, plunged into a desperate struggle against the plague-bearing forces of Chaos.

The final story – **Storm Riders** is a tale of terror and betrayal set in the ancient and haunted land of Albion.

These novels are available from all Games Workshop stores, Games Workshop Mail Order and good bookstores everywhere.

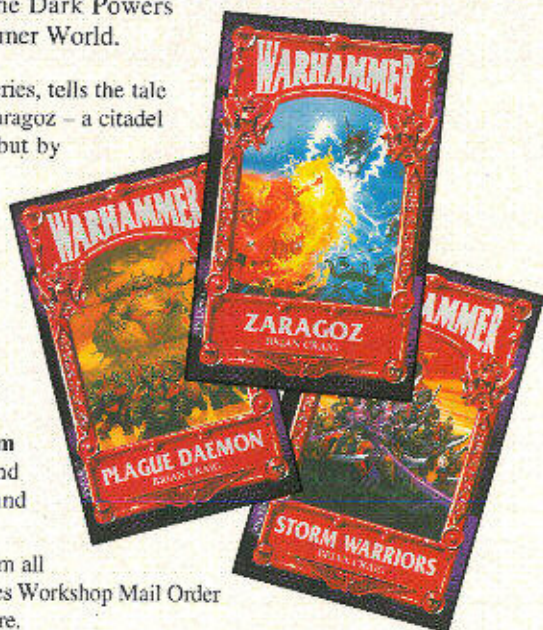

**NEW MAIL ORDER HOTLINES**

Due to the incredible demand, from Monday the 25th of July, our Mail Order telephone Hotlines will now be open from 8.00am to 10pm

**SEVEN DAYS A WEEK**

**WARHAMMER PAINTING GUIDE**

Mike McVey is currently putting the finishing touches to the new **Warhammer Painting Guide**. This companion to the already available **Warhammer 40,000 Painting Guide** will be the complete reference guide to collecting and painting armies of Citadel Miniatures for Warhammer.

The book contains chapters on all aspects of creating a Warhammer army from: how to quickly paint-up your rank and file regiments, to how to create the kind of standards and banners for your regiments and army that feature in White Dwarf.

Special sections will also cover many of the advanced methods and techniques that Mike uses to create the wonderful character models and creature conversions



that make his own miniatures so stunning.

The Warhammer Painting Guide will be available in early September.

**GAMES WORKSHOP**

**STOCKPORT OPEN NOW!**

32 MERSEY SQUARE  
Telephone: 061 4741427

Normal opening hours:

Mon. Tue. Wed. Fri. 10.00am to 6.00pm

Thursday 10.00am to 8.00pm (Games Night)

Saturday 9.30am to 5.30pm

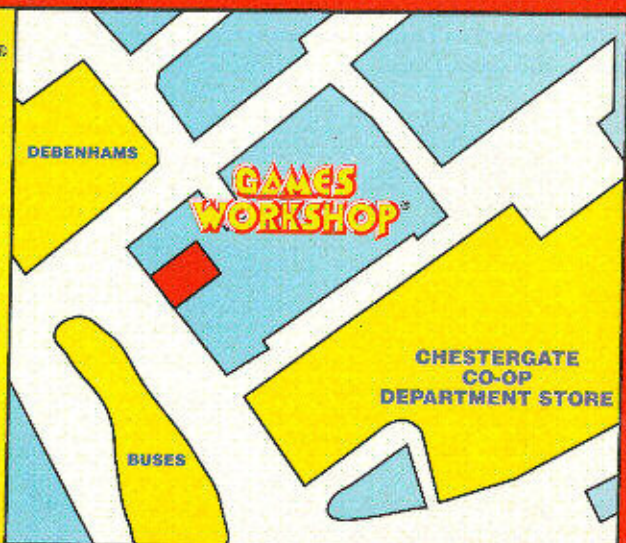



# WARHAMMER

## 40,000

# SNAKEBITE ORK BOARBOYZ



### BOARBOYZ BOXED SET CONTAINS:

- 4 Ork Boarboyz
- 4 plastic Warboars
- 4 Boarboyz banner poles
- 1 plastic Ork weapons sprues
- 1 plastic Ork arms sprue
- 1 Ork transfer sheet
- 4 Ork banners

Orks of the Snakebite clan are among the most vicious of all the Orks and like nothing better than to charge across the battlefield and clash with the enemy in deadly hand-to-hand combat.

Mounted on snorting warboars, they smash through the enemy squads dealing out death to their foes with bolt pistol and axe.



WARNING! This product contains lead and may be harmful if chewed or swallowed.

Citadel Miniatures are not recommended for children under 14 years of age.

This model requires assembly. We recommend that the parts are cleaned and trimmed with a modelling knife before being painted with Citadel paints.

Citadel, the Citadel castle, Games Workshop and Warhammer are registered trademarks of Games Workshop Ltd. Ork and Snakebite are trademarks of Games Workshop Ltd. © Games Workshop Ltd, 1994. All rights reserved.

**GAMES  
WORKSHOP**

**THIS BOXED SET  
CONTAINS A  
SNAKEBITE ORK™  
BOARBOYZ  
TRANSFER SHEET  
AND BANNERS**

# SKAVENBLIGHT SCRAMBLERS

Skaven are not the toughest or the strongest players to take to the Blood Bowl pitch but they are among the fastest! Against most teams, Skaven Gutter Runners dominate the game, dashing through any gap in their opponents line to make a lightning fast touchdown. As Skaven teams develop, the player's consumption of Warpstone results in many grotesque but often useful mutations that are always popular with the fans.



SKAVEN LINEMAN

SKAVEN GUTTER  
RUNNER

SKAVEN THROWER



SKAVEN LINEMAN

HEADSPITTER -  
RAT OGRE STAR PLAYERSKAVEN  
STORMVERMIN

SKAVENBLIGHT SCRAMBLERS

# BLOOD BOWL®

## THE KILLING FIELD

by Carl Brown, Jervis Johnson and Gavin Thorpe

The crunch of bone drowns out the roar of the crowds as the Orcs and Undead take to the field for this exciting Blood Bowl match between the infamous Deff Skwadd and the mighty Champions of Death.

Recently we've been playing a lot of Blood Bowl in the Studio league, with at least one team of each race taking part – even Halflings! With the release of Death Zone, we felt that the time was right to print a match report that demonstrated how the new teams and rules in this supplement really enhance the game. Two veteran coaches, Carl Brown and Gavin Thorpe, were rounded up and asked to create two rookie teams, just as if they were starting to play in a Death Zone league.

In this report we decided to use slightly different maps from the ones we used for Blood Bowl in White Dwarf 173. Instead

of each map showing only one team's moves, each one includes several turns worth of blitzes, blocks, moves and passing plays. This enables each map to show how a series of turns builds up into a scoring play and to illustrate the flow of the game. On all of the maps, the yellow arrows and text boxes refer to the Orcs' moves and the blue ones to the Undead. A dotted yellow line indicates a pass.

Each of the players on the maps is identified by his position rather than his number. For example, a Black Orc is 'BO', a Skeleton 'S', a Thrower 'T' and a Ghoul 'G'.



## DA DEFF SKWADD

by Carl Brown



When Jervis asked me to coach Da Deff Skwadd for another match report in White Dwarf I quite happily agreed. Gavin was to be my opponent, leading the Champions of Death and we would use all of the Death Zone rules. I have played against Gavin and the Undead on several occasions and have discovered that it's almost completely useless to try the standard Orc tactic of

beating your opponents to a pulp! This has forced me to develop slightly different tactics from the ones I would normally use with Orcs (see *Ere we go, Ere we go, Ere we go* in White Dwarf 175).

Team selection was pretty simple as Jervis had asked us to create teams that could be used in a league. Consequently, my team was more of a foundation to build on than a tough one-off game killer-squad. I chose two Throwers and two Blitzers to pass the ball and two Black Orcs to form the basis of a strong line of scrimmage. As well as these I took Nobbla Blackwart with his chainsaw – my favourite of the Goblin secret weapons. Finally, I brought my team up to thirteen strong with six Orc Linemen.

Back to tactics. Because of their natural, or should that be unnatural, resistance to pain, the Undead are very difficult to get off the field for any length of time. With this in mind I had to find a way to quickly capitalise on any Undead casualties that might occur. My plan was heavily influenced by the Special Play cards I had for the match. On offence the general aim for this game was to concentrate my efforts in one place, smash a hole in the Undead line and try to get players downfield beyond the reach of the slow Undead players. This sounds like a throwing game tactic I hear you cry! Well I must admit it is, but as my opponents were even slower than my own team, I reckoned I could afford to risk it. If something did go wrong there wasn't too much of a chance of Gavin's team being able to mount a swift counter-attack, especially not with most of his team shambling around at four or five spaces a turn. The benefits of playing against the Undead like this are that it cuts down on fighting time, and seeing as dead people don't hurt easy, it stops you wasting downs trying to kill something that's already dead! From a league point of view it also cuts down the chances of your team suffering early casualties that would cause trouble in future games.



On defence things were going to be a bit trickier. I was expecting a running play from Gavin and that could be messy. However, you can't defend by keeping out of your opponent's way just to save your own skin. My plan was to block only when I needed to and gradually withdraw from the Undead

advance, simultaneously trying to work somebody into the opposing half to act as a receiver. Then when the opportunity arose, Blitz the ball carrier, grab the ball and chuck it upfield where my waiting player would grab it and run into the End Zone for a touchdown! If any Ghouls should manage to get into my backfield I would try to dispose of them as quickly as possible, postponing the attack on the ball-carrier in favour of stopping Gavin's option of a throwing play. If I could do this, then I could almost predict where Gavin's players were going to go, thus making it easier to launch a counter-attack.

Having considered my plan, all that was left to do was join in the rousing chorus of the Orc fans...

"Ere we go, Ere we go, Ere we go..."

## THE CHAMPIONS OF DEATH

by Gavin Thorpe



In the current Studio league I have been running a fairly successful Undead team called the Washington Deadskins. I have played against Carl's Deff Skwadd a couple of times and although the games have been very close, he has just beaten me. So here I am, out to get my revenge in front of thousands of readers...

The first important decision to make, after you have opted for an Undead team, is to pick your players. Mummies and Wights have the best stats on the team list, so make sure you take the maximum allowance of two of each. Ghouls are a bit of a problem. They are the fastest members of your team, but don't come with the *Catch* skill like proper Catchers. They do, however, make most of your plays, as they can *Dodge*, run fairly fast and pick up and catch the ball with a pretty good success rate. You can opt to take the maximum of four and have a pretty agile team, but then you may have too few players to hold a strong front line. For a balanced team I think that two or three Ghouls is better to start with. The choice between Skeletons and Zombies is perhaps the most difficult. Skeletons are faster, but Zombies have better armour. You need to decide whether to trade off survivability for speed, or to go for the slow grinding team that can take a lot of punishment. I chose a mixture of the two.

Get a Vampire if you can afford one – they are excellent. The *Hypnotic Gaze* skill is great for exploiting small gaps in your opponent's defence, allowing a Ghoul or Wight to slip through without making a large number of *Dodge* rolls, and I have used it to devastating effect against Dwarfs and other low agility teams. With *Block* and *Dodge*, Vampires are also great for cracking open a pocket around the opposing team's Throwers. If your opponent is running the ball and has formed a cage around the ball-carrier, a Vampire can Blitz in and split up the formation, letting the nearby Wights and Ghouls move in to crunch the player with the ball.

The biggest bonus of an Undead team is that, with the exception of Ghouls, they all get the Regenerate skill. This allows them to come through almost any injury, including death, as fresh as a daisy! If you are playing in a league this is marvellous news – as other teams start to lose their multi-skilled players to injury and death, your players just keep piling up their Star Player Points.

# BLOOD BOWL



Models supplied unpainted.

Miniatures designed by Gary Morley

## ★ CHAMPIONS OF DEATH ★



BLOOD BOWL WIGHT

Blood Bowl fans both love and fear Undead teams. Although they have a tendency to fall to pieces in the middle of the scrimmage, they are renowned for their ability to make a come back!

Their opponents often stand aghast as Skeletons and Zombies rise from fatal blows and return to the fray with renewed vigour. Many Blood Bowl teams have even found themselves playing against a formerly deceased team mate or Star Player who has been returned to undeath!

**THIS BOXED SET CONTAINS THE COMPLETE CHAMPIONS OF DEATH BLOOD BOWL TEAM CONSISTING OF:**

- 2 Mummies    2 Ghouls
- 2 Wights    3 Zombies
- 3 Skeletons

1 Champions of Death transfer sheet to allow you to detail your team with numbers and symbols.

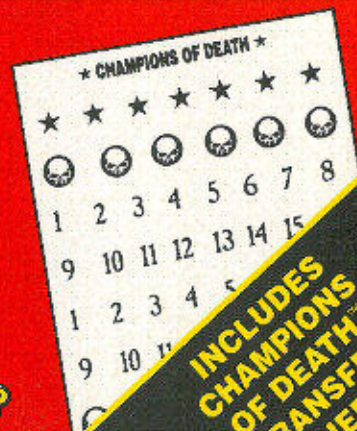

**WARNING!** This product contains lead and may be harmful if chewed or swallowed. Citadel Miniatures are not recommended for children under 14 years of age.

Games Workshop, the Games Workshop logo, Blood Bowl, Citadel and the Citadel castle are registered trademarks of Games Workshop Ltd.

Champions of Death is a trademark of Games Workshop Ltd. © Copyright Games Workshop Ltd, 1994. All rights reserved.

**GAMES WORKSHOP**

**INCLUDES CHAMPIONS OF DEATH TRANSFER SHEET**

# BLOOD BOWL



## ★ NAGGAROTH NIGHTMARES ★™



WITCH ELF

Dark Elves make superb Blood Bowl players, combining their strength, speed and agility with a low cunning and an evil temperament.

Although best suited to the throwing game, sheer spite makes the Dark Elves enjoy the violent conflict of the running game. Witch Elves and Dark Elf Blitzers in particular, excel at punching a hole in the opposing line of scrimmage through which their fleet-footed team mates can run.

**THIS BOXED SET CONTAINS THE COMPLETE NAGGAROTH NIGHTMARES BLOOD BOWL TEAM CONSISTING OF:**

- 1 Dark Elf Thrower
- 2 Witch Elves
- 2 Dark Elf Blitzers
- 7 Dark Elf Linemen

1 Naggaroth Nightmares transfer sheet to allow you to detail your team with numbers and symbols.

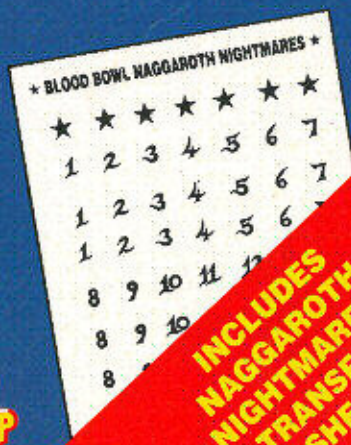

**INCLUDES NAGGAROTH NIGHTMARES™ TRANSFER SHEET**



WARNING! This product contains lead and may be harmful if chewed or swallowed. Citadel Miniatures are not recommended for children under 14 years of age.

Games Workshop, the Games Workshop logo, Blood Bowl, Citadel and the Citadel castle are registered trademarks of Games Workshop Ltd.

Naggaroth Nightmares is a trademark of Games Workshop Ltd. © Copyright Games Workshop Ltd, 1994. All rights reserved.

**GAMES WORKSHOP**

Turning to this game against Carl, I think that it will be a bit of a slugging match, as the Undead and Orcs are both slow, hard teams. Carl loves to use Goblins with secret weapons so I expect to face at least one of them. I know for a fact that Nobbla Blackwart is bringing his chainsaw to the match! My purchase of a Vampire should help to counter this threat, as long as it can get to them and make those vicious strength 5 Blocks.

The most comforting thought for me is that I've had several games against Carl's Orcs and know how they play. In classic Orc style, they generally crunch through you and slowly stomp up the field to score. This is fine by me. With two Strength 5 Mummies on my front line I can happily slog it out. If Carl opts for a passing attack, my Ghouls are faster than his players and I should be able to get one or two on him before he has moved more than a few squares from the Line of Scrimmage.

When I'm on the offence I also like to smash my way through the other team and wade through the bodies for a touchdown. Unfortunately, this does not work as well with a rookie team like the one I'm using in this game. Hopefully my Vampire's high Agility and the Ghouls good turn of speed should let me keep my options open for a pass. This is provided that they can get deep into the Orcs' half without getting jumped on and beaten up by those vicious Black Orcs!

As always with Blood Bowl tactics, remember that anything can happen and often does! Expect the unexpected, don't panic when things go wrong and always try to do it to them before they do it to you!

## PRE-MATCH SEQUENCE

When you use the new Death Zone rules, before the match can begin the two coaches must first go through the pre-match sequence. This simple six-step sequence covers all of the important activity that occurs before the two teams make their way onto the playing field.

The first thing either coach can do is hire freebooters. Freebooters are mercenary players that will play for anyone who has the cash to pay for them. They are hired just before the game starts, and will only play for one game. However, as both Gavin and Carl had spent all of their starting treasury creating their teams, they didn't have any money left over to hire freebooters.

The second step in the pre-match sequence is to roll on the weather table from the Blood Bowl rulebook. The weather table uses 2D6, and at the Studio we have each coach roll a dice and then add the scores together to find out what the weather will be for the match. Gavin and Carl each rolled a dice, and both scored a 6! This gave a total of 12, which meant that the match started off being played in blizzard! The ice on the playing field from the blizzard meant that chances of a player falling over when they went for an extra square was doubled, while all the snow that was blowing about meant that only quick or short passes could be attempted!

The next step is to work out how many fans turn up to watch the match. This is called the gate and has an effect on how much money the teams earn for playing the game. To work out the gate each coach rolls a number of dice equal to their fan factor. They add the scores together and multiply the total by 1,000 to find out how many of their fans come along to the match. Gavin's Undead team has a fan factor of 5, so Gavin



rolled 5 dice and scored a total of 19. This means that 19,000 Champions of Death fans had turned up for the match. Carl rolled a total of 15 and so only 15,000 Deff Skwadd fans turned up. The total gate for the match was 34,000 fans.

The fourth step in the pre-match sequence is to work out the handicap. In a league, all teams have a team rating which shows how good they are. If two teams with differing team ratings play a match, then the lower rated team receives a number of handicap bonuses to help balance out the game. However, as Gavin and Carl's teams had identical team ratings (all starting teams have a rating of exactly 100 points), neither received any handicap bonuses.

The next step is for each coach to take their Special Play cards. The Special Play cards allow all kinds of dirty tricks and underhand tactics to be used, like bribing the referee or hiring an assassin to use against the opposition. The cards are split into three decks: Dirty Trick cards, Random Event cards and Magic Item cards. At the start of a match each coach is allowed to draw one or more Special Play cards (the exact number is determined by a dice roll), each of which may be used once during the game and must then be discarded. Both Gavin and Carl were allowed to take two Special Play cards, and they both decided to take one card from the Dirty Tricks deck and one card from the Magic Item deck. We will keep the cards that were drawn secret until they are actually used in the game – it's a cheap way to build up suspense I know, it's more exciting that way.

The final step in the pre-match sequence is to roll for niggling injuries. For this match, however, we skipped this as neither team had any players who had picked up any injuries – yet!

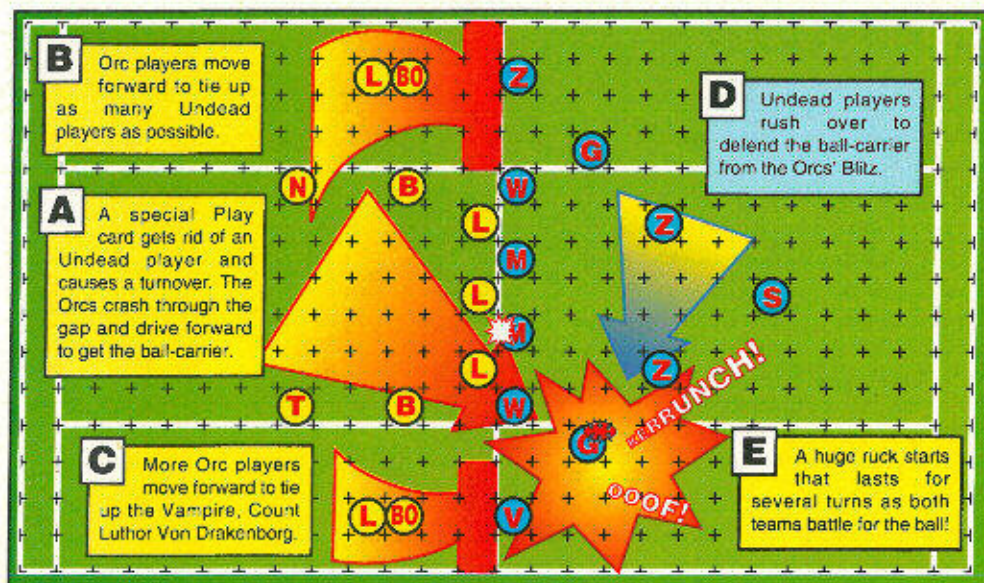

Initial set up and the Orc Blitz.

### INITIAL SET-UP

The Orc team won the toss to see who kicked-off and, rather surprisingly, Carl elected to kick-off in this half and receive in the second. Normally the player who wins the toss elects to receive, in order to build up an early lead.

As the Orcs were kicking-off, they had to set-up first followed by the Undead team, and then Carl had to roll on the Kick Off table. Unfortunately he got a 'Bad Kick' result and the ball proceeded to scatter off the field. This gave the Undead team a touchback, allowing Gavin to give the ball to any player in his team. Gavin decided to give the ball to one of his Ghouls.



### SPECIAL PLAY

As Gavin got ready to take his first turn all seemed to be going well for the Undead team – which just goes to show that you shouldn't take things for granted in Blood Bowl! Before a single player in the Undead team had a chance to move, Carl played his *I'll Get You!* Dirty Trick card. The card meant that one of the Undead Mummies had been wound up to such an extent by the insults hurled at him by one of the Orc Linemen that he threw a highly illegal block at him!

This resulted in the Mummy being sent off for the rest of the match by the referee and caused a turnover, ending the Undead team's turn! The reason that Carl had decided to kick-off in the first half became apparent, as it was now the Orc team's turn and the Undead hadn't yet had a chance to move...

### THE ORC BLITZ

Without wasting any time, the Orcs poured through the hole in the Undead team's front line left by the absent Mummy. An assisted block opened up a clear path to the Ghoul holding the football and two Orc Blitzers charged through the gap, knocked him over and grabbed the ball. The rest of the Orc team moved up, attempting to tie up as many Undead player's as possible by getting tackle zones on them. This would make it difficult for the Undead to get many players back to deal with the Orc Blitzer that now had the ball. Things were looking very good for the Orcs, the only disappointment being that Nobbla Blackwart failed to start up his chainsaw!

### THE RUCK

However, the Orcs had reckoned without Count Luthor von Drakenborg, the Undead team's Vampire Star Player. Easily dodging away from the Orc players who tried to stop him, the Count used a Blitz action to move back and throw a block at the Orc with the ball, smashing him to the ground and knocking him out! Unfortunately, none of the Undead players nearby managed to pick up the ball, and soon a huge fight developed around the football. More and more Undead and Orc players were drawn into the melee, which lasted for several turns.

When the dust finally settled, the Ghoul who'd first picked up the ball after the kick-off had managed to get it back again! The Orc's daring attempt to steal the ball had been stopped. To add insult to injury, while all this was going on Gavin took the opportunity to play his *Sorry Dirty Trick* card. This caused one of the Undead team's players to "accidentally" trip over and crash off the field and into the Orc's dug-out, tragically flattening the Orc coach in the process and injuring him so badly that he had to miss the rest of the game! What's more, although Nobbla did finally manage to get his chainsaw started, he had failed to hurt any Undead player's with it.



## THE UNDEAD DRIVE

The position of the players at the end of the Undead team's fourth turn is shown on the second map. As you can see, quite a few Orc players had been drawn in to the Undead team's half of the field during the fight for the ball, and were now on the wrong side of the ball-carrier. Carl pulled players back to contain the Undead team as best he could, but was unable to stop Gavin's team forming a pocket around the ball-carrier and grinding down the field towards the Orc's End Zone. Nobbla Blackwart did give the Undead team a scare (if such a thing is possible?!?), chopping a Wight out of the way with his chainsaw and then hacking at the Ghoul holding the ball, but bad dice rolling on Carl's part meant that the Ghoul survived the attack and the Undead drive continued.

## THE TOUCHDOWN

During their sixth and seventh turns, the Undead continued their inexorable drive down the field. A Mummy and Skeleton moved over to stop Nobbla causing any more trouble, which they succeeded in doing although the Skeleton did end up getting chopped down by Nobbla's chainsaw! The sacrifice was worth it however, for with Nobbla tied up and so many

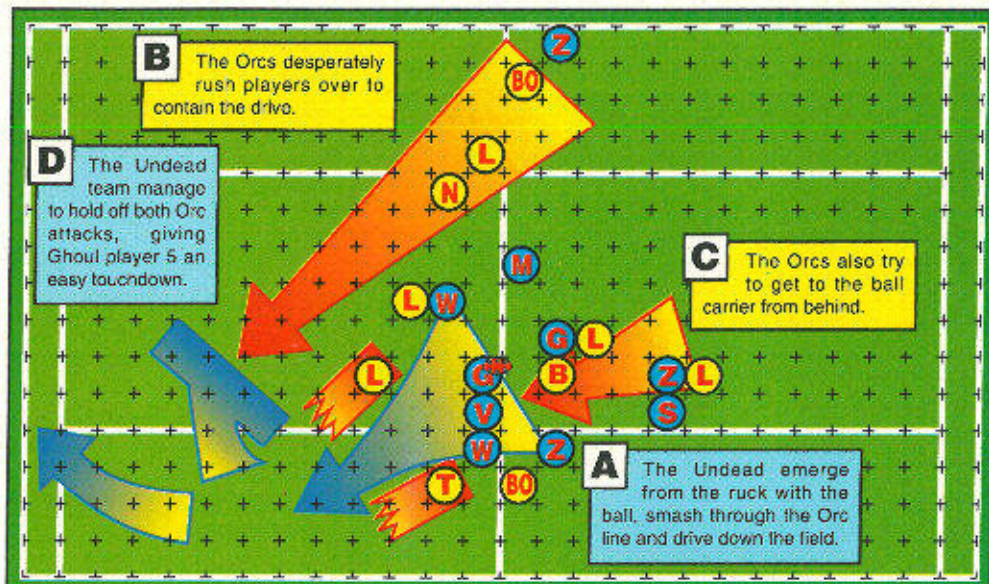

*The Undead counter-attack and score a touchdown!*

other Orc players on the wrong side of the ball, Carl was unable to scramble enough players back to form a strong defensive line. The Undead team drove forward led by Count Luthor and easily brushed aside the few Orcs in their path, leaving the Ghoul with an easy run into the End Zone for a touchdown!

Gavin paused in his victory celebrations only to note down the Ghoul's star player points on the team roster. In a league the players in a team can improve over time by earning star player points. Once the player has earned enough points he is allowed to roll on the Star Player table to see if he has gained a new skill or some other ability. Scoring a touchdown earned the Ghoul player 3 star player points towards the 6 he would need for his first roll.



*The Undead team form a protective pocket around the ball-carrier.*

## A DESPERATE GAMBLE

The fight for the ball and the Undead team's steady drive down the field had eaten up a lot of time, and the Orcs were left with only two turns in which to try to score before the half ended. With so little time remaining, Carl had no choice but to attempt a passing play. This is never easy with an Orc team, and was made even harder by the blizzard that was still blanketing the field with snow and ice! To make things even more difficult, Carl had used up both his team re-rolls during the desperate fight for the ball and then the referee banned Nobbla from playing for the rest of the match. Finally, Gavin rolled a 'Perfect Defence' result on the Kick-Off table which allowed him to change his team's set up after seeing how the Orcs were deployed! The third map shows both teams' positions as the ball was about to be kicked-off.



The Orcs started the drive by throwing a series of blocks at the players on the Undead team's left flank. This cleared a hole for one of the Orc Blitzers to rush down the field so that he was in a scoring position – if he could catch the pass. Meanwhile, Orc players moved up to pin as many Undead players as possible. Finally, one of the Orc Throwers moved up and picked up the ball.

## THE UNDEAD CORDON

So far the Orc drive was working like clockwork and Gavin was starting to look a little bit worried. Nonetheless he was

able to form a tight cordon around Orc Blitzer by pulling two Ghouls out of the front line (the Ghouls *Dodge* skill allowed them to dodge away from the Orcs that were trying to hold them up). Elsewhere Undead players blocked any Orcs that were within reach, trying to cause as much damage as possible before the half ended. This resulted in a Black Orc being knocked out by the Undead team's remaining Mummy.

## LAST GASP PASS

The crowd held its breath as the Orc Thrower dashed forward and made a short pass to the Orc Blitzer. The pass was accurate and all the Blitzer need to do was catch the ball. Normally he would have succeeded on a roll of 3 or more, but the presence of the two Ghouls meant that he needed to roll a 5+ with no re-roll. Carl rolled the dice – and scored a miserable 2. The Orcs in the crowd groaned as the Blitzer dropped the ball, causing a turnover and ending the first half of the match.

## THE SECOND HALF KICK-OFF

Things were looking grim for the Orcs as the two teams trooped back on to the field for the second half. Both Black Orcs had been KO'd in the first half of the game, and neither had recovered consciousness in time for the start of the second half. With Nobbla banned for the rest of the match this seriously reduced the Orcs ability to slug it out with the Undead team. Things weren't all bad – the Orcs were receiving the Kick-Off, and Gavin rolled a 'Weather' result on the Kick-Off table which stopped the blizzard and greatly increased the Orcs' chance of pulling off a passing play.

## OH NO!

And then disaster struck! The first move the Orcs made was to run one of their Throwers over to pick up the ball. This should have been easy, as the Thrower only needed to roll a 3+, and his *Sure Hands* skill meant that he got to re-roll the dice if he failed at the first attempt. Carl proceeded to roll a 1 followed by a 2, and then headbutt the table as the Thrower fumbled the pick-up, and the Orcs suffered a turnover...

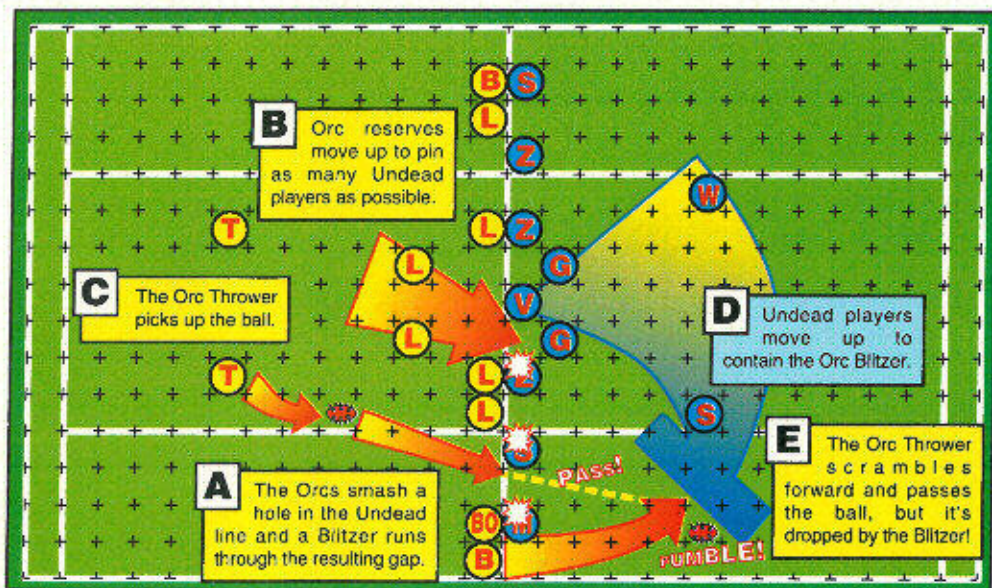

The second set up and the Orcs' last gasp pass.

The Undead team surged forward up the centre of the field to grasp this opportunity. There was only one Orc player in their path and he was easily pushed aside, leaving a clear path for Count Luthor to run through.

Fortunately for the Orcs, the ball was just too far away for the Count to reach in one turn. Nonetheless, if the Orcs failed to pick up the ball a second time he would be in a perfect position to steal it and score.

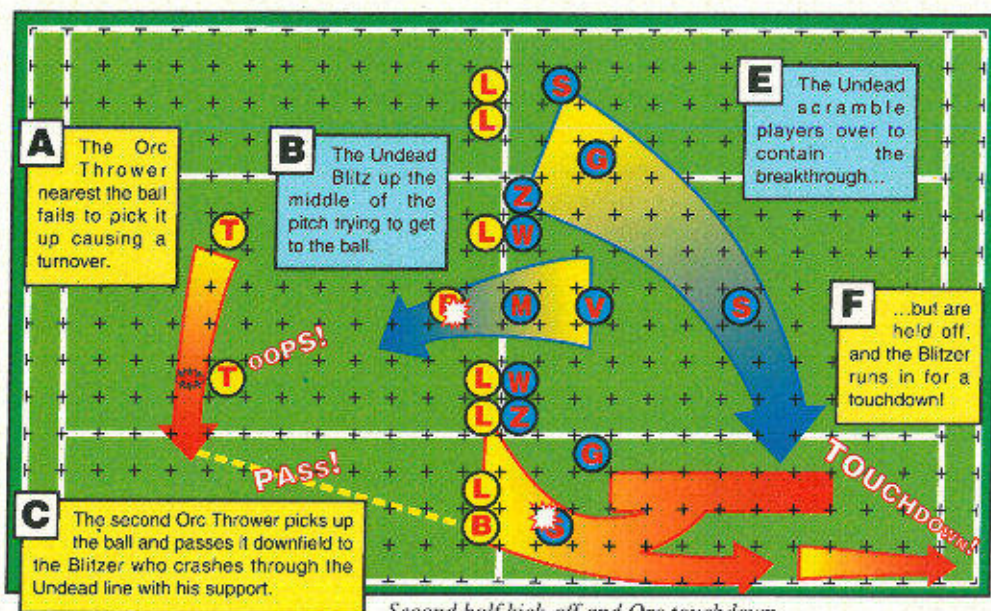

Second half kick-off and Orc touchdown.

## COUNTER-ATTACK

The Orcs, however, had other plans. The second Orc Throwing in the back-field hurriedly scrambled over, grabbed the ball and hurled it forward to the Orc Blitzzer who had dropped the pass at the end of the first half. To make sure that the pass was on target Carl played his Magic Item card, which was a scroll with the spell *Eye of the Eagle*. The spell meant that the pass was automatically on target, but the Blitzzer still needed to catch the ball. This time, much to Carl's relief, he managed it! The Blitzzer and a bodyguard of Orc Lineman punched their way through the Undead front line, and headed off down the field towards the Undead End Zone.

Gavin desperately tried to bring players back to contain the Orcs, but his Blitz up the middle of the field had left him with

allows you to increase a player's move by up to 2 squares, with a 1 in 6 chance they will trip per extra square).

This almost proved disastrous for the Orcs. Carl had gambled on the fact that there was only one Undead player (a Ghoul) who could reach the Blitzzer, and such a weedy player would have little chance of bringing the Orc Blitzzer down.

What Carl didn't know was that Gavin's Magic Item card was *Knutt's Spell of Awesome Strength*, which would increase the Ghoul's strength by D6 points. The card meant that what would have been a 1 dice block became a 3 dice block! Fortunately for Carl, the super-strong Ghoul only managed to push the Blitzzer back a square, and he was able to score an easy touchdown in the next Orc turn. The game was tied at one-all!



The Undead form a cordon around the Orc Blitzzer to stop him scoring.



*An Orc Thrower sneaks through the middle of the Undead line to steal the ball!*

### THE CROWD GOES WILD

Obviously woken-up by the resounding cheers of the Orc fans, both Black Orcs finally recovered consciousness and returned to the game, bringing the Orc team pretty much back to full-strength. Having scored the last touchdown, the Orcs now kicked-off to the Undead team and Carl's roll on the Kick-Off

table was, appropriately enough, 'Cheering Fans'. This meant each coach rolled a dice and added their fan factor, with the highest getting a bonus team re-roll. However, the Undead supporters must have been spurred into action by the antics of the Orc fans, because Gavin won the dice roll and added the extra counter to the track on his dugout.

### BUTTER-FINGERS

The Undead started their drive by attacking both Orc flanks, with Count Luthor spear heading the attack on the Orc team's left. The Undead fought slowly and surely forward, but were unable to make any large holes in the Orc line – although they did manage to KO an Orc Lineman. Then things started to go wrong. First of all, a Ghoul fumbled two attempts at picking up the ball, costing the Undead team its final re-roll counter (the one that they'd got from the their Cheering Fans). This caused a turnover, and allowed the Orcs to strengthen their front line and apply pressure to the weakly held Undead centre. Then a Mummy blew an easy block by rolling double skulls, causing another turnover, and providing the Orcs with a golden opportunity to steal the football from under the very noses of the Undead team.

### A DARING BREAK

The Undead team's two-pronged attack had created a weak-point in Undead line the centre of the field. A weak-point like this is often called a 'hinge', because it occurs at the junction between the two prongs of an attack.

The Orcs smashed into the hinge, creating a gaping hole through which one of the Orc Throwers was able to run. In a daring move the Thrower dodged out of one Undead tackle zone, moved to the ball and picked it up, dodged out of another tackle zone (though this did cost Carl his last re-roll counter) and finished this dazzling move off by successfully 'going for it' to move an extra couple of squares towards the Undead team's End Zone!



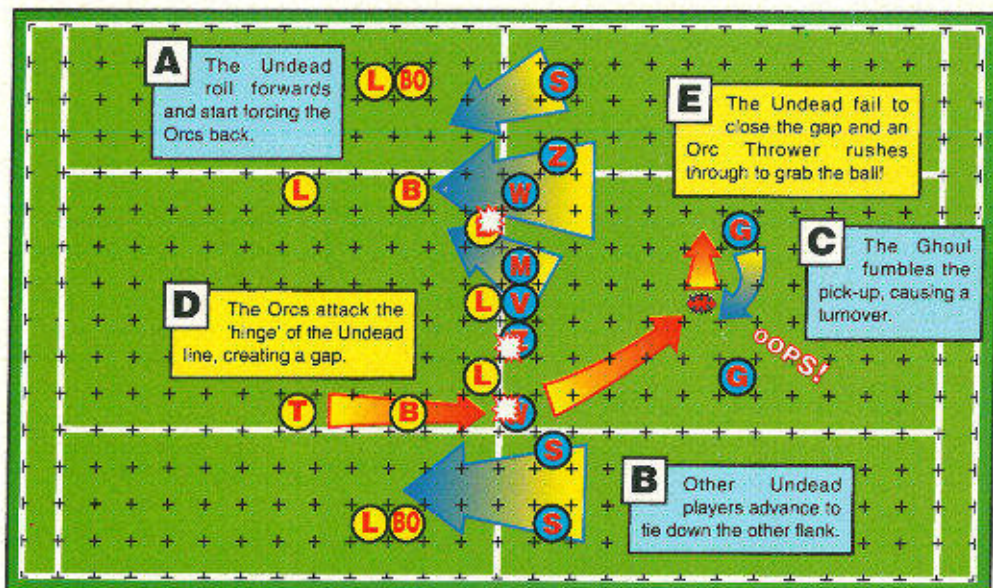

The crowd goes wild as the Orcs break through and steal the ball.

### OH NO YOU DON'T!

Unfortunately for the Orc Thrower, none of the rest of the Orc team had managed to follow him down the field, and he was now all on his own, deep in Undead territory. Pausing only to stand a couple of players up and plug the gap in the centre of his line, Gavin moved up the two Ghouls he had in reserve and threw a punishing block at the Orc Thrower, which not only knocked him over, but knocked him out as well!

The removal of the Thrower left the Orcs with only nine men on the field to the Undead's eleven. What's more, the hole in the Undead team's line had been plugged, which left the Orcs with very little they could do other than regroup to form as good a defensive position as possible.

### THE RIGHT HOOK

The heavy Orc casualties combined with their counter-attack up the centre of the field had left the Orcs' left flank very weak. Gavin exploited this weakness by delivering a powerful right hook which demolished the Orc flank, killing a Black Orc in the process and leaving the Orcs with only eight players on the field! Count Luthor finished the move off by blitzing down the field, to ensure that he would be in a scoring position during the final turn of the game.

Finally, one of the Ghouls picked up the ball and moved up the field ready to make a pass on the next turn.

would be no way for the Undead team to score.

The Count, however, proved a tough nut to crack, and even though surrounded by four Orc players he managed to stay on his feet.



The whole game would be decided by the Undead team's passing play on the final turn of the match!

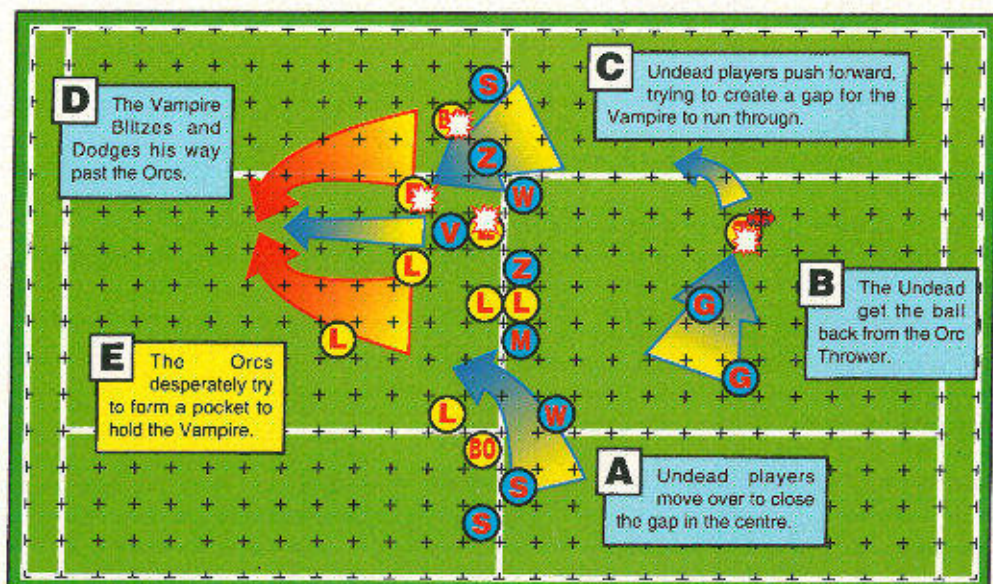

The Undead take the ball back and drive down the pitch.

### QUICK LADZ, GET HIM!

Although the Undead were in an excellent scoring position, there was only one turn remaining in the second half of the game, and if the Orcs could just stop the Undead team from scoring then maybe some of their KO'd players would recover and be able to play in Overtime.

Unfortunately, the ball-carrier was too well-protected for the Orcs to reach him, but Count Luthor was all on his own. If he could be brought down there

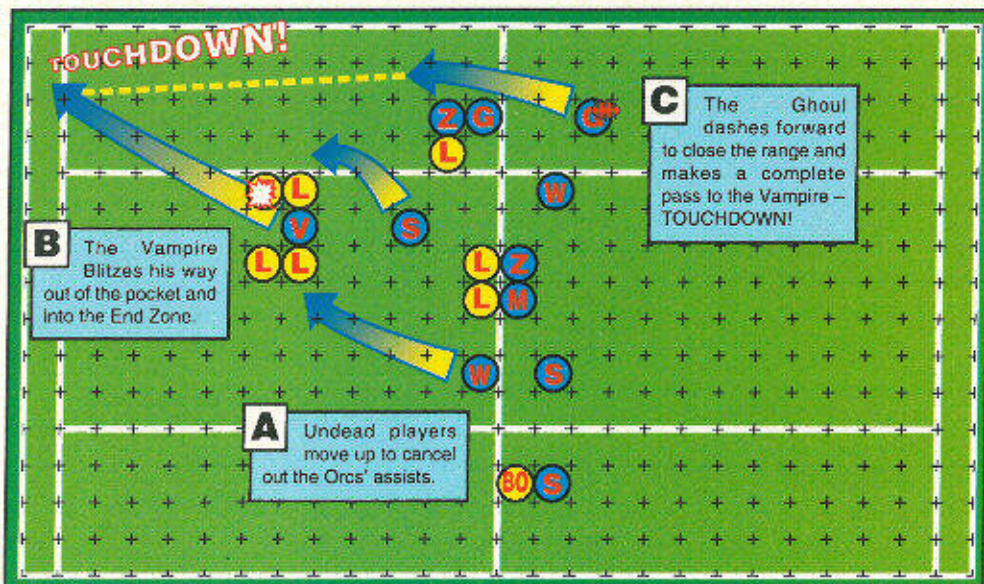

Count Luthor von Drakenborg breaks through the Orc line to score the winning touchdown!

### THE FINAL NAIL

The situation at the start of the last turn is shown on the final map. As you can see, Count Luthor is the only Undead play in a position to score but he is completely surrounded by Orcs! There was no way he would be able to catch the ball from this position, so the first thing Gavin had to do was get him out of the pocket and into the Orcs' End Zone.

To accomplish this Gavin first moved up two Undead players to stop any Orcs from lending assists when the Count made a block. Then the Count started a Blitz action by throwing his block at the Orc Blitzer standing next to him. The Vampire's strength of 5 against the Blitzer's strength of 3 gave the Count a two dice block which resulted in the Orc being pushed back and knocked over. Count Luthor followed up, dodged out of the tackle zone of the single Orc Lineman still standing beside him and moved into the End Zone.

All that was left was for the Ghoul to throw him the ball. The crowd held its breath once more as the Ghoul moved forward – and threw the ball bang on target! With contemptuous ease the Count caught the ball (he only need to roll a 2+), scoring a touchdown and winning the match for the Undead!

### POST-MATCH SEQUENCE

At the end of any match using the Death Zone rules the two coaches must go through a special five-step sequence called the post-match sequence.

The first step in the sequence is to work out the two teams' winnings. This is done by rolling a dice, adding a modifier determined by the gate for the match, and adding a further +1 to the score if you win. The result is multiplied by 10,000 to find the team's winnings for the game. Gavin rolled first, getting a 3. The gate modifier for this match was +2, and Gavin had won the match giving him another +1, for a final score of 6. This meant that the Undead team had earned 60,000 gold pieces for the game. Carl managed to roll a 4, which with the +2 gate modifier also gave him 60,000 gold pieces in winnings.

The next step in the post-match sequence is to work out if any players have earned enough star player points to gain new abilities. Before this is done, however, each team is given a

'Most Valuable Player' award (or MVP), which is awarded to a randomly selected player in the team. The player who receives the reward gains an extra 5 star player points, which is often enough to put them up a level. Carl's MVP went, appropriately enough, to the Orc Blitzer who'd scored the touchdown giving him just enough experience points to go up a level and gain an extra skill! Carl rolled on the Star Player table and got a 7. This meant he could choose a new skill for the Blitzer, and he

decided to take *Strip Ball*. None of the other players in the match earned enough points to go up a level, though a few were starting to get close.

The third step in the post-match sequence is for each coach to roll on the Fan Factor table to see if their fan factor has gone up or down depending on their performance in the game. Both Gavin and Carl made average rolls and their fan factors both remained unchanged.

The final two steps are used to make any purchases and update the team roster to show any changes that have occurred as a result of the match. Carl had lost a Black Orc, but hadn't earned enough cash from the game to replace him, so he decided to hire a new Orc Lineman to take the Black Orc's place for the time being. The remaining 10,000 gold pieces went into the team's treasury. Gavin decided to bank all of his winnings as he wanted to save up for an extra Ghoul to add to his team.

### ORC CONCLUSION:

**Carl:** AARGH!!! what a frustrating game. Well, what can I say, "We wuz robbed". Moaning aside I learned a few more lessons about playing Blood Bowl and that's worth a lot in the long run. With hindsight I think it may have been a better idea to let Gavin receive in the first half and try to get rid of the Vampire with the *I'll Get You* card. As it was, I couldn't guarantee the Vampire being on the front line. Still, I got rid of a Mummy and that probably cut down on the casualties I received in the game.

The Vampire did prove to be more than a handful, the winning touchdown was a classic example of how useful he is. Surrounded by Orcs he still fought his way to the End Zone to hammer the proverbial nail into my coffin (sorry, but I had to say it) on the last down. I was a bit disappointed with the performance of Nobbla – he failed to beat the Undead armour values on more than a few occasions and then got himself sent off! In the second half, my counter-attack was a bit hasty. My lone Thrower hurtling downfield was lucky to get the ball and, being totally unprotected, couldn't be expected to keep hold of it very long. This was a play for which I would ideally have used a Blitzer but due to circumstances (my Blitzer had been carried off the field unconscious trying the same thing on the

previous down) I was forced to use the Thrower – a long shot that didn't pay off. I think it would have been much better to use the gap I'd created to run a player downfield, and tried to grab the ball a down or two later when I could have got more players in on the job. That had been my plan initially and in the excitement of the game I rushed forward, and lost a player for my troubles, making it even harder for myself to defend.

If only I had stuck to the plan! It just goes to show if you decide on a tactic, stick to it, and don't get carried away with bizarre one-offs that "just might work". They invariably don't.

Looking at the way Gavin played, he did a very good job although I must admit I was surprised that he managed to score in the first half. I feel I was a bit unlucky not to have held his advance, especially after the amazing start when I had eleven players to his ten, I was in possession when he'd received, and all this after my first down! Unfortunately, Gavin re-formed and launched a very strong drive which took its toll on my team, quickly crushing my chances of defending.

Despite losing it was a really enjoyable game. No doubt Gavin and I shall meet again, and next time "Itz gonna be diffrrunt!"

## HURRAH! HURRAH!

**Gavin:** Tense? My nerves are still recovering. Well it just goes to show that you can never be too sure about what's going to happen. Still, when all is said and done, the Champions of Death scraped through to a victory, and we all know that's what really counts! It was a very taxing game, but one of the most enjoyable I've had and I can't wait to play against Carl again.

The last touchdown just goes to show what a powerful asset a Star Player can be. Occasionally they have their off-games and you are tempted to sell them off and get someone else, but a lot of the time they perform admirably. As I said in my introduction, Vampires and Ghouls are going to make most of your plays for you. If I had opted for another couple of Zombies and Ghouls it is very doubtful that I would have been in a decent position to score the second touchdown, and would have had little chance of actually getting the ball over the line. But there's no point in going over 'ifs and buts', lets have a quick look at what did happen.

The first three turns were depressing for me. I saw all those Orc players clamping down on my team and I had little hope of making a quick break through the middle like I usually do. The fight for the ball near the sidelines was extremely uncomfortable, with both of us being in a position to swing the balance if our opponent made a mistake. It is interesting to note that the maxims that win battles in Warhammer 40,000, Space Marine and Warhammer apply equally well to Blood Bowl. The first of these common principles is Maintenance Of Aim. I was determined to get a running play moving up the flank, and I continually made moves that prevented the ruck from spreading into the middle of the field too far. The second basic idea is Concentration of Force. There would have been little point in running my Ghouls up the field in the hope of a lucky pass action, so I kept them handy, where they could assist my blocks and exert tackle zones on the Deff Skwadd.

Once I finally got the ball rolling, my play began to pick up momentum, and it is the impetus of a drive that a defending team has to break. Fortunately for me Carl didn't quite find a weakness to my attack, but it was close once or twice.



What can I say about defence? I freely admit that I am much better attacking than defending and I was expecting Carl to score. I was hoping my first touchdown wouldn't take so long, and I would have time to pop in a second, with my Mummies and Vampire protecting the ball and allowing me to run the clock down a little.

With Carl's touchdown drive it came down to impetus again. Once he started churning up the field you really need to be on top form to stop him. As I said, I'm not on top form when I am defending and Carl manage to push all the way through. I can't really see what more I could have done, but I am sure plenty of other people will...

The first two touchdowns came about because of the slowness of the two teams. When Carl scored it was totally impossible for me to get enough players back from the line of scrimmage to counter the unexpected pass action. After that it was a question of clutching at straws. Although I exerted a couple of tackle zones and generally got in the way, what it came down to was the fact that I didn't have anybody big, tough or fast enough to catch up with the Blitzter. I forgot my earlier plan about a deep defence and I paid for it.

My second touchdown was lucky to say the least. I didn't have any skilled Throwers and so the whole play came down to the vagaries of chance. Luck smiled on me and the pass action was a success. That play was another example of the power of carefully chosen, if expensive Star Players. My Vampire was in a position that seemed to be inescapable, however, his Strength of 5 proved enough to force his way clear. Vampires are not only stronger than most players but also have an Agility of 4. Compared to another similarly priced Star Player, say, an Ogre with Agility 3, that's an extra 17% (ish) chance of actually catching the ball (Undead can't have an Ogre, but who cares when you have players like this?).

The final aspect of games played with the Death Zone Supplement is the Special Play cards. I must say I was a bit disappointed with my *Sorry!* card as there are much more useful Dirty Tricks to be picked up. Carl's use of his *I'll Get You!* card was good, but I am very glad he didn't use it on my Vampire. That would have been 180,000 gold pieces down the drain and a different result for the match...

# GAMES WORKSHOP®

## A WORLD OF FANTASY GAMING

The first thing you notice when entering a Games Workshop store is how different it is from nearly every other shop. Here you'll find not only all you need for the gaming hobby, but much more besides. With friendly, approachable staff and a vast range of Citadel Miniatures, you'll find everything you need to build up an army for Warhammer 40,000, Space Marine, Warhammer, Man O' War or Blood Bowl.

Every Games Workshop store carries the complete range of Games Workshop games and all the latest Citadel Miniatures. Our staff of gamers will be more than happy to advise you on any aspect of the hobby, from painting individual models to building terrain for your games.



At every store, we also run regular Thursday Games Nights where you can come along and join in with one of the games. Different games are featured every week, so please phone the store first to see what's being played.

If you've never played a Games Workshop game before, then the staff at any of our stores will be pleased to show you how the rules work and take you through your first battle.

### GAMES WORKSHOP®

#### UK STORES

ABERDEEN: UNIT 1, 3040 KIRKGAZE, TEL: 0224 621261  
 BATH: 30 UPPER BOROUGH WALLS, BA1 1RC TEL: 0225 314414  
 BUCKENHAM: 292-294 HIGH ST. TEL: 081 658 8192  
 BELFAST: 20A CASTLE COURT, TEL: 0232 233684  
 BIRMINGHAM: 116 CORPORATION STREET, TEL: 021 236 7880  
 BLACKPOOL: 8 BIRLEY STREET, TEL: 0253 752056  
 BOLTON: UNIT 25, FIRST FLOOR GALLERY, SHIPGATES CENTRE TEL: 0204 362131  
 BOURNEMOUTH: 24 POST OFFICE ROAD TEL: 0202 319292

BRIGHTON: 7 NILE PAVILIONS, NILE ST. TEL: 0273 203332  
 BRISTOL: 13 BROAD WALK, TEL: 0272 251535  
 BROMLEY: 8 BROMLEY MALL TEL: 081 466 0578  
 CAMBRIDGE: 4 QUAYSIDE, (OFF BRIDGE ST), TEL: 0223 513350  
 CARLIFE: 29 30 HIGH STREET, TEL: 0273 644917  
 CHELMSFORD: UNIT K5, THE GALLERY, THE MEADOWS CENTRE, TEL: 0246 490348  
 CHELTENHAM: 16 PITVILLE STREET, TEL: 0242 228419  
 CHESTER: 112 FOREGATE STREET, TEL: 0244 307967  
 COLCHESTER: 2 SHORT WYRE STREET, TEL: 0206 707279  
 COVENTRY: 14 CITY ARCADE, TEL: 0203 227511  
 CRAWLEY: 11 BROADWAY, TEL: 0293 552072  
 CROYDON: UNIT 25, DRUMMOND CENTRE, KEFLEY RD TEL: 081 680 4600  
 DERBY: 42 SADLER GAYE, TEL: 0133 371657

DUDLEY: KIOSK 1, UPPER LEVEL, MERRY HILL CENTRE, DUDLEY, TEL: 0884 481818  
 EALING: 52D ST SAVIDOURS MALL, EALING BROADWAY CENTRE, TEL: 081 8400171  
 EDENBURGH: 136 HIGH ST. TEL: 081 220 6510  
**NEW STORE!** EXETER: 37 PRINCESSHAY, TEL: 0392 450305  
 GLASGOW: 66 QUEEN ST, TEL: 041 226 3762  
 Guildford: 12 TUNSGATE, TEL: 0483 457793  
 HAMBERSMITH: 1 DALLING ROAD TEL: 081 741 3445  
 BARRÓW: 296 STATION RD, TEL: 081 861 2350  
 HIGH WYCOMBE: UNIT 25, THE BALCONY, THE OCTAGON CENTRE, TEL: 0494 531494  
 Hull: 30 PARAGON STREET, TEL: 0482 589576  
 IPSWICH: 2ND FLOOR, DEBENHAMS, WESTGATE STREET, TEL: 0473 210031  
 KINGSTON ON THAMES: 33 FIFE ROAD, TEL: 081 549 5224  
 LEEDS: 12-16 CENTRAL ROAD, TEL: 0532 426834





The gaming tables at our Manchester - Arndale Centre - store.

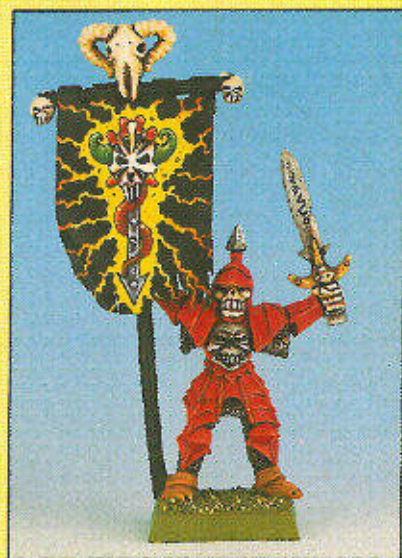

**LEICESTER:** 1620 SILVER ST. TEL: 0533 540540  
**LIVERPOOL:** 47 LORD STREET. TEL: 051 258 3404  
**CENTRAL LONDON:** UNIT F10, THE PLAZA,  
 118-128 OXFORD STREET. TEL: 071 435 0839  
**LUTON:** 12 PARK STREET. TEL: 0582 417474  
**MAIDSTONE:** UNIT 6, 1-9 PUDDING LANE.  
 TEL: 0622 677435  
**MAIDENHEAD:** 5 B. ANDY HSE, 55 KING ST.  
 TEL: 0628 21852  
**MANCHESTER:** 6970 MARSDEN COURT,  
 ARNDALE CENTRE, MANCHESTER.  
 TEL: 061 834 6871  
**MEADOWHALL CENTRE SHEFFIELD:**  
 91B, HIGH ST, UPPER MALL. TEL: 0742 569836  
 Opening hours Mon-Thurs 10am to 8pm, Fri 10am to 9pm,  
 Sat 9am to 7pm and Sundays 11 am to 5 pm  
**METROCENTRE NEWCASTLE:** UNIT B14,  
 FIRST FLOOR. TEL: 091 461 3950  
**MIDDLESBROUGH:** 29 DUNDAS ST.  
 TEL: 0642 254091  
**NEWCASTLE:** 63 CLAYTON STREET.  
 TEL: 091 232 2418

**NORWICH:** 15-14 EXCHANGE STREET,  
 TEL: 0603 767056  
**NOTTINGHAM:** 34 FRIAR LANE. TEL: 052 480551  
**OXFORD:** 1A NEW INN HALL ST.  
 TEL: 0865 242182  
**PETERBOROUGH:** 3 WENTWORTH STREET.  
 TEL: 0733 890052  
**PLYMOUTH:** 94 CORNWALL STREET.  
 TEL: 0752 254121  
**PORTSMOUTH:** 34 ARUNDEL STREET.  
 TEL: 0705 876259  
**PRESTON:** 15 MILLER ARCADE. TEL: 0772 821855  
**READING:** UNIT 3, CHEAPSIDE. TEL: 0734 598693  
**ROMFORD:** 12 QUADRANT ARCADE.  
 TEL: 0708 742149  
**SHEFFIELD:** 16 FITZWILLIAM GATE.  
 TEL: 0742 730114  
**SHREWSBURY:** UNIT 2, BRIDGE ST.  
 TEL: 0745 362007  
**SOUTHAMPTON:** 25 EAST STREET.  
 TEL: 0703 331962

**SOUTHEND:** 12 SOUTHCHURCH RD.  
 TEL: 0732 461251  
**NEW STORE! STOCKPORT:** 32 MERSEY SQUARE  
 TEL: 061 4741427  
**STORLON TRINT:** 27 STAFFORD ST, RANLEY.  
 TEL: 0782 265287  
**SUTTON ON THAMES:** UNIT 26, UPPER MALL,  
 300ES SQUARE SHOPPING CENTRE.  
 TEL: 081 770 9454  
**SWINDON:** 17 FLEET STREET. TEL: 0793 436096  
**THURROCK LAKESIDE:** UNIT 415,  
 LEVEL 30, OGD COURT, THURROCK LAKESIDE  
 JUNCTIONS 9/21, M25. TEL: 0708 867133  
**TORQUAY:** 12 MARKET ST. TEL: 0803 701056  
**WATFORD:** UNIT Q1A,  
 HARLEQUIN CENTRE, QUEENS ROAD.  
 TEL: 0923 245388  
**WORCESTER:** 4 CHARLES STREET.  
 TEL: 0925 616207  
**YORK:** 26 GOODRAMGATE. TEL: 0904 653575

## ☠ CHAOS BEASTMEN ☠



BEASTMAN STANDARD BEARER



BEASTMAN SHAMAN



BEASTMAN STANDARD BEARER



BEASTMAN HORNBLOWER



BEASTMAN CHAMPION



BEASTMAN CHAMPION



BEASTMAN HORNBLOWER



BEASTMAN SHAMAN



## CHAOS KNIGHTS



CHAOS KNIGHT



CHAOS KNIGHT



CHAOS KNIGHT

The Gods of Chaos conduct their endless war in the mortal universe, recruiting countless warbands to follow their dark banners. The mortal followers of Chaos come from all walks of life – many are bandits, renegades or criminals, though some are dispossessed noblemen. All have one thing in common – they are willing to exchange their mortal souls for the power and rewards that only the dark Powers of Chaos can bestow. Every Chaos Warrior and Knight strives by acts of valour and savagery to attract the attention of his god, for if his talents are recognised he will be elevated to the rank of Chaos Champion.



CHAOS KNIGHT PENNANTS

## CHAOS MUTATIONS

BY MIKE MCVEY

Collecting a Chaos army for Warhammer presents many opportunities for all manner of conversion and modelling work. Individualised Chaos Champions, mutants and Spawn can be created using a few well-established techniques. This short section demonstrates a few of the limitless possibilities modelling provides and includes an extract from the Citadel Miniatures Modelling Guide detailing an ambitious project – a splendid Sorcerer of Slaanesh mounted on a Chaos Dragon.

*Chaos Spawn**Chaos Spawn of Nurgle*

**CHAOS SPAWN** The scope for converting miniatures into hellishly mutated Chaos Spawn is infinite. The model shown above left illustrates the potential that Citadel's plastic miniatures have for this type of project. The addition of a barbarian's upper torso to a wolf body creates a convincing centaur effect. A little remodelling of the face using epoxy putty, horns and spikes from plastic sprue oddments and a pair of metal castings for the tentacle arms complete the gruesome picture. The Spawn of Nurgle, by contrast, is an entirely metal and modelling putty piece. The techniques used to create this monstrosity are explained in detail in the Modelling Guide.

CHAOS BEASTMAN  
CHAMPION

This model illustrates how to get the most out of your modelling hobby. The raised sword arm is in fact the original arm of the barbarian used to create the Spawn model above. The extra arm is taken from a Citadel plastic Skaven. Because both sword arms and the Beastman are all plastic components this sort of complex effect is achieved easily. Once the various components have cut and filled to fit, the polystyrene glue used to stick them together not only forms a permanent and very strong bond but it actually "welds" the pieces together. This results in a really smooth fit which requires little or no filling.





*Chaos Sorcerer of Tzeentch*



## CHAOS SORCERER OF TZEENTCH



This conversion is of a Tzeentch Sorcerer with the addition of a pair of wings from the Greater Daemon of Tzeentch and claws from a Fiend of Slaanesh.

The large metal components such as the wings require pinning in place. Sleeves have been added to the claw arms using epoxy modelling putty.



## CHAOS CHAMPION CONVERSION



One of the simplest and yet most effective conversions that you can apply to a Chaos Champion is to add a tail. The champion of Nurgle shown here has been transformed by the addition of a scorpion tail taken from a Chaos Hound. The tail was carefully removed with a razor saw to ensure that the cut was flat and would fit neatly onto the back of the Champion. Remember to put the rest of the Chaos Hound into your bits box, so it can be used on a



*The completed Chaos Champion of Nurgle with a scorpion tail.*



future modelling project. Attaching the tail was very straightforward, the back of Champion was filed down flat and the tail was pinned into place and glued.

# CHAOS DRAGON

Dragons are the most powerful monsters in Warhammer and some of the most spectacular miniatures. Their huge size and ferocious appearance makes them tower above even the largest units or war machines. They also make impressive mounts for a character or an army general. In this section I'll be looking at a conversion of a Chaos General mounted on a dragon. This is a large, complex conversion, and the most ambitious of those covered in this guide.

## PLANNING THE CONVERSION

Most of the conversions covered so far have been quite small, which makes them easy to work with. Progressing from converting small figures to a dragon may seem like a huge leap, but there is really very little difference. The techniques applied are exactly the same, just on a larger scale. In fact the rider is, if anything, a slightly more complex conversion than the dragon itself.

This modelling project differs from the other special conversions in the guide in that it is not based on anything specific, such as a piece of artwork, so I had total freedom to do what I wanted.

The initial inspiration came from the model itself – it is without doubt the most spectacular monster in the entire range and just cries out for a bit of special attention. The obvious thing to do was to mount a rider on it and turn it into the centre-piece for an army. You couldn't want a more spectacular army general!

## Choosing the components

The first step was to decide which parts I was going to use for the different elements of the conversion. This was no problem for the dragon itself, as I didn't want to make any major component changes, just some alterations in the pose. I used a couple of extra pieces: an additional tail section and a left arm.

The rider uses parts from two basic miniatures, with detail added from others. The legs were the first part I chose. They were taken from the High Elf Griffon rider and came complete with a saddle back. The upper body was cut from a Champion of Slaanesh, which has a snake tail instead of legs. The whip is from another Chaos Champion and I also used the back banner from an Eldar Dark Reaper Exarch.

The photograph at the top of the page shows all of the main components used in this conversion. There were also some other minor pieces and materials that I found in my bits box. The only other things I used were modelling putty, plasticard and scenic material for the base.



## THE DRAGON

As I mentioned earlier, the dragon itself has not actually been converted that much, only the position and some of the details have been changed. Altering the pose of such a large model can be tricky and requires the use of a little force. The photograph below shows how the neck was bent. The end of the neck was wrapped in paper and clamped in the jaws of a bench vice, making it far easier and safer to manipulate. You need to be very careful not to snap the metal, so apply the force smoothly. Any sudden movements will stress the metal.

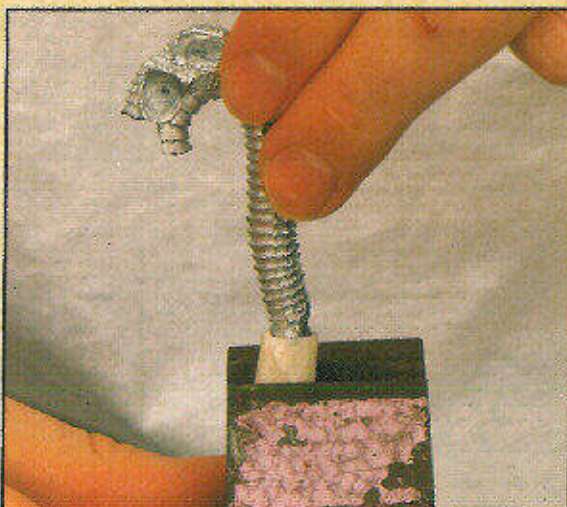

*The end of the neck is held in a vice to make the bend easier.*

## The tail

To give the dragon more of an unusual look consistent with Chaos, I decided to give the tail two tips. This was quite easy: I simply cut off the tips of two tails about two inches from the end and glued them both back onto the stump of one of the lower body sections. I had to taper the inner edges of the ends of the tails to get them to fit neatly together. I cut the sides down with a heavy craft knife, and smoothed the joining surfaces with an emery board. I glued the two tail sections together first and then smoothed down the combined end of the join and attached them to the body with a strengthening pin.

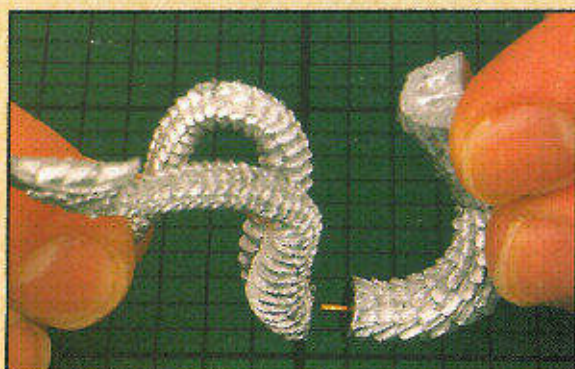

*When the two tails had been joined I smoothed down their combined end and attached them to the body.*



*The arms were pinned into place so that there was a gap between the shoulder and the body. They were then bent into the desired position and the gap between them was filled with modelling putty.*

## Positioning the arms

The arms on the original model are positioned quite high, making it difficult to add a rider. To make it easier to place the rider, I altered the position of the arms. A hole was drilled in the end of each of the arms and in the centre of the sockets. The arms were then pinned into place, but with a length of wire that was slightly too long, so there was a small gap between the components. This allowed the arms to be bent into the right positions. Then all I had to do was fill the gaps with modelling putty and model on some scales.

## MODELLING TIPS

### USING FINE WIRE AND CHAIN

One of the interesting features of this conversion are the reins. These are different from the paper reins covered earlier in the guide, requiring a slightly higher level of modelling skill to create.

Fine chain is available from modelling shops or jewellers. It isn't particularly cheap, but I only use it occasionally, in short lengths, so it lasts for quite some time. The best sort of wire to use is either fine fuse wire or florists' wire. The best quality of this sort of wire is that it is easy to bend and form into different shapes.

On the Chaos Dragon I attached the lengths of chain to the hands and the horns using loops of wire. This was made by wrapping the wire round a narrow length of tube as shown in the photographs. The easiest way to attach the chain to the wire is to thread the end link of chain onto the wire and then glue this closed into a loop. Alternatively, you can split one of the links in the chain, hook it over an already formed wire loop and re-glue it. I keep a pair of tweezers and a needle handy for opening and closing links.

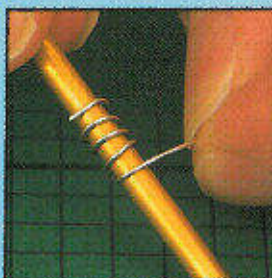

*The wire is wrapped round a circular former, in this case a length of brass tube. You can vary the diameter of the loops by using different sized formers.*

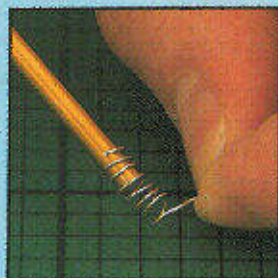

*The next step is to slide the coiled wire off the former, so make sure that you don't wrap it round too tightly. You should end up with a spring shape.*



*Individual loops can be cut off this 'spring' with a pair of sharp clippers. Keep the rest of the coil in a safe place so that you can use it again.*

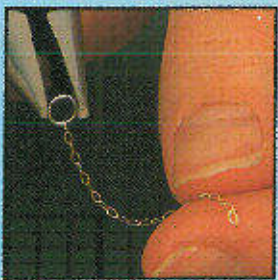

*The chain is carefully threaded onto the loop and the loop is glued together. I use a pair of long nosed pliers to squeeze the wire into a closed loop.*

## The legs

The original dragon is positioned standing on both hind legs, giving it a stable base. I wanted to create as much movement as possible in the miniature, so I decided to alter the position of the right leg. This was not difficult, I just pinned it on in a raised position and filled the gap around the joint using putty. The original foot has a flattened underside to make a stable joint with the base. To get rid of this I removed the foot at the ankle and replaced it with a casting of one of the hands. I also removed the thumb and re-attached it to the inside of the leg just below the knee.



*The hand has been pinned into place just below the ankle and the thumb is being attached to the inside of the leg.*

## THE CHAOS CHAMPION

### Removing components

The first task was to remove the separate components from their original miniatures. The most difficult part to remove was the upper body. This required some careful cutting with a fret saw. I had to cut up behind the lowest right hand and then across the body, keeping the cut as flat as possible. The cut needed to cross the body just below the ribbon at the waist and come out at the back of the left gauntlet. Cutting with a fret saw is not very neat, so the surface needed to be filed flat afterwards.



*The miniature is held in a vice by the tail section and the upper body is carefully removed with a fret saw.*

### Adding detail to the body

The two main features I added to the body were the whip and the handle for the reins. The whip was easy to add: the sword was removed with a pair of clippers and the whip was pinned on in its place. Before it was glued on to the hand I bent it into a shape to suit the shape of the miniature.

The handle for the reins was a more delicate operation, requiring the removal of the scroll from the right hand. This was mostly snipped away with a pair of clippers and then cleaned up with a craft knife. The handle itself was made from the hilts of Chaos swords that I found in my bits box. I drilled a hole right through the hand and pinned one hilt to each side. The wire loops for the reins were glued on under the tongue on each side.

### The standard pole

The back of the saddle is topped with a standard pole bearing the Slaanesh Chaos rune. This replaces the High Elf design that was originally on the top of the saddle, and which was removed directly below the heart ready to take the new piece. The pole is the back banner from an Eldar Dark Reaper Phoenix Lord, with the rune on the top altered. This did not entail a great deal of work. The original rune was snipped off the pole and the triangular section was removed. The circular piece was made from a short length of plastic tubing which was pinned onto the upper part of the rune. The whole thing was attached to the top of the pole.



*The new rune is pinned into place on the top of the pole.*

### Attaching the model to the base

When the whole conversion was finished it had to be securely attached to the base. This was quite tricky as the dragon is a large and heavy model, only supported by one leg. I pinned the dragon onto the base using a far heavier gauge of wire than I normally use, approximately 2mm in diameter rather than 1mm. I used this gauge of wire to pin the left leg to the body, as this joint also takes a great deal of strain. When the model was pinned and glued to the base, I drilled another hole between the claws, down into the base and glued in a pin at a different angle to the first. This made the joint even stronger.



## THE FINISHED CHAOS DRAGON CONVERSION

The photographs below show the finished and painted Chaos dragon. The base, rider and dragon were all fully painted and varnished before they were put together. This made it far easier to work on each one. I made a separate large base, glued it to the top of a large paint pot and attached the dragon to this to make it easier to hold while I painted it. The rider was lightly glued to the back of a plastic horse while he was being painted.

One of the inset photographs show the rider close up. This shows clearly how well all of the components work together in the finished conversion. Notice how the right arm, head, whip and sword are all moving in the same direction. This makes the miniature look even more dynamic. I painted the dragon's wings in black and deep red to complement the lighter tones of the Chaos Champion, and bent the wings into a curved shape to act as a visual frame. It is important to check how the separate elements of a large conversion like this look together at every stage of the process, not only when they are being modelled, but also during their painting. If the colours clash then the conversion will be ruined. This also applies to the base, it doesn't want to be so heavily covered in detail that it takes your attention away from the model. Decorate it just enough to add interest and realism.



# UNDEAD CHARACTERS



NAGASH, SUPREME LORD OF THE UNDEAD



NECROMANCER



WIGHT LORD MOUNTED ON A ZOMBIE DRAGON



GAMES WORKSHOP

# GAMES DAY '94

SUNDAY 23rd OCTOBER 1994  
BIRMINGHAM NATIONAL INDOOR ARENA



**G**ames Day is the highlight of the Games Workshop calendar. Every autumn, thousands of gamers get together for a day of fun, excitement, games, competitions and special events based around the Games Workshop hobby.

This year, over 8000 gamers will pack the National Indoor Arena in Birmingham for our biggest and best convention ever. Games Day '94 will feature **Titan Legions** and **Space Marine** battles, a massive **Blood Bowl Tournament**, **Warhammer** and **Warhammer 40,000** knockout games and some very very special prize draws.

As well as the hundreds of games that will be running all day, all the Games Workshop artists, Citadel Miniatures' sculptors, games designers and personalities will be there to answer your questions, preview future games, or just chat about the hobby. Don't miss out on this exciting event, get your ticket now!



GAMES WORKSHOP

# GAMES DAY '94™

This years Games Day will feature more gaming events than ever before. Following the success of this year's Golden Demon Awards, we've once again booked the National Indoor Arena in Birmingham for a day of competitions, madness and mayhem.

## MASSIVE PARTICIPATION GAMES

Whether your favourite Game is **Warhammer**, **Warhammer 40,000**, **Blood Bowl** or **Man 'O War** there will be loads of participation games for you to join in with.

The miniatures and terrain are all provided, so the only thing you have to do is turn up at the table and play. Its an excellent opportunity to try out something new, or to demonstrate your skill in battle.

For **Epic** fans, Games Day will also feature gigantic display and participation games of **Titan Legions**. Andy Chambers' massive new expansion of the Epic system allows you to now include Imperial Emperor Titans and Ork Mega Gargants in your **Space Marine** games.

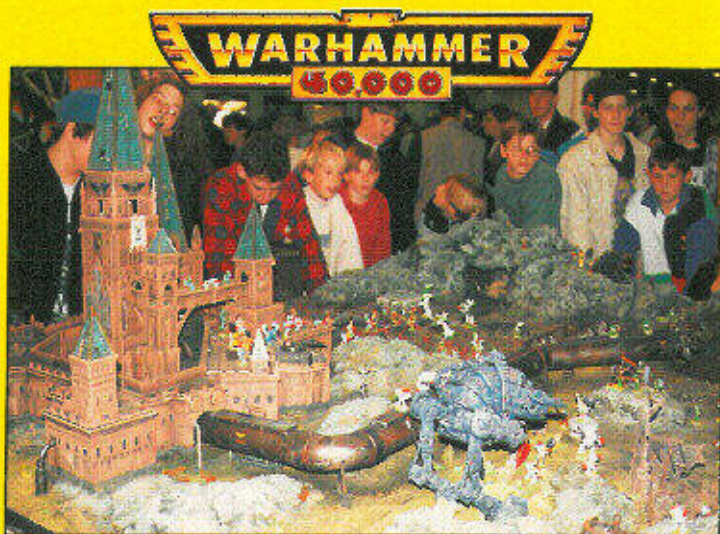

## SPACE MARINE®



Throughout September, every Games Workshop store will be running a massive **Blood Bowl** competition to select a player to represent their area.

These games will reach their climax at **Games Day '94** when the National Champion will be chosen from amongst the participants.

The winning team coach will be awarded a full size replica of the **NFL Blood Bowl Trophy** created by the team at Bright Light Studios.

Throughout the day, the best players in each game system will be selected to compete in a series of knockout games, with the winners being awarded the titles of best **Warhammer General**, best **Warhammer 40,000 Commander** and **Titan Legions Princeps**. The three winners will also carry away some awesome prizes!

## BLOOD BOWL





## GAMES WORKSHOP STUDIO

All of the artists, Citadel Miniatures sculptors and games designers from the Studio will be on hand to answer your questions, give advice or just chat about any aspect of the hobby.

As well as meeting all of the Studio staff, you'll be able to see all of their latest projects and up-and-coming developments in the hobby.

### BATTLE REPORTS 'LIVE'

On the White Dwarf stand we'll be doing 'Battle Reports Live' where you can see Jake Thornton and Adrian Wood fight out a Warhammer 40,000 game over the kind of stunning terrain you see each month in White Dwarf and with armies painted by the Studio 'Eavy Metal team.



### 'EAVY METAL 'LIVE'

At 'Eavy Metal live, you can talk to the Studio 'Eavy Metal team, hone your skills at the painting clinic and take part in the outrageous Speed Freek – speed painting competition

### COMPETITIONS AND PRIZES

And throughout the day there will also be a host of other events, prize draws and competitions with some great prizes to be won.



GAMES WORKSHOP

# GAMES DAY '94™

## TICKETS AND HOW TO GET THERE

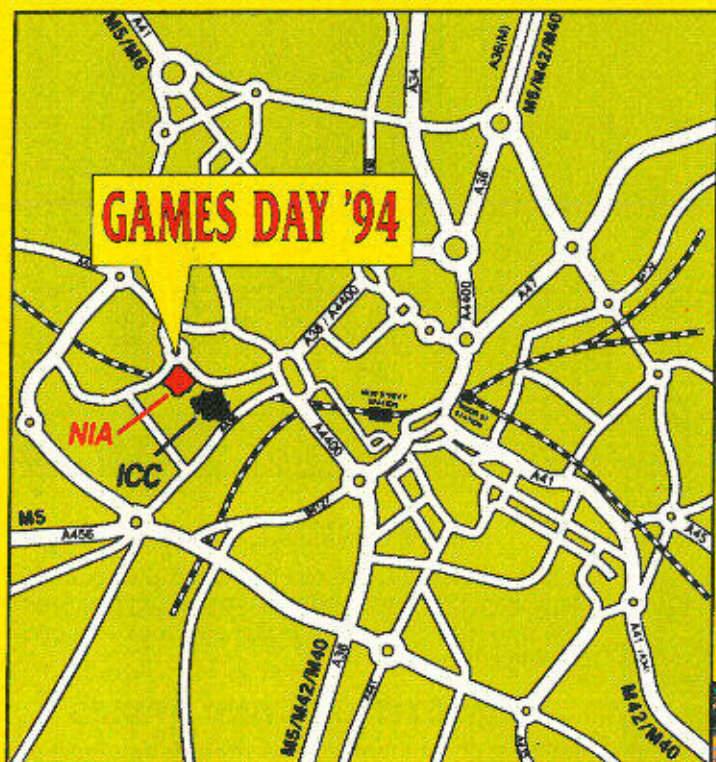

### ADVANCE TICKETS FOR GAMES DAY '94 ARE NOW ON SALE PRICED £7.00

Entry to Games Day '94 is by advanced ticket only and there will be no ticket sales on the day.

Tickets are available from all Games Workshop stores or post free from Games Workshop Mail Order.

Our Mail Order Telephone Hotlines are open from 8.00am – 10.00pm seven days a week on:

**0773 713213**

or you can post your order to:

**Games Workshop Mail Order Service,  
Chewton Street, Hilltop,  
Eastwood, Nottingham NG16 3HY.**

### HOW TO GET THERE

The National Indoor Arena – Birmingham, is undoubtedly the UK's finest indoor arena. The purpose-designed facilities are among the finest in the world and combine with an easily accessible location to make the NIA an ideal location for Games Day '94.



The simplest way to get to Games Day '94 is to get in touch with your local Games Workshop. Every UK store will be running coaches to the event so see your store manager for details.

If you are travelling by car or train, Birmingham is easily accessible from all of the major motorway networks. The Arena itself is only about 15 minutes walk from Birmingham's New Street Station.

**The National Indoor Arena itself is right next door to the Birmingham International Conference Centre and the two venues should not be confused.**

Please note that there is a large multi-storey car park behind the National Indoor Arena, but there is no free parking on site.

# WARHAMMER

## 40,000

# ELDAR WAR WALKER™



The War Walker is one of the Eldar's most potent weapons of war. Controlled by a single crewman, War Walkers are highly mobile and easily traverse difficult ground on their long powerful limbs.

As they engage the enemy, War Walkers blast heavily armoured targets with their devastating Lascannons and obliterate massed troops with their deadly Scatter Lasers.



Miniature supplied unpainted.

Miniature designed by Jez Goodwin.



**WARNING!** This product contains lead and may be harmful if chewed or swallowed.

Citadel Miniatures are not recommended for children under 14 years of age.

This is a Citadel Miniatures Expert kit which requires a degree of modelling skill. We do not recommend this kit for young or inexperienced modelers.

This model requires assembly. We recommend that the parts are cleared and trimmed with a modelling knife before being painted with Citadel paints.

Citadel, the Citadel castle, Eldar, Games Workshop and Warhammer are registered trademarks of Games Workshop Ltd. War Walker is a trademark of Games Workshop Ltd. © Games Workshop Ltd, 1994. All rights reserved.

**GAMES  
WORKSHOP**



**THIS BOXED SET  
CONTAINS AN  
ELDAR WAR WALKER  
TRANSFER SHEET  
AND BANNER**

# WARHAMMER

## 40,000

## ORK SPECIAL CHARACTERS

by Jervis Johnson

In this extract from Codex Orks, Jervis provides the background and rules for using the legendary Warlord Ghazghkull Thraka and the Snakebite Runtherd Zodgrod Wortsnagga in your games of Warhammer 40,000.



### ZODGROD WORTSNAGGA SNAKEBITE RUNTMASTER

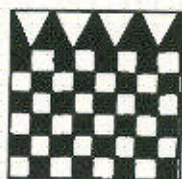

45 points +20 points Runtherd's Grabba-Stick

Zodgrod Wortsnagga is one of the most famous Runtherdz in the whole of Orkdom. He started his career as a member of Ugulhardz Chargerz, a ferocious Snakebite tribe led by the reactionary old Ork Warboss called Ugulhard Duffgrunta. Zodgrod was in charge of the Snotlings that were dispatched through the Chargerz' Shokk Attack Gun, and before long he and his specially trained herd of 'Kommando Snotlings' began to earn a certain amount of fame and notoriety.

As time went on, however, Zodgrod became more and more loth to waste his highly trained Snotlings on anything other than choice targets. This reached a head at the battle of Gimbli's Bunker, when Zodgrod completely lost his temper with the Mekaniak who operated the Shokk Attack Gun and ended up firing the unfortunate Mekaniak through his own gun! This was a terminal experience for the Mekaniak and very nearly cost the Chargerz the battle, and not surprisingly Zodgrod was promptly banished from the tribe once the battle was over.



Zodgrod left the tribe accompanied only by his herd of faithful Runts, and wandered the galaxy, selling his services to the highest bidder. During his travels he come across a set of dusty tomes that detailed the discoveries of a deranged Runtherd philosopher called Narflung, who had devised a unique way of training Runts to a higher level of performance, creating what he called 'Super-Runts'.

Zodgrod copied Narflung's techniques, which involved ringing bells and rewarding the Runts with juicy squigs among other things, and the results were nothing short of remarkable! The Super-Runts performed better on the battlefield and were generally more aggressive and dangerous. This alarmed most

traditionally-minded Orks, who viewed Zodgrod's Super-Runts as a threat to the stability of Ork kultur, but there were still more than enough Warbosses who were desperate or reckless enough to hire Zodgrod and try out his dreaded Super-Runts in battle.

Zodgrod may be included in an Ork army in place of one of the army's normal Runtherdz.

Profile	M	WS	BS	S	T	W	I	A	Ld
Zodgrod	4	5	4	4	5	2	4	2	8

**WEAPONS:** Bolt pistol, *Runtherd's Grabba-Stikk* (see Wargear cards).

**ARMOUR:** Ork 'eavy armour (4+ save).

**WARGEAR:** Zodgrod may have up to two Wargear cards. One of these must be the *Runtherd's Grabba-Stikk*.

Zodgrod may be given additional equipment chosen from the Armour, Assault Weapons, Special Weapons, Transport and Stikkbombz sections of the Wargear list in Codex Orks.

#### SPECIAL RULES

If Zodgrod is included with an Ork army then one mob of Gretchin or Snotlings bought at additional cost from the Mobs section of the army list may be upgraded to 'Super-Runts' at no additional cost in points. Super-Runts have enhanced abilities as a result of their selective breeding and thorough training, which is shown by the special set of characteristics below. Zodgrod will not allow Super Snotlings to be fired through a Shokk Attack Gun, they are far too precious!

Profile	M	WS	BS	S	T	W	I	A	Ld
Super Gretchin	4	3	3	3	3	1	4	2	7
Super Snotlings	4	3	2	2	2	4	4	4	6



## WARLORD GHAZGHKULL MAG URUK THRAKA



Warlord Ghazghkull started his career as a Goff trooper. However, after half his brain was pulped by a bolter shell, the resulting 'treatment' triggered his latent psychic powers.



GHAZGHKULL'S  
BOSSPOLE



GHAZGHKULL'S  
BACK BANNER



WARLORD GHAZGHKULL MAG URUK THRAKA  
WITH MAKARI CARRYING HIS BOSSPOLE

In battle Ghazghkull is a masterly opportunist and a great tactician. Once combat is joined he is always in the thick of the fighting ensuring everything is going according to 'da plan'. In combat Ghazghkull is an awesome opponent, gunning down enemy with his specially kustomised blasta and demonstrating the effects of his adamantium skull when the fighting gets 'up close and personal'.



ZODGROD WORTSNAGGA



## ZODGROD WORTSNAGGA RENEGADE RUNTMASTER

Zodgrod is the most famous Runtherd in the whole of Orkdom, earning fame and notoriety throughout the galaxy. His specially trained herds of Super Gretchin and Snotlings mean that Zodgrod is a most sought-after mercenary.



ZODGROD'S BACK BANNER

Zodgrod Wortsnagga was a member of Ugulhardz Chargerz, a ferocious Snakebite tribe led by the old Ork Warboss Ugulhard Duffgrunta. During the battle of Gimbli's Bunker Zodgrod lost his temper, fired a Mekaniak through his own Shokk Attack Gun, and was banished from the tribe. So began Zodgrod's wanderings, during which time the Runtherd devised a unique way of training Runts into what he called 'Super-Runts'.



# GHAZGHKULL URUK THRAGA

## MIGHTY GOFF WARLORD AND LEADER OF THE WAAAGH!

135 points +30 points Kustom Blasta, +15 points Adamantium Skull

Ghazghkull Mag Uruk Thraka started his career as a common Goff Ork trooper on the backwater planet of Urk. During a raid a bolter shell pulped a large area of his cranium and he suffered extensive brain damage. An Ork Painboy called Doc Grotznik replaced part of his cerebellum with a bionic device made of an incredibly strong metal called adamantium. It may be that this device triggered his latent psychic powers or it may be that Ghazghkull simply suffered from delusions, but, for whatever reason, ever after his 'accident' he claimed to be in contact with the Ork deities Gork and Mork.

Some dark power certainly favoured Ghazghkull, for his rise to prominence among the Orks of Urk was meteoric. He swiftly fought his way through the ranks till he achieved the position of supreme planetary boss. Orks are simple, brutal creatures, respecting little other than courage and battle prowess. It cannot be doubted that Ghazghkull possessed both of these qualities in abundance. In addition, he had something most Orks lack: he had vision. He stirred the Orks with impassioned speeches telling them that it was their mission to conquer the galaxy, to force all others to bow before them and pay tribute. He gave them a sense of common purpose and an overwhelming sense of destiny.

All this might have come to nothing had not Urk's sun started to flicker and die. Ghazghkull told the Orks that this was a sign from Gork that the time had come to launch a Waaagh! Those who wished to join the great crusade would follow Ghazghkull. Those who wished to disobey their gods would die. To an Ork they chose to follow Ghazghkull. They would conquer the galaxy or die in the attempt!

The first Imperial planet to be attacked by Ghazghkull's hordes was Armageddon. The full story of this cataclysmic conflict can be found in the Games Workshop game of the same name, but for the moment suffice to say that Ghazghkull's army was defeated and he was presumed killed. However, before long it became clear that Ghazghkull had managed to escape, and was still at large within the Imperium.

In battle Ghazghkull is a masterly opportunist and a great tactician, ever ready to exploit any weakness an opponent might present. Once combat is joined Ghazghkull is always in the thick of the fighting, roaming the battlefield in his highly mobile battlewagon so that he can ensure that everything is going according to "da plan". In close combat Ghazghkull is an awesome opponent, gunning down opponents with his specially kustomised blasta and demonstrating the devastating effects of his adamantium skull when the fighting gets 'up close and personal'.

Your army may include Ghazghkull as its commander instead of a Warboss.

Profile	M	WS	BS	S	T	W	I	A	Ld
Ghazghkull	4	7	6	4	5(+1)	4	5	3	10

**WEAPONS:** Bolt pistol, power sword, frag stikkbombz, krak stikkbombz.

**ARMOUR:** Ork mega-armour with targeter (2+ save, and 4+ unmodified re-roll if first save is failed).

**WARGEAR:** Ghazghkull may have up to three Wargear cards. One of these must be the *Kustom Blasta*, and one must be *Ghazghkull's Adamantium Skull*.

Ghazghkull may be given additional equipment chosen from the Armour, Assault Weapons, Special Weapons, Transport and Stikkbombz sections of the Wargear list in Codex Orks.

**STRATEGY:** Ghazghkull has a strategy rating of 3.

### SPECIAL RULES

Once per game Ghazghkull may call on the Ork gods Mork and Gork to invoke the power of the Waaagh! He may do this at any time, including his opponent's turn. As soon as Ghazghkull calls on the power of the Waaagh, any fleeing Ork models immediately rally. For the remainder of the turn and all of the following turn Ghazghkull is immune to any damage – he cannot be harmed in any way at all – and all Orks (including Ghazghkull himself) receive a +1 modifier in hand-to-hand combat.

### MAKARI, GHAZGHKULL'S BATTLE STANDARD BEARER

70 points

Makari has been Ghazghkull's standard bearer for longer than either can remember, and now Ghazghkull would feel quite lost without the pointy-headed little chap. Makari can be included instead of the army's normal Battle Standard bearer in any Ork army that also includes Ghazghkull. He must attempt to remain within 2" of Ghazghkull at all times.

Profile	M	WS	BS	S	T	W	I	A	Ld
Makari	4	3	4	3	3	1	3	1	6

**WEAPONS:** Hand weapon.

**ARMOUR:** Incredible Good Luck (2+ unmodified save, see special rules below).

**WARGEAR:** None.

### SPECIAL RULES

The main reason for Makari's longevity is his quite extraordinary good luck. The number of times that bolter shells have been deflected by medals, grenades landing at his feet have proved duds, or attackers have slipped on a patch of oil is legendary. Makari's good luck is represented by a special saving throw of 2 or more on a D6, which is never modified for any reason, and which he gets against any and all damage that he suffers for whatever reason.

## BLOOD AXES



The Blood Axes have had the closest contact with the Imperium of all the Ork clans, and have even gone so far as to use camouflaged combat gear.

All of the Boyz in a mob will use the same camouflage pattern, although patterns do vary from mob to mob. Each Ork also wears a distinctive backplate bearing the mob badge.



KOMMANDO KAPTIN



KOMMANDO



These pictures show in detail a few of the many different camouflage patterns used by the Blood Axes. These patterns can be reversed in almost any combination of colours.

### BLOOD AXE KOMMANDOS



Blood Axe Kommandos are carefully selected for their ferocity, intelligence and initiative. They perform daring raids behind enemy lines, ambushing enemy troops and destroying supply dumps.

## EVIL SUNZ



MEKBOY WITH SHOKK ATTACK GUN AND SNOTLING "AMMO"



SHOKK ATTACK GUN DETAIL



MEKBOY'S BACKPLATE

## BAD MOON



The Bad Moons are the richest clan and can afford the best and newest wargear of all the Orks. Each mob wears a distinctive uniform derived from the traditional Bad Moon motif of a leering moon set in the night sky.

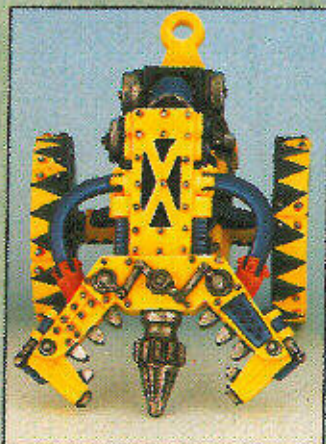

SMASHA GUN DETAIL



SMASHA GUN AND GRETCHIN CREW



## WARGEAR CARD

### GHAZGHKULL'S ADAMANTIUM SKULL 15 Points

Ghazghkull's adamantium skull adds +1 to Ghazghkull's Toughness, and also allows him to deliver a truly awesome head butt! He may headbutt an opponent in close combat instead of making a normal attack. If he does this and wins the combat, then he only scores 1 hit, no matter what the margin he beat his opponent's score by. However, the hit has a Strength of 10 and a -4 saving throw modifier, and causes 1D3 wounds.

**GHAZGHKULL ONLY**



## WARGEAR CARD

### RUNTHERD'S GRABBA-STICK 20 Points

The Grabba-stick can be used at the start of any hand-to-hand combat phase to attack one enemy model in base-to-base contact with the Runtherd. This attack is made before normal hand-to-hand attacks are resolved and will hit on a roll of 4 or more on a D6. If the attack hits then the claws of the Grabba-stick spring shut and deliver an electric shock. In battle the Grabba-stick is always used at its most powerful setting which delivers a Strength 8 hit with no saving throw for armour allowed. The victim is stunned even if they survive the shock, so their Weapon Skill is reduced to 0 in the ensuing round of combat.

**RUNTHERDZ ONLY**



## WARGEAR CARD

### KUSTOM BLASTA 30 Points

A kustom blasta is a big rocket launcher or grenade lobber fitted with an Ork Mekboy's speshul kustom warheads. The kustom blasta has an unpredictable blast marker with a D3' radius - roll for the size of the blast marker each time the weapon is fired. It also has a variable Strength which is rolled on the artillery dice each time it is fired, giving it a Strength of between 2 and 10. If a misfire is rolled on the artillery dice the kustom blasta has exploded! The blasta is destroyed and the Ork carrying it suffers an S4 hit.

RANGE		TO HIT		STR.	DAM.	SAVE MOD.	ARMOUR PENE.	SPECIAL
SHORT	LONG	SHORT	LONG					
0-15	16-36	-	-1	Art. dice	1	-1	Various	D3' blast

**ORKS ONLY**



## WARGEAR CARD

### KUSTOM SHOOTA 20 Points

An impressive-looking kustom shoota is an Ork Mekboy's pride and joy. It fires long, ragged bursts of shots with a hugely variable effect. The kustom shoota has sustained fire, rolling 2 dice. It also has a variable Strength which is rolled on the artillery dice each time it is fired, giving it a Strength of between 2 and 10. If a misfire is rolled on the artillery dice the kustom shoota has exploded! The shoota is destroyed and the Ork carrying it suffers an S4 hit.

RANGE		TO HIT		STR.	DAM.	SAVE MOD.	ARMOUR PENE.	SPECIAL
SHORT	LONG	SHORT	LONG					
0-12	12-32	+1	-1	Art. dice	1	-2	Various	Sustained fire - 2 dice

**ORKS ONLY**

# COME AND PLAY WARHAMMER 40,000 AT THE SUN! SQUIGS! AND STORMBOLTERS! ROADSHOW



Throughout July and August we'll be running massive games of Warhammer 40,000 at the following Games Workshop stores. The picture above shows the specially made terrain. All of the miniatures are provided, so all **YOU** have to do is turn up and play.



## STORE DATES AND VENUES



SATURDAY 23 JULY - **TORQUAY**

SATURDAY 13 AUGUST - **BLACKPOOL**

SATURDAY 30 JULY - **PLYMOUTH**

SATURDAY 20 AUGUST - **SOUTHEND**

SATURDAY 6 AUGUST - **BOURNEMOUTH**

SATURDAY 27 AUGUST - **BRIGHTON**

# WARHAMMER

## 40,000



At every roadshow there'll be a host of special Games Workshop events and competitions plus we've also got 10 limited edition T-shirts to give away as prizes at every show.

Don't miss out on a great day of gaming. The battles start at 10.00am so see you there!



# GAMES WORKSHOP

## EXETER

### GRAND OPENING SATURDAY 10th SEPTEMBER

37 PRINCESSHAY. TEL: 0392 490305

#### NORMAL OPENING HOURS

Monday to Friday  
10.00am to 6.00pm

Thursday  
10.00am to 8.00pm

Saturday  
9.30am to 5.30pm

**DOORS  
OPEN  
9.00am**



#### MASSIVE DEALS ALL DAY ONLY £43.50 EACH!

That's up to a 33% saving!  
Don't miss these amazing offers and  
massive discounts on the whole  
range of exciting Games Workshop  
products.

REDEEMABLE AT GAMES WORKSHOP  
EXETER 10TH SEPTEMBER 1994

**25% OFF** ANY GAMES  
WORKSHOP  
OR CITADEL PRODUCT.  
ONLY ONE VOUCHER PER PRODUCT. NOT TO BE  
USED WITH ANY OTHER OFFER.

REDEEMABLE AT GAMES WORKSHOP  
EXETER 10TH SEPTEMBER 1994

**25% OFF** ANY GAMES  
WORKSHOP  
OR CITADEL PRODUCT.  
ONLY ONE VOUCHER PER PRODUCT. NOT TO BE  
USED WITH ANY OTHER OFFER.

REDEEMABLE AT GAMES WORKSHOP  
EXETER 10TH SEPTEMBER 1994

**10% OFF** ANY GAMES  
WORKSHOP  
OR CITADEL PRODUCT.  
ONLY ONE VOUCHER PER PRODUCT. NOT TO BE  
USED WITH ANY OTHER OFFER.

REDEEMABLE AT GAMES WORKSHOP  
EXETER 10TH SEPTEMBER 1994

**10% OFF** ANY GAMES  
WORKSHOP  
OR CITADEL PRODUCT.  
ONLY ONE VOUCHER PER PRODUCT. NOT TO BE  
USED WITH ANY OTHER OFFER.

REDEEMABLE AT GAMES WORKSHOP  
EXETER 10TH SEPTEMBER 1994

**10% OFF** ANY GAMES  
WORKSHOP  
OR CITADEL PRODUCT.  
ONLY ONE VOUCHER PER PRODUCT. NOT TO BE  
USED WITH ANY OTHER OFFER.

REDEEMABLE AT GAMES WORKSHOP  
EXETER 10TH SEPTEMBER 1994

**10% OFF** ANY GAMES  
WORKSHOP  
OR CITADEL PRODUCT.  
ONLY ONE VOUCHER PER PRODUCT. NOT TO BE  
USED WITH ANY OTHER OFFER.

**BUY ANY THREE  
BLISTER PACKS  
AND GET THE  
CHEAPEST ONE  
FREE!**

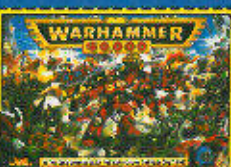

**WARHAMMER  
40,000  
plus!  
DARK  
MILLENNIUM  
plus!  
any one  
CODEX BOOK  
Normal price  
£64.97**



**WARHAMMER  
plus!  
WARHAMMER  
BATTLE  
MAGIC  
plus!  
any one  
ARMIES BOOK  
Normal price  
£64.97**



**MAN O' WAR  
plus!  
UP TO £15  
WORTH OF  
BOXED SHIPS  
plus either!  
PLAGUE FLEET  
or  
SEA OF BLOOD  
Normal price  
£54.98**



**SPACE  
MARINE  
plus!  
any one  
BOXED  
SUPPLEMENT  
Normal price  
£59.97**

JUST CUT OUT YOUR MONEY-OFF VOUCHERS TO GET THESE GREAT DEALS

PLEASE NOTE: NONE OF THE VOUCHERS ON THIS PAGE MAY BE USED IN COMBINATION WITH ANY OTHER OFFER NOR MAY THEY BE USED ON MII GAMES THROUGHOUT, SPACE CRUSADE, OR BATTLEMASTERS; DOCTRINE BOOKS® WARHAMMER NOVELS, OR ELECTRONIC ARTS' SPACE BULK COMBAT GAME.



# MODELLING WORKSHOP

## ORK BUILDINGS

By Adrian Wild and Simon Tift

We often receive letters at the Games Workshop Studio, asking how all the models and buildings we show in the photographs in *White Dwarf* have been made. They are all scratch built by our modelling expert Adrian Wild, and in this article he explains how to go about designing and constructing Ork buildings for *Warhammer 40,000*.

### MAKING TERRAIN

Building gaming terrain is one of the most rewarding aspects of the Games Workshop hobby. If you're new to *Warhammer*, *Space Marine* or *Warhammer 40,000*, your first few battles will probably be played on a flat tabletop with the terrain you get in the different boxes. This is fine to start off with, but sooner or later you will want to add some pieces of your own, to create more challenging and interesting battlefields.

Modelling terrain, like painting miniatures, involves the use of a few simple-to-learn techniques that you adapt to the task in hand. In previous articles we've talked about some of the methods you can use to create different kinds of cover such as hedges, walls and jungle (WD164), and also how to go about constructing model buildings (WD154). With the release of the Ork Codex, we decided to take a more detailed look at how to construct Ork buildings (or Orkitekture!) for your games of *Warhammer 40,000*.



The very nature of Ork buildings makes them one of the simplest Warhammer 40,000 modelling projects you can have a go at. Ork construct their buildings in a very haphazard manner, often making no more than a collection of square or rectangular boxes that attach together to form an Ork settlement. Once you've got the hang of making the basic shapes, you can add more and more detail and personalise your models by painting them to match your own Ork clan colour scheme or covering them with Ork glyphs and symbols.

## WALLS

I normally use foam card to make my building walls although thick cardboard would do just as well. If you haven't seen foam card, it consists of a sheet of polystyrene foam sandwiched between thin card. It's light, easy to cut but still very strong which makes it the ideal material to make model buildings with.

You start making an Ork building by marking out the walls. Firstly, cut out a strip about 300mm long and 90mm wide. Try to cut the sides as square to one another as possible but don't worry if your walls aren't perfect. It's best if you mark one of the long sides of the foam card strip as the bottom of the wall to avoid confusion later on.

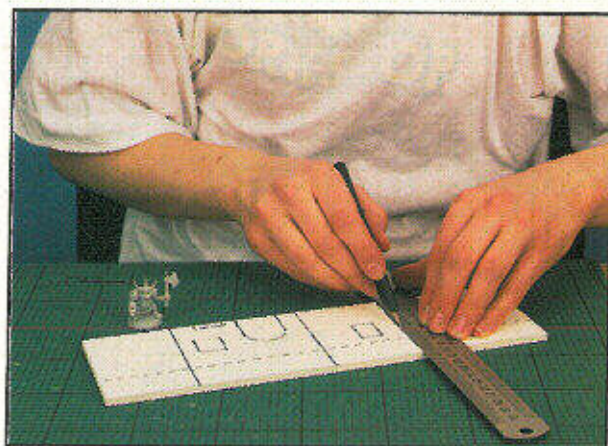

Once you've marked out the details, you can separate the individual wall sections.

Once you have your strip of foam card you can draw on the location of wall sections and mark the position of the roof. The small Ork building is made from four wall sections that give a building about 90mm long, 70mm wide and 90mm high. Obviously, once you've finished your first model you can alter these dimensions to make a selection of different sized Ork buildings. I made my building this size so that a five man squad can easily fit on the roof.

Measure along the bottom of the foam card strip two sections 60mm wide and two sections 90mm wide and mark their positions with a pencil. Next, measure the same widths along the top of your strip and join the marks from top to bottom. Now, measure 65mm up from the bottom of the wall at both ends of the strip of foam card and draw a thin pencil line joining these two points. This line shows where the ceiling will be inside your Ork building and gives the position of the roof.

## DOORS AND WINDOWS

Below the position marked by the ceiling line you can place doors and windows. I normally position and cut out all the doors and windows before I cut out the wall sections because it's easier to work on a single large piece of foam card than several small ones. Fortunately, Orks are not too concerned where they have their doors and windows, which makes them really easy to make! The random placing of windows throughout an Ork building looks good and adds character to the model.

I have cut three windows in my building, which vary from a narrow slit to a window large enough to show most of an Ork miniature. When cutting windows or doorways, try to leave a 10mm gap between the frame and the edge of the wall, or the next frame. This gap helps the foam card retain some of its strength. When you have decided where the windows will be just cut them out carefully with a sharp craft knife.

An arched doorway looks good on an Ork building and is actually quite easy to make. First decide where you want the doorway to be and draw a rough outline onto the wall. Place a Citadel miniature by the side of the wall to give you some idea how tall and wide the doorway should be. Whenever I make any terrain pieces I always have a miniature close at hand to help get the building proportions right. The doorway on my building is 30mm wide by 40mm high with an arched top. Once you have marked the outline for your doorway, carefully cut along the lines with your craft knife.

## TOOLS AND MATERIALS

Before you start to construct your Ork Building, you'll need to find the following tools and materials:

### Tools:

- Modelling knife
- Steel rule
- Sand Paper
- Masking Tape

### Materials:

**Foam card** – a modelling material available from most art shops, made from a sandwich of foam between two sheets of card. I used foam card to construct the walls of my building, but thick card could be used instead.

**Thick card** – such as mounting board available from art shops.

**Hardboard** – for the base section. Alternatively you can use thick card, but this has a tendency to warp.

**Ready Mixed Filler** – like ready mixed Polyfilla or Das Modelling clay, used for filling gaps and modelling the base.

**Glue** – different types for different tasks – PVA for general gluing and Copydex for fixing the base materials together.

**Polystyrene Sheet** – such as insulation board, or alternatively, layers of ceiling tiles available from DIY suppliers, for building up the height of the base.

**Textured Paint** – or a homemade alternative such as sand mixed with paint or thinned PVA glue.

**Balsa Wood** – available from model shops.

**Pins** – with rounded heads for studding wooden doors.

**Citadel Paint** – a selection of Citadel acrylic paints as mentioned in the article.

**Texturing Materials** – cut litter, small rocks and fine sand to texture areas of the base.

**Modeller's Flock** – available from Games Workshop stores and model shops, used to add the grassy effect to the base.

## ASSEMBLY

Once you've finished cutting out all the doors and windows, the wall sections can be separated from each other. Carefully cut along the lines with a sharp knife and metal ruler and you'll end up with two long and two short walls.

Take one of your long wall sections and glue one of the two shorter sections to the inside wall with PVA to make an 'L' shape as shown in the diagram (If you are using foam card to make your model don't use an impact adhesive such as Bostick as it will 'melt' the foam!). Make sure that the bottom of each section is flat on the tabletop and to help position the walls, match up the line of the ceiling you drew earlier. Repeat this process with your other two sections to make a second "L". Put both of these "L" shapes on one side to dry. When the glue is firm, you can attach the two "L" shapes together to make up your box. The advantage of using PVA glue is that it dries slowly, and gives you time to reposition the walls if necessary. When gluing the walls together its important they are positioned as square to one another as possible.

I usually add reinforcement corners to my buildings. These not only strengthen them and support the roof but also help to ensure the building is glued together squarely. Reinforcement corners are right-angled triangular pieces of card glued inside each corner of the building. Normally I use two reinforcements in each corner, positioned at the bottom of the wall and along the ceiling line. It is important that the reinforcements are large enough to provide a lip for the roof to rest on – mine measure 20mm along the right-angled edges. Glue your reinforcements

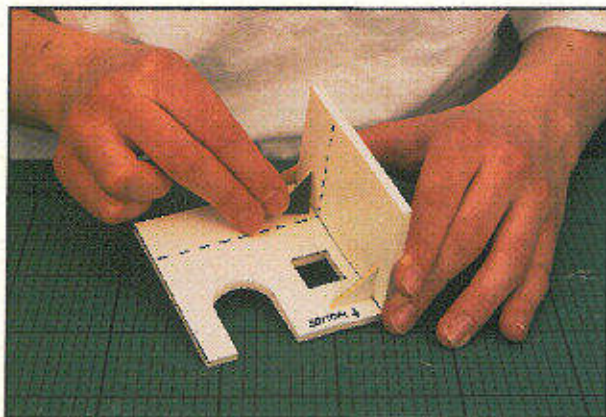

Reinforcing the corners.

## ORK BUILDING ASSEMBLY DIAGRAM



1. Glue one 'short' wall to the inside of one of the 'long' walls with PVA glue in order to make an "L" shape.
2. Repeat this with the other two wall sections and place both "L" shapes on one side to dry.
3. Glue the two "L"s together to make a box
4. Cut out the triangular corner pieces and glue them into the corners of your building along the line of the roof. When these are dry, carefully position and glue the roof so that it rests on top of them.

in position with either PVA glue or all-purpose adhesive. Because of its quick-drying properties, all-purpose adhesive is better.

## THE ROOF

To give my Orks hard cover to hide behind, I constructed my building with a recessed roof. This means that da Boyz can stand on the roof and pour fire down on unwary attackers.

The roof of the building is made from another piece of foam card which rests on the corner reinforcements. Measure and cut out your roof section and try slotting it into the roof space. Don't worry if the roof doesn't exactly fit the roof recess – if the roof section is too big just trim the sides a little until it drops into position. If you have gaps around the edges because the roof is too small, you can either cut out a new section and try again, or fill in the gaps with modelling clay. Once your roof fits snugly, you can glue it down onto the reinforcement corners.

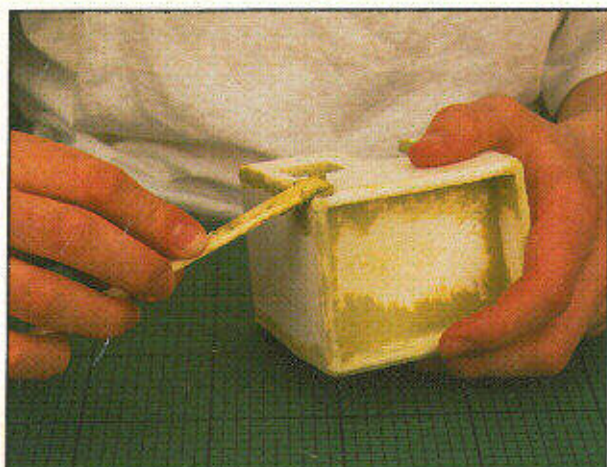

*Texturing the walls and filling in the gaps.*

### FILLING IN GAPS

Now that your building is assembled you may find there are gaps around the walls and roof joints. There's no need to worry about these because most of the gaps will disappear when you texture the building. Larger gaps will need filling properly with either a modelling clay, like Das, or filling plaster – ready mixed Polyfilla is quite good. Carefully fill the gaps and allow the filler to dry.

I prefer rounding-off the exposed wall sections of my Ork buildings to give a neater appearance. To do this, trim along the exposed edges on both sides of the wall at a slight angle.

Coat all the exposed wall edges in PVA glue to seal the foam card and allow this to dry. Using modelling clay, gently form the rounded wall edge. The advantage of Das modelling clay is that by mixing it with PVA glue you can make a stickier and more malleable filling and sculpting material. The modelled edge can then be smoothed with a wet finger. Once the clay is dry, any rough areas can be carefully smoothed-off with fine sandpaper.

### TEXTURING THE WALLS

I used textured paint to create the rough finish of the walls on my buildings. This can be purchased from most hardware shops or you can make your own by simply mixing sand and paint together. When texturing the walls, try and avoid painting smoothly in straight lines – I use an old paint brush and stipple on a plastered wall effect. It is important to fully texture over any exposed areas of foam card, otherwise, when the building is undercoated with spray paint any exposed areas of foam may melt!

### PAINTING YOUR BUILDING

Once the roof and walls have been assembled, filled and textured the main building is ready for painting. Citadel white spray paint gives a good undercoat and covers any mistakes you may have made earlier. Once undercoated, the building can be painted with Citadel acrylic Bleached Bone. Staining on the walls and in recesses can be added with either Bestial Brown or Snakebite Leather. Thin down the stain colour with plenty of water and paint it very carefully onto the building. You can mop up any excess with tissue paper before it dries. Lightly dry brushing over the stained area with Bleached Bone and Skull White will blend it into the overall appearance of the building.

When the building is dry I add bands of colour and geometric designs that characterise the building's Ork owner. To paint the bands, first mask off the area you wish to paint. I use two long strips of masking tape set about 20mm apart to mark off the top and bottom of the band of colour. If the masking tape is only applied lightly to the walls, it won't damage them when you remove it.

Once the area of the band has been marked out you can experiment with different designs and patterns by drawing them between the bands. You may wish to personalise your building for one particular Ork Nob, or just use standard Ork designs. When you have drawn your design within the band, simply colour it in with Citadel Paints. Peel the masking tape off when the paint has dried thoroughly.

### ADDING DETAIL

Adding small details like window ledges and doors really adds to the look of a building and is really easy to do.

My wooden door is made from a sheet of balsa wood 45mm long by 40mm wide. I use fairly thick balsa because plank detail can easily be engraved in to the wood surface giving it a realistic look. To make your wooden door, cut out a piece of balsa wood that will fully cover the doorway. Cut the door larger than the doorway as this will overlap with the door frame and so you can stick the door to the inside of the building. Roughly mark the position of the planks along the wood grain about 8mm apart, and cut along the lines you have drawn at a slight angle. Don't worry about keeping neat parallel lines, most planks are a bit warped and the odd variation will add to the door's appearance.

In true Ork fashion, I added metal studs and a big handle to my door. The metal studs were made using pin heads pushed through the balsa and superglued on the inside. As balsa wood isn't very strong, I supported the door with a ball of plasticine as I pushed in the pins (this also makes it less likely that you'll push a pin through your finger!). I used two looped lengths of fuse wire linked together to make the big metal door handle. Once all of the detail had been added, I painted the door Chaos Black and then drybrushed it first with Bestial Brown and finally with Orc Brown. Metal detail, like the studs and the door handle were just painted in Chainmail. Once the paintwork is all dry, just glue the door into position on the inside of the doorway.

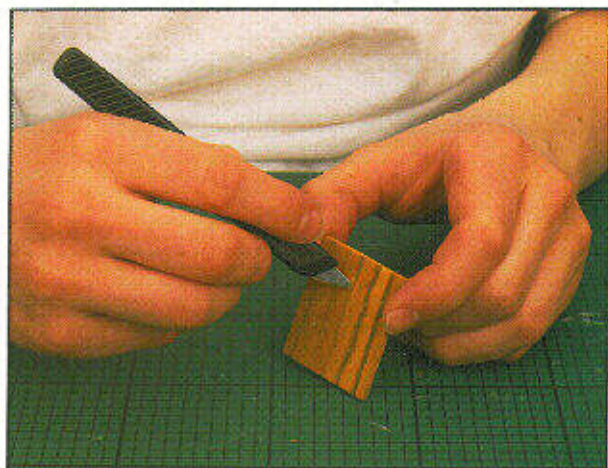

*Cutting the details of the planking onto the door.*

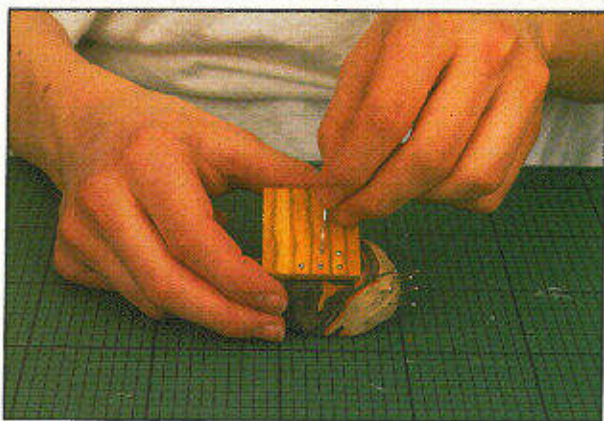

*Pressing pins into the door to create the effect of metal studs.*

## WINDOWS

Window ledges are made from thinner strips of balsa wood cut and trimmed to fit the holes you cut in the walls. For plain open windows simply stick a piece of black card on the inside of the building to cover the window opening. I have added grills and iron bars to a couple of my windows make the building look more Orky. The grill is made from car body mesh that's been painted and then stuck to the inside of the wall with a black cardboard backing. Metal bars can be added by sticking either fuse wire or lengths of plastic rod to the inside of the building, painting them, and then backing them with black card. All metalwork like the bars, grills and studs is best painted with Chainmail paint and washed with a rust brown ink.

If you are feeling adventurous you can try sticking wooden shutters at the side of the windows in the same way as described for the roof hatch below.

## ROOF HATCH

To give the Orks access to the top of the building, you can add a roof hatch. I made the hatch on my model from thin pieces of balsa wood. First cut out a piece about 20mm square, this will be used for the hatch. Plank detail can be engraved into the hatch in the same way as for the door although you will have to be far more careful not to cut all the way through the thinner wood. The hatch is framed with small strips of balsa about 5mm wide. Trim the edges of these strips to make them look a little worn. Now stick the hatch to the roof of the building with PVA glue and use the small balsa strips as a frame. Again I added metal studs to my hatchway using pins in the same way as the doorway.

## PAINTING WOODEN AREAS

To achieve a realistic wooden effect look on areas like doors and ledges I first paint them Chaos Black. When they have thoroughly dried, these areas are drybrushed with Orc Brown and Bleached Bone to pick out the detail of the wood.

## BASING YOUR MODEL

I mounted my building onto hardboard but thick card will do just as well, as it is readily available and easy to work with. The advantage of hardboard is that it is more durable and stronger than cardboard. At the Studio we base our terrain on hardboard because it is in constant use and needs the extra

strength. To base your building, cut out a rounded piece of thick card or hardboard that will give you about a 40mm border all the way around the building. The edges of the base can be smoothed and rounded using fine sandpaper. On top of this, I stick a polystyrene ceiling tile to raise the height of the building and make it more of a centrepiece on the battlefield.

Use Copydex glue to stick the polystyrene to the cardboard base. This avoids the warping that PVA glue can cause when it dries and contracts. Copydex is a rubber-based adhesive that does not contract when dry and so doesn't warp the base.

When the glue is dry, trim the polystyrene with a knife so that it follows the shape of the base. Gently sandpaper the edges to make a slight slope but be careful to leave enough room for the building. The building can now be stuck to the hill with Copydex glue and allowed to dry. I mould modelling clay around the bottom of the building's walls and base to help it blend in.

Texture the base in the same way as the walls, painting liberally all over the base and up to the sides of your building. You can create contrast between the model and the base by adding piles of rocks and debris. Smashed up pieces of masonry, cat litter (unused!) and fine sand are ideal materials. When sticking bits to the base of your building it is a good idea to avoid gluing them in areas that will hinder the movement of miniatures when you play your games. I always keep an unpainted Citadel miniature nearby when I am making terrain so that I can check at each stage to see if the models will fit on my new scenery. I use an unpainted model because building scenery can be messy and I don't want to spoil my finished miniatures.

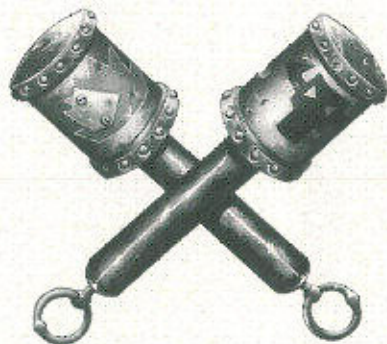

Once the general debris has been added and the glue is dry, the entire base can be painted Chaos Black. The base, and in particular the rocky areas, can be drybrushed Bestial Brown followed by Orc Brown and a very light drybrush of Bleached Bone. The grassy effect is added by painting the areas where I wanted grass Goblin Green followed by watered down PVA glue and then sprinkling on modeller's flock. Shake off the excess flock onto a sheet of newspaper, so that it can be used again.

Your Ork building should now be complete and ready to use. With a few changes to the dimensions and by adding extensions, balconies and even banners, you can create an almost endless variety of different Ork buildings to enhance your games of Warhammer 40,000 – have fun!

# GAMES WORKSHOP



## BATTLE DAYS



Games Workshop is hitting the highways and byways of the U.K. again this summer. Following the success of last year's tour, our team will be visiting cities and towns that don't have a Games Workshop store. They will arrive with fantastic scenery and superbly painted armies for an exciting day of massive Warhammer 40,000 battles.

The games start at 10am and at every event we'll also be holding a Citadel Miniatures painting competition, with awards for the most impressive entries. So bring along your best painted single miniature, squad or regiment and you could win a prize!



### AUGUST DATES

<b>TRURO</b>	<b>Tue 2nd</b>	Carrick Sport and Recreation Centre, Carew Road, Hendra.
<b>TAUNTON</b>	<b>Wed 3rd</b>	Youth and Community Centre, Tangier.
<b>GLOUCESTER</b>	<b>Thurs 4th</b>	Gloucester YMCA, Sebert Sreet, Kingholme.
<b>RUGBY</b>	<b>Fri 5th</b>	Rugby and District Railway Employees Sports & Social Club, Hillmorton Road.
<b>CHESTERFIELD</b>	<b>Mon 8th</b>	Chesterfield YMCA, Holywell Cross.
<b>WARRINGTON</b>	<b>Tues 9th</b>	Masonic Hall, 15 Winmarleigh Sreet.
<b>WAKEFIELD</b>	<b>Wed 10th</b>	Lightwaves Leisure Centre, Lower York Sreet.

# WARHAMMER

## 40,000



<b>HUDDERSFIELD</b>	<b>Thurs 11th</b>	Huddersfield Hotel (Johnny's Main Dance Floor), Kirkgate.
<b>BURNLEY</b>	<b>Fri 12th</b>	Friendly Stop Inn (formerley the Keirby) Keirby Walk.
<b>CANTERBURY</b>	<b>Tues 16th</b>	Hullabaloo, 6 Marshwood Close.
<b>GRAVESEND</b>	<b>Wed 17th</b>	Emmanuel Baptist Hall, Windmill Street.
<b>HASTINGS</b>	<b>Thurs 18th</b>	The Carlisle, 24 Pelham Street.
<b>TUNBRIDGE WELLS</b>	<b>Fri 19th</b>	Camden Centre, the Market Square, Victoria Road.
<b>HERTFORD</b>	<b>Mon 22nd</b>	Red Cross Hall, Baker Street.
<b>FINCHLEY</b>	<b>Tues 23rd</b>	The Old Finchleians Sport Club, Southover, Woodside Park.
<b>BOGNOR REGIS</b>	<b>Wed 24th</b>	Masonic Centre, Canada Grove.
<b>ASHFORD MIDDLESEX</b>	<b>Thurs 25th</b>	St Michael's Social Centre, Fordbridge Road.
<b>NORTHAMPTON</b>	<b>Fri 26th</b>	The Exeter Rooms, Kettering Road.

# WARHAMMER

## A CHRONICLE OF BLOOD

by Jeremy Vetock and Richard Helliwell

Two mighty armies clash in this merciless struggle between ancient enemies. Ungrim Ironfist and the loyal Dwarfs of Karak Kadrin are all who stand across the path of the ravaging Chaos horde of Dundesh the Black.

Down from the bleak Northern Wastes they had come to fall upon the hapless villages of men. Killing all before them in a frenzied orgy of destruction and death, they left nothing in their wake but ashes and despair. In their blind, unreasoning hatred they asked for no mercy and expected none in return. They had not come to bargain or entreat, nor for conquest or glory. They had come only to kill for the sheer love of slaughter.

Great drums made from the skulls of ancient beasts beat the pace for the foul army. The ground shook with the tread of the cloven hooves of countless mis-shapen Beastmen. Garbed in blood and black and brass, great Chaos Knights sat astride their pitch black steeds, eyes glowing like burning coals. And all about ran the daemons, warped monstrosities prancing and cackling in their twisted glee as the army marched and slithered south on a pilgrimage of destruction.



Brave armies made their stand, hastily arrayed and equipped. Huntsmen and trappers of Kislev and Ostland mixed with merchants and traders of far off cities. All waiting for their moment of glory when they would halt the tide of Chaos. The songs they would sing of their victory!

Battle was not the name for the frenzy of blood-letting which the Chaos horde unleashed upon the armies of

men. Nothing could stand before them and the bravest of the Empire's Knights fell alongside the meanest of peasants.



The chant of death followed the dark legions of Chaos. The sick music of screams and the last death rattle of the dying was their song. The mesmerising pounding of drums goaded them on as it marked time for their victims' hearts as they beat their lifeblood into the cold black dust. And after the fight, the harsh bray of the war horns as the dark legions mustered once more for their march onwards.

Nothing escaped the trail of devastation. The most sacred temples of the Empire were defiled by the unholy blood rites of the four Chaos powers. Relics, passed down for generations with careful reverence, were trampled into the mud as the dark army marched on, burning and killing all they could find.

For weeks rumour and dark whispers had come to the Dwarf halls. Messengers told of the bloody slaughter and the destruction of the cities of men. A great council of Dwarfs was assembled.

In their cool stone halls they had waited but now they must act. Ungrim Ironfist heard the last of his council. He rose to his feet, and drawing his cloak about him spoke in a booming voice. "If the cities of men fall, the halls of Dwarfs cannot stand alone. I myself will lead the warriors, sound the battle horns - tomorrow we march to war!"





## INTRODUCTION

Before each of our games is released, we fight a lot of battles with the new armies and rules to make sure that even with the hundreds of different possibilities in a Warhammer game the result is reasonably balanced. It was in the middle of the frenzied battles to develop Warhammer Armies – Chaos that one of our American staff came over to the Studio. Almost as soon as he had arrived, Jeremy had been given command of a Dwarf army with the unenviable job of trying to halt Richard's well-honed Chaos force.

This battle was fought using the latest rules from Warhammer Armies – Chaos. These include the expanded new spells for Tzeentch, Nurgle and Slaanesh Sorcerers, Chaos Gifts, Chaos Spawn and lots more.

As usual, the battle was fought out over one of the Studio's eight by four foot tables with the scenery you see in the photographs. Jeremy and Richard kept notes while they played so that they could write up the turn-by-turn account that follows. They also took snapshots of the battle as it happened. It isn't possible to get good enough photographs to print in White Dwarf like this, but you can use the snaps to recreate the battle scenes later under proper photographic lights and with a better camera.

So that both sides could deploy their army at the same time, we set up a screen on boxes behind which they set up. When Richard and Jeremy were both ready, the screen was removed to reveal the armies as you see on the deployment map.



You may notice that some of the models used in this battle report are not yet available in the shops. At the moment, the Citadel Miniatures designers and the 'Eavy Metal painting team are putting the final touches to a complete new range of Chaos models which will be released over the next few months.

## CHOOSING THE DWARF ARMY

by Jeremy Vetock



After working for Games Workshop U.S. for over four years, including recent work on the stateside edition of White Dwarf, I came over to the Studio in Nottingham to slave under the cruel tutelage of White Dwarf Editor Robin Dews. When I arrived at the Studio there were several games being fought and through lucky coincidence, cruel fate, or a healthy bribe I

quickly found myself in command of a Dwarf Army attempting to halt the tide of Chaos...

For years, I've fielded a large, if slightly unlucky Dwarf Army and I've recently started to build up a Chaos Army as well. Despite this experience I must admit to feeling a little intimidated as I began to select troops for the upcoming battle. No other army strikes more fear into the hearts of a Warhammer player than the Chaos army. To make matters more frightening I'd had a look at the newly released Warhammer Armies - Chaos and all the brilliant new models that the 'Eavy Metal team had just finished painting. What could I do against so varied and powerful an army?

However, in the Warhammer world, Dwarfs have stood defiant against the hordes of Chaos for centuries. Now was not the time to show fear or to give any ground, and so gathering my resolve I planned out my forces and strategies. The first regiments I selected were my large blocks of infantry. A hefty regiment of Longbeards is relatively inexpensive and their high Weapon Skill and Strength give them a fighting chance against even the toughest of Chaos troops. When you add a *Banner of Might* and a hero, the Longbeards become quite formidable. To anchor the centre of my battle line I chose twenty-five Dwarf Warriors, a large unit which could be relied upon to stand firm, helped by their massed ranks and standard bonus. In my own army, I field a large unit of Dwarf Miners with much success, so I took as many as the Studio had painted up. Their heavy armour and two-handed picks always come in handy against foes with high Toughness.

One of the great strengths of Chaos is the wide variety of daemons and terror causing monsters that can be included in their armies. With this in mind, I decided to take as many Dwarf Slayers as I could get my hands on. These fearless Dwarfs have vowed to seek death in battle at the hands of as large and deadly a foe as possible. They fear nothing and relish fighting monsters that most other troops would flee from.

Chaos Armies are rarely subtle, being much more suited to rush forward and attack hand-to-hand. They are, however, very vulnerable to missile fire on their way across the battlefield. The crucial first few turns of the game would give me the opportunity to even the odds for the bitter fighting that would erupt when they finally reached my lines. As one of the most technologically advanced of all Warhammer races, Dwarf Generals are spoiled for choice when it comes to engines of destruction. A war machine stands a fair chance of causing damage and multiple wounds, even against the high Toughness of the monstrous creatures Chaos armies can field. I was

tempted to take a battery of three cannons but I finally settled on one cannon, a flame cannon, and a gyrocopter. I improved my odds of not self-destructing by enscribing the *Rune of Forging* on the cannon, allowing me a re-roll in the event of a misfire. To provide yet more firepower, I chose a unit each of Thunderers and Crossbowmen to pepper the Chaos ranks with missiles.

Now I had to choose my General, and select any magic runes my remaining points would allow. With a large number of Slayers in my army, the natural choice was Ungrim Ironfist, the Slayer King of Karak Kadrin. Ungrim is armed with some formidable magic items: including the rune-encrusted *Axe of Dargo*, the *Slayer Crown*, and the *Dragon Cloak*. To accompany my General I selected a Battle Standard Bearer. This is a great idea for Dwarfs as it not only gives you the luxury of re-rolling break tests within 12", but there are several extremely potent Dwarf runes that may only be placed on the Battle Standard itself. Against the awesome powers of Chaos I chose the *Master Rune of Groth One Eye*. This rune gives all friendly troops within 12" a Leadership of 10 regardless of any modifiers - even combat results!

Dwarfs do not have magic and the prospect of facing Chaos Sorcerers and spell-casting daemons made me cringe. There are, however, quite a few Dwarf runes to limit the effects of hostile magics. The most popular anti-magic device is the fabled *Master Rune of Valaya*, an incredibly effective Dwarf rune that offers a chance to dispel any enemy spell cast anywhere on the battlefield. Since this rune may only be placed on the Battle Standard I had to look elsewhere for magical protection as you can never combine master runes. To protect myself from any horrors the winds of magic might bring, I settled on a Master Runesmith with several *Runes of Spellbreaking*. The advantage of the *Rune of Spellbreaking* is that it gives Dwarf players an automatic dispel, with no dice rolls to go wrong. To add to his strength, I placed the Runesmith atop the Anvil of Doom.

### THE PLAN

There is no getting round the fact that Dwarfs are slow. With this in mind I based my strategy on the fact that Richard would get to pick when and where he would charge. Often in Warhammer, a concerted charge can spell doom for the opposing regiment. Despite this, small units of even the most powerful cavalry and monsters can be ground-down by infantry with ranks and standard bonuses if you can survive the initial attack. I was hoping to stand firm and absorb the Chaos charge with my large units. Then, like a prize fighter taking one on the chin, I would come back with a hammer-blow of my own by charging the flanks of his already engaged units.

To facilitate this plan I placed my Longbeards and Warriors in the centre of my line, with smaller units like the Slayers and Miners poised on the flanks. Dwarf armies can contain any number of Slayer Regiments, so long as they don't outnumber your Dwarf regiments, so I split my large unit of Slayers into two smaller groups. To ensure my large units didn't break before I got a chance to pile in more Dwarfs, I placed the Battle Standard so that its magical effects would cover as many of my troops as possible. This gave me an iron-hard centre that would not rout no matter what hit me and the flanks were rock solid with fearless Slayers. The longer my troops held out, the longer I would have to counter-charge Richard's Chaos army in the sides and rain doom upon his forces with my war machines.



## UNGRIM IRONFIST'S DWARF ARMY



**Ungrim Ironfist the Slayer King.** He wears the *Dragon Cloak* and the *Slayer Crown*. In battle he fights with the *Axe of Dargo* which is inscribed with the *Rune of Smiting* and the *Rune of Parrying*.



**Master Runesmith** on the *Anvil of Doom* with three *Runes of Spell Breaking*.



**Battle Standard Bearer** wearing heavy armour and carrying a pistol. The army standard bears the *Master Rune of Groth One Eye*.



**24 Dwarf Warriors** wearing light armour and carrying shields. They are armed with hand weapons. The regiment includes a standard bearer.



**18 Longbeards** armed with hand weapons and protected by heavy armour and shields. The regiment includes a standard bearer who carries the *Banner of Might*.



**8 Slayers.** Some are armed with extra hand weapons and some with two handed weapons. They are led by a *Giant Slayer* whose axe bears the *Master Rune of Swiftmess* and *Rune of Fury*.



**12 Slayers.** Some are armed with extra hand weapons and some with two handed weapons.



**10 Dwarf Crossbowmen** wearing light armour and armed with hand weapons.



**12 Miners** armed with double-handed picks and wearing heavy armour. The regiment includes a standard bearer.



**8 Thunderers** armed with hand guns and wearing light armour. The regiment also includes a standard bearer.



**1 Flame Cannon.**



**1 Cannon** engraved with the *Rune of Forging*.



**Gyrocopter.**

## THE ARMY OF CHAOS by Richard Helliwell



As the resident horned-one and general Chaos worshipper here at the Studio, nothing could have pleased my twisted imagination more than to see the hordes of new Chaos models pouring forth from the miniature designers' rooms. Over the last few weeks these have been expertly painted and at the same time the Warhammer Armies – Chaos book completed. After play-

testing some of the new rules with my own Chaos army, I gleefully took up the challenge of a battle report and a chance to use some of the new models available in the Studio army.

We decided to play a 3000 point battle which was probably a good thing for an army with daemons and other very costly regiments like Dragon Ogres or Chaos Knights. The high points cost often means that the Chaos army has fewer models on the table than its opponents, but there are no weak regiments in a Chaos host and most units can hold their own in battle against any foe.

I began my army by choosing the Slaanesh General – Dundesh the Black. His basic cost was 305 points but I decided to mount him on a Dragon and give him some magic items which put his total cost well over 800 points. He carried a *Chaos Runeshield* to negate the effects of his enemies' magical weapons and as a cruel twist of fate for his foes I gave him the *Sword of Change*.



One nick from this hellish weapon and his opponents would be transmuted into a writhing tentacled mass of Chaos Spawn.

Hordes of Chaos creatures and warped humans do not make for a subtle army. Without any form of missile fire their usual tactic is to race across the battlefield as quickly as possible, taking enemy missile fire as best they can. Be assured that when you get there, the carnage will begin as you smash into the weak fools who dare to stand in the way of an army of Chaos.

With speed in mind I choose two units that could take the battle to the enemy early on in the game, these were the Dragon Ogres and Chaos Knights. Hopefully, the sight of these two regiments crashing into his line would distract Jeremy from the rest of my army and allow them to advance in relative safety. The Dragon Ogres, which are already expensive, are fearsome enough to be let loose on the battlefield without the addition of a costly champion.

The Knights, on the other hand, are somewhat more brittle and need all the protection they can get. I did two things to ensure their survival. Firstly, I gave them all Chaos armour which with bonuses for being mounted, armed with shields, and barding for their steeds, gave them a 1+ save against normal attacks. This meant that some of the Dwarf regiments wouldn't actually be able to harm my Knights at all as any wound they inflicted would automatically be saved!

Secondly, I put the army Battle Standard Bearer with them. This Chaos hero also wore Chaos armour and carried as the army banner the *Rapturous Standard*. This magical banner makes it impossible to break the regiment carrying it and allows them to ignore all effects of psychology. Whatever losses the Knights took in combat they would never flee, but battle on to the bitter end.

My favourite units on the battlefield are the Beastmen. These servants of Chaos are foul and misshapen, but strong and hard to kill, so I took two regiments of them, both with magical banners. The first unit was equipped with light armour, shields and hand weapons and carried a *Banner of Wrath*. The second regiment carried a *Standard of Shielding* and were armed with light armour and halberds. Beastmen suffer a new form of psychology called 'infighting'. This is similar to Orc and Goblin animosity and to help them pass this test and provide them with good leadership, I put a Champion of Khorne with the halberd-carrying Beastmen, and a Sorcerer of Nurgle with the other unit.

My last unit was very small, consisting of just six Pink Horrors – my only regiment of daemons. Although initially small, this unit has the capacity to grow in number because every time a Pink Horror is slain it splits into two Blue Horrors! This makes a very daunting prospect for the enemy who see a unit growing instead of diminishing as it is cut down. Regiments of Pink Horrors are also enhanced with magical powers, gaining a spell for every five models they have. With six Pink Horrors, I would start the battle with two Tzeentch spells for this unit. Luckily, I drew my favourite spell from this deck – *Tzeentch's Firestorm*. Not only does this slay the enemy with horrific ease, but it also forms new Pink Horrors from the ashes of the those it kills!

In order for me to have a unit of Tzeentch Daemons in the first place, I must have at least one Tzeentch character somewhere on the table, so in the spirit of the master of Sorcery, I chose a Tzeentch Sorcerer mounted on a Flying Disc to aid his mobility across the battlefield.



## THE CHAOS HORDE OF DUNDESH THE BLACK



**Dundesh the Black** – Slaanesh Chaos General. He wears heavy armour and carries a *Chaos Runeshield*, a *Sword of Change* and a lance.

He has the Chaos Reward *Iron Hard Skin* which gives him a 4+ saving throw.

In battle, he rides a **Dragon**.



**11 Beastmen** armed with halberds and wearing light armour. The regiment includes a musician and a standard bearer who carries the *Standard of Shielding*.

The leader of this regiment is a **Chaos Champion of Khorne**. He wears Chaos armour and carries a shield and hand weapon.



**13 Beastmen** with hand weapons, shields and wearing light armour. The regiment includes a standard bearer who carries the *Banner of Wrath*.

The regiment is led by a first level **Chaos Sorcerer of Nurgle** who is armed with a hand weapon.



**6 Horrors**, daemons of Tzeentch.



**Chaos Spawn**.



**5 Slaanesh Chaos Knights**. They wear Chaos armour and ride barded Chaos Steeds. They carry shields and are armed with hand weapons and lances.

They are led into battle by the Chaos army **Battle Standard Bearer** who is a follower of Slaanesh. He wears heavy armour and rides a barded Chaos Steed. He carries a shield and is armed with hand weapon and lance. The Battle Banner is the *Rapturous Standard* which makes the regiment immune to psychology and impossible to break!



First level **Chaos Sorcerer of Tzeentch** riding a *Flying Disc*. He is armed with a hand weapon.



**5 Dragon Ogres** with double handed weapons.



DEPLOYMENT MAP

## CHAOS TURN 1

Both sides rolled a dice to see who would go first and Richard won. With the new rules in Warhammer Armies – Chaos, the first thing that he had to do each turn was draw two Chaos Gifts. These cards represent the random mutations, special powers and uniquely chaotic occurrences that characterise the Chaos host.

The first of the Chaos Gifts that Richard drew was *Lose Gifts*. This must be played immediately, unlike most of the other cards which can be held until the Chaos player wants to use them. This card forced Richard to discard all the Gifts in his hand including the other one drawn this turn. Although not a lucky card to start with, it's better to draw *Lose Gifts* before you've collected a lot of other Gifts.

Next, the Beastmen had to make an infighting test. This works a bit like Goblin animosity and means that any Beastmen who aren't charging or already in combat must roll under their Leadership or they begin to fight amongst themselves. If they fail an infighting test, then the regiment cannot move for that turn whilst its leaders attempt to restore order. Both of the regiments passed their test using the General's Leadership and were able to move normally.

Chaos armies have no missile troops or war machines but are devastating in hand-to-hand combat. Knowing his army well, Richard moved the entire Chaos host as fast as possible towards the waiting Dwarf battleline. The fewer turns the army spent in the open being shot at the better they would fare when they closed for the hand-to-hand fighting.

The winds of magic provided eight cards for the turn and as he had chosen to take a Dark magic spell, Richard was able to discard two *Dispels* and take another two cards instead. This meant that he would have more power cards for his lethal magical attacks.

The first spell cast was *Tzeentch's Firestorm* which the regiment of Pink Horrors loosed on the Dwarf Miners. Jeremy looked at his hand of cards and shook his head – no *Dispels*. Not wanting to start the battle with one of his regiments turning into Pink Horrors, he used one of his *Runes of Spellbreaking* to stop the spell in its tracks.

At the end of the turn, the Dwarf Runesmith stored two power cards, *Rebound* and *Mental Duel* in the Anvil of Doom, ready to cast them as bolts of energy in the next turn.

## DWARF TURN 1

Not surprisingly, none of the Dwarfs charged, but they did move to reposition their regiments in the face of the approaching Chaos army. With a hiss of steam, the gyrocopter swept out from behind the building to make a bombing run over the foul Chaos Knights.

The Dwarfs opened the shooting phase with their flame cannon which pivoted to fire at the Dragon Ogres. A great sheet of fire engulfed two of these hideous creatures, injuring one of them. The regiment of Crossbowmen also shot at the Dragon Ogres hitting them with six bolts and wounding them three times. This was enough to kill one of the fearsome beasts but not enough to force a panic test on the rest.

The Thunderers in front of the Crossbow-armed Dwarfs chose to fire at the Beastmen in the centre of the Chaos army. Several of the shots hit their targets but all of them failed to wound the foul creatures.

The Dwarf cannon fired at the same Beastmen regiment but, rolled a misfire! Luckily, Jeremy had expected this to happen and had engraved the *Rune of Forging* on the war machine. This meant that he was able to re-roll the dice, and this time the Dwarf crew managed to overshoot the target instead!

Having overflowed the Chaos Knights, the gyrocopter rolled for the accuracy of its bomb, with the result that it bounced directly into them! The Knights were engulfed by a massive explosion as the bomb detonated but their armour saved them and they all emerged completely unharmed.

The dice roll for the winds of magic totalled eight again and the Dwarfs began the phase by using some of the cards they had stored in the Anvil of Doom the previous turn. Two bolts of lightning lashed out at the Chaos Knights killing two of the models and stunning Richard who'd not been expecting so much damage to this extremely tough regiment. Armour doesn't protect troops from the Anvil's lightning and without their 1+ saves the Chaos Knights were very vulnerable.

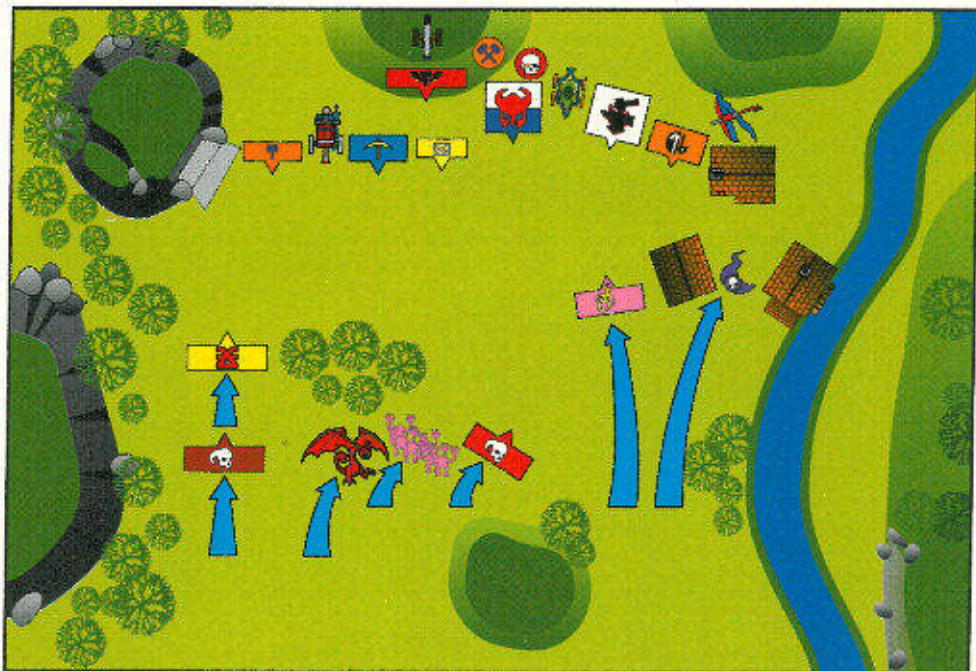

CHAOS TURN 1

Despite their losses, the *Rapturous Standard* ensured that the Chaos Knights continued their advance.

Again, the Pink Horrors cast *Tzeentch's Firestorm*, but this time with *Total Power*. Jeremy was unable to do anything to stop it and just had to watch as eight of the Dwarf Warriors were consumed by the magical scarlet flames and two new Pink Horrors rose from their ashes! The newly formed regiment of Pink Horrors were placed in hand-to-hand combat with the survivors of the stunned Dwarf Warriors. As there were still Tzeentch spells left unused, Richard drew one for the new Pink Horrors, getting *Bolt of Change*.

In an effort to stop a repeat of this attack, the Runesmith cast *Mental Duel* on the Pink Horrors with *Tzeentch's Firestorm*.

Both sides counted as second level, so the outcome rested on a single dice roll. Richard rolled a 5 to Jeremy's 1, so won easily. As the Chaos General cackled madly, Jeremy threw away the last card left in the Anvil.

The Tzeentch Disc rider cast the next spell, targetting the Runesmith with an *Incandescent Assassin*. Once again, the Dwarf army had no *Dispels* and so used another *Rune of Spellbreaking* to protect their characters.

Finally, the Runesmith stored four new cards in the Anvil of Doom in preparation for the next magic phase.

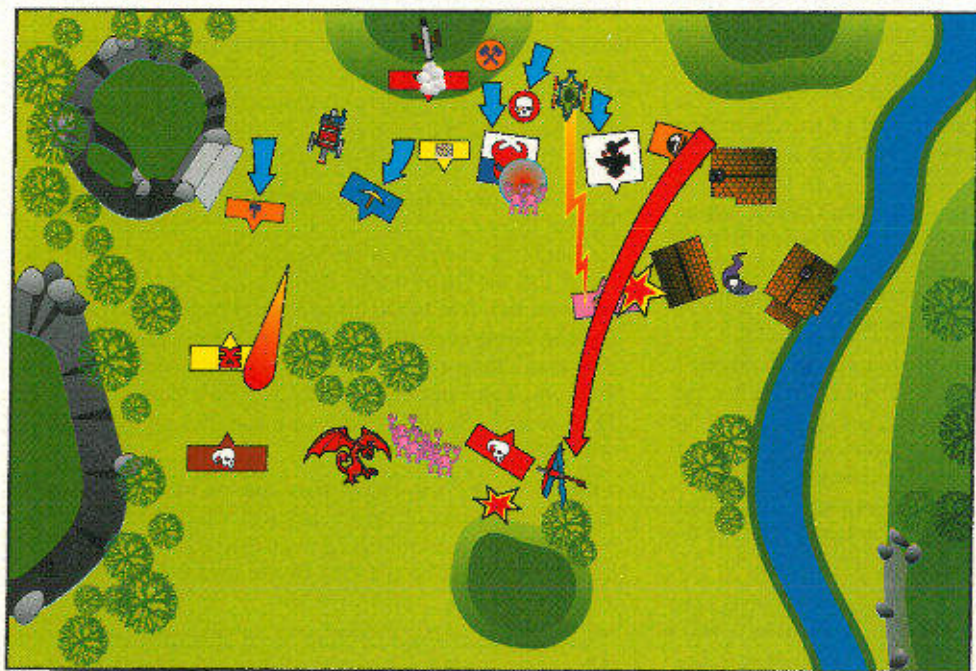

DWARF TURN 1

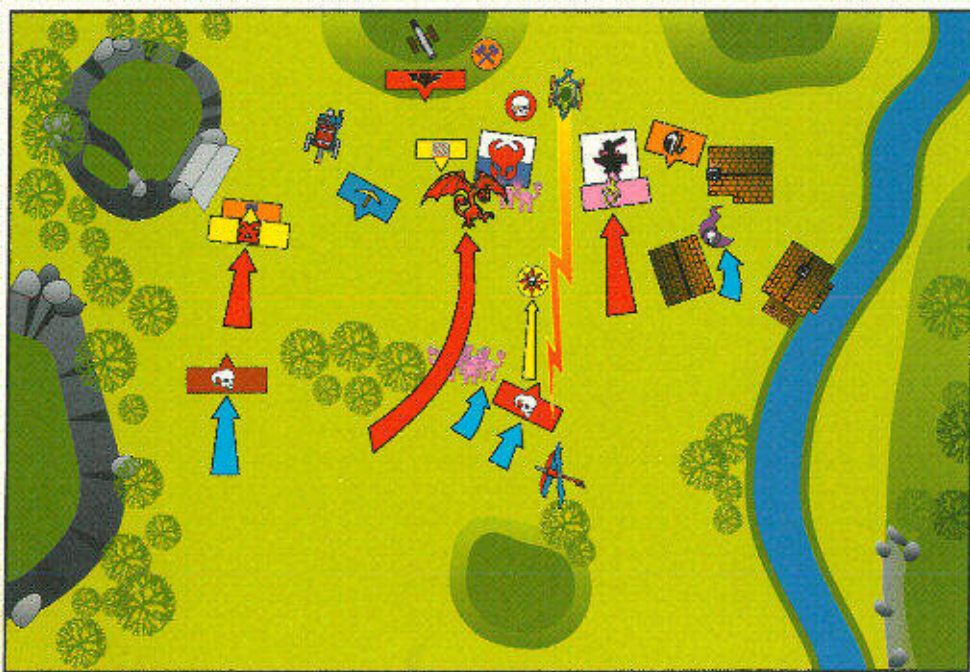

CHAOS TURN 2

## CHAOS TURN 2

At the start of his turn Richard drew another two Chaos Gifts. The first was *Venomous Bite* and the second was *Eye of God* which, like *Lose Gifts*, must be played as soon as it is picked up. The *Eye of God* card represents the Chaos gods taking particular interest in one of their servants. They bestow mutations on their follower without thought for their ultimate effect, which may be very useful or completely devastating. Richard chose the Champion of Khorne leading the Beastmen to be subject of the *Eye of God* and rolled a dice – turning him into Chaos Spawn! The new Spawn rolled for its mutations, ending up with seven which warped its body in many strange ways. The Spawn *Levitated* above the ground, had *Awesome Strength*, three extra attacks from its *Cloven Hooves*, *Iron Spikes* and *Vicious Beak* and two 4+ saves from its *Iron Hard* and *Scaly Skin*! All told, the Chaos Spawn was a devastating mutation. As its form warped and twisted, it moved forward into the gap between the two armies.

If the first turn had been the approach of the Chaos host, then the second was the attack. On the right of the Chaos army, the Knights charged the Longbeards. On the left, the Dragon Ogres charged the Slayers. In the centre, the General astride his Dragon charged the regiment of Dwarf Warriors who were locked in combat with the newly raised Pink Horrors. The Warriors passed their terror test for being charged by the Dragon and the Dwarf line held its ground.

Although the Dragon Ogres had charged, the Giant Slayer's *Rune of Swiftness* enabled him to strike first. He hit the fearsome creatures twice and wounded one of them, but the rest of his regiments' attacks were ineffective against the tough hides of the Dragon Ogres. The Chaos creatures fought back, cutting down three of the Slayers and winning the combat. Fresh fighters stepped into the gaps in the Dwarf ranks as the doughty warriors gritted their teeth and grimly fought on.

As they charged forward, the Chaos Knights were challenged to single combat by Durek Tanglebeard, the Dwarf Hero leading the Longbeards. The Chaos Battle Standard Bearer accepted the challenge and made straight for the brave Dwarf.

The charging Chaos Hero struck first, but failed to wound the Dwarf whose counter-blow was also deflected by the Knight's massive armour. The rest of the Chaos Knights slew two Longbeards for no loss. The many ranks of Dwarfs won the combat but the Chaos Knights' *Rapturous Standard* meant that they could not be broken.

In the centre, the General and his Dragon began to slaughter the Dwarf Warriors, cutting down six of them including their regimental standard. The Pink Horrors killed two more and the Dwarf Warriors lost the combat badly. However, because they were near to their

Battle Standard Bearer with the *Rune of Groth One-Eye*, they took all their LD tests on an unmodifiable value of 10 and the survivors stood their ground.

Nine cards were dealt in the magic phase. The Chaos Sorcerer of Nurgle in the regiment of Beastmen cast *Arnipal's Black Horror* towards the Dwarf Miners, but the Dwarfs dispelled it. Crashing his hammer against the the Anvil of Doom, the Runesmith threw three bolts of lightning at the nearest Beastmen incinerating two and wounding a third. With the magic phase turning against him, Richard used *Drain Magic* to end the turn.

## DWARF TURN 2

At the start of the turn, nearly all the Dwarf units had to take a terror test because of the Dragon in their midst. True to their heroic tradition they all held their positions.

So far it had all gone according to plan. The Chaos army had advanced to engage the Dwarfs and now was the time to strike back. The second regiment of Slayers charged into the side of the Chaos Knights and the Miners passed their fear test and charged the Dragon Ogres' flank.

The Dwarf missile fire now concentrated on the Pink Horrors. First to fire was the cannon which killed one of the daemons but out of its shattered body two Blue Horrors emerged. This meant that the Richard now had only five Pink Horrors in the regiment and so he had to discard one of their spells. The flame cannon fired next, its fire playing over the regiment of daemons killing a Blue Horror and splitting another two Pink Horrors. The Thunderers and Crossbowmen fired on the Horrors as well, hitting two more and leaving the regiment with only one Pink Horror left.

Finally, the gyrocopters' steam cannon opened fire at the Beastmen. The jet of steam spewed forth, killing one of the mutated creatures before it overflowed and engulfed the Horrors as well! The last Pink Horror died and with it the last of their spells.

Vicious hand-to-hand fighting raged along the battleline as both sides sought to break the others' resolve. The Chaos Knights ignored the Slayers who'd charged their flank as the





The Chaos horde charges the brave Dwarfs.

Dwarfs' Strength 3 couldn't penetrate their armour. Turning to the Longbeards, the Chaos Battle Standard Bearer cut down their leader, Durek Tanglebeard. The rest of the Knights fought on, striking the Longbeards but failing to wound them. The Longbeards too were unable to wound their targets but the Dwarfs won the combat because of their rank bonuses. The *Rapturous Standard* still held the Chaos Knights firm.

At the other end of the line, the Miners and smaller Slayer regiment were fighting hard against the Dragon Ogres. The Dwarf Giant Slayer struck first, cutting down the already wounded Dragon Ogre, the rest of the regiment hitting and wounding another. The Miners fought next, swinging their two

handed picks to wound the Dragon Ogres again and again. Enraged by the attacks the Dragon Ogres retaliated, cutting down two Miners and killing all the Slayers except their leader – the Giant Slayer. Even so, the Dwarfs won the round of combat and the Dragon Ogres failed their Break test and fled. Rolling for the distance, Richard only managed to get a 4 and the Giant Slayer easily overran them and cut them all down. Jeremy elected to avoid pursuit with the Miners and they passed their Ld test to stand their ground.

In the centre, the General and his Dragon fighting alongside the Pink Horrors, chopped down the front rank of the Dwarf Warriors. The Dwarfs lost the round but once more, the influence of the *Rune of Groth One-Eye* held them steady. This choice of Battle Standard was proving to have been a very wise one.

The winds of magic again provided a higher than average number of cards. As last turn's *Drain Magic* had taken all the cards from the Anvil, the Runesmith stored three new ones this turn. The Nurgle Sorcerer cast *Amizipal's Black Horror* and Jeremy's *Dispel* failed to halt it. Not ready to accept the damage that this would cause amongst the Dwarf ranks, he used the last of his *Runes of Spellbreaking*. Chuckling quietly to himself, Richard used *Drain Magic* yet again!



DWARF TURN 2



Ungrim Ironfist duels with the Chaos General at the height of the battle.

### CHAOS TURN 3

Before he moved his army, Richard dived to see in which direction the Chaos Spawn would move. To his horror it turned and ploughed straight back through the regiment of Beastmen from which it had come! The Chaos Spawn cut through their ranks, causing five wounds despite the *Standard of Shielding*. But the Spawn had been hit too. Its movement roll was double 5, and when a Spawn rolls doubles it takes that number of hits – in this case five. Even so, its incredible toughness shrugged off all five hits without taking a single wound!

After all of this, the Beastmen still had to pass their infighting test in order to move normally. They rolled a 3 and so continued their advance.

The Sorcerer on the Disc charged the gyrocopter which chose to flee rather than fight a hopeless battle. The Disc rider made a failed charge move and Richard muttered under his breath.

The Beastmen on the left of the Chaos line were now confronted by the Giant Slayer who had slaughtered the Dragon Ogres. Before the lone Dwarf could ready himself, the Beastmen charged. The Giant Slayer issued a challenge to

single combat but the Nurgle Sorcerer decided to let the Beastmen do the fighting and he retired to the back of the regiment. The Giant Slayer with his *Rune of Swiftmess* struck the first blow – or would have if he hadn't rolled triple 1's! The Beastmen fought back, cutting him down in revenge for the Dragon Ogres.

Back in the centre of the battlefield, another Dwarf regiment was wiped out, as the last of the Warriors were cut down by the Chaos General, Dragon and Pink Horrors.

All was going very well for Chaos as they turned to the last of the hand-to-



CHAOS TURN 3

hand combats. The Chaos Knights, led by the Battle Standard Bearer, cleaved through the Longbeards, cutting down all but one of the front rank. Every unit in the Dwarf army took a panic test for the regiments that had been wiped out this turn, but with grim determination they all held their ground.

The Beastmen opened the magic phase with four bolts of lightning from their *Banner of Wrath*. The Dwarf Miners were lucky and only one of them was killed by the flashes of energy. Freed from the combat in the centre, the magically created Pink Horrors cast a *Bolt of Change* at the Dwarf Battle Standard Bearer.

Horrified at the thought of losing this character who had steadied the whole of the Dwarf defence, Jeremy tried to *Dispel* it but succeeded only on his second attempt. Having been deprived of their stored power again by the *Chaos Drain Magic*, the Runesmith stored a single card in the Anvil of Doom. At the rear of the Chaos lines, the Tzeentch Disc rider cast *Incandescent Assassin* at the gyrocopter he was pursuing. The Dwarfs were unable to do anything to stop this attack but fortunately the pilot escaped completely unharmed.

### DWARF TURN 3

Both armies were locked in a bitter struggle, but the Chaos General had managed to break through. To hold the line and attempt to decide the outcome by a clash of Generals, Ungrim Ironfist heroically charged Dundesh the Black. Behind the Chaos lines the gyrocopter rallied, ready to try another bombing run next turn.

Again the Dwarfs' shooting was concentrated on the Blue Horrors in an effort to destroy the regiment of daemons before they could get into combat. The flame cannon fired first, burning four of them to a crisp. Next, the cannon fired but its shot fell short of the target. Finally, the Thunderers and Crossbows killed the rest of the regiment – except one surviving Blue Horror.

In the hand-to-hand phase, the Chaos Battle Standard Bearer cut down a single Longbeard. The rest of the Chaos Knights missed completely, but their Chaos Steeds did better, killing a second Dwarf. The Longbeards fought back but their blows all rebounded from the heavy armour of their foes.

In the desperate combat in the centre, Ungrim split his attacks between Dundesh and his mount. He wounded the Dragon but with his weapon runes negated by the *Chaos Runeshield* he couldn't find a chink in the Chaos General's armour. Dundesh struck back with his magical sword, hitting Ungrim twice and wounding him. Richard gleefully explained the horrific effects of his *Sword of Change* and then Jeremy equally happily described the rebounding properties of the *Rune of Spite* on the



DWARF TURN 3

*Dragon Cloak*. What they needed to know was – would the mutating power of the *Sword of Change* be rebounded too? Both Richard and Jeremy carefully read the *Sword of Change* card and the *Rune of Spite* description but it wasn't entirely clear. They decided to roll a dice: 1-3 the mutation didn't rebound and 4-6 it did. This is what we always do at the Studio when we can't immediately resolve a conflict between magic items, spells or runes. It is a simple system which keeps the game moving and avoids arguments. Next time the result might be different, but particularly with the forces of Chaos, nothing is fixed. Both Generals were now rather nervous about the result of the next dice roll – whichever one took the hit could be turned into Chaos Spawn! Jeremy rolled the dice and got a 1 which failed miserably to reflect the blow. In desperation he used his *Rune of Luck* which allowed him to re-roll the dice – and rolled another 1, his fourth in a row! The *Sword of Change* struck Ungrim, twisting his form into the warped shape of a Chaos Spawn which fled from the Chaos General, straight into the Anvil of Doom, killing the Runesmith as well! Disaster upon disaster!

Until this point the battle had been very close, but with fortune not favouring the brave, it was clear that Chaos had the upper hand. With their General and Runesmith slain in a single move, the Dwarfs reeled, but all the regiments passed their panic test and fought on.

With the Runesmith dead, the Dwarfs had nothing left to do in the magic phase. Just to rub salt into the wound Richard rolled a 10 for the winds of magic and grinned maniacally as he prepared his magical assault. The forces of Chaos had been dealt *Total Power* once more – this time it sent *Arnizipal's Black Horror* ploughing through the Dwarf Miners, killing two of them before they could react. Bolts of lightning crackled from the Beastmen's *Banner of Wrath* and more of the hapless Dwarf Miners fell. Under repeated magical attacks their nerve finally broke and they fled from the battle.

Behind the Chaos line the Tzeentch Disc rider fought out his struggle with the gyrocopter, again casting the *Incandescent Assassin*. Once more Jeremy's luck held and the Dwarf war machine was safe for another turn.



CHAOS TURN 4

## CHAOS TURN 4

The sickening Chaos Spawn rippled with vile horror as they both moved randomly across the battlefield, but neither of them came into contact with any other models. On the Chaos right, the regiment of Beastmen failed their leadership test, succumbed to infighting and were unable to move.

In an attempt to kill more of the Dwarfs before the battle was over, the unengaged Chaos forces attacked whoever they could. At the back of the army, the Tzeentch Sorcerer riding the Flying Disc charged the gyrocopter which had no room left to run. The Pink Horrors charged into the Dwarf Battle Standard Bearer who bravely passed his fear test to stand and fire with his pistol. One of the foul daemons was hit as it charged but proved too tough to wound.

With the disgustingly mutated remains of the Dwarf General crawling and slithering before him, Dundesh was free to chose his target and charged into the Dwarf cannon crew. Despite the engulfing darkness they passed their fear test and stood their ground, but the charging General and his Dragon ripped them to pieces before they could even raise their swords. Once more the Dwarfs were forced to take a series of panic tests as they witnessed the massacre of this unit, but again they all held their positions.

Richard had been saving his Chaos Gifts throughout the game and now lavished them on his Disc rider and regiment of Chaos Knights. Firstly, the Disc rider was given *Hypnotic Gaze*, and because he was a character model he had to roll on the Eye of God table. This table is the same one as was used with the card which turned the Khorne Champion into a Chaos Spawn at the start of turn two. It is used whenever a Chaos Gift is given to a Chaos Champion or Sorcerer rather than a normal rank and file model. In this case, the Sorcerer was unharmed by his Gift and fought on, killing the gyrocopter pilot. With a blood-curdling shriek of triumph, the Sorcerer watched as the Dwarf machine spiralled out of control to crash into the woods behind the Chaos lines.

The rest of the Chaos Gifts were given to the Chaos Knights. One was given *Bitter Hatred* which made the whole regiment *hate* their enemy, one grew *Many Arms* and gained an extra attack, another's arms became *Writhing Tentacles* and their teeth dripped with poison from their *Venomous Bite* all of which gave him two more attacks this turn. Invigorated by these unholy blessings from their foul gods, the Battle Standard Bearer lead his regiment in an orgy of killing. The entire front rank of the Dwarf regiment was hacked down but still they held fast.

The Dwarf Battle Standard Bearer now fought bravely against the daemons attacking him, taking several hits from the Pink Horrors but no wounds. In return he wounded one of the monsters, turning it into two Blue Horrors. The daemons had lost the combat but still carried on fighting.

The winds of magic roll was the lowest in the game so far with only six cards being dealt. However, before either side could act, the spells already in play took effect once more. *Armizipal's Black Horror* moved through the flame cannon and off the table. Luckily, only one of the Dwarf crew was dragged to his doom by the writhing tentacles and the rest passed their test to remain with their gun.

Jeremy watched in disbelief as Richard cast *Armizipal's Black Horror* again (he could do this as it had just left the table). The Dwarf attempt to *Dispel* failed and it rolled over the fleeing Miners, killing three of them. The remains of the regiment of Dwarf Miners were removed from play because there weren't enough of them to rally.

## DWARF TURN 4

The remnants of the Dwarf army stood its ground and fired into the howling horde of Chaos that faced them. The Thunderers killed the last of the Blue Horrors with ease. To their right, the depleted flame cannon crew fired at the Beastmen consuming one with the flames and wounding another. The Crossbow-armed Dwarfs chose the same target and peppered the Beastmen with bolts. Despite these attacks and the panic tests for the destroyed regiment of daemons, none of the Chaos regiments broke.

The struggle between the Horrors and the Dwarf Battle Standard Bearer ground on as both sides failed to score hits. The Chaos Knights did manage to strike their foes several times but each blow was deflected by Dwarf armour and none were killed. Only the Chaos Battle Standard Bearer managed to kill any of the Dwarfs, cutting down two of the Longbeards.



*Dundesh the Black swoops down to attack the unfortunate Dwarf cannon crew.*

The desperate Dwarfs fought back but they too missed their targets and the combat was drawn again.

Finally, the winds of magic swelled once more dealing 10 cards to the armies. *Arnizipal's Black Horror* was already in play so it was moved before any new spells were cast. Jeremy watched in dismay as yet another of his regiments was crushed, eight of the Thunderers being killed by the cloud of darkness which swept across their ranks. The remainder of the regiment were stunned by the slaughter but passed their panic test.

In a final effort to kill the Dwarf Battle Standard Bearer, the Horrors in combat with him cast the *Bolt of Change*. However, the Dwarfs dispelled the Chaos magic and readied themselves for the next onslaught.

The *Banner of Wrath* carried by the Beastmen cast four lightning bolts at the Dwarfs, but again their innate magical

resistance dispelled the attacks before they could do any harm. Having destroyed the gyrocopter in the previous turn, the Tzeentch Sorcerer cast the spell *Incandescent Assassin* at the regiment of Thunderers, killing one of them.

With this last spell the battle was over, all that remained was to count the cost and see who had won.

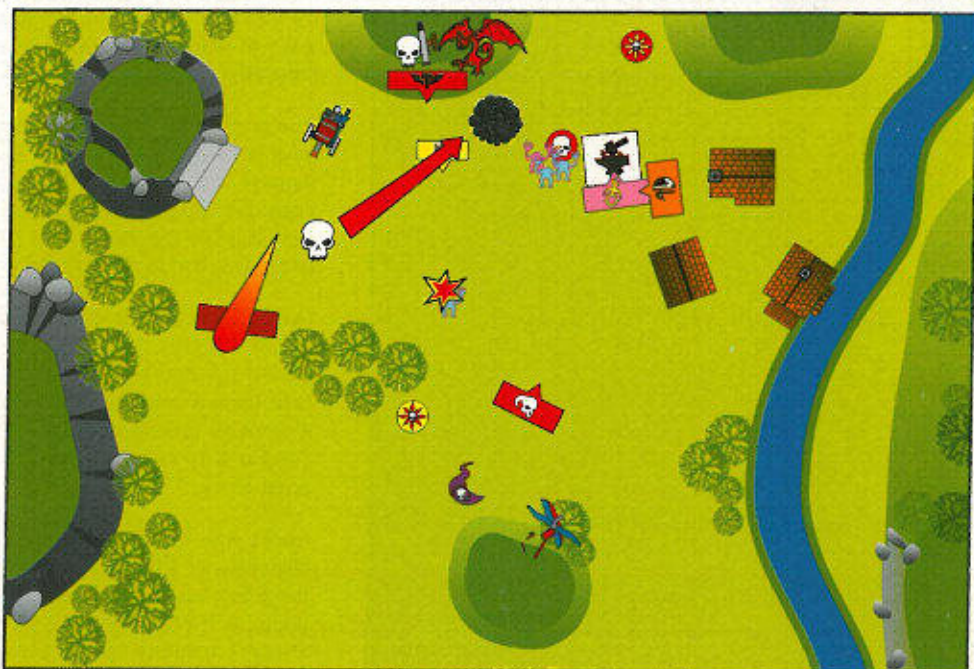

*DWARF TURN 4*

## VICTORY IS MINE!

My foul masters will be pleased! The slaughter was far greater than I could have hoped for, a mountain of skulls were collected today and the river ran thick with the blood of the Dwarfs.

To be fair on Jeremy, I do wield the great axe of a Chaos General quite often and have sharpened my tactics on the skulls my enemies with great regularity. The Dwarfs, however, can be the bane of any Chaos army as they have the weapons I fear the most, in the form of missile fire. Many armies field archers, maybe a bolt thrower or even a few small cannon, but Dwarfs get just about everything. They are masters of the war machine and can deplete a Chaos army before it gets even half-way across the battlefield. Without any missile fire of its own, a Chaos army must push forward to engage its enemy, and with each step comes the fear of some Chaos Hero getting smashed to pulp by a cannon ball, or even your General being impaled by a shot from a bolt thrower. In the end you must take the missile fire as best you can, use the terrain to shield your troops and screen expensive units with cheaper, harder ones such as Beastmen. Despite the hail of death, you can be sure that when your troops finally do arrive in hand-to-hand combat, you can snap bones and smash skulls better than anyone else.

The Chaos army is also a potent magical force, but up against Dwarfs with so many options to repel magical attacks, I had decided to take a number of lesser Sorcerers, instead of a single potent one which would be my normal plan. With two first level Chaos Sorcerers, and the casting ability of the Pink

Horrors, I was able to split my magical attacks across the whole battlefield. By having both a Tzeentch and Nurgle Sorcerer I was able to vary the types of spells I used. Although I could have taken one of the potent Nurgle spells for my Nurgle sorcerer, I decided to draw his spell from the Dark magic deck. This allowed me to use the Dark magic ability of discarding special cards and replace them with new ones drawn from the deck.

The first major blow to the Dwarfs came from the Pink Horrors. With some lucky dice, I managed to turn eight of the Warriors to ash and in the process summon up two more of these daemons. These were to be a pain in Jeremy's side for the rest of the battle and all I could do to console him was to remind him that if I had been just a little bit more lucky and killed another Dwarf, I would have created a third new Pink Horror!

After spending so many points on my General with his Dragon, magical weapons and armour, I knew he would have to take a major role in the battle. By getting him into action quickly I avoided him being a target for the cannon. So my General and Dragon got stuck-in to the Dwarf Warriors and that's exactly what happened – they got stuck. The Dwarfs died in droves but with the *Rune of Groth One-Eye* allowing them to test on an unmodified Leadership of 10 they just wouldn't run away. In the end I had to kill them all, but that wasn't a problem because by this time Ungrim was next in our path.

I knew that the battle of the Generals would be a turning point in what had up to this point been a close game. Ungrim's blows were deflected harmlessly away by my General's armour. My face filled with glee as the deadly *Sword of Change* pricked the skin of Dwarf, the glee turned to horror when I discovered the *Rune of Spite*, a rune that could turn my evil plan against myself. But the prince of Chaos smiled down on me, and the Slayer King ran out of luck as twisted spines broke from his flesh and his mind was shredded by the power of Chaos. This was the downfall of the Dwarfs. Only I could revel in the horror of "Ungrim the spawn" turning against his own and destroying the Runesmith – an act which caused a wave of terror to cross the Dwarf army and spelled doom for them all.

The greatest disappointment for me in the whole battle must have been the Dragon Ogres. They probably did their worth in damage and took some flame cannon shots that could have been directed elsewhere to possibly greater effect, but to be chased off by the Slayers was embarrassing. I suppose I had to have some bad luck somewhere.

On the other hand, I was delighted by the performance of the Chaos Knights. By giving them Chaos armour, they were almost invulnerable and four Chaos Knights were able to hold up two units of Dwarfs for the whole battle. Having the *Rapturous Standard* guaranteed that they would stay locked in combat with an enemy so stubborn that they too would not break away.

Little will be said of the ultimate monstrosity that my champion of Khorne became. Although I was a jubilant when the gifts were handed out, my Beastmen had nothing to smile about as it ploughed back through their ranks. One should always remember that the gods of Chaos are all too willing to play the cosmic joker and remind you who's really in charge.



to summon the *Drain Magic* and the *Total Power* cards twice each in a four turn game?

Whether it was the vile Chaos gods or the strange curse associated with Trans-Atlantic Jet Lag, the dice deserted me. In one unforeseen and horrible series of events I lost my General, Runesmith, and the Anvil of Doom in an instant.

Despite the bitter drubbing the Dwarfs received in turns three and four, there were some glorious moments as well. The Giant Slayer and a timely in-the-flank charge by the Miners certainly proved too much for the Dragon Ogres. The gradual annihilation of the Pink Horrors (and subsequently the Blue Horrors) by massed missile and war machines fire was certainly pleasant to witness as well.

In conclusion, I've just got to say that I want a rematch! Perhaps the Dwarf Throne of Power, a complete battery of cannon, or simply better luck could help me in a second contest. It is the incredible

variations of troops, magic items, spells, and characters that make Warhammer the fantastic game it is. Although I return to the States shamed with my loss, I've learned valuable lessons about facing the hordes of Chaos and the next time Dwarfs march to battle, victory shall be mine!



## THE DWARF TALE OF WOE

What a game! In stone fortresses high in the mountains and deep cavern halls across the Old World, Dwarfs tear their beards and hang their heads in lament and anguish. The game ended shamefully but there were times when it looked promising for the Dwarfs. What went wrong?

The key to what went wrong was Richard's General on a Dragon! Equipping a powerful hero with potent magic items and mounting him on a large monster is often a win big or lose big gamble. It certainly paid off for Richard! I am not convinced the Dwarf plan was completely hopeless, but as so often happens in Warhammer, the execution of a strategy does not always work.

Where I lost the game was by not being able to counterattack effectively. The Dwarf troops, with the aid of the *Rune of Groth One-Eye*, held up admirably to a powerful Chaos onslaught. Unfortunately, while my troops held the line, they proved incapable of delivering any knockout blows. The Chaos Knights were stopped in their tracks, but their cursed Chaos armour was impenetrable to the Slayers (Argh! I still groan in frustration!).

Had Ungrim been able to get into battle earlier with the Chaos General while he was still engaged with the Dwarf Warriors the battle might have been very different. With a proper challenge Ungrim could have used the rank bonuses from the troops to force the Dragon to fly off a devastating result in a four turn game. As it was, he couldn't reach the fight early enough – alas for the short legs of Dwarfs!

A new chapter has been written in the Book of Grudges and Richard's name is prominent. Which Chaos power did he use



# GAMES WORKSHOP®

## MAIL ORDER

Games Workshop Mail Order is a great way to purchase all the latest releases from Games Workshop and Citadel Miniatures. Our Mail Order staff are all Games Workshop enthusiasts and will be more than happy to advise you on any special character miniatures or other models that you might need for your armies.

**FROM MONDAY 25TH JULY OUR MAIL ORDER TELEPHONE LINES ARE OPEN:**

**8am - 10pm SEVEN DAYS A WEEK!**

If you are posting your order, please send it to:

**GAMES WORKSHOP MAIL ORDER SERVICE, CHEWTON STREET, HILLTOP, EASTWOOD, NOTTINGHAM NG16 3HY**

Or you can fax your order through on: (0773) 530155



**AVAILABLE NOW!**

The Warhammer Armies - Chaos supplement contains new rules, spells and a complete army list for fighting battles with Chaos armies in Warhammer. The box contains an 88 page book which details the four Chaos Powers - Khorne, Nurgle, Slaanesh and Tzeentch and the set also contains dozens of full-colour cards describing Chaos Gifts, new Magic Items, Magic Spells and Chaos Rewards.

New from Citadel Miniatures, the High Elf Army box contains a complete 2000 point High Elf army. This 60 piece set includes the following models from Citadel Miniature's High Elf range: Prince Tyrion, a Hero on a Pegasus, a Tiranoc Chariot, 5 Dragon Princes, 5 Silver Helms, a Regiment of 12 Archers, a Regiment of 12 Spearmen, 8 Swordmasters of Hoeth, 10 Phoenix Guards and a High Elf Repeater Bolt Thrower with 2 crew. Also included in the boxed set is a booklet containing a full army list for all the models in the box with points values, characteristics and magic items and a set of full-colour, self-adhesive standards and banners for your army.

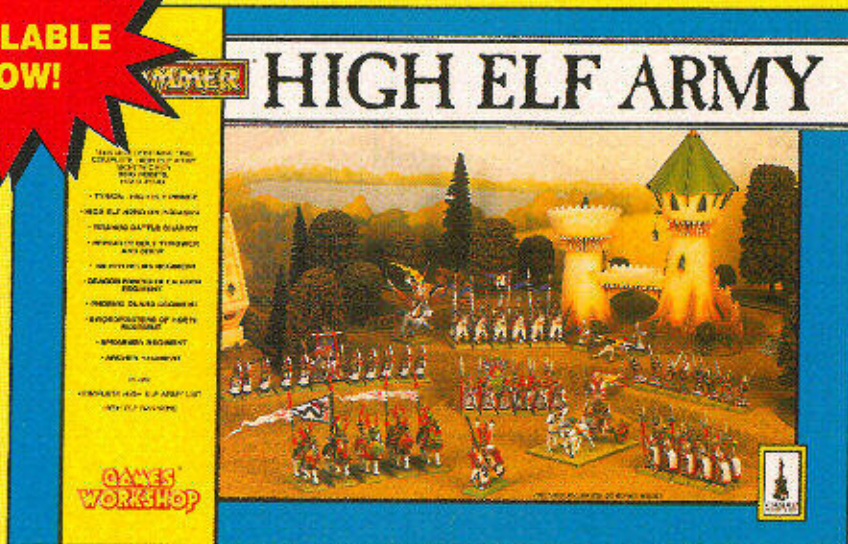



# GAMES WORKSHOP MAIL ORDER IS



*Amanda hand-picks an order ready for despatch.*

## THE FULL RANGE OF PRODUCTS!

Our Mail Order service can supply the full range of Games Workshop games and Citadel Miniatures, and we don't stop there! We can also supply any individual game component or miniature. So if the dog's chewed your **Warhammer 40,000** buildings, we can supply a brand new set! If you want the rulebook from **Warhammer**, we can provide it! If you want the dice from **Space Marine** all you need to do is ask!

If the models you want for your army aren't in your local store, or you are looking for an out of stock or hard to find range of miniatures, give us a call. Because we're based at the factory, our staff can arrange to cast up any number of miniatures especially for you, from the original moulds.

We can also supply any component from any multi-part model for those of you who like to customise or convert your miniatures.



*Scott grabs a brand new copy of Talisman for a Mail Order customer.*

## PLUS!

No queues! No parking! No bus fare! And it's really great fun using the catalogues to choose **exactly** the models you want for your army. We've found that many gamers get together with their friends to place an order so that the £2.50 UK and BFPO postage is applied to the whole order and the money saved buys them all a few extra miniatures.

## CONVENIENT!

Mail Order is convenient, with the entire range of Citadel Miniatures and Games Workshop games, just a phone call away.

## FAST!

Mail Order is fast. Most customers receive their orders within 2 days in the UK. (Some second class orders, or packages over 1Kg may take a day or so longer). Plus, on any telephone orders received before 1.00pm, our **Special Delivery Service** guarantees you'll receive your order the very next day.

We also have a special Troll who ensures that all **First Class** telephone orders received between 9.00am and 1.00pm are despatched the same day!

Most overseas orders are delivered within 8 days.

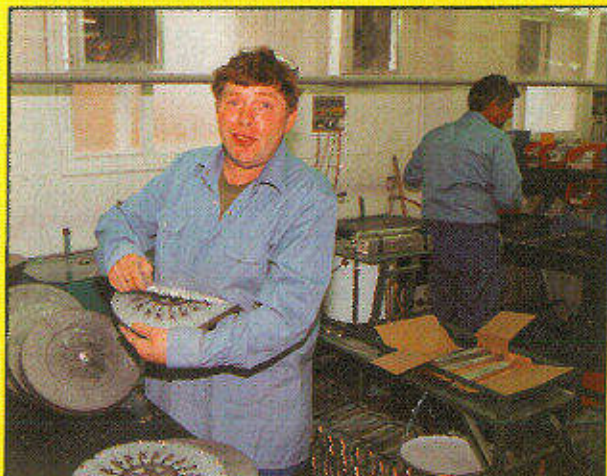

*Angus casts up a set of miniatures in the Citadel foundry.*

## FRIENDLY KNOWLEDGEABLE STAFF!

Our Mail Order service is staffed by enthusiastic hobbyists like yourself, who will be more than happy to tell you about all the latest releases for your particular army or favourite game.

## ACCURATE!

Every order is hand-checked against the catalogues to ensure that every model is perfectly cast and that your order is exactly what you want.



*Chris checks an order before it is posted out.*



## CITADEL JOURNAL

**Citadel Journal 3** contains yet more exciting gaming articles including rules for trenches and concealed bunkers in **Warhammer 40,000**, a new **Space Hulk** campaign, a full psychic system for **Space Marine**, new rules for **Man O' War** and much more.

**Issue 3** of the **Citadel Journal** is available now direct from Mail Order priced only £3.99 with FREE P&P within the UK and BFPO. Overseas add £1 P&P.

### SUBSCRIPTIONS

Issue 1 of the **Citadel Journal** is now completely sold out and stocks of Issue 2 are very limited. To be certain of your copy please place an early order. We now also offer a special five-issue subscription.

**Price: UK/BFPO - £20.00. Overseas - £30.00**

With every subscription we'll send your sixth issue absolutely **FREE!** Each subscription to the **Journal** will begin with the next issue to be published - unfortunately we cannot include back copies in subscriptions as they are in such limited supply.

## MODELLING GUIDE

The **Citadel Miniatures Modelling Guide** contains everything you need to know about modelling. Inside you'll find detailed information about all of the different techniques from preparing, assembling and converting your single miniatures to building dioramas.

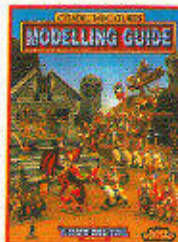

The **Citadel Miniatures Modelling Guide** is available now priced £9.99.

## SPACE MARINE ARMY

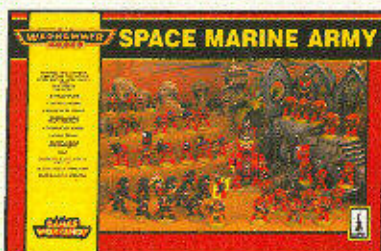

New from Citadel Miniatures, the **Space Marine Army** box contains a complete 2000 point Blood Angel army. This 50 piece set includes a booklet containing a full force list for all the models in the box and a complete set of banners.

The **Space Marine Army** is available now priced £85.00.

The **Citadel Miniatures Catalogue Section 4** is now available priced £4.99.

## WARHAMMER

WARHAMMER BOXED GAME	£34.99
WARHAMMER BATTLE MAGIC	£19.99
<b>NEW!</b> WARHAMMER ARMIES - CHAOS	£14.99
WARHAMMER ARMIES - DWARFS	£9.99
WARHAMMER ARMIES - SKAVEN	£9.99
WARHAMMER ARMIES - UNDEAD	£9.99
SELF ADHESIVE BANNERS Each pack contains 5 sheets of banners. (Available for Orcs, Goblins, High Elves, Dwarfs and <b>NEW!</b> Undead.)	£3.50 per pack

### HIGH ELVES

**NEW!** 2000 POINT HIGH ELF ARMY £100.00

## UNDEAD

<b>NEW!</b> NAGASH (Boxed Set)	£9.99
<b>NEW!</b> ZOMBIE DRAGON (Boxed Set)	£14.99
<b>NEW!</b> NECROMANCERS	£2.50 each

## SKAVEN

<b>NEW!</b> JEZZAIL TEAM	£4.50
GLOBADIERS	£2.50 each
PLAGUE MONKS COMMAND	£1.50 each

## CHAOS

<b>NEW!</b> CHAOS BEASTMEN Boxed set contains 10 plastic Beastmen	£4.99
<b>NEW!</b> CHAOS BEASTMEN COMMAND GROUP	£1.50 each
<b>NEW!</b> CHAOS BEASTMAN SHAMAN	£2.50 each
<b>NEW!</b> CHAOS KNIGHTS Boxed set contains 3 Chaos Knights	£9.99
CHAOS BEASTMEN	£1.15 each

## DWARFS

DAEMON SLAYER	£2.99 each
DRAGON SLAYERS	£2.99 each
GIANT SLAYERS	£2.00 each
TROLL SLAYERS	£1.00 each
DWARFS	£1.15 each
FLAME CANNON (Boxed Set)	£14.99
ANVIL OF DOOM (Boxed Set)	£14.99

## WARHAMMER 40,000

WARHAMMER 40,000 BOXED GAME	£34.99
DARK MILLENNIUM	£19.99
CODEX SPACE WOLVES	£9.99
CODEX ELGAR	£9.99
CODEX ORKS	£9.99
WARHAMMER 40,000 PAINTING GUIDE	£9.99
SUSTAINED FIRE DICE	£0.49 each

## SPACE MARINES

<b>NEW!</b> ASSAULT MARINES WITH JUMP PACKS	£2.50 each
BLOOD ANGEL'S BANNERS Each pack contains 5 sheets of banners.	£3.50 per pack
RAZORBACK (Boxed Set)	£14.99

## ORKS

<b>NEW!</b> ZODGROD WORTSNAGA	£4.99 each
<b>NEW!</b> BLOOD AXE KOMMANDOS	£1.50 each
<b>NEW!</b> SMASHA GUN	£7.99 each
SNAKEBITE BOARBOYZ Boxed set contains 4 complete Boarboyz and boars	£9.99
SNAKEBITE BOARBOYZ NOBZ	£3.99 each
ORK DREADNOUGHT (Boxed Set)	£19.99

## ELDAR

<b>NEW!</b> ELDAR DREADNOUGHT (Boxed Set)	£14.99
<b>NEW!</b> WRAITHGUARD	£4.50 each
WARLOCKS	£2.50 each
WAR WALKER (Boxed Set)	£12.99

## SPACE MARINE

SPACE MARINE BOXED GAME	£34.99
SPACE MARINE BATTLES (BOOK)	£9.99
ARMIES OF THE IMPERIUM	£14.99
RENEGADES (Chaos and Eidar armies)	£14.99
ORK & SQUAT WARLORDS	£14.99

## BLOOD BOWL



BLOOD BOWL BOXED GAME	£29.99
DEATH ZONE	£14.99
<b>NEW!</b> BLOCKING DICE	£0.49 each
<b>NEW!</b> HEADSPLITTER – RAT OGRE STAR PLAYER	£5.99 each
BOMBER DRIBBLESNOT – GOBLIN STAR PLAYER	£2.50 each
VARAG GHOUL-CHEWER – ORK STAR PLAYER	£2.50 each
RIPPER BOLGROT – TROLL STAR PLAYER	£7.99 each
MORG 'N' THORG – OGRE STAR PLAYER	£5.99 each
GRIFF OBERWALD – HUMAN STAR PLAYER	£2.50 each
THE MIGHTY ZUG – HUMAN STAR PLAYER	£2.50 each
FUNGUS THE LOON – GOBLIN STAR PLAYER	£2.50 each

NOBBLA BLACKWORT – GOBLIN STAR PLAYER	£2.50 each
SCRAPPA SOREHEAD – GOBLIN STAR PLAYER	£2.50 each
<b>NEW!</b> SKAVENBRIGHT SCRAMBLERS BOXED SET	£12.99
Boxed set contains: 2 Stormvermin, 3 Gutter Runners, 1 Skaven Thrower and 6 Skaven Linemen	
CHAMPIONS OF DEATH BOXED SET	£12.99
Boxed set contains: 2 Mummies, 2 Ghouls, 2 Wights, 3 Zombies and 3 Skeletons	
NAGGAROTH NIGHT MARES BOXED SET	£12.99
Boxed set contains: 1 Dark Elf Thrower, 2 Dark Elf Blitzers, 2 Witch Elves and 7 Dark Elf Linemen	
ORCLAND RAIDERS BOXED SET	£14.99
Boxed set contains 1 Orc Thrower, 3 Orc Blitzers, 2 Black Orcs and 5 Orc Linemen	

## MAN O' WAR

MAN O' WAR BOXED GAME	£24.99
PLAGUE FLEET	£14.99
SEA OF BLOOD	£14.99
SLAANESH HELLSHIP BOXED SET	£4.99
SLAANESH HELLSLICER AND HELLHAMMER BOXED SET	£4.99
Boxed set contains 1 Slaanesh Hellslicer and 1 Slaanesh Hellhammer	

## TALISMAN



TALISMAN BOXED GAME	£29.99
---------------------	--------

## WHITE DWARF SUBSCRIPTIONS

### UK, EUROPE, & THE REST OF THE WORLD

UK & BFPO: £27.50 for one year (12 issues).  
EUROPE: £35.

REST OF THE WORLD: £45 for one year.

Please send payments to Games Workshop Mail Order, Chewton St, Hilltop, Eastwood, NOTTINGHAM, NG16 3HY. All payments should be in pounds sterling. Please make cheques payable to Games Workshop Ltd.

If you have a Visa, Access, Mastercard or Switch you may place your subscription by phoning our Mail Order department on 0773 713213.

### USA & CANADA

Please contact: White Dwarf Subscriptions, 3451 C Benson Avenue, Baltimore, Maryland 21227-1072.

For VISA and Mastercard orders, please telephone our Mail Order hotline on (410) 644 5699, Monday to Friday, 9am - 5pm EST.

Please state which issue you would like your subscription to start with.

### CORRESPONDENCE

We welcome comments about White Dwarf, Games Workshop games and Citadel Miniatures. All letters except subscriptions and Mail Order should be addressed to: The Editor, White Dwarf, Games Workshop, Howard House, 16 Castle Boulevard, Nottingham NG7 1PL.

Clearly mark your envelope with the name of the game you are writing to us about. If you want a reply you must enclose a self-addressed stamped envelope (overseas readers should include IRCs). We receive an enormous amount of mail. We do read every letter, but it may take a little time for us to reply to you, so please be patient!

### COPYRIGHTS AND TRADEMARKS

All subject matter in White Dwarf is © Copyright Games Workshop Ltd 1994. All artwork in all Games Workshop products, and all images contained therein have been produced either in-house or as work for hire. The exclusive copyright in the artwork and the images it depicts is the property of Games Workshop Ltd. © Copyright Games Workshop Ltd 1994. All rights reserved.

#### Registered Trademarks

The following are all registered trademarks of Games Workshop Ltd.

Armageddon, Blood Bowl, Chivalry, Citadel, the Citadel logo, Confrontation, Dark Angels, Dark Future, Deshwing, Eldar, Elder Attraction, Epic, the Games Workshop logo, Games Workshop, the GW logo, Genestealer, Realm of Chaos, Sletthouse, Space/Fleet, Space Marine, Talisman, Warhammer, Warhammer, White Dwarf and the White Dwarf figure.

Marauder is a registered trade mark of Marauder Miniatures Ltd. Used with permission.

#### Trademarks

The following are all trademarks of Games Workshop Ltd.

Aspect Warrior, Avatar, Blood Angels, Bloodletter, Bloodletter, Daemonette, Dark Reaper, Death Zone, Dragonmaster, Dungeonquest, Exo Armored, Exarch, Eye of Terror, Farseer, Fire Dragon, Flesh Hoard, Gargant, Gobbo, Great Unclean One, Greichin, Grey Knight, Hunter Slayer, Keeper of Secrets, Khornas, Knights Panther, Leman Russ, Lichemaster, Lightning Claw, Lord of Change, Madboy, Man O' War, Mekboy, Mighty Empires, Nurgie, Nurgling, Ogryn, Old World, Ork, Painboy, Plaguebearer, Plague Fleet, Psyker, Ratling, Ravenwing, Sea of Blood, Skaven, Slaanesh, Slann, Snottling, Space Hulk, Space Wolves, Squig, Squig, Sweeping Hawk, Striking Scorpion, Terminator, Thunder Hammer, Troll Slayer, Tyrants, Tzeentch, Ultramarines, Weirdboy, Knights of the White Wolf, Wulfdentor.

Flame is a trademark of Flame Publications Ltd. Used with permission.

Herzog and Space Crusade are both trademarks of Milton Bradley Games. Used with permission.

Scatter dice are UK registered design No. 2017484.



## TROLL SLAYERS



**TROLL SLAYER 1**  
88091/57



**TROLL SLAYER 2**  
88091/51



**TROLL SLAYER 3**  
88091/52

## GIANT SLAYERS



**GIANT SLAYER 1**  
88092/54



**GIANT SLAYER 2**  
88092/53

## DRAGON SLAYER



**DRAGON SLAYER**  
88097/55

## DAEMON SLAYER



**DAEMON SLAYER**  
88098/58

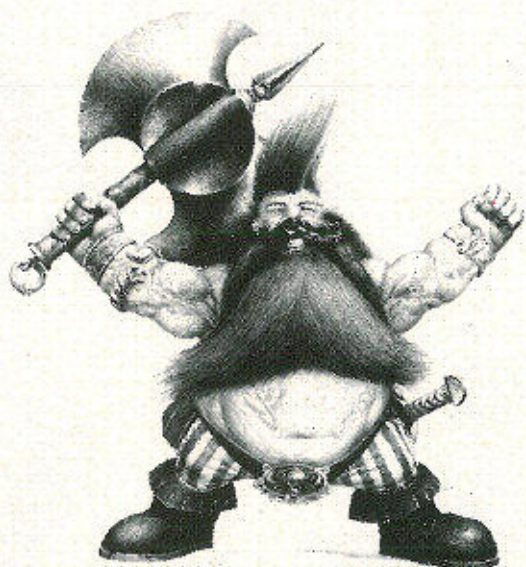

# ANVIL OF DOOM

## DWARF RUNESMITH'S ANVIL OF DOOM

THE COMPLETE ANVIL OF DOOM  
 CONSISTS OF:  
 1 x RUNEPIRIEST  
 2 x GUARDIAN  
 1 x ANVIL OF DOOM  
 1 x ANVIL PEDESTAL  
 1 x ANVIL BASE  
 2 x BANNER POLE  
 4 x PLASTIC SPOKED WHEELS



EXAMPLE OF COMPLETED DWARF RUNESMITH AND THE ANVIL OF DOOM

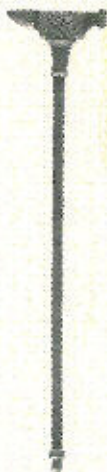

BANNER POLE  
0836/6



ANVIL OF DOOM  
0836/3

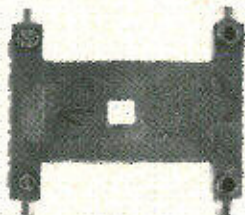

ANVIL BASE  
0836/4

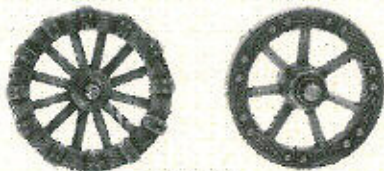

PLASTIC  
SPOKED WHEELS  
100557



ANVIL PEDESTAL  
0836/5



RUNEPIRIEST  
0836/2



GUARDIAN  
0836/1

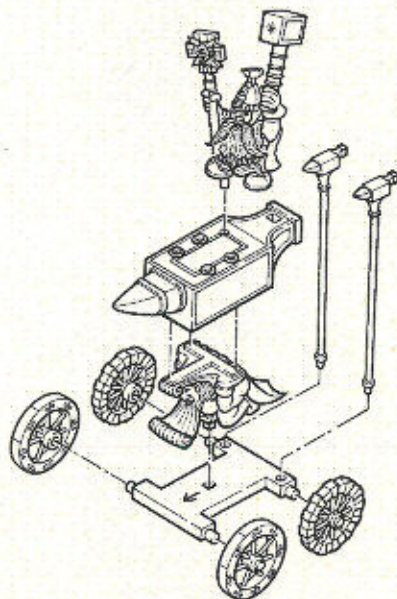

Minatures supplied unpainted. **WARNING:** This product contains lead which may be harmful if chewed or swallowed. Citadel Minatures are not recommended for children under 14 years of age.  
 © Copyright Games Workshop Ltd 1993. All rights reserved.



# FLAME CANNON

## DWARF FLAME CANNON

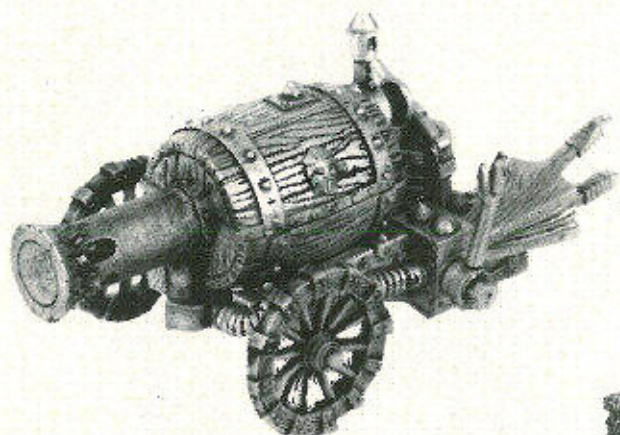

THE COMPLETE DWARF FLAME CANNON  
CONSISTS OF:  
3 x CREW  
1 x CANNON  
1 x UPPER BARREL  
1 x LOWER BARREL  
1 x LEVER  
1 x BELLOWS  
1 x PUMP  
1 x STEAM WHISTLE  
1 x INSTRUMENTS PANEL  
1 x FRONT BASE  
1 x REAR BASE  
2 x PLASTIC SPOKED WHEELS

EXAMPLE OF COMPLETED DWARF FLAME CANNON



MASTER GUNNER  
0837/1



LOADER  
0837/2



SWABBER  
0837/3

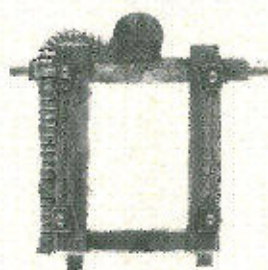

FRONT BASE  
0837/7

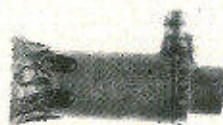

CANNON  
0837/8



LEVER  
0837/11



BELLOWS  
0837/13



PLASTIC  
SPOKED WHEELS  
100557

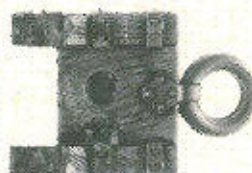

REAR BASE  
0837/6

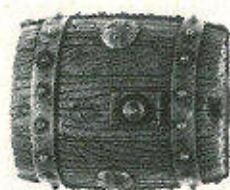

UPPER BARREL  
0837/5



PUMP  
0837/10



STEAM WHISTLE  
0837/12

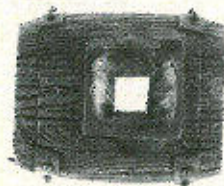

LOWER BARREL  
0837/4



INSTRUMENTS PANEL  
0837/9

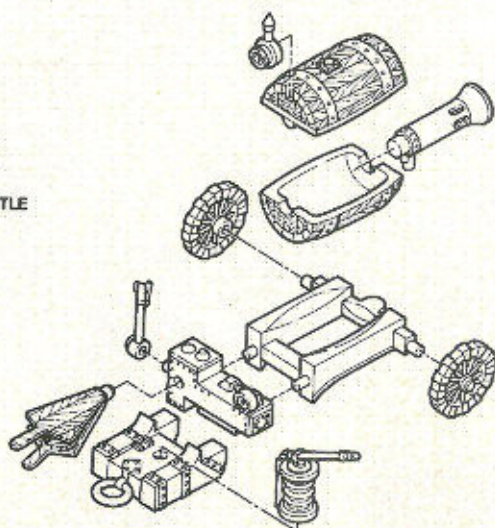

Minatures supplied unpainted. WARNING. This product contains lead which may be harmful if chewed or swallowed. Citadel Miniatures are not recommended for children under 14 years of age.  
© Copyright Games Workshop Ltd 1993. All rights reserved.



## HAMMERERS



**HAMMERER 1**  
88095/23



**HAMMERER 2**  
88095/24



**HAMMERER 3**  
88095/25



**HAMMERER 4**  
88095/26



**HAMMERER 5**  
88095/43



**HAMMERER 6**  
88095/44



**HAMMERER 7**  
88095/45



**HAMMERER 8**  
88095/46

## LONG BEARDS



**LONG BEARD 1**  
88094/15

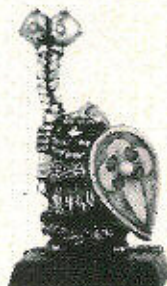

**LONG BEARD 2**  
88094/16



**LONG BEARD 3**  
88094/17



**LONG BEARD 4**  
88094/18



**LONG BEARD 5**  
88094/31



**LONG BEARD 6**  
88094/32

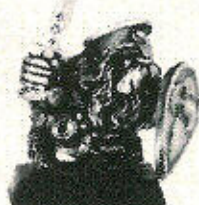

**LONG BEARD 7**  
88094/33



**LONG BEARD 8**  
88094/34

## IRON BREAKERS



**IRON BREAKER 1**  
88093/19



**IRON BREAKER 2**  
88093/20



**IRON BREAKER 3**  
88093/21



**IRON BREAKER 4**  
88093/22



**IRON BREAKER 7**  
88093/49



**IRON BREAKER 6**  
88093/48



**IRON BREAKER 5**  
88093/47



**IRON BREAKER 8**  
88093/50



# CHAOS

## CHAOS BEASTMEN



**BEASTMAN  
HORNBLOWER 1**  
73001/7



**BEASTMAN  
SHAMAN 2**  
73002/2



**BEASTMAN  
HORNBLOWER 2**  
73001/8



**BEASTMAN  
CHAMPION 2**  
73001/2



**BEASTMAN  
CHAMPION 1**  
73001/1

A COMPLETED BEASTMAN  
STANDARD BEARER  
CONSISTS OF:  
1 x BEASTMAN  
STANDARD BEARER  
1 x BEASTMAN BANNER TOP



**BEASTMAN  
STANDARD BEARER 2**  
73001/4



**BEASTMAN  
STANDARD BEARER 1**  
73001/3



**BEASTMAN 2**  
73000/2



**BEASTMAN  
SHAMAN 1**  
73002/1



**BEASTMAN 4**  
73000/4



**BEASTMAN BANNER TOP 1**  
73001/5



**BEASTMAN BANNER TOP 2**  
73001/8



**BEASTMAN 7**  
73000/7



**BEASTMAN 3**  
73000/3



**BEASTMAN 5**  
73000/5



**BEASTMAN 8**  
73000/8



**BEASTMAN 6**  
73000/6



**BEASTMAN 1**  
73000/1

THESE MODELS ARE SUPPLIED WITH APPROPRIATE PLASTIC SHIELDS AS STANDARD

Minatures supplied unpainted. **WARNING:** This product contains toxic which may be harmful if chewed or swallowed. Citadel Miniatures are not recommended for children under 14 years of age.  
© Copyright Games Workshop Ltd 1994. All rights reserved.



Designed by Michael Perry

# CHAOS

## CHAOS KNIGHTS



CHAOS CHAMPION  
73004/2



CHAOS KNIGHT 1  
0525/4

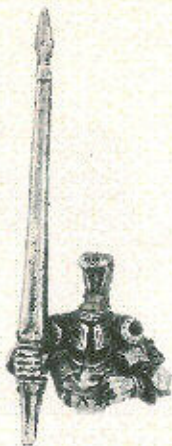

CHAOS KNIGHT 2  
0525/3

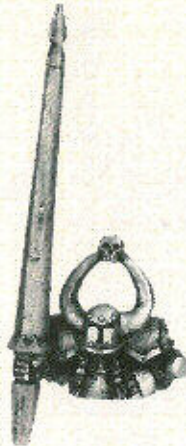

CHAOS KNIGHT 3  
0525/2



CHAOS KNIGHT  
STANDARD BEARER  
73004/3



CHAOS KNIGHT LEGS  
0525/1

A COMPLETED CHAOS KNIGHT  
CONSISTS OF:  
1 x CHAOS KNIGHT  
1 x CHAOS KNIGHT LEGS  
1 x CHAOS STEED HEAD  
1 x PLASTIC ARMOURED HORSE SPRUE



CHAOS KNIGHT BANNER TOP  
73004/4



CHAOS STEED HEAD 1  
0525/5



CHAOS STEED HEAD 2  
0525/6



CHAOS STEED HEAD 3  
0525/7



CHAOS STEED HEAD 4  
73004/5



CHAOS STEED HEAD 5  
73004/6

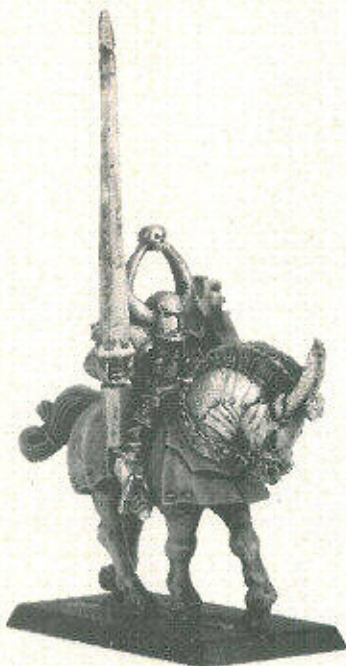

THESE MODELS ARE SUPPLIED WITH A PLASTIC ARMOURED HORSE SPRUE AND APPROPRIATE PLASTIC SHIELDS AS STANDARD

Minatures supplied unpainted. **WARNING:** This product contains lead which may be harmful if chewed or swallowed. Citadel Miniatures are not recommended for children under 14 years of age.  
© Copyright Games Workshop Ltd 1994. All rights reserved.



# SKAVEN

## SKAVEN JEZZAIL

THE COMPLETED SKAVEN JEZZAIL  
TEAM CONSISTS OF:  
1 x JEZZAIL  
1 x JEZZAIL REST



JEZZAIL  
74469/1



JEZZAIL REST  
7469/2

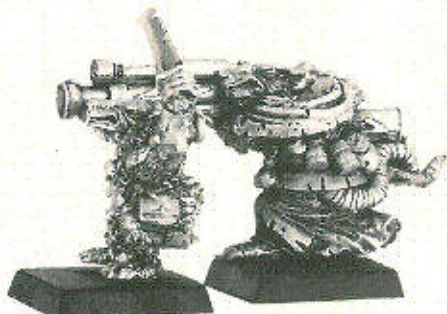

EXAMPLE OF COMPLETED SKAVEN JEZZAIL TEAM

## CLAN SKRYRE POISONED WIND GLOBADIERS



GLOBADIER 1  
74458/2



GLOBADIER 2  
74458/3

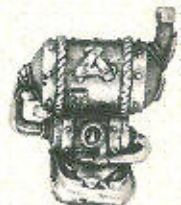

GLOBADIER BACKPACK  
74458/4

THE COMPLETED POISONED WIND  
GLOBADIERS CONSIST OF:  
1 x GLOBADIER  
1 x GLOBADIER BACKPACK

EXAMPLES OF COMPLETED POISONED WIND GLOBADIERS



## CLAN PESTILENS PLAGUE MONK COMMAND



CHAMPION  
74451/5



MUSICIAN  
74451/7



STANDARD BEARER  
74451/6

Minifigures supplied unpainted. **WARNING:** This product contains lead which may be harmful if chewed or swallowed. Citadel Miniatures are not recommended for children under 14 years of age.  
© Copyright Games Workshop Ltd 1994. All rights reserved.



# UNDEAD

## ZOMBIE DRAGON

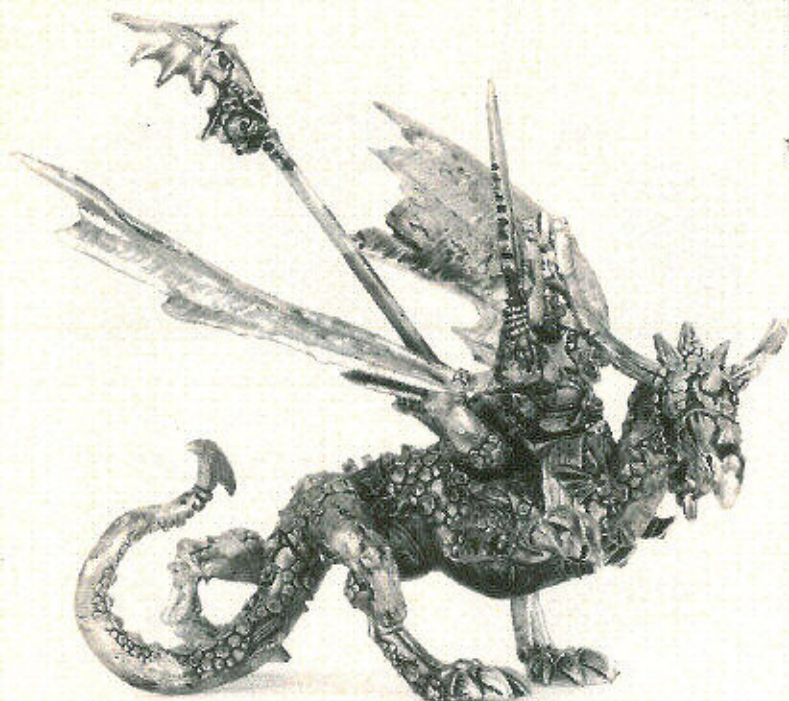

EXAMPLE OF THE COMPLETED ZOMBIE DRAGON AND RIDER

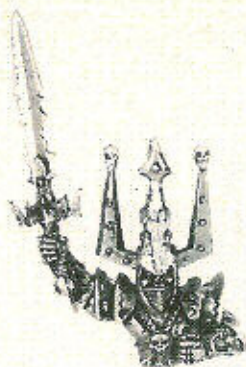

ZOMBIE DRAGON  
RIDER TORSO  
0524/11



BANNER  
0524/13



ZOMBIE DRAGON  
RIDER LEGS  
0524/12



BACK LEFT LEG  
0524/8



BACK RIGHT LEG  
0524/7



FRONT LEFT LEG  
0524/6



FRONT RIGHT LEG  
0524/5



BODY  
0524/3



NECK  
0524/2



HEAD  
0524/1



TAIL  
0524/4

### THE COMPLETED ZOMBIE DRAGON AND RIDER CONSISTS OF:

- 1 x RIDER TORSO
- 1 x RIDER LEGS
- 1 x BANNER
- 1 x BODY
- 1 x HEAD
- 1 x NECK
- 1 x FRONT LEFT LEG
- 1 x FRONT RIGHT LEG
- 1 x BACK LEFT LEG
- 1 x BACK RIGHT LEG
- 1 x TAIL
- 1 x LEFT WING
- 1 x RIGHT WING

Miniatures supplied unpainted. **WARNING:** This product contains lead which may be harmful if chewed or swallowed. Citadel Miniatures are not recommended for children under 14 years of age.  
 © Copyright Games Workshop Ltd 1994. All rights reserved.



# UNDEAD

## ZOMBIE DRAGON

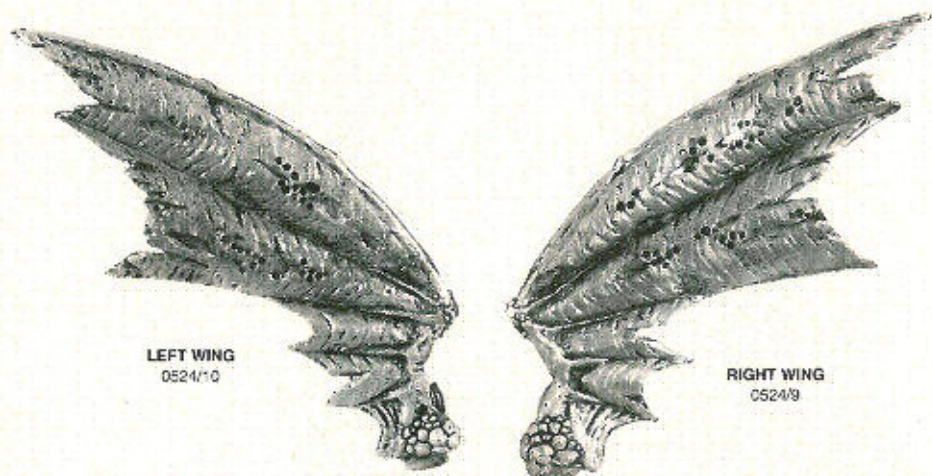

LEFT WING  
0524/10

RIGHT WING  
0524/9



## NECROMANCERS



NECROMANCER 1  
74521/1



NECROMANCER 2  
74521/2

Miniatures supplied unpainted. WARNING: This product contains lead which may be harmful if chewed or swallowed. Citadel Miniatures are not recommended for children under 14 years of age.  
© Copyright Games Workshop Ltd 1994. All rights reserved.



# UNDEAD

## NAGASH



EXAMPLE OF COMPLETED NAGASH



HEAD  
0523/4



TORSO  
0523/3

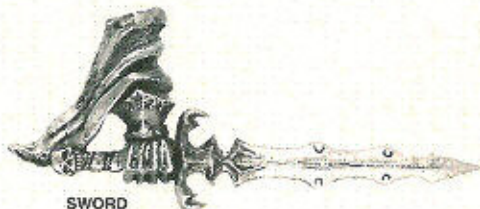

SWORD  
0523/6



STAFF  
0523/5



FRONT BODY  
0523/2



REAR BODY  
0523/1

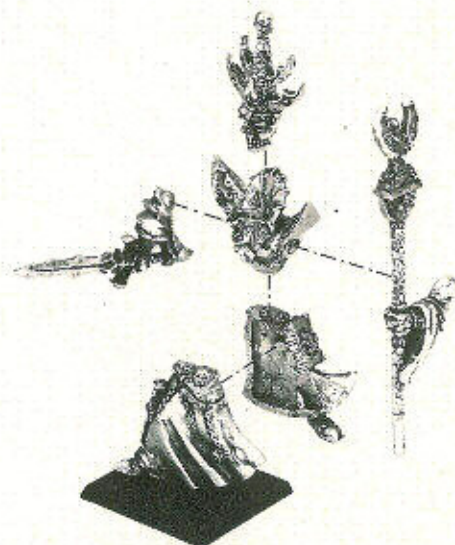

THE COMPLETED NAGASH  
CONSISTS OF:  
1 x HEAD  
1 x TORSO  
1 x FRONT BODY  
1 x REAR BODY  
1 x STAFF  
1 x SWORD

Miniatures supplied unpainted. **WARNING:** This product contains lead which may be harmful if chewed or swallowed. Citadel Miniatures are not recommended for children under 14 years of age.  
© Copyright Games Workshop Ltd 1994. All rights reserved.



# BLOOD BOWL

## HEADSPLITTER



EXAMPLE OF COMPLETED HEADSPLITTER

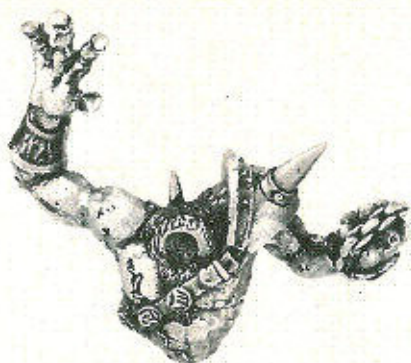

TORSO  
73510/2



HEAD  
73510/1



LEGS  
73510/3

THE COMPLETED HEADSPLITTER  
CONSISTS OF:  
1 x HEAD  
1 x TORSO  
1 x LEGS

## STAR PLAYERS



FUNGUS THE LOON  
73506/1



NOBBLA BLACKWART  
73501/1



SCRAPPA SOREHEAD  
73502/1



BOMBER DRIBBLESNOT  
73507/1



VARAG GHOUL-CHEWER  
73509/1



THE MIGHTY ZUG  
73505/1



GRIFF OBERWALD  
73503/1

Miniatures supplied unpainted. WARNING: This product contains lead which may be harmful if chewed or swallowed. Citadel Miniatures are not recommended for children under 14 years of age.  
© Copyright Games Workshop Ltd. 1994. All rights reserved.



# ORKS

## ZODGROD WORTSNAGGA

THE COMPLETE ZODGROD WORTSNAGGA CONSISTS OF:  
1 x ZODGROD BODY  
1 x ZODGROD'S BANNER



ZODGROD WORTSNAGGA  
70806/1



ZODGROD'S BANNER  
70806/2

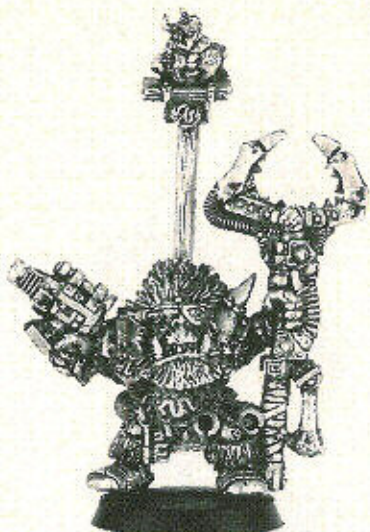

EXAMPLE OF COMPLETED  
ZODGROD WORTSNAGGA

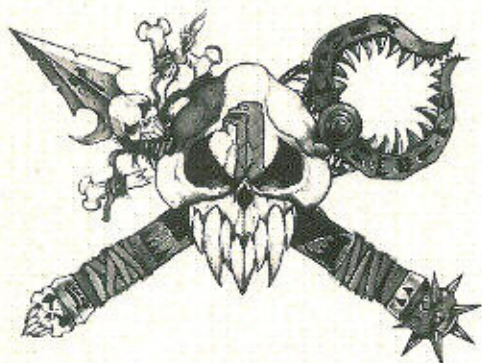

## BLOODAXE KOMMANDOS



BLOODAXE  
KOMMANDO 1  
70807/1



BLOODAXE  
KOMMANDO 2  
70807/2



BLOODAXE  
KOMMANDO 3  
70807/3

Miniatures supplied unpainted. **WARNING:** This product contains lead which may be harmful if created or swallowed. Citadel Miniatures are not recommended for children under 14 years of age.  
© Copyright Games Workshop Ltd 1994. All rights reserved.





# ORKS

## SMASHA GUN

THE COMPLETE SMASHA GUN  
CONSISTS OF:  
1 x SMASHA GUN TOP  
1 x SMASHA GUN SUPPORT  
1 x CHASSIS  
2 x WHEEL  
1 x GRETCHIN WITH HAMMER  
1 x GRETCHIN WITH WRENCH

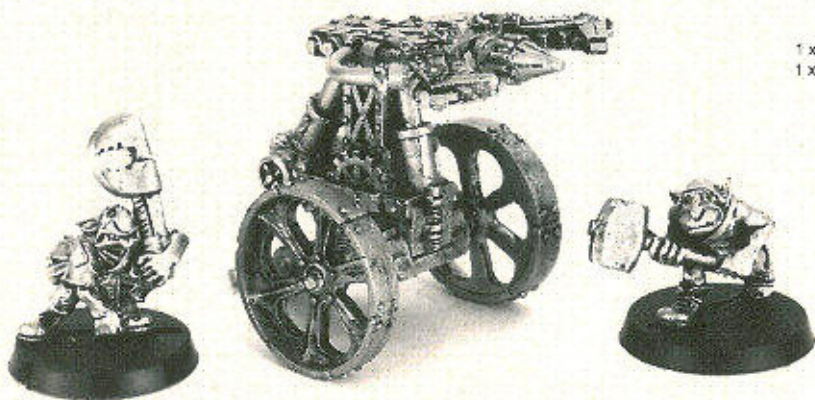

EXAMPLE OF COMPLETED SMASHA GUN

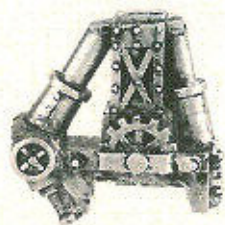

SMASHA GUN SUPPORT  
70811/2

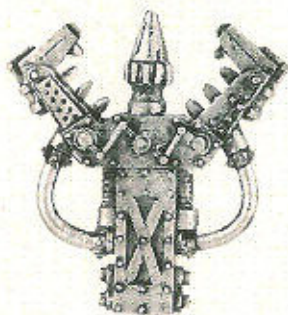

SMASHA GUN TOP  
70811/1

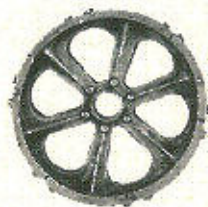

WHEEL  
70805/6

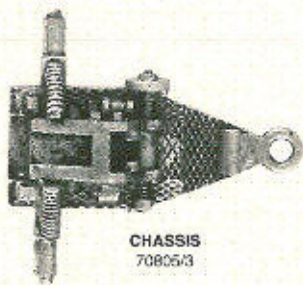

CHASSIS  
70805/3



GRETCHIN WITH  
HAMMER  
70811/4



GRETCHIN  
WITH WRENCH  
70811/3

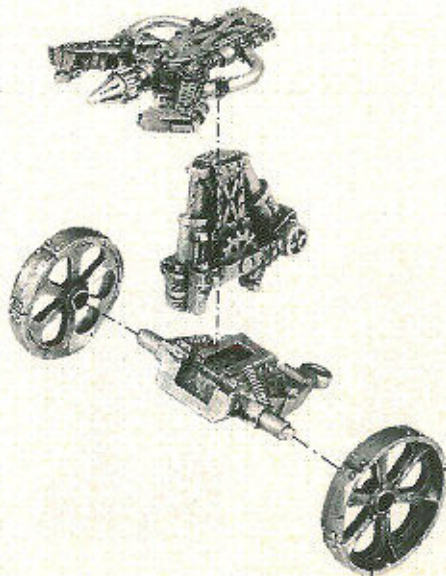

Minatures supplied unpainted. WARNING: This product contains lead which may be harmful if chewed or swallowed. Citadel Miniatures are not recommended for children under 14 years of age.  
© Copyright Games Workshop Ltd 1994. All rights reserved.



# SPACE MARINES

## JUMP PACK ASSAULT TROOPS



JUMP PACK TROOPER 1  
0426/2



JUMP PACK TROOPER 2  
0426/1



JUMP PACK SERGEANT 1  
0426/3



JUMP PACK TROOPER 3  
70100/2



JUMP PACK TROOPER 4  
70100/3



JUMP PACK SERGEANT 2  
70100/1

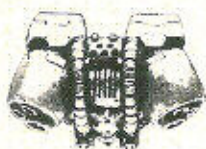

JUMP PACK  
0426/4

A COMPLETE JUMP PACK ASSAULT  
TROOPER CONSISTS OF:  
1 x JUMP PACK MARINE  
1 x JUMP PACK  
1 x PLASTIC MARINE ARMS SPRUE  
1 x MARINE CLOSE COMBAT SPRUE



EXAMPLES OF COMPLETED JUMP PACK ASSAULT TROOPS

Minifigures supplied unpainted. **WARNING:** This product contains lead which may be harmful if chewed or swallowed. Citadel Miniatures are not recommended for children under 14 years of age.  
© Copyright Games Workshop Ltd 1994. All rights reserved.



# WARHAMMER ARMIES

# CHAOS



**The sun dims in the sky. Blood rains from the darkening clouds. The Realm of Chaos spews a tide of monstrous creatures upon the lands of men. Hideous beasts swarm south, leaving terror and destruction in their wake. Mortals despair, for your doom is come upon you!**

The Warhammer Armies - Chaos supplement contains new rules, spells, magic items and a complete army list for fighting battles with Chaos armies in Warhammer. The box contains an 88 page book which details the history and background of the four Chaos Powers - Khorne, Nurgle, Slaanesh and Tzeentch - and provides a full list of their earthly minions, from mighty Chaos Champions to depraved Chaos Spawn. The set also contains dozens of full-colour cards describing Chaos Gifts, new Magic Items, Magic Spells and Chaos Rewards.

**WARHAMMER ARMIES - CHAOS IS NOT A COMPLETE GAME.  
YOU NEED A COPY OF WARHAMMER TO USE  
THE CONTENTS OF THIS SUPPLEMENT.**

The Games Workshop logo and the Warhammer logo are registered trademarks of Games Workshop Ltd. Citadel, Games Workshop, Khorne, Nurgle, Tzeentch and Slaanesh are trademarks of Games Workshop Ltd.

© Games Workshop Ltd, 1994. All rights reserved.



# GAMES WORKSHOP

GOLDEN DENNON SPACE MARINE TROPHY WINNER FRED REED FROM OUR BRISTOL STORE PAINTED THIS HOWLING CRITHONS ARMY

