

GAMES WORKSHOP

PRESENTS ITS MONTHLY HOBBY SUPPLEMENT AND MINIATURES CATALOGUE



WHITE DWARF

169
£2.25



FREE INSIDE!
WARHAMMER
GOOOO
CARD BATTLE
BUNKER

ISSN 0265-8712
01
9 770265 871028



AN ULTRAMARINES ASSAULT SQUAD LEAPS INTO BATTLE



DWARF SLAYERS AND A GYROCOPTER CONFRONT A GROUP OF RIVER TROLLS LED BY AN ORC BOSS

CONTENTS

COVER: SPACE WOLVES — *Geoff Taylor*

INSIDE FRONT

Ultramarines assault troops and Dwarf Trollslayers.

GW AND CITADEL NEWS

All the latest news from Games Workshop and Citadel Miniatures.

2

ADEPTUS ARBITES — *Andy Chambers*

Andy gives us a full description of the Adeptus Arbites including full rules for the Arbites combat shotgun and its deadly "Executioner" ammo.

5

WARHAMMER 40,000 PAINTING GUIDE — *Mike McVey*

In this special preview of Mike McVey's second painting guide, he describes the best ways to paint miniatures for Warhammer 40,000, in particular the alien Eldar.

11

ARKHAN THE BLACK, THE LICHE KING — *Jervis Johnson*

The nightmare Undead General is detailed in this fascinating article.

18

THE 1994 GOLDEN DEMON AWARDS

The Golden Demon Awards are the world's premier miniature painting competition. We provide all the category details and information you need to enter the 1994 competition.

21

SKAVEN MONSTERS AND CHARACTERS — *Andy Chambers*

From the monstrous Vermin Lord to the Council of Thirteen's favoured Lords Skrolk and Queek, this article provides full background and rules for these most recent additions to the fearsome Skaven army.

26

WARHAMMER 40,000 BATTLE BUNKER — *Jervis Johnson*

Jervis gives us the full rules for buying these fortifications for your armies and fighting with them in your Warhammer 40,000 battles.

33

THE STRONGPOINT — *Jervis Johnson*

In this exciting new scenario Jervis continues the Battles for Armageddon campaign as the Space Marines defend their Battle Bunkers against the Ork onslaught.

43

ASSEMBLING YOUR BATTLE BUNKER — *Adrian Wild*

All the instructions for building your free Warhammer 40,000 Battle Bunker.

48

DEATH ON THE SEA OF CLAWS — *Andy Jones and Jervis Johnson*

The Empire's war fleet struggles against the foul monsters and magical powers of their Dark Elf enemies.

50

ADVERTS

Codex Space Wolves.....	4	Ultramarines Assault Squad.....	40
Games Workshop Stores.....	8	Man O' War.....	58
Manchester New Store.....	10	Games Workshop Mail Order.....	70
Skaven Plague Fleet boxed sets.....	17	Citadel Miniatures Catalogue.....	74
GW Australia New Stores.....	32	Sea of Blood.....	78
Space Marine Rhino.....	37		



WARHAMMER®

NEW SKAVEN CHARACTERS

Following the publication of the *Warhammer Armies – Skaven* book, this month sees the release of a number of exciting new miniatures for all you Skaven Generals.

First up are the Skaven characters, **Lord Skrolk** and **Warlord Queek**. Elsewhere in this issue of *White Dwarf* you'll find full rules and battle stats for both of these dark heroes.

SKAVEN MONSTERS

In the same article you'll find the rules and background for the **Vermin Lord** and the brand new **Rat Ogres**. Designed by Mike Perry, these fearsomely warped monsters are an essential addition to any Skaven force. Indeed as soon as he saw the finished models, Andy Chambers had to be physically restrained while he chortled

Mine! Mine! Mine! at the top of his voice.

LICHE KING'S CHARIOT

Also new for Warhammer this month is **Arkhan, the Black – the Liche King**. This mighty Undead champion rides into battle mounted on a monstrous chariot constructed from the carcass of a Manticore.

Jervis Johnson is at the moment putting the final touches to the *Warhammer Armies – Undead* book, and the next few months should see the release of many new and exciting models for Undead generals.

HOBGOBLIN SNEAKY GITS

The other new release this month is the **Hobgoblin Sneaky Gits**. These malevolent greenskins ally with the mighty Chaos Dwarfs and in the

THIS MONTH'S WARHAMMER RELEASES

Skaven Vermin Lord (One miniature per blister)	£11.99
Skaven Rat Ogres (One miniature per blister)	£5.99
Skaven Lord Skrolk (One miniature per blister)	£4.99
Skaven Warlord Queek (One miniature per blister)	£4.99
Liche King's Chariot (Boxed set)	£14.99
Hobgoblin Sneaky Gits (Four miniatures per blister)	£3.99
Hobgoblin Bolt Thrower (One miniature per blister)	£5.99

company of their masters, they roam the battlefields of the Old World swarming over their foes and stabbing at them with their poisoned daggers!

In next month's issue of *White Dwarf* we'll be featuring a report of a Warhammer battle between a Chaos Dwarf army and a Wood Elf force. It was a major defeat for one side, but we'll keep you in suspense until next month.



A regiment of Hobgoblin Sneaky Gits.



WARHAMMER 40,000 PAINTING GUIDE

A well painted Warhammer 40,000 army is always a stunning sight on the battlefield and is far easier to achieve than you might think. Mike McVey has just completed work on the second volume of a series of 'Eavy Metal painting guides. The **Warhammer 40,000 Painting Guide** is the essential reference for all the techniques you need to paint your army. It covers basic colour schemes and how to apply them, as well as his own expert hints and tips for special character models and leaders. Mike talks about the guide elsewhere in this issue and we preview several pages from the Eldar section of the book.

NEW MINIATURES

A new addition to the Imperial forces are featured this month in the form of the Adeptus Arbites. Sculpted by Jes Goodwin, the Arbites are armed with combat shotguns or grenade launchers and led by an Adeptus Arbites Captain.

Also released this month are two boxed sets containing reinforcements for your Space Marine and Ork armies. The models are the same as the ones supplied in the Warhammer 40,000 game and you get ten in each box.

CODEX -- SPACE WOLVES

This month sees the release of the first of the Codex series of army books for **Warhammer 40,000**. The first book concentrates on the **Space Wolves**, one of the founding chapters of Space Marines. The **Codex -- Space Wolves** is a unique guide to the character and organisation of these savage warriors. It contains a complete background and history to the Space Wolves chapter together with detailed rules for all of their major characters and a complete Space Wolves army list.



Now that this first volume is out at the printers, work has started on the second book in the series: **Codex -- Eldar**. This should be ready for publication early in the new year.

To coincide with the release of the **Codex -- Space Wolves**, Jes Goodwin has designed an awesome new Space Wolf Dreadnought, Bjorn the Fell-Handed. This model is available now and is featured on an 'Eavy Metal page elsewhere in this issue.

THIS MONTH'S WARHAMMER 40,000 RELEASES

Codex Space Wolves	£9.99
Warhammer 40,000 Painting Guide	£9.99
Space Wolf Dreadnought (Boxed set)	£19.99
Adeptus Arbites (Three miniatures per blister)	£3.99
Adeptus Arbites Captain (Two miniatures per blister)	£3.99
Space Marine Warriors (Boxed set)	£9.99
Space Ork Warriors (Boxed set)	£7.99

DARK MILLENNIUM

Staying with Warhammer 40,000, Andy Chambers is currently working on the first boxed supplement -- **Dark Millennium**.

Dark Millennium brings the full range of deadly fighting machines, devastating psykers and exotic wargear to the Warhammer 40,000 game. It will contain over twenty full-colour vehicle datacards covering everything from Eldar Jet Bikes to the Lemman Russ Imperial Battle Tank.

Also included are the full psychic rules and psychic power cards for all the races as well as dozens of new Wargear cards, new Mission cards and Strategy cards.

Dark Millennium will be available at the end of February 1994.

SPACE MARINE



This month, the Squat forces in **Space Marine** can take to the battlefield with a brand new mobile fortress known as the **Cyclops**. In the next issue of White Dwarf we'll be publishing complete rules and a special army card for this super heavy vehicle. The Cyclops is armed with a gigantic Hellfury Cannon as well as a plethora of secondary weapons including Doomstorm missiles, a Battlecannon, a Melta-cannon and an arsenal of Bolters!

The Squat Cyclops is available now.

THIS MONTH'S SPACE MARINE RELEASE

Squat Cyclops (Boxed set)	£9.99
---------------------------	-------

WARHAMMER

40,000

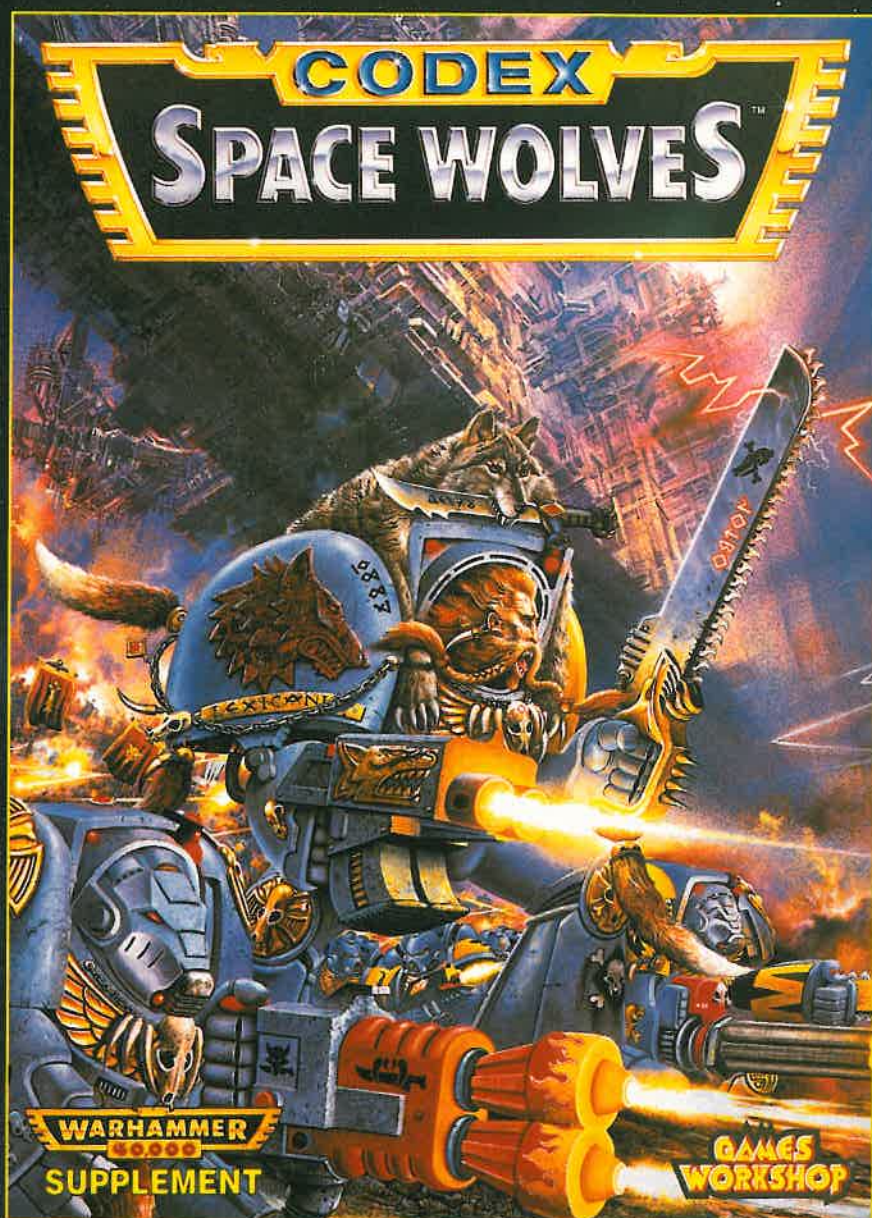

THE SPACE WOLVES

In ages past the mighty Primarch Leman Russ led the Space Wolves Chapter of Space Marines. Never was there a warrior as fierce as Leman Russ, and never were there Space Marine Warriors as headstrong and battle-keen as the Space Wolves. This invaluable companion to the Warhammer 40,000 game describes the armies of the Space Wolves Chapter in complete detail.

THE MIGHT OF THE SPACE WOLVES

The creation of the Space Wolves in the days of the Primarch Leman Russ is described together with their forbidding homeworld, the icy planet of Fenris.

ORGANISATION AND SPECIAL RULES

Organisational details and special rules are provided for the Space Wolves, including details of the Long Fangs, Grey Hunters, and Blood Claws.

ARMY LIST

A complete army list for the Space Wolves Chapter is given including special characters such as Njal Stormcaller, Ulrik the Slayer, Ragnar Blackmane and Logan Grimnar.



CODIX SPACE WOLVES IS NOT A COMPLETE GAME. YOU NEED A COPY OF WARHAMMER 40,000 TO USE THE CONTENTS OF THIS BOOK.

The Citadel castle, the Games Workshop logo and the Warhammer 40,000 logo are registered trademarks of Games Workshop Ltd. Citadel, Games Workshop and Space Wolves are trademarks of Games Workshop Ltd. © Games Workshop Ltd, 1994. All rights reserved.

GAMES WORKSHOP

WARHAMMER

40,000

ADEPTUS ARBITES

By Andy Chambers

" They live there in that great plascrete tower surrounded by walls and razor wire, only emerging to seize some unfortunate who has transgressed against the Imperial Laws or to patrol the city to prove that it belongs to them. There are crystal lenses and sound wave detectors on that tower that can watch citizens and listen to their conversations 100 leagues away, Imperial spy satellites watch what they can't see directly and even the Governor fears them. They aren't from here and have nothing to do with us, no more than Orks or Eldar, if they have families or children we don't know about them and we don't care. They wouldn't so much as buy a glowbulb from us and we would not sell it to them. Its ironic that they have the rather benevolent title of Arbitrators"

Vorkas Zolowski prior to his arrest for pernicious sedition against the Emperor of mankind.

The Adeptus Arbites are the keepers of the Imperium's laws and watchdogs of the far-flung empire of humanity. The Imperium is an organisation where rebellion and defiance of the Imperial will are Crimes Against Humanity. The Arbitrators are the grim and uncompromising reminder of the

Imperium's presence which no planetary governor can ignore. They cannot be bought off or threatened or corrupted or negotiated with. Indeed the Adeptus Arbites goes to a great lengths to ensure that those recruited into their ranks do not serve on their own homeworlds nor anywhere within a dozen light years of home. They do not communicate with the citizenry unless absolutely necessary and only leave their great fortress-precincts on official business.

Should a planet revolt against the Imperium the Arbitrators will be the first to go into battle against the traitors. More often than not a rebellious governor will order the destruction of the Adeptus Arbites precinct on his planet as his first treachery and a great battle will break out between rebel planetary defence forces and the besieged Arbites. The one-sided struggle of a few hundred against an entire world should not last long and the result would seem inevitable but the Judges are well trained in their task and always ready.

During the rebellion of Ichar IV the Arbitrators held their precinct for twenty seven days before finally escaping via a secret tunnel and capturing four of the hive's power generators. These they held for a further six days before destroying them as the last of the judge's positions was overrun. When the Ultramarines Chapter of Space Marines



An Adeptus Arbites squad led by an Arbitrator Champion.

arrived to crush the rebellion they found twenty percent of the planets ground defences inoperative and successfully staged a drop directly into the core hive, shortening the whole campaign by two months.

In truth the Arbitrators need only to hold out until their astropath has transmitted a message summoning help. Mobile fleets of Arbitrators stand in constant readiness to answer the call of their precincts and bring retribution upon the transgressors of the Emperors laws. Beyond them the entire might of the Imperium can be called upon with Space Marine Chapters and the Imperial Guard prepared to quell the fiercest rebellion.

Equally the Arbitrators stand ready to fight against the foes of humanity in the case of Genestealer infestation, Chaos incursion or alien attack. The well armed and rigorously trained Arbitrators make excellent troops and Squads of Judges can add vital backbone to the planetary defence forces. It is ironic that planetary governors who may have plotted against the Imperium for years are always the first to squeal for help when the Orks arrive.

ARBITES TROOPS ON THE BATTLEFIELD

The forces of the Adeptus Arbites are deliberately better equipped than those of either Planetary Defence forces or the Imperial Guard to discourage attack. Every Arbitrator is equipped with a complete suit of carapace armour, giving them a saving roll of 4, 5 or 6 on a D6. All Arbitrators also carry a bolt pistol as their standard side arm.

Beyond this basic equipment the specific armament of Arbitrator squads varies according to their mission. The most common armament for patrol groups, execution teams and snatch squads is either standard boltguns or the specially designed Arbites Combat Shotgun. Arbites shock troops are frequently deployed as heavy assault troops and carry the much feared Power maul and Suppression shield.

One member of the five man Arbitrator squad is usually armed with a special weapon drawn from the extensive precinct

THE ARBITES COMBAT SHOTGUN

The Arbites combat shotgun is a simple shotgun with a number of adaptations which allow it to fire a special ammunition type available only to the Adeptus Arbites. In addition to the standard solid and scatter rounds fired by ordinary shotguns the Adeptus Arbites labs have developed the "Executioner" adamantium-tipped armour piercing round to seek out and destroy the toughest targets. This sophisticated shell has a tiny robot brain which locks onto the target's energy pattern and seeks it out with unerring accuracy. This variety of ammunition types makes the Arbites Combat Shotgun a uniquely flexible weapon.

SPECIAL RULES

Solid shells have a strength of 4. Scatter shells have a strength of only 3 but also have a 1" radius blast marker. Executioner rounds have a strength of 4 and -2 save modifier. In addition they receive a +D3 modification to their armour penetration value against vehicles and buildings, increasing their armour penetration value to 4+D6+D3.

Because it locks onto a target's energy signature the Executioner shell may even be fired at hidden targets providing they have already been detected. The Executioner round is unusual in that it receives a +1 to hit modifier at long range and a -1 to hit modifier at short range. This because the shell's tiny brain cannot lock onto its target until it has travelled several meters.

ARBITES COMBAT SHOTGUN AMMO TABLE

Shot type	Strength	Save Modifier	Blast Area
Solid Shell	4	0	None
Scatter Shot	3	0	1"
Executioner	4	-2	None

The considerable mass of solid or scatter shells mean that if a target is hit by one but not slain, then it is automatically knocked back 2" away from the firer and will fall over on a D6 roll of 4+. A knocked over model must spend its next movement phase standing up. Note that this rule only affects ordinary troopers - not vehicles, robots, Terminators or Dreadnoughts. Executioner rounds are lighter so they do not knock back targets like ordinary solid and scatter shells.

THE ARBITES COMBAT SHOTGUN

Ammo	Short Range	Long Range	To Hit Short	To Hit Long	Strength	Damage	Save Mod	Armour Pene	Special
Solid	0-4"	4-18"	-	-1	4	1	0	4+D6	See above
Scatter	0-4"	4-18"	-	-1	3	1	0	3+D6	1" blast
Executioner	0-4"	4-18"	-1	+1	4	1	-2	4+D6+D3	See above

armouries. The most common choice is a grenade launcher as this offers the greatest tactical flexibility. Arbitres squads also have access to a range of special grenade types such as photon flash, scare and choke, which are invaluable for crowd suppression and the capture of criminals. These have also proved very potent against poorly equipped opponents such as Orks and Gretchin, Chaos cultists and Genestealer broodbrothers.

Because of their heavy armour and (if armed with Arbitres Combat Shotguns) their potent short ranged firepower Arbitres squads are most useful at short ranges in dense terrain, either attacking enemy held positions or defending key points. They excel in street fighting where their small squad size enables them to make best use of available cover. Arbitres squads are very hard to shift at the best of times and they can fight off the fiercest assaults with sufficient heavy weapons support.

CHARACTERS

ARBITRATOR CHAMPION

Special

An Arbitrator champion is a fearsomely dedicated and skilled opponent. In his commanding presence Arbitrators will make herculean efforts to fulfil their mission. Any Arbitrator squad may upgrade its squad leader to an Arbitrator champion for +10 points.

Profile	M	WS	BS	S	T	W	I	A	L
Arbitrator Champion	4	4	4	3	3	1	4	1	8

WEAPONS: Bolt pistol

ARMOUR: Carapace armour (4+ save).

WARGEAR: The Arbitrator champion may have up to one wargear card and any combination of equipment permitted by the Adeptus Arbitres wargear list.



SQUADS

ARBITRATOR SQUAD

70 points

Arbitrators are the grim custodians of Imperial justice. They are relentless in the prosecution of their duties and unswervingly loyal to the Imperium and the Emperor of Mankind. Traitors and criminals live in mortal fear of their penetrating vigilance and swift retribution.

Profile	M	WS	BS	S	T	W	I	A	L
Arbitrators	4	3	3	3	3	1	3	1	7

SQUAD SIZE: An Arbitrator squad consists of five Arbitrators.

WEAPONS: Bolt pistol

ARMOUR: Carapace armour (4+ save).

WARGEAR: Any models may be equipped with additional assault or basic weapons chosen from the Adeptus Arbitres wargear list.

One Arbitrator may be given a weapon chosen from the special weapons section of the Adeptus Arbitres wargear list.

The entire squad may be given any combination of the following grenades:

Choke Grenades	10 pts/ squad
Frag Grenades	10 pts/ squad
Melta Bombs	25 pts/ squad
Photon Flash	10 pts/ squad
Scare Grenades	10 pts/ squad

SUPPORT: An Arbitrator squad may be mounted on bike at an additional cost of 100 points or in a Rhino at an additional cost of 50 points.

ADEPTUS ARBITES WARGEAR LIST

ASSAULT WEAPONS

A model may carry any number of assault weapons.

Power Sword	6 pts
Power Maul and Suppression Shield	10 pts

BASIC WEAPONS

A model may only carry a single basic weapon

Bolt Gun	3
Arbitres Combat shotgun	3

SPECIAL WEAPONS

A model may only carry a single special weapon

Flamer	7
Grenade Launcher with Frag and Krak grenades	10
Extra to include Choke grenades for the above	+4 pts
Extra to include Photon flares for the above	+4 pts
Extra to include Scare grenades for the above	+4 pts
Meltagun	6
Needle Rifle	8
Plasma Gun	6

GAMES WORKSHOP®

A WORLD OF FANTASY GAMING

The first thing you notice when entering a Games Workshop store is how different it is from nearly every other shop. Here you'll find not only everything you need for the gaming hobby, but much more besides. With friendly, approachable staff and a vast range of Citadel and Marauder miniatures, you'll find everything you need to build up an army for Warhammer 40,000, Space Marine, Warhammer or Man O' War.

Whether you're a newcomer to the hobby or an experienced gamer, you'll find the staff at your local Games Workshop Store helpful and informative.

All our staff are experienced gamers and will be more than happy to show you how to play our games, which models are best for your army and how to paint them. They'll also know about all of the latest miniature releases and what's up and coming for your favourite games.



SPECIAL EVENTS

Throughout the year your local Games Workshop Store runs a wide variety of special events ranging from Grand Openings, special Battledays, painting workshops and visits by the ever popular Warhammer Days team to name but a few.

Keep an eye on the adverts in White Dwarf for up and coming events, and look out for posters in your local Games Workshop Store.

Don't forget our regular Thursday Games Night when all of our stores stay open late to host whatever games people want to come and play. Everyone is welcome so why not come along this Thursday and join in?

SPACE MARINE®



Above: Enthusiasts enjoying an exciting game of Space Marine at the regular Thursday Games Night in our Nottingham store.

Below: The gaming tables at the Peterborough store.





Below: If you've never played a Games Workshop game, but think it might be fun, just pop along to your local Games Workshop and join in. Each store runs regular introductory games of Warhammer, Space Marine, Warhammer 40,000 and Man O' War. Please phone first to see what's being played each day.



Top: Each month Citadel Miniatures and Marauder Miniatures release many exciting new models. Your local Games Workshop stocks the full range of these miniatures and the staff will be glad to help you select the ones you need for your army.

Left: A Space Wolf Terminator painted by an expert miniature painter.

Below: One of our friendly Games Workshop staff gives some advice on miniature painting. Each Games Workshop has an area for you to paint your own models and expert staff to give hints and tips.



GAMES WORKSHOP STORES

ABERDEEN: UNIT 1, 30/40 KIRKGATE. TEL: 0224 621261
 BECKENHAM: 292-294 HIGH STREET. TEL: 081 658 8102
 BELFAST: 20A CASTLE COURT. TEL: 0232 233684
 BIRMINGHAM: 116 CORPORATION STREET. TEL: 021 236 7880
 BLACKPOOL: 8 BIRLEY STREET. TEL: 0253 752056
 BOLTON: UNIT 25, FIRST FLOOR GALLERY, SHIPGATES CENTRE. TEL: 0204 362131
 BOURNEMOUTH: 24, POST OFFICE ROAD. TEL: 0202 319292
 BRIGHTON: 7 NILE PAVILIONS, NILE STREET. TEL: 0273 203333
 BRISTOL: 13 BROAD WEIR. TEL: 0272 251533
 BROMLEY: 8 BROMLEY MALL. TEL: 081 466 0678
 CAMBRIDGE: 4 QUAYSIDE, (OFF BRIDGE ST). TEL: 0223 313350
 CARDIFF: 29-30, HIGH STREET. TEL: 0222 644917
 CHELTENHAM: 16 PITVILLE STREET. TEL: 0242 228419
 CHESTER: 112 FOREGATE STREET. TEL: 0244 311967
 COLCHESTER: 2 SHORT WYRE STREET. TEL: 0206 767279
 COVENTRY: 14 CITY ARCADE. TEL: 0203 227311
 CROYDON: UNIT 35, DRUMMOND CENTRE, KEELEY ROAD. TEL: 081 680 4600
 DERBY: 42 SADDLER GATE. TEL: 0532 371657
 DUDLEY: KIOSK U, UPPER LEVEL, MERRY HILL CENTRE.
 DUDLEY. GAMES NIGHT: THURS TILL 9.00. OPEN MON - FRI 10.00 TILL 8.00. SAT 9.00 TILL 7.00. TEL: 0384 481818
 EDINBURGH: 136 HIGH ST. OPEN SUN 11 - 5. TEL: 051 220 6540
 GLASGOW: 66 QUEEN STREET. TEL: 041 226 3762
 GUILDFORD: 12 TUNSGATE. TEL: 0483 451793
 HAMMERSMITH: 1 DALLING ROAD. TEL: 081 741 3445
 HARROW: 296 STATION ROAD. TEL: 081 861 2350
 HIGH WYCOMBE: UNIT 29, THE BALCONY, THE OCTAGON CENTRE. TEL: 0494 531494
 HULL: 30 PARAGON STREET. TEL: 0482 589576
 IPSWICH: 2ND FLOOR, DEBENHAMS, WESTGATE STREET. TEL: 0473 210031
 KINGSTON ON THAMES: 33, FIFE ROAD. TEL: 081 549 5224
 LEEDS: 12-16 CENTRAL ROAD. TEL: 0532 420834
 LEICESTER: 16/20 SILVER ST. TEL: 0533 530510
 LIVERPOOL: 47 LORD STREET. TEL: 051 258 1404
 CENTRAL LONDON: UNIT F10, THE PLAZA, 116-128 OXFORD STREET. TEL: 071 436 0839
 LUTON: 12 PARK STREET. TEL: 0582 417474
 MADDENSTONE: UNIT 6, 1/9 PUDDING LANE. TEL: 0622 677435
 MAIDENHEAD: 2 BLANDY HSE, 3/5 KING ST. TEL: 0628 21854
 MANCHESTER: UNIT 1, 3 BROWN STREET. TEL: 061 832 6863
 MEADOWHALL CENTRE SHEFFIELD: 91B, HIGH ST, UPPER MALL. OPEN MON TO THURS 10 - 8. FRIDAYS 10 - 9, SATURDAYS 9 - 7, SUNDAYS 12 - 4. TEL: 0742 569836
 METROCENTRE NEWCASTLE: UNIT B14, FIRST FLOOR. TEL: 091 461 0950
 MIDDLÉSBOURGH: 19 DUNDAS ST. TEL: 0642 254091
 NEWCASTLE: 63 CLAYTON STREET. TEL: 091 232 2418
 NORWICH: 12-14 EXCHANGE STREET. TEL: 0603 767656
 NOTTINGHAM: 342 FRIAR LANE. TEL: 0602 480651
 OXFORD: 1A NEW INN HALL ST. TEL: 0865 242182
 PETERBOROUGH: 3 WENTWORTH STREET. TEL: 0733 890052
 PLUMOUTH: 84 CORNWALL STREET. TEL: 0752 254121
 PORTSMOUTH: 34 ARUNDEL STREET. TEL: 0705 876266
 PRESTON: 15 MILLER ARCADE. TEL: 0772 821855
 READING: UNIT 3, CHEAPSIDE. TEL: 0734 598693
 SHEFFIELD: 18 FITZWILLIAM GATE. TEL: 0742 750114
 SHREWSBURY: UNIT 2, BRIDGE STREET. TEL: 0743 362007
 SOUTHAMPTON: 23 EAST STREET. TEL: 0703 331962
 SOUTHBEND: 12 SOUTH CHURCH ROAD. TEL: 0702 461251
 STOKE ON TRENT: 27 STAFFORD ST, HANLEY. TEL: 0782 205287
 SWINDON: 17 FLEET STREET. TEL: 0793 436036
 THURROCK LAKESIDE: UNIT 415, LEVEL 3/FOOD COURT, THURROCK LAKESIDE (JUNCTIONS 30/31, M25). TEL: 0708 857133. OPEN MON - THU 10 - 8, FRI 10 - 9, SAT 10 - 7.30.
 TORQUAY: 12 MARKET STREET. TEL: 0803 201036.
 WORCESTER: 4 CHARLES STREET. TEL: 0905 616707
 YORK: 26 GOODRAMGATE. TEL: 0904 653575

GAMES WORKSHOP®

MANCHESTER

WILL BE MOVING TO THEIR
MASSIVE NEW STORE

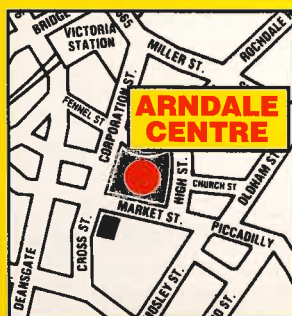

**69/70 MARSDEN COURT
ARNDALE CENTRE
MANCHESTER**

OPENING HOURS

**Mon to Sat: 9.30am to
5.30pm**

**Late opening on
Thursdays until 8.00pm**



Our gigantic new store in the Manchester Arndale Centre will be the biggest Games Workshop Store in the UK!



There you'll find lots of gaming tables for Warhammer 40,000, Space Marine, Warhammer and all of the other Games Workshop games.



Our in-store experts will be happy to help you with their professional painting advice.



The store has the entire range of Games Workshop and Citadel games and miniatures.



Our friendly and knowledgeable Games Workshop staff will be on hand to offer advice on any aspect of the hobby.

'EAVY METAL

WARHAMMER 40,000 PAINTING GUIDE

By Mike McVey

This month sees the release of the second of Mike McVey's 'Eavy Metal painting books – the Warhammer 40,000 painting guide. This volume is by far the most comprehensive work ever published on the art of painting your Warhammer 40,000 miniatures. It covers all you'll need to know, from assembling a Space Marine to painting an Eldar Dreadnought.



Mike McVey

The Warhammer 40,000 painting guide will appeal to both new and experienced painters alike. It contains in-depth descriptions of how to paint many races and troop types from the Warhammer 40,000 universe, and includes details of colour schemes and all of the techniques used to achieve them.

The guide begins with a section showing how to assemble your models. Using a Space Marine as an example, I've explained the best ways to attach plastic arms and weapons to metal models and demonstrate how to position the components for the most dynamic effects.

The main body of the Warhammer 40,000 painting guide is broken down into easy-to-follow sections, firstly by race and secondly by troop type. For instance, the Space Marines section begins with a general introductory page



explaining details such as how to organise your painting time, and the general principles behind painting Space Marine armour. The next sections illustrate how to paint Space Wolves, Ultramarines, Dark Angels and Blood Angels. Each of these sections include a stage-by-stage example of a standard trooper and demonstrate how I painted the more specialised troop types and character models. For instance, the Dark Angels section has a stage-by-stage example of how to paint Deathwing Terminators, a bike and rider from the Raven Wing and a Dark Angels Captain.

In addition to Space Marines, there are pages for the Orks, the Imperial Guard, Squats, Tyranids, Genestealers and Chaos Space Marines. There's also a detailed section on Eldar, some of which is included in this issue of White Dwarf. The last few pages of the painting guide focuses on how to construct and attach banners to your Warhammer 40,000 models and there are some colour examples for you to cut out for use with your own army.

ELDAR

The Eldar are one of the oldest and most mysterious races in the entire galaxy. After the Powers of Chaos brought the downfall of their empire, the survivors were left to wander through the vast expanses of warp space in their huge city-sized space craft known as Craftworlds.

COLLECTING AND PAINTING AN ELDAR ARMY

Eldar armies contain a wide variety of different troop types, each one specialising in a different kind of warfare. Every squad has a unique colour scheme, making it interesting and fun to paint, and contrasting sharply with an army such as the Space Marines, which is basically one colour throughout.

The Eldar are without doubt one of the brightest and most colourful of all the Warhammer 40,000 races. This is great from a miniature-painting point of view as there are always new and interesting challenges to meet.

THE CRAFTWORLDS

Before you begin painting an Eldar army, you'll need to choose which of the many Craftworlds your army comes from. Your Guardian squads, vehicles and Dreadnoughts will follow that Craftworld's colour scheme and marking system. These forces will form the backbone of your Eldar army.

This section covers five of the largest and most famous of all Eldar Craftworlds and their colour schemes. It also explains how to go about painting the more specialised troop types such as Aspect Warriors, Harlequins, Warlocks, Warlocks and Farseers as well as the mighty Avatar.



ASPECT WARRIORS

Many Eldar spend a period of their lives following the Warrior Path to become Aspect Warriors. Aspect Warrior colour schemes remain basically the same, whichever Craftworld they come from. Although no two Aspects have exactly the same colour scheme and markings, each one uses a pallet of colours that best represents the feel of the Aspect. For example, Striking Scorpions are always primarily green and yellow with contrasting details and markings, giving them a very insect-like appearance.

WAYSTONES

The many other interesting and exciting parts of the Eldar army utilise a wide variety of different painting techniques. One distinct feature of all Eldar models is the waystone. This is a gemstone worn by all Eldar to receive their souls should their mortal bodies be killed. The wearing of the waystone prevents the soul from being cast into the Warp and consumed by Slaanesh.

I like to give these gems special attention to make them look bright, colourful and realistic. The techniques you'll need to create a realistic finish are described below.

PAINTING WAYSTONES

Paint the stone and the surrounding mount with a thin coat of black, trying not to let the black stray onto the area behind. When this is dry, the mount can be painted either gold or silver depending on the colour of the gem, and the stone itself can be painted white. Be careful to leave a fine line of black all the way round the stone to define the shape.

The stone is then painted in the desired colour and the highlighting and shading added. The highlights are applied to the bottom half, getting lighter towards the edge, and the upper half is shaded. The final touch is to add a sharp white highlight to the top. This technique can also be applied to the gemstones of other races.

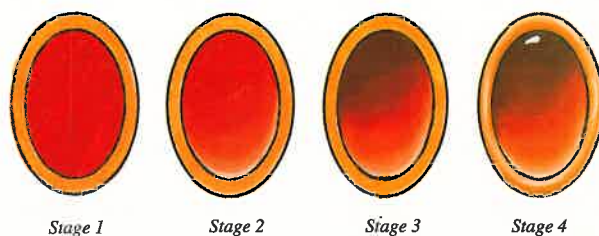

Stage 1

Stage 2

Stage 3

Stage 4



THE ELDAR CRAFTWORLDS

When the once mighty Eldar empire fell, its survivors were left to wander through warp space in vast ships, known as the Craftworlds. These ships are defended not only by the Aspect Warriors, but also by the civilian population. In times of dire need the people of the Craftworlds take up arms and join the ranks of the Guardians.

Each of the Craftworlds is a completely independent and self-contained realm, though Eldar society and the structure of its armies is remarkably similar from one Craftworld to the next. Although an Eldar army in Warhammer 40,000 is based around a particular Craftworld, this makes little difference to the painting of the squads of Aspect Warriors, whose markings and colour schemes are consistent throughout the Eldar culture. The only real difference it makes is to the colours of the rank and file Eldar troops, the Guardians.

ELDAR GUARDIANS

All of the Eldar on a Craftworld are sufficiently trained in the use of weapons to be able to pick up a gun and rally to their designated Guardian units in times of war. These Guardian troops form the core of any Eldar army, not only

as infantry, but also by manning heavy weapons and crewing vehicles. The Guardians of each Craftworld use a unique colour scheme, with their Craftworld rune as their badge.

The following section of the guide gives colour schemes and painting information for the five largest and most famous Craftworlds, which are Alaitoc, Ulthwé, Saim-hann, Biel-tan and Iyanden. I have included a stage-by-stage example of how a basic Guardian miniature is painted. Although there is some weapon variation, the miniatures are all basically alike. The colour scheme may vary slightly from squad to squad within a particular Craftworld, but overall it remains constant. The leaders of Guardian units are identified by the back banners they wear, which normally bear the Craftworld rune. It is also usual for one of the Guardian troops to carry the army banner into battle.

ALAITOC

The Alaitoc Craftworld lies on the fringes of the galaxy where the threat of war is constant. The Guardians of Alaitoc have a predominantly blue colour scheme, with yellow used as a contrast on areas of detail such as the helmet and gun. The stage-by-stage example below was painted entirely in blue with a yellow helmet and gun.

The armour suit was base-coated with Ultramarine Blue. Guardian armour differs from Aspect armour, in that it is a mix of hard plates and mesh armour. The mesh armour on the Guardian below was base-coated with Chaos Black and then drybrushed with Chainmail.

The hard armour plates were highlighted first with Enchanted Blue, and then with an Enchanted Blue and Skull White mix to define the edges. The helmet and gun were given a base coat of Sunburst Yellow, deepened with a spot of orange, and highlighted with Sunburst Yellow and Skull White. The eyes and face grille were both painted black before the eyes were painted first with white, and then with Blood Red.

Tiger striping is a common form of decoration on Alaitoc Guardians and can be applied over the yellow on the helmet.



ULTHWE

Ulthwé is the most overtly militarist of all the Eldar Craftworlds. Its people have long been accustomed to warfare, as Ulthwé is situated perilously close to the Eye of Terror. Constant warfare has hardened its people and has led to the creation of a standing force of Guardians known as the Black Guardians of Ulthwe.

As their name suggests, Ulthwé's Guardians are predominantly black, with their golden yellow helmets providing sharp contrast. This gives them a dramatic and dangerous look, especially in large numbers on your tabletop.

To speed up the painting process, each model was given a

black undercoat. When this was dry, the helmet and gun were re-undercoated in white, to help brighten the yellow. The black was highlighted initially with Moody Blue, and then with a mix of Moody Blue and Space Wolf Grey. This maintains a deep, rich black that isn't turned too grey. The helmet was base-coated with Sunburst Yellow and highlighted with yellow and Skull White.

A very thin glaze of orange ink was applied when the highlight tones were dry, which helped to eliminate any paleness and warmed the yellow up. The mesh armour was carefully drybrushed with Mithril Silver to accentuate the links.



SAIM-HANN

Some Eldar regard the Saim-Hann Craftworld as a nest of wild barbarians living on the fringe of Eldar society. The raucous, boastful warriors of Saim-Hann are aggressive, mobile troops and skilled bikers. This Craftworld is renowned as a wild and dangerous place, where the inhabitants adhere to the Eldar Path less rigidly.

The main colour used by the Guardians of Saim-Hann is a bright, flaming red, with which their uniforms are coloured almost entirely. Helmets are usually painted in a contrasting tone such as black or white. The notorious bikers of the Saim-Hann Craftworld normally wear black leather uniforms with bright red helmets.

On the example shown below the Guardian miniature was first undercoated with white and then given a base coat of Go Fasta Red which, when mixed with a little Blood Angel Orange, produced an extremely bright red to build the highlights onto.

When the base coat was fully dry, a wash of red ink was applied fairly thinly to create shading without dulling the red. The first highlight applied was slightly thinned down Blood Angel Orange. This was then lightened slightly with Sunburst Yellow and applied round the edges of the hard plates to create some sharp highlights.



BIEL-TAN

Biel-tan is renowned for the strong warrior ideals of its people. For the Eldar of Biel-tan the Way of the Warrior, the life stage encompassing the Aspect Warriors, is considered the first step upon the Eldar Path.

Guardians from the Biel-tan Craftworld have a predominantly white colour scheme. I like to make this a slightly off-white colour which, with ivory coloured shading, gives the miniatures a warmer look. I find that the best way to paint this colour is to apply a base coat of thinned-down Orc Brown over a white undercoat. This runs into the recesses and provides the shading. When the base coat is dry, I mix up some Skull White adding just a tiny spot of Orc Brown to take the edge off the white. This colour is applied over the entire surface of the model, only

leaving the base colour showing on the mesh armour and round the edges of the armour plates. Finally, pure white highlights are applied to the edges of the armour plates. The mesh armour is gently drybrushed with Skull White to emphasise the texture.

The colour of the helmet varies from host to host, but in general I like to paint this green, to provide an effective contrast with the white. A base coat of Ork Flesh is highlighted with Striking Scorpion Green and Sunburst Yellow. This combination gives a good, rich green.

The heart symbol is part of this Craftworld's rune. As a common form of decoration on all the Craftworld troops, it can be applied to any part of the Guardian armour.



IYANDEN

Iyanden was once the largest of all the Eldar Craftworlds, until it became the scene of the Eldar's first encounter with the Tyranids. Hive fleet Kraken launched wave after wave of attack on the Eldar Craftworld. Each wave was beaten off, but only at the cost of thousands of Eldar lives. Iyanden is now a shadow of its former self, and much of the huge ship lies empty.

The main colour of the Iyanden Craftworld is a yellowy bone. This is applied to the uniforms of the Guardian as well as vehicles and heavy weapons. When painting Iyanden Guardians, the easiest way to achieve an effective base colour is with ink. I mix up some brown and yellow ink and apply this to the whole miniature. The white base coat shows through and the end result is a deep bone

colour, with fairly dark shading. When the ink is fully dry I highlight the miniature, first with a mix of Snakebite Leather and Bleached Bone and then with Bleached Bone and Skull White. This gives a very effective bone colour.

As this tone is fairly yellow, one of the most effective colours to paint the helmets is rich blue, this gives the maximum contrast. The base colour is a mix of Moody Blue and Enchanted Blue and this is highlighted with Enchanted Blue and Skull White.

As most of the Guardian colour schemes are mainly two colour, it's good to introduce a third colour for picking out the details and making the model brighter. In the case of Iyanden, I've chosen red as the contrast colour.



PLAGUE FLEET

SKAVEN BOXED SETS

MAN O' WAR



SKAVEN DEATHBURNERS

Models supplied unpainted

Box contains 3 Skaven Deathburners and a sheet of full-colour sails

Inspired by the fiendish plans of the Council of Thirteen, vast Skaven fleets spread corruption, destruction and pestilence across the seas of the Old World. As the paddle-driven vessels cut the fetid water, their mutated crews man huge warpfire throwers that spew forth flaming death, and the apocalyptic tolling of the Great Bell of Doom sounds across the waves.



WARNING! This product contains lead which may be harmful if chewed or swallowed. Citadel Miniatures are not recommended for children under 14 years of age.

Games Workshop and Citadel are registered trademarks of Games Workshop Ltd. Man O' War and Plague Fleet are trademarks of Games Workshop Ltd. © Copyright Games Workshop Ltd 1994. All rights reserved.

MAN O' WAR



SKAVEN DOOMBRINGER

Model supplied unpainted

Box contains 1 Skaven Doombringer and a sheet of full-colour sails

MAN O' WAR



SKAVEN WARP-RAIDERS

Models supplied unpainted

Box contains 3 Skaven Warp-Raiders and a sheet of full-colour sails

All miniatures supplied unpainted

GAMES
WORKSHOP®



ARKHAN THE BLACK

THE LICHE KING

By Jervis Johnson

ARKHAN THE BLACK

Cost for Arkhan the Black 210 points

+50 points Staff of Damnation

+50 points Tomb Blade of Arkhan

+25 points The Cursed Book

Your army may include Arkhan the Black. He may lead the army if you wish, though he does not have to. If you choose to use him to lead the army then he replaces the general described in the main army list.

Arkhan was the first and most loyal of Nagash's followers. He grew up with Nagash in the ancient city of Khemri and was the first person apart from Nagash to partake of the elixir which granted Nagash and his followers eternal life. A powerful wizard in his own right, Arkhan came to be Nagash's right hand man. He helped lead the coup which first brought Nagash to power. When the Priest Kings formed an alliance to attack Nagash, Arkhan was Nagash's principle lieutenant in the many battles that followed. He led many armies and fought numerous battles against Nagash's enemies, and was never once defeated in open battle.



In the end, however, the sheer numbers of the Priest Kings' armies proved too much for Nagash's forces, and they were forced to retreat to Khemri where they were besieged. When Nagash's capital city finally fell to the Priest Kings' armies, Arkhan led a suicidal counter-attack which gave Nagash the opportunity to escape. Arkhan and his bodyguard fought to the last man, hopelessly outnumbered and surrounded on all sides. When the last of his bodyguard was slain Arkhan fought on alone for over an hour, standing atop a growing pile of bodies.

Arkhan finally fell, not to a hero's sword, but to a single spear hurled by an unknown soldier. Arkhan stared in

horror at the spear shaft that had pierced his heart, and then slumped to the ground and died. Within seconds his body had become a blackened skeleton. The Priest Kings buried Arkhan under a rough cairn of stones along with those he had slain. He was the only foe they honoured in this way. The rest of Nagash's followers were beheaded and burnt, and their ashes scattered to the winds. For generations Arkhan's body laid under this cairn of stones, long forgotten by all but Nagash.

But Nagash did not forget his most able lieutenant, or that he had died so that Nagash could escape. While Arkhan rested in his rough stone tomb, Nagash built a mighty Undead empire and returned to finally defeat the Priest Kings and their followers. Once the Priest Kings were defeated Nagash cast an immensely powerful Necromantic spell which woke all of the dead warriors that lay in the Priest Kings' realm. When the spell was cast Arkhan was reborn. With a mighty roar he hurled aside the stones of the cairn and stood once more, both less and more than he had been in life. Arkhan had become the first of the creatures known as the Dark Lords of Nagash. These fell beings were in ancient times the foremost of Nagash's captains and apprentices and the most feared hunters of his enemies, and still walk the world bringing despair to the living.

When Nagash was defeated by the last surviving Priest King Alcadizaar just hours after casting the great spell, Arkhan gathered a vast Undead army from those creatures that had been awakened by Nagash's spell. Determined to wreak revenge on all living creatures for the destruction of his Lord and master, Arkhan turned south towards the nearest living opponents he could find. For generations Arkhan and the Undead host under his command battered the kingdoms of Araby, in what the Arabian chroniclers came to call the Wars of Death.

Arkhan and his army inhabited the desert wastes that surround the lands of Araby, uncaring of the sweltering heat and total lack of water which would have destroyed any living army. From here they would swoop on an unsuspecting Arabian city, destroy it and burn it to the ground, and disappear back to the desert from whence they had come. When Nagash was finally reborn, Arkhan turned his army about and marched north to rejoin him and resume his position as his chief lieutenant and second in command. From that day until this Arkhan has remained Nagash's most able and trusted general, leading Nagash's Undead legions against many opponents.

ARKHAN THE BLACK THE LICHE KING



ARKHAN THE BLACK

Awakened by the most powerful necromancy that Nagash could unleash, Arkhan the Black – the Liche King, stood alongside Nagash as his most trusted and able lieutenant, both in life and now after death.

Standing astride his huge chariot, the Liche King musters his forces in a most diabolical manner. As he strikes down his foes with the dread Tomb Blade, their very flesh and bones arise once more to join his undead host.

At the head of this vast army, Arkhan spreads terror and fear across the realms of the Old World.



GREAT BANNER OF DEATH

THE LICHE KING'S MIGHTY CHARIOT



ARKHAN THE BLACK

PROFILE	M	WS	BS	S	T	W	I	A	Ld
Arkhan the Black	4	5	0	4	5	4	5	3	8
Arkhan's Chariot	-	4	-	6	6	3	-	D6	-
Skeletal Steed	8	2	3	3	3	1	2	1	5

WEAPONS/ARMOUR: Arkhan the Black is armed with a sword, staff and ride into battle in a huge Undead Chariot.

MAGIC ITEMS: Arkhan may take up to three magic items in total. Usually he carries the Staff of Damnation, The Cursed Book, and the Tomb Blade of Arkhan. The magic cards for these items are included in this book (The Cursed Book) and in Warhammer Battle Magic (Staff of Damnation and the Tomb Blade of Arkhan), and the rules are summarised below for your convenience.

THE TOMB BLADE OF ARKHAN

Whenever a creature with only 1 wound is killed by the Tomb Blade the slain model is removed and replaced with a Skeleton warrior (mounted on a skeletal steed if it was mounted on a steed before). The Skeletons raised in this way form a new unit with Arkhan as the unit leader and have the standard profile given for Skeleton warriors. Each time another foe is slain an additional Skeleton is added to the unit. Heroes and other creatures with more than 1 wound are never raised as Skeletons.

THE STAFF OF DAMNATION

The Staff contains a spell that can be used to invigorate every friendly Undead unit within 36" of the caster in the magic phase. Each unit can take one of the following extra



actions immediately, even though it is out of normal sequence: charge, march move, fight a round of hand-to-hand combat, or shoot with missile weapons. Note that these effects are the same as Vanhels Danse Macabre, except that several units may be affected rather than just one. The notes in the rulebook pertaining to this spell also apply. Roll a D6 each time Arkhan uses the staff. On a roll of 1 or 2 its energy is exhausted and it cannot be used again.

THE CURSED BOOK

The Cursed Book contains the writings of Har-Ak-Iman, a vile Arabian Necromancer who is said to have been the most evil and depraved man who ever lived. The book is written on human skin and in human blood. It radiates an aura of pure evil that will affect any living creature within 6". Affected models are so overcome with a feeling of dread that they shiver and shake, and suffer a -1 modifier to all their hit rolls with ranged weapons or in hand-to-hand combat.

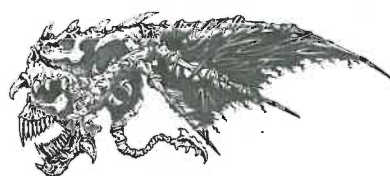

SPECIAL RULES

Arkhan is one of the Dark Lords of Nagash. He is an independent character and does not have to lead or be part of a unit. The Dark Lords may use any of the magic item cards that are normally only available to Liches, Vampires or Necromancers. In addition, the following special rules apply to Arkhan.

IMMUNE TO PSYCHOLOGY

Arkhan is not affected by psychology. He is immune to fear, terror, panic and all other psychology tests.

TERROR

Arkhan is a huge and frightening monster who causes *terror* as described in the Psychology section of the Warhammer rulebook. Remember that creatures that cause terror also cause *fear*.

ARKHAN'S CHARIOT

Arkhan's chariot is very special, even by the unholy standards of the chariots used by Undead armies. It is made from the carcass of a slain manticore, and has a special profile which is higher than the profile of a normal Undead chariot (see the Undead chariot rules in the forthcoming Warhammer Armies Undead). The head of the manticore is part of the yoke of the chariot, and snaps and bites when the chariot is in combat. To represent this the head is allowed to make one attack in hand-to-hand combat with a Weapon Skill of 4 and a Strength of 6. This attack is in addition to the D6 hits the chariot causes when it charges into combat.

FLY

Arkhan's Chariot can *fly* as described in the Warhammer rulebook. The chariot can fly even if all of the skeletal steeds that pull it are destroyed, as it is the wings of the dead manticore that allow it to fly.

GOLDEN '94 DEMON '94

THE 7th INTERNATIONAL CITADEL MINIATURES
PAINTING CHAMPIONSHIPS

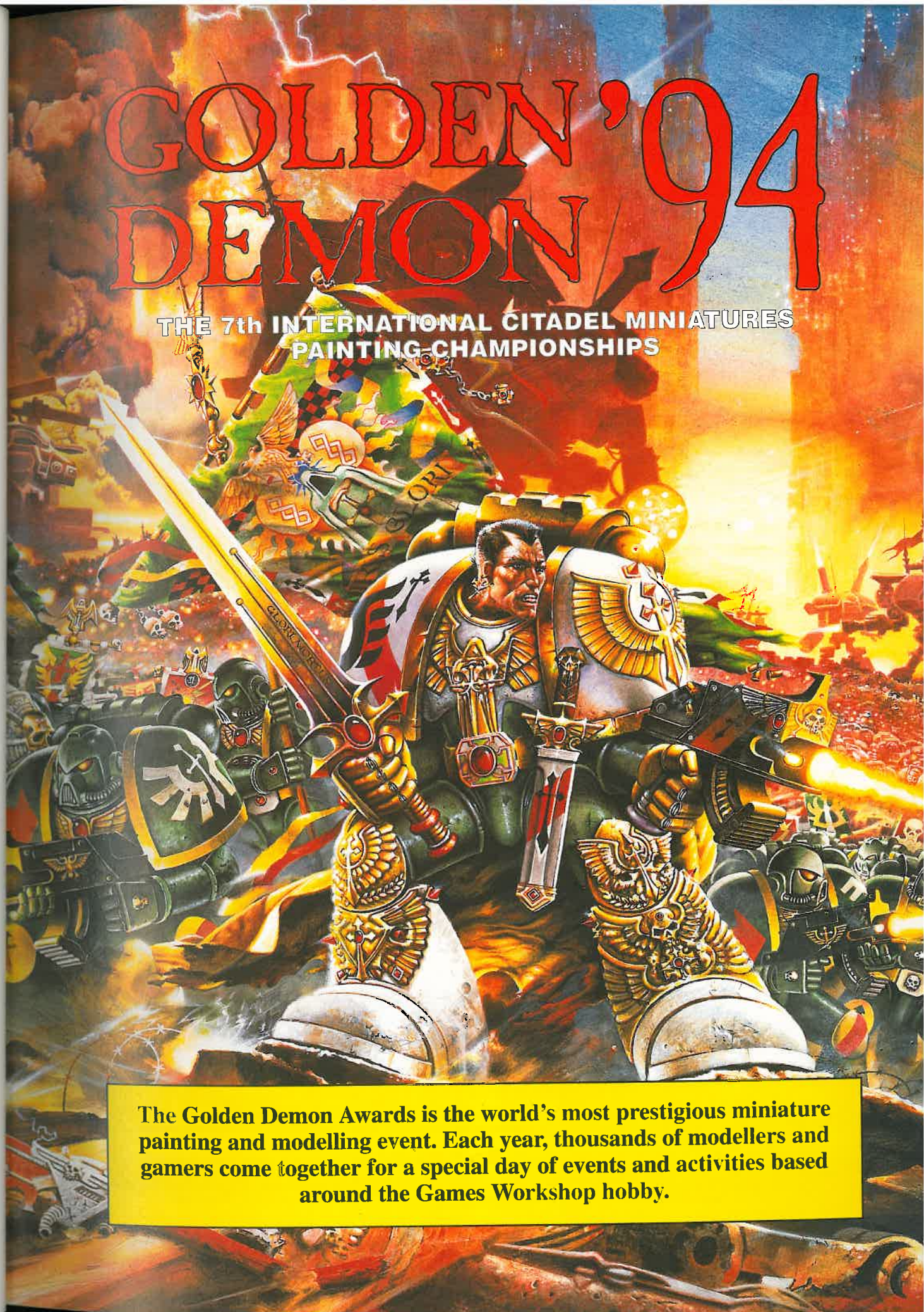

The Golden Demon Awards is the world's most prestigious miniature painting and modelling event. Each year, thousands of modellers and gamers come together for a special day of events and activities based around the Games Workshop hobby.

GOLDEN '94 DEMON 94

THE 7th INTERNATIONAL CITADEL MINIATURES PAINTING CHAMPIONSHIPS

Each year, the Golden Demon Awards bring together the best miniature painters and modellers in the world in a challenging competition designed to test their skills to the limit. On these pages we present a full set of categories for next year's competition. You can enter as many categories as you wish, So pop into your nearest Games Workshop Store, pick up a free entry form and get painting those miniatures. This year it could be your turn to win a prize!



1994 GOLDEN DEMON AWARD CATEGORIES

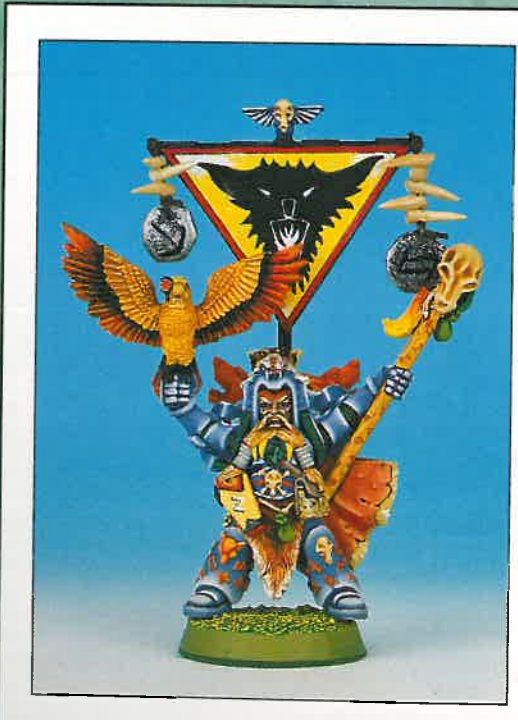

- 1. Best Warhammer 40,000 Miniature**
Any single Warhammer 40,000 miniature on a standard round slottabase.
- 2. Best Warhammer 40,000 Squad**
This category is for the best Warhammer 40,000 squad chosen from the Squads section of the Codex army lists. Note: Space Marine squads must be full ten-man squads and not five-man combat squads. Other races may be chosen within the army list parameters (eg: Striking Scorpions 5 models, Dark Reapers 3 models, Death Skull Mob 5-20 models, Snotling Herd 2-10 bases plus Runtherd, Genestealers 5 models etc). All models must be presented on standard slottabases.
- 3. Best Warhammer 40,000 Vehicle**
This category is open to a single Warhammer 40,000 vehicle or Dreadnought model.

WARHAMMER®

4. Best Warhammer Single Miniature

This category is open to single Warhammer miniatures on standard gaming slottabases up to 25mm x 50mm maximum size (cavalry base) ie: not models on 40mm x 40mm bases.

5. Best Warhammer Commanders

Entries for this category consist of any four Warhammer miniatures on their standard slottabases (25mm x 50mm maximum size as for single miniatures). Your entry must include **four** of the following five models for any one army: an Army General, an Army Standard Bearer, a Regimental Musician, a Regimental Champion or a Wizard.

6. Best Warhammer Monster

This category is open to all Warhammer monsters on 40mm x 40mm standard slottabases. You may include a rider if you wish. Eg: Orc Wyvern, Chaos Dwarf Bull Taurus, Ogre etc.



SPACE MARINE®

7. Best Epic Model

This category includes either a single model of a Titan or a Gargant or a unit of up to three Super Heavy Vehicles or Chaos Daemon War Engines.





8. BATTLE SCENE

Entries for this category must consist of a battle scene from either Warhammer 40,000, Warhammer or Space Marine. The entire display must not be larger than 20cm x 20cm and the maximum permitted height is 30cm.

The model should have at least two miniatures arranged in a combat scene but otherwise there is no restriction on theme or content.

GOLDEN DEMON COMPETITIONS

This year, as well as the Golden Demon Awards, we will be holding two additional competitions.

9. YOUNG BLOODS COMPETITION



Entries for this category consist of any single plastic miniature.

The Young Bloods category is open to competitors aged 14 or under.

10. SPACE MARINE CHAPTER DESIGN COMPETITION

This category consists of a single Warhammer 40,000 Space Marine miniature painted in a new Chapter colour scheme designed by the entrant.

The judges will be looking for original and imaginative ideas rather than brilliantly painted models, although clean, neat painting will help to show your ideas in the best light.

The winning design in this category will be used by the Studio miniature painters to create a new Chapter of Space Marines, which will then be featured in White Dwarf.

COMPETITORS GUIDELINES

All entries must be Citadel or Marauder miniatures.

All single miniatures must be mounted on the appropriate gaming bases. To help the judges compare the entries, we prefer these to be painted green.

Conversions are allowed, but must adhere to the atmosphere of the game world and spirit of the miniatures.

The judges will be looking for well-painted miniatures that adhere to the imagery and ethos of Games Workshop's fantasy universes.

All entries to the 1994 competition must be personally handed in at a Games Workshop Store. No postal entries will be accepted.

The greatest care will be taken with all competitors' entries, but Games Workshop can accept no responsibility for models that are accidentally damaged or broken in transit.

Entry into the competition gives Games Workshop the right to display, photograph and publish any entry as they see fit. The judges' decision is final and no correspondence will be entered into.

GOLDEN '94 DEMON

The Golden Demon Awards is the world's most prestigious miniature painting and modelling event. Each year, thousands of modellers and gamers come together for a special day of events and activities based around the Games Workshop hobby.

The 1994 event, will be the biggest games and miniatures convention we have ever organised. As well as the painting competition, The Golden Demon Awards will be the host to a whole series of events and competitions with loads of special prizes.

THE SPACE MARINE CHAMPION TROPHY

This year's Golden Demon Awards will combine all the most exciting aspects of the Games Workshop hobby into a single event.

First and foremost there will be thousands of wonderfully painted miniatures on display. As well as all of the usual **Golden Demon Awards**, this year for the first time we will be awarding the **Space Marine Champion Trophy**.

This magnificent bronze Space Marine trophy will be awarded to the Games Workshop Store whose staff produce the very best painted squad of Space Marines. The trophy will then be inscribed and retained by the store until the following year's competition.

GAMING EVENTS

All day long, you'll be able to join in with games of Warhammer 40,000, Space Marine, Warhammer, and Man O' War. Everything is provided and all you have to do is turn up at the tables and play. At the end of the day we'll also be giving a special prize known as the **Demon General Award**. This will be given to the gamer who, in the opinion of the judges, displays not only the most tactical skill, but also shows a fun, friendly approach to gaming.

Over the years, the format of both Games Day and the Golden Demon Awards has evolved so that each year we include more events and displays than ever before.

One of the events that we've run at both Games Day and the Golden Demon Awards is the Speed Painting competition. For those of you who have never been to a Games Workshop event before, Speed Painting involves painting a Citadel Miniature quickly and often under the most unreasonable conditions (Martin Perkins succeeded

blindfolded last year!). It's become a hilarious part of every event and this year we have decided to award the special **Speed Freck** prize to the most accomplished speed painter, so get practising.

The imagination and attention to detail that has gone into the production of the Retail Store banners has become almost an art in itself. As perusal each store will be bringing its own banner to the event for the final victory parade. Your chance to shout and scream for your shop.

We've also noticed that increasing numbers of people have been coming along to our events dressed as characters from the Warhammer and Warhammer 40,000 universes. This year we've decided to pick out the best costume for a special prize so lets see as many of them as possible.

REGULAR ATTRACTIONS

In addition to the above, the Golden Demon Awards will showcase all of our regular attractions. The Games Designers, White Dwarf team and other Studio staff will be on hand to answer your questions or chat about what's new in our hobby. Many of you also enjoyed the display games that were such a feature of Games Day. These provided the opportunity to see the painted armies featured each month in White Dwarf battle it out over stunning terrain created by modelling experts Adrian Wild and Tom Lauten.

The massive Games Workshop retail stands will be there with all of the latest games and miniatures, together with dozens of back issues of White Dwarf and special deals for the day.

More than this, whether you're a seasoned veteran, or new to the hobby, the Golden Demon Awards provides the opportunity for everyone to get together and spend a fun day devoted to games and miniatures.

See you there!

WARHAMMER

SKAVEN MONSTERS AND CHARACTERS

by Andy Chambers

VERMIN LORD - DAEMON OF THE HORNED RAT

600 Points

The Vermin Lords are thought to be the daemonic forms of ancient Lords of Decay, warped by the influence of the Horned Rat into his immortal servants. They are great, powerful creatures surrounded by an aura of creeping decay and inscrutable knowledge. Their heads are bedecked with the spiralling horns and sloughing flesh of the Horned Rat himself. Warpstone amulets and torcs decorate the Vermin Lord's leprous form, along with chunks of raw warpstone hammered into their flesh. Vermin Lords are often seen armed with huge, wicked-



looking glaives that are fully twice the height of a man but their chisel-teeth and sharp claws are easily capable of tearing a creature to pieces.

Only the Grey Seers hold the keys to summon the Vermin Lords into the material world, and they are loath to do so without great need, fearing to summon up what they cannot dismiss. A Vermin Lord is wiser and more wicked than any living Skaven and yet retains its mortal lust for power and love of betrayal. A bargain struck with one of the Vermin Lords will bring great power to the supplicant but will cost him dearly – the unwary can find themselves paying with their soul as well as their life.

SPECIAL RULES

GREATER DAEMON

All the special rules for daemons apply as described in the Warhammer rulebook (see pages 86-87). Note that the Vermin Lord has a saving throw of 4+ due to its daemonic aura.

TERROR!

The Vermin Lord is amongst the most terrifying of all monsters. The psychology rules for *terror* apply. Remember that monsters which cause *terror* automatically cause *fear* as well.

DOOM GLAIVE

The glaives wielded by the Vermin Lords are heavily ensorcelled with death magic. A hit from a Doom Glaive inflicts not 1 but D3 wounds.

SPELLS

Vermin Lords are well versed in the realms of magic and have a magic level of 4, equivalent to a Grey Seer. Vermin Lords may draw their spell cards from the Skaven spell deck (including the Grey Seer spells) and/or the Dark Magic spell deck.

Troop Type	M	WS	BS	S	T	W	I	A	Ld
VERMIN LORD	8	8	8	8	7	7	10	8	10



SKAVEN VERMIN LORD

Towering high over even the great Rat Ogres, a Vermin Lord is a sight to make even the most resolute enemy's blood run cold. Crowned with long twisted horns and surrounded by an aura of pestilence and decay, the Vermin Lord is considered to be the evil embodiment of the Great Horned Rat himself.



THE VERMIN LORD ATTACKS A WHITE WOLVES REGIMENT

RAT OGRES

Rat Ogres are the most feared of all of the Clan Moulder's mutant beasts. Rat Ogres are huge, Skaven-like creatures the size and strength of true Ogres but possessed of the speed and ferocity of Skaven. A Rat Ogre's small brain is devoted entirely to fighting and bloodshed so in battle units of Rat Ogres are controlled by Clan Moulder Packmasters who direct the monsters and unleash their devastating charges when the time is ripe.

SPECIAL RULES

FEAR

Rat Ogres are big, frightening blasphemies against nature which cause *fear* in other creatures. The psychological rules for fear therefore apply.

STUPIDITY

Being incredibly single-minded, Rat-Ogres that aren't in close combat are subject to the psychological rules for *stupidity*. However, as long as they are led by a Clan Moulder Packmaster or a Skaven character acting as Packmaster the Rat-Ogres don't have to think for themselves and don't suffer from stupidity.

Troop Type	M	WS	BS	S	T	W	I	A	Ld
RAT OGRE	6	4	0	5	5	3	5	2	5



LORD SKROLK, PLAGUELORD OF CLAN PESTILENS

225 points

Liber Bubonicus +75 points

Rod of Corruption +100 points

Your army may include Lord Skrolk, agent of one of the most infamous Lords of Decay, Arch-Plaguelord Nurglitch of Clan Pestilens. Lord Skrolk can be chosen either as an independent character or as the army General. If he is chosen as the army General he replaces the Skaven Warlord in the main army list. Your army must include at least one regiment of Plague Monks if you want to use Lord Skrolk.

Lord Skrolk is very old and unutterably evil. By the blessing of the Horned Rat, he has lived many times his ordinary span and unleashed unspeakable woes upon the world of men. At the beginning of his life Skrolk was a simple Plague Monk but his devotion to the Horned Rat drew him up the long struggle for power which eventually led him to



Skavenblight to offer his services to Nurglitch, the seventh Arch-Plaguelord. Nurglitch-who-is-seventh set him many long and arduous trials, including traversing the insanely dangerous Blindwyrms Labyrinth beneath Clan Pestilens' hold in Lustria. Success came to Skrolk in all things.

Lord Skrolk is a powerful warrior well capable of slaying any challengers to his position as the Arch-Plaguelord's favoured agent. Most fearsome of his weapons is the Rod of Corruption, a dreadful rod of spiderwood which can slay with a single touch. He also bears one of the sacred volumes of the Liber Bubonicus or Book of Woe, a magical tome which contains the secrets of every disease and plague in the world. Lord Skrolk has spent long centuries drawing together the alchemical and occult knowledge hidden in its pages to make himself a potent sorcerer steeped in the ways of death and decay.

Lord Skrolk is terrifying to look upon, his flesh has long since rotted into ragged tatters. He clawed out his own eyes at the sight of the radiant corruption of the Arch-Plaguelord, wishing to see no other creature after witnessing one so glorious. Now diabolic vitality burns through his limbs and by the blessing of the Horned Rat he sees the world again, but only as the purples and greens of corruption and decay. The noisome diseases which cling to Skrolk's putrescent body are so deadly that only his brother Plague Monks can approach him safely.

PROFILE	M	WS	BS	S	T	W	I	A	Ld
Lord Skrolk	5	6	4	4	5	3	7	4	7

WEAPONS/ARMOUR: Lord Skrolk wears no armour and carries for weapons only a plague censer and the Rod of Corruption.

MAGIC ITEMS: Lord Skrolk may carry up to three magic items in total but two of these will always be the Rod of Corruption and the Liber Bubonicus. The third item may be chosen freely from the Warhammer Battle Magic cards or the cards in the Warhammer Armies – Skaven book.

CLAN MOULDER RAT OGRES



CLAN MOULDER PACKMASTER

Clan Moulder has relatively few warriors but sends packs of its mutant beasts into battle. They are driven on by specially trained Packmasters, experts in plying the lash and goading their truculent beasts into combat. Rat Ogres are the most feared of all Clan Moulder's mutant beasts: huge, Skaven-like creatures the size and strength of true Ogres but possessed of the speed and ferocity of Skaven. A Rat Ogre's small brain is devoted entirely to fighting and bloodshed so in battle units of Rat Ogres are controlled by Clan Moulder Packmasters who direct the monsters and unleash their devastating charges when the time is ripe.



SPECIAL RULES

Frenzy

Like all Plague Monks Lord Skrolk is subject to the psychology rules for *frenzy*. This means he will always charge enemy within reach, being so fanatical that he won't hesitate to attack his foes immediately. When he is frenzied Lord Skrolk doubles his number of attacks so he will have eight attacks instead of four. Also, he must always pursue enemy who break and flee in combat. See the psychology rules in the Warhammer rulebook.

Terror!

Lord Skrolk is so utterly disgusting and fearsome-looking that the psychology rules for *terror* apply. This means he also causes *fear* as well. See the description of Terror in the Warhammer rulebook for full details.



Aura of Pestilence

The pestilential aura of Lord Skrolk is so potent that any models in base-to-base contact with him suffer a -1 penalty to their Weapon Skill, Bow Skill and Initiative. Members of Clan Pestilens are immune to this effect.

The Liber Bubonicus

The Liber Bubonicus gives Lord Skrolk the ability to cast spells as if he were a wizard champion, so he has a magic level of 2 and two spell cards. Lord Skrolk does not have to draw his spells at random, instead he can choose his spell cards from the following list:

Skaven spells: *Putrefy*, *Plague*, *Pestilent Breath*, *Wither*.

Chaos (Nurgle) spells: *Stream of Corruption*, *Miasma of Pestilence*, *Stench of Nurgle*.

Note. For the purposes of *Miasma of Pestilence* and *Stench of Nurgle* cast using the Liber Bubonicus, Lord Skrolk and members of Clan Pestilens are immune to these spells effects just like followers of Nurgle.

The Rod of Corruption

The Rod of Corruption thrums with the foul energies of pestilence and corruption, and for any creature other than Lord Skrolk to wield it would mean certain death. Whenever Skrolk hits with the Rod in hand-to-hand combat the victim must roll a D6 against their Toughness. If they roll higher than their Toughness (a roll of 6 is always a failure regardless of the victim's Toughness) then they instantly collapse into a festering pile of rotted flesh and excrement, quite quite dead. Normal armour does not

protect the victim from the Rod, though magic armour saves as normal. Roll for wounds and armour saves as normal if the victim passes its Toughness test.

Plague Censer

Lord Skrolk carries a plague censer which swings from the Rod of Corruption. He can choose to use either the plague censer or the Rod of Corruption in hand-to-hand combat, he may not use both at the same time. In combat the plague censer counts as a flail. In addition the swinging censer creates a fog of death in a 1" radius around Lord Skrolk. Roll a D6 for any models inside this area at the start of the hand-to-hand combat phase: if the roll is higher than the model's Toughness score the bubonic vapours inflict one wound on it with no armour saving throw possible. Skaven (including the Lord Skrolk) only suffer damage on a roll of 6.

WARLORD QUEEK HEAD-TAKER

138 points

Dwarf-Gouger +50 points

Warpstone Armour +50 points

You may include Warlord Queek Head-taker in your army as an independent character or the army General if you wish. If he is chosen as the army General he replaces the Skaven Warlord in the main army list, otherwise he may act independently and/or lead a unit as desired. Your army must include at least one regiment of Clanrat warriors if you want to use Warlord Queek.

Warlord Queek Head-taker is the right claw of Warlord Gnawdwell, the ruler of Clan Mors and the City of Pillars. Gnawdwell is one of the Lords of Decay and without doubt one of the most powerful Warlords in the Under-Empire. Warlord Gnawdwell has groomed Queek as his lieutenant since his birthing, supplying him with the best armour and weapons, protecting him from the other Lords of Decay



and staging attempted assassinations to keep Queek on his toes.

Warlord Queek has led several armies into battle against the Dwarf strongholds of the Worlds Edge Mountains and against the notorious Night Goblin Warlord Skarsnik, who holds the upper levels of Karak Eight Peaks in an iron grip.

Queek has enjoyed considerable success in these forays to date, most notably in the Battle of the North Stair where he led Clan Mors warriors in a surprise raid on the unprepared Night Goblin guards through an old sewer outlet. The Clanrats quickly swarmed over the surprised Goblins, killing most of them and enslaving the rest. Warlord Queek personally slew the Night Goblin chief, shattering the Goblins' resistance and enhancing his own fearsome reputation in the process.

Queek's vitriolic temper and immense ego are well known amongst the Skaven and greatly admired. He takes the greatest pleasure in challenging opposing leaders and heroes to single combat and slaying them. The severed heads on Queek's trophy rack are kept as mementoes of the more challenging fights, making him an unmistakable sight on the battlefield – his collection includes the head of Krug Ironhand of Karak Drazh, Ikit Slash of Fester Spike and the hands of Albrecht Kraus.

The patronage of Warlord Gnawdwell means that Queek is very well equipped for a Warlord. He usually wears warpstone armour and carries Dwarf-Gouger, a potent ancient weapon forged long ago when the Skaven started their long and bitter wars with the Dwarfs of the Worlds Edge Mountains.

PROFILE	M	WS	BS	S	T	W	I	A	Ld
Warlord Queek	5	7	6	4	4	3	7	4	8

WEAPONS/ARMOUR: Queek wears heavy armour and carries two weapons, a sword and pick, giving him an additional attack for a total of 5 attacks.

MAGIC ITEMS: Queek may carry up to four magic items in total but the first magic item he chooses must be Dwarf-Gouger and the second must be warpstone armour. The third and fourth items may be chosen freely from the Warhammer Battle Magic cards or the cards in the Warhammer Armies – Skaven book.



SPECIAL RULES

Hatred

Warlord Queek is quick to anger and develops a deeply psychotic hatred of anyone and anything that stands in his way. Dwarfs, Orcs and Goblins stand in his way a lot – so he hates them all! See the Psychology rules for the effects of hatred, but remember that Warlord Queek only hates Dwarfs, Orcs and Goblins.

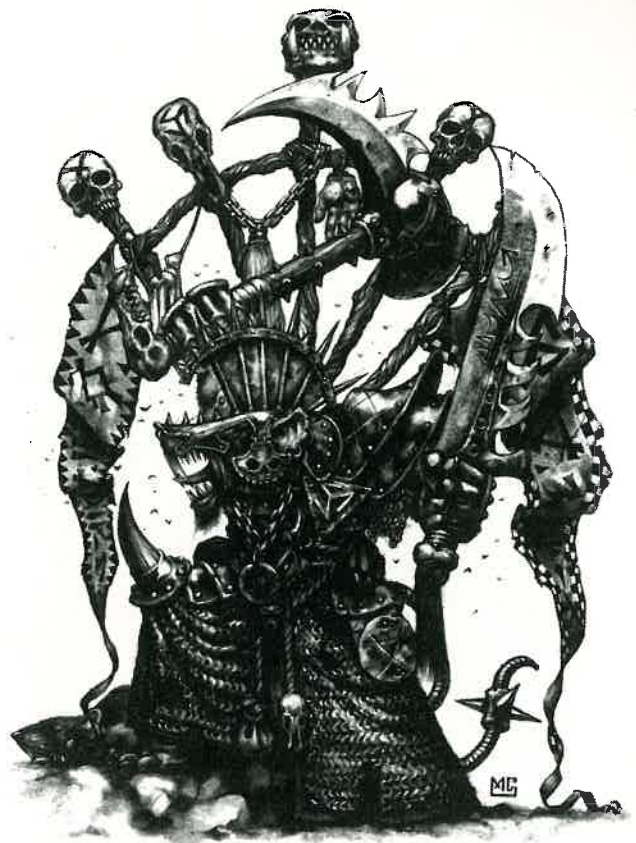

Challenge

Queek is supremely confident in his own capabilities. Whenever Warlord Queek is in hand-to-hand combat he will always issue a Challenge to single combat against any enemy characters, whether you want him to or not (see page 66 of the Warhammer rulebook for more details on Challenges). When Queek is fighting in a challenge he fights with the fury of the deeply conceited so he always adds +1 to his hit roll and +1 to his roll to wound.

Dwarf-Gouger

Dwarf-Gouger is a wicked Skaven weapon dating back to their early history when the Skaven battled relentlessly against the Dwarfs in the Worlds Edge Mountains. When Queek is wielding Dwarf-Gouger he rolls to hit and wound as normal. Wounds inflicted have an extra -3 saving throw modifier, any unsaved wounds inflict double damage, eg. 2 wounds. If the target only has 1 wound and is killed by one hit the extra wound is wasted. The weapon is enchanted to be especially deadly to Dwarfs, so it always wounds them on a 2+ in addition to the effects noted above.

Warpstone Armour

Queek often wears magical armour made of metal mixed with warpstone and inscribed with runes to draw the malign influence of the Horned Rat around the wearer. Warpstone armour gives a saving throw of 4, 5 or 6 on a D6 which is not reduced by saving throw modifiers. For every hit saved in hand-to-hand combat the baneful energies of the armour will inflict a S3 hit against the model which struck the blow.

GAMES WORKSHOP

AUSTRALIA



**ANNOUNCE THE OPENING OF OUR
FIRST TWO STORES IN SYDNEY
NOW OPEN SEVEN DAYS A WEEK!**

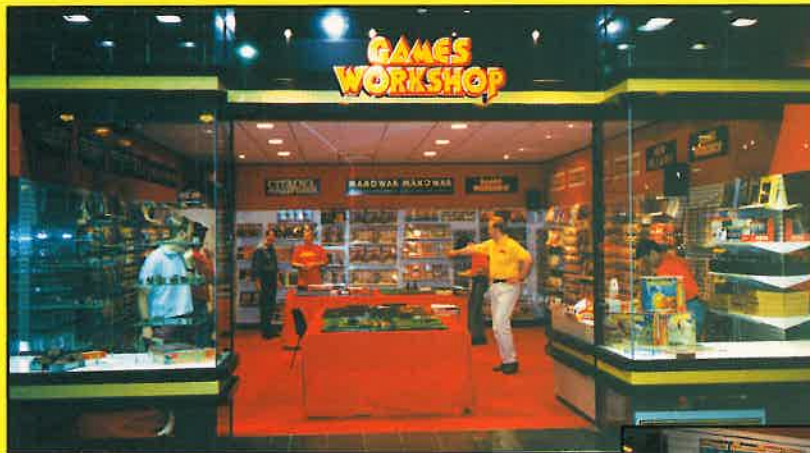

Australia's first ever Games Workshop Store is on the 4th floor, by the food court at:

**Westfield Shoppingtown
Chatswood
Sydney**

Tel: (02) 415 3968

Opening Times:

Mon-Wed	9.00 - 5.30
Thursday	9.00 - 9.00
Friday	9.00 - 5.30
Saturday	9.00 - 4.00
Sunday	10.00 - 4.00

Our brand new store, right in the heart of Sydney is:

**Shop G05, City Centre Mall, Market St,
Sydney (Pitt Street entrance).**

Tel: (02) 267 6020

Opening Times:

Mon-Wed	9.00 - 6.00
Thursday	9.00 - 9.00
Friday	9.00 - 6.00
Saturday	9.00 - 4.00
Sunday	10.00 - 4.00



Our Stores

Like every Games Workshop Store we carry a huge range of Citadel Miniatures and all of the Games Workshop games. We have friendly store staff who run regular in-store gaming sessions, special events and miniature painting sessions. Every Thursday night is Games Night, where you can come along and join in with a game of Warhammer, Warhammer 40,000, Man O' War or Space Marine.

Our Staff

Andy is our miniature painting expert and a keen *Space Marine* gamer.

Tim is a *Warhammer* specialist who'll be more than happy to chat about collecting an army.

TQ is a complete *Warhammer 40,000* nut!

Gavin is another *Warhammer* expert who can advise on tactics for the different races.

Pete is our other resident *Warhammer 40,000* general.

WARHAMMER

40,000

BATTLE BUNKER

Fortifications in Warhammer 40,000

By Jervis Johnson

Massively built armoured strongpoints dominate whole sectors of the bloody battlefields of the 41st millennium. Concealed behind a Battle Bunker's armoured walls, a handful of troops can easily hold off all but the most determined of enemy assaults.

INTRODUCTION

The battlefields of the 41st Millennium are dangerous places where death lurks in many forms and can strike at any moment. In order to protect themselves troops will often build fortifications, especially if they have to defend the same position for a long period of time. Many types of battlefield fortification have been constructed over the centuries, both to provide protection for the defending troops or to hamper and disorganise the attacking forces. Of these the Battle Bunker is one of the most popular and commonly used of all defensive fortifications. The following rules allow you to use such bunkers in Warhammer 40,000, and will provide you with a new and exciting set of tactical problems to face.

PREPARING FOR BATTLE

Once you have constructed your Battle Bunker you can use it in a game. Unlike other buildings, Battle Bunkers are purchased as part of your army. Each Battle Bunker costs 50 points, which count against the number of points you can spend on Support Troops for your army. Any force may use Battle Bunkers – even if they don't build them, they can capture them as they advance and make use of them in defence later. A datafax for the Battle Bunker is included in this issue which you can either cut out or photocopy for use in your games of Warhammer 40,000.

Bunkers are immobile fortifications that take some time to construct, and if you use one or more in a battle then your



BATTLE BUNKER

opponent would certainly know where they were before he deployed his troops. To represent this fact, bunkers must be set up before *either* army is deployed. If you are playing a pre-planned scenario like the one included at the end of this article then this is not a problem, as the locations of the Battle Bunkers are included on the deployment map. If you are playing a game to a set point value then you will need to use the following sequence of play when you are setting up the game:

1. Select forces to a pre-determined points value. If you want to use any bunkers they must be chosen at this point and included in your points cost.
2. **Set up the terrain for the game.** Each player rolls a D6 and the one with the highest score can pick which deployment zone he will use.
3. **Deploy Battle Bunkers.** If both players have bunkers then the player with the lower strategy rating must deploy his first. Bunkers may be deployed on any level ground within your deployment zone. It is permissible to remove *small* pieces of terrain such as rocks or low bushes in order to make room for the bunker on the table, as construction troops could have cleared away such items as they built the bunker. Major items of terrain such as hills, rivers, woods or buildings may not be removed. Bunkers may not be set up in difficult terrain or on top of obstacles or other buildings.
4. Take Mission cards.
5. Deploy forces. The player with the lower strategy rating must deploy his forces first.
6. Start the first turn of the game...

You will probably already have noticed that bunkers are deployed *before* Mission cards are selected, this is so you can

use the Bunker Assault and Hold The Line Mission cards if either side has deployed any bunkers. These new cards are used to represent the fact that if there are bunkers in the battlezone there is a fairly good chance that one side's main objective will be either to destroy or capture them, while the other side are likely to have orders to hold them at all costs!



The Bunker Assault and Hold the Line Mission cards are included with this article and you can either cut them out or photocopy them for use in your own Warhammer 40,000 battles. If your opponent has used any bunkers then you may include the Bunker Assault card with the other Mission cards from Warhammer 40,000 when you decide which mission you must perform. If you have included a bunker in your own army then you may use the Hold The Line mission card. If both you and your opponent are using bunkers then you may include both of the new cards.

BUNKER FLOORPLAN

Photocopy or cut-out your bunker template to keep track of the position of your models inside your Battle Bunker.

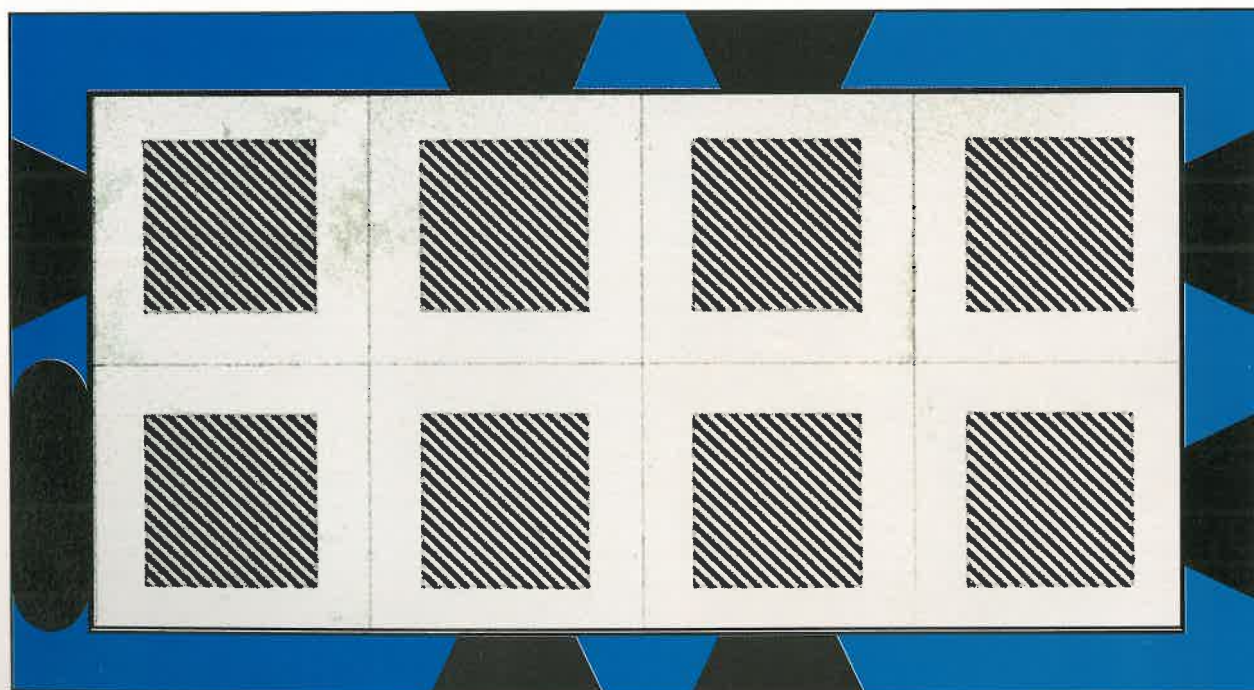

MOVING INTO OR OUT OF A BUNKER

Normally troops may only enter a Battle Bunker through the steel door in the side wall of the bunker. Only models that are physically small enough to fit through the door may enter the bunker, which means that large models such as Dreadnoughts, Tyranids and Ogryns may not enter the building. A maximum of eight models will fit inside the bunker, and any number of models may enter or leave the bunker in the same turn. We've included a floor plan of the inside of the bunker for you to use to keep track of the position of any models inside the bunker. Moving a square on the floor plan costs the model 1" of its movement, so a model with a movement of 4 could move 2" to the doorway of the bunker, and then move up to 2 squares on the floor plan.



Models that are inside the bunker are allowed to move through the trapdoor to the roof at the cost of their entire movement. Up to five models can be placed on the roof. Models that move to the roof may fire weapons and engage in hand-to-hand combat in the same turn, although models that enter hand-to-hand combat lose their charge bonus. The same rules are used for models moving from the roof back into the bunker. Models equipped with jump packs may attempt to leap onto the roof using the normal rules for moving with jump packs.

Models that are inside the bunker can deny access to any enemy models by the simple expedient of locking the doors. Therefore models that are outside the bunker may not enter if it is occupied by one or more enemy models. This restriction does not apply if the entrance the model wants to use has been destroyed earlier in the battle.

SUPPORT WEAPONS

Support weapons such as Rapiers, Tarantulas, Thudd Guns, Eldar Grav Support Platforms and Ork Hop Splat Guns or Squig Katapults may be set up on the roof of a bunker at the start of the game. This represents the weapon being dismantled on the ground and re-assembled on the roof of the bunker. Support weapons may not be moved to the roof of a bunker during the game, and those set up on the roof must remain there for the duration of the battle. Mole Mortars may not be set up on the roof of a bunker in this way! Support weapons may not be set up inside the bunker.

ATTACKING FROM THE BUNKER

Models that are inside the bunker are allowed to fire through the vision slits in the walls. A maximum of one model may fire through each vision slit. If you are using the floor plans of the bunker then a model must fire through the vision slit that is on the side of the square that they occupy. Any model firing through a vision slit has a limited line of sight, and so has its arc of fire restricted to a 90° arc straight through the vision slit (see the diagram). Models on the roof may shoot using the normal rules in the Warhammer 40,000 Rulebook.

BUNKER FIRE ARCS

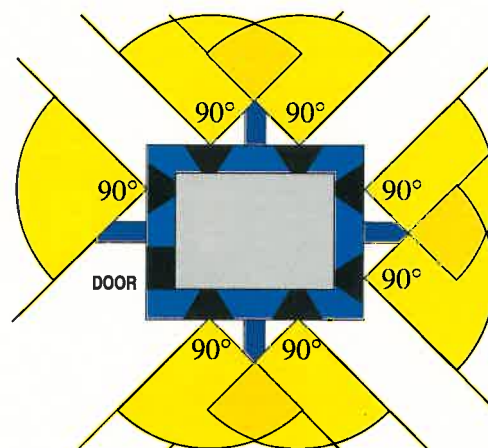

Models inside the Battle Bunker have their fire arcs limited by the size of the vision slits as shown above. This leaves blind spots at the corners which clever attackers will use to get close to the bunker. The Battle Bunker's commander must decide whether to station men on the roof with normal arcs of fire, but outside the bunker's armoured walls, in order to cover these lines of approach.

ATTACKING THE BUNKER

Models that shoot at the bunker may either attack the bunker itself or models that are on the roof. Note that models inside the bunker may not be attacked directly, even if they fired out of a vision slit in their previous turn. Models on the roof are attacked using the normal shooting rules. They receive the benefit of the -2 to hit modifier for being in hard cover.

Attacks made on the bunker benefit from the fact that it is a large stationary target and therefore very easy to hit with ranged attacks. To represent this, attacks that are made at long range count the bunker as a large target and receive a +1 modifier to their to hit rolls, while attacks made at short range hit the bunker automatically.

When the bunker is hit by a ranged attack, roll to see which area was hit and what damage was caused as you would if you were attacking a vehicle, using the Battle Bunker damage tables printed on the back of the Battle Bunker datafax. Unlike a vehicle, however, the bunker is only effected by attacks that score a direct hit. Weapons with a blast marker that are fired at models on the roof, or which scatter when attacking the bunker or another target nearby, will only effect models on the roof and will not cause any damage to the bunker itself. This represents the fact that the bunker is a very solidly built construction which will only be damaged by a direct hit - peripheral damage from area effect weapons may blow a few chunks off the bunker but won't cause any serious damage.

For the same reason, weapons with a blast marker that hit the bunker will only damage one location, chosen at random by rolling on the Battle Bunker damage table printed on the back



of the Battle Bunker datafax, although the blast marker will effect any models that are on the roof using the normal rules.

A Battle Bunker may also be attacked in the Hand-to-Hand Combat part of the turn in exactly the same way as you would attack a vehicle.

ATTACKING BUNKER DOORS AND VISION SLITS

Models that are within 6" of the side door, and have a clear line of sight to it, may shoot at the door. The attack hits the door automatically, no to hit roll is required, and the attacker does not have to roll on the hit location table. Armour penetration and damage are worked out using the normal rules. Models that are on the roof may choose to attack the trapdoor in the same way. The trapdoor has an armour value of 15 and uses the door damage table on the Battle Bunker's datafax.

If the door is destroyed, subsequent attacks that hit the door location will go through the doorway and hit one of the models inside the bunker. The attack hits a randomly chosen model causing damage using the normal Warhammer 40,000 rules.

Models within 6" of a destroyed doorway or trapdoor, or that are within 1" of a vision slit may choose to fire or throw grenades through the entrance or vision slit at a model inside the bunker. Roll to hit and wound the target model using the normal rules. (Don't forget to use the special rules for scatter and blast markers printed on page 89 of the Warhammer rules if you shoot or throw a weapon with a blast marker into the bunker in this way).

SPECIAL WEAPON RULES

Harlequins Kiss: A model armed with a harlequins kiss that is within 1" of a vision slit or open bunker door may use the weapon to attack any models inside the bunker. Roll on the harlequin kiss *Vehicle Crew Penetration Table* in the Wargear book to see what happens to any models inside the bunker.

Hand Flamers, Flamers & Heavy Flamers: The flames from these weapons will wash over the bunker and flow through any vision slits to affect the models inside. If a flamer is used to attack the bunker then it will *automatically* hit a vision slit. Roll a D6 for each model in the bunker, they are hit by the flamer on a roll of 3 or more. Note that flamers *do not* receive the strength bonus and save modifiers normally applied to weapons with a blast marker in a building.

Graviton Gun: If a graviton gun is used to attack a bunker it will *automatically* hit the the bunker and ignores armour penetration. Roll on the bunker damage table adding +1 to the dice score.

Distort Cannon: Roll a D6 if any part of the bunker falls under the Distort Area template. On a roll of 4, 5 or 6 the bunker and all of the models in or on it are affected by the distort cannon. Make *one* distort test to see what happens to the bunker and its occupants.

Mole Mortars: If a mole mortar is used to attack a bunker, then roll on the following table instead of the Mole Mortar Accuracy table printed in the Wargear book:

MOLE MORTAR DAMAGE TABLE

D6	EFFECT
1	Off Target. Randomly determine scatter as normal and then reroll on the Mole Mortar Accuracy Table in the Wargear book.
2-5	No Effect. The missile is stopped by the bunker's plasteel floor and has no effect.
6	Cave In! The torpedo explodes under the bunker and blasts out a deep crater which the bunker collapses into. The bunker and all models in or on it are destroyed. Remove the bunker model and replace it with a crater.

Only direct hits by a mole mortar that cause a cave in will damage a bunker. If a mole mortar torpedo scatters or explodes near the bunker and creates a crater, then the crater will *not* damage the bunker.



Choke, Hallucinogen, Scare, Toxin: The gas from these weapons will seep through any vision slits into the bunker. If a vision slit on a bunker falls under the blast marker template for the grenade then roll a D6 for each model inside. On a roll of 3, 4, 5 or 6 then the model is effected by the grenade as described in the Wargear book.

Photon Flash Flare: Photon flash flares that go off outside a bunker will not affect any models inside the bunker. If the flare goes off inside the bunker then it automatically effects any models in the bunker, and +1 is added to the dice roll on the Flash Effect table printed in the Wargear book.

WARHAMMER

40,000

SPACE MARINE RHINO



Model supplied unpainted. Banners not included.

THE SPACE MARINE RHINO BOX SET CONTAINS:

One complete Rhino model kit consisting of:
 2 Rhino track sprues
 2 Rhino chassis sprues
 Blood Angels, Dark Angels, Ultramarines and Space Wolves transfer sheets to allow you to detail your Rhino model in the Chapter markings of your choice.

The Rhino is the imperium's most versatile armoured personnel carrier, able to smash through the front line and strike deep into enemy territory. Protected within its armoured hull Space Marine squads can charge straight into battle, scattering their foes before them, whilst the Rhino lays down a hail of fire from its twin-mounted boltguns.



**INCLUDES
FOUR
SPACE MARINE
TRANSFER
SHEETS**

This is a multi-part plastic kit which requires a degree of modelling skill to assemble.

The Citadel castle, the Games Workshop logo, Warhammer 40,000 and Space Marine are registered trademarks of Games Workshop Ltd. Citadel and Games Workshop are trademarks of Games Workshop Ltd.
 © Games Workshop Ltd. 1994. All rights reserved.

**GAMES
WORKSHOP**



To assemble your Mission cards first copy or cut them from this page and fold each in half along the dotted line. Spread a thin layer of glue across the back of each card and press their two halves firmly together. If you want to make them a little more hard wearing, it's a good idea to insert a thin layer of cardboard (cereal packet is ideal) between the two halves before you glue them together.

HOLD THE LINE

Your troops are occupying a vitally important section of the front line, which has been heavily fortified to stop it falling into enemy hands. You must hold your positions against any and all enemy attacks until you are relieved.

Primary Objective

In addition to victory points gained for destroying enemy forces you receive the following bonus victory points for holding off enemy forces.

If there are no enemy squads with greater than half of their starting strength, or undamaged enemy vehicles in your half of the table at the end of the game: +5 victory points

Secondary Objective

In addition to the points for completing your primary objective you receive the following points for keeping control of your bunkers.

For each bunker that has at least one of your models in it and no enemy models: +1 victory point

Note: In order to satisfy the second victory condition the models must be inside the bunker; models that are on the roof do not count.

BUNKER ASSAULT

Patrols have identified several bunkers just inside enemy lines. The importance of these strategic installations cannot be over-stated. You have been ordered to lead your forces in a raid to capture the enemy bunkers in your sector. Any bunkers that cannot be captured must be destroyed.

Primary Objective

In addition to victory points gained for destroying enemy forces you receive the following bonus victory points for capturing enemy bunkers.

For each bunker that has at least one of your models in it and no enemy models: +5 victory points

Secondary Objective

In addition to the points for completing your primary objective you receive the following points for destroying enemy bunkers.

For each bunker that is destroyed: +3 victory points

Special Rule

If either or both players have taken the Bunker Assault mission, then the game lasts for six turns rather than the normal four turns.

MISSION
CARD



MISSION
CARD



To assemble your datafax first copy or cut out the card from this page and fold it in half along the dotted line. Spread a thin layer of glue across the back of the card and press the two halves firmly together. If you want to make your card a little more hard wearing, it's a good idea to insert a thin layer of cardboard (cereal packet is ideal) between the two halves before you glue them together.

Fold
along
dotted
line

BATTLE BUNKER



BUILDING DATA

Building Access:

Any number of models may enter or leave the bunker through the side door, or move from the bunker to the roof, or from the roof to the bunker, each turn. A single support weapon may be set up on the bunker's roof at the start of the battle, but may not leave once the battle is in progress.

Building Capacity:

Up to eight models may be placed inside the bunker, and an additional five models, or a single support weapon and crew may be placed on the roof.

Fire Arcs:

Models placed on the roof may fire using the normal rules. Models inside may fire through the vision slits on the side of the bunker. No more than one model may fire out of each vision slit.

WEAPON DATA

Because of the tremendous variation of models that can use the Battle Bunker, no weapons data is included here.

POINTS COST: 50 points

D6	LOCATION	ARMOUR	
		FRONT	SIDE/REAR
1	Vision Slit	See Below	See Below
2	Door*	20	20
3-6	Bunker	25	25

* Only if the door is visible to the attacker. If it isn't then count this as a Bunker hit instead.

D6 Bunker Damage Table

1-4 The bunker rocks violently. Any models inside the bunker or on the roof are knocked off their feet and may not move or shoot in their next turn. They may fight normally if engaged in hand-to-hand combat. Add +1 to all future damage rolls against this bunker from now on.

5-6 The bunker collapses into a pile of rubble. Any models inside the bunker or on the roof must make their armour saving roll on a D6 or be slain by falling debris. Survivors may not move or shoot in their next turn. If they are engaged in hand-to-hand combat they are separated immediately.

D6 Door Damage Table

1 The door is badly buckled and jammed shut. No model may enter or leave the building until the door is blown off its hinges.

2-5 The door is blown off, leaving a large door shaped hole. Any future hits on this location will pass onto the bunker with the same effect as a Vision Slit hit (see below).

6 The door is totally obliterated and part of the bunker has gone with it! Make a roll on the Bunker Damage Table to see what effect this additional damage has.

Vision Slit Damage

The attack goes through the vision slit hitting one of the models inside the bunker. The attack hits a randomly chosen model in the bunker causing damage using the normal Warhammer 40,000 rules.



WARHAMMER

40,000

ULTRAMARINES SPACE MARINE ASSAULT SQUAD



THE ULTRAMARINES ASSAULT SQUAD BOX SET CONTAINS:

- 5 Space Marine assault troop bodies
- 2 Space Marine jump packs
- 2 Space Marine bolter and back pack sprues
- 1 Space Marine arm sprue
- 2 close combat weapon sprues
- 5 25mm round Slottabase
- 1 Ultramarines assault squad transfer sheet

Space Marine assault troops are ever at the forefront of the hardest fought battles in the galaxy. Equipped with powerful jump packs to quickly seize objectives, and armed with chainswords, plasma pistols and other deadly hand-to-hand weapons, Space Marine assault troops are some of the toughest close combat warriors in the Imperium.

The Ultramarines are amongst the oldest and most renowned Space Marine Chapters. They are famous not only for their many victories in battle but also for their strict adherence to the Imperial orthodoxy laid out in the Codex Astartes.

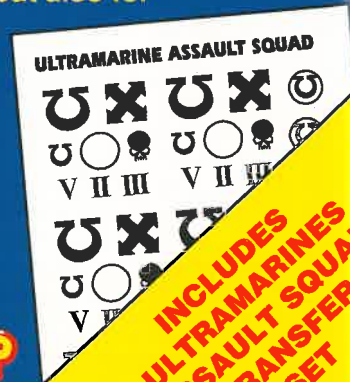

WARNING! These miniatures contain lead and may be harmful if chewed or swallowed. Citadel Miniatures are not recommended for children under 14 years of age.

The Citadel castle, the Games Workshop logo, Slottabase and Space Marine are registered trademarks of Games Workshop Ltd. Citadel, Games Workshop and Ultramarines are trademarks of Games Workshop Ltd.
© Games Workshop Ltd, 1994. All rights reserved.

GAMES WORKSHOP

**INCLUDES
ULTRAMARINES
ASSAULT SQUAD
TRANSFER
SET**

BJORN THE FELL-HANDED SPACE WOLVES DREADNOUGHT

Bjorn the Fell-Handed is a mighty totem of the Space Wolves fighting history. His massive Dreadnought armour is an honoured Chapter artifact that represents an unbroken link through the centuries to the Space Wolves' legendary founder Leman Russ. Bjorn actually fought alongside Russ during the early days of the Space Wolves Chapter and he is a potent reminder of those epic times.

Between battles Bjorn's armour is constantly maintained by the Chapter's Iron Priests, Rune Priests and Artificiers.

Within the armour Bjorn rests, gathering his strength, awaiting the moment when his awesome power is needed by the Space Wolves and once more he has to crush their foes.

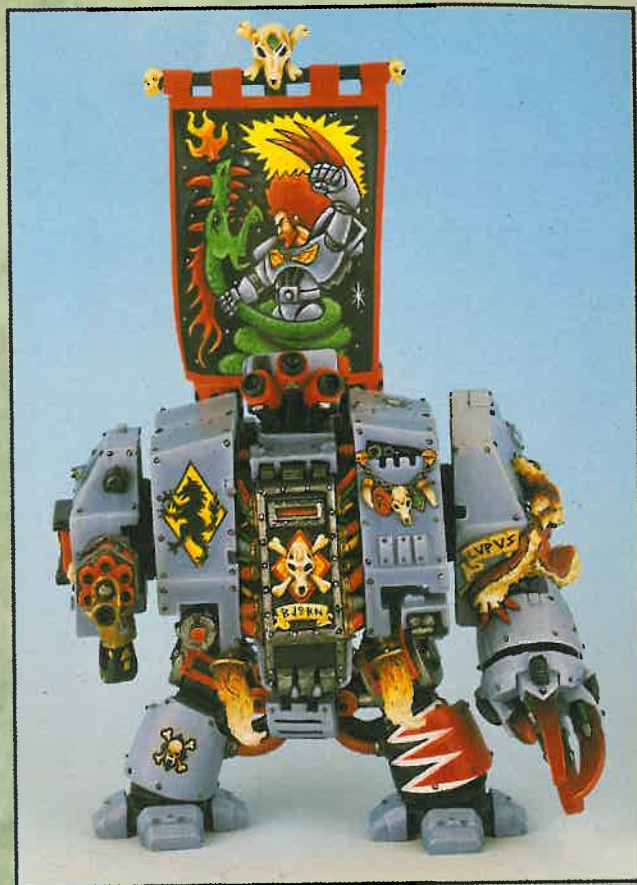

LEMAN'S BADGE



PACK MARKING



RAGNAR'S BADGE



ARMY BADGE



BJORN'S BANNER depicts him as a powerful member of the Blood Claws in the days of Leman Russ.



Amongst the trophies and icons displayed by Bjorn are badges and markings which refer to his early days as a warrior with the famed Leman Russ. The black, red and white pack marking is an archaic form of those currently in use by the Space Wolves.

Leman's badge marks Bjorn as having fought alongside Russ in ancient times. The badge of Ragnar and the army badge are additions to Bjorn's heraldry and simply refer to his being a part of Ragnar's current task force.



ASSAULT CANNON

BJORN'S WEAPONS

Over the centuries Bjorn has wielded an enormous variety of different weapons. He is currently armed with an assault cannon and a lightning claw, the latter having an additional heavy flamer attached. Despite the vast destructive potential of this wargear it is his fighting spirit, legendary personality and battlefield experience which are Bjorn's strongest weapons.



LIGHTNING CLAW WITH HEAVY FLAMER

GOFF ORKS



GOFF NOBZ



GOFF SKARBOYZ



GOFF ORKS READY THEMSELVES FOR BATTLE.

MISSION 4

THE STRONGPOINT

The battle for the bridges over the Skeletus river on Armageddon lasted for several months, with both sides pouring reinforcements into the area. Once it became obvious that they were in for a prolonged defensive campaign the Blood Angels began to dig in and build defensive fortifications. The Orks continued to batter away at the Space



Marines' defensive positions, hurling their forces at the stalwart defenders. On numerous occasions they managed to capture Space Marine positions, only to be beaten back by the furious counter-attacks of the Blood Angels' reserves. Casualties on both sides were enormous, but the Orks as the

attackers suffered particularly heavily. Finally, after weeks of fruitless attacks and with his reserves of troops running out, Ghazghkull decided to stake everything on one last big offensive...

IMPORTANT NOTE: In order to play this scenario you will need *two* Battle Bunkers. As long as you and your opponent each have a bunker model this should not be a problem. Alternatively you can photocopy the bunker included with this issue of White Dwarf to make extra Battle Bunkers for your own use.

WAR OF ATTRITION Blood Angels Briefing

You have defended your position against numerous Ork attacks over the last few days. Although each attack has been beaten off your command has been reduced to almost 50% of its starting strength. Now reports are flooding in of a major Ork offensive all along the line. No reserves are available to help you, so you must defeat the Ork attack with only the forces under your command. Above all you must make sure that the Orks do not capture either of your Battle Bunkers. The Eyes of the Emperor are upon you. You must not fail!



FORCES

You have three combat squads of Space Marines under your command. All Space Marines are equipped with Mk7 power armour, bolt pistol and frag and krak grenades. In addition, the Space Marines are armed with the following weapons.



Squad Danton

- Sergeant Danton – Chainsword
- 3 Space Marines – Boltgun
- 1 Space Marine – Flamer

Squad Leonardius

- Brother Leonardius – Boltgun
- 3 Space Marines – Boltgun
- 1 Space Marine – Missile Launcher (targeter, frag and krak missiles)

Squad Faustus

- Sergeant Faustus – Chainsword
- 3 Space Marines – Boltgun
- 1 Space Marine – Missile Launcher (targeter, frag and krak missiles)

Battle Bunkers

The Space Marine forces include two Battle Bunkers which must be placed in the locations shown on the Deployment map.

VICTORY POINTS

You must destroy the Ork forces wherever possible and minimise your own losses. In addition you must prevent the Orks occupying your half of the table and capturing any of your Battle Bunkers. The player with the most victory points at the end of the game is the winner.

	5+ Casualties	Wiped Out
Gretchin Mob	0 victory points	1 victory point
Ork Mob	1 victory point	1 victory point
	Damaged	Destroyed or Disabled
Dreadnought	1 victory point	1 victory point

You receive a bonus of **+5 victory points** if there are no Ork or Gretchin mobs with 6 or more models or an undamaged Dreadnought in your half of the table at the end of the game. In addition you receive **+1 victory point** for each Battle Bunker that is occupied by one or more Space Marine models and no Ork models at the end of the game. In order to satisfy the second victory condition the models must be *inside* the bunker; models that are on the roof do not count.

DEPLOYMENT AND GAME LENGTH

Set up first anywhere with 12" of your own table edge but no closer than 12" to either corner. Roll a D6 and add +5 to the score before comparing it to the Ork player's roll; the player with the highest total moves first.

IMPORTANT: The game lasts six turns.



OVER THE TOP Goff Orks Briefing

"Dis is da big 'un ladz! Da boss says we've gotta capture da humie bunkers and kill all da humie skumbags in 'em. We've got a Dreadnought, some dead 'ard Goffs and a bunch of sneaky Gretchin to do it wiv, and da Boss sez dat he's sent a bunch of Goffs an' a Dreadnought to sneak round da side of da humies an jump 'em while da gits is shooting at us. Hur Hur! Dat'll teach 'em, ay lads! Right den , Ere We Go, Ere We Go, Ere We Go..."

FORCES

All Orks and Gretchin wear flak armour. In addition, the Orks and Gretchin are equipped with the following weapons.

Da Destroya

Ork Dreadnought armed with two power claws, a heavy bolter and a lascannon.

Skardreg's Mob

Ten Orks armed with bolt pistols, axes, and frag & krak stikkbomz.

Waazod's Mob

Ten Orks armed with bolt pistols, axes, and frag & krak stikkbomz.

Botchit's Mob

Ten Gretchin armed with autoguns.

Fixup's Mob

Ten Gretchin armed with autoguns.

Runtrat's Mob

Ten Gretchin armed with autoguns.

Scrimp's Mob

Ten Gretchin armed with autoguns.

ORK REINFORCEMENTS

The Orks sent a small force on a night march in order to fall on the Space Marines' flank while the main Ork force engaged the Space Marines from the front. Unfortunately, the Orks got delayed and did not arrive until the battle was well under way.

In this scenario Ork models which have been killed are used to represent the troops sent on the flank march, and can be brought back into play as Ork reinforcements. When (or if...) the Ork player loses 10 Goff Ork models, he can bring them back into play as a reinforcement Goff Ork mob. If the Ork Dreadnought is destroyed the Ork can bring it back into play as a Dreadnought reinforcement. No other models may be brought back into play as reinforcements apart from those noted above.

The reinforcements may be set up at the start of the Ork turn within 6" of the *side* table edges – this represents the fact that they have been sent on a flank march. They may move and attack as normal on the turn that they arrive.

Da Snapper

Ork Dreadnought armed with two power claws, a heavy bolter and a lascannon.

Badfang's Mob

Ten Orks armed with bolt pistols, axes, and frag & krak stikkbomz.

VICTORY POINTS

"Splat as many of da gurlly humies as ya can, but don't get yerselves too smashed up an' don't get da Dreadnought trashed. An' capture do bunker thingies wot the humies are hiding in, or blow 'em up if you can't capture 'em."

The Ork player receives the following victory points for destroying Space Marine Squads.

	3+ Casualties	Wiped Out
Space Marine Squad	1 victory point	1 victory points

The Ork player also receives +5 victory points for each bunker that is occupied by 1 or more Orks and no Space Marines at the end of the game, or +3 victory points for each bunker that is destroyed. In order to satisfy the first victory condition the models must be *inside* the bunker; models that are on the roof do not count.

DEPLOYMENT AND GAME LENGTH

Set up second anywhere with 12" of your own table edge but no closer that 12" to either corner. Roll a D6 and add +3 to the score before comparing it to the Space Marine player's roll; the player with the highest total moves first.

IMPORTANT: The game lasts six turns.



SPACE MARINE TACTICS

When deploying your Space Marines it is best to place a combat squad in each bunker and the third combat squad in the ruins between them. This formation allows you to cover most of the best approach routes to the bunkers. Whether you deploy inside or on top of the bunker can make a difference to the



outcome. Models on top have a greater field of fire and you can bring more weapons to bear in one direction, but they suffer from a lesser degree of protection. Once the Orks get in close enough to receive bonuses to hit for firing at short range it is best to nip through the trapdoor and seek the comfort of those thick walls.

With two missile launchers you have a choice to make. You can either frag the Orks and Gretchin with both as they run up, thereby causing Break tests with any luck. You can also fire krak missiles at the Dreadnought in the hope of bringing it down, but remember that the Orks get another as soon as the first is destroyed. I think it is best to fire one each of the krak and frag missiles and rely mainly on your Rapid Firing bolters to kill the Ork hordes.



Despite the fact that the Ork player gets another Dreadnought as soon as the first is destroyed, you should not be dissuaded from firing at it. The Dreadnought is worth victory points whether it is replaced or not. It has the best Ballistic Skill of the Ork army and is equipped with a heavy bolter which is perfect for shooting up your Space Marines. The Dreadnought's lascannon is useful for destroying the bunker's doors and should not be allowed too many opportunities to fire at these vulnerable points. It also has two deadly power claws that will rip those doors off in no time given the chance, so don't let that big brute get too close.

You should also attempt to concentrate your fire. Try to remove as many casualties as you can from a single mob, forcing Break tests which can seriously hamper the Ork advance. A moderate number of casualties in one mob is usually preferable to a larger number spread over all the attacking mobs. Let each squad pick a mob to deal with in any given turn and pour as much fire into as you can. If it is destroyed or broken you can turn the attention of the squad to the next mob, and so on. Use frag grenades when the Orks get within range, their armour save will not help them much if you keep throwing grenades into the middle of those tightly packed Ork mobs.



If the Ork player directs all of his troops (including reinforcements) against one bunker, you may consider moving the furthest squad into a supporting position. Beware of letting some sneaky Grotz past your defensive line though, as they will be able to walk into the empty bunker unopposed.

Lastly, let the Orks come to you. This may seem obvious, but some players do not like to wait in their deployment zone, they want to take the fight to the enemy. In this scenario your best defence are the bunkers and the Space Marines ability to Rapid Fire. Don't waste them.

Follow these guidelines and the Hives of Armageddon will survive for a while longer...

ORK TACTICS

This scenario is designed to follow on from the three printed in the Battle for Armageddon Scenario booklet in the Warhammer 40,000 boxed set. If you have been playing the Orks in these then you should have a fair idea of how the different troops operate. You will probably find this scenario the most challenging one so far but you will need to use all your Ork cunning and tactics to ensure victory. There are three main points which you must bear in mind throughout the game if you are to stand any chance of winning. Firstly, you must secure one of the bunkers for the Orks, as this is your major source of victory points. Secondly, do not try to secure both bunkers as you will spread your force too thinly. Lastly, do not under any circumstances attempt to destroy a bunker, your chances of penetrating the thick masonry walls are very, very remote.

Use your Orks and Dreadnought to attack one of the bunkers. Your best plan is to run them down behind the buildings,

where most of the Orks will at least be in cover, if not concealed by the ruins, should your Gretchin screen collapse. Try not to be tempted into using the Dreadnought as a static weapons platform to shoot at the Space Marines. You might be able to draw the fire of the Space Marine missile launchers, but the chances of them actually destroying the Dreadnought, and the reinforcement Dreadnought coming on, are rather slim. The other factor to remember is that the Dreadnought is the only thing capable of breaking down the bunker door. If you run the Dreadnought, it should reach the door in three turns so you can attack the door with the Dreadnought's awesome power claws (If you attack the bunker door don't forget to add a D20 to armour penetration roll for using a strength 8 weapon in Hand-to-Hand Combat). You can now use the heavy bolter to clear any Space Marines out of the bunker, ready for your Goff boyz to move in. If the premises are still occupied when the Orks get there charge the bunker and throw your frag grenades through the vision slits. In the enclosed space of the bunker your grenades receive a +1 strength modifier.

Another important factor in this game is the reinforcements. If everything goes well you won't need them, but you might have a bad start, perhaps the Space Marines get a lucky shot on the Dreadnought or your Orks fall victim to a hail of frag missiles. If this happens, your reinforcements will be able to threaten the Space Marine's flanks. Any reinforcements which arrive at an early stage in the battle can follow the plan above, breaking down the door and throwing frag grenades through the vision slits. Surviving Gretchin mobs can be moved in really close to the bunkers to prevent the Space Marines shooting up your reinforcements with their Rapid Fire capability. Ork reinforcements will start much closer to the bunkers, allowing you an extra one or two turns to complete your attack.

Once you have some troops in a bunker, it is vital that you protect them. The Space Marines aren't going to stand around watching. Use the Dreadnought to stand between your bunker and the ruins between the two bunkers. It is highly likely that



the Space Marine player will have his flamer squad set up here and they will probably try and make a last minute bid to flush you out, and believe me a flamer is very good at flushing out bunkers. Any Orks in the bunker should set overwatch, the Space Marines have frag and krak grenades and he will probably try to charge your bunker and throw their grenades through the vision slits. The overwatch will give you a chance to shoot at them at close range and hopefully give you extra victory points.

If you follow all these points and keep your attack rolling forward regardless of casualties and minor set backs, your boyz should be inside one of those bunkers in time to break out the Squiglets and Fungus beer.

Should you choose to use the first of the game variants below, you will have to decide how to split your Gretchin into units. This is quite important as different sizes of mobs have different advantages. Mobs of ten models are more flexible, but the Space Marine player only needs to kill three Gretchin

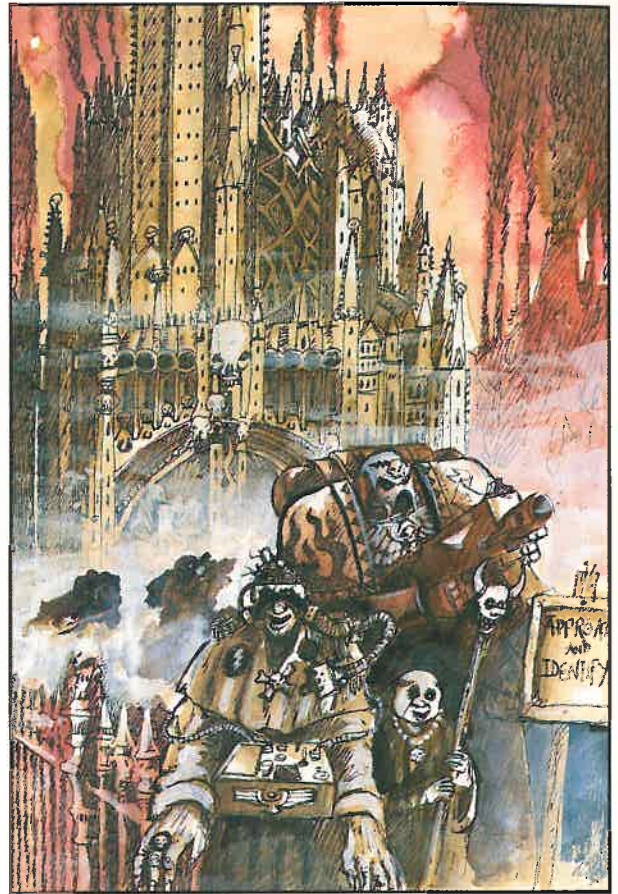

before you have to make a Break test. A large mob forty strong needs to take ten casualties before it takes a Break test, but if you failed it all your Gretchin would run away. A couple of mobs of twenty, or one mob of twenty and two mobs of ten, usually gives your Gretchin a bit more staying power and flexibility to move across the battlefield. In the battle use the Gretchin to shield your Orks (remember the Space Marines will have to usually fire at the nearest enemy because of the Choosing a Target rule). Keep the Gretchin moving forward, with maximum spacing to reduce the number of casualties from frag missiles. If they do break then don't forget to rally them and get those Grotz back up front protecting da boyz.



GAME VARIANTS

Let the Ork player have twenty Orks and forty Gretchin and organise them into mobs as he likes. The minimum size for an Ork mob is five models and the minimum size of a Gretchin mob is ten models.

Don't use one of the Battle Bunkers and Squad Faustus, and don't allow the Orks any reinforcements.



ASSEMBLING YOUR BATTLE BUNKER

By Adrian Wild

Inserted between these pages of your copy of *White Dwarf*, you'll find two sheets of card printed with the components of a free full-colour Warhammer 40,000 Battle Bunker. This superb model, designed by Adrian Wild, comes complete with a datafax, new Mission cards and a special 'Battle for Armageddon' scenario written by Jervis Johnson. In this article, Adrian gives his advice on the best way to assemble your Battle Bunker.

TOOLS AND MATERIALS

Work Surface: Before you start to assemble your Battle Bunker make sure that you have a clear work surface and a few simple tools and materials close at hand. If you are going to work on a table, it's best to protect the surface with thick card or several thicknesses of newspaper.

Modelling Knife: To cut out the individual model sections, it's best to use a modelling knife with a sharp blade. Blunt blades are far more dangerous, because you have to press down much harder and there is a greater likelihood that you will slip and cut your fingers. Always make cuts away from yourself.

Steel Rule: A steel rule is essential for making straight cuts. The edge on a plastic or wooden ruler will rapidly get damaged by the blade on your knife.

Scissors: Scissors are useful for trimming off any excess bits of card or snipping the pieces to fit.

Adhesive Tape: Sellotape or masking tape is useful for supporting the various building sections and holding them firmly in place while the glue is drying.

Glue: The best type of glue is an impact/contact adhesive such as Bostik. With this type of glue you first spread it on both sides of the sections to be joined and then place them to one side for a moment. When the glue has gone tacky, you can press the two pieces together and they'll form an extremely strong bond.

You can use other types of glue suitable for paper and card such as PVA or general purpose adhesive, but because of their longer drying time, you'll have to support the pieces with tape or elastic bands.

GETTING STARTED

The basic model is quite easy to assemble. First of all remove both sheets of card out of your copy of *White Dwarf*. Before you cut out the individual sections it's a good idea to score all of the fold lines that are marked with black arrow heads.

To score the card use the back of the blade of your modelling knife. Use light strokes, guiding the knife tip with a steel ruler. If, once you've scored it, the card is still a little difficult to fold, then re-score the line using less pressure than before. Should you cut all of the way through by mistake, you can easily repair the damage by sticking a strip of sellotape on the inside of the fold.

The battle platform folds up into a tray and so you'll need to score the fold lines on the back not the front of the sheet. To do this, press a pin, or the tip of your modelling knife through the card to mark a rectangle on the back of the card. This will allow you to accurately score the lines of the reversed folds.

Once all the folds have been scored, carefully cut out the different parts of your model. You should then fold each of the pieces and make sure that you understand how they fit together. You are now ready to assemble your model.

ASSEMBLY

The first job is to glue the two **Main Walls** together. Spread a little glue along the tabs on the **Back/Left** and **Front/Right** wall sections and allow it to go tacky – the stage before the glue actually dries – then join the sections together. Press them together firmly to get a really good bond.

While you are waiting for the glue to go tacky on the wall sections, you can prepare the battle platform and parapet. Fold the sides of the **Battle Platform** inwards to form an open box,

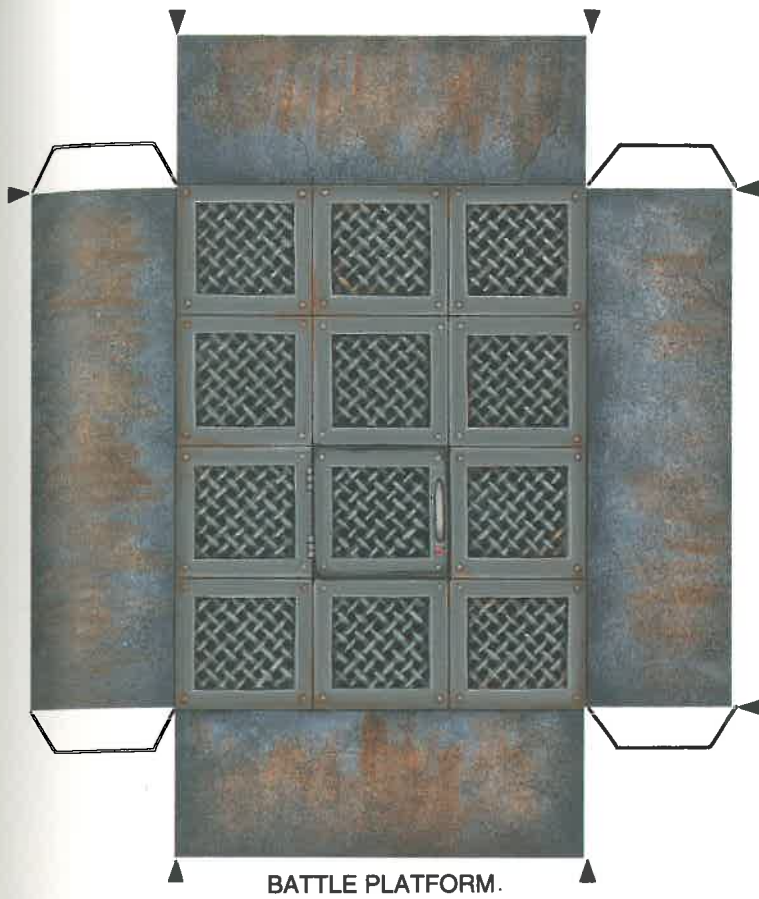

BATTLE PLATFORM.

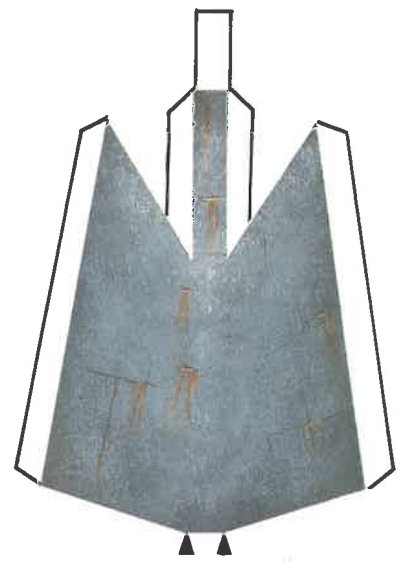

LEFT BUTTRESS



RIGHT BUTTRESS

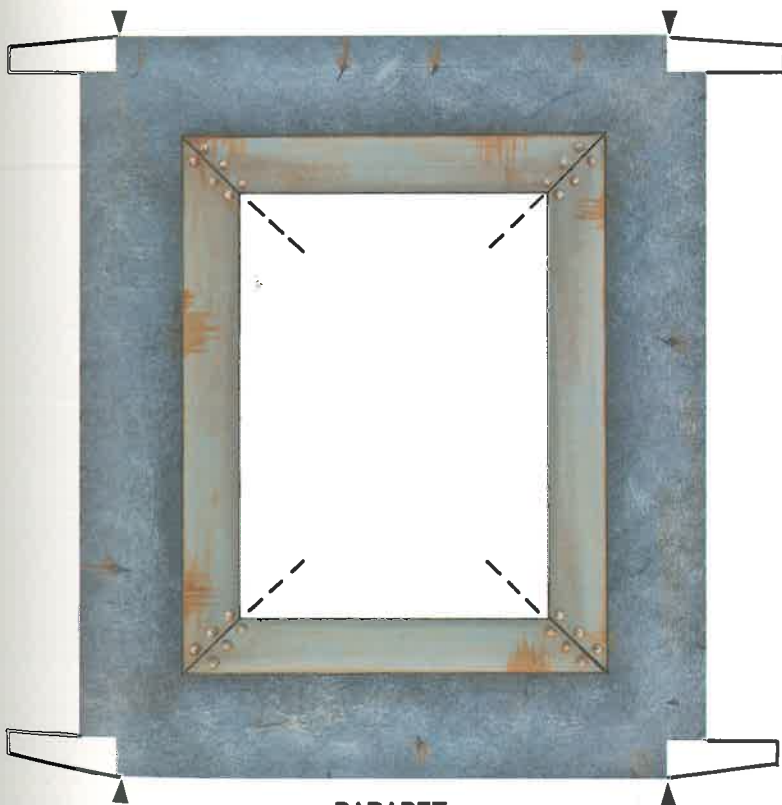

PARAPET

FRONT BUTTRESS



move
efore
re all

elling
ruler.
ult to
efore.
u can
on the

ed to
To do
gh the
s will
ds.

it the
of the
ey fit

read a
Right
re the
them

wall
Fold
t box,



BACK AND LEFT WALLS

BACK BUTTRESS

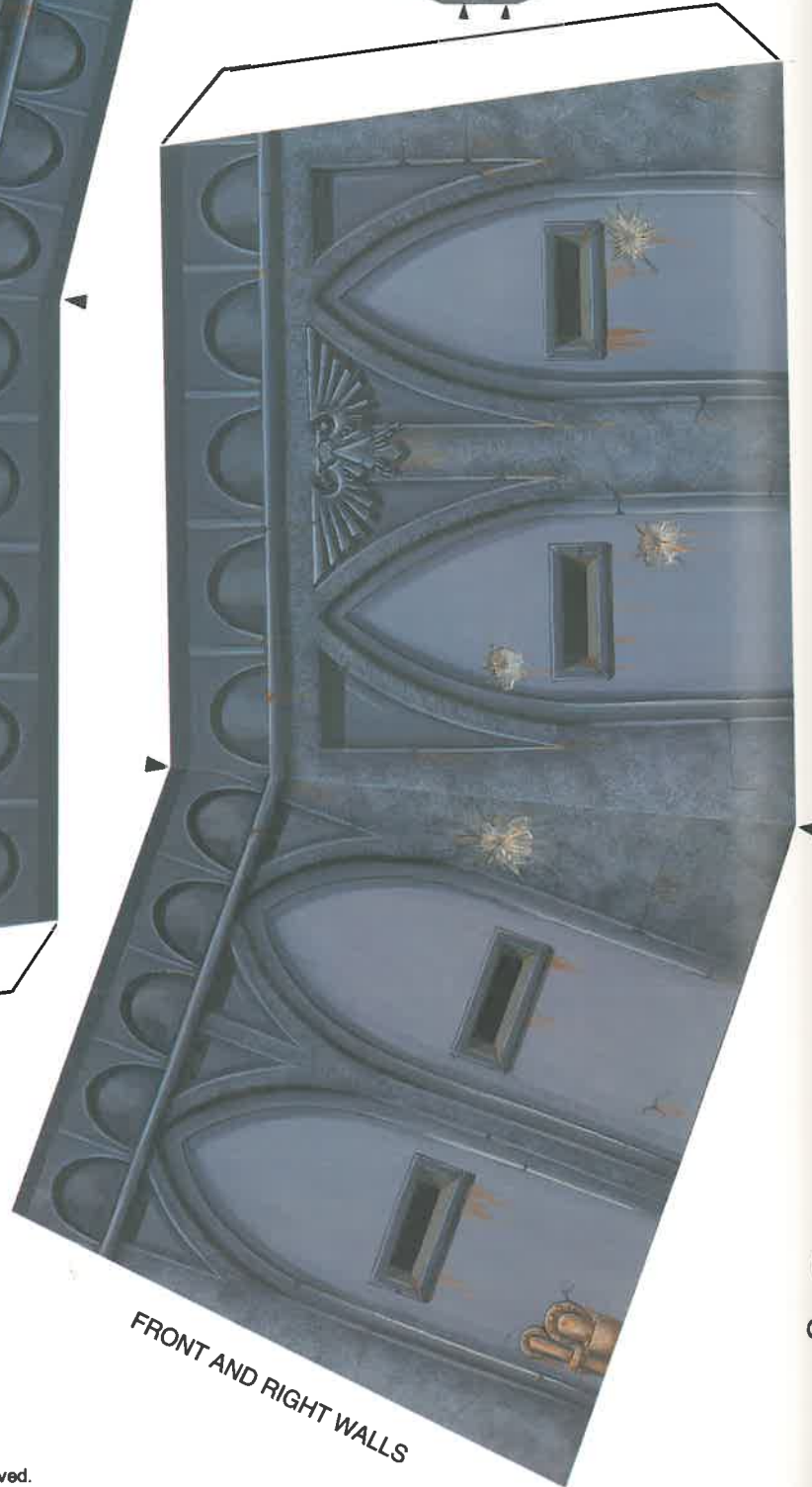
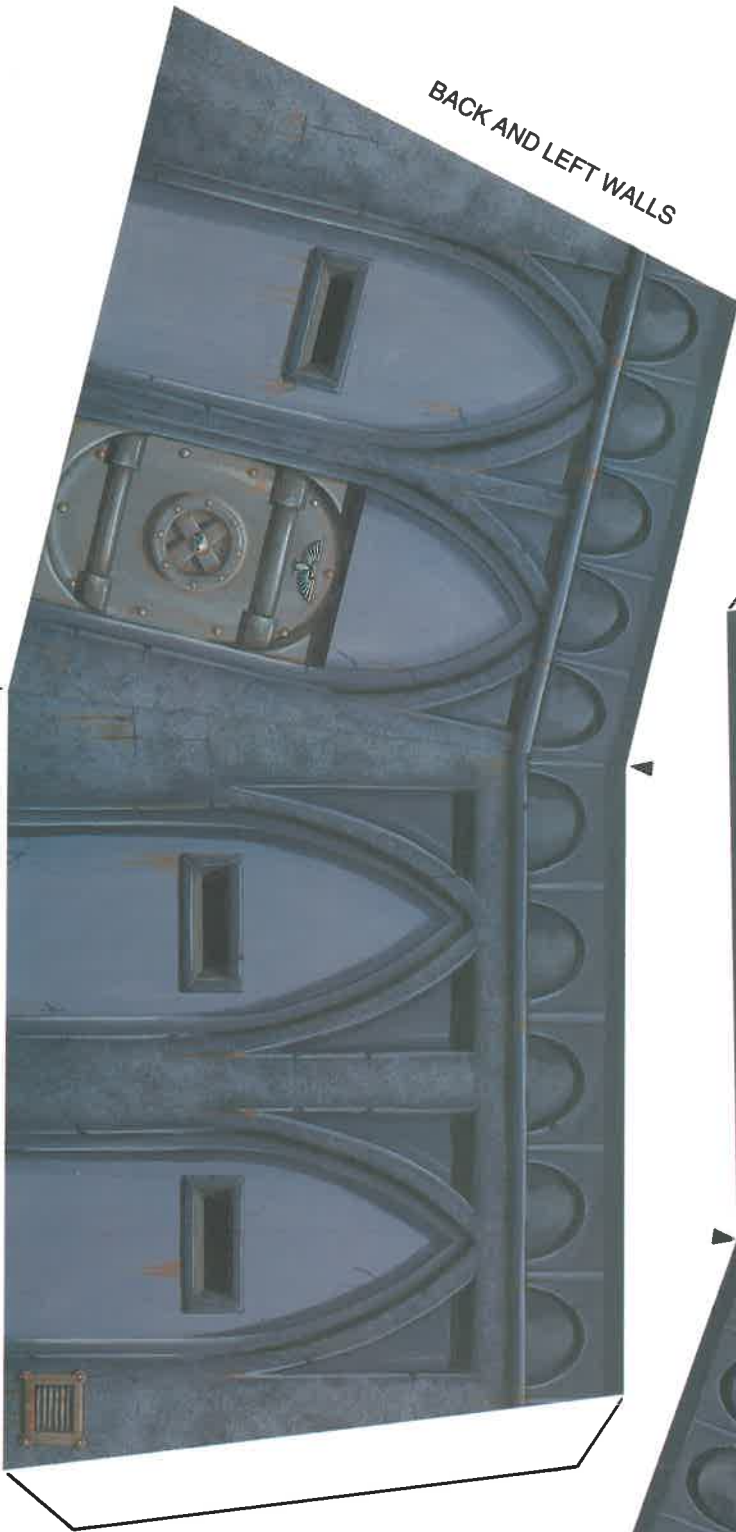
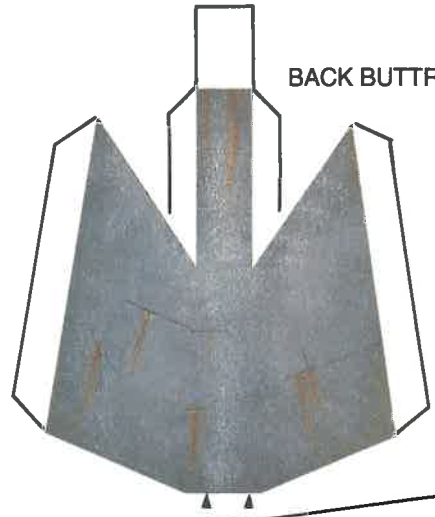

ALTERNATIVE BLAST DOORS

© Copyright Games Workshop Ltd, 1994. All rights Reserved.

FRONT AND RIGHT WALLS



and apply a thin layer of glue to the tabs before putting it aside to go tacky.

The next piece to assemble is the **Parapet**. The thin outer strips around the edge of this section form the edge of the overhang, and the thicker strips on the inner edge are used to attach the parapet to the battle platform. At this point, only apply glue to the outer tabs, leaving the inner strips until the battle platform has been fully constructed.

You should now have three different sections on the table in front of you – the main walls, the battle platform and the parapet.

When each section has completely dried, join the parapet and battle platform together by applying glue to the underside of the metal plates on the parapet and to the inside of the battle platform walls. Once again, allow the glue to dry before attaching the now assembled battle platform to the main walls.

BATTLE BUNKER ASSEMBLY DIAGRAM

Parapet: Remove the white card from the centre of the parapet and snip the corners as shown below. Score and fold along the edges of the metal plates so that they form the inside walls of a box.

Score and fold between the arrows and level with the tabs to construct the outside wall of the box then place this on one side to dry.

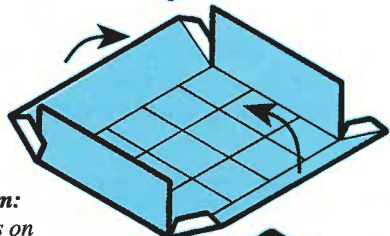
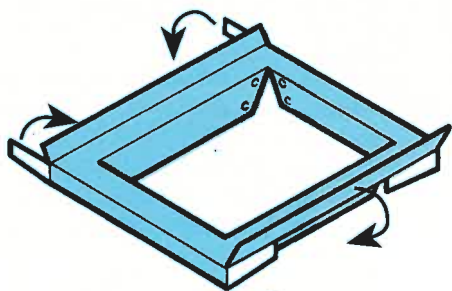

Battle Platform: Score the folds on the back of the Battle Platform and fold up the sides to form a tray.

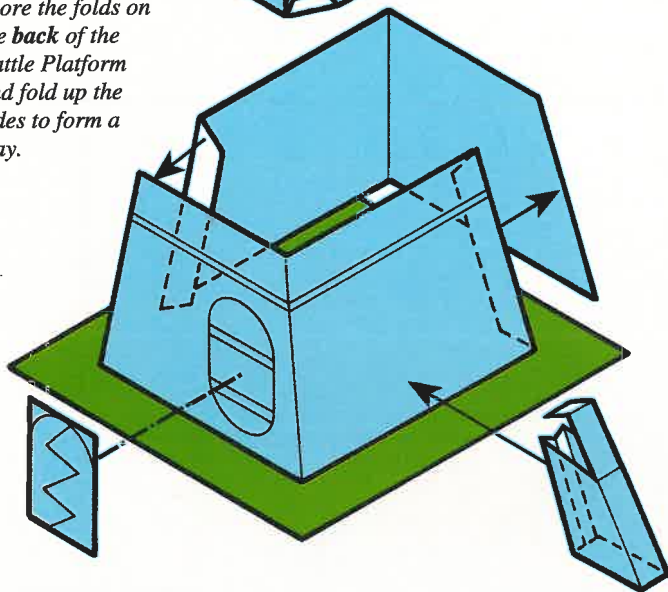

Walls and base: Fold and glue the walls together using the tabs. If you want to add one of the alternative blast doors, attach it at this stage. Note that the door is listed on the bunker profile and must be placed in this position.

THE BUTTRESSES

The **Buttresses** are optional, but if you decide to use them they should be added after the rest of the model has been assembled and left to dry. Check that you attach the correct buttresses to the appropriate walls. The two narrower ones will fit on either of the side walls and the wider ones will only fit on the front or back wall.

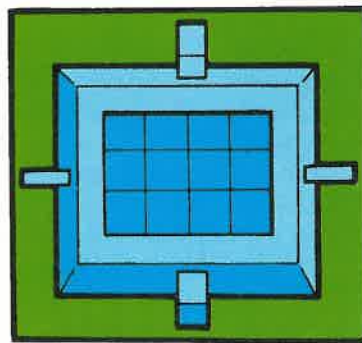

Top view of the completed bunker showing the buttresses in position.

FINISHING OFF

Once your model is completely dry, it's a good idea to touch up the edges where the scored folds have exposed the white card. The original model was painted with Citadel Blue Grey paint and so you'll find that this colour is an extremely good match. Thin the paint with a little water and run it along the crease lines with a small brush. Any paint that gets onto the printed surface is easily wiped off whilst it is still wet.

To make the whole model more rigid we attached our model to a base. A simple card one will be fine, cut from mounting board or box card. Trim it slightly larger than the base area of the model, and then paint it with a suitable colour to match the rest of your terrain. If you are feeling more ambitious, you may want to add some details such as model rocks, vegetation or even contour it with polystyrene slopes.

On our model we decided to add further detail by attaching triangular 'spikes' to the top of the parapet. These were cut out of some spare bits of card and simply glued around the top of the model. Once the glue was dry, they were painted black and then drybrushed with Mithril Silver to make them look like metal blades.

The Battle Bunker is now finished and ready for use in your games.

MAN O' WAR

DEATH ON THE SEA OF CLAWS

By Andy Jones and Jervis Johnson

This month's battle is the report of an exciting Man O' War game fought between an Empire fleet commanded by Andy Jones, and a Dark Elf fleet led by Admiral Jervis Johnson. Over the last year or so, our regular battle reports have become one of the most popular features in White Dwarf, but this is our first ever Man O' War game report.

Man O' War has been around for a few months now, and we have been playing plenty of sea battles here at the studio. In White Dwarf 161, in the article *The Battle of Death's Point*, we took you through a single turn from one of our battles, highlighting the action as it happened, and explaining some of the tactical implications of the moves that were made. Since then, we have received so many letters asking about our other battles we thought it was time we wrote one up for publication.

Presenting a battle report for a new system like Man O' War raises many new problems. Unlike Warhammer,

Space Marine and Warhammer 40,000, Man O' War games are usually longer than three or four turns – they can be anything up to ten turns or more (though the turns are themselves shorter). Presented as a battle report in the normal turn by turn detail, explaining exactly what each ship did each turn, would take up a whole issue of White Dwarf!

Also, Man O' War games have a lot more manoeuvring before battle compared to our other game systems. As the fleets approach each other they jockey for position, taking advantage of wind and tide to outmanoeuvre the



The Dark Elf fleet closes in on the Imperial vessels.

enemy. During these opening turns it is not as important to keep track of each ship's movement, but rather the disposition of each fleet as a whole.

When the first shots are exchanged, a Man O' War battle moves into a new phase, where the preliminary planning, moving and positioning pays off (or not, as the case may be). These turns we have described in more detail, particularly where an especially important or exciting bit of action took place. This is what we showed in *The Battle of Death's Point*: a single turn within a game of Man O' War game that had particularly important moments for the outcome of the battle.

For this battle report we decided to play a straight forward 'fight to the last' battle, without any particular scenario, and stuck with the 1000 points per fleet suggested in the Man O' War rulebook.

We also decided that the battle was to be between the powerful Empire fleet, and the arcane majesty of the Dark Elf Fleet. I would have the honour of commanding the Empire, while Jervis would take the Dark Elves.

TERRAIN

We set up the game on the 4' by 4' Man O' War table that we have at the studio, following the normal rules from the rulebook to set up the terrain. The result was a fairly uncluttered table, with the wind initially blowing south.

Next we rolled to choose table edge and decide who would set up first. I won, and chose to deploy on the eastern edge, next to the volcano.

At the side of the playing surface we cleared a sizeable area to put our ship templates on, together with their Man O' War Cards, Spell Cards, etc; by doing this, everything is at hand as the game progresses. One of the most important parts of any Man O' War game is to keep track of the damage and status of your ships, so you can take stock of your fleet at a glance.

BACKGROUND

The River Reik is one of the most important gateways to the Empire. Any trading or military sea-borne traffic destined for the cities of the Empire – or leaving them for far-off realms – must navigate this mighty river.



The Reik is thus one of the Empire's main arteries – a lifeline through which flows the country's lifeblood. Many nations have tried to blockade the Reik in the past, or attempted to subvert the powerful City State of Marienburg to stop the flow of trade, but none have so far succeeded.

The Empire has many powerful fleets of mighty warships, and at least one patrols the waters around the mouth of the Reik at all times, ready to do battle with any enemy vessels that might seek to gain control of these valuable waters. The Empire is also careful to maintain strong ties with the rulers of Marienburg, lest they attempt to prevent them using the river.

So far the unthinkable has never happened, and the Empire's only access to the sea has remained open.

Now, however, the greatest threat to the Empire's control of the waters around the mouth of the Reik has been perceived by the Wizards of Altdorf. They have seen a black shadow upon the sea, and a great darkness approaching the coastal waters of the Reik. After much deliberation they have concluded that one of the legendary city ships of the Dark Elves – a Black Ark of Naggaroth – has strayed into the Empire's waters. They also know that with it come terrible sea monsters and horrific weapons beyond their understanding. The purpose of the Dark Elves is clear – seize control of the Reik's estuary and strangle the Empire into submission.

With great haste, a powerful Empire warfleet has been despatched into the Sea Of Claws, to smash the threat before it is too late. Admiral Gustav Von Graaf, aboard his flagship the Karl Franz, has taken his warfleet to meet the terrible foe. The rest, as they say, is history...

THE DARK ELF FLEET

(Jervis Johnson)



It's been a while now since I've had a game of Man O' War, and so when Andy Jones asked if I'd like to help him sort out a Man O' War battle report for White Dwarf I was more than happy to agree. As Andy wanted to use this game primarily to work out the best format for Man O' War battle reports, we decided to keep

things fairly simple; to this end we decided to limit ourselves to two 1,000 point fleets and not to use any of the flying machines or sea monsters from Sea of Blood (the latest Man O' War supplement).

Next we needed to pick the two races we would use. One side really had to be the Empire – given they are strongly featured in the main game – so Andy bravely volunteered to take command of the Empire's fleet. This left me with a fairly free choice as to which side to take.

After a minute to two's pondering I decided to take the Dark Elves, my choice being influenced by the awesome presence of the Black Ark and Death Fortresses lurking evilly in the Studio's miniature cabinets, and by the fact that I am running a Dark Elf team in the Studio's Blood Bowl league.

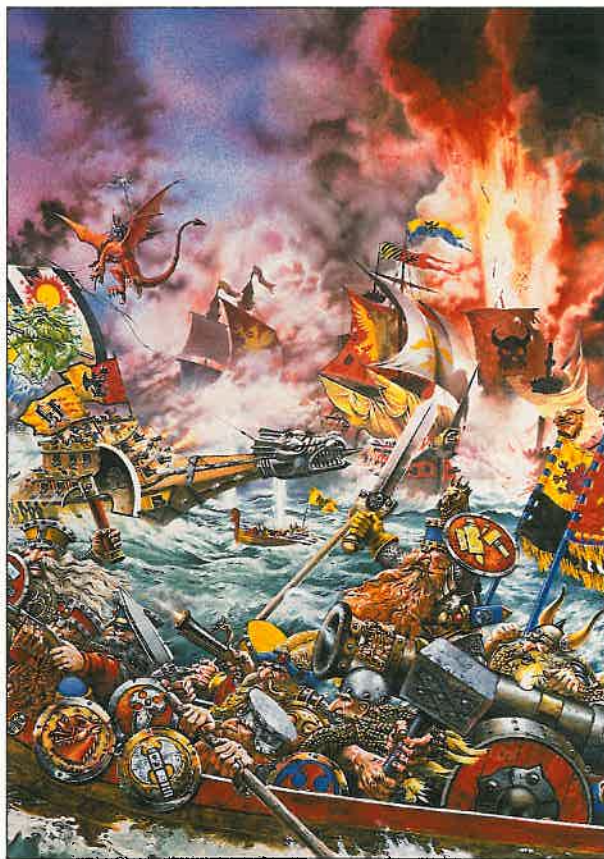

Unfortunately I quickly ran into a problem, as it transpired that the Studio's miniature painters had not yet completed enough models to make a 1,000 point Dark Elf fleet! After having arranged for the snivelling wretches to be soundly flogged (their pitiful excuses about "having hundreds of other models to paint" and "already working 23 hours a day" cut no ice with me, let me assure you), I sat down and studied the Man O' War allies article from Sea of Blood.

Many people see allies as a method of 'plugging gaps' in a fleet, allowing it access to troop types it does not normally possess. Personally, however, I prefer to pick allies that compliment the other units in my fleet and enhance their effectiveness, rather than choose disparate elements that are hard to work together.

Before I could pick any allies, then, I had to get a firm picture in my mind of the strengths and weaknesses of the Dark Elf fleet itself. As anyone who has played against a Dark Elf fleet will tell you, its main strength is its ability in close range combat. The Black Ark is the single most powerful ship in any fleet, but it only really achieves its full potential when it is in amongst an enemy fleet and able to fire off several of its Reaper batteries at once while attempting to board enemy ships.

This is also true for the Death Fortress, which is at its most effective in close actions when it can both fire its Reaper battery and the Sea Dragon can attack.

The final 'ship' in the Dark Elf armoury is the Doomreaver that does not have any ranged weapons at all, and relies solely on the Helldrake's vicious attacks. In addition to their combat abilities, all Dark Elf ships are highly manoeuvrable, being able to move 6" in any direction. This makes them even more effective at close range, as they can out-maneuvre just about any other vessel they might meet.

Powerful though the Dark Elf fleet is, it does have two important weaknesses. The first is that both the Death Fortresses and Doomreavers (that make up the bulk of the Dark Elf fleet) have a vulnerable 'Achilles heel' in their Battle Towers. If this location is destroyed the entire model is removed from play, as the Sea Monster that forms the rest of the 'ship' dives below the surface and swims off once its Dark Elf controllers have been killed. Because of this it is vital that the Dark Elf player keeps these vulnerable units out of harm's way for as long as possible by hiding them inside the Black Ark. Care must be taken with this tactic, however, as any ships inside the Black Ark are unable to fire, and may become trapped if the Black Ark is damaged.

This brings us to the Dark Elves second weakness – the Black Ark itself. Although the Black Ark is extremely powerful it can still be sunk, especially if the enemy is allowed to concentrate enough fire upon it. It goes without saying that the loss of the Black Ark can deal a serious blow to any chance of a Dark Elf victory.



THE DARK ELF FLEET



1 × Black Ark of Naggaroth
250 points



1 × Wizard Lord
150 Points

1 × Squadron of 3 Doomreavers
150 points



ALLIES

3 × Death Fortresses
100 points each, for a total 300 points



1 × Squadron of 3 Plaguecrushers
150 points



Bearing these points in mind, I studied the potential allies I could draw on from the models available in the Studio miniature cabinets, and was very happy to come across a squadron of Nurgle Plaguecrushers. These would form a perfect 'skirmish screen', stopping Andy taking any long range pot-shots by interposing themselves between the rest of my fleet and the Empire ships, while still allowing the Death Fortresses to make attacks with their Reaper batteries.

Plaguecrushers are also quite tough enough to absorb considerable punishment and keep functioning, and would be able to provide valuable supporting fire once my Dark Elves were directly engaged with the Empire fleet.

Finally, the Plaguecrushers had another, more insidious benefit: any hit from their catapults has a chance of causing Nurgle's Rot, killing the target's crew and making it more susceptible to attack by the Dark Elves in close combat.

*Nurgle Plaguecrusher
and Deathgalley*

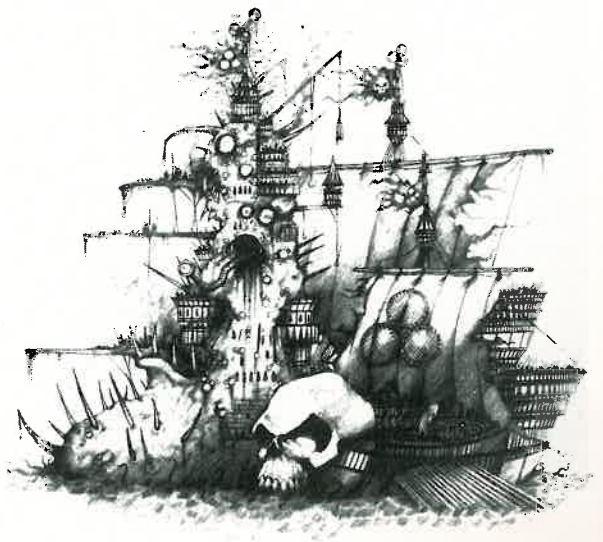

THE DARK ELF SET UP AND EVIL PLAN

My battle formation was pretty much decided before I even looked at the table, being based on the strengths and weaknesses of my various ships. The Plaguecrushers would be my front line, forming a screen in front of the Death Fortresses. My Doomreavers would be kept safely hidden in the hold of the Black Ark, ready to be unleashed once they came within range of the enemy.

The Black Ark itself would be best kept to one side and slightly back from the Plaguecrushers, ready to swoop round them and attack the enemy fleet at the appropriate moment.

Of course, at this point I didn't know the exact location I would form up this battle line, and on which flank I would place the Black Ark, as both depended on the terrain, the wind direction, and the final position of Andy's fleet.

As it turned out, the placement of terrain and the direction of the wind was extremely fortuitous for me. On my half of the table there was very little terrain, which left me plenty of room to set up my battle formation without it getting disrupted by rocks or small islands. Andy on the other hand was lumbered with a large volcano almost in the centre of his set-up zone.

What's more, Andy had to place the first squadron of ships on the table, which meant I would get a valuable clue as to which direction round the volcano he planned to advance before I had to set up any of my ships. If you study the map showing our set-up you will see that Andy decided to take the northern route round the volcano, through the gap between the island and rocks. Although this meant that he couldn't set up his fleet in a line abreast (the best formation for an Empire fleet), it did mean that he kept the wind behind him so that he would be able to sail at full speed.

I was more than pleased with his set-up, as it would allow me to meet his fleet as it emerged through the gap, and (hopefully) before it could deploy into a proper formation. I therefore set-up my Plaguecrushers and Death Fortresses directly in front of, and as close as possible to the gap, so that they would be able to engage the Empire fleet as quickly as possible.

The last model I set-up, the Black Ark, went to the left of my line, where it could swoop round and hit the Empire fleet in the flank as it emerged from the gap, unleashing the Doomreavers as it did so.

My set-up was complete, and my battle plan firmly fixed in my mind. 'Poor old Andy,' I thought, 'he doesn't stand a chance.'

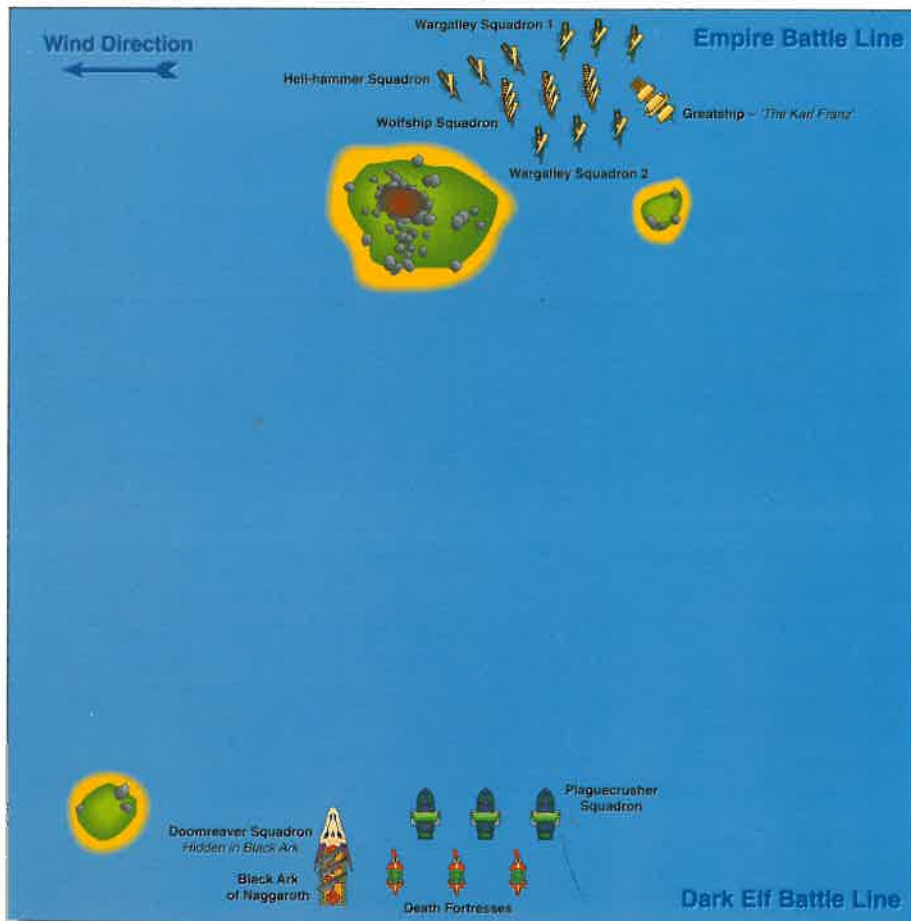

THE EMPIRE FLEET

(Andy Jones)



In all the time I've spent writing about Empire warships I've very rarely, if ever, played them, normally taking the Bretonnian fleet out to war. Now that the Empire fleet has the added attraction of the Hellhammers, however, I decided to take to the high seas and crush the Dark Elves with an Empire fleet.

The main difference between the Empire fleet and the Bretonnian fleet is that all the Empire vessels, except the Greatship, can move under oars as well as sail, and are therefore not at the mercy of the wind as much. In addition their armament is made up of forward firing cannons, rather than broadsides like the Bretonnians.

Bearing these differences in mind, I now had to pick my fleet. First was the Greatship Karl Franz, for a cost of 150 points including the fleet Admiral. Next I put a Master Wizard aboard the Karl Franz, at a cost of 100 points; bringing my running total up to 250 points.

Then came the other compulsory elements of the fleet – a squadron of three Wolfships and a squadron of three Wargalleys, which at 450 points brought me up to a grand total of 700 points. Now came the hard part – what to buy with the remaining 300 points?

I knew that I wanted either a squadron of Hellhammers or another Greatship, as these would probably stand the best chance of sinking Jervis' Black Ark. Given that you stand a two in six chance per turn of being baffled by the Black Ark's spells and therefore unable to shoot at it, I decided that a squadron of Hellhammers seemed the best choice, as at least I'd then have three chances to get past the Ark's illusions each turn. With a single Greatship, there was a much greater chance of being completely baffled and not firing anything!

That still left me with 150 points to spare, so maybe I could have that extra Greatship after all. The firepower was certainly attractive, but in the end I decided to opt for another three Wargalleys instead as they fitted in better with the rest of the fleet. With a single Greatship, I'd only have one ship to worry about sailing into the wind, and the bulk of my fleet would be unaffected by changes in the wind direction.

THE EMPIRE SET UP AND CUNNING PLAN

By this time I knew which fleet Jervis had chosen, and the prospect of fighting it was quite daunting. The Doomreavers and Death Fortresses are potent adversaries, as they don't suffer critical hits at all. They are also ferocious in boarding actions, and I didn't really

have anything to match them in that department. On the other hand, they both have single location which if damaged can send them to the bottom of the briny. It seemed to me that the best thing I could do was bombard them from a distance, and try and get a few rams in if the opportunity presented itself. With any luck I'd hit some of those vulnerable locations and send the foul beasts back to the depths they came from before they did too much damage.

The Black Ark is the most powerful vessel in the Man O' War game, being fast, huge, well-armed, and protected by magic. With all this against me, there was no way at all that I would ever think of engaging it in a boarding action. Not only that, but its magical movement means it can quite simply push my ships out of the way – running them aground or causing collisions. The best, and possible only chance I had of sinking the Black Ark would be to choose my moment and hit him with my Hellhammers.

The last element of Jervis' fleet was a squadron of Nurgle Plaguecrushers, chosen using the allies rules from Sea Of Blood. These were a nasty addition to his fleet and put me in something of a quandary. If I tried to stand off and shoot at his Sea Monsters, he could bombard me with plague catapults; if I closed in, his Doomreavers and Death Fortresses could shred me to pieces.

On balance, I decided that the best tactic would be to get into close range as soon as possible, using the multiple guns of the Wolfships, Wargalleys, and Greatship to cause as much damage as early on in the game as I could manage. The Dark Elf fleet is fairly brittle, so the more cannon shot I could I could pound them with at close range the better. If I could sink a number of vessels and cripple others with rams and cannon, I would be less vulnerable to the boarding actions that the Dark Elves are especially good at.

I wasn't overly worried which College of Magic I drew because casting magic against the Dark Elf fleet is fairly peculiar. I assumed that as they have little or no crew, spells that remove crew counters cause wounds instead. Spells that change the wind direction also prove to be fairly useless against Dark Elves, as they are immune to the wind. My oft-used tactic of using spells to immobilise a squadron's flagship – so that the squadron cannot move far if it wants to maintain formation – wouldn't prove useful against the bulk of the Dark Elf fleet either, as it would have no effect against the Independent Death Fortresses.

All in all, what I really needed was a Wizard with some fiery spells – a Bright Wizard would be great. In another game against the Dark Elves a Volcano spell had worked wonders against the Black Ark, setting it alight from stem to stern. Failing a Bright Wizard, an Amethyst Wizard would do the trick. As it happened, I got a Celestial Wizard.



THE EMPIRE FLEET



1 × Greatship 'The Karl Franz'
150 points



1 × Squadron of 3 Wargalleys
150 points



1 × Squadron of 3 Wolfships
300 points



1 × Squadron of 3 Hellhammers
150 points



1 × Squadron of 3 Wargalleys
150 points



1 × Master Wizard
100 Points

I won the roll to choose table edge, and decided to deploy along the eastern edge of the table. I wanted to get to the open sea as soon as possible, and reasoned that if I let Jervis have the edge with the volcano and the rocks, he'd lurk about waiting for me to get caught in the confined space and be ripped up by his Sea Monsters. The best thing I could do was to get through the gap as soon as possible into open waters where I could better manoeuvre and bring my guns to bear.

I aimed to sail the Karl Franz quickly around the rock, and tack across the face of the wind to get behind his fleet as they approached, from where I could bring my broadside guns to bear. I felt I could afford to get her in pretty close, as she bristled with cannon, had plenty of crew, and her Man O' War Card – Heavy Timbers – gave me a +1 on all low location saving rolls.

To summarise, my fleet was set up bunched tightly together, aiming to move as fast as possible forwards into open waters. I led with a squadron of Wargalleys, who were followed by squadrons of Wolfships, Wargalleys and Hellhammers. Finally, I drew four Spell Cards, and my fleet was ready for battle!





HOW TO PLAY MAN O' WAR

Man O' War is more than just a game - it's an absorbing hobby that encompasses painting, modelling, constructing scenery, preparing your fleets for battle, and... another Man O' War player's boat. This exciting hobby is the most powerful fleet in the Old World. It is characterized by its fast moving warships and mighty floating castles. Long range support is provided by the Galleys while swift moving Wargalleys close with and destroy the enemy.

EMPIRE FLEET

EMPIRE WARGALLEY
Wargalleys are swiftest, lightest, nimblest frigates and are essential to the Empire's strategy.

CREW: 2

MOVES: 4 per movement phase. May be used in any direction, or backwards.

SEARCH: 2 (including ahead). Cannot ever replenish.

EMPIRE GALLEY
May only move in line of sight. Cannot ever replenish.

CAPTAIN'S CHART

The Captain's Chart and the Battle Honour are used to track the progress of the game.

PIRATE

Pirates are an ever present threat to the Empire - posed by the Wargalleys.

PIRATE
The Pirates are the most powerful of the Wargalleys.

MOVES: 4 per movement phase.

SEARCH: 2 (including ahead).

EMPIRE GALLEY
May only move in line of sight. Cannot ever replenish.

EMPIRE WARGALLEY

SHIP OF THE LINE

CREW 2

MOVES: 4 per movement phase. May be used in any direction, or backwards.

SEARCH: 2 (including ahead). Cannot ever replenish.

FORE CASTLE
Saves 4 or 5
Cannot be used if the ship is damaged.

OAR DECK
Saves 2 or 3
Oars lost. Cannot move unless full.

BELOW WATERLINE
Saves 6 or 8
First to take no effect. Second to take effect.

OARS: 4(6) SAIL: 6(8) BATTLE HONOURS: 2



. TURNS 3 TO 5 . THE CARNAGE COMMENCES!

TURN THREE

As luck would have it, the fickle forces of nature intervened, swinging the wind clockwise so it once again blew south. Meanwhile, the Imperial Wizard failed to ward off a Serpents of Doom spell that immobilised the Karl Franz.

With their most powerful ship out of action, the other Imperial Captains ordered ramming speed, and their ships surged forwards to try and sink the Plaguecrushers in their way.

The usually devastating rams failed to bite deep. The Imperial Admiral cursed as he watched helpless from the bridge of the immobilised Karl Franz. Cannons thundered, their choking thick smoke nearly obscuring his view of the battle.

When it lifted, he was horrified by what he saw: the Black Ark had glided forward, a floating mountain of shadows, its deadly reaper batteries raining a hail of death down onto the Imperial vessels.



The Empire fleets fails to inflict much damage by ramming, and is mauled by the Dark Elf Death Fortresses.



The Imperial Wargalleys crash into the Dark Elf fleet.



The Black Ark releases the Dark Elf Doomreavers into the fray.

A Wolfship, the Sigmar, was sinking below the waves, smashed by countless Reaper bolts. A Wargalley, the Sollund, broke in two before his eyes. Next to it, mauled by the ravaging attacks of the Death Fortresses, two abandoned Wargalleys drifted on the tide.

Even though the enemy Plaguecrushers had gaping rents in their sails and great chunks torn from their rotting hulls by his own guns, the Imperial Admiral knew it was not enough, and that his Hellhammers had to try and retrieve the situation.

TURN FOUR

As the Empire fleet reeled under the frenzied assault, the Dark Elf Admiral seized the initiative, though both sides' Wizards failed in their attempts to invoke their powers.

The Black Ark unleashed the fleet's three Doomreavers as it approached. The nightmarish reptiles crashed into the Imperial fleet savaging a Wargalley and destroying a Hellhammer with their brutal attacks.

The third Doomreaver in the squadron rampaged across the waves, incensed into a berserk fury and totally out of control. It smashed into one of the Death Fortresses in a blind rage, tearing the castle to pieces and slaying the Dark Elves within. No longer guided by its Dark Elf masters, the Sea Dragon, and the tattered remnants of the shattered Death Fortress atop its back, dived below the waves and out of the battle.

NURGLE PLAGUECRUSHER SHIP OF THE LINE		CREW 2
CATAPULTS Save 4, 5 or 6 Each hit destroys 1 Plague Catapult	SAIL Save 5 or 6 Mast lost: Ship cannot move under sail Any further hits do not cause critical damage	DAMAGE
2 TOWER Save 4, 5 or 6 If Tower is destroyed, crew are to fight unarmoured from enemy perspective	3 PADDLES Save 4, 5 or 6 Paddles lost: Cannot move under Paddles	4 AFTCASTLE Save 4, 5 or 6
NO EFFECT	SINKS	BELOW WATERLINE Save 4, 5 or 6 Final hit has no effect. Sunk but not sunk ship
PADDLES: 6" SAIL: 6"		BATTLE HONOURS: 2

Above: a Plaguecrusher has its sails and catapults destroyed by Imperial cannonfire.

EMPIRE WARGALLEY SHIP OF THE LINE		CREW 2
4 MAST Save 5 or 6 Mast lost: Ship cannot move under sail Any further hits do not cause critical damage	5 FORECASTLE Save 5 or 6 Mastin destroyed. May not fire	6 OAR DECK Save 5 or 6 Oars lost: Cannot move under oars
NO EFFECT	SINKS	BELOW WATERLINE Save 5 or 6 Final hit has no effect. Sunk but not sunk ship
OARS: 4"(6") SAIL: 6"		BATTLE HONOURS: 2

Left: Typically, the Imperial Wargalley is left intact but abandoned, its crew having been slaughtered by the Dark Elves' Sea Monsters.

In the front-line, a proud Wolfship fell to a fierce boarding action by the foul Chaos Cultists aboard the Plaguecrushers, who then hurriedly scuttled the vessel to prevent its recapture. Another Wolfship had all its crew killed by the merciless onslaught of a Dark Elf Death Fortress, but before it could be scuttled a gallant Wargalley remanned the stricken vessel.

The Empire fleet was being severely mauled, and things looked pretty grim.

EMPIRE WOLFSHIP						CREW 3
4	5	6				
FORE MAST Save 5 or 6 Mast lost Ship speed reduced by 2" (2") Any further hits do not cause critical damage	MAIN MAST Save 5 or 6 Mast lost Ship speed reduced by 2" (2") Any further hits do not cause critical damage	AFT MAST Save 5 or 6 Mast lost Ship speed reduced by 2" (2") Any further hits do not cause critical damage				
2	FORECASTLE Save 4, 5 or 6 Bow lost Mast lost Mast lost		MAIN DECK Save 4, 5 or 6 Broadside Cannon destroyed		3	
DAMAGE		DAMAGE				
BOWS Save 4, 5 or 6 Bow lost		5	OAR DECK Save 4, 5 or 6 Oars lost Cannot move under oars	6	STERN Save 4, 5 or 6	
DAMAGE		DAMAGE				
NO EFFECT		NO EFFECT		SINKS		
BELOW WATERLINE Save 4, 5 or 6 First and second hits have no effect Third hit sinks ship						
BATTLE HONOURS: 1						
OARS: 4" (6") SAIL: 6" BATTLE HONOURS: 2						

The brave crew of the Wargalley re-crewed the abandoned Wolfship, leaving 1 crew counter aboard each.

EMPIRE WARGALLEY						CREW
MAST Save 5 or 6 Mast lost Cannot move under sail Any further hits do not cause critical damage						
4					6	
FORECASTLE Save 4, 5 or 6 Cannon destroyed Mast not lost		OAR DECK Save 5 or 6 Oars lost Cannot move under oars		6		
5		6				
NO EFFECT		SINKS				
BELOW WATERLINE Save 5 or 6 First hit has no effect Second hit sinks ship						
BATTLE HONOURS: 2						
OARS: 4" (6") SAIL: 6" BATTLE HONOURS: 2						

DARK ELF BLACK ARK OF NAGGAROTH						CREW
MAN O' WAR						
4	5	6				
BLAZE FORE MAST Save 4, 5 or 6 First hit has no effect Second hit destroys mast Ship speed reduced by 3" (3") Any further hits do not cause critical damage	BLAZE MAIN MAST Save 4, 5 or 6 First hit has no effect Second hit destroys mast Ship speed reduced by 3" (3") Any further hits do not cause critical damage	BLAZE AFT MAST Save 4, 5 or 6 First hit has no effect Second hit destroys mast Ship speed reduced by 3" (3") Any further hits do not cause critical damage				
BLAZE FORWARD BATTLE TOWERS Save 4, 5 or 6 Fire ranges: battery lost		BLAZE REAR BATTLE TOWERS Save 4, 5 or 6 All vapor battery lost		DAMAGE		
4	5	6				
BOWS Save 4, 5 or 6 First and second hits Save no effect Third hit causes normal critical	BATTLE PLATFORMS Save 4, 5 or 6 Breaks down vapor battery lost	6	BEAST-PORTAL Save 4, 5 or 6 First 2 hits for each Squadron masts. On a 4, 5 or 6 they escape.			
DAMAGE	DAMAGE	DAMAGE	DAMAGE	NO EFFECT		SINKS
BELOW WATERLINE Save 4, 5 or 6 First, second, third, fourth and fifth hits have no effect Sixth hit sinks ship						
SAIL: 9" (9") MAGIC: 6" (6") BATTLE HONOURS: 10						

The Black Ark is initially heavily damaged by the attacks of the Imperial Hellhammers, and is then finished off by the guns of the Karl Franz.

Then the two remaining Hellhammers surged through the drifting debris and unleashed their deadly cannons at point blank range into the towering Black Ark. The roar of their immense guns blotted out all other sound, and the great cloud of smoke obscured the sun. The Black Ark began to list heavily, great gaping rents torn in its mountainous sides.



The Black Ark is surrounded by the deadly Hellhammers.

Undaunted, the monstrous vessel leapt forward, smashing the remaining Hellhammers apart. As the Dark Elves ran amok on their blood-soaked decks, the Imperial Admiral brought the Karl Franz into the fray, firing a devastating broadside at the Dark Elf flagship. Expecting to be crippled by the returning Reaper fire, a great cheer went up as the Black Ark turned turtle, and with a groaning of timber and shattered stone sank without a trace.

The Doomreaver picks up the Dark Elf Admiral and Wizard from the water.

WIZARD LORD ADMIRAL		DARK ELF DOOMREAVES MONSTER		WOUNDS 3
4,5	HELLDRAKE Save 5 or 6 Hell Drake takes 1 wound; place 1 wound counter on the wound track	6	DOOMREAVES Save 5 or 6 The Hell Drake goes out of control, dries, and is removed from play (along with Doomreaver with it).	
NO EFFECT	NO EFFECT	DEAD	WOUND TRACK Save Against Reims: 5 or 6 Each wound reduces movement by 1". Third wound kills Hell Drake.	
MONSTER: 6" - May turn freely.		BATTLE HOURS: 2		



Even though the Black Ark is no more, the Empire have only five functional ships against the Dark Elves' eight.

Through his telescope, the Imperial Admiral scanned the debris floating on the waves, and to his horror spotted the unmistakable forms of the Dark Elf Wizard and Admiral clinging to the sinking ship. Although he sent signals to run them down, there were no Imperial ships in their vicinity left to follow his orders. He watched powerless, as one of the Doomreavers picked up the Admiral and the Wizard just as the last remnants of the Black Ark disappeared.

TURN 5

Incensed by the loss of his flagship, the Dark Elf Admiral redoubled his efforts, goading his crews into a frenzied attack on the remaining enemy vessels. The Imperial ships, pounded and mauled, began to buckle under the continued assault. The Karl Franz sailed into the middle of the fray to try and redeem the situation with her great broadsides, before engaging one of the immense sea monsters in a vicious assault. Her crew streamed across onto its immense body, stabbing at its leathery skin with their swords and halberds, and sending volley after volley of gunfire into its flesh. Soon the crippled beast, howling its agony, was forced away from the fray.

The remaining Imperial ships - horribly outnumbered but undaunted - fought to the last. The sea ran red as the Doomreavers attacked repeatedly, and sharks began to circle the area, drawn by the blood in the water.

By the end of the turn, the only Imperial vessel left was the Karl Franz, with all the other Empire ships captured, abandoned or sunk. The Dark Elves, on the other hand, had abandoned one Plaguecrusher, while one Sea Dragon was horribly wounded and near death.

DARK ELF DEATH FORTRESS INDEPENDENT MONSTER			WOUNDS 6
4	SEA DRAGON HEAD Save 4, 5 or 6 Sea Dragon takes 1 wound; place 1 wound counter on the wound track	5	DEATH FORTRESS Save 4, 5 or 6 Sea Dragon goes out of control and dries - the model is removed from play
3		SEA DRAGON BODY Save 4, 5 or 6 Sea Dragon takes 1 wound; place 1 wound counter on the wound track	6
WOUND TRACK Against Reims: 5 or 6 Each wound reduces movement by 1"			DEAD
MONSTER: 6" - May turn freely.			BATTLE HOURS: 4

The Dark Elf Death Fortress is engaged by the crew of the Karl Franz, who cripple the beast and force it to break away from the combat.

. TURNS 6 TO 9 . HUNT THE KARL FRANZ

Outnumbered, outgunned and surrounded, the Imperial Admiral realised that victory was now beyond his grasp. Yet again, the Imperial Wizard failed to cast any magic, while the Dark Elf Wizard casts a Spectre spell, slaughtering many crew aboard the Imperial flagship.

Meanwhile, one of the Plaguecrushers managed to get some Cultists aboard her abandoned sister ship, bringing it back into the fray.

Bombarded by plague catapults, the Greatship's guns were destroyed one by one, until the Imperial Admiral had no choice but to try to escape the battle with his remaining crew. The Karl Franz's gundecks were alight, and the blaze was spreading rapidly.

Manoeuvring to get the wind in his sails, the Imperial Admiral attempted to take the Karl Franz to safety and escape from the relentless pounding of the plague catapults. Infected with Nurgle's Rot, and with the crew sorely depleted, the Karl Franz could not defend herself against a boarding



Although there are five Empire ships afloat, by this time only the Karl Franz has any crew left to carry on the fight!



Empire Greatship

action by the pursuing Doomreavers and Death Fortresses, so turned tail and fled. The chase was on in earnest, with three Plaguecrushers, three Doomreavers, plus a single Death Fortress pursuing the crippled Imperial flagship. By now the fires were raging out of control below her decks, and the once mighty Greatship did not have a gun left to fire.

Then, a sudden stroke of luck; the Empire Wizard finally managed to cast a spell successfully, causing a torrent of blinding rain to put out all the blazes. The relief was short lived, however, as the Dark Elf Wizard brought forth the power of the Warp to cast a spell to immobilise the Karl Franz.

Closing for the kill, one of the Doomreavers attacked the Karl Franz, hoping to slay the crew and leave the mighty warship abandoned. Enraged to a snarling, slashing frenzy, the beast instead rampaged out of control, attacking and destroying one of the remaining Death Fortresses in a welter of blood and bone. But the remorseless pounding of the Plaguecrushers carried on unabated, and the Greatship was reduced to a ruin – barely afloat yet desperately trying to flee.

. TURN 10 . THE KILLING BLOW

Now was the last chance for the Karl Franz to escape, but it was not to be. Both Wizards failed to cast their chosen spells – the Dark Elf Wizard attempting to immobilise the Greatship with a Storm Strike, while the Imperial Wizard tried desperately to gain a few yards movement with a Blizzard spell to put him out of range of his pursuers.

This failed exchange of sorcery sealed the fate of the stricken Karl Franz, as the leading Doomreaver finally caught up with her and tore her crew to pieces, leaving yet another abandoned Imperial ship drifting across the seascape.

The battle was over, and all that was left was to count the cost...



The Karl Franz's crew is killed by a Dark Elf Doomreaver, leaving it drifting, abandoned and shattered beyond repair.

EMPIRE <b style="font-size: 1.5em;">GREATSHIP MAN O' WAR				CREW 5
4 FORE MAST Save 5 or 6 First hit has no effect. Second hit destroys mast. Ship speed reduced by 2 (3*). Any further hits do not cause critical damage.	5 MAIN MAST Save 5 or 6 First hit has no effect. Second hit destroys mast. Ship speed reduced by 2 (3*). Any further hits do not cause critical damage.	DAMAGE	AFT MAST Save 5 or 6 First hit has no effect. Second hit destroys mast. Ship speed reduced by 2 (3*). Any further hits do not cause critical damage.	
ABANDONED				
2 DAMAGE	FORECASTLE Save 4, 5 or 6 Each hit destroys 1 row cannon battery.	DAMAGE	AFTCASTLE Save 4, 5 or 6 Each hit destroys 1 row cannon battery.	
DAMAGE	BOWS Save 4, 5 or 6 1 broadside cannon battery lost.	DAMAGE	GUN DECK Save 4, 5 or 6 1 broadside cannon battery lost.	
DAMAGE	DAMAGE	DAMAGE	STERN Save 4, 5 or 6 1 broadside cannon battery lost.	
NO EFFECT	NO EFFECT	NO EFFECT	SINKS	
BELOW WATERLINE Save 4, 5 or 6 First, second and third hits have no effect. Fourth hit destroys hull.				
SAIL: 6*(9*)		BATTLE HONOURS: 6	NAME: Karl Franz	



The Karl Franz is set upon by a Dark Elf Doomreaver.

CONCLUSION

At the end of the day, the Imperial fleet was utterly destroyed at the hands of the Dark Elves, although the Dark Elf fleet took a severe mauling too. One of the Dark Elves floating cities was gone forever but the Admiral and Sorcerer still lived to wreak further revenge on the Empire for the loss of their ancient home.

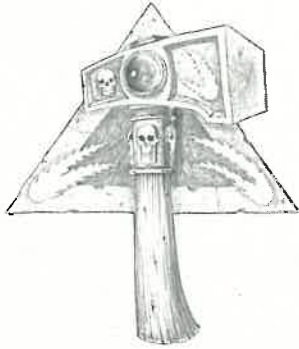

THE DARK ELF ADMIRAL GLOATS

Woe, oh terrible, terrible woe. Losing the Black Ark – the shame of it! How could I have allowed it to happen? Seriously though, as it turns out I was right and Andy really didn't stand a chance in this battle, but he put up a much harder fight than I would have thought possible. At the end of the day, however, the cluttered terrain combined with my Wizard being able to cast the Wind Master and then Mire to blow Andy's flagship off course and then bog it down early in the battle is what caused his doom. The loss of the Black Ark aside, my plan went almost perfectly, and there is very little I would change if I were to fight the battle again. Nonetheless, I did learn a number of valuable lessons.

As I have already pointed out, my Wizard certainly earned his keep, which is more than could be said for the Empire's Wizard. This just goes to show what a difference a +1 dice roll modifier and a couple of extra Spell Cards can make! I think that in future I will stick with taking a Master Wizard, at least if I am using a Dark Elf fleet. The Plaguecrushers and Death Fortresses proved an excellent combination, borne out by the fact that they wiped out most of the Empire fleet with very little help from the Black Ark and Doomreavers. As the battle progressed, it turned out that the Plaguecrushers were even more useful than I had first realised. As Death Fortresses and Doomreavers cannot capture an enemy ship once they have wiped out its crew, many enemy ships end up abandoned but otherwise fairly intact. A wise opponent will re-crew such ships and bring them back into the fray. However, as I discovered during the battle, the Chaos Cultists onboard the Plaguecrushers were just right for scuttling enemy ships that had been abandoned before Andy could re-crew them.

Which brings me to the Dark Elves biggest loss in the battle, the destruction of the Black Ark. Although Andy was a little lucky to take out the Black Ark quite so easily, nonetheless his Hellhammers are extremely potent weapons – especially at close range – and I should have treated them with a lot more respect. What is even more galling in retrospect is that if I had concentrated my Doomreavers against the Hellhammers at the start of turn 4, I would have had the opportunity to destroy them all before they fired a shot! In future I will take more care to protect the Black Ark under such circumstances.

The final lesson I learned also concerned the Doomreavers, and their ability to make a frenzied attack. Although this special attack can be devastating, it is highly unpredictable. As it was, both times I used it the Doomreaver in question went out of control and destroyed one of my own Death Fortresses! What made this even more annoying was that in both cases the Death Fortress hadn't had its turn yet, and so I lost the chance to fire its Reaper batteries and use its deadly close range attack. In future I will make sure that I only goad a Doomreaver into frenzy if it is really worth the risk, and try to make sure that I make the attack at the end of my turn rather than at the beginning.

Turning my attention to the other half of the table, I would have to say that Andy probably paid too much attention to keeping the wind in his sails as opposed to forming a good line abreast formation. I have a strong hunch that this is because Andy's main experience is with a Bretonnian fleet (with which he has a fearsome and highly justified reputation). The Bretonnians use completely different tactics and battle formations to the Empire, and being powered by sails the wind direction becomes vitally important. In any case, I'm sure that Andy will not make the same mistake the next time we meet, now that he has had a bit of practice using (or should I say losing...) an Empire fleet.

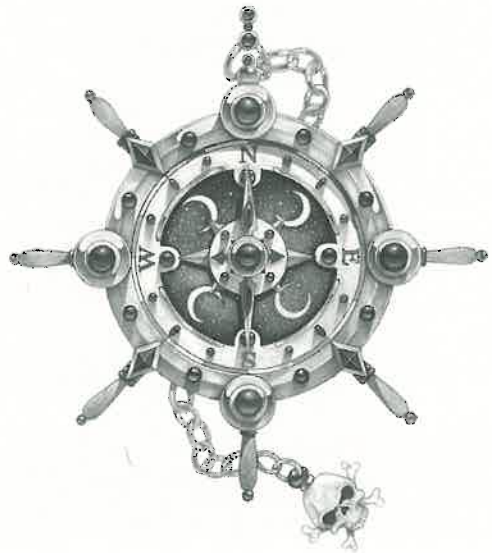

*Empire Ironfist*

THE EMPIRE ADMIRAL LAMENTS

Well, what can I say? The Empire fleet received a thorough drubbing at the hands of the dreaded Dark Elves, although in retrospect it could have been a lot worse.

I think it's fair to say that I lost the game due to bad planning, bad luck and a Wizard who must have smooth-talked his way onboard ship by pulling rabbits out of hats (he certainly wasn't doing anything else during the game).

My experience with the mighty Bretonnian Armada has left a residual fear of sailing into the wind, and so I set up my fleet taking great care not to leave the Greatship behind. Looking at my set up, you can see that if I had gone round the volcano the other way, the Greatship would have been sailing into the wind almost immediately; as it was, all I had to do was round the rocky outcrop and turn so that the wind was in my sails. Then I would be able to bear down upon Jervis' fleet with all guns blazing – and a Greatship has a lot of guns!

This meant that the rest of my fleet was bottled up in the straits between the outcrop and the volcano, but I manfully set up my ships in line abreast formation, guns forward, planning to get through the gap quickly under sail, spread out and catch the Dark Elves between the hammer of the Greatship and the anvil of the rest of my fleet.

Alas, it was not to be, as right from the start things went horribly wrong. My fear of the wind was borne out as Jervis luckily started the game with the Windmaster spell in his hand, and quickly cast it against me, slowing down my fleet and making things almost impossible for the Karl Franz.

From then on things went from bad to worse. As quite often happens, I gained the initiative for the first few turns as the fleets approached each other; then, in the crucial stages of the battle, I lost the initiative continually, which allowed Jervis to do his worst.

In other games I've been rammed by the Imperial fleet, and know how devastating it can be, but my planned 'ram and smash' attack at the start of the game failed to do anything conclusive. I failed to sink a single enemy vessel, even though I used 3 Wargalleys and 3 Wolfships (12 guns and six rams) in the assault. In fact, all that it did was place my ships in just the right position to be torn apart by the Death Fortresses.

About the only thing that did work in the way I anticipated was the Hellhammers. If you have an Imperial fleet, get some – they are invaluable and saved me from a total disaster!

Actually, a very important lesson that I learnt from the battle was 'know your enemy'. It's been a little while since I put the rules for the Dark Elves together, and it's funny how time muddies your memory. I was under the impression (as stated in my plan) that Dark Elves were more or less invulnerable to spells that kill crew. Not so – they are the spells that can wipe out Death Fortresses and Doomreavers immediately, by killing the few Dark Elves that control them.

I foolishly discarded these spells, going after those that could set the enemy on fire. I should have been going through as many cards as I could, and actively searching for the very spells whose usefulness I had discounted, using them to wipe out the Death Fortresses' and Doomreavers' crews.

In future, I'd perhaps be tempted to have either a 50 point Wizard Champion, giving me an extra 50 points to spend on ships, or a 150 point Wizard Lord. The 100 point Master Wizard fell somewhere between the two, and didn't do anything much at all (though that could of course be attributed to my dismal dice rolls as much as anything else).

Empire Hell-hammer

The Dark Elf movement rules also meant Jervis could continually manoeuvre around to my unguarded sides or rear and attack me where I couldn't add my cannons to the defence.

Finally, I was perhaps more scared of the Plaguecrushers than I should have been. I might have been better served if I had set up in line abreast formation in the more open area of the sea on the other side of the volcano, attempting to tack with my Greatship and showering the approaching Dark Elves with cannon fire for as long as possible. Instead, I closed too soon to avoid being bottled up in the narrow straits, and the Empire ship templates show the results: 5 out of my 13 ships were unharmed but abandoned, as Jervis' Sea Monsters did their worse. Many of my other ships had also been boarded and their crews slain before they were scuttled. In a nutshell, it was the boarding actions that were the death of me. The lesson to be learnt here is to keep the Dark Elves at arm's reach!

Still, it was not a complete debacle, and I certainly ruined Jervis' fleet as a viable fighting force. Next time I'll maintain strict Imperial discipline and keep the thin red line together. Let's see how Jervis' Dark Elves like an impenetrable battle line of cannon fire and cold steel!

BATTLE HONOURS

At the end of the battle, the Empire fleet had gained 18 Battle Honours, while the Dark Elves had gained a massive total of 47 Battle Honours.

This total is a little deceptive, however, as things could have been a lot closer if I'd only managed to sink the remaining Death Fortress... if only the Dark Elf Admiral and Wizard had died with the Black Ark... if only the Karl Franz had escaped off the table... if only... But next time things will be different, and I will have my revenge!

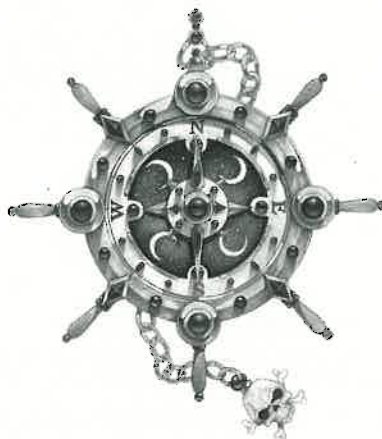

FLYING CREATURES

The soul-tearing screech of bat-winged Manticores strikes fear in the enemies of the Dark Elf fleet. Ridden by Dark Elf lords, these gigantic beasts soar high above the waters to swoop down upon their enemy's ships. As they dive towards their victim, the Manticore releases a deadly projectile, known as the Doomfist. The heavy barbed sphere smashes into the target, shattering timbers and ripping through the hull, to send the vessel to a watery grave.

Aware of the dangers posed by such attacks from the air, Bretonnian warfleets enlist valiant Knights for protection. Bretonnian Pegasus riders are heavily armoured champions mounted on mighty winged horses. Soaring aloft on these great beasts, they lunge at their foes, piercing them with heavy lances or striking them from the sky with their great swords.

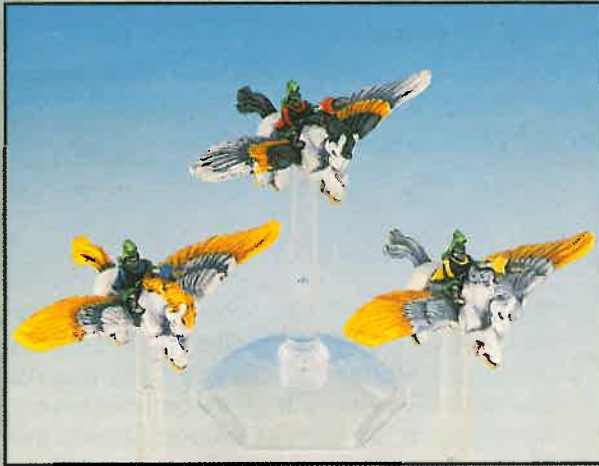

BRETONNIAN PEGASUS RIDERS

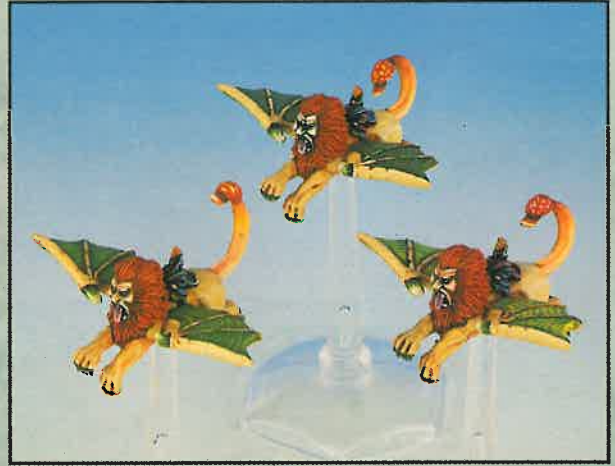

DARK ELF MANTICORE RIDERS



A BRETONNIAN FLEET CLASHES WITH DARK ELVES ON THE HIGH SEAS.

GAMES WORKSHOP®

UK MAIL ORDER

OUR TELEPHONE HOTLINES ARE OPEN FROM

**9.00am – 6.30pm Monday to Friday
9.00am – 5.00pm on Saturdays**

Games Workshop Mail Order is a great way to purchase all of the new releases from Games Workshop and Citadel and Marauder Miniatures. Our friendly staff are always ready to advise you on all the latest miniatures and they also have details of special Mail Order deals.

**AVAILABLE
NOW!**

WARHAMMER 40,000 BOXED SET



The new boxed Warhammer 40,000 game contains 80 new plastic Citadel Miniatures (20 Space Marines, 20 Space Orks and 40 Gretchin with Autoguns), a comprehensive Rulebook, a Wargear equipment book, the Codex Imperialis background book, a Scenario booklet, plus full-colour templates, counters, fast playsheet and 20 card buildings. Also included in the box are Wargear, Mission, Vehicle and Dreadnought cards, Squad data and Weapons reference cards, a full-colour guide to painting the models, ten ordinary dice and four special dice for moderating heavy weapons and artillery fire.



AUSTRALIAN MAIL ORDER

**Good News! We now have a
Mail Order Hotline in Sydney**

02-317-2550

Along with the opening of our first two Australian Games Workshop Stores, we've also established our Australian Mail Order Hotlines. You can call between **9.00 and 5.30 Monday to Friday** and order a huge selection of Games Workshop Games and Citadel and Marauder miniatures. Phone now to see what's new and our friendly staff will be more than happy to advise you on all the latest models and releases.

**SAME DAY TURNAROUND
SUPER FAST
DISPATCH!**

UK MAIL ORDER

Our UK Mail Order Hotlines are open six days a week, and you can pay by Visa, Access or Switch.

**(0773) 713213, Monday to Friday
between 9.00am and 6.30pm
Saturdays 9.00am to 5.00pm**

If you're posting your order, please send it to:

**GAMES WORKSHOP
MAIL ORDER SERVICE,
CHEWTON STREET, HILLTOP,
EASTWOOD, NOTTINGHAM NG16 3HY.**

Or you can fax the order through on
(0773) 530155.

WARHAMMER

WARHAMMER BOXED SET	£29.99
WARHAMMER BATTLE MAGIC	£17.99
WARHAMMER ARMIES – THE EMPIRE	£9.99
WARHAMMER ARMIES – HIGH ELVES	£9.99
WARHAMMER ARMIES – ORCS & GOBLINS	£9.99
WARHAMMER ARMIES – DWARFS	£9.99
NEW! WARHAMMER ARMIES – SKAVEN	£9.99
SELF ADHESIVE BANNERS Each pack contains 5 sheets of banners (Available for Orcs, Goblins, High Elves and Dwarfs.)	£2.99

UNDEAD

NEW! LICHE KING'S CHARIOT	£14.99 each
----------------------------------	-------------

SKAVEN

NEW! SKAVEN VERMIN LORD	£11.99 each
NEW! SKAVEN WARLORD QUEEK	£4.99 each
NEW! SKAVEN LORD SKROLK	£4.99 each
NEW! SKAVEN RAT OGRES	£5.99 each

HOBGOBLINS

NEW! HOBGOBLIN SNEAKY GITS	£1.00 each
NEW! HOBGOBLIN BOLT THROWER	£5.99 each
HOBGOBLIN COMMAND GROUP	£1.35 each

WARHAMMER 40,000

NEW! WARHAMMER 40,000 BOXED SET	£34.99
NEW! CODEX SPACE WOLVES (Phone for availability)	£9.99
NEW! WARHAMMER 40,000 PAINTING GUIDE (Phone for availability)	£9.99
NEW! WARHAMMER 40,000 POSTER	£4.99
NEW! WARHAMMER 40,000 BADGE	£4.99
NEW! WARHAMMER 40,000 T-SHIRT	£9.99

ULTRAMARINES BOXED MINIATURES

NEW! ASSAULT TROOPS BOXED SET	£9.99
--------------------------------------	-------

SPACE WOLVES BOXED MINIATURES

NEW! SPACE WOLVES DREADNOUGHT	£19.99 each
GREY HUNTERS BOXED SET	£12.99
LONG FANGS BOXED SET	£9.99
BLOOD CLAWS BOXED SET	£12.99
WOLF GUARD BOXED SET	£12.99

SPACE MARINES

NEW! RHINO BOXED SET	£5.99
NEW! SPACE MARINE WARRIORS	£9.99
PREDATOR BOXED SET	£9.99
SPACE MARINE DREADNOUGHT	£19.99 each
SPACE MARINES	£1.35 each
SPACE MARINE DEVASTATOR BODIES	£1.35 each

HEAVY WEAPONS	£1.25 each
DEVASTATORS BOXED SET	£9.99

IMPERIAL AGENTS

NEW! ADEPTUS ARBITES	£1.35 each
NEW! ADEPTUS ARBITES CAPTAIN	£2.00 each
NEW! ADEPTUS ARBITES GRENADE LAUNCHER	£2.00 each

ORKS

NEW! SPACE ORK WARRIORS Contains 10 Plastic Ork Sprues	£7.99
GOFF SKARBOYZ	£1.35 each
GOFF NOBZ	£2.99 each

SPACE MARINE

SPACE MARINE	£29.99
SPACE MARINE BATTLES (BOOK)	£9.99
ARMIES OF THE IMPERIUM	£14.99
RENEGADES (Chaos and Eldar armies)	£14.99
ORK & SQUAT WARLORDS	£14.99

EPIC SQUATS

NEW! CYCLOPS	£9.99
---------------------	-------

MAN 'O' WAR

MAN O' WAR	£24.99
PLAGUE FLEET	£14.99
SEA OF BLOOD	£14.99

MAN O' WAR BOXED MINIATURES

SKAVEN SHIPS

NEW! SKAVEN DOOMBRINGER	£4.99
NEW! SKAVEN PLAGUE BURNERS (BOX OF 3)	£4.99
NEW! SKAVEN WARP-RAIDERS (BOX OF 3)	£4.99

CHAOS

PLAGUE CRUSHERS (BOX OF THREE)	£4.99
PLAGUE SHIP	£4.99

MONSTERS AND FLYERS

NEW! BRETONNIAN PEGASUS RIDERS (BOX OF 3)	£4.99
NEW! DARK ELF MANTICORE RIDERS (BOX OF 3)	£4.99
IMPERIAL GRIFFON RIDERS (BOX OF 3)	£4.99
ORC WYVERN RIDERS (BOX OF 3)	£4.99
DWARF GYROCOPTERS (BOX OF 3)	£4.99
DWARF WAR BALLOONS (BOX OF 3)	£4.99
HIGH ELF EAGLE RIDERS (BOX OF 3)	£4.99
HIGH ELF DRAGON RIDERS (BOX OF 3)	£4.99



DEATH ON THE SEA OF CLAWS

SPECIAL MAN O' WAR FLEET DEALS

BUY BOTH FLEETS TOGETHER FOR £57.50

Post free in the UK and BFPO

EMPIRE FLEET

IMPERIAL GREATSHIP BOXED SET	£4.99
IMPERIAL WOLFSHIPS BOXED SET	£9.99
IMPERIAL WARGALLEY BOXED SET	£4.99
IMPERIAL WARGALLEY BOXED SET	£4.99
IMPERIAL HELLHAMMERS BOXED SET	£4.99

TOTAL VALUE £34.96

SPECIAL OFFER PRICE £31.50

Post free in the UK and BFPO

DARK ELF FLEET

DARK ELF BLACK ARK BOXED SET	£9.99
DARK ELF DOOMREEVERS BOXED SET	£4.99
DARK ELF DEATH FORTRESS BOXED SET	£9.99
NURGLE PLAGUECRUSHERS BOXED SET	£9.99

TOTAL VALUE £29.95

SPECIAL OFFER PRICE £27.50

Post free in the UK and BFPO

WHITE DWARF SUBSCRIPTIONS

UK, EUROPE, & THE REST OF THE WORLD

UK & BFPO: £27.50 for one year (12 issues).

EUROPE: £35.

REST OF THE WORLD: £45 for one year.

Please send payments to Games Workshop Mail Order, Chewton St, Hilltop, Eastwood, NOTTINGHAM, NG16 3HY. All payments should be in pounds sterling. Please make cheques payable to Games Workshop Ltd.

If you have a Visa, Access or Mastercard you may place your subscription by phoning our Mail Order department on 0773 713213.

USA & CANADA

Please contact: White Dwarf Subscriptions, 3431 C Benson Avenue, Baltimore, Maryland 21227-1072. For VISA and Mastercard orders, please telephone our Mail Order hotline on (410) 644 5699, Monday to Friday, 9am - 5pm EST.

Please state which issue you would like your subscription to start with.

CORRESPONDENCE

We welcome comments about White Dwarf, Games Workshop games and Citadel Miniatures. All letters except subscriptions and Mail Order should be addressed to: The Editor, White Dwarf, Games Workshop, Howard House, 16 Castle Boulevard, Nottingham NG7 1FL.

Clearly mark your envelope with the name of the game you are writing to us about. If you want a reply you *must* enclose a self-addressed stamped envelope (overseas readers should include IRCs). We receive an enormous amount of mail. We do read every letter, but it may take a little time for us to reply to you, so please be patient!



COPYRIGHTS AND TRADEMARKS

All subject matter in White Dwarf is © Copyright Games Workshop Ltd 1994.

All artwork in all Games Workshop products, and all images contained therein have been produced either in-house or as work for hire. The exclusive copyright in the artwork and the images it depicts is the property of Games Workshop Ltd. © Copyright Games Workshop Ltd 1994. All rights reserved.

Registered Trademarks

The following are all registered trademarks of Games Workshop Ltd.

Armageddon, Blood Bowl, Chivalry, the Citadel logo, Confrontation, Dark Future, Eldar Attack, Epic, the Flame logo, the Games Workshop logo, Games Workshop, Realm of Chaos, Slottabase, SpaceFleet, Space Marine, Talisman, White Dwarf and the White Dwarf figure, and Warhammer.

Trademarks

The following are all trademarks of Games Workshop Ltd.

Aspect Warrior, Avatar, Blood Angels, Bloodletter, Bloodthirster, Citadel, Daemnette, Dark Angels, Dark Reaper, Deathwing, Dragonmasters, Dungeonquest, Eldar, Exo Armour, Exarch, Eye of Terror, Farseer, Fire Dragon, Flesh Hound, Gargant, Genestealer, Gobbo, Great Unclean One, Gretchin, Grey Knight, Hunter Slayer, Keeper of Secrets, Khorne, Knights Panther, Leman Russ, Lichemaster, Lightning Claw, Lord of Change, Madboy, Mekboy, Mighty Empires, Nurgle, Nurgling, Ogryn, Old World, Ork, Painboy, Plaguebearer, Psyker, Ratling, Ravenwing, Skaven, Slaanesh, Slann, Snotling, Space Hulk, Space Wolves, Squat, Squig, Swooping Hawk, Striking Scorpion, Terminator, Thunder Hammer, Troll Slayer, Tyranids, Tzeentch, Ultramarines, Warmaster, Weirdboy, Knights of the White Wolf, Worldeater.

GW Books is a trademark of GW Books Ltd. Used with permission.

Flame is a trademark of Flame Publications Ltd. Used with permission.

Marauder Miniatures is a trademark of Marauder Miniatures Ltd. Used with permission.

Heroquest and Space Crusade are both trademarks of Milton Bradley Games. Used with permission.

Scatter dice are UK registered design No. 2017484.

EMPIRE WARSHIPS

IMPERIAL GREATSHIP

AN IMPERIAL GREATSHIP CONSISTS OF:

- 1 x HULL
- 1 x AFT CASTLE
- 1 x FORE CASTLE

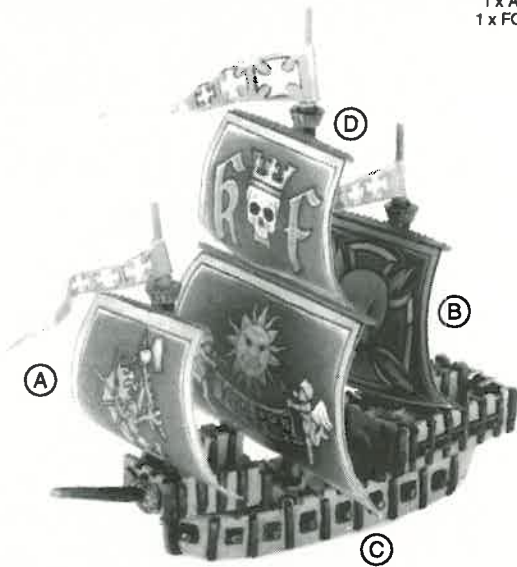

EXAMPLE OF COMPLETED AND FULLY PAINTED GREATSHIP

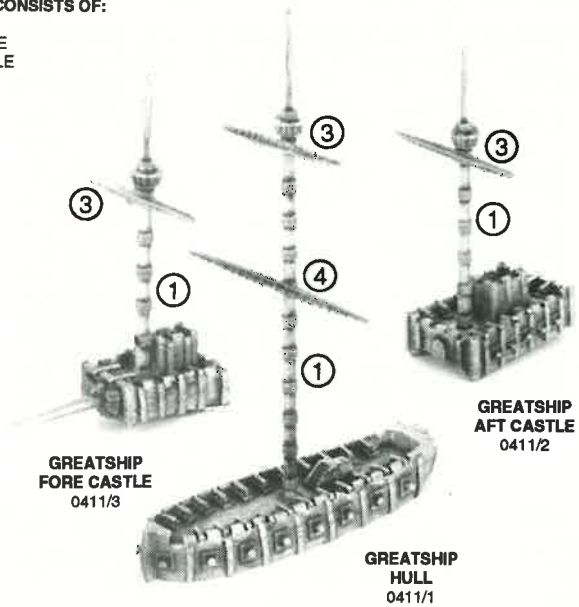

IMPERIAL WOLFSHIP

AN IMPERIAL WOLFSHIP CONSISTS OF:

- 1 x HULL
- 1 x AFT CASTLE

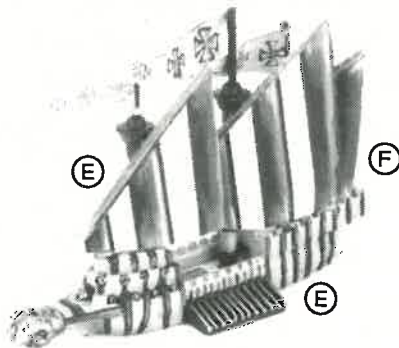

EXAMPLE OF COMPLETED AND FULLY PAINTED WOLFSHIP

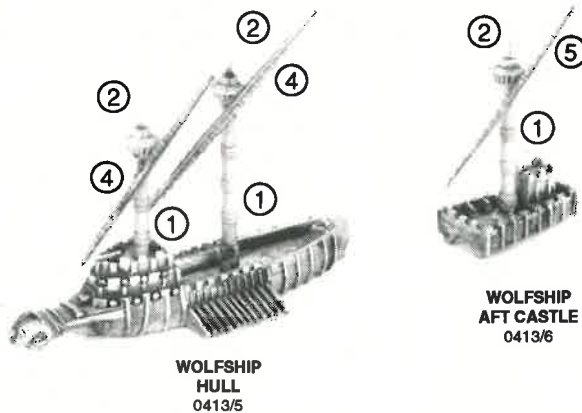

NOTE THAT SOME OF THESE SHIPS' MASTS HAVE BEEN SHORTENED TO MAKE THEM THE CORRECT LENGTH FOR EACH TYPE OF SHIP; REFER TO THE MAN O' WAR PAINTING GUIDE FOR MORE DETAILS ON HOW TO DO THIS.

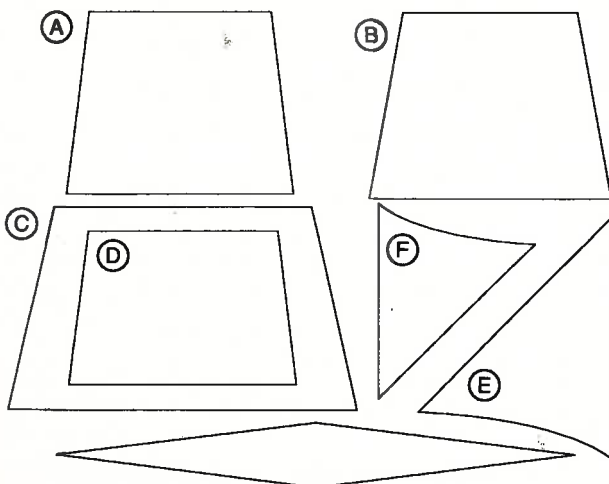

THESE SAILS AND PENNANTS MAY BE PHOTOCOPIED, CUT OUT, PAINTED AND STUCK ONTO YOUR MINIATURES. PERMISSION GRANTED TO PHOTOCOPY FOR PERSONAL USE ONLY.

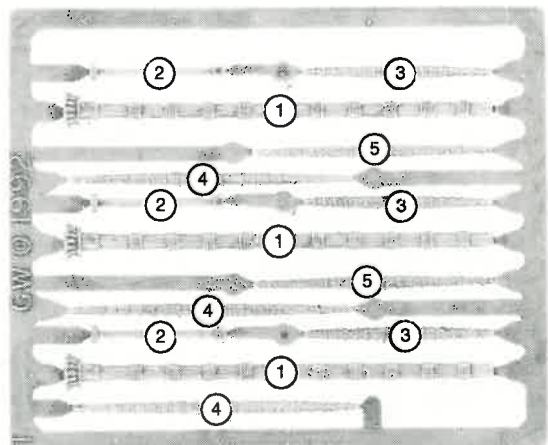

MAN O' WAR PLASTIC MAST SPRUE
MOWPLA2

THESE MODELS ARE SUPPLIED WITH ONE OR MORE MAST SPRUES WHERE NECESSARY.

Miniatures supplied unpainted. WARNING: This product contains lead which may be harmful if chewed or swallowed. Citadel Miniatures are not recommended for children under 14 years of age. © Copyright Games Workshop Ltd 1994. All rights reserved.



Designed by Norman Swales

EMPIRE WARSHIPS

IMPERIAL WARGALLEY

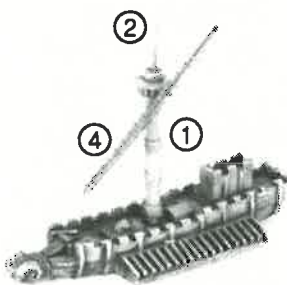
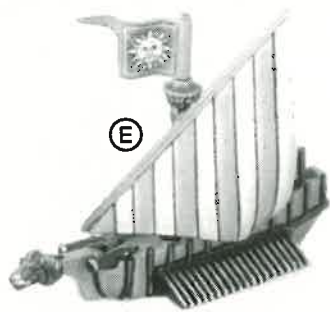

IMPERIAL
WARGALLEY
04127

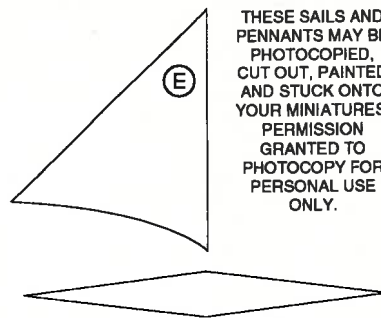

THESE SAILS AND
PENNANTS MAY BE
PHOTOCOPIED,
CUT OUT, PAINTED
AND STUCK ONTO
YOUR MINIATURES.
PERMISSION
GRANTED TO
PHOTOCOPY FOR
PERSONAL USE
ONLY.

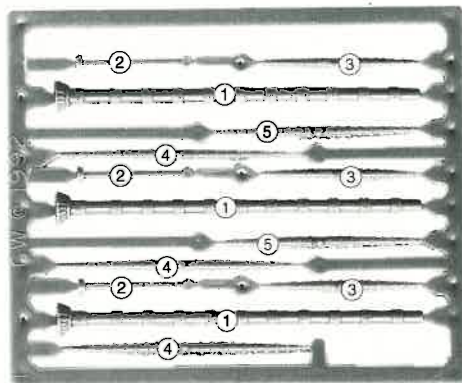
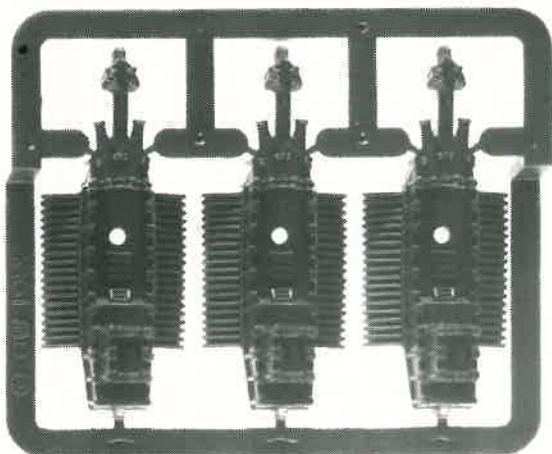

MAN O'WAR PLASTIC MAST SPRUE
MOWPLA/2

HELLHAMMER



CANNON
78064/2



HULL
78064/1

THE COMPLETE
HELLHAMMER
CONSISTS OF:
1 x HELLHAMMER HULL
1 x HELLHAMMER CANNON

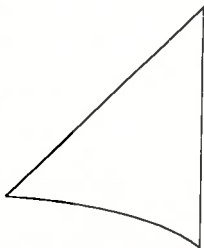

THESE SAILS AND PENNANTS MAY BE PHOTOCOPIED,
CUT OUT, PAINTED AND STUCK ONTO YOUR MINIATURES.
PERMISSION GRANTED TO PHOTOCOPY FOR PERSONAL USE ONLY.

Designed by Norman Swales

Minatures supplied unpainted. **WARNING:** This product contains lead which may be harmful if chewed or swallowed. Citadel Miniatures are not recommended for children under 14 years of age.
© Copyright Games Workshop Ltd 1994. All rights reserved.



DARK ELF WARSHIPS

BLACK ARK OF NAGGAROTH

THE COMPLETE BLACK ARK OF NAGGAROTH CONSISTS OF:

- 2 x LARGE TOWERS
- 2 x SMALL TOWERS
- 1 x SKULL PROW
- 1 x STERN GATE
- 1 x RIGHT SIDE
- 1 x LEFT SIDE
- 1 x DECK 1
- 2 x DECK 2
- 2 x PLASTIC MAST SPRUES

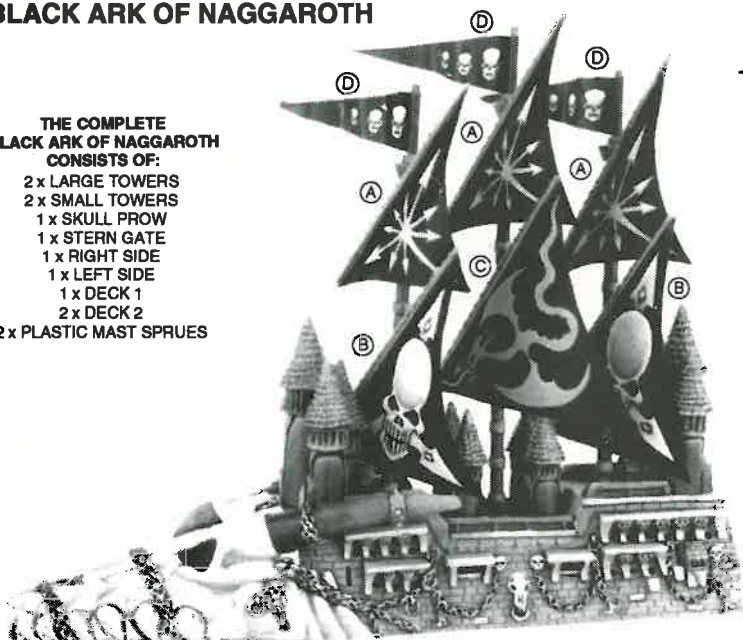

EXAMPLE OF COMPLETED AND FULLY PAINTED BLACK ARK OF NAGGAROTH

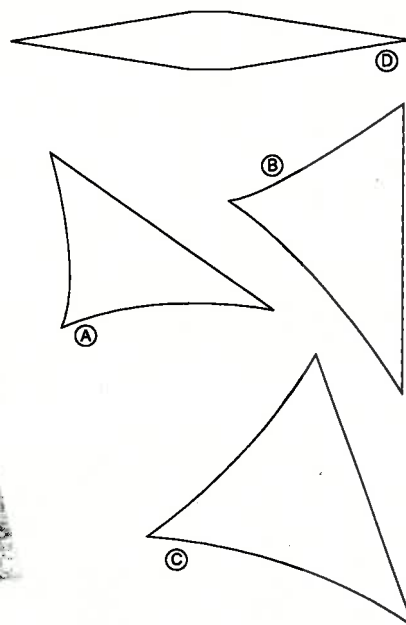

SKULL PROW
78021/1



BLACK ARK SMALL TOWER
78021/5



BLACK ARK DECK 2
78021/8



BLACK ARK DECK 1
78021/7



BLACK ARK STERN GATE
78021/6



BLACK ARK LARGE TOWER
78021/4



BLACK ARK RIGHT SIDE
78021/3



BLACK ARK LEFT SIDE
78021/2

SHIP CONSTRUCTION DIAGRAMS

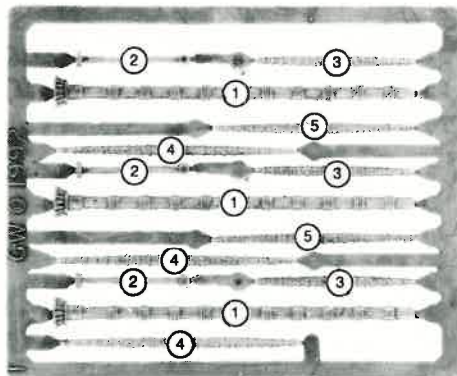

MAN O' WAR PLASTIC MAST SPRUE MOW PLA/2

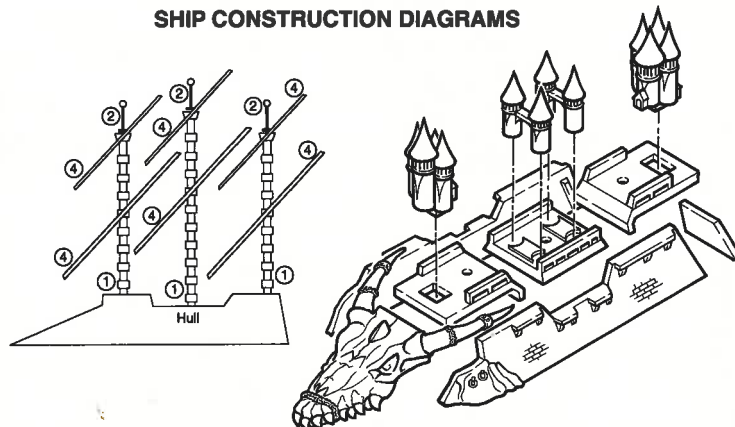

THE DIAGRAM ABOVE ILLUSTRATES THE CORRECT LENGTH FOR EACH MAST AND THE TYPE AND NUMBER OF YARD ARMS.

THE SAILS AND PENNANTS ABOVE MAY BE PHOTOCOPIED, CUT OUT, PAINTED AND STUCK ONTO YOUR MINIATURES.
PERMISSION GRANTED TO PHOTOCOPY FOR PERSONAL USE ONLY.

Minatures supplied unpainted. WARNING: This product contains lead which may be harmful if chewed or swallowed. Citadel Miniatures are not recommended for children under 14 years of age. © Copyright Games Workshop Ltd 1993. All rights reserved.



Designed by Norman Swales and Michael Perry

CHAOS WARSHIPS

PLAGUE CRUSHER

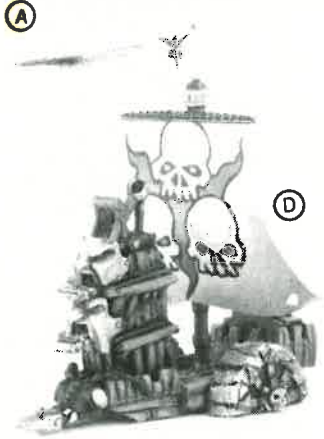

CATAPULT TOWER
8042/2

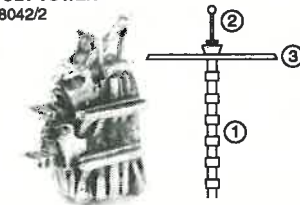

HULL
8042/1



PADDLES
8042/3

THE COMPLETE
NURGLE PLAGUE CRUSHER
CONSISTS OF:

- 1 x HULL
- 1 x CATAPULT TOWER
- 2 x PADDLES

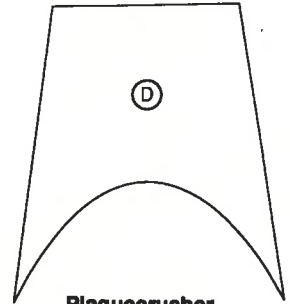

Plaguecrusher
Masts: one 1, one 2
Yard: one 3

PLAGUE SHIP

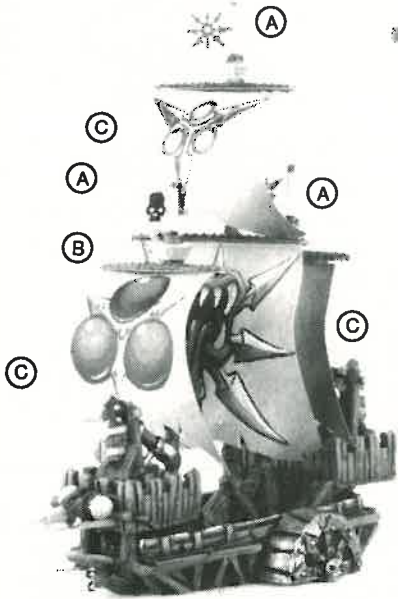

HULL
8041/1



FORE CASTLE
8041/4



PADDLES
8041/3



PLAGUE CATAPULT
8041/5



AFT CASTLE
8041/2

THE COMPLETE
NURGLE PLAGUE SHIP
CONSISTS OF:

- 1 x HULL
- 1 x ART CASTLE
- 1 x FORECASTLE
- 2 x PADDLES
- 3 x PLAGUE CATAPULT

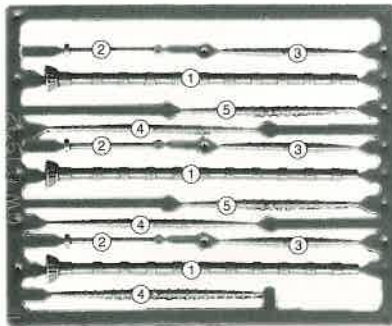
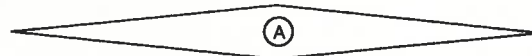

MAN O' WAR PLASTIC
MAST SPRUE
MOWPLA/2

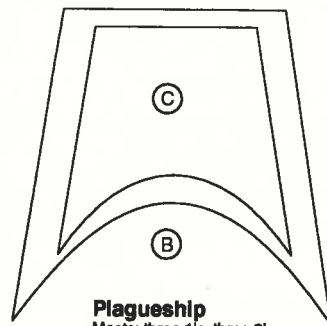

Plagueship
Masts: three 1's, three 2's
Yard: three 3's, one 5

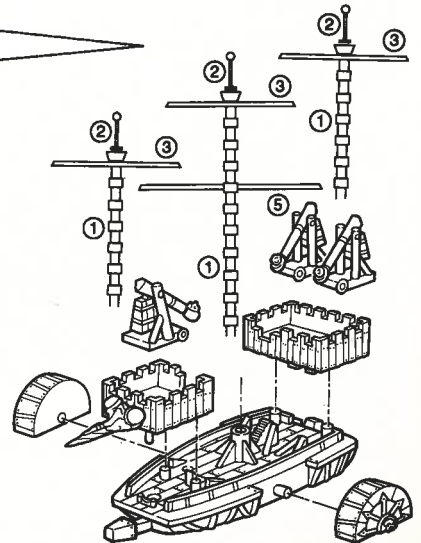

THE DIAGRAM ABOVE ILLUSTRATES THE CORRECT LENGTH FOR EACH MAST AND THE TYPE AND NUMBER OF YARD ARMS.
THE SAILS AND PENNANTS ABOVE MAY BE PHOTOCOPIED, CUT OUT, PAINTED AND STUCK ONTO YOUR MINIATURES.
PERMISSION GRANTED TO PHOTOCOPY FOR PERSONAL USE ONLY.

Designed by Dave Andrews

Minatures supplied unpainted. **WARNING.** This product contains lead which may be harmful if chewed or swallowed. Citadel Miniatures are not recommended for children under 14 years of age.
© Copyright Games Workshop Ltd 1994. All rights reserved.



MAN O'WAR

BRETONNIAN PEGASUS RIDER



PEGASUS BODY
78014/2



WINGS 1
78004/1

THE COMPLETE BRETONNIAN PEGASUS RIDER CONSISTS OF:
1 x PEGASUS BODY
1 x WINGS 1



DARK ELF MANTICORE RIDER



MANTICORE BODY
78024/2



WINGS 2
78005/1

THE COMPLETE DARK ELF MANTICORE RIDER CONSISTS OF:
1 x MANTICORE BODY
1 x WINGS 2



Designed by Michael Perry

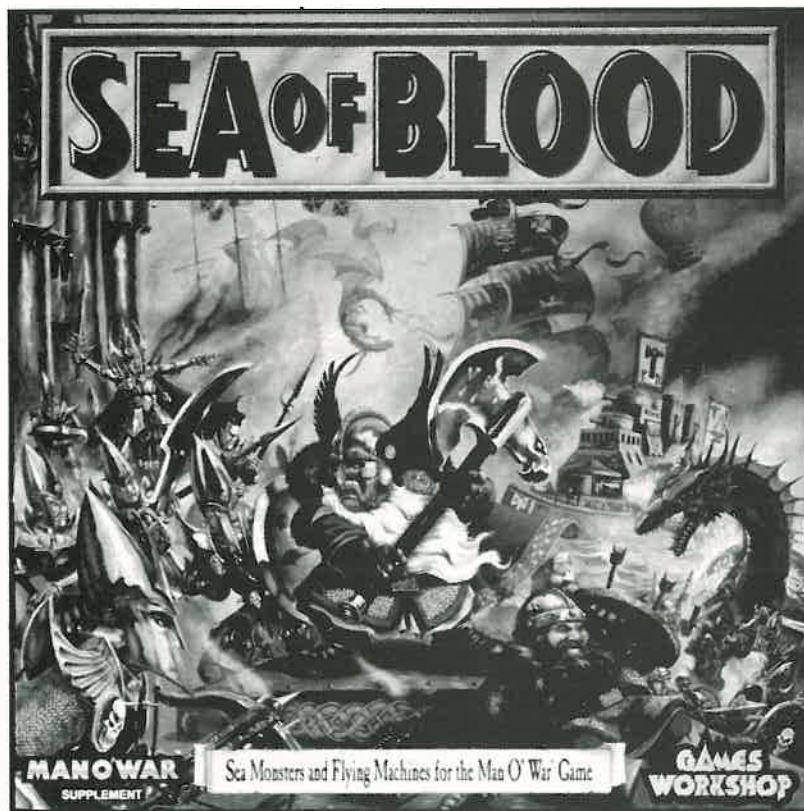

SEA OF BLOOD IS THE SECOND SUPPLEMENT TO THE MAN O'WAR GAME OF RAGING SEA BATTLES.

Sea of Blood contains new rules for sea monsters and flying creatures, to be used in conjunction with the Man O'War game and the Plague Fleet supplement:

Sea Monsters

The Triton, Sea Elemental, Sea Dragon, Megaladon, Promethean, Black Leviathan, Gargantuan and Behemoth rise to the surface to vent their fury against the fleets of the Known World.

Airpower

Bretonnian Pegasus Riders, Dwarf Gyrocopters and War Balloons, Elf Dragon Riders and War Eagles, Imperial Griffon Riders, Orc Wyvern Riders, Dark Elf Manticore Lords, Chaos Dwarf Taurus Riders and Lords of Change fill the smoke-laden skies above the battle.

MAN O'WARTM
SUPPLEMENT

SEA OF BLOOD IS NOT A COMPLETE GAME. YOU WILL NEED A COPY OF THE MAN O'WAR GAME TO USE THE CONTENTS OF THIS BOX

GAMES[®]
WORKSHOP



MAN O' WAR

IMPERIAL GRIFFON RIDER



GRIFFON BODY
78066/2



WINGS 1
78004/1

THE COMPLETE
IMPERIAL GRIFFON RIDER
CONSISTS OF:
1 x GRIFFON BODY
1 x WINGS 1

ORC WYVERN RIDER



WYVERN BODY
78034/2



WINGS 2
78005/1

THE COMPLETE
ORC WYVERN RIDER
CONSISTS OF:
1 x WYVERN BODY
1 x WINGS 2

HIGH ELF EAGLE RIDER



EAGLE BODY
78004/2



WINGS 1
78004/1

THE COMPLETE
HIGH ELF EAGLE RIDER
CONSISTS OF:
1 x EAGLE BODY
1 x WINGS 1

HIGH ELF DRAGON RIDER



DRAGON BODY
78005/2



WINGS 2
78005/1

THE COMPLETE
HIGH ELF DRAGON RIDER
CONSISTS OF:
1 x DRAGON BODY
1 x WINGS 2

DWARF GYROCOPTER

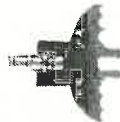

GYROCOPTER WINGS
78063/2



GYROCOPTER BODY
78063/1

THE COMPLETE
DWARF GYROCOPTER
CONSISTS OF:
1 x GYROCOPTER BODY
1 x GYROCOPTER WINGS

DWARF WAR BALLOON



BALLOON
78065/1



GONDOLA
78065/2

THE COMPLETE
DWARF WAR BALLOON
CONSISTS OF:
1 x BALLOON
1 x ARMOURD GONDOLA

Designed by Michael Perry and Norman Swales

Minatures supplied unpainted. WARNING. This product contains lead which may be harmful if chewed or swallowed. Citadel Miniatures are not recommended for children under 14 years of age.

Minatures supplied unpainted. WARNING. This product contains lead which may be harmful if chewed or swallowed. Citadel Miniatures are not recommended for children under 14 years of age.

© Copyright Games Workshop Ltd 1993. All rights reserved.

© Copyright Games Workshop Ltd 1993. All rights reserved.



HOBGOBLINS

COMMAND

THESE MINIATURES ARE SUPPLIED WITH APPROPRIATE PLASTIC SHIELDS AS STANDARD



**HOBGOBLIN
BIG BOSS 1**
75860/4



**HOBGOBLIN
BOSS 1**
75860/3



**HOBGOBLIN
DRUMMER**
75860/2



**HOBGOBLIN
STANDARD BEARER 1**
75860/1



**HOBGOBLIN
BIG BOSS 2**
75860/8



**HOBGOBLIN
STANDARD BEARER 2**
75860/5



**HOBGOBLIN
BOSS 2**
75860/7



**HOBGOBLIN
TRUMPETER**
75860/6

SNEAKY GITS



SNEAKY GIT 1
75873/1



SNEAKY GIT 2
75873/2



SNEAKY GIT 3
75873/3

Designed by Alan Perry

Miniatures supplied unpainted. **WARNING:** This product contains lead which may be harmful if chewed or swallowed. Citadel Miniatures are not recommended for children under 14 years of age.

© Copyright Games Workshop Ltd 1983. All rights reserved.



HOBGOBLINS

HOBGOBLIN BOLT THROWER

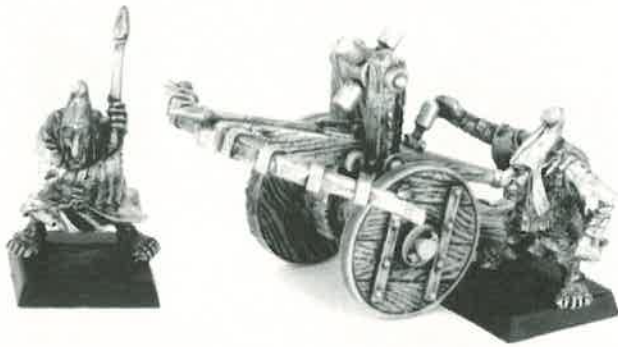

THE COMPLETED HOBGOBLIN BOLT THROWER CONSISTS OF:
 1 x HOBGOBLIN BOLT FIRER
 1 x HOBGOBLIN SPEAR LOADER
 1 x RIGHT SIDE
 1 x LEFT SIDE
 1 x BOLT THROWER
 1 x BOW
 1 x TOWING RING
 1 x WINDLASS
 2 x SOLID PLASTIC WHEELS

EXAMPLE OF COMPLETED HOBGOBLIN BOLT THROWER

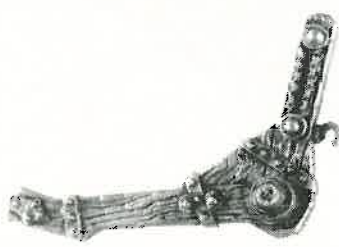

RIGHT SIDE
75874/3

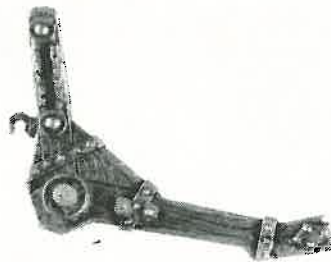

LEFT SIDE
75874/4



SOLID PLASTIC WHEEL



BOW
75874/6



BOLT THROWER
75874/5



TOWING RING
75874/7



WINDLASS
75874/8



HOBGOBLIN SPEAR LOADER
75874/2



HOBGOBLIN BOLT FIRER
75874/1

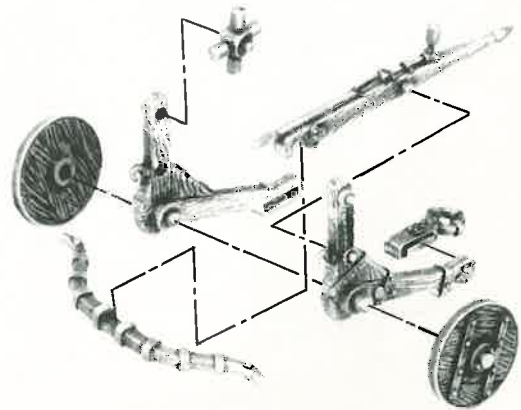

Designed by Norman Swales and Alan Perry

Miniatures supplied unpainted. **WARNING.** This product contains lead which may be harmful if chewed or swallowed. Citadel Miniatures are not recommended for children under 14 years of age.

Miniatures supplied unpainted. **WARNING.** This product contains lead which may be harmful if chewed or swallowed. Citadel Miniatures are not recommended for children under 14 years of age.

© Copyright Games Workshop Ltd 1993. All rights reserved.

© Copyright Games Workshop Ltd 1993. All rights reserved.



UNDEAD

LICHE KING'S CHARIOT



WHEEL
0519/9

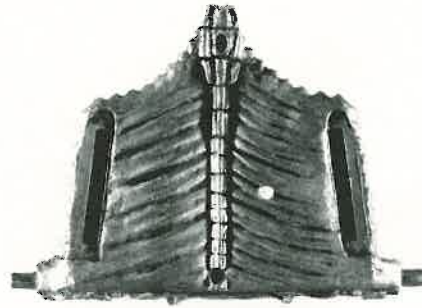

CHARIOT BASE
0519/2



LECTERN
0519/7



LEFT WING
0519/4

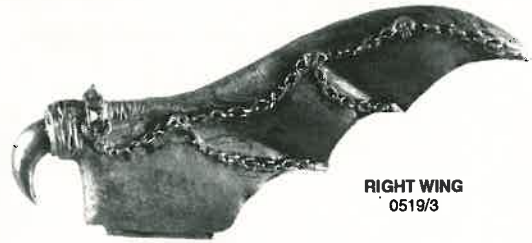

RIGHT WING
0519/3



YOKE
0519/6



CHARIOT HAFT
0519/5



BANNER
0519/8



LICHE KING
0519/1

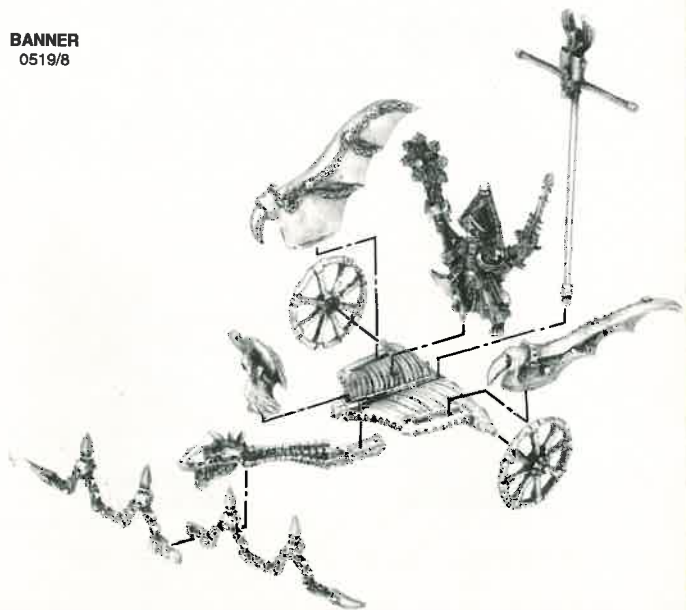

Minatures supplied unpainted. **WARNING:** This product contains lead which may be harmful if chewed or swallowed. Citadel Miniatures are not recommended for children under 14 years of age. © Copyright Games Workshop Ltd 1994. All rights reserved.



Designed by Gary Morley

UNDEAD

LICHE KING'S CHARIOT



- THE COMPLETED LICHE KING'S CHARIOT CONSISTS OF:**
- 1 X LICHE KING
 - 1 X CHARIOT BASE
 - 1 X LECTERN
 - 1 X CHARIOT HAFT
 - 1 X BANNER
 - 1 X LEFT WING
 - 1 X RIGHT WING
 - 2 X YOKE
 - 2 X WHEEL
 - 4 X PLASTIC SKELETON HORSES

EXAMPLE OF COMPLETED LICHE KING'S CHARIOT

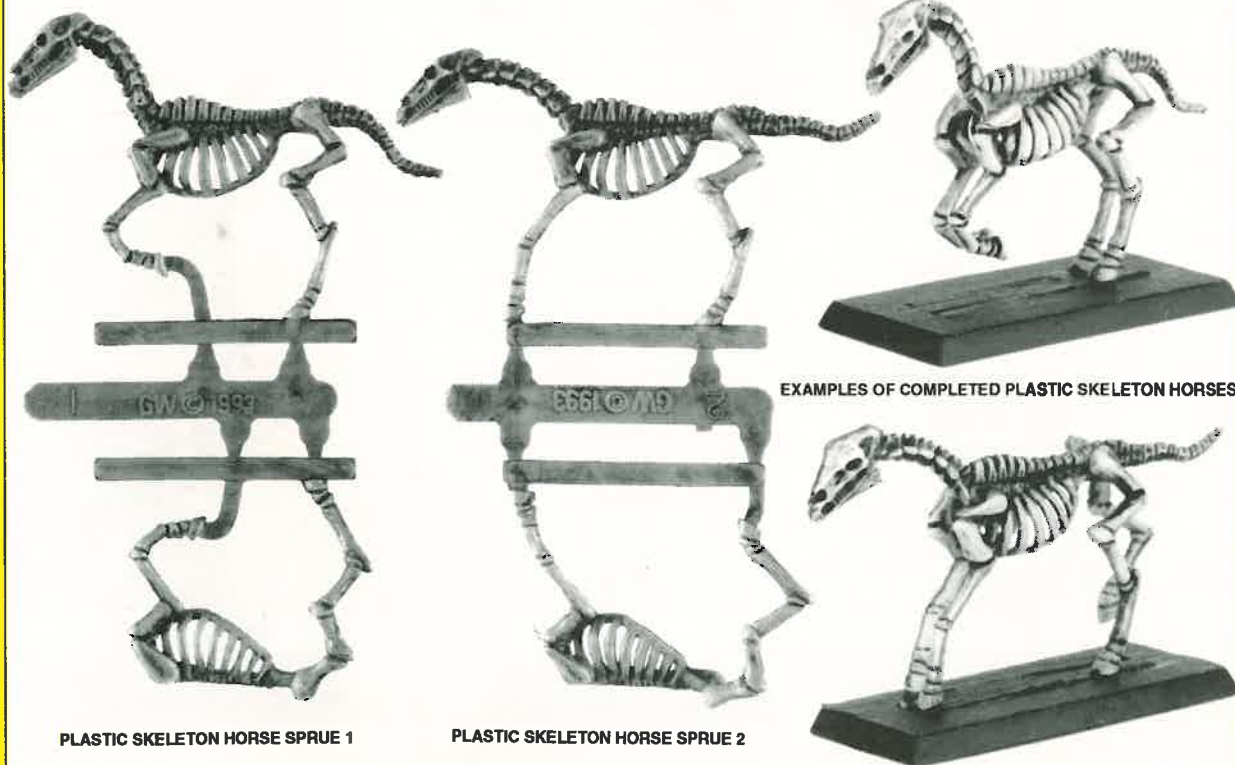

EXAMPLES OF COMPLETED PLASTIC SKELETON HORSES

PLASTIC SKELETON HORSE SPRUE 1

PLASTIC SKELETON HORSE SPRUE 2

Designed by Gary Morley

Minatures supplied unpainted. **WARNING:** This product contains lead which may be harmful if chewed or swallowed. Citadel Miniatures are not recommended for children under 14 years of age.
© Copyright Games Workshop Ltd 1994. All rights reserved.



CITADEL
MINIATURES

CITADEL
MINIATURES

SKAVEN

RAT OGRES



**RAT OGRE
HEAD 1**
74460/2



**RAT OGRE
HEAD 2**
74460/3



**RAT OGRE
HEAD 3**
74460/1



**RAT OGRE
TORSO 1**
74460/5



**RAT OGRE
TORSO 2**
74460/4



**RAT OGRE
TORSO 3**
74460/6

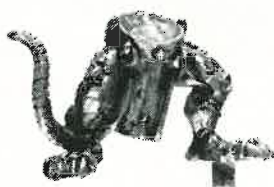

**RAT OGRE
LEGS 1**
74460/7



**RAT OGRE
LEGS 2**
74460/8

**THE COMPLETED RAT OGRE
MODELS CONSIST OF:**
1 X RAT OGRE HEAD
1 X RAT OGRE TORSO
1 X RAT OGRE LEGS



EXAMPLES OF COMPLETED RAT OGRES

Minatures supplied unpainted. **WARNING:** This product contains lead which may be harmful if chewed or swallowed. Citadel Miniatures are not recommended for children under 14 years of age. © Copyright Games Workshop Ltd 1993. All rights reserved.



Designed by Michael Perry

SKAVEN

VERMIN LORD, GREATER DAEMON OF THE HORNED RAT

THE COMPLETED VERMIN LORD
CONSISTS OF:
1 X HEAD
1 X TORSO
1 X LEGS
1 X LEFT ARM
1 X RIGHT ARM
1 X TAIL



EXAMPLE OF COMPLETED VERMIN LORD



HEAD
0516/1



TORSO
0516/2



LEGS
0516/3



RIGHT ARM
WITH HALBERD
0516/4



LEFT ARM
0516/5



TAIL
0516/6

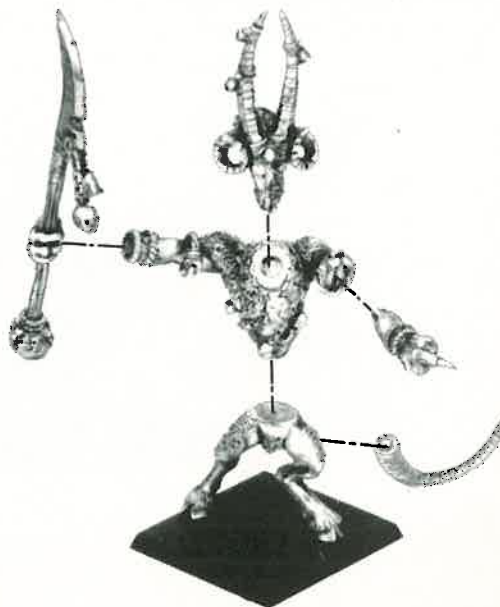

Miniatures supplied unpainted. WARNING. This product contains lead which may be harmful if chewed or swallowed. Citadel Miniatures are not recommended for children under 14 years of age.

© Copyright Games Workshop Ltd 1993. All rights reserved.

Miniatures supplied unpainted. WARNING. This product contains lead which may be harmful if chewed or swallowed. Citadel Miniatures are not recommended for children under 14 years of age.

© Copyright Games Workshop Ltd 1993. All rights reserved.

CITADEL
MINIATURES

CITADEL
MINIATURES

Designed by Michael Perry

SKAVEN

LORDS



LORD SKROLK
74463/1



EXAMPLE OF COMPLETED WARLORD QUEEK



WARLORD QUEEK
74465/1

THE COMPLETED WARLORD QUEEK
CONSISTS OF:
1 x WARLORD QUEEK
1 x TROPHY RACK

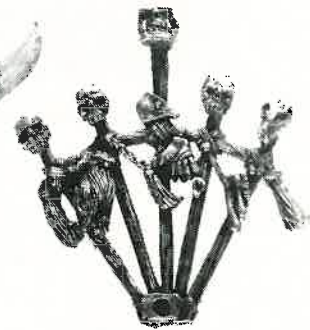

QUEEK'S TROPHY RACK
74465/2

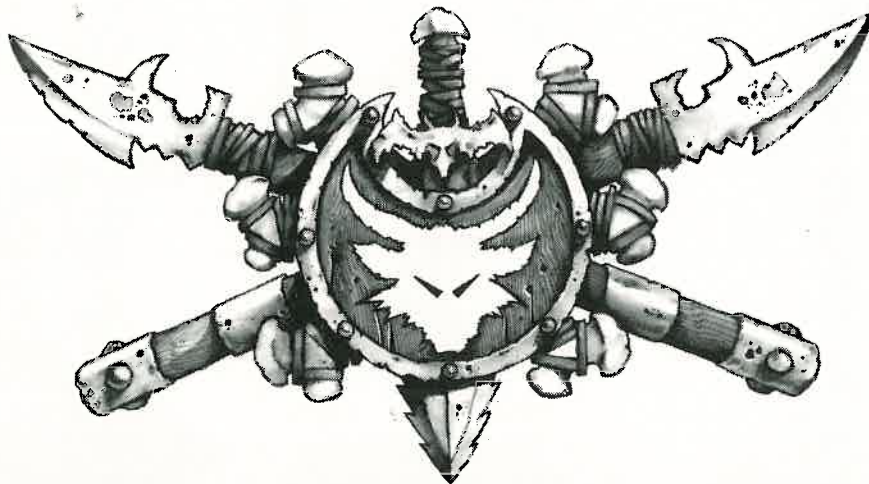

Designed by Jes Goodwin

Minatures supplied unpainted. **WARNING.** This product contains lead which may be harmful if chewed or swallowed. Citadel Miniatures are not recommended for children under 14 years of age. © Copyright Games Workshop Ltd 1994. All rights reserved.



EPIC SQUAT

SQUAT CYCLOPS

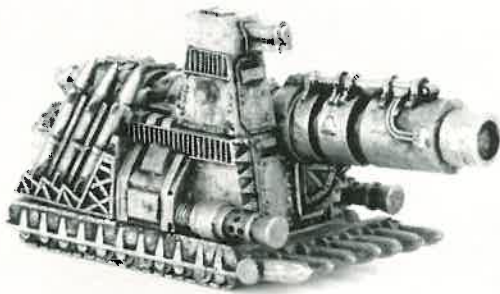

THE COMPLETED SQUAT CYCLOPS

CONSISTS OF:

- 1 x HELLFURY CANNON BARREL
- 1 x HELLFURY CANNON END
- 1 x HELLFURY CANNON TOP
- 2 x DOOMSTORM MISSILES
- 1 x RAM
- 1 x BATTLE CANNON TURRET
- 2 x MELTA CANNON
- 1 x HULL LEFT SIDE
- 1 x HULL RIGHT SIDE
- 1 x HULL REAR
- 1 x BARREL SUPPORT

EXAMPLE OF COMPLETED SQUAT CYCLOPS

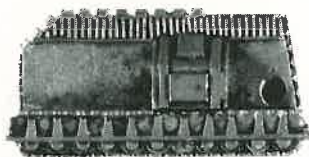

HULL RIGHT SIDE
0500/1



HELLFURY CANNON TOP
0500/3

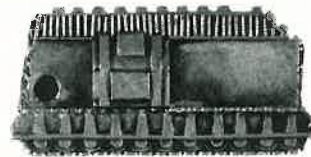

HULL LEFT SIDE
0500/2



HULL REAR
0500/5



BARREL SUPPORT
0500/4



HELLFURY CANNON BARREL
0500/6



HELLFURY CANNON END
0500/7



RAM
0500/10



MELTA CANNON
0500/8



DOOMSTORM MISSILES
0500/11



BATTLE CANNON TURRET
0500/9

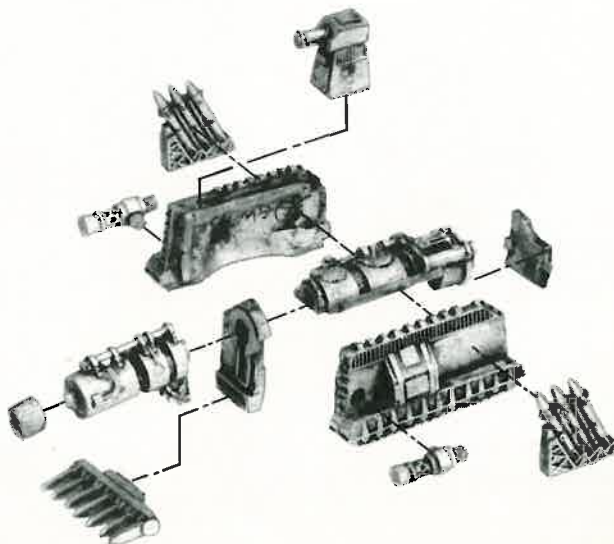

Minatures supplied unpainted. **WARNING:** This product contains lead which may be harmful if chewed or swallowed. Citadel Miniatures are not recommended for children under 14 years of age.

© Copyright Games Workshop Ltd 1994. All rights reserved.

Minatures supplied unpainted. **WARNING:** This product contains lead which may be harmful if chewed or swallowed. Citadel Miniatures are not recommended for children under 14 years of age.

© Copyright Games Workshop Ltd 1994. All rights reserved.



Designed by Norman Swales

SPACE WOLVES DREADNOUGHT

BJORN THE FELL-HANDED

THE COMPLETED BJORN THE FELL-HANDED

- CONSISTS OF:
 1 x SARCOPHAGUS 2
 1 x REAR BODY
 1 x LOWER BODY
 1 x LEGS
 2 x FOOT
 1 x BACK SECTION
 1 x ASSAULT CANNON
 1 x POWER CLAW ARM
 1 x POWER CLAW
 1 x AUTO LAUNCHER
 1 x BANNER POLE 2

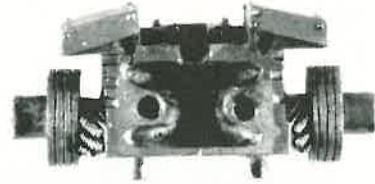
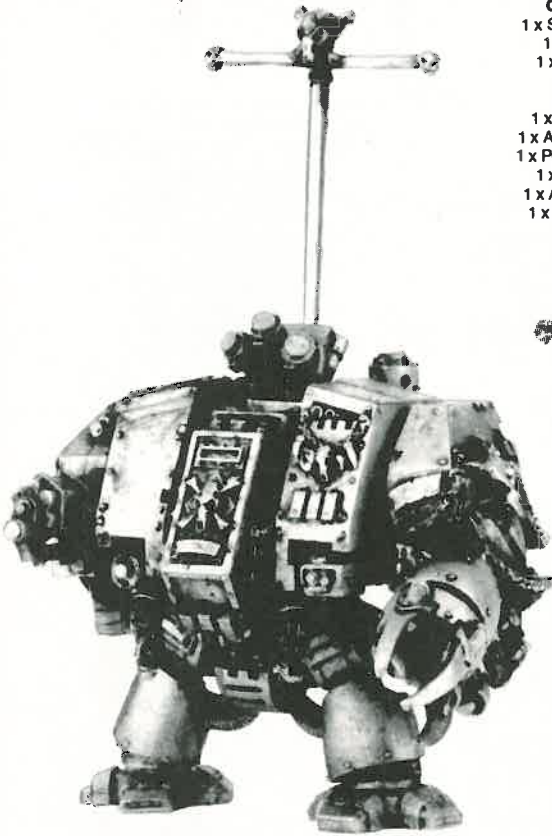

REAR BODY
0425/11



BANNER POLE 2
0427/15

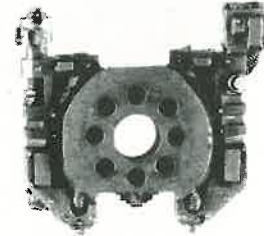

LOWER BODY
0425/2

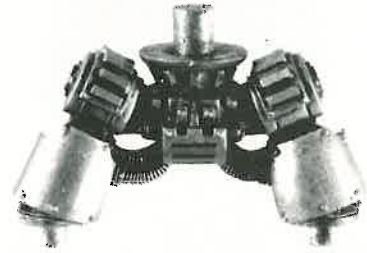

LEGS
0425/9

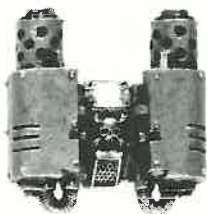

BACK SECTION
0425/4

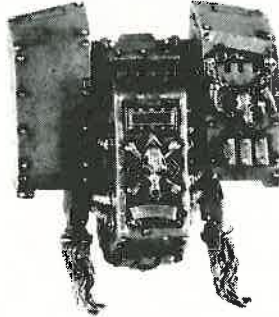

SARCOPHAGUS 2
0427/10

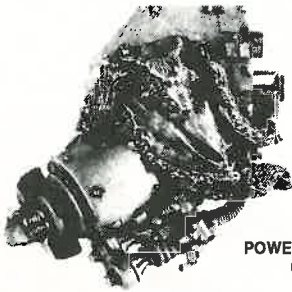

POWER CLAW ARM
0427/13

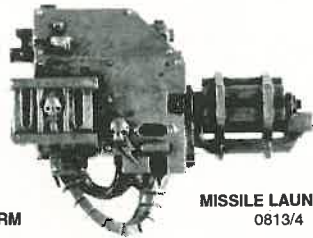

MISSILE LAUNCHER
0813/4

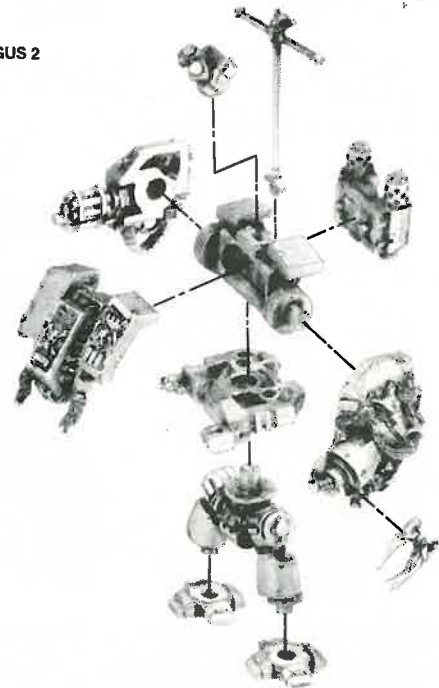

AUTO LAUNCHER
0425/7



POWER CLAW
0427/14



FOOT
0425/8

Minatures supplied unpainted. **WARNING:** This product contains lead which may be harmful if chewed or swallowed. Citadel Miniatures are not recommended for children under 14 years of age.
 © Copyright Games Workshop Ltd 1993. All rights reserved.



Designed by Jes Goodwin

IMPERIAL AGENTS

ADEPTUS ARBITES



ADEPTUS ARBITES
CHAMPION WITH SHOTGUN
72401/4



ADEPTUS ARBITES
WITH GRENADE LAUNCHER
72401/4



ADEPTUS ARBITES
WITH BOLTER
72400/2



ADEPTUS ARBITES
WITH SHOTGUN
72400/1

Designed by Jes Goodwin



JOHN BLANCHE

Miniatures supplied unpainted. **WARNING.** This product contains lead which may be harmful if chewed or swallowed. Citadel Miniatures are not recommended for children under 14 years of age.

© Copyright Games Workshop Ltd 1993. All rights reserved.

Miniatures supplied unpainted. **WARNING.** This product contains lead which may be harmful if chewed or swallowed. Citadel Miniatures are not recommended for children under 14 years of age.

© Copyright Games Workshop Ltd 1994. All rights reserved.





AN EMPIRE ARMY FACES AN UNDEAD HOST LEAD BY ARKHAN THE BLACK - THE LICHE KING