

# GAMES WORKSHOP

PRESENTS ITS MONTHLY HOBBY SUPPLEMENT AND MINIATURES CATALOGUE



# WHITE DWARF



CITADEL  
MINIATURES

167

£2.25



ISSN 0265-8712



9 770265 871028

11



SKAVEN GUTTER RUNNERS AMBUSH AN EMPIRE ARMY



DWARFS DEFEND THEIR MOUNTAIN STRONGHOLD AGAINST A SKAVEN ATTACK

## CONTENTS

<b>COVER: SKAVEN</b> — <i>Dave Gallagher</i> Dave's painting evokes the savage ferocity of a Skaven attack.	
<b>INSIDE FRONT</b>	
Skaven armies painted by the Studio 'Eavy Metal Team.	
<b>GW AND CITADEL NEWS</b>	
All the latest news from Games Workshop and Citadel Miniatures.	<b>2</b>
<b>SPACE MARINE DREADNOUGHTS</b> — <i>Andy Chambers</i>	
Andy describes the background and provides weapon details and a datafax for the brand new Space Marine Dreadnought for <b>Warhammer 40,000</b> . Plus a special 'Eavy Metal and datafax for the Predator Battle Tank.	<b>4</b>
<b>'EAVY METAL</b> — <i>Studio 'Eavy Metal Team</i>	
Space Marine Dreadnought. Space Marine Predator. Blood Angels Space Marine Devastators. Blood Angels Space Marine Death Company.	<b>5-9</b>
<b>WARHAMMER ONE YEAR ON</b> — <i>Rick Priestley</i>	
Rick takes the time to look back over the last year's developments and provides a preview of our future plans for <b>Warhammer</b> .	<b>17</b>
<b>'EAVY METAL</b> — <i>Studio 'Eavy Metal Team</i>	
Hobgoblin Archers.	<b>19</b>
<b>GAMES DAY '93</b>	
We take a look back at some of the highlights of Games Day '93.	<b>20</b>
<b>SHOREFORTS</b> — <i>Andy Jones</i>	
Andy provides new rules and background for including coastal defences and towering Shoreforts in your games of <b>Man O' War</b> .	<b>22</b>
<b>'EAVY METAL</b> — <i>Studio 'Eavy Metal Team</i>	
Tzeentch flyers in <b>Man O' War</b> .	<b>31</b>
<b>FLYING MONSTERS</b> — <i>Rick Priestley</i>	
Rick takes a look at the role of flying monsters in <b>Warhammer</b> . He describes aerial attack strategies designed to terrorise your opponent, and discusses tactics for countering these ferocious beasts.	<b>33</b>
<b>MODELLING WORKSHOP</b> — <i>Adrian Wild</i>	
Games Workshop's modelling expert Adrian Wild explains how to build islands and sandbars for your <b>Man O' War</b> games.	<b>45</b>
<b>BRIDGE OF DEATH</b> — <i>Jake Thornton and Adrian Wood</i>	
A small force of Space Marines attempts to prevent the advance of a desperate Ork horde in this bloody <b>Warhammer 40,000</b> battle report.	<b>52</b>

### ADVERTS

Retail Warhammer Days.....3	Dwarf Anvil of Doom.....43
Space Marine Devastators.....10	Games Workshop New Stores.....50
Dark Angel Tactical Squad.....12	Space Wolf Grey Hunters.....51
Games Workshop Stores.....14	Warhammer 40,000.....65
Retail Career Opportunities.....16	Shrewsbury Grand Opening.....66
Sea of Blood.....30	Imperial Stormblades.....67
Space Marine Battles.....32	Games Workshop Mail Order.....68
Warhammer.....38	Citadel Miniatures Catalogue.....72





## NEW BLOOD ANGEL SPACE MARINES BOXED SETS

Following the launch of the new **Warhammer 40,000** this month we have the first releases in a brand new range of **Warhammer 40,000** boxed sets.

The **Blood Angels Devastators** boxed set features a complete battle squad of Space Marines. Four are armed with a variety of heavy weapons and the sergeant is equipped with a power fist. The miniatures were designed by Jes Goodwin with weapons by Norman Swales.

THIS MONTH'S WARHAMMER 40,000 RELEASES	
<b>Blood Angels Devastators</b> (Boxed set of five miniatures)	£9.99
<b>Blood Angels Dreadnought</b> (Boxed Set)	£19.99
<b>Blood Angels Death Company</b> (Boxed set of ten miniatures)	£12.99
<b>Blood Angels Predator</b> (Boxed Set)	£9.99

The **Predator** boxed set contains everything you need to create a highly mobile battle tank. The plastic kit comes complete with insignia transfers to apply army badges and company markings.

Another mighty piece of wargear is the Space Marine **Dreadnought**, designed by Jes Goodwin, complete with heavy armament and transfer sheets.

The last Blood Angels Space Marines boxed set released this month is the famous **Death Company**. These superb miniatures, also designed by Jes Goodwin, feature a marvelous Chaplain miniature as well as the **Death Company** Space Marines themselves. These can be armed with a variety of different weapons, including wargear from the plastic close combat sprue provided in the box. A sheet of **Death Company** transfers enable you to apply squad and army badges to your completed miniatures.

New rules and data sheets for both the **Dreadnought** and the **Predator** are printed elsewhere in this issue as well as 'Eavy Metal pages for all the boxed sets.

## MAN O' WAR NEW NORSE KINGSHIP

The new Norse **Kingship**, designed by Norman Swales and Michael Perry, now completes the Norse Fleet from **Sea of Blood**.

You can also reinforce your **Plague Fleet** with new flying ships from the Chaos Power Tzeentch. These manifest themselves in the form of the magical **Bane Tower of Tzeentch** and the **Great Winged Terror**.

Look out for the **Man O' War** Shoreforts rules, and Islands and Sandbanks Modelling Workshop elsewhere in this issue.

THIS MONTH'S MAN O' WAR RELEASES	
<b>Norse Kingship</b>	£4.99
<b>Bane Tower</b>	£4.99
<b>Winged Terror</b>	£4.99



## HOBGOBLINS

The sneaky **Hobgoblins**, allies of the **Chaos Dwarfs**, have their ranks swelled by the release of the new **Hobgoblin Archers**, including the Command Section. Also available are new **Hobgoblin Warriors** with axes. Designed by Alan Perry, these miniatures are featured in an 'Eavy Metal page in this issue.

THIS MONTH'S WARHAMMER RELEASES	
<b>Hobgoblin Axemen</b>	£3.99
<b>Hobgoblin Archers</b>	£3.99
<b>Hobgoblin Command</b>	£3.99

## SPACE HULK

**Space Hulk**, the award winning computer game from Electronic Arts, is now available for the Commodore Amiga. **Space Hulk** puts you in command of a squad of Terminator Marines, venturing into the depths of a Genestealer infested craft.

# GAMES WORKSHOP<sup>®</sup> AUSTRALIA

We are pleased to announce the opening of our new Australian headquarters in Sydney.

For details of store openings and forthcoming events, look out for more news in future issues of White Dwarf.

Please address all correspondence to:

**Games Workshop**  
Unit 7, 7-9 Kent Road, Mascot,  
NSW 2020, Australia

Tel: 02-317-2755  
Fax: 02-317-2525

# GAMES WORKSHOP<sup>®</sup>

## WARHAMMER DAYS

Throughout the autumn, Games Workshop Stores will be running special Warhammer Days. There'll be competitions, prizes, painting and modelling demonstrations, and loads of games of Warhammer 40,000, Space Marine, Warhammer and Man O' War for you to join in. Games Workshop's expert gamers, painters and modellers will all be there, so come along and join the fun.



### AUTUMN WARHAMMER DAYS

<b>30th Oct</b>	<b>6th Nov</b>	<b>13th Nov</b>	<b>20th Nov</b>	<b>27th Nov</b>	<b>4th Dec</b>
<b>Newcastle</b>	<b>Reading</b>	<b>Thurrock</b>	<b>Nottingham</b>	<b>Maidenhead</b>	<b>Metrocentre</b>
		<b>and</b>	<b>and</b>	<b>and</b>	<b>and</b>
		<b>Bolton</b>	<b>Bristol</b>	<b>Shrewsbury</b>	<b>Southampton</b>

# WARHAMMER

## 40,000

## SPACE MARINE DREADNOUGHTS

By Andy Chambers

Dreadnoughts are huge fighting machines which stand two or three times the height of a man and weigh several tons. As they stride into battle, incoming fire spatters like rain off their thick ceramite hide, fiery death roars from the myriad of weapons mounted on their towering hulls and their great metal arms crush and smash through anything in their path. No serious assault can begin without a wave of Dreadnoughts to first drive a wedge through the enemy's defences.

The full rules for dreadnoughts can be found in the new Warhammer 40,000 rulebook.

Dreadnoughts are often mistaken for robots or very large armoured fighting suits. In fact they are similar in design to both and yet the same as neither. Dreadnoughts are quite unique because each one contains a single sentient creature whose nervous system is permanently interfaced with the electro-fibre bundles and magna-coils which form the

machine's 'muscles', enabling it to walk and balance with the ease of a living creature. It is a sentient creature that stares out through the machine's crystal lenses and which motivates the machine's metal limbs. Once a creature is interred inside Dreadnought armour it cannot leave its metal womb and still survive; it is destined for a life of endless battle until its walking tomb is destroyed.

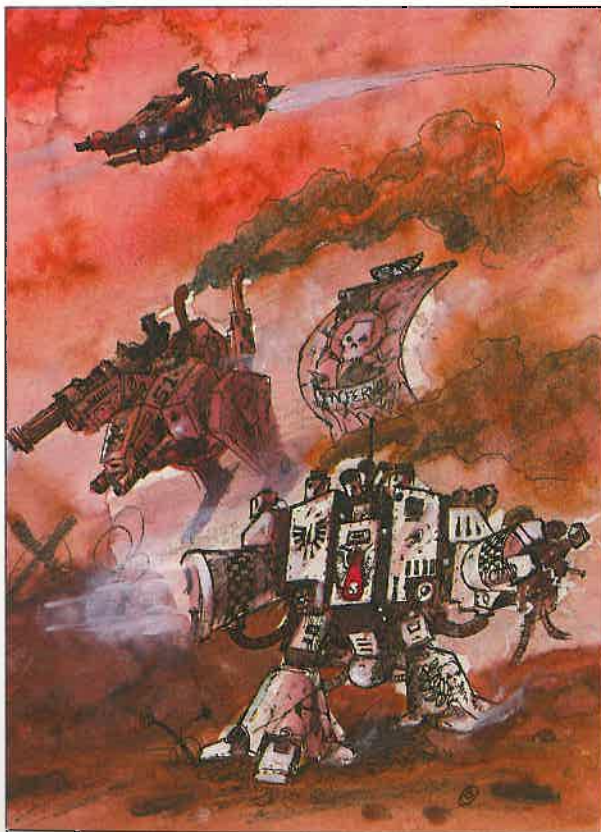

The Space Marine Dreadnoughts are possibly the most ancient Dreadnought design, with some machines dating back tens of thousands of years to the Age of Strife. Dreadnoughts are complex machines, requiring special materials and skills to construct and all Space Marine Dreadnoughts are revered in themselves because the art of their construction is almost lost. The operator of each Space Marine Dreadnought is not an ordinary Space Marine, he is one of the Old Ones – a heroic Space Marine warrior mortally wounded in battle long ago and given the honour of continuing to serve the Emperor as a deathless, living Dreadnought. The Old One's body lies curled in a foetal position inside the Dreadnought's shell with his nervous system linked directly to the machine's systems. In this way the Old One is reborn into a body of metal which has become his sarcophagus.

The memories of some of the Old Ones may extend back tens of centuries to the founding of their Chapter and its earliest history. Thus they are revered by the other Space Marines not just as potent warriors but also as ageless forebears and as a living embodiment of battles fought long ago. The Dreadnoughts that still survive are carefully maintained and repaired when necessary. If a Space Marine Dreadnought is destroyed in action the Space Marines will fight with righteous anger to retrieve the shell so that they may lay its occupant to rest in the Chapter's mausoleum. The Dreadnought armour itself will be repaired and prepared for another dying Space Marine who will become an Old One to future generations.

## BLOOD ANGELS SPACE MARINE DREADNOUGHT

The Space Marine Dreadnought is the living embodiment of a Chapter's fighting spirit and heroic history. Over the ages successive Space Marines will have fought out their last years entombed within the Dreadnought's massively armoured shell. The deeds and honours accorded to the Dreadnought are ritually sculpted onto the very armour itself by the Chapter's artificers and Tech-priests. Extremely venerable Dreadnoughts are littered with honours, badges and other markings alluding to great deeds done in ages past.

Whole sections of armour are often covered in carvings and devices to describe these ancient histories. The great banner raised proudly above the Dreadnought is an honour accorded to the Space Marine who is entombed within. When he eventually dies, a new banner is raised to mark the ascension of his successor.



### UNIT MARKINGS



#### CHAPTER BADGE

In its basic form this is simply painted on the Dreadnought's armour plates but some Chapter badges are carved or sculpted by Artificers and Tech-priests.



#### ARMY BADGE

Applied at the beginning of a campaign or war the army badge is displayed on all Imperial uniforms and equipment.



#### COMPANY MARKING

Each Dreadnought is assigned a simple number for quick identification purposes. The example shown is number two Dreadnought of the second company (yellow drop symbol).



HONOUR BANNER



MULTI-MELTA



POWER FIST

### DREADNOUGHT WEAPONS

A Space Marine Dreadnought is one of the most destructive devices ever operated by the Imperium. Its powerfully constructed frame is able to bear enormous stresses and acts as a sturdy platform from which to fire virtually any heavy weapon. A Dreadnought's weapon options generally combine blistering long range fire capability with terrifying close-combat potential. More specialist combinations are, however, quite common. The example here is a mighty close-combat variation particularly suited for close assaults.

## SPECIAL RULES FOR SPACE MARINE DREADNOUGHTS

Like most Dreadnoughts, Space Marine Dreadnoughts have variable configuration weapon mounts on their arms. This facilitates easy conversion of the Dreadnought to a number of different weapon fits according to different tactical situations. The weapons mounted on the Space Marine Dreadnought are superficially similar to heavy weapons carried by Space Marines or Space Marine Terminators. However, Dreadnought weapon systems are superior in a number of ways because of their sturdier construction, increased ammunition capacity and improved targeting systems. These improvements are partially subsumed into the Space Marine Dreadnought's ballistic skill and its ability to move and fire heavy weapons, but in addition to these the following special rules apply to Space Marine Dreadnought weapons.

### Assault Cannon and Storm Bolter

The most frequent causes of jams for sustained fire weapons like assault cannon and storm bolters are faulty ammunition, overheating components or empty magazines. The Space Marine Dreadnought features a large ammo hopper holding many thousands of rounds of ammunition for its sustained fire weapons. This is combined with a liquid nitrogen cooling system and a flexible powered ammo feed which literally pushes rounds into the weapon and extracts any dud rounds before they can block the breach.

To represent these improvements a Space Marine Dreadnought firing an assault cannon or a storm bolter ignores the first jam rolled on the sustained fire dice each turn. This means that a storm bolter will never jam if it's mounted on a Dreadnought and an assault cannon will only jam if it rolls two or more jams together. However, if an assault cannon rolls three jams together it will still explode, automatically destroying the assault cannon itself but inflicting no further damage to the Dreadnought.

### Missile Launcher

Though some older Space Marine Dreadnoughts carry a normal missile launcher, most have been upgraded to carry a specialist salvo-firing launcher capable of launching up to three missiles simultaneously. Unfortunately, the launcher has a slightly temperamental guidance system which occasionally locks on to only some, or none, of the extra designated targets. However, the masters of the Space Marine Chapters generally consider the extra firepower supplied by the launcher a worthwhile trade off.

A Space Marine Dreadnought armed with a missile launcher can opt to either fire a normal shot or salvo fire. The decision to use salvo fire must be made before the hit roll is made. If salvo fire is used roll a sustained fire dice, the number rolled is the number of missiles launched. Roll to hit for each missile separately, the missiles can be fired at different targets but the targets can't be more than 2" apart. The whole salvo must be either Frag or Krak missiles, not a mix of both. If a jam is rolled on the sustained fire dice no missiles are fired and the missile launcher is affected in exactly the same way as a sustained fire weapon. This means the missile launcher (but not the Dreadnought's other weapons) must miss its shot in the next shooting phase while it clears the 'jam' (or to be more accurate, the Dreadnought resets its guidance system).

### Multi-Melta

A normal melta weapon fires a fairly tight stream of energy which strikes the target and instantly super heats it to a point where it vapourises explosively. The Space Marine Dreadnought mounts a multi-melta with a variable focus, allowing it to broaden the energy beam. This sacrifices range and power to burn a wider area more thoroughly. This is particularly useful when fighting at close quarters against large groups of troops.

A Space Marine Dreadnought armed with a multi-melta can opt to fire either narrow beam with the effects of a standard multi-melta, or it can be fired on a broad focus with the same effects as a heavy flamer.



### Twin Lascannon

A common Space Marine Dreadnought weapon is a twin lascannon mount for destroying vehicles and fortifications at long range. The twin lascannon weapon system features a sophisticated scanning system which can separate and identify the different components of a target. This system allows the Dreadnought to adjust its aim with pinpoint accuracy to strike the desired component.

A Space Marine Dreadnought armed with a twin lascannon rolls to hit normally. If a hit is scored against a vehicle make a D6 roll for hit location as usual, the Space Marine player is then allowed to add +1 or deduct -1 from the hit location roll. So, for example, if the Dreadnought hit a Predator and rolled a 4 for the hit location it would normally hit the sponson. However, the Space Marine player could opt to add +1 to the location roll to make it a 5 (hitting the turret) or deduct -1 from the roll to make it a 3 (hitting the hull). Note, however, that it is not possible to hit a location which is behind cover by adjusting the hit location roll.

### Power Fist

Power fists mounted on Space Marine Dreadnoughts incorporate extra power servos so that they can grip and then rotate to tear pieces off the target. This is most useful for ripping apart vehicles, inflicting catastrophic damage on the component attacked.

The special tear attack can only be used against other vehicles including Dreadnoughts. The Dreadnought can make one tear attack for every two hits it would have normally scored. For example, if the Dreadnought was in combat with an Ork Dreadnought and won the combat by two points, it could opt to score two normal hits or make one tear attack. If the Dreadnought was attacking a vehicle, it would normally score three hits, but it could choose to make one tear attack and score one normal hit instead.

To resolve a tear attack the Space Marine player nominates a single location on the target. The Dreadnought seizes that location and attempts to tear part of it away. Roll for penetration as normal. If the location chosen is penetrated the part is torn away, roll for damage with a +2 modifier on the damage chart.



## SPACE MARINE PREDATOR



### BLOOD ANGEL SPACE MARINES



CHAPTER BADGE



ARMY BADGE



COMPANY INSIGNIA AND  
VEHICLE NUMBER

Predator Battle Tanks form the mainstay of a Space Marine company's support vehicles. Whole squadrons of these powerful tanks are carefully maintained by the company Artificers. In large battles these squadrons are often massed to form mighty armoured companies. However, they are usually deployed in smaller numbers with perhaps one or two Predators providing strong tactical support for each of the company's task forces.



BATTLE BANNERS



## SPACE MARINE BLOOD ANGEL DEVASTATORS



SERGEANT

The Devastator Squads of the Blood Angels Chapter are distinguished from the Tactical Squads by their blue helmets. Otherwise they display standard Blood Angel insignia: bright red armour with predominantly black markings. The Sergeant and Veteran trooper have reversed shoulder pad schemes to denote rank—each can lead a five-man combat squad into battle.

The Sergeant's banner displays the squad number, in this case nine, and each Space Marine displays the squad badge on their right kneepad.



WITH LASCANNON



WITH HEAVY  
PLASMA GUN



WITH MISSILE LAUNCHER



WITH HEAVY BOLTER



SERGEANT'S  
BANNER



2ND COMPANY BADGES



CHAPTER BADGES



SERGEANT'S  
HONOUR  
BADGE



SQUAD  
BADGE



ARMY BADGES



A COMPLETE BLOOD ANGELS DEVASTATOR SQUAD

## BLOOD ANGELS SPACE MARINE DEATH COMPANY



The Blood Angels Chapter of Space Marines suffers from a grievous flaw in their genetic makeup and the Death Company is its inevitable result. All Space Marines are created in part by the implantation of the mysterious geneseed. This shapes the Space Marine's development, preparing his body for organ transplants and the rigorous physical and psychological training required to make him a Space Marine.

However, the Blood Angels' geneseed is flawed and although the Chapter's warriors are as powerful as any other they each carry this flaw. On the eve of battle the afflicted Space Marine is driven to maddening rages and an unholy bloodlust washes over him. All Blood Angels recognise immediately that their time has come and so they seek absolution, preferring a heroic death in battle to an endless descent into drooling madness. Tormented by visions of their great Primarch Sanguinius they don suits of jet-black armour and daub great red crosses over it to symbolise his wounds. Icons of skulls and blood are carefully applied by the Chapter's Artificers as Chaplains chant their requiem.

Each Space Marine in the Death Company chooses to fight with the weapons he is most familiar with. These are painted red and blessed by the accompanying Chaplain. The Chaplain's role is to lead and direct the maddened Death Company Space Marines to ensure that their final sacrifice is not in vain.



CHAPLAIN'S  
BANNER



SHOULDER PAD  
DETAIL



A few examples of the many ways the Death Company decorate their armour in preparation for their final battle.

# SPACE MARINE DEVASTATORS



Space Marines designed by Jes Goodwin and Norman Swales

The Space Marine Devastators box contains five new Space Marine models designed by sculptors Jes Goodwin and Norman Swales. Four Space Marines carry awesome heavy weapons: two have Heavy Bolters, ideal for laying down a withering curtain of fire; one is armed with a Lascannon, the ultimate tank buster of the 41st Millennium and the fourth has a Missile Launcher, a long ranged weapon which can fire either armour penetrating shells or explosives. The fifth Space Marine is a sergeant armed with a deadly power fist – an energised gauntlet that can tear apart armour and crush enemies in hand-to-hand combat.

These Space Marines with heavy weapons make an excellent addition to a Devastator Squad or Tactical Space Marine Squad from any Space Marine Chapter. We've chosen to paint our Space Marines as the heavy-weapon element from an Ultramarines Devastator Squad.

All five of the Space Marines are supplied with separate metal weapons and plastic arms and shoulder pads, allowing you to assemble them in a variety of combinations and poses.

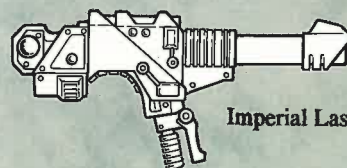

Imperial Lascannon

Missile Launcher

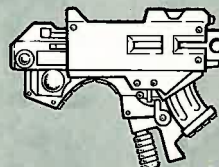
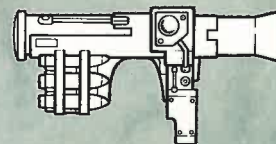

Heavy Bolter



CITADEL  
MINIATURES

Models supplied unpainted. Banners not supplied

WARNING! This model contains lead and may be harmful if chewed or swallowed. Citadel Miniatures are not recommended for children under 14 years of age.

GAMES™  
WORKSHOP

Fold on this line.

To assemble your data card, first photocopy or cut out the card from this page and fold it in half along the dotted line. Spread a thin layer of glue across the back of the card and press the two halves firmly together. If you want to make your card a little more hard wearing, its a good idea to insert a thin layer of cardboard (cereal packet is ideal) between the two halves before you glue them together.

## DAMAGE TABLES

D6	Location	Armour	
		Front	Side/Rear
1	Legs	20	18
2	Left Arm	19	17
3	Right Arm	19	17
4-6	Body	21	19

### D6 Leg Damage Table

- The inch thick armour plates on the Dreadnought's leg hold, but the force of the blow slows it down. The Dreadnought may not move in its next turn.
- The Dreadnought is knocked sprawling. It staggers D3" in a random direction, colliding with anything moved into.
- 4 The leg is seriously damaged. The Dreadnought may now only limp D3" per turn.
- 6 The leg is blown off and the Dreadnought crashes to the ground. It may not move or attack for the rest of the game, and is effectively destroyed.

### D6 Arm Damage Table

- The arm is hit and partially paralysed. Any ranged weapons incorporated into the arm may still be used, but the arm cannot be used to fight in hand-to-hand combat. Reduce the Dreadnought's Attacks characteristic by one point.
- Any weapons mounted on the arm are jammed or partially damaged and can only be used if you first roll a 4+ on 1D6.
- 5 The arm is torn from the Dreadnought's body. Any weapons mounted on the arm are destroyed, and the Dreadnought's Attacks characteristic is reduced by one point.
- 6 The arm is destroyed and any weapons mounted on it explode! The explosion flashes back to the Dreadnought's body, bypassing all armour, and causing a secondary explosion. Roll on the Body Damage Table to find out what effect this second explosion has.

### D6 Body Damage Table

- The Dreadnought's controls go crazy making the Dreadnought difficult to control. The Dreadnought may only move or attack if you first roll a 4+ on a D6.
- The Space Marine controlling the Dreadnought is badly wounded. All of the Dreadnought's characteristics are halved for the rest of the game.
- 4 The Dreadnought's engine bursts into flames and the machine is immobilised. The pilot may use emergency controls to fire one weapon. Roll a D6 at the beginning of each player's turn: the machine explodes on a roll of 1 or 2. Any models within 3" suffer D6 Strength 10 hits with a -3 saving throw modifier.
- The Space Marine controlling the Dreadnought is slain. The Dreadnought staggers D3" in a random direction, colliding with anything moved into, and then collapses to the ground.
- The Dreadnought's ammunition explodes. The Dreadnought is destroyed and any models within 3" suffer D6 Strength 10 hits with a -3 saving throw modifier.

## SPACE MARINE DREADNOUGHT



### VEHICLE DATA

M	WS	BS	S	I	A	LD
6	6	6	7	5	3	10

### CREW:

ONE SPACE MARINE

### RAM VALUE:

STRENGTH 7  
D10 DAMAGE  
-4 SAVE

### WEAPONS:

Power Fist with built-in Storm bolter, with a 90° field of fire to the front and a Multi-Melta with a 90° field of fire to the front. 195 Pts

OR

Assault Cannon with a 90° field of fire to the front and a Missile Launcher with a 90° field of fire to the front. 205 Pts

OR

Twin Lascannon with a 90° field of fire to the front and a Missile Launcher with a 90° field of fire to the front. 215 Pts

The Dreadnought may be fitted with a set of auto-launchers carrying frag or blind grenades at an additional cost of +5 points.

### WEAPON DATA

Weapon	Range		To Hit		Save	Armour	Special
	Short	Long	Short	Long			
Storm Bolter	0-12	12-24	+1	-	4	1	-1 D6+4 Sustained fire 1D
Power Fist	Close	Combat	Only	-	8	1	-5 D6+D20+8
Lascannon	0-20	20-60	-	-	9	2D6	-6 3D6+9
Frag Missile	0-20	20-72	-	-	4	1	-1 D6+3 2" Blast Marker
Krak Missile	0-20	20-72	-	-	8	D10	-6 D6+D10+8
Assault Cannon	0-12	12-32	+1	-	8	D10	-3 D6+D10+8 Sustained fire 3D
Multi Melta	0-12	12-24	+1	-	8	2D12	-4 D6+2D12+8 2" Blast Marker

**POINTS COST: Varies with armament**

# WARHAMMER

## 40,000

# DARK ANGEL SPACE MARINES<sup>®</sup>

# TACTICAL SQUAD



Miniatures supplied unpainted. Banners not included

Miniatures designed by Jes Goodwin

The Dark Angels Chapter of the Imperial Space Marines are one of the Chapters of the first founding. Utterly loyal to the Emperor and their battle brothers, the Dark Angels are among the finest warriors in the Imperium. For almost 10,000 years they have stood, grim and resolute, against all the enemies of mankind.

The Dark Angels Tactical Squad box contains ten Space Marines in Mark 7 power armour. These metal miniatures come with separate plastic arms, backpacks and bolters, allowing you to assemble your models in an almost endless variety of poses. Two of the miniatures are equipped with a Lascannon and a Plasma gun and the box also contains a Dark Angels transfer sheet with all the basic markings you need, to apply chapter, squad and army badges to your models.



# GAMES WORKSHOP<sup>®</sup>

WARNING! These miniatures contain lead and may be harmful if chewed or swallowed. Citadel Miniatures are not recommended for children under 14 years of age.

The Citadel castle, the Games Workshop logo and Space Marine are registered trademarks of Games Workshop Ltd. Citadel, Games Workshop and Dark Angel are trademarks of Games Workshop Ltd.  
© Games Workshop Ltd, 1993. All rights reserved.

DARK ANGEL TACTICAL SQUAD



**INCLUDES  
DARK ANGELS  
TRANSFER  
SET**

To assemble your data card, first photocopy or cut out the card from this page and fold it in half along the dotted line. Spread a thin layer of glue across the back of the card and press the two halves firmly together. If you want to make your card a little more hard wearing, it's a good idea to insert a thin layer of cardboard (cereal packet is ideal) between the two halves before you glue them together.

Fold on this line.

## DAMAGE TABLES

D6	Location	Armour	
		Front	Side/Rear
1	Track*	15	15
2-3	Hull	20	18
4	Sponson*	17	15
5-6	Turret	22	22

\* Hit the one nearest to the attacker

### D6 Track Damage Table

- The track is damaged but keeps running. The Predator may only move at slow speed for the rest of the game.
- The track is blown off. The Predator moves out of control next turn and then comes to a permanent halt for the rest of the battle.
- A track is blown off and the resulting damage smashes the vehicle's drive shaft, causing it to flip over. The wreck comes to rest D6" away in a random direction. Any model it lands on takes D6 S7 hits with a -2 saving throw modifier. Roll a D6 for each model on board. They are killed in the crash on a D6 roll of 4, 5 or 6. Surviving models may dismount using the normal rules.

### D6 Hull Damage Table

- A large explosion tears through the crew compartment. Roll a D6 for each crew member. On a roll of 4, 5 or 6 they are hit and killed.
- The Predator's engine explodes, killing the crew. The tank is spun round to face in a random direction by the force of the explosion and then comes to a permanent halt.
- A spark ignites the Predator's fuel tank and it bursts into flames, killing all of the crew. The flaming wreck moves out of control next turn and then explodes. Anything within 3" of the point where it ends up is caught in the explosion, suffering damage exactly as if hit by a heavy flamer.
- The Predator's ammunition explodes. The Predator is destroyed and any models within 3" suffer D6 Strength 10 hits with a -3 saving throw modifier.

### D6 Sponson Damage Table

- The lascannon mounted in the sponson is damaged and may only be fired if you first roll a 4 or more on a D6.
- The sponson is destroyed. The lascannon mounted in it may not fire for the rest of the game.
- The sponson is destroyed as above, but the explosion causes a flashback to the hull causing a secondary explosion there. Roll on the Hull Damage Table to find out what effect this second explosion has.

### D6 Turret Damage Table

- The autocannon mounted in the turret is damaged and may only be fired if you first roll a 4 or more on a D6.
- The turret is jammed and may no longer rotate. The autocannon may only fire in a straight line at targets that are directly in front of it.
- The turret gunner is killed. Unless his position is taken over by another crew member the autocannon may no longer be fired.
- The ammunition stored in the turret explodes and the Predator is destroyed. All the crew are killed and the turret is blown off, flying 2D6" in a random direction before it crashes to the ground. Anything under the spot where it lands takes D6 Strength 9 hits with a -6 saving throw modifier.

## SPACE MARINE PREDATOR



### VEHICLE DATA

#### CREW:

- 1 SPACE MARINE DRIVER
- 3 SPACE MARINE GUNNERS

#### RAM VALUE:

- STRENGTH 8
- D12 DAMAGE
- 5 SAVE

#### MOVEMENT:

- SLOW SPEED: 7"
- COMBAT SPEED: 20"
- FAST SPEED: 25"
- TYPE: TRACKED

#### WEAPONS:

Two lascannon, one in each side mount, and one autocannon mounted in the turret. Each lascannon has a targeter and an 180° field of fire to their side of the vehicle. The autocannon is fitted with a targeter and has a 360° field of fire. The Predator may be fitted with a set of auto-launchers carrying frag or blind grenades at an additional cost of +5 points.

### WEAPON DATA

Weapon	Range		To Hit		Save	Strength	Damage	Modifier	Armour	
	Short	Long	Short	Long					Penet.	Special
Autocannon	0-20	20-72	-	-	8	D6	-3	-	2D6+8	Sustained Fire 1D
Lascannon	0-20	20-60	-	-	9	2D6	-6	-	3D6+9	-
Auto-launcher	6	-	-	-	-	Grenade Type	-	-	-	-
Frag Grenade	-	-	-	-	3	1	-1	-	D6+3	2" Blast Marker
Blind Grenade	-	-	-	-	-	-	-	-	-	2" Blast Marker

**POINTS COST: 180 points**

# GAMES WORKSHOP<sup>®</sup>

## A WORLD OF FANTASY GAMING

The first thing you notice when entering a Games Workshop store is how different it is from nearly every other shop. Here you'll find not only everything you need for the gaming hobby, but much more besides. With friendly approachable staff and a vast range of Citadel and Marauder miniatures, you'll find everything you need to build up an army for Warhammer 40,000, Space Marine, Warhammer or Man O' War.

Whether you're a newcomer to the hobby or an experienced gamer, you'll find the staff at your local Games Workshop helpful and informative.

Our staff are all experienced gamers and will be more than happy to show you how to play our games, which models are best for your army and how to how to paint them. They'll also know about all of the latest miniature releases and what's up and coming for your favourite games.



Above: Enthusiasts enjoying a game of Space Marine.



Left: A display of new releases including the new boxed Warhammer 40,000 and the latest issues of White Dwarf.



Below: The gaming tables at the Peterborough store.





**Top:** Each month Citadel Miniatures and Marauder Miniatures release exciting new models. Your local Games Workshop stocks the full range of these miniatures and the staff will be glad to help you select the ones you need for your army.

**Below right:** One of our friendly Games Workshop staff gives some advice on miniature painting. Each Games Workshop has an area for you to paint your own models and expert staff to give hints and tips.

**Below:** If you've never played a Games Workshop game, but think it might be fun, just pop along to your local Games Workshop and join in. Each store runs regular introductory games of Warhammer, Space Marine, Warhammer 40,000 and Man O' War. Please phone first to see what's being played each day.

Also, every Thursday night is Games Night, when our stores stay open until 8.00pm. Anyone can come along to play their favourite game so why not join us this Thursday?



# GAMES WORKSHOP®

## STORES

- ABERDEEN: UNIT 1, 30/40 KIRKGATE. TEL. 0224 621261  
 BECKENHAM: 292-294 HIGH ST. TEL. 081 658 8102  
 BELFAST: 20A CASTLE COURT. TEL. 0232 233684  
 BIRMINGHAM: 116 CORPORATION STREET. TEL. 021 236 7880  
**NEW STORE! BLACKPOOL: 5 BIRLEY STREET**  
 BOLTON: UNIT 25, FIRST FLOOR GALLERY, SHIPGATES CENTRE, TEL. 0204 362131  
 BOURNEMOUTH: 24, POST OFFICE ROAD TEL. 0202 319292  
 BRIGHTON: 7 NILE PAVILIONS, NILE ST. TEL. 0273 203333  
 BRISTOL: 13 BROAD WEIR. TEL. 0272 251533  
 BROMLEY: 8 BROMLEY MALL. TEL. 081 466 0678  
 CAMBRIDGE: 4 QUAYSIDE, (OFF BRIDGE ST). TEL. 0223 313550  
 CARDIFF: 29-30, HIGH STREET TEL. 0222 644917  
**CHELTENHAM:** 16 PITVILLE STREET, TEL. 0242 228419  
 CHESTER: 112 FOREGATE STREET. TEL. 0244 311967  
 COLCHESTER: 2 SHORT WYRE STREET. TEL. 0206 767279  
 COVENTRY: 14 CITY ARCADE. TEL. 0203 227311  
 CROYDON: UNIT 35, DRUMMOND CENTRE, KEEBLEY RD. TEL. 081 680 4600  
 DERBY: 42 SADLER GATE. TEL. 0332 371657  
 DUDLEY: KIOSK U, UPPER LEVEL, MERRY HILL CENTRE, DUDLEY. GAMES NIGHT: THURS TILL 9.00 OPEN MON - FRI 10.00 TILL 8.00 SAT 9.00 TILL 7.00 TEL. 0394 481818  
 EDINBURGH: 136 HIGH ST. OPEN SUN 11 - 5 TEL. 031 220 6540  
 GLASGOW: 66 QUEEN ST. TEL. 041 226 3762  
 GOLDFORD: 12 TUNSGATE TEL. 0483 451793  
 HAMMERSMITH: 1 DALLING ROAD. TEL. 081 741 3445  
 HARROW: 296 STATION RD. TEL. 081 861 2350  
 HIGH WYCOMBE: UNIT 29, THE BALCONY, THE OCTAGON CENTRE. TEL. 0494 531494  
 HULL: 30 PARAGON STREET. TEL. 0482 589576  
**NEW STORE! IPSWICH: 2ND FLOOR, DEBENHAMS, WESTGATE STREET**  
 KINGSTON ON THAMES: 33, FIFE ROAD. TEL. 081 549 5224  
 LEEDS: 12-16 CENTRAL ROAD. TEL. 0532 420834  
 LEICESTER: 16/20 SILVER ST. TEL. 0533 530510  
 LIVERPOOL: 47 LORD STREET. TEL. 051 258 1404  
 CENTRAL LONDON: UNIT F10, THE PLAZA, 116-128 OXFORD STREET. TEL. 071 436 0839  
 LITON: 12 PARK STREET. TEL. 0582 417474  
 MAIDSTONE: UNIT 6, 1-9 PUDDING LANE. TEL. 0622 677435  
 MAIDENHEAD: 2 BLANDY HSE. 3/5 KING ST. TEL. 0628 21854  
 MANCHESTER: UNIT 1, 3 BROWN STREET. TEL. 061 832 6863  
 MEADOWHALL CENTRE, SHEFFIELD: 91B, HIGH ST. UPPER MALL. OPEN MON TO THURS 10 - 8. FRIDAYS 10 - 9, SATURDAYS 9 - 7, SUNDAYS 12 - 4. TEL. 0742 569636  
 METROCENTRE NEWCASTLE: UNIT B14, FIRST FLOOR. TEL. 091 461 0950  
 MIDDLESBROUGH: 39 DUNDAS ST. TEL. 0642 254091  
 NEWCASTLE: 63 CLAYTON STREET. TEL. 091 232 2418  
 NORWICH: 12-14 EXCHANGE STREET. TEL. 0603 767656  
 NOTTINGHAM: 34A FRIAR LANE. TEL. 0602 480651  
 OXFORD: 1A NEW INN HALL ST. TEL. 0865 242182  
 PETERBOROUGH: 3 WENTWORTH STREET. TEL. 0733 890652  
 PLYMOUTH: 84 CORNWALL STREET. TEL. 0752 254121  
 PORTSMOUTH: 34 ARUNDEL STREET. TEL. 0705 876266  
 PRESTON: 15 MILLER ARCADE. TEL. 0772 821855  
 READING: UNIT 3, CHEAPSIDE. TEL. 0734 598693  
 SHEFFIELD: 16 FITZWILLIAM GATE. TEL. 0742 750114  
**NEW STORE! SHREWSBURY: UNIT 2, BRIDGE ST**  
 SOUTHAMPTON: 23 EAST STREET. TEL. 0703 331982  
 SOUTHEND: 12 SOUTHCHURCH RD. TEL. 0702 461251  
 STOKE ON TRENT: 27 STAFFORD ST. HANLEY. TEL. 0782 205287  
 SWINDON: 17 FLEET STREET. TEL. 0793 436036  
 THURROCK LAKESIDE: UNIT 415, LEVEL 3/FOOD COURT, THURROCK LAKESIDE (JUNCTIONS 30/31, M25) TEL. 0708 867133 OPEN MON - THU 10 - 8, FRI 10 - 9, SAT 10 - 7.30  
 TORQUAY: 12 MARKET ST. TEL. 0803 201036 (Closed Tuesdays)  
 WORCESTER: 4 CHARLES STREET. TEL. 0905 616707

# GAMES WORKSHOP

## RETAIL OPPORTUNITIES

Games Workshop is dedicated to producing the finest games and miniatures in the world. We are currently seeking to recruit more bright, energetic and enthusiastic young people to join us in our existing and new Games Workshop Stores. We are a young and rapidly expanding company where there are plenty of opportunities for career advancement for the right people.

### RETAIL MANAGERS

Games Workshop is planning to expand rapidly in 1994 and so we need to employ energetic Retail Managers for our growing chain of stores.

As well as a thorough knowledge of Warhammer, Space Marine and Warhammer 40,000, our ideal applicant would have at least 2 years experience in a retail environment preferably with some supervisory experience.

Salary will be commensurate with experience and the company offers a number of generous staff benefits.



### KEY-TIME STAFF

The following Games Workshop Stores have immediate vacancies for key-time staff:

**Meadowhall**      **Thurrock**  
**Metrocentre**      **Aberdeen**

Key-time staff work a fixed number of hours each week in our stores including evenings and weekends. As well as being a keen gamer with a sound knowledge of Warhammer 40,000, Space Marine and Warhammer, our ideal applicant would be working, or in full-time education at college or university.

Closing date for applications is 1st December 1993.

### HOW TO APPLY

Apply in writing on a Games Workshop Application form stating which job you are interested in. Application forms are available from Bob or Matt at Retail Head Office (tel: 0773 769731), or from the Manager of your local Games Workshop Store.

Send your completed Application form to:

**Simone Greasley**  
**Games Workshop Limited**  
**Chewton Street**  
**Hilltop**  
**Eastwood**  
**Nottingham NG16 3HY**



# WARHAMMER

## ONE YEAR ON

By Rick Priestley

**It's just over a year since we launched Warhammer – the Game of Fantasy Battles – and it's been a busy time for us at the Games Workshop Studio. There have been new models to design and books and supplements to produce, whilst also getting the new edition of Warhammer 40,000 ready for publication.**

During the last twelve months we've received lots of mail about Warhammer, and we've continued to play our own armies against new opponents. Naturally, we've learned a great deal about how the armies shape up against each other and most of us have developed a few new tricks, as various tactics have been tried and counter-tactics developed.

Occasional rule interpretations have had to be made of course, and we've tried to pass on the benefit of our constantly expanding experience to those of you who have written with your own rules queries and ideas.

All in all, now seems a good time to take a look at what we've already done for Warhammer and what we have planned for the next twelve months. No less than five supplements have already appeared: Battle Magic, and army books for The Empire, High Elves, Orcs and Goblins, and Dwarfs. Two further supplements are being worked on, the Skaven book and the Undead book. In addition, we are collating a supplementary series of cards for Battle Magic – of which more later. If everything goes to schedule the Skaven book should be ready soon after you read this. Andy Chambers has done the development work on this book, and it follows the



*Skaven and Undead armies clash deep in the World's Edge Mountains.*



same format as the existing books, with background, new rules, war machines, special characters, army list and so on. Jes Goodwin has designed some superb new Skaven character models, and Colin Dixon has produced some excellent new rank and file troops. One of the most spectacular pieces is the Skaven Doomwheel, a monstrous rat-powered war machine that generates lethal lightning bolts as it moves over the battlefield.

## THE UNDEAD

A massive range of models has already been built-up for the Undead army. The entire range has been designed by Gary Morley, and includes new zombies, skeletons, wraiths, ghouls, wights, and character models. The most unusual model in the entire range is probably that of Nagash the Liche Lord, the greatest manifestation of arcane evil ever to prowl the Old World and no less than 80mm tall to the tip of his crown!

Although work on the Undead book is still at the developmental stage, one of the things we're already committed to is expanding the Dark Magic deck into separate Dark Magic and Necromantic Magic decks. So far the Necromantic deck includes several spells which confer extra movement and actions along the lines of *Vanhel's Danse Macabre*, effectively dividing that spell into low and high powered versions. We've also been varying the effects of Undead characters by introducing levels for Vampires and Liches. Overall, the Undead are proving immensely powerful, but playtesting is revealing a few unexpected weaknesses so there's still hope for the rest of us!

With the release of the new Warhammer 40,000 we'll be diverting some effort towards producing new models and

Codex books for that range. However, we'll also be pressing ahead with the Warhammer Armies series and accompanying fantasy model ranges. After the Undead we'll be turning our attentions back towards Chaos and then the Dark Elves. We're often asked whether there will be a full length Chaos Dwarf book, and this is certainly one option, although for the future.

A more certain proposal is to produce a supplementary set for Battle Magic. This would incorporate all the new spells and magic items from the various Armies Books and White Dwarf articles, but it would also include new magic items as well. If we follow through the current plan to split the existing Dark Magic deck then it seems only sensible to make the cards available in a proper card format rather than leaving it up to players to make them up from photocopies. The only thing that's stopped us printing the new spells as cards already is that we haven't got enough spells and items to fill the standard size card sheet, but once the Undead spells are finalised we'll be able to go ahead.

We're often asked if new models will be designed for some of the characters described in the Warhammer Armies books. The intention was to describe more characters than we'd ever be able to make, and then pick and choose from amongst them. However, it's always possible to go back and make a model from a book which has been out for a while, and this is certainly something we'll do now and again. A Skarsnik model has been designed for the Night Goblins, for example, and there will certainly be a Morglum Necksnapper riding a ferocious war boar.

Enough time has now elapsed for us to be able to identify some of the gaming pitfalls that Warhammer poses for unwary gamers. We've also worked out a number of interesting tactical ruses and received some valuable insights from fellow gamers. Elsewhere in this issue of White Dwarf you'll find a special article that takes a close look at the role of flying creatures and large monsters in Warhammer. This was written as a direct result of questions and comments we received from Warhammer gamers worldwide, and in future White Dwarfs we'll be explaining more of these ideas, and taking the opportunity to examine other aspects of the game in some detail.



Obviously when we receive a lot of questions about a particular rule we'll try to clarify things a bit too. Remember, we depend on feedback from fellow gamers, so please write in if you've a particular topic you'd like discussed. Please remember, we are happy to answer rule queries if you send us a stamped self-addressed envelope. Leave space on your letter for us to write in a reply underneath your questions, as we will return your letter complete with our comments. This saves us a lot of time and enables us to provide an answer reasonably quickly. It helps a great deal if answers are framed so that they can be answered yes or no, or with a relatively short reply. We can't promise to give definitive answers to every question, but we always do our best!

# HOBGOBLIN ARCHERS



BIG BOSS



BOSS



STANDARD BEARER



HORN BLOWER



ARCHER



REGIMENTAL BANNER



A HOBGOBLIN ARCHER REGIMENT

# GAMES DAY '93

Games Day '93 was the biggest and best Games Day ever. Over five thousand gamers made the trip to Donington to meet their favourite games designers and join in the huge participation games. Throughout the day dozens of battles were won and lost as mighty armies clashed in games of Warhammer 40,000, Warhammer and Space Marine. Thanks for coming and making it such great fun. See you at Golden Demon '94!



#### Photos top to bottom:

- An Imperial Titan stalks past the specially constructed gothic defences of a Warhammer 40,000 game.
- The Games Workshop game designers were busy all day signing autographs and answering questions. Andy Chambers explains the new Warhammer 40,000 to a crowd of eager gamers.
- Rik Priestley pauses between autographs to answer questions about Warhammer.
- Andy Jones, one of the designers of Man O' War, autographs a Games Day '93 poster for a fan.
- The stunning scenery you see every month in White Dwarf was there 'in the flesh' on the Warhammer 40,000 game run by the Studio staff.



**Photos top to bottom:**

- Dozens of magnificently painted banners parade around the hall before the final judging takes place.
- Die Imperial scum! Chaos forces beat off an Imperial assault in the Studio demo game of Space Marine.
- Waaargh Warhammer!
- Artist Dave Gallagher demonstrates his painting skills on Citadel's new Blood Angels' Dreadnought.
- Mighty Dark Elf and Empire fleets clash in an exciting game of Man O' War.
- One of the lucky winners of pre-release copies of the brand new Warhammer 40,000 boxed set.
- The paint flies in the speed painting competition.



# MAN O' WAR

## SHOREFORTS

TM

By Andy Jones

Most nations in the Warhammer World face the threat of coastal attack at some time or another, from the many cut throat pirates and raiders at large on the vast oceans. There is no better deterrent to any would-be invader than a towering edifice of stone and steel rising out of the waves, bristling with cannon and other deadly armaments.

This article provides a set of rules for creating your own Shoreforts to use in your games of Man O' War, as well as providing a few examples to get you started. The Man O' War Modelling Workshop companion article elsewhere describes how to build these fortresses, creating impressive centrepieces for your gaming table.

A Shorefort is a powerful playing piece. It is very difficult to destroy as it has good saving throws, and is immune to critical damage and below the waterline hits. In addition, a Shorefort is armed with many guns, and can wreak enormous amounts of damage on any ships that are foolish enough to stray into range.

Of course, a Shorefort also has disadvantages – primarily the fact that it cannot move at all! A clever player will avoid an enemy Shorefort until he feels that the time is right to attack – usually once he has immobilised the enemy fleet.

Conversely, if you have a Shorefort in your own fleet you would be well served to keep some of your ships close to it, in the hope of drawing the enemy fleet into range of the Shorefort's guns.

### DESIGNING SHOREFORTS

Unless specifically contradicted, all the rules for Shoreforts given in the Man O' War rulebook apply to the new Shoreforts given here.

The Shorefort template given in the Man O' War rulebook is a medium sized Shorefort, but its details apply to both smaller and larger Shoreforts with only minor modifications:

A medium size Shorefort, like the one given in the Man O' War rulebook, has 3 locations, is hit on a 4, 5 or 6 (a 3 in 6 chance), has 3 points of structural damage, 3 cannon batteries and 3 crew.

It follows that a Shorefort with 5 locations (like the Coastal Bastion shown at the top of the next column) will be hit on a 2, 3, 4, 5 or 6 (a 5 in 6 chance), has 5 points of structural damage, is armed with 5 cannon batteries and has 5 crew.



There is a direct relationship between the number of areas on a Shorefort and how easy it is to hit, how much damage it can take, how many guns it has, and the number of soldiers inside.

### The Rule of One

If you are designing a Shorefort template of your own, you cannot have a location numbered one, as an attack roll of one in the Man O' War game always misses.

### SHOREFORTS AND DAMAGE

Each location on a Shorefort has a saving throw of 3+, and when it takes a point of damage the cannon battery in that location is destroyed. Further hits to the same location cause structural damage – for each additional hit, the Shorefort loses one of its structural damage points and one crew counter as masonry and rubble collapse and crush them.

### BUYING SHOREFORTS

The main problem to overcome with the Shoreforts you design is structuring their points cost to fit in with the Fleet Lists. I have settled on 50 points per cannon battery, making the Shorefort in the rulebook very good value.

You cannot have more Shoreforts in your fleet than you have Ships of the Line squadrons.



## BATTLE HONOURS

When working out the Battle Honours for your Shorefort, use the rule of 1 Battle Honour per 25 points the Shorefort is worth.

## FIRING ARCS

To give you more freedom when selecting targets, you can split a Shorefort's attacks as you wish. For instance, if you have a Shorefort with 6 cannon batteries, you could fire all 6 at a single target, 2 batteries at 3 separate targets, or any other combination you can think of.

## DIFFERENT RACES

You can modify your Shoreforts to take into account the different weapons employed by your fleet. An Elf Shorefort, for example, could have batteries of Eagle Claw bolt throwers rather than cannons, while an Orc Shorefort might have Big Chukkas.

The only problem with arming Shoreforts in this manner comes with Dark Elves, as a Shorefort with numerous Reaper batteries would be devastating and very, very expensive. Instead, Dark Elf Shoreforts have single bolt thrower batteries that follow all the rules for Reaper bolt throwers, except the rule about rolling to see how many bolts you fire (each Reaper battery mounted in a Shorefort only ever fires one bolt).

Alternatively, you could buy the Shorefort as an ally and arm it with cannons as normal.



## EXAMPLE SHOREFORTS

The following examples, complete with templates, show you how you can construct Shoreforts of different sizes to suit different purposes.

### DEFENCE TOWER

Defence Towers are the smallest type of Shorefort, and are used as the first line of defence against attacks from enemy ships. They are usually stationed some miles out to sea, usually on a rocky outcrop where they can act as lighthouses in peacetime. When attacked, the same beacons they use to warn friendly ships of shallow water can be used to warn the bigger and stronger shoreforts inland that an enemy fleet is approaching.

A Defence Tower has the following profile:

<b>Locations:</b>	1
<b>Structural Damage:</b>	1
<b>Cannon Batteries:</b>	1
<b>Crew:</b>	1
<b>Points Cost:</b>	50
<b>Battle Honours:</b>	2

## COASTAL BASTION

A Coastal Bastion is the penultimate line of defence in a well-protected coastal city's armament. If the enemy fleet manages to get past the city's Defence Towers and Shoreforts, they will come up against their Coastal Bastions. These awesome installations are packed with guns and soldiers, and are a match for even the largest ships.

A Coastal Bastion has the following profile:

<b>Locations:</b>	5
<b>Structural Damage:</b>	5
<b>Cannon Batteries:</b>	5
<b>Crew:</b>	5
<b>Points Cost:</b>	250
<b>Battle Honours:</b>	10

## SEA FORTRESS

After a Coastal Bastion, the next step is to split your Shorefort into high and low locations. This gives up to 10 locations on an immense, impregnable Sea Fortress, against which the attacker has to aim either high or low.

In a boarding action, a Shorefort of this size, if undamaged, would get a dice+10 for its crew and +10 for its cannon batteries. It also gains a further +1 for having stone walls, giving it a total of 1 dice+21!

The only way a Sea Fortress can be captured would be by constant bombardment to wear down its defences, coupled with powerful magic and a boarding action to finish it off.

A Sea Fortress has the following profile:

<b>Locations:</b>	10
<b>Structural Damage:</b>	10
<b>Cannon Batteries:</b>	10
<b>Crew:</b>	10
<b>Points Cost:</b>	500
<b>Battle Honours:</b>	20

## USING SHOREFORTS IN MAN O' WAR

Shoreforts are interesting additions to any fleet, but are best used in conjunction with a set scenario for your game. If a Shorefort is just added to your fleet, in all probability your opponent will simply avoid it until all your ships are sunk, or even for the whole game.

However, a Shorefort can make a great focal point for a scenario-driven game, where the capture or destruction of the Shorefort is essential to victory.

The *Storm the Shoreforts* scenario in the Man O' War rulebook is a good example, where both players have a Shorefort and the winner is the first player to reduce his opponent's Shorefort to rubble.

Over the page are a few scenario ideas, that give examples of how you can use Shoreforts to create really exciting games of Man O' War.

## SHOREFORT SCENARIOS

The following scenarios can be used in any Man O' War campaign if all the players agree. To combine the Shorefort scenarios with those in the Man O' War and Plague Fleet rulebooks, you can roll on the following table to see which scenario you use for each battle in your campaign.

### Roll Scenario

- 1-3 Play a normal battle
- 4 Play a scenario from the Man O' War rulebook. Roll on the following table.
  - 1 After the Storm
  - 2 Treacherous Waters
  - 3 In the Jaws of a Trap
  - 4 Buried Gold
  - 5 The Treasure Fleet
  - 6 Storm the Shoreforts
- 5\* Play a scenario from the Plague Fleet rulebook. Roll on the following table.
  - 1 Gold of The Dark Gods
  - 2 Plaguemonger
  - 3 Escape from the Chaos Wastes
  - 4 Dark Crusade
  - 5 The Straits of Despair
  - 6 Isle of Dread
- 6 Play a Shorefort scenario. Roll on the following table.
  - 1 Free the Trade Route
  - 2 Convoy
  - 3 Neutral Waters
  - 4 Rescue
  - 5 Invasion
  - 6 Storm the Shoreforts (Man O' War)

*\*If neither player has a Chaos fleet, re-roll the dice.*

### FREE THE TRADE ROUTE.

One of the players has a large Shorefort that is protecting a vital trade route. The Shorefort can be of any size within any normal points limitations for the game. His opponent has to crush the Shorefort and free the trade route. The player who owns the Shorefort does not place any ships on the table for 1 to 6 turns (roll a dice), as he has to wait for his fleet to turn up and rescue the Shorefort.

*Black Leviathan*

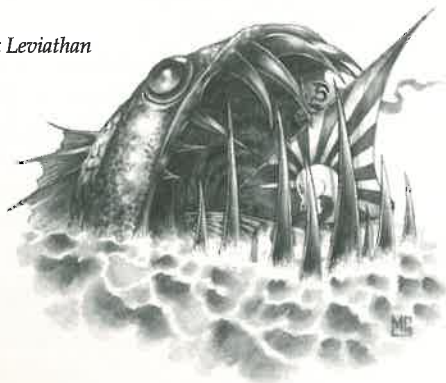

### CONVOY

A convoy is due to make its way through the straits between two Shoreforts in 10 turns time. If the Shoreforts are not destroyed, the chance to slip through will be lost, and the convoy will be shot to pieces.

One player chooses two Shoreforts as part of his fleet, while the other player must destroy them to afford his ships free passage. The Shoreforts can be of any size within any normal points limitations for the game.

### NEUTRAL WATERS

After all terrain has been placed, and the fleets chosen, each player places a standard Shorefort, from the Man O' War rulebook, anywhere on the table except in the deployment zones. These are neutral Shoreforts and will not take any part in a battle unless their neutrality is violated. As soon as any ship sails within range of a Shorefort's guns they will open fire.

A Shorefort fires at any targets within range (9") after all other ships have been moved. Each Shorefort fires all of its guns at the same target. If there is more than one eligible target, roll a dice to see which is fired upon.

### RESCUE

Each player must have a Shorefort in his fleet. They can be of any size within any normal points limitations for the game. Each Shorefort holds a high ranking officer from the opponent's side as a prisoner. The first player to rescue a prisoner and escape off the board is the winner.

Destroying your opponent's Shorefort will kill the prisoner inside - he must be rescued in a boarding action. Once you have captured the Shorefort in a boarding action, nominate one of your ships involved in the boarding action and note down that the prisoner is now rescued and aboard this vessel. To win the game, that ship has to escape off the board with the prisoner.

### INVASION!

A major invasion is planned, and is due to get underway in a few days. The major stumbling block is the great Shorefort that blocks the fleet's route. The Shorefort is rumoured to be the dwelling place of a powerful Wizard, who uses his arcane powers to scry the surrounding area for many miles. Any enemy vessels that try and approach are immediately spotted, and the Wizard's masters forewarned. Without the destruction of the Shorefort, the invasion is doomed.

One of the players chooses a Shorefort as part of his fleet. The Shorefort can be of any size up to the points limitation for the game. Included in the price is a free Master Wizard. This is the only Wizard in the fleet, and if the Shorefort is destroyed he is killed. The player with the Shorefort positions it in the middle of the playing area. His opponent must capture or destroy it to win.

In addition, the player who owns the Shorefort must roll 2 dice and add them up. This is the number of turns he must survive before he can place the rest of his fleet on the table.

*Wreathed in gun smoke, the Sea Fortress was barely visible, just its top most turrets poking through the thick vapours. The infernal row caused by the endless roaring of its cannon batteries deafened every living thing for miles around.*

*Standing at the top of the turret that sat astride the gatehouse, Commander Krieger lowered his sword to signal another battery to fire at the attacking ships. Behind and below him, in the courtyard, numerous small fires burned fiercely, the fire teams silhouetted against the flames as they threw bucket after bucket onto the blaze.*

*The Sea Fortress had been under attack for two days now, subjected to a ceaseless battering from the guns of the Galleons riding at anchor below. Krieger was seriously outnumbered and outgunned, but his castle stood on the firm bedrock whilst the mightiest Galleon was after all just timber floating on the waves. As soon as the threat was revealed, Krieger had dispatched carrier birds to the Empire to bring help to the besieged city, and his Wizard had been desperately sending messages through whatever arcane channels he could open. The air around his tower had crackled blue-black for the last two hours, and it was evident that he was meeting resistance from the Wizards of the Bretonnian fleet.*

*Only two months ago, Krieger was stationed in Nuln, teaching gunnery and siege warfare to recruits for the war in the North. Then the alliance with Tilea was formalised, and the hitherto neutral Sea Fortress on Black Rock – with its stranglehold on the main trade route to Araby and far Cathay – took on a new status. The Bretonnians were desperate to take the Sea Fortress from the Empire and had immediately dispatched a large warfleet, despite protestations from the Emperor himself. As yet, Bretonnia and the Empire were not officially at war, as the constant threat of attack from Orcs or the armies of Chaos held the two powerful nations in a state of uneasy non-aggression.*

*The Tileans were renowned as poor shots and having little or no stomach for a fight, so Krieger and a hundred hand-picked gunners and soldiers had rapidly been dispatched to the Sea Fortress, arriving scant days before the biggest Bretonnian battlefleet Krieger had ever seen. And they were not even supposed to be at war . .*

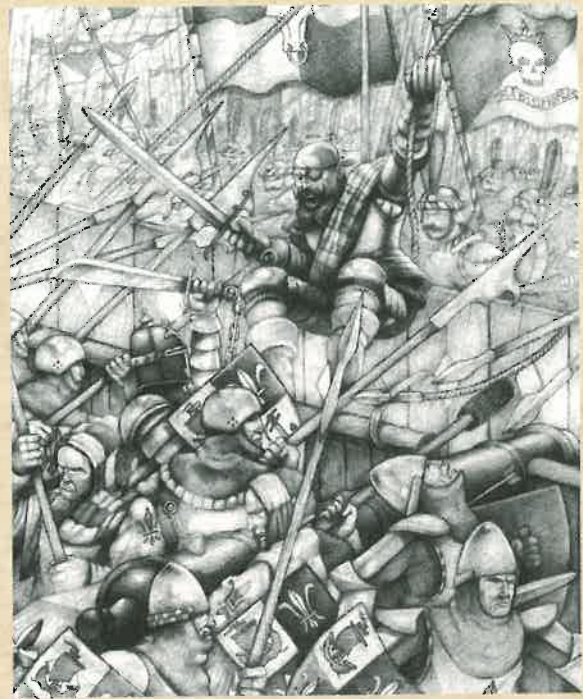

*Admiral Krieger and his men put up a stalwart defence against the attacking Bretonnian Fleet.*

## CAMPAIGN GAMES

The Scenario list is by no means exhaustive, and you should feel free to invent your own scenarios for using Shoreforts.

Alternatively, you could play linked games, where the outcome of one game has an effect on the next.

For instance, the first game is played on the open sea, with no terrain, and the winner gets to push on to his opponent's home waters in the second game.

In the second game, the loser of the first battle must spend some of his points on a Shorefort to defend his coastline, now under threat of invasion.

By game three – if the same player has lost games 1 and 2 – place lots of terrain pieces in his deployment zone to represent his coastline. If the enemy fleet can destroy his ships and reach the coastline, the invasion is on in earnest! Perhaps the objective is to capture a town or city, or destroy something of great importance such as a temple, mine or citadel.

Of course, you cannot play the final invasion battle using the Man O' War rules, as once the ships disgorge their troops onto the beaches their part is done. However, you could always finish off the campaign with a game of Warhammer Battle to determine the outcome of the invasion itself...



# COASTAL BASTION

**CREW**  
5

INDEPENDENT TERRAIN PIECE

<div style="text-align: center; font-size: 2em; color: red; font-weight: bold;">5</div> <div style="text-align: center; background-color: #e0f0ff; padding: 5px;"> </div> <p style="text-align: center; font-weight: bold; margin: 0;">UPPER LEFT CANNON BATTERY</p> <p style="text-align: center; font-weight: bold; margin: 0;">Save 3, 4, 5 or 6</p> <p style="font-size: 0.8em; margin: 0;">1 cannon battery destroyed. Further hits cause structural damage.</p>	<div style="text-align: center; font-size: 2em; color: red; font-weight: bold;">6</div> <div style="text-align: center; background-color: #e0f0ff; padding: 5px;"> </div> <p style="text-align: center; font-weight: bold; margin: 0;">UPPER RIGHT CANNON BATTERY</p> <p style="text-align: center; font-weight: bold; margin: 0;">Save 3, 4, 5 or 6</p> <p style="font-size: 0.8em; margin: 0;">1 cannon battery destroyed. Further hits cause structural damage.</p>	
<div style="text-align: center; font-size: 2em; color: red; font-weight: bold;">2</div> <div style="text-align: center; background-color: #e0f0ff; padding: 5px;"> </div> <p style="text-align: center; font-weight: bold; margin: 0;">LEFT CANNON BATTERY</p> <p style="text-align: center; font-weight: bold; margin: 0;">Save 3, 4, 5 or 6</p> <p style="font-size: 0.8em; margin: 0;">1 cannon battery destroyed. Further hits cause structural damage.</p>	<div style="text-align: center; font-size: 2em; color: red; font-weight: bold;">3</div> <div style="text-align: center; background-color: #e0f0ff; padding: 5px;"> </div> <p style="text-align: center; font-weight: bold; margin: 0;">CENTRE CANNON BATTERY</p> <p style="text-align: center; font-weight: bold; margin: 0;">Save 3, 4, 5 or 6</p> <p style="font-size: 0.8em; margin: 0;">1 cannon battery destroyed. Further hits cause structural damage.</p>	<div style="text-align: center; font-size: 2em; color: red; font-weight: bold;">4</div> <div style="text-align: center; background-color: #e0f0ff; padding: 5px;"> </div> <p style="text-align: center; font-weight: bold; margin: 0;">RIGHT CANNON BATTERY</p> <p style="text-align: center; font-weight: bold; margin: 0;">Save 3, 4, 5 or 6</p> <p style="font-size: 0.8em; margin: 0;">1 cannon battery destroyed. Further hits cause structural damage.</p>

1

Capturing a Coastal Bastion

Move your ship so that it touches the Bastion. Roll a dice. On a 5 or 6 you have run aground.

Whether or not you run aground, you may conduct a boarding action. The Bastion fires its guns in defence, adding +1 to its dice roll for its thick walls.

MAY NOT MOVE

POINTS COST: 250

BATTLE HONOURS: 10

REMOVE 1 CREW COUNTER

REMOVE 1 CREW COUNTER

REMOVE 1 CREW COUNTER

REMOVE 1 CREW COUNTER

COASTAL BASTION DESTROYED

STRUCTURAL DAMAGE

Immune against rams: rammers run aground

Each hit reduces number of crew counters by 1.



*On the very edges of The Seas of Chaos, stalwart Coastal Bastions stand firm, supported by the warship of their allies.*

*Krieger instinctively ducked as a cannon ball struck the parapet, sending shards of red hot stone and steel flying in all directions.*

*So far the Galleons had reduced one tower to a smoking ruin, killing twenty gunners as the side of the Sea Fortress collapsed into the sea. Krieger blamed that catastrophe on poor Tilean construction, and thanked the gods he had set up his headquarters in the older, original section that some rumoured to be of Elf origin. The tower he stood in was so old and weathered that it looked to have been sculpted from the stone of the island rather than built on top of it.*

*The mighty cannons anchored to the stone floor of the Sea Fortress had been firing day and night, buckets of water cooling the gaping iron barrels so they could maintain a constant barrage. Their crews were near exhaustion, but the results of their efforts were plain to see.*

*In the shallows around the Sea Fortress, and smashed against the rocks, were no less than three Galleons, four Corsairs and any number of wrecked Buccaneers. The surface of the water was covered with a slick of flotsam, jetsam and desperate sailors hanging onto whatever bits of wood they could find. And amongst them circled the sharks.*

*Further away, at least a dozen other Bretonnian warships were ablaze, staining the sky with a crimson glow. Yet there were many ships left, their guns still firing, battering away at the stone walls with desperate persistence. Cracks were appearing in the sturdy walls of a number of the towers, and Krieger did not know how much more punishment the Sea Fortress could take.*

*On the far side of the Sea Fortress a shout went up, alarm bells and signal flags warning Krieger that something was amiss. Gathering his best troops, he ran around the battlements to see first hand what new threat gathered. As Krieger reached the distant Wizard's tower, the floor shook and the air burst into shimmering flame. Leaping backwards just in time, Krieger hung onto the battlements as the tower crumbled and slid into the sea, a deluge of stone and steel and flesh. A huge breach gaped in the walls, and already Krieger saw ships and boats closing in to launch landing parties.*

*"Magic, curse it. Always magic" growled Krieger through clenched teeth, before turning to his lieutenants*

*"Prepare to fight. Get the troops into the breach there and there, crossbow men to cover there and there." His finger stabbed out to identify the strategic cover, and his men rushed off to take up their positions.*

*Cocking his pistol, Krieger spat over the wall before turning back to his men.*

*"And don't expect the Tilean dogs to stand and fight. It's up to us now lads"*

*Thirty Empire soldiers formed a thin line in the rubble, stubbornly defiant in the face of the hundreds of approaching Bretonnians.*

*Just over the horizon, the Greatship Karl Franz and a dozen Wolfship squadrons sailed with a following wind toward the Sea Fortress. They could see a heavy column of smoke over the skyline, but had no way of telling if it was the Sea Fortress or the Bretonnian fleet that was aflame...*

# DEFENCE TOWER

**CREW**  
1

INDEPENDENT TERRAIN PIECE

5,6

**CANNON BATTERY**  
 Save 3, 4, 5 or 6  
 Cannon battery destroyed.  
 Further hits cause structural damage.

○1

**Capturing a Defence Tower**  
 Move your ship so that it touches the Tower. Roll a dice. On a 5 or 6 you have run aground.  
 Whether or not you run aground, you may conduct a boarding action. The Tower fires its guns in defence, adding +1 to its dice roll for its thick walls.

DEFENCE TOWER DESTROYED

**STRUCTURAL DAMAGE**  
 Immune against rams: rammers run aground  
 Each hit reduces number of crew counters by 1.

**MAY NOT MOVE**  
**POINTS COST: 50**  
**BATTLE HONOURS: 2**

# SHOREFORT

**CREW**  
3

INDEPENDENT TERRAIN PIECE

4

**LEFT CANNON BATTERY**  
 Save 3, 4, 5 or 6  
 1 cannon battery destroyed.  
 Further hits cause structural damage.

5

**CENTRE CANNON BATTERY**  
 Save 3, 4, 5 or 6  
 1 cannon battery destroyed.  
 Further hits cause structural damage.

6

**RIGHT CANNON BATTERY**  
 Save 3, 4, 5 or 6  
 1 cannon battery destroyed.  
 Further hits cause structural damage.

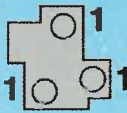

**Capturing a Shorefort**  
 Move your ship so that it touches the Shorefort. Roll a dice. On a 5 or 6 you have run aground.  
 Whether or not you run aground, you may conduct a boarding action. The Shorefort fires its guns in defence, adding +1 to its dice roll for its thick walls.

REMOVE 1 CREW COUNTER

REMOVE 1 CREW COUNTER

SHOREFORT DESTROYED

**STRUCTURAL DAMAGE**  
 Immune against rams: rammers run aground  
 Each hit reduces number of crew counters by 1.

**MAY NOT MOVE**  
**POINTS COST: 150**  
**BATTLE HONOURS: 5**

Permission granted to photocopy for personal use only. © Games Workshop Ltd., 1993. All rights reserved.

Permission granted to photocopy for personal use only. © Games Workshop Ltd., 1993. All rights reserved.

# SEA FORTRESS

INDEPENDENT TERRAIN PIECE

**CREW**  
**10**

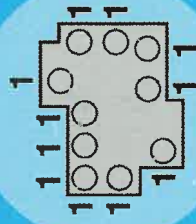

**Capturing a Sea Fortress**

Move your ship so that it touches the Fortress. Roll a dice. On a 5 or 6 you have run aground. Whether or not you run aground, you may conduct a boarding action. The Fortress fires its guns in defence, adding +1 to its dice roll for its thick walls.

**MAY NOT MOVE**  
**POINTS COST: 500**  
**BATTLE HOURS: 20**



		HIGH				LOW				STRUCTURAL DAMAGE	
<p><b>2</b></p> <p><b>GARRISON TOWER</b> Save 3, 4, 5 or 6 1 cannon battery destroyed. Further hits cause structural damage.</p>	<p><b>2</b></p> <p><b>SEA WALL</b> Save 3, 4, 5 or 6 1 cannon battery destroyed. Further hits cause structural damage.</p>	<p><b>3</b></p> <p><b>GATETOWER</b> Save 3, 4, 5 or 6 1 cannon battery destroyed. Further hits cause structural damage.</p>	<p><b>4</b></p> <p><b>KING'S TOWER</b> Save 3, 4, 5 or 6 1 cannon battery destroyed. Further hits cause structural damage.</p>	<p><b>5</b></p> <p><b>PRISON TOWER</b> Save 3, 4, 5 or 6 1 cannon battery destroyed. Further hits cause structural damage.</p>	<p><b>6</b></p> <p><b>FLAG TOWER</b> Save 3, 4, 5 or 6 1 cannon battery destroyed. Further hits cause structural damage.</p>	<p><b>3</b></p> <p><b>MAIN GATE</b> Save 3, 4, 5 or 6 1 cannon battery destroyed. Further hits cause structural damage.</p>	<p><b>4</b></p> <p><b>CURTAIN WALL</b> Save 3, 4, 5 or 6 1 cannon battery destroyed. Further hits cause structural damage.</p>	<p><b>5</b></p> <p><b>COURTYARD WALL</b> Save 3, 4, 5 or 6 1 cannon battery destroyed. Further hits cause structural damage.</p>	<p><b>6</b></p> <p><b>DUNGEON WALL</b> Save 3, 4, 5 or 6 1 cannon battery destroyed. Further hits cause structural damage.</p>	REMOVE 1 CREW COUNTER	REMOVE 1 CREW COUNTER
										REMOVE 1 CREW COUNTER	REMOVE 1 CREW COUNTER
										REMOVE 1 CREW COUNTER	REMOVE 1 CREW COUNTER
										REMOVE 1 CREW COUNTER	REMOVE 1 CREW COUNTER
										REMOVE 1 CREW COUNTER	REMOVE 1 CREW COUNTER
										REMOVE 1 CREW COUNTER	REMOVE 1 CREW COUNTER
		REMOVE 1 CREW COUNTER		REMOVE 1 CREW COUNTER		REMOVE 1 CREW COUNTER		REMOVE 1 CREW COUNTER		SEA FORTRESS DESTROYED	

**STRUCTURAL DAMAGE**  
Immune against rams:  
rammers run aground  
Each hit reduces number  
of crew counters by 1.

# SEA OF BLOOD



**SEA OF BLOOD IS THE SECOND SUPPLEMENT TO THE MAN O' WAR GAME OF RAGING SEA BATTLES.**

Sea of Blood contains new rules for Sea Monsters and Flying Creatures, to be used in conjunction with the Man O' War game and the Plague Fleet supplement:

### Sea Monsters

The Triton, Sea Elemental, Kraken, Sea Dragon, Megaladon, Promethean, Black Leviathan, Gargantuan, and Behemoth rise to the surface to vent their fury against the fleets of the Known World.

### Airpower

Brettonian Pegasus Riders, Dwarf Gyrocopters and War Balloons, Elf Dragon Riders and War Eagles, Imperial Griffon Riders, Orc Wyvern Riders, Dark Elf Manticore Lords, Chaos Dwarf Taurus Riders and Lords of Change fill the smoke-laden skies above the battle.



**MAN O' WAR**<sup>TM</sup>  
SUPPLEMENT

SEA OF BLOOD IS NOT A COMPLETE GAME. YOU WILL NEED A COPY OF THE MAN O' WAR GAME TO USE THE CONTENTS OF THIS BOX

**GAMES**<sup>®</sup>  
**WORKSHOP**



# MAN O' WAR TZEENTCH FLYERS



GREAT WINGED TERROR

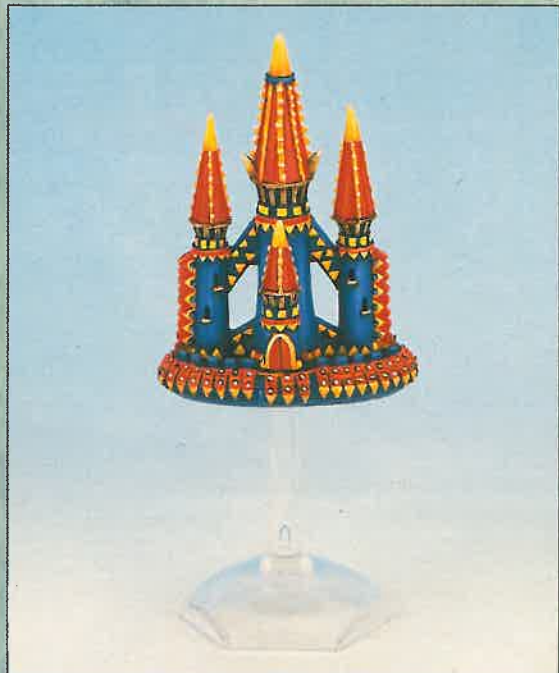

BANE TOWER OF TZEENTCH



CHAOS FORCES ATTACK AN ORC FLEET

# SPACE MARINE®

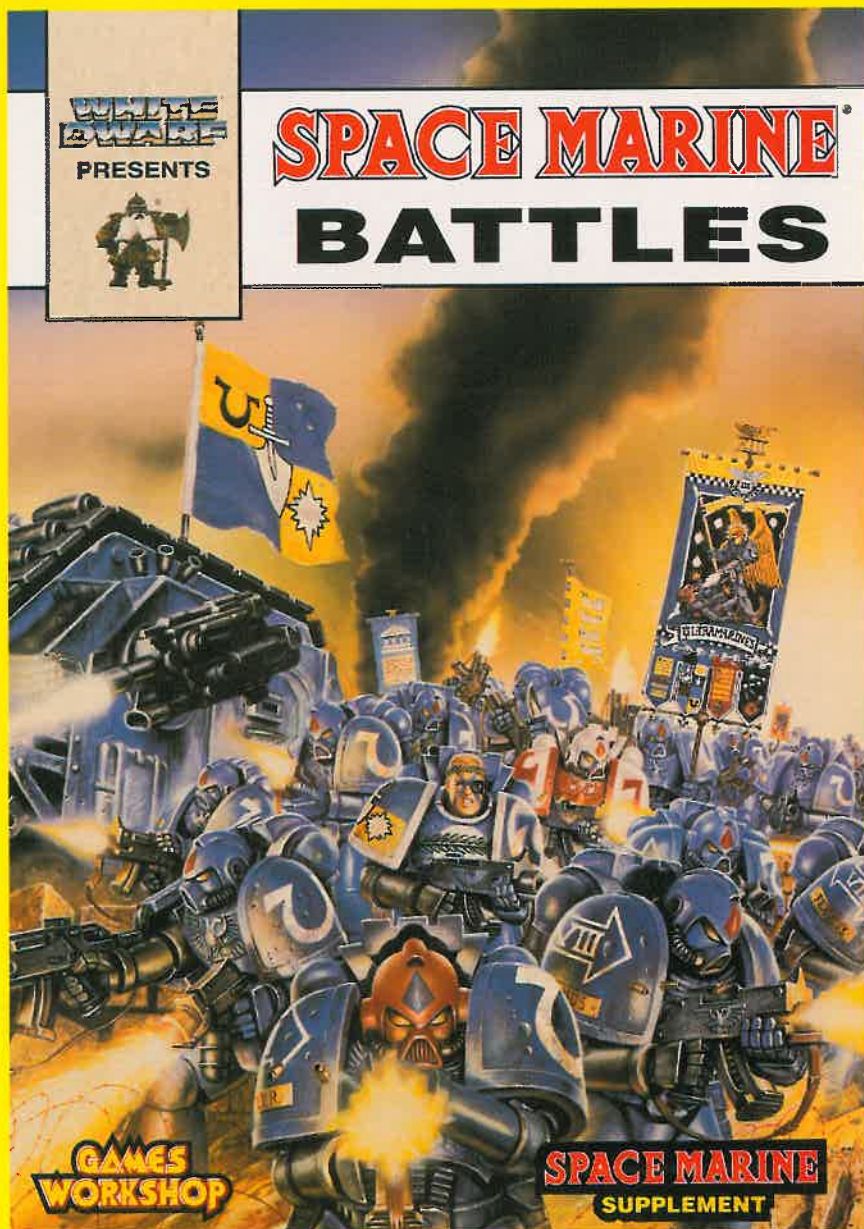

The Space Marine Battles compilation features some of the most sought after Space Marine articles from White Dwarf magazine. The book contains four exciting epic battle reports featuring the forces of the Eldar, Orks, Squats, Chaos, Space Marines, and the Imperial Guard.



It also features brand new tactics articles for many of these armies, plus special rules for fighting attack and defence games in Epic scale including: bunkers,

razor wire, minefields and fortifications. In addition, there are full rules for all of the awesomely destructive Imperial Titan weapons and full-colour card data sheets, rules and army cards for the Imperial Reaver and Warhound Titans, the Ork Great Gargant, Tzeentch Daemon Engines and epic heroes such as Ghazghkull Thraka, Commissar Yarrick and Ragnar Blackmane.

**WHITE DWARF®**

SPACE MARINE BATTLES IS NOT A COMPLETE GAME. YOU WILL NEED A COPY OF SPACE MARINE TO USE THE CONTENTS OF THIS BOOK.

**GAMES WORKSHOP®**

# WARHAMMER

®

## FLYING MONSTERS

By Rick Priestley

We receive many letters about large flying monsters in Warhammer. Some players seem convinced that the only way to win battles is to mount up the general on a large and brutal beast like a Griffon. It is easy to overestimate the value of flying monster/rider combinations. Indeed some players misinterpret the flying rules, making such creatures even more powerful than intended. In this article we will look at the pros and cons of these so-called super-weapons, and examine some of the tactical options both for using and countering them.

A general or wizard riding a big flying monster makes an impressive centrepiece for a collection. This is as good a reason as any for including one in your army! Aesthetics aside, what attracts most people to the combination of hero and monster is its combat potency.

Take for example a High Elf Lord riding a Griffon. The Griffon has WS5, S6, and 4 attacks, against an average-to-good WS4 T4 opponent it will hit on 3+ and wound on 2+. Saves are at -3 and can therefore be discounted on the whole. With 4 attacks this gives a reasonably safe 2 wounds and you can be fairly sure of 3. Remember this is in addition to the damage your hero is going to cause.

In the case of an Elf Lord with WS7, S4 and 4 attacks you are looking at inflicting another 2 wounds against a similar T4 opponent. A hero costing as many points as this (160 for the Elf Lord and 150 for the Griffon) is worth tooling up a little. You would expect him to be carrying a magic weapon of some kind, probably accounting for at least one more wound or the equivalent. Taken together, this equals the killing power of a unit of good troops concentrated into a single model. I'm sure it isn't really necessary to labour this particular point as any experienced Warhammer player will appreciate just how awesome these monsters and heroes can be. This is probably their most obvious and significant advantage... they are dead hard!



A High Elf hero mounted on a Griffon clashes with a Chaos Dwarf Great Taurus.

What makes flying monsters uniquely powerful is their extraordinary mobility. They move very quickly (24") and can hop over scenery such as woods or buildings. In addition, they can pull away from a hand-to-hand combat engagement which means they don't get stuck into protracted combats as would a non-flying character (more of this later). Most importantly, these creatures can fly high into the air from where they can swoop down onto any part of the battlefield in subsequent turns. This extra mobility means that flying monsters can be used to pick off vulnerable targets such as enemy war machines or even enemy characters, and you can charge into existing engagements to swing the tide in favour of your side. Often a fear or terror test will be required when a monster charges, and this may be enough to send the enemy fleeing.

There are some disadvantages to the monster with character tactic. The main drawback of choosing a flying monster and massively powerful rider is simply cost. On a 3000 point army you will probably have a maximum of 50% points available for characters including their mounts and magic. By the time you've chosen a general, a wizard, and champions for your most important units, the chances are you'll be hard pushed to scratch together enough points for a hero, a monster, and magic items. Players who go for this option always find themselves stretched elsewhere, and this is something which a skilful opponent will exploit. Some players mount the general himself on a flying monster, which means they tend to lose the usual advantages of having a general with or near a unit (ie. the ability to make leadership based tests using the general's own Ld value). If your army has good leadership, such as High Elves, this might not matter too much; but humans, Orcs, Goblins and many other troops need these Ld bonuses and therefore must have the general as close as possible.



*This Wood Elf eagle rider is a stunning miniature conversion by master painter Mike McVey.*

Bear in mind a monster and its heroic rider is a big commitment in terms of the army's overall points value. A single model is just a single target, and can be taken out by one cannon shot or a magic spell. This adds up to a significant risk. Players will naturally try to protect their heroes using appropriate magic items, although this increases the cost even further. Often magic items will account for several hundred points. It is important not to exaggerate the perils of over commitment, as points spent on counter magic are often well worthwhile, but it does help to explain how the monster with hero syndrome works.

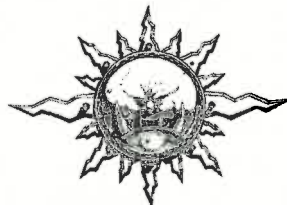

You can see why some players end up with armies consisting of pitifully few units, a smattering of artillery pieces, and a single overladen, high-cost super-character. This is major risk territory! Such armies will win or lose with the big character whilst the rest of the army takes little part in the battle. The result of the entire game will often depend upon one round of hand-to-hand combat, one cannon blast, or a single spell. There will always be players who are convinced they can find the winning combination, the perfect stat-heavy super-monster that's a certain game winner. It's even quite entertaining trying to put together this ultimate warrior! This is a subject which even hardened veterans find plenty to talk about. Ultimately however, the perfect warrior isn't the perfect army, and most players prefer a more balanced approach to their gaming.

It's worth saying that we always use the points restrictions on characters! This may seem obvious but some people don't, thereby allowing armies to have a disproportionate amount of characters and making flying monster mounts too easily available. The points value restrictions, turn lengths, and victory points are all there to balance the game. The longer a game the more effective flying creatures are relatively speaking, because they can fly up high and make repeated attacks. Also, if you play with very big armies the availability of characters becomes relatively easier. Army Lists are always balanced for armies of about 3000 points – so if you are in the habit of playing 10,000 or 20,000 points a side battles you might have to introduce additional restrictions.

### GET THE RULES RIGHT!

So, what is the best tactic to keep these awesome flying death dealers at bay? Well, the first thing is to make sure you're playing the rules properly. We receive so many letters about flyers that it's obvious there are some quite innovative interpretations out there. Most work strongly in favour of flyers and make them disproportionately effective. In fact, when I started putting this article together it emerged that even within the Games Workshop Studio there were several different interpretations of the rules in play! Some clarification would therefore be a good thing.

The biggest area of confusion is the rule for flying high. The rule for flying high is very simple. A model which is on the tabletop can elect to fly high at the beginning of its movement phase. This means exactly what is says – ie the model **must** be



*An Imperial Hero mounted on a Pegasus charges into the flank of a Dwarf unit who are in combat with a regiment of Halberdiers.*

on the tabletop, and it **must** be removed at the beginning of its movement phase. In effect the model elects to fly high instead of moving. Note that this means that it is **impossible to start the game flying high**.

The flying high rule is absolute – there are no other circumstances when a model can fly high. A model may never fly high when it is driven off from hand-to-hand combat, or when it leaves hand-to-hand combat voluntarily. Many players confuse the flying high rule with the driven off/voluntary retreat rule, and assume that flyers that are driven off, or which retreat from combat voluntarily, are automatically flying high. **This is not the case!**

To return to the flying high rule itself. A model which is already flying high at the start of its turn may either continue to fly high (effectively taking no part in the ground battle) or it can drop down anywhere you like onto the tabletop. It can drop down onto an enemy unit or other suitable target, and counts as charging as it does so. The question this often poses is ‘can the enemy unit respond to the charge as normal (stand-and-shoot, hold or flee) and if it stands-and-shoots at what range do you work out the fire?’. The answer is that the target can make any of these responses in the normal manner, and can stand-and-shoot at the maximum range of its weapon. Note, however, that war machines can never stand-and-shoot. This is true against any target, not just aerial attackers, and is worth noting in your Warhammer Rulebook.

Skaven jezzails and warp-fire throwers are an exception to this rule, but even warp-fire throwers are not allowed to stand and shoot at attackers from on high (for reasons which are self evident!).

If a flying creature drops down from on high its enemy may well need to take a terror or fear test, and could fail this and flee as a result. This poses the question ‘does the flyer automatically catch the fleeing troops?’ In fact, what happens is that the flyer drops down exactly in front of the target’s original position and stays there. It has expended its entire movement, and has none left to follow the fleeing enemy. This means that an enemy which flees from an high flying aerial attack can always escape (assuming of course that it is not already engaged against some other enemy in which case it is unable to flee). Many players assume that because the flyer can drop down anywhere it can automatically catch a fleeing unit and therefore destroy it. This is not the case. This is important because it means that the flyer remains vulnerable in the enemy’s following turn.

Players occasionally ask whether flyers need to take a break test, mistakenly assuming that the driven off/voluntary retreat rule replaces the usual combat results. **A break test is taken exactly as normal as soon as combat results are worked out.** The flyer flees if it is defeated and fails a break test. A flyer is never allowed to make a voluntary retreat to avoid a break test. Flyers simply obey the normal fleeing and pursuit rules. So, a flyer always flees and pursues 3D6” in common with other creatures which have a move of more than 6” – the flyer’s 24” move being assumed to be its standard move in this case.

A voluntary retreat is normally an option for flyers at the very end of a combat phase. As this comes after break tests, and after any flee/pursuit has been worked out, a pursuing flyer will have either destroyed its enemy (caught them!) or failed to catch them (leaving the model adrift). In either case there is no combat to retreat from, and the model stays on the table.

The **driven off** rule deserves a little more discussion and works like this. If a flyer is beaten in hand-to-hand combat it takes a break test as normal. If the flyer breaks then the usual break, flee and pursuit rules apply. If the flyer does not break then it is driven off and the model is removed from the table – it has literally been driven away and is assumed to be wheeling around preparing to re-enter the fray.

The model spends then its next turn off the table. In its following turn the model is placed on the table edge and may move normally during its movement phase (it may, for example, choose to fly up high). A flyer which leaves the table is generally placed on the edge in a position which corresponds to where it would have theoretically left the battle, ie: if driven off from combat, it flies directly away from the enemy as you’d expect. If in doubt (which will happen occasionally) re-enter the model on your own table edge.

A flyer has the unique ability to **retreat voluntarily** from a hand-to-hand combat engagement at the end of the phase. When it does so the model is removed from the table exactly as if it had been driven off and the procedure is exactly the same. This rule does **not** allow you to simply remove your flyers from the table and place them in a flying high mode ready to pounce next turn! In fact the rule is intended to give flyers a last-ditch option to disengage from a combat if they are in real trouble. Missing an entire turn before you can reappear is not a good idea, particularly in a four turn game, so this option really is to be avoided if possible.

So much for the rules! In passing I ought to say that a hero who has his mount shot from under him while flying high is destroyed... no parachutes in the Warhammer World I’m afraid!

## AERIAL TACTICS

Before considering individual tactical options it is worth remembering that a flying monster and hero has to fit into your overall game plan. The average game of Warhammer is resolved within four turns, so any plan which involves flying high is going to cut down your fighting time considerably. Similarly a flyer which is driven off, or which makes a voluntary retreat, can be regarded as pretty much out of the game. Given that a hero and monster is always an expensive option, it would be foolish to commit to a combat you are not certain to win quickly. Some players choose to play without the turn limits. The effect of this is to increase the value of flying creatures as it enables them to make repeated attacks. This is up to you, but bear in mind that the points values are based on armies of about 3000 points using the conventional turn limits and victory conditions.

Many players use their flyers to attack and destroy enemy artillery pieces or important enemy characters. This tactic can work very effectively and is a potential game winner. You can either use the 24" move to reach your target as soon as possible, or fly high in turn 1 and attack in turn 2 (this option works best if you have the first turn). The main drawback to this tactic is that it is very obvious! The chances are that your enemy will anticipate your move and take some measure to counter it. Unless you choose a soft target (such as a war machine whose crew are basically ordinary troops) you can find yourself fighting a very powerful character and things may not go entirely your way. If you can't break or destroy your target in one turn the chances are you'll play no more part in the game. The favourite targets for this tactic are therefore cannons and other war machines, stray second-rate heroes, and wizards. If you have the first turn of the game you should be able to attack and destroy your target in turn 2, leaving you free to attack a fresh enemy in turn 3. Unless you get driven off



*A mighty Imperial hero mounted on a Pegasus.*



*The Emperor Karl Franz riding his war Griffon Deathclaw.*

or bogged down in combat (even if you retreat voluntarily you lose a turn) you will then be free to lend your weight where it is most needed to win the game.

Remember, if you attack an artillery piece or another target at the back of your enemy's army, you will be in an excellent position to threaten the rear of his formations in the following turn. This will place your opponent in a traumatic position, and will almost certainly spoil his overall battleplan. Most players go to pieces in this situation!

Another tactic which some players use to good effect is to keep one or more flying creatures flying high. This enables them to attack any enemy who are also flying high. This isn't as effective a tactic as many people believe, because basically the advantages of flying high are not as great as many players think they are! On the other hand you can use flying monsters without riders in this role, enabling you to exploit the monster allowance of your points cost without affecting the characters allowance. Remember, hand-to-hand combat in the air is slightly different to ground combat, representing a series of wheeling passes rather than solidly locked combat. There is no formal charge as such, and so no charge reactions or charge bonuses. The player whose turn it is still strikes his blows first as if he had charged. No psychology tests are taken for fear/terror etc. The normal challenge rules do not apply. Blows are struck as normal but there is no combat result and therefore no winner or loser. Surviving combatants are free to move onto the tabletop in the following turn. You cannot therefore 'pin' an enemy flyer into a flying high position by combat. You can, however, use **all** of your flying high creatures against any single enemy, so you can concentrate your attacks far more effectively than with ground combat.

## The Battle of Iron Peak

The Battle of Iron Peak from WD159, provides an almost textbook example of how a large flying creature – in this case an Orc War Wyvern ridden by a Shaman – can be used to destroy an enemy force. The battle was fought between an Orc and Goblin army and a force of Dwarfs. Throughout the game, the War Wyvern was used with great skill by Jervis Johnson, first of all to destroy his opponent's superiority in artillery, before finally routing and destroying the centre of the Dwarf line.



**Map 1 – Deployment**

At the start of the game, Jervis placed the Wyvern behind the cover of the buildings in the village. This ensured that it could not be attacked by the Dwarf cannon and bolt thrower if the Dwarfs won the dice roll for the first turn.

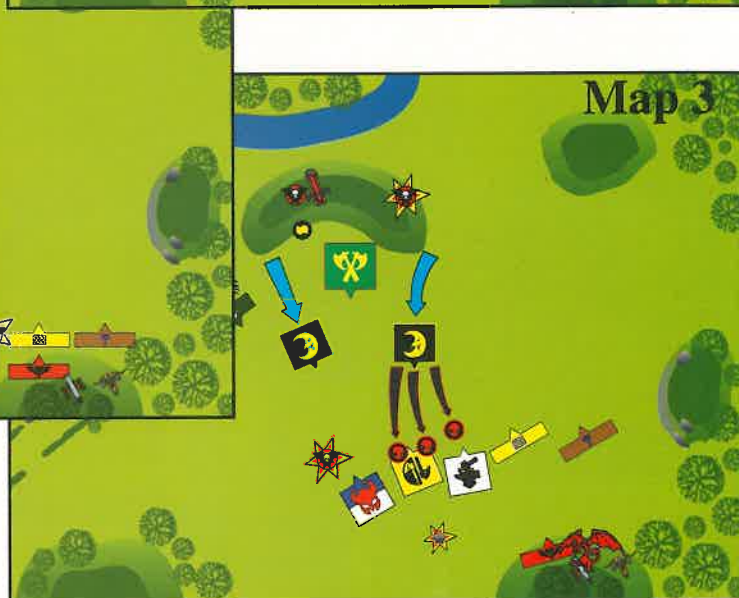

**Map 2 – Orc Turn 1**

At the beginning of the Orc movement phase the Wyvern took to the skies, flying high, as the rest of the army advanced. This allowed the monster to move into position to attack the Dwarf war machines on Turn 2, without coming under fire as it moved forward.

**Map 3 and Photo – Orc Turn 2**

On the second turn, the great monster swooped down and attacked the Dwarf cannon. Even though Bill had placed his bolt thrower and a regiment of crossbows nearby to defend against this attack, they failed to damage the Wyvern and the cannon was destroyed. In fact, Bill was lucky that his forces remained in place, as all three units on the hill had to take a Terror test when the great beast swooped down to attack. The position was only saved by the Dwarfs' high leadership, and all three units passed their test.



MINIATURES SUPPLIED UNPAINTED. CONTENTS AND COLOURS MAY VARY FROM THOSE SHOWN.



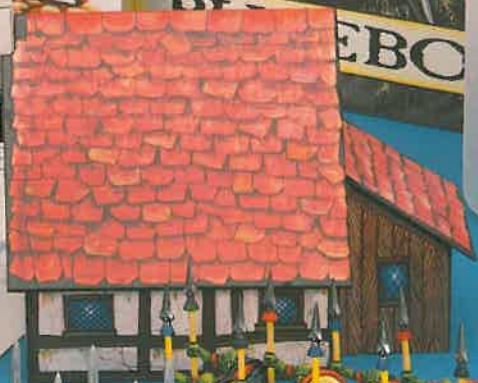
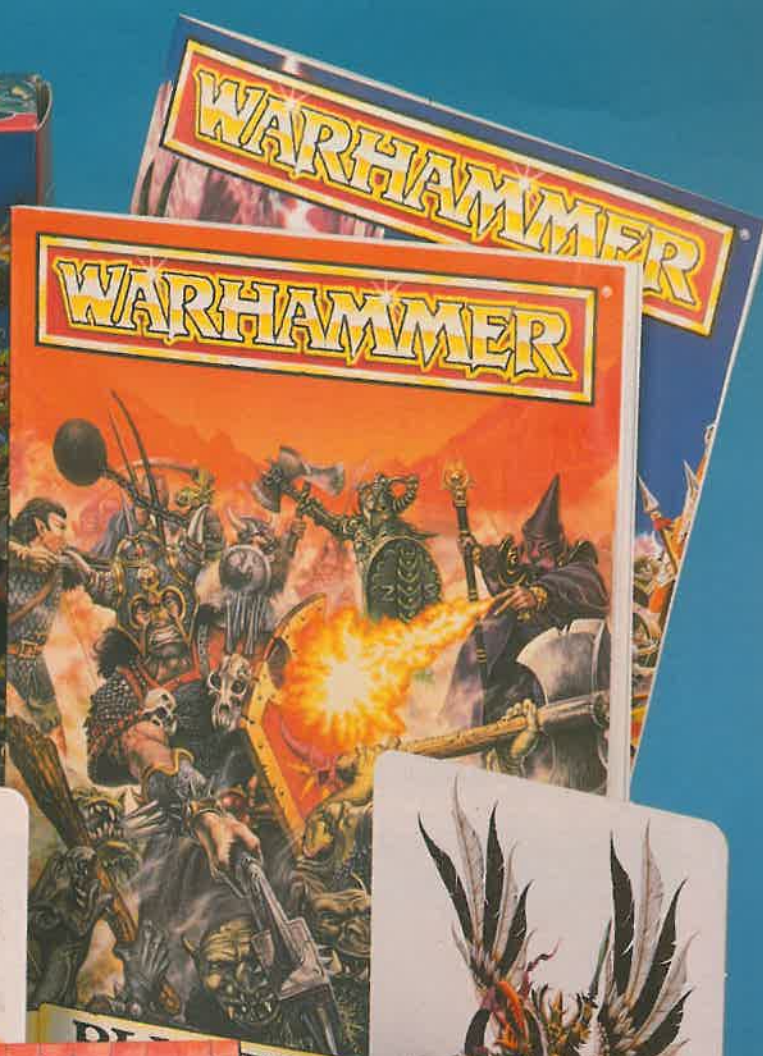
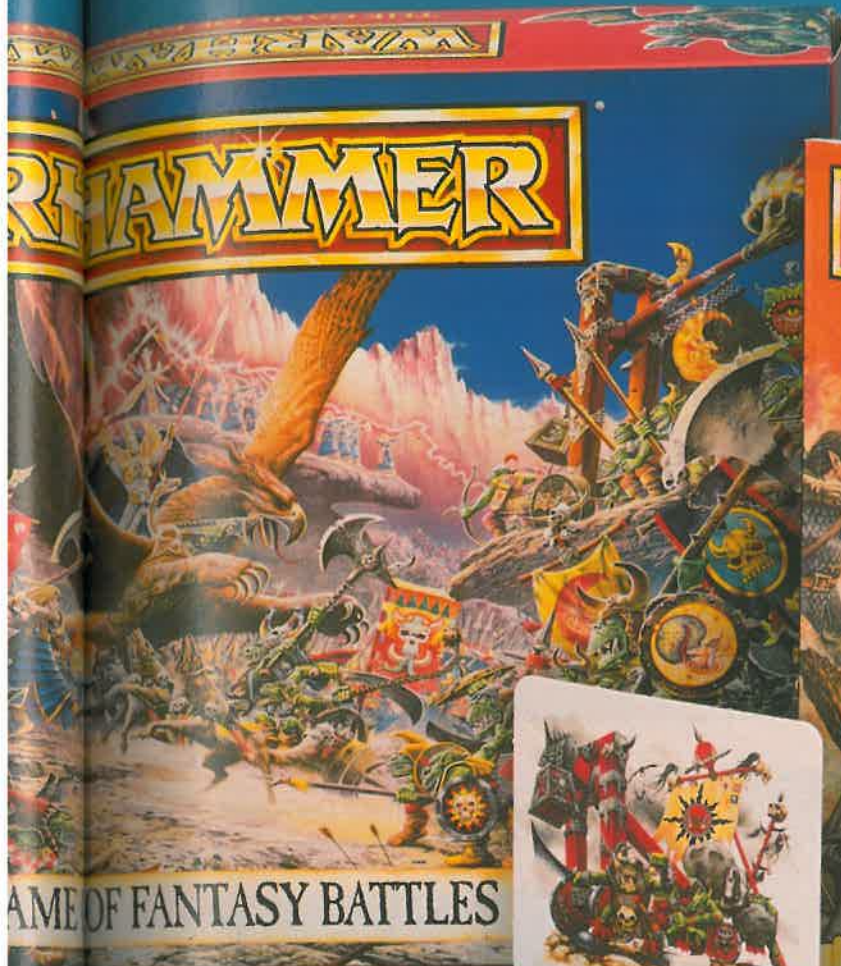

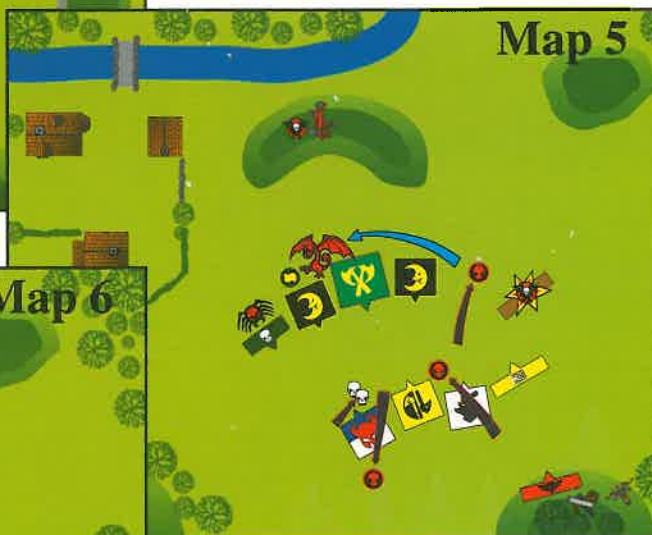

*Photo (above)*

The Wyvern rejoins the main Orc and Goblin battle line and prepares to attack.

**Maps 4 and 5 – Orc Turns 3 and 4**

After the attack on the cannon, the Wyvern withdrew to defend the flank of the Orc army, flying low across the tabletop. However, during the Dwarf turn, it was wounded by the bolt thrower and so on Turn 5, Jervis moved it behind the centre of his line, ready to attack once more (map 5).



**Map 6 – Orc Turn 5**

On the final turn of the game, the whole of the Orc and Goblin army, including the War Wyvern, crashed into the remaining Dwarfs who broke and fled. The Wyvern lunged forward 3D6" in pursuit and caught the fleeing Dwarfs and the game was all but over. In five turns, the Wyvern had only attacked twice, but in both cases it had a decisive effect on the outcome of the battle.

## COUNTER MEASURES

Probably the most obvious and effective counter measure is another character riding a flying monster, and/or a powerful monster without a rider. With the fast move and power equal to your enemy you'll be able to attack him when flying high or pounce on him when he commits to ground combat. Of course it may be too late by then! The problem here is high points cost. Buying a monster and character just to keep enemy flyers at bay is probably not going to be cost effective. The Pegasus will get you into the air for a mere 50 points, but WS3, S4, T4 and only 2 Attacks is hardly going to deter a Griffon or Wyvern.

Few players will risk their flying monsters and characters in a lone assault against an enemy unit. If units have champions, they are fairly safe from this kind of opportunistic attack, because the champion can always challenge the flying attacker to single combat. This reduces the amount of damage the flyer and character can do, and makes it hard for him to win. What happens is that the champion valiently keeps the flyer occupied while the rest of the unit drives it away (The unit rank bonus and a standard are usually enough to off-set the wounds inflicted on the champion.). Though the champion will sometimes be killed, the sacrifice is worth it if the unit is saved.

More thoughtful players will also exploit the cheap deterrents. It has to be said these don't always work, but they will certainly make the enemy think twice before he swoops down

on your unprotected artillery or on top of your best unit. One option is to buy a smallish, cheap unit, or even a modest character, which you can station with your war machines specially to guard against aerial attack. This won't stop a high flying enemy swooping on your cannons, but it does give you the chance to charge him in your following turn whilst he is vulnerable.

War machine crews are so defenceless against aerial attack that there is no point in staying around to be killed – always go for the flee option if there is the slightest chance of avoiding being caught. If the enemy attacks from high always flee as you will always escape. This will leave the monster and hero able to hack at the machine itself, but these are quite robust compared to the crew!

A small guardian unit or character will be able to attack a stranded flyer once your artillery crews have fled (hopefully they will rally and return to crew their weapons once the monster has gone). Guardian units should be as effective as possible. The best way of doing this is to rack the unit into a formation of four ranks with a minimum frontage and include a standard – in fact anything that pushes your combat result bonus up is a good idea. Some troops, or monsters, are especially useful for tackling big monsters ridden by characters. For example, Cockatrices and Gorgons can petrify (useful against modest Initiative level monsters such as Wyverns and Manticores). Similarly a Vampire's *Transfixing Glare* is effective, and Wraiths are good because monsters cannot harm them.



*A hero of the Empire and a Wood Elf eagle rider struggle to the death, high above the battlefield.*

Another good idea with artillery is to have two! Not only does this make each war machine less vulnerable, but you can use the free machine to attack the flyer whilst it is busy attacking the other. Make sure that you position the machines sufficiently far apart that a flyer cannot land on both simultaneously. This works well with bolt throwers and even better with Helblaster volley guns if you have an Empire army. Indeed, you could always buy a bolt thrower specifically to cover your other war machines from aerial attack. Such a machine wouldn't ever be wasted as it could also shoot at the enemy's main formations. Remember, a war machine can be turned around to face its target and fire in the same turn, so there is no problem with directional facing.

An interesting variant of the guardian unit is available to Orc and Goblin players in the form of the Gobbo Netter Clubbers. These are cheap troops, which means you can afford the champion, standard, and even a magic item to help boost their effectiveness. The advantage of these critters is that an enemy struck by a netter cannot fight back that turn, so if you manage to score just 1 hit on both monster and rider neither may fight back. If you manage this then your combat bonuses should see off the enemy and if you're lucky you might even catch him on the pursuit! It's not a cast iron tactic by any means but it is cheap! Another option is a small unit of gobbos with fanatics, as these will release as soon as the flying creature is within 8". With D6 S5 hits and no saves these are deadly enough to seriously worry any monster with T up to 6, and can affect a monster up to T8.

Flyers are always vulnerable once they have won a combat and forced their enemy to flee. This is just as true if the monster attacks from high, and forces the enemy to flee with a psychology test. Given that big monsters/heroes usually break or destroy their enemies in one turn, you have two complete magic phases to wreak sorcerous revenge (firstly your opponent's turn and then your own). An army with a decent provision for wizards is therefore always less vulnerable to flyers than one with few wizards, and if you have a positive magical superiority you can use this as your primary anti-aerial defence.

Magic provides some of the most effective ways of deterring flyers. Many players use the Orb of Thunder to prevent enemy flyers flying high, or to trap flyers above the battlefield. If your opponent is over-keen on the hero/big flying monster gambit then this is worthwhile at only 50 points. Even if you can trap an enemy in the air for a single turn the points investment will have paid off. The other way in which you can use magic is to provide troops and units with magic items which make them less

vulnerable. Basically, the disadvantage of a single rider and monster is that any magic item which negates attacks or prevents a model fighting will be more effective than it is against a unit of troops. Therefore any magic items which prevent the rider or monster attacking are worth looking at. The other disadvantage of the rider/monster is that it will have no rank or banner bonuses for combat, so it is a good idea to make sure potential targets have a good stack of combat result bonuses. These are things which any commander should think about for all his troops. The only real problem comes with war machine crew who remain vulnerable because they don't carry standards or have champions. Always flee with crewmen if there is any chance of avoiding a flying monster.

Spells which work well against powerful characters (flying or otherwise) include all the 'entrapment' type spells which basically trap or immobilise a target. For example, the Bright Magic spell *Crimson Bands*. The Grey Magic spell *Dance of Despair* is also useful, forcing the target to move off and effectively taking it out of the game while the spell lasts. Most of the spell decks have spells which can be used to good effect to trap or incapacitate a single powerful enemy and it is well worth studying the decks carefully to find examples. The Amber spell *Curse of Anraheir* is an interesting choice because it is tailor made for upsetting these rider and monster combinations, reducing the target's 'to hit' score to 6, halving its move (12" rather than 24") and also forcing a panic test (and you might get lucky here!). Most flyers will carry some sort of magical protection, or the player will keep back a dispel scroll for emergencies, but it's still worth trying.

## AFTERTHOUGHT

Whilst on the subject of flyers, **yes Carrion, Chimeras and Cockatrices can fly** although the accompanying descriptions were missed out of the Warhammer Bestiary.



A Chaos Dwarf sorcerer mounted on a Lammasu.

# WARHAMMER

®

## DWARF RUNESMITH'S ANVIL OF DOOM



Models designed by Michael Perry

The Dwarf Runesmiths wreak havoc on the battlefields of the Old World with their massive Anvils of Doom. With a mighty blow of his hammer, the Runesmith releases the Anvil's power. Lightning bolts blast from its rune-emblazoned surface to smash into the enemy ranks as mighty energies unfurl and the sky darkens with brooding power.



CITADEL  
MINIATURES

This is a Citadel Miniatures expert kit that requires a degree of modelling skill. This model is not recommended for young or inexperienced modellers.

We recommend that parts are carefully cleaned and trimmed with a modelling knife before assembly, and that the models are undercoated before painting with Citadel paints.

WARNING! These miniatures contain lead and may be harmful if chewed or swallowed. Citadel Miniatures are not recommended for children under 14 years of age.

GAMES  
WORKSHOP

# GAMES WORKSHOP®

## BLACKPOOL

### GRAND OPENING

SATURDAY 6th NOVEMBER

DON'T MISS OUT ON THIS DAY OF SPECIAL OFFERS!

DOORS OPEN 9.00am



**NORMAL OPENING HOURS**  
 Mon to Wed  
 10.00am to 6.00pm  
 Thursday  
 10.00am to 8.00pm  
 Friday  
 10.00am to 6.00pm  
 Saturday  
 9.30am to 5.30pm

**8 BIRLEY ST  
 BLACKPOOL**

**THE BIG  
 BLISTER  
 DEAL**

**BUY ANY THREE  
 BLISTER PACKS  
 AND GET THE  
 CHEAPEST ONE  
 FREE!**

**MASSIVE DEALS ALL DAY  
 ONLY £38.50 EACH!**

That's up to a 33% saving!  
 Don't miss these amazing offers and massive discounts on the whole range of exciting Games Workshop products.



**SPACE HULK**  
 plus!  
**SPACE HULK CAMPAIGNS**  
 plus either!  
**DEATHWING**  
 or  
**GENESTEALER**  
 Normal price  
 £51.97



**WARHAMMER**  
 plus!  
**WARHAMMER BATTLE MAGIC**  
 plus!  
 any one  
**ARMIES BOOK**  
 Normal price  
 £57.97



**MAN O' WAR**  
 plus!  
**UP TO £15 WORTH OF BOXED SHIPS**  
 plus either!  
**PLAGUE FLEET**  
 or  
**SEA OF BLOOD**  
 Normal price  
 £54.98



**SPACE MARINE**  
 plus!  
**SPACE MARINE BATTLES BOOK**  
 plus!  
 any one  
**BOXED SUPPLEMENT**  
 Normal price  
 £54.97

**YOUR  
 SPECIAL  
 DISCOUNT  
 VOUCHERS**

REDEEMABLE AT GAMES  
 WORKSHOP BLACKPOOL 6TH NOV 93  
**25% OFF** ANY GAMES  
 WORKSHOP  
 OR CITADEL PRODUCT.  
 ONLY ONE VOUCHER PER PRODUCT. NOT TO BE  
 USED WITH ANY OTHER OFFER.

REDEEMABLE AT GAMES  
 WORKSHOP BLACKPOOL 6TH NOV 93  
**25% OFF** ANY GAMES  
 WORKSHOP  
 OR CITADEL PRODUCT.  
 ONLY ONE VOUCHER PER PRODUCT. NOT TO BE  
 USED WITH ANY OTHER OFFER.

REDEEMABLE AT GAMES  
 WORKSHOP BLACKPOOL 6TH NOV 93  
**10% OFF** ANY GAMES  
 WORKSHOP  
 OR CITADEL PRODUCT.  
 ONLY ONE VOUCHER PER PRODUCT. NOT TO BE  
 USED WITH ANY OTHER OFFER.

REDEEMABLE AT GAMES  
 WORKSHOP BLACKPOOL 6TH NOV 93  
**10% OFF** ANY GAMES  
 WORKSHOP  
 OR CITADEL PRODUCT.  
 ONLY ONE VOUCHER PER PRODUCT. NOT TO BE  
 USED WITH ANY OTHER OFFER.

REDEEMABLE AT GAMES  
 WORKSHOP BLACKPOOL 6TH NOV 93  
**10% OFF** ANY GAMES  
 WORKSHOP  
 OR CITADEL PRODUCT.  
 ONLY ONE VOUCHER PER PRODUCT. NOT TO BE  
 USED WITH ANY OTHER OFFER.

REDEEMABLE AT GAMES  
 WORKSHOP BLACKPOOL 6TH NOV 93  
**10% OFF** ANY GAMES  
 WORKSHOP  
 OR CITADEL PRODUCT.  
 ONLY ONE VOUCHER PER PRODUCT. NOT TO BE  
 USED WITH ANY OTHER OFFER.



JUST CUT OUT YOUR MONEY-OFF VOUCHERS TO GET THESE GREAT DEALS

PLEASE NOTE: NONE OF THE VOUCHERS ON THIS PAGE MAY BE USED IN COMBINATION WITH ANY OTHER OFFER NOR MAY THEY BE USED ON MB GAMES' HEROQUEST, SPACE CRUSADER, OR BATTLEMASTERS. BOX TREE BOOKS' WARHAMMER NOVELS, OR ELECTRONIC ARTS' SPACE HULK COMPUTER GAME.

# MODELLING WORKSHOP

## ISLANDS AND SANDBARS FOR MAN O' WAR

By Adrian Wild

Modelling workshop supremo Adrian Wild takes us onto the high seas and navigates his way around the simple modelling techniques for making islands, sand banks and other terrain pieces that add a new dimension to your Man O' War battles.

### GETTING STARTED

Any of you who have read the previous Modelling Workshop articles will find that many of the methods described in this article will be familiar. Even if you haven't read them, the techniques for modelling terrain featured in this article are designed to enable you to have very little trouble in turning your attention to making models of islands, and other features for your sea battles. On the next page is a list of the materials and tools I have used to construct the models in this article.

Before you start to assemble your Man O' War terrain, make sure you have a clear work surface and a few simple tools and materials close to hand. If you are going to work on a table, it's best to protect the surface with a piece of thick card or several sheets of newspaper otherwise you might scratch it.

### TABLETOP

First of all, a quick word about your Man O' War playing area is in order. In the rulebook, we suggested you use a table or area of floor to play on. This is alright as a start, but it is much better if you can actually make the tabletop look more like the sea.

The easiest way to do this is to lay down a piece of blue cloth or blue sugar paper on the table before you start. This has the added advantage of protecting the table from scratches!

The best method, and the one we use at the studio, is to make a special gaming board. This is what we use in the photographs in White Dwarf every month. Ours is made from a piece of polystyrene insulation board, about 1½" thick and about 4' x 4', available from D.I.Y. superstores.



*The Dwarf Fleet of Barak Varr sets sail into the Black Gulf*

This was first covered with thinned plaster filler to give the surface a slightly rough texture and to help the paint take better. Once dry, it was painted with blue water-based emulsion paint (the kind you use to paint your living room walls!). This was then drybrushed with white paint to give the effect of waves. We do this so the board will look good in our photographs, but you needn't do it if you think plain blue is alright.

Once you've got your playing area sorted out, its time to have a go at making some terrain to sail around...

## SANDBANKS

The simplest terrain piece to start with is a sandbank. The techniques for making a sandbank will stand you in good stead when making other, more complicated pieces of terrain such as islands or headlands.

Before you start modelling a sandbank, the first decision you need to make is how big is it going to be. You can make it any size you like, but about 10-15cm in length and 5-10cm wide is reasonable.

### TOOLS AND MATERIALS

Before you start to construct your Man O' War terrain, you'll need the following tools and materials.

#### Tools

1. Modelling knife
2. Steel ruler.
3. Fretsaw or hacksaw – to cut the cardboard.
4. Retractable craft knife – for shaving the polystyrene.
5. Foam sanding block or sand paper.

#### Materials

1. Thick card – such as the mounting board available from art shops
2. Plastic pan scourer – available from supermarkets
3. Polystyrene sheet – such as the insulation board from D.I.Y. suppliers, or built-up layers of ceiling tiles.
4. Glue – different types for different tasks. Copydex or P.V.A. for fixing polystyrene, impact adhesive such as Bostik for gluing card.
5. Hardboard – for the base section. Alternatively, you can use thick card, but this has a tendency to warp.
6. Textured paint – or a home made alternative such as a sand and P.V.A. mix or thinned plaster filler.
7. A selection of Citadel acrylic paints – as mentioned in the article.
8. Flock or other scatter material.
9. Cat litter, coral sand and sand to texture sections of the base.

### THE BASE

The first thing to do is to cut the sandbank's base out of hardboard or thick card. It is a good idea to draw out the shape of the sandbank on the material before you cut it out to give yourself a line to work to. The template below shows a typical sandbar shape, although yours will of course be a lot bigger – about 15cm long by 10cm wide. If you are using hardboard, you will need to use a fret saw or hack saw to cut out your sandbank; if you are using thick card, a modelling knife will be fine. Remember to protect both your work surface and yourself when using sharp tools!

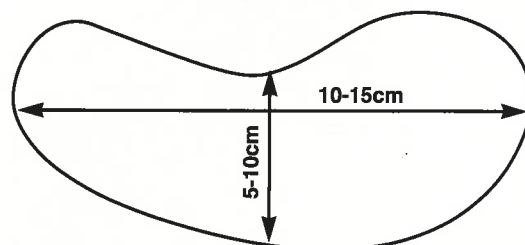

Once the base is cut out, you can trim its edges to make the gentle slope of the beach down into the sea. This will look more natural than leaving the edge of the hardboard square. Hardboard is reasonably soft and can be trimmed with a modelling knife, but take extreme care and remember to cut away from your body in case you slip. If you are in any doubt, either get someone else to do the trimming for you, or simply sand the edges with a foam sanding-block or sandpaper.

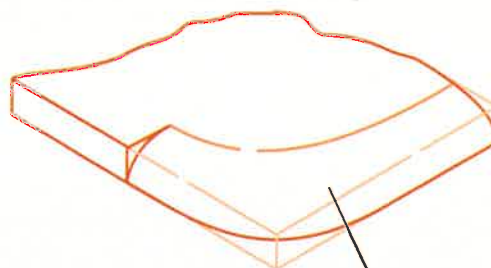

Edge of hardboard is trimmed with a modelling knife to form a slope.

### THE SANDBANK ITSELF

Once the base is made, you can turn your attention to making the sandbank itself. You can either use polystyrene tiles stuck together using P.V.A. glue – making a single block about 25mm thick – or a single piece of polystyrene insulation sheet. Once you have the correct thickness, the next thing to do is stick it to the base.

To fix the polystyrene to the base, you can use either P.V.A. or Copydex glue. If you use P.V.A, make sure you are working on a flat surface as it has a tendency to run. Apply the glue to the base and stick the polystyrene straight onto it.

If you are using Copydex, it should be applied to both surfaces – the base and the polystyrene – before they are pressed together, letting it go tacky before you join the two parts together.



Once the pieces have been glued together, lay some books (or something equally weighty) on top of the whole construction until the glue dries. By laying something heavy on top of the pieces, you help prevent the moisture in the glue from warping the base as it sets.

After letting the glue set properly, carefully shape the polystyrene so that you end up with a mound shape. There are several ways of doing this, varying from using a small toothed saw, through to a purpose made 'hot wire' cutter. The most readily available tools for this job, however, are either a small-toothed saw or a sharp kitchen knife.

### Sandbar Construction. Side View

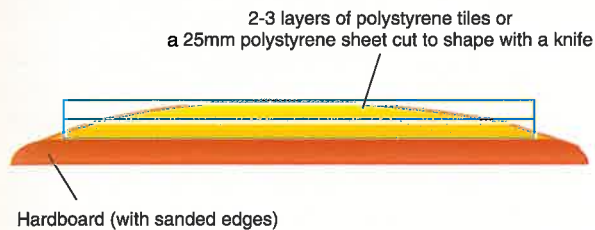

Top View

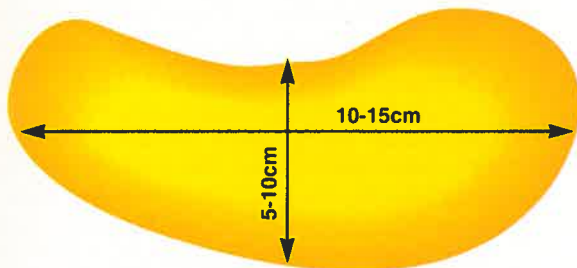

Whichever method you choose always remember to cut slowly and carefully. First cut out the basic shape with the knife or saw, and then use a medium/fine sanding block to smooth off any rough edges.

### TEXTURING AND PAINTING

Once you have cut the sandbank into the correct shape, the next stage is to cover the whole thing with a textured layer to make it look like sand rather than polystyrene. This can be done using textured paint or by gluing sand on a layer of P.V.A glue. Once this is complete and dry, you are ready to paint the sandbank.

When painting sand colours, I use a base colour of Sulphur Desert Yellow, dry-brushed with Bleached Bone and Skull White. Your sandbank is now ready.



## ISLANDS

Islands are made in much the same way as a sandbank, but are slightly larger: around 15-20cm in diameter and about 25-50mm thick. They are also less likely to be simple mounds, instead having a more rugged and rocky shape.

Once you have made your basic island shape, you need to decide what sort of island it is: rocky, stony, sandy, grassy, inhabited or whatever. Of course, your island could have a combination of many terrain features; it does not have to be all grass or stone.

Remember that each island will need a beach area around the edge, made using the techniques explained for constructing sandbanks.

If you want an island to look like the classic desert island it will need to be sand coloured like a sandbank. If it is to be a rocky island, a stone colour would be more appropriate. You can of course use a mixture of both stone and sand to get a combined effect.

### Island Construction. Side View

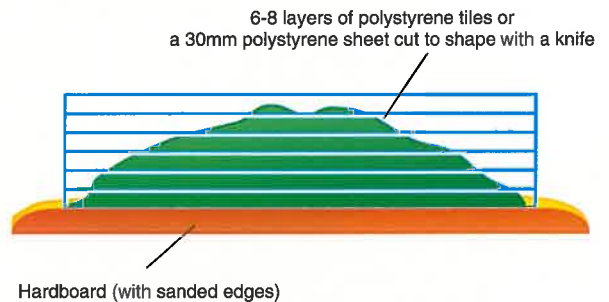

Top View

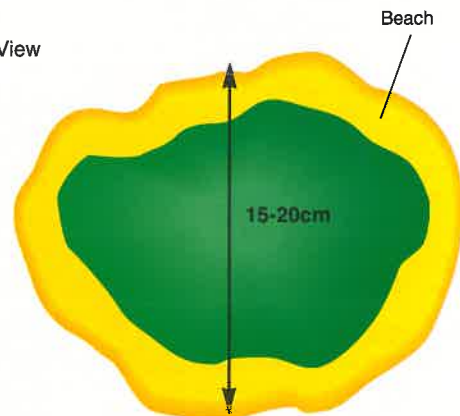

### DETAILING

With an island of this scale, there is no need to make really detailed features. You can get good results just by modelling those features that are readily identifiable from a distance, such as wooded or rocky areas, small cliffs, or even simple shapes to represent buildings. If you decide to make more than one island, you can use different features on each to make it look unique.



*This craggy island is a good example of how to model a cliff face and rocks.*

### Rocks

Rocky areas can be modelled by gluing on different sized stones and sand. Apply P.V.A glue to the area you want to be rocky, then add some of the larger stones and shake off any surplus. Repeat, this time adding smaller stones, so that they automatically cover any areas left exposed.

When you come to paint rocks, you have a greater number of choices. If you look at natural rocks you will notice that they vary in colour considerably. To reproduce this, apply a dark base colour, then highlight with a lighter colour to simulate where light and shade fall.

If, for example, you wanted some dark rocks, you could first apply Chaos Black, then dry-brush Bestial Brown over that, followed by Orc Brown, Bleached Bone, and finally Skull White. To provide contrast you could then paint some of the other rocks a slightly lighter colour, drybrushing them with Skull White.

### Grass

Not all islands are parched sand and rocks – some do have grassy areas and woods. To add this effect, apply some watered down P.V.A. – thinned just enough to make it easy to paint accurately – where you want the grass to be and sprinkle the area with flock, blowing off any excess.

If any areas still look bare simply repeat the above process until they are covered. It is worth noting that sometimes, because these models get moved around and knocked as you game with them, bits of flock can fall off. If this does happen, all you have to do is re-apply it using the techniques given above.

### Woods

Wooded areas can be made by sticking small shreds of foam or small pieces of nylon pan scourer to the island using P.V.A glue. Once dry, they can either be painted

in dark green and then drybrushed with light green, or covered in flock.

### Cliffs

Small cliffs are made by cutting a block of polystyrene to a steep or even vertical angle using a sharp knife. Once carved out, these can either be covered with textured paint or coated with a layer of glue and sprinkled with sand.

### Buildings

You may well want a particular island to look deserted. If, however, you would like some inhabited areas you can add some buildings. Bear in mind that constructions at this scale are only intended to give the feel of inhabited areas and will not need to be accurate scale models.

To make simple buildings, take a sheet of balsa wood 3-5mm thick and cut off a 5mm wide strip. To get a basic building shape, carefully trim the top edge to a wedge or roof shape with a sharp modelling knife.

If you have cut your strip too big and the buildings appear a little oversized don't worry, they can represent large multi-dwellings or garrison buildings.

Once the buildings have been trimmed, you can paint them with Skull White walls and a contrasting Terracotta roof drybrushed with a Blood Angel Orange/Bleached Bone mix.

Alternatively, you can use the plastic and metal villages, towers and castles from Games Workshop's Mighty Empires game. There is a large selection to choose from, ranging from a Wizard's Tower to a Temple, and all are available from Games Workshop Mail Order. They can be stuck onto your island with P.V.A. glue and then painted as normal. For more details see the Citadel Catalogue pages.



*This splendid Shorefort has some good examples of a beach area, grass, woods and plenty of buildings.*



The headland above illustrates the techniques for making grass and beaches covered in this article, while the island in the background uses a Mighty Empires Wizard's Tower mounted atop an excellent cliff.

### Hedges and Fields

Hedges can be made from thin strips of plastic pan scourer, glued down, covered in flock and painted in Goblin Green. Alternatively, thin pieces of string painted with P.V.A., dipped in flock, and then allowed to dry before being stuck down can be used.

Fields can be modelled by gluing lines of flock over soil-coloured ground areas, or the ground areas can be covered in a thin layer of plaster and striped with a cocktail stick. Different coloured flock, or even different types of flock can be used to represent different crops.

## HEADLANDS

One feature that you often see in coastal areas are headlands. These are basically the tail-ends of larger land masses that slope into the sea. The techniques that you use to make these are the same as those for making islands (as are the materials), only on a larger scale.

The first stage is to cut out the base section, bearing in mind that one of the edges (or two if you want the model to jut in from the corner of the table) will be straight.

Take your block of polystyrene and, using the base as a template, draw around it to mark out the shape required, remembering to allow for the beach area. Carefully cut out the shape and begin carving out the cliffs, shaving the headland to the desired shape. Once you have finished, using the same techniques outlined in the islands section, texture the surface of the polystyrene, adding any details that you feel appropriate.

This type of model can offer quite a choice in terms of the possible additional features. You will, for example, have sufficient room to add fields with hedges, walled towns, and so on.

### Headlands. Top View

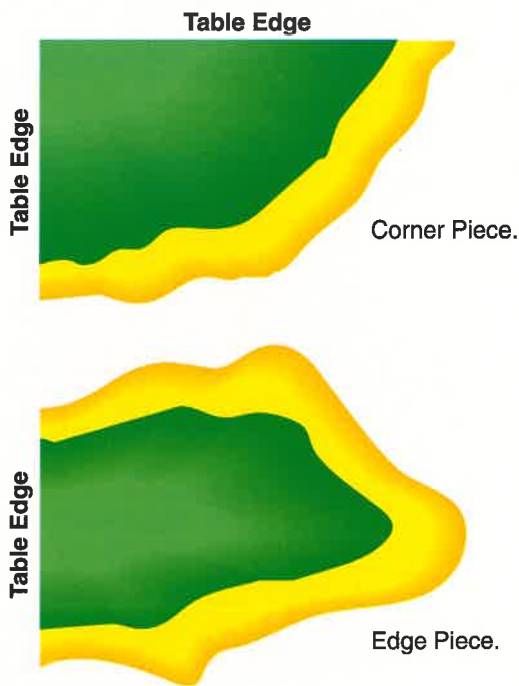

## AFTERWORD

Looking at the techniques listed in this article, what quickly becomes apparent is that you have a great deal of choice when making Man O' War terrain. Whatever type of Man O' War terrain you are making, it can be as complicated or as simple as you like. As the basic techniques are essentially the same for each type of terrain, you should have very little trouble progressing from one type to another. Enjoy your modelling!

# GAMES WORKSHOP®

## NEW STORES!

**OPEN SOON**  
**2nd FLOOR**  
**DEBENHAMS**  
**WESTGATE STREET**  
**IPSWICH**

Normal opening hours:  
 Monday to Saturday 9.00am to 5.30pm  
 (Yes it really is a proper Games Workshop Store with gaming tables, our full range of products and friendly Games Workshop staff inside a Debenhams store!)

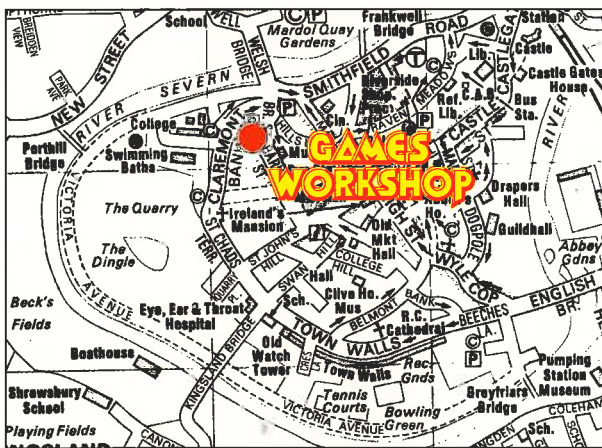

**OPEN SOON**  
**UNIT 2**  
**BRIDGE STREET**  
**SHREWSBURY**

Normal opening hours:  
 Mon. Tue. Wed. Fri. 10.00am to 6.00pm  
 Thursday 10.00am to 8.00pm (Games Night)  
 Saturday 9.30am to 5.30pm

**OPEN SOON**  
**8 BIRLEY STREET**  
**BLACKPOOL**

Normal opening hours:  
 Mon. Tue. Wed. Fri. 10.00am to 6.00pm  
 Thursday 10.00am to 8.00pm (Games Night)  
 Saturday 9.30am to 5.30pm



# WARHAMMER<sup>®</sup>

## 40,000



# SPACE WOLVES

# GREY HUNTERS



The Space Wolves are the most ferocious of all Space Marine warriors, bred on the harsh world of Fenris where savage tribes are locked in a continual struggle for existence. The Grey Hunters make up the majority of any army fielded by the Space Wolves. These are warriors in their prime, tempered by battle yet still hungry for a place in the elite Wolf Guard. They are proud and fierce fighters who have acquired all the skills of combat to enable them to crush any foe in battle.

This box contains ten Space Marines in Mark VI and Mark VII power armour, including six with wolf totems and pelts to add variety to your squads. These metal miniatures come with separate plastic arms, backpacks and bolters plus a sprue of close combat weapons. Allowing you to assemble your Grey Hunters in an almost endless variety of poses. Also included in this box is a Space Wolves transfer sheet which provides all the markings you will need to complete your Space Wolves Grey Hunter squad plus a number of honour badges and distinctions.



CITADEL<sup>®</sup>  
MINIATURES

Miniatures designed by  
Jes Goodwin

Miniatures supplied unpainted.  
Banners not included.

GAMES  
WORKSHOP<sup>®</sup>

SPACE WOLF GREY HUNTERS

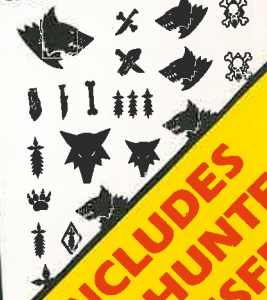

INCLUDES  
GREY HUNTERS  
TRANSFER  
SET

WARNING! These miniatures contain lead and may be harmful if chewed or swallowed. Citadel Miniatures are not recommended for children under 14 years of age.

The Citadel castle, the Games Workshop logo and Space Marine are registered trademarks of Games Workshop Ltd. Citadel, Games Workshop, and Space Wolf are trademarks of Games Workshop Ltd.

© Games Workshop Ltd. 1993. All rights reserved.

# WARHAMMER

## 40,000

## BRIDGE OF DEATH

By Jake Thornton & Adrian Wood

This month's battle report is a bitter struggle between Space Marines and Orks. The game was based on one of the Battle for Armageddon scenarios from the new Warhammer 40,000 boxed set.

*The Orks were surrounded. Warlord Ghazghkull Thraka, Overboss of all the Goffs had been outflanked and outwitted and now he was trapped.*

*With the noose drawing tighter, the Orks made one final attempt to break out of the trap. Ghazghkull ordered his boyz forward in a last desperate attack to capture the bridge over the corrosive sludge known as the Skeletus river. All that lay between the Orks and safety was a handful of Space Marines.*

metal one. Apart from these small alterations, the scenario was played exactly as it is given in the scenario booklet using most of the miniatures and all of the card buildings in the box.

We played this game on one of our 8'x4' tables here at the Studio, and kept notes of moves and casualties as we went along for later reference when writing up the conflict. Due to the difficulties of taking good photos of a game in progress we took polaroids of the action and re-shot the pictures for this article some time later with proper lighting and cameras. This technique allows us to play an uninterrupted game and still get the best photos.

### INTRODUCTION

This game was based on the Battle for the Bridge, the third battle in the scenario booklet from the new Warhammer 40,000 boxed set. Each of these Battle for Armageddon scenarios includes full background details, victory conditions and tactical hints both for Space Marine and Ork commanders. In fact the scenarios provide all the information you need to recreate this exciting period of Imperial history, together with a campaign system to link the individual battles together. Whether you're a veteran gamer or a newcomer to the hobby, you'll find the Battle for Armageddon campaign an exciting challenge.

### SET-UP

Before we started, we agreed to alter the scenario set-up slightly by adding four extra pieces of jungle terrain, one piece on either side and two pieces placed amongst the buildings in the middle of the table. This gave the tabletop a more varied look and would ensure a close fought battle. Under the new Warhammer 40,000 rules there is a definite maxim that 'the more terrain, the better the game!'

Jake also decided to vary the look of the Space Marine force by including two Ultramarines' battle squads from the Studio collection as replacements for two of the Blood Angels' battle squads listed in the set-up. This didn't alter their weapons or other equipment, it's just that Jake has his own Ultramarine army and wanted to include them in his force.

Adrian also chose to use some of the brilliant new metal Gretchin and replace the card dreadnought with the Studio's



## SPACE MARINES' BATTLE PLAN (Jake Thornton)

*"Ork forces have been spotted advancing through sector 307 towards the bridge across the Skeletus. Your squads of Space Marines must hold the bridgehead against the forward elements of the Ork advance until relieved. Do not allow the Orks to capture the bridge under any circumstances – if the situation warrants it the sacrifice of your entire command may be necessary to prevent this. Place your faith in your sanctified weapons and commend thy souls to the Emperor. Let the slaughter commence."*



My orders were clear. Defend the bridge at all costs against a horde of ferocious Orks.

Given the tactical finesse that Orks are famous for, I expect nothing less than a solid wall of Orks charging towards me. All Adrian needs to do is to get one intact mob into my deployment zone and he'll get five victory points (VPs). This is a large amount of points and could easily swing the battle in Adrian's favour, so stopping his advance has to be my priority. In order for me to get 5 VPs I have to kill at least twenty-five greenskins. With this in mind, I'll deploy my forces across the whole of my side of the battlefield. A long thin line of troops isn't my favourite set up but I have a large area to defend with only a few men so I have little choice.

The one advantage of a wide deployment is that you can often catch the enemy in your crossfire. What this means is that an Ork hiding behind a wall may be in hard cover to Squad Lazarus' bolters, but will often be in the open to Squad

Typhon, Brutus or Cleon. Those hiding from each squad can usually be fired at by another squad. Few pieces of cover offer all-round protection so your crossfire denies the enemy hiding places and you can shoot them to pieces.

The Ork dreadnought poses slightly more of a problem than the mobs as all I have that can deal with it are my missile launchers. I expect these to be prime targets for the Orks but they need good fire arcs to be useful, so I placed them prominently, covering as much of the battlefield as I could.



Rather than using frag missiles against the mobs, I intend to concentrate my missile fire against the dreadnought until it is no longer a threat. I placed my flamers to cover the approaches to my lines in case the Orks tried anything sneaky. The rest of my troops were armed with bolters so I put them in positions where they would be able to see most of the advancing Orks.

Finally, as I was defending a fixed position, I would try to move as little as possible in order to maximise my use of rapid fire. This new rule allows Space Marines to fire twice if they don't move at all in their turn. The Orks only outnumbered me three to one so my main worry now was whether I'd brought along enough ammo for my bolters!



*Battle Squads Lazarus and Cleon of the Blood Angels Space Marines.*



Grugnat's Goff Ork Mob.

## ORK BATTLE PLAN (Adrian Wood)

*"Da boss sez go skrunch up the humies an' let 'em know the rest of uz is comin', grab da bridge an' 'old it until dey get 'ere. You've got a Dreadnought, two mobz of reel hard Goff Orks and four mobz of sneaky Gretchin so you should be able to smush anyfing that's dumb enough to get in yer way."*

*"Splat as many of da gurlly humies as ya can, but don't get yerselves too smashed up an' don't get da Dreadnought trashed. Get a mob or da dread close to da bridge to 'old it."*



I have been looking forward to fighting some of the Battle for Armageddon scenarios from the new Warhammer 40,000 boxed set and when Jake challenged me to Mission Three, The Battle for the Bridge, I jumped at the chance.

I decided to play the Orks as they are one of the most colourful and varied armies of the 41st millennium and have a special place in my heart. I usually field an 3000 point Ork army with a broad selection of different troops for different jobs on the battlefield so the fixed army list given in the mission would prove quite a challenge to use effectively.

From the set-up I can see that this scenario is going to be pretty hard on the Orks. All the Marines have to do to win is sit tight in hard cover and rapid fire at me in order to inflict as many casualties as possible as I advance. This is potentially devastating to all of my mobs but particularly the Gretchin who are simply not as tough or resilient as Orks and are likely to sustain heavy casualties.

My battle plan is probably as simple as it could be. Run hell for leather over to the other side of the battlefield and either charge into close combat, or fire en masse at individual Space Marine squads. As Space Marines are so hard to kill, you always need to mass your fire against them to have a hope of causing any damage. The Orks do, however, outnumber the Space Marines three to one and I only need a single unbroken squad of six or more models in the Space Marine's deployment area to gain 5 VPs, more than enough to swing the battle in the Orks favour.



In this game it will be crucial to keep a careful eye on every last victory point. The more I play using the new victory point system the more I become aware of its importance. This is particularly true during the last turn of a battle in which both sides have already achieved their mission objective and often just have to sit tight or establish a fire base. A scenario can be won or lost with the victory points you get for rallying broken troops or reducing a squad to fifty percent of its starting strength.





*Scumbo's Gretchin mob.*

The new card buildings look great when laid out on the table and they'll also provide my boyz with lots of hard cover. The additional trees and undergrowth we added to the scenario create extra blind spots that should allow my mobs to run forward virtually unseen.

Initially, I deployed as far forward and as spread out as possible to avoid the Space Marines' frag missiles. I was aware of the lethality of explosives against closely grouped targets so the mobs made full use of their 2" squad coherency.

The cover on my left flank gives Grot's Gretchin the best chance of making it across the battlefield intact (to pick up the 5 VPs). However, if either of the Ork mobs can close assault the Space Marines they stand a pretty good chance of killing

enough to gain some extra VPs, but of course they have to get there first...

My dreadnought, da Krusher, takes pride of place in the centre of my battleline. Da Krusher has the only long range weapons in my army and the best ballistic skill, so this position gives it the most things to shoot at. I might use it to soften the Space Marines up or perhaps to interfere with their overwatch should they choose to try and catch the mobs as they charge forward. I also think that it will attract the attention of the Space Marines with missile launchers who have the only weapons with the range and the power to penetrate da Krusher's thick armour. At this stage I don't consider it wise to move the dreadnought forward to achieve the mission objective. There are more than enough mobs to do that.



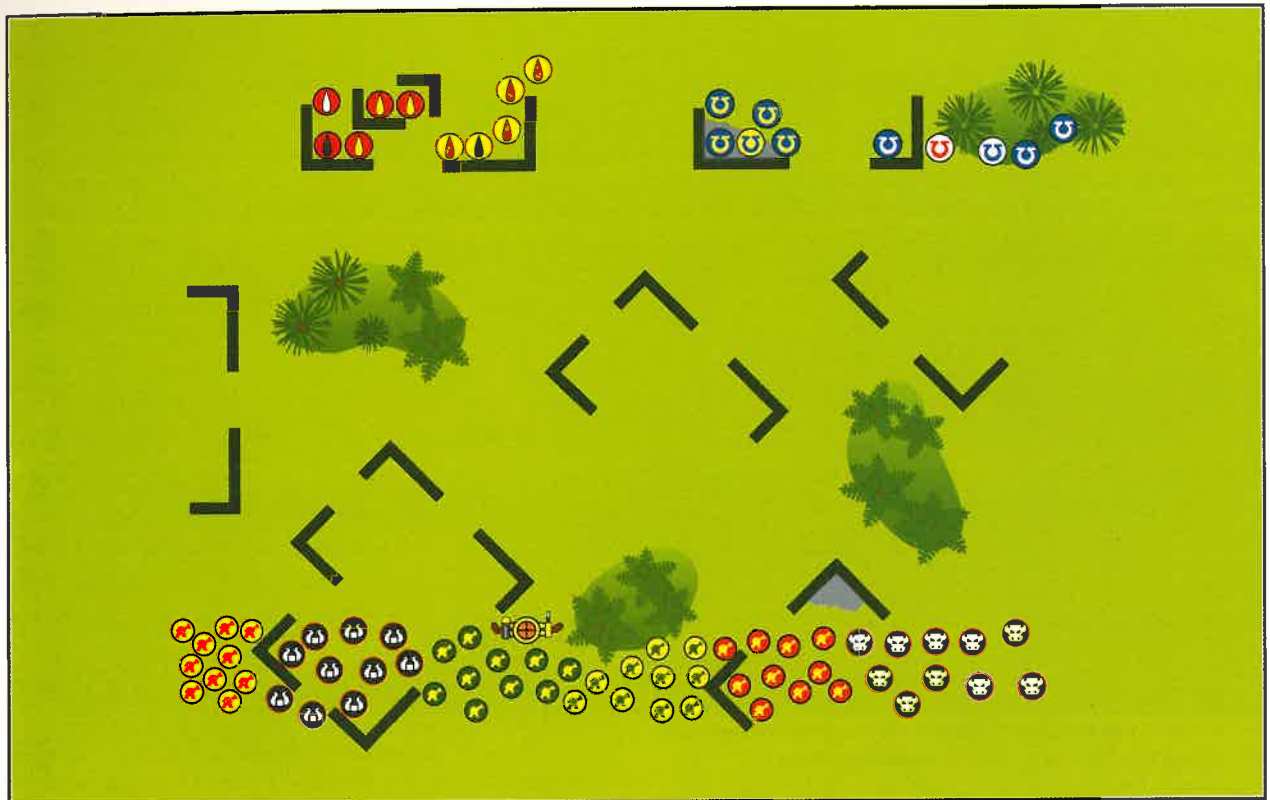



## THE SPACE MARINES



### BLOOD ANGELS TACTICAL SQUAD

All Space Marines are equipped with Mk 7 power armour, bolt pistol, frag grenades, and weapons as noted below.

#### Battle Squad Lazarus

-  Sergeant Lazarus: Chainsword.
-  3 Marines: Boltgun.
-  1 Marine: Flamer.



#### Battle Squad Cleon

-  Brother Cleon: Boltgun.
-  3 Marines: Boltgun.
-  1 Marine: Missile Launcher.



### ULTRAMARINE TACTICAL SQUAD

All Space Marines are equipped with Mk 7 power armour, bolt pistol, frag grenades, and weapons as noted below.

#### Battle Squad Typhon

-  Sergeant Typhon: Chainsword.
-  3 Marines: Boltgun.
-  1 Marine: Flamer.

#### Battle Squad Brutus

-  Brother Brutus: Boltgun.
-  3 Marines: Boltgun.
-  1 Marine: Missile Launcher.

## THE ORK HORDE



#### Grugnat's Mob

-  Ten Orks armed with bolt pistol, axe, frag stikkbomz and flak armour.

#### Snikbog's Mob

-  Ten Orks armed with bolt pistol, axe, frag stikkbomz and flak armour.

#### Grit's Mob

-  Ten Gretchin armed with autoguns.

#### Grot's Mob

-  Ten Gretchin armed with autoguns.

#### Scumbo's Mob

-  Ten Gretchin armed with autoguns.

#### Fergit's Mob

-  Ten Gretchin armed with autoguns.

#### Da Krusher



One Ork Dreadnought armed with two power claws, lascannon and a heavy bolter.

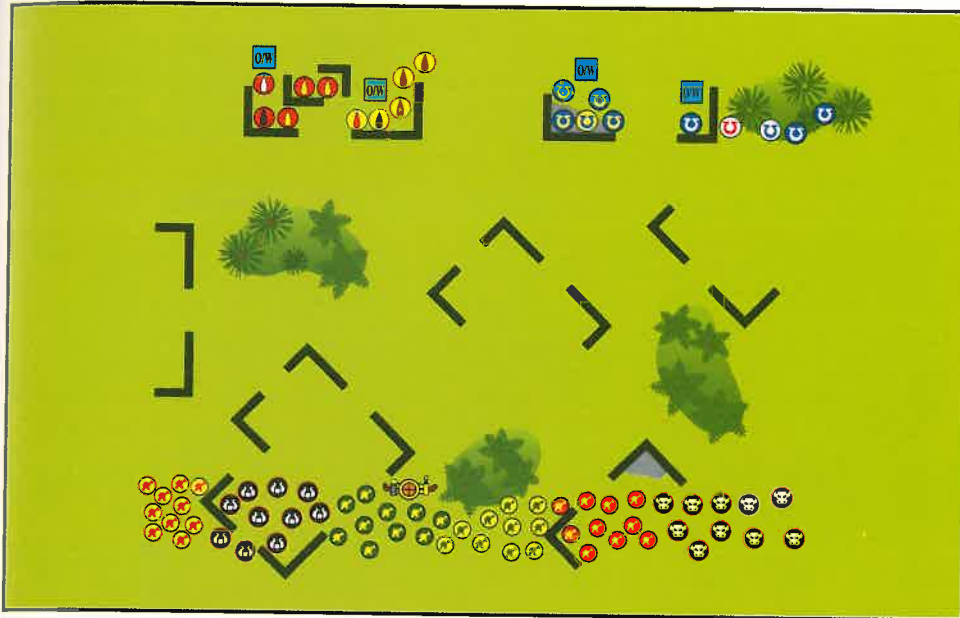

SPACE MARINES TURN 1

## SPACE MARINES TURN 1

To determine who moves first in the new Warhammer 40,000 each side rolls a six sided dice and adds their Strategy Rating to it. With a Strategy Rating of 5 compared to the Orks' 3, I definitely had the advantage here. The Space Marines seized the initiative and went first.



Given their objective I was confident that the Orks would close the range fairly quickly. My mission was to sit tight and blow away the Orks as they raced forwards, and not charge

recklessly into hand-to-hand combat where the Orks' numbers would be to their advantage. My troops were set up in the best cover on the board and I saw no reason to leave it. Consequently I placed all four of my squads on overwatch and waited for the Orks to come to me.

This decision meant that many more of the Space Marines would get to fire (all of their bolters started out of range) and the Orks might waste their movement hiding and using cover rather than just piling forward. Although I could see the dreadnought with my missile launcher from the

beginning of the turn, I decided to hold my fire. By using overwatch I would still get to fire before it did.

Under the new rules, overwatch is declared for whole squads rather than for individual models. This meant that my bolter fire would all be wasted if I fired the missile launcher in my turn as I wouldn't be able to put the rest of the squad on overwatch. Toasting the dreadnought would have to wait till the Orks' turn.

## ORKS TURN 1

Facing Space Marines on overwatch, the Ork mobs nevertheless surged forward as far as they could.

Grugnat's mob ran forwards amid a hail of bolter fire from the overwatching Squad Brutus. The Orks dived into the cover of the ruins, the bolter fire chewing up the ground around them. The old walls shook as explosive rounds thudded into them, but no one was hit.



Battle Squads Typhon and Brutus of the Ultramarines Chapter of Space Marines.

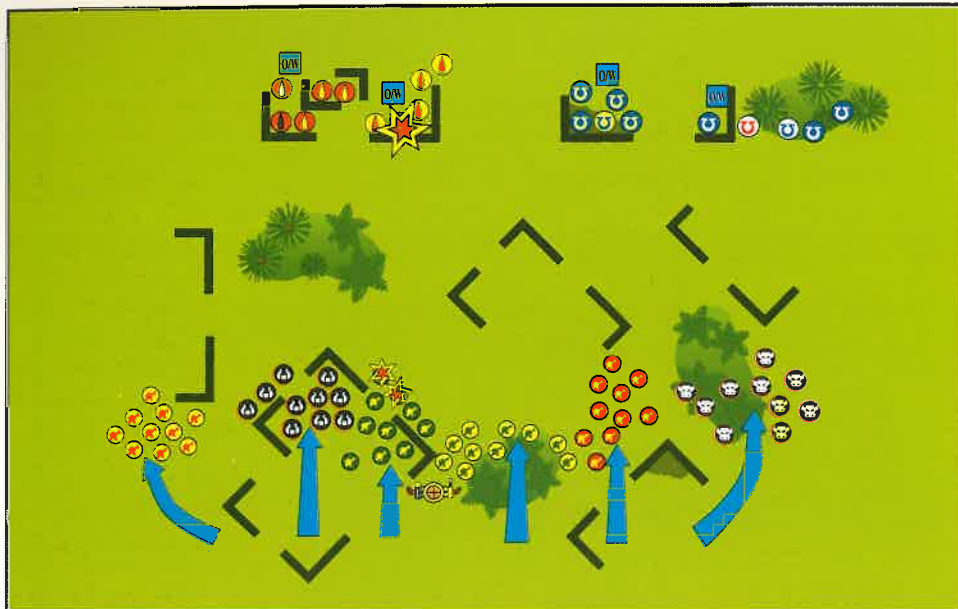

*ORKS TURN 1*

Suddenly Grugnat looked up through a gap in the wall and found himself staring down the barrel of Squad Cleon's missile launcher. With growing fear, he realised that an explosion in the confined space of the building would be lethal and that it was too late to run. Pressing his fingers to his ears and closing his eyes, Grugnat's short, brutal life flashed before him as he waited for the end.

The explosion seemed very far away and Grugnat was still breathing. He cautiously opened an eye and saw a plume of smoke rising from the ruins where the Blood Angel armed with the missile launcher had been taking cover. With a

trooper in Squad Brutus fired a super-krak missile at da Krusher. The missile streaked in and the massive machine was engulfed by a huge explosion. The fireball obscured it for a moment but as the smoke cleared da Krusher could be seen still standing, a little scorched, but undamaged. At this range (over 24") the penetration of the missile had been reduced by 1 and the armour proved too hard to get through. The dreadnought now swivelled its lascannon and a vivid beam of light pulsed across the battlefield towards Squads Cleon and Brutus. However, the Space Marines were firmly concealed amid the ruins and the dreadnought failed to hit anything.

blinding flash, the weapon had misfired, showering the squad with debris. "Fawlty kit", Grugnat smirked.

Although the missile launcher had been destroyed, both of the Space Marines caught in the blast passed their saving throws thanks to the high quality of Space Marine power armour. However, Jake was now down to one missile launcher and my dreadnought hadn't even been scratched.

As Scumbo's Gretchin ran forward, two fell to overwatch fire from Squads Cleon and Brutus. The heavy weapons

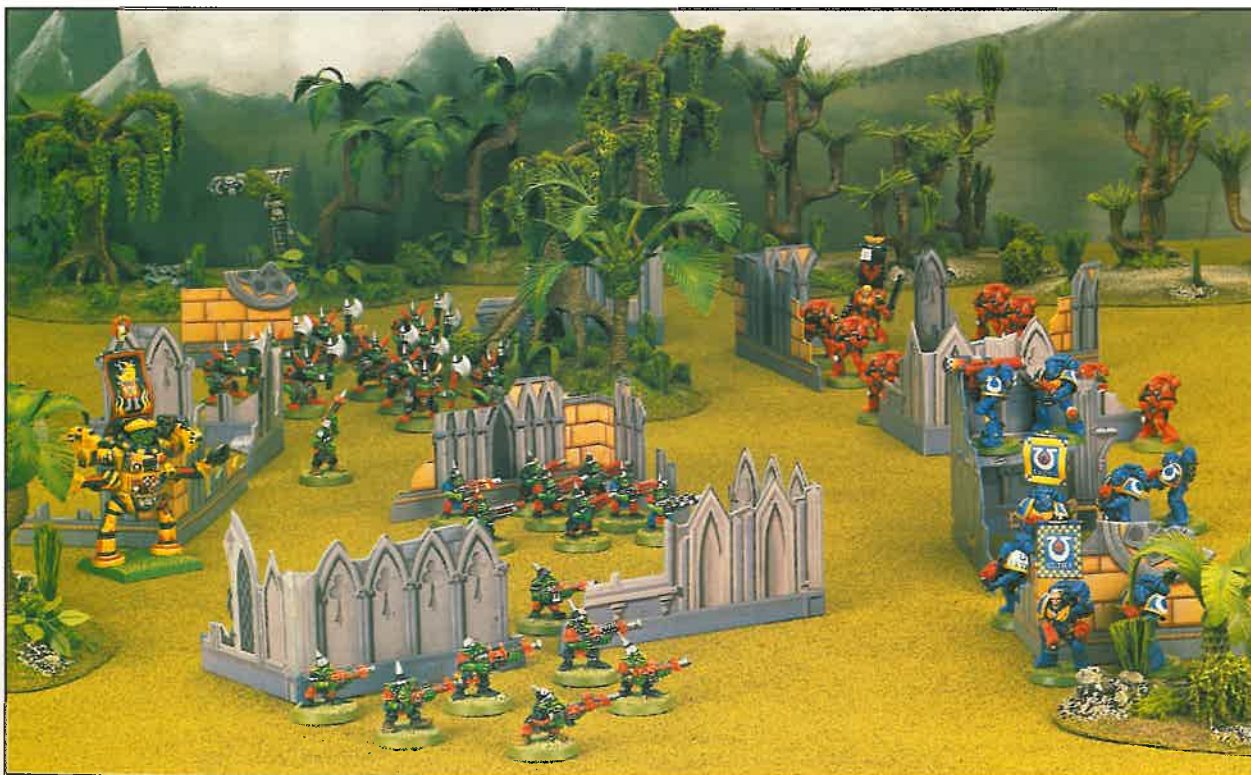

*The Ork horde charges towards the Space Marine position.*

## SPACE MARINES TURN 2

As I'd predicted, the Orks had charged forward in one long line. Although my overwatch had been rather disappointing, the greenskins still offered a huge and inviting target for my bolters. The Orks were obviously eager to die so I obliged them.

Squads Typhon and Brutus began the carnage by mowing down five of Snigbot's mob. Spattered with the green blood of their comrades, the rest of the mob fled into the cover of the jungle. One VP to the Space Marines for killing half of the Ork mob.

My other troopers were all closest to Scumbo's mob, so everyone who could see them poured their fire into the hapless Gretchin. The rapid fire of the Space Marines killed all except their leader, Scumbo himself, who resolutely refused either to die or break!

The surviving missile launcher with Squad Brutus hit the dreadnought again, and once more, the missile failed to penetrate its armour because of the long range.

Despite my inability to harm da Krusher this was a much better turn. Twelve kills and a Goff mob broken.

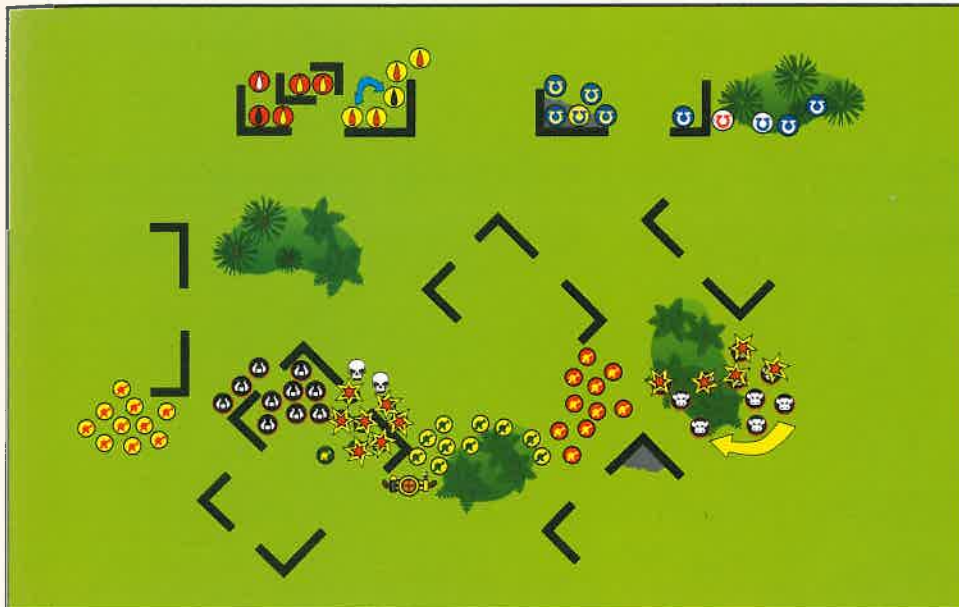

SPACE MARINES TURN 2

In the centre, Grit's and Fergit's mobs suffered no ill effects from the overwatch fire as they crossed the open ground between them and the safety of cover.



On the right, Snikbog's Orks ran forward through the jungle towards Squad Typhon. Concealed amongst the foliage ahead, the Space Marines looked like easy meat for the Goffs' axes, and as if in confirmation of their fate, the burst of overwatch fire from Squad Typhon failed to hit a single one of Snikbog's mob. Howling their battlecry, the Orks readied their weapons and prepared to charge their foes.

On the left flank, Grot's mob moved into the relative safety of the building in front of them. They could now use the walls as cover for the next two turns in order to run forward. Unless they were ambushed in the meantime they would be able to charge into the Space Marines' deployment zone in the last turn.

### TURN 1 VICTORY POINTS

SPACE MARINES 0 POINTS

ORKS 0 POINTS

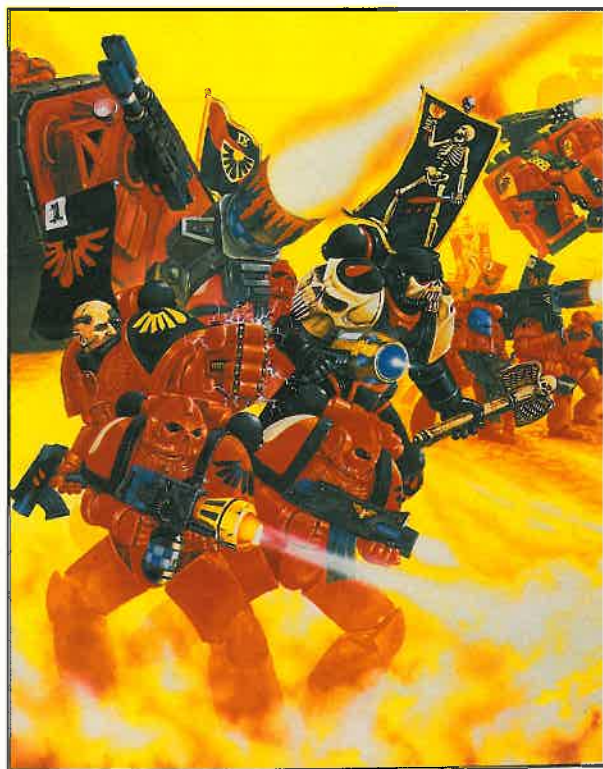

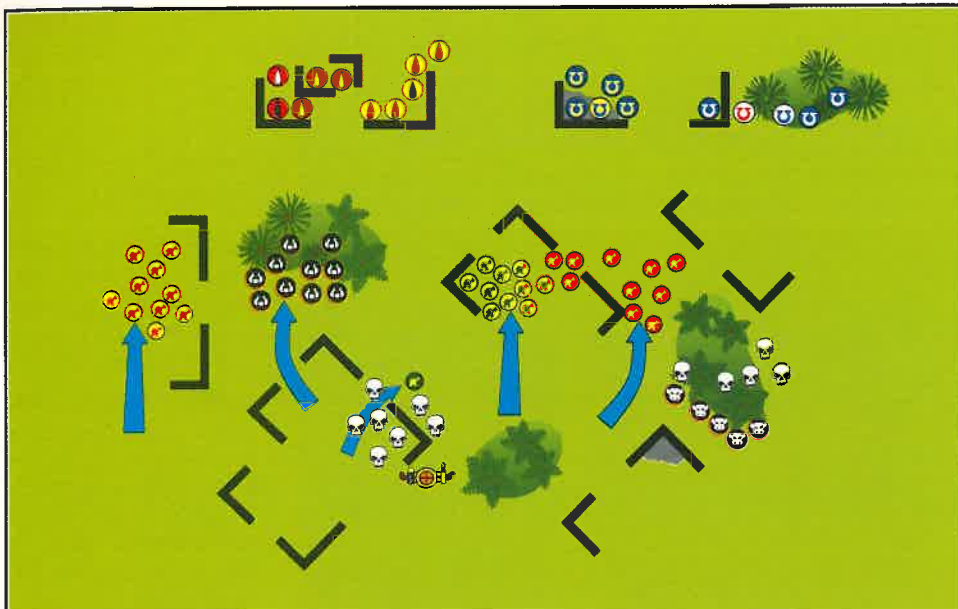

ORKS TURN 2

### ORKS TURN 2

Scumbo's Gretchin had taken something of a hammering and Snikbog's Orks had paused to pull themselves together, but the Orks didn't care. Despite these minor setbacks the rest of the mobs surged forward.

Grot's mob continued to dash from cover to cover, while Grugnat's Orks ran up behind the relative safety of the trees in front of Squad Lazarus. Grit's mob took cover behind a wall whilst Fergit's Gretchin presented themselves in the open to draw the Space Marines' fire.

In a courageous, if not stupid display of bravado, the lone Scumbo advanced on Squad Cleon to wreak terrible revenge for his fallen comrades. Needless to say autoguns, unless used in large numbers, are pretty feeble against Space Marine power

armour and Scumbo didn't even hit the Space Marine anyway. Scumbo was in deep trouble!

Da Krusher remained where he was, taking advantage of the fact that he was over 24" away from the opposing missile launcher. Firing at Squads Cleon and Brutus, both the heavy bolter and the lascannon failed to hit.

My plan to use the dreadnought as a firebase was failing miserably. I could, however, use it to charge into close combat with Squad Cleon over the next two turns, in an attempt to draw the missile launcher's fire

away from the mobs. Snikbog's Orks had rallied and needed a distraction such as a charging dreadnought to help them to edge forward towards the enemy again. Even though the Orks could not reach the deployment zone in time they could try to get VPs by wiping out Squad Typhon.

### TURN 2 VICTORY POINTS

SPACE MARINES 1 POINTS

ORKS 0 POINTS



Scumbo – the recklessly brave Gretchin – advances into the teeth of the Space Marines.



SPACE MARINES TURN 3

### SPACE MARINES TURN 3

All along the line the horde of greenskin scum was getting closer. I had hoped to be able to bring Squad Typhon around to reinforce the centre, but the Orks they'd broken last turn rallied immediately and even now were on their way back into the fray. My only movement was to improve my fields of fire by swapping the positions of Squad Typhon's flamer-armed trooper and one armed with a bolter. All of the Space Marines' weapons opened fire once more.



Scumbo was the last of his mob, so killing him was now worth 2 VP. He was rather foolishly standing in the open so troopers from Squad Lazarus saw to it that he wouldn't have the chance to pass another Break test. Fergit's mob too was marked for death, with six of them going to meet their disgusting alien gods. Fergit was, however, totally unimpressed and passed the Break test easily. Yet again Adrian's dice rolls came to his rescue.

Having seen the ineffectiveness of the dreadnought I considered fragging one of the tightly packed herds of greenskins with my missile launcher. The dreadnought was too far away to reach my deployment zone and I didn't think that it could do too much damage as my men were all in hard cover. On the other hand, Adrian's spawny dice rolls for his Break tests had kept all of his mobs moving forward and four of them still had enough greenskins left in them to claim the 5 VPs for getting to my deployment zone.

My choice was made for me when I took a models-eye view. My missile launcher couldn't see enough of any of the mobs to shoot at – just the tops of some spiky helmets – so I fired a super krak at the da Krusher. The missile streaked in and smashed into one of the dreadnought's weapon arms tearing it apart. Exploding ammo crackled around the smoking machine as heavy bolter shells rained down around it. Fighting

desperately for control, the Gretchin pilot was fried by a massive electric shock as explosions flashed back to the cramped cockpit and the dreadnought went berserk.

By the end of the turn I'd killed eleven more of the Orkish scum and toasted the dreadnought. Grit's and Grugnat's mobs each had two of their number killed, but as these were the first casualties they had suffered neither had to take a Break test. My marines reloaded their weapons and checked in on the comm-net. Still no casualties and only one turn to go.

### ORKS TURN 3

So much for my plan to charge the dreadnought towards the enemy ranks! Da Krusher span around, out of control, and ran smack into a wall shooting wildly with its remaining lascannon. The Space Marines of Squad Cleon who were its nearest target were only saved by the ruins they were cowering in.

Grugnat's Orks charged towards Squad Lazarus, falling short by a few inches. They now faced the flamer which could easily burn through flak armour regardless of the 5 or 6 save it afforded from area effect weapons. However, if Grugnat and his boyz were to make it into close combat next turn they had to cross the open ground in front of their enemies. Even if they held back there would be no escape from the flamer or from frag grenades thrown by the Space Marines.

Fergit's mob ducked into cover for a turn, hopefully to redeploy and open fire at close range during Turn 4. I wasn't going to make the same mistake as I had done with Scumbo and leave 2 VPs for the Space Marines to snap up. I wouldn't sacrifice these heroic Gretchin who had spectacularly passed a Break test (as had almost every Gretchin mob in the game so far!). Grit's mob now presented themselves as decoys to draw the missile launcher away from Snikbog's Orks who had now moved up into cover behind a wall and would possibly be visible to long-range weapons fire.

All now rested on the last two player turns. The Space Marines would continue to try to fend off the Ork charge but as long as Grot's mob could survive the Space Marines next turn, 5 VPs would be mine!

### TURN 3 VICTORY POINTS

SPACE MARINES 4 POINTS

ORKS 0 POINTS



ORKS TURN 3

### SPACE MARINES TURN 4

The stubborn refusal of the Orks to lie down and die on cue was becoming rather worrying. This was my last turn and an awfully large number of the orkish filth were still alive.

In order to stop the Orks getting the 5 VPs for reaching my deployment zone I had to break, or reduce to less than six, Grugnat's Orks and Grot's and Grit's Gretchin mobs. Three mobs to destroy in one turn was difficult but by no means impossible. Calling upon the Emperor, the Ultramarines and Blood Angels advanced from cover to get as many shots as possible at the greenskins that weren't cowering out of sight.

Squad Brutus's missile launcher fired a frag missile at Snikbog's Orks who weren't in as much cover as they thought. Three of them were blown to pieces by the blast and the remaining two cowered out of sight. By this stage I expected nothing less than for them to pass their break test which they duly did. This was especially annoying because their failure to pass would have caused them to be removed as casualties (broken with less than 25% remaining) gaining me a VP.

The troopers of Squads Typhon and Brutus all opened fire with their bolters but somehow only managed to kill a single Gretchin between them. I was not impressed at all and began to wonder about their spiritual purity.

My right flank lay down a storm of bolter fire which



SPACE MARINES TURN 4

reduced Grugnat's mob to 50% for which I got another 1 VP. This also stopped them from claiming the 5 VPs for getting into my deployment zone.

Squad Lazarus' flamer finally got into action torching the charging Goffs. Flames licked around the burning Orks as they ran about on fire, trailing greasy smoke. Two were killed and one of the survivors was left ablaze. Predictably, they also passed their Break test!

To my frustration Grot's mob walked through the bolter fire as if it wasn't there and survived

without a scratch. Grit's mob had more of its number mown down, reducing it to only three, but yet again they passed their Break test!

### ORKS TURN 4

All the mobs remained steady during the Space Marine turn despite the horrendous casualties the flamer had inflicted. Even the Gretchin proved as cool as ice. Grot's mob charged forward, a lone Gretchin sacrificing himself by entering close combat with Squad Lazarus' Sergeant so as to allow the rest of the mob to charge into the deployment zone. The Sergeant made short work of him but the Orks had achieved their objective! Five VPs each. Now all I needed to do to win was kill three Space Marines from one squad.





*Grot's mob charge forward into the Space Marines' deployment zone.*

The burning Ork in Grugnat's mob promptly dropped dead and the surviving two Orks passed yet another Break test! This was just as well as they would both have been removed as casualties if they had failed. Squad Lazarus stood amazed as the unstoppable Orks charged into them.

Having already passed a Break test that turn the Orks would not need to take another if, for instance, an Ork died in close combat. The Space Marines would gain no victory points unless both Orks were killed in the fighting.

Before the Space Marines could react to the threat, da Krusher intervened. The crippled dreadnought let fly a wild burst from its lascannon but only succeeded in blowing Grugnat himself into the arms of Gork and Mork! The remaining Goff was beaten back unharmed by his Blood Angel opponent. The Space Marine's bolt pistol had failed to penetrate the Ork's tough hide and again, the Orks were saved from defeat by the fall of the dice.

Snikbog's Orks were finally close enough to fire their bolt pistols and promptly killed two Space Marines from Squad Typhon. Fergit's mob now emerged from cover and along with Grit's mob also opened fire. Under such a hail of lead, normal troops

would be cut to pieces by the sheer weight of fire. Not so the Space Marines who escaped untouched!

The game was over.

## TURN 4 VICTORY POINTS

SPACE MARINES 5 POINTS

ORKS 5 POINTS



*ORKS TURN 4*

## NOTES FROM THE RECLUSIAM (Jake Thornton)

Next time Adrian, next time!

By the end of Turn 4, the bodies of over two-thirds of the Ork horde littered the battlefield. Forty-one greenskins lay dead or dying, the Ork dreadnought was crashing about wildly, shooting up its own side and I had lost only two Space Marines. To spoil this delightful image one measly mob of Gretchin had evaded the cleansing fire of my bolters and reached my deployment zone. Only one mob, but that was enough.

What went wrong? How could the subhuman scum have made it so far? I shall spend much time in the Reclusiam meditating upon this.

I think that my tactics were right in the circumstances though hindsight suggests that a heavy use of grenades in my last turn may have been more effective. My original idea had been that I would sit and fire for a couple of turns, then, as mobs broke and gaps appeared in the Ork line, I would redeploy forward. Gaps simply never appeared.

To my immense frustration Adrian only failed one of the five Break tests I forced his mobs to take, and even that mob rallied immediately. I don't know what Warboss Wood puts in their fungus beer but it makes those Gretchin unstoppable.



From my side of the table the Orks did much as expected with the single exception of the dreadnought. Da Krusher hung about at the back shuffling its feet nervously and served only to draw the fire of my missile launcher. The horrible possibility of having to deal with the dreadnought in hand-to-hand combat never arose and that was fine by me, but perhaps not Adrian's best plan.

All things considered I think that I fulfilled my brief fairly well. The Ork assault had been shot to pieces and the Space Marines were still in place. This time was a draw but next time there would be no mercy.

## 'ERE WE GO 'ERE WE GO! (Adrian Wood)

In hindsight, I now realise how close to victory the Orks were. However, had it not been for some amazing dice rolls, particularly for the Break tests, things could have been very different. The advance, en masse, of the Ork forces certainly tied up Jake's Space Marines on all fronts so that he just couldn't cover Grot's Gretchin creeping round the side into his deployment zone.



Losing Scumbo was a stupid error. As I said at the beginning, you must not give away points to the enemy like that. In the end I wasted an ice-cool Gretchin and, more importantly, 2 VPs! Fergit's mob was a good example of avoiding the complete loss of a squad which has been badly mauled. Even though they inflicted no casualties themselves in the last turn at least they were still in the battle to try.



Da Krusher seemed to do very little in the way of actual combat. The only time he managed to hit anything was in the last turn when he killed Grugnat. He did attract a lot of fire from the surviving heavy weapon when the Space Marines could have been punching great holes in the Ork attack and this was what I had intended from the start. At least he didn't grind to a halt completely and give Jake another victory point.

On the whole the favourite Ork tactic of using their considerable numbers to swamp an enemy worked really well. Space Marines excel in either lightning raids or, as this scenario demonstrated, digging their heels in and relying on their superiority at arms. However, there are only ever a handful of them and they are susceptible to being overwhelmed. The tactic worked well and even though I didn't win I certainly gave "da gurlly Space Marines somefing to fink about!"

# WARHAMMER

## 40,000

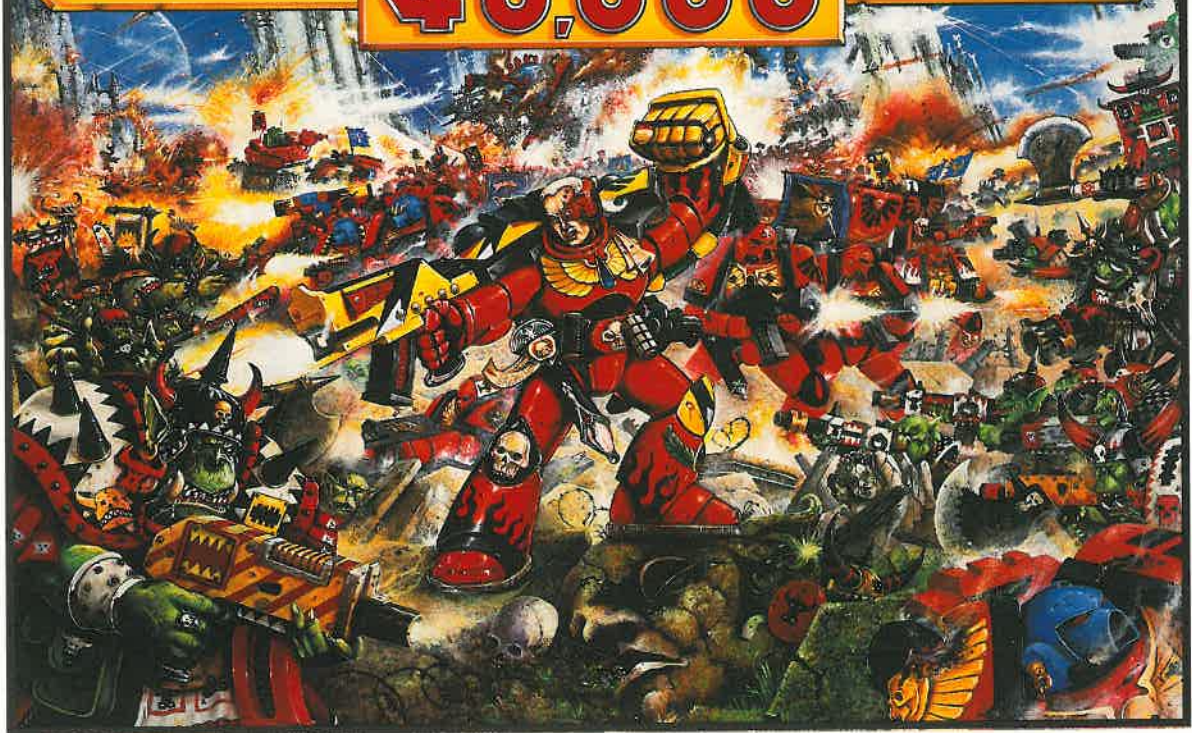

## BATTLES IN THE WAR-TORN HORROR OF THE FAR FUTURE

The new boxed Warhammer 40,000 game contains 80 new plastic Citadel Miniatures (20 Space Marines, 20 Space Orks and 40 Gretchin with Autoguns), a comprehensive Rulebook, a Wargear Equipment Book, the Codex Imperialis background book, a Scenario booklet, plus full-colour burst templates, counters, fast playsheet and 20 card scenic buildings. Also included in the box are Wargear, Mission, Vehicle and Dreadnought cards, Squad data and Weapons reference cards, a full-colour guide to painting the models, ten ordinary dice and four special dice for moderating heavy weapons and artillery fire.



Warhammer, Games Workshop and the Games Workshop logo are registered trademarks of Games Workshop Ltd.  
© Copyright Games Workshop Ltd 1993. All rights reserved.

# GAMES WORKSHOP

# GAMES WORKSHOP®

## SHREWSBURY GRAND OPENING SATURDAY 18th SEPTEMBER

Doors Open 9am!



**UNIT 2  
NCP BUILDING  
BARKER STREET**

**NORMAL OPENING HOURS**  
 Mon. Tue. Wed. Fri. 10am to 6pm  
 Thursday 10am to 8pm  
 Saturday 9.00am to 5.30pm



**BUY ANY TWO RED DOT ITEMS AND GET ONE YELLOW DOT ITEM FREE!**

Eg., Buy Bloodbowl and Mighty Empires and get Dungeonbowl FREE!

**BUY ANY TWO BLISTER PACKS AT £3.99 OR MORE AND GET ONE ADDITIONAL £3.99 BLISTER PACK FREE!**

Offers open all day (while stocks last).

<p>ONLY ONE VOUCHER PER PRODUCT                  REDEEMABLE AT GAMES WORKSHOP                  SHREWSBURY 18th SEPTEMBER 1993</p> <p><b>10</b> % OFF                  ANY GAMES WORKSHOP OR CITADEL PRODUCT</p> <p>NOT TO BE USED WITH ANY OTHER OFFER</p>	<p>ONLY ONE VOUCHER PER PRODUCT                  REDEEMABLE AT GAMES WORKSHOP                  SHREWSBURY 18th SEPTEMBER 1993</p> <p><b>10</b> % OFF                  ANY GAMES WORKSHOP OR CITADEL PRODUCT</p> <p>NOT TO BE USED WITH ANY OTHER OFFER</p>
<p>ONLY ONE VOUCHER PER PRODUCT                  REDEEMABLE AT GAMES WORKSHOP                  SHREWSBURY 18th SEPTEMBER 1993</p> <p><b>10</b> % OFF                  ANY GAMES WORKSHOP OR CITADEL PRODUCT</p> <p>NOT TO BE USED WITH ANY OTHER OFFER</p>	<p>ONLY ONE VOUCHER PER PRODUCT                  REDEEMABLE AT GAMES WORKSHOP                  SHREWSBURY 18th SEPTEMBER 1993</p> <p><b>10</b> % OFF                  ANY GAMES WORKSHOP OR CITADEL PRODUCT</p> <p>NOT TO BE USED WITH ANY OTHER OFFER</p>
<p>ONLY ONE VOUCHER PER PRODUCT                  REDEEMABLE AT GAMES WORKSHOP                  SHREWSBURY 18th SEPTEMBER 1993</p> <p><b>25</b> % OFF                  ANY GAMES WORKSHOP OR CITADEL PRODUCT</p> <p>NOT TO BE USED WITH ANY OTHER OFFER</p>	<p>ONLY ONE VOUCHER PER PRODUCT                  REDEEMABLE AT GAMES WORKSHOP                  SHREWSBURY 18th SEPTEMBER 1993</p> <p><b>25</b> % OFF                  ANY GAMES WORKSHOP OR CITADEL PRODUCT</p> <p>NOT TO BE USED WITH ANY OTHER OFFER</p>

PLEASE NOTE: YOU CANNOT USE THE VOUCHERS WITH ANY OF THE ABOVE OFFERS OR ON MB GAMES' HEROQUEST, SPACE CRUSADE OR BATTLEMASTERS, AND BOXTREE BOOKS' WARHAMMER NOVELS ARE NOT INCLUDED.

# SPACE MARINE®

## IMPERIAL STORMBLADES SUPER-HEAVY TANK COMPANY



Models designed by Norman Swales

Armed with an awesome array of powerful weapons, Stormblades are among the most powerful of the Imperium's super-heavy battle tanks. They are specifically designed to give close support to Storm Hammer companies, destroying Titans and other super-heavy tanks at short ranges. Their main armament is the huge plasma blast gun, a devastating weapon usually mounted on Titans. They also carry two types of missile, the Titan-killing Hellion missile and a rack of sleek Hunter-Killer missiles. To complete their destructive arsenal, Stormblades mount heavy battlecannon on their left sponsons as well as a plethora of close-range bolters for staving off infantry attacks.

The Imperial Stormblades boxed set also contains a transfer sheet of full colour insignia and a sheet of full colour banners to use on your Stormblade models.



These models require assembly. We recommend that parts are carefully cleaned and trimmed with a modelling knife before assembly and that the models are undercoated before painting with Citadel paints.

Warning! this product contains lead which may be harmful if chewed or swallowed. Citadel Miniatures are not recommended for children under 14 years of age.

### GAMES WORKSHOP®

EPIC IMPERIAL STORMBLADES



**INCLUDES  
STORMBLADE  
TRANSFER  
SET**

# GAMES WORKSHOP®

## SHREWSBURY GRAND OPENING SATURDAY 18th SEPTEMBER

Doors Open 9am!



**UNIT 2  
NCP BUILDING  
BARKER STREET**

**NORMAL OPENING HOURS**  
 Mon. Tue. Wed. Fri. 10am to 6pm  
 Thursday 10am to 8pm  
 Saturday 9.00am to 5.30pm



**BUY ANY TWO RED DOT ITEMS AND GET ONE YELLOW DOT ITEM FREE!**

Eg., Buy Bloodbowl and Mighty Empires and get Dungeonbowl FREE!

**BUY ANY TWO BLISTER PACKS AT £3.99 OR MORE AND GET ONE ADDITIONAL £3.99 BLISTER PACK FREE!**

Offers open all day (while stocks last).

<p>ONLY ONE VOUCHER PER PRODUCT REDEEMABLE AT GAMES WORKSHOP SHREWSBURY 18th SEPTEMBER 1993</p> <p><b>10</b> % OFF</p> <p>ANY GAMES WORKSHOP OR CITADEL PRODUCT</p> <p>NOT TO BE USED WITH ANY OTHER OFFER</p>	<p>ONLY ONE VOUCHER PER PRODUCT REDEEMABLE AT GAMES WORKSHOP SHREWSBURY 18th SEPTEMBER 1993</p> <p><b>10</b> % OFF</p> <p>ANY GAMES WORKSHOP OR CITADEL PRODUCT</p> <p>NOT TO BE USED WITH ANY OTHER OFFER</p>
<p>ONLY ONE VOUCHER PER PRODUCT REDEEMABLE AT GAMES WORKSHOP SHREWSBURY 18th SEPTEMBER 1993</p> <p><b>10</b> % OFF</p> <p>ANY GAMES WORKSHOP OR CITADEL PRODUCT</p> <p>NOT TO BE USED WITH ANY OTHER OFFER</p>	<p>ONLY ONE VOUCHER PER PRODUCT REDEEMABLE AT GAMES WORKSHOP SHREWSBURY 18th SEPTEMBER 1993</p> <p><b>10</b> % OFF</p> <p>ANY GAMES WORKSHOP OR CITADEL PRODUCT</p> <p>NOT TO BE USED WITH ANY OTHER OFFER</p>
<p>ONLY ONE VOUCHER PER PRODUCT REDEEMABLE AT GAMES WORKSHOP SHREWSBURY 18th SEPTEMBER 1993</p> <p><b>25</b> % OFF</p> <p>ANY GAMES WORKSHOP OR CITADEL PRODUCT</p> <p>NOT TO BE USED WITH ANY OTHER OFFER</p>	<p>ONLY ONE VOUCHER PER PRODUCT REDEEMABLE AT GAMES WORKSHOP SHREWSBURY 18th SEPTEMBER 1993</p> <p><b>25</b> % OFF</p> <p>ANY GAMES WORKSHOP OR CITADEL PRODUCT</p> <p>NOT TO BE USED WITH ANY OTHER OFFER</p>

PLEASE NOTE: YOU CANNOT USE THE VOUCHERS WITH ANY OF THE ABOVE OFFERS OR ON MB GAMES' HEROQUEST, SPACE CRUSADE OR BATTLEMASTERS, AND BOXTREE BOOKS' WARHAMMER NOVELS ARE NOT INCLUDED.

# SPACE MARINE<sup>®</sup>

## IMPERIAL STORMBLADES SUPER-HEAVY TANK COMPANY



Models designed by Norman Scales

Armed with an awesome array of powerful weapons, Stormblades are among the most powerful of the Imperium's super-heavy battle tanks. They are specifically designed to give close support to Storm Hammer companies, destroying Titans and other super-heavy tanks at short ranges. Their main armament is the huge plasma blast gun, a devastating weapon usually mounted on Titans. They also carry two types of missile, the Titan-killing Hellion missile and a rack of sleek Hunter-Killer missiles. To complete their destructive arsenal, Stormblades mount heavy battlecannon on their left sponsons as well as a plethora of close-range bolters for staving off infantry attacks.

The Imperial Stormblades boxed set also contains a transfer sheet of full colour insignia and a sheet of full colour banners to use on your Stormblade models.

These models require assembly. We recommend that parts are carefully cleaned and trimmed with a modelling knife before assembly and that the models are undercoated before painting with Citadel paints.

Warning! this product contains lead which may be harmful if chewed or swallowed. Citadel Miniatures are not recommended for children under 14 years of age.



**GAMES  
WORKSHOP**

EPIC IMPERIAL STORMBLADES



**INCLUDES  
STORMBLADE  
TRANSFER  
SET**

OP GAMES WORKSHOP STORES • SHREWSBURY • GAMES WORKSHOP STORES OP

# GAMES WORKSHOP®

## UK MAIL ORDER

OUR TELEPHONE HOTLINES ARE OPEN FROM

9.00am – 6.30pm Monday to Friday  
9.00am – 5.00pm on Saturdays

Our Mail Order Trolls will be packing parcels for Santa right up until Christmas Eve. However, for them to dispatch your games and miniatures in time for Christmas, we must receive overseas orders by the **26th November 1993**, and UK orders by the **10th December 1993**.

AVAILABLE  
NOW!

### WARHAMMER 40,000 BOXED SET



The new boxed Warhammer 40,000 game contains 80 new plastic Citadel Miniatures (20 Space Marines, 20 Space Orks and 40 Gretchin with Autoguns), a comprehensive Rulebook, a Wargear equipment book, the Codex Imperialis background book, a Scenario booklet, plus full-colour templates, counters, fast playsheet and 20 card buildings. Also included in the box are Wargear, Mission, Vehicle and Dreadnought cards, Squad data and Weapons reference cards, a full-colour guide to painting the models, ten ordinary dice and four special dice for moderating heavy weapons and artillery fire.

### GAMES WORKSHOP GIFT VOUCHERS

Fed up of receiving sensible socks and hankies for Christmas? Tired of the same old slippers and woollen hats that you get every year?

Why not ask your Granny to buy you Games Workshop Gift Vouchers instead?!

Games Workshop Gift Vouchers are available in £5 or £10 denominations from our Mail Order Trolls or from your local Games Workshop Store NOW!



### UK MAIL ORDER

Our UK Mail Order Hotlines are open six days a week, and you can pay by Visa, Access or Switch.

(0773) 713213, Monday to Friday  
between 9.00am and 6.30pm  
Saturdays 9.00am to 5.00pm

If you're posting your order, please send it to:

**GAMES WORKSHOP  
MAIL ORDER SERVICE,  
CHEWTON STREET, HILLTOP,  
EASTWOOD, NOTTINGHAM NG16 3HY.**

Or you can fax the order through on  
(0773) 530155.





# MAIL ORDER FORM

DESCRIPTION/CODE	PRICE	QTY	TOTAL PRICE

Use this form to mail order Games Workshop products, Citadel and Marauder Miniatures from this or any recent issue of White Dwarf, or from the Citadel Miniatures Catalogue. When you have totalled up your order, please don't forget to add the postage and packing charge.

<b>SUBTOTAL</b>	
<b>POSTAGE &amp; PACKING</b>	
<b>GRAND TOTAL (TOTAL + P&amp;P)</b>	

**METHODS OF PAYMENT**  
 You can pay by cheque or postal order. Alternatively, we take Access/Mastercard, Visa, and (in the UK) Switch. If you wish to pay by credit card, please fill in the relevant details on the form below. If you have a credit card, you can place an immediate order by phoning our Mail Order Hotlines – but make sure you have your card with you when you phone.

**POSTAGE & PACKING**  
**UK & BFPO:** Add £2.50.  
**Overseas (including Eire):** Add 40% of order value. If you pay by credit card, P&P will be charged at cost if less than this (minimum P&P £2.50).

**DESPATCH & DELIVERY**  
 We always try to despatch your order on the day of receipt, and you should usually get your order back within 10 days.

*Please feel free to photocopy this form*

**NAME** ..... **ADDRESS**.....

.....

.....





**COUNTRY** ..... **Postcode** ..... **Tel:** .....

**Method of Payment:** Cheque  Postal Order  Access/Mastercard  Visa  Switch

**Card No:** [ ] **Issue No:** [ ] [ ] [ ] [ ] (Switch only)

**Card expiry date:** ..... **Cardholder Name:** .....

**Cardholder Signature:** .....

**WARHAMMER**



WARHAMMER BOXED SET	£29.99
WARHAMMER BATTLE MAGIC	£17.99
WARHAMMER ARMIES – THE EMPIRE	£9.99
WARHAMMER ARMIES – HIGH ELVES	£9.99
WARHAMMER ARMIES – ORCS & GOBLINS	£9.99
WARHAMMER ARMIES – DWARFS	£9.99
SELF ADHESIVE BANNERS Each pack contains 5 sheets of banners (Available for Orcs, Goblins, High Elves and Dwarfs.)	£2.99

**THE EMPIRE**

IMPERIAL HERO RIDING PEGASUS	£14.99
EMPEROR RIDING WAR GRIFFON DEATHCLAW	£14.99

**HOBGOBLINS**

HOBGOBLIN COMMAND	£1.35 each
HOBGOBLIN WARRIORS	£1 00 each
HOBGOBLIN ARCHERS	£1 00 each

**DWARFS**

ANVIL OF DOOM BOXED SET	£12.99
-------------------------	--------

**HIGH ELVES**

<b>NEW!</b> DRAGON PRINCES OF CALEDOR (Boxed set contains 3 Dragon Princes and their steeds)	£9.99
<b>NEW!</b> DRAGON PRINCES OF CALEDOR	£3.99 each
ELTHARION RIDING STORMWING	£14.99
HIGH ELF EAGLE RIDER	£7.99
HIGH ELF TIRANOC CHARIOT BOXED SET	£14.99
HIGH ELF COMMAND	£1.35 each
HIGH ELF WARRIORS	£1 00 each
HIGH ELF SILVER HELM KNIGHTS	£2.99 each
HIGH ELF SILVER HELMS BOXED SET (Boxed set contains 4 Silver Helm Knights)	£9.99

**CHAOS DWARFS**

CHAOS DWARF SORCERER RIDING LAMMASU	£14.99
CHAOS DWARF LORD RIDING GREAT TAURUS	£14.99

**WARHAMMER 40,000**



<b>NEW!</b> WARHAMMER 40,000 BOXED SET	£34.99
<b>NEW!</b> WARHAMMER 40,000 POSTER	£4.99
<b>NEW!</b> WARHAMMER 40,000 BADGE	£4.99
<b>NEW!</b> WARHAMMER 40,000 T-SHIRT	£7.99

**BLOOD ANGELS BOXED MINIATURES**

<b>NEW!</b> DEVASTATORS BOXED SET	£9.99
<b>NEW!</b> DEATH COMPANY BOXED SET	£12.99

**SPACE WOLVES BOXED MINIATURES**

GREY HUNTERS BOXED SET	£12.99
LONG FANGS BOXED SET	£9.99
BLOOD CLAWS BOXED SET	£12.99
WOLF GUARD BOXED SET	£12.99

**SPACE MARINES**

<b>NEW!</b> PREDATOR BOXED SET	£9.99
<b>NEW!</b> SPACE MARINE DREADNOUGHT	£19.99
SPACE MARINES	£1.35 each
SPACE MARINE DEVASTATOR BODIES	£1.35 each
HEAVY WEAPONS	£1.25 each
DEVASTATORS BOXED SET	£9.99

**ORKS**

WARLORD GHAZGHKULL THRAKA & MAKARI HIS STANDARD BEARER	£4.99
BOSS ORKS	£2.00 each
ORKS	£1.35 each

**SPACE MARINE**

SPACE MARINE	£29.99
SPACE MARINE BATTLES (BOOK)	£9.99
ARMIES OF THE IMPERIUM	£14.99
RENEGADES (Chaos and Eldar armies)	£14.99
ORK & SQUAT WARLORDS	£14.99
<b>NEW!</b> IMPERIAL STORMBLADE (Box of 3)	£11.99

**MAN O' WAR**



MAN O' WAR	£24.99
PLAGUE FLEET	£14.99
SEA OF BLOOD	£14.99

**MAN O' WAR BOXED MINIATURES**

**NORSE SHIPS**

NORSE LONGSHIPS (BOX OF 3)	£9.99
<b>NEW!</b> NORSE KINGSHIP	£4.99

**CHAOS SHIPS**

<b>NEW!</b> BANE TOWER OF TZEENTCH	£4.99
<b>NEW!</b> WINGED TERROR OF TZEENTCH	£4.99
PLAGUE SHIP	£4.99
PLAGUE CRUSHER (BOX OF 3)	£9.99

**ORC SHIPS**

ORC HULK	£4.99
DRILLAKILLAS (BOX OF 3)	£9.99
BIGCHUKKAS (BOX OF 3)	£4.99



**WHITE DWARF SUBSCRIPTIONS**

**UK, EUROPE, & THE REST OF THE WORLD**

**UK & BFPO:** £27.50 for one year (12 issues). **EUROPE:** £35.  
**REST OF THE WORLD (excluding US and Canada):** £45 for one year.  
 Please send payments to Games Workshop Mail Order, Chewton St, Hilltop, Eastwood, NOTTINGHAM, NG16 3HY. All payments should be in pounds sterling. Please make cheques payable to Games Workshop Ltd.  
 If you have a Visa, Access or Mastercard you may place your subscription by phoning our Mail Order department on 0773 713213.

**USA & CANADA**

**USA:** \$35 for one year (12 issues) / \$63 for 2 years (24 issues). (Maryland residents please add 5% state sales tax).  
**CANADA:** \$45 for one year/ \$81 for 2 years.  
 Payment can be by check, US money order, Mastercard or Visa. Canadian postal money orders not accepted. Please make checks and money orders payable to Games Workshop. Payment should be sent to White Dwarf Subscriptions, 3431 C Benson Avenue, Baltimore, Maryland 21227-1072. For VISA and Mastercard orders, please telephone our Mail Order hotline on (410) 644 5699, Monday to Friday, 9am - 5pm EST.  
 Please state which issue you would like your subscription to start with.

**CORRESPONDENCE**

We welcome comments about White Dwarf, Games Workshop games and Citadel Miniatures. All letters except subscriptions and Mail Order should be addressed to: The Editor, White Dwarf, Games Workshop, Howard House, 16 Castle Boulevard, Nottingham NG7 1FL.

Clearly mark your envelope with the name of the game you are writing to us about. If you want a reply you *must* enclose a self-addressed stamped envelope (overseas readers should include IRCs). We receive an enormous amount of mail. We do read every letter, but it may take a little time for us to reply to you, so please be patient!



**COPYRIGHTS AND TRADEMARKS**

All subject matter in White Dwarf is © Copyright Games Workshop Ltd 1993.  
 All artwork in all Games Workshop products, and all images contained therein have been produced either in-house or as work for hire. The exclusive copyright in the artwork and the images it depicts is the property of Games Workshop Ltd. © Copyright Games Workshop Ltd 1993. All rights reserved.

**Registered Trademarks**

The following are all registered trademarks of Games Workshop Ltd.  
 Armageddon, Blood Bowl, Chivalry, the Citadel logo, Confrontation, Dark Future, Eldar Attack, Epic, the Flame logo, the Games Workshop logo, Games Workshop, Realm of Chaos, Slottabase, SpaceFleet, Space Marine, Talisman, White Dwarf and the White Dwarf figure, and Warhammer.

**Trademarks**

The following are all trademarks of Games Workshop Ltd.  
 Aspect Warrior, Avatar, Blood Angels, Bloodletter, Bloodthirster, Citadel, Daemonette, Dark Angels, Dark Reaper, Deathwing, Dragonmasters, Dungeonquest, Eldar, Exo Armour, Exarch, Eye of Terror, Farseer, Fire Dragon, Flesh Hound, Gargant, Genestealer, Gobbo, Great Unclean One, Gretchin, Grey Knight, Hunter Slayer, Keeper of Secrets, Khorne, Knights Panther, Leman Russ, Lichemaster, Lightning Claw, Lord of Change, Madboy, Mekboy, Mighty Empires, Nurgle, Nurgling, Ogryn, Old World, Ork, Painboy, Plaguebearer, Psyker, Ratling, Ravenwing, Skaven, Slaanesh, Slann, Snotling, Space Hulk, Space Wolves, Squat, Squig, Swooping Hawk, Striking Scorpion, Terminator, Thunder Hammer, Troll Slayer, Tyranids, Tzeentch, Ultramarines, Warmaster, Weirdboy, Knights of the White Wolf, Worlddeater.

*GW Books* is a trademark of GW Books Ltd. Used with permission.  
*Flame* is a trademark of Flame Publications Ltd. Used with permission.  
*Marauder Miniatures* is a trademark of Marauder Miniatures Ltd. Used with permission.  
*Heroquest* and *Space Crusade* are both trademarks of Milton Bradley Games. Used with permission.  
*Scatter dice* are UK registered design No. 2017484.

# CHAOS WARSHIPS

## PLAGUE CRUSHER

(A)

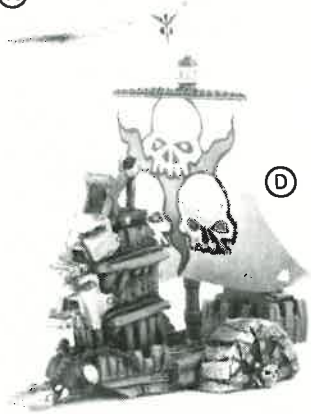

CATAPULT TOWER  
8042/2

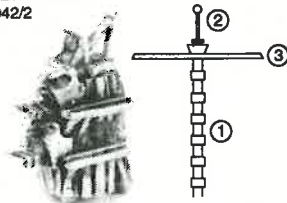

HULL  
8042/1

PADDLES  
8042/3

THE COMPLETE  
NURGLE PLAGUE CRUSHER  
CONSISTS OF:  
1 x HULL  
1 x CATAPULT TOWER  
2 x PADDLES

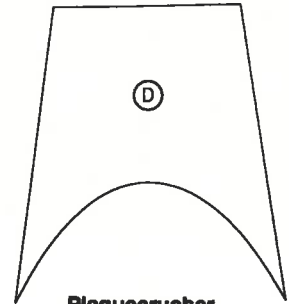

Plaguecrusher  
Masts: one 1, one 2  
Yard: one 3

## PLAGUE SHIP

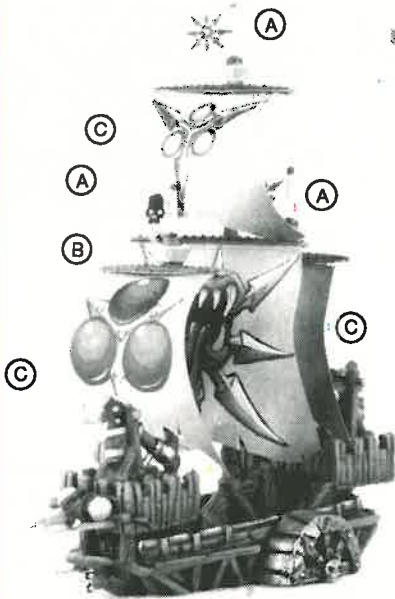

HULL  
8041/1

THE COMPLETE  
NURGLE PLAGUE SHIP  
CONSISTS OF:  
1 x HULL  
1 x ART CASTLE  
1 x FORECASTLE  
2 x PADDLES  
3 x PLAGUE CATAPULT



FORE CASTLE  
8041/4



PADDLES  
8041/3



PLAGUE CATAPULT  
8041/5



AFT CASTLE  
8041/2

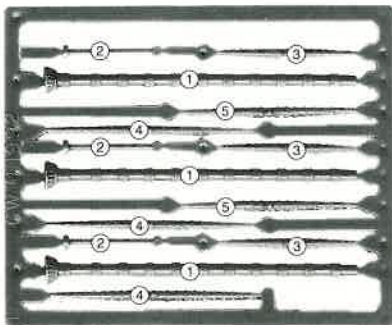
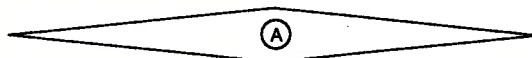

MAN O' WAR PLASTIC  
MAST SPRUE  
MOWPLA/2

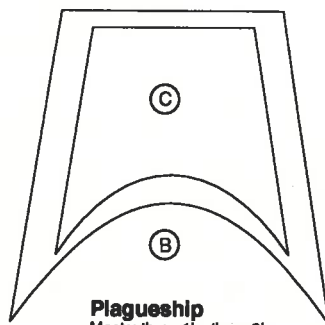

Plagueship  
Masts: three 1's, three 2's  
Yard: three 3's, one 5

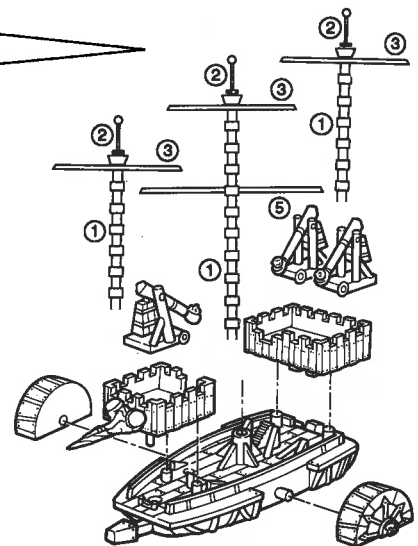

THE DIAGRAM ABOVE ILLUSTRATES THE CORRECT LENGTH FOR EACH MAST AND THE TYPE AND NUMBER OF YARD ARMS.  
THE SAILS AND PENNANTS ABOVE MAY BE PHOTOCOPIED, CUT OUT, PAINTED AND STUCK ONTO YOUR MINIATURES.  
PERMISSION GRANTED TO PHOTOCOPY FOR PERSONAL USE ONLY.

Designed by Dave Andrews

Miniatures supplied unpainted. WARNING: This product contains lead which may be harmful if chewed or swallowed. Citadel Miniatures are not recommended for children under 14 years of age. © Copyright Games Workshop Ltd 1993. All rights reserved.



# CHAOS WARSHIPS

## BANETOWER OF TZEENTCH

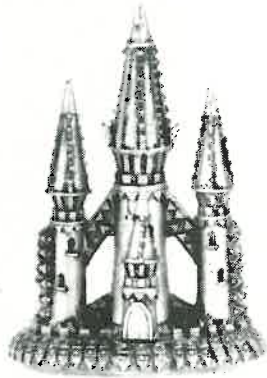

EXAMPLE OF COMPLETED BANETOWER OF TZEENTCH

THE COMPLETE BANETOWER OF TZEENTCH CONSISTS OF:  
 1 x TOWER BASE  
 1 x MAIN TOWER  
 2 x SMALL TOWER

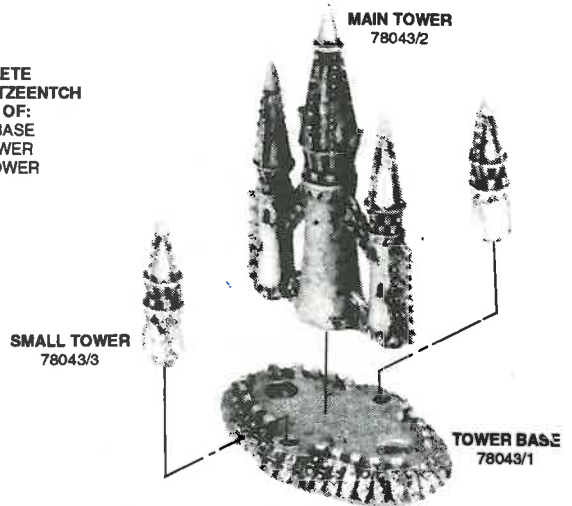

## GREAT WINGED TERROR OF TZEENTCH

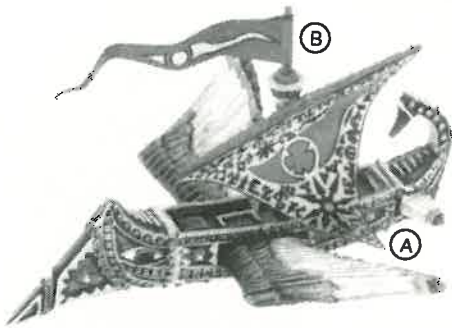

EXAMPLE OF COMPLETED GREAT WINGED TERROR OF TZEENTCH

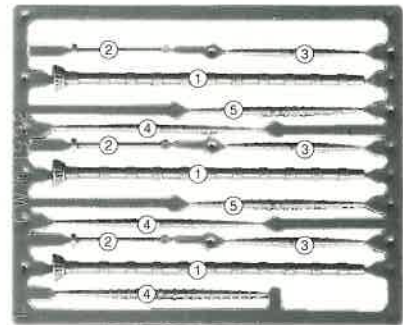

MAN O' WAR PLASTIC MAST SPRUE  
 MOWPLA/2

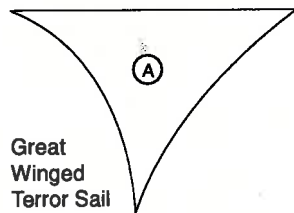

Great Winged Terror Sail

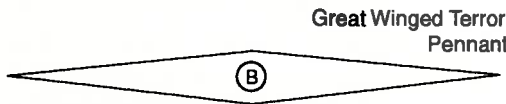

Great Winged Terror Pennant

THE COMPLETE GREAT WINGED TERROR OF TZEENTCH CONSISTS OF:  
 1 x PROW  
 1 x HULL  
 1 x STERN

### Great Winged Terror

Masts: one 1, one 2  
 Yard: one 4

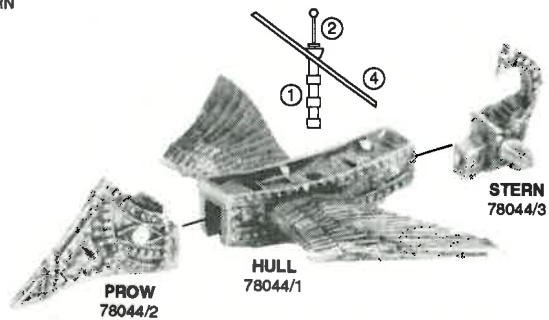

THE DIAGRAM ABOVE ILLUSTRATES THE CORRECT LENGTH FOR EACH MAST AND THE TYPE AND NUMBER OF YARD ARMS.  
 THE SAILS AND PENNANTS ABOVE MAY BE PHOTOCOPIED, CUT OUT, PAINTED AND STUCK ONTO YOUR MINIATURES.  
 PERMISSION GRANTED TO PHOTOCOPY FOR PERSONAL USE ONLY.

Designed by Norman Swales

Miniatures supplied unpainted. WARNING. This product contains lead which may be harmful if chewed or swallowed. Citadel Miniatures are not recommended for children under 14 years of age.  
 © Copyright Games Workshop Ltd 1993. All rights reserved.

CITADEL  
 MINIATURES

WARRIORS

# NORSE WARSHIPS

## NORSE LONGSHIP

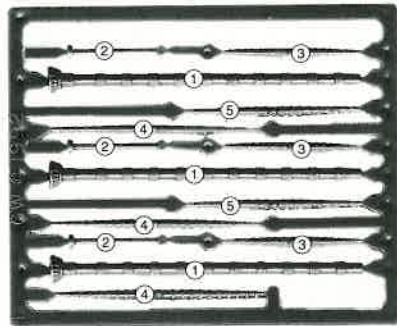
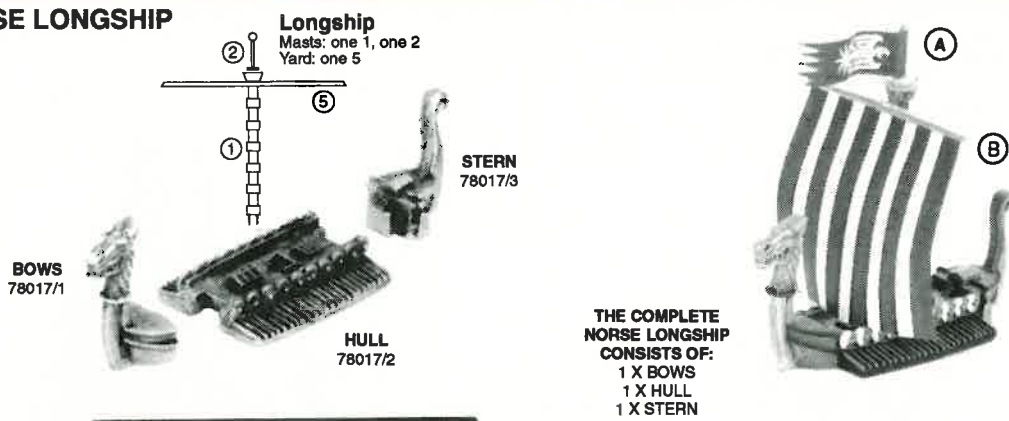

MAN O'WAR PLASTIC MAST SPRUE MOW PLA/2

THE DIAGRAM ABOVE ILLUSTRATES THE CORRECT LENGTH FOR EACH MAST AND THE TYPE AND NUMBER OF YARD ARMS.  
THE SAILS AND PENNANTS ABOVE MAY BE PHOTOCOPIED, CUT OUT, PAINTED AND STUCK ONTO YOUR MINIATURES.  
PERMISSION GRANTED TO PHOTOCOPY FOR PERSONAL USE ONLY.

## NORSE KINGSHIP

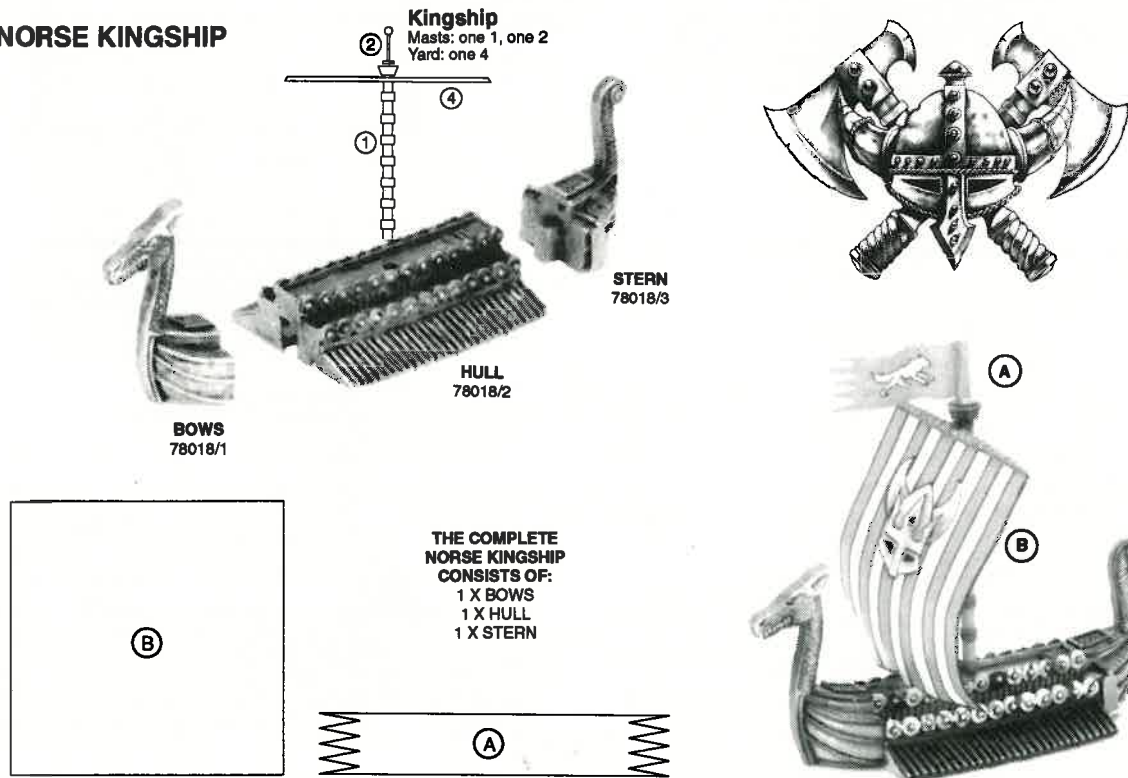

THE DIAGRAM ABOVE ILLUSTRATES THE CORRECT LENGTH FOR EACH MAST AND THE TYPE AND NUMBER OF YARD ARMS.  
THE SAILS AND PENNANTS ABOVE MAY BE PHOTOCOPIED, CUT OUT, PAINTED AND STUCK ONTO YOUR MINIATURES.  
PERMISSION GRANTED TO PHOTOCOPY FOR PERSONAL USE ONLY.

Designed by Norman Swales with Michael Perry

# ORC WARSHIPS

## BIGCHUKKA

THE COMPLETE BIGCHUKKA  
CONSISTS OF:  
1 x HULL  
1 x CHUKKA

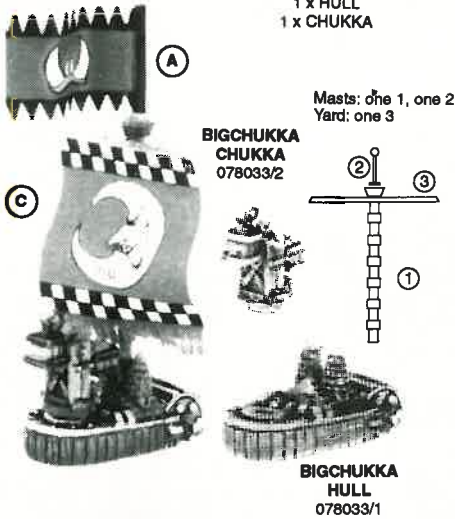

## DRILLA KILLA

THE COMPLETE DRILLA KILLA  
CONSISTS OF:  
1 x HULL  
1 x TREADWHEEL

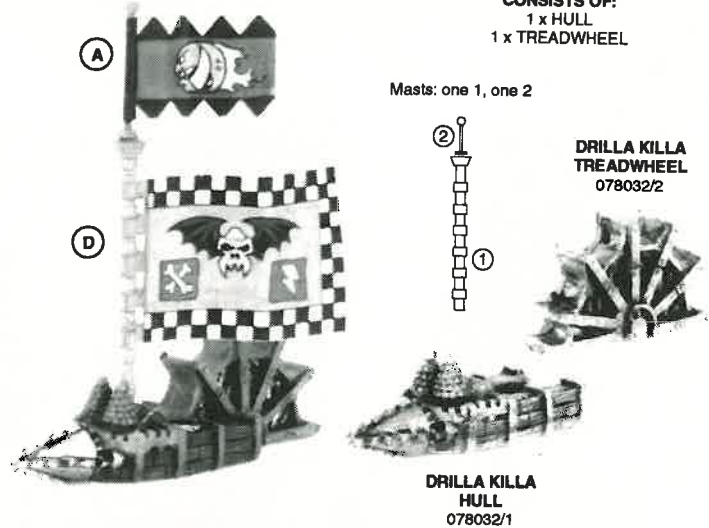

## ORC HULK

THE COMPLETE ORC HULK  
CONSISTS OF:  
1 x CHUKKA PLATFORM  
1 x SMASH HAMMER  
2 x IRON CLAWZ  
2 x CHUKKA  
1 x HULL

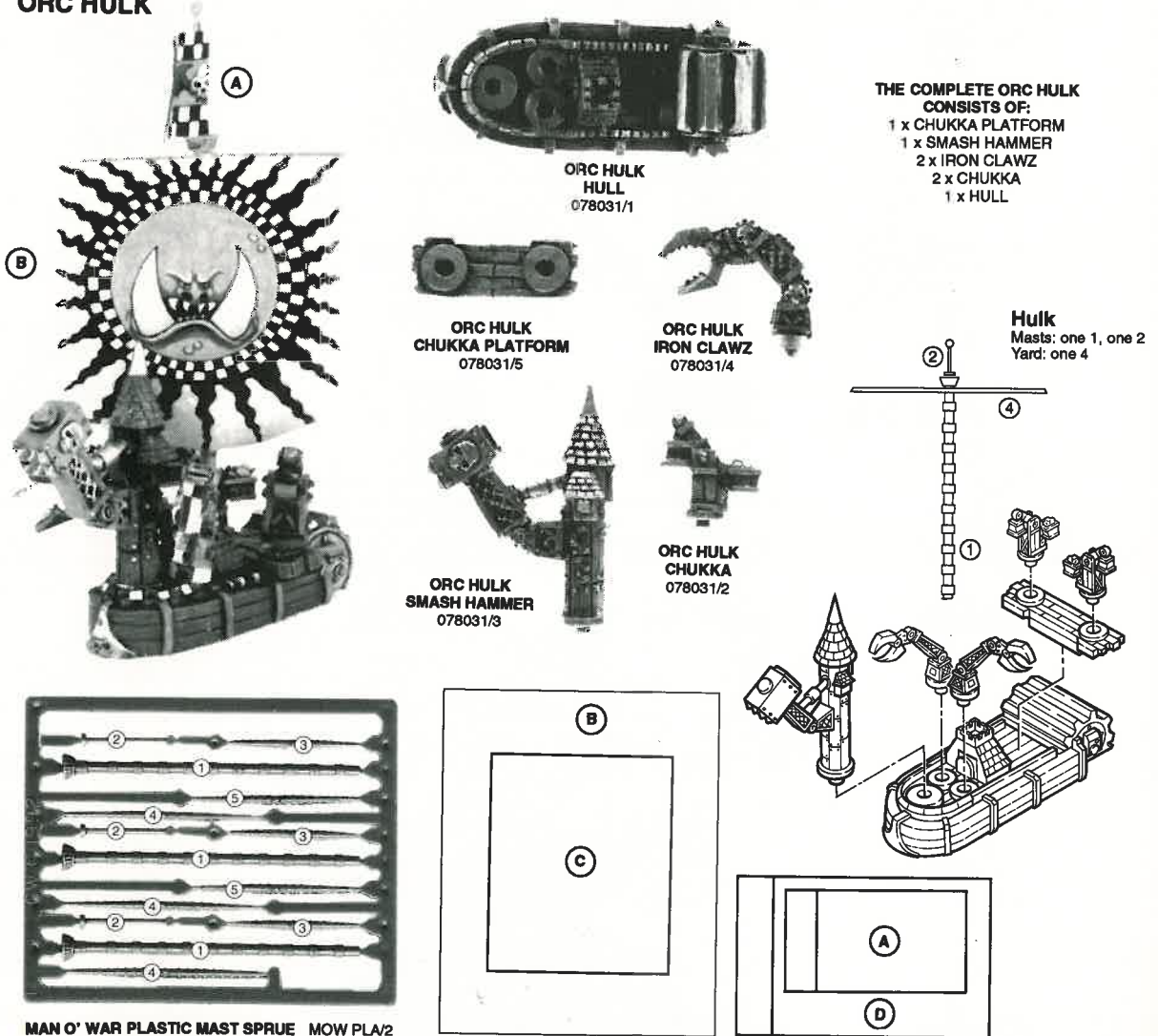

THE DIAGRAM ABOVE ILLUSTRATES THE CORRECT LENGTH FOR EACH MAST AND THE TYPE AND NUMBER OF YARD ARMS.  
THE SAILS AND PENNANTS ABOVE MAY BE PHOTOCOPIED, CUT OUT, PAINTED AND STUCK ONTO YOUR MINIATURES.  
PERMISSION GRANTED TO PHOTOCOPY FOR PERSONAL USE ONLY.

Designed by Kev Adams and Norman Swales

# HOBGOBLINS

## COMMAND

THESE MINIATURES ARE SUPPLIED WITH THE APPROPRIATE PLASTIC SHIELDS AS STANDARD



**HOBGOBLIN  
BIG BOSS 1**  
75860/4



**HOBGOBLIN  
BOSS 1**  
75860/3



**HOBGOBLIN  
DRUMMER**  
75860/2



**HOBGOBLIN  
STANDARD BEARER 1**  
75860/1



**HOBGOBLIN  
BIG BOSS 2**  
75860/8



**HOBGOBLIN  
STANDARD BEARER 2**  
75860/5



**HOBGOBLIN  
BOSS 2**  
75860/7



**HOBGOBLIN  
TRUMPETER**  
75860/6

Designed by Alan Perry



MARK GIBBONS

Miniatures supplied unpainted. **WARNING.** This product contains lead which may be harmful if chewed or swallowed. Citadel Miniatures are not recommended for children under 14 years of age. © Copyright Games Workshop Ltd 1993. All rights reserved.

  
**CITADEL  
MINIATURES**



# HOBGOBLINS

## ARCHERS



HOBGOBLIN  
ARCHER 1  
75855/1



HOBGOBLIN  
ARCHER 2  
75855/2



HOBGOBLIN  
ARCHER 3  
75855/3



HOBGOBLIN  
ARCHER 4  
75855/4



HOBGOBLIN  
ARCHER 5  
75855/5



HOBGOBLIN  
ARCHER 6  
75855/6



HOBGOBLIN  
ARCHER 7  
75855/7



HOBGOBLIN  
ARCHER 8  
75855/8

## WARRIORS

THESE MINIATURES ARE SUPPLIED WITH THE APPROPRIATE PLASTIC SHIELDS AS STANDARD



HOBGOBLIN  
WARRIOR 1  
75850/1



HOBGOBLIN  
WARRIOR 2  
75850/2



HOBGOBLIN  
WARRIOR 3  
75850/3



HOBGOBLIN  
WARRIOR 4  
75850/4



HOBGOBLIN  
WARRIOR 5  
75850/5



HOBGOBLIN  
WARRIOR 6  
75850/6



HOBGOBLIN  
WARRIOR 7  
75850/7



HOBGOBLIN  
WARRIOR 8  
75850/8

Designed by Alan Perry

Minatures supplied unpainted. WARNING. This product contains lead which may be harmful if chewed or swallowed. Citadel Miniatures are not recommended for children under 14 years of age.

© Copyright Games Workshop Ltd 1993. All rights reserved.

Minatures supplied unpainted. WARNING. This product contains lead which may be harmful if chewed or swallowed. Citadel Miniatures are not recommended for children under 14 years of age.

© Copyright Games Workshop Ltd 1993. All rights reserved.

# CHAOS DWARFS

## CHAOS DWARF LORD ON GREAT TAURUS

THE COMPLETE CHAOS DWARF LORD ON TAURUS CONSISTS OF:  
1 x LORD  
1 x BACK BANNER  
1 x LEFT WING  
1 x RIGHT WING  
1 x LEFT TORSO OF TAURUS  
1 x RIGHT TORSO OF TAURUS  
1 x HEAD OF TAURUS



EXAMPLE OF COMPLETED LORD ON GREAT TAURUS



CHAOS DWARF BACK BANNER 1  
0833/7



CHAOS DWARF LORD ON TAURUS 1  
0833/1



LEFT TORSO 1  
0833/4



RIGHT TORSO 1  
0833/3



TAURUS HEAD 1  
0833/2



LEFT WING  
0833/5



RIGHT WING  
0833/6

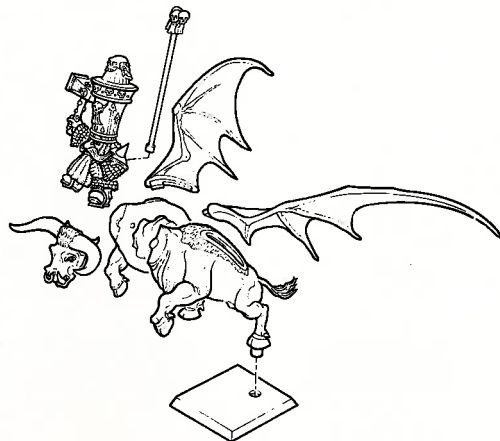

Minatures supplied unpainted. **WARNING:** This product contains lead which may be harmful if chewed or swallowed. Citadel Miniatures are not recommended for children under 14 years of age.

© Copyright Games Workshop Ltd 1983. All rights reserved.



Designed by Alan Perry

## EMPEROR RIDING THE WAR GRIFFON DEATHCLAW

- THE COMPLETE EMPEROR RIDING WAR GRIFFON CONSISTS OF:**
- 1 x EMPEROR
  - 1 x BACK BANNER
  - 1 x LEFT WING
  - 1 x RIGHT WING
  - 1 x GRIFFON'S LEFT SIDE
  - 1 x GRIFFON'S RIGHT SIDE
  - 1 x LEFT CLAW
  - 1 x RIGHT CLAW
  - 1 x TAIL



**EMPEROR  
KARL FRANZ**  
0835/1



**EMPEROR'S  
BANNER POLE**  
0835/2

**EXAMPLE OF COMPLETED EMPEROR ON DEATHCLAW**



**LEFT CLAW**  
0835/6



**RIGHT CLAW**  
0835/5



**GRIFFON'S BODY  
RIGHT SIDE**  
0835/4

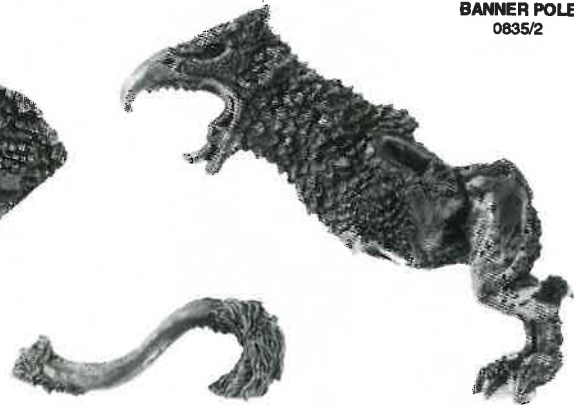

**GRIFFON'S TAIL**  
0835/7

**GRIFFON'S BODY  
LEFT SIDE 2**  
0835/3



**RIGHT WING**  
0835/9



**LEFT WING**  
0835/8



Miniatures supplied unpainted. WARNING: This product contains lead which may be harmful if chewed or swallowed. Citadel Miniatures are not recommended for children under 14 years of age. © Copyright Games Workshop Ltd 1993. All rights reserved.

## IMPERIAL HERO RIDING A PEGASUS



**BACK REST**  
0826/4



**SADDLE**  
0826/3

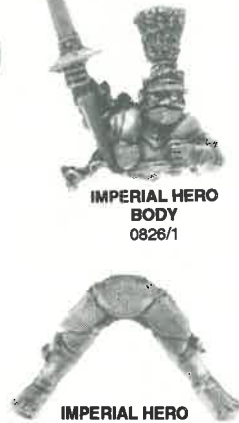

**IMPERIAL HERO  
BODY**  
0826/1

**IMPERIAL HERO  
LEGS**  
0826/2



**EXAMPLE OF IMPERIAL HERO RIDING A PEGASUS**

### THE COMPLETE IMPERIAL HERO ON A PEGASUS CONSISTS OF:

- 1 X IMPERIAL HERO BODY
- 1 X IMPERIAL HERO LEGS
- 1 X SADDLE
- 1 X BACKREST
- 1 X PEGASUS LEFT WING
- 1 X PEGASUS LEFT SIDE
- 1 X PEGASUS RIGHT WING
- 1 X PEGASUS RIGHT SIDE



**PEGASUS  
LEFT WING**  
0826/7

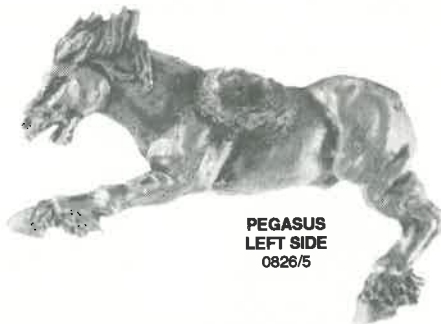

**PEGASUS  
LEFT SIDE**  
0826/5



**PEGASUS  
RIGHT SIDE**  
0826/6



**PEGASUS  
RIGHT WING**  
0826/8

# WAR WYVERN

THE COMPLETE ORC WAR WYVERN  
CONSISTS OF;  
1 x ORC SHAMAN RIDER  
1 x WYVERN BACKREST  
1 x WYVERN SADDLE  
1 x WYVERN BODY  
1 x WYVERN NECK  
1 x WYVERN HEAD  
1 x WYVERN TAIL  
1 x WYVERN LEG  
1 x RIGHT WING  
1 x LEFT WING  
1 x MONSTER BASE

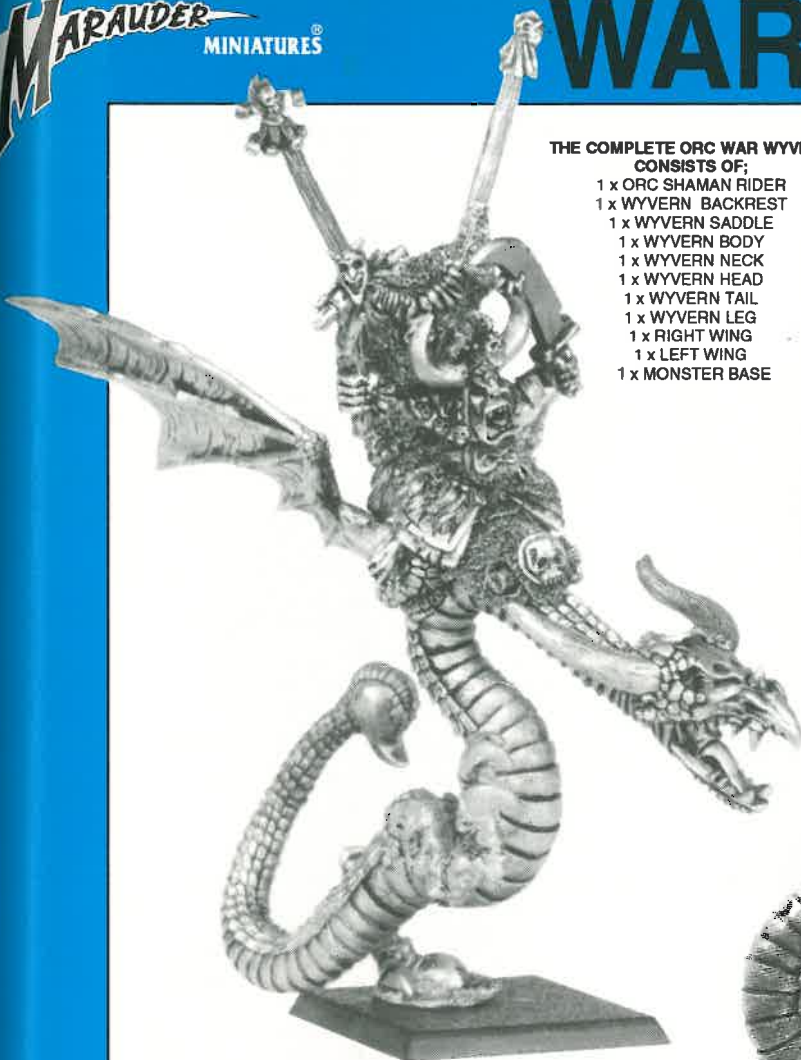

EXAMPLE OF A COMPLETED ORC WAR WYVERN



RIGHT WING  
0824/10

LEFT WING  
0824/9

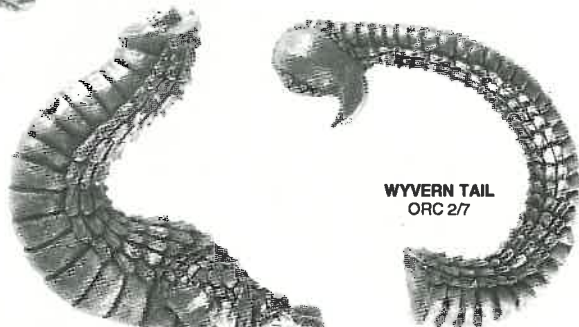

WYVERN TAIL  
ORC 2/7



ORC SHAMAN RIDER  
ORC 2/1



WYVERN BACKREST  
ORC 2/2



WYVERN BODY  
ORC 2/4



WYVERN LEG  
ORC 2/8



WYVERN HEAD  
ORC 2/6

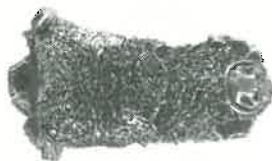

WYVERN SADDLE  
ORC 2/3



WYVERN NECK  
ORC 2/5



# CHAOS DWARFS

## CHAOS DWARF SORCERER ON LAMMASU

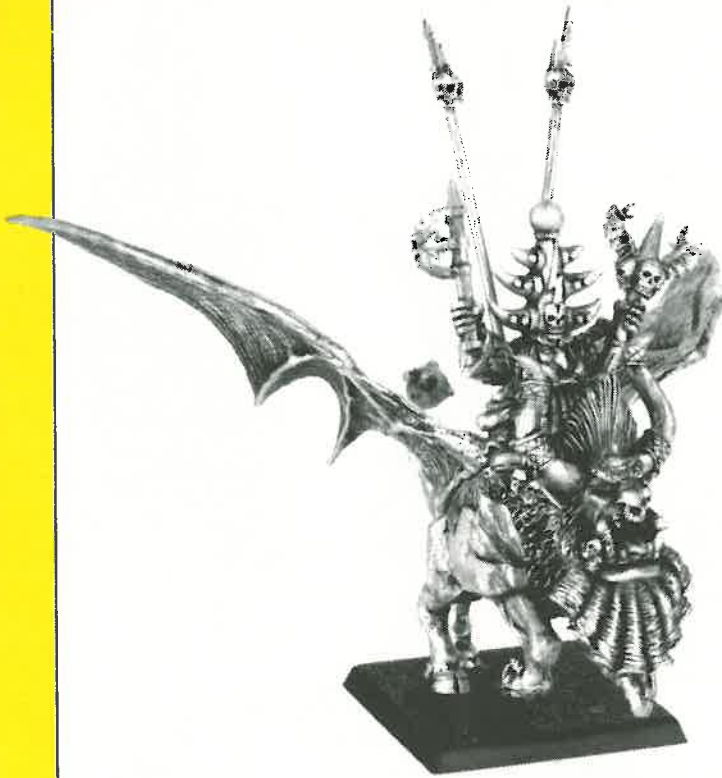

EXAMPLE OF COMPLETED CHAOS DWARF SORCERER ON LAMMASU

THE COMPLETE CHAOS DWARF SORCERER ON LAMMASU CONSISTS OF:

- 1 x SORCERER'S BACKBANNER
- 1 x SORCERER
- 1 x LAMMASU'S RIGHT TORSO
- 1 x LAMMASU'S LEFT TORSO
- 1 x LAMMASU'S HEAD
- 1 x RIGHT WING
- 1 x LEFT WING



SORCERER'S BACK BANNER  
0838/2



CHAOS DWARF SORCERER  
0838/1

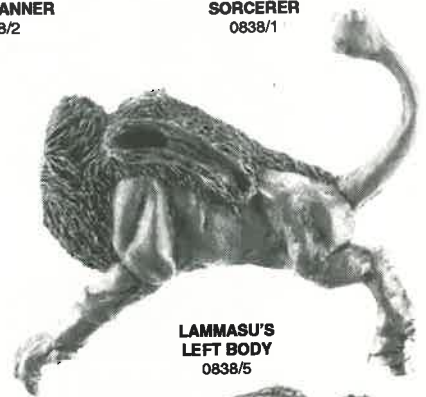

LAMMASU'S LEFT BODY  
0838/5



LAMMASU'S RIGHT BODY  
0838/4

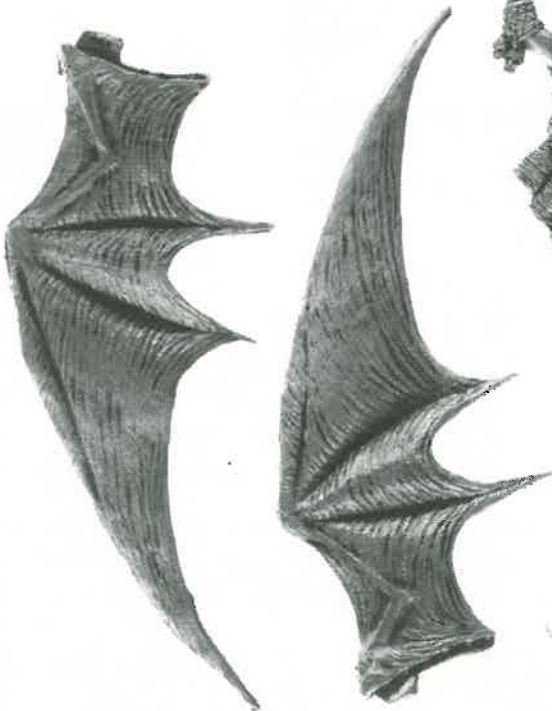

LEFT WING  
0838/6

RIGHT WING  
0838/7



LAMMASU'S HEAD  
0838/3

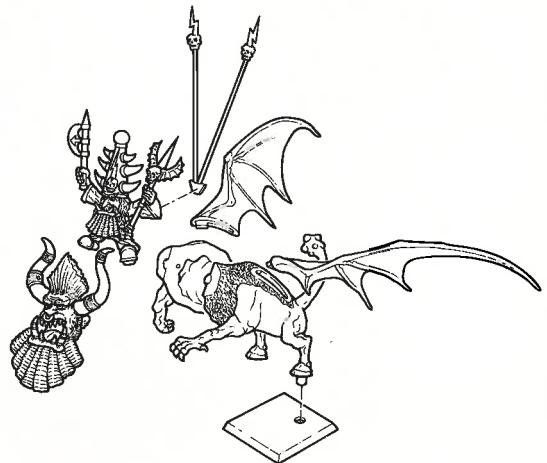

Minatures supplied unpainted. WARNING: This product contains lead which may be harmful if chewed or swallowed. Citadel Miniatures are not recommended for children under 14 years of age. © Copyright Games Workshop Ltd 1993. All rights reserved.



Designed by Alan Perry

## ELTHARION RIDING STORMWING

**THE COMPLETE  
ELTHARION RIDING STORMWING  
CONSISTS OF:**

- 1 x ELTHARION BODY
- 1 x ELTHARION LEGS
- 1 x GRIFFON BODY RIGHT SIDE
- 1 x GRIFFON BODY LEFT SIDE
- 1 x RIGHT CLAW
- 1 x LEFT CLAW
- 1 x RIGHT WING
- 1 x LEFT WING
- 1 x TAIL

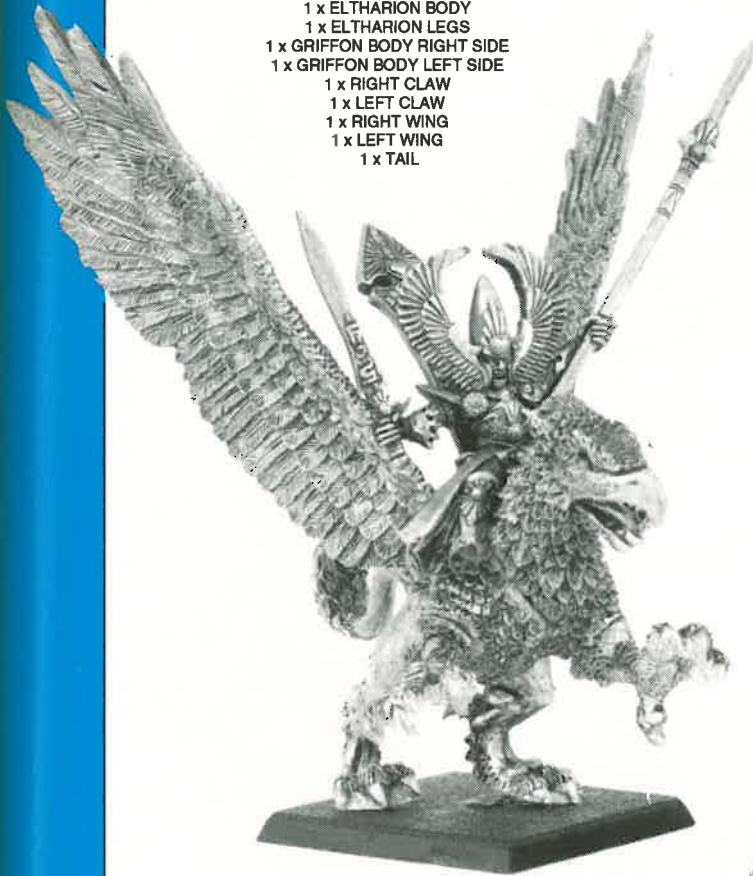

**RIGHT WING**  
0822/9



**LEFT WING**  
0822/10



**GRIFFON BODY  
LEFT SIDE**  
0822/4



**GRIFFON BODY  
RIGHT SIDE**  
0822/5



**TAIL**  
0822/8



**RIGHT CLAW**  
0822/6



**LEFT CLAW**  
0822/7



**ELTHARION'S BODY**  
0822/1



**ELTHARION'S LEGS**  
0822/2



# ORK BOSSES

THESE MODELS, EXCEPT THOSE MARKED WITH AN ASTERISK, ARE ALL SUPPLIED WITH AN ORK ARMS SPRUE AND AN ORK WEAPONS SPRUE AS STANDARD



**DEATH SKULL**  
070669/6



**GRETCHIN  
STANDARD BEARER\***  
070794/2



**WARLORD  
GHAZGHKULL THRAKA\***  
070794/1

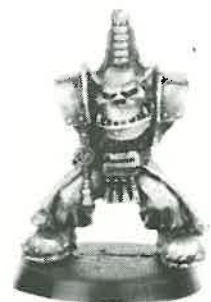

**SNAKE BITE 2**  
070561/7



**BAD MOON 1\***  
070669/4



**GOFF 3**  
070561/8



**EVIL SUNZ 2**  
070561/10



**BLOOD AXE 1\***  
070669/1



**BAD MOON 2**  
070669/11



**GOFF 1**  
070669/3



**EVIL SUNZ 1**  
070669/5



**BLOOD AXE 2**  
070561/9



EXAMPLES OF THE COMPLETED ORK BOSSES

Designed by Kev Adams

Minatures supplied unpainted. WARNING: This product contains lead which may be harmful if chewed or swallowed. Citadel Miniatures are not recommended for children under 14 years of age.  
© Copyright Games Workshop Ltd 1993. All rights reserved.





# ORK BOYZ

## GOFFS



GOFF 1  
070605/1



GOFF 2  
070605/6



SNAKE BITE 1  
070605/8



SNAKE BITE 2  
070605/7

## BAD MOONS



BAD MOON 1  
070605/16



BAD MOON 2  
070605/14



BAD MOON 3  
070605/13



BAD MOON 4  
070605/28

## BLOOD AXES



BLOOD AXE 1  
070605/21



BLOOD AXE 2  
070605/2



BLOOD AXE 3  
070605/3

THESE MODELS ARE ALL SUPPLIED WITH AN ORK ARM SPRUE AND AN ORK WEAPONS SPRUE AS STANDARD.



EXAMPLES OF THE COMPLETED ORK BOYZ.

Designed by Kev Adams

Minifigures supplied unpainted. WARNING: This product contains lead which may be harmful if chewed or swallowed. Citadel Miniatures are not recommended for children under 14 years of age.

© Copyright Games Workshop Ltd 1993. All rights reserved.



# SPACE MARINES

## SPACE MARINE DEVASTATORS

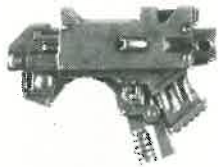

HEAVY BOLTER  
070099/6



IMPERIAL LASCANNON  
070099/5



MISSILE LAUNCHER  
070099/4



Mk7 SPACE MARINE  
DEVASTATOR 1  
070099/2

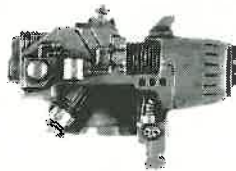

HEAVY PLASMA GUN  
0422/7



Mk7 SPACE MARINE  
DEVASTATOR 2  
070099/3

THESE MINIATURES ARE SUPPLIED WITH A SEPARATE PLASTIC SPACE MARINE ARM SPRUE AND A PLASTIC SPACE MARINE BACKPACK SPRUE.

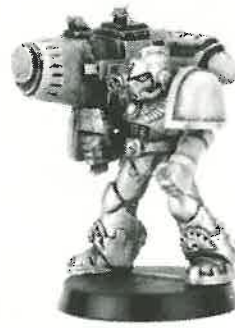

EXAMPLES OF COMPLETED Mk7 SPACE MARINE DEVASTATORS

## SPACE MARINES WITH SPECIAL WEAPONS



SPACE MARINE  
WITH FLAMER  
0819/4



SPACE MARINE  
WITH MELTA GUN  
0808/2



SPACE MARINE  
WITH PLASMA GUN  
CAT3/3

THESE MINIATURES ARE SUPPLIED WITH A SEPARATE PLASTIC SPACE MARINE BACKPACK SPRUE.

Minifigures supplied unpainted. WARNING: This product contains lead which may be harmful if chewed or swallowed. Citadel Miniatures are not recommended for children under 14 years of age.  
© Copyright Games Workshop Ltd 1993. All rights reserved.



CITADEL  
MINIATURES

Designed by Jes Goodwin and Norman Swales

# SPACE MARINES



**SPACE MARINE  
MK2 'CRUSADE' ARMOUR**  
070197/2



**SPACE MARINE  
MK3 'IRON' ARMOUR**  
070197/1



**SPACE MARINE  
MK4 'MAXIMUS' ARMOUR**  
070197/4



**SPACE MARINE  
MK5 'HERESY' ARMOUR**  
070197/3



**SPACE MARINE  
MK6 ARMOUR 1**  
070158/1



**SPACE MARINE  
MK6 ARMOUR 2**  
070158/2



**SPACE MARINE  
MK6 ARMOUR 3**  
70119/42



**SPACE MARINE  
MK6 ARMOUR 4**  
70119/43



**SPACE MARINE  
MK7 ARMOUR 1**  
070172/1



**SPACE MARINE  
MK7 ARMOUR 2**  
070172/2



**SPACE MARINE  
MK7 ARMOUR 3**  
0819/1



**SPACE MARINE  
MK7 ARMOUR 4**  
0819/2



**SPACE MARINE  
MK7 ARMOUR 5**  
0819/6



**SPACE MARINE  
MK7 ARMOUR 6**  
0819/7



**SPACE MARINE  
MK7 ARMOUR 7**  
0819/5



**SPACE MARINE  
MK8 'ERRANT' ARMOUR**  
070197/5

THESE MINIATURES ARE SUPPLIED WITH A SEPARATE PLASTIC SPACE MARINE ARM SPRUE AND A SPACE MARINE BOLTER AND BACKPACK SPRUE.



EXAMPLES OF COMPLETED MK7, MK6 AND MK3 SPACE MARINES.

Minatures supplied unpainted. WARNING. This product contains lead which may be harmful if chewed or swallowed. Citadel Miniatures are not recommended for children under 14 years of age.

© Copyright Games Workshop Ltd 1992. All rights reserved.



**CITADEL  
MINIATURES**

Designed by Jes Goodwin



AN ORK RAIDING PARTY CLASHES WITH A FORCE OF BLOOD ANGELS SPACE MARINES