

# GAMES WORKSHOP®

PRESENT THEIR MONTHLY GAMES MAGAZINE



CITADEL  
MINIATURES

163

£2.25

# WHITE DWARF®





AN IMPERIAL ARMY LED BY THE EMPEROR KARL FRANZ, FIGHT AGAINST A CHAOS DWARF HORDE.



A TYRANID FORCE, SPEARHEADED BY GENESTEALERS ASSAULT ELДАР DIRE AVENGERS AND DARK REAPERS.



AUDITED AT  
67,805 COPIES  
PER MONTH

# WHITE DWARF

Issue 163  
July 1993

Product Code: 0978  
Ref. No: 009784  
ISSN: 0265-8712

Editor: Robin Dews

## CONTENTS

### COVER: SPACE HULK — *Dave Gallagher*

Dave's stunning painting of a Deathwing Terminator is the cover to the new Space Hulk computer game.

### INSIDE FRONT

Chaos Dwarfs fight against an Empire army and the Eldar struggle with a Tyranid force.

### GW AND CITADEL NEWS

All the latest news from Games Workshop and Citadel Miniatures.

2

### SPACE HULK COMPUTER GAME — *Robin Dews*

Electronic Arts' computer version of **Space Hulk** is ready for release. Robin straps on his Storm Bolter and finds out how the game compares with its board predecessor.

4

### CHAOS DWARF BLUNDERBUSS — *Rick Priestley*

Rick provides the rules and background for this devastating Chaos Dwarf weapon in **Warhammer**.

7

### 'EAVY METAL — *Studio 'Eavy Metal Team*

Chaos Dwarf Bull Centaurs, Chaos Dwarf Sorcerer on Lammasu, Hobgoblins and Savage Orcs

9

### CHAOS DWARF MAGIC CARDS — *Grant Williams*

A complete set of magic cards for use with Chaos Dwarf Sorcerers in **Warhammer**.

11

### MAN O' WAR ALLIES — *Andy Jones*

How to fight battles with allied fleets in **Man O' War**, plus a quick reference sheet to use in your games.

19

### ILLUMINATIONS — *Mark Gibbons*

Mark is one of the small team of illustrators who create the stunning images of the **Warhammer** Universe that fill our games and publications. We take a look at some of his best work.

27

### WARHAMMER CAMPAIGNS — *Rick Priestley*

Rick explains how to use **Mighty Empires** to link your **Warhammer** games into a full-blown fantasy campaign and updates the **Mighty Empires** rules for the new **Warhammer**.

31

### 'EAVY METAL PAINTING GUIDE — *Mike McVey*

Mike describes how the complete guide to painting Citadel Miniatures came to be produced.

36

### THE BATTLE OF EAST GATE — *Rick Priestley*

This new **Warhammer** scenario complete with maps and force lists describes how a Dwarf army is ambushed deep in the World's Edge Mountains.

40

### 'EAVY METAL — *Studio 'Eavy Metal team*

High Elf Reaver Knights and Phoenix Guard.

52

### PLAGUE FLEET — *Andy Jones*

The first supplement for **Man O' War** is ready for release. Andy describes the background of the fleets of Chaos, Chaos Dwarfs and Skaven.

55

### MAN O' WAR QUESTIONS AND ANSWERS — *Andy Jones*

Andy answers some of the most commonly asked questions about **Man O' War** games.

63

### ADVERTS

Staff Ad and Citadel Spray Paints.....3	Citadel Miniatures Catalogue.....35
'Eavy Metal Painting Guide.....6	Wolf Riders.....51
Warhammer Boxed Sets.....17	Aberdeen and Metrocentre Stores.....54
Maidenhead and Bolton Stores.....18	Leeds Grand Re-opening.....62
High Wycombe Grand Opening.....25	White Dwarf Subscriptions.....66
Thurrock Grand Opening.....26	European Staff and Alfil.....67
Deathclaw Griffon Boxed Set.....30	Space Marine Battles.....Inside Back



# GAMES<sup>®</sup> WORKSHOP<sup>®</sup> AND CITADEL<sup>™</sup> NEWS

## SPACE MARINE BATTLES

Space Marine Battles, a compilation of the most requested re-prints from White Dwarf magazine is ready for release and will be in the shops next month. The book features four of the very best Epic battle reports from White Dwarf together with new tactics articles, plus rules for bunkers, razor wire, minefields and fortifications. It also includes eight pages of heavy duty card stock, with full-colour data cards and army cards for the Imperial Reaver and Warhound Titans, Ork Great Gargant and Tzeentch Daemon Engines.

## WARHAMMER RECORDS

This month has been a busy one for Warhammer Records, as there are three new albums being released. The first of these is "Riot", the second album in a year from Nottingham Rockers Wraith, who are now touring Britain.

The second release is from Saxon, one of Britains best known Rock bands. "Forever Free" has already been described as "The British Heavy Metal Album Of The Year" by Kerrang! Magazine. Saxon are also out on the road in June, Playing from York to London, and appearing at local HMV stores for album signings.

The final release is the debut album from Hull based Rich Rags. "Psycho Dead Heads from Outer Space" is a great album from a band that played over 200 gigs last year - and hope to play even more in 1993!

## SPACE HULK COMPETITION

Next month's issue of White Dwarf will feature a special free competition in which you can win a copy of Electronic Arts' stunning conversion of Space Hulk. The game is reviewed in this issue, so don't miss out and order your copy now.

And finally...our apologies to **Nick Drake** of Newcastle. In last months issue, his Golden Demon Eldar army was wrongly credited to Simon Kicks.

# WARHAMMER<sup>®</sup> 40,000

Just arrived at the Games Workshop studio are pre-production models of some new plastic miniatures for Warhammer 40,000. The models are two Space Marines designed by Jes Goodwin and an Ork and Gretchin designed by Kev Adams.

*Space Marine armed with a Missile Launcher*



*Space Marine Sergeant*

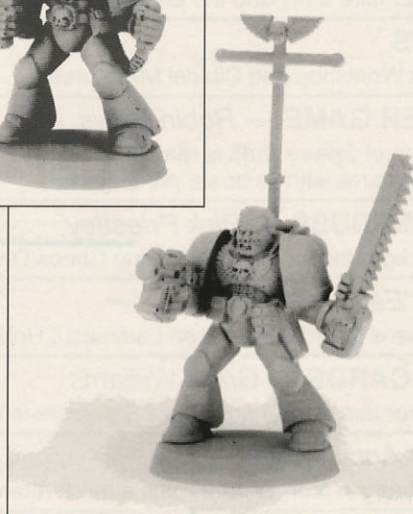

*Goff Ork*



*Gretchin with Autogun*

These models won't be available for some time yet, but as soon as we have final versions, we'll let the 'Eavy Metal team loose on them and show you the results in White Dwarf.

## SPACE MARINE<sup>®</sup>

*Dave Andrews' Khorne Titan kit.*

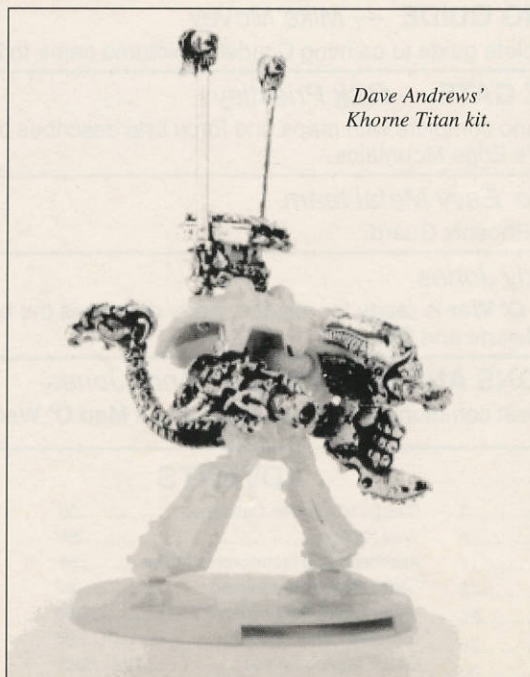

Citadel designer Norman Swales has been hard at work on new variants for the Shadowsword Super Heavy Tank and Leviathan Command Centre. New names, rules and release dates will be available soon and of course as soon as we have a photo of the new models we'll let you see what they look like.

Meanwhile, Dave Andrews has been creating some new Chaos Titan weapons and three more Daemon Engines of Khorne. Pictured here you can see a Titan armed with a carapace rack of Havok missiles, a Hellstrike cannon, and a Bloodletter battlehead.

# GAMES WORKSHOP®

## PRODUCTION STAFF

Games Workshop are currently looking to recruit new staff to work on the production of our expanding range of books, games and magazines.

The creative hub of the company is the Nottingham Studio. This is where all of our games and miniatures are designed. The studio is also responsible for creating the paper, plastic and cardboard components of our products, as well as all of the company's packaging, display and promotional materials.

The Studio is also where White Dwarf, our monthly hobby games magazine is designed, edited and laid-out and where all our photography and illustration is done.

The Studio is equipped with a fully-integrated Macintosh DTP system, and most of the production work on our rulebooks, boxed games and White Dwarf is done on this equipment. However, because of the complexity of much of our material, a great deal of work is still hand finished. Many book pages and large sheets of card are manually laid out and pasted-up, with bromides, positionals and colour specifications being added by hand.

We are currently looking to recruit qualified production staff to our Studio. Applicants should have a working knowledge and at least one year's professional experience of paste-up

and pre-press production techniques. Use of large format process cameras, some photographic skills or aptitude and a familiarity with desk-top publishing would be a definite advantage.

Just as important as all of the above is the fact that applicants should be immersed in the Games Workshop world of hobby games and miniatures. It may seem an unusual qualification, but the difference between an Orc and an Ork is a crucial one to us! It is essential that we employ staff who can bring an understanding and knowledge of our games and miniatures to their work.

If you feel that you can meet these requirements, then we'd like to hear from you.

Please write giving details of your educational background, employment history and gaming experience to:

**Simone Greasley (Production Staff)**  
Games Workshop Ltd, Chewton Street, Hilltop,  
Eastwood, Nottingham NG16 3HY

# CITADEL MINIATURES®

## NEW SPRAY PAINTS AND VARNISH

The brand new **Citadel Miniatures Spray Paints** are perfectly formulated for undercoating metal or plastic miniatures. The paints are available in White or Black and are the ideal way to prepare single models or entire regiments for painting.

**Citadel Miniatures Matt Varnish** gives your painted models a tough, non-shiny finish that looks great on the tabletop and dramatically reduces the effects of wear and tear on your miniatures.



# SPACE HULK

## THE COMPUTER GAME

This month sees the release of the first ever computer version of a Games Workshop game. Space Hulk is the result of a two year collaboration between Electronic Arts and Games Workshop and the game is already receiving rave reviews in the computer press, including the accolade "computer game of the year". We take a close look at the game and see how it compares with its board predecessor.

When Space Hulk was first released over four years ago, it generated a wave of excitement amongst science fiction and fantasy gamers. Here was a game that was simple to learn, but very difficult to master. Drawing from the rich background of the Warhammer 40,000 universe, it pitted Terminator Marines against deadly Genestealers in the claustrophobic depths of a Space Hulk. The original game displayed many innovative features, a time limit for the Space Marine player turns, full-colour interlocking board sections that enable an almost endless variety of scenarios to be played out or invented by the players, and the semi-hidden movement system that allows the Genestealer player to conceal the strength of his attacks until the last moment.

After a long collaboration between Games Workshop and Electronic Arts, the arrival of the Space Hulk computer game looks set to replicate that original excitement.

It's now been almost two years since work started on what was to be the very first computer conversion of a Games Workshop game. From the outset, we were clear that we wanted more than just a straightforward conversion of the board game onto the computer. This has been done in the past with a number of games and has proved less than successful. Without the tactile qualities of playing with painted miniatures, the result has been quite dull. The strengths of a computer are completely different to those of a boxed board game played with Citadel Miniatures. A computer works best at presenting real action, with dazzling graphics and sound effects to back up the gameplay. What we wanted to create was an exciting, fast-action combat and strategy game that would bring a whole new perspective to the atmosphere and tension of the Space Hulk boardgame. On a computer, you can experience the twisting corridors of the Space Hulk from the point of view of a Terminator Marine, listening out for the enemy and shooting

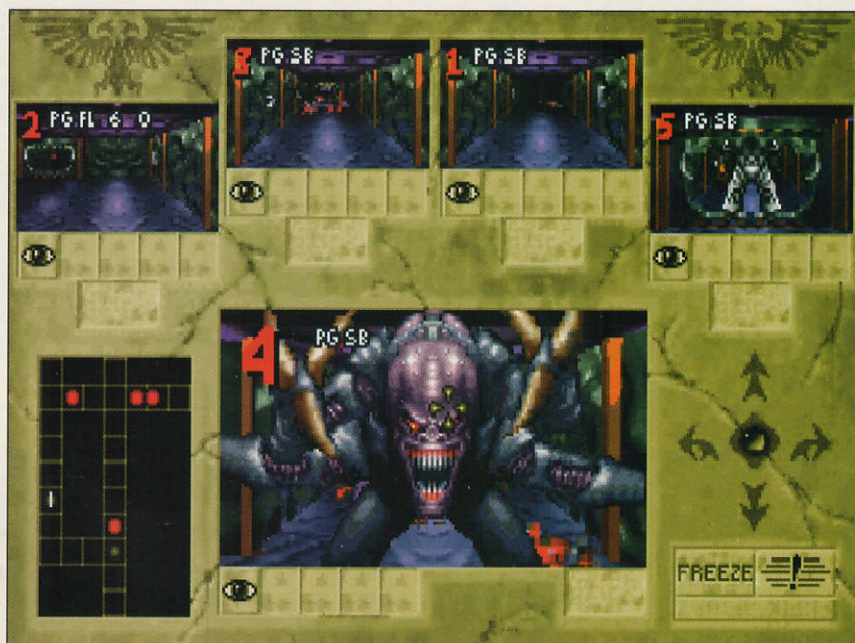

*Terminator 4 confronts a Genestealer in close combat. The letters PG and SB on the screen indicate that he is armed with a Power Glove and Storm Bolter. If he had Lightning Claws, a Thunder Hammer or a Power Sword, his chances of survival would be much greater. The smaller screens show you the viewpoints of the other Terminators in your squad.*

your Storm Bolter at a grim shadow in the darkness. You can feel the terror as Genestealers rush out at you down dimly lit corridors, trying to rip you asunder with their claws.

As well as the look of the game, it was also important that the depths of tactical and strategic gameplay that are inherent in the boardgame were also transferred over to the computer version. It was also essential that the effects of various close combat and ranged weapons such as Chainfists, Thunder Hammers and Assault Cannon were also included and that they performed in the appropriate way. In short, however the computer game was presented, it should have the same feel and character as the original game.

Under the careful guidance of Games Workshop, and with some innovative programming from Electronic Arts, the game that finally emerged is something we are really proud of, and which adds a whole new dimension to Space Hulk.

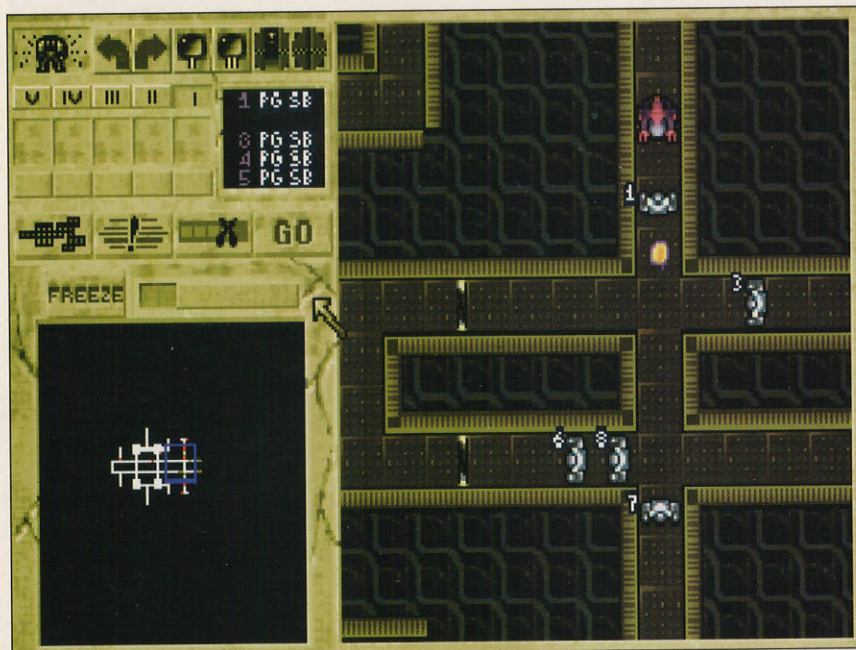

*The Tactical Map. The perimeter is breached! Terminator 1 is trapped between a charging Genestealer and an unidentified blip behind him. Space Marine 3 might be able to hold them off, but the red dots on the scanner show that more Genestealers are closing in.*

## GAMEPLAY

All aspects of the gameplay are controlled by pointing and clicking with a mouse. Although some of the screens look a little complex at first, you soon get used to giving orders to your squad on a tactical map before switching to the live action screen to watch the battle unfold from a Terminator's eye-view. From here you can take command of a Space Marine as you race down the corridors firing your Storm Bolter and blasting away at the oncoming Genestealers.

Throughout the game, the sound is handled brilliantly. As your squad moves forward, there are echoing shrieks and crashes and the whole Hulk sometimes seems to be alive. Steam hisses from broken pipes and severed cables crackle and spark as you advance down the dark tunnels.

Digitised speech is used to instruct you on your mission objectives and as you play you can hear your squad members shouting warnings of danger to each other. I particularly enjoyed the triumphant "Eat this!" as my Terminator armed with a Chainfist hacked down an attacking Genestealer in close combat. There is also a terrifying scream that alerts you to the fact that one of your Space Marines has been ripped to pieces.

As well as all of the scenarios from the original boxed game, there is a set of basic missions designed to help familiarise new players with the control system and a further advanced set of training missions. These take you in easy stages through progressively harder missions as you penetrate ever deeper into the Hulk to secure areas, retrieve objects or merely eliminate a specified number of Genestealers. In addition there are numerous new missions involving one or two squads of Marines plus a complete Deathwing campaign. With this amount of material it will take even the toughest Space Marine commander many months to work though all of the missions let alone master them.

The time limits on the Marine player's turn are controlled on the computer version by the use of 'Freeze Time™'.

As you play the game in real time, you build up 'Freeze Time™'. At any point you can freeze the action, to give orders to your squad or examine the overall position, but as soon as you do so, your precious 'freeze time' begins to tick away. As soon as it is all gone, you are immediately catapulted back into the 'real time' action and the killing continues.

Without the constraints of having to provide card floorplans for all of the scenarios, some of the new map layouts are really spectacular with large open areas, tight winding corridors and endless rooms to be explored. In some scenarios artifacts have to be removed from the Hulk, and this involves searching from room to room, while other members of your squad attempt to hold a perimeter. The recovered objects can then be picked up and transferred from Marine to Marine and so to safety.

For veterans of the boardgame, Space Hulk the computer game will offer new challenges and the opportunity to try out their skills in a whole new arena. Computer game players who have never seen the boardgame will undoubtedly enjoy the terror and excitement of playing Space Hulk against a real "human" opponent who will undoubtedly show even less mercy than even the computer controlled Genestealers.



*Space Hulk from Electronic Arts is available in June for IBM compatible PC's and the Commodore Amiga® in the Autumn.*



# EAVY METAL™

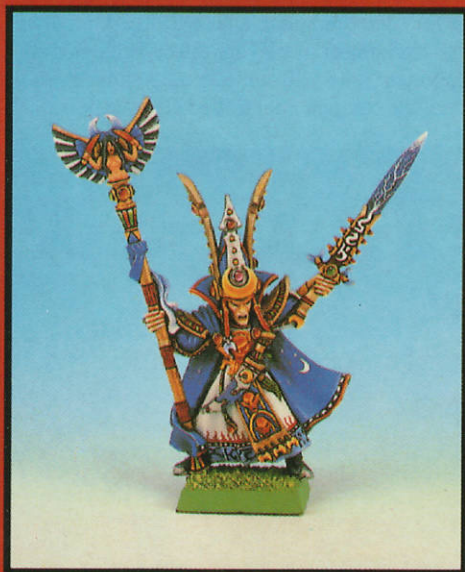

A **GAMES®**  
**WORKSHOP**  
PRODUCT

**THE COMPLETE GUIDE TO  
PAINTING CITADEL MINIATURES**



The full-colour 'Eavy Metal painting guide is the most comprehensive reference manual for painting Citadel miniatures ever published. Written by Mike McVey and illustrated with hundreds of painted miniatures, the guide explains how to achieve the brilliant results you see in White Dwarf each month. Whether you are a complete beginner or a veteran painter, this definitive guide is packed full of information on how to develop and improve your painting skills.

**GAMES®**  
**WORKSHOP**



**CITADEL**  
MINIATURES



# WARHAMMER

## THE CHAOS DWARF BLUNDERBUSS

By Rick Priestley

The Chaos Dwarfs generally fight with one of two weapons, both equally destructive in their own way. The first is the double handed axe, a short hafted weapon with a heavy metal blade which can crack open armour and cleave a foe in two. The second is the Blunderbuss, a short ranged weapon of devastating effect. The Blunderbuss uses a gunpowder charge to fire shards of spiked iron at the enemy, although it can also fire hot coals, lead shot, pieces of scrap metal, and even stones if need be. The weapon is so robustly made that it can be loaded with far more powder and shot than a simple handgun, and its effect is quite different.

When a Blunderbuss regiment fires a volley the whole zone to its front is filled with spinning razor sharp pieces of iron which spread out covering a broad front. As the enemy are hit and slain, more slicing metal ploughs into the ranks behind, causing untold devastation to all foes unfortunate enough to be close. Blunderbusses have only a very short range, as all the energy of the shot is dispersed over a short distance, but within this range they are deadly.

The Blunderbuss armed Chaos Dwarfs are also ferocious hand-to-hand fighters. Their preferred tactic is to give their enemy a single blast and follow up by charging into close combat.

### GAME RULES FOR THE BLUNDERBUSS

A regiment of Blunderbuss armed troops shoots in a unique way. The weapon has a range of 12" and the regiment may only shoot if it did not move during its movement phase. Work out the results of shooting as follows.

Draw an imaginary line from the extreme left hand side of the regiment which extends 12" directly in front of the regiment. Now draw a similar line on the right hand side. Draw a line across to form an area which extends across the regiment's entire frontage and 12" in front of it. This zone is indicated on the diagram below. This is the regiment's fire zone.

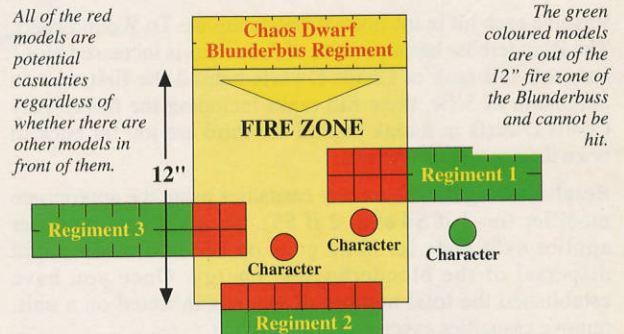

Every model within the regiment's fire zone is a potential casualty, even models which are behind other models, or behind cover. Only targets which lie on the other side of a hill or building are protected from the Blunderbusses. It makes no difference how many Blunderbusses are firing, the important consideration is the fire zone covered by the unit. The number or ranks in the Blunderbuss unit also has an effect. It is assumed that the models behind poke their weapons forward and add their fire to the volley. The effect of extra ranks of Blunderbusses is described later.



A REGIMENT OF CHAOS DWARF BLUNDERBUSSES

## CHAOS DWARF BLUNDERBUSS

Roll a dice for each potential casualty to determine if you hit. It is easiest to do this unit by unit, rolling a handful of dice at one go, for each unit. For example, if there are 16 potential casualties in an enemy unit, roll 16 dice to determine how many are hit. Some enemy targets will inevitably lie only partly within the area described, in which case you must use your judgement to decide if they are potential hits or not. The general rule is that a model is a potential hit if its base is at least halfway within the fire zone — in the same way as a target from a war machine or spell template. Of course, some judgement will be required, as it is never possible to exactly measure the proportion of a model's base covered by a template, so if there is any doubt you will have to reach agreement with your opponent or decide the matter with a further dice roll.

Roll to hit each potential target using the ballistic skill (BS) of the Chaos Dwarfs as normal. None of the usual to hit modifiers apply, except for cover (-1 soft cover and -2 hard cover). This reflects the fact that the volley represents a massive wall of fire, where individuals are hit because they are in the way rather than because they have been specifically aimed at. As Chaos Dwarfs have a BS of 3 this will mean targets are usually hit on the roll of a 4.

Resolve each hit in the normal way using the To Wound chart. The Blunderbuss has a strength of 3, but this is increased by +1 for each full rank of Chaos Dwarfs behind the first up to a maximum of 5 (ie. three full ranks including the front). Any Chaos Dwarfs in a rank behind the third are too far back to poke their weapons forward.

Resolve saving throws for any casualties using the appropriate modifier (ie -1 if S4 and -2 if S5). No additional modifier applies as it does for hand guns on account of the rapid dispersal of the blunderbusses' energy. Once you have established the total number of wounds inflicted on a unit, remove casualties exactly as normal.

Proceed with each potential target unit or individual model until you have resolved all casualties.

### TARGETS WITH SEVERAL WOUNDS

Once the total number of wounds inflicted has been calculated remove casualties from target units exactly as you would for normal shooting from bows, crossbows etc. So, if you fire at a unit of 20 Ogres of which 16 are potential hits, roll 16 dice to hit, resolve the number of wounds as normal, and then remove the total number of casualties as appropriate. So, if you cause 6 wounds you will remove 2 models (they have 3 wounds each) just as you would for bow shots. This may seem obvious, but it is an easy mistake to assume that just because you roll a dice for each potential target that the wounds have to be distributed amongst all those targets — this would be unbearably tedious!

### CHARACTERS AND MONSTERS

In the case of enemy characters and single models with many wounds, only one dice is rolled and only a maximum of one wound is normally suffered. If a hero is mounted on a monster then both are potentially hit if they lie within the fire zone. In the case of characters and war machines, each crew member, each horse or wolf pulling a chariot, and the machine or chariot itself are each potentially hit assuming they lie within the fire zone. This is effectively the same as if the war machine or chariot were hit by a stonethrower template which covered them.

If a monster with several wounds, a character and monster, a war machine, a character model, or a war machine is either: 1) the only model in the fire zone, or 2) the closest target in the

fire zone measuring from the unit's front, then the Blunderbusses may elect to Concentrate Fire on this target alone. This is bad news for the target concerned as the concentrated volley is the most devastating of all.

When firing a concentrated volley, roll one dice to hit for each Chaos Dwarf in the front rank, applying modifiers only for cover exactly as described above. Resolve all hits against the target as you would for normal shooting with the addition of the strength bonuses for ranks as before. If the models being fired at consist of a chariot, character riding a monster, or other multiple targets, randomly distribute hits exactly as you would with normal shooting.

WEAPON	RANGE	STRENGTH	SAVE
Blunderbuss	12"	S3+1 per rank up to S5 max	-1 if S4 -2 if S5

### FRIENDLY UNITS IN THE FIRE ZONE

This is generally a bad idea as you can imagine. The flying shards of iron, hot coals and other debris fired from the Chaos Dwarfs' Blunderbusses does not discriminate between friend and foe. It is therefore vital for the Chaos Dwarf general to position his Blunderbuss units appropriately.

### STAND AND FIRE

A Blunderbuss armed unit can stand and fire against a charging enemy unit if it starts its move more than half its own charge distance away as per normal. The Blunderbuss armed Chaos Dwarfs hold their fire until the last moment. Then they concentrate fire on the charging foe in the same manner described for firing at isolated characters and machines. Roll a D6 for each Chaos Dwarf front ranker ignoring the to hit modifiers as usual for Blunderbusses (the -1 which is generally applied to troops shooting at charging troops does not apply for Blunderbusses). Work out wounds and remove casualties as normal, applying the strength modifier for a second or third rank. When a Blunderbuss unit stands and fires it only shoots at its chargers, not at other troops within its fire zone, because the Chaos Dwarfs wait until their enemy are so close that they absorb all the energy of the shot!

### SUMMARY

1. Establish fire zone 12" in front of the unit extending across the unit's frontage.
2. Roll to hit each model within the fire zone. It is convenient to deal with each target unit at a time, rolling the appropriate number of dice to establish hits, then resolving wounds and saves as normal. Finally remove the appropriate number of casualties.
3. Proceed until all potential hits have been resolved.
4. Chaos Dwarf Blunderbusses may not move and fire in the same turn.
5. The strength of the hit is 3 for one full rank, increasing to 4 for two full ranks and a maximum of 5 for three full ranks. Ranks which are not full do not count, and save modifiers are adjusted according to strength as per normal.
6. It is possible to concentrate fire against a single target if it is the only target in the fire zone or if it is the closest target. Resolve damage as you would for normal shooting, rolling once to hit with each Blunderbuss in the front rank.

# Chaos Dwarf Bull Centaurs



BULL CENTAUR HERO



BULL CENTAUR



STANDARD BEARER



A CHAOS DWARF ARMY PREPARES FOR BATTLE

Chaos Dwarf  
Sorcerer riding  
Mighty Lammasu



DETAIL OF LAMMASU



SORCERER'S WAR BANNER



CHAOS DWARF ARMY  
STANDARD AND PENNANTS



®

## CHAOS DWARF MAGIC CARDS

By Grant Williams

The Chaos Dwarf Sorcerers rule over the Tower of Zharr-Naggrund as the lords and masters of the Chaos Dwarfs and high priests of Hashut. Their lore is deep and ancient, the study of machines and magic combined to produce arcane engines of power and destruction.

It was the Chaos Dwarf Sorcerers who constructed the city in past ages, who carved its shape from obsidian and raised its dark towers and fashioned its massive gateways. They are few in number, probably no more than a few hundred amongst the whole Chaos Dwarf race.

In the Temple of Hashut the Chaos Dwarf Sorcerers meet in a conclave of evil to make their plans of domination. There is no leader nor formal hierarchy amongst them, but the strongest voice belongs to the oldest and most powerful, for Chaos Dwarfs respect age and knowledge just as much as other Dwarfs. Each Chaos Dwarf Sorcerer controls part of the city, with its workshops and forges, slaves and warriors, as part of his personal dominion.

As Chaos Dwarf Sorcerers use magic it gradually seeps into their bodies, evoking changes in them which are both unique and horrific. Starting with his feet, the Chaos Dwarf Sorcerer slowly begins to turn to immobile stone. At first his legs turn grey and solid so that he is unable to move, and his followers are obliged to carry him around or else he has them construct a mechanical engine to move him about. This condition gradually spreads upwards throughout the whole of the Sorcerer's body until he is made up entirely of stone. These Chaos Dwarf Sorcerer stone statues are lined up along the roadways around the tower of Zharr-Naggrund, forming rank upon rank of grey stones watching over the approach to the city.

To use these spell cards in your Warhammer games, first carefully cut out the front and back of each card as a single piece. Fold the card in half along the dotted line and glue the two sides back-to-back. To make them a little more hard wearing, it's a good idea to insert some thin card between the two halves before you glue them together.

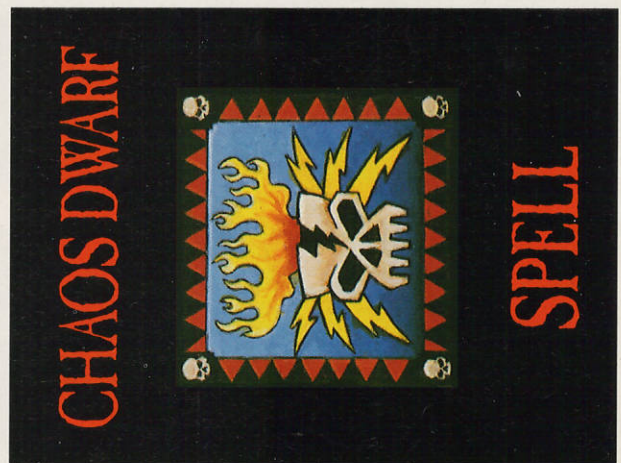
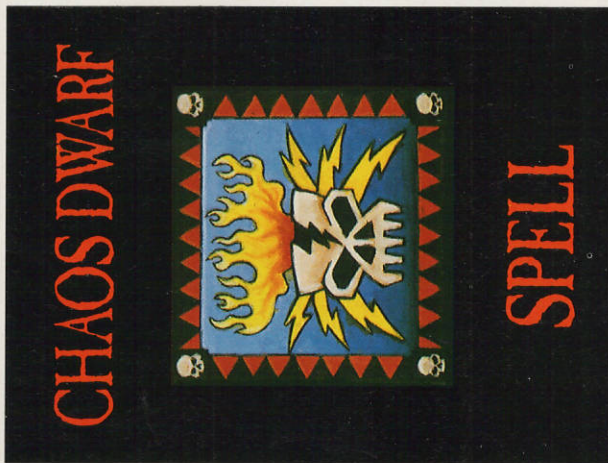

**POWER 2**      **RANGE: 36"**

### DOOMROAR

The Sorcerer's eyes blaze with power and his head slowly begins to transform, taking on the aspect of the mighty Bull-God Hashut. Massive twisted horns sprout from his temple and large flared nostrils belch forth smoke and fire. The transformed sorcerer lifts his bull-head and bellows forth a deafening roar across the battlefield. Friends hearing it are filled with courage, while enemies suffer a feeling of doom and dread. All enemy units engaged in hand-to-hand combat must take a panic test immediately. If they fail they are broken and will flee directly away from the nearest enemy. All fleeing friendly units within range immediately rally.

**POWER 2**      **RANGE: 18"**

### SHADOWS OF HASHUT

The air around the sorcerer grows cold and a shadowy form begins to coalesce next to him. It forms into a visage of Hashut, the mighty God of the Chaos Dwarfs. With a deafening roar, the shadow bull charges forward smashing everything out of its way. The player draws a line 18" from the sorcerer. Every model crossed by the line suffers one S4 hit causing 1 wound. Any unit suffering one or more casualties from the Shadows of Hashut must take an immediate panic test.

## HOBGOBLINS

Hobgoblins are taller than ordinary Goblins, though nowhere near as burly as Orcs. In fact, their whole appearance is thin and sneaky, with narrow eyes and mouths full of pointy teeth. The Chaos Dwarfs utilise many evil Hobgoblins in their armies but don't really trust them. The Chaos Dwarfs know that the Hobgoblins are despised by other greenskins, and that they need the protection of the Chaos Dwarfs to survive.

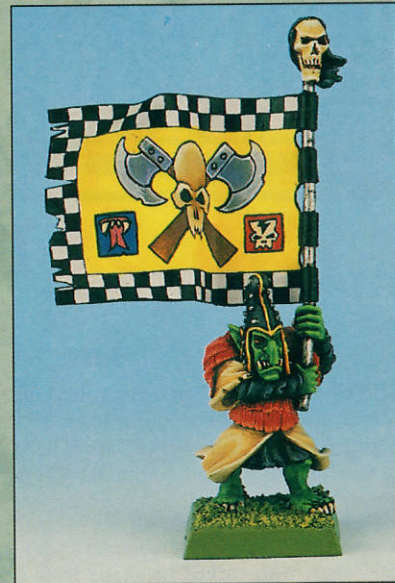
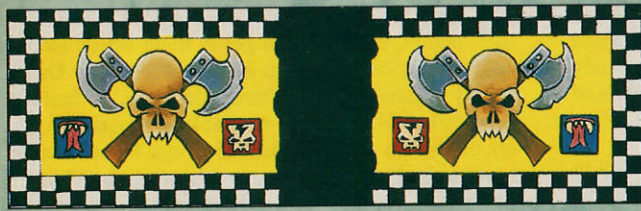

STANDARD BEARER



CHAMPION



HOBGOBLIN



DRUMMER



A HOBGOBLIN REGIMENT



HERO

# CHAOS DWARF



# SPELL

**POWER 1**      **RANGE: 6"**

## FLAMING HIDE

The sorcerer may cast this spell upon himself or any single model within 6". The skin of the affected model begins to glow red hot and flickers with sparks. The flaming hide will negate any wound suffered by the model on the D6 roll of 4, 5 or 6. In hand-to-hand combat, any model which hits the flaming hide will suffer one automatic S3 hit for each card next to the model or somewhere convenient on the table edge to show that it is in play. Once cast, the spell remains effective for the rest of the game, until it is dispelled or until the Sorcerer is slain. Only one Flaming Hide may be used at a time.

# CHAOS DWARF



# SPELL

**POWER 2**      **RANGE: 18"**

## ASH CLOUD

The sorcerer summons up a cloud of hot volcanic ash which appears under any unit within 18". The ash cloud stings the eyes of the unit members and causes coughing and spluttering. The unit affected will have its Movement, Weapon skill, Bow skill, Initiative and Attacks characteristics halved (rounding fractions up) until the beginning of the next magic phase. This spell is only effective against living targets and has no effect on undead or demons.

# CHAOS DWARF



# SPELL

**POWER 1**

## MAGMA POOL

The sorcerer begins to melt into molten lava which flows away into the ground. The sorcerer reappears in another part of the battlefield, slowly seeping through the ground, then gradually re-forming and solidifying. The Magma Pool can be used to transport the sorcerer into hand-to-hand combat, in which case he fights as normal from the next combat phase onwards and counts as charging in the first round of fighting.

# CHAOS DWARF



# SPELL

**POWER 3**

**RANGE: 24"**

## ERUPTION

The Sorcerer chants words of power and smashes his staff on the ground. There is a low rumbling then the ground erupts spewing forth molten lava and clouds of hot ash. Place the 3" diameter circular template over the target to represent the area of the eruption. Any models beneath the template must roll equal to or under their initiative to leap aside. Anything which fails to leap aside is instantly vapourised by the molten lava. War machines such as stone throwers and chariots will be automatically consumed (though their crews get to roll to avoid death) and buildings at least half under the card will collapse on the D6 roll of 4, 5 or 6.

## SAVAGE ORCS

Savage Orcs cover their bodies with tattoos and war paint. They are wild fighters, whooping and screaming as they attack, calling upon Gork and Mork to help them as they crash into the enemy ranks.



ARCHER



ARCHER



BIG BOSS



STANDARD BEARER



DRUMMER



BOSS



SHAMAN



A MOB OF SAVAGE ORC ARRER BOYZ.



**POWER 2**

**RANGE: 24"**

## SORCERER'S CURSE

The sorcerer motions towards an enemy model and instills him with the curse of the Chaos Dwarf Sorcerers. The victim slowly begins to turn to stone from the feet upwards. To perform any action the model must first roll under his strength characteristic on 2D6 at the start of every turn. If he succeeds he can perform as normal that turn, but if not the model may do nothing as the encumbering bulk of his stoney form proves too difficult to move. The curse lasts for the rest of the game, until it is dispelled, or until the caster is slain or chooses to end the spell. Place the card next to the affected model. The caster can end the spell in his turn of the magic phase by removing the card from the table — the spell can then be used normally from the following magic phase.

CHAOS DWARF



SPELL

**POWER 2**

**RANGE: 18"**

## LAVA STORM

With a sweep of the sorcerer's arm the air fills with balls of molten lava. The Lava Storm flies in a straight line up to a distance of 18" hitting the first unit in it's path. The Lava Storm causes 2D6 on the target unit and each hit causes a wound on the D6 roll of 4, 5 or 6. No saving throw is allowed even for magical armour.

**POWER 3**

## FLAMES OF AZGORH

The sorcerer breathes out whirling tendrils of sorcerous flame. Use the teardrop shaped template from the Warhammer game and place the narrow end at the sorcerer's base and the broad end over the target. Any models under the template are hit on the D6 score of 4, 5 or 6. Any model hit suffers a S4 hit from the lashing flames. No armour saving throw is allowed, even for magical armour.

CHAOS DWARF



SPELL

**POWER 2**

## FIST OF FIRE

The sorcerer's hands are enwrapped with glowing bands of magical fire that snake out and envelope hand-to-hand combat opponents. Any close combat opponents that are hit are automatically wounded suffering not one but D3 wounds for the magical fire. Armour saving throws may be taken as normal. The spell remains in play until dispelled. It should be placed by the sorcerer or at the table edge to indicate that it is in play.

CHAOS DWARF



SPELL

CHAOS DWARF



SPELL

# WARHAMMER

**WARHAMMER**  
THE GAME OF FANTASY BATTLES

## IMPERIAL ELECTOR COUNTS



4 WARRIOR NOBLES OF THE EMPIRE

## KNIGHTS OF THE WHITE WOLF



3 MIGHTY ARMOURD KNIGHTS OF THE EMPIRE

**WARHAMMER**  
THE GAME OF FANTASY BATTLES

## HIGH ELF S



**WARHAMMER**  
THE GAME OF FANTASY BATTLES

## ROCK LOBBER

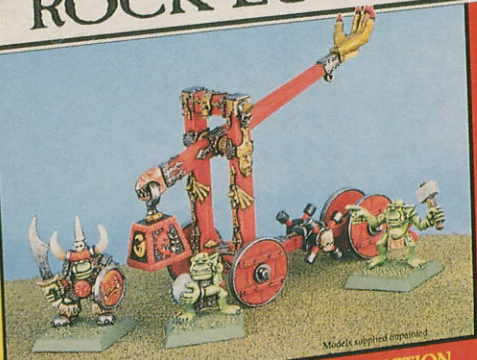

MIGHTY ORC MACHINERY OF DESTRUCTION

## ONLORD



**WARHAMMER**  
THE GAME OF FANTASY BATTLES

## IMPER

**MARAUDER**  
MINIATURES

Denmark, not included.



**WARHAMMER**  
THE GAME OF FANTASY BATTLES

## HIGH ELF BATTLE CHARIOT



MIRANOC BATTLE CHARIO

**WARHAMMER**  
THE GAME OF FANTASY BATTLES

## IMPERIAL STEAM TANK



STEAM-POWERED WAR MA



# WARHAMMER®

WARHAMMER THE GAME OF FANTASY BATTLES  
SILVER HELMS

WARHAMMER THE GAME OF FANTASY BATTLES  
HIGH ELF PEGASUS

WARHAMMER THE GAME OF FANTASY BATTLES  
HIGH ELF WAR GRIFFON

WARHAMMER THE GAME OF FANTASY BATTLES  
IMPERIAL PEGASUS

CITADEL MINIATURES  
WARHAMMER THE GAME OF FANTASY BATTLES  
IMPERIAL

WARHAMMER THE GAME OF FANTASY BATTLES  
HEROES OF THE EMPIRE

WARHAMMER THE GAME OF FANTASY BATTLES  
KNIGHTS PANTHER

MARAUDER MINIATURES  
ORC WAR WYVERN



WARNING These products contain lead which may be harmful if chewed or swallowed. Citadel Miniatures are not recommended for children under 14 years of age.

GAMES WORKSHOP • GAMES WORKSHOP • BOLTON • GAMES WORKSHOP

GAMES WORKSHOP STORES • GAMES WORKSHOP STORES

GAMES WORKSHOP STORES • GAMES WORKSHOP STORES

# OPEN NOW!

# GAMES WORKSHOP®

## BOLTON



Unit 25,  
First Floor Gallery  
Shipgates Centre

**NORMAL OPENING HOURS**

Monday – Saturday 9.30am to 5.30pm  
Thursday 9.30am to 8pm

GAMES WORKSHOP • GAMES WORKSHOP • BOLTON • GAMES WORKSHOP

GAMES WORKSHOP • GAMES WORKSHOP • MAIDENHEAD • GAMES WORKSHOP

GAMES WORKSHOP STORES • GAMES WORKSHOP STORES

GAMES WORKSHOP STORES • GAMES WORKSHOP STORES

# OPEN NOW!

# GAMES WORKSHOP®

## MAIDENHEAD



2, Blandy House,  
3/5, King Street.

Tel: 0628 21854

**NORMAL OPENING HOURS**

Monday – Wednesday 10am to 6pm  
Thursday 10am to 8pm, Friday 10am to 6pm  
Saturdays 9.00am to 5.30pm  
Games night every Thursday

GAMES WORKSHOP • GAMES WORKSHOP • MAIDENHEAD • GAMES WORKSHOP

# MAN O' WAR

TM

## ALLIES

By Andy Jones

There are many races and nations in the Old World, most warring constantly with their neighbours for supremacy or even survival. Some nations, however, manage to find common ground with others, and may forge alliances to promote mutual trade in times of peace, or to unite as a powerful opponent in times of war.

It is often the case that alliances are hastily formed in response to assault or invasion by a common enemy. Such friendships, forged in times of war, often carry over into times of peace, and the two nations will gain much from the exchange of resource, skills and ideas.

The Empire, for instance, has an age-long understanding with the Dwarfs of the World's Edge Mountains, and the two great nations have learned much from one another. In times of war, the Dwarfs come to the aid of the Empire, and vice versa. At sea, an Empire Fleet will often enlist the Dwarf Sealords' help to augment its own forces with the mighty guns of a Dreadnought or the special attacks of the Nautilus submarines.

*Deathmonger howled in frustration, smashing his Daemon Blade into the deck of the Bloodship. Wood fragments flew in all directions, and the sword struck sparks from iron rivets in the deck. Gesturing at the Empire Fleet rounding the headland, he bellowed his rage to the skies.*

*"They escape from me! I had their souls in my grasp, and now they escape me!" His hoarse shout travelled the length of the ship.*

*Turning to the Chaos Warriors assembled on the bridge of the Bloodship, his voice dropped and took on a menacing snarl.*

*"Where is the Greenskin? Bring him to me, I would speak with him".*

*The Plaguefleet had waited three days for the appointed hour, riding at anchor under cover of the overhanging cliffs. The arcane magics of the fleet's Sorcerer had protected their black presence from detection, so that even when the Empire Fleet had turned the headland as expected, the Empire Wizard had not discovered them.*

*The Orc Fleet should have been on the other side of the headland to cut the Empire Fleet off, preventing their escape. Pacts had been made with them for their help; blood had been spilled, gold had changed hands and much wine had been drunk to form this awful alliance. And the result? Here, at the first battle, the Orcs were nowhere in sight. Victory was slipping from Deathmonger's grasp before his eyes.*

Likewise, Orcs make uneasy pacts with the forces of Chaos or Dark Elves, so that together they can crush their opposition and share the spoils of war. Such truces hold together only by the strength of will of a great leader, as Orcs, Chaos Warriors and Dark Elves have no great love for one another.

As long as there are battles to fight and wars to win, an alliance may hold, but once the conflict is over, it will usually fragment and splinter into violently warring factions.

Other, more warlike nations or leaders sell their martial skills to the highest bidders. Such soldiers-of-fortune fight anyone for a chest or two of gold. The lowest of these mercenaries are amoral scum who are not averse to changing sides mid-battle for a few extra coins.

At the other end of the scale are the professional soldiers who honour their commitments to the death. Once a deal is struck with these warriors, no amount of extra money will persuade them to change sides until they have fulfilled the letter of their contract.

### CHOOSING ALLIES

Each Man O' War Fleet has its own character and tactics to discover. The allies rules allow you to expand your favourite fleets and incorporate other races' ships to utilise their special abilities.

You may spend up to a third of the total points value of your fleet on allies and mercenaries. First buy the Men O' War of your parent fleet, plus the minimum quantities of other vessels you must have, as stated in the Man O' War Fleet Lists.

For instance, you cannot buy a 'Bretonnian Fleet' that has just one squadron of Buccaneers and a Wizard, with the rest of the fleet made up of Dwarf Dreadnoughts and Ironclads. Clearly, this is a Dwarf Fleet with an allied squadron of Buccaneers. (And as a Dwarf Fleet, of course, it isn't allowed to have a Wizard!)

To prevent confusion, the special rules for the parent fleet always take priority; an Empire Fleet with Dwarf allies may have a Wizard and cast spells as normal, and because the Dwarfs are allies, their ability to dispel magic will not operate. Similarly, a Dwarf Fleet with a single Greatship ally may not have a Wizard, but the Dwarfs ability to dispel magic would now apply.

It is important, therefore, to declare the type of fleet you are buying, buy the required minimums for that fleet, and then spend up to a third of your points on allies.

The Admiral of the combined fleet is always of the race of the parent fleet, and starts the game aboard a Man O' War of that fleet. So, for instance, an Orc Fleet with Chaos allies will have an Orc Admiral onboard a Hulk.

The allies must conform to the normal ratio of ship types in the parent fleet. So, if you cannot normally have more Men O' War than Ships of the Line in your fleet, this rule still holds even if some of the Men O' War are allies.

For example, if you had a Dwarf fleet with Empire allies, you couldn't have more than one Man O' War for every two Monitor Squadrons you had, even if some of the Men O' War were not Dwarf vessels. Likewise the rules governing individual ship types also apply. For example, you cannot have more Nautilus submarines as allies than the fleet has Men O' War - even if not all the Men O' War are Ironclads.

### Who can ally with who?

The table below shows you which race can ally with each race.

To determine if you can choose allies of a particular race, cross reference the parent fleet's race with that of the allies you are thinking of buying.

If the result is a 'Yes' the chosen race will ally with you. They are a nation who have a long-standing agreement or understanding with yours, and are likely to send troops or ships to your aid in times of war. You may choose any ships from this race's Fleet List within the limits already outlined.

If the result is a 'No' the chosen race will not ally with you. They are age-old enemies, sworn to destroy you and everything you stand for. There is no way that they will ever stand alongside you in battle, except to stab you in the back at the first opportunity! You may not select this race's ships as allies.

If the result is a 'Maybe' there is a fair chance that the chosen race will ally with you. They hold no particular loyalty or friendship towards your nation, but neither do they hold any enmity. If circumstances dictate, they will join you in battle against a common enemy. At the start of the battle, if your opponent agrees, you may choose ships from this race as allies.

## MAN O' WAR ALLIES TABLE

	Dwarfs	Elves	Dark Elves	Orcs	Chaos	C. Dw.	Empire	Bret.	Pirates	Skaven	Norse
Dwarfs	No	Maybe	No	No	No	No	Yes	Yes	No	No	Yes
Elves	Maybe	No	No	No	No	No	Maybe	Yes	No	No	Yes
Dark Elves	No	No	No	Maybe	Yes	Yes	No	No	Yes	Maybe	Yes
Orcs	No	No	Maybe	No	Maybe	Yes	No	No	Yes	Maybe	Yes
Chaos	No	No	Yes	Maybe	No	Yes	No	No	Maybe	Yes	Yes
Chaos Dwarfs	No	No	Yes	Yes	Yes	No	No	No	Maybe	Yes	Yes
Empire	Yes	Maybe	No	No	No	No	No	Maybe	No	No	Yes
Bretonnians	Yes	Yes	No	No	No	No	Maybe	No	Maybe	No	Yes
Pirates	No	No	Yes	Yes	Maybe	Maybe	No	Maybe	No	Maybe	Yes
Skaven	No	No	Maybe	Maybe	Yes	Yes	No	No	Maybe	No	Yes
Norse	Yes	Yes	Yes	Yes	Yes	Yes	Yes	Yes	Yes	Yes	No

- No These two races will not ally together under any circumstances.
- Maybe These two races may ally together, but roll to see if the alliance holds at the start of the battle.
- Yes These two races ally together readily; you may choose freely from their Fleet Lists.

C. DW. – Chaos Dwarfs    Bret. – Bretonnians

If your opponent doesn't agree, you may still buy this race's ships as allies, but must then roll two dice and consult the following table at the start of each battle to see when they turn up. Once you have decided to buy allies and roll on this table, you must abide by the result. If your allies do not turn up on time you will have to fight without them.

#### Roll Allies' Loyalty

- 2 Your allies arrive late. Roll 2 dice; they arrive that many turns after the start of the battle.
- 3-5 Your allies arrive late. Roll 1 dice; they arrive that many turns after the start of the battle.
- 6-12 Your allies arrive precisely on time and ready for battle.

If you have a number of different allies in your fleet, and more than one of them are 'Maybes', you must roll on the above table for each contingent. Note that you roll on the table for each race that you ally with, not for each ship or squadron.

#### Allies of the Same Race

The only races in Man O' War that will readily fight amongst themselves are Orcs and Chaos. So, for instance, two Orc Admirals may fight for a stretch of coastline, or two Chaos Fleets will clash for command of a trade route. Indeed, two Chaos Fleets or Orc Fleets may fight just for the joy of a good fight!

Orcs and Chaos aside, other races will not fight amongst themselves. They are usually far too hard-pressed fighting off their enemies to split up into factions and fight each other. Even if different Admirals of the same race do not really get on, they will make an uneasy alliance for the duration of a battle.

This means that if you and your opponent have allies of the same race, or have fleets of the same nation, then they will not fight.

To resolve such situations, look at the *Man O' War Allies Table*. If one of the parent fleets gives a 'Maybe' result with the allies' race, and the other gives a 'Yes' result, the player who gets the 'Yes' gets the allies for this battle. The other player's allies will not fight.

For instance, if an Empire Fleet is fighting a Bretonnian Fleet, and both sides have Elf allies, resolve the situation as follows:

Looking at the table, the Empire gets a 'Maybe' result with Elf allies, while the Bretonnians get a definite 'Yes'. This means that the Elves favour the Bretonnians, and will side with them if both fleets have Elf allies.

This doesn't mean that any Elf allies chosen by the Empire Fleet go over to the Bretonnians, simply that they do not turn up at all. The Empire player must either select a complete Empire Fleet, or choose another race to ally with.

The only exceptions to the above rule are if both players agree to use the same race as allies, or if you have written a special scenario about a war between two nations or Admirals of the same race.

For instance, you might like to fight a battle between two Empire Fleets. One could be led by a renegade Admiral who has fled the Empire, while the other could be the Empire Fleet that has been sent to capture him and bring him to justice.

## MULTI-PLAYER GAMES

It is possible to fight a Man O' War battle between, say, four players, with two players a side, where each player has a different race. In such cases, each side's fleets must be of races that will ally with each other. (Orcs and Elves, for instance, never fight alongside each other.)

You can use the Man O' War Allies Table to determine which nations may fight on the same side; any nations who get a 'Yes' or 'Maybe' result on the table may fight together. In this situation, the races are not allies as such, but simply separate fleets of equal size who have joined up for the battle. In other words, the two players form an 'Allied Fleet'.

So, for instance, you could fight a four player game with the Empire and Bretonnians on one side as an Allied Fleet, against a combined force of Orcs and Dark Elves as another Allied Fleet.

*"We can take them ourselves, my Lord." Saardis Vaarn, Champion of Slaanesh, licked his lips eagerly as he surveyed the approaching Empire vessels.*

*"Not before I speak with the Orc-thing," spat Deathmonger. "A pact has been broken."*

*At that moment, two iron-clad warriors marched onto the deck, an immense Orc warrior striding between them. He sniffed the air suspiciously, his huge nostrils flaring and his hand resting on the hilt of his war axe. The Chaos Warriors shoved him forward roughly. He turned and snarled, dealing a savage blow with a mailed fist to the nearest one.*

*"See our foe, scabhide, running for safety and your fleet nowhere to be found. Where are they?" Deathmonger's voice was little more than a whisper, but the words carried clear.*

*"Ugrak Headcleaver come soon, big metalman," growled the Orc. "My blood on it."*

*"If you are lying greenskin, it will be. Believe me, it will be."*

*"Kill him now lord. They are escaping and time is short," Saardis Vaarn called urgently, beckoning towards the last few ships passing the headland.*

*Deathmonger raised his black blade. His eyes shone through the visor of his warhelm, small red pin pricks that flamed with the fires of hell. The Orc grinned as his axe began swinging left and right in a glittering arc.*

*"I die, you die, big metalman."*

*Deathmonger jerked his blade around with lightning fast, cruel precision, and the Orc's head spun over the bow rail, suspended on a plume of green blood. The body stood for a split second, still swinging its axe, before buckling at the knees and crumpling in a heap on the deck.*

*"I believe not," Deathmonger exhaled in a long rasping sigh.*

In terms of initiative and turn sequencing, the battle is still fought between two fleets, not four. The two players on each side have to decide who rolls for the initiative in their Allied Fleet, and in which order their squadrons move and fight. We suggest that within each Allied Fleet you take it in turns to roll the dice.

Of course, in a battle of this size, you will need to double up the points available per side, so that in a game with two Allied Fleets, each with two players, each player still gets 1000 points to spend. This means that each Allied Fleet is 2000 points in total.

### Magic in Multi-player Games

If you are playing a multi-player game using one set of Magic Cards, then there may only be one Wizard per Allied Fleet. If you have two or more sets of Magic Cards, you may combine them to make one big deck, adding one deck to the pack for every two players in the game.

In this case, each of the 'sub-fleets' within each Allied Fleet may have a Wizard, and each may attempt to cast one spell per turn and dispel one spell per turn. Once you have rolled for initiative, you will have to decide which of your Wizards goes first, and who dispels which incoming spells, etc.

Note that you must have a Wizard Card for each Wizard in the Allied Fleet, and they must keep their Magic Cards separate from each other. You may not swap spells between Wizards within the fleet!

If you are using more than one Chaos Sorcerer or Grey Seer, you must have one deck of Chaos Magic Cards for each Chaos Sorcerer in the game, and one deck of Skaven Magic Cards for each Grey Seer in the game. Like normal Wizards, each Chaos Sorcerer or Grey Seer must keep his spells separate, and each may attempt to cast and dispel one spell per turn.

*A great cry went up from the lookouts. They had sighted the Orc ships.*

*Glancing to port, Deathmonger saw the clumsy shapes of the Hulks lurch around the headland, just in front of the Empire Fleet. The Imperial vessels showed no signs of stopping; they outnumbered the Orcs and their battle ensigns were flying. Clouds of gunsmoke quickly obscured the ships as the distant roar of cannons echoed across the water.*

*Glancing at the steaming Orc corpse, Deathmonger gave a short, barking laugh.*

*"Your lord comes too late for you, greenskin. Now your soul belongs to Khorne."*

*Grabbing a lanyard, Saardis Vaarn lithely swung across onto his waiting Hellship, which greedily urged its way forward towards the conflict.*

*"To battle," roared Deathmonger. "We go to battle."*

*Occupied by the Orc Hulks to their fore, the Empire fleet failed to notice the Plaguefleet emerging from the shadows of the cliffs until it was far too late...*



John Blanche



# MAN O'WAR

## TURN SEQUENCE

1. INITIATIVE PHASE
2. MAGIC PHASE
3. BATTLE PHASE
4. END PHASE

## INITIATIVE PHASE

Both players roll a dice. The highest score has the initiative this turn.

If both roll the same number, the wind direction changes and then re-roll.

**Changing The Wind:** The wind changes clockwise one position on an even double, anticlockwise on an odd double.

## MAGIC PHASE

The player with the initiative may attempt to cast a spell and, if it works, his opponent may attempt to dispel it.

The second player may then attempt to cast a spell, and the first player attempt to dispel it.

### WIZARDS

You may choose which College of Magic your Wizard belongs to, either: Bright, Jade, Amethyst, Gold, Amber, Celestial, Light or Grey.

Mastery Level	Points Cost	Magic Cards	Battle Honours
Wizard Champion	50	2	1
Master Wizard	100	4	2
Wizard Lord	150	6	3

### CASTING SPELLS

To cast a spell, roll a dice; a score equal to or above the spell's casting number is required. If you have a Wizard Lord, you may add a +1 to your casting roll.

If the spell is of the same College as your Wizard, you may re-roll the dice if you fail to cast the spell first time.

Once a spell has been cast, discard it, whether successful or not.

### DISPELLING MAGIC

You may attempt to dispel an enemy spell if any one of your spell cards is of an opposing colour to it (indicated by the coloured bar at the bottom of your Magic Card).

To successfully dispel the enemy spell, you must score equal to or over the casting number on your card. If you have a Wizard Lord, you may add +1 to your dispel roll.

If the incoming spell is of the same colour as your Wizard, you may re-roll the dice if the first dispel attempt fails.

Once a Magic Card has been used to try and dispel an enemy spell it is discarded, whether or not the attempt was successful.

## BATTLE PHASE

The player with the initiative chooses one of his squadrons, or a Man O' War, or an Independent vessel, and then moves and fights with it.

The second player then does the same. This continues until all the models on the table have moved and fought.

A ship may make the following actions, completed in order, before moving onto the next vessel.

1. MOVEMENT
2. COMBAT AND DAMAGE
3. RAMMING AND BOARDING ACTIONS

### MOVEMENT

Each ship has one or more movement rates – given in inches – on its template. Before moving a ship, declare which method of propulsion it is using, usually oars or sail.

**The Turning Template:** The turning template is used when turning a ship, whether it is moving under oars or sail. Full instructions for using the turning template are printed on it.

As a ship turns it moves 2" along the turning template. A ship can make as many turns as you like, up to the limits of its movement rate. For example, a ship with a move of 6" may make 3 turns.

Once a ship has made a move, it is committed. You may not change your mind or reposition it to avoid colliding with something or running aground.

**Moving Under Sail:** Most ships have two movement rates under sail, one of which is printed in brackets. The number in brackets is used if the ship starts its turn with the wind behind it.

If a ship turns to sail into the wind, it stops moving immediately and forfeits the rest of its move. If a ship starts its turn facing into the wind, it may make a single turn so that it is no longer facing into the wind, ready to move normally next turn.

**Moving Under Oars:** Most ships have two movement rates under oars, one of which is printed in brackets. The number in brackets is used if the ship moves in a straight line and doesn't make any turns.

When moving under oars, a ship can either use the turning template to turn, or turn on the spot. If turning on the spot, a turn of 90° or less takes half a ship's move, while a turn of between 90° and 180° takes up all of its move.

**Backing Water:** Some ships with oars may make a backward move instead of making a normal move, as indicated on the Fleet List.

**Ramming:** Some ships have rams and may make a ram attack. Ships that are able to do this, and the details of their attack, are listed on the Fleet List.

To ram an enemy vessel, a ship simply moves so that its bow is in contact with its target. The rammer's oars must be intact, and at least the last 3" of its move must have been in a straight line. The victim must make a below the waterline save to avoid damage.

**Obstructions:** If a ship touches any type of terrain feature, it has run aground and must roll on the following table.

Roll	Damage
1-2	3 points of below the waterline damage.
5-6	1 point of below the waterline damage.

To free a ship that starts its turn aground, roll a dice. If you roll a 4 or more the ship may move off the obstruction safely. If you roll a 1, 2 or 3, the ship remains stuck and you must roll again next turn.

**Collisions:** If your ship hits another ship it forfeits the rest of its movement that turn. The ships are left touching each other and you may now make a boarding action against the enemy vessel.

**Pushing Clear:** If a ship starts its turn with its bows touching another ship, it may use half of its movement rate to push clear. Turn the prow of the ship so that it lies along the side of the other ship and its path is clear. The ship may now take the remaining half of its move.

## COMBAT AND DAMAGE

Once a ship has moved, it may fire. It may fire each battery of guns once per turn.

**Firing Your Cannons:** Most weapons in Man O' War have a 9" range and use the standard range ruler. Unless stated otherwise, a ship's cannons are fixed in place and cannot swivel – they shoot straight out from the ship.

To fire at an enemy ship, use the following procedure.

1. **Nominate your target.**
2. **Check it is within range and line of sight.**
3. **Declare whether you are aiming high or low.**
4. **Open fire.**
5. **If you hit, the enemy must make a saving throw**
6. **Apply any damage done, rolling for critical hits if necessary.**

**Checking Range and Line of Sight:** Lay down the range ruler so that the Close Range end is touching your ship, and it lies in the direction your cannons fire (your Fleet List shows you this information). If the range ruler touches any part of your target, it is within range.

Cannons can only hit the first thing that lies under the range ruler, even if only partially. If one of your own vessels, a sandbank, or other object is closer than your intended target, you will hit that instead if you decide to open fire. Once you have checked to see whether the enemy is within range and line of sight, you may decide not to fire after all.

**Aiming High Or Low:** Some of the larger ships, such as Men O' War, are divided into high and low areas. If the enemy ship's template is set-up in this way, declare whether you are aiming high or low before you open fire.

**Opening Fire:** Your Fleet List shows how many gun batteries your ship fires in each direction. When you open fire, roll that many dice. The number or numbers rolled show which locations of the enemy ship you have hit. If the enemy ship does not have a number on its template that matches the number you rolled, the shot missed. In any case, an unmodified roll of 1 always misses.

**Saving Throws:** Once you have determined which locations on the enemy ship you have hit, your opponent makes a saving roll. The basic saving roll for each location is printed on the ship's template. Your opponent must add any modifiers for range to his roll to determine his final total.

Range	Modifier
Close	-1
Medium	0
Long	+1

If your opponent's total is equal to or over the saving roll, the shot has no effect. If it is less than the saving roll, the location has been damaged.

When a location is hit and fails its saving throw, it is usually destroyed. Place a damage marker on that location to indicate this. Some locations can take more than one hit, as indicated by the number of light coloured squares on the template. They are not destroyed until all the squares on that location have been filled with a damage marker. The effects of destroying a location are printed on the template.

**Critical Hits:** Once a location has been destroyed, any further damage causes a critical hit. Roll a dice and consult the critical hit table which is on the small card sheet in the Man O' War game.

**Below the Waterline Hits:** The below the waterline location on a ship's template can usually only be damaged by a ram or as a result of a critical hit. Once all the below the waterline hits of a ship are gone, the ship sinks and is removed from play. On the turn that a ship sinks, place a wreckage marker where the model was on the table. If the Wizard and Admiral were onboard they may cling to the wreckage.

## BOARDING ACTIONS

Once a ship is in contact with an enemy vessel, and you have resolved any shooting and ramming, its crew may attempt to board and capture your opponent's ship.

Roll a dice and add the number of crew counters on your ship. Your opponent does the same, adding +1 to his roll for every cannon he can bring to bear in defence. The player with the lowest total loses 1 crew counter.

If you won, you may carry on attacking, repeating the above procedure, and so on. If you lost, or the result is a draw, your opponent chooses whether he wishes to stop the boarding action and 'breaks off', or whether he wishes to take the initiative and attack you. If he attacks you, you are now the defender and may add any cannons you have in defence to your dice roll.

Once a ship has lost all its crew counters, it has lost the boarding action. The winner may leave it empty or capture it. To capture a ship, the victor must place a spare crew counter from his ship on the enemy ship's template and place it next to his own templates.

**Captured Ships:** Captured ships may be scuttled during the End Phase. If it is kept afloat, a captured ship may not be moved or fire its guns, though it can repel boarders if attacked. At the end of the game a captured ship counts towards the Battle Honours of the player who captured it.

**Crew Limits:** A ship may never have more crew counters on its template than the number indicated on it.

## THE END PHASE

During the End Phase proceed in the following order:

**Pick up Survivors:** Characters (such as Admirals and Wizards) who are clinging to wreckage, may be rescued if one of your ships is touching the wreckage.

**Remove Debris:** Any debris markers on the table are removed. Any characters clinging to the debris are drowned. Any wreckage markers are now swapped for debris markers.

**Fires Spreading:** Roll on the Blaze Spreading Table (on the small card sheet from the Man O' War game) for any of your ship locations that are ablaze. If a blaze goes out, remove the blaze counter and replace it with a damage marker.

**Move Stragglers:** Any stragglers are moved now in an attempt to reunite them with the rest of their squadron.

**Scuttle Ships:** If you decide to scuttle a ship you have captured, remove the model from the table and replace it with a wreckage marker. Any crew onboard are lost unless there is a friendly ship touching the scuttled vessel on which they can be placed, if there is room.

**Remove Counters:** Remove all 'no movement' and 'no firing' counters from the table.

**Pick up Magic Cards:** If your Wizard is still alive, and is not in the water, you may discard any Magic Cards you do not want, and then replenish your hand back up to its maximum.

**Decide Victory:** If the game is over, total up the Battle Honours value of any enemy ships sunk or captured and for any dead characters to determine who has won.



# HIGH WYCOMBE

# GAMES WORKSHOP®

**GRAND OPENING**  
**SATURDAY 24th JULY 1993**



**UNIT 29**  
**THE BALCONY**  
**THE OCTAGON CENTRE**  
**Tel: 0494 531494**

**DOORS OPEN 9.00am!**

**NORMAL OPENING HOURS**

Monday to Saturday 9.00am to 5.30pm

<p>ONLY ONE VOUCHER PER PRODUCT                  REDEEMABLE AT GAMES WORKSHOP                  HIGH WYCOMBE 24TH JULY 1993</p> <p><b>10</b> % OFF</p> <p>ANY GAMES WORKSHOP OR CITADEL PRODUCT</p> <p>NOT TO BE USED WITH ANY OTHER OFFER</p>	<p>ONLY ONE VOUCHER PER PRODUCT                  REDEEMABLE AT GAMES WORKSHOP                  HIGH WYCOMBE 24TH JULY 1993</p> <p><b>10</b> % OFF</p> <p>ANY GAMES WORKSHOP OR CITADEL PRODUCT</p> <p>NOT TO BE USED WITH ANY OTHER OFFER</p>
<p>ONLY ONE VOUCHER PER PRODUCT                  REDEEMABLE AT GAMES WORKSHOP                  HIGH WYCOMBE 24TH JULY 1993</p> <p><b>10</b> % OFF</p> <p>ANY GAMES WORKSHOP OR CITADEL PRODUCT</p> <p>NOT TO BE USED WITH ANY OTHER OFFER</p>	<p>ONLY ONE VOUCHER PER PRODUCT                  REDEEMABLE AT GAMES WORKSHOP                  HIGH WYCOMBE 24TH JULY 1993</p> <p><b>10</b> % OFF</p> <p>ANY GAMES WORKSHOP OR CITADEL PRODUCT</p> <p>NOT TO BE USED WITH ANY OTHER OFFER</p>
<p>ONLY ONE VOUCHER PER PRODUCT                  REDEEMABLE AT GAMES WORKSHOP                  HIGH WYCOMBE 24TH JULY 1993</p> <p><b>25</b> % OFF</p> <p>ANY GAMES WORKSHOP OR CITADEL PRODUCT</p> <p>NOT TO BE USED WITH ANY OTHER OFFER</p>	<p>ONLY ONE VOUCHER PER PRODUCT                  REDEEMABLE AT GAMES WORKSHOP                  HIGH WYCOMBE 24TH JULY 1993</p> <p><b>25</b> % OFF</p> <p>ANY GAMES WORKSHOP OR CITADEL PRODUCT</p> <p>NOT TO BE USED WITH ANY OTHER OFFER</p>

PLEASE NOTE: YOU CANNOT USE THE VOUCHERS WITH ANY OF THE ABOVE OFFERS OR ON MB GAMES' HEROQUEST, SPACE CRUSADE OR BATTLEMASTERS.



**BUY ANY TWO RED DOT ITEMS AND GET ONE YELLOW DOT ITEM FREE!**

Eg., Buy Bloodbowl and Mighty Empires and get Dungeombowl FREE!

**BUY ANY TWO BLISTER PACKS AT £3.99 OR MORE AND GET ONE ADDITIONAL £3.99 BLISTER PACK FREE!**

Offers open all day (while stocks last).

# THURROCK LAKESIDE

# GAMES WORKSHOP®

## GRAND OPENING

**SATURDAY 17th JULY**

**Doors Open 9am!**

**UNIT 415  
LEVEL 3 / FOOD COURT  
THURROCK LAKESIDE  
SHOPPING CENTRE  
Tel: 0708 867133**

**Normal Opening Hours  
Monday to Thursday 10am – 8pm,  
Friday 10am to 9pm, Saturday 10am to 7.30pm  
Games Night every Thursday**

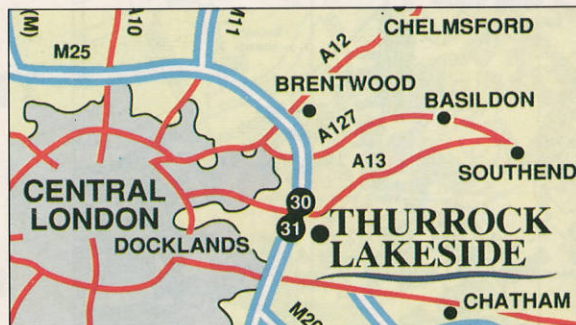

**BUY ANY TWO RED DOT ITEMS AND GET ONE YELLOW DOT ITEM FREE!**

**Eg., Buy Warhammer 40,000 and Space Hulk and get the Warhammer 40,000 Battle Manual FREE!**

**BUY ANY TWO BLISTER PACKS AT £3.99 OR MORE AND GET ONE ADDITIONAL £3.99 BLISTER PACK FREE!**

**Offers open all day (while stocks last).**

<p>ONLY ONE VOUCHER PER PRODUCT REDEEMABLE AT GAMES WORKSHOP THURROCK 17TH JULY 1993</p> <p><b>10 % OFF</b></p> <p>ANY GAMES WORKSHOP OR CITADEL PRODUCT</p> <p>NOT TO BE USED WITH ANY OTHER OFFER</p>	<p>ONLY ONE VOUCHER PER PRODUCT REDEEMABLE AT GAMES WORKSHOP THURROCK 17TH JULY 1993</p> <p><b>10 % OFF</b></p> <p>ANY GAMES WORKSHOP OR CITADEL PRODUCT</p> <p>NOT TO BE USED WITH ANY OTHER OFFER</p>
<p>ONLY ONE VOUCHER PER PRODUCT REDEEMABLE AT GAMES WORKSHOP THURROCK 17TH JULY 1993</p> <p><b>10 % OFF</b></p> <p>ANY GAMES WORKSHOP OR CITADEL PRODUCT</p> <p>NOT TO BE USED WITH ANY OTHER OFFER</p>	<p>ONLY ONE VOUCHER PER PRODUCT REDEEMABLE AT GAMES WORKSHOP THURROCK 17TH JULY 1993</p> <p><b>10 % OFF</b></p> <p>ANY GAMES WORKSHOP OR CITADEL PRODUCT</p> <p>NOT TO BE USED WITH ANY OTHER OFFER</p>
<p>ONLY ONE VOUCHER PER PRODUCT REDEEMABLE AT GAMES WORKSHOP THURROCK 17TH JULY 1993</p> <p><b>25 % OFF</b></p> <p>ANY GAMES WORKSHOP OR CITADEL PRODUCT</p> <p>NOT TO BE USED WITH ANY OTHER OFFER</p>	<p>ONLY ONE VOUCHER PER PRODUCT REDEEMABLE AT GAMES WORKSHOP THURROCK 17TH JULY 1993</p> <p><b>25 % OFF</b></p> <p>ANY GAMES WORKSHOP OR CITADEL PRODUCT</p> <p>NOT TO BE USED WITH ANY OTHER OFFER</p>

PLEASE NOTE: YOU CANNOT USE THE VOUCHERS WITH ANY OF THE ABOVE OFFERS OR ON MB GAMES' HEROQUEST, SPACE CRUSADE OR BATTLEMASTERS.

# ILLUMINATIONS



Mark Gibbons is a 27 year old Welshman who dropped out of Art School to play guitar in a hard rock band and has never looked back.

Mark worked as a freelance illustrator for Games Workshop for nearly two years before the winning combination of his artistic skill and dedicated enthusiasm for the Games Workshop imagery, led to him joining the studio team as a full-time artist in February 1992.

Although largely self-taught, Mark's artwork displays a unique vision of the dark and brooding worlds of Warhammer.





NIGHT GOBLIN SQUIG HOPPERS



FELIX AND GOTREK



NJAL STORMCALLER



DARK ANGEL TERMINATOR



GENESTEALER MAGUS AND TERMINATORS

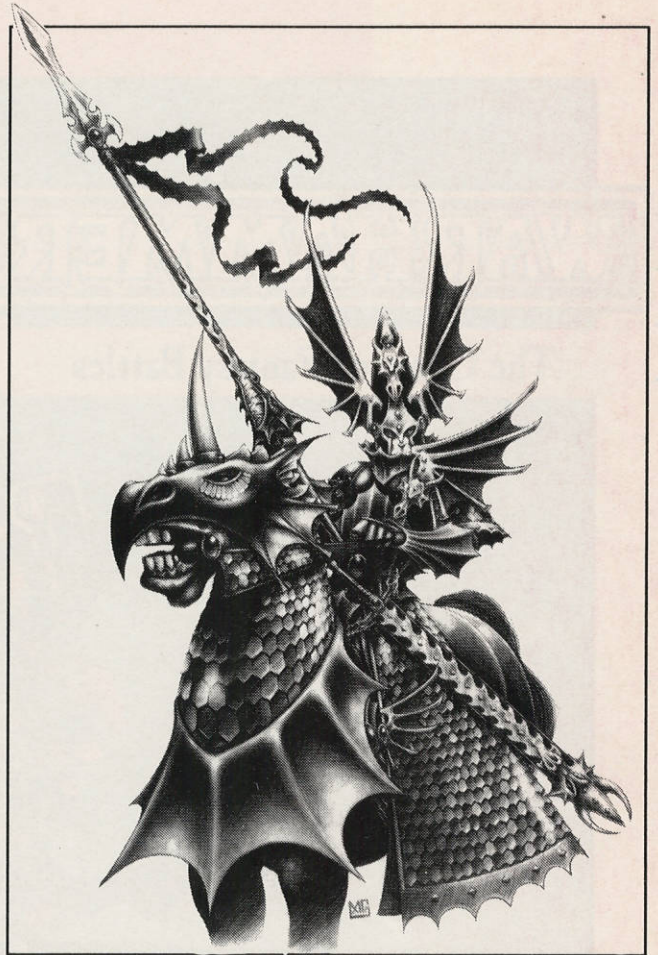

DRAGON PRINCE OF KALEDOR

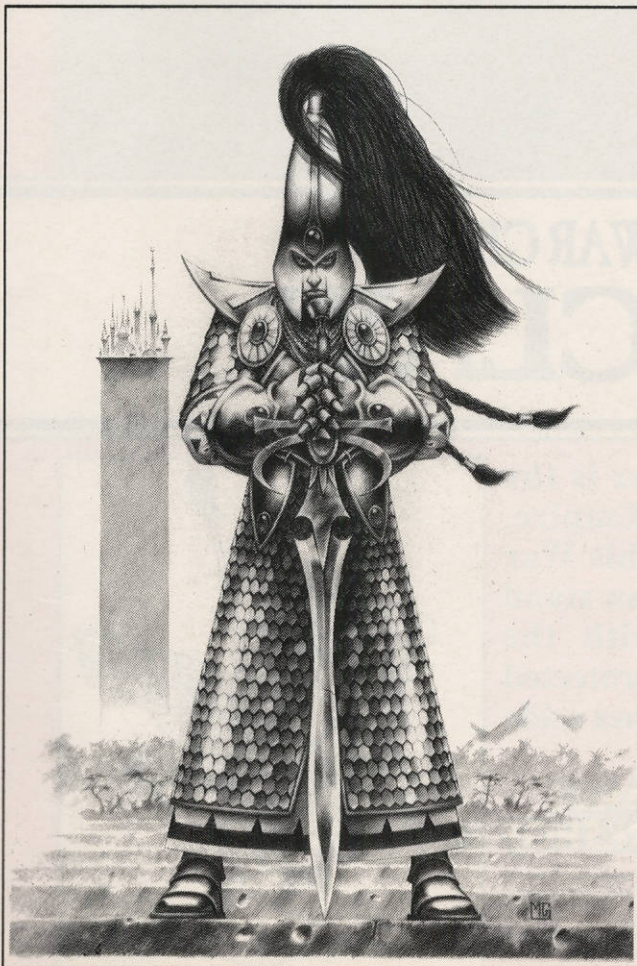

SWORD MASTER OF HOETH



BRAT GANG

# WARHAMMER

The Game of Fantasy Battles



## THE EMPEROR'S WAR GRIFFON DEATHCLAW

**MARAUDER**  
MINIATURES

Griffon model designed by  
Trish Morrison

Emperor model designed  
by Michael Perry

Miniatures supplied unpainted.  
Banner not included.

The Games Workshop logo and Warhammer are registered trademarks of Games Workshop Ltd. Citadel and Games Workshop are trademarks of Games Workshop Ltd.

© Games Workshop Ltd 1993.

The Emperor Karl Franz is the mightiest hero of the Empire. Charging into battle on his War Griffon Deathclaw, few can stand against him. Armed with the Hammer of Sigmar and protected by the Silver Seal he smashes aside his enemies and leads his armies to glorious victory.

**GAMES**  
**WORKSHOP**

Marauder miniatures are supplied unpainted. This model requires assembly. We recommend that parts are carefully cleaned and trimmed with a modelling knife before assembly, and that the model is undercoated before painting with Citadel paints.

**WARNING!** These models contain lead and may be harmful if chewed or swallowed. Citadel Miniatures are not recommended for children under 14 years of age.

Marauder is a registered trademark of Marauder Miniatures Ltd. Used with Permission.





# MIGHTY EMPIRES™

## WARHAMMER CAMPAIGNS

**For experienced players, the campaign is the logical progression from fighting one-off battles. The Mighty Empires game is designed to link individual Warhammer battles into a full-blown campaign between several players. Rick Priestley explains...**

I am often asked if there will be additional models or rules for Mighty Empires, and all the more so now that so many new gamers have taken up Warhammer with the release of the boxed game. Warhammer is of course, a game about fantasy battles, where each player represents the commander of an army pitting his wits against an enemy general and his forces. At the end of the day you have a winner and a loser, one army victorious and another fleeing in ignominious retreat.

The challenge of generalship, of assembling a potent army and wielding it with skill and understanding, is considerable in itself. Indeed these abilities don't always come easily even after years of experience! However the battle isn't the end of the road by any means. For experienced Warhammer players looking for a fresh challenge there is the campaign.

In a campaign, each player represents a whole nation, with as many armies as he can recruit and with an imperial treasury to spend on military adventures. Unlike the battle, which is won or lost in a single playing session, the campaign can last for weeks at a time – even longer if you want it to. Over several game turns representing years of real time, you will see your empires expand, your armies fight battles (lots of them!) and your coffers swell as trade and conquest bring riches into your capital.

By means of moving pieces around the map, you'll be able to watch your progress, observe enemy threats and direct your armies around your far flung empire. In essence that is what Mighty Empires is about. The winner is the player whose armies subdue the enemy, destroy his cities, and ultimately conquer the whole world!



## MIGHTY EMPIRES

Following on from last year's release of the the new boxed Warhammer game, I thought it a good idea to go back to Mighty Empires, partly to bring it to the attention of all the new Warhammer players, but also to discuss our future plans for the new Mighty Empires miniatures. The inspiration for this article came from the dank depths of the Mail Order department, where fastened on the wall there is a huge and spectacular Mighty Empires map. Over this map range the armies of the Mail Order staff, from Empire to Orcs, with a few High Elves for good measure. It is here that moves are enacted at lunchtime and battles fought out in the evenings. The players have mounted the map onto a sheet of stiff card and covered it with polythene to keep it clean. Because the map is mounted on the wall (rather than laid flat), map pins designate the movements of the armies instead of the usual plastic pieces. Amongst the sounds of frenzied packing and the cracking of the lash, the dribbly Mail Order Trolls, lay crazed plans for conquest under the gaze of that map!

### THE MIGHTY EMPIRES MAP

For those who have yet to take part in a Mighty Empires campaign, the game is fought out over a map. The map represents a fantasy world, or part of a world created by the players - it could be an obscure corner of the Warhammer World if you want to think of it as such. As you can make and remake maps quickly, it is possible to create a world and fight out a few satisfying battles without spending long hours in preparation. In fact, making maps is one of the most fun things about the Mighty Empires game. The maps are made using the Mighty Empires tiles. The tiles are hexagon shaped and illustrated with terrain features: these are plains, hills, mountain ranges, rivers, coasts and various special geographic features such as marshlands. By arranging the tiles together you can create a dramatic world to fight over. The Mighty Empires game describes ways in which the tiles can be arranged either by one person or by several players together

As the map unfolds before you, the locations of capital cities will be revealed - these locations being marked on the tiles themselves. Capital cities are where the various players begin from. The capital city and its surrounding area is known as the player's realm. Capital cities and other locations, cities, villages and fortresses are represented by counters which are provided in the game itself. Further locations have been described at various times in White

Dwarf and a range of metal models is available to represent them. These extra models, some of which are shown on the 'Eavy Metal page in this issue, include mines which provide extra revenue from gold and silver, ancient necropolises where treasures can be uncovered, temples where you can summon the aid of the gods and so on. Once each player has chosen and populated his realm he is ready to make plans for world domination.

### THE GAME UNFOLDS

A player's ambitions will usually centre around rapid expansion. By exploring new territories you can build up a sprawling empire, with more cities, villages and a vast population to recruit into your armies. The bigger your empire, the more money comes into your imperial coffers by way of taxation, and the more you can spend on raising new armies. Simple enough! However, remember your opponents are all trying to do exactly the same thing. At the start of the campaign there will be plenty of empty space on the map, room enough to expand and explore without coming into conflict with your neighbours. This harmonious state of affairs never lasts very long. Soon you will have gathered all of the unconquered territories into your empire and borders will have to be established between you and the adjoining players. At this point you will have to play carefully, especially if there are several players involved, all willing to conspire against you if it serves their interests.

Armies are represented by counters called banners, each of which represents somewhere between 500 and 1500 points worth of troops. These armies are moved about the map in order to explore unknown lands, meet and defeat enemy armies and attack enemy settlements. Inevitably there will be battles, as rival players clash over disputed territory. When two armies meet on the map, the resulting conflict is played out as a Warhammer battle on the tabletop, using appropriate model armies. Obviously the battles won't always be fair, with equal forces engaged on both sides, sometimes they will be distinctly unfair, but that is all part and parcel of the campaign. Tiny forces will get cut off and small bands of warriors will be forced to fight a heroic defence in the face of overwhelming odds. There will even be occasions, when small armies beat much larger forces, turning the tide of history by some outstanding deed of valour. All this is part of the fascination of a campaign in which the results of your battles influence the entire course of history and determine the fate of whole nations.



**MIGHTY EMPIRES™**

Mighty Empires is not just a complete campaign system for Warhammer players, it can also be played as a game in its own right. This page shows some of the growing range of Mighty Empires models, including some of the plastic models from the game itself.

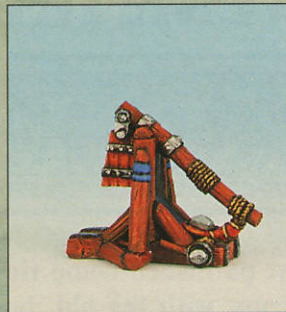

THE MONSTER  
STONE THROWER



THE GIANT  
BATTERING RAM

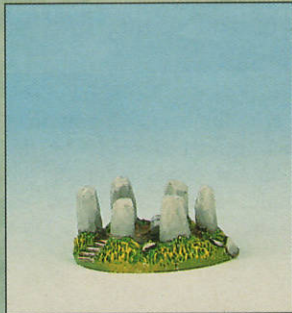

STONE CIRCLE



VILLAGE



SIEGE TOWER



GREAT CANNON



TEMPLE

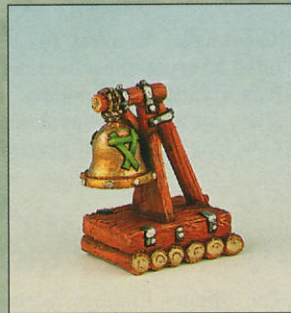

SKAVEN SCREAMING BELL



CITY



MINE

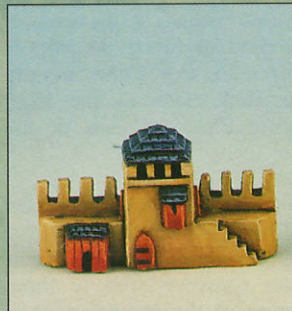

GREAT WALL

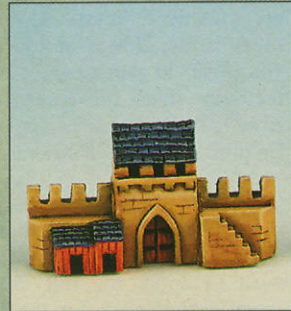

GREAT WALL



GREAT WALL

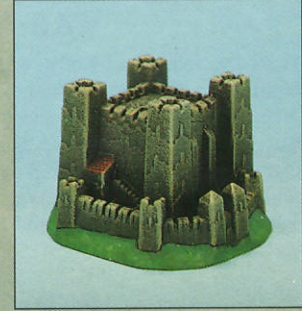

FORTRESS



SHIP



SKAVEN BANNER



DRAGON



HUMAN BANNER

# MIGHTY EMPIRES AND THE NEW



Mighty Empires was first published some time before the new boxed Warhammer game and was originally design for use with the old, book version of Warhammer. However, this makes almost no difference to the game except for a few details which are discussed here. Certainly, new Warhammer players shouldn't feel daunted by exploring Might Empires for themselves. The following rules amendments will be of interest to existing players of the game, and of course, to anyone who is planning to start a Might Empires campaign soon.

## THE REALM'S ARMY

The Realm's Army is represented by a number of counters called Banners — each banner represents between 500 and 1500 points of troops. The Mighty Empires rulebook describes how to choose your troops and allocate them to individual banners before the campaign starts. In practice, players find it much better not to do this. An alternative method is simply to allocate the points value to the banner as normal, but don't choose the actual armies until you come to fighting a battle.

For example, your 1200 point banner of High Elves comes into conflict with a 1500 point banner of Orcs — you choose 1200 points of High Elves from the Warhammer Armies list and your opponent chooses 1500 points of Orcs from the Warhammer Armies Orc and Goblin list. Simple! Should the game banners fight again at some future point in the game you are free to choose your armies from scratch once more — it isn't necessary to use the same troops as before. Although not 100% logical by any means, this is a much more practical way of fighting a battle, and ensures that games are always reasonably balanced.

## WAR AT SEA

With the release of the new Man O' War game, it will be possible to fight engagements at sea rather than by a simple dice roll as described in the Mighty Empires rulebook. This can be done in the same manner as a land battle, with each Mighty Empires ship counter representing, say 1000 points worth of Man O' War ship models. This allows you to play a properly integrated campaign with naval action as well as land forces.

## RECRUITMENT

The rules given for recruitment are not used if armies are chosen only as and when encounters occur, as already described. Choose your army from the Warhammer Armies list as you would for a battle. Ignore the rulebook section on *revising old units, characters, recruiting mercenaries and recruiting allies*. When you choose your army immediately prior to the battle, you can include elite troops, characters, and allies as defined by your Warhammer Armies list.

## ASSASSINS

The Assassin table describes how specific characters in an army can be slain. As the revisions discussed above do not

allocate specific characters to specific banners, you must reduce the points value of each banner instead. As this alternative is already covered on the Assassin chart, this poses no problem. For example, a roll of 4 on the Assassin's chart will reduce the size of the banner by D6 x 100 points.

## FIGHTING BATTLES AND DURATION OF PLAY

The Mighty Empires rules suggest allowing up to 16 -D6 turns to represent a Warhammer battle. This is a bit on the long side to put it mildly. Instead, it is suggested that you allow up to 6 turns as described in Warhammer — or agree how long you are to play for yourselves.

## CASUALTY RECOVERY OF CHARACTERS

The Mighty Empires rulebook describes how your specific characters may be obliged to spend time recovering their wounds after a battle. This won't really work where troops are effectively dissolved back into points at the end of every battle. However, you may continue to use the rules if you wish. In particular, it makes sense to use the casualty recovery rules for named characters, such as the High Elves, Tyrion and Teclis, specific Elector Counts of the Empire, Grom the Warlord etc.

Obviously it is a bit peculiar to allow players to choose the same character, for example Tyrion, time after time for different armies fighting in different places. So, you might wish to apply the full character recovery rules to these specific characters for the duration of the campaign. It is perhaps unnecessary to tie a specific character to a specific banner, but it does seem sensible to rule that the same character cannot be in two places simultaneously. In practice this means that when you are fighting two battles in the same turn, you can only include the same specific individual in one battle and not both. Of course, this doesn't stop you using your character models to represent other heroes or wizards as is convenient.

Rules for Battlefield Damage, Routers and Booty in the Tabletop battle section may be ignored as all these assume a continuous record is kept of the contents of each army. The rules for Prisoners may be used for specific character models.

# CITADEL MINIATURES™



## CATALOGUE



The third volume of the Citadel Miniatures Catalogue updates the vast Warhammer and Warhammer 40,000 miniature ranges covered in the previous two volumes. It also includes the complete Epic Space Marine range, a section on Marauder Miniatures and all the latest Games Workshop games and supplements.





# EAVY METAL

## PAINTING GUIDE

By Mike McVey

This month sees the release of the long awaited 'Eavy Metal Painting Guide. This book is the most comprehensive guide to collecting and painting Citadel Miniatures ever published, a compilation of miniature painting lore collected over the last ten years, bound into a single volume. It covers everything from preparing and painting your very first miniature, to the wonderfully subtle techniques used by The 'Eavy Metal Team.



The 'Eavy Metal Painting Guide is the first volume in a series of painting and modelling guides that we have planned. As the first in the series the aim of the 'Eavy Metal guide is to lay the groundwork for subsequent works. Though we have published several painting guides in the past, these have always been brief, pamphlet type publications, designed to

demonstrate only the absolute basic techniques. The 'Eavy Metal guide caters for everyone, from the complete beginner to experienced Golden Demon entrants. By writing the 'Eavy Metal Painting Guide I hope to provide a book that people will keep going back to, not only to refer to and learn new techniques, but also to act as a constant source of inspiration. You never stop learning. After six years as a professional miniature painter in the Games Workshop studio, I'm still constantly discovering and being shown new and varied techniques. Not only by the other miniature painters in the Studio, but also from events like the Golden Demon Awards, where some of the finest painters in the world battle it out. By collecting and compiling these new methods and techniques and sharing them with a wide audience, I'm hoping that everyone will benefit and the standard of miniature painting in general will be raised.

The main bulk of the 'Eavy Metal Painting Guide is split into sections that concentrate on different types, or even specific parts of miniatures. These sections include armour and weapons, fur and hair, patterns and decoration, monsters, vehicles and horses. When I'm giving painting demonstrations in Games Workshop stores and answering my mail, the most commonly asked question is how to paint faces. So there's a whole section devoted to painting faces and skin: this is further broken down into sub-sections about teeth, eyes, lips, different skin tones and even warpaint and tattoos. Each point is carefully demonstrated on miniatures, and where appropriate, with diagrams and illustrations — there's even a stage by stage diagram of how to paint the eyes on your miniature. These sections demonstrate techniques, such as the best ways of shading and highlighting fur, which can then be applied to any appropriate miniature, and will apply equally to painting a Beastman or the fur cloak on a Space Wolf Lord.

Many of the sections have 'Eavy Metal pages included within them, packed full of photographs of painted miniatures that are relevant to that section — ranging from standard bearers to Epic troops and tanks. These pages are there not only to demonstrate how particular techniques work in practice but will hopefully inspire beginners and experienced painters alike.



invaluable reference point for anyone who is collecting an army. Not only does it give a detailed step-by-step guide on painting the troopers, but it also shows a unit leader or character figure for that particular race. The reference guide is not designed to give you every piece of information that you'll need to paint a particular army, just a starting point for the most common troop types. This will hopefully give you a feel for the colour schemes and markings of that race and also give you the confidence to go on and paint the rest of your army.

I've also included two full pages of banners for you to cut out and use on your miniatures. One page is full colour and the other has black and white line drawings for you to colour in. The banners section includes detailed descriptions of several different ways of painting your banners. Both of these pages are blank on the reverse side, so you won't be losing any valuable information by cutting them out!

I've tried to make the 'Eavy Metal Painting Guide as valuable a reference work as possible, complete with descriptions of techniques, personal tips and of course photographs of many painted examples. Hopefully it is a volume which will serve every painter, whether your interest is in painting individual miniatures or whole armies, and you'll keep on going back to it for years to come.

As I mentioned earlier, the 'Eavy Metal Painting Guide is only the first book in a whole series that we have planned for the next couple of years. We haven't made any definite decisions yet but there are several subjects that would make invaluable guides, and the next book in the series is already underway.



## THE WARHAMMER 40,000 PAINTING GUIDE

The Warhammer 40,000 Painting Guide will concentrate on painting the wide variety of miniatures found in the game. Imagine a book that will give you highly detailed descriptions about how to paint every race and every troop type found within the Warhammer 40,000 Universe! That's exactly what we're aiming to do— provide a source book that will benefit every single Warhammer 40,000 player by providing in-depth information about colour schemes and all the techniques used to achieve them. The book will be divided up into different races, and each section will start by looking at the characteristic colours used and techniques needed before moving onto the different troop types and specialists. Vehicles and characters will be dealt with separately, as the most important aspect of the game they need special attention. The Warhammer 40,000 Painting Guide will contain some of the same features as the 'Eavy Metal Painting Guide — stage-by-stage guides to painting specific miniatures, 'Eavy Metal pages for reference and inspiration, and more pages of cut out banners.

For the future we are considering other guides too. One of these is a Scenery and Modelling Guide, which will show you how to build your own gaming table and kit it out with the superb terrain that you see in White Dwarf every month. Then there is the Epic Painting Guide which will contain detailed information about how to paint Titans as well as every sort of Epic Troop and Vehicle. A follow on from these will be an Advanced Painting and Conversion Guide. This will cover the methods used to create new and original miniatures by compiling parts from different models. It will also feature more advanced painting techniques that will really make characters and display miniatures come to life

All in all it's an exciting time for me, working on a series of books that will hopefully be used by, and be of benefit to miniature painters throughout the world. The first book in the series, The 'Eavy Metal Painting Guide is finished and already available, so watch the pages of White Dwarf for more news on how the others are progressing.



# GAMES WORKSHOP®

## A WORLD OF FANTASY GAMING

The first thing you notice when entering a Games Workshop store is how different it is from nearly every other shop. Here you'll find not only everything you need for the gaming hobby, but much more besides. With friendly approachable staff and a vast range of Citadel and Marauder miniatures, you'll find everything you need to build up an army for Warhammer, Warhammer 40,000 or Space Marine.



Top: The gaming tables at the Peterborough store.

Right: Enthusiasts enjoying a game of Warhammer at the Leicester store.



## WARHAMMER DAYS



Throughout the summer, every Games Workshop Store in the UK will be running special Warhammer Days. There'll be competitions, prizes, quizzes, painting and modelling demonstrations, and of course loads of games of Warhammer, Warhammer 40,000 and Space Marine that you can join in with. Games Workshop's expert gamers, painters and modellers will all be there so come along and join in the fun.

<b>10th July</b>	<b>17th July</b>	<b>24th July</b>	<b>31st July</b>
<b>HULL</b>	<b>LIVERPOOL</b>	<b>LUTON</b>	<b>STOKE</b>
<b>and</b>	<b>and</b>	<b>and</b>	<b>and</b>
<b>BRIGHTON</b>	<b>HAMMERSMITH</b>	<b>SHEFFIELD</b>	<b>TORQUAY</b>



## SPACE MARINE



**Top:** A game of Space Marine at the Leicester store.



**Left:** Bob from the Nottingham store gives some tips on miniature painting.

**Below:** Some of the vast range of stock in a typical store.

**Bottom:** An exciting game of Warhammer 40,000 at the Peterborough store.



**WARHAMMER**  
40,000

## GAMES<sup>®</sup> WORKSHOP STORES

**NEW STORE!** ABERDEEN: UNIT 1, UPPER KIRGATE.  
TEL: 0224 621261

BECKENHAM: 292-294 HIGH ST. TEL: 081 658 8102

BELFAST: 20A CASTLE COURT. TEL: 0232 233684

BIRMINGHAM: 116 CORPORATION STREET. TEL: 021 236 7880

**NEW STORE!** BOLTON: UNIT 25, FIRST FLOOR GALLERY,  
SHIPGATES CENTRE.

BRIGHTON: 7 NILE PAVILIONS, NILE ST. TEL: 0273 203333

BRISTOL: 13 BROAD WEIR. TEL: 0272 251533

BROMLEY: 8 BROMLEY MALL. TEL: 081 466 0678

CAMBRIDGE: 4 QUAYSIDE, (OFF BRIDGE ST). TEL: 0223 313350

CARDIFF: 29-30, HIGH STREET. TEL: 0222 644917

CHELTENHAM: 16 PITVILLE STREET. TEL: 0242 228419

CHESTER: 112 FOREGATE STREET. TEL: 0244 311967

COLCHESTER: 2 SHORT WYRE STREET. TEL: 0206 767279

COVENTRY: 14 CITY ARCADE. TEL: 0203 227311

CROYDON: UNIT 35, DRUMMOND CENTRE, KEELEY RD.  
TEL: 081 680 4600

DERBY: 42 SADLER GATE. TEL: 0332 371657

DUDLEY: KIOSK U, UPPER LEVEL, MERRY HILL CENTRE,  
DUDLEY. GAMES NIGHT: THURS TILL 9.00. OPEN MON - FRI.  
10.00 TILL 8.00. SAT 9.00 TILL 7.00. TEL: 0384 481818

EDINBURGH: 136 HIGH ST. OPEN SUN 11 - 5. TEL: 031 220 6540

GLASGOW: 66 QUEEN ST. TEL: 041 226 3762

GUILDFORD: 12 TUNSGATE. TEL: 0483 451793

HAMMERSMITH: 1 DALLING ROAD. TEL: 081 741 3445

HARROW: 296 STATION RD. TEL: 081 861 2350

**NEW STORE!** HIGH WYCOMBE: UNIT 29, THE BALCONY,  
THE OCTAGON CENTRE. TEL: 0494 531494

HULL: 30 PARAGON STREET. TEL: 0482 589576

LEEDS: 12-16 CENTRAL ROAD. TEL: 0532 420834

LEICESTER: 16/20 SILVER ST. TEL: 0533 530510

LIVERPOOL: 47 LORD STREET. TEL: 051 258 1404

CENTRAL LONDON: UNIT F10, THE PLAZA, 116-128 OXFORD  
STREET. TEL: 071 436 0839

LUTON: 12 PARK STREET. TEL: 0582 417474

MAIDSTONE: UNIT 6, 1-9 PUDDING LANE. TEL: 0622 677435

**NEW STORE!** MAIDENHEAD: 2 BLANDY HSE, 3/5 KING ST.  
TEL: 0628 21854

MANCHESTER: UNIT 1, 3 BROWN STREET. TEL: 061 832 6863

MEADOWHALL CENTRE SHEFFIELD: 91B, HIGH ST,  
UPPER MALL. OPEN MON TO THURS 10 - 8. FRIDAYS 10 - 9,  
SATURDAYS 9 - 7, SUNDAYS 12 - 4. TEL: 0742 569836

MIDDLESBROUGH: 39 DUNDAS ST. TEL: 0642 254091

NEWCASTLE: 63 CLAYTON STREET. TEL: 091 232 2418

**NEW STORE -** NEWCASTLE: METROCENTRE, UNIT R14,  
FIRST FLOOR. TEL: 091 461 0950

NORWICH: 12-14 EXCHANGE STREET. TEL: 0603 767656

NOTTINGHAM: 34a FRIAR LANE. TEL: 0602 480651

OXFORD: 1A NEW INN HALL ST. TEL: 0865 242182

PETERBOROUGH: 3 WENTWORTH STREET. TEL: 0733 890052

PLYMOUTH: 84 CORNWALL STREET. TEL: 0752 254121

PORTSMOUTH: 34 ARUNDEL STREET. TEL: 0705 876266

PRESTON: 15 MILLER ARCADE. TEL: 0772 821855

READING: UNIT 3, CHEAPSIDE. TEL: 0734 598693

SHEFFIELD: 16 FITZWILLIAM GATE. TEL: 0742 750114

SOUTHAMPTON: 23 EAST STREET. TEL: 0703 331962

SOUTHEND: 12 SOUTHCHURCH RD. TEL: 0702 461251

STOKE ON TRENT: 27 STAFFORD ST, HANLEY. TEL: 0782 205287

SWINDON: 17 FLEET STREET. TEL: 0793 436036

THURROCK LAKESIDE: UNIT 415, LEVEL 3/FOOD COURT,  
THURROCK LAKESIDE (JUNCTIONS 30/31, M25).  
TEL: 0708 867133. OPEN MON - THU 10 - 8, FRI 10 - 9, SAT 10 - 7.30.

TORQUAY: 12 MARKET ST. TEL: 0803 201036. (Closed Tuesdays)

WORCESTER: 4 CHARLES STREET. TEL: 0905 616707

YORK: 26 GOODRAMGATE. TEL: 0904 653575



## THE BATTLE AT THE EAST GATE OF KARAK EIGHT PEAKS

Karak Eight Peaks was once the most powerful of all the holds in the southern part of the Worlds Edge Mountains. Its vast halls, cavernous mines and untold splendours were the envy of the Dwarf realms. Only the newer and larger hold of Karaz-a-Karak was richer and more renowned. Even so, Karak Eight Peaks was accorded the most respect for it was the older of the two strongholds. The people of this ancient hold were descended from some of the earliest settlers, even from the Ancestor Gods and their sons. When Karak Eight Peaks fell it was a sorrowful day for the Dwarfs. Many inhabitants died defending their hold, but some fled to seek sanctuary in the north.

As the years passed the Dwarfs watched as their once powerful realm became the lair of Night Goblins and Skaven. The descendants of Lunn, the last king of Karak Eight Peaks, made what plans they could to reclaim their lost realm, but it was not until many hundreds of years later that they were able to make any serious attempt to retake the hold. After several terrible defeats, and many further generations of preparation, the Dwarf Lord Belegar led a partially successful expedition to reclaim his inheritance. He drove the Night Goblins from the ruins on the surface, and reoccupied the old citadel. Before the Goblins could regather their strength, the Dwarfs refortified and strengthened the citadel to make it virtually impregnable.

Belegar hoped to use the citadel as a base from which to launch expeditions into the surrounding mountains and underground into the ancient subterranean halls. Although the Dwarfs have managed to reach some of the old mines and recover many valuable treasures, they have never succeeded in expanding their control beyond the citadel. The surrounding mountains and the depths below remain in the hands of their enemies. The Dwarfs live in a state of perpetual siege, threatened from all sides by hostile Goblins and from below by the Skaven.

In an attempt to break this deadlock King Belegar sent word back to his kinsmen in Karaz-a-Karak to raise reinforcements and come to his aid. The king's oldest relative, Lord Duregar, immediately set about gathering an army to march south. Duregar's forces were somewhat hurriedly assembled, and included a band of Slayers as well as the Runesmith Hurgar the Black. The army moved south along the western edge of the Worlds Edge Mountains. The army was soon confronted by foes, and fought a large Orc army at the Battle of the Jaws at the western end of Mad Dog Pass. After vanquishing the Orcs, Duregar moved eastwards through the pass and then continued south towards Death Pass and the East Gate of Karak Eight Peaks.

The East Gate of Karak Eight Peaks lay several miles inside Death Pass, through a broad side valley paved with ancient stones and studded with the ruined tombs of Dwarf ancestors. The Dwarfs advanced in battle formation fully expecting an attack from the steep mountain slopes which towered ominously above the old Dwarf road. The East Gate had been built thousands of years before at a place where a long ridge ran down into the valley causing it to narrow to a hundred yards or less. Here the Dwarfs of antiquity had built their gate, once a vast and impregnable fortress but now little more than a pile of stone through which the road still led. In front of the gate and connected to it by a high causeway was a tall grey watchtower whose summit commanded the approach down the valley. Although partially ruined, the watchtower had been rebuilt and fortified by Night Goblins. As the Dwarfs marched towards the gate, they saw that the watchtower was held against them.

As the Dwarfs marched onwards Orcs and Goblins emerged from the rocks along the valley slopes and closed in on either side. Behind them a group of Orcs moved up to block the Dwarfs' escape. Duregar's army was surrounded by foes on all sides. Stones from a rock lobster perched on top of the watchtower began to fall amongst the Dwarfs' densely packed ranks. The Dwarfs pushed forward quickly, pinning their hopes on breaking through the East Gate and reaching the citadel beyond. As they approached the first rank of Night Goblins a massive whoop went up amongst the greenskins, and from out of their formation charged Night Goblin Fanatics whirling balls and chains. Like spinning tops they lurched crazily towards the Dwarfs. Many were shot down with crossbow bolts, some whirled away and missed the Dwarfs altogether, but some made contact killing many Dwarfs before collapsing from exhaustion.

The Dwarfs advanced. The Night Goblins in front were easily driven away, but just as soon as a gap appeared and the Dwarfs caught sight of the gate more Night Goblins charged in to hold them. Night Goblin archers rained arrows down from the watchtower. Black-fletched arrows hit Dwarf and Night Goblin alike, but the archers carried on shooting regardless, ignoring the hurt done to their fellows.

Things looked bleak for the Dwarfs. Over half of their army had been destroyed during the initial rush towards the gate. The Goblin horde seemed hardly diminished. With typical Dwarf stubbornness Duregar led his troops up onto a small mound, the remains of an ancient Dwarf tomb, to make his last

stand. As the Dwarfs steeled themselves for the inevitable assault, there was a loud explosion and the gateway burst apart in a cloud of dust. As the dust cleared Duregar saw Dwarfs pouring through the gateway towards them. The confused Night Goblins scattered leaving piles of dead in their wake. It was King Belegar and the Dwarfs of Karak Eight Peaks. They had advanced eastwards from the other side of the gate and destroyed the unsuspecting Night Goblin rear-guard before blowing the gates with gunpowder.

The Night Goblins and Orcs were thrown into disorder. The Night Goblin warlord, an evil and twisted creature called Skarsnik, watched from his vantage point above the valley and saw his army begin to waver. For the Dwarfs it was a much needed respite. Their two forces met across a sea of blood and green bodies. Forming into a huge and solidly packed square the combined Dwarf army began to move steadily back towards the gateway. Before they were halfway there the Orcs and Goblins regrouped, their confidence restored by seeing how few Dwarfs were left. Stones from the rock lobster smashed into the Dwarf column and arrows fell amongst their ranks.

Many Dwarfs stumbled to the ground dead with Goblin arrows embedded in them, but more still made it to the gate. Cave squigs were unleashed upon the Dwarfs, but several were killed by Troll Slayers while others ran wild snapping at the Night Goblins, biting off limbs and heads before vanishing into the mountains. Smashing through the few Night Goblins that remained to oppose them Lord Duregar and King Belegar headed west. The Night Goblins continued to harass the Dwarf

column all the way to the citadel, but thanks to their heavy armour there were few more casualties. As night fell Skarsnik was master of the battlefield, but Duregar and Belegar had escaped his net.

The Battle of East Gate went down in the Dwarf annals as a great and heroic adventure against overwhelming odds. The Dwarfs could never have won the battle, but they came about as close as it was possible to get. Perhaps it was foolish of Duregar to fall so easily into Skarsnik's trap, but when it came to the crunch the Dwarfs' heroism and determination saved the day. The Dwarfs were unlucky to find themselves facing one of the most cunning Night Goblins of all time. Ordinarily the natural disorganisation of the Orcs and Goblins would have enabled Duregar to move his army before the greenskins could muster much resistance. However, with Skarsnik's iron grip over the mountains, and his extensive network of spies and watchtowers, the Dwarfs found their every footstep shadowed and their every move blocked.

The Dwarfs lost many warriors in their attempt to reinforce Karak Eight Peaks. On balance, the new troops more than made up for the losses incurred, and any immediate threat to the citadel was removed. Over the following years the Dwarfs were able to mount several successful expeditions into the mountains where they recovered a number of great treasures and discovered some of the old tombs of the kings. However, they were still unable to expand their territory any more. Karak Eight Peaks remains a realm controlled by Skarsnik and the Skaven, while the Dwarfs are nothing but a tiny enclave of adventurers holding out in a hostile land.



DAVE GALLAGHER

## FIGHTING THE BATTLE OF EAST GATE

The Battle of East Gate is particularly interesting because it pitches unequal sides against each other in circumstances that are even more unbalanced. In the actual battle the Dwarfs survived, but things could very easily have gone the other way. What if Belegar's reinforcements had taken longer to arrive, or if Skarsnik's rear-guard had spotted them earlier? You can fight the battle for yourself and answer these and other questions, compare your own performance against that of the commanders of the day, and find out if you can save Karak Eight Peaks or destroy the Dwarfs forever.

### THE BATTLEFIELD

Set up your table area as shown on the accompanying battle maps. The action takes place along the old Dwarf road which runs east to west along a steep-sided gully. The north and south table edges represent the gully sides. These are too steep for the Dwarfs to move into and effectively block movement, although some of the Goblin forces are hidden among the rocky slopes at the start of the battle. The eastern edge is the way the Dwarfs have come, and leads back towards Death Pass. The western edge of the table leads off towards the citadel some miles beyond.

You will need to represent the salient features of the battlefield on the tabletop in some way. If you have suitable model scenery so much the better, but you may have to improvise because the scenery is quite unusual. The most important

feature is the long ridge running from the north edge about half way across the valley. On top of this ridge runs the old Dwarf wall which then continues to the southern edge of the valley and incorporates the gateway itself.

The wall is probably the most difficult part of the battlefield to represent. If you own one of the Citadel Mighty Fortress models then you have enough wall and a gateway – absolutely ideal! If you don't have a Mighty Fortress then you can improvise using a line of low boxes, or even cardboard. All you have to do is indicate where the wall is. The watchtower is also tricky, but once again the Mighty Fortress comes to the rescue, as one of the towers is perfect for this purpose. Alternatively you can make yourself a tower (always useful items to have around) or resort to using a tall cardboard box. The remaining features are simple. The old tomb where Duregar makes his last stand is nothing more than a roughly circular hill. The path of the Dwarf road does not need to be represented as such. The north and south valley edges can also be left to the imagination, or you can add low hills along the table edges to represent the ascending valley sides.

Although the size of your battlefield isn't of paramount importance, it is important that the Dwarfs start a reasonable distance from the enemy forces defending the gateway – 24" is about right. This gives the Dwarfs a considerable distance to cross even at their maximum march rate of 6" and it allows the Orcs time to fire their stone thrower.



**BATTLEFIELD MAP**

## DWARF DEPLOYMENT



In the actual battle King Belegar and the relief force appeared through the blasted gateway, having previously been hidden from the embattled armies by the wall and gate. However, to maintain the element of surprise, the Dwarfs can appear in any one of three random positions (see the Dwarf Deployment Map). Roll a D6 when King Belegar's relief force appears:

D6 Roll	Dwarfs appear
1-4	The Gateway (west)
5	Old Mines (north)
6	Ancient Tombs (south)

### DWARF DEPLOYMENT MAP

The Dwarf forces are divided into two: the main force under Lord Duregar and the force from Karak Eight Peaks led by King Belegar. At the beginning of the game Duregar's army is advancing westwards along the Dwarf road. In the actual battle Duregar was unaware that the king was also approaching the gate from the other side, but in the refigt the Dwarf player knows that this is likely to happen. To represent Duregar's position, Belegar's force begins the game off table to the west. This force may arrive at almost any time during the battle, and when and where it arrives is established by the Dwarf player during the game.

The main Dwarf force is detailed on the accompanying roster sheets. If you prefer you may wish to change the exact troops involved to take account of your own model collection. However, the points value of troops should remain about the same, or at least in proportion relative to the enemy forces. The Dwarf force deploys between 9" and 24" into the table edge, within the area shown on the deployment map. If your table is small you may prefer to deploy closer to the eastern edge and delay the appearance of the Orc blocking force by one further turn (see Orc deployment). No Dwarfs may be deployed within 9" of the north or south table edges.

King Belegar and the Dwarfs from Karak Eight Peaks begin the game to the west and are not initially placed on the table. The Dwarf player rolls a dice at the start of each turn after the first (he does not roll in his first turn) to determine whether Belegar's force will appear or not. If the Dwarfs have not appeared by the beginning of Dwarf Turn 5 then they do so automatically (although by then it may be too late!).

Dwarf Turn	Dwarfs appear on roll of
2	6
3	5 or 6
4	4, 5 or 6
5	Dwarfs appear.

**1 THE GATEWAY.** The Dwarfs pour onto the battlefield after quietly disposing of the Night Goblin rear-guard and blasting through the East Gate or wall with gunpowder. You may deploy the Dwarfs within a 9" x 18" zone outside the gate. You may not deploy within 4" of enemy troops, except for broken units which are automatically removed if they are within the deployment zone. Any troops that cannot be deployed within the zone are instead deployed on the western side of the gate and may move through in subsequent turns. The gateway (and surrounding rubble) is assumed to be wide enough to let through an 8-wide column at normal move rates. The Dwarfs may not move in the turn in which they deploy, but can otherwise fight as normal and crossbow or hand gun-armed Dwarfs may shoot (even though they have moved). This is a special rule which reflects the advantage of surprise, and *only* applies during the turn the Dwarfs deploy.

**2 OLD MINES.** The Dwarfs have secretly moved through old mine workings which remain unexplored by the Night Goblins. The mine comes out at an old entrance in the northern slopes. The Dwarfs have emerged from the mine and sneaked up on the Night Goblins from the north. Deploy the army up to 9" into the table along the northern edge. Troops are not deployed within 4" of enemy units unless this is unavoidable, in which case they may be deployed closer but not touching. Any broken enemy units within the deployment area are automatically removed from the battle. The Dwarfs may not move in the turn in which they deploy, but can otherwise fight as normal and crossbow or hand gun-armed Dwarfs may shoot.

**3 ANCIENT TOMBS.** The Dwarfs have secretly opened up an underground tunnel which leads into the ancient tombs in the southern slopes. The tunnel comes out amongst the tombs, and the Dwarfs have managed to infiltrate the southern valley slopes without the Night Goblins spotting them. Deploy the army up to 9" into the table along the southern edge. Troops are not deployed within 4" of enemy units unless this is unavoidable, in which case they may be deployed closer but not touching. Any broken enemy units within the deployment area are automatically removed from the battle. The Dwarfs may not move in the turn in which they deploy, but can otherwise fight as normal and crossbow or hand gun-armed Dwarfs may shoot.

## GOBLIN DEPLOYMENT

The Orc and Goblin force is divided into four parts. During the actual battle Warlord Skarsnik watched the fighting from a high point to the north, but the player has the option of placing Skarsnik on the battlefield itself. The warlord's plan was to lure the advancing Dwarf army into the narrowest part of the valley and then attack from all sides at once.

At the start of the game a force is positioned at the East Gate to block the Dwarfs' progress. These troops are indicated on the roster sheet (West Force) and may be deployed in the western set-up area within 6" of the wall as indicated on the Orc Deployment Map.

The second group of Orcs shadows the Dwarf army as it moves along the valley and comes in from the east to prevent the Dwarfs retreating back the way they have come. This force is indicated on the roster sheet (East Force) and appears on the eastern table edge during Goblin Turn 1. The entire force may be deployed within 6" of the table edge. The Orcs may not move that turn other than to deploy, but may otherwise fight normally and may shoot their bows.

The third Goblin contingent (North Force) comes in from the northern slopes of the valley where it has been hiding amongst the rocks. This contingent only begins to move once the Dwarfs are in position. As this is a matter requiring coordination and good leadership it is by no means certain when the contingent will appear. The Orc and Goblin player rolls a dice at the start of each turn.

If the Dwarfs from Karaz-a-Karak arrive at the northern slopes (via the old mine) before the Goblin contingent can deploy, then the Dwarfs have surprised the Goblins and slaughtered them! The Goblins do not therefore appear at all. If the Goblins have not appeared by the start of Orc and Goblin Turn 4 then they never will – their leader has let you down in some typically Goblin fashion. Perhaps the entire contingent has destroyed itself by internal squabbles, or maybe they have all run off into the hills. Assuming the third contingent arrives successfully it is deployed within 6" of the table edge as shown on the Orc and Goblin Deployment Map. Troops may not be deployed within 4" of Dwarf units, not even if these are fleeing.

The fourth Goblin contingent (South Force) comes in from the south of the valley where it has been hiding amongst the many Dwarf tombs that litter the rocky slopes. This contingent only begins to move when the Dwarfs are in position. As this is a matter requiring coordination and good leadership it is by no means certain when the contingent will appear. The Orc and Goblin player rolls a dice at the start of each turn to see when the South Force will appear (in the same way as the northern contingent), but note that both north and south contingents may not arrive in the same turn. Roll for the northern contingent first, and if it appears this turn do not roll for the southern contingent. This not only breaks up the Goblin attack, but decreases the chance of the southern contingent appearing at all.

Orc & Goblin Turn	North Force Appears on D6 roll of
1	6
2	4, 5 or 6
3	2, 3, 4, 5 or 6
4	Never!

Orc & Goblin Turn	South Force Appears on D6 roll of
1	6
2	4, 5 or 6
3	2, 3, 4, 5 or 6
4	4, 5 or 6
5	6
6	Never!

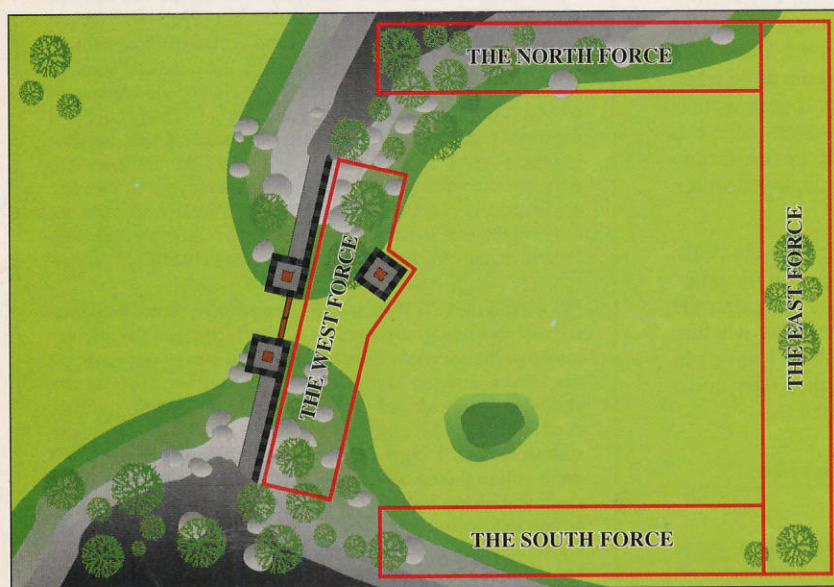

If the Dwarfs from Karaz-a-Karak arrive at the southern slopes (via the ancient tombs) before the Goblin contingent can deploy, then the Dwarfs have surprised the Goblins and slaughtered them! The Goblins do not therefore appear at all. If the Goblins have not appeared by the start of Orc and Goblin Turn 6 then they never will – in characteristic Goblin fashion their leader has let you down by forgetting what he was supposed to do or allowing his troops to start scrapping. Assuming the fourth contingent arrives successfully it is deployed within 6" of the table edge as shown on the Orc and Goblin Deployment Map. Troops may not be deployed within 4" of Dwarf units, not even if these are fleeing.

ORC & GOBLIN DEPLOYMENT MAP

## TACTICAL NOTES

This is going to be an exceptionally hard fought and bloody game because the adversaries are ancient and embittered enemies. Remember that Dwarfs *hate* all Orcs and Goblins, which means they will be testing on an unmodified Leadership value of 10 for all their break tests. Dwarfs are hard enough to break at the best of times, but facing Goblins they will almost certainly fight to the last man.

For their part, the Night Goblins also *hate* the Dwarfs, and so also take break tests on an unmodified Leadership value of 10. This is quite something for Goblin players, who usually have to cope with a basic value of only 5! So, for a change, the Night Goblins are not going to break from hand-to-hand fighting unless they are very unlucky. The Goblin player must bear in mind that the unmodified Leadership of 10 only applies to break tests and not to psychology tests such as panic or fear, so the Night Goblins are still as fragile as ever in this respect. The Orcs do not *hate* the Dwarfs and so use their standard Leadership values, but these are quite respectable in any case.

The Dwarf player's aim is to leave via the western table edge with as many of his units intact as possible (see *Victory*). He should therefore try to keep moving if he can, probably avoiding hand-to-hand combat until he is confronted by enemy units in his path.

The Goblin player can try to stop the Dwarfs by engaging them with Night Goblins. This will effectively bog the opposing units down, and because both sides *hate* each other neither is likely to break. There is nothing to stop the Goblin player continuing to shoot arrows or fire the stone thrower into units engaged in hand-to-hand combat, although casualties are divided randomly between friend and foe (not something that need bother the Goblin player!).

The Goblin player's best chance of actually defeating the Dwarfs is to use the Orcs to kill as many as possible, although the Orcs can break and if they do this will cause panic tests in nearby Night Goblins. The Goblin player should be able to cause considerable damage using the stone thrower and Orc archer units, not to mention the Fanatics from the Night Goblin Mobs. The stone thrower is potentially the most dangerous part of the whole army as far as the Dwarfs are concerned, but there is not much they can do about it other than to direct such missile weapons as they have at the crew.

Magic is unlikely to play a big part in the battle. The Dwarfs are quite resilient to magic in any case, and the Goblins have only two quite low level shamans. The chances are that the Dwarfs will manage to counter any magic the Goblins come up with, but one or two magic 'hits' can turn things in favour of the greenskins.

## STARTING THE GAME

The Dwarf player deploys all of Duregar's army first, then the Goblin player deploys his initial force. Once both forces are deployed the Dwarf player has the first turn. Play then proceeds as normal, players dicing at the beginning of each turn for reinforcements as described above. The battle continues for seven turns on each side and then players add up victory points to determine who has won. The end of Goblin Turn 7 denotes nightfall, and any surviving troops are assumed to escape under cover of darkness (they do not necessarily make it back to safety!).

## VICTORY

If all of Skarsnik's troops have been slain and/or routed from the battlefield the battle is an outright victory for the Dwarfs. If all the Dwarfs have been slain and/or routed the battle is an outright victory for the Orcs and Goblins. If night falls before either side has been decisively beaten, then calculate the victory points awarded to each side to determine who wins. If the Dwarfs win on points it is assumed that the surviving Dwarfs make it back to Karak Eight Peaks. If the Goblins win on points any surviving Dwarfs are either scattered or slain, and only a few ever make it to Karak Eight Peaks. If victory points are equal the result is a draw; some Dwarfs make it back but not many.

### DWARF VICTORY POINTS

No victory points are awarded for occupying table quarters or for capturing the enemy battle standard (there isn't one!). Victory points are awarded for destroyed enemy units and slaying the General as normal. In addition, points are awarded for units which reach the western table edge. Note that no points are awarded for Orc or Goblin units which either fail to turn up, or which are destroyed by the Dwarf flanking forces prior to their appearance.

Each enemy unit destroyed, fleeing, or having fled from table.

..... 1 VP for each 100 points (or part) the unit cost.

Skarsnik slain, fleeing or having fled the table.

..... 1 VP in addition to points for fleeing/destroyed unit.

Each Dwarf unit which leaves via the western table edge with at least 50% of its original numbers intact.

..... 2 VPs for each unit.

Each Dwarf unit positioned west of the gateway at the end of the game but still on the table, and with at least 50% of its original numbers intact. .... 1 VP for each unit.

### GOBLIN VICTORY POINTS

The Orc and Goblin player is awarded victory points for destroying enemy units and +1 bonus point for slaying or breaking either of the two main Dwarf characters (unlikely, but pretty decisive if it does happen). Points are also awarded for causing 50% casualties on Dwarf units. No points are awarded for occupying table quarters.

Each enemy unit destroyed, fleeing or having fled from table. .... 1 VP for each 100 points (or part) the unit cost.

Belegar or Duregar slain, fleeing or having fled the table.  
1 VP each in addition to points for fleeing/destroyed unit.

Army battle standard captured ..... 1 VP.

Each Dwarf regiment reduced to 50% strength, but not otherwise destroyed or fleeing. .... 1 VP.

## THE DWARF ARMY

The Dwarf army at the Battle for the East Gate of Karak Eight Peaks consisted of the troops listed on the Dwarf roster sheet, opposite. You may wish to substitute some of these for models from your own collection instead, in which case choose your army from the Dwarf army list as normal but note that you may not choose any war machines, allies or monsters. This restriction represents the special and unusual circumstances of the battle, where the Dwarf forces are marching light, leaving behind the war engines that they would normally bring along. As long as the points values remain constant and the division of the army is within the guidelines given this is fine. The chart below shows the actual division in the battle, and the

maximum percentage of points which you can allocate to each force should you wish to use different troops.

You may wish to reduce, or even increase, the size of the battle to suit the size of forces available to you. This is fine so long as both sides are altered in proportion, and have the same number of points.



FORCE	ACTUAL FORCES	MAXIMUM %	POINTS
DUREGAR'S FORCE	1723 POINTS	66% (2/3)	2000 POINTS
BELEGAR'S FORCE	1270 POINTS	50% (1/2)	1500 POINTS
<i>TOTAL:</i>	2993 POINTS		NOMINAL 3000 POINTS

## ORC & GOBLIN ARMY

The Orc and Goblin army at the Battle of the East Gate consisted of the troops listed on the two Orc & Goblin roster sheets. You may wish to substitute some of these for models from your own collection instead, in which case choose your army from the Orc and Goblin army list as normal but note that you may not choose allies.

You may choose war machines and monsters within the normal limitations of the points value, even though there was only a single war machine at the actual battle and no monsters. As long as the points values remain constant and the forces are divided roughly in proportion this is fine.

The chart below shows the actual division in the battle, and the maximum percentage of points which you can allocate to each force. Skarsnik may be placed with any force and his points cost is not included in that group's points value although it is included in the army's total value.

You may wish to reduce, or even increase, the size of the battle to suit the size of forces available to you. For example, you might have about 2000 points of troops available rather than 3000, or you might be lucky enough to have 6000 points of troops at your disposal. Again, this is fine so long as both sides are altered in proportion.



FORCE	ACTUAL FORCES	MAXIMUM %	POINTS
WEST FORCE	758 POINTS	33% (1/3)	1000 POINTS
NORTH FORCE	569 1/2 POINTS	25% (1/4)	750 POINTS
SOUTH FORCE	434 1/2 POINTS	25% (1/4)	750 POINTS
EAST FORCE	977 1/2 POINTS	50% (1/2)	1500 POINTS
SKARSNIK (General)	255 POINTS		
<i>TOTAL:</i>	2994 1/2		NOMINAL 3000 POINTS



## DWARF ROSTER SHEET

### BELEGAR'S FORCE

#### KING BELEGAR ..... 505 points

Belegar carries three runic items: a double-handed axe with the Master Rune of Death (all wounds kill), Rune of Fury (+1 Attack) and Rune of Cleaving (+1 Strength); heavy armour with the Master Rune of Gromril (Toughness 10); and a Talismanic Warhorn with the Master Rune of Dismay (one use – immobilises enemy for one turn).

PROFILE	M	WS	BS	S	T	W	I	A	Ld
BELEGAR	3	7	6	4	5	3	5	4	10
Runic Bonuses				+1	10				+1

#### 10 LONG BEARDS ..... 227 points

Armed with hand weapons. Wearing heavy armour and carrying shields (save 4+). Includes Champion and standard bearer. The standard bearer has a magic standard with the Rune of Battle (+1 combat resolution).

PROFILE	M	WS	BS	S	T	W	I	A	Ld
LONG BEARD	3	5	3	4	4	1	3	1	9
CHAMPION	3	5	4	4	4	1	3	2	9

#### 16 THUNDERERS ..... 260 points

Armed with hand weapons and hand guns. Equipped with light armour. Includes Champion with pistol and standard bearer.

PROFILE	M	WS	BS	S	T	W	I	A	Ld
DWARFS	3	4	3	3	4	1	2	1	9
CHAMPION	3	5	4	4	4	1	3	2	9

#### 16 DWARF CROSSBOWS ..... 278 points

Armed with hand weapons, light armour and shields, and crossbows. Includes standard bearer and Champion.

PROFILE	M	WS	BS	S	T	W	I	A	Ld
DWARFS	3	4	3	3	4	1	2	1	9
CHAMPION	3	5	4	4	4	1	3	2	9

### DUREGAR'S FORCE

#### LORD DUREGAR (Dwarf General) ..... 410 points

Duregar carries two runic magic items: a double-handed axe with Skalf Blackhammer's Master Rune (always wounds) and the Rune of Fury (+1 Attack); and heavy armour with the Master Rune of Adamant (saves on a 3+ in conjunction with armour) and two Runes of Iron (+2 Toughness).

PROFILE	M	WS	BS	S	T	W	I	A	Ld
DUREGAR	3	7	6	4	5	3	5	4	10
Runic Bonuses				AW	+2				+1

#### ARMY BATTLE STANDARD ..... 206 points

Duregar's battle standard is carried by a Dwarf Champion. The Dwarf wears heavy armour and carries a hand weapon. His armour is a magic item and has a Rune of Stone (total save 4+), and two Runes of Iron.

PROFILE	M	WS	BS	S	T	W	I	A	Ld
CHAMPION	3	5	4	4	4	1	3	2	9
Runic Bonus									+2

#### RUNESMITH HURGAR THE BLACK ..... 246 points

Hurgar has three runic items: a hammer with Rune of Cleaving (+1 Strength), Rune of Fury (+1 Attack) and Rune of Cutting (-1 save); heavy armour with the Rune of Resistance (re-roll save on 4+), Rune of Stone (+1 save – ie 4+), and Rune of Iron (+1 Toughness); and a talisman with the Rune of the Furnace (immune to fire attacks).

PROFILE	M	WS	BS	S	T	W	I	A	Ld
RUNESMITH	3	6	4	4	5	2	3	2	9
Runic Bonuses				+1	+1				+1

#### 10 SLAYERS ..... 368 points

The Slayers unit consists of 8 Troll Slayers, 1 Giant Slayer, and a Dragon Slayer. The Troll Slayers and Giant Slayer are armed with two handed weapons. The Dragon Slayer is armed with a double-handed weapon with a Master Rune of Flight (12" attack range) and Rune of Fury (+1 Attack).

PROFILE	M	WS	BS	S	T	W	I	A	Ld
TROLL SLYR	3	4	3	3	4	1	2	1	9
GIANT SLYR	3	5	4	4	4	1	3	2	9
DAEMON SLYR	3	7	6	4	5	3	5	4	10
Runic Bonus									+1

#### 10 HAMMERERS ..... 222 points

Equipped with hammers, heavy armour and shields. Includes standard bearer. Led by a Dwarf Champion carrying a hammer with Rune of Cleaving (+1 Strength, giving him a Strength of 5).

PROFILE	M	WS	BS	S	T	W	I	A	Ld
HAMMERERS	3	5	3	4	4	1	3	1	9
CHAMPION	3	5	4	4	4	1	3	2	9
Runic bonus									+1

#### 20 DWARF WARRIORS ..... 271 points

Armed with hand weapons, light armour and shields. Includes standard bearer and Champion.

PROFILE	M	WS	BS	S	T	W	I	A	Ld
DWARFS	3	4	3	3	4	1	2	1	9
CHAMPION	3	5	4	4	4	1	3	2	9

## ORC & GOBLIN ROSTER SHEET 1

### WEST FORCE (INITIAL FORCE DEPLOYED AT START OF THE BATTLE)

**ORC BIG BOSS ..... 125 points**  
Armed with sword, light armour, and shield. Carries the Sword of Resilience (+1 Toughness – increasing Toughness from 5 to 6) from Warhammer Battle Magic.

PROFILE	M	WS	BS	S	T	W	I	A	Ld
BIG BOSS	4	5	5	4	5	2	4	3	8

**ORC SHAMAN CHAMPION ..... 218 points**  
Armed with a sword. Carries the magic items Staff of Lightning (24" blast 3S6 hits with no saves, exhausted on a 1 or 2) and the Black Amulet (4+ save and saved wounds rebound in hand-to-hand fighting). Both these items are from the Warhammer game.

PROFILE	M	WS	BS	S	T	W	I	A	Ld
SHAMAN CHAMPION	4	3	3	4	5	2	3	1	7

**ORC ROCK LOBBER ..... 96 1/2 points**

PROFILE	M	WS	BS	S	T	W	I	A	Ld
ROCK LOBBER					7	3			
CREW (3)	4	3	3	3	4	1	2	1	7

RANGE	STRENGTH	SAVE	WOUNDS PER HIT
60"	10	none	D6

**20 NIGHT GOBLIN ARCHERS ..... 75 1/2 points**  
Armed with swords and short bows, led by a Night Goblin Boss, and including a unit standard.

PROFILE	M	WS	BS	S	T	W	I	A	Ld
ARCHERS	4	2	3	3	3	1	2	1	5
BOSS	4	3	4	4	3	1	3	2	5

**20 ORC BIG'UNS ..... 243 points**  
Armed with swords, light armour and shield. The Mob has a standard. Led by an Orc Boss with Blade of Ensorcelled Iron (+1 to hit). This magic item comes from Warhammer Battle Magic.

PROFILE	M	WS	BS	S	T	W	I	A	Ld
BIG'UNS	4	4	3	4	4	1	3	1	7
ORC BOSS	4	4	4	4	4	1	3	2	7

### NORTH FORCE

**NIGHT GOBLIN BIG BOSS ..... 134 points**  
Armed with sword and shield. Carries two magic items: a Blade of Leaping Bronze (+2 Attacks, giving him 5 in total) and Armour of Protection (as heavy armour with reroll save on 4+). Both these items are from Warhammer Battle Magic. Note that the basic save is 4+ with shield and magic armour.

PROFILE	M	WS	BS	S	T	W	I	A	Ld
BIG BOSS	4	4	5	4	4	2	4	3	6

**28 NIGHT GOBLINS WITH 3 FANATICS ..... 224 points**  
Armed with spears and shields. The unit includes standard bearer and Boss. It also include three Fanatics. The Boss has a Parrying Blade (-1 enemy Attack). This comes from Warhammer Battle Magic.

PROFILE	M	WS	BS	S	T	W	I	A	Ld
GOBLINS	4	2	3	3	3	1	2	1	5
BOSS	4	3	4	4	3	1	3	2	5

**2 SQUIG HUNTER TEAMS WITH 6 SQUIGS ..... 136 points**  
Squig Hunters are armed with long prodders (+1 Strength) which they use to goad the Squigs into battle. See the Warhammer Armies Orcs and Goblin book for full rules.

PROFILE	M	WS	BS	S	T	W	I	A	Ld
GOBLIN	4	2	3	3	3	1	2	1	5
CAVE SQUIG	2D6"	4	0	5	3	1	5	2	2

**20 NIGHT GOBLIN ARCHERS ..... 75 1/2 points**  
Armed with short bows. The Mob includes a Night Goblin Boss and standard bearer.

PROFILE	M	WS	BS	S	T	W	I	A	Ld
ARCHERS	4	2	3	3	3	1	2	1	5
BOSS	4	3	4	4	3	1	3	2	5



## ORC & GOBLIN ROSTER SHEET 2

### SOUTH FORCE

**NIGHT GOBLIN BIG BOSS** ..... 71 points  
Armed with light armour and shield. Carries the Shrieking Blade (causes *fear*), from Warhammer Battle Magic.

PROFILE	M	WS	BS	S	T	W	I	A	Ld
BIG BOSS	4	4	5	4	4	2	4	3	6

**30 NIGHT GOBLINS WITH 3 FANATICS** ..... 260 points

Armed with spears and shields. The unit includes standard bearer, Boss, and three Fanatics. The standard bearer carries a Standard of Shielding (+1 save for whole unit, giving a save of 5+). The Boss has a Rending Sword (all wounds cause double damage – ie 2 rather than 1). Both of these magic items come from Warhammer Battle Magic.

PROFILE	M	WS	BS	S	T	W	I	A	Ld
GOBLINS	4	2	3	3	3	1	2	1	5
BOSS	4	3	4	4	3	1	3	2	5

**20 NIGHT GOBLIN ARCHERS** ..... 75 1/2 points  
Armed with short bows. The Mob includes a Night Goblin Boss and standard bearer.

PROFILE	M	WS	BS	S	T	W	I	A	Ld
ARCHERS	4	2	3	3	3	1	2	1	5
BOSS	4	3	4	4	3	1	3	2	5

**NIGHT GOBLIN SHAMAN** ..... 28 points  
Armed with sword.

PROFILE	M	WS	BS	S	T	W	I	A	Ld
SHAMAN	4	3	3	3	5	1	3	1	7



**SKARSNIK** ..... 255 points

Skarsnik the Night Goblin General may be placed with any of the four contingents. Skarsnik is described in detail in the Warhammer Armies Orc and Goblin book. He is accompanied by his monster squig Gobbla, who always moves with and beside his master. Skarsnik carries two magic items – Skarsnik's Prodder and the Golden Helm of Atrazar. Skarsnik's Prodder is described in the Orc and Goblin book. It fights in combat at +1 Strength and can fire one magic blast in the magic phase per Orc or Goblin unit within 12" + one extra blast for each unit in hand-to-hand combat. Orc units must be 10

**BLACK ORC BIG BOSS** ..... 214 points  
Light armour and shield. He has the magic axe Morgor the Mangler (+1WS, +1 T, +1 S, always strikes first and ignores normal armour saves). This comes from the Warhammer Armies Orc and Goblins book. He therefore has an effective WS of 7, T of 6 and S of 6, making him the single most destructive Orc on the battlefield.

PROFILE	M	WS	BS	S	T	W	I	A	Ld
BLACK ORC BIG BOSS	4	6	5	5	5	2	4	3	9

**15 ORC ARRRER BOYZ** ..... 179 1/2 points  
Armed with bows and swords, wearing light armour. The Mob has a standard and is led by an Orc Boss.

PROFILE	M	WS	BS	S	T	W	I	A	Ld
ORC	4	3	3	3	4	1	2	1	7
BOSS	4	4	4	4	4	1	3	2	7

**10 ORC WAR BOARS** ..... 414 points  
Armed with swords, with light armour and shields. The Mob is led by a Boss and has a standard bearer. The Boss carries a Blade of Leaping Gold (+3 Attacks, giving him 5 in total). Both magic items come from Warhammer Battle Magic.

PROFILE	M	WS	BS	S	T	W	I	A	Ld
BOAR BOY	4	4	3	3	4	1	2	1	7
WAR BOAR	7	4	0	3	4	1	3	1	3
BOSS	4	4	4	4	4	1	3	2	7

**3 STONE TROLLS** ..... 195 points  
Stone Trolls have a natural magical resistance and spells cast against them are dispelled on the D6 roll of 4+ (see Warhammer Armies Orcs and Goblins for full rules).

PROFILE	M	WS	BS	S	T	W	I	A	Ld
STONE TROLL	6	3	1	5	4	3	1	3	4

strong and Goblins 20 strong to count. Maximum range is 24" and the blast causes a single S4 hit in the same way as a fireball spell. The Golden Helm of Atrazar comes from the Warhammer game and gives its wearer a non-modifiable saving throw of 3+.

PROFILE	M	WS	BS	S	T	W	I	A	Ld
SKARSNIK	4	5	6	4	4	3	6	4	9
GOBBLA	-	6	0	6	4	3	6	4	2

## DESIGNER'S NOTES

The Battle at the East Gate of Karak Eight Peaks is a scenario with very specific objectives for each side. As they stand, the forces are evenly matched and both sides will find it relatively hard to meet their objectives. The Dwarfs are hindered by the limit of seven turns and their own slow move rate. They will be doing well to get any of Duregar's units off the western table edge. Getting them past the gate without losing too many casualties should be your principal aim.

The Goblins must fight an awesomely powerful array of troops and tend to die in droves. Mutual hatred will usually hold them in place against their adversaries. The largest Goblin force comes from the east but is positioned a long way behind the Dwarfs and will have a job to catch up. They cannot be relied upon to make much impact, but the Boar Boyz are an exception as they can move faster. Their hard hitting power will be needed if you are to destroy any Dwarf units. The random appearance of the Goblin forces and Belegar's relief force makes the game unpredictable but entertaining!

Whatever the order of appearance it is possible to win with either side. Obviously things can go badly wrong in this department, making life easier or harder for one side or the other. The chances of Belegar turning up in Turn 1 and neither Goblin force putting in an appearance at all is very low... and if this happens the Goblin player will find it almost impossible to stop the Dwarfs breaking through. On the other hand, a late appearance by Belegar can spell disaster for the Dwarfs. Combined with early entries from

the north and south this gives the Goblin player the opportunity to destroy one force and then the other. The Dwarfs are very tough though, and it is difficult to bring numbers to bear against them. The Goblin player will be doing well to make a serious impression on Duregar's army before Belegar turns up. Remember that the Goblin North and South Forces never turn up on the same turn.

It has probably already occurred to the reader that this is an ideal game for several players to participate in, each player taking control of one or more of the forces available. This, together with the relatively large number of troops involved, means it is an ideal format for a club game where players can pool their armies together. Obviously, one player from each side will be in overall command, although in the case of the Dwarfs the overall command switches from Duregar to Belegar once the Dwarf king comes into play. If you do this then note that Belegar becomes the army's General as soon as this happens.

If your players have the patience you can arrange the game so that only players whose forces are on the table are permitted to offer advice. Until their forces turn up players are expressly forbidden from talking to their fellow team mates. It is possible to arrange the game so that players whose forces are not on the table are not even allowed in the room and must wait while the initial stages of the battle unfold. However, this can get a bit boring for the parties concerned if their forces decide to show up late or not at all! A good alternative is to allow everyone in the games room by Turn 3 whatever happens, but ban communication until their force is present.

Players may also wish to refight the battle using different armies: High Elves, Chaos, Empire, or whatever. Obviously, there is no reason why you shouldn't do this, although the results will depend a great deal on the forces involved. When using faster moving troops than Dwarfs you might consider stretching the distances a little so that the ambushed force has a reasonable challenge.

By substituting different armies you'll get a good idea of how different races react in an ambush situation. Should you decide to have a bash with different or allied armies, then there's no reason why not to go the whole hog and change the details of the scenario to take account of the races involved. For example, the old Dwarf mines could become a narrow pass through the mountains which the High Elves come through, or the old tombs become the hidden entrance to a Skaven lair.

One of the biggest changes in the way the scenario works comes by introducing flying troops. In fact you can do this with the Dwarfs by selecting one or more gyrocopters for Belegar's force. These can make a very spectacular entrance as they come zooming over the gateway, bombs bursting all around and cannons blazing! In a similar vein, the entirety of Belegar's force or one of the Goblin ambushing forces could be aerial – High Elf eagles, Orc wyverns, Imperial griffons or pegasuses, and so on. The more varied and interesting you make the game the further away it gets from the original battle. In fact it becomes a new scenario of your own, one which uses the troops and players available to you as its basis.



# WARHAMMER

## GOBLIN WOLF RIDERS



**MARAUDER**<sup>®</sup>  
MINIATURES

Models designed by  
Colin Dixon

Miniatures supplied  
unpainted.

The Games Workshop logo and  
Warhammer logo are registered  
trademarks of Games Workshop Ltd.

Citadel and Games Workshop are  
trademarks of Games Workshop Ltd.

© Games Workshop Ltd 1993

Goblin Wolf Riders are amongst the fastest and most mobile of all warriors. Their snarling wolves are vicious, bloodthirsty creatures, whose powerful jaws can tear out an enemy's throat with a single bite. The riders are evil and malicious greenskins, quick to take advantage of any weakness in their enemy's battlelines.

These models require assembly. We recommend that parts are carefully cleaned and trimmed with a modelling knife before assembly, and that the models are undercoated before painting with Citadel paints.

**Warning!** this product contains lead which may be harmful if chewed or swallowed. Citadel Miniatures are not recommended for children under 14 years of age.

**GAMES**<sup>®</sup>  
**WORKSHOP**

**HIGH ELF  
REAVER KNIGHTS**



REAVER KNIGHT CHAMPION



REAVER KNIGHT STANDARD BEARER

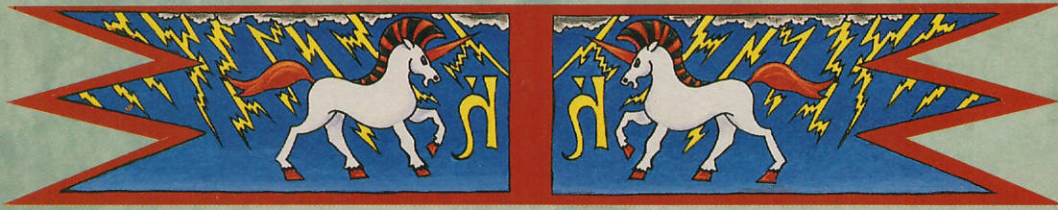

REAVER KNIGHT'S BANNER



HIGH ELF REAVER KNIGHT REGIMENT

# HIGH ELF PHOENIX GUARD



HIGH ELF PHOENIX GUARD AND REAVER KNIGHTS

GAMES WORKSHOP • GAMES WORKSHOP NEWCASTLE METROCENTRE • GAMES WORKSHOP

GAMES WORKSHOP STORES • GAMES WORKSHOP STORES

# OPEN NOW!

# GAMES WORKSHOP®

## NEWCASTLE METROCENTRE

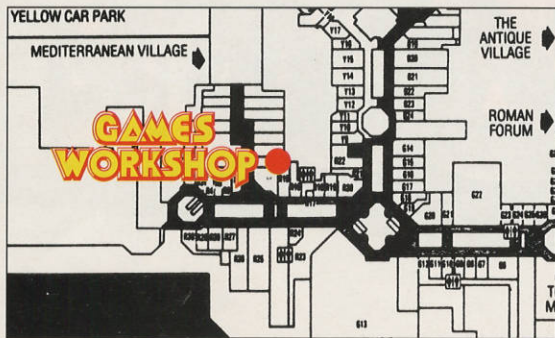

UNIT R14, FIRST FLOOR,  
METROCENTRE,  
GATESHEAD,  
NEWCASTLE-UPON-TYNE

Tel: 091 461 0950

**NORMAL OPENING HOURS**

Mon. Tue. Wed. Fri. 10am to 8pm  
Thursday 10am to 9pm, Saturday 9am to 7pm  
Games night every Thursday

GAMES WORKSHOP STORES • GAMES WORKSHOP STORES

GAMES WORKSHOP • GAMES WORKSHOP NEWCASTLE METROCENTRE • GAMES WORKSHOP

GAMES WORKSHOP • GAMES WORKSHOP ABERDEEN • GAMES WORKSHOP

GAMES WORKSHOP STORES • GAMES WORKSHOP STORES

# OPEN NOW!

# GAMES WORKSHOP®

## ABERDEEN



UNIT 1, 30/40  
UPPER KIRKGATE  
Tel: 0224 621261

**NORMAL OPENING HOURS**

Monday – Wednesday 10am to 6pm  
Thursday 10am to 8pm, Friday 10am to 6pm  
Saturday 9am to 5.30pm  
Games night every Thursday

GAMES WORKSHOP STORES • GAMES WORKSHOP STORES

GAMES WORKSHOP • GAMES WORKSHOP ABERDEEN • GAMES WORKSHOP



# MAN O' WAR

TM

## PLAGUEFLEET

Next month is the release of *Plague Fleet*, the first supplement for *Man O' War*, the game of raging sea battles on the high seas of the Warhammer World. In this article Andy Jones takes a look at the background of the fleets covered in *Plague Fleet* – Chaos, Chaos Dwarfs and Skaven.

Beyond the icy seas of Kislev, beyond the Sea Of Claws, is the dark Realm of Chaos. Here lies a greater danger than any posed by the mortal enemies of the nations of the Known World. Here the natural has been corrupted to become unnatural. Here the very earth rebels against what it has become: trees moan in chilling, eldritch voices, and the rocks scream their hate at a dark and uncaring sky.

Released into the world by misfortune and accident in the long dead past, the creatures of Chaos roam these lands in warbands and armies, hurling themselves in an endless torrent against the bastions of civilisation.

The seas of this inhuman domain of death are the most dangerous and deadly waters of the Known World. From these seas sail forth the Plague Fleets, waging constant war against all comers and carrying the fatal, mutating taint of Chaos across the surface of the world.

Any ship can join the ranks of the Plague Fleets. Pirates and privateers are drawn by the dark lure of the forbidden rewards of Chaos, and are sucked into a world of despair and carnage.

Initially the differences between pirates fighting for Chaos and those fighting for gold and booty may be superficial – as little as a chaos banner flying from the mast or a particularly evil-looking figurehead on the prow of the vessel. But as the crew progress on their dark path to damnation, the rewards of their chosen Power manifest themselves in ever more obvious ways. Eventually, as the captain of a vessel walks the bloody path to Daemonhood, his fame and notoriety begin to

draw foul creatures to crew his vessels that now bear the unmistakable stamp of his Chaos masters. From the Bloodships of Khorne to the Plagueships of Nurgle, these ships strike abject terror into the hearts of all who behold them.

Following in the wake of these great Men O' War come the vessels of the Chaos Lords' lieutenants – some almost as awesome as their Flagship – crewed by cackling, insensate spawn. Crammed onto the decks of these Deathgalleys, the crew are whipped into a frenzy by the Chaos Lord's warrior slaves.

A Plaguefleet is an immensely powerful foe; perhaps the ultimate enemy and greatest threat to the ocean-going warfleets of the Warhammer World.

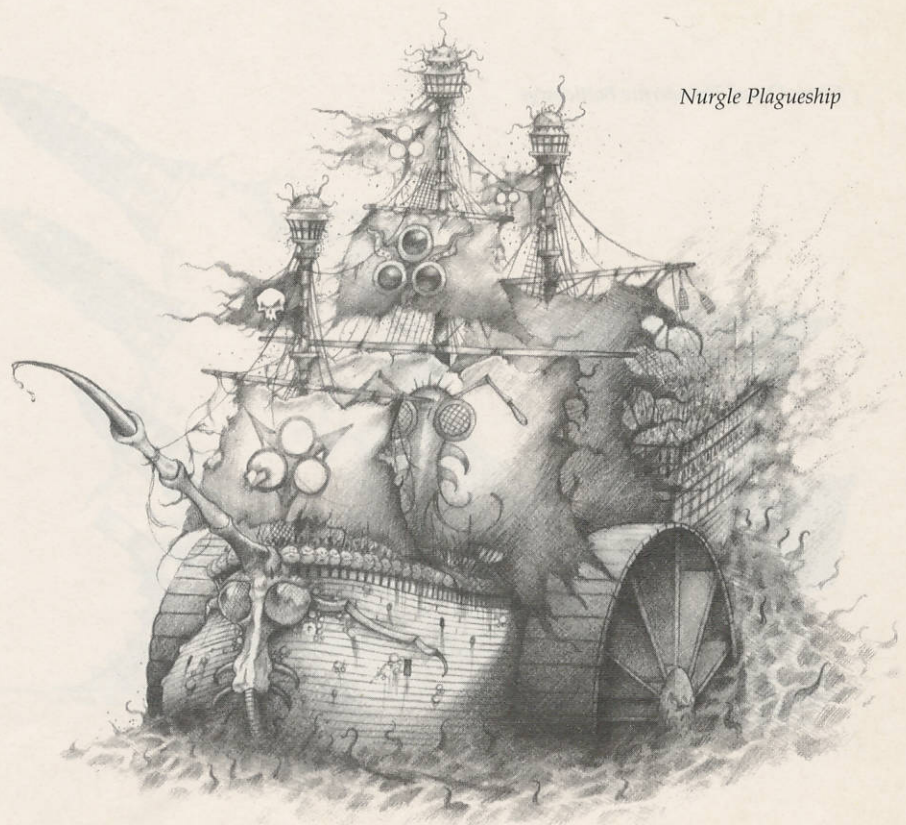

*Nurgle Plagueship*

## CHAOS DWARFS

The ever-present threats to the navies of the Warhammer World come not only from the Plaguefleets that sweep down from the Realms of Chaos. There are other evil creatures whose warfleets put to sea with the sole intent of crushing, capturing and plundering whoever they meet. One such fleet is that of the Chaos Dwarfs, with its Great Leveller Battlebarges, Thunderfire Battlebarges, Hull-destroyers and Thunder-rollers.

The Chaos Dwarfs are the long-lost kin of the true Dwarfs, cut off from their brethren by the forces of Chaos for hundreds of years, until all other Dwarfs had presumed them long dead.

Perhaps it would have been better if they had perished under the tides of Chaos, but they did not. True to the stubborn nature of all Dwarfs, they endured the warping influence of Chaos and, in time, came to embrace it as it worked its hideous changes on these, the hardiest of creatures. So was born the race of Chaos Dwarfs, a perverse mockery of their stalwart brethren to the West.

The Chaos Dwarfs turned wholeheartedly towards Chaos, becoming mighty Sorcerers and Lords of the Dark Arts that Dwarfs traditionally shun. They have built a huge mountain city in the Dark Lands – Mingol Zharr-naggrund – that straddles the River Ruin. Over the centuries their great machines and industries have ravaged the surrounding lands for hundreds of miles.

The Warfleets of the Chaos Dwarfs set sail down the River Ruin towards the sea, intent on the capture of slaves to toil and die amidst the immense machinery of their city's great towers.

Chaos Dwarf ships are mighty floating war-engines, capable of devastating destruction, carrying massive rocket-launchers, mortars and battering rams.

*Chaos Dwarf Thunderfire Battlebarge*

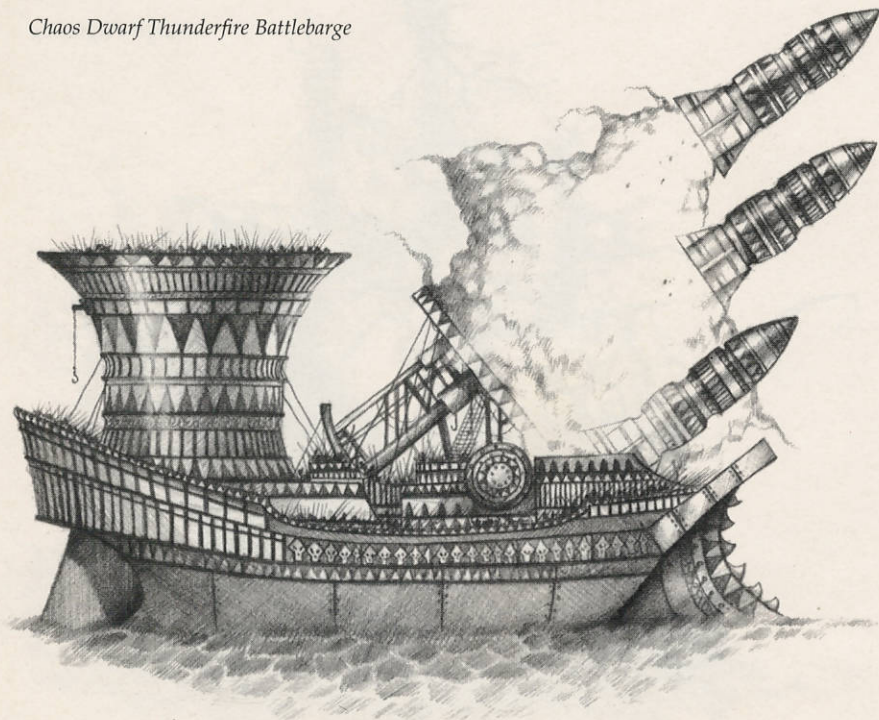

*"Well, Spellmaster," sneered Deathmonger, the words dripping scorn. "What do your bones and baubles tell you?"*

*The white-faced Sorcerer smiled to himself, his long fingers idly stirring the coagulating blood in the upturned skull. Raising a finger to his lips, he bade the Warlord to be silent.*

*"The fog lifts. My Lord shows me things that you will never know."*

*His voice was barely a whisper, yet it resonated strongly in the small room at the top of the Banetower.*

*The chamber was suffused with a shifting blue light, emanating from the dancing flames in the ornate bronze brazier. The skull sat on a siloered plinth, the blood carefully measured and mixed from two slender black vases. They looked more like drinking goblets, better suited for fine wines or spirits.*

*Thick rugs covered the walls, crazy patterns of bright colours woven into them. Strange creatures squawked from wicker cages swinging from the room's low beams. A fog of greasy smoke obscured the stone flagstones, curling round the feet of the Sorcerer as he moved silently about the room. Wind chimes rattled and clanged as a gale gathered outside. Skulls and bones littered the table, and a number of black-bladed vicious-looking knives were imbedded in the red-stained wooden surface.*

stacks, they churn the freezing waters of the River Ruin with their great paddles as they make their way south.

Alternatively, they brave the perilous journey north, through the tunnel between The Falls of Doom and the fortress of Uzkulak, to wreak carnage along the shores of the Sea of Chaos.

If the Chaos Dwarfs prevail, the cities of the Old World will be pulled down, and their inhabitants condemned to an eternity of slavery in the factories of Zharr-naggrund.

Skaven Doombringer

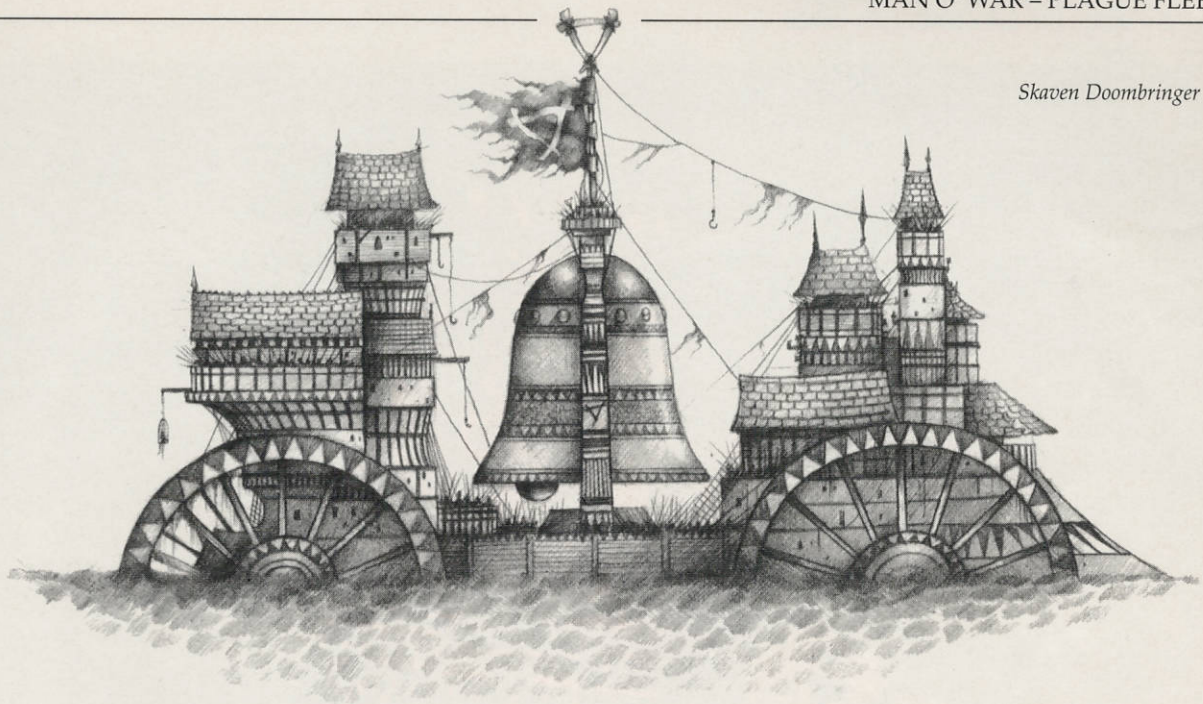

## SKAVEN

The Skaven are the children of Chaos – rats mutated into parodies of men by exposure to the seething influence of warpstone.

Warpstone is raw Chaos solidified, and most creatures quickly shrivel and die under its influence. Not so the giant rats who first consumed the substance in ages past. Whether they did so by chance, or as part of some hideous plan, no-one knows, but the effects the warpstone had upon them were profound: they grew; they thrived; and they changed. Now a cunning and cruel intelligence drives the Skaven on. Their web of subterranean tunnels stretches for thousands of miles under the Warhammer World, corrupting all it touches.

This web centres on the great Skaven city – Skavenblight – located in the fog enshrouded depths of the Blighted Marshes, on the borders of Tilea and Estalia. As with most things Skaven, it is likely that Skavenblight once belonged to someone else, and was stolen, warped and twisted many years ago.

From Skavenblight emerge the Clanfleets, their slave-driven treadwheels lazily churning the stagnant waters of the marshes as they progress down the mud-dredged canals to the sea. In times of war, the Skaven Clanfleets emerge from their hidden marshside moorings, their great paddles splashing the fetid waters as they head for the sea. The chimes of the Doombringers split the heavy air, the Warpfire-throwers roar, and the Deathburners blow gouts of vile vapours across the blasted landscape.

The Clanfleets venture the length of the Tilean sea, bringing pestilence, fear and death to all they meet. When they set sail, the fleets of Tilea and their Empire allies also put to sea to do battle with the Skaven ships, staining the sea and sky red with fire and blood.

Flushed with recent successes, the Skaven Clanfleets have ventured ever further, striking as far as Brionne.

*A fierce wind howled around the tower, and the floor lurched for a moment, reminding Deathmonger that this tower was no land-bound construction, but a hovering edifice that rode the waves supported by the glittering energies of its master. This was a Banetower of Tzeentch, the Changer of Ways, and Kweezel Mestrange was his sorcerous servant.*

*Lightning flashed and flickered, earthing against the iron spikes atop the tower. The shutters on the open window banged and clattered, flapping against the window frame like the wings of some demented bird.*

*Kweezel made intricate patterns in the air with his bony hands, and a streak of lightning shot into the room, illuminating the scene in incandescent white. The energy bolt struck the skull, splitting it into flying shards of bone, and spilling thick blood across the table. Splinters of bone landed in the spreading pool of gore, making a grotesque mosaic on the tabletop.*

*Kweezel bent over it, eagerly studying the pattern that only he could interpret. He stared intently, drawing in a deep breath every so often, but otherwise remaining as still as death. Soon his eyes glazed, and his breathing seemed to stop altogether. Sweat broke on his brow, and thin wisps of steam issued from his flared nostrils.*

*"Well?" Deathmonger's grating voice broke the heavy silence.*

*"They come. They take the bait my Lord. They will round the Sea Of Fire in no more than a day or so."*

*The Sorcerers voice was a sing-song, disembodied chant – not the voice of Kweezel at all. His vocal chords strained, not designed to make the crooning noises issuing from his throat.*

*"Are they many?"*

*"Yes. Oh yes. Many souls. Much young life. Much courage."*

*A thin black tongue licked the lips of the thing that was Kweezel – yet was not Kweezel – and his eyes glowed intense blue.*

*"New souls for Tzeentch. A fine, fresh crop."*



THE MIGHTY BLACK ARK OF NAGGAROTH – FLAGSHIP OF THE DARK ELF FLEET



DARK ELF DEATH FORTRESS



DARK ELF DOOM REAVER

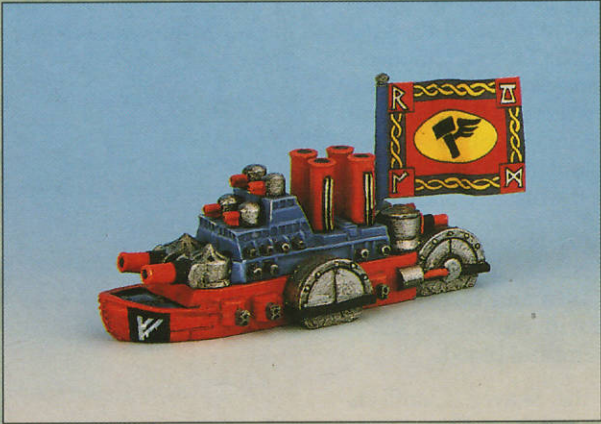

DWARF DREADNOUGHT





ORC HULK



ORC BIG CHUKKA

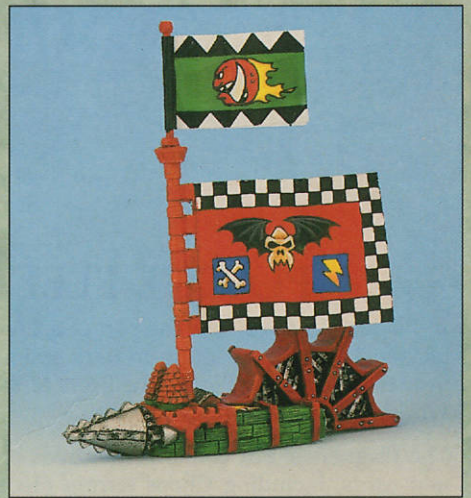

ORC DRILLA KILLA



AN EMPIRE FLEET AND A DREADNOUGHT CONFRONTS A DARK ELF FLEET AND ITS ORC ALLIES

*Khorne Ironshark*

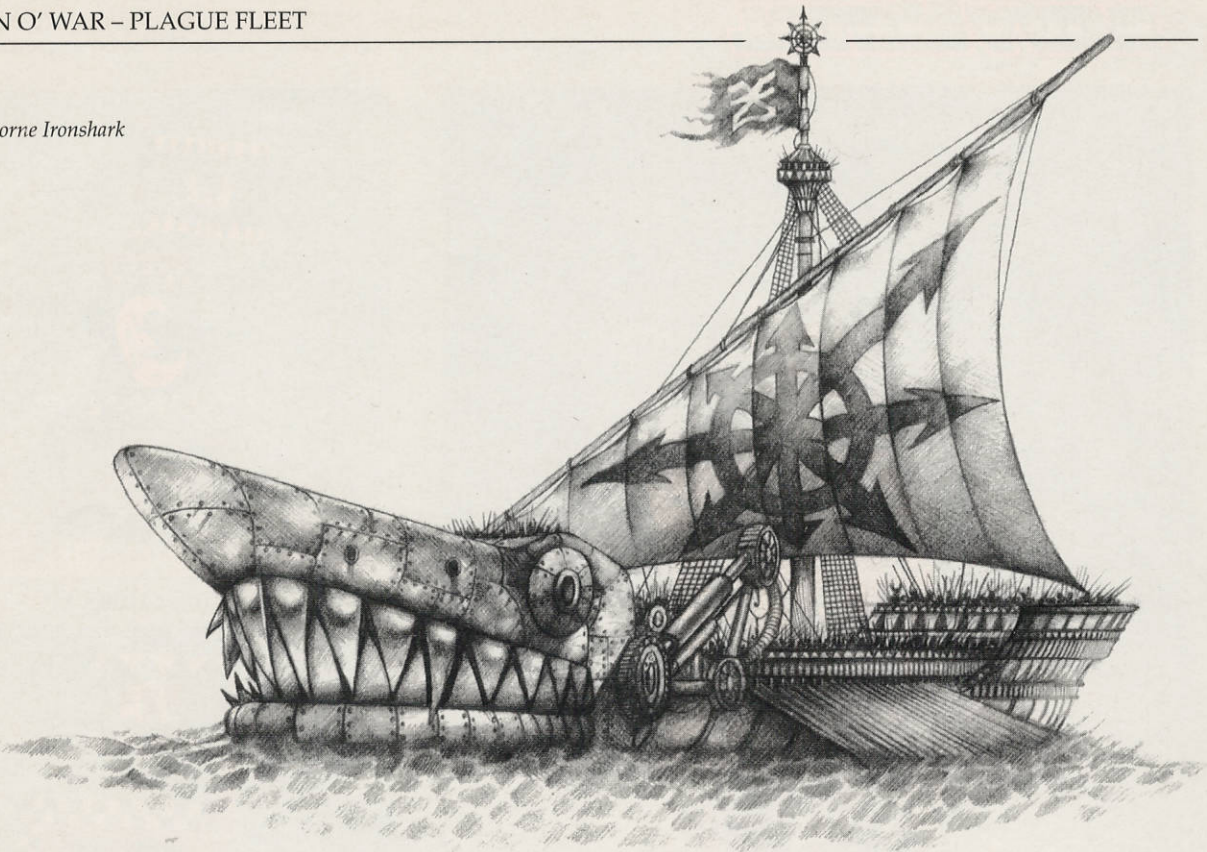

## PLAGUE FLEET

In Plague Fleet you take the part of a Chaos Admiral or Skaven Warlord, emerging in dark splendour from the Seas of Chaos to challenge the fleets of the Warhammer World. Few will stand before you!

The Plaguefleet box contains hundreds of new counters and cards, including Chaos terrain pieces, Chaos ship templates, Chaos Magic Cards, Chaos Reward Cards and Chaos crew counters so you can crew your ships with Chaos Warriors, Beastmen, Chaos Knights or Chaos Spawn.

The rulebook contains full rules for collecting and fighting with the feared Men O' War of the Plaguefleets: Khorne Bloodships, Hellships of Slaanesh, Winged Terrors of Tzeentch, and of course the Plagueships of Nurgle, the Lord of Decay. The fleet lists section also contains full details of the Chaos Ships of the Line, including Ironsharks of Khorne, Plaguecrushers of Nurgle and Hellslicers of Slaanesh.

The fleet lists in Plague Fleet give you the option of fielding either a Chaos fleet that features ships of all the Chaos Powers, or a fleet made up entirely of the warships of one Chaos Power, such as Khorne.

All the ships described in the rulebook will be available as part of Citadel Miniatures's range of Man O' War models, and will come with full-colour sails and banners.

## CHAOS SORCERERS

Plague Fleet introduces a new type of Wizard – Chaos Sorcerers – to your games of Man O' War. These dark wizards draw on the power of the warp to wreak

*The Sorcerer's eyes closed, and blue light crept from under his eyelids.*

*"Not the pact, Daemon thing. Those I kill, Khorne keeps. Those you take, you keep. My sword will reap a fine harvest, but you take the chaff I leave."*

*Deathmonger grunted and turned on his heel, impatient to return to his Bloodship.*

*As he joined his waiting warriors in the antechamber, Deathmonger could hear taunting words receding into the distance*

*"One for Khorne, One for Tzeentch. One for Khorne, One for Tzeentch..."*

*On the bridge of his Bloodship, Deathmonger laughed aloud. The waves crashed against the prow of the vast ship, yet it barely shifted in the jet-black waters. Here in the Seas Of Chaos Deathmonger and his kind ruled supreme, the raw power of Chaos surging through them. He knew that his master would claim any Empire fleet that dared sail into these hell-warped waters. And the battle would be won by the sword, not by petty magic – he knew that too.*

*Around him sailed his massed fleet of Khorne warships - Bloodships, Deathgalleys and Ironsharks. The chanting and jeering of their crews reached his ears across the waters, as they threw the pre-battle slave offerings into the icy seas. The doomed slaves struggled briefly in the chill waters before tentacles grasped them and pulled them below the waves.*

*To port rolled the Nurgle Plagueships and Plaguecrushers. Deathmonger could smell the ships' decay from fifty lengths away. Inside his black helm he grimaced, silently uncomfortable about fighting on the same side as the corpulent, stenching Warlords of the Nurgle fleet. Still, he had his instructions, and knew not to question the wishes of his Lord.*

hideous destruction on the enemy. Plaguefleet contains a completely new magic system for these spellcasters, together with a pack of Chaos Magic Cards.

### SKAVEN CLANFLEETS

Plaguefleet also contains rules for Skaven Clanfleets, plus the special crew counters for Assassins, Rat-ogres, Slaves and Storm Vermin. There is also a complete set of rules for Grey Seers - the Skavens' Wizards - complete with their own set of spell cards.

### CHAOS TERRAIN

Also included in the Plague Fleet supplement is a new set of terrain pieces, to represent some of the twisted and fearsome islands and obstacles that lie deep within the Seas of Chaos.

In these forsaken areas of water the sea itself burns, rocks clash together, and energies surge and flash across the blackened skies. Foolish mortals sometime venture into the Seas of Chaos in search of treasure and glory. Few are seen or heard of again...

### CHAOS SCENARIOS

Plaguefleet contains a new set of game scenarios set in the Seas of Chaos, and which use the Chaos terrain pieces. From "Gold Of The Dark Gods" to "Plaguemonger", you can link your scenarios into a continent spanning campaign game of Man O' War.

*The lone Slaanesh vessel to join the Plaguefleet was the elegant Hellship commanded by Saardis Vaarn. Deathmonger knew it would play its part well in the coming battle; Saardis Vaarn might appear a decadent, foppish dandy (which indeed he was) but he was silent death to those who underestimated him in battle. Deathmonger never made such mistakes.*

*In the distance, the leaping flames of the Sea Of Fire illuminated the sky an outlandish red. Silhouetted against it were countless Empire ships.*

*This was no small convoy of adventurers, drawn to the Seas of Chaos by thoughtless greed and the stories of long lost treasure. This was a full blown warfleet of hundreds of vessels, perhaps a crusade in the name of the weak gods of the Empire.*

*The sheer number of ships sent against him caused Deathmonger a small moment of doubt, but the prospect of the slaughter to come filled him with shivering delight. This would be a battle of immense proportions, and the total destruction of the Empire's best ships would be long remembered in song and legend. Perhaps even Kweezel Mestrange and his magic would have a small part to play...*

*The Banetower of Tzeentch hovered overhead, swaying and rocking in the howling gale. Lightning flickered around its topmost tower, and a thin, piping voice carried on the wind.*

*"One for Khorne, One for Tzeentch. One for Khorne, One for Tzeentch..."*

### TEMPLATES

In the Plague Fleet box, you'll also find full-colour ship templates for all the Chaos ships covered by the rules. In addition, we have included full colour templates for the Dark Elf ships from the Man O' War game itself. No more photocopying of templates from the rulebook - they are all here in glorious colour. Those templates that you don't get in Plaguefleet will be included in the next supplement - we just couldn't get any more in the box!

*Khorne Bloodship*

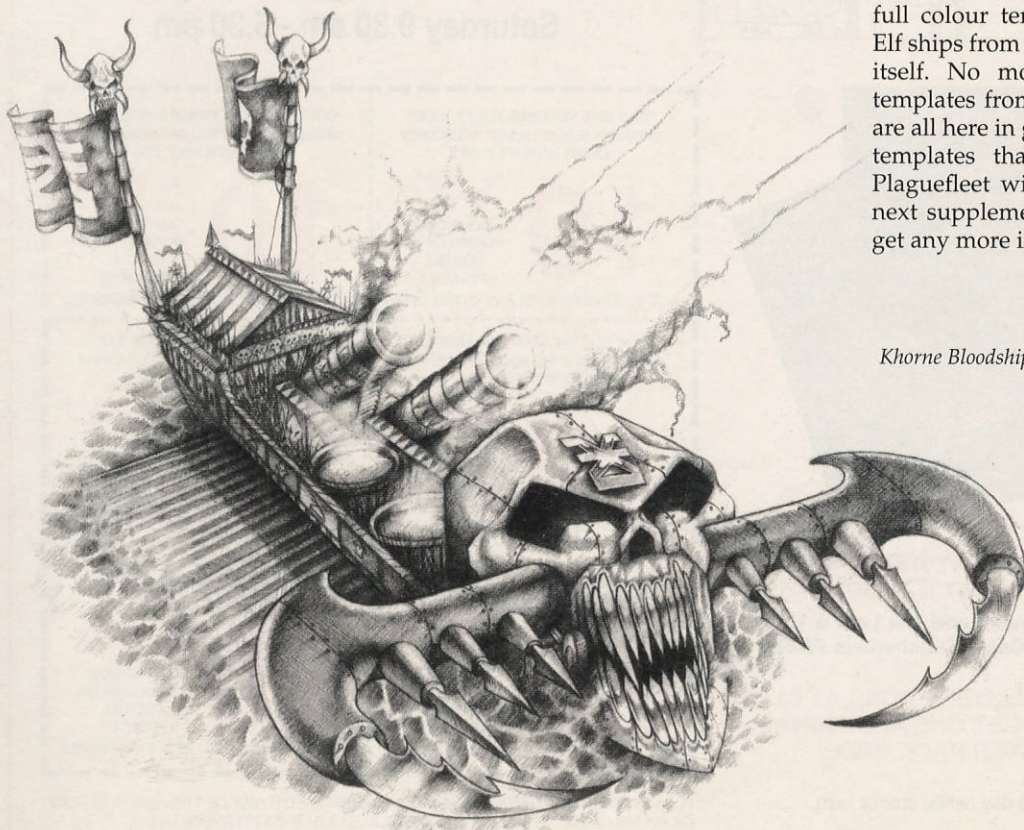

# LEEDS

# GAMES WORKSHOP®

## GRAND RE-OPENING

(of our newly re-furnished store)

**SATURDAY 10TH JULY**

**Doors Open 9am!**



**12-16 CENTRAL ROAD**

**LEEDS**

**Tel: 0532 420834**

**Normal Opening Hours**

**Monday to Friday 10am - 6pm,**

**Saturday 9.30 am - 5.30 pm**



**BUY ANY TWO RED DOT ITEMS AND GET ONE YELLOW DOT ITEM FREE!**

Eg., Buy Warhammer and The Lost & The Damned and get Castle Drachenfels FREE!

**BUY ANY TWO BLISTER PACKS AT £3.99 OR MORE AND GET ONE ADDITIONAL £3.99 BLISTER PACK FREE!**

Offers open all day (while stocks last).

<p>ONLY ONE VOUCHER PER PRODUCT REDEEMABLE AT GAMES WORKSHOP LEEDS 10TH JULY 1993</p> <p><b>10 % OFF</b></p> <p>ANY GAMES WORKSHOP OR CITADEL PRODUCT</p> <p>NOT TO BE USED WITH ANY OTHER OFFER</p>	<p>ONLY ONE VOUCHER PER PRODUCT REDEEMABLE AT GAMES WORKSHOP LEEDS 10TH JULY 1993</p> <p><b>10 % OFF</b></p> <p>ANY GAMES WORKSHOP OR CITADEL PRODUCT</p> <p>NOT TO BE USED WITH ANY OTHER OFFER</p>
<p>ONLY ONE VOUCHER PER PRODUCT REDEEMABLE AT GAMES WORKSHOP LEEDS 10TH JULY 1993</p> <p><b>10 % OFF</b></p> <p>ANY GAMES WORKSHOP OR CITADEL PRODUCT</p> <p>NOT TO BE USED WITH ANY OTHER OFFER</p>	<p>ONLY ONE VOUCHER PER PRODUCT REDEEMABLE AT GAMES WORKSHOP LEEDS 10TH JULY 1993</p> <p><b>10 % OFF</b></p> <p>ANY GAMES WORKSHOP OR CITADEL PRODUCT</p> <p>NOT TO BE USED WITH ANY OTHER OFFER</p>
<p>ONLY ONE VOUCHER PER PRODUCT REDEEMABLE AT GAMES WORKSHOP LEEDS 10TH JULY 1993</p> <p><b>25 % OFF</b></p> <p>ANY GAMES WORKSHOP OR CITADEL PRODUCT</p> <p>NOT TO BE USED WITH ANY OTHER OFFER</p>	<p>ONLY ONE VOUCHER PER PRODUCT REDEEMABLE AT GAMES WORKSHOP LEEDS 10TH JULY 1993</p> <p><b>25 % OFF</b></p> <p>ANY GAMES WORKSHOP OR CITADEL PRODUCT</p> <p>NOT TO BE USED WITH ANY OTHER OFFER</p>

PLEASE NOTE: YOU CANNOT USE THE VOUCHERS WITH ANY OF THE ABOVE OFFERS OR ON MB GAMES' HEROQUEST, SPACE CRUSADE OR BATTLEMASTERS.



# MAN O' WAR™

## QUESTIONS AND ANSWERS

By Andy Jones

Man O' War was released just before the Golden Demon Awards in Sheffield, and it was inevitable that on the day I would be bombarded with questions about the game. Most were easily resolved just by referring to the relevant section of the rulebook, but a few, more difficult questions cropped up repeatedly. Having lost my voice quite early on that day, I scrawled the answers to the most common queries on pieces of card...

Some of the Man O' War questions covered here are topics of discussion rather than straight 'Yes' or 'No' answers, but they should help your understanding of the game.

### MAGIC

The magic system in Man O' War was the subject of many questions, as although it seems similar to the system in Warhammer Battle, it is actually quite different.

**Q** "How does the magic system work, and how many spells can you cast each turn?"

**A** This was a common question. The second part is the easiest to answer – each Wizard can cast just one spell per turn.

In answer to the first part, how the Man O' War magic system works – and how to play it to its full advantage – is a complicated subject. Bill King is writing an article about this at the moment, so look out for it in a future issue of White Dwarf. In short, the magic system works like this:

#### Magic Cards

Each player has a hand of Magic Cards. The number of Magic Cards in your hand is dependent on the power of your Wizard – the more powerful he is, the more Magic Cards you have in your hand.

Looking at the example, you can see that Magic Cards (and Wizards for

that matter) are split into coloured groups, according to the Colleges of Magic. Each Magic card has a casting number printed on it. You have to roll equal to or greater than this number for the spell to succeed. It is easier to cast spells that are the same colour as your Wizard.

College Colour      Casting Number



College this Magic Card can dispel

Each Magic Card also has an alternative function – it can be used to dispel a Magic Card of a certain colour. Each Magic Card has a bar along the bottom that shows which colour Magic Card it can dispel. You have to roll equal to or greater than the casting number on your Magic Card for the dispel to succeed.

#### Using Magic

Each turn, during the Magic Phase, you have a chance to cast a single

spell from your hand of Magic Cards. If you won the initiative roll for this turn, you go first.

Select a Magic Card and roll a dice, aiming to get equal to or higher than its casting number. If the spell succeeds, your opponent has a chance to try and dispel it. If your opponent does not have a suitable Magic Card with which to dispel it, or his dispel fails, the spell takes effect – read out what the Magic Card says and apply the effects.

A Magic Card is discarded after use, whether it was used to try and cast a spell or to try and dispel your opponent's spell. It is discarded even if the spell or dispel fails.

Once both Wizards have attempted to cast their spells, the Magic Phase is over...

### Cycling Cards

The strength of the Man O' War magic system is that in the End Phase of every turn, you may discard some or all of your remaining Magic Cards and pick up a new set for the next turn. This means that once you have learnt the Magic Cards, you can cycle through the deck looking for those you need. Likewise, you can hang onto the Magic Cards that you think your opponent may be looking for, denying him the opportunity to cast them against you.

### SHIPS

**Q** "What happens when your opponent places one of his ships so that it is on top of your submerged Nautilus at the start of the next turn? Does it still have to surface and come up underneath the enemy ship, or is it forced to stay under?"

**A** Actually, it would be impossible to place another model on top of the submerged Nautilus, so this situation should never occur. The Nautilus model never leaves the tabletop even when submerged; it just has a submerged marker placed next to it to show that it is submerged, and is then moved about the table as normal.

Unless you are happy to let your opponent place his vessel on top of

your carefully painted model (which will look distinctly odd on the table), the best your opponent can do is move his ship right up to the submerged Nautilus until the two models are touching.

In the next turn, when the Nautilus surfaces, if the two vessels are still touching, the rules for a collision apply, as explained in the Man O' War rulebook.

**Q** "If my Nautilus has been set ablaze, do the fires go out when it dives?"

**A** No, they are internal fires. However, remember that a damaged Nautilus runs a much greater risk of sinking. See the Man O' War rulebook, page 46.

**Q** "The rulebook states that Ironclads have 2 crew in one place, and have 3 crew in another. Which is correct?"

**A** An Ironclad has 3 crew.

**Q** "The rulebook states that Drillakillas have 2 crew in one place, and have 1 crew in another. Which is correct?"

**A** A Drillakilla has 2 crew.

**Q** "Are an Orc Hulk's smash-hammers destroyed after just one hit?"

**A** No. It takes two hits to destroy them – the first hit on the location has no effect.

*Slaanesh Hellrammer and Slaanesh Hellslicer*

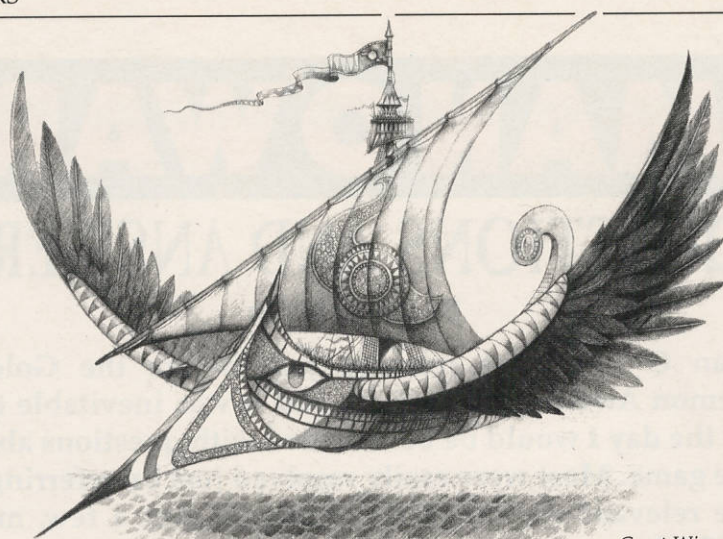
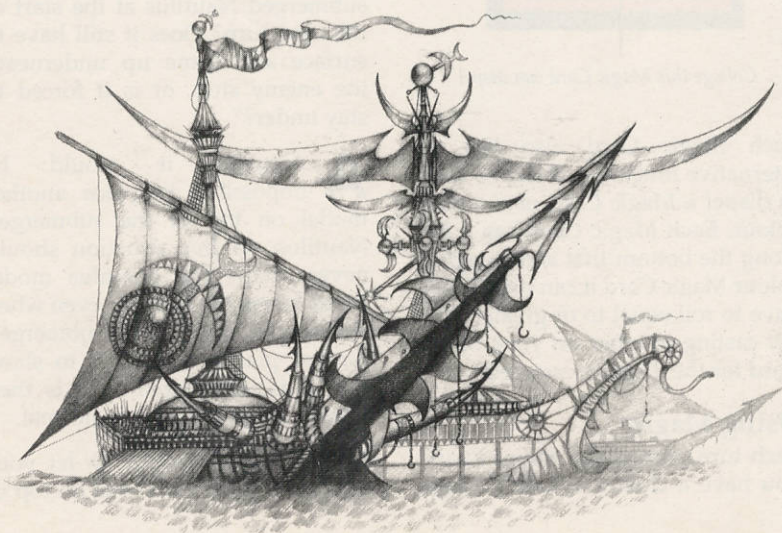

*Great Winged Terror Of Tzeentch*

**Q** "Why are there two damage boxes on the Black Ark's Bow location?"

**A** The extra hit has no effect other than to indicate the location is very tough. The third hit on the location causes critical damage in the normal way.

**Q** "Do Dwarf Engineers mend all the damage on a ship?"

"Do you roll one dice for repairs to the whole Dwarf fleet at once?"

**A** Each Dwarf ship has a contingent of Engineers aboard. They can try to fix any one damaged location on their own ship each turn. If you fail to mend the location, you can try again next turn, and so on.

### Firing with turrets

The Dwarf ships' turrets seem to be being used in a number of interesting ways that were not envisaged when writing the rules. The question most often asked about them is:

**Q** "When my Ironclads fire their turret guns to the side, is the shot resolved separately to any broadside attacks that I make. And is the range ruler laid down level with the turret itself, or with the centre of the Ironclad model?"

**A** If you fire a turret to the side, simply add the power of the turret to any broadside already firing in that direction.

If both turrets on an Ironclad fire to the right, for example, they would both be added to the single dice broadside already firing in that direction, to give a total broadside of three dice. This is resolved just like any other three dice broadside – fired at a single target, aimed high or low, with the range ruler lined up to the centre of the Ironclad.

### GENERAL

Judging from the questions asked at Golden Demon, the turn sequence of Man O' War is causing confusion for a few people.

Everyone seems to have grasped the idea of there being four phases in a turn, but the Battle Phase of each turn appears to be being interpreted in a fairly liberal manner.

**Q** “In each Battle Phase, do all the ships in a squadron move, then all of them fire, then all of them ram, then all of them board?”

“When a squadron gangs up and boards a single ship, do all the attacking crew count towards one big boarding action?”

**A** When you choose to move a squadron, each ship in that squadron must complete all of its actions before the next ship in the squadron can do anything at all. The ship must move, fire, ram and board all on its own, before the next ship in the squadron takes its actions.

If you follow this sequence, you will see that it is impossible for crews to be merged into one big boarding action, as each ship will finish its own boarding action before the next ship has a chance to even start moving.

Once all the ships in a squadron have moved and fought, it is your opponent's turn to do the same with one of his squadrons, and so on, until all the ships on the table have moved and fought.

**Q** “Can I fire grapeshot when I am attacking?”

**A** No, you cannot fire grapeshot when attacking! If you tried, you would mow down your own troops as they board the enemy ship.

**Q** “Do spells like Rotting Timbers affect Dwarfs?”

**A** Yes. Even if the target does not possess a wooden hull it is still affected by Rotting Timbers – read

*Empire Hellhammer*

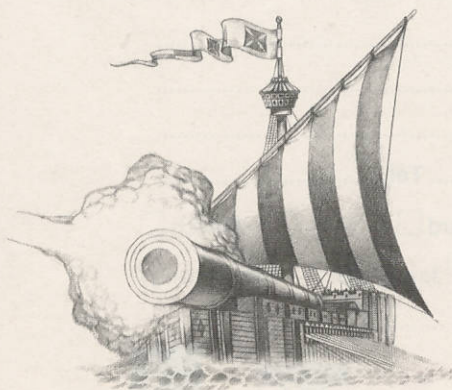

*Slaanesh Hellship*

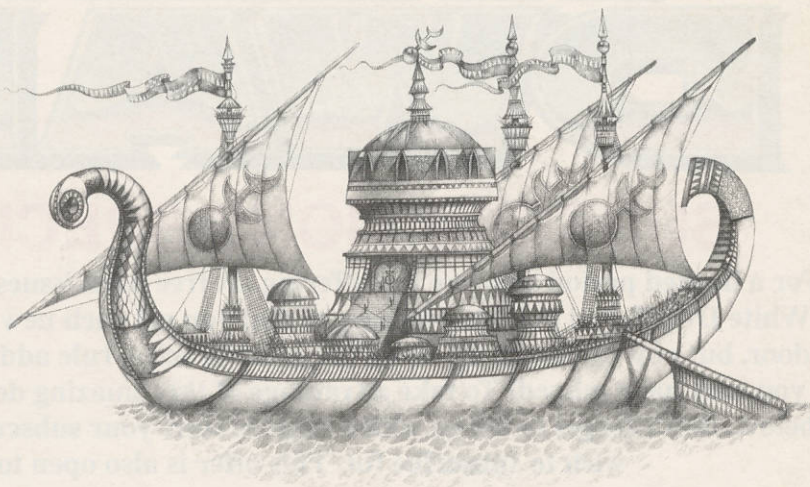

the spell as 'Rusting Steel'. Other spells work in the same way, affecting components that the target does have.

**Q** “How do you re-crew a friendly ship?”

**A** Move alongside it and transfer some of your crew counters to the abandoned vessel.

**Q** “Do abandoned ships sink or float?”

**A** They remain where they are – afloat and causing a hazard to other vessels. (Though there are usually a few moaning, fatally wounded crewmen on board any abandoned vessel!)

**Q** “If I win a boarding action and wish to capture an enemy ship, how do I do it and when?”

**A** Once you win a boarding action, and have killed all the crew onboard the enemy vessel, you may either leave the ship abandoned or capture it.

To capture the ship, as soon as the boarding action is over place one or more of your crew counters on the enemy ship's template. Remember that this reduces the number of crew counters on your ship, making it more vulnerable in a boarding action. For more details, see page 22 of the rulebook.

**Q** “Does a magical Iceberg attack another target if its original target is destroyed?”

**A** No. If an Iceberg's target is destroyed, whether by the Iceberg itself or by another ship, the Iceberg vanishes.

Most of the questions so far addressed apply to the Dwarfs and the Empire fleet, as these were the box sets available when Golden Demon was held in early May. Now, of course, the Bretonnians and Elves are out in force, with the Dark Elves following fast. The new Dwarf Dreadnought is also available, and the Orcs loom large on the horizon.

No doubt these fleets will throw up their own questions and queries. If you cannot resolve these amongst yourselves when playing the games, by all means drop us a line with your thoughts. If you think you spot a gap in the rules and have an excellent solution, let us know. We might even print the answer in White Dwarf for all the other Man O' War players.

*Dwarf Ironclad*

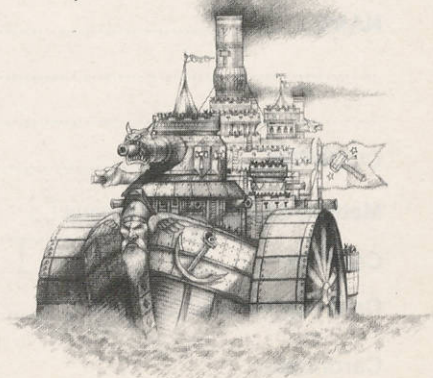

# WHITE DWARF®

## SUBSCRIPTIONS SPECIAL OFFER

For a limited period only, we are offering six free back issues for every new subscription to White Dwarf. Not only do you ensure that you get each new issue delivered direct to your door, but you can catch up on all the great articles, rule additions and modelling tips that you may have missed! To take advantage of this amazing deal, simply complete the form below. Don't forget to tell us which issue to start your subscription with and how long you wish to subscribe for. This offer is also open to re-subscribers.

UK: £27.50 for 1 year — £50.00 for 2 years.

EUROPE: £35.00 for 1 year — £65.00 for 2 years

REST OF THE WORLD: £45.00 for 1 year — £80.00 for 2 years

You can pay by cheque or postal order made payable to Games Workshop, or by credit card. Please send to:

WHITE DWARF MAGAZINE SUBSCRIPTIONS

Games Workshop Ltd, Chewton Street, Hilltop, Eastwood, Notts, NG16 3HY

For telephone orders please ring: (0773) 713213

We accept Barclaycard/Visa, Mastercard/Access and Switch.

OFFER APPLIES TO NEW AND RE-SUBSCRIBERS  
CLOSING DATE 30th  
SEPTEMBER  
1993

The following back issues are still available. Please select six issues in order of preference. For example: if issue 131 is your first choice enter a '1' in the box to the right of 131. You should also indicate a couple of alternatives as stocks are limited. We will endeavour to send you your first choice of six, but if an issue becomes unavailable we will send you your alternative choice.

131	<input type="checkbox"/>	138	<input type="checkbox"/>	142	<input type="checkbox"/>	146	<input type="checkbox"/>	150	<input type="checkbox"/>	154	<input type="checkbox"/>	159	<input type="checkbox"/>
135	<input type="checkbox"/>	139	<input type="checkbox"/>	143	<input type="checkbox"/>	147	<input type="checkbox"/>	151	<input type="checkbox"/>	155	<input type="checkbox"/>	160	<input type="checkbox"/>
136	<input type="checkbox"/>	140	<input type="checkbox"/>	144	<input type="checkbox"/>	148	<input type="checkbox"/>	152	<input type="checkbox"/>	156	<input type="checkbox"/>	161	<input type="checkbox"/>
137	<input type="checkbox"/>	141	<input type="checkbox"/>	145	<input type="checkbox"/>	149	<input type="checkbox"/>	153	<input type="checkbox"/>	158	<input type="checkbox"/>	162	<input type="checkbox"/>

PLEASE START MY WHITE DWARF SUBSCRIPTION WITH ISSUE No ..... FOR ..... YEARS

NAME ..... ADDRESS .....

COUNTRY ..... Postcode ..... Tel: .....

Method of Payment: Cheque  Postal Order  Access/Mastercard  Visa  Switch

Card No: ..... Issue No: (Switch only)

Card expiry date: ..... Cardholder Name: .....

Cardholder Signature: .....





# GAMES WORKSHOP®



## Attention! Attenzione! Achtung!

Calling all German and Italian fans of Games Workshop and Citadel Miniatures! Would You Like to Work for Games Workshop?

Games Workshop is a rapidly growing multi-national business. Our headquarters are in Nottingham in central England, but we own subsidiaries in the USA, Canada, and France. We want to spread our hobby throughout Western Europe and as part of that process we need to recruit bright, enthusiastic young people from Germany and Italy – now!

### The Job

If selected, your first task will be to learn as much as possible about how Games Workshop operates. This will mean working in a number of different roles. Your training will start in one of our retail outlets in or close to Nottingham. Thereafter, you will spend some time with our telesales team and go on to assist our export sales. If things go well, you could even end up running a retail operation in your own country.

### Qualifications

We are less interested in formal qualifications than in your enthusiasm for and knowledge of Games Workshop games and Citadel miniatures. Your spoken English must be first

class and you should have a bright, cheerful telephone manner.

It is essential that you should have a good working knowledge of the **Warhammer Fantasy Battle**, **Warhammer 40,000**, and **Space Marine** game systems. You will also be an avid collector of **Citadel Miniatures**.

We anticipate that successful applicants will be between 20 and 30 with a good level of education. A university degree (or similar) is not essential, but you should be of graduate calibre. You should also be mature, and well organised enough to cope with finding accommodation and adjusting to life in a foreign country.

### The Deal

Your starting salary is unlikely to be huge. However, if you can demonstrate your worth, we won't be slow in providing appropriate rewards!

### How to Apply

Send a full CV, together with details of your gaming experience and the armies you collect to: Simone Greasley, Games Workshop Ltd., Chewton Street, Hilltop, Eastwood, Notts, England, NG16 3HY

## DIA DEL JUEGO GAMES WORKSHOP SABADO 10 DE JULIO

### HORARIO ESPECIAL DE 10'00 A 21'00 HORAS

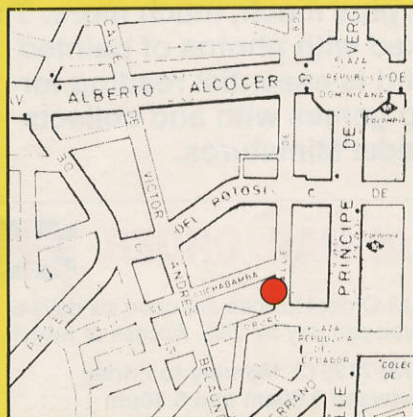

**PRECIO ESPECIAL EN LOS PRODUCTOS MARCADOS CON UN PUNTO ROJO**

**DESCUENTO DEL 10% EN PRODUCTOS GAMES WORKSHOP Y CITADEL MINIATURES**

**PARTIDAS DE WARHAMMER 40,000, TYRANID ATTACK, MAN O' WAR (¡VEN Y JUEGA!)**

**OFERTAS SORPRESA**

**LOS DIEZ PRIMEROS CLIENTES SERAN OBSEQUIADOS CON UNA CAMISETA GAMES WORKSHOP**



C/Bolivia nº1 - 28016 MADRID  
Tel. (91) 457 1941

### ¡¡¡ NO TE PIERDAS EL ACONTECIMIENTO DEL MES !!!



GAMES WORKSHOP, EL CASTILLO CITADEL, WARHAMMER 40,000, TYRANID ATTACK, MAN O' WAR, SON MARCAS DE GAMES WORKSHOP LIMITED. © 1993 COPYRIGHT GAMES WORKSHOP LTD. TODOS LOS DERECHOS RESERVADOS

# GAMES WORKSHOP®

# GAMES WORKSHOP®

## UK MAIL ORDER

OUR TELEPHONE HOTLINES ARE OPEN

9.00am – 6.30pm Monday to Friday  
and 9.00am – 1.00pm on Saturdays

£7.99!

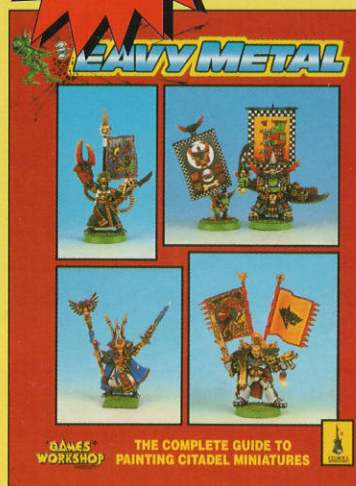

## NEW FOR JULY!

### 'EAVY METAL PAINTING GUIDE

Now available, the 'Eavy Metal Painting Guide, by Games Workshop miniature painter Mike McVey. In this full-colour volume, Mike covers all aspects of miniature painting, from preparation through to the final finishing touches. There are sections for beginners and experts alike, covering basic techniques such as washing and drybrushing, and advanced skills such as glazing and blending. The guide covers all areas of the Games Workshop hobby, with special sections on painting epic armies, Warhammer 40,000 vehicles, and war machines for Warhammer. Also included are articles on banners, painting armour and weapons, an extensive step-by-step reference guide, painting horses, plus much, much more. The Guide is packed with photos of painted miniatures, and is essential reading for everyone who games with and collects Citadel Miniatures.

### CITADEL MINIATURES CATALOGUE – Section Three

Now available, the third volume of the Citadel Miniatures Catalogue. This new update contains all the latest Citadel and Marauder Miniatures, plus details of all the most recent games releases.



SECTIONS  
1 & 2  
£9.99 FOR  
BOTH

SECTION 3  
£4.99



### UK MAIL ORDER



Our UK Mail Order Hotlines are open six days a week, and you can pay by Visa, Access or Switch.

(0773) 713213, Monday to Friday  
between 9.00am and 6.30pm  
Saturdays 9.00am to 1.00pm

If you're posting your order, please send it to:

GAMES WORKSHOP MAIL ORDER SERVICE,  
CHEWTON STREET, HILLTOP,  
EASTWOOD, NOTTINGHAM NG16 3HY.

Or you can fax the order through on (0773) 530155.



## WARHAMMER

WARHAMMER	£29.99
WARHAMMER BATTLE MAGIC	£17.99
WARHAMMER ARMIES – THE EMPIRE	£9.99
WARHAMMER ARMIES – HIGH ELVES	£9.99
WARHAMMER ARMIES – ORCS & GOBLINS	£9.99
<b>NEW!</b> WARHAMMER ARMIES – DWARFS	£9.99

### CHAOS DWARFS

<b>NEW!</b> CHAOS DWARF SORCERER RIDING LAMMASU	£14.99
CHAOS DWARF COMMAND	£1.65 each
CHAOS DWARF AXEMEN	£1.35 each
CHAOS DWARF WITH BLUNDERBUSS	£1.35 each
CHAOS DWARF BULL CENTAURS	£3.99 each
BULL CENTAUR STANDARD BEARER	£3.99
EARTHSHAKER CANNON	£14.99
CHAOS DWARF ROCKET LAUNCHER	£5.99
CHAOS DWARF LORD RIDING GREAT TAURUS	£14.99

### HOBGOBLINS

<b>NEW!</b> HOBGOBLIN COMMAND	£1.35 each
<b>NEW!</b> HOBGOBLIN WARRIORS	£1 each
<b>NEW!</b> HOBGOBLIN ARCHERS	£1 each

### DWARFS

<b>NEW!</b> DWARF FLAME CANNON	£14.99
<b>NEW!</b> DWARFS WITH CROSSBOW	£1 each
ANVIL OF DOOM BOXED SET	£12.99
DWARF HAMMERERS	£1 each
DWARF LONG BEARDS	£1 each
DWARF IRON BREAKERS	£1 each

### HIGH ELVES

<b>NEW!</b> HIGH ELF REAVER KNIGHTS BOXED SET (4 Reaver Knights with spears)	£9.99
<b>NEW!</b> HIGH ELF REAVER KNIGHTS	£2.99 each
HIGH ELF BANNERS (Pack of 5 self-adhesive colour banners)	£2.99

### GOBLIN WOLF RIDERS

<b>NEW!</b> GOBLIN WOLF RIDERS BOXED SET (5 Goblin Wolf Riders with spears)	£9.99
GOBLIN WOLF RIDERS	£2.99 each

### SAVAGE ORCS

SAVAGE ORC COMMAND	£1.35 each
SAVAGE ORC ARRER BOYZ	£1 each

## PAINTING GUIDE

<b>NEW!</b> 'EAVY METAL PAINTING GUIDE	£7.99
--	-------

## BOXED MINIATURES

EMPIRE WAR WAGON	£19.99
EMPIRE STEAM TANK	£14.99
KNIGHTS PANTHER	£9.99
KNIGHTS OF THE WHITE WOLF	£9.99
IMPERIAL WAR ALTAR	£14.99
HEROES OF THE EMPIRE	£9.99
IMPERIAL ELECTOR COUNTS	£9.99
IMPERIAL PEGASUS	£12.99
THE EMPEROR RIDING GRIFFON	£14.99
HIGH ELF DRAGONLORD	£14.99
HIGH ELF SILVERHELMES	£9.99
ELTHARION ON STORMWING	£14.99
HIGH ELF BATTLE CHARIOT	£9.99
HIGH ELF PEGASUS	£12.99
HIGH ELF WAR GRIFFON	£14.99
ORC WAR WYVERN	£19.99
ORC ROCK LOBBER	£14.99
MARAUDER GIANT	£19.99
DWARF THRONE OF POWER	£12.99

## MAN O'WAR

MAN O'WAR	£24.99
-----------	--------

### MAN O'WAR BOXED MINIATURES

#### ORC SHIPS (Available 12th July)

<b>NEW!</b> ORC HULK	£4.99
<b>NEW!</b> DRILLAKILLAS (BOX OF 3)	£9.99
<b>NEW!</b> BIGCHUKKAS (BOX OF 3)	£4.99

#### DWARF SHIPS

DWARF IRONCLAD (BOX OF 3)	£9.99
DWARF MONITORS (BOX OF 3)	£4.99
DWARF NAUTILUS (BOX OF 3)	£4.99
DWARF DREADNOUGHT	£4.99

#### DARK ELF SHIPS

DARK ELF DOOMREAVERS (BOX OF 3)	£4.99
DARK ELF DEATH FORTRESS (BOX OF 3)	£9.99
<b>NEW!</b> BLACK ARK OF NAGGAROTH	£9.99

## SPRAY PAINTS & VARNISH

<b>NEW!</b> WHITE UNDERCOAT (SPRAY CAN)	£3.99
<b>NEW!</b> BLACK UNDERCOAT (SPRAY CAN)	£3.99
<b>NEW!</b> MATT VARNISH (SPRAY CAN)	£3.99



## WARHAMMER 40,000



### WARHAMMER 40,000 MINIATURES

DEATHWING TERMINATORS BOXED SET (Contains 5 Deathwing Terminators and a Dark Angel transfer sheet.)	£12.99
DEATHWING TERMINATORS	£2.99 each

### SPACE MARINE

SPACE MARINE	£29.99
<b>NEW!</b> SPACE MARINE BATTLES (BOOK)	please phone for price and availability
ARMIES OF THE IMPERIUM	£14.99
RENEGADES (Chaos and Eldar armies)	£14.99
ORK & SQUAT WARLORDS	£14.99

### CITADEL CATALOGUE

<b>NEW!</b> CITADEL CATALOGUE SECTION 3	£4.99
CITADEL CATALOGUE SECTIONS 1 & 2	£9.99 for both

## MIGHTY EMPIRES

MIGHTY EMPIRES	£24.99
----------------	--------

### MIGHTY EMPIRES MINIATURES

GREAT CANNON	50P
BATTERING RAM	£1.00
SIEGE TOWER	£1.50
STONE THROWER	£1.00
TEMPLE	£1.50
STONE CIRCLE	50P
MINE	£1.00
BRIDGE 1	50P
BRIDGE 2	50P
SKELETON ARMY BANNER	£1.00
WIZARD'S TOWER	75P
NECROPOLIS	£2.00
PIRATE SHIP	£1.35
MIGHTY EMPIRES PLASTIC SPRUE	£1.00

### WARHAMMER BOOKS

<b>NEW!</b> GENEVIEVE UNDEAD, by Jack Yeovil	£3.99
DEATHWING (40k anthology)	£3.99

### WHITE DWARF SUBSCRIPTIONS

#### UK, EUROPE, & THE REST OF THE WORLD

UK & BFPO: £27.50 for one year (12 issues). EUROPE: £35.

REST OF THE WORLD (excluding US and Canada): £45 for one year.

Please send payments to Games Workshop Mail Order, Chewton St, Hilltop, Eastwood, NOTTINGHAM, NG16 3HY. All payments should be in pounds sterling. Please make cheques payable to Games Workshop Ltd.

If you have a Visa, Access or Mastercard you may place your subscription by phoning our Mail Order department on 0773 713213.

#### USA & CANADA

USA: \$35 for one year (12 issues) / \$63 for 2 years (24 issues). (Maryland residents please add 5% state sales tax).

CANADA: \$45 for one year/ \$81 for 2 years.

Payment can be by check, US money order, Mastercard or Visa. Canadian postal money orders not accepted. Please make checks and money orders payable to Games Workshop. Payment should be sent to White Dwarf Subscriptions, 3431 C Benson Avenue, Baltimore, Maryland 21227-1072. For VISA and Mastercard orders, please telephone our Mail Order hotline on (410) 644 5699, Monday to Friday, 9am - 5pm EST. Please state which issue you would like your subscription to start with.

### CORRESPONDENCE

We welcome comments about White Dwarf, Games Workshop games and Citadel Miniatures. All letters except subscriptions and Mail Order should be addressed to: The Editor, White Dwarf, Games Workshop, Howard House, 16 Castle Boulevard, Nottingham NG7 1FL.

Clearly mark your envelope with the name of the game you are writing to us about. If you want a reply you *must* enclose a self-addressed stamped envelope (overseas readers should include IRCs). We receive an enormous amount of mail. We do read every letter, but it may take a little time for us to reply to you, so please be patient!



### COPYRIGHTS AND TRADEMARKS

All subject matter in White Dwarf is © Copyright Games Workshop Ltd 1993.

All artwork in all Games Workshop products, and all images contained therein have been produced either in-house or as work for hire. The exclusive copyright in the artwork and the images it depicts is the property of Games Workshop Ltd. © Copyright Games Workshop Ltd 1993. All rights reserved.

#### Registered Trademarks

The following are all registered trademarks of Games Workshop Ltd.

Armageddon, Blood Bowl, Chivalry, the Citadel logo, Confrontation, Dark Future, Eldar Attack, Epic, the Flame logo, the Games Workshop logo, Games Workshop, Realm of Chaos, Slottabase, Space•Fleet, Space Marine, Talisman, White Dwarf and the White Dwarf figure, and Warhammer.

#### Trademarks

The following are all trademarks of Games Workshop Ltd.

Aspect Warrior, Avatar, Blood Angels, Bloodletter, Bloodthirster, Citadel, Daemonette, Dark Angels, Dark Reaper, Deathwing, Dragonmasters, Dungeonquest, Eldar, Exo Armour, Exarch, Eye of Terror, Farseer, Fire Dragon, Flesh Hound, Gargant, Genestealer, Gobbo, Great Unclean One, Gretchin, Grey Knight, Hunter Slayer, Keeper of Secrets, Khorne, Knights Panther, Leman Russ, Lichemaster, Lightning Claw, Lord of Change, Madboy, Mekboy, Mighty Empires, Nurgle, Nurgling, Ogryn, Old World, Ork, Painboy, Plaguebearer, Psyker, Ratling, Ravenwing, Skaven, Slaanesh, Slann, Snotling, Space Hulk, Space Wolves, Squat, Squig, Swooping Hawk, Striking Scorpion, Terminator, Thunder Hammer, Troll Slayer, Tyranids, Tzeentch, Ultramarines, Warmaster, Weirdboy, Knights of the White Wolf, Worlddeater.

GW Books is a trademark of GW Books Ltd. Used with permission.

Flame is a trademark of Flame Publications Ltd. Used with permission.

Marauder Miniatures is a trademark of Marauder Miniatures Ltd. Used with permission.

Heroquest and Space Crusade are both trademarks of Milton Bradley Games. Used with permission.

Scatter dice are UK registered design No. 2017484.

# CHAOS DWARFS

## CHAOS DWARF SORCERER ON LAMMASU

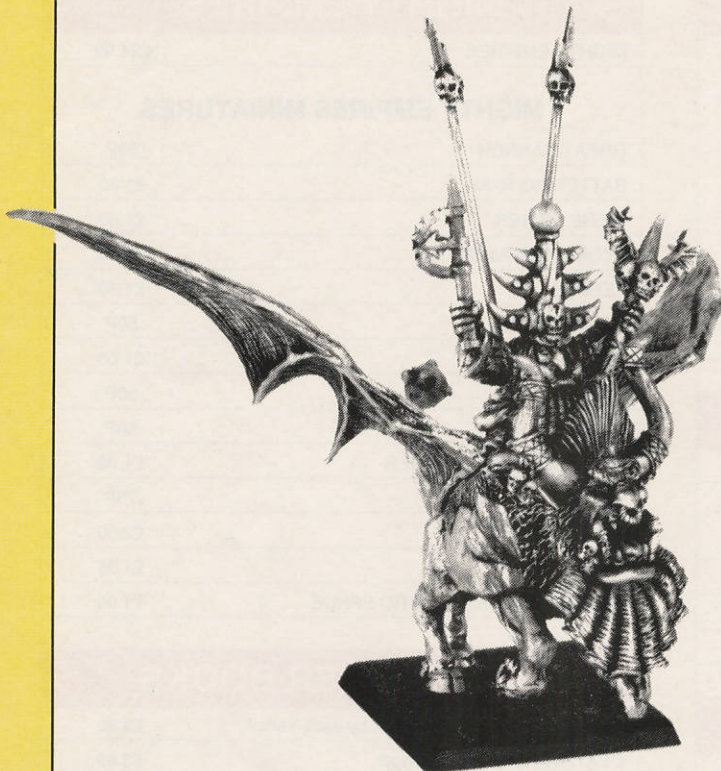

EXAMPLE OF COMPLETED CHAOS DWARF SORCERER ON LAMMASU

THE COMPLETE CHAOS DWARF SORCERER ON LAMMASU CONSISTS OF:  
 1 x SORCERER  
 1 x SORCERER'S BACK BANNER  
 1 x LAMMASU'S HEAD  
 2 x LAMMASU'S BODY  
 2 x LAMMASU'S WINGS

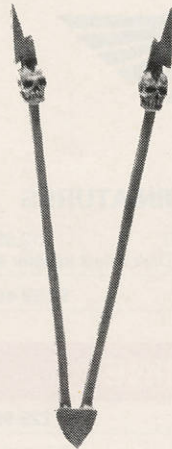

SORCERER'S BACK BANNER  
0838/2



CHAOS DWARF SORCERER  
0838/1

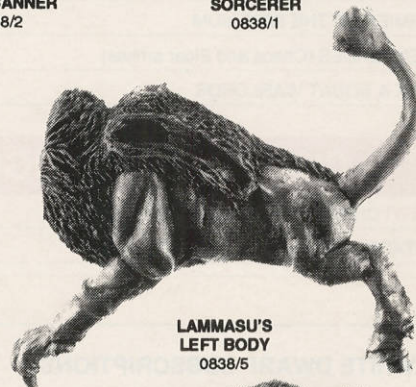

LAMMASU'S LEFT BODY  
0838/5

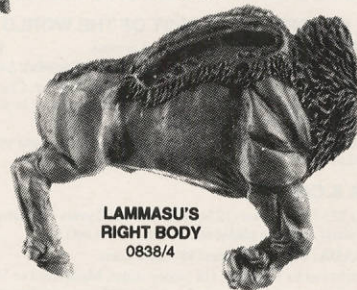

LAMMASU'S RIGHT BODY  
0838/4



LAMMASU'S HEAD  
0838/3

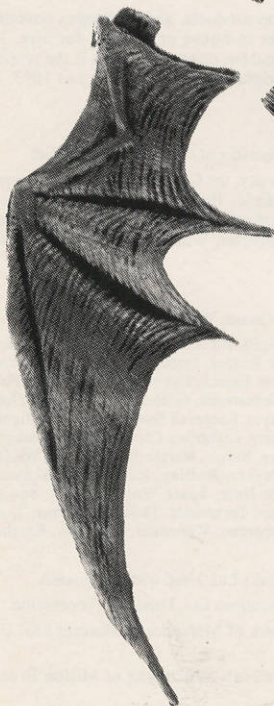

LEFT WING  
0838/6

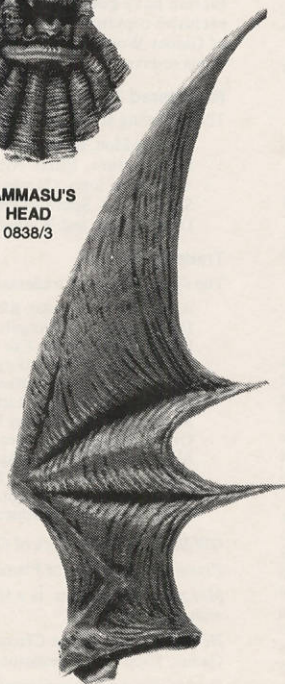

RIGHT WING  
0838/7

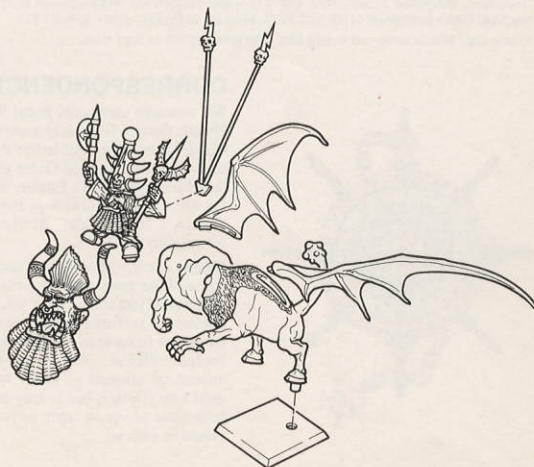

Minatures supplied unpainted. **WARNING.** This product contains lead which may be harmful if chewed or swallowed. Citadel Miniatures are not recommended for children under 14 years of age. © Copyright Games Workshop Ltd 1993. All rights reserved.



Designed by Alan Perry

# HOBGOBLINS

## COMMAND



**HOBGOBLIN  
BIG BOSS**  
75860/4



**HOBGOBLIN  
BOSS**  
75860/3



**HOBGOBLIN  
DRUMMER**  
75860/2



**HOBGOBLIN  
STANDARD BEARER**  
75860/1

## WARRIORS



**HOBGOBLIN  
WARRIOR 1**  
75850/1



**HOBGOBLIN  
WARRIOR 2**  
75850/2



**HOBGOBLIN  
WARRIOR 3**  
75850/3



**HOBGOBLIN  
WARRIOR 4**  
75850/4

THESE MINIATURES ARE SUPPLIED WITH THE APPROPRIATE PLASTIC SHIELDS AS STANDARD

## ARCHERS



**HOBGOBLIN  
ARCHER 1**  
75855/1



**HOBGOBLIN  
ARCHER 2**  
75855/2



**HOBGOBLIN  
ARCHER 3**  
75855/3



**HOBGOBLIN  
ARCHER 4**  
75855/4

Miniatures supplied unpainted. **WARNING.** This product contains lead which may be harmful if chewed or swallowed. Citadel Miniatures are not recommended for children under 14 years of age.  
© Copyright Games Workshop Ltd 1993. All rights reserved.

# CHAOS DWARFS

## COMMAND FIGURES



LEADER WITH SWORD 1  
75805/1

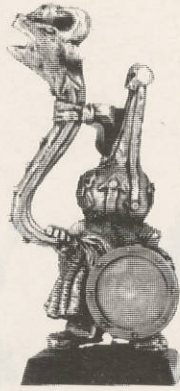

HORNBLOWER  
75805/2



STANDARD BEARER 1  
75805/3



LEADER WITH SWORD 2  
75805/4



DRUMMER  
75805/5



STANDARD BEARER 2  
75805/6

## AXEMEN

THESE MINIATURES ARE SUPPLIED WITH THE APPROPRIATE PLASTIC SHIELDS AS STANDARD



WITH AXE 1  
75800/1



WITH AXE 2  
75800/2

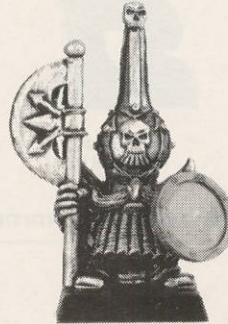

WITH AXE 3  
75800/3



WITH AXE 4  
75800/4

## BLUNDERBUSSES



WITH BLUNDERBUSS 1  
75810/1



WITH BLUNDERBUSS 2  
75810/2



WITH BLUNDERBUSS 3  
75810/3



WITH BLUNDERBUSS 4  
75810/4

Minatures supplied unpainted. **WARNING.** This product contains lead which may be harmful if chewed or swallowed. Citadel Miniatures are not recommended for children under 14 years of age.

© Copyright Games Workshop Ltd 1993. All rights reserved.



Designed by Alan Perry

# CHAOS DWARFS

## BULL CENTAURS



UPPER TORSO  
WITH AXE 1  
75815/3



UPPER TORSO  
WITH AXE 2  
75815/4



UPPER TORSO  
WITH AXE 3  
75815/8



UPPER TORSO  
WITH AXE 4  
75815/9



UPPER TORSO  
WITH AXE 5  
75815/10



UPPER TORSO  
WITH AXE 6  
75815/11



BULL CENTAUR  
STANDARD BEARER  
075816/7

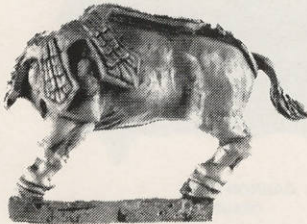

BULL BODY  
LEFT SIDE 1  
75815/1



BULL BODY  
RIGHT SIDE 1  
75815/2

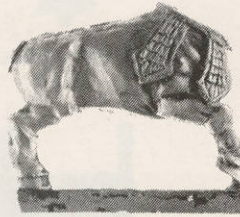

BULL BODY  
RIGHT SIDE 2  
75815/5

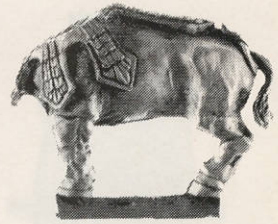

BULL BODY  
LEFT SIDE 2  
75815/6

THESE MINIATURES ARE SUPPLIED WITH THE APPROPRIATE PLASTIC SHIELDS AS STANDARD



EXAMPLES OF COMPLETED CHAOS DWARF BULL CENTAURS

Miniatures supplied unpainted. **WARNING.** This product contains lead which may be harmful if chewed or swallowed. Citadel Miniatures are not recommended for children under 14 years of age.  
© Copyright Games Workshop Ltd 1993. All rights reserved.



Designed by Alan Perry

# CHAOS DWARF

## EARTHSHAKER CANNON

### THE COMPLETE EARTHSHAKER CANNON CONSISTS OF:

- 3 x CREW
- 1 x CANNON SHELL
- 1 x CANNON SHELL PLATFORM
- 1 x CANNON UPPER
- 1 x CANNON LOWER
- 1 x CANNON RIM
- 1 x BANNER POLE
- 1 x CANNON CRANK
- 1 x CANNON BASE
- 2 x CANNON SUPPORT
- 4 x PLASTIC SOLID WHEEL

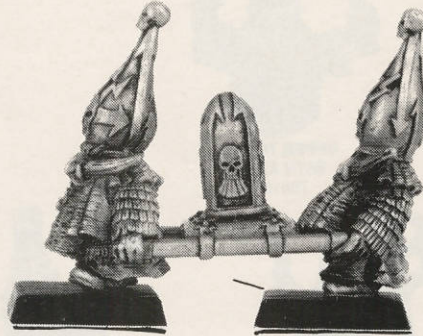
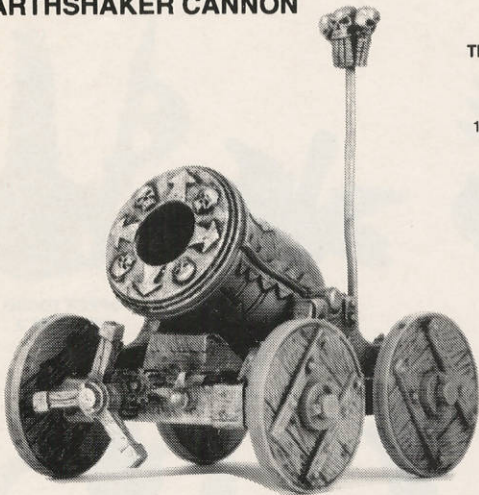

EXAMPLE OF COMPLETED CHAOS DWARF EARTHSHAKER



CANNON RIM  
0834/10



CANNON SHELL  
0834/5



BANNER POLE  
0834/7

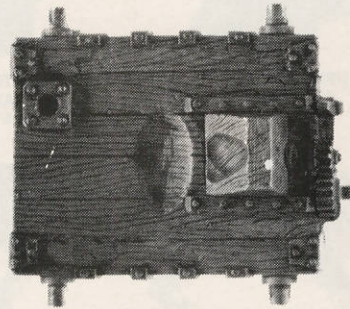

CANNON BASE  
0834/6

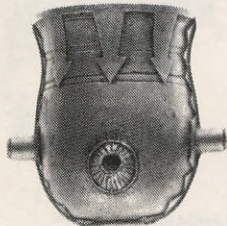

CANNON UPPER  
0834/8

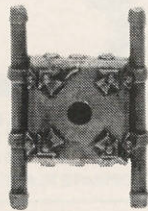

SHELL PLATFORM  
0834/4

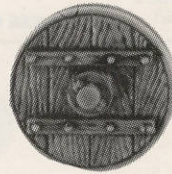

PLASTIC SOLID WHEEL  
100558

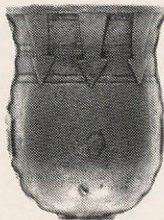

CANNON LOWER  
0834/9



CANNON SUPPORT  
0834/11

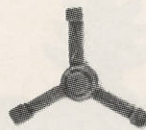

CANNON CRANK  
0834/12



MASTER GUNNER  
0834/1



SHELL CARRIER 1  
0834/2



SHELL CARRIER 2  
0834/3

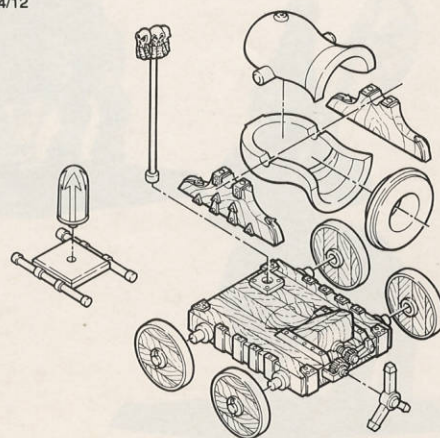

Minatures supplied unpainted. **WARNING.** This product contains lead which may be harmful if chewed or swallowed. Citadel Miniatures are not recommended for children under 14 years of age. ©  
© Copyright Games Workshop Ltd 1993. All rights reserved.



Designed by Alan Perry and Norman Swales

# CHAOS DWARFS

## ROCKET LAUNCHER

THE COMPLETE CHAOS DWARF  
ROCKET LAUNCHER CONSISTS OF:  
2 x CREW  
1 x LEFT BASE  
1 x RIGHT BASE  
1 x CRANK  
2 x PLASTIC SPOKED WHEEL

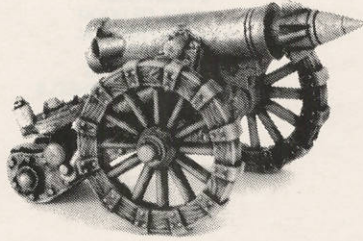

EXAMPLE OF COMPLETED CHAOS DWARF ROCKET LAUNCHER



ROCKET LAUNCHER  
GUNNER  
075820/1



ROCKET LAUNCHER  
LOADER  
075820/2

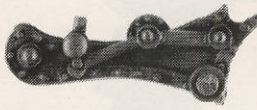

ROCKET LAUNCHER  
RIGHT BASE  
075820/4



ROCKET LAUNCHER  
075820/5



ROCKET LAUNCHER  
LEFT BASE  
075820/3



ROCKET LAUNCHER  
CRANK  
075820/6

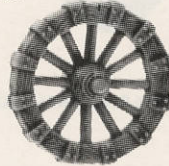

PLASTIC  
SPOKED WHEEL  
100557

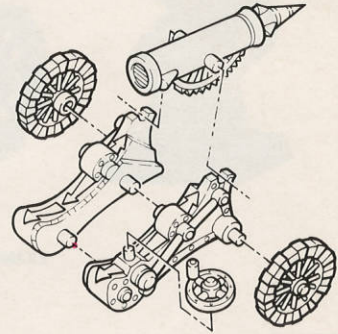

Designed by Alan Perry and Norman Swales



MG

Minatures supplied unpainted. **WARNING.** This product contains lead which may be harmful if chewed or swallowed. Citadel Miniatures are not recommended for children under 14 years of age  
© Copyright Games Workshop Ltd 1993. All rights reserved.

# ANVIL OF DOOM

## DWARF RUNESMITH'S ANVIL OF DOOM

THE COMPLETE ANVIL OF DOOM  
CONSISTS OF:  
1 x RUNEPRIEST  
2 x GUARDIAN  
1 x ANVIL OF DOOM  
1 x ANVIL PEDESTAL  
1 x ANVIL BASE  
2 x BANNER POLE  
4 x PLASTIC SPOKED WHEELS

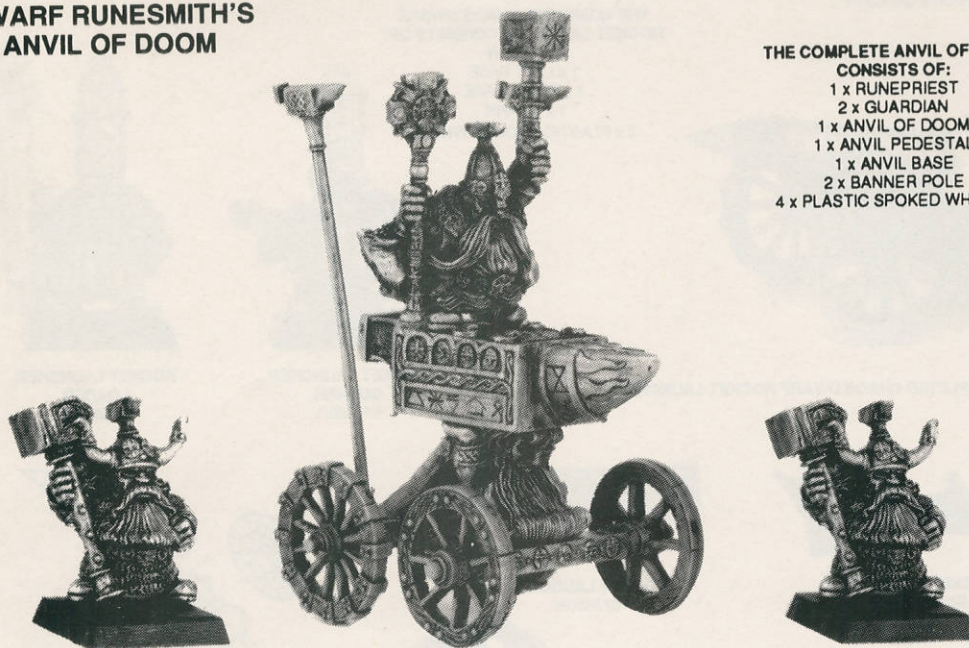

EXAMPLE OF COMPLETED DWARF RUNESMITH AND THE ANVIL OF DOOM



BANNER POLE  
0836/6



ANVIL OF DOOM  
0836/3

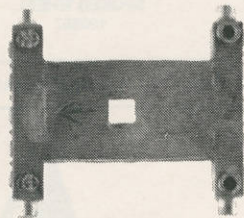

ANVIL BASE  
0836/4

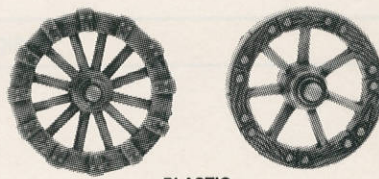

PLASTIC  
SPOKED WHEELS  
100557



ANVIL PEDESTAL  
0836/5



RUNEPRIEST  
0836/2



GUARDIAN  
0836/1

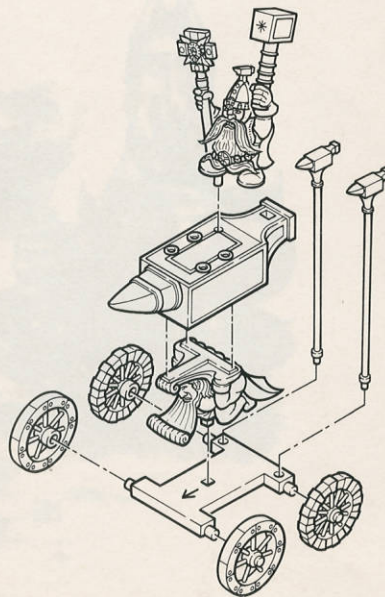

Minatures supplied unpainted. **WARNING.** This product contains lead which may be harmful if chewed or swallowed. Citadel Miniatures are not recommended for children under 14 years of age.

© Copyright Games Workshop Ltd 1993. All rights reserved.



CITADEL  
MINIATURES

Designed by Michael Perry



# FLAME CANNON

## DWARF FLAME CANNON

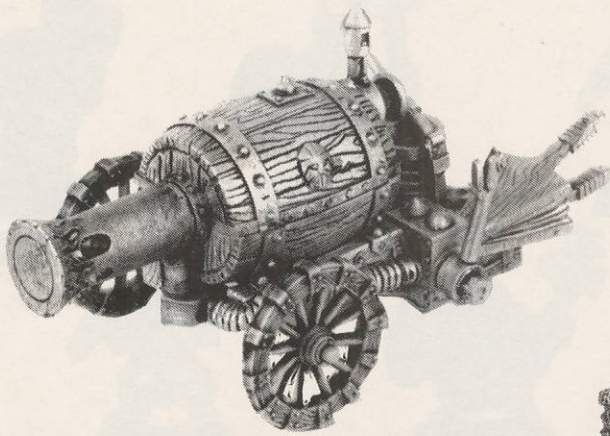

### THE COMPLETE DWARF FLAME CANNON CONSISTS OF:

- 3 x CREW
- 1 x CANNON
- 1 x UPPER BARREL
- 1 x LOWER BARREL
- 1 x LEVER
- 1 x BELLOWS
- 1 x PUMP
- 1 x STEAM WHISTLE
- 1 x INSTRUMENTS PANEL
- 1 x FRONT BASE
- 1 x REAR BASE
- 2 x PLASTIC SPOKED WHEELS

### EXAMPLE OF COMPLETED DWARF FLAME CANNON



**MASTER GUNNER**  
0837/1



**LOADER**  
0837/2



**SWABBER**  
0837/3

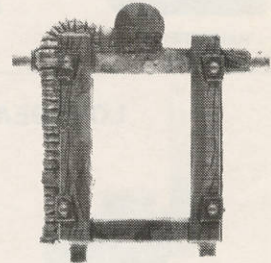

**FRONT BASE**  
0837/7

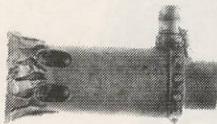

**CANNON**  
0837/8



**LEVER**  
0837/11



**BELLOWS**  
0837/13

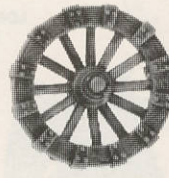

**PLASTIC SPOKED WHEELS**  
100557

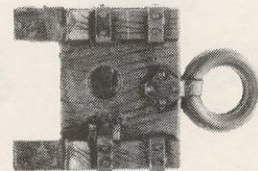

**REAR BASE**  
0837/6

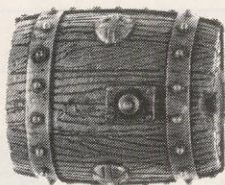

**UPPER BARREL**  
0837/5

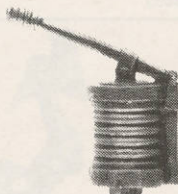

**PUMP**  
0837/10



**STEAM WHISTLE**  
0837/12

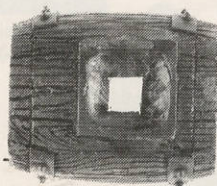

**LOWER BARREL**  
0837/4



**INSTRUMENTS PANEL**  
0837/9

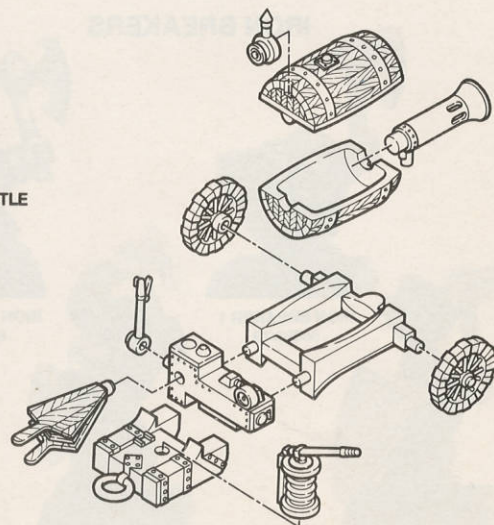

Miniatures supplied unpainted. **WARNING.** This product contains lead which may be harmful if chewed or swallowed. Citadel Miniatures are not recommended for children under 14 years of age.  
 © Copyright Games Workshop Ltd 1993. All rights reserved.



Designed by Michael Perry and Norman Swales

# DWARFS

## HAMMERERS



## LONGBEARDS



## IRON BREAKERS

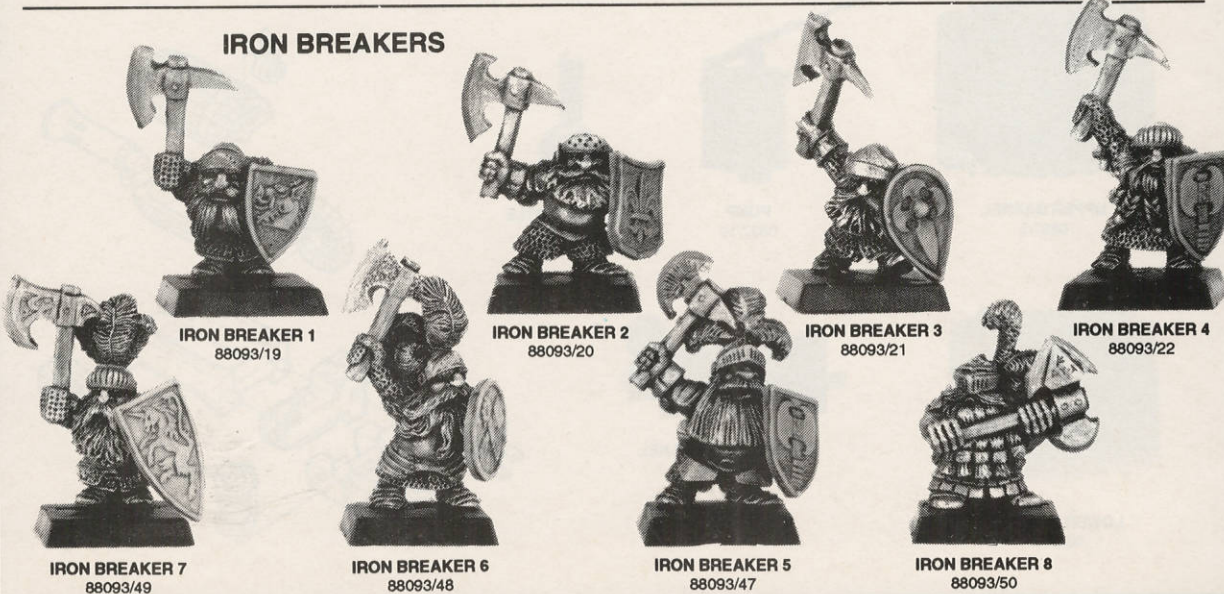

# DWARFS

## DWARF CROSSBOWS



**CROSSBOW 1**  
88051/33



**CROSSBOW 2**  
88051/34



**CROSSBOW 3**  
88051/35



**CROSSBOW 4**  
88051/36



**CROSSBOW 5**  
88051/57



**CROSSBOW 6**  
88051/58



**CROSSBOW 7**  
88051/59



**CROSSBOW 8**  
88051/60



**CROSSBOW 9**  
88051/61



**CROSSBOW 10**  
88051/62



**CROSSBOW 11**  
88051/63



**CROSSBOW 12**  
88051/64



**CROSSBOW 13**  
88001/5



**CROSSBOW 14**  
88001/8

THESE MINIATURES ARE SUPPLIED WITH A SEPARATE PLUG-IN CROSSBOW



**CROSSBOW 15**  
88051/38



**CROSSBOW 16**  
88051/37



**CROSSBOW 17**  
88051/39



**CROSSBOW 18**  
88051/40

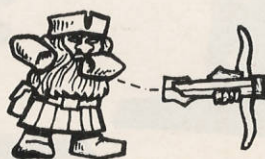

**PLUG-IN CROSSBOW 1A**  
88051/1A

# GOBLINS



## WOLF RIDERS

THESE MINIATURES ARE SUPPLIED WITH APPROPRIATE PLASTIC SHIELDS AS STANDARD

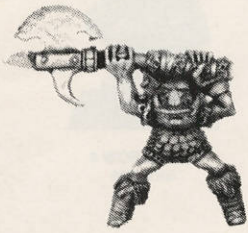

**BOSS**  
88260/1



**BIG BOSS**  
88260/2



**HORN BLOWER**  
88260/3



**BANNER BEARER**  
88260/4



**WITH SPIKED CLUB AND SHIELD**  
88260/10



**WITH SWORD AND SHIELD 1**  
88260/7



**WITH AXE AND SHIELD**  
88260/9



**WITH SWORD AND SHIELD 2**  
88260/8



**ARCHER 1**  
88260/6



**ARCHER 2**  
88260/11



**ARCHER 3**  
88260/12



**ARCHER WITH SWORD**  
88260/5



**WITH SPEAR 1**  
0831/1



**WITH SPEAR 2**  
0831/2



**WITH SPEAR 3**  
0831/3



**WITH SPEAR 4**  
0831/4



EXAMPLES OF COMPLETED GOBLIN WOLF BOYZ

# HIGH ELVES

## REAVER KNIGHTS



**REAVER KNIGHT  
CHAMPION**  
75675/1

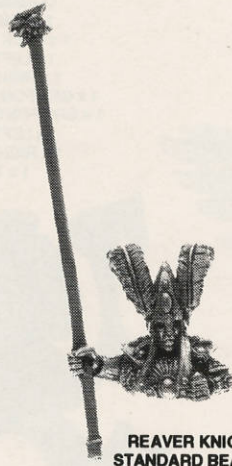

**REAVER KNIGHT  
STANDARD BEARER**  
75675/2



**REAVER KNIGHT 1**  
0816/3



**REAVER KNIGHT 2**  
0816/4



**REAVER KNIGHT  
LEGS 2**  
0816/6

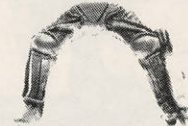

**REAVER KNIGHT  
LEGS 1**  
0816/5

THESE MINIATURES ARE SUPPLIED WITH PLASTIC UNARMoured HORSE AS STANDARD



EXAMPLES OF COMPLETED HIGH ELF REAVER KNIGHTS

## EMPEROR RIDING THE WAR GRIFFON DEATHCLAW

THE COMPLETE EMPEROR  
RIDING WAR GRIFFON  
CONSISTS OF:  
1 x EMPEROR  
1 x BACK BANNER  
1 x LEFT WING  
1 x RIGHT WING  
1 x GRIFFON'S LEFT SIDE  
1 x GRIFFON'S RIGHT SIDE  
1 x LEFT CLAW  
1 x RIGHT CLAW  
1 x TAIL



EMPEROR  
KARL FRANZ  
0835/1

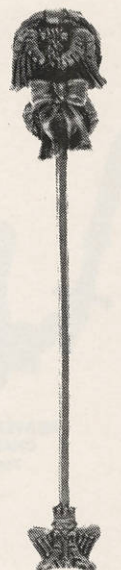

EMPEROR'S  
BANNER POLE  
0835/2

EXAMPLE OF COMPLETED EMPEROR ON DEATHCLAW



LEFT CLAW  
0835/6



RIGHT CLAW  
0835/5



GRIFFON'S BODY  
RIGHT SIDE  
0835/4



GRIFFON'S TAIL  
0835/7

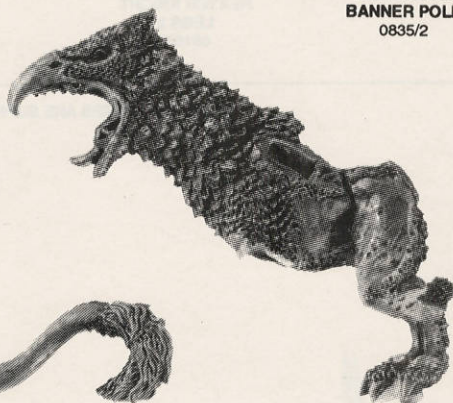

GRIFFON'S BODY  
(LEFT SIDE) 2  
0835/3



RIGHT WING  
0835/9

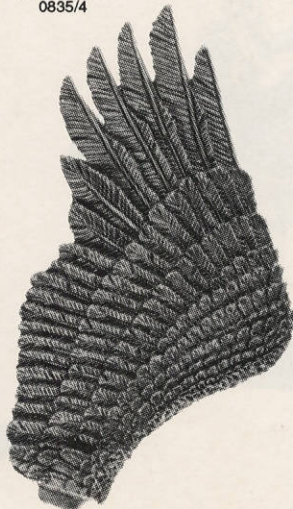

LEFT WING  
0835/8



# ORC WARSHIPS

Miniatures supplied unpainted. **WARNING.** This product contains lead which may be harmful if chewed or swallowed. Citadel Miniatures are not recommended for children under 14 years of age.  
 © Copyright Games Workshop Ltd 1992. All rights reserved.

## BIGCHUKKA

**THE COMPLETE BIGCHUKKA  
 CONSISTS OF:**  
 1 x HULL  
 1 x CHUKKA

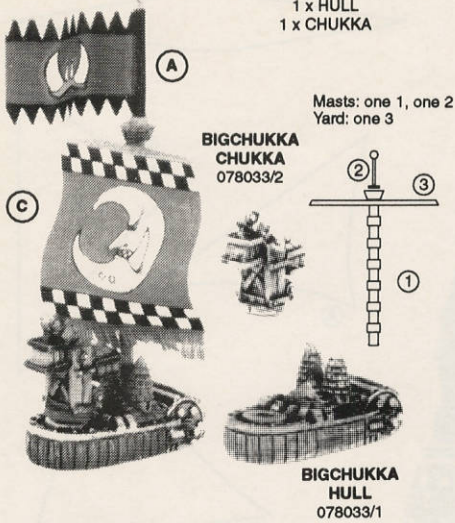

## DRILLA KILLA

**THE COMPLETE DRILLA KILLA  
 CONSISTS OF:**  
 1 x HULL  
 1 x TREADWHEEL



## ORC HULK

**THE COMPLETE ORC HULK  
 CONSISTS OF:**  
 1 x CHUKKA PLATFORM  
 1 x SMASH HAMMER  
 2 x IRON CLAWZ  
 2 x CHUKKA  
 1 x HULL

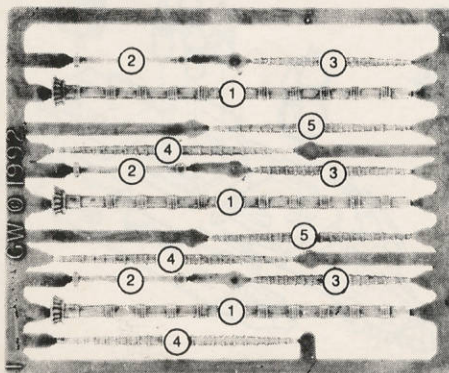
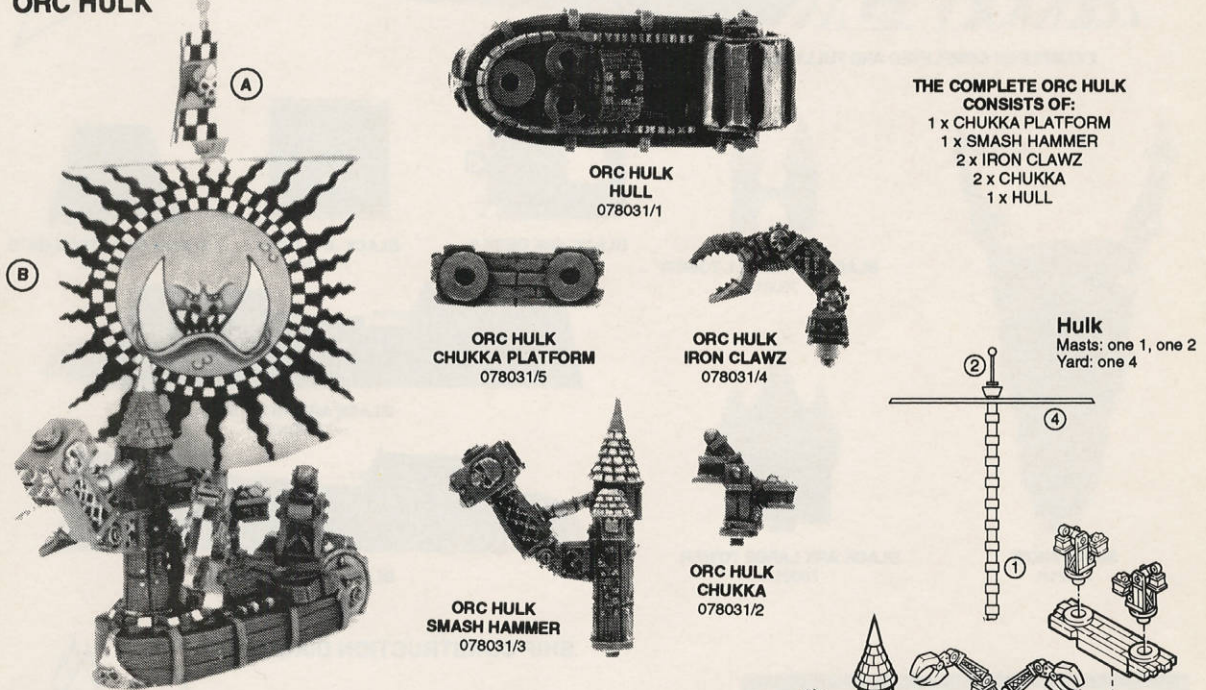

MAN O' WAR PLASTIC MAST SPRUE MOW PLA/2

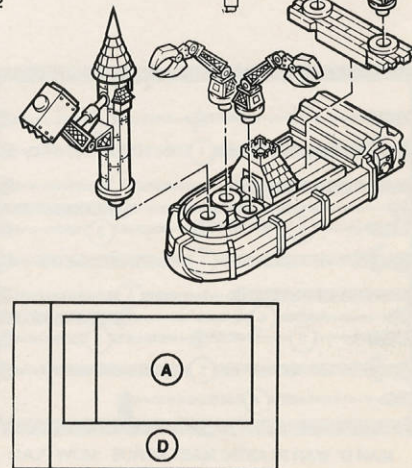
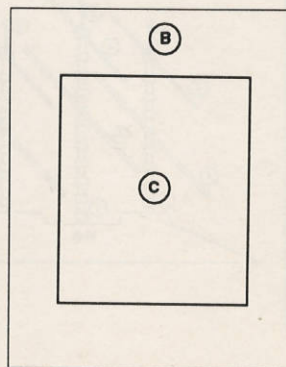

THE DIAGRAM ABOVE ILLUSTRATES THE CORRECT LENGTH FOR EACH MAST AND THE TYPE AND NUMBER OF YARD ARMS.  
 THE SAILS AND PENNANTS ABOVE MAY BE PHOTOCOPIED, CUT OUT, PAINTED AND STUCK ONTO YOUR MINIATURES.

PERMISSION GRANTED TO PHOTOCOPY FOR PERSONAL USE ONLY.



Designed by Kev Adams and Norman Swales

# DARK ELF WARSHIPS

## BLACK ARK OF NAGGAROTH

THE COMPLETE  
BLACK ARK OF NAGGAROTH  
CONSISTS OF:

- 2 x LARGE TOWERS
- 2 x SMALL TOWERS
- 1 x SKULL PROW
- 1 x STERN GATE
- 1 x RIGHT SIDE
- 1 x LEFT SIDE
- 1 x DECK 1
- 2 x DECK 2
- 2 x PLASTIC MAST SPRUES

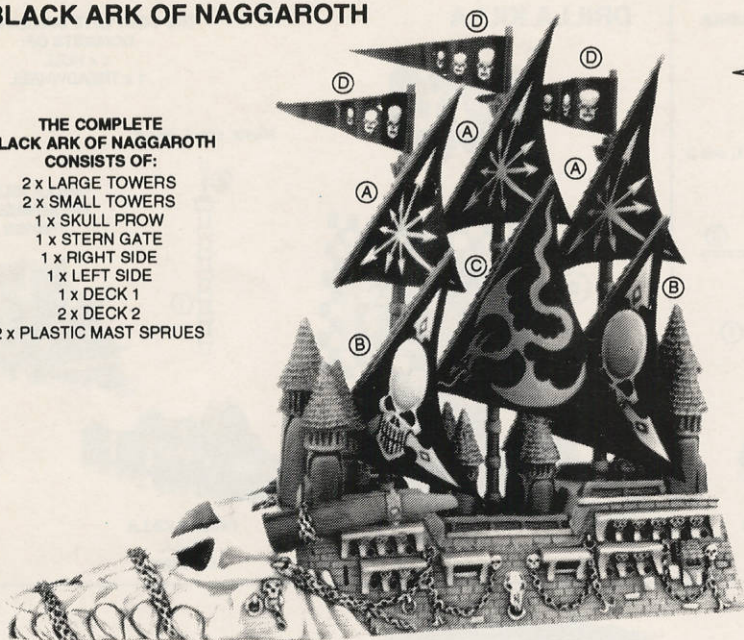

EXAMPLE OF COMPLETED AND FULLY PAINTED BLACK ARK OF NAGGAROTH

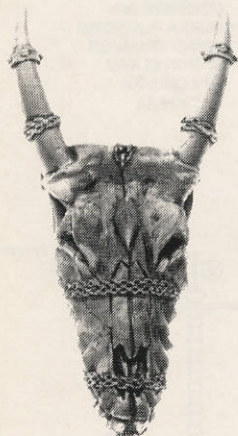
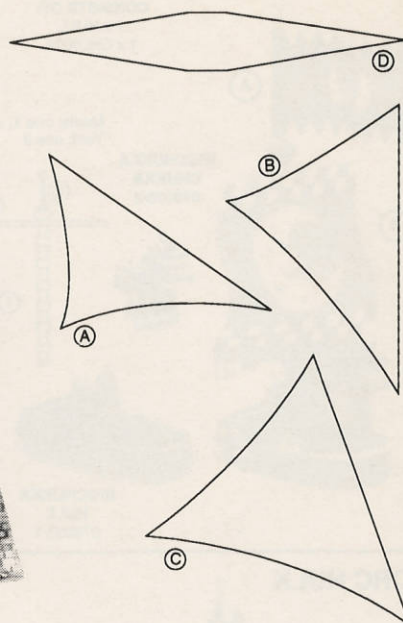

SKULL PROW  
78021/1



BLACK ARK SMALL TOWER  
78021/5

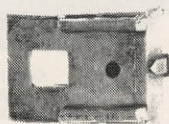

BLACK ARK DECK 2  
78021/8



BLACK ARK DECK 1  
78021/7



BLACK ARK STERN GATE  
78021/6



BLACK ARK RIGHT SIDE  
78021/3



BLACK ARK LARGE TOWER  
78021/4



BLACK ARK LEFT SIDE  
78021/2

### SHIP CONSTRUCTION DIAGRAMS

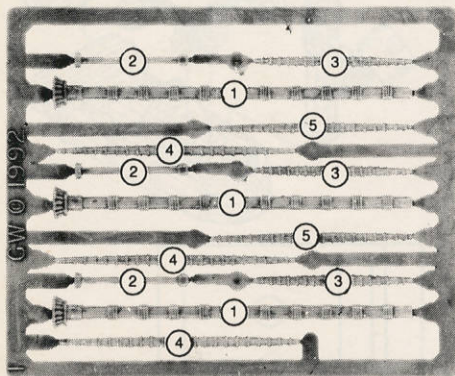

MAN O' WAR PLASTIC MAST SPRUE MOW PLA/2

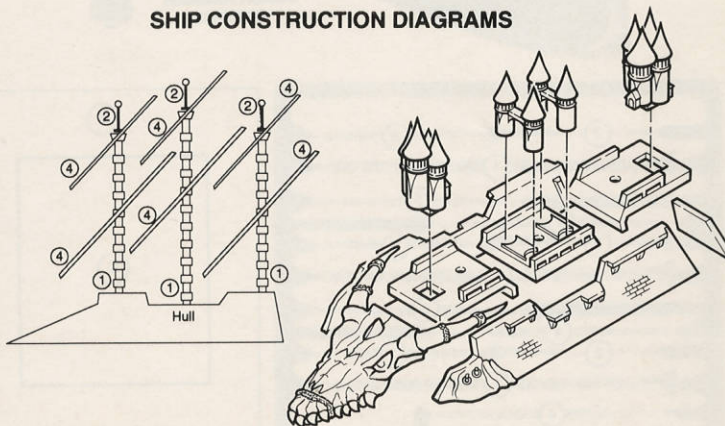

THE DIAGRAM ABOVE ILLUSTRATES THE CORRECT LENGTH FOR EACH MAST AND THE TYPE AND NUMBER OF YARD ARMS.

THE SAILS AND PENNANTS ABOVE MAY BE PHOTOCOPIED, CUT OUT, PAINTED AND STUCK ONTO YOUR MINIATURES.

PERMISSION GRANTED TO PHOTOCOPY FOR PERSONAL USE ONLY.

Miniatures supplied unpainted. **WARNING:** This product contains lead which may be harmful if chewed or swallowed. Citadel Miniatures are not recommended for children under 14 years of age.  
 © Copyright Games Workshop Ltd 1993. All rights reserved.





# DWARF WARSHIPS

## DWARF IRONCLAD

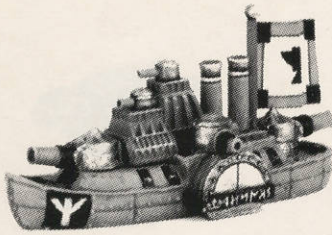

EXAMPLE OF COMPLETED AND FULLY PAINTED IRONCLAD

A DWARF IRONCLAD  
CONSISTS OF:  
1 x HULL  
1 x BRIDGE  
1 x FUNNELS

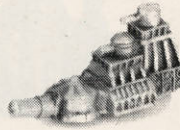

IRONCLAD  
BRIDGE  
0414/3

ALL DWARF WARSHIPS ARE SUPPLIED  
WITH 1 PLASTIC MAST SPRUE



IRONCLAD  
FUNNELS  
0414/2

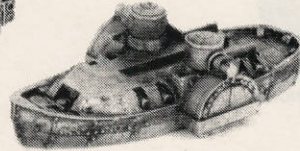

IRONCLAD  
HULL  
0414/1

## DWARF MONITOR

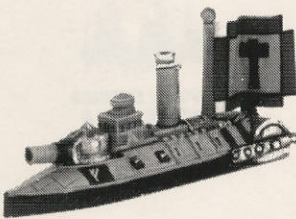

EXAMPLE OF COMPLETED AND  
FULLY PAINTED MONITOR

A DWARF MONITOR  
CONSISTS OF:  
1 x HULL  
1 x BRIDGE

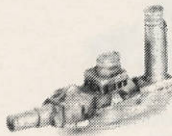

MONITOR  
BRIDGE  
0416/5



MONITOR  
HULL  
0416/4

## DWARF NAUTILUS

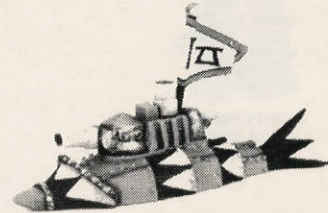

DWARF  
NAUTILUS  
0415/6

## DWARF DREADNOUGHT

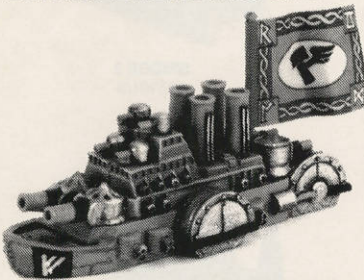

EXAMPLE OF COMPLETED AND  
FULLY PAINTED DWARF DREADNOUGHT

THE COMPLETE DWARF DREADNOUGHT  
CONSISTS OF:  
1 x LEFT BRIDGE  
1 x RIGHT BRIDGE  
1 x HULL



DREADNOUGHT  
RIGHT BRIDGE  
0417/3

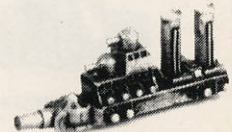

DREADNOUGHT  
LEFT BRIDGE  
0417/2



DREADNOUGHT  
HULL  
0417/1

Designed by Norman Swales

# DARK ELF WARSHIPS

## DARK ELF DEATH FORTRESS

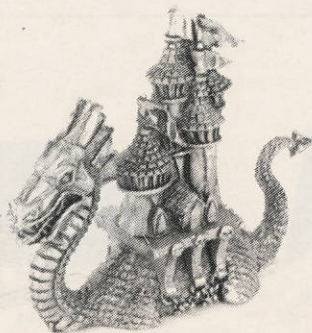

DEATH FORTRESS  
78022

## DARK ELF DOOMREAPER

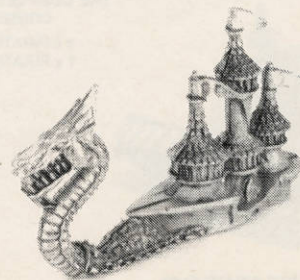

DOOMREAPER  
78023

Designed by Michael Perry

Miniatures supplied unpainted. WARNING. This product contains lead which may be harmful if chewed or swallowed. Citadel Miniatures are not recommended for children under 14 years of age.  
 © Copyright Games Workshop Ltd 1993. All rights reserved.



# MIGHTY EMPIRES



**MIGHTY EMPIRES  
GREAT CANNON**  
075094/7



**MIGHTY EMPIRES  
TEMPLE**  
075094/1

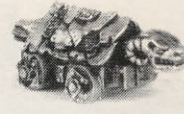

**MIGHTY EMPIRES  
BATTERING RAM**  
075094/6



**MIGHTY EMPIRES  
SIEGE TOWER**  
075094/5



**MIGHTY EMPIRES  
STONE THROWER**  
075094/4



**MIGHTY EMPIRES  
STONE CIRCLE**  
075094/3



**MIGHTY EMPIRES  
MINE**  
075094/2



**BRIDGE 1**  
075101/2

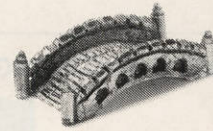

**BRIDGE 2**  
075101/3



**SKELETON ARMY  
BANNER**  
075101/7



**WIZARDS TOWER**  
075101/1



**NECROPOLIS**  
075101/6

**THE COMPLETE PIRATE SHIP  
CONSISTS OF:**

- 1 x PIRATE SHIP SAIL
- 1 x PIRATE SHIP HULL

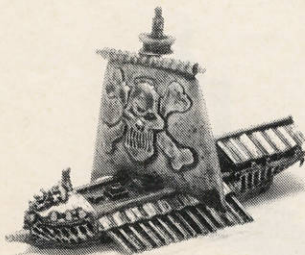

**COMPLETE PIRATE SHIP**



**PIRATE SHIP SAIL**  
075101/5

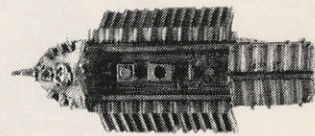

**PIRATE SHIP HULL**  
075101/4

Miniatures supplied unpainted. **WARNING.** This product contains lead which may be harmful if chewed or swallowed. Citadel Miniatures are not recommended for children under 14 years of age. ©  
 © Copyright Games Workshop Ltd 1993. All rights reserved.



# SPACE MARINE®

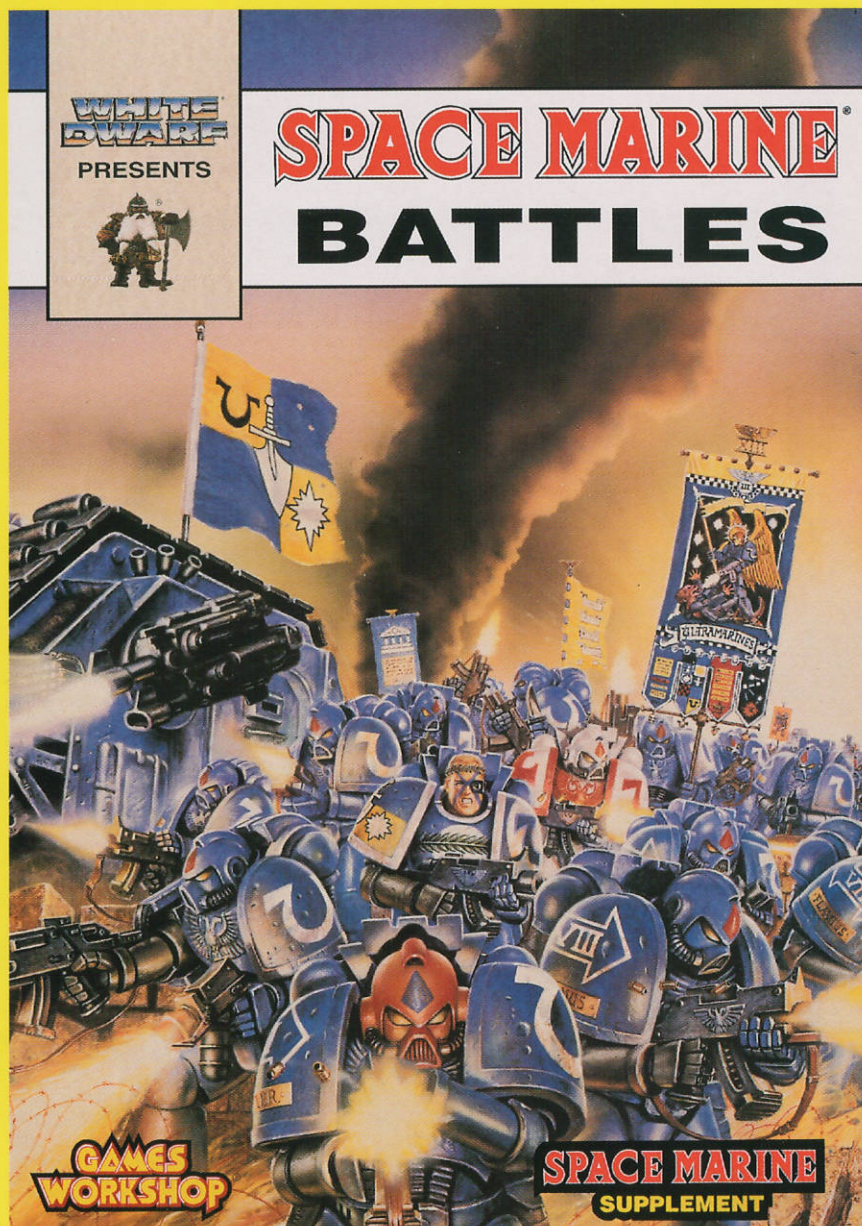

The Space Marine Battles compilation features some of the most sought after Space Marine articles from White Dwarf magazine. The book contains four exciting epic battle reports featuring the forces of the Eldar, Orks, Squats, Chaos, Space Marines, and the Imperial Guard.



It also features brand new tactics articles for many of these armies, plus special rules for fighting attack and defence games in Epic scale including: bunkers,

razor wire, minefields and fortifications. In addition, there are full rules for all of the awesomely destructive Imperial Titan weapons and full-colour card data sheets, rules and army cards for the Imperial Reaver and Warhound Titans, the Ork Great Gargant, Tzeentch Daemon Engines and epic heroes such as Ghazghkull Thraka, Commissar Yarrick and Ragnar Blackmane.

**WHITE DWARF®**

SPACE MARINE BATTLES IS NOT A COMPLETE GAME. YOU WILL NEED A COPY OF SPACE MARINE TO USE THE CONTENTS OF THIS BOOK.

**GAMES WORKSHOP®**



EVIL SUNZ AND GOFF ORKS ASSAULT AN IMPERIAL FORTIFICATION