

# GAMES WORKSHOP®

PRESENT THEIR MONTHLY GAMES MAGAZINE



CITADEL  
MINIATURES

162

£2.25

# WHITE DWARF®



GIANT OPEN DAY  
FREE MONEY-OFF  
VOUCHERS  
INSIDE





WOOD ELVES AMBUSH A DWARF ARMY



FELIX AND GOTREK HELP DEFEND A DWARF FORGE

## CONTENTS

### COVER: TYRANID ATTACK — *Gerry Grace*

Gerry's painting captures the full horror of the Tyranids' assault.

### INSIDE FRONT

Two action photos of the Dwarf army in battle.

### GW AND CITADEL NEWS

All the latest news from Games Workshop and Citadel Miniatures.

2

### FELIX AND GOTREK — *Bill King*

Bill's fictional characters come fully to life with full **Warhammer** stats, magic items and two new Citadel Miniatures.

5

### 'EAVY METAL DWARFS

Three pages of the finest painted miniatures including Felix and Gotrek and the new Dwarf Thunderers.

7

### THE ANVIL OF DOOM — *Rick Priestley*

Full rules and background for using this ancient Dwarf artifact in **Warhammer**.

10

### GIANT OPEN DAY

Games Workshop are having a massive celebration sale with free money-off vouchers.

14

### DREADNOUGHTS IN TYRANID ATTACK — *Jervis Johnson*

Jervis provides the rules for including mighty Dreadnoughts in your **Tyranid Attack** forces.

17

### ACROSS THE RAGING SEA — *Bill King*

Bill takes a look at the two major sailing fleets of the Warhammer World – the High Elves and Bretonnians – and comes up with some hints and tactics for your **Man O' War** battles.

25

### GOLDEN DEMON 1993

Here are the category winners, and the very best of the other entries at the Golden Demon Awards.

32

### DWARF DREADNOUGHTS — *Andy Jones*

The Dreadnought is the greatest warship in the Dwarf navy. Andy provides the rules and gives the background to the mighty Dwarf warfleet.

49

### CHAOS DWARF ARMY LIST — *Rick Priestley*

Following on from last month's article, Rick has written a full army list for Chaos Dwarfs in **Warhammer**, including rules for the Earthshaker Cannon and the Chaos Dwarf Death Rocket.

55

### ADVERTS

Ork Great Gargant .....	3	Marauder Giant Boxed Set.....	41
Deathwing Boxed Set .....	4	Space Marine Boxed Sets.....	46
Warhammer Plastic Dwarfs.....	13	Games Developers .....	48
Newcastle Metrocentre Store.....	16	High Elf and Bretonnian Ships .....	54
Aberdeen Store .....	16	Games Workshop Mail Order.....	68
Telesales Staff .....	23	Bolton Store & Thurrock Store .....	72
High Wycombe Store .....	23	Citadel Miniatures Catalogue.....	73
Chaos Dwarf Great Taurus .....	24	Warhammer Armies – Dwarfs ...	Inside Back



# GAMES<sup>®</sup> WORKSHOP AND CITADEL<sup>™</sup> NEWS

## GOLDEN DEMON 1993

Many thanks to everyone who came along to the Golden Demon Awards. It was great to meet you all and spend the day chatting about our hobby and joining in with the games. Congratulations to all of the Golden Demon Award winners. It was your hard work over the last few months that really made the day with the absolutely stunning display of painted miniatures.

## 'EAVY METAL PAINTING GUIDE

If you didn't enter the competition this year, now is the time to start preparing your ideas for next year's competition. If you are in need of some further inspiration, there is no better way to start than to take a look at Mike McVey's brand new 'Eavy Metal Painting Guide. The book is now almost ready and promises to be the definitive guide to collecting, painting and gaming with Citadel Miniatures.

Mike has spent many months painting models and writing explanations so that you can benefit from his years of experience as a miniature painter. The book should be in the shops in the next couple of months.

## WARHAMMER ARMIES

Following the release of **Warhammer Armies - Dwarfs**, the latest volume in the brand new series of Warhammer army lists, the scribes at the Studio have been set to work preparing the next two books covering the background and armies of the Skaven and the Undead. Those of you who were at the Golden Demon Awards will have seen **Gary Morley's** exciting new range of Undead miniatures and the book will cover the full history of the Undead including the dark majesty of the great Necromancer and Liche Lord - Nagash.

The Skaven volume will finally reveal the ancient secretive masters of the Skaven race - the Thirteen Lords of Decay as well as the return of Grey Seer Thanquol.

## DWARF FLAME CANNON

Straight from the talented hands of Norman Swales and Michael Perry comes this brilliant new Dwarf Flame Cannon for **Warhammer**. Full rules for this awesome weapon are published in the new **Warhammer Armies - Dwarfs** book, and we hope to bring you a battle report showing its performance on the tabletop in the near future.

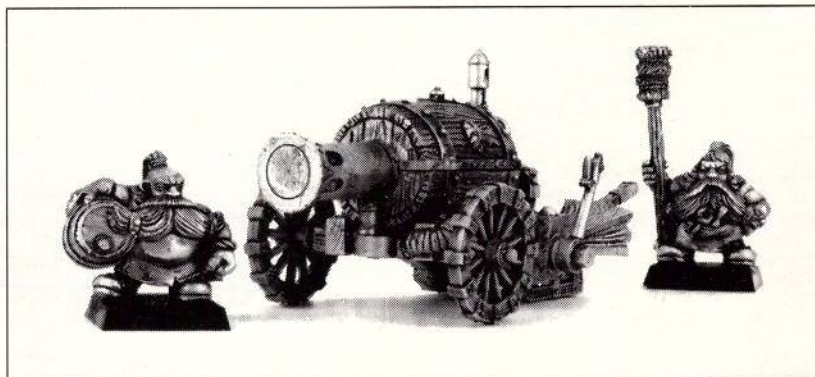

THE DWARF FLAME CANNON

## NEW HIGH ELF BANNERS

New from Citadel Miniatures is the first release in a brand new series of self-adhesive miniature banners. The banners are full-colour reproductions of the ones created by the Studio 'Eavy Metal team and are printed on adhesive backed paper so that they can be folded round a banner-pole to make an instant and startling addition to your Warhammer army. As soon as they are ready, we will be releasing further banners in the series for Orc and Goblin, Empire, Dwarf, and indeed all of the races of the Warhammer world.

The banners are available now from your local Games Workshop store or Games Workshop Mail Order.



# SPACE MARINE®

## SPACE ORK GREAT GARGANT

TOWERING ORK WAR  
MACHINE OF DESTRUCTION



CLAN BANNER



WARBOSS BANNER

**SPACE MARINE®**  
EPIC CONFLICT IN THE 41st MILLENNIUM



Model supplied unpainted. Banners not included.



EPIC

Model designed by Kevin Adams

The Great Gargant is the most powerful of all Space Ork Mekboy inventions. Its vast body houses a multitude of orky engines, generators and dynamos, which power its frightening array of awesome weaponry. The Mega-cannon mounted in its belly and on its arm blast its enemies with massive destructive power. The Super Lifta-Droppa can pound armoured enemies into the ground and the Gork head has massive Traktor Cannons mounted in the eye sockets to drag its opponents to their certain doom.



Citadel Miniatures are supplied unpainted. This model requires assembly. We recommend that parts are carefully cleaned and trimmed with a modelling knife before painting with Citadel paints. This is a Citadel Miniatures expert kit and requires a degree of modelling skill. We do not recommend this kit for young or inexperienced modellers.

**GAMES®**  
**WORKSHOP**

# WARHAMMER<sup>®</sup>

## 40,000



### SPACE MARINE<sup>®</sup> TERMINATORS

# DEATHWING<sup>™</sup>

INCLUDES  
DARK ANGEL  
TRANSFER SET

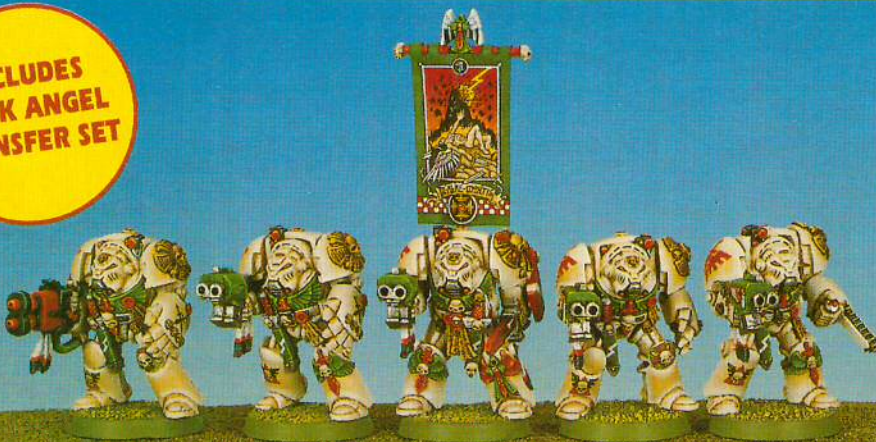

Banner not included. Models supplied unpainted.



### 5 DARK ANGELS IN SPACE MARINE TERMINATOR ARMOUR

Miniatures designed by Jes Goodwin

The Deathwing are the first company of the Dark Angels Space Marine chapter and are vastly experienced in all manner of war and battle. Their usual role is pinpoint strikes by individual squads, putting the fear of the Emperor straight into the hearts of his enemies. Only in the face of the most dangerous foes or threat is the entire company mustered.

This boxed set contains a transfer sheet for the Deathwing models. The sheet includes enough winged sword symbols to apply onto all 5 of the Terminators.

Citadel Miniatures are supplied unpainted. Scenery not included. These models require assembly. We recommend that parts are cleaned and trimmed with a modelling knife before assembly, and that the models are undercoated before painting with Citadel paints.



# GAMES WORKSHOP<sup>®</sup>

# WARHAMMER

## GOTREK GURNISSON & FELIX JAEGAR

By Bill King

### GOTREK GURNISSON

Gotrek Gurnisson is certainly the most, or the least, successful Troll Slayer in this age of the world. His quest to find death at the hands of a worthy opponent has never been fulfilled, but in the search he has slain monsters, Skaven, Orcs, Beastmen and Goblins beyond count. He has been an outlaw in the Empire and he has fought in the Emperor's armies. Rumour has it that he was once a member of the Dwarf Engineers Guild, but Gotrek never talks about his past either to confirm or deny this. No-one knows why he shaved his head and took the Slayer's Oath and no-one has ever had the courage to ask, not even his human henchman Felix Jaegar.

Gotrek has been unsuccessfully seeking a heroic death for many years now but seems just too mighty, too tough or too

lucky to die! His many adventures have taken him from Tilea in the south, to Norsca in the north and across the Western Sea to the lost continent of Lustria. It is rumoured that in the early days of his wandering, he ventured into the Chaos Wastes and returned with his axe. This weapon may be one of the reasons Gotrek has lived so long. Its power rivals that of the legendary Axe of Grimnir, born by the Dwarf High King Thorgrim Grudgebearer. No Runesmith has been able to decipher or duplicate the ancient runes upon the axe's blade. No foe has ever been able to withstand its killing power. Since acquiring the axe Gotrek has become all but invincible in battle. The Trollslayer lost his eye holding the gate of Fort Diehl single-handed against an entire tribe of Goblin wolf riders.

**GOTREK'S WEAPONS:** Gotrek is armed with his double-handed rune axe.

**MAGIC ITEMS:** The only magic item Gotrek carries is Gotrek's Rune Axe. Details for this weapon are included in this book.

### SPECIAL RULES

Gotrek is subject to all the normal rules for Slayers, except that he always fights alongside Felix Jaegar. He may never join or lead a unit. In addition, he is affected by the special rule of *Gotrek's Doom*. This is described after Felix, as it affects both characters.

### FELIX JAEGAR

The man, Felix Jaegar, is the youngest son of the wealthy Jaegar clan of wool merchants. He was a student at the University of Altdorf until he was expelled for killing a fellow student in a duel. Disinherited by his family he drifted into the wild life of a minor poet and political agitator until the fateful and drunken day when his destiny became intertwined with Gotrek's. Felix was one of the instigators of the Window Tax riots in Altdorf, a demonstration of public feeling that rapidly grew beyond the control of its organisers and expanded into an outbreak of looting and mob violence so bad that the Emperor was obliged to send his knights to restore public order.



Many innocent people were caught between the pounding hooves of the knights and the ferocity of the mob. Dismayed by his involvement in what was threatening to become a massacre, Felix tried to get between the charging knights and a crowd of panicking women and children. Perhaps impressed by the sheer senselessness of Felix's heroism, Gotrek intervened, slew ten of the knights and dragged Felix to safety. The two then went on a drunken binge of epic proportions. When Felix awoke the next day he was horrified to discover that he had sworn to follow the Slayer and record his doom in an epic poem. Since that day he has followed Gotrek across the Empire and the lands of the Border Princes to the near-abandoned Dwarf citadel of Karak Eight Peaks and back.

**FELIX'S WEAPONS/ARMOUR:** Felix is armed with a magic sword and light armour.

**MAGIC ITEMS:** Felix Jaegar carries a Blade of Leaping Bronze which gives him +2 extra Attacks.

**SPECIAL RULES**

Felix must always fight alongside Gotrek and neither may join or lead a unit while Gotrek lives. While Gotrek is alive Felix shares his immunity to psychology and break tests. Should Gotrek be slain, Felix may join or lead units as normal. While Gotrek is alive Felix is affected by the rules for *Gotrek's Doom* as described below. Should Gotrek be slain these rules cease to apply.

**GOTREK'S DOOM**

Time and again Gotrek has cheated death. Time and time again he has survived situations that no mortal should have survived no matter how strong, tough, lucky or skillful. It would seem that fate, Dwarf gods or some other power is preserving his life for a mighty doom indeed. To simulate this, whenever Gotrek or Felix take a wound under any circumstance whatsoever, roll a D6. If the result is 4 or more then ignore the wound: the blow was turned at the last second, the character just managed to throw himself clear of the explosion, a freak gust of the winds of magic dissipated the spell, whatever.

The doom also protects the pair from magic. On a roll of 4+ any hostile spell which would otherwise harm them fails to do so. Note that the save against magic only saves Felix or Gotrek, it does not dispel the spell. The spell might still affect other models nearby if appropriate.

Oddly enough, Gotrek's Doom seems to mean that the heroes can never settle happily, keep any possessions or even earn much money. They are destined to wander till whatever their allotted fate is overtakes them. Because of this the two have difficulty holding onto any possessions at all. The only magic item Gotrek is allowed to possess is his axe, and the only magic item Felix can have is his sword. The Doom also ensures the two are never separated, so they always fight together.

Profile	M	WS	BS	S	T	W	I	A	Ld	Pts	Notes
Gotrek	3	8	6	4	5	3	5	4	10	185	+125 points for Gotrek's Axe
Felix	4	6	5	4	4	2	5	3	8	77	+ 50 points for Felix's sword

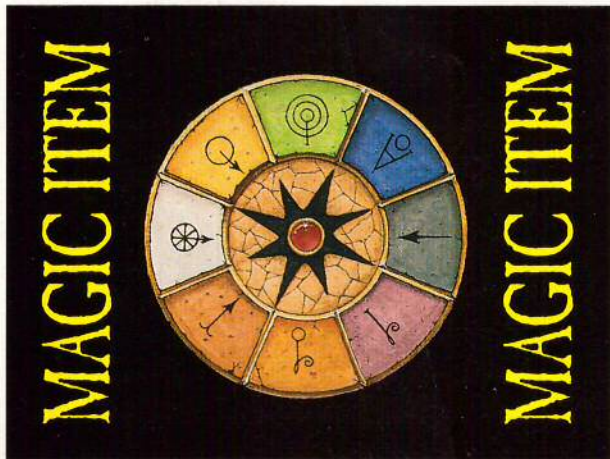

**MAGIC ITEM** **125 POINTS**  
**GOTREK'S AXE**

*This is the axe carried by the Slayer Gotrek Gurnisson - where he found it remains a mystery. It has glowing runes inscribed upon it, but these are of such archaic form that no living Runesmith has succeeded in reading or duplicating them. Its extreme antiquity and potency are beyond doubt.*

Any hit inflicted by this axe will wound on the D6 roll of a 2 or more regardless of the user's Strength or target's Toughness. The target receives no save for armour, unless it is magical armour, and even magical armour suffers a -3 saving throw modifier. Each wound inflicted causes not 1 wound but D3. In the case of dragons and daemons each wound inflicted causes D6 wounds.

**DWARF SLAYERS ONLY**

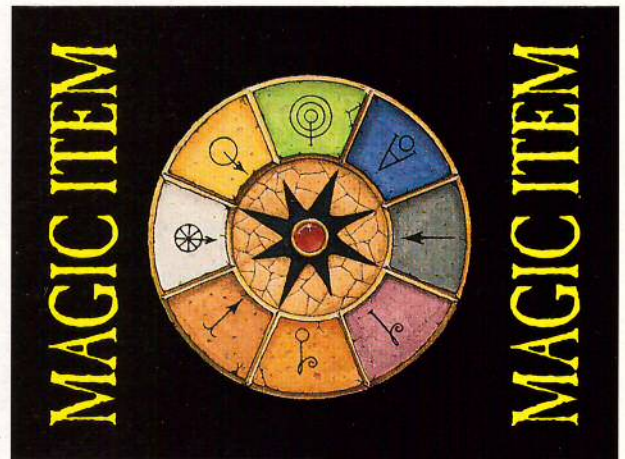

**MAGIC ITEM** **50 POINTS**  
**BLADE OF LEAPING BRONZE**

*Speed and uncanny swiftness characterises sorcerous blades made from copper alloys. A warrior armed with this blade attacks with the speed of lightning.*

A character using this blade gains +2 on his Attacks characteristic.

**+2 ATTACKS**



# DWARFS



STANDARD BEARER



GOTREK



FELIX



STANDARD BEARER



CLANSMAN



TROLL SLAYER



IRON BREAKER



TROLL SLAYER



HORNBLOWER



CLANSMAN



DRUMMER



LONGBEARD



LONGBEARD



ORGAN GUN AND CREW

## DWARF ARMY UNITS



DWARF CLANSMEN



DWARF LONGBEARDS



DWARF CROSSBOWMEN

# DWARF THUNDERERS



# THE DWARF ANVIL OF DOOM

The Anvils of Doom are ancient devices forged with great skill by the Runesmiths of old in the bowels of Thunder Mountain. Using the energy of the volcano's heart, Kurgaz, the most skilled of the old ones, melted gromril to forge the anvils. As they cooled Kurgaz himself beat the Rune of Sorcery onto each gleaming anvil.

No one knows how many anvils were forged before the secret of the Rune of Sorcery was lost. The Dwarf Book of Grudges records how an evil dragon attacked Thunder Mountain and slew the old Runesmith in a mighty battle which rent the mountain apart. During the devastation the forges of Thunder Mountain were destroyed and many Runesmiths slain. The Anvils of Doom are ancient and valuable heirlooms, and the Dwarfs value them more highly than any of their other possessions.

Runesmiths use the Anvils of Doom for making magic items. Most anvils are owned by the various strongholds or by the guilds, and the Runesmiths make use of these when they need to. A few anvils are owned by Runesmiths, but these tend to be the sedentary Runesmiths who reside in the halls of Karaz-a-Karak and the weapon shops of Karak Azul.

The anvils are objects of great power and in times of extreme need a Runesmith can unleash spells and lightning upon his foes. With a mighty blow of his hammer the Runesmith can release the anvil's power. Lightning bolts blast from its surface as mighty energies unfurl, the sky darkens with brooding energy, and clouds of multicoloured magic swirl and sparkle in the air.

## THE ANVIL IN BATTLE

A Dwarf Runesmith may bring an anvil to battle. The anvil is mounted on its own wheeled platform and the Runesmith stands proudly on top. The anvil is protected by Dwarf guards who have sworn to defend it to the death. The Dwarf army can use the anvil to draw energy from the Winds of Magic, the nebulous source of magic power that flows over the battlefield. Wizards draw upon the Winds of Magic to power their spells, and the anvil absorbs and stores magical energy in a similar way.



During the magic phase the Dwarf player is dealt magic cards from the power deck according to the normal rules described in Warhammer Battle Magic. Dwarf armies are not normally able to use these cards except for Dispels and Drain Magic. However, if the Dwarf army includes an anvil all the magic cards can be used as described below.

When the Dwarf player is dealt his magic cards he may choose any four and 'store' them in the anvil, which 'absorbs' the energy of these cards within itself. The Dwarf player may hold onto these cards and play them in any subsequent magic phases. Note that cards can only be used if they have already been stored in a previous magic phase – it is not possible to store and use the same card in one phase.

The anvil can hold no more than four cards and is considered fully charged when this limit is reached. During any subsequent magic phase the Dwarf player can choose to play or discard any cards he has stored in order to make space for more. If the Drain Magic card is played in the magic phase by either player then all the cards currently stored in the anvil are removed and discarded.

Cards stored in the anvil are played on behalf of the Runesmith himself. Rebound and Destroy cards which have been stored in the anvil may be played against any enemy spell targeted at either the anvil, the Runesmith, or the anvil guards. When using the Destroy Spell card the Runesmith may add any power cards already stored in the anvil to his total score, but may not add other power cards as can wizards. The Escape card applies only to the Runesmith himself. If the Runesmith fights a Mental Duel and loses then any cards stored in the anvil are discarded.

## LIGHTNING

The anvil may also be used to unleash raw power in the form of a Lightning Bolt spell. In effect the Runesmith casts a spell in the same way as a wizard, and all the normal rules for spell casting apply unless specified otherwise. See Warhammer Battle Magic for details. In order to unleash lightning the Runesmith must have at least one power card already stored in the anvil. During his turn of the magic phase the Dwarf player may unleash the lightning just as other players may cast a spell. One lightning bolt is unleashed for every power card expended from the anvil. Obviously the greatest number of lightning bolts that can be unleashed in this way is therefore 4. All lightning bolts are cast at once, but they can be directed against separate targets if you wish. Any power cards used to cast the lightning bolts are removed from the anvil and placed on the magic card discard pile as normal for cast spells.

Each lightning strike is worked out separately. Each bolt has a range of 24" and strikes the first target in its path. Each bolt inflicts a Strength 6 hit and causes not 1 wound but D3. Chariots, war machines, and comparable constructions suffer D3 Strength 10 hits. No saving throw is allowed, not even for magical armour. These details are exactly the same as for the Celestial Lightning spell in Warhammer Battle Magic and the same rules apply as for all spell casting. All lightning bolts can be dispelled or rebounded by the enemy by use of the appropriate magic cards. Note that a Dispel card will dispel all lightning bolts from the anvil that turn, while a successful Rebound will also dispel any bolts not already cast. Enemy dispels always work on a 4+, regardless of the magic level of the enemy wizard.

## DWARF RUNESMITH'S ANVIL OF DOOM



MIGHTY RUNESMITH RIDES INTO BATTLE WITH THE ANVIL OF DOOM



RUNESMITH

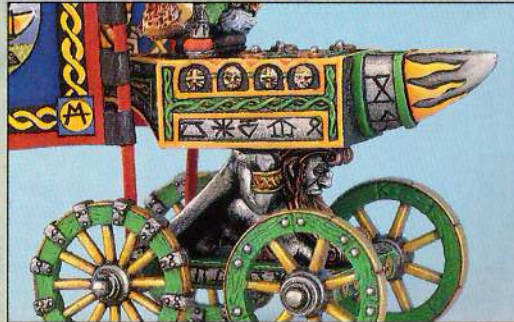

DETAIL OF THE ANVIL



ANVIL GUARD

Only in times of great need will a Dwarf Runesmith bring an Anvil of Doom into battle. With a mighty blow from his hammer, the Runesmith releases the Anvil's power, sending billowing clouds of multi-coloured magical energy and blasts of lightning into the air.

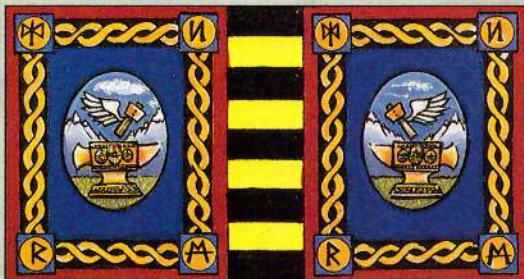

STRONGHOLD BANNER



RUNESMITH'S BANNER

## TOTAL POWER

The Total Power card represents energies so cataclysmic and difficult to control that they are potentially disastrous, even to the Anvil of Doom. If you choose to store the Total Power card in the anvil the following rules apply.

When the Total Power card is stored in the anvil the Dwarf player must announce the fact to his opponent – the anvil glows with such incandescent power that it is visible for all to see! At the start of any magic phase the Dwarf player must make a test if the Total Power card is in the anvil. Roll a D6. If the result is a 1 then roll another D6 and consult the following table.

### D6 Result

**1-2** *Disaster.* The power is so great that the anvil shatters apart in a gout of flame. The Runesmith is slain. Shrapnel from the exploding anvil strikes every model within 3" causing a single Strength 6 hit. For every additional magic card stored within the anvil increase the strength of the hit by 1. So if the player had one extra card in the anvil it would be S7; two extra power cards would make it S8 etc.

**3-4** Unable to control the roiling power in the anvil the Runesmith is forced to discharge all the energy in a random, uncontrolled fashion. A storm of lightning rages about the anvil as lightning bolts fly in all directions. Roll a D6 to determine the number of lightning strikes that are unleashed. Each bolt is exactly the same as a normal lightning bolt unleashed by a stored power card. Roll a scatter dice to establish the direction taken by each lightning bolt. Each bolt strikes the first target in its path. Resolve the effects of the bolts one at a time, they cannot be dispelled or rebounded. All stored cards are discarded and the anvil may not be used to store more cards this battle.

**5-6** Wrestling with the magical energies the Runesmith is forced to invoke Grungni to earth the writhing power of the anvil. All cards contained within the altar are discarded and the anvil may not be used to store more cards until the next magic phase.

Assuming the Total Power card has been successfully stored it may be used during the magic phase to unleash more lightning bolts. The number of bolts unleashed is D6 + 1 for each additional stored power card. Each bolt is exactly the same as already described and can be fired in any direction the player wishes. As the lightning bolts are powered by the Total Power card they cannot be dispelled or rebounded. Once all lightning strikes have been resolved any remaining cards in the anvil are discarded.

Finally roll a D6:

- 1** The anvil is temporarily exhausted and its powers are now gone. No more cards may be stored this battle.
- 2-6** The anvil cannot be used to store more power cards until the next magic phase.

## GUARDS

The anvil is accompanied by two guards whose job is to protect the anvil and the Runesmith. These stout Dwarfs are apprentice Runesmiths, or close relatives of the Runesmith, and they are bound to their duties by severe Dwarf oath. No Dwarf would break such an oath and most would rather die than fail to do their duty.

The anvil guards are individual Champions. They must remain within 4" of the anvil and are exempt from the normal pursuit rules to allow them to do this. The anvil Guard are immune to the psychology rules while the Runesmith is alive, and cannot be broken either.

## MOVEMENT

The Anvil of Doom moves under its own magical power at the normal movement rate of the Runesmith.

## COMBAT AND DAMAGE

The Anvil of Doom is impossible to damage – all attacks against it are directed against the Runesmith. The anvil does not attack and has no effect on hand-to-hand fighting. If the Runesmith is forced to flee he does so with the anvil. If pursued and destroyed the anvil is removed from play.

## SHOOTING

The anvil, Runesmith and Champions are considered to be a single entity for purposes of shooting, in a similar way to a chariot. The anvil counts as a large target for shooting purposes and any hits scored against it are randomised between the anvil itself, the Runesmith and the Champions. For each hit scored roll a D6 and consult the following chart. Note that any hits scored against the anvil are immediately discounted – the anvil cannot be harmed.

D6 Roll	Hits
1	The Runesmith
2-3	The Guards
4-6	Anvil (discount hit)

If the anvil is hit by a cannonball, a bolt thrower, or similar war machine, roll to determine whether the Runesmith, anvil or guards are hit as described above. If hit by a war machine with a template, such as a stone thrower, the usual rules apply. Ie, any part of the anvil group which lies under the template is hit. Note that the usual guidelines apply when deciding if a model lies under a template – it is considered to have been hit if at least half the base area is covered by the template.

## POINTS COST

Any Runesmith may take the Anvil of Doom into battle at a cost of 200 points.

This value includes the cost of the two Dwarf Champions who act as Anvil guards.

Full rules for the Anvil of Doom, Runesmiths and a host of other Dwarf special weapons and characters can be found in the forthcoming Dwarfs Warhammer Armies book

# WARHAMMER

WARHAMMER

# DWARFS



MODELS SUPPLIED UNPAINTED



## 10 FINELY DETAILED PLASTIC MODELS

Dwarfs are grim faced warriors who never forgive, never forget, and never surrender. They are renowned for their fierce courage on the battlefield, making armies that are as solid as the rock from their mountain strongholds.

Troop Type	M	WS	BS	S	T	W	I	A	L	Save
Dwarf Warrior	3	4	3	3	4	1	2	1	9	5+

This boxed set contains 10 plastic Citadel Miniatures – 10 Dwarf Warriors  
 Citadel miniatures are supplied unpainted. These models require assembly. We recommend that models are carefully removed from the plastic sprue using suitable clippers before assembly and that the models are undercoated before painting with Citadel paints. These plastic Citadel miniatures are moulded in a hard styrene compound which is particularly suitable for painting and modelling.



# GAMES WORKSHOP®

## GIANT OPEN DAY

**SATURDAY 29th MAY 1993**

### A DAY OF MONSTER BARGAINS IN ALL OUR UK STORES

Games Workshop have recently opened their 50th UK store. As a celebration of this event, we are going to hold a day of fantastic offers in all our stores.

On this special day, every Games Workshop store will be open from 8.00am\* until 6.00pm. There will be hundreds of bargains with many games and books at half-price and selected blister packs at £1.00 each. You can also use your free money-off vouchers to make great savings on the whole range of Games Workshop games and miniatures.

\* Stores in shopping centres may open at different times. Please phone your local store for up to the minute information.

**50  
STORES**

**BUY ANY TWO  
CITADEL OR  
MARAUDER  
BLISTER PACKS  
AT £3.99 OR  
MORE AND GET  
ANY £3.99 BLISTER  
PACK ABSOLUTELY  
FREE!**

**USE YOUR SPECIAL FREE  
VOUCHERS TO GET ANY BLUE  
DOT ITEMS IN THE STORE AT HALF PRICE.**

**BLUE DOT ITEMS INCLUDE:**

**WARHAMMER  
40,000**



**ADVANCED  
HEROQUEST**

**AND MANY OTHER EXCITING  
GAMES WORKSHOP PRODUCTS.**



**SPECIAL  
BARGAINS  
ALL DAY**

**DON'T  
MISS OUT**



**GAMES WORKSHOP®**

**GIANT OPEN DAY**

**SATURDAY 29TH MAY 1993**

**50% OFF**

**ALL BLUE DOT ITEMS IN THE STORE**



**GAMES WORKSHOP®**

**GIANT OPEN DAY**

**SATURDAY 29TH MAY 1993**

**50% OFF**

**ALL BLUE DOT ITEMS IN THE STORE**



**GAMES WORKSHOP®**

**GIANT OPEN DAY**

**SATURDAY 29TH MAY 1993**

**25% OFF**



ALL GAMES WORKSHOP GAMES AND CITADEL AND MARAUDER MINIATURES

**GAMES WORKSHOP®**

**GIANT OPEN DAY**

**SATURDAY 29TH MAY 1993**

**25% OFF**



ALL GAMES WORKSHOP GAMES AND CITADEL AND MARAUDER MINIATURES

**GAMES WORKSHOP®**

**10% OFF**

**GIANT OPEN DAY**

**SATURDAY 29TH MAY 1993**

ALL GAMES WORKSHOP GAMES AND CITADEL AND MARAUDER MINIATURES

**GAMES WORKSHOP®**

**10% OFF**

**GIANT OPEN DAY**

**SATURDAY 29TH MAY 1993**

ALL GAMES WORKSHOP GAMES AND CITADEL AND MARAUDER MINIATURES

**GAMES WORKSHOP®**

**10% OFF**

**GIANT OPEN DAY**

**SATURDAY 29TH MAY 1993**

ALL GAMES WORKSHOP GAMES AND CITADEL AND MARAUDER MINIATURES

**GAMES WORKSHOP®**

**10% OFF**

**GIANT OPEN DAY**

**SATURDAY 29TH MAY 1993**

ALL GAMES WORKSHOP GAMES AND CITADEL AND MARAUDER MINIATURES

**THE GIANT OPEN DAY IS AT ALL THESE STORES**

- BECKENHAM: 292-294 HIGH ST. TEL: 081 658 8102
- BELFAST: 20A CASTLE COURT. TEL: 0232 233684
- BIRMINGHAM: 116 CORPORATION STREET. TEL: 021 236 7880
- BRIGHTON: 7 NILE PAVILIONS, NILE ST. TEL: 0273 203333
- BRISTOL: 13 BROAD WEIR. TEL: 0272 251533
- BROMLEY: 8 BROMLEY MALL. TEL: 081 466 0678
- CAMBRIDGE: 4 QUAYSIDE, (OFF BRIDGE ST). TEL: 0223 313350
- CARDIFF: 29-30, HIGH STREET. TEL: 0222 644917
- CHELTENHAM: 16 PITVILLE STREET. TEL: 0242 228419
- CHESTER: 112 FOREGATE STREET. TEL: 0244 311967
- COLCHESTER: 2 SHORT WYRE STREET. TEL: 0206 767279
- COVENTRY: 14 CITY ARCADE. TEL: 0203 227311
- CROYDON: UNIT 35, DRUMMOND CENTRE, KEELEY RD. TEL: 081 680 4600
- DERBY: 42 SADLER GATE. TEL: 0332 371657
- DUDLEY: KIOSK U, UPPER LEVEL, MERRY HILL CENTRE, DUDLEY. GAMES NIGHT: THURS TILL 9.00. OPEN MON - FRI. 10.00 TILL 8.00. SAT 9.00 TILL 7.00. TEL: 0384 481818
- EDINBURGH: 136 HIGH ST. OPEN SUN 11 - 5. TEL: 031 220 6540
- GLASGOW: 66 QUEEN ST. TEL: 041 226 3762
- GUILDFORD: 12 TUNSGATE. TEL: 0483 451793
- HAMMERSMITH: 1 DALLING ROAD. TEL: 081 741 3445
- HARROW: 296 STATION RD. TEL: 081 861 2350
- HIGH WYCOMBE: UNIT 29, THE BALCONY, THE OCTAGON CENTRE, HIGH WYCOMBE
- HULL: 30 PARAGON STREET. TEL: 0482 589576
- LEEDS: 12-16 CENTRAL ROAD. TEL: 0532 420834
- LEICESTER: 1620 SILVER ST. TEL: 0533 530510
- LIVERPOOL: 47 LORD STREET. TEL: 051 258 1404
- CENTRAL LONDON: UNIT F10, THE PLAZA, 116-128 OXFORD STREET. TEL: 071 436 0839
- LUTON: 12 PARK STREET. TEL: 0582 417474
- MAIDSTONE: UNIT 6, 1-9 PUDDING LANE. TEL: 0622 677435
- MANCHESTER: UNIT 1, 3 BROWN STREET. TEL: 061 832 6863
- MEADOWHALL CENTRE SHEFFIELD: 91B, HIGH ST, UPPER MALL. OPEN MON TO THURS 10 - 8. FRIDAYS 10 - 9. SATURDAYS 9 - 7. SUNDAYS 12 - 4. TEL: 0742 569836
- MIDDLESBROUGH: 39 DUNDAS ST. TEL: 0642 254091
- NEWCASTLE: 63 CLAYTON STREET. TEL: 091 232 2418
- NEWCASTLE METROCENTRE: UNIT R14, FIRST FLOOR, METROCENTRE, GATESHEAD, NEWCASTLE-UPON-TYNE
- NORWICH: 12-14 EXCHANGE STREET. TEL: 0603 767656
- NOTTINGHAM: 34a FRIAR LANE. TEL: 0602 480651
- OXFORD: 1A NEW INN HALL ST. TEL: 0865 242182
- PETERBOROUGH: 3 WENTWORTH STREET. TEL: 0733 890052
- PLYMOUTH: 84 CORNWALL STREET. TEL: 0752 254121
- PORTSMOUTH: 34 ARUNDEL STREET. TEL: 0705 876266
- PRESTON: 15 MILLER ARCADE. TEL: 0772 821855
- READING: UNIT 3, CHEAPSIDE. TEL: 0734 598693
- SHEFFIELD: 16 FITZWILLIAM GATE. TEL: 0742 750114
- SOUTHAMPTON: 23 EAST STREET. TEL: 0703 331962
- SOUTHEND: 12 SOUTHCHURCH RD. TEL: 0702 461251
- STOKE ON TRENT: 27 STAFFORD ST, HANLEY. TEL: 0782 205287
- SWINDON: 17 FLEET STREET. TEL: 0793 436036
- NEW STORE! THURROCK LAKESIDE: UNIT 415, LEVEL 3/FOOD COURT, THURROCK LAKESIDE JUNCTIONS 30/31, M251. TEL: 0708 867133. OPEN MON - THU 10 - 8, FRI 10 - 9, SAT 10 - 7.30.
- TORQUAY: 12 MARKET ST. TEL: 0803 201036. (Closed Tuesdays)
- WORCESTER: 4 CHARLES STREET. TEL: 0905 616707
- YORK: 26 GOODRAMGATE. TEL: 0904 653575



Vouchers may not be used in combination with each other or with any other offer. Discounts apply only to Games Workshop games and Citadel and Marauder miniatures. MB Games' Heroquest, Space Crusade or Battle Masters and the Boxtree Books' Warhammer novels are not included.

GAMES WORKSHOP • GAMES WORKSHOP NEWCASTLE METROCENTRE • GAMES WORKSHOP

GAMES WORKSHOP STORES • GAMES WORKSHOP STORES

GAMES WORKSHOP STORES • GAMES WORKSHOP STORES

# OPEN NOW!

# GAMES WORKSHOP®

## NEWCASTLE METROCENTRE



UNIT R14, FIRST FLOOR,  
METROCENTRE,  
GATESHEAD,  
NEWCASTLE-UPON-TYNE.

**NORMAL OPENING HOURS**

Mon. Tue. Wed. Fri. 10am to 8pm  
Thursday 10am to 9pm, Saturday 9am to 7pm  
Games night every Thursday

GAMES WORKSHOP • GAMES WORKSHOP NEWCASTLE METROCENTRE • GAMES WORKSHOP

GAMES WORKSHOP • GAMES WORKSHOP ABERDEEN • GAMES WORKSHOP

GAMES WORKSHOP STORES • GAMES WORKSHOP STORES

GAMES WORKSHOP STORES • GAMES WORKSHOP STORES

# OPEN SOON!

# GAMES WORKSHOP®

## ABERDEEN



UNIT 1, 30/40  
UPPER KIRKGATE

**NORMAL OPENING HOURS**

Monday – Wednesday 10am to 6pm  
Thursday 10am to 8pm, Friday 10am to 6pm  
Saturday 9am to 5.30pm  
Games night every Thursday

GAMES WORKSHOP • GAMES WORKSHOP ABERDEEN • GAMES WORKSHOP

# TYRANID ATTACK

## DREADNOUGHTS

By Jervis Johnson

Hidden away in the back of the Tyranid Attack rulebook is a section of rules describing how you can use Chaos Dreadnoughts in the game. The rules are necessarily brief (after all, you don't actually get Chaos Dreadnought models in the game) and quite a few players have written in to me asking if I could explain the rules in a bit more depth, and also whether it is possible to use any other Dreadnought models with the game. Never being one to let my adoring public down, I've put together this article to answer both sets of questions at the same time!

### DREADNOUGHTS IN THE WARHAMMER UNIVERSE

The Dreadnought is the ultimate form of personal armour. Inside his giant armour suit, the wearer – or more correctly the pilot – controls the Dreadnought's movement, armament and defences. Dreadnoughts are a common sight on battlefields across the galaxy, being ideally suited to close support and spearheading attacks in dense terrain where their thick armour and heavy weapons are a real advantage. These characteristics make Dreadnoughts ideal for boarding actions, where their relatively small size means that they are the only armoured

vehicle that can move about the narrow corridors and through the small doorways found on a typical spacecraft or Tyranid hive ship.

Although employed by every race in the Warhammer 40,000 universe, Dreadnoughts are complex machines that require special materials to construct and special skills to pilot. Nevertheless, some are more complex than others. Ork machines are among the most primitive and least reliable. Human machines are solidly built and efficient and Eldar Dreadnoughts are probably the most sophisticated of all. The main differences between each type of Dreadnought is described below and the special gaming rules for each type reflect these vital racial differences.

#### Space Marine Dreadnought

The pilot of a Space Marine Dreadnought is not an ordinary Space Marine but one of the Old Ones – a Space Marine mortally wounded in battle long ago. Rather than being allowed to die he has been implanted inside the Dreadnought, his nervous system connected directly to the machine itself. The Space Marine now only exists as a tightly curled and shrivelled organic component deep inside the Dreadnought. He loses all sensation from his body and relies completely on the artificial senses of the machine. Space Marine Dreadnoughts are often very ancient, sometimes many thousands of years old. They are revered by the other Space Marines as potent warriors and also as living embodiments of the Chapter's proud history.

#### Chaos Dreadnought

A great Chaos Space Marine Champion may be fortunate enough to find himself implanted into a Dreadnought rather than die of his wounds. Just as Space Marine Dreadnoughts combine the barely living remnants of a Space Marine with a complex fighting machine, so the Chaos Dreadnought uses sophisticated technology and arcane secrets to prolong the lives of Chaos Champions in machine form. The Chaos Dreadnoughts derive from the ancient time before the Horus Heresy, but many of these machines have mutated under the warping power of Chaos into a combination of bone, metal, and living flesh. Relatively few survive and they are carefully maintained and repaired by Chaos Dwarf artificiers. If the Dreadnought's occupant is killed in action, the Dreadnought is recovered and refurbished to house a new Chaos Champion.

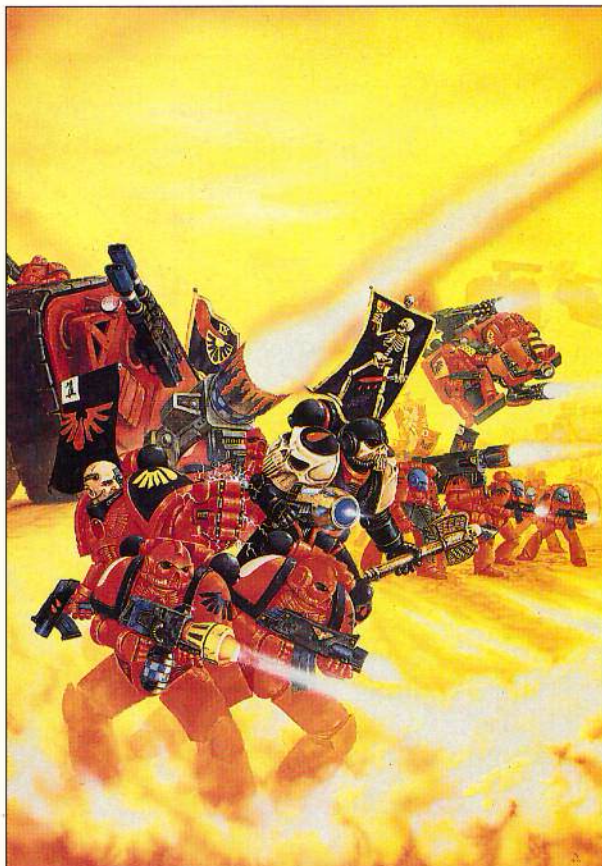

### Ork Dreadnought

The Ork Dreadnought is piloted by a Gretchin which has been surgically implanted into the machine by the combined efforts of an Ork Painboy and Mekboy. Gretchin are fortunately very resilient and usually survive the operation to wake up and find themselves wired into a huge metal body which is even bigger and stronger than an Ork's! This is very cheering for the Gretchin who has had to suffer years of beating from his Ork masters, and not surprisingly the power goes to his head. In battle, Ork Dreadnoughts often charge off towards the first enemy they see, bellowing loud metallic "Waaargh!" noises out of their speakers. Fortunately, most Ork Dreadnoughts are equipped with a couple of fearsome power claws so that the Gretchin can work off some of its angst in close combat and then (hopefully) settle down for the rest of the battle.

### Eldar Dreadnought

Wraithguard are cybernetic warriors controlled by the spirits of dead Eldar heroes. Wraithguard bodies come in a number of different sizes ranging from man-sized to Dreadnoughts. Indeed, Eldar Titans are in a sense large Wraithguard themselves. The Eldar spirits are held in a *spirit stone* and interface directly into the psychic Wraithbone core of the Wraithguard suits. The spirits gradually lose their perception of the material universe in a physical respect, eventually 'seeing' purely in terms of emotions and psychic flux. Because of their increasingly psychic perception, Wraithguard need to have friendly troops or psykers nearby to act as an anchor or reference point for their perception of reality, otherwise they become confused and act randomly. Because of their nature, Wraithguard make powerful opponents for daemons, being in a sense daemons of the material universe themselves.

### Tyranid Screamer Killer

The Screamer Killer is one of the larger Tyranid bio-constructs: a living engine of destruction designed for use in assaults, boarding actions and massed battles. Because of its exceptional size and toughness, the Screamer Killer is treated as a Dreadnought in all respects, even though it is a living creature. At close quarters it uses its deadly claws to tear the enemy to pieces, ripping through armour and shredding flesh with ease. The Screamer Killer's ranged attack is even more terrible. Rasping plates in the mouth, gases secreted in the lungs, and a high frequency scream produced by the creature's vocal cords combine to produce a highly unstable bio-plasma energy bolt. This forms for a split-second in front of the Screamer Killer, held in place by a flickering electrical field generated around the creature's claws, before it is belched forth to burn its path across the battlefield and explode with incandescent fury.

## USING DREADNOUGHTS IN TYRANID ATTACK

Dreadnoughts may now be used by either player in Tyranid Attack. The Tyranid player may include Chaos Dreadnoughts, Ork Dreadnoughts and Screamer Killers with his defending forces, while Space Marine and Eldar boarding parties may include Space Marine or Eldar Dreadnoughts respectively. Whichever side is using them, the Dreadnought must be represented by an appropriate model, which really should be painted if you want it to fight effectively! Included with this article are a set of Dreadnought *Data Cards* which include all of the information you will need in order to use the appropriate Dreadnought model in Tyranid Attack.

If the Tyranid player has any Chaos Dreadnought, Ork Dreadnought or Screamer Killer models he may add them to his available forces for the game, as described on the Additional Force List on the back page of the Tyranid Attack rulebook. If the Tyranid player decides to use a Dreadnought, then it counts as **three** models against the number of models he is allowed to take, rather than just one. For example, say that the Tyranid player rolled a '3' for the number of models defending an objective. He could choose to take three normal models, or he could take one Dreadnought instead. Note that this means that the Tyranid player may **not** take a Dreadnought if he is only allowed to place one or two models on the board. As Chaos Dreadnoughts and Ork Dreadnoughts are captured *mind slaves*, while Screamer Killers are special *bio-constructs*, each model may only be used once per game.



### Space Marine and Eldar Dreadnoughts

Space Marine Dreadnoughts may be included with any Space Marine boarding party, and Eldar Dreadnoughts may be included with any Eldar boarding party. In order to include a Dreadnought with a Space Marine boarding party you will have to use the rules for designing your own boarding parties included on the Additional Force List on the last page of the Tyranid Attack rulebook, and you will need the rules for using the Eldar in Tyranid Attack from WD159 in order to use Eldar Dreadnoughts. Both Space Marine and Eldar Dreadnoughts cost 15 points each.

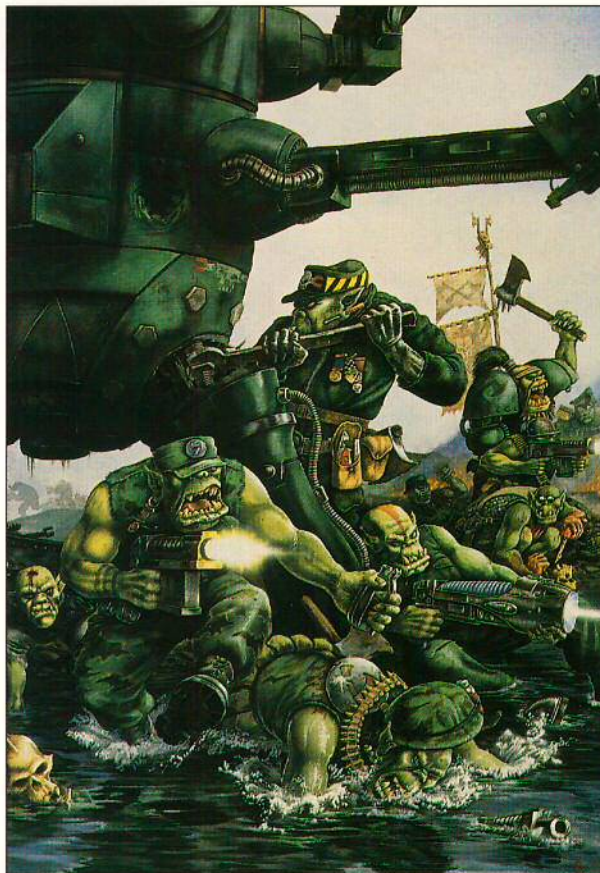

### Moving Dreadnoughts



Dreadnought models are large and impressive, and at first glance it may appear that they take up more than one square on the board in Tyranid Attack. In fact this is not the case, and although the Dreadnought model is large, you should place it on the board so that it is centred on a single square. This square is the one used for movement, line of sight to or from the model, combat and so on.



You'll find that although the Dreadnought's base is slightly larger than the square it is placed in, there is still plenty of room to fit models into the adjacent squares.



The Screamer Killer may move just like any other model.



The Screamer Killer has moved four squares.

### Dreadnoughts And Combat

Most Dreadnoughts can be fitted with a wide variety of different weapon combinations. The Dreadnought's data card has the quantity and rules for the weapons that may be fitted to the Dreadnought. At the end of the day, however, the actual 'weapon fit' for a Dreadnought is determined by the model itself. So if you have an Ork Dreadnought model that is armed with a lascannon, a heavy bolter, and two power claws, then these are the weapons it must use if you want to include it in a game of Tyranid Attack! When a Dreadnought fires it may fire all the weapons it is carrying, not just one of them. The weapons may be fired all at the same target, or each may fire at a different target.

All Dreadnoughts have a basic hand-to-hand combat value listed on their data card, to which is added the hand-to-hand combat value of the weapons that the Dreadnought is carrying. When a Dreadnought fights in hand-to-hand combat, add the Hand-To-Hand dice for all of the weapons that it is carrying to the Dreadnought's basic hand-to-hand combat value to find out how many dice it rolls for the combat. For example, the Ork Dreadnought described above would roll an extra dice for each of its power claws, which also increase the dice bonus to +2, giving it a grand total of 4D(+2) in hand-to-hand combat instead of its normal 2D(+1)!

### Dreadnought Life Points

All Dreadnoughts have more than one life point, the actual number being listed on the Dreadnought's data card. Each successful attack on the Dreadnought reduces the number of life points it has by one. When all the Dreadnought's life points have been lost it is destroyed and must be removed from play. In addition, whenever a Dreadnought loses a life point, one of the weapons it is carrying is damaged and will no longer work. The player in command of the Dreadnought is allowed to decide which weapon is disabled, and should either record this information on a piece of scrap paper or place a suitable marker on the model to show which weapon no longer works. A small piece of white cotton wool attached to the weapon is ideal for this purpose, and the effect can be enhanced further by painting the cotton wool with black and red paint to simulate smoke and fire.

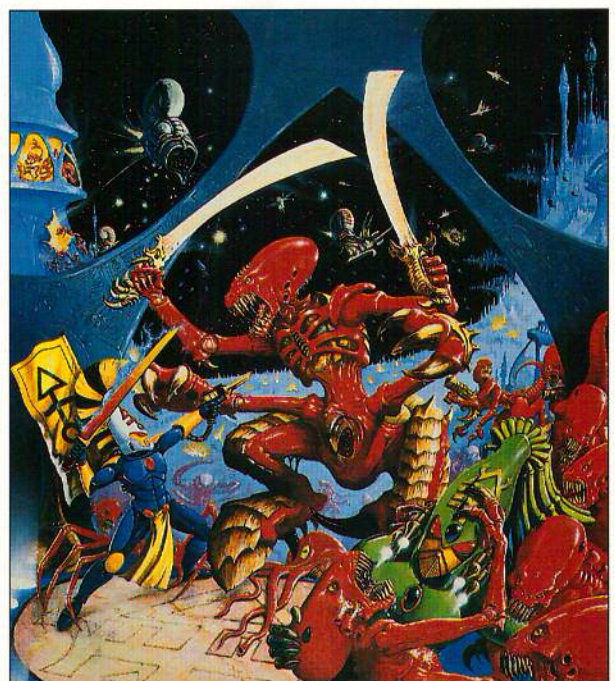

# TYRANID ATTACK DREADNOUGHT DATA CARDS

## SPACE MARINE DREADNOUGHT

**MOVE:** 4 squares

**POINTS:** 15

**ARMOUR:** 6+

**LIFE POINTS:** 3

**HAND-TO-HAND:** 2D(+1)



### WEAPON FIT:

The Space Marine Dreadnought may have up to two weapons chosen from the list below.

Weapon	Range	Fire	Hand-to-Hand	Notes
Lascannon	60	1D(+4)	-	Add +4 to the score of the dice when you attack a target with the Lascannon. However, a score of '1' on the dice before the bonus is added is always a miss.
Missile Launcher	72	2D	-	The Missile Launcher attacks any models adjacent to the main target with 2 dice each.
Power Fist & Bolter	24	3D	1D(+2)	A Space Marine Dreadnought armed with a Power Fist adds +2 to its score in hand-to-hand combat instead of only +1.

## ORK DREADNOUGHT

**MOVE:** 4 squares

**ARMOUR:** 6+

**LIFE POINTS:** 2

**HAND-TO-HAND:** 2D(+1)



### WEAPON FIT:

The Ork Dreadnought may have up to four weapons chosen from the list below.

Weapon	Range	Fire	Hand-to-Hand	Notes
Lascannon	60	1D(+4)	-	Add +4 to the score of the dice when you attack a target with the lascannon. However, a score of '1' on the dice before the bonus is added is always a miss.
Heavy Bolter	48	4D	-	
Heavy flamer	6	2D	-	The Flamer is an area effect weapon, and attacks any models adjacent to the target with 2 dice each.
Power Claw	-	-	1D (+2)	An Ork Dreadnought armed with a Power Claw adds +2 to its score in hand-to-hand combat instead of only +1.

## CHAOS DREADNOUGHT

**MOVE:** 4 squares

**ARMOUR:** 6+

**LIFE POINTS:** 3

**HAND-TO-HAND:** 2D(+1)



### WEAPON FIT:

The Chaos Dreadnought may have up to three weapons chosen from the list below.

Weapon	Range	Fire	Hand-to-Hand	Notes
Bolters	24	2D	-	
Heavy Plasma Gun	12	2D	-	The Heavy Plasma Gun fires at all models along a straight line of squares, which may be horizontal, vertical or diagonal. All targets are attacked with 2 dice each. The line of fire is blocked as soon as it hits a wall.
Missile Launcher	72	2D	-	The Missile Launcher attacks any models adjacent to the main target with 2 dice each.
Power Claw	-	-	1D (+2)	A Chaos Dreadnought armed with a Power Claw adds +2 to its score in hand-to-hand combat instead of only +1.
Assault Cannon	36	4D(+1)	-	Add +1 to the score of each dice when firing the Assault Cannon.

## SCREAMER KILLER

**MOVE:** 4 squares

**ARMOUR:** 6+

**LIFE POINTS:** 4

**HAND-TO-HAND:** see below



### WEAPON FIT:

The Screamer Killer is always armed with four Gigantic Claws and one Bio-Plasma Bolt.

Weapon	Range	Fire	Hand-to-Hand	Notes
Bio-Plasma Bolt	24	2D	-	The Bio-Plasma Bolt is an area effect weapon, and attacks adjacent to the target with 2 dice each.
Gigantic Claw	-	-	1D (+2)	A Gigantic Claw adds +2 to the Screamer Killer's dice roll in hand-to-hand combat.

# ELDAR DREADNOUGHT

<b>MOVE:</b>	<b>6 squares</b>
<b>POINTS:</b>	<b>15</b>
<b>ARMOUR:</b>	<b>6+</b>
<b>LIFE POINTS:</b>	<b>2</b>
<b>HAND-TO-HAND:</b>	<b>2D</b>



## WEAPON FIT:

The Eldar Dreadnought may have up to three weapons chosen from the list below.

Weapon	Range	Fire	Hand-to-Hand	Notes
Distortion Cannon	72	special	-	The Distortion cannon is an area effect weapon and attacks any models adjacent to the main target as well as the main target itself. Roll a D6 for each target affected: 1-3= No effect; 4-5= Teleported. Move the model to any square you like anywhere on the same board section; 6= Destroyed in the Warp. The model is eliminated no matter how many life points it has left!
Missile Launcher	72	2D	-	The Missile Launcher attacks any models adjacent to the main target with 2 dice each.
Scatter Laser	60	6D	-	
Lascannon	60	1D(+4)	-	Add +4 to the score of the dice when you attack a target with the lascannon. However, a score of '1' on the dice before the bonus is added is always a miss.
Power Fist & Shuriken	24	3D	1D(+2)	An Eldar Dreadnought armed with a Power Fist adds +2 to its score in hand-to-hand combat instead of only +1.
Heavy Plasma Gun	12	2D	-	The Plasma Gun fires at all models along a straight line of squares, which may be horizontal, vertical or diagonal. All targets are attacked with 2 dice each. The line of fire is blocked as soon as it hits a wall.





# GAMES WORKSHOP

## TELESALES OPPORTUNITIES



We are currently seeking to recruit bright, energetic and enthusiastic young people to work full-time as part of the Sales team based at our Head Office in Eastwood.

Previous Tele-sales experience is not essential, but applicants must show initiative, eloquence and be of a cheery disposition. Equally important is the knowledge of, and enthusiasm for, Games Workshop's products.

**Games Workshop** is a rapidly expanding company where there are plenty of opportunities for career advancement. Starting salary will be commensurate with age and experience.

If you are young, dynamic, and would enjoy the challenge of Tele-sales, please contact:

**Helen King** on: (0773) 769731 for an application form.

GAMES WORKSHOP • GAMES WORKSHOP • HIGH WYCOMBE • GAMES WORKSHOP

# OPEN NOW!

# GAMES WORKSHOP<sup>®</sup>

## HIGH WYCOMBE

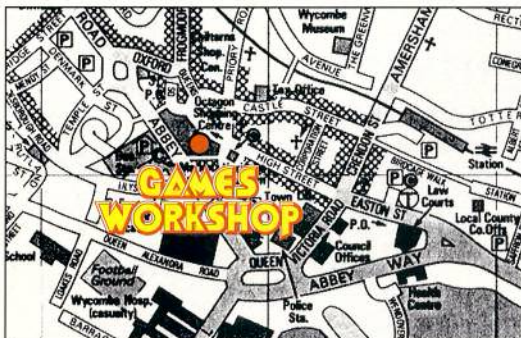

**Unit 29  
The Balcony  
The Octagon Centre**

**NORMAL OPENING HOURS**  
Monday – Saturday 9.00 am to 5.30 pm

GAMES WORKSHOP STORES • GAMES WORKSHOP STORES

GAMES WORKSHOP STORES • GAMES WORKSHOP STORES

GAMES WORKSHOP • GAMES WORKSHOP • HIGH WYCOMBE • GAMES WORKSHOP

# WARHAMMER

WARHAMMER

THE GAME OF FANTASY BATTLES

## CHAOS DWARF LORD ON GREAT TAURUS



CHAOS DWARF LORD'S  
WARBANNER



Miniature designed by Alan Perry

The Great Taurus, or Red Bull of Hashut, is a huge monster with the body of a massive bull and membranous wings like a dragon. Its hide burns with terrific intensity and its whole body is wreathed in fire and smoke. When it moves across the ground sparks fly from its hooves and lightning plays about its feet. It breathes fire in great snorting bursts and black smoke curls from its gaping maw. The Chaos Dwarfs believe that the Great Tauruses were once Chaos Dwarfs and that they were mutated by the warping power of Chaos into living bull-furnaces like the statue of the god Hashut himself.

Citadel Miniatures are supplied unpainted. This model requires assembly. We recommend that parts are carefully cleaned and trimmed with a modelling knife before assembly, and that the model is undercoated before painting with Citadel paints.



CITADEL  
MINIATURES

GAMES  
WORKSHOP

# MAN O'WAR

## ACROSS THE RAGING SEA

By Bill King

**With the release of the first models for the Elf and Bretonnian fleets, Bill King takes a look at the strengths and weaknesses of these wind-borne races and offers his hints and tips for fighting battles with their mighty seafaring forces.**

### INTRODUCTION

The Bretonnians and High Elves have many things in common. They are arguably the two greatest seafaring nations in the Known world. Both nations use powerful ocean-going fleets that rely on the power of the wind for propulsion. Both nations produce superlatively skilled seamen.

These similarities are hardly surprising. There is a long history of communication between the people of Bretonnia and the folk of Ulthuan. Indeed the Bretonnians inherited many of their deepwater ports from the High Elves, including L'Anguille with its famous lighthouse, and the humans have picked up much of their nautical lore from the Elf race.

### GENERAL PRINCIPLES

Both Elves and Bretonnians possess ships that are generally faster than those of any other race. The price of this greater speed is reliance on the vagaries of the wind, and upon vulnerable sails for propulsion. These facts more than any others should be borne in mind by both Elf and Bretonnian players. The movement of an entire fleet can be stopped dead simply by a change of wind direction. Conversely, an Elf or Bretonnian fleet with the wind in its favour can usually outmanoeuvre any opposition.

Sailing fleets should set up with the wind direction in mind. Usually they should aim to sweep from one edge of the table.



*HIGH ELF AND BRETONNIAN FLEETS PREPARE TO JOIN BATTLE.*

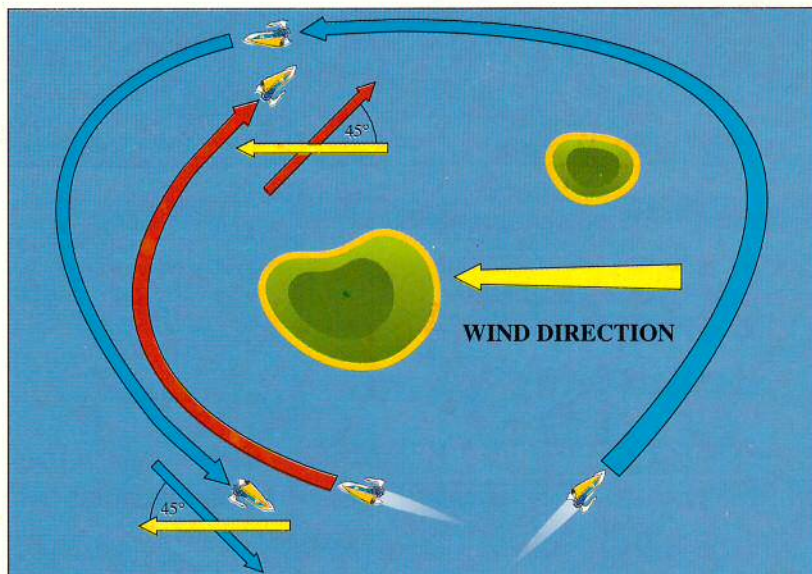

Careful deployment of your sailing fleet will enable it to circumnavigate the tabletop at the fastest possible speed. A poor initial position will put you at a clear disadvantage.

to the other, keeping the wind in their sails for as long as possible. Providing the wind doesn't change, the movement of a sailing fleet will resemble a great curving arc round the table. If they can keep the wind in their favour, then sailing fleets can usually use their superior speed to dictate when and where they fight, closing at their leisure when they find a weakness in their opponent's position, moving away out of range if things go against them.

## MAGIC AND SAILING FLEETS

In the Known world, Admirals must take another factor into consideration, namely that even natural forces such as tide and wind are subject to another, much greater power — magic. Wizards can bend even the mightiest of storms to their will and their power can pose a real threat to a sailing fleet.

Imagine if you will, a Bretonnian squadron that suddenly finds that the wind has turned against it just as the Empire's wargalleys come into range. Under oars the Imperial Player can close at his leisure, approaching Bretonnian ships from an angle at which they cannot shoot, possibly even ramming them if the range is right. Perhaps, if the Imperial Admiral has been cunning he is even using the wind to close with his hapless enemy. All the Bretonnian ships can do to counter this is make a single turn out of the wind. At a critical point in the battle this could be devastating. The spell *Wind Master* makes this possible.

Or imagine an Elf Admiral facing a fleet of evil Dark Elves. As the Dark Elf Wizard casts *Sea of Glass* across the entire playing area, the Elf Admiral suddenly finds all his ships totally becalmed, without a breath of wind to fill their sails. The Black Ark can still sail in using its sorcerous power. The great monsters of Naggaroth can move as they will, but the High Elf Fleet can do nothing to respond.

The Grey spell *Wind Master* can change the direction of the wind at its caster's whim. The Celestial spell *Sea of Glass* becalms the entire table. Nothing can move under sail. If you are the Admiral of a sailing fleet, the importance of these two spells cannot be overestimated. Cast at the right time, they can win or lose a battle. You should do all within your power to take this into account. Fortunately there are things you can do

to minimise the chances of these things happening. All you need is a little understanding of the way magic works.

Spells are discarded when cast and replenished during the End Phase of the game. If you have a sailing fleet and you pick up a *Sea of Glass* spell you should hold it in your hand and never use or discard it. This way your opponent cannot pick it up and use it against you. The only way he will ever gain access to it is by killing your magician and forcing you to discard all your spells.

Suppose however you do not pick up *Sea of Glass* and you suspect your opponent has it, and is saving it for use against you at a crucial point, what can you do? Do not despair — all is not lost. You can still dispel it if you have a Jade Magic spell in your hand. If you don't have *Sea of Glass* and you pick up a Jade spell during the End Phase of your turn — hold on to it! It may save your entire fleet.

Also remember the spell *Wind Master* can be as useful to you as it is to your enemy. Your entire cunningly laid plan can be negated at a stroke if the wind turns against you at the wrong time. You can use *Wind Master* to stop this. Alternatively you can use the spell to turn the wind around as you need it, and take your opponent by surprise.

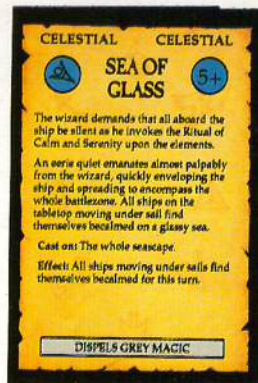

Most of the above Jade magic spells will dispel the Celestial magic spell *Sea of Glass* on a roll of 4+. The exception to this, is the spell *Hell Storm* which dispels it on a roll of 5+. It is worth noting that if you have a Jade Wizard in your fleet and fail to cast or dispel with a Jade magic spell, you are entitled to a re-roll on the dice. A Wizard Lord would give you +1 on your dice roll!

Supposing for example he thinks you're going to be sailing into the wind next turn and expects to catch you out because of it. Under these circumstances this spell could be extremely handy. Indeed, so useful is this spell that there is an argument for saying that sailing fleets should always take a Grey Magician. The increased chance of successfully casting spells of your own colour can make this a very worthwhile option.

You might think that all this makes sailing fleets sound very vulnerable and you'd be partially right. You might also think that the fact your ships can be totally immobilised by losing all their sails is another huge disadvantage — in this you'd be wrong.

True, sails have very poor saving throws but this is not the whole story. On large ships, sails are not nearly as vulnerable as they look. Once destroyed, unlike almost every other location, they don't cause critical hits if hit again. This means that your foe will never sink your ship by shooting at its sails, and that every hit landed on a Destroyed Sail location is wasted.

This makes it very counter productive to keep shooting High and hoping to hit the sails on a Corsair for example. If the sails at location High 5, 6 on a Corsair have already been destroyed, then your opponent has to hit location 4 to immobilise your ship. This means he has only a 1 in 6 chance of hitting that location, and a 2 in 6 chance that his shots will be wasted by hitting an already destroyed location. The odds are in your favour. So, as you can see sailing ships are not really all that vulnerable to immobilisation.

Having looked at the similarities between the two fleets it's now time to look at the differences. Let's start with the Bretonnians.

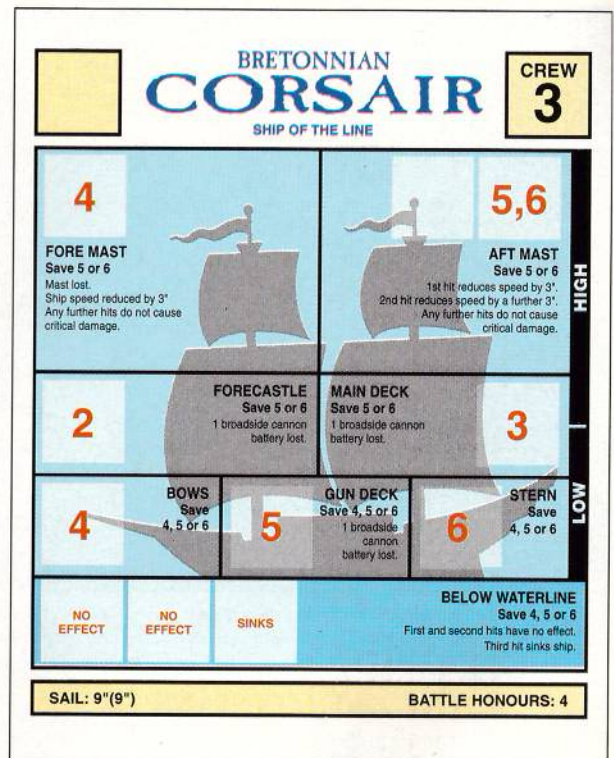

*Corsair Template.* The sails are at locations 4, 5 and 6 and so a high shot has only a 50% chance of causing damage (assuming they fail their saving rolls). However once one of the locations has been destroyed, the chances of causing further damage drops dramatically.

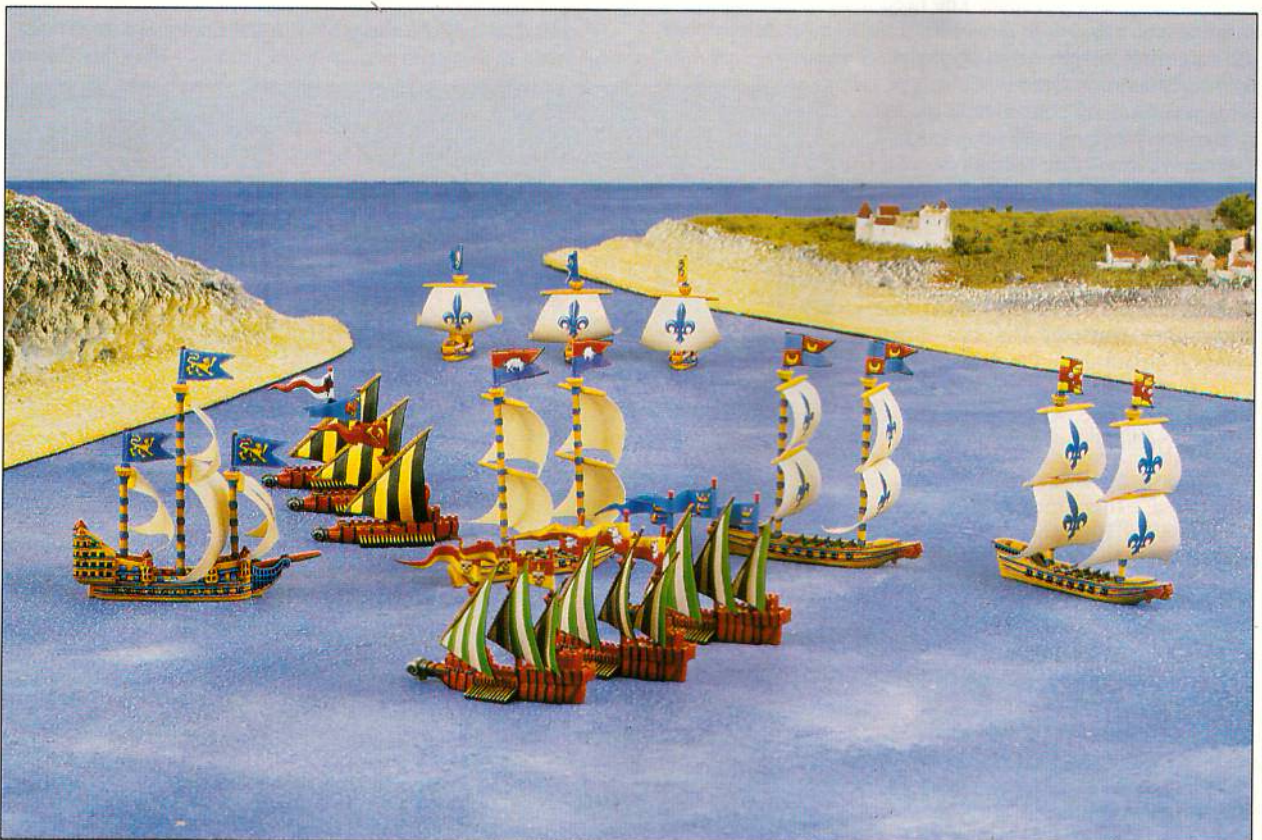

BRETONNIAN CORSAIRS BREAK THROUGH THE IMPERIAL LINE.

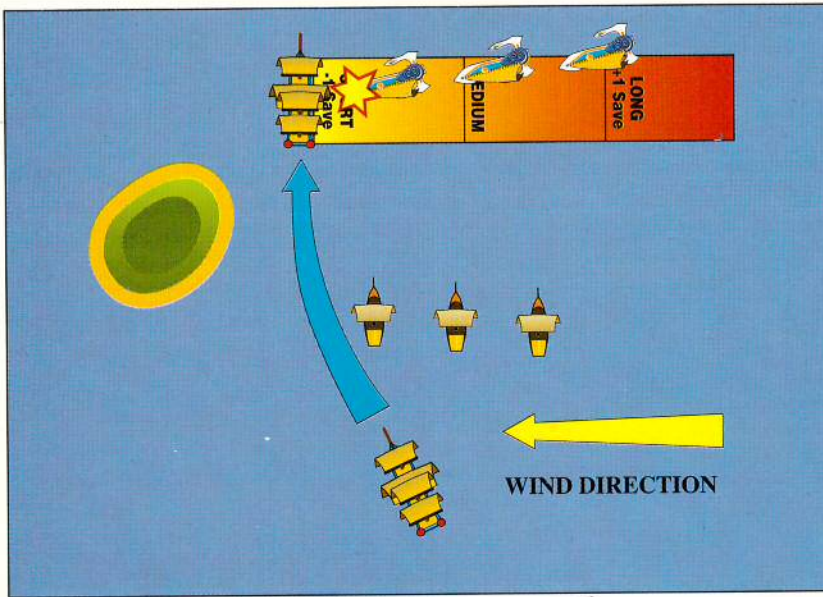

The Bretonnian Galleon uses the Buccaneers as a defensive screen until it can race forward and unleash a devastating broadside against the leading High Elf Eagleship.

## THE BRETONNIANS

If you are the Admiral of the Bretonnian Fleet, you should consider the specific strengths and weaknesses of every ship and squadron in your fleet. It's wise to be aware of a good general guideline for Man O' War which is that, if the majority of your weapons fire forward, then the best formation is line abreast. If the majority of them fire broadside, the best formation is line astern.

The reason for this is simple. You need to keep as clear a line of fire as you can, while maximising the number of weapons you can bring to bear on an enemy. If all your weapons fire forward, you don't want any of your own ships in front of you blocking your line of sight. If your weapons fire sideways, you don't want any of your own ships beside you getting in the way.

With the exception of the Buccaneers, the Bretonnian fleet is armed with cannons that fire broadside. Indeed, the Bretonnian Galleon has the most powerful broadside in the game. It can bring an awesome four gun battery to bear on either side. At close range this can be incredibly destructive.

As far as the Bretonnian fleet is concerned, this means the best formation for Buccaneers, with their forward firing catapults, is line abreast. The best formation for Corsairs and Galleons is line astern.

As a Bretonnian Admiral, your tactics should be to take advantage of your broadside weapons at every opportunity. This means that, whenever possible, you should try and sail your ships between two enemy squadrons, thus enabling you to fire on two enemies at once. If you are facing a foe who uses mostly forward firing weapons this can be especially deadly.

You may find that your career is a quest to find a hole in the enemy line. If you can find a gap between squadrons and sail through it you will get to bring those mighty broadsides to bear.

Cannons are the secret of success as a Bretonnian Admiral. Your best bet is to fire from as close in as possible. Massed firepower used at close range provides your greatest chance of destroying most enemies. The -1 saving throw modifier for firing at close range can be devastating. You should take advantage of it.

While your ships are not undermanned, they are generally not as well crewed as Imperial ships or Orc ships. This can make boarding actions difficult against such foes. Conversely, against Elves or Dwarfs this could be a very viable option. Generally speaking, against more numerous or equal numbers of foes, boarding actions are last resort tactics. Usually you simply can't afford to spare the crew.

In defence, their deadly batteries of cannon make the larger Bretonnian ships nearly impossible to board from the side while the guns are intact. However, your ships are usually vulnerable to being attacked from the front and rear. You should be aware of this and try to avoid letting ships attack you from either position.

Buccaneers are often dismissed as little more than cannon-fodder. This seriously underestimates these useful little ships. It's true that they are cheap but this does not make them bad.

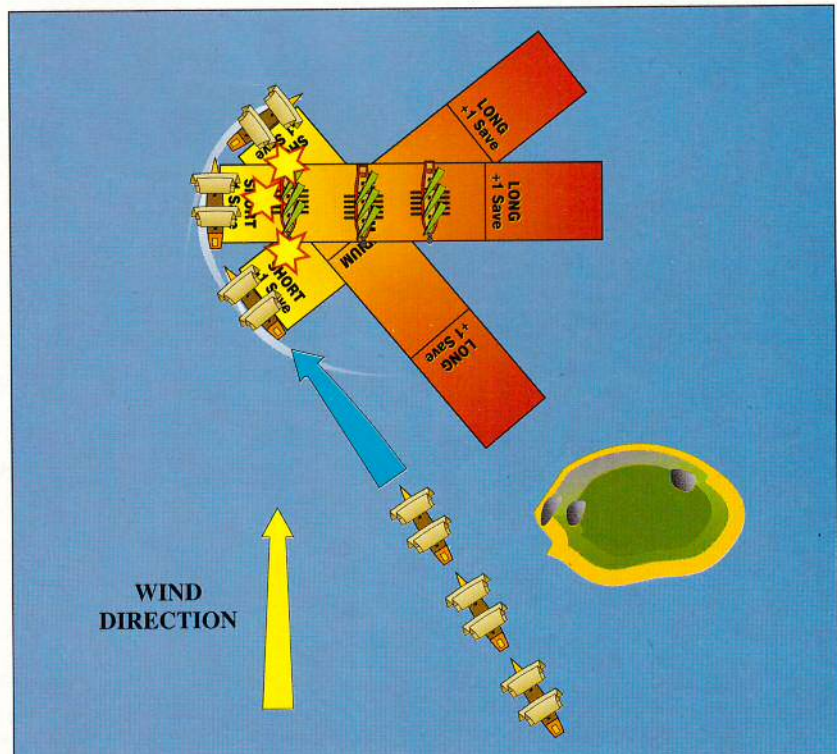

A squadron of three Bretonnian Corsairs snake round the edge of the Imperial line in order to unleash a triple close range fusillade against the helpless Imperial Wolfship.



A HIGH ELF FORCE UNDER ATTACK BY A DARK ELF FLEET, LED BY THE MIGHTY BLACK ARK OF NAGGAROTH.

A lucky shot from a catapult can do untold damage to enemy vessels and their two crew counters can be useful in boarding actions against enemy craft who have lost some of their own crew.

Your best bet with Buccaneers is to hold off at long-range and bombard your enemy. Remember, catapults can't fire at close range anyway, so you have nothing to gain from closing with the enemy unless you intend to board. Later in the battle, when your enemy has been worn down, you can close and initiate a boarding action. Another use for Buccaneers is as a screen to approach behind. They can be used to block line of sight to your larger ships while you move towards the enemy. Your Corsairs and Galleon can then surge past them to get to closer quarters.

Corsairs are the backbone of your fleet. They are hardy, reliable, fast and manoeuvrable. The fact that they operate as a squadron allows them to bring enormous amounts of firepower to bear. A particularly useful tactic is to snake a squadron of Corsairs round the outside of an enemy line so that all three Corsairs can fire on one particular ship. There are very few foes who can withstand nine cannon batteries firing at point blank range. With any luck the target vessel will be at the bottom of the briny before it can fire a shot in response!

Galleons are awesome engines of destruction, more than capable of holding their own against any comparably sized craft. They can pound most opponents to splinters with their four massed batteries. Given their enormous ruggedness and deadly firepower, the best place for them is close to the enemy, as always, preferably between two foes. Close range is best so that you get that -1 saving throw modifier.

Overall then, the best tactics for your Bretonnian fleet are to try and exploit gaps in the enemy line, getting in close and using your greater firepower against the maximum number of foes. Fortunately you have the speed to be able to move from long-range to close range in one phase, providing your sails are all intact, so a swift strike is easily possible. You will probably only get one chance at this so the timing of your attacks is vital. You may have to expose yourself to some long-range fire to pull off your attack, but the risk will be worth it if you can.

## THE ELVES

The Elves are a very special fleet, with certain unique abilities. Whilst every other ship in the Man O' War game has to follow the rule of move and then shoot, the Elf warships can move, shoot and then move again. What is more, the weapons on the Elf ships have a longer range than all other fleets.

As an Elf Admiral your strategy will be very different from the Bretonnians. Your battleplan will be shaped by three factors: the range of your weapons, your ships ability to double move, and their comparative weakness in boarding actions.

All your ships share one advantage: they are less vulnerable to changes in the wind than other sailing ships. Your ability to double move, means that you can turn into the wind and stop with your first move, then make your single turn out of it with your next. Sailing into the wind still impairs your manoeuvrability but not as much as it does the Bretonnians'.

Elves also use a special range ruler that lets them fire three inches further than anyone else. Equally importantly their

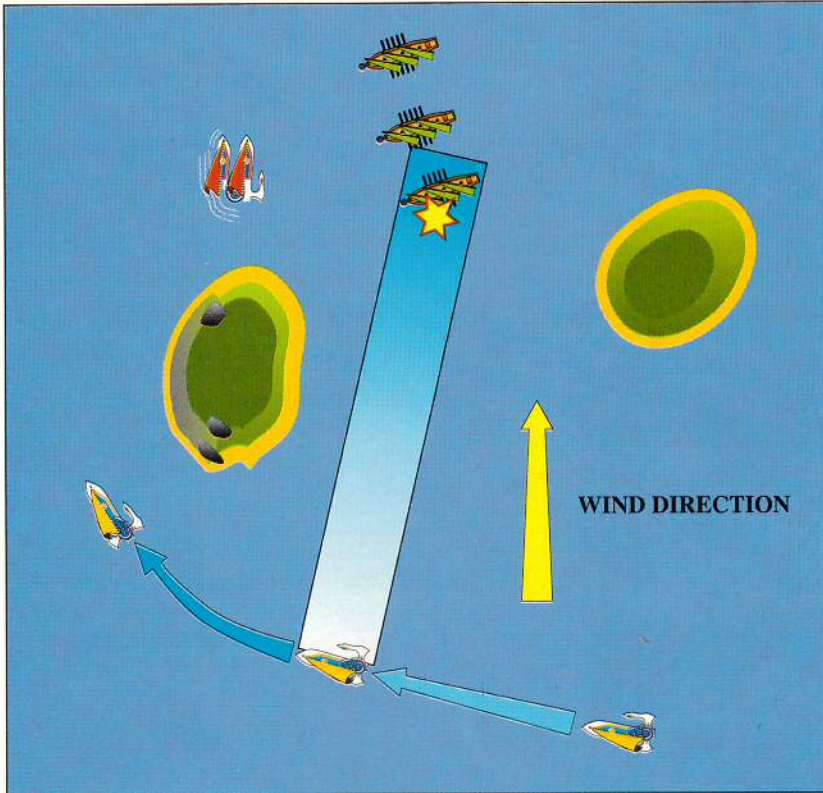

*In this example, the High Elf Eagleship moves into a firing position before shooting at the nearest Wolfship. It then moves off behind the cover of the island before the Wolfship can close and return fire. The floundering Dragonship can also be used as cover for the Elf player's next attack.*

magically propelled ballista shots are unaffected by range. This means they gain no benefit from firing at close range, and suffer no penalty for firing at long-range.

Most Elf ships are comparatively under crewed for their cost, and they lack cannons to fire grapeshot in boarding actions, so they can be vulnerable to being boarded. If you take into consideration the fact that their weapons are equally effective at the closest and most extreme of ranges, and they have the ability to move, fire and move again, the bones of a sound Elf strategy emerge that can be summed up in the phrase – keep your distance.

For most Elf ships it is better to keep the enemy at as long a range as possible for as long as possible. This tactic will enable you to manoeuvre and cast spells in an attempt to reduce the crews on the opposing ships. You should also remember that both Eagleships and Dragonships are Men O' War. This means that they move and fire individually and cannot bring to bear the

enormous amounts of co-ordinated firepower that Bretonnian Corsairs can. For example: a squadron of Corsairs or Wargalley's will all move and fire before their enemy gets a chance to respond. During this period you can only move one Eagleship or a Dragonship. Close up, squadrons will usually savage individual Elf ships, so you should prevent your opponent getting within range for as long as possible.

This will often mean that you will sail towards your foe, fire, then turn away. The longer you can do this for, the better your chance will be of winning the battle. You can erode your enemies at long-range to the point where you can send in your Dragonship and overcome them. Eventually you may be cornered by the foe, or slowed down by the wind to the point where your foes catch you but until that happens, hit and run will usually be your best tactic. The one exception to this is the Dragonship but we'll come to that later.

The fact that Elf ships can double move makes possible another interesting tactic – hiding. They can often move into position, fire and then slip away behind terrain that obscures line of sight, such as an island. Usually you can only pull this off once from any

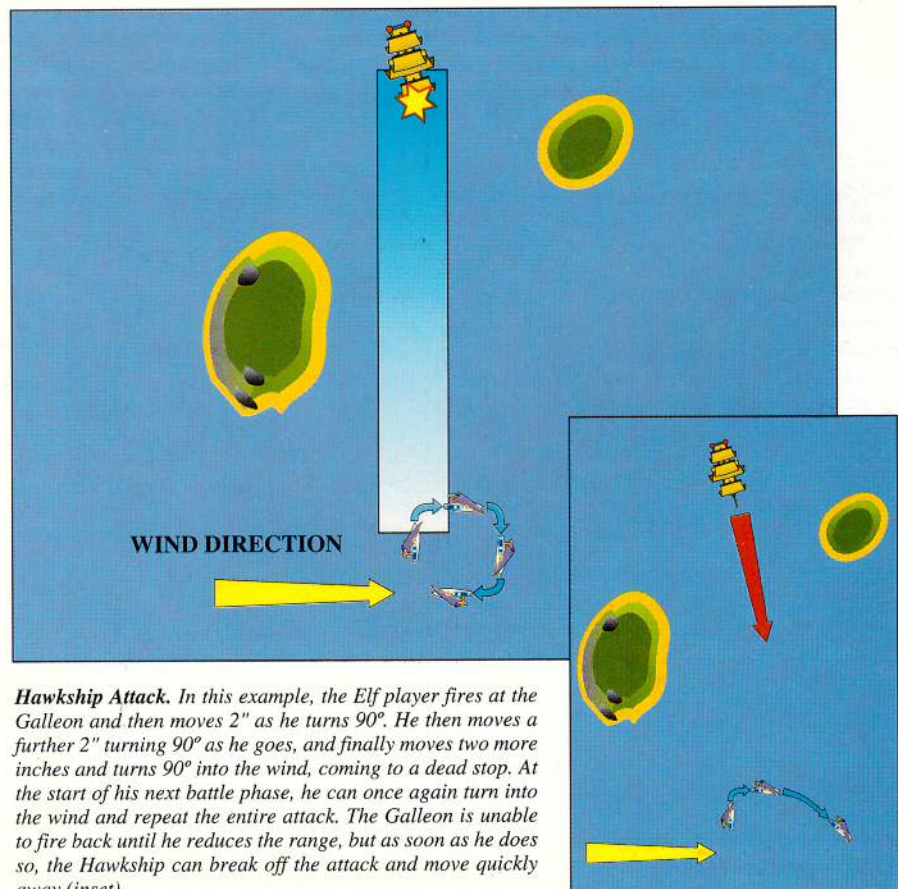

**Hawkship Attack.** *In this example, the Elf player fires at the Galleon and then moves 2" as he turns 90°. He then moves a further 2" turning 90° as he goes, and finally moves two more inches and turns 90° into the wind, coming to a dead stop. At the start of his next battle phase, he can once again turn into the wind and repeat the entire attack. The Galleon is unable to fire back until he reduces the range, but as soon as he does so, the Hawkship can break off the attack and move quickly away (inset).*



given position before your opponent gets into a position to stop you, but should the opportunity present itself, consider it. If you have a crippled ship it might even be worth using it as cover.

Elf Hawkships have a unique special ability. They can make turns of up to 90° instead of the usual 45°. This lets them perform a special circling attack. They can often move into range, shoot, then turn away directly and put some distance between them and their foes. This makes them virtually perfect hit and run raiders. Add to this the fact that your opponent will usually be too busy worrying about other larger vessels to pursue them and these craft can be very handy indeed at wearing down your foe. Since they are forward firing, Hawkships are best organised in a line abreast formation.

Eagleships are the mainstay of the Elf fleets just as Corsairs are the mainstay of Bretonnian ones. If you are keeping your fleet together then they are usually best organised in a line astern formation so that they don't get in the way of each others broadsides. This way they can move in, fire, and move away one after the other.

Alternatively, unlike most fleets, it's sometimes better for Elf Fleets to operate separately. That way your ships can approach your foe from both sides. They have sufficient range to be able to concentrate on any enemy ship they choose, and then they can split up to confuse any pursuit. The danger with this is that your fleet may be destroyed piecemeal but this is less likely for the Elves than any other fleet. They can usually escape any trap they fall into because of their great speed.

Dragonships are an exception to almost all the rules concerning Elf ships. They are at their most dangerous when close to the enemy fleet. In many ways they are the deadliest ship on the sea. Dragonships are capable of simply splitting

most foes in two with their deadly Starblade rams and continuing on their way virtually unhindered. Indeed it is perfectly possible for a Dragonship to sink multiple enemy ships in this manner. If it scores sufficient damage to sink the opposing ship they sail into, then they can move on unhindered and ram another vessel.

The very deadliness of the starblade is often the Dragonship's undoing. All too often Elf Admirals, driven by an understandable desire to bring this devastating weapon into play, simply sail the Dragonship into the heart of the enemy fleet, hoping for some quick kills. This can be madness. Tough though they are, even a Dragonship cannot survive an encounter with an entire enemy fleet, on their own.

Difficult though it may be to resist the temptation to use it at once, you should hold back this ultimate weapon till the right moment, hopefully after you've worn down your enemy in a long and exciting chase. Then you should use it to hit the most dangerous of your opponents ships, hopefully destroying them instantly.

As a last word on the Dragonship, if it becomes locked with an enemy by ramming it and not sinking the enemy vessel instantly, it may be best to board immediately. A pinned Dragonship is usually a dead Dragonship. Board the enemy ship and capture it if you can then scuttle your prey instantly. This will free the Dragonship to prowl again. Of course this advice doesn't apply if you are trying to board an unscathed Imperial Greatship from the side. Those three cannons and five crew will probably be the death of you. However, against a Corsair the presence of your admiral might just shift the odds in your favour.

To recap then. In my opinion your best plan as a High Elf Admiral is to fight a prolonged hit and run action against your enemy, only closing at the very end, once you've worn your foe down. This is a strategy that should grant you victory. So, as you can see, despite their similarities the High Elf and Bretonnian Fleets actually require very different handling.

The Bretonnians best chance of success comes from a swift strike that brings overwhelming firepower to bear. The Elves greatest hope of victory comes from a long battle of pursuit and evasion. However you can rest assured of one thing: whichever of these mighty fleets you choose, you'll have a good chance of staining the seas red with the blood of your enemies. So what are you waiting for! — get out there and get to grips with those dogs. May treasure and glory cover the winner, and the daemons of Chaos take the loser.

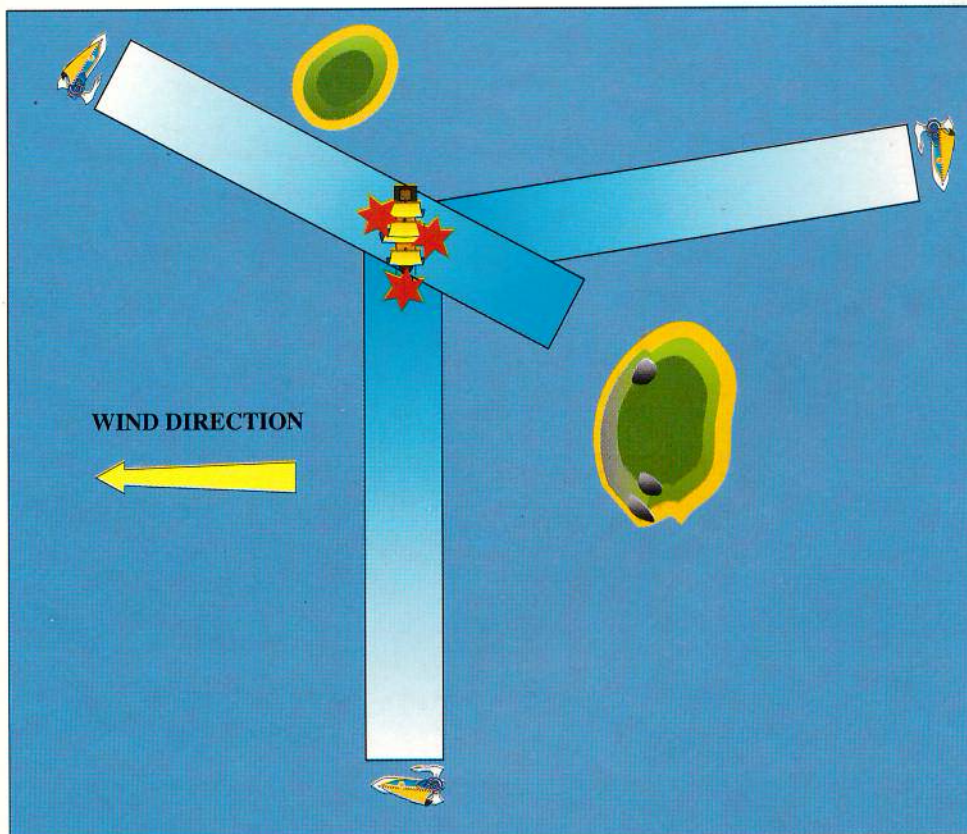

One of the great strengths of the High Elf fleet is its ability to concentrate high levels of firepower against a single target from all parts of the playing area. In this example, the Imperial Greatship suffers three devastating broadsides and is unable to fire back.

# GOLDEN '93 DEMON

## THE 6th INTERNATIONAL CITADEL MINIATURES PAINTING CHAMPIONSHIPS



PAUL McCARTHY – BEST  
WARHAMMER SINGLE  
MINIATURE (READING)

WINNER OF THE GOLDEN  
DEMON SLAYER SWORD

As you can see on the following pages, the standard of entries into the 1993 competition was higher than ever before, and the judges had an extremely difficult task in picking out the finalists, let alone the category winners. Well done all of you, and a special thank you to everyone who entered the competition this year. Next year it might be your turn to win.

The 1993 Golden Demon winner was **Paul McCarthy** from the Reading store. Paul, who's been collecting, painting and gaming with Citadel miniatures for almost ten years is a big fan of **Warhammer** and has armies of High Elves, Wood Elves and Dark Elves as well as sizeable Orc and Dwarf forces. The Tyrion miniature that won Paul the Golden Demon Slayer Sword, is actually the general of the High Elf army that Paul regularly games with. As you can see, the choice of bright, clean colours and stunning attention to detail on the jewels, armour and horse barding made this miniature a clear favourite with the judges.



PAUL McCARTHY  
GOLDEN DEMON  
CHAMPION



RICHARD HARRIS – BEST WARHAMMER BATTLE SCENE  
(MANCHESTER)



ANTHONY WARRINGTON – BEST WARHAMMER ARMY (OXFORD)



IVAN BROOKE – BEST WARHAMMER 40,000 VEHICLE (LUTON)



JOHN BREEZE – BEST WARHAMMER 40,000 ARMY (BECKENHAM)

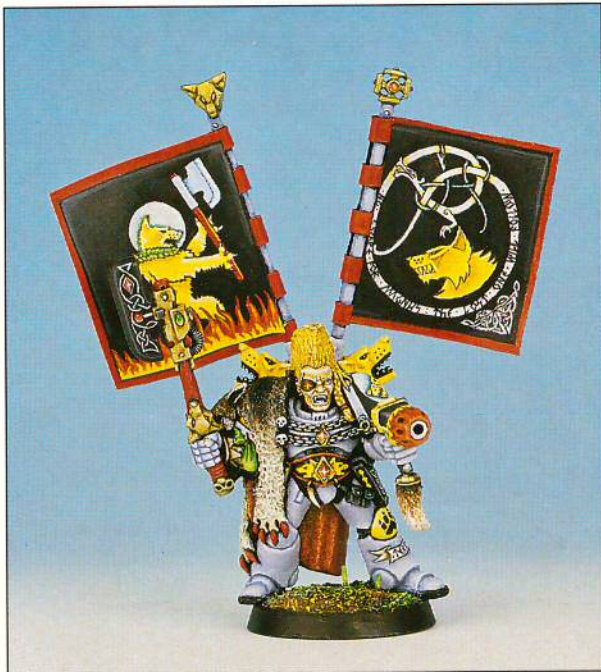

NEIL THOMPSON – BEST WARHAMMER 40,000 SINGLE MINIATURE (CHESTER)



ADRIAN WAIN – BEST SPACE MARINE SINGLE MINIATURE (PLYMOUTH)



BARRY LEES – VETERAN'S CATEGORY (LUTON)



JONATHAN ROOHE – BEST SPACE MARINE BATTLEFORCE (CAMBRIDGE)

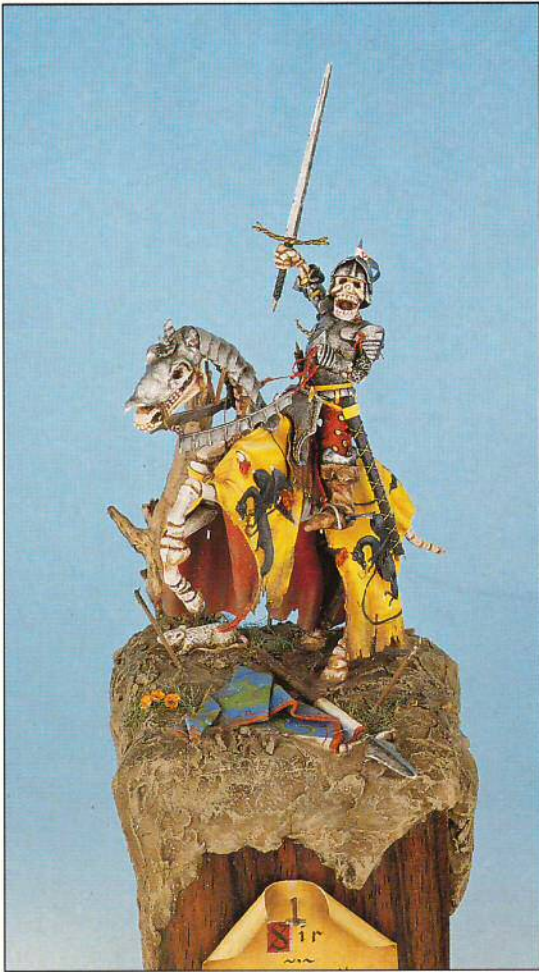

CARL WARDLE - LEEDS

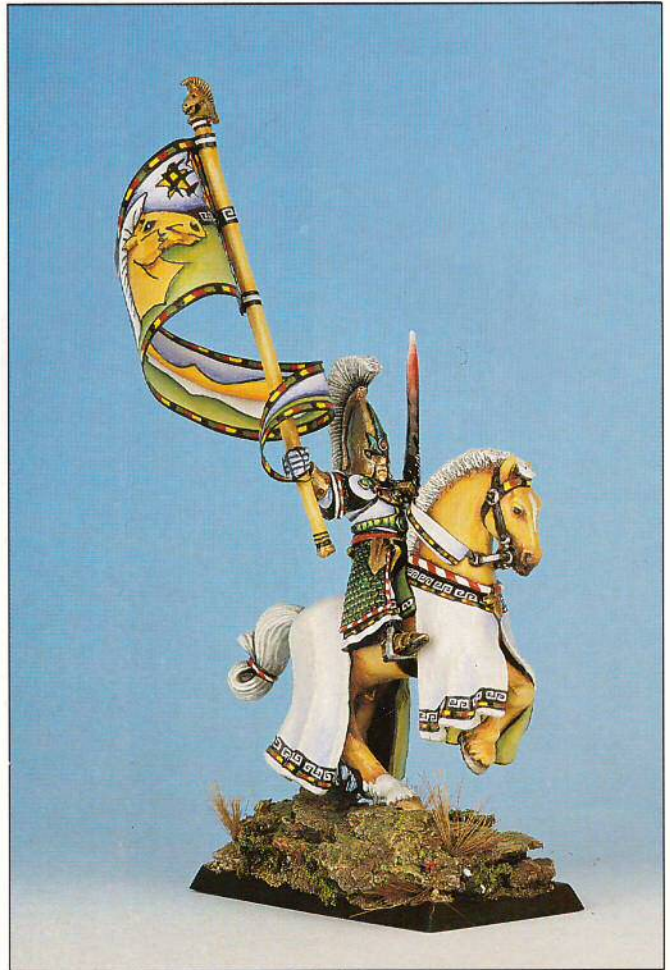

FRANCES ELLYARD - YORK



ROBERT MANLEY - STOKE



MIKE POOLE - SOUTHAMPTON

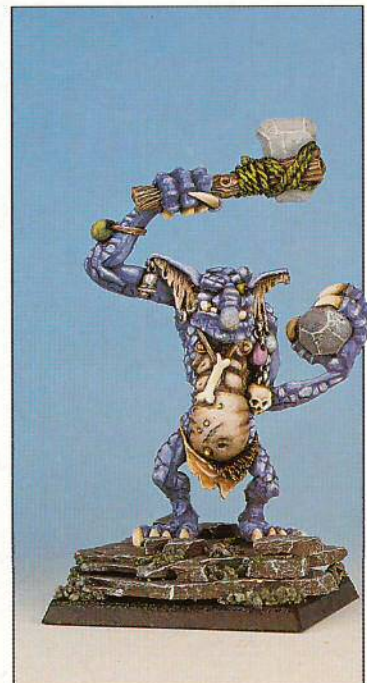

SIAN HOURD - NOTTINGHAM



MATTHEW STEVENS – NORWICH



MAXINE ANDERSON – LIVERPOOL

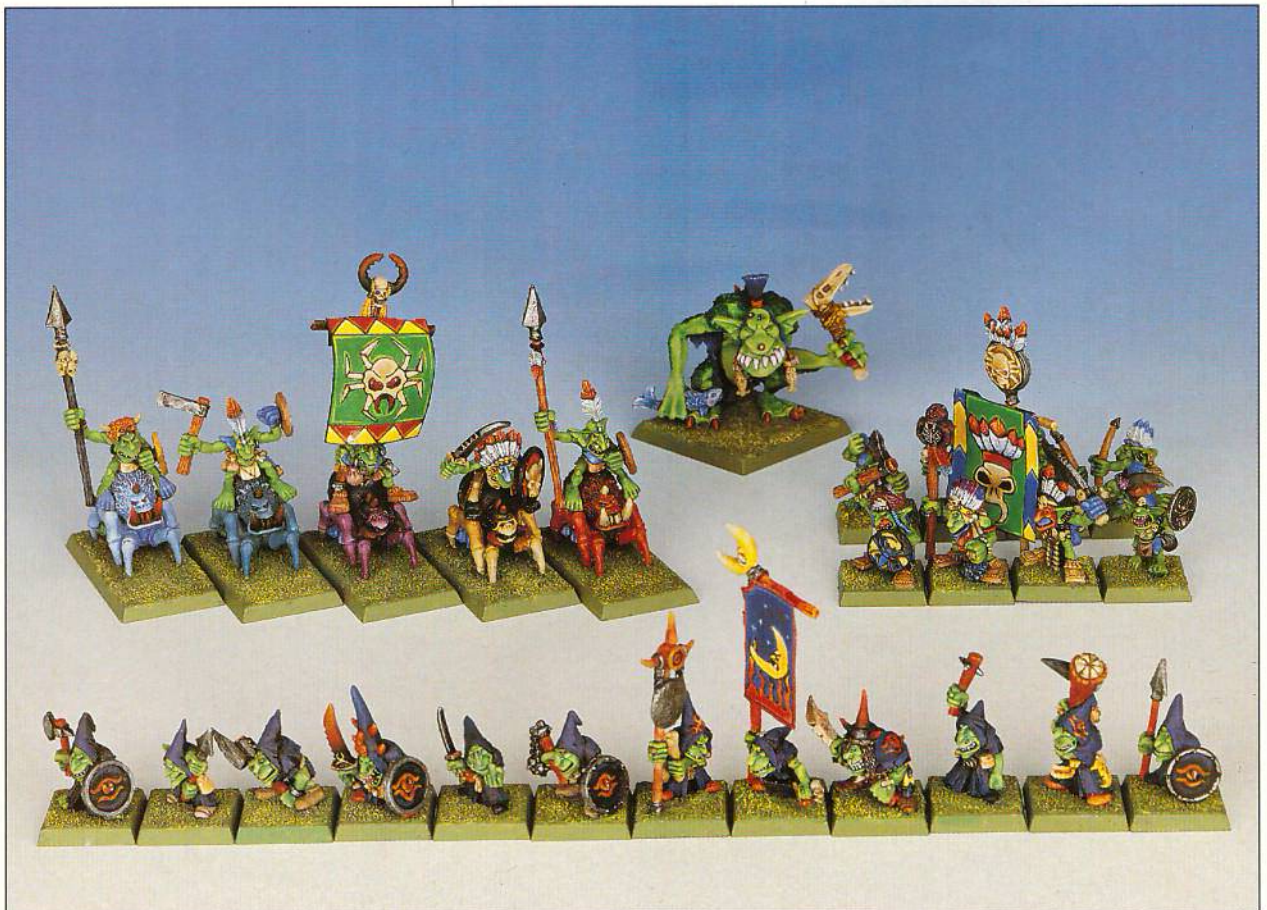

RICHARD AND GERALD MOORE – NOTTINGHAM



ADRIAN WAIN - PLYMOUTH



PETER UNDERWOOD - LEICESTER



JEFF HARROD - MANCHESTER





MARK BOARDLEY - PETERBOROUGH



CHRIS JACKSON - LEEDS



NICHOLAS TIMUS - SHEFFIELD

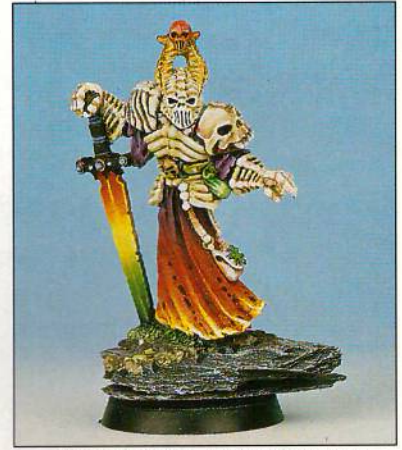

NIC SINTON - BECKENHAM



DAVID TOURLE - BRIGHTON



NATHAN JONES – BIRMINGHAM



MARK WALTHAM – NOTTINGHAM



ADRIAN WINK – COLCHESTER

# WARHAMMER

WARHAMMER

THE GAME OF FANTASY BATTLES

MARAUDER

## GIANT

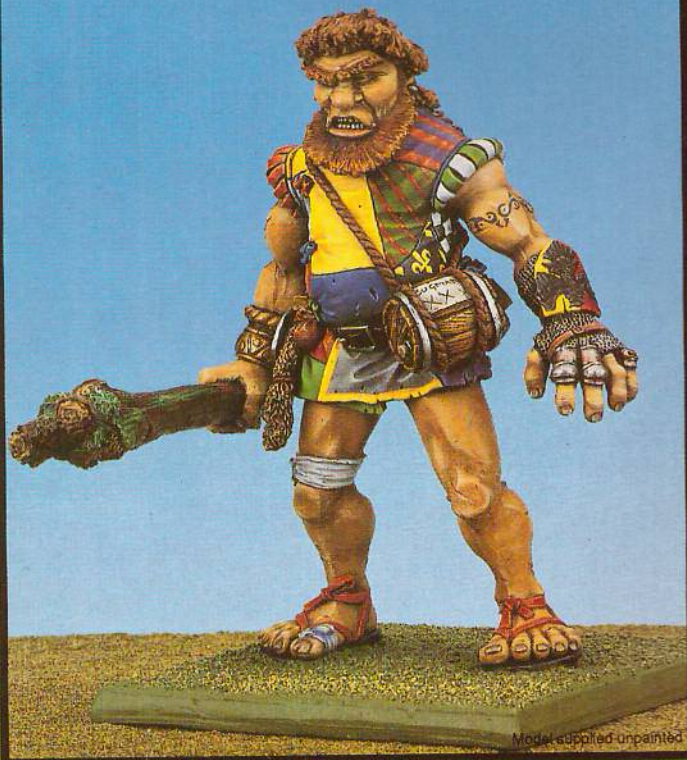

Model supplied unpainted

MARAUDER  
MINIATURES

HUGE AND DEVASTATING  
WARHAMMER MONSTER

Model designed by Aly Morrison

The Giant strides about the battlefield yelling and belching, instilling fear into even the most stalwart of warriors. Immense size and strength give him a huge advantage in combat. A blow from a Giant has no chance of being stopped by ordinary armour. Even if you can defend yourself against the Giant's powerful attacks you are by no means safe. Giants are notorious drunkards and have a tendency to fall over when startled, crushing anything beneath them.

This is a Marauder Miniature expert kit that requires a degree of modelling skill. This model is not recommended for young or inexperienced modellers.

Marauder Miniatures are supplied unpainted. This model requires assembly. We recommend that parts are carefully cleaned and trimmed with a modelling knife before assembly, and that the model is undercoated before painting with Citadel paints.

GAMES  
WORKSHOP



ROBIN ETHERINGTON –  
BRIGHTON



PHIL RILEY –  
MAIDSTONE



CARL EBANKS –  
BIRMINGHAM



PAUL SMITH – PLAZA



ADRIAN BOUSTRED – CROYDON



SIMON KICKS – LEICESTER



B. CAMPBELL - SWINDON



GARY WARRENER - MIDLANDS



ROBIN EWBank - GUILDFORD

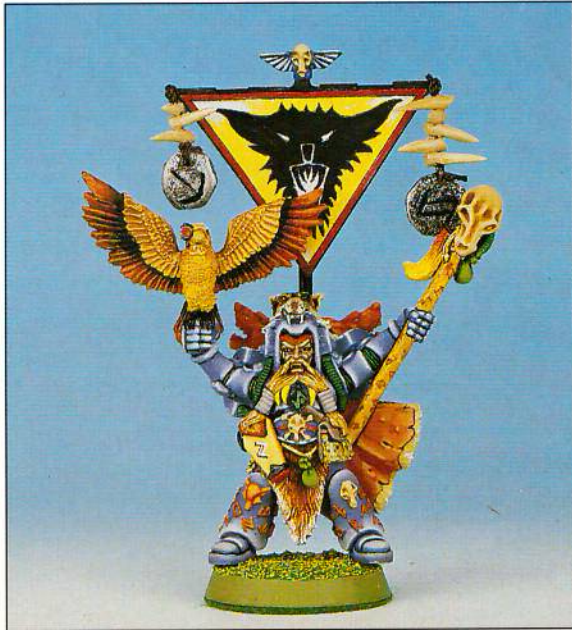

DAVE TELLETT - LIVERPOOL



PHILIP WRIGHT - NOTTINGHAM



NICK SIMMERSON - YORK



THOMAS WOOD - DERBY



JAMES KARTON - EDINBURGH



JONATHON MIDDLETON - EDINBURGH



IVAN BROOKE - LUTON



DAVID ROBERTSON - EDINBURGH



BRIAN SPURGATIS – NEWCASTLE

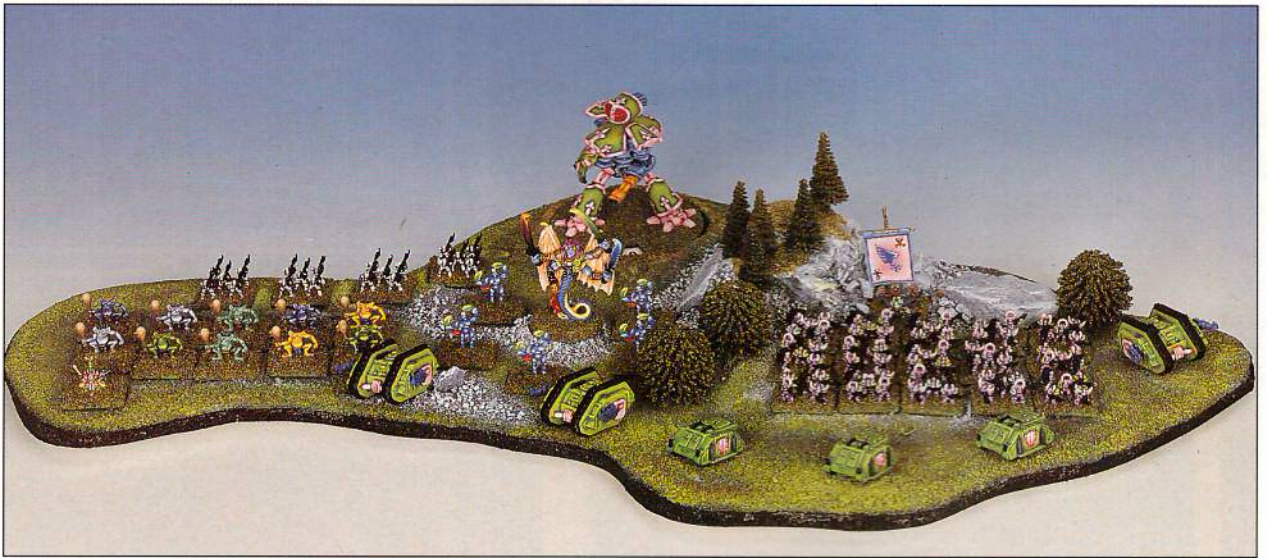

ALAN BULL – CARDIFF



DAVE BARLOW – PRESTON

# SPACE MARINE

## EPIC SCALE PLASTIC MODELS

### SPACE MARINE TACTICAL COMPANY



CONTAINS 120 SPACE MARINES AND 24 RHINOS.

### SPACE MARINE LEGION



CONTAINS 5 LANDSPEEDERS, 145 SPACE MARINES, 5 ROBOTS, 10 BIKES, AND 10 SPACE MARINES IN TERMINATOR ARMOUR..

### ELDAR WAR HOST



CONTAINS 5 VIBRO-CANNONS, 5 LAS-CANNONS, 20 JETBIKES, 10 WRAITHGUARD AND 125 ELDAR INFANTRY.

### IMPERIAL GUARD



CONTAINS 5 ROBOTS, 5 SENTINALS, 10 ROUGH RIDERS, 10 BIKES AND 135 IMPERIAL INFANTRY.

### SQUAT WARRIORS



CONTAINS 20 BIKES, 5 GUILD WEAPON TEAMS, 5 THUDD GUNS, 5 MOLE MORTARS AND 130 SQUAT INFANTRY.

### ORK INVASION



CONTAINS 5 BOARBOYZ, 5 WAR BUGGIES, 5 WARBIKES, 5 TRAKTOR CANNONS AND 150 ORK INFANTRY.



# MARINE®

## MINIATURE BOXED SETS

### SPACE MARINE LAND RAIDERS



CONTAINS 120 SPACE MARINES AND 12 LAND RAIDERS.

### ELDAR LEGION



CONTAINS 120 ELDAR AND 12 FALCON GRAV-TANKS.

### CHAOS HORDE



CONTAINS 105 CHAOS INFANTRY, 30 RIDING BEASTS, 10 MINOTAURS AND 5 TROLLS.

### ORK HORDE



CONTAINS 120 ORK BOYZ AND 18 BATTLEWAGONS.

### STOMPERS



CONTAINS 64 MINIATURES INCLUDING ORK STOMPERS AND IMPERIAL, CHAOS, ORK AND ELDAR DREADNOUGHTS.

Each Space Marine Epic boxed set contains an exciting selection of finely detailed plastic miniatures for you to expand your Space Marine armies.

Miniatures supplied unpainted. Banners not included. © Copyright Games Workshop Ltd 1993. All rights reserved.

**GAMES  
WORKSHOP®**



# GAMES WORKSHOP<sup>®</sup>

## ASSISTANT GAMES DEVELOPERS

Games Workshop is offering a unique opportunity to join our staff at the Nottingham studio. We have three places for the newly created role of Assistant Games Developer. The three successful applicants will be employed on a maximum two year contract specifically to assist our design teams to invent and produce new games and supplements. The work of the Assistant Games Developers will be assessed over this two year period, at the end of which we will offer permanent places to those who have proven sufficiently able.

### THE WORK

The work of an Assistant Games Developer is intended to teach you how games are invented, developed and produced. You will begin by assisting our Games Designers and Games Developers. This will mean making mock-ups of games, books, and cards, working out and checking points values from army lists, and playing games along with our design teams. Yes we do want you to play games for a living! If you prove capable then the work will eventually expand to cover all aspects of games development and production, including assembling rule books, writing up rules, producing White Dwarf articles, preparing work for printing, seeing print jobs through to completion, coordination of model making and production, co-ordinating release dates with White Dwarf publication, and preparing supporting articles and adverts, and ... yes the list is endless, that's why you get two years to figure it out.

### QUALIFICATIONS

There are few formal qualifications for this position although an unquenchable enthusiasm for Games Workshop is an absolute necessity. A good knowledge of Warhammer, Warhammer 40,000 and Space Marine is essential too. You must be between 20 and 25 years old, with some post A-level education. We are looking for people with degrees or the equivalent, but if you dropped out of college, or are willing to do so to take up this position, we will consider you. You must be reasonably literate, with a good command and understanding of written English. You must also be keyboard literate, that is to say you need to know how to use a computer and you need to be comfortable about typing. We would require you to have at least O level maths, or comparable or better maths qualifications, as a lot of our work involves calculations or the manipulation of dice probabilities.

### THE DEAL

The three people we take on will be provided with lodgings at our expense, in a house owned by the company. We will also provide you with a bus pass to get you into work and back. In addition you will receive a wage of £6,000 a year.

We will assess your work periodically and may ask you to complete specific projects with a view to your assessment. Your continued employment depends upon a satisfactory work record, and successful completion of any projects you are given.

Upon successful completion of your two years as Assistant Games Developer, we will offer you a suitable job. We anticipate that this will be as a Games Developer, but if your skills develop in a specific direction you could become a Games Designer, Editor, or Production Artist.

### WHERE TO APPLY

Send us your full C.V. together with as many details as possible about your gaming experience, the armies you collect and your abilities as a miniature painter, to:

**Assistant Games Designer  
c/o Simone Greasley  
Games Workshop Ltd  
Chewton Street, Hilltop, Eastwood  
Nottingham NG16 3HY**

# MAN O'WAR

## DWARF DREADNOUGHTS

By Andy Jones

The Dreadnought is the greatest warship in the Dwarf Navy, some would say it is the most powerful ship afloat. Like the Ironclad, upon which it is based, it is a Man O' War. That is where the resemblance ends. This single ship manages to carry more guns than a squadron of Meribons, has armour plating that is more than a foot thick, has an engine that can build up an awesome speed for its size, and still holds a sizeable crew.

Dreadnoughts have a unique arrangement of helms linked to the main paddle wheels at the side and to the single large wheel at the rear, which combine to give it maximum speed for a ship of its size. This arrangement also makes the Dreadnought incredibly difficult to stop, as both side and rear paddles must be destroyed before it will go to a halt. The firepower of a Dreadnought is extraordinary, and legends tell of these vast iron ships holding up and destroying entire Plate Fleets within the Black Gulf and off the island of Soribus.

These huge armoured paddle-steamers are clad in iron plates, which means they can withstand an enormous pounding. The steam-powered survival barrels can be fired to bring guns to bear on all sides. As such, Dreadnoughts are a powerful addition to the Dwarf fleet, as they can bring devastating cannon fire down on any targets in the front, rear or sides.

The next few pages give you all the rules you need to use Dreadnoughts in your Man O' War games, together with a revised Dwarf fleet list.



### DREADNOUGHT RULES

The following rules apply to the Dwarf Dreadnought. In addition, unless specifically contradicted here, all Man O' War game rules and Dwarf special rules also apply.

#### MOVEMENT

The Dreadnought is designed so that it can continue to move even if heavily damaged. If you look at the Dreadnought's template you will see that there are two paddle wheel locations, one for the paddles mounted on the side, and one for the paddle mounted on the back. Even if one of these locations is destroyed, the second can still manage to take the strain and the Dreadnought can still move, albeit at a reduced rate. If a single paddle location is destroyed, the Dreadnought movement rate is reduced by half to 3". This means that the Dreadnought is only immobilised if both of its paddle locations are destroyed, and therefore is very hard to stop!

The Dreadnought may turn on the spot, just like other steam-powered and wood ships, as long as it has its side paddles. Once these are destroyed, it must use the turning template to turn, like a sailing ship.

The Dreadnought may move up to 4" backwards. This takes up its entire movement.

The Dreadnought may ram other ships. To do so, it must move at least 2" in a straight line towards the target.

#### COMBAT

In addition to the standard rules, the following special combat rules apply to the Dwarf Dreadnought.

##### Broadsides

The Dreadnought's broadsides give it a 2 dice attack to left and right each turn, while both batteries are operational. Losing a single broadside battery will deny the guns at that location on both sides of the ship, just as in the Man O' War rulebook.

## DWARF DREADNOUGHT



### Weapons

- 2 fire cannon battery turrets, firing through X\*
- 2 air cannon (battery) turrets, firing through X\*
- 1 broadside cannon battery
- All cannons may target broadsides.

### Special Rules

May gain ship movement power at level 7 on a straight line, broadside line, or center line only; fire must make a hit on the water line turret of the hits and a die.

- 1 1 point of below the waterline damage
- 2-4 2 points of below the waterline damage
- 2-5 3 points of below the waterline damage

Engines on board may repair 1 broadside turreting 1 turret to the end phase.

### Targets

The Dreadnought's two sets of turrets, mounted to front and rear, operate independently, with each turret having a firing arc of 90°. This means that the front right battery can either fire straight ahead or to the right; the rear left battery can fire either straight ahead or to the left, etc. When a turret is fired to the side, its attacks are added to the number of broadside guns fired. Shots from a turret are therefore targeted in exactly the same way as those from a broadside - from the center of the ship and not from the turret's location.

For example, while it has all of its guns operational, the Dreadnought may make use of the following combination of attacks:

1. It may fire both fire-turrets forward, both rear-turrets backward, and two broadsides from broadside; this gives it a 2 dice attack in every direction.
2. It may fire one fire-turret to the right, one rear-turret to the right, one fire-turret to the left, one rear-turret to the left, and two broadsides; this gives it a four dice attack to the right and left.

These are by no means the only attacks it may make, but serve as examples of what is possible. Within the rules for arc and line of sight etc., a Dreadnought may combine its attacks as it likes.

However, note that the left-hand turret may not fire to the right, and the right-hand turret may not fire left. This means that a 4 dice broadside is not allowed, for instance. The Dreadnought's template shows this.

### Damaging the Dreadnought's Guns

**Turrets:** Each turret is an individual gun position, and damage to one doesn't affect the others. When a turret location is damaged, the attacking player chooses which turret in that location is destroyed - the right or the left.

**Broadsides:** The broadside cannons are mounted in batteries that run the width of the ship, and each hit will destroy guns on both sides of the vessel. Therefore, the first hit on the broadside gun-deck location will reduce both broadsides to 1 die - the distinction between sides is not made. A second hit will disable both broadsides by a further 1 die, destroying the broadside guns.

## DWARF FLEET LIST

The following supervises the Dwarf Fleet List posted in the Man Of War subforum.

## DWARF FLEET

A Dwarf Fleet may consist of the following:

### Man Of War 7+

The fleet must have at least one Dreadnought to be your Admiral's flagship. You may have one Dreadnought for every 10000.

Cost: 200 points per Dreadnought.

The fleet must have at least one broadside.

Cost: 130 points per broadside.

### Ship of the Line Squadrons 1+

At least one squadron of three Monitors. You may have a maximum of two squadrons of Monitors for every Man Of War in your fleet.

Cost: 150 points per squadron.

### Independents 1+

At least one Nautilus. You cannot have more Nautiluses than the total Man Of War.

Cost: 75 points per Nautilus.

### Admiral 1

Cost: Free.

### Man Of War-Carrier 1+

Cost: 1st cost free with the Admiral, subsequent costs at 75 points per cost.

# DWARF DREADNOUGHT™

MAN OF WAR

CREW  
**4**

HIGH		LOW						
<p><b>3</b></p> <p>Left Turret</p> <p><b>FORE TURRETS</b> Save 2, 4, 5 or 6 Each in turn, roll of six (1000 points) The attacking player announces which turret is destroyed (1000 points)</p> <p>Right Turret</p>	<p><b>6</b></p> <p>Left Turret</p> <p><b>AFT TURRETS</b> Save 2, 4, 5 or 6 Each in turn, roll of six (1000 points) The attacking player announces which turret is destroyed (1000 points)</p> <p>Right Turret</p>	<p><b>2</b></p> <p>NO EFFECT</p> <p><b>BOWS</b> Save 3, 4, 5 or 6</p>	<p><b>3</b></p> <p>NO EFFECT</p> <p><b>BROADSIDE GUN DECK</b> Save 3, 4, 5 or 6 Each in turn, roll a die (1000 points) Reducing thickness by 1 plate</p>	<p><b>4</b></p> <p><b>PRODDLE</b> Save 4, 5 or 6 Maximum speed '60'</p>	<p><b>5</b></p> <p><b>BOILER</b> Save 2, 4, 5 or 6 Maximum speed '60'</p>	<p><b>6</b></p> <p><b>PRODDLE</b> Save 4, 5 or 6 Maximum speed '60'</p>	<p><b>BELLOW WATERLINE</b> Save 2, 4, 5 or 6 Each in turn, roll of six (1000 points) Flashes for 1000 points</p>	
<p><b>STEAM: 6"</b></p>				<p><b>BATTLE HONOURS: 8</b></p>				<p>NAME:</p>

# THE DWARF FLEET

**T**he sea had not yet risen when the first waters seeped through the newly opened sluices in the dry dock at Barak-Vær. They rose slowly around the vast iron hull that sat resolutely in its cradle: the cradle that had housed the *Dwarf* brought for the two years it had taken to construct. The rushing waters idly turned its great paddles this way and that, as if testing the tides.

Chief Engineer Bengt Craghner tapped at his hand and grinned as he surveyed the scene with satisfaction. The ancient *Dwarf* had laboured long for this day to dawn. His vision of engineers had faded by many years in being Craghner's greatest dream, his reality.

Barak Vær, the great inland stronghold of the Dwarf Dale and gateway to the Dwarf strongholds of the Færdale Edge Mountains, had seen many vessels built within its walls. From its iron doors had issued forth the *Dwarf* and *Miner* of the Dwarf Provinces. Now an *Dwarf* would join them.

Perhaps, a vessel even greater than any other ships in the Black Gulf, or able to surge against ferocious Dwar who tried to establish a foothold on the banks of the Black River. He was reminded of the *Warrior* that had put to sea a few months ago to crack a large pirate fleet that had been terrorising shipping around Sarkov. What a sight the long lines of *Dwarf*, *Miner* and *Nautilus* had been, steering a fleet some of pride in the old region.

Craghner sometimes wondered if he was the only Dwarf engineer who really believed in the strength of his power, who could truly see beyond the small dreams of father-ordained plans to more powerful concepts. It seemed so long ago that his father, Osmund Craghner, as his *Dwarf* had, had pursued the secret plans for his ship that eventually he knew. Now that his father had gone to join the ancestors, it was Bengt's task to carry on the development programme.

Within the pages of the ancient iron-bound book - handed to him from his son, Jan Craghner to Craghner down the ages - lay much valuable information, including the plans for the first Dwarf ship, the *Miner*. When they had first emerged from the Engineer's works on the Black River, countless years ago, a new era had dawned. The birth of an age where Dwar could put to sea or study secrets of their own devising, with which they felt fully confident. There was no reliance on the wisdom of the council for the Dwarf ships, for their vessels were propelled by steam engines and paddle wheels, powered by the *Miner* through the water. More sophisticated Dwarf philosophy inspired the Craghner Clan and their workers wherever. If not used, the construction of such a construction, and the vision of the *Miner* were regarded throughout Dwarf society with the same respect and regard afforded to *Tridagers*. Many engineers within the Dwarf guilds were already sure that the *Miner* would set that, and their eyes were fixed to a path long to the distant depths of the living. Yet in their

concern, the slowest period always results in their first encounters with many trials, who found it difficult to let the line back of the *Miner*. The *Miner*'s metal hulls were almost impossible to penetrate, and with their own bodies, usually intended from the Dwarf ships presented no problems in anyone trying to board them.

While the Dwarf fleet was in its infancy, and the *Miner* were digging around the seas of the Old World making their mark as administrators they set off. Bengt's great-grand grandfather and his kind engineers were working hard on their next project - the *Ironclad*. *Digger*, better known and brighter than the *Miner*, the *Dwarf* was the first ship ever going Dwarf working, its construction argued that first was the first real evidence that the Craghner Clan were truly mad. Not many younger Dwarfs dared to cross the *Ironclad*, said by promises of better glory, honour and treasure from across the sea. The ancient Engineers and working swimming ability of the *Ironclad*, coupled with its truly outstanding ability to withstand a battle proceeding from other vessels, meant that the Dwarf saw it as a vital piece to be reckoned with.

When the book came into his possession, Bengt had a vision of still greater things to come: a Dwarf ship that would be the King of the sea, and that would carry a whole Dwarf-hull to sea. Over the decades his mind began to build and hardened into an ambition, yet achievable design using the technology already held in the *Miner* and *Ironclad*. While not big enough to carry a whole Dwarf-hull to sea, it was huge by anyone's standards. Bengt was confident that his new ship would be the biggest steel construction anywhere in the Old World, whether on land or sea. It would be the only problem was the sheer expense of building him in the face of opposition from the many established engineer's guilds.

For a long time he studied all the ships ever built from the seas of the Dwarf Provinces in spirit of open-minded. Such a course of action grated against Craghner's character, but Bengt justified his wish and decided to put up with the frequent objections of the Overseer standards of the sailing authorities. After meeting in silence with a number of rich Dwarfs that Bengt usually thought were backed with *gip* and he could see no other reason for their behaviour or motivations, Craghner turned into Margrave Nordmann, the great ruler of the Gulfstream Kingdom. Margrave agreed to fund the new Dwarf, and gave an ship to build. He granted a quick loan, although rich of time, and Craghner set fire to the path to the construction of his dream. But Margrave had



A DRAGON FLEET OF SUPPLIES BY MINGOON, AND A NOVELLY OTHER, A DRAGON FLEET.

his own design, and refused to be copied by Creighton.

At about the same time that Creighton completed his new design, his old partner unveiled his own design for the Navigator, a substantial warship. Mongoose had quickly granted it his full and unconditional approval by Mingoon's standards, and it seemed that the Navigator was something of a joke to Creighton. The other drafting engineers here was a monitor that did indeed play a role in the great battle—and then prepared to come back up again.

Although armed with impressive technical ingenuity, Mingoon's Navigator looked destined to a life of virtual inactivity. Mongoose was reluctant to try these boats at his new form of travel and, given a choice, most recruits seemed to stay the great ports of the lowlands. Mongoose was at a real loss here to recruit the first Navigator's successors. It was only by publicly challenging the captain of the "Seventy," the most famous Dragoon Monitor, to a battle, and taking his own family fortune on the outcome, that Mongoose managed to persuade the valiant Dragoon sailor to climb aboard the Navigator.

Others remained here on board of a large assembled crowd. It was all over! The "Seventy" lay listing to port, her hull made hollow from a gaping forward hole in her side, and her crew clinging to pieces of wreckage. Mongoose was a Dragoon hero and Creighton solidified his reputation and consolidated his prestige as a truly valiant and impressive design.

The "Seventy" monitorer crowded such an interest in the ship, that more money was made available to Mongoose and his engineers. He was finally able to put his plans into operation. He told his sailors that his ship would never see the mighty lowlands, leaving them to spend happiness and endurance. He named it the Dragoon.

and the long months of construction began in earnest.

A land crawling and growing drew Creighton from his work, and his gaze returned to the finished ship, as the rising water lifted it close to its cradle. Although he had every faith in his tried and tested designs, it never failed to surprise him when his construction actually floated. Now it was, the first Dragoon, floating to the dock. The gathered engineers thronged up their boats and cheered in uncharacteristic fervor as the great sea beast in the dock began to open. Gouts of smoke poured from the four smoke-stacks as the powerful engines in the bowels of the great vessel started with a deafening roar. As it built up steam, the Dragoon's huge hydraulic turret barrels began to rotate to port and starboard as the complex mechanisms were tested for faults. The turret moved its huge bulk forward towards the open sea and its captain like a long single note on the lips of a sailor. The sail was taken up by the squadrons of monitors and lowlands at rest in the military dockyard, and soon the active sea was rocking to the deafening roar of a hundred throats.

Hearing footsteps approaching, Mongoose turned to see an extremely pretty Dragoon, dressed in formal and elegant, approaching him. This was Admiral Insult, First Sea Lord of the Dragoon Fleet. He pulled Mongoose on the shoulder and pressed broadly at him, shouting a word of praise that brought down the curtain of many sea battles, and drew the water to prove it.

"A grand day for us, Creighton," he said proudly. "This ship—the Dragoon—will surely establish our fleet as the best in the world."

Looking at the tall bulk of the Dragoon, Creighton said: "I doubt that this was overly true."

# MAN O' WAR MINIATURES

The Man O' War game is supported by a range of Citadel Miniatures boxed sets, making up all the famous fleets of the Warhammer World. Each box contains either a single mighty Man O' War – the biggest warships on the seas – or a complete squadron of Ships of the Line. Each set comes complete with plastic masts and flag-poles, plus a sheet of full-colour sails and pennants for the models in the box.



The Man O' War Bretonnian boxed sets consist of 3 Buccaneers, 3 Corsairs and a mighty Bretonnian Galleon.



The Man O' War High Elf boxed sets consist of 3 Hawkships, 3 Eagleships and a mighty Dragonship.

Illustration supplied unpainted. Contents unpainted and unglued.

**WARNING:** This product contains lead which may be harmful if swallowed.  
Citadel Miniatures are not recommended for children under 12 years of age.

CITADEL  
20003718037

Games Workshop and Citadel are registered trademarks of Games Workshop Ltd. Man O' War is a trademark of Games Workshop Ltd. © Copyright Games Workshop Ltd 1985. All rights reserved.

**GAMES<sup>®</sup>  
WORKSHOP**





# CHAOS DWARF ARMY LIST

BY RICK PRIESTLEY

This month we present the Chaos Dwarf army list. Of course, there's still a bit more work to do on it, testing out the new weapons, and finalising details, so if you'd like to write in with your comments it isn't too late! Next month we hope to publish the Chaos Dwarf magic cards which are currently under development, and the rules for Chaos Dwarf Blunderbusses (no room in this issue sorry!). The Blunderbusses will have special rules you can use the standard hand gun rules for now.

Like all Warhammer army lists this one has been designed so that you can choose an army to a preset points value agreed upon by your opponent and yourself. There is no upper limit to the size of a Warhammer army, but one thousand points is probably the smallest size that will enable you to field a battleworthy force. Two thousand points is sufficient to give you a battle that will last an entire evening, while three thousand points is enough to fight a battle that will last the best part of a day.

It is a good idea to collect armies in blocks of a thousand or five hundred points, starting with, say, a one thousand point core force then adding blocks of five hundred points at a time. This allows you time to paint the models and try them out on the tabletop before deciding what to include next. Chaos Dwarfs can use Chaos or Orc and Goblin allies, and can also use some of the Orc and Goblin troops directly in the form of subjugated tribes. If you already have these armies you can build up a usable force of Chaos Dwarfs quite quickly, and then decide whether to expand the army with more Chaos Dwarfs later.

Before the game both players agree upon a points value for the battle. This will usually be the same for both sides (eg 2000 points a side). You may choose up to the agreed points worth of troops from the Chaos Dwarf list, including up to 25% allies from the appropriate Warhammer Armies lists if you wish. Your opponent chooses his troops from the Warhammer Armies list for his army. The total value of your army may be up to the agreed points total, and in practice it may be a few points short simply because it is impossible to find something to spend the odd point on. A

small points difference between the opposing armies makes no difference to the outcome!

## THE ARMY

The army list is divided into five sections from which you may choose your troops: Characters, Units, War Machines, Monsters and Allies. You are permitted to spend only a certain proportion of your total points on each of these categories as described under Army Selection at the start of the list. For example, the Chaos Dwarf army can spend a maximum of 50% of its points on characters. These limitations ensure that the armies are reasonably balanced and do not have a predominance of characters, war machines, or large monsters.



## CHARACTERS

The points you are allowed to spend on characters includes the value of the characters' weapons and equipment, and includes magic armour, magic weapons and other magic items. It also includes any creature the character rides, whether a steed or a big monster. If the character rides in a chariot then the points value of the chariot and its crew is also included in with the Characters points allowance.

Note that if you choose a monster or a chariot for a character to ride, you must refer to the Monster section of the list or the War Machines section of the list for details of points values, profiles, crew, etc. Don't let this confuse you – the points value of these monsters and chariots counts towards the points you are allowed to spend on *characters*; their points cost does not count towards the points you are allowed to spend on monsters or war machines.



There are two types of Chaos Dwarf character: Sorcerers and Heroes. There are three types of Hero: Champions, Heroes and Lords. Of these three types, Heroes and Lords may be given any of the equipment described in the Equipment List, as well as monsters, chariots, and magic items as described in the army list itself. Champions, however, are purchased to include in your units. Champions always fight with the units they belong to and they are armed and armoured exactly like the ordinary troops in the unit, except that they may have one magic item in addition. The points value of their equipment may be found on the Equipment List in the same way as other characters, but remember you do not have a free choice.

A character can carry appropriate magic items chosen from the magic item cards in Warhammer, Warhammer Battle Magic or which have been printed in White Dwarf or the growing number of Warhammer supplements. The points values of magic items is printed on the cards themselves together with the rules. The maximum number of magic items a character can have is restricted to between one and four, as indicated in the army list.

Note that some magic items can only be used by specific races or by specific types of character. For example, a scroll can only be used by a wizard (called Sorcerers in the case of Chaos Dwarfs). These restrictions are indicated on the cards themselves. Chaos Dwarfs cannot use magic items if they can only be used by Dwarfs – the magic of ordinary Dwarfs is completely opposed to that of the Chaos Dwarfs and will not work for them. Chaos Dwarfs can use any items that can be employed by Chaos, but not items restricted to a follower of one of the four Chaos gods Khorne, Tzeentch, Slaanesh or Nurgle. The Chaos Dwarfs have their own Chaos god, Hashut, who is completely distinct and uniquely associated with Chaos Dwarfs.

## UNITS

The Units section of the army list describes the troops that form the bulk of a Chaos Dwarf army. Troops are organised into units which must be at least five models and can be bigger. The size of the unit includes its leader, standard bearer, musician, and champion if it has them.

All units are assumed to have a leader equipped in the same way as his troops and with identical characteristics. The leader costs the same points as an ordinary trooper and no separate account is made of them in the army list.

Standard bearers and musicians are assumed to be armed with the same weapons and equipment as the ordinary troopers and fight in the same way. Minor differences in the actual equipment carried by the models may be ignored. Standard bearers and musicians cost double the points of an ordinary trooper. See the Warhammer rulebook for complete rules on how these troops work.

Some units are permitted magic standards. These are covered in the Warhammer Battle Magic supplement and are included as magic item cards. If you include a magic standard with a unit the points value of the standard is part of the unit's cost.

Units are permitted Champions – heroic individuals amongst the rank and file troops. A unit's Champion is always equipped exactly like the ordinary troopers except that he may also carry one magic item. Note that the points cost of the Champion comes from the points allocated for characters, and not units.

## WAR MACHINES

War Machines includes all the artillery and other machines used by the Chaos Dwarfs. This section of the army list is completely straightforward, all you have to do is choose the war machines you want up to a maximum of 25% of the points value of your army.

## MONSTERS

Monsters are beasts brought along to fight beside the army. They include captive monsters goaded into fighting and monsters which have been magically bound by spells of obedience. Monsters chosen as mounts for characters are NOT included in the points allocation for monsters, they are included in the points for characters instead.

## ALLIES

Chaos Dwarfs may include a proportion of allies worth up to 25% of the army's points value. Chaos Dwarfs are permitted two types of allies: Chaos, and Orcs & Goblins. You can include either or both of these in your army if you wish.

To choose allies refer to the Warhammer Armies list for that race. You may choose forces from the Characters, Units, and War Machines sections of those army lists. In the case of the Chaos list you may also choose Daemons. You may not choose monsters or further allies from the allied lists.

When choosing allies you may ignore the normal restrictions on army selection. This is the section at the start of each list which defines the proportion of points which may be spent on the army. For example, in the case of an Orc & Goblin army you can normally spend 0-50% of your points on characters and 25%+ points on units (called Mobs in the case of greenskins). In the case of allies these proportions are ignored, you can spend your points freely between the categories.

However, you are still bound by any other restrictions regarding the number of units, inclusion of special troops, etc. For example, in the Orc & Goblin list you must have a Mob of Savage Orcs to entitle you to a Savage Orc character. You do not need to include a General for your allies, though you may choose a General character if you wish. An allied General does not count as the army's General and is treated as if he were a subordinate character.

*Note. The paragraph above about choosing allies is true of all armies which may have allies, including the Empire and High Elves. The army selection restrictions are always ignored when choosing allies, although other internal restrictions and conditions do continue to apply.*

*This is common sense really if you think about it. If the normal army selection percentages were followed the points available for specific characters or war machines would be impossibly tiny and extremely irritating to work out (eg, characters would be up to 25% of 25% of your army's points value). On the other hand, it would*

*be very silly to allow players to include, say, Goblin Fanatics without buying the Mobs they normally belong to! Similarly, it would be unfair to allow a player to have two units of Big'Uns when an Orc army can only have one! In the case of Orcs and Goblins you must include at least one Mob of a greenskin race before you can buy either characters or war machines of that race (see the Orc & Goblin Warhammer Armies book).*

## PRESENTATION OF PROFILES

Profiles are presented in the normal way for Warhammer creatures. The movement characteristic (M) does not take into account any deductions for armour which may apply. See the Warhammer rulebook for details. Saving throws for armour are not included on the profiles as these may vary depending on what armour you choose to buy.

Cavalry have two profiles: one for the rider and one for the mount (giant wolves in the case of Hobgoblins, for example).

M = Movement	WS = Weapon Skill
BS = Ballistic Skill	S = Strength
T = Toughness	W = Wounds
I = Initiative	A = Attacks
Ld = Leadership	



## LIMITATION OF CHOICE

For the most part there are no extra limits imposed regarding the number of troops, units, or characters you can buy. However, there are some limitations and these are indicated along with the pertinent army list entry. For example, you may only ever include one General model regardless of how big your army is.

## ARMOUR

The saving throw of troops is not given on their profile as it is inclined to vary in some cases. Saving throws are summarised below.

Armour	Save	Cavalry Save
None	None	6+
Shield or light armour	6+	5+
Shield and light armour or heavy armour only	5+	4+
Shield and heavy armour	4+	3+

## EQUIPMENT LIST

The following list gives all the usual weapons in the Warhammer game. We have included this list so you can choose weapons for your character models without consulting the Warhammer rulebook. We have provided a complete list for the sake of reference and comparison, but Chaos Dwarf characters are not permitted to use all the items on it. Items marked with an asterix (\*) are not available to Chaos Dwarfs or Bull Centaurs, those marked with two asterixes (\*\*) are not available to Chaos Dwarfs, Bull Centaurs or Hobgoblins.

## EQUIPMENT LIST

### HAND-TO-HAND COMBAT WEAPONS

A single sword, axe, mace or other hand weapon .....	Free
An additional sword, axe, etc .....	1
A double-handed weapon, including double-handed axe, sword, etc .....	2
Flail .....	1
Halberd .....	2
Spear .....	1
A lance for a mounted warrior .....	2**

### MISSILE WEAPONS

Bow .....	2*
Short Bow .....	1*
Long Bow .....	3**
Crossbow .....	3**
Repeating Crossbow .....	4**
Javelin .....	1*
Sling .....	1*
Hand Gun .....	3
Pistol .....	2

### ARMOUR

Shield .....	1
Light Armour .....	2
Heavy Armour .....	3
Barding for Steed .....	4**

## ARMY SELECTION

Characters	0-50%	Up to half the points value of the army may be spent on characters. This includes the cost of monsters ridden by a character.
Units	25%+	At least a quarter of the total points value of the army must be spent on units. This does not include the cost of Champions, who count as characters and are paid for out of the points allocated for characters.
War Machines	0-25%	Up to a quarter of the points value of the army may be spent on war machines.
Monsters	0-25%	Up to a quarter of the points value of the army may be spent on monsters. This does not include the cost of monsters ridden by characters, which must be paid for out of the points allocated for characters.
Allies	0-25%	Up to a quarter of the points value of the army may be spent on allies chosen from either or both of the following lists: Orcs & Goblins, and Chaos.

# CHAOS DWARF ARMY LIST

## CHARACTERS

Your Chaos Dwarf army may include up to 50% of its points value as characters chosen from the list below. Your army must always include a General, but otherwise you are free to choose as many or as few characters as you wish.

### 1 CHAOS DWARF GENERAL

**LORD** ..... 160 points

**SORCERER LORD** ..... 328 points

Your army must include a General to lead it. In the case of Chaos Dwarfs the General can be either a Lord or a Sorcerer Lord. He represents a mighty servant of the Masters of Zharr-Naggrund, or perhaps even one of the Masters themselves.

PROFILE	M	WS	BS	S	T	W	I	A	Ld
LORD	3	7	6	4	5	3	5	4	10
SORCERER LORD	3	4	3	4	5	4	5	3	10

**EQUIPMENT:** Hand weapon – axe, mace, club etc.

**WEAPONS/ARMOUR:** The General may be armed with any combination of weapons/armour allowed to any of the troop types in the army list and included on the Equipment List. See the Equipment List for points values.

**MAY RIDE:** The General may ride a monster (see the Monster List for points values). The usual mount of a Chaos Dwarf of great importance is either a Lammasu or a Great Taurus.

**MAGIC ITEMS:** If the General is a Lord character he may carry up to three magic items. If he is a Sorcerer Lord he may carry up to four items. Magic items are chosen from the appropriate cards as described in Warhammer Battle Magic.

### 0-1 BATTLE STANDARD

**CHAOS DWARF** ..... 98 points

**BULL CENTAUR** ..... 156 points

If you wish your army may include a battle standard together with its bearer. The bearer can be either a Chaos Dwarf or a Bull Centaur.

PROFILE	M	WS	BS	S	T	W	I	A	Ld
CHAOS DWARF	3	5	4	4	4	1	3	2	9
BULL CENTAUR	8	5	4	5	4	2	4	3	9

**EQUIPMENT:** Hand weapon – axe, mace, club etc, and battle standard.

**WEAPONS/ARMOUR:** The Battle Standard Bearer may be armed with any combination of weapons/armour allowed to any of the troop types in the list and included on the Equipment List. See the Equipment List for points values.

**MAY RIDE:** If the Battle Standard Bearer is a Chaos Dwarf he may ride a monster (see the Monster List for points values). The usual mount of a Chaos Dwarf of great importance is either a Lammasu or a Great Taurus.

**MAGIC ITEMS:** The Battle Standard Bearer is a Champion character and is therefore entitled to one magic item as described in Warhammer Battle Magic. This may be a magic standard, effectively turning the army's banner into a magic battle banner.

### 0-1 BULL CENTAUR LORD ..... 368 points

Your army may include a Bull Centaur Lord – the most powerful of all the mighty race of Bull Centaurs and most trusted of all captains of the Masters of Zharr-Naggrund.

PROFILE	M	WS	BS	S	T	W	I	A	Ld
BULL CENTAUR LD	8	7	6	5	5	4	6	5	10

**EQUIPMENT:** Hand weapon – axe, mace, club etc.

**WEAPONS/ARMOUR:** The Bull Centaur Lord may be armed with any combination of weapons/armour allowed to any of the troop types in the list and included on the Equipment List. See the Equipment List for points values.

**MAGIC ITEMS:** As a Lord character he may carry up to three magic items chosen from the appropriate cards as described in Warhammer Battle Magic.



## CHAOS DWARFS

### HEROES

<b>CHAOS DWARF</b> .....	<b>104 points</b>
<b>BULL CENTAUR</b> .....	<b>232 points</b>
<b>HOBGOBLIN</b> .....	<b>59 points</b>

The army may include as many Heroes as you wish within the normal limitations of the points available. Hobgoblin Heroes may only be included if your army also has at least one unit of Hobgoblins; if your army contains no Hobgoblin units then it may not include Hobgoblin Heroes. Heroes represents great captains amongst the Chaos Dwarfs, the most trusted and the mightiest of all the servants of the Sorcerer Lords who are the Masters of Zharr-Naggrund. In the case of Hobgoblin Heroes these represent tribal leaders amongst their treacherous kind, individuals whose sense of cunning and instinct for survival mark them out from the bulk of their craven race.

PROFILE	M	WS	BS	S	T	W	I	A	Ld
CHAOS DWARF	3	6	5	4	5	2	4	3	10
BULL CENTAUR	8	6	5	5	5	3	5	4	10
HOBGOBLIN	4	5	5	4	4	2	4	3	7
GIANT WOLF	9	4	0	3	3	1	3	1	3

**EQUIPMENT:** Hand weapon – axe, mace, club etc.

**WEAPONS/ARMOUR:** A Hero may be armed with any combination of weapons/armour allowed to any of the troop types in the list and included on the Equipment List. See the Equipment List for points values.

**MAY RIDE:** A Chaos Dwarf Hero may ride a monster (see the Monster List for points values). A Hobgoblin Hero may ride a giant wolf (+4 points).

**MAGIC ITEMS:** A Hero character may carry up to two magic items chosen from the appropriate Warhammer magic item cards. See Warhammer Battle Magic for details.

### CHAMPIONS

<b>CHAOS DWARF</b> .....	<b>48 points</b>
<b>BULL CENTAUR</b> .....	<b>106 points</b>
<b>HOBGOBLIN</b> .....	<b>27 points</b>
<b>ORC</b> .....	<b>33 points</b>
<b>BLACK ORC</b> .....	<b>42 points</b>
<b>GOBLIN</b> .....	<b>15 points</b>

Any unit may include a Champion armed and equipped in the same way as the rest of the unit. See the Equipment List for details of points costs. Champions represent especially strong or skilled individuals, literally the best fighter in the unit! A Champion can be the unit's leader, but doesn't have to be, and many players prefer to have a separate leader and Champion model.

PROFILE	M	WS	BS	S	T	W	I	A	Ld
CHAOS DWARF	3	5	4	4	4	1	3	2	9
BULL CENTAUR	8	5	4	5	4	2	4	3	9
HOBGOBLIN	4	4	4	4	3	1	3	2	6
ORC	4	4	4	4	4	1	3	2	7
BLACK ORC	4	5	4	5	4	1	3	2	8
GOBLIN	4	3	4	4	3	1	3	2	5

**EQUIPMENT:** A Champion is always armed and equipped in the same way as the rest of the unit. See the Equipment List for points values.

**MAGIC ITEMS:** A Champion may carry a single magic item chosen from the appropriate magic item cards. See Warhammer Battle Magic for details.

### CHAOS DWARF SORCERERS

<b>SORCERER</b> .....	<b>59 points</b>
<b>SORCERER CHAMPION</b> .....	<b>121 points</b>
<b>MASTER SORCERER</b> .....	<b>219 points</b>
<b>SORCERER LORD</b> .....	<b>328 points</b>

Your army may include any number of Chaos Dwarf Sorcerers within the limits of the points available. Chaos Dwarf Sorcerers are important members of their race, it is they who organise and direct the Chaos Dwarfs. The most powerful of all are the Masters of Zharr-Naggrund who meet at the Temple of Hashut to make their plans of conquest.

PROFILE	M	WS	BS	S	T	W	I	A	Ld
SORCERER	3	4	3	3	5	1	3	1	9
SORCERER CHAMPION	3	4	3	4	5	2	3	1	9
MASTER SORCERER	3	4	3	4	5	3	4	2	9
SORCERER LORD	3	4	3	4	5	4	5	3	10

**EQUIPMENT:** Hand weapon – axe, mace, club etc.

**WEAPONS/ARMOUR:** A Sorcerer may be armed with any combination of weapons/armour allowed to any of the troop types in the list and included on the Equipment List. See the Equipment List for points values.

**MAY RIDE:** A Chaos Dwarf Sorcerer may ride a monster (see the Monster List for points values). The favoured mount of important Sorcerers is either a Lammasu or a Great Taurus.

**MAGIC ITEMS:** A Sorcerer is entitled to magic items chosen from the magic item cards as described in Warhammer Battle Magic. A Sorcerer may have one item, a Sorcerer Champion two items, a Master Sorcerer three items, and a Sorcerer Lord four items.

# UNITS

The Chaos Dwarf army is built from a core of Chaos Dwarf warriors: grim and cruel, confident in their superiority over the lesser races of the world. Your army must contain at least 25% of its points value as units chosen from the list below, it may include more if you wish. Note that your army must include at least one unit of Chaos Dwarf Warriors, but in other respects you are free to choose amongst the units as indicated.

## 1+ UNITS OF CHAOS DWARF

### WARRIORS ..... 14 points per model

Your army must include at least one unit of Chaos Dwarf Warriors and may include more if you wish. They form the backbone of the army: sturdy, arrogant and dependable, they regard all foes with contempt and are utterly loyal to the evil Masters of Zharr-Naggrund.

PROFILE	M	WS	BS	S	T	W	I	A	Ld
CHAOS DWARF	3	4	3	3	4	1	2	1	9

**EQUIPMENT:** Chaos Dwarfs wear heavy armour made from metal scales and carry shields. They carry hand weapons and brutal double-handed axes with heavy cleaving blades.

**SAVE:** 4+.

**OPTIONS:** One unit of Chaos Dwarfs may carry a magic standard. This may be chosen from the appropriate magic cards and its cost is indicated on the card itself. See Warhammer Battle Magic for details.

## CHAOS DWARF

### BLUNDERBUSSES ..... 14 points per model

Your army may include any number of units of Chaos Dwarfs with blunderbusses. The blunderbuss is an unusual and deadly weapon with a short range but devastating effect, especially against massed unarmoured targets.

PROFILE	M	WS	BS	S	T	W	I	A	Ld
CHAOS DWARF	3	4	3	3	4	1	2	1	9

**EQUIPMENT:** Chaos Dwarfs wear heavy armour made from metal scales. They are armed with a blunderbuss and hand weapon.

**SAVE:** 5+.

**OPTIONS:** Any units of Chaos Dwarfs with blunderbusses may be equipped with shields at an additional cost of +1 point per model.

## BULL CENTAURS ..... 41 points per model

Your army may include any number of units of Bull Centaurs. Bull Centaurs are arrogant and cruel creatures, utterly dedicated to the Masters of Zharr-Naggrund and their horrifying deity Hashut the Father of Darkness.

PROFILE	M	WS	BS	S	T	W	I	A	Ld
BULL CENTAURS	8	4	3	4	4	2	3	2	9

**EQUIPMENT:** Bull Centaurs wear light armour and carry shields. They are armed with brutal double-handed axes with heavy cleaving blades.

**SAVE:** 5+.

**OPTIONS:** One unit of Bull Centaurs may carry a magic standard. This may be chosen from the appropriate magic cards and its cost is indicated on the card itself. See Warhammer Battle Magic for details.

## HOBGOBLIN

### WARRIORS ..... 5 points per model

Your army may include any number of units of Hobgoblin Warriors. Hobgoblins are sneaky, distrustful creatures who rely upon the protection of Chaos Dwarfs to prevent other greenskins attacking them. Although cowardly, they are bigger and meaner than ordinary Goblins. Hobgoblins are cunning and malicious fighters too, and in large numbers they are dangerous opponents.

PROFILE	M	WS	BS	S	T	W	I	A	Ld
HOBGOBLINS	4	3	3	3	3	1	2	1	6

**EQUIPMENT:** Hobgoblin Warriors carry a hand weapon and shield.

**SAVE:** 6+.

**OPTIONS:** Any units of Hobgoblins may be equipped with light armour at a cost of +1 point per model.



## HOBGOBLIN ARCHERS ..... 5 1/2 points per model

Your army may include any number of units of Hobgoblins armed with bows. Hobgoblins favour the bow as it allows them to attack their enemies from a distance.

PROFILE	M	WS	BS	S	T	W	I	A	Ld
HOBGOBLINS	4	3	3	3	3	1	2	1	6

**EQUIPMENT:** Hobgoblin archers carry a hand weapon and bow.

**SAVE:** None.

**OPTIONS:** Any units of Hobgoblin archers may be equipped with light armour at a cost of +1 point per model. Any units of Hobgoblin archers may be equipped with a shield at a cost of +1/2 point per model.

## HOBGOBLIN WOLF RIDERS ..... 14 points per model

Your army may include any number of units of Hobgoblin Wolf Riders.

PROFILE	M	WS	BS	S	T	W	I	A	Ld
HOBGOBLINS	4	3	3	3	3	1	2	1	6
GIANT WOLF	9	4	0	3	3	1	3	1	3

**EQUIPMENT:** Hobgoblin Wolf Riders carry a shield and are armed with hand weapons.

**SAVE:** 5+.

**OPTIONS:** Any units of Hobgoblin Wolf Riders may be equipped with light armour at a cost of +2 points per model. Any units of Hobgoblin Wolf Riders may be armed with short bows at a cost of +1 point per model.

**SPECIAL RULES:** Hobgoblin Wolf Riders can *skirmish* as described in the rules for skirmishing troops in the Warhammer rulebook.

## 0-1 UNIT OF BLACK ORCS ..... 9 points per model

Black Orcs were bred by Chaos Dwarfs in an attempt to improve the Orc breed and produce a race of slave warriors. The experiment went wrong and the Black Orcs rebelled, nearly destroying the Chaos Dwarfs and the Tower of Zharr-Naggrund. Only the betrayal of the Hobgoblins halted the Black Orcs, and since that time the Chaos Dwarfs have chosen to rely upon the craven but easily led Hobgoblins rather than the powerful but independently minded Black Orcs. Not all the Black Orcs were wiped out, and a few remain in the service of the Masters of Zharr-Naggrund, though they are not permitted to enter the city itself.

PROFILE	M	WS	BS	S	T	W	I	A	Ld
BLACK ORC	4	4	3	4	4	1	2	1	8

**EQUIPMENT:** Black Orcs wear light armour and carry a hand weapon.

**SAVE:** 6+.

**OPTIONS:** The unit of Black Orcs may be armed with one of the following: double-handed weapons (+2 points per model), halberds (+2 points per model), spears (+1 point per model) or an additional hand weapon (+1 point per model). The unit of Black Orcs may carry shields (+1 point per model).

## ORCS ..... 5 1/2 points per model

The Chaos Dwarfs keep many Orc and Goblin tribes enslaved in their dark workshops and mines. Some of the tribes which live in the Mountains of Mourn guard the mountain passes for their Chaos Dwarf masters. Though these tribes are rebellious the Chaos Dwarfs employ the Hobgoblins to keep them in line.

PROFILE	M	WS	BS	S	T	W	I	A	Ld
ORC	4	3	3	3	4	1	2	1	7

**EQUIPMENT:** Orcs carry a hand weapon.

**SAVE:** None.

**OPTIONS:** Any units of Orcs may be equipped with light armour at an additional cost of +2 points per model. Any units may be equipped with shields at a cost of +1 point per model. Any units may be armed with one of the following weapons: either a double-handed weapon (+2 points per model), a halberd (+2 points per model), a spear (+1 point per model), an additional hand weapon (+1 point per model), or a bow (+2 points per model).

## GOBLINS ..... 2 1/2 points per model

Thousands of Goblins labour in the mines of the Plains of Zharrduk and throughout the sprawling Chaos Dwarf Empire. They are poor warriors, but their lives are of such little consequence that the Chaos Dwarfs drive them into battle in their thousands, throwing them upon the enemy battle lines merely to tire the foe and blunt his attack.

PROFILE	M	WS	BS	S	T	W	I	A	Ld
GOBLIN	4	2	3	3	3	1	2	1	5

**EQUIPMENT:** Goblins carry a hand weapon.

**SAVE:** None.

**OPTIONS:** Any units of Goblins may carry shields at an additional cost of +1/2 point per model. Any units of Goblins may wear light armour at an additional cost of +1 point per model. Any units may be armed with one of the following weapons: either a double-handed weapon (+1 point per model), a halberd (+1 point per model), spears (+1/2 point per model), or short bows (+1/2 point per model).



# WAR MACHINES

The Chaos Dwarfs are great artificers and sorcerers and their war machines are huge and powerful. Your army may include up to 25% of its points value as war machines chosen from the following list.

## EARTHSHAKER CANNON .... 140 points each

Your army may include any number of Earthshakers. Each Earthshaker has a crew of three to operate the weapon and defend it if necessary.

PROFILE	M	WS	BS	S	T	W	I	A	Ld
CANNON	-	-	-	-	7	3	-	-	-
CHAOS DWARF	3	4	3	3	4	1	2	1	9

	Maximum Range You may guess	Strength	Wounds	Save
EARTH-SHAKER	12-48"	7	D3	-4

**EQUIPMENT:** The crew are armed with hand weapons.

**SAVE:** 5+.

## DEATH ROCKET ..... 75 points each

Your army may include any number of Death Rockets. Each rocket has a crew of two Dwarfs to operate the weapon.

PROFILE	M	WS	BS	S	T	W	I	A	Ld
LAUNCHER	-	-	-	-	7	3	-	-	-
CHAOS DWARF	3	4	3	3	4	1	2	1	9

	Maximum Range You may guess	Strength	Wounds	Save
LAUNCHER	48"	5	D3	-2

**EQUIPMENT:** The crew are armed with hand weapons.

**SAVE:** 5+.



# MONSTERS

Up to a quarter of the points value of the army may be spent on monsters. This does not include the cost of monsters ridden by characters, which must be paid for out of the points allocated for characters.

## CHIMERA ..... 250 points

PROFILE	M	WS	BS	S	T	W	I	A	Ld
CHIMERA	6	4	0	7	6	6	4	6	8

## COCKATRICE ..... 150 points

PROFILE	M	WS	BS	S	T	W	I	A	Ld
COCKATRICE	4	3	0	4	4	2	4	3	6

## DRAGON

- Dragon ..... 450 points
- Great Dragon ..... 600 points
- Emperor Dragon ..... 750 points

PROFILE	M	WS	BS	S	T	W	I	A	Ld
DRAGON	6	6	0	6	6	7	8	7	7
GREAT DRAGON	6	7	0	7	7	8	7	8	8
EMPEROR DRAGON	6	8	0	8	8	9	6	9	9



## GREAT TAURUS ..... 225 points

PROFILE	M	WS	BS	S	T	W	I	A	Ld
GRT TAURUS	6	6	0	6	6	5	7	4	8

## GRIFFON ..... 150 points

PROFILE	M	WS	BS	S	T	W	I	A	Ld
GRIFFON	6	5	0	6	5	5	7	4	8

## HIPPOGRIFF ..... 145 points

PROFILE	M	WS	BS	S	T	W	I	A	Ld
HIPPOGRIFF	8	5	0	6	5	5	6	3	8

## HYDRA ..... 225 points

PROFILE	M	WS	BS	S	T	W	I	A	Ld
HYDRA	6	3	0	5	6	7	3	5	6

## GIGANTIC SPIDER ..... 50 points

PROFILE	M	WS	BS	S	T	W	I	A	Ld
GIGANTIC SPIDER	5	3	0	5	4	4	1	2	7

## LAMMASU ..... 200 points

PROFILE	M	WS	BS	S	T	W	I	A	Ld
LAMMASU	6	6	0	6	7	5	6	3	8

## MANTICORE ..... 200 points

PROFILE	M	WS	BS	S	T	W	I	A	Ld
MANTICORE	6	6	0	7	7	5	4	4	8

## WYVERN ..... 180 points

PROFILE	M	WS	BS	S	T	W	I	A	Ld
WYVERN	6	5	0	5	6	4	4	3	5

## GIANT SCORPION ..... 50 points

PROFILE	M	WS	BS	S	T	W	I	A	Ld
GIANT SCORPION	5	3	0	5	4	4	1	2	7

## SWARMS ..... 100 points

PROFILE	M	WS	BS	S	T	W	I	A	Ld
RATS	6	3	0	3	2	5	1	5	10
FROGS	4	3	0	3	2	5	1	5	10
LIZARDS	4	3	0	3	2	5	1	5	10
BATS	8	3	0	3	2	5	1	5	10
SERPENTS	3	3	0	4	2	5	1	5	10
INSECTS/ SPIDERS	4	3	0	3	2	5	1	5	10
SCORPIONS	4	3	0	4	2	5	1	5	10

# CHAOS DWARF EARTHSHAKER CANNON

The Earthshaker cannon is a massive weapon of destruction and one of the most deadly weapons in the arsenal of the Chaos Dwarfs. It fires a heavy shell full of powerful explosive. When the shell lands it smashes into the ground, burying itself deeply before it explodes, creating devastating shock waves. As well as blowing its target apart, the shockwaves of the explosion are so strong that nearby models are knocked to the ground. Troops close to the blast will be far too shocked by the impact to fight, or even to move. All they can do is lie on the ground, dazed and confused, until they recover their senses.

The Earthshaker cannon's shots are worked out in the same way as shots from a stone thrower. You will need the standard missile template with the hole in the centre, the artillery dice, and the scatter dice.

First pivot the cannon so that it is pointing in the direction you wish to fire. Now declare how far you want to fire the Earthshaker shell. As with stone throwers, you must do this without measuring, guessing the range as accurately as you can. You must guess a distance of between 12" and 48" – you cannot guess less than 12" because the barrel can only be depressed by a certain amount. Once you have made your guess place the missile template directly over the spot you have estimated.

To see where the shell lands roll both the scatter and artillery dice. If the scatter dice rolls a HIT then the shell lands where you have aimed it. If you roll an arrow then the shell veers off in the direction indicated.

If the artillery dice rolls a MISFIRE then something has gone wrong – roll a D6 and consult the Earthshaker Misfire Chart below. A misfire roll automatically cancels out the whole shot regardless of the scatter dice result. If you roll a number on the artillery dice then this is the distance in inches the shell veers off target as shown by the arrow on the scatter dice. Move the template the distance indicated in the direction shown by the arrow. If you roll a HIT on the scatter dice then the numbers are ignored: a number simply indicates that the shot has not misfired.

## EARTHSHAKER MISFIRE CHART

D6	Roll
1-2	<i>Boom!</i> The shell explodes as it is being loaded. The cannon is destroyed and the crew slain. Any troops within 2D6" are thrown to the ground as described in the text.
3-4	The fuse fizzles out and the cannon fails to fire. It takes a complete turn to replace the shell and prepare to fire, so you not only fail to shoot this turn but you cannot shoot again next turn either.
5-6	The shell explodes in mid-air causing no damage. Your shot has no effect this turn.

## DAMAGE

Once you have established where the shell lands damage can be worked out. Any model that lies directly under the hole in the template is hit automatically. Note that only one model can lie within the hole and if there is any doubt, it is the model under the exact centre of the template which is hit. Models whose bases lie under the rest of the template are hit on the D6 roll of 4+. As with stone throwers this is a matter of judgement and common sense. A good rule of thumb is that a model may be considered a potential hit if at least half its base area lies under the template, while models whose bases are only touched or grazed can be ignored.

Once you have worked out which models have been struck by the exploding shell work out damage in the normal way. Roll for each target to determine if you have caused damage, the exploding shell has a Strength of 7. A damaging hit from an Earthshaker cannon causes D3 wounds, but as most creatures have only one wound it is not always necessary to make this dice roll. This ability to inflict several wounds at once on a large target does, however, make the Earthshaker cannon extremely useful against big monsters.

Maximum Range you may guess	Strength	Wounds	Save
12-48"	7	D3	-4 Modifier

The Earthshaker cannon is massive and extremely solid. As a result it has a high Toughness and is difficult to damage.

Move	Toughness	Wounds
3"	7	3

An Earthshaker cannon can be moved by its Chaos Dwarf crew at 3" per turn so long as it has a full crew of three. Loss of crew members reduces the movement rate proportionately. The Earthshaker cannon cannot move and fire during the same turn, other than to pivot on the spot to aim at its target.

If crew are lost the Earthshaker cannon's rate of fire may be affected. If a single crewman is slain the cannon can continue to fire normally. If two crewmen are slain the remaining crewman may fire, but it takes him a complete turn to load the cannon, which may therefore only fire every other turn. This is in addition to any penalty imposed by a misfire result. Should all the crew be slain the weapon is useless and may not fire.

## EARTHSHAKER!

In addition to the damage it causes the Earthshaker shell literally shakes the ground when it lands, causing troops to fall to their knees and drop their weapons. The area affected by the Earthshaker shell is established by rolling 2D6. This establishes the radius of the Earthshaker effect measured in inches from the point of impact.

Any models within the range of the Earthshaker effect may be temporarily thrown to the ground and disorientated by the blast. Roll a D6 and consult the Earthshaker Chart below. The result applies to all troops within the area.

- 1 **QUAKE!** Troops are thrown to the ground and may neither move, shoot, fight or do anything at all in their following turn.
- 2-5 **RATTLE!** Although severely rattled by the shaking ground the troops stay on their feet. In the following turn movement is at half rate and troops may not shoot. Troops may fight normally in hand-to-hand combat. War machines such as cannons and stone throwers may shoot on the D6 roll of a 4+.
- 6 **WOAH!** Bracing themselves against the shock waves the troops suffer no ill effects and are ready to move and fight as normal.

The shock waves affect models from both sides. It is quite likely for some members of a unit to be affected while others are not. In this case the entire unit is bound by any movement penalties that apply, but only models actually

within the Earthshaker's effect range suffer the shooting or fighting penalties. This may mean that some models can shoot or fight while other members of the same unit are unable to do so.

If a unit is broken while some of its members are suffering from a *Quake* or *Rattle* result then any models suffering movement penalties are destroyed automatically, while the rest flee at their normal rate. If a unit pursues while some of its member are suffering a *Quake* or *Rattle* result then the pursuit is worked out as normal and the move, shoot and fighting penalties cease to apply immediately.

## CHAOS DWARF DEATH ROCKET

The Death Rocket is a fiendish invention of the Chaos Dwarf Sorcerers. It consists of a tubular rocket packed full of a chemical propellant synthesised from the abundant raw materials of the Plain of Zharr. The propellant chemicals are highly unstable and extremely toxic, and the slaves that work in the rocket factories of Zharr rarely last for long. The poisonous fumes and deadly chemicals

inevitably kill those lucky enough not to be involved in one of the regular explosions.

Although the Chaos Dwarfs have built and launched some extremely large rockets, they have achieved the greatest success with the small battlefield weapon known as the Death Rocket. This is about seven or eight feet long and is packed full of propellant. It contains a small explosive charge at its tip and is stabilised in flight by means of fins at the rear.

Despite the grand ambitions of the Chaos Dwarfs' experiments, their rockets have not proven very reliable. One especially large

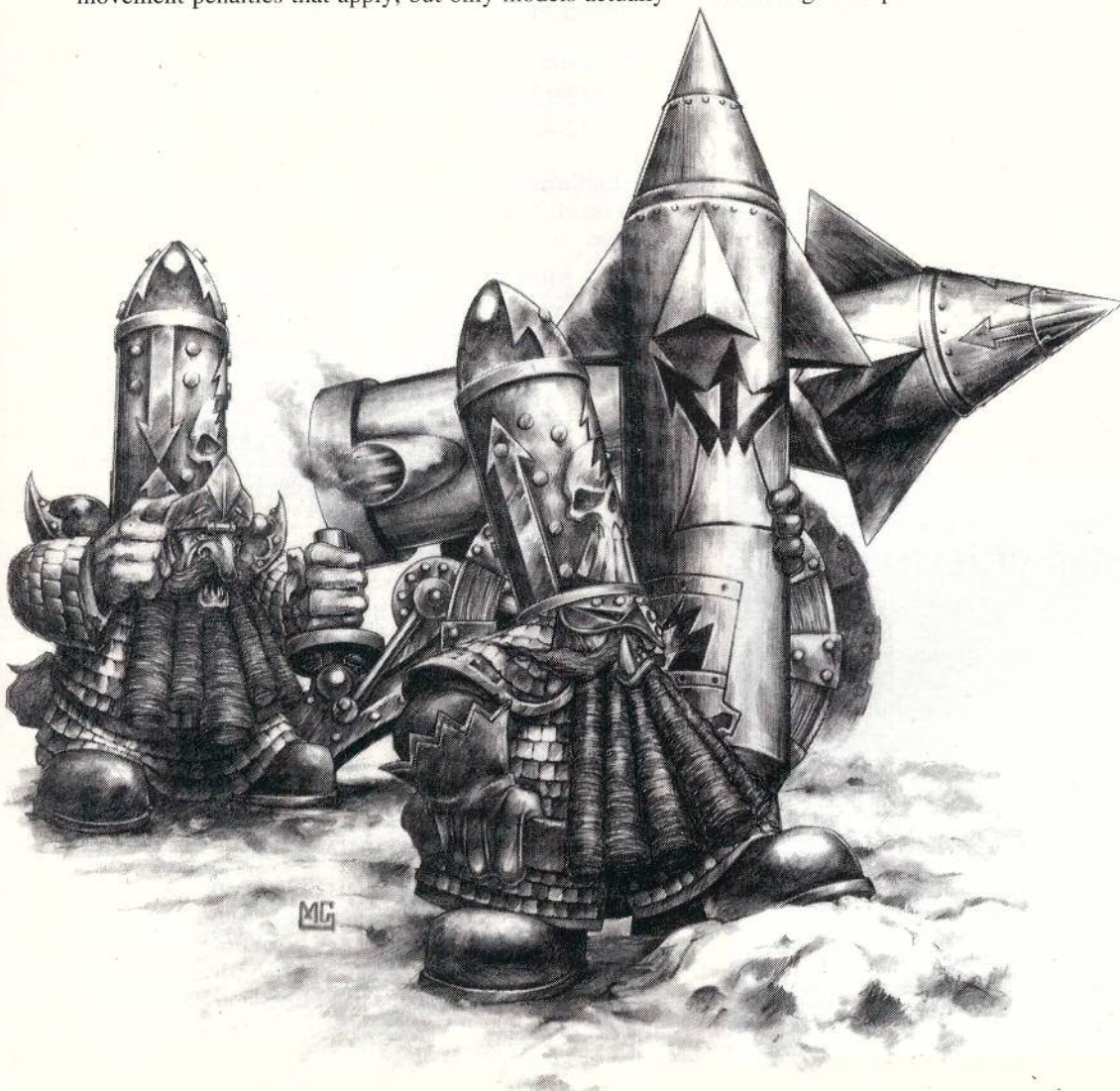

rocket, a huge thing as high as a tower and known as the Hammer of Hashut, went disastrously off course and almost hit Zharr-Naggrund itself, eventually landing on a Goblin camp, blowing a crater in the plain of Zharr hundreds of yards across. Fortunately on this occasion little damage was done, Goblins excepted, but the Chaos Dwarf Sorcerers wisely decided to confine their experiments to the distant and mostly uninhabited Howling Wastes to the south.

The Death Rocket carries an explosive charge, but due to its unpredictable nature it does not always explode when the rocket lands. Sometimes the rocket will smash into the ground and simply bury itself without exploding. On other occasions the rocket will hit the ground and spin round madly before its propellant splutters into life once more carrying the rocket off in a new direction. A rocket which goes wild in this way can sometimes hop and skip across the battlefield, changing direction several times before it explodes.

The Death Rocket's shots are worked out in the same way as shots from a stone thrower or the Earthshaker cannon already described. First pivot the launcher so that it is pointing in the direction you wish to fire, then declare how far you want to fire the rocket, guessing the range as accurately as you can. The maximum range you are permitted to guess is 48". Once you have made your guess place the missile template directly over the spot you have guessed.

To see where the rocket lands roll both the scatter and artillery dice. If the scatter dice rolls a HIT then the rocket lands where you have aimed it. If you roll an arrow then the rocket veers off course and lands in the direction indicated.

If the artillery dice rolls a MISFIRE then something has gone wrong – roll a D6 and consult the Death Rocket Misfire Chart opposite. If you roll a number on the artillery dice then this is the distance in inches the shell veers off target as shown by the arrow on the scatter dice. Move the template the distance indicated in the direction shown by the arrow. If you roll a HIT on the scatter dice then a numbers score on the artillery dice is ignored (a number simply indicates that the shot has not misfired).

## DAMAGE

The rocket only causes damage when it explodes; it inflicts no damage if it merely strikes the ground and shoots off in another direction. Once you have established where the rocket explodes damage can be worked out. Any model that lies directly under the hole in the template is hit automatically. Note that only one model can lie within the hole and if there is any doubt it is the model which lies under the exact centre which is hit. As with stone throwers and the Earthshaker cannon models whose bases lie under the rest of the template are hit on the D6 roll of a 4+.

Once you have worked out which models have been struck by the exploding shell work out damage in the normal way. Roll for each target to determine if you have caused damage. The exploding shell has a Strength of 5. A damaging hit from a Death Rocket causes D3 wounds, but as most creatures have only one wound it is not always necessary to make this dice roll.

Maximum Range you may guess	Strength	Wounds	Save
48"	5	D3	-2 Modifier

The rocket launcher itself is solidly built and difficult to damage. It has a profile as shown below and has 3 wounds. However, because of the explosive nature of the rockets, every time a wound is suffered roll a D6. On the score of a 6 the launcher explodes and is destroyed together with its crew.

Move	Toughness	Wounds
3"	7	3

A Death Rocket launcher can be moved by its Chaos Dwarf crew at 3" per turn so long as it has a full crew of two. If one crew member is slain movement is reduced proportionally (ie, halved). The Death Rocket cannot move and fire during the same turn, other than to pivot on the spot to aim at its target.

If one crewman is slain the weapon may continue to fire normally. Should both crew be slain the weapon is useless and may not fire.

## DEATH ROCKET MISFIRE CHART

D6	Roll
1-2	<i>Boom!</i> The rocket explodes as it is being loaded. The machine is destroyed and the crew slain.
3-4	The fuse fizzles out and the rocket fails to fire. It takes a complete turn to replace the rocket and prepare to fire, so you not only fail to shoot this turn but you cannot shoot again next turn either.
5-6	The rocket goes out of control and lands 4D6" in the direction you have aimed it. Place a small token, dice, or other convenient marker on the spot and roll a D6.
1, 2 or 3	The rocket explodes. Place the template where the rocket lands and work out damage as normal.
4, 5 or 6	The rocket strikes the ground and spins like crazy before relaunching itself into the air. The rocket lurches a further 4D6" through the air in a random direction (use scatter dice). Mark where the rocket lands and roll another D6 on this chart (1-3 explodes, 4-6 spins off randomly 4D6"). Continue rolling until the rocket explodes.

# GAMES WORKSHOP®

## UK MAIL ORDER

OUR TELEPHONE HOTLINES ARE OPEN

9.00am – 6.30pm Monday to Friday  
and 9.00am – 1.00pm on Saturdays



## NEW FOR JUNE!

New for Space Marine, an exciting range of epic boxed miniature sets. Eleven sets of plastic miniatures packed in new design boxes, and priced at £5.99 each. Choose from: Space Marine Legion, Space Marine Land Raiders, Space Marine Tactical Company, Ork Horde, Ork Invasion, Stompers, Chaos Horde, Eldar Legion, Eldar Warhost, Imperial Guard and Squat Warriors.



## WARHAMMER ARMIES DWARFS

The latest volume in the Warhammer Armies series includes the background and history of the Dwarf realms, their language, culture and mysterious runic magic. There is a full army list with details of all Dwarf war machines and even special characters such as Thorgrim Grudgebearer, and the Troll Slayer Gotrek Gurnisson, plus a gripping battle scenario at the very gates of Karak Eight Peaks.

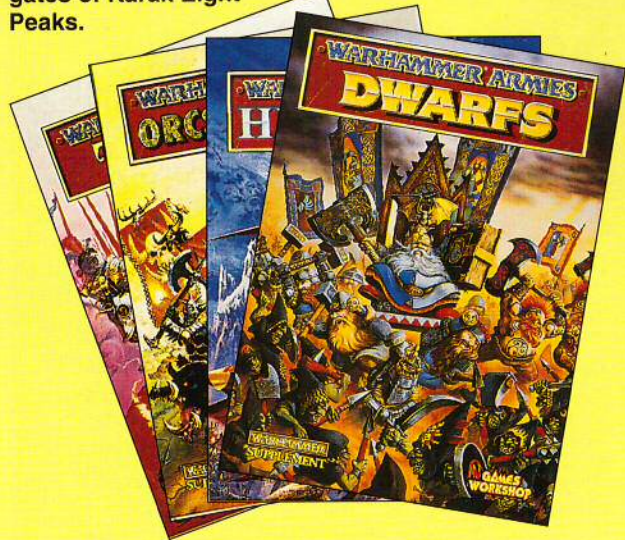

## UK MAIL ORDER

Our UK Mail Order Hotlines are open six days a week, and you can pay by Visa, Access or Switch.

(0773) 713213, Monday to Friday  
between 9.00am and 6.30pm  
Saturdays 9.00am to 1.00pm

If you're posting your order, please send it to:

GAMES WORKSHOP MAIL ORDER SERVICE,  
CHEWTON STREET, HILLTOP,  
EASTWOOD, NOTTINGHAM NG16 3HY.

Or you can fax the order through on (0773) 530155.



## WARHAMMER

WARHAMMER	£29.99
WARHAMMER BATTLE MAGIC	£17.99
WARHAMMER ARMIES – THE EMPIRE	£9.99
WARHAMMER ARMIES – HIGH ELVES	£9.99
WARHAMMER ARMIES – ORCS & GOBLINS	£9.99
<b>NEW!</b> WARHAMMER ARMIES – DWARFS	£9.99

## SAVAGE ORCS

<b>NEW!</b> SAVAGE ORC COMMAND	£1.35 each
<b>NEW!</b> SAVAGE ORC ARRER BOYZ	£1 each

## CHAOS DWARFS

<b>NEW!</b> BULL CENTAUR STANDARD BEARER	£3.99
<b>NEW!</b> CHAOS DWARF ROCKET LAUNCHER	£5.99
<b>NEW!</b> EARTHSHAKER CANNON	£14.99
CHAOS DWARF COMMAND	£1.65 each
CHAOS DWARF AXEMEN	£1.35 each
CHAOS DWARF WITH BLUNDERBUSS	£1.35 each
CHAOS DWARF BULL CENTAURS	£3.99 each
CHAOS DWARF LORD RIDING GREAT TAURUS	£14.99

## DWARFS

<b>NEW!</b> DWARF THUNDERERS	£1 each
<b>NEW!</b> DWARF LONG BEARDS	£1 each
<b>NEW!</b> ANVIL OF DOOM	£12.99
DWARF THRONE OF POWER BOXED SET	£12.99
TROLL SLAYERS	£1 each
DWARF HAMMERERS	£1 each
DWARF IRON BREAKERS	£1 each
DWARF ORGAN GUN & CREW	£4.50

## OTHER WARHAMMER MINIATURES

<b>NEW!</b> GOTREK & FELIX	£4.99 the pair
<b>NEW!</b> THE EMPEROR RIDING GRIFFON	£14.99
<b>NEW!</b> DWARFS (10 plastic Dwarfs)	£4.99
MARAUDER GIANT	£19.99
<b>NEW!</b> HIGH ELF BANNERS (Pack of 5 self-adhesive colour banners)	£2.99

## WARGAMES SERIES

<b>NEW!</b> HORUS HERESY	£14.99
--------------------------	--------

## WARHAMMER 40,000

WARHAMMER 40,000	£14.99
WARHAMMER 40,000 VEHICLE MANUAL	£12.99
WARHAMMER 40,000 BATTLE MANUAL	£11.99
WARHAMMER 40,000 COMPILATION	£9.99
WARHAMMER 40,000 COMPENDIUM	£11.99

## WARHAMMER 40,000 MINIATURES

<b>NEW!</b> SPACE WOLF RUNEPRIEST IN TERMINATOR ARMOUR	£2.99
SPACE WOLF LONG FANGS	£2.50 each
WOLF GUARD TERMINATORS	£2.99 each
<b>NEW!</b> DEATHWING TERMINATORS BOXED SET (Contains 5 Deathwing Terminators and a Dark Angel transfer sheet.)	£12.99
TERMINATORS	£2.99 each
DEATHWING TERMINATORS	£2.99 each

## MAN O'WAR

MAN O'WAR	£24.99
-----------	--------

## MAN O'WAR BOXED MINIATURES

### IMPERIAL SHIPS

IMPERIAL GREATSHIP	£4.99
IMPERIAL WOLFSHIPS (BOX OF 3)	£9.99
IMPERIAL WARGALLEYS (BOX OF 3)	£4.99

### DWARF SHIPS

DWARF IRONCLAD (BOX OF 3)	£9.99
DWARF MONITORS (BOX OF 3)	£4.99
DWARF NAUTILUS (BOX OF 3)	£4.99
<b>NEW!</b> DWARF DREADNOUGHT	£4.99

### HIGH ELF SHIPS

HIGH ELF DRAGONSHIP	£4.99
HIGH ELF HAWKSHIP (BOX OF 3)	£4.99
HIGH ELF EAGLESHIP (BOX OF 3)	£9.99

### BRETONNIAN SHIPS

BRETONNIAN GALLEON	£4.99
BRETONNIAN CORSAIR (BOX OF 3)	£9.99
BRETONNIAN BUCCANEERS (BOX OF 3)	£4.99

### DARK ELF SHIPS

<b>NEW!</b> DARK ELF DOOMREAVERS (BOX OF 3)	£4.99
<b>NEW!</b> DARK ELF DEATH FORTRESS (BOX OF 3)	£9.99
<b>NEW!</b> BLACK ARK OF NAGGAROTH	please phone





## SPACE MARINE

SPACE MARINE	£29.99
ARMIES OF THE IMPERIUM (Space Marines and the Imperial Guard)	£14.99
RENEGADES (Chaos and Eldar armies)	£14.99
ORK & SQUAT WARLORDS	£14.99

## EPIC BOXED MINIATURE SETS

<b>NEW!</b> SPACE MARINE LEGION	£5.99
<b>NEW!</b> SPACE MARINE LAND RAIDERS	£5.99
<b>NEW!</b> SPACE MARINE TACTICAL COMPANY	£5.99
<b>NEW!</b> ORK HORDE	£5.99
<b>NEW!</b> ORK INVASION	£5.99
<b>NEW!</b> STOMPERS	£5.99
<b>NEW!</b> CHAOS HORDE	£5.99
<b>NEW!</b> ELДАР LEGION	£5.99
<b>NEW!</b> ELДАР WARHOST	£5.99
<b>NEW!</b> IMPERIAL GUARD	£5.99
<b>NEW!</b> SQUAT WARRIORS	£5.99

## GREAT GARGANT

GREAT GARGANT	£14.99
---------------	--------

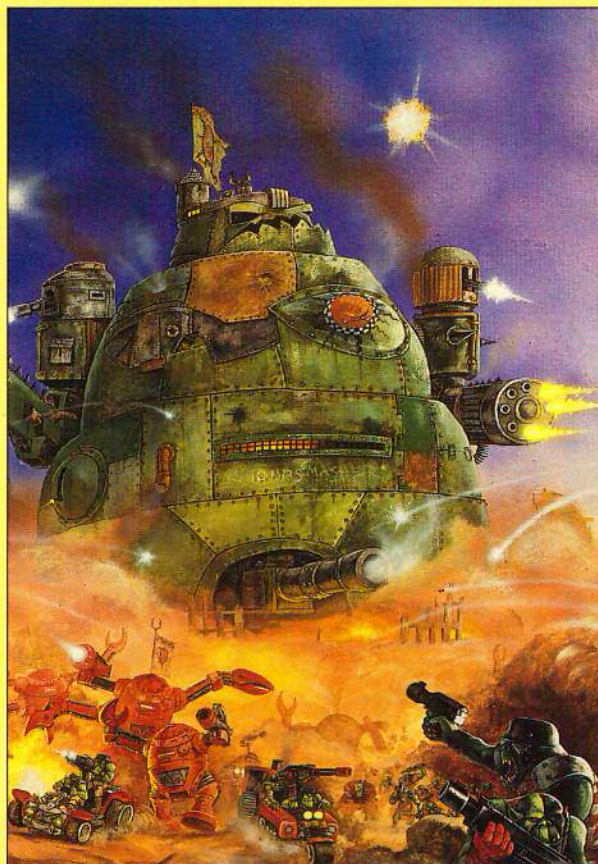

## WHITE DWARF SUBSCRIPTIONS

### UK, EUROPE, & THE REST OF THE WORLD

**UK & BFPO:** £27.50 for one year (12 issues). **EUROPE:** £35.

**REST OF THE WORLD (excluding US and Canada):** £45 for one year.

Please send payments to Games Workshop Mail Order, Chewton St, Hilltop, Eastwood, NOTTINGHAM, NG16 3HY. All payments should be in pounds sterling. Please make cheques payable to Games Workshop Ltd.

If you have a Visa, Access or Mastercard you may place your subscription by phoning our Mail Order department on 0773 713213.

### USA & CANADA

**USA:** \$35 for one year (12 issues) / \$63 for 2 years (24 issues).

(Maryland residents please add 5% state sales tax).

**CANADA:** \$45 for one year/ \$81 for 2 years.

Payment can be by check, US money order, Mastercard or Visa. Canadian postal money orders not accepted. Please make checks and money orders payable to Games Workshop. Payment should be sent to White Dwarf Subscriptions, 3431 C Benson Avenue, Baltimore, Maryland 21227-1072. For VISA and Mastercard orders, please telephone our Mail Order hotline on (410) 644 5699, Monday to Friday, 9am - 5pm EST.

Please state which issue you would like your subscription to start with.

## CORRESPONDENCE

We welcome comments about White Dwarf, Games Workshop games and Citadel Miniatures. All letters except subscriptions and Mail Order should be addressed to: The Editor, White Dwarf, Games Workshop, Howard House, 16 Castle Boulevard, Nottingham NG7 1FL.

Clearly mark your envelope with the name of the game you are writing to us about. If you want a reply you *must* enclose a self-addressed stamped envelope (overseas readers should include IRCs). We receive an enormous amount of mail. We do read every letter, but it may take a little time for us to reply to you, so please be patient!



## COPYRIGHTS AND TRADEMARKS

All subject matter in White Dwarf is © Copyright Games Workshop Ltd 1993.

All artwork in Games Workshop products, and all images contained therein have been produced either in-house or as work for hire. The exclusive copyright on the artwork and the images it depicts is the copyright of Games Workshop Ltd. © Copyright Games Workshop Ltd 1993. All rights reserved.

### Registered Trademarks

The following are all registered trademarks of Games Workshop Ltd.

Armageddon, Blood Bowl, Chivalry, the Citadel logo, Confrontation, Dark Future, Epic, the Games Workshop logo, Games Workshop, Realm of Chaos, Slottabase, Space•Fleet, Space Marine, White Dwarf and the White Dwarf figure, Talisman, and Warhammer.

### Trademarks

The following are all trademarks of Games Workshop Ltd.

Aspect Warrior, Avatar, Blood Angel, Bloodletter, Bloodthirster, Citadel, Daemonette, Dark Angels, Dark Reaper, Deathwing, Dragonmasters, Dungeonquest, Eldar, Exo Armour, Exarch, Eye of Terror, Farseer, Fire Dragon, Flesh Hound, Gargant, Genestealer, Gobbo, Great Unclean One, Gretchin, Grey Knight, Hunter Slayer, Keeper of Secrets, Khorne, Knights Panther, Leman Russ, Lichemaster, Lightning Claw, Lord of Change, Madboy, Mekboy, Mighty Empires, Nurgle, Nurgling, Ogryn, Old World, Ork, Painboy, Plaguebearer, Psyker, Ratling, Ravenwing, Skaven, Slaanesh, Slann, Snotling, Space Hulk, Space Wolf, Squat, Squig, Swooping Hawk, Striking Scorpion, Terminator, Thunder Hammer, Troll Slayer, Tyrannid, Tzeentch, Ultramarines, Weirdboy, Knights of the White Wolf, World eater.

*GW Books* is a trademark of GW Books Ltd. Used with permission.

*Flame* is a trademark of Flame Publications Ltd. Used with permission.

*Marauder Miniatures* is a trademark of Marauder Miniatures Ltd. Used with permission.

*Heroquest* and *Space Crusade* are both trademarks of Milton Bradley Games. Used with permission.

GAMES WORKSHOP • GAMES WORKSHOP • BOLTON • GAMES WORKSHOP

GAMES WORKSHOP STORES • GAMES WORKSHOP STORES

GAMES WORKSHOP STORES • GAMES WORKSHOP STORES

# OPEN SOON!

# GAMES WORKSHOP®

## BOLTON



**Unit 25,  
First Floor Gallery  
Shipgates Centre**

**NORMAL OPENING HOURS**

Monday – Saturday 9.30am to 5.30pm  
Thursday 9.30am to 8pm

GAMES WORKSHOP • GAMES WORKSHOP • BOLTON • GAMES WORKSHOP

GAMES WORKSHOP • GAMES WORKSHOP THURROCK LAKESIDE • GAMES WORKSHOP

GAMES WORKSHOP STORES • GAMES WORKSHOP STORES

GAMES WORKSHOP STORES • GAMES WORKSHOP STORES

# NOW OPEN!

# GAMES WORKSHOP®

## THURROCK LAKESIDE

**UNIT 415, LEVEL 3/FOOD  
COURT, THURROCK  
LAKESIDE SHOPPING  
CENTRE**

**TELEPHONE: 0708 867133**

**NORMAL OPENING HOURS**

Monday – Thursday 10am till 8pm  
Friday 10am till 9pm  
Saturday 10am till 7.30pm.

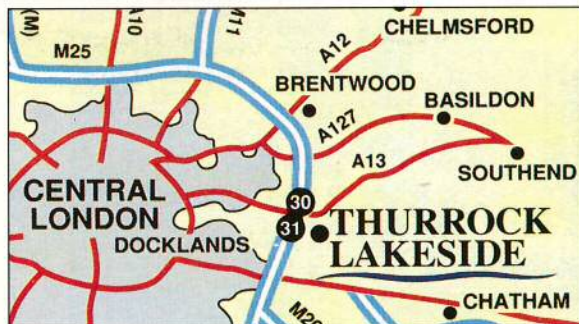

GAMES WORKSHOP • GAMES WORKSHOP THURROCK LAKESIDE • GAMES WORKSHOP

## EMPEROR RIDING THE WAR GRIFFON DEATHCLAW

THE COMPLETE EMPEROR  
RIDING WAR GRIFFON  
CONSISTS OF:  
1 x EMPEROR  
1 x BACK BANNER  
1 x LEFT WING  
1 x RIGHT WING  
1 x GRIFFON'S LEFT SIDE  
1 x GRIFFON'S RIGHT SIDE  
2 x CLAWS  
1 x TAIL

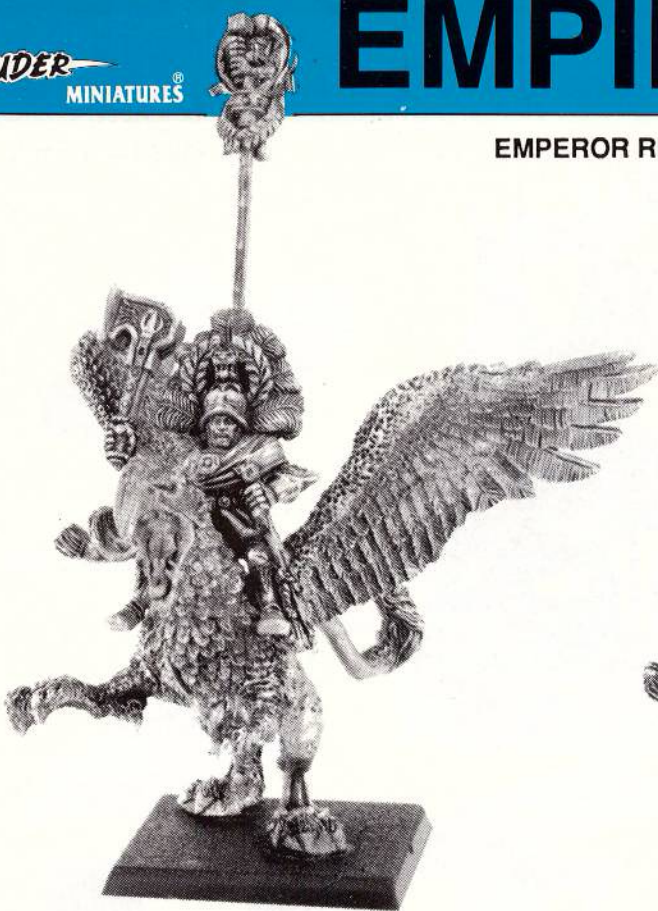

EMPEROR  
KARL FRANZ  
0835/1



EMPEROR'S  
BANNER POLE  
0835/2

EXAMPLE OF COMPLETED EMPEROR ON DEATHCLAW



LEFT CLAW  
0835/6



RIGHT CLAW  
0835/5



GRIFFON'S BODY  
RIGHT SIDE  
0835/4



GRIFFON'S BODY  
(LEFT SIDE) 2  
0835/3



GRIFFON'S TAIL  
0835/7



RIGHT WING  
0835/9



LEFT WING  
0835/8



# DARK ELF WARSHIPS

## BLACK ARK OF NAGGAROTH

**THE COMPLETE  
BLACK ARK OF NAGGAROTH  
CONSISTS OF:**  
 2 x LARGE TOWERS  
 2 x SMALL TOWERS  
 1 x SKULL PROW  
 1 x STERN GATE  
 1 x RIGHT SIDE  
 1 x LEFT SIDE  
 1 x DECK 1  
 2 x DECK 2  
 2 x PLASTIC MAST SPRUES

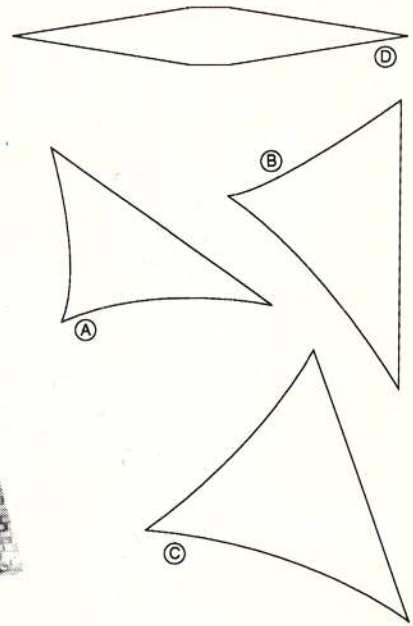
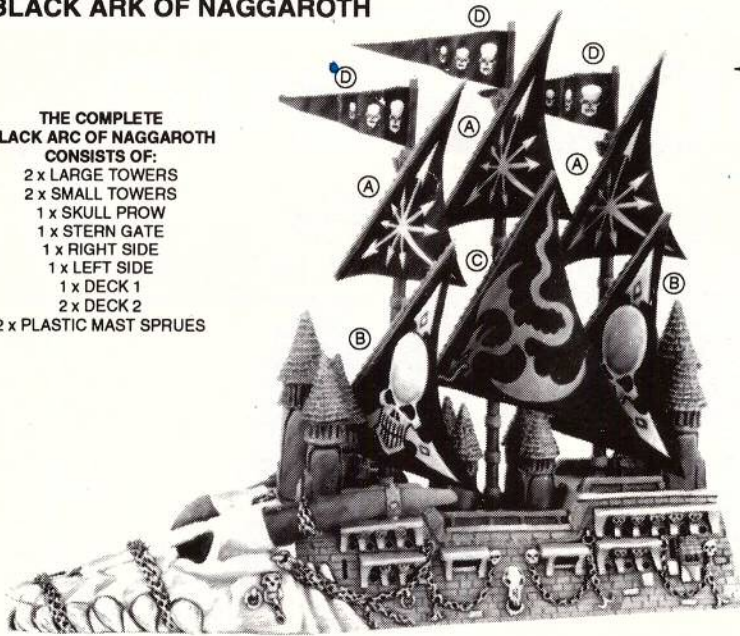

EXAMPLE OF COMPLETED AND FULLY PAINTED BLACK ARK OF NAGGAROTH



SKULL PROW  
78021/1



BLACK ARK SMALL TOWER  
78021/5



BLACK ARK DECK 2  
78021/8



BLACK ARK DECK 1  
78021/7



BLACK ARK STERN GATE  
78021/6



BLACK ARK LARGE TOWER  
78021/4



BLACK ARK RIGHT SIDE  
78021/3



BLACK ARK LEFT SIDE  
78021/2

### SHIP CONSTRUCTION DIAGRAMS

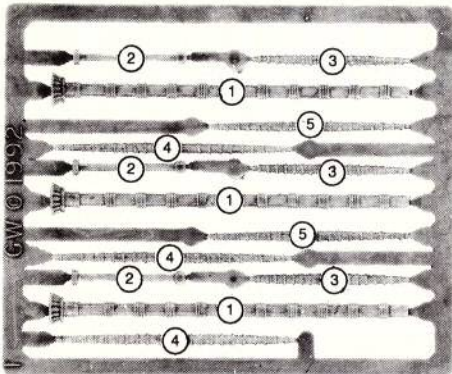

MAN O' WAR PLASTIC MAST SPRUE MOW PLA/2

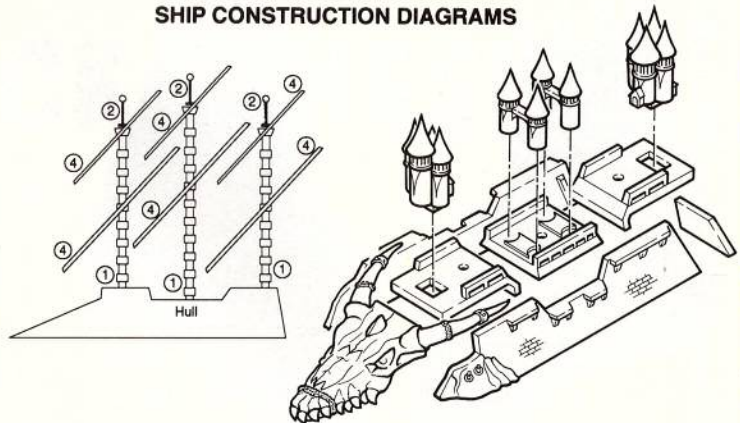

THE DIAGRAM ABOVE ILLUSTRATES THE CORRECT LENGTH FOR EACH MAST AND THE TYPE AND NUMBER OF YARD ARMS.

THE SAILS AND PENNANTS ABOVE MAY BE PHOTOCOPIED, CUT OUT, PAINTED AND STUCK ONTO YOUR MINIATURES.

PERMISSION GRANTED TO PHOTOCOPY FOR PERSONAL USE ONLY.

Miniatures supplied unpainted. WARNING: This product contains lead which may be harmful if chewed or swallowed. Citadel Miniatures are not recommended for children under 14 years of age. © Copyright Games Workshop Ltd 1993. All rights reserved.



# DWARF WARSHIPS

## DWARF IRONCLAD

A DWARF IRONCLAD  
CONSISTS OF:  
1 x HULL  
1 x BRIDGE  
1 x FUNNELS

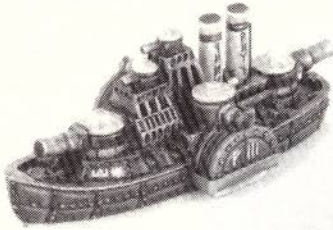

IRONCLAD  
BRIDGE  
0414/3



IRONCLAD  
FUNNELS  
0414/2



IRONCLAD  
HULL  
0414/1

EXAMPLE OF COMPLETED AND FULLY PAINTED IRONCLAD

## DWARF MONITOR

A DWARF MONITOR  
CONSISTS OF:  
1 x HULL  
1 x BRIDGE



EXAMPLE OF COMPLETED AND  
FULLY PAINTED MONITOR



MONITOR  
BRIDGE  
0416/5



MONITOR  
HULL  
0416/4

## DWARF NAUTILUS



DWARF  
NAUTILUS  
0415/6

## DWARF DREADNOUGHT

THE COMPLETE DWARF DREADNOUGHT  
CONSISTS OF:  
1 x LEFT BRIDGE  
1 x RIGHT BRIDGE  
1 x HULL

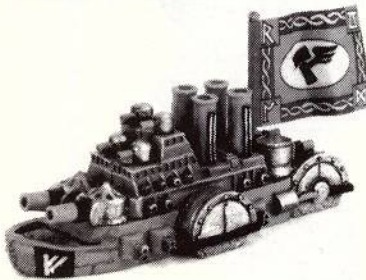

EXAMPLE OF COMPLETED AND  
FULLY PAINTED DWARF DREADNOUGHT



DREADNOUGHT  
RIGHT BRIDGE  
0417/3



DREADNOUGHT  
LEFT BRIDGE  
0417/2



DREADNOUGHT  
HULL  
0417/1

Designed by Norman Swales

# DWARF WARSHIPS

## DARK ELF DEATH FORTRESS

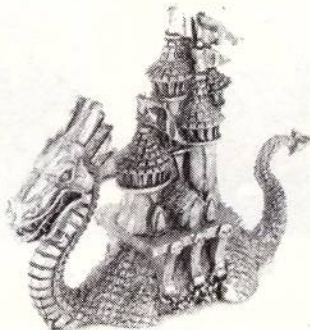

DEATH FORTRESS  
78022

## DARK ELF DOOM REAVER

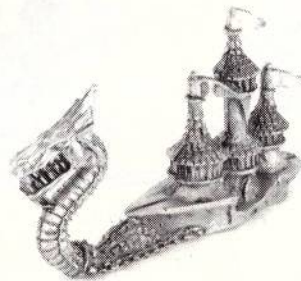

DOOMREAVER  
78023

Designed by Norman Swales and Michael Perry

Minatures supplied unpainted. WARNING. This product contains lead which may be harmful if chewed or swallowed. Citadel Miniatures are not recommended for children under 14 years of age  
© Copyright Games Workshop Ltd 1993. All rights reserved.



# DWARFS

## GOTREK AND FELIX



GOTREK  
GURNISSON  
74380/1



FELIX  
JAEGAR  
74380/2

Designed by Michael Perry

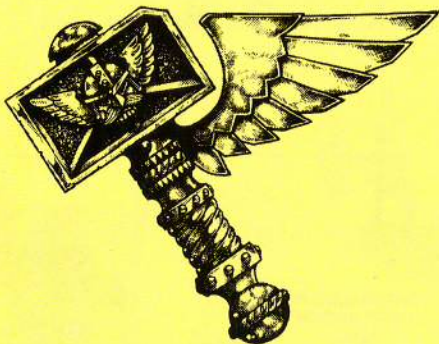

# PLASTICS

## PLASTIC DWARFS

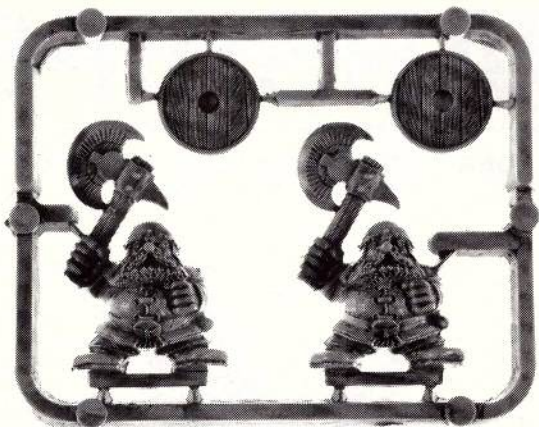

PLASTIC DWARF SPRUE 103305



EXAMPLES OF COMPLETED PLASTIC DWARFS

THE DWARF SPRUE IS SUPPLIED WITH A VARIETY OF DIFFERENT SHIELD DESIGNS

Minifigures supplied unpainted. **WARNING.** This product contains lead which may be harmful if chewed or swallowed. Citadel Miniatures are not recommended for children under 14 years of age. © Copyright Games Workshop Ltd 1993. All rights reserved.

# ANVIL OF DOOM

## DWARF RUNESMITH'S ANVIL OF DOOM

THE COMPLETE ANVIL OF DOOM  
CONSISTS OF:  
1 x RUNEPRIEST  
2 x GUARDIAN  
1 x ANVIL OF DOOM  
1 x ANVIL PEDESTAL  
1 x ANVIL BASE  
2 x BANNER POLE  
4 x PLASTIC SPOKED WHEELS



EXAMPLE OF COMPLETED DWARF RUNESMITH AND THE ANVIL OF DOOM



BANNER POLE  
0836/6



ANVIL OF DOOM  
0836/3

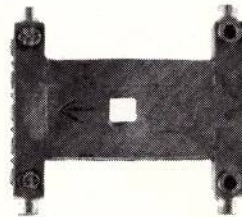

ANVIL BASE  
0836/4

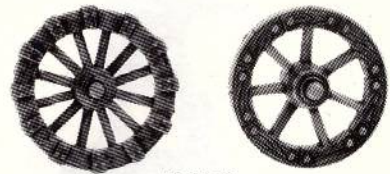

PLASTIC  
SPOKED WHEELS  
100557



ANVIL PEDESTAL  
0836/5



RUNEPRIEST  
0836/2



GUARDIAN  
0836/1

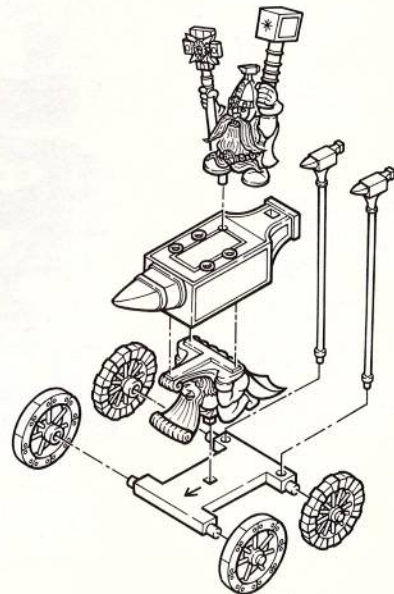

Miniatures supplied unpainted. WARNING. This product contains lead which may be harmful if chewed or swallowed. Citadel Miniatures are not recommended for children under 14 years of age.  
© Copyright Games Workshop Ltd 1993. All rights reserved.



CITADEL  
MINIATURES

# SAVAGE ORCS

## COMMAND FIGURES



**SAVAGE ORC  
BIG BOSS 1**  
075250/2



**SAVAGE ORC  
BIG BOSS 2**  
075250/9



**SAVAGE ORC  
BANNER BEARER 2**  
075250/7



**SAVAGE ORC  
BANNER BEARER 1**  
075250/5



**SAVAGE ORC  
SHAMAN 1**  
075250/3



**SAVAGE ORC  
SHAMAN 2**  
075250/10



**SAVAGE ORC  
BOSS 1**  
075250/1



**SAVAGE ORC  
BOSS 2**  
075250/8



**SAVAGE ORC  
DRUMMER**  
075250/6



**SAVAGE ORC  
HORN BLOWER**  
075250/4

Minatures supplied unpainted. **WARNING.** This product contains lead which may be harmful if chewed or swallowed. Citadel Miniatures are not recommended for children under 14 years of age. © Copyright Games Workshop Ltd 1993. All rights reserved.





# SAVAGE ORCS

## ARRER BOYZ



**SAVAGE ORC  
WITH BOW AND HAMMER**  
075210/1



**SAVAGE ORC  
WITH BOW 1**  
075210/2



**SAVAGE ORC  
WITH BOW 2**  
075210/3



**SAVAGE ORC  
WITH BOW 3**  
075210/4



**SAVAGE ORC  
WITH BOW 4**  
075210/5



**SAVAGE ORC  
WITH BOW 5**  
075210/6



**SAVAGE ORC  
WITH BOW 6**  
075210/7



**SAVAGE ORC  
WITH BOW 7**  
075210/8



**SAVAGE ORC  
WITH BOW 8**  
075210/9



**SAVAGE ORC  
WITH BOW 9**  
075210/10



**SAVAGE ORC  
WITH BOW 10**  
075210/11



**SAVAGE ORC  
WITH BOW 11**  
075210/12



**SAVAGE ORC  
WITH BOW 12**  
075210/13



**SAVAGE ORC  
WITH BOW AND KNIFE**  
075210/14



**SAVAGE ORC  
WITH BOW 13**  
075210/15



**SAVAGE ORC  
WITH BOW 14**  
075210/16

Miniatures supplied unpainted. **WARNING.** This product contains lead which may be harmful if chewed or swallowed. Citadel Miniatures are not recommended for children under 14 years of age.  
© Copyright Games Workshop Ltd 1993. All rights reserved.



## HAMMERERS



**HAMMERER 1**  
MM16/23



**HAMMERER 2**  
MM16/24



**HAMMERER 3**  
MM16/25



**HAMMERER 4**  
MM16/26

## LONGBEARDS



**LONGBEARD 1**  
MM16/15



**LONGBEARD 2**  
MM16/16



**LONGBEARD 3**  
MM16/17



**LONGBEARD 4**  
MM16/18



**LONGBEARD 5**  
88094/31



**LONGBEARD 6**  
88094/32



**LONGBEARD 7**  
88094/33



**LONGBEARD 8**  
88094/34

## IRON BREAKERS



**IRON BREAKER 1**  
MM16/19



**IRON BREAKER 2**  
MM16/20



**IRON BREAKER 3**  
MM16/21



**IRON BREAKER 4**  
MM16/22

## TROLL SLAYERS



WITH SWORD  
MM16/8



WITH MACE  
MM16/9



WITH AXE  
MM16/10



WITH HAMMER  
MM16/6



WITH AXE 2  
MM16/7



WITH AXE 3  
MM16/5



WITH TWO SWORDS  
MM16/1



WITH MACE 2  
MM16/2



WITH FLAIL  
MM16/3



WITH TWO HANDED AXE  
MM16/4

## THUNDERERS



THUNDERER 1  
MM16/27



THUNDERER 2  
MM16/28



THUNDERER 3  
MM16/29



THUNDERER 4  
MM16/30



THUNDERER 5  
88096/35



THUNDERER 6  
88096/36



THUNDERER 7  
88096/37



THUNDERER 8  
88096/38



THUNDERER 9  
88096/39



THUNDERER 10  
88096/40



THUNDERER 11  
88096/41



THUNDERER 12  
88096/42

# CHAOS DWARFS

## COMMAND FIGURES



LEADER WITH SWORD 1  
75805/1



HORNBLOWER  
75805/2



STANDARD BEARER 1  
75805/3



LEADER WITH SWORD 2  
75805/4



DRUMMER  
75805/5



STANDARD BEARER 2  
75805/6

## AXEMEN

THESE MINATURES ARE SUPPLIED WITH THE APPROPRIATE PLASTIC SHIELDS AS STANDARD



WITH AXE 1  
75800/1



WITH AXE 2  
75800/2

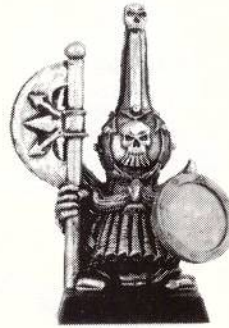

WITH AXE 3  
75800/3



WITH AXE 4  
75800/4

## BLUNDERBUSSES



WITH BLUNDERBUSS 1  
75810/1



WITH BLUNDERBUSS 2  
75810/2



WITH BLUNDERBUSS 3  
75810/3



WITH BLUNDERBUSS 4  
75810/4

Minatures supplied unpainted. **WARNING:** This product contains lead which may be harmful if chewed or swallowed. Citadel Miniatures are not recommended for children under 14 years of age. © Copyright Games Workshop Ltd 1993. All rights reserved.



# CHAOS DWARFS

## BULL CENTAURS



UPPER TORSO  
WITH AXE 1  
75815/3



UPPER TORSO  
WITH AXE 2  
75815/4



UPPER TORSO  
WITH AXE 3  
75815/8



UPPER TORSO  
WITH AXE 4  
75815/9



UPPER TORSO  
WITH AXE 5  
75815/10



UPPER TORSO  
WITH AXE 6  
75815/11



BULL CENTAUR  
STANDARD BEARER  
075816/7



BULL BODY  
LEFT SIDE 1  
75815/1



BULL BODY  
RIGHT SIDE 1  
75815/2

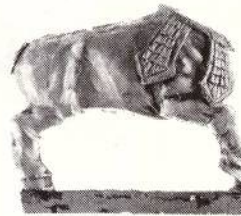

BULL BODY  
RIGHT SIDE 2  
75815/5



BULL BODY  
LEFT SIDE 2  
75815/6

THESE MINIATURES ARE SUPPLIED WITH THE APPROPRIATE PLASTIC SHIELDS AS STANDARD



EXAMPLES OF COMPLETED CHAOS DWARF BULL CENTAURS

Miniatures supplied unpainted. **WARNING.** This product contains lead which may be harmful if chewed or swallowed. Citadel Miniatures are not recommended for children under 14 years of age.  
© Copyright Games Workshop Ltd 1993. All rights reserved.



CITADEL  
MINIATURES

Designed by Alan Perry

# CHAOS DWARF

## EARTHSHAKER CANNON

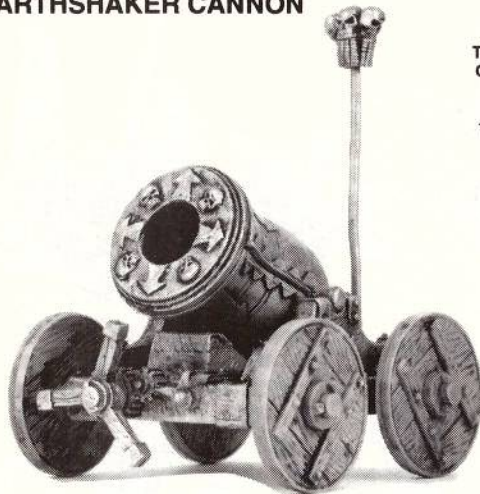

- THE COMPLETE EARTHSHAKER  
GIANT CANNON CONSISTS OF:**
- 3 x CREW
  - 1 x CANNON SHELL
  - 1 x CANNON SHELL PLATFORM
  - 1 x CANNON UPPER
  - 1 x CANNON LOWER
  - 1 x CANNON RIM
  - 1 x BANNER POLE
  - 1 x CANNON CRANK
  - 1 x CANNON BASE
  - 2 x CANNON SUPPORT
  - 4 x PLASTIC SOLID WHEEL



EXAMPLE OF COMPLETED CHAOS DWARF EARTHSHAKER



CANNON RIM  
0834/10



CANNON SHELL  
0834/5



BANNER POLE  
0834/7

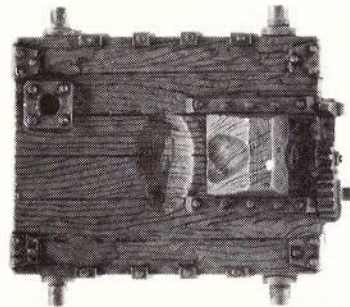

CANNON BASE  
0834/6

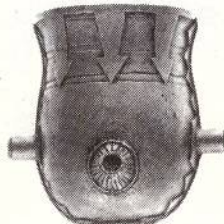

CANNON UPPER  
0834/8

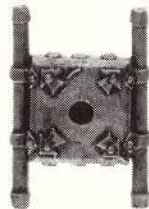

SHELL PLATFORM  
0834/4



PLASTIC  
SOLID WHEEL  
100558

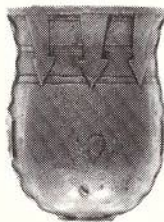

CANNON LOWER  
0834/9



CANNON SUPPORT  
0834/11



CANNON CRANK  
0834/12



MASTER GUNNER  
0834/1



SHELL CARRIER 1  
0834/2



SHELL CARRIER 2  
0834/3

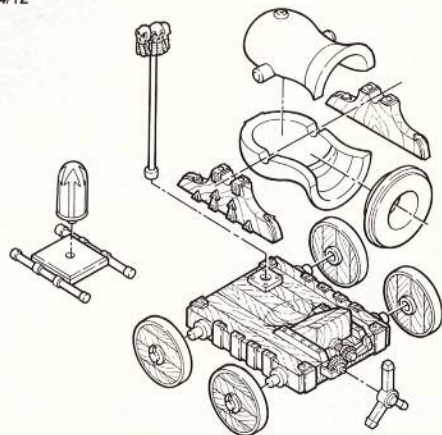

Miniatures supplied unpainted. **WARNING:** This product contains lead which may be harmful if chewed or swallowed. Citadel Miniatures are not recommended for children under 14 years of age. © Copyright Games Workshop Ltd 1993. All rights reserved.



# CHAOS DWARFS

## ROCKET LAUNCHER

THE COMPLETE CHAOS DWARF  
ROCKET LAUNCHER CONSISTS OF:  
2 x CREW  
1 x LEFT BASE  
1 x RIGHT BASE  
1 x CRANK  
2 x PLASTIC SPOKED WHEEL

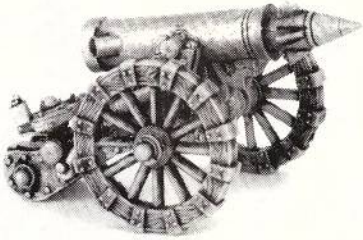

EXAMPLE OF COMPLETED CHAOS DWARF ROCKET LAUNCHER



ROCKET LAUNCHER  
GUNNER  
075820/1



ROCKET LAUNCHER  
LOADER  
075820/2



ROCKET LAUNCHER  
RIGHT BASE  
075820/4



ROCKET LAUNCHER  
075820/5



ROCKET LAUNCHER  
LEFT BASE  
075820/3



ROCKET LAUNCHER  
CRANK  
075820/6



PLASTIC  
SPOKED WHEEL  
100557

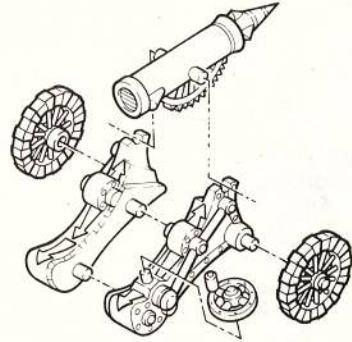

MLG

MARK GIBBONS

Miniatures supplied unpainted. **WARNING.** This product contains lead which may be harmful if chewed or swallowed. Citadel Miniatures are not recommended for children under 14 years of age.  
© Copyright Games Workshop Ltd 1993. All rights reserved.



CITADEL  
MINIATURES

Designed by Michael Perry and Norman Swales

# TERMINATORS

## DEATHWING TERMINATORS

A DEATHWING TERMINATOR SQUAD MAY INCLUDE OTHER MODELS FROM OUR SPACE MARINE RANGES



DEATHWING  
SERGEANT  
0809/7



DEATHWING  
TERMINATOR 1  
0809/1



DEATHWING  
TERMINATOR 2  
0809/2

### LEFT ARM

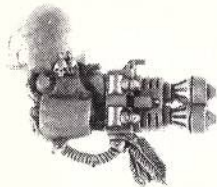

DEATHWING  
HEAVY FLAMER  
0809/4

THE COMPLETE DEATHWING  
TERMINATOR CONSISTS OF:

- 1 x BODY
- 1 x LEFT ARM
- 1 x RIGHT ARM

(THE SERGEANT TERMINATOR  
IS ALSO SUPPLIED WITH  
1 x BACK BANNER  
1 x STORM SHIELD)

THE DEATHWING TERMINATORS  
ARE AVAILABLE AS A BOXED SET.

THIS BOX CONSISTS OF:

- 1 x SERGEANT BODY
- 4 x TERMINATOR BODIES
- 4 x STORM BOLTERS
- 1 x HEAVY FLAMER
- 1 x BACK BANNER
- 1 x STORM SHIELD
- 1 x POWER SWORD
- 1 x CHAINFIST
- 4 x POWER GLOVE

### RIGHT ARM



DEATHWING  
CHAIN FIST  
0809/6

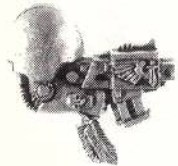

DEATHWING  
STORM BOLTER  
0809/3



DEATHWING  
STORM SHIELD  
0809/9



DEATHWING  
POWER GLOVE  
0809/5

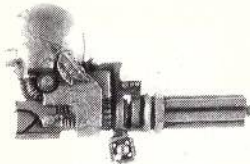

DEATHWING  
ASSAULT CANNON  
0809/11

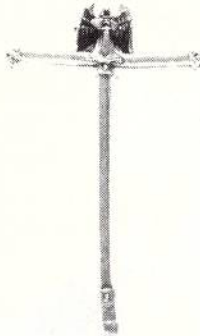

DEATHWING  
BACK BANNER  
0809/10

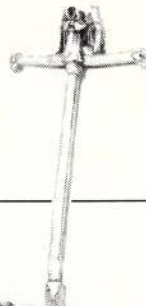

DEATHWING  
POWER SWORD  
0809/8



EXAMPLES OF COMPLETED DEATHWING TERMINATORS

Minatures supplied unpainted. WARNING: This product contains lead which may be harmful if chewed or swallowed. Citadel Miniatures are not recommended for children under 14 years of age. © Copyright Games Workshop Ltd 1993. All rights reserved.





# TERMINATORS

## WOLF GUARD TERMINATORS

A SPACE WOLF SQUAD MAY INCLUDE OTHER MODELS FROM OUR SPACE MARINE RANGES

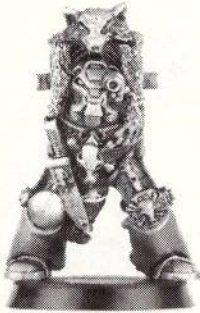

WOLF GUARD  
TERMINATOR  
SERGEANT  
RTB21/1

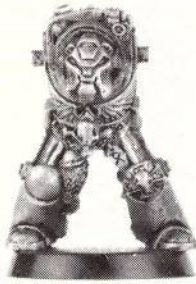

WOLF GUARD  
TERMINATOR 1  
70050/2



WOLF GUARD  
TERMINATOR 2  
70050/3



WOLF GUARD  
RUNE PRIEST  
70050/10

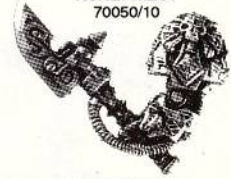

WOLF GUARD  
FORCE AXE  
70050/11



### RIGHT ARMS

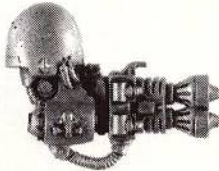

WOLF GUARD  
HEAVY FLAMER  
70050/6



WOLF GUARD  
STORM BOLTER  
70050/5

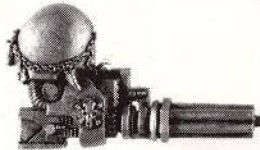

WOLF GUARD  
ASSAULT CANNON  
70050/4

EACH COMPLETE  
WOLF GUARD TERMINATOR  
CONSISTS OF:  
1 x RIGHT ARM  
1 x LEFT ARM  
1 x BODY  
PLEASE STATE WHICH  
ITEMS YOU REQUIRE  
WHEN ORDERING

### LEFT ARMS

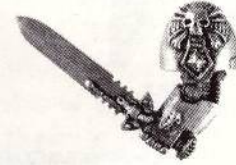

WOLF GUARD  
POWER SWORD  
70050/9



WOLF GUARD  
POWER FIST  
70050/7

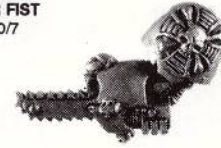

WOLF GUARD  
CHAIN FIST  
70050/8



EXAMPLES OF COMPLETED WOLF GUARD TERMINATORS

Minatures supplied unpainted. **WARNING.** This product contains lead which may be harmful if chewed or swallowed. Citadel Miniatures are not recommended for children under 14 years of age.  
© Copyright Games Workshop Ltd 1993. All rights reserved.



CITADEL  
MINIATURES

Designed by Jes Goodwin

# SPACE WOLVES

## LONG FANGS

A SPACE WOLF SQUAD MAY INCLUDE OTHER MODELS FROM OUR SPACE MARINE RANGES



SPACE WOLF  
LONG FANG 1  
70045/2



SPACE WOLF  
LONG FANG 2  
70045/3



SPACE WOLF  
LONG FANG 3  
70045/4



SPACE WOLF  
LONG FANG SERGEANT  
0804/1



IMPERIAL  
LASCANNON MK2  
70045/6

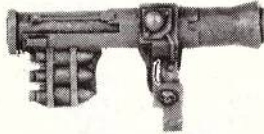

MISSILE  
LAUNCHER MK2  
70045/5

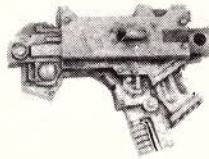

HEAVY BOLTER MK2  
70045/7

## EXAMPLES OF COMPLETED SPACE WOLF BLOOD CLAWS



THESE MINIATURES ARE SUPPLIED WITH A PLASTIC SPACE MARINE ARM SPRUE AND A PLASTIC BACKPACK SPRUE

## BLOOD CLAWS

A SPACE WOLF SQUAD MAY INCLUDE OTHER MODELS FROM OUR SPACE MARINE RANGES



SPACE WOLF  
BLOOD CLAW 1  
70040/2



SPACE WOLF  
BLOOD CLAW SERGEANT  
0805/1



SPACE WOLF  
BLOOD CLAW 2  
70040/3



SPACE WOLF  
BLOOD CLAW 3  
70040/4



## CLOSE COMBAT WEAPON SPRUE

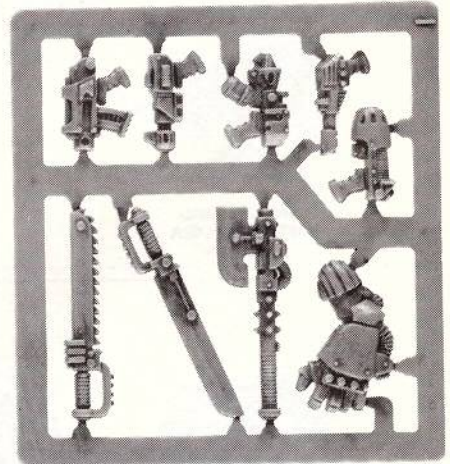

1 x PLASMA PISTOL  
1 x AUTO PISTOL  
1 x BOLT PISTOL  
1 x LAS PISTOL

1 x POWER SWORD  
1 x POWER GLOVE  
1 x POWER AXE  
1 x CHAIN SWORD  
1 x HAND FLAMER

THESE MINIATURES ARE SUPPLIED WITH ADEQUATE PLASTIC CLOSE COMBAT WEAPON SPRUES AND PLASTIC SPACE MARINE ARM AND BACKPACK SPRUES AS STANDARD



# WARHAMMER

®

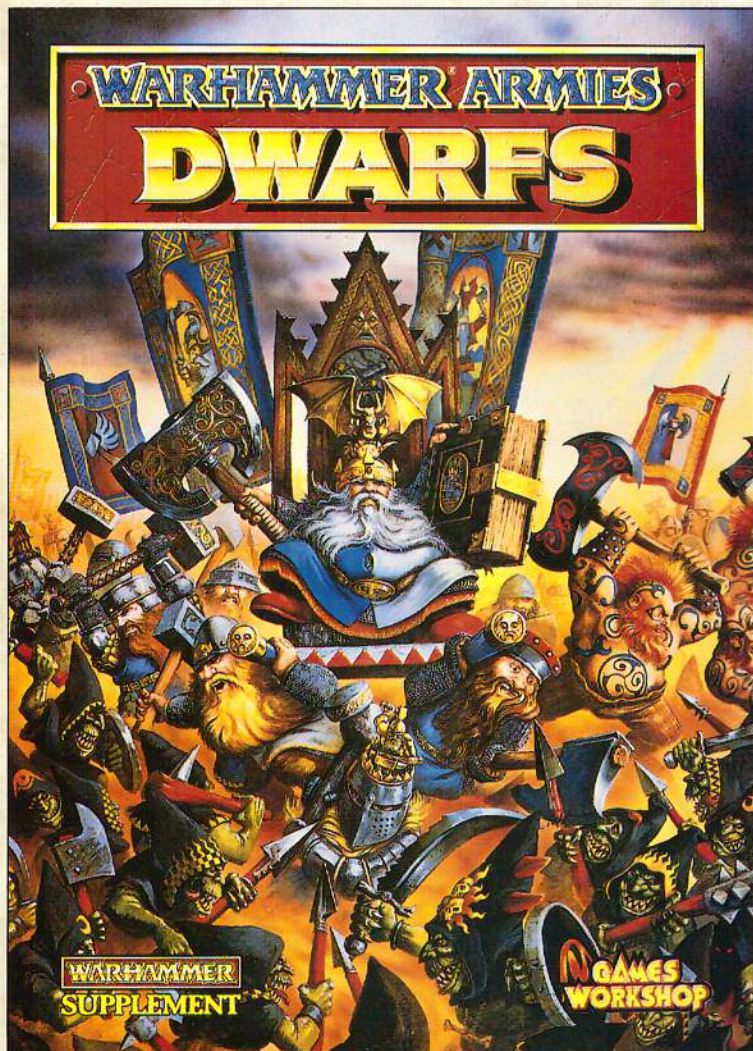

Each fully illustrated volume in the Warhammer Armies series is packed with background, history, special rules and a complete army list. With detailed, full-colour painting guides, these books form the essential reference collection for all Warhammer gamers.

## WARHAMMER ARMIES DWARFS

Renowned as battle-hardened warriors, Dwarfs have endured centuries of war and conquest to establish their mighty Empire among the World's Edge Mountains. This supplement describes the Dwarfs' Empire and history, from the great days of the Ancestor Gods to the sorry times of the present. It includes details of the Dwarfs' language, their music, writing, and magic runes.

The Dwarf army list includes details about Runesmiths, Hammerers, Iron Breakers, Long

Beards, Thunderers, Slayers, Cannons, Organ Guns, Flame Cannons, and more warriors and war machines. A full list is provided for Dwarf heroes past and present, including Ungrim Ironfist the Slayer King of Karak Kadrin, Thorgrim Grudgebearer the High King of Karaz-a-Karak, the renowned Slayer Gotrek Gurnisson and Joseph Bugman Dwarf Master Brewer.

**Special rules** include details of the game rules for all Dwarf war machines and warriors including the Flame Cannon, Organ Gun, Slayers, and Runesmiths. A complete new magic rune system is described allowing Dwarfs to build their own powerful magic weapons, armour, standards, war machines and talismans.

**In addition** Lord Duregar leads a Dwarf army into a ferocious battle against Orcs and Night Goblins at the very gates to the ancient stronghold of Karak Eight Peaks — a new Warhammer scenario.



DWARFS PREPARE TO WREAK VENGEANCE ON AN ADVANCING ORC HORDE