

GAMES WORKSHOP®

PRESENT THEIR MONTHLY GAMES MAGAZINE



WHITE DWARF®



CITADEL
MINIATURES

161
£2.25



**FREE GAME
INSIDE!**

05



9 770265 871028



DEATHWING TERMINATORS BATTLE AGAINST WORLD EATER CHAOS SPACE MARINES



GOFF AND BADMOON ORKS LED BY A GARGANT BIG MOB

CONTENTS

COVER: CHAOS DWARFS — Dave Gallagher

A Chaos Dwarf army, led by Bull Taurus, marches to war.

GW AND CITADEL NEWS

All the latest news from Games Workshop and Citadel Miniatures.

2

DEATHWING TERMINATORS — Andy Chambers

Andy provides the background and equipment lists for Deathwing Terminators in **Warhammer 40,000**.

4

CHAOS DWARFS — Rick Priestley

To accompany the release of the new miniatures, Rick has been delving into the history and background of Chaos Dwarfs in the **Warhammer** world.

11

CHAOS DWARF BESTIARY — Rick Priestley

A **Warhammer** bestiary for the new Chaos Dwarf miniature releases.

18

MAN O' WAR — Andy Jones

Andy Jones has taken to the water to offer some tactics and tips for fighting battles with the Empire and Dwarf fleets in Man O' War.

23

HORUS HERESY — Jervis Johnson and Bill King

The latest in our Wargame series of battle games is about to be released. Jervis explains the background to the development of the game and Bill King has written a complete campaign history.

37

WARMASTER — Jervis Johnson

To accompany the release of **Horus Heresy**, Jervis has written **Warmaster**, a complete game based upon the attack on Horus's battlebarge. You'll find your free copy of the game in the centre of the magazine, together with rules and reference sheets.

44

'EAVY METAL: REFERENCE GUIDE — Mike McVey

Mike has painted the models and written a complete step by step guide to painting **Citadel Miniatures**.

52

'EAVY METAL:

All the latest models painted by the Studio 'Eavy Metal Team:

Ogres

Marauder Giant

Man O' War Miniatures

61

GARGANTS — Andy Chambers

Andy provides the full rules, army cards, data sheet and damage tables for including the new Ork Great Gargant in your **Space Marine Ork** army.

65

ADVERTS

| | |
|--------------------------------|-------------------------------------|
| Golden Demon Awards.....3 | Southend Grand Opening.....51 |
| Games Workshop UK Stores.....8 | Man O' War.....64 |
| Man O' War Boxed Sets.....22 | Ork and Squat Warlords.....70 |
| Retail Warhammer Days.....36 | Games Workshop Mail Order.....74 |
| Horus Heresy.....43 | Citadel Miniatures Catalogue.....78 |



GAMES[®] WORKSHOP AND CITADEL[™] NEWS

GOLDEN DEMON '93

Tickets are now selling fast for the 1993 Golden Demon Award Grand Finals. The total number is strictly limited, so don't miss out on the world's premier miniatures and hobby gaming event. Tickets are available from all Games Workshop stores, or post-free from Games Workshop Mail Order, price £5.00. All Games Workshop stores are running coaches to the event so drop into your local store and book your place.

This year we decided that we would judge the event in advance so that we could better display the miniatures on the day, and not have to keep removing them from their cabinets in order to photograph and examine all of the entries. As a result, over the last few weeks, thousands of wonderfully painted miniatures have been arriving at the Nottingham Studio.

Even though we are used to seeing some of the very finest painted miniatures in the world before they are photographed and laid out for 'Eavy Metal pages, we have been absolutely stunned by the quantity and quality of the entries for this year's event.

Over the last few years, the quality of the entries for the competition has steadily increased as more and more people become involved in the Games Workshop hobby, but we know that this year's display will surpass anything that we've seen before.

GAMES WORKSHOP IN SPAIN

If you are on holiday near Barcelona this summer and fancy doing a spot of miniature painting then pop along to Jocs and Games.

They stock the complete range of Games Workshop games and Citadel miniatures including all of the latest releases. They also provide a complete mail-order service, covering the whole of Spain. The

store is at 193 Calle Muntaner, on the corner of Calle Londres and is open Mondays to Saturdays from 10.00am until 8.00pm.

WARHAMMER RECORDS

The latest Saxon single — Forever Free is out on Warhammer Records on the 26th April. Watch out for the band's appearance on the Big Breakfast show.

CHAOS DWARFS

In next month's issue of White Dwarf we will be publishing a complete army list for the forces of Chaos Dwarfs in **Warhammer**. As you can see from some of the 'Eavy Metal pages in this issue, Alan Perry has been busily creating a complete range of models for these malevolently warped creatures, with many new releases to come.



ALAN PERRY'S NEW GIANT CHAOS DWARF WAR CANNON

Tu Especialista en BARCELONA

Por primera vez en España te ofrecemos el catálogo completo y las últimas novedades de:

GAMES WORKSHOP

y

CITADEL MINIATURES

JOCS & GAMES

C/Muntaner, 193 (esquina c/Londres)
Tel. (93) 322 09 53. Fax (93) 410 88 75.
Barcelona 08036 España

¡HORARIO ININTERRUMPIDO DE 10 A 20
HORAS DE LUNES A SABADO!

VENTA POR CORREO A TODA ESPAÑA
¡SOLICITA NUESTRO CATALOGO DE MINATURAS!

GAMES WORKSHOP®

PRESENTS

GOLDEN '93 DEMON

THE 6th INTERNATIONAL CITADEL MINIATURES
PAINTING CHAMPIONSHIPS

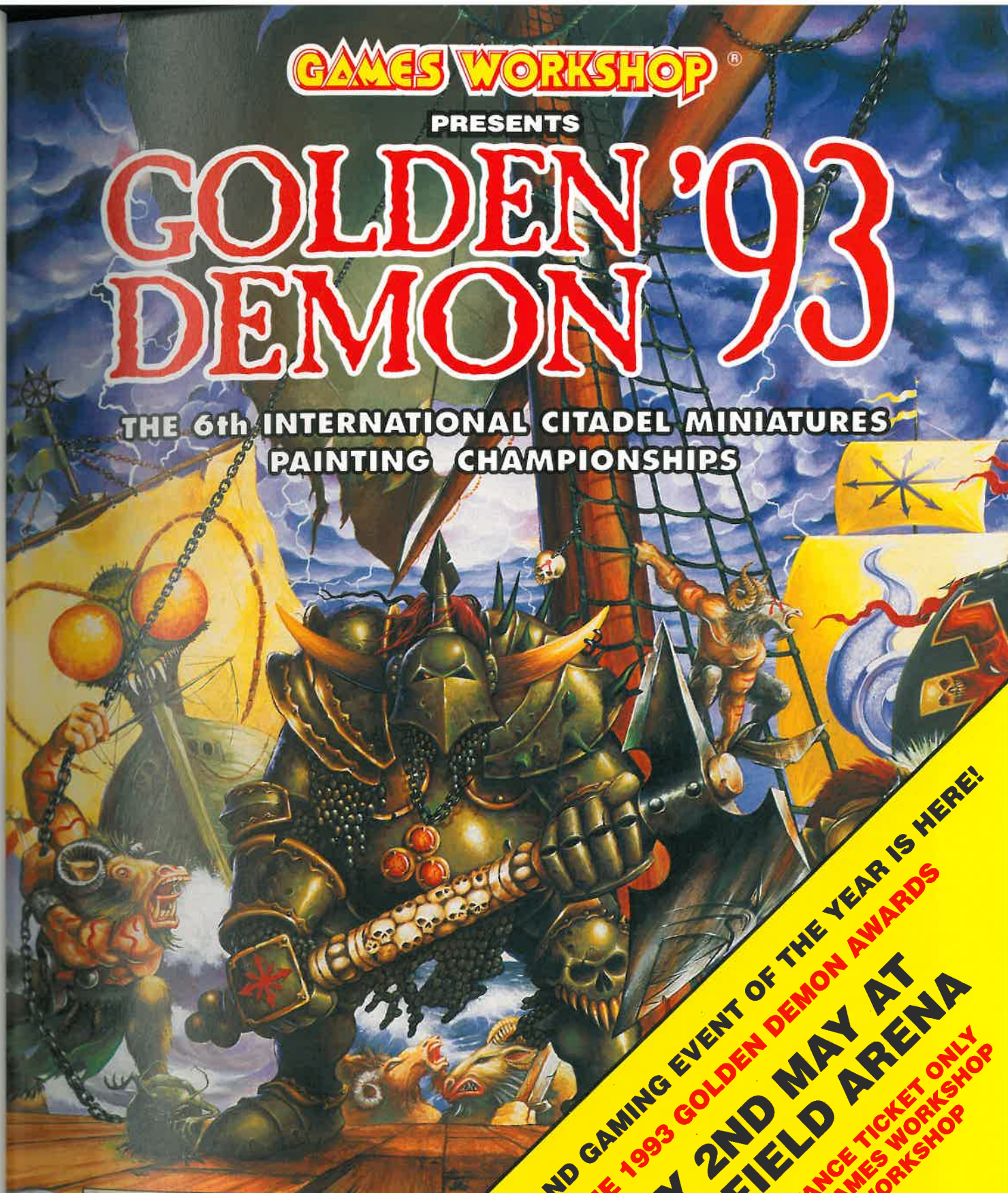

The annual Golden Demon Awards
Workshop gaming calendar. Each
modellers compete for the honour
year, the grand finals will be held
be thousands of wonderful
awarded their prizes.

THE MINIATURES AND GAMING EVENT OF THE YEAR IS HERE!
DON'T MISS THE 1993 GOLDEN DEMON AWARDS
SUNDAY 2ND MAY AT
THE SHEFFIELD ARENA
ADMISSION IS BY ADVANCE TICKET ONLY
AVAILABLE FROM ALL GAMES WORKSHOP
STORES OR GAMES WORKSHOP
MAIL ORDER
THERE WILL BE
NO TICKET
SALES ON THE
DOOR

WARHAMMER®

40,000

DEATHWING TERMINATORS

By Andy Chambers

The first company of all Space Marine Chapters is traditionally the veteran company and contains the most experienced and deadly Space Marines in the whole Chapter. After elevation to the first company the only higher honour a Space Marine can aspire to is being interred in Dreadnought armour if he is mortally wounded so he can continue warring for the Emperor for centuries to come.

The Deathwing is the famed and feared first company of the Dark Angels Space Marine Chapter. The tough veteran warriors of the Deathwing are renowned throughout the galaxy for their cool determination and ruthless efficiency in the face

of seemingly insurmountable odds. As Space Marines of the first company the warriors of the Deathwing are supplied with the finest armour and weapons the Adeptus Mechanicus can construct. The Deathwing is particularly blessed in that it has one hundred suits of Tactical Dreadnought armour, enough to equip the entire company.

Though the Dark Angels' assigned codex colour is dark green, the armour of the Deathwing is a distinctive bone white colour. This is a mark of honour to the members of the original Deathwing company who freed one of the Dark Angel's recruiting worlds from Genestealer infestation. The original Deathwing company returned to their homeworld and found their people enslaved by a genestealer brood. They decided to free their people even though such an act was prohibited by their orders. Because they did not expect to survive a confrontation with the whole 'stealer horde, the Terminators painted their armour white in preparation for their deaths as was traditional amongst their people. In the event, the Deathwing triumphed and a vital part of the Dark Angels' heritage was saved.

TACTICAL DREADNOUGHT ARMOUR

Tactical Dreadnought armour, or Terminator armour as it is more commonly known, is without doubt the toughest personal armour in the galaxy. The armour itself is massively bulky so it contains a full exo-skeleton arrangement of nerve impulse actuated electro-fibre bundles and adamantium rods. These support a heavy outer carapace of high density plasteel and ceramite plates capable of absorbing a massive amount of punishment.

Saving Throw: Terminator armour confers a basic armour saving throw of 2 or more on a D6. This is reduced as normal by the saving throw modifier of an attack. However, Terminator armour always confers a minimum saving throw of 6, even if the enemy's saving throw modifier is -5 or more.

REFRACTOR FIELD

At an additional points cost, Terminator armour can be equipped with a built-in refractor field. The refractor field gives a Terminator an additional armour saving throw of 5 or 6 on a D6 which totally ignores the enemy's armour saving throw modifier – a roll of 5 or 6 will save against a hit whether it's from a laspistol or a battlecannon.



DEATHWING

The First Company of the Dark Angels Space Marine Chapter.

The Deathwing are feared across the galaxy. Vastly experienced in all manner of war and battle the Deathwing is a mighty opponent. Only in the face of the most dangerous foes or threat would the entire Company be mustered together. The Deathwing's more usual role is pinpoint strikes by individual squads to put the fear of the Emperor into the hearts of his enemies.



Company Banner



Deathwing Terminator with Heavy Flamer



COMPANY BADGE

The Deathwing Company is honoured among the ranks of the Dark Angels. Its special status is reflected in many ways, not least of which is the breaking of the sword in the Deathwing variant of the Dark Angel Chapter icon.



THE ARMY BADGE

At the start of a war or campaign, Tech-priests move through the ranks of the Imperium's fighting forces blessing the warriors and war machines.

Whilst an ancient litany is chanted a special device is painted or carved onto the armour or uniforms of each Space Marine or fighting vehicle. This device is the army or company badge.



Deathwing Badge



Army Badge



Deathwing Terminator



Honour Badge



Detail of Sergeant's Power Sword and Shield



Detail of Chainfist

DEATHWING Terminator Company of the Dark Angels Chapter of Space Marines



WEAPON SYSTEMS

Standard armament for a Terminator is a rapid-fire bolt gun called a storm bolter and a power glove. Numerous other hand-to-hand and heavy weapons have been developed over the millennia which integrate with Terminator armour. Full details of these can be found in the Warhammer 40,000 Battle Manual.

For extra firepower many Terminator squads are equipped with the grenade harness. This is a simple six-barrelled grenade launcher built into the Terminator armour. When it is triggered it fires off three grenades in a preset pattern in front of the Terminator. The harness carries six grenades, all of the same type, which are fired off in two salvos of three.

The harness can be triggered in the shooting phase of the Terminators turn in addition to normal firing. The first grenade in the spread automatically hits a point exactly 6" away in the Terminators forward 90° fire arc. The other two grenades deviate D3" away from the target point of the first grenade. A grenade harness may be equipped with frag, krak or blind grenades.

AUXILIARY SYSTEMS

All Terminator suits include their own independent power supply and fully sealed life-support systems. This enables Terminators to fight unimpeded in the vacuum of space or hostile environments, as well as rendering gas and virus weapons totally ineffective against them. The armour includes an integral communicator, auto-senses, and suspensors which offset the movement penalty of any weapons carried. There is also a neuro-link targeter system which gives Terminators +1 on all their to hit rolls when shooting.

TELEPORTING

Terminators are often teleported straight into and out of combat, their armour even includes teleporter homers to make this easier. However, even at the best of times teleporting can be dangerously unpredictable, though many commanders consider the surprise element to be well worth the risk. A Terminator squad which is going to be teleported into battle costs 50% more points, so a Terminator squad normally costing 300 points would cost 450 points if it was going to be teleported. Only Terminator squads can teleport in this way.

A Terminator squad is teleported during the Space Marine players movement phase. Place one model from the squad on the table where the squad intends to teleport to. To determine the deviation roll a scatter dice and 2D10. If you roll a double 1 on the 2D10 the entire Terminator squad is wiped out in a catastrophic teleporter accident. Otherwise the model is moved in the direction of the arrow on the scatter dice a number of inches equal to the roll on the 2D10 (note that there is a small arrow above the 1 on the face reading 'HIT'). If the model is moved off the edge of the table, the teleport attempt has failed and the squad must try again next turn. Safety devices built

into the teleporter mechanism prevent it materialising the subject inside solid matter, so if the model ends up in a building, vehicle or other solid object, roll for deviation again from that point

Once the first model has been deviated the rest of the squad can be placed anywhere within 2" of it. The Terminators can shoot or fight in hand-to-hand combat on the turn they arrive but do not count as charging if they teleport directly into hand-to-hand combat.

If Terminators are teleporting to a point within 6" of an active teleporter homer, (carried by another Terminator squad for example) a roll of a 'HIT' on the scatter dice indicates that the Terminators have locked onto the homer and come in right on target unless the 2D10 roll is a double 1. In this case roll for deviation again, ignoring the presence of the teleport homer. A roll of an arrow indicates the squad is deviated as normal.

Terminators which have paid the points cost to teleport into a battle may teleport out again during the Space Marine player's turn. The squad is simply removed from the table during the movement phase and may not return later.

TACTICAL USES

Terminators are most commonly used in boarding space hulks or fighting through tunnels, buildings and other enclosed spaces. Here the Terminators heavy short-range firepower and thick armour place him at a great advantage over most opponents. Terminators can quickly batter through almost any defenses and are nigh on impossible to shift once they take up a defensive position.

On the open battlefield the Terminator's lack of manoeuvrability becomes a limiting factor in their deployment, though sometimes Terminators can be teleported into battle to overcome this. Their great size also means they attract a lot of fire, frequently from heavy weapons capable of punching through even Terminator armour. Teleporting the Terminators directly into combat can overcome many of these problems but the inaccuracy of teleporting can throw up many problems of its own. Nonetheless, once the Terminators get into range they can inflict horrendous casualties with their storm bolters and grenade harnesses, not to mention the much-feared assault cannon.

POINTS VALUE

The points value of a Terminator squad in the Warhammer 40,000 Compendium is 450 points per squad, this includes the additional 50% points cost to allow the Terminators to be teleported in. The new value shown for Deathwing Terminators does not include the cost of being able to teleport. We have tried this revised value in a number of games here at the studio and we reckon it's fair but we welcome any comments for or against. Remember if you write in that you need to include a self addressed envelope if you want a reply.

| Weapon | Short | Long | To Hit | | Strength | Damage | Save Mod | Special Rules |
|--------------|-------------------|--------|--------|------|----------|--------|----------|----------------|
| | Range | Range | Short | Long | | | | |
| Storm Bolter | 0-12" | 12-24" | +1 | - | 4 | 1 | -1 | Sustained Fire |
| Power Glove | Close Combat only | | | | | | | |
| Heavy Flamer | Template | | | | | | | |
| Chain Fist | Close Combat only | | | | | | | |
| Power Sword | Close Combat only | | | | | | | |

DEATHWING TERMINATORS

The Deathwing is the famed and feared first company of the Dark Angels Space Marine Chapter. The tough veteran warriors of the Deathwing are renowned throughout the galaxy for their cool determination and ruthless efficiency in the face of seemingly insurmountable odds. As Space Marines of the first company the warriors of the Deathwing are supplied with the finest armour and weapons the Adeptus Mechanicus can construct. The Deathwing is particularly blessed in that it has one hundred suits of Tactical Dreadnought armour, enough to equip the entire company.

| | M | WS | BS | S | T | W | I | A | Ld | Int | CI | WP |
|----------------------------|---|----|----|---|---|---|---|---|----|-----|----|----|
| Deathwing Terminator | 4 | 5 | 5 | 4 | 4 | 1 | 5 | 1 | 9 | 8 | 9 | 9 |
| Deathwing Sergeant | 4 | 5 | 5 | 4 | 4 | 1 | 5 | 1 | 9 | 8 | 9 | 9 |
| Deathwing Veteran Sergeant | 4 | 6 | 6 | 5 | 5 | 2 | 6 | 2 | 9 | 9 | 9 | 9 |

EQUIPMENT

Deathwing Terminators are armed and equipped as detailed below, but weapons may be exchanged or upgraded and additional equipment chosen as noted below. Basic equipment consists of:

Terminator Armour giving a basic saving throw of 2 or more on a D6 and including a targeter.

Weapons: Each Deathwing Terminator is armed with a storm bolter and power glove.

OPTIONAL UPGRADES

A Deathwing Terminator Squad may replace its sergeant with a veteran sergeant at the points cost indicated.

| | |
|-------------------------|-----------|
| Veteran Sergeant | 30 |
|-------------------------|-----------|

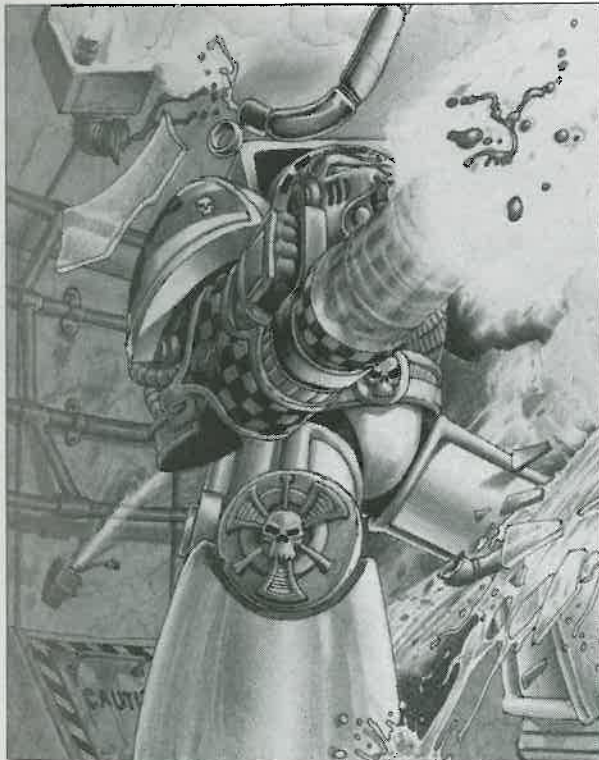

OPTIONAL WARGEAR

A Deathwing Terminator may exchange his power glove for one of the weapons shown below at the points cost indicated.

| | |
|--|-----------|
| Chain Fist | 5 |
| Power Sword (sergeants only) | 0 |
| Cyclone Missile Launcher (maximum of one Cyclone per Terminator squad) | 50 |



A Deathwing Terminator may exchange his power glove and storm bolter for one of the weapons shown below at the points cost indicated.

| | |
|--|----------|
| Lightning Claws | 0 |
| Thunder Hammer and Storm shield | 0 |

One Deathwing Terminator in the squad may exchange his storm bolter for a heavy weapon shown below at the points cost indicated.

| | |
|-----------------------|-----------|
| Assault Cannon | 30 |
| Heavy Flamer | 20 |

A Deathwing Terminator squad may be equipped with any of the wargear listed below at the points cost indicated.

| | |
|--|------------|
| Refractor Fields | 100 |
| Grenade Harnesses (Frag, Blind or Krak) | 50 |

POINTS COST

280 POINTS PER SQUAD

(Each Squad consists of 4 Deathwing Terminators and 1 Deathwing Terminator Sergeant)

You may include up to 6 Deathwing Terminator squads in your force.

GAMES WORKSHOP®

A WORLD OF FANTASY GAMING

At Games Workshop we are committed to providing exciting stores to form the centre of the growing hobby in your area. The first thing you notice when entering a Games Workshop store is how different it is from nearly any other store. Here you'll find not only everything you need for the gaming hobby but much more besides.

OUR RANGE OF STOCK

The range of products available is of course very important and all our stores stock the complete range of Games Workshop games, Citadel Miniatures and Marauder Miniatures. There are current copies of White Dwarf magazine and lots of back issues, plus Citadel paints, inks, brushes and modelling accessories as well as lots of other great products like T-shirts, posters, badges and novels.



The amount of Citadel and Marauder Miniatures we stock is enormous. You'll find everything you need to build up any army for Warhammer, Warhammer 40,000 or Space Marine, or any team for Blood Bowl plus many models for all our other games.

We release many new products every month, and all Games Workshop stores will have all of these the day they are first available.

OUR STAFF

Our friendly staff have been specially selected to make sure you get the maximum enjoyment from your hobby. Whether you play Warhammer, Warhammer 40,000 or Space Marine or any of our other games, at least one member of staff at each store will be busy collecting and painting an army or making terrain for each of our games.



Mark at the Peterborough store demonstrates the basics of Warhammer



Bob gives some tips on painting miniatures at the Nottingham store.



Just like you they are all enthusiastic gamers and are always happy to answer your questions about game rules, miniature painting and modelling, or help you to plan your army.

They'll also be able to tell you about the the latest new games and miniatures that have come into stock and what exciting new releases are coming in the future.

IN-STORE MINIATURE PAINTING

Most of our stores have a special table set aside where our staff can teach you the basics of painting Citadel and Marauder miniatures. All the paints and brushes are provided but it's best if you bring along one or two of your own miniatures to paint. We believe as long as you have a steady hand and a bit of patience you can be taught to paint your miniatures to a good gaming standard.

PAINTED MINIATURE DISPLAYS

All Games Workshop stores have stunning displays of hundreds of beautifully painted Citadel and Marauder miniatures and models. These displays include everything from single character models and monsters to large vehicle kits.

Also on display are several examples of painted armies which can be used for in-store gaming. You should hopefully be able to get some good ideas and inspiration from these displays and the staff are always willing to discuss the techniques used for painting the miniatures.

IN-STORE GAMING

Every shop holds in-store gaming on weekdays and also on Saturdays when you and your friends can try out one of the existing range of Games Workshop's exciting games or learn how to play newly released ones.

If you are new to the hobby, then every store has a set of painted armies and terrain for playing games of Warhammer.

Warhammer 40,000 and Space Marine as well as all of the other great Games Workshop games. But it won't be long before you are proudly bringing in your own newly painted force to do battle.



WARHAMMER®

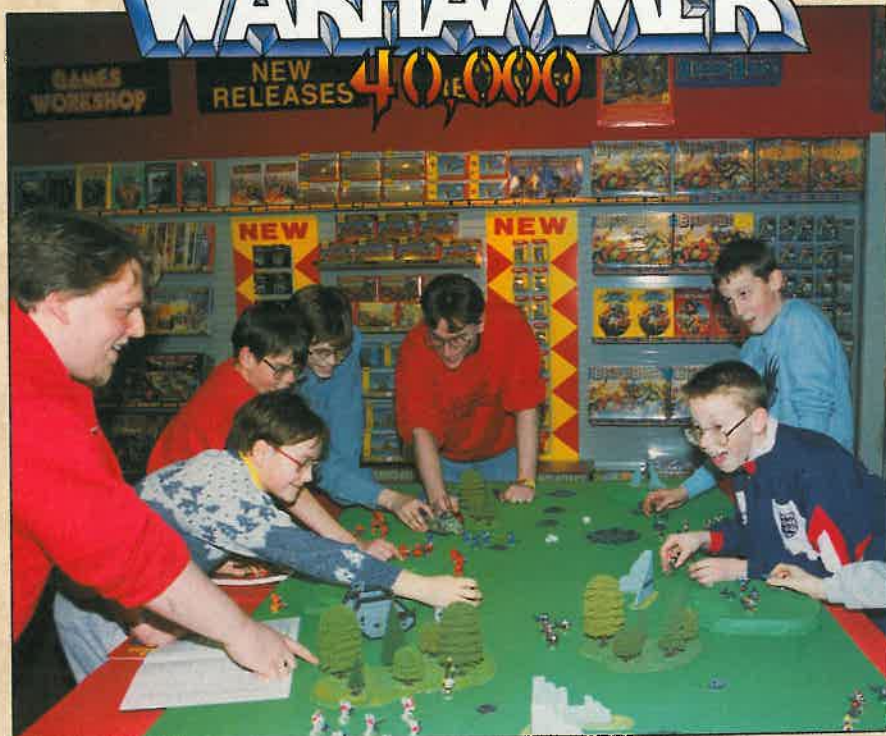

Enthusiasts enjoying a game of Warhammer 40,000 at the Peterborough store.

GAMES WORKSHOP

RECKENHAM: 292-294 HIGH ST. TEL: 061 658 8102
 BELFAST: 30A CASTLE COURT. TEL: 0232 233654
 BIRMINGHAM: 116 CORPORATION STREET TEL: 021 236 7880
 BRIGHTON: 7 NILE PAVILIONS, NILE ST. TEL: 0273 203332
 BRISTOL: 13 BROAD WEIR TEL: 0272 251533
 BROMLEY: 8 BROMLEY MALL. TEL: 081 466 0678
 CAMBRIDGE: 4 QUAYSIDE (OFF BRIDGE ST) TEL: 0223 313350
 CARDIFF: 29-30 HIGH STREET TEL: 0222 644917
 CHELSEA: 16 PITVILLE STREET TEL: 0242 228419
 CHESTER: 112 FOREGATE STREET TEL: 0244 211967
 COLCHESTER: 2 SHORT WYRE STREET TEL: 0206 767279
 COVENTRY: 14 CITY ARCADE TEL: 0203 227311
 CROYDON: UNIT 55 DRUMMOND CENTRE, KEELEY RD
 TEL: 081 680 4600
 DERBY: 42 SADDLER GATE TEL: 0332 371657
 DUDLEY: KIOSK U, UPPER LEVEL, MERRY HILL CENTRE
 DUDLEY GAMES NIGHT THURS TILL 9.00 OPEN MON - FRI
 10.00 TILL 8.00 SAT 9.00 TILL 7.00 TEL: 0384 481818
 EDINBURGH: 136 HIGH ST. OPEN SUN 11 - 5 TEL: 031 220 6540
 GLASGOW: 66 QUEEN ST TEL: 041 226 3762
 GUILDFORD: 12 TUNSGATE TEL: 0483 451793
 HAMMERSMITH: 1 DALLING ROAD TEL: 081 741 3445
 HARROW: 296 STATION RD TEL: 081 861 2350
 HULL: 30 PARAGON STREET TEL: 0482 589576
 LEEDS: 12-16 CENTRAL ROAD TEL: 0532 430834
 LEICESTER: 16-20 SILVER ST TEL: 0533 530510
 LIVERPOOL: 47 LORD STREET TEL: 051 258 1404
 CENTRAL LONDON: UNIT F10, THE PLAZA, 116-128 OXFORD
 STREET TEL: 071 436 0839
 LUTON: 12 PARK STREET TEL: 0582 417474
 MAIDSTONE: UNIT 6, 1-9 PUDDING LANE TEL: 0622 677435
 MANCHESTER: UNIT 1, 3 BROWN STREET TEL: 061 832 6863
 MEADOWHALL CENTRE SHEFFIELD: 91B HIGH ST.
 UPPER MALL OPEN MON TO THURS 10 - 8 FRIDAYS 10 - 7,
 SATURDAYS 9 - 7, SUNDAYS 12 - 4 TEL: 0742 569836
 MIDDLESBROUGH: 39 DUNDAS ST TEL: 0642 254091
 NEWCASTLE: 63 CLAYTON STREET TEL: 091 232 2418
 NORWICH: 12-14 EXCHANGE STREET TEL: 0603 767656
 NOTTINGHAM: 34a FRIAR LANE TEL: 0602 480651
 OXFORD: 1A NEW INN HALL ST TEL: 0865 242182
 PETERBOROUGH: 3 WENTWORTH STREET TEL: 0733 890052
 PLYMOUTH: 84 CORNWALL STREET TEL: 0752 254121
 PORTSMOUTH: 34 ARUNDEL STREET TEL: 0705 876266
 PRESTON: 15 MILLER ARCADE TEL: 0772 821855
 READING: UNIT 3 CHEAPSIDE TEL: 0734 598693
 SHEFFIELD: 16 FITZWILLIAM GATE TEL: 0742 750114
 SOUTHAMPTON: 23 EAST STREET TEL: 0703 331962
 SOUTHEND: 12 SOUTHCHURCH RD TEL: 0702 461251
 STOKE ON TRENT: 27 STAFFORD ST HAMLEY TEL: 0782 205287
 SWINDON: 17 FLEET STREET TEL: 0793 436036
 NEW STORE: THURROCK LAKESIDE, UNIT 415, LEVEL 3/FOOD
 COURT, THURROCK LAKESIDE (JUNCTIONS 30/31, M25)
 TEL: 0708 867133 OPEN MON - THU 10 - 8, FRI 10 - 9, SAT 10 - 7.30
 TORQUAY: 12 MARKET ST. TEL: 0843 201036. (Closed Tuesdays)
 WORCESTER: 4 CHARLES STREET TEL: 0905 616707
 YORK: 26 GOODRAMGATE TEL: 0904 653575



SPACE MARINE



A game of Space Marine at the Leicester store.

Each store is also open late at least one night each week (usually Thursday for our special gaming night) when everyone can come along and play games. At **Games Workshop** we are always keen to teach people how to play our games and our staff are always willing to set up a small game for you to try (please note however, that at busy times this unfortunately might not be possible so it's best to ring your nearest store first to make sure).



SPECIAL EVENTS

All our stores hold special events. These include our new **Warhammer Days** where you'll find all sorts of competitions, large battle games, special offers and sometimes surprise guest personalities.

We also hold the heats every year for our two premier gaming and miniature painting events **Games Day** and the **Golden Demon Awards**.

Also don't forget that all our new and refitted stores have a **Grand Opening Day** where you can join in the fun and pick up some great bargains

WARHAMMER

CHAOS DWARFS

By Rick Priestley

This month sees the release of the first models in a brand new series of Chaos Dwarf miniatures by Alan Perry. To accompany these models, Rick has been delving into the background of this dark race.

Many thousands of years ago the Dwarf race moved northwards from its ancestral home somewhere in the Southlands. They moved along the high ridge of mountains known as the Worlds Edge Mountains, following the trail of mineral ores and precious gems.

The Dwarfs spread amongst the mountains, driven onwards by their lust for the secrets of rock and metal. Over a period of many hundreds of years they dug shafts and excavated cavernous underground cities, they sank mines deep into the mountain roots, and constructed tunnels which carried them further north.

Eventually, some time in the dim and distant past, the Dwarfs reached the upland region at the far north of the

Worlds Edge Mountains which they called *Zorn Uzkul* or the Great Skull Land. Here they found a vast and inhospitable plateau where the air was thin and cold and the rocks barren. Many turned back south to swell the growing numbers of Dwarfs in the Worlds Edge Mountains, others turned west into the cold lands of Norsca, but some of the most adventurous turned east and then south along the bleak Mountains of Mourn.

At first these widespread Dwarf kindreds maintained contact with each other, but the eastern Dwarfs strayed far and when the Time of Chaos came the northern regions were cut off forever. The Dwarfs of the west believed their eastern kin dead, destroyed by the tides of Chaos that came from the north, but they were mistaken. Chaos did not kill the hardy Dwarfs, instead it worked a dreadful change upon them.

THE DARK LANDS

The Chaos Dwarf Empire is sited amidst the Mountains of Mourn and the adjoining eastern part of the Dark Lands. It is a stark and cheerless place, where nature has rent the ground and burst the mountains apart. Amongst the peaks volcanoes spew black smoke into the filthy sky. In the plains the stench of tar pits and oil pools hangs heavily in the air. Steaming lava from beneath the earth's crust covers the ash wastes with a blanket of bubbling magma.

Almost nothing can grow in the Dark Lands. The dim light and choking air combine to ensure that the land remains devoid of vegetation except for a few straggly black thorns. The volcanoes and gaping pits bring up all kinds of minerals and gems from beneath the earth: gold and silver, iron and copper, diamonds and sapphires, as well as sulphur, oil and tar. It is a land rich in the materials that Dwarfs especially covet.

THE CHAOS DWARF EMPIRE

It is impossible to say for certain how or when the Dwarf kindred of the east became the Chaos Dwarfs. Probably it was a slow process of warping and twisting, for Dwarfs are stubborn by nature and more resistant to magic than other creatures. Nonetheless they were changed.



DAVE GALLAGHER

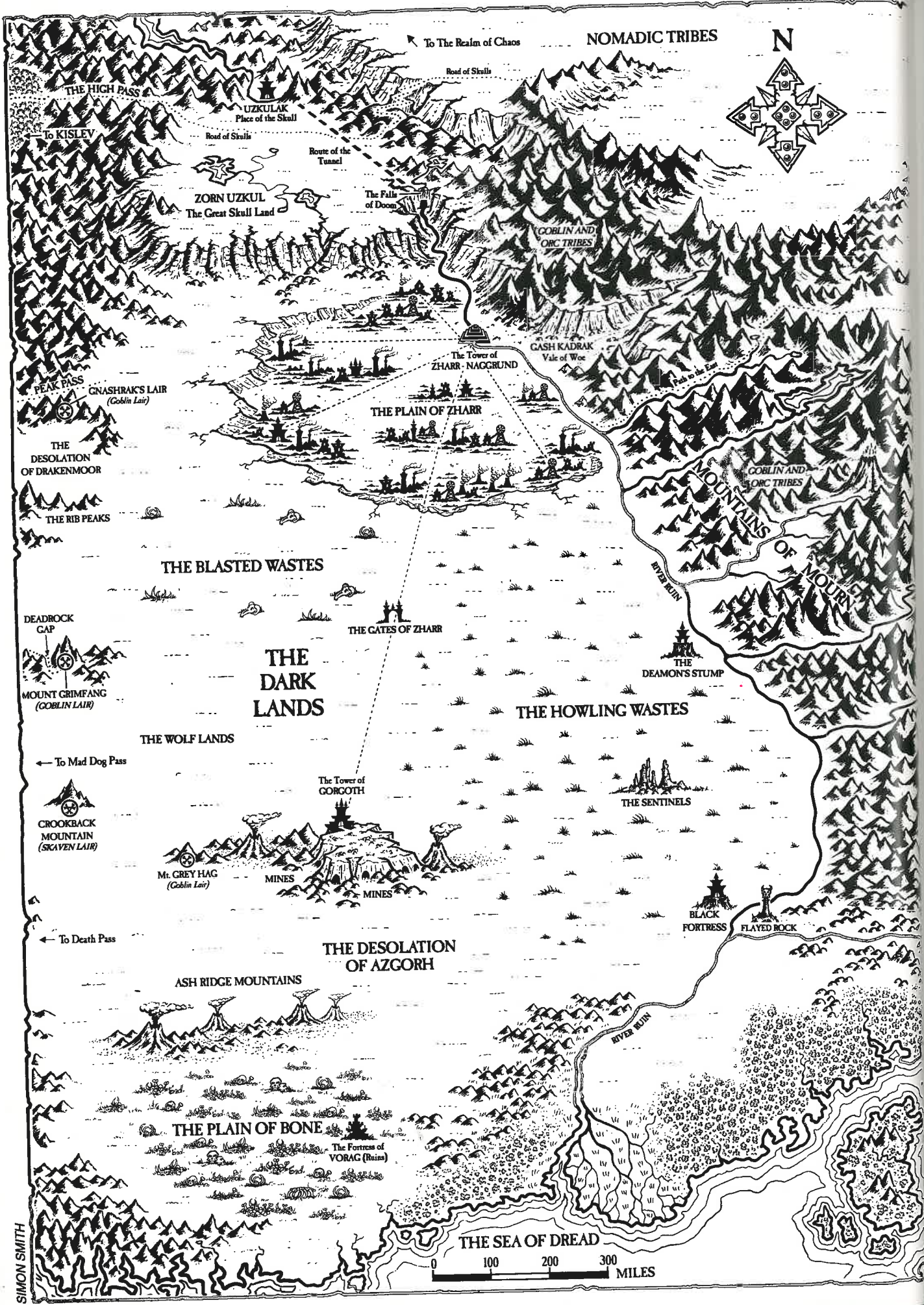

NOMADIC TRIBES

N

To The Realm of Chaos

Road of Skulls

THE HIGH PASS

UZKULAK
Place of the Skull

To KISLEV

Road of Skulls

Route of the Tunnel

ZORN UZKUL
The Great Skull Land

The Falls of Doom

GOBLIN AND ORC TRIBES

GASH KADRAK
Vale of Woe

The Tower of ZHARR-NAGGRUND

THE PLAIN OF ZHARR

PEAK PASS

GNASHRAK'S LAIR
(Goblin Lair)

THE DESOLATION OF DRAKENMOOR

THE RIB PEAKS

MOUNTAINS OF MOURN

GOBLIN AND ORC TRIBES

THE BLASTED WASTES

THE GATES OF ZHARR

THE DARK LANDS

THE DEMON'S STUMP

THE HOWLING WASTES

DEADROCK GAP

MOUNT GRIMFANG
(GOBLIN LAIR)

THE WOLF LANDS

The Tower of GORGOOTH

THE SENTINELS

To Mad Dog Pass

CROCKBACK MOUNTAIN
(SKAVEN LAIR)

Mt. GREY HAG
(Goblin Lair)

MINES

MINES

BLACK FORTRESS

PLAYED ROCK

To Death Pass

THE DESOLATION OF AZGORH

ASH RIDGE MOUNTAINS

THE PLAIN OF BONE

The Fortress of VORAG (Ruins)

THE SEA OF DREAD

0 100 200 300 MILES

SIMON SMITH

Their Dwarf instincts became perverted into a mockery of traditional values. The huge and monstrous Tower of Zharr-Naggrund, the City of Fire and Desolation, arose on the plain of Zharrduk. This monstrous city is fashioned from black obsidian and stained with the red glow of a thousand diabolic furnaces. Where Dwarfs shun magic the Chaos Dwarfs embraced it and became mighty sorcerers, the creators of arcane machineries and horrific engines. They built the Tower of Zharr-Naggrund in the shape of a mountain rising tier upon tier to its summit. At its top they built a temple to their evil god *Hashut*, the Father of Darkness.

Around their dark city the Chaos Dwarfs sunk mines into the earth, delving deep into the rock and filth in pursuit of the treasures that lie below. They built engines down in the depths, using steam power generated by the heat of the rocks themselves. They dug for coal and piled it high into black mounds. They drilled for oil and tar, and dug open pits in which to store it, creating lakes of sticky blackness over the land. In the mountains they quarried stone and used it to build roadways to connect all their lands together, so that the plundered riches of the earth might flow all the faster into their gargantuan city.

The refuse of thousands of years of labour fills the Plain of Zharrduk where industry tears at the earth, pock-marking the surface with ugly scars of endeavour. Beneath the flickering flames of countless forges untold thousands of slaves, creatures of many races captured in war or traded from the Orcs of the west, work at the enterprises of the Chaos Dwarfs.

THE TOWER OF ZHARR-NAGGRUND

The Tower of Zharr-Naggrund lies at the centre of the Chaos Dwarf Empire and is the object of all their labours and enterprise. Though there are numerous mines, workshops, foundries and fortresses throughout the Plain of Zharrduk and beyond, there is just one mighty city in all the empire. The Tower of Zharr-Naggrund is built of obsidian, black volcanic glass whose light reflects the flames of the myriad furnaces that burn both day and night. The entire city is built in a series of tall steps, like a ziggurat, each step hundreds of feet high and surmounted by battlements that jut upwards like a row of ugly fangs.

Each step is square, and the bottom step is pierced by four huge stone gateways bound in iron. The gates are almost as high as the walls and massive beyond any obvious need. From the east and west gateways roads paved with slabs of gold and brass lead to the Mountains of Mourn and the Dark Lands. The north and south gateways are the river sluices through which the waters of the River Ruin pour. The cold river enters the city from the north and it is put to use cooling the huge forges of the Chaos Dwarf Sorcerers, powering the steam-driven engines, and flushing the effluent of industry out to the south. Where it leaves the city the river is stained red and yellow with filth, laden with noxious sediments and its steaming water is thick and poisonous. A foul yellow cloud hangs about the river and its banks are choked with drifts of spectacularly coloured pollutants.

A thousand massive furnaces burn within the vastness of Zharr-Naggrund, smelting the metals that are the lifeblood of the city. The city is a huge living workshop full of smoke and noise, illuminated by its inner fires and driven by machines of vast size and power. Gigantic steam-driven hammers stamp out sheets of iron and bronze with rhythmic booms like the heartbeats of a cyclopean god.

Massive cauldrons of bubbling metal pour out their molten contents into twisted moulds of intricate construction. The roaring of furnaces, groaning of huge wheels and grinding of arcane machines fills the oily air. The noise and the labours never cease. The Dark Lands are shrouded in thick volcanic clouds and smoke from the workshops of Zharrduk, so the Tower of Zharr-Naggrund exists in a timeless twilight, illuminated by the carmine fires of its own forges.

THE TEMPLE OF HASHUT

At the pinnacle of the city is the Temple of Hashut, the bull-shaped god of the Chaos Dwarfs, who they call the Father of Darkness. His temple is guarded by Bull Centaurs, creatures mutated from Chaos Dwarfs long ago. They have the body of a bull but the torso of a Chaos Dwarf, with long snaggly tusks and exotically curled beards. Inside the temple its guardians perform bloodthirsty rites, throwing captives into cauldrons of molten metal to the echoing laughter of the assembled Chaos Dwarf Sorcerers. On top of the temple stands the iron statue of Hashut. Its hollow iron belly contains a furnace heated by coals so that the statue glows red hot and anyone who touches its surface suffers searing wounds. The god is the embodiment of the city, its deity and its master, whose power flows through the Chaos Dwarf Sorcerers, and for whom thousands of slaves are sacrificed by fire and furnace.

CHAOS DWARF SORCERERS

The Chaos Dwarf Sorcerers rule over the Tower of Zharr-Naggrund as the lords and masters of the Chaos Dwarfs and high priests of Hashut. Their lore is deep and ancient, the study of machines and magic combined to produce arcane engines of power and destruction. It was Chaos Dwarf Sorcerers who constructed the city in past ages, who carved its shape from obsidian and raised its dark towers and fashioned its massive gateways. They are few in number, probably no more than a few hundred amongst the whole Chaos Dwarf race.

In the Temple of Hashut the Chaos Dwarf Sorcerers meet in a great conclave of evil to make their plans of domination. There is no leader nor formal hierarchy amongst them, but the strongest voice belongs to the oldest and most powerful, for Chaos Dwarfs respect age and knowledge just as much as other Dwarfs. Each Chaos Dwarf Sorcerer controls part of the city, with its workshops and forges, slaves and warriors, as part of his personal dominion.

Chaos Dwarfs are resistant to magic, as are all Dwarfs after a fashion, but they are not immune to its effects. As Chaos Dwarf Sorcerers use magic it gradually seeps into their bodies, evoking changes in them which are both unique and horrific. After many centuries of labour a Chaos Dwarf Sorcerer begins to change: the pace of change is slow, but once it begins, his fate is sealed.

Starting with his feet, the Chaos Dwarf Sorcerer slowly begins to turn to immobile stone. At first his legs turn grey and solid so that he is unable to move, and his followers are obliged to carry him around or else he has them construct a mechanical engine to move him about. Then his lower body and torso turn to stone, making him extraordinarily tough. Once his arms become stone he is entirely dependent upon his followers to perform his magic, as all he can do is speak and watch their progress. After a while his entire body turns to stone and he becomes

a statue. The statues of Chaos Dwarf Sorcerers are lined up along the roadways around the Tower of Zharr-Naggrund, forming rank upon rank of grey stones watching over the approach to the city.

CHAOS DWARF WARRIORS

There are relatively few Chaos Dwarfs. The vast numbers of slaves who toil in the Tower of Zharr-Naggrund and in the Plain of Zharrduk outnumber them many times over. All the Chaos Dwarfs belong to one of the Chaos Dwarf Sorcerers, they are his subjects and also his kinsmen, bonded by ties of blood-loyalty which all Chaos Dwarfs deem unbreakable. Bands of Chaos Dwarfs scour the Dark Lands searching for captives to bring back to Zharr-Naggrund to work in the mines and forges, or to sacrifice at the Temple of Hashut.

The acquisition of slaves is very important to Chaos Dwarfs because they are totally dependent upon captives to keep their city and industries going. Bands of Chaos Dwarfs will travel many hundreds of miles to raid Orc or Goblin strongholds in the Mountains of Mourn, and when they conquer a tribe they take as many prisoners back to their city as they can. The more captives they take the more successful the expedition is judged to have been. All wars of conquest are fought with the aim of taking slaves; the Chaos Dwarfs are not interested in expanding their territories further, for the Mountains of Mourn and the Plain of Zharrduk contain all the wealth that they require. Sometimes whole armies of Chaos Dwarfs march against the Orc and Goblin tribes, subduing one tribe after another before returning to the Tower of Zharr-Naggrund laden with slaves.

The Chaos Dwarfs also raid to the north, attacking the fierce horse-riding human tribes of the northern highlands, but these are distant conquests for them and the horse tribes often flee rather than fight. The furthest west the Chaos Dwarf armies have reached to date is the verdant valleys of Farside: the province of Kislev which lies in the eastern foothills of the Worlds Edge Mountains. Smaller bands of Chaos Dwarfs have penetrated as far as the lands around Death Pass, where they have encountered the many tribes of Goblins that live in the western part of the Dark Lands. The Chaos Dwarfs trade slaves with the Goblin tribes, choosing to use the Goblins as intermediaries rather than advance further into the Old World. In this way captive Dwarfs and Men from the Old World have been taken prisoner first by the Goblins and then sold on to the Chaos Dwarfs, only to end their days in the pits of Zharrduk or upon the burning altars of Hashut.

BLACK ORCS

Many years ago the Chaos Dwarf Sorcerers tried to breed their own Orc race, a race of slaves that could work in the most hostile parts of their realm. They already had thousands of Orc and Goblin slaves, but the Chaos Dwarfs found them unruly and inefficient because they would often fight amongst themselves. Using evil magic and careful selection, the Chaos Dwarfs created a new type of Orc: stronger than an ordinary Orc but more loyal and not given to squabbling. This was how the race of Black Orcs came into being.

The experiment worked at first, but the Chaos Dwarfs soon realised that although their creations were much tougher, they were far too independent-minded to make

good slaves. Ordinary Orcs and Goblins were constantly riven by disputes and so never had time to plot against their masters. Black Orcs, on the other hand, were too well organised, often starting rebellions and leading the other Orcs and Goblins into armed revolt. After several near disasters when Black Orc-led armies ravaged parts of the Tower of Zharr-Naggrund the Chaos Dwarfs decided to drive them from the city forever. Many Black Orcs escaped into the Mountains of Mourn where their descendants remain to this day, while others undertook the long journey to the west and eventually reached the Old World. The Chaos Dwarfs destroyed many Black Orcs, but they left some tribes free to roam the mountains so that they could recruit them as troops into their armies.

HOBGOBLINS

During the height of the largest and most savage Black Orc rebellion the Chaos Dwarfs were almost overcome. Vastly outnumbered by their former slaves they were driven upwards through the layers of their city, fighting for each level, ascending ever closer to the Temple of Hashut itself. At the final hour the city was saved by the treachery of the Hobgoblins, who, having rebelled along with the Black Orcs, switched their allegiance once more and turned the tide against the Orc rebels. In doing so the Hobgoblins earned the enmity of the other green-skinned races who deeply distrust them to this day.

The Hobgoblins enjoy the favour of the Chaos Dwarfs and care little what other greenskins think of them. Unlike the Chaos Dwarfs' other slaves, they are not made to work in the pits and workshops, but are used as warriors. They are a sneaky, evil-minded race, who remain as dishonest and cowardly in the service of the Chaos Dwarfs as they were when fighting for the Black Orcs. Other greenskins despise them and would certainly kill them were it not for the power they enjoy amongst the Chaos Dwarfs.

Hobgoblins are distinctive in appearance. They look much like Goblins, but they are taller, though nowhere near as burly as Orcs. In fact their whole appearance is thin and sneaky, with narrow eyes and sneering mouths full of pointy teeth. They ride giant wolves and often carry bows to shoot the enemy from a distance. The Chaos Dwarfs utilise many Hobgoblins in their armies but don't really trust them. The Chaos Dwarfs know that the Hobgoblins are despised by other greenskins, and need the protection of the Chaos Dwarfs to survive.



MARK GIBBCNS



MARK GIBBONS

JOHN BLANCHE

CHAOS DWARFS

Chaos Dwarfs are evil, self-centred creatures, caring nothing for the life of others and directing all their labours to the construction of their great city, the Tower of Zharr-Naggrund. Chaos Dwarf armies scour the Dark Lands and beyond for slaves to labour in the mines and factories or as sacrifices to their dark god Hashut.



STANDARD BEARER



STANDARD BEARER



DRUMMER



LEADER WITH SWORD



WITH AXE



WITH BLUNDERBUSS



LEADER WITH SWORD



A REGIMENT OF CHAOS DWARFS WITH BLUNDERBUSSES



HORN BLOWER



A REGIMENT OF CHAOS DWARF AXEMEN

GREAT TAURUS



CHAOS DWARF
LORD RIDING
GREAT TAURUS

CHAOS DWARF BESTIARY

CHAOS DWARFS

The exact origin of the Chaos Dwarfs is not known for certain. In the distant past some Dwarfs moved northwards into the Great Skull Lands or *Zorn Uzku!*, and then south along the Mountains of Mourn. These explorers were undoubtedly the ancestors of the Chaos Dwarfs. The great influx of Chaos has since worked terrifying changes on their bodies and souls. Chaos Dwarfs are evil, self-centred creatures, caring nothing for the life of others and directing all their labours to the construction of their great city, the Tower of Zharr-Naggrund. Chaos Dwarf armies scour the Dark Lands and beyond for slaves to fill their city and labour beneath the earth in the pits that surround it.

Physically, Chaos Dwarfs resemble other Dwarfs, for all Dwarfs are resistant to the influence of magic and so Chaos has not warped them to the gross degree it has some other creatures. Apart from their long tusks they display few of the mutations that Chaos brings. Some develop bull-like features, even cloven hooves and occasionally horns. These mutations are rarely seen amongst Chaos Dwarf Warriors; it is Chaos Dwarf Sorcerers who are most likely to show the effects of magic.



Unlike other Dwarfs, the Chaos Dwarfs are extremely learned in magic. The Chaos Dwarf Sorcerers run the Tower of Zharr-Naggrund. They are the masters of their race, directing the labours of the slaves and the conquests of the armies. The Chaos Dwarf Sorcerers are also the high priests of the Chaos Dwarfs' god *Hashut*, the Father of Darkness, whose burning temple sits atop the mountainous city. The iron statue of Hashut is wrought in the form of a gigantic bull which glows red hot with the heat of the burning furnace within its metal belly. The Chaos Dwarfs sacrifice captives to their god by throwing them into cauldrons of molten iron or tossing them into roaring furnaces.

The Chaos Dwarf civilisation has grown up apart from the influences and developments of the Old World and has acquired a distinctive character of its own. Chaos Dwarfs wear armour made from metal scales bound together with flexible wire that makes a strong but pliable defence. This armour is usually painted red. They wear extremely tall helmets which are as much a symbol of status as they are for protection. Depending upon his expertise a Chaos Dwarf's helmet can be a distinctive shape or may be decorated in a specific way. The most important Chaos Dwarfs wear especially large and elaborate helmets. All Dwarfs have thick beards and Chaos Dwarfs curl their beards in exotic styles. This makes them look even more ferocious and draws attention to their long snaggly tusks.

| Troop Type | M | WS | BS | S | T | W | I | A | Ld |
|-------------|---|----|----|---|---|---|---|---|----|
| CHAOS DWARF | 3 | 4 | 3 | 3 | 4 | 1 | 2 | 1 | 9 |
| CHAMPION | 3 | 5 | 4 | 4 | 4 | 1 | 3 | 2 | 9 |
| HERO | 3 | 6 | 5 | 4 | 5 | 2 | 4 | 3 | 10 |
| LORD | 3 | 7 | 6 | 4 | 5 | 3 | 5 | 4 | 10 |

| Troop Type | M | WS | BS | S | T | W | I | A | Ld |
|-------------------|---|----|----|---|---|---|---|---|----|
| SORCERER | 3 | 4 | 3 | 3 | 5 | 1 | 3 | 1 | 9 |
| SORCERER CHAMPION | 3 | 4 | 3 | 4 | 5 | 2 | 3 | 1 | 9 |
| MASTER SORCERER | 3 | 4 | 3 | 4 | 5 | 3 | 4 | 2 | 9 |
| SORCERER LORD | 3 | 4 | 3 | 4 | 5 | 4 | 5 | 3 | 10 |

SPECIAL RULES

ARMOUR

Chaos Dwarfs are sturdy creatures who can bear the weight of armour more easily than fragile humans and other races. A Chaos Dwarf therefore has a move value of 3" regardless of any armour he wears.

PURSUIT AND FLEE

Chaos Dwarfs are not particularly fast, even in the frantic running combat of close pursuit. To represent this they flee and pursue 1" less than other troops, ie. 2D6 -1" rather than 2D6".

MAGIC

As described in Warhammer Magic, other Dwarfs benefit from natural magical resistance and so magic Dispels always work on a 4+ even if there is no wizard available to cast the Dispel. This proviso does not apply to Chaos Dwarfs, who utilise Dispels exactly like human or other armies.

CHAOS DWARF SORCERERS

Chaos Dwarf Sorcerers do not use the same spell cards as other Chaos Sorcerers, they have their own pack of ten Chaos Dwarf spells. The spell cards are dealt in exactly the same way as for colour wizards. Begin by shuffling the cards and then deal out the appropriate number to each sorcerer (one for a Sorcerer, two for a Sorcerer Champion, three for a Master Sorcerer, and four for a Sorcerer Lord). When he examines his hand of cards the player may choose to exchange any for a further random deal from the same deck.

BULL CENTAURS

Bull Centaurs are creatures with the upper torso of a Chaos Dwarf but the body of a ferocious bull. Many centuries ago, when the Chaos Dwarfs were first twisted by Chaos, some of their race were transformed into Bull Centaurs. Since those days the Bull Centaurs have guarded the great statue of Hashut in the temple high atop the Tower of Zharr-Naggrund. They are as keen witted and intelligent as Chaos Dwarfs and completely devoted to the worship of Hashut the Father of Darkness.

The Chaos Dwarf Sorcerers trust them completely, and often entrust them with complex or dangerous tasks. Although they are few in number they are more powerful than Chaos Dwarfs and much swifter in battle. Even though there are mighty individuals amongst them, there are no sorcerers in their number.

| Troop Type | M | WS | BS | S | T | W | I | A | Id |
|--------------|---|----|----|---|---|---|---|---|----|
| BULL CENTAUR | 8 | 4 | 3 | 4 | 4 | 2 | 3 | 2 | 9 |
| CHAMPION | 8 | 5 | 4 | 5 | 4 | 2 | 4 | 3 | 9 |
| HERO | 8 | 6 | 5 | 5 | 5 | 3 | 5 | 4 | 10 |
| LORD | 8 | 7 | 6 | 5 | 5 | 4 | 6 | 5 | 10 |



MARK GIBBONS

GREAT TAURUS

The Great Taurus is a huge and terrifying monster with the body of a massive bull and membranous wings like a dragon. These creatures are stabled in great pens beneath the Temple of Hashut, the bull god of the Chaos Dwarfs. Powerful Chaos Dwarfs ride Great Tauruses into battle. The creature burns with a terrific intensity, so that its whole body is wreathed in fire and smoke. When it moves across the ground sparks fly from its hooves and lightning plays about its feet. It breathes fire in great snorting bursts and black smoke curls from its gaping maw. The Chaos Dwarfs believe that the Great Tauruses were once Chaos Dwarfs, and that they were mutated by the warping power of Chaos into living bull-furnaces like the statue of the god Hashut himself. The Chaos Dwarfs sometimes call the Great Tauruses the Red Bulls of Hashut.



SPECIAL RULES

FLY

The Great Taurus has huge membranous wings which enable it to *fly* as described in the Warhammer rulebook.

| Troop Type | M | WS | BS | S | T | W | I | A | Id |
|--------------|---|----|----|---|---|---|---|---|----|
| GREAT TAURUS | 6 | 6 | 0 | 6 | 6 | 5 | 7 | 4 | 8 |

TERROR

The Great Taurus causes *terror* as described in the Warhammer rulebook. Remember – creatures that cause *terror* automatically cause *fear* as well.

FIERY SKIN

The Great Taurus's hide glows red hot and flickers with sparks, and can turn weapons in a similar way to armour. The Great Taurus therefore has an armour saving throw of 4, 5 or 6.

FIERY BREATH

The Great Taurus can breathe flames over its enemy. Use the teardrop-shaped flame template from the Warhammer game and place the narrow end at the mouth of the Great Taurus and the broad end over the target. Any model lying under the template is hit on the D6 score of a 4 or more. Each model hit suffers a single strength 3 attack. Damage and saving throws are worked out normally. In addition, it is possible to set buildings on fire as described in the Warhammer rulebook, and to cause extra damage on targets which burn easily such as Treemen and Mummies.

LAMMASU

The Lammasu has the body of a gigantic bull, a powerful mace-tipped tail, and a massive, ugly head. The Chaos Dwarfs believe that the Lammasu is a rare mutation of the Great Taurus, a creature whose forebears were once Chaos Dwarfs, but which has become twisted by the powers of Chaos into a huge bull-shaped monster. The Lammasu's ancestry is evident in its tusked head, its thickly curled beard, and its considerable intelligence. It is a creature with magical properties. It breathes not ordinary air but the power of magic itself, drawing into itself the power of the winds of magic. As it exhales the creature breathes out whirling clouds of black sorcery which wreath themselves around the Lammasu, enwrapping it with protective power. The Lammasu is the favourite mount of Chaos Dwarf Sorcerers.

| Troop Type | M | WS | BS | S | T | W | I | A | Ld |
|------------|---|----|----|---|---|---|---|---|----|
| LAMMASU | 6 | 6 | 0 | 6 | 7 | 5 | 6 | 3 | 8 |

SPECIAL RULES

TERROR

The Lammasu causes *terror* as described in the Warhammer rulebook. Remember creatures that cause *terror* automatically cause *fear* as well.

FLY

The Lammasu has huge membranous wings which enable it to *fly* as described in the Warhammer rulebook.

SORCEROUS EXHALATION.

The Lammasu breathes out whirling tendrils of magic which enwrap it in a cloud of sorcerous protection. If a spell is cast on the Lammasu or its rider then it will fail on the D6 roll of a 4, 5 or 6 – exactly as if a Dispel card had been played by a wizard. Only one such roll may be made against each spell cast against the creature. Should you not succeed then Dispel cards may be used exactly as normal.

In addition, the smoky black threads of sorcery may entangle and foul any magical weapons wielded against the Lammasu and its rider in hand-to-hand combat. If an enemy attempts to hit the Lammasu or its rider with a magic weapon then the chance of hitting is always reduced by -1 regardless of any other bonuses or special considerations. The greatest chance of hitting is therefore a 2+, because even a weapon which would normally hit automatically must roll to hit requiring a 2+. An enemy armed with a magic weapon may choose to use an ordinary weapon instead, which hits and causes damage exactly as normal. Note that this special ability only applies to weapons wielded in hand-to-hand combat and not to fire balls, lightning bolts or other magic effects which a weapon may have – these would be cast as spells and can be stopped by the Lammasu's basic dispel as described above.

HOBGOBLINS

Hobgoblins are taller than ordinary Goblins, though nowhere near as burly as Orcs. In fact, their whole appearance is thin and sneaky, with narrow eyes and sneering mouths full of pointy teeth. The Chaos Dwarfs utilise many evil Hobgoblins in their armies but don't really trust them. The Chaos Dwarfs know that the Hobgoblins are despised by other greenskins, and that they need the protection of the Chaos Dwarfs to survive.

| Troop Type | M | WS | BS | S | T | W | I | A | Ld |
|------------|---|----|----|---|---|---|---|---|----|
| HOBGOBLIN | 4 | 3 | 3 | 3 | 3 | 1 | 2 | 1 | 6 |
| CHAMPION | 4 | 4 | 4 | 4 | 3 | 1 | 3 | 2 | 6 |
| HERO | 4 | 5 | 5 | 4 | 4 | 2 | 4 | 3 | 7 |
| LORD | 4 | 6 | 6 | 4 | 4 | 3 | 5 | 4 | 8 |

SPECIAL RULES

ANIMOSITY

Hobgoblins are affected by Orc and Goblin animosity as defined in the Warhammer Armies book for Orcs and Goblins. If your army includes mobs of Hobgoblins plus other kinds of Orcs and Goblins, then these other kinds of greenskins will automatically pass their animosity tests. No dice roll is required – it is simply assumed that the mobs have passed their tests. This is because other greenskins distrust the Hobgoblins so much that they stop squabbling

amongst themselves and concentrate on keeping an eye on the treacherous Hobgobs. The Hobgoblins must test for animosity as normal, and may still attack or shoot at Goblins, Orcs and each other as described in the animosity rules.

PANIC

If Hobgoblins break or flee past a unit of any other kind of Goblin or Orc then no panic test is required. In fact, the sight of Hobgoblins running away and being killed evokes nothing but cheers of joy and whoops of laughter from other greenskins.

Hobgoblins are not able to ignore fleeing Goblins (as Orcs can), and must take a panic test if other Orcs or Goblins break past them.

BLACK ORC LEADERS

Black Orc Big Bosses and War Bosses can normally lead units of other greenskins, but will have nothing to do with Hobgoblins... and who can blame them.

'Stick 'em wiv arrers'. Stick 'em with knives, 'an swords, and spears. Stick 'em quick and suck 'em where it hurts. But most of all, suck 'em when they's looking the other way.'

Gorduz Backstubber, Hobgoblin Chieftain

BULL CENTAURS

Bull Centaurs are creatures with the upper torso of a Chaos Dwarf but the body of a ferocious bull. Many centuries ago, when Chaos Dwarfs were first twisted by the powers of Chaos, some of their race were transformed into Bull Centaurs.

These powerful creatures guard the great statue of Hashut in the Temple high atop the Tower of Zharr-Naggrund.



CHAOS DWARF BULL CENTAURS

MAN O' WAR MINIATURES

The Man O' War game is supported by a range of Citadel Miniatures boxed sets, making up all the famous fleets of the Warhammer World. Each box contains either a single mighty Man O' War – the biggest warships on the seas – or a complete squadron of Ships of the Line. Each set comes complete with plastic masts and flag-poles, plus a sheet of full-colour sails and pennants for the models in the box.



DWARF NAUTILUS

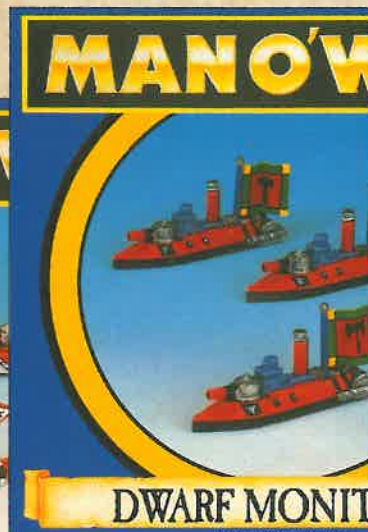

DWARF MONITOR



DWARF IRONCLADS

The Man O' War Dwarf boxed sets consist of 3 Dwarf Ironclads, 3 Dwarf Nautilus and 3 Dwarf Monitors.

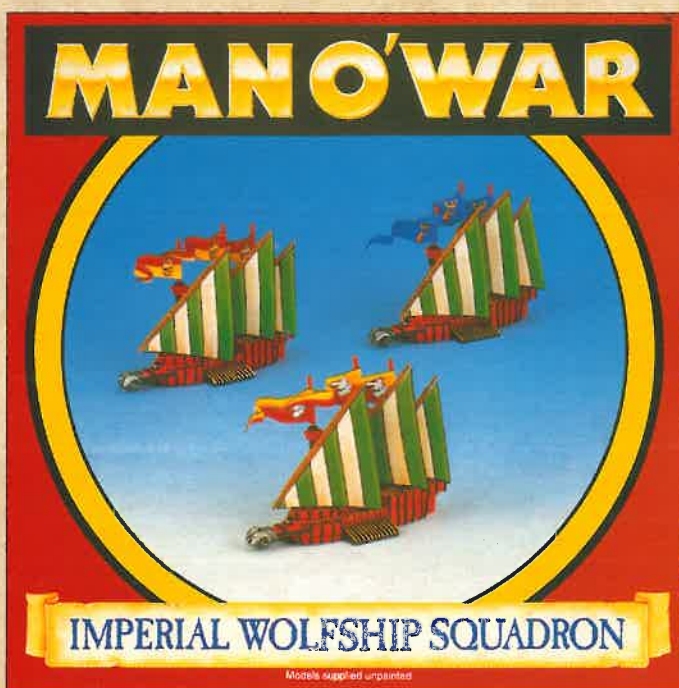

IMPERIAL WOLFSHIP SQUADRON



IMPERIAL WARGALLEYS



IMPERIAL GREATSHIP

The Man O' War Imperial boxed sets consist of 3 Wolfships, 3 Wargalleys and a mighty Imperial Greatship.



Miniatures supplied unpainted. Contents and colours may vary.

WARNING. This product contains lead which may be harmful if chewed or swallowed. Citadel Miniatures are not recommended for children under 14 years of age.

Games Workshop and Citadel are registered trademarks of Games Workshop Ltd. Man O' War is a trademark of Games Workshop Ltd. © Copyright Games Workshop Ltd 1993. All rights reserved.



MAN O' WAR

SEA OF DOOM

By Andy Jones

Man O' War, the game of raging sea battles, contains full details of warfare at sea in the grim world of Warhammer, including rules for the seagoing vessels of the major races of the Known World — The Empire, Bretonnians, Elves, Dark Elves, Dwarfs and Orcs. Man O' War also contains a complete campaign system, scenarios, an exciting magic system, 12 plastic Wargalley models to start your fleet, plus lots more.

Available this month are the first releases in the exciting range of Man O' War models. The first boxes contain ships for the Empire and Dwarf fleets, so that you can now fight massive sea-battles between these two powerful races. Although the Wargalleys included in the Man O' War box are mighty warships in their own right, they cannot be compared with the Wolfships, Ironclads and other ships that can now join the fray!

Man O' War ships are packaged in boxes, rather than blisters, and generally contain exactly the right number of each particular type of ship that you'll use in the game. For instance, Dwarf Monitors fight in squadrons of three, so they are packaged three to a box. A Greatship on the other hand is a mighty Man O' War, and therefore comes as a single model in its own box.

Each box also contains a sheet of full-colour, cutout sails and pennants for your ships, together with plastic masts and flagpoles — in fact everything you need to get the ship ready for battle, except a lick of paint!

As with all tabletop battle games, it is important when playing Man O' War that you understand your forces, and what they can do before committing them to action. In combat at sea, this becomes crucial, because rather than having an army made up of hundreds of troops which you can afford to throw at the enemy, you have a fleet of perhaps a dozen warships in which every vessel counts. This being the case, there is very little room for error — the loss of one vessel due to carelessness or ignorance about its strengths and weaknesses could easily lose you the battle.



Geoff Taylor

This introductory article looks at the Empire and Dwarf fleets, and assesses their capabilities and relative strengths, as well as suggesting some suitable deployments, strategies and tactics which may help you win the day!

When playing Man O' War, it is vital that you not only consider the strengths of your fleet, but also those of the ships you are about to face in battle. Underestimating your foe is a sure ticket to a watery grave...

BASIC CONCEPTS

Man O' War differs from most of our other games in a number of very important areas. The first is in the initial deployment of your forces. In any game this is of paramount importance, but becomes especially true in Man O' War. I've played a few games where a thoughtless deployment resulted in me losing within a turn or two, before a single shot had been fired.

Not that I didn't struggle on to the bitter end, it was just that my initial deployment didn't allow me to manoeuvre my vessels to their best advantage, and as a result my ships were still jostling for position when the first enemy shots rained down on my fleet. Extricating your fleet from a confused or constricted initial deployment is difficult, costly and will often lose you the game.

What follows are general rules for deployment that I've worked out over the course of many battles. While they may not be ideal in all situations, they provide a good starting point to work from.

DEPLOYMENT

Some of the following suggestions are plain common sense whatever ships you are using, while others are specific to different types of vessels under your command.

- 1) It may sound obvious, but point your ships in the direction you want to go, being careful not to start them facing into the wind if you intend moving them under sail.
- 2) Set up your squadrons so that each squadron's flagship is in the middle of the formation — that way it is much easier for all the ships in the squadron to stay within 6" of the squadron flagship, and thus avoid stragglers.
- 3) Position your ships so that when the game starts they are free to move in a number of different directions, depending on what your opponent does.
- 4) Remember that the squadrons are positioned one at a time — one of your squadrons followed by one of your opponent's. Bearing this in mind, place your weakest and least important squadrons on the table first, leaving your most powerful ships until last so that you can react better to your opponent's setup.

An interesting tactic available to fleets with cheaper squadrons, is to deliberately buy a number of these squadrons for the initiative advantage they give you. Because you have more squadrons than your opponent, he will have deployed or moved all his ships before you have finished, and you therefore have the opportunity to deploy or move your most powerful vessels last, in response to his actions.





In the deployment on the left, the Buccaneers provide a screen for the Corsairs and the Galleon, who are able to tack very close to the wind to get behind the solid Imperial battle line.

The Greatship, however, is in trouble: if it tries to turn to meet the enemy Corsairs or Galleon, it could easily find itself sailing into the wind and be forced to come to an abrupt stop.

5) Because setting up is so important in Man O' War, learn to be flexible. Rather than basing your deployment entirely around strategic pieces of terrain, pay more attention to where your opponent places his ships on the table. Deployment will therefore largely be a case of reacting to where your opponent places his vessels, combined with an awareness of terrain features, wind direction etc.

6) If you are planning to attack down the left-hand side of the table, place your first squadrons towards the middle of the deployment zone and work outwards from there. If you put your first ships on the far left, your opponent will know exactly what you are doing. Also, by placing your ships nearer the centre and working outwards, you can change your mind and decide to attack down the right or the centre if the opportunity arises. You want to keep your opponent guessing at your plans until the very last moment if possible.

Of course, you could always bluff your opponent by placing a relatively cheap squadron far out on the right while you plan to attack down the left! Hopefully your opponent may become convinced that you are attacking on the right flank, when you are actually saving your bigger vessels for the strike on the left.

6) Try to avoid placing ships too close to terrain pieces. Remember that Man O' War is a game of magic as well as mighty ships, and there are a number of spells that can move ships a fair distance towards nearby islands and possibly run them aground!

7) Make sure that your squadrons' formations maximise your available firepower. If your ships have their main armaments firing from the front, place them in line abreast, like the Buccaneers in the above diagram that all have forward firing catapults.

If they have guns firing to port and starboard, this formation will lead to blocked lines of fire, so you should deploy them in a line astern, like the Corsairs in the diagram.

8) If you have some ships armed with rams, don't place them behind your other ships unless you intend to save them until later in the battle.

9) If you have some ships that can fire over other vessels, place them at the back. That way, both ranks of ships can fire.

If you manage to achieve most, if not all of these objectives with your initial deployment, you will be in a strong position to start the game.





THE EMPIRE

The Empire fleet is best described as solid. Its ships are tough, quite fast, have plenty of well-armed crew, lots of guns and can move under both oars and sail. In addition, many of its ships can ram, which makes them deadly close up. Empire ships are good all-rounders in most situations, and an Empire fleet is therefore a very good fleet to start with. What's more, you will already understand much of their tactical value and how to deploy them from playing with the Wargalleys that came with your game of Man O' War.

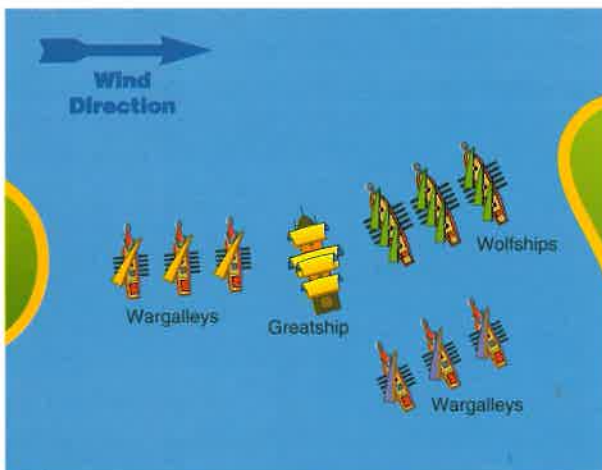

An Empire fleet is best deployed line abreast, as most of its ships' weapons are forward firing.

Deployment considerations

The Empire fleet is split into two very different types of warships: those which move under oars or sail (such as the Wargalley and Wolfship) and those that move under sail only (the Greatship). As an Imperial Admiral, you'll have to take this into account when you deploy and manoeuvre your vessels.

For instance, as Wargalleys and Wolfships can ignore the wind when moving under oars, they can be deployed upwind and also facing into the wind. These ships may move slightly faster under sail, but they can still make good headway into the wind using oars, which means that they are very flexible in their deployment. It is very difficult to position Wargalleys and Wolfships so that you can't move them out of trouble if you realise you have made a mistake. At the very worst, they have to spend a whole turn changing direction under oars so they are ready to move next turn.

Wargalleys and Wolfships make up the backbone of the Imperial fleet. They are designed so that all their offensive weaponry — their main guns and deadly rams — is pointing forward, so that they can cause as much damage as possible as they close with the enemy. In an ideal situation, a Wargalley or Wolfship is able to ram its target, possibly sinking it with one blow!

Remember that although Wargalleys and Wolfships are fairly vulnerable from the rear or from the side, they can quickly turn under oars to meet any new threat and are therefore rarely caught by surprise.

Wargalleys and Wolfships are best arranged in a line abreast. That way they can advance forwards rather like a moving wall of artillery, and make the idea of attacking them a daunting prospect for any opponent.

Alternatively, you could adopt a more limited frontage, and keep a squadron or two behind to support the front line ships. That way, if any enemy vessels break through the line, the ships behind will hopefully be in a position to fire at, or even ram and sink the intruders.

Wolfships provide the greatest hitting power in an Empire fleet, so they should be deployed where you want to do the most damage. Generally, it is a good idea to place them in the centre of your battle line, either with a screen of Wargalleys in front to draw out your opponent, or with Wargalleys to either side ready to ram any enemy ships that the Wolfships manage to pin down.

The tactics for an Empire fleet are relatively straightforward, or so it seems! The only problem it has is actually also its most powerful weapon — the Greatship.

The Greatship is a floating fortress, packed with warriors and bristling with guns that can fire in every direction. It can devastate squadrons of smaller vessels if it gets amongst them, and is a worthy opponent for the biggest ships of the other seagoing races.

From the point of view of the Imperial player, it is his most important ship, and his Admiral and Wizard will always be aboard. What causes a problem for the Imperial player is that the Greatship has no oars.

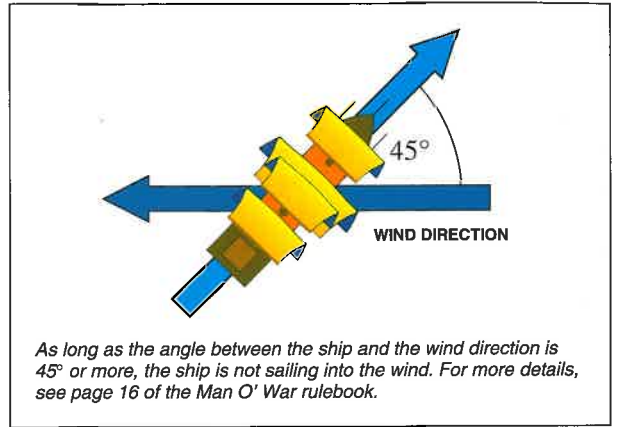

This means that the Greatship cannot sail into the wind or turn on the spot, and therefore has to be positioned very carefully at the start of the game. The deployment of the rest of the fleet must take this weakness into consideration, and unless you deliberately want to isolate your Greatship, it is no good having a strategy which relies entirely upon rowing your fleet into the wind.

The diagram below shows how taking the all important factor of wind direction into account during deployment allows a sailing ship like the Greatship to achieve the maximum freedom of movement. Positioning the ship at one end of the deployment zone (Greatship A), ensures that as long as the wind doesn't change it will be able to move freely, while positioning it at the other end (Greatship B), means it will be struggling against the wind immediately.

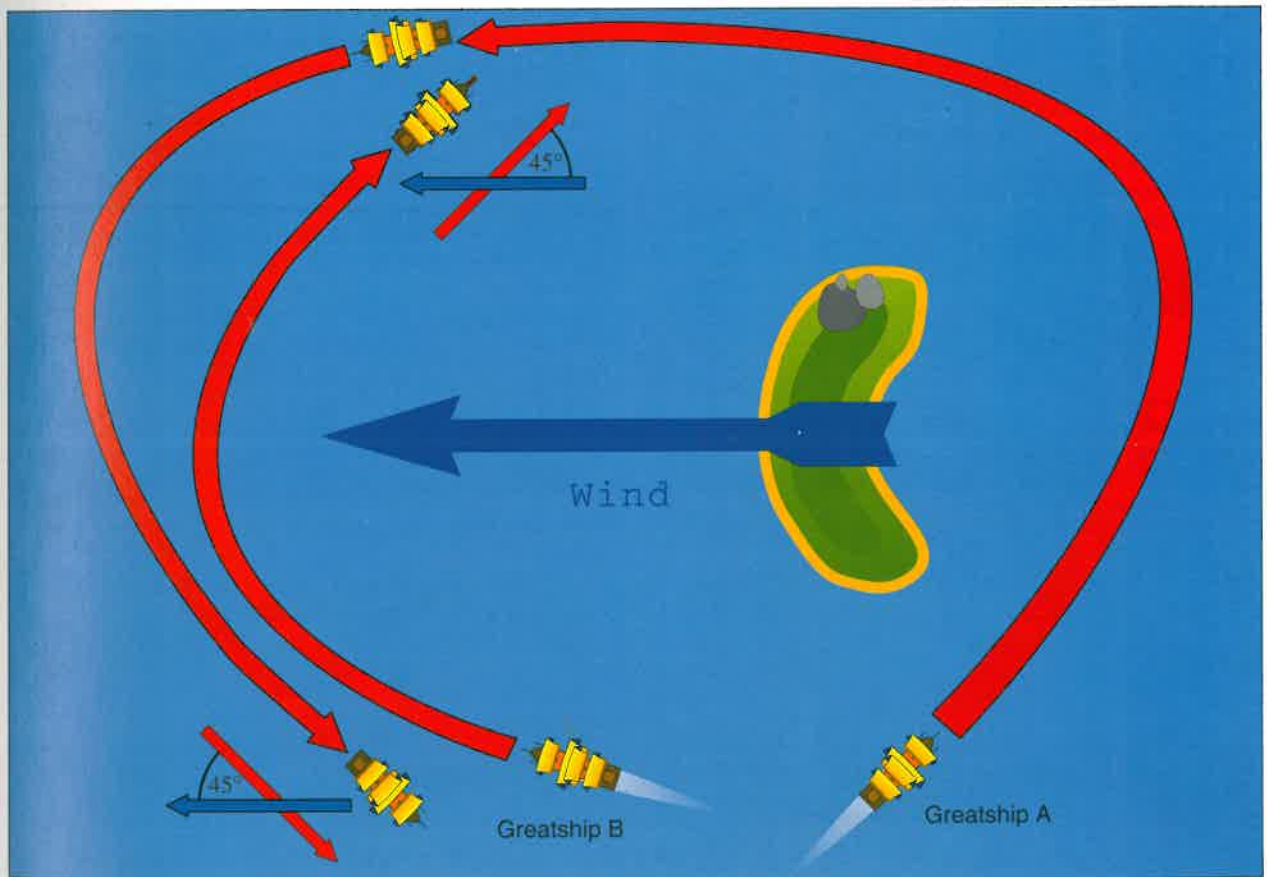

The Greatship is a powerful pivot for an Empire fleet, and is often used as the outer edge in a wheel formation designed to sweep round and trap the enemy. Positioning the Greatship at one end of your battle line gives it greater freedom of firepower, stops it being cramped and bogged down by other squadrons, and makes that end of the battle line a tough target.

Another option is to set up your fleet in a formation suited to oared ships and leave the Greatship until last. Placing the Greatship in the centre of the deployment zone, a little behind the front line ships, means that as the battle unfolds it can react to events, and is not committed to one particular end of the board.

You should decide what you intend to do with your Greatship at the start of the game and stick to it, unless things get desperate or an unrepeatable opportunity presents itself (and even then beware of traps!).

Your two choices are: commit your Greatship, sending it into the depths of the enemy formations where it will hopefully be able to bring guns to bear in all directions, or keep it back until the course of the battle seems to be clear. The former option can wreak utter devastation on the enemy, but you risk losing your flagship (and your Admiral and Wizard!). The latter is the safer bet, marshalling your forces for the right opportunity and safeguarding your characters, but does not maximise the amount of damage the Greatship can cause.

Even with a fairly simple Empire fleet, made up of Wargalleys, Wolfships and a Greatship, there are a great many decisions to be made when setting up your fleet. By the time you have mastered these Empire vessels, there are many more to collect, such as the Hellhammer with its single immense cannon, or the Ironfist with its huge siege mortar. These vessels present even more tactical options to try out as you refine your battle plans.



Empire Greatship

One important point to bear in mind is that it is often the case that no amount of heroic and brilliant manoeuvring later on will rescue your proud fleet from a flawed initial deployment. If your opponent has any sense at all, he will seize upon the opportunities presented by your lack of foresight (or carelessness) and will go a long way to destroying your fleet while you are still trying to get some sort of strategy together. Conversely, if you set up in a sensible fashion, taking the above points into account and your luck with dice is not as utterly dreadful as mine is sometimes prone to be, you should be able to cope with whatever your opponent throws at you.

THE DWARF FLEET

In some respects, the Empire fleet and the Dwarf fleet are fairly similar. Both fleets have ships that can ram, neither fleet depends on the wind, and both fleets have ships that are fairly tough. Looking at the fleets more carefully however, reveals stark differences!

On the face of it, the Dwarf fleet looks like being exceptionally good — streets ahead of the Empire in fact. Dwarf warships are harder to hit, have better saving throws, are nearly as fast as Empire ships, and can ram just as well. They also have specialist weapons, can repair damage, are naturally resistant to magic, cannot be boarded until a hole is blasted in their hull, and have a wonderful field of fire because their guns are mounted in swivel turrets. Looking at it from this point of view, the Empire player may be tempted to give up and sail off into the sunset before the battle even starts. However, there are weaknesses in the Dwarf fleet and strengths in the Empire fleet that balance out the two sides.

The most obvious weakness is that the Dwarf fleet has no Wizard and therefore cannot cast any spells. This means that although as a Dwarf player you can never assail your opponent with crippling spells in the game, you effectively have extra points to spend on another Ironclad or squadron of Monitors. This means you will probably have more squadrons than your opponent and will therefore gain an initiative advantage when deploying your fleet, as discussed earlier.

The downside is that your opponent has the whole spell deck to plunder! You will never be able to hold that spell he desperately wants, and he knows that if he cycles through the magic deck as quickly as possible he will get all the spells he needs — and there is nothing you can do to stop him.

The Dwarfs' natural magic resistance goes a little way to making up for this weakness, but as the Dwarfs, you should watch out for the opponent who stays well out of reach of your fleet for a few turns, casting spell after spell until your ships are magically immobilised, burning, run aground or crewless, and then closes in to finish you off with guns and swords.

Your other weakness is that you have comparatively few crew, and are therefore quite vulnerable to boarding actions. Although it is quite difficult to board a Dwarf ship (the ship has to have a hole blasted in its iron hull before it can be boarded), once your opponent is aboard he tends to have a big advantage in numbers.

Dwarf ships are therefore vulnerable to spells that kill crew, and are at risk of being turned into abandoned hulks. For both these reasons, you should endeavour to kill the enemy Wizard as quickly as possible.

Another weakness of the Dwarf fleet that your opponent might exploit if you are not careful is that Dwarf ships are much easier to bring to a halt than other vessels. A hit on the engine rooms or paddles stops them dead in their tracks and leaves them as sitting targets. There is no easy way to avoid this other than not getting shot!

With all this stacked against you, you may wonder what advantages you do have! The Dwarfs' secret weapon is the Nautilus. This unique submarine is very difficult to destroy when submerged, and can fire torpedoes to sink the enemy ships before they can do any damage. It is worth half-a-dozen normal ships if used properly.

Setting up a Dwarf Fleet

The Dwarf fleet has an even more flexible deployment scheme than the Empire fleet. Dwarfs have no sailing ships to consider, and so the wind plays no part in the decision about where to place your fleet. All Dwarf ships can turn on the spot, so it is very simple to change your mind about where the fleet is heading. The Nautilus can also submerge and sail under other ships in your fleet if you decide that you have put it in the wrong place.

Of course, it is still a good idea to decide what you are doing at the start of the game rather than trusting to the mobility of your ships to get you out of a mess later on.

Also, because the only ships in a Dwarf fleet organised in squadrons are Monitors, you have to worry much less about maintaining formation. Most of your ships are perfectly capable of acting on their own.

Whenever I play the Dwarf fleet, my set up tends to be a close grouping centred around the Ironclads. My Monitors are put on the flanks, and I often leave at least one Nautilus out to one side to act as a distraction, deterrent and general nuisance. Having a Nautilus skulking around on the edge of the board can put the enemy player off his plan, leading him to either split up his fleet while a number of ships go off sub hunting, or to forget about the Nautilus in the heat of the battle.

The bulk of the fleet is usually organised in a box formation, so that all the ships' turrets can be brought to bear from almost any angle, thus enabling the ships to protect each other.



Dwarf Ironclad

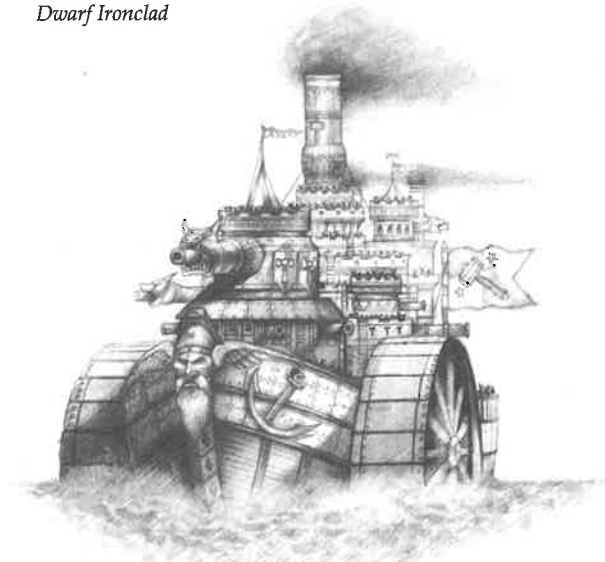

Playing hints for Dwarf Admirals

As a Dwarf player, I am not worried about getting shot at, especially at long-range, as my excellent saving throws and the extra +1 from being at long-range makes me almost invulnerable.

Having said that, my usual aim when playing with the Dwarf fleet is to get up close to the enemy ships and either ram them or destroy them with my gun batteries. Even at close range my saving throws are still pretty good, while the enemy ships will be suffering under my guns!

What I do not want to happen is to get engaged in a boarding action. As long as I generally present my flank to the opponent, maximising the cannon bonuses for defence, it is possible to fend off any enemy that attempts to board me. For instance, even though a 150 point Ironclad only has three crew (a Greatship gets 5 crew and costs the same), in a boarding action, so long as I am attacked from the side, I get a dice +6 in defence (+3 for the crew, and +3 for the guns). This is often enough of a deterrent to put off the most ardent attacker.

Monitors

Monitors are fast, difficult to hit, and have good saving throws. In a squadron of three they can prove a real headache for the enemy Admiral. Apart from anything else, he has to watch out for them ramming his ships with devastating effect.

As Monitors have very little crew, don't let them get involved in boarding actions. They are also vulnerable to being stopped in their tracks, as one well placed shot can immobilise them (though, like all Dwarf ships, they have engineers to try and repair the damage).

Because Monitors' guns are mounted in turrets, you shouldn't have any problems establishing line of sight. A squadron of Monitors should almost certainly be able to maintain positions that will guarantee all their guns can be brought to bear on the enemy.

Ironclads

Ironclads are very powerful ships, rivalling the Greatship in many ways. They are the pride of the Dwarf fleet, and a terrible foe to face. They might not have the firepower of a Greatship, but they can ram and do not have to worry about the wind. Because their turreted guns can be swivelled to face in any direction, Ironclads often move in a line astern so that they can fire deadly broadside salvos.

Looking at an Ironclad's template, you can see that its 'high' area is more difficult to hit than most other big ships— a shot which rolls 1 or 2 misses completely. Also note that there is no 'mid' section on an Ironclad like the fore and aftcastle on a Greatship. This means that an Ironclad has no locations that are vulnerable to being hit whether the shots are being aimed high or low.

The Nautilus

The Nautilus is best used in a hit and run capacity. Get as close as you can to the enemy in the turn before your torpedo attack, staying out of range or line of sight of his guns if possible. Next turn, submerge your Nautilus straight away, as once it dives it is safe for the whole turn. The following turn, surface it right next to a number of enemy ships and fire, so that even if your torpedo deviates it is likely to hit something. By the same token, try to avoid using torpedoes close to your own ships as deviations in this situation can be most embarrassing!

Try to make sure that when you do attack with the Nautilus, that there are plenty of your other ships close by to draw his fire. As the Nautilus is very vulnerable when it surfaces, you should try and make sure your opponent has to decide whether to try and sink the pesky Nautilus, or concentrate on getting his teeth into your bigger ships.

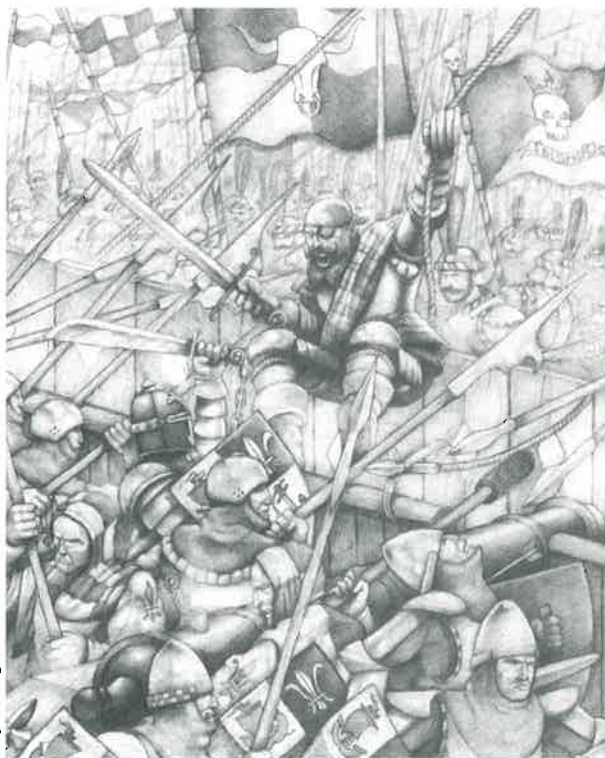

Wayne England

GENERAL GAMING HINTS AND TIPS

It is usually the case that the dynamics that govern the best way of setting up your fleet at the very start of the game will continue to be true throughout the battle. Be careful to maintain sensible formations for the type of ships you use, looking out for the wind if it affects them, and maintain squadron formation at all costs. Try not to move into positions that obstruct line of sight, especially if you have spent some time carefully setting up your fleet to avoid this in the first place.

The Initiative Advantage

In fact, it is a good idea to remember that Man O' War is a game of "phased initiative", that is, you each take it in turns to move and fight with a squadron or single vessel. This is an important difference to many of our other games, where each player takes it in turn to move and fight with all his forces. Phased initiative can be played to your advantage at certain parts of the game.

Although you should always be aware of which of your ships are under attack, *never* be tempted to retaliate by firing at an enemy ship that has just attacked you. It is likely that your opponent still has other ships to move, and where possible you should concentrate on disabling these to limit the damage inflicted on your fleet in the rest of the turn. You can always return to the ship that has just sunk your flagship at the end of the turn, and give it a good seeing to then.

A Typical Game of Man O' War

It is often the case that a game of Man O' War has several distinct stages:

First of all the two fleets are deployed.

Next comes several turns spent manoeuvring for position, looking for a gap in the opposing fleet's formation.

Then there is a 'waiting' phase, where both fleets are in position and ready to fight, yet no-one is willing to make the first move. This is generally because both sides start the turn out of range, but are well aware that the player who moves first will probably move his ships within the enemy's long-range, after which the enemy will move up to close range and give his ships a good hammering.

If you get into this position, you can use the phased initiative to your advantage by moving your smaller ships first, or those that obviously cannot do anything this turn (if they are too far away to get involved in the fray this turn, for instance). That way, you may force your opponent's hand.

At any time during the game there may be ships around that are 'ineffective'. This may be because they are too far away to get involved this turn, or that they are so badly damaged that they are almost hopeless in battle.

As a rule, it is a good idea to use your 'ineffective' ships first in any turn, to try and save your 'effective' ships until your opponent has moved most, if not all of his ships. Even if you pick a ship which is immobilised and has no guns left and say 'this ship is doing nothing this turn', you are hopefully forcing your opponent into action, and maintaining the initiative advantage.

THE BATTLE OF DEATH'S POINT

The notes over the next few pages tell the story of the vital moments of The Battle of Death's Point, just off the coast of L'Anguille, that occurred when the Dwarf fleet of Hengist Hendrikk was attacked by the Bretonnian fleet of Admiral Villeneuve.

The Dwarfs were waiting to secretly rendezvous with an Empire fleet, ready to attack the port. However, the Bretonnian Sea Lords had become aware of the Dwarfs' presence and decided that attack was the best form of defence. They dispatched two mighty fleets to prevent the rendezvous taking place: one to ambush the Dwarfs and one to track down the Empire fleet and destroy it. The fateful meeting between the Dwarfs and the Bretonnians is known as the Battle of Death's Point.

The Dwarf's Admiral, Hengist Hendrikk, didn't catch sight of the Bretonnian's approach until almost the last minute, and had to make a rapid decision — should he make good his escape and try and rendezvous with the Empire fleet, or should he turn about and face the Bretonnian dogs? To Hengist there was no real choice the klaxons of the Ironclad *Doomhammer*, the fleet's flagship, sounded the signal for battle.

By the time the Bretonnians arrived, the Dwarfs had hastily formed into a wall, made up of three Monitors and the *Doomhammer*, flanked by the *Nautilus Silent Death*. Behind the iron battle line waited a second squadron of Monitors, ready to intercept any stray Bretonnians who broke through.

As the fleets stormed towards each other, the Bretonnian Admiral Villeneuve, with over twenty years experience at sea, decided to adopt a snake formation with his two squadrons of Corsairs, and hold the right flank with his

flagship, the immense Galleon *L'Indomitable*. With the wind abreast, the Corsairs strung out nose-to-tail over many leagues, presenting a broadside wall of hundreds of cannon to the approaching Dwarfs.

Both fleets faced the daunting prospect of sailing into a curtain of cannon fire, as each fleet's vessels were in the optimum positions to attack.

We take up the action just as Admiral Villeneuve has lost the initiative to Admiral Hengist Hendrikk. The diagrams and notes over the next few pages take us through the first turn of the game in which shots were exchanged. The manoeuvring for position is already done, and the fleets are ready for the blood and iron of battle.

The Bretonnians have lost the initiative, and look like they'll be rammed, torpedoed and blasted out of the water. However, the Bretonnian Wizard Lord — *Andre L'Inflammable* of the Bright College, successfully casts a *Panic* spell on the Dwarfs, getting past their natural magical resistance. As the Dwarfs struggle with numerous blazes that spring up, the Bretonnians seize the initiative and attack.

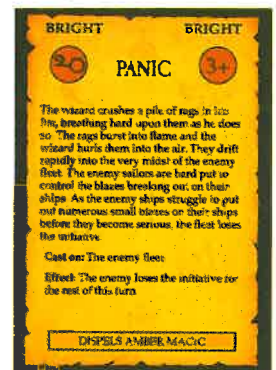

BRETONNIAN SQUADRON 1

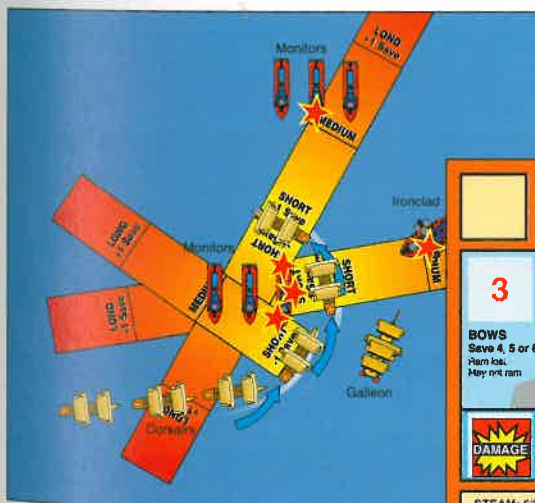

The *Firebreath* is sent to a watery grave by the *Chevaliers de la Soleil*.

The Corsair Squadron *Chevaliers de la Soleil* break through the Dwarf battle line, encircling the Monitor *Firebreath* and unleash a devastating hail of cannon fire upon the hapless Dwarf vessel from all three ships.

Although a difficult target due to its low waterline position, the Monitor takes four direct hits at close range, which prove too much even for the tough Dwarf ship. Immobilised by a well aimed shot that destroys its paddle wheel, and disarmed by another that wrecks its turret, *Firebreath* is ruptured by two more close range salvos to the same locations, causing critical damage and splitting its hull from end-to-end.

MAN O' WAR – THE BATTLE OF DEATH'S POINT

Meanwhile, the lead Corsair, *L'Espace*, finds a medium range target for its right broadside, and lets loose a volley at the Monitor *Hammerblow*, flagship of the second Monitor squadron. Perhaps due to the range, or to the distraction of the explosions to its left side, *L'Espace* misses and all of the shots splash harmlessly into the sea.

Soleil Rouge, the squadron leader of the *Chevaliers* fares much better, unleashing a devastating broadside at the Ironclad *Doomhammer*, smashing its fore turret and bridge.



| DWARF IRONCLAD | | | | | CREW |
|--|--|--|--|------------------------------|------|
| MAN O' WAR | | | | | |
| DAMAGE FORE TURRET Save 5, 4, 3 or 6 Fore turret guns lost | DAMAGE BRIDGE Save 4, 5 or 6 | 5 FUNNEL Save 5 or 6 | 6 AFT TURRET Save 3, 4, 5 or 6 Aft turret guns lost | HIGH | |
| 2 BOWS Save 3, 4, 5 or 6 Ram lost. May not ram | 3 GUN DECK Save 3, 4, 5 or 6 Broadside battery lost | 4 PADDLER Save 3, 4, 5 or 6 Simpson's | 5 BOILER Save 4, 5 or 6 Impoverished | 6 STERN Save 4, 5 or 6 | LOW |
| NO EFFECT | NO EFFECT | SINKS | BELOW WATERLINE Save 3, 4, 5 or 6 First and second hits have no effect Third hit sinks ship | | |
| STEAM: 6"(6") | | | BATTLE HONOURS: 6 | | |

DWARF SQUADRON 1

Overcome with fury, Hengist commands the *Doomhammer* to ram the impudent Corsair that has just fired at him.

The *Doomhammer's* ram bites home with devastating effect, smashing the *Soleil Rouge* in two and splintering the proud Bretonnian ship into unrecognisable pieces of matchwood.

| BRETONNIAN CORSAIR | | | | CREW |
|---|---|------------------------------|---|------|
| SHIP OF THE LINE | | | | |
| 4 FORE MAST Save 5 or 6 Mast lost Ship speed reduced by 3" Any further hits do not cause critical damage | 5,6 AFT MAST Save 5 or 6 1st hit reduces speed by 2" 2nd hit reduces speed by a further 3" Any further hits do not cause critical damage | HIGH | | |
| 2 FORECASTLE Save 5 or 6 1 broadside cannon battery lost | 3 MAIN DECK Save 5 or 6 1 broadside cannon battery lost | LOW | | |
| 4 BOWS Save 4, 5 or 6 | 5 GUN DECK Save 4, 5 or 6 1 broadside cannon battery lost | 6 STERN Save 4, 5 or 6 | | |
| DAMAGE DAMAGE DAMAGE | | | BELOW WATERLINE Save 4, 5 or 6 First and second hits have no effect Third hit sinks ship | |
| SAIL: 9"(9") | | BATTLE HONOURS: 4 | | |

At the same time the *Doomhammer's* remaining guns speak for the first time in the battle, as its aft turret and left broadside guns fire at the Galleon *L'Indomitable*. However, true to its name, the Bretonnian Flagship suffers little damage, other than a gaping hole in its bows.

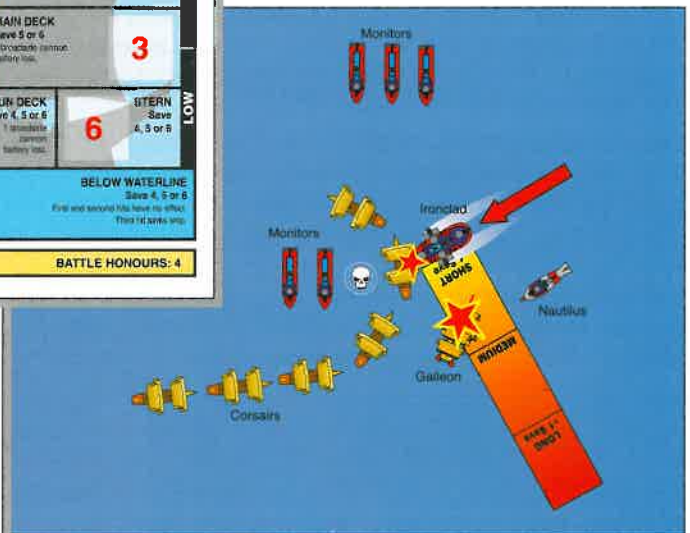

Soleil Rouge and *L'Indomitable* come under attack from the *Doomhammer*.

| BRETONNIAN GALLEON | | | | CREW |
|---|---|--|-------|---|
| MAN O' WAR | | | | |
| 4 FORE MAST Save 5 or 6 First hit has no effect. Second hit destroys mast. Ship speed reduced by 3" Any further hits do not cause critical damage | 5 MAIN MAST Save 5 or 6 First hit has no effect. Second hit destroys mast. Ship speed reduced by 3" Any further hits do not cause critical damage | 6 AFT MAST Save 5 or 6 First hit has no effect. Second hit destroys mast. Ship speed reduced by 3" Any further hits do not cause critical damage | HIGH | |
| 2 FORECASTLE Save 4, 5 or 6 Broadside cannon battery destroyed | 3 AFTCASTLE Save 4, 5 or 6 Broadside cannon battery destroyed | LOW | | |
| DAMAGE BOWS Save 4, 5 or 6 | 5 GUN DECK Save 4, 5 or 6 Broadside cannon battery | 6 STERN Save 4, 5 or 6 | | |
| NO EFFECT | NO EFFECT | NO EFFECT | SINKS | BELOW WATERLINE Save 4, 5 or 6 First, second and third hits have no effect Fourth hit sinks ship |
| SAIL: 9"(9") | | BATTLE HONOURS: 6 | | NAME: |

In retrospect, the Dwarf Admiral might have been better served attacking another ship — perhaps concentrating everything on the Bretonnian Galleon.

After all, the Corsairs have already moved this turn and thus pose no further threat. The Galleon, on the other hand, has yet to move, and its guns can easily sink a ship in one turn. As it turned out however, luck was with the Dwarf fleet and the decision to ram paid off, sending the Corsair to the bottom of the sea.

BRETONNIAN SQUADRON 2

Villeneuve decides to take *L'Indomitable* into the fray, and sails between the Ironclad and the Nautilus, ready to unleash the full fury of his guns at them from close range. The ship's cannons roar and the area is covered with thick powder smoke. As it clears, Villeneuve sees that the *Doomhammer* is listing heavily, now with its fore turret on fire as a result of another hit, and black smoke pouring from its ruptured funnels.

| DWARF IRONCLAD | | | | | | CREW |
|---|---|--|--|---------------------------------|------|---|
| BLAZE FORE TURRET Save 3, 4, 5 or 6 Fore turret gone! | | DAMAGE BRIDGE Save 4, 5 or 6 | | DAMAGE FUNNEL Save 5 or 6 | | 6 AFT TURRET Save 3, 4, 5 or 6 +2 extra gun lost |
| 2 BOWS Save 3, 4, 5 or 6 Fore and aft turrets lost | 3 GUN DECK Save 3, 4, 5 or 6 Barracks, gunpowder | 4 PADDLER Save 4, 5 or 6 Propellers | 5 BOILER Save 3, 4, 5 or 6 Ironclad | 6 STEM Save 4, 5 or 6 | HIGH | |
| BELOW WATERLINE Save 3, 4, 5 or 6 Fore and aft turrets lost Turret not on fire | | | | | | LOW |
| STEAM: 6"(6") | | | | | | BATTLE HONOURS: 6 |

The *Doomhammer* is heavily damaged by *L'Indomitable's* attack – its turret is set ablaze and its bridge and funnel destroyed.

The *Silent Death's* conning tower is caught by the *L'Indomitable's* volley.

| DWARF NAUTILUS | | | CREW |
|--|---|---|-------------------|
| INDEPENDENT | | | |
| 3 BOWS Save 5 or 6 Trebuchet masts lost | DAMAGE CONNING TOWER Save 5 or 6 Turret gun lost | 6 ENGINES Save 5 or 6 Ironclad | |
| 5 HULL Save 5 or 6 | | | |
| BELOW WATERLINE Save 6 Fore and aft turrets lost | | | |
| STEAM: 6"(6") | | | BATTLE HONOURS: 3 |

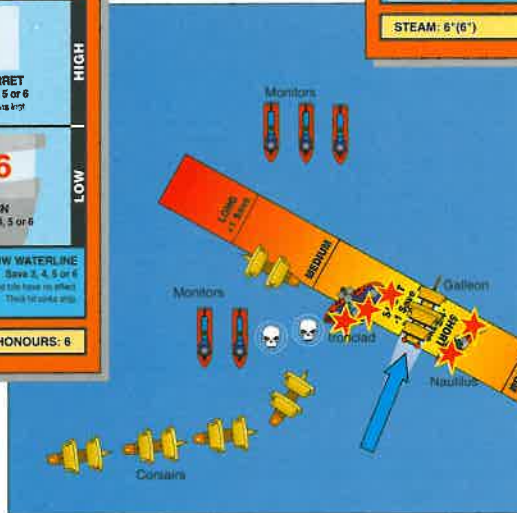

To the right, the Nautilus, *Silent Death*, fares better, skillfully jinking to avoid most of the incoming shots. However, its turret is clipped, and now sits askew on its mounting, leaking hydraulic fluid and oil through rents torn in the swivel casings.

DWARF SQUADRON 2

The klaxon aboard the stricken *Doomhammer* blares, signalling the remaining two frontline Monitors, *Ironteeth* and *Hammer of Grungni*, to attack. Seizing the moment, they surge forwards, their paddles clawing the water for extra purchase. Their evil looking prows break the surface of the waves as they head straight for the leading Corsair in the second Bretonnian squadron, *Rage*. Hemmed in to fore and aft, *Rage* has no time to react, and the Monitors' rams bite home, deep below the Corsair's waterline.

For a moment, it looks as though the Bretonnian vessel may hold fast, albeit crippled and taking on water at a rapid rate. Then the massive cannons mounted in the Monitors' turrets roar, smashing into *Rage's* gundeck. A column of fire leaps hundreds of feet into the sky as *Rage* is critically damaged and its hull is blown apart.

| BRETONNIAN CORSAIR | | | | CREW |
|---|--|-----------------------------|--|-------------------|
| SHIP OF THE LINE | | | | |
| 4 FORE MAST Save 5 or 6 Mast lost Ship speed reduced by 3" with further loss do not reuse critical damage | 5,6 AFT MAST Save 5 or 6 Mast lost Ship speed reduced by 3" with further loss do not reuse critical damage | | HIGH | |
| 2 FORECASTLE Save 5 or 6 1 breakable wooden battery lost | 3 MAIN DECK Save 5 or 2 1 breakable cannon battery lost | | LOW | |
| 4 BOWS Save 4, 5 or 6 | DAMAGE GUN DECK Save 4, 5 or 6 1 breakable cannon battery lost | 6 STEM Save 4, 5 or 6 | BELOW WATERLINE Save 4, 5 or 6 Fore and aft turrets lost Turret not on fire | |
| SAIL: 9"(9") | | | | BATTLE HONOURS: 4 |

She stays speared on the rams of the Dwarf ships for mere moments, then slides off and vanishes beneath the waves with all hands. *Rage* is lost without firing a shot in anger.

The *Ironteeth* and *Hammer of Grungni* ram the *Rage*, blowing it apart.

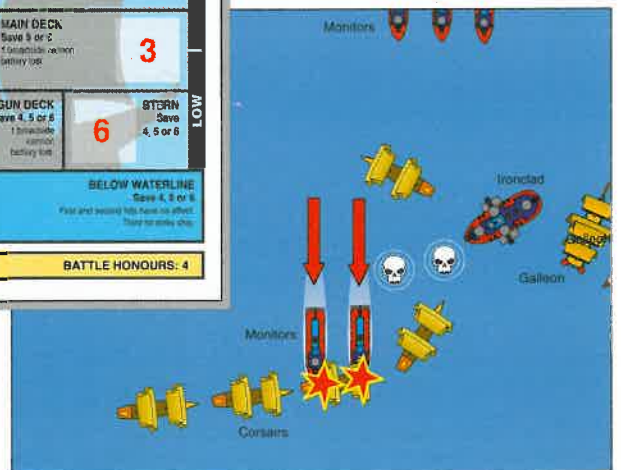

BRETONNIAN SQUADRON 3

The last Bretonnian ships in the squadron, the Corsairs *Fury* and *Tempest*, now have few options open to them. Their path is blocked to the fore by the wreckage of *Rage*, so all they can do is attempt to destroy the impudent Monitors who sank their compatriot.

Fury slides forwards in the water, nudging up to the wreck of *Rage*, and unleashes a broadside at *Ironteeth* from close range. The tough hull of the *Ironteeth* withstands the hammering however, and none of the Bretonnian vessel's shots manage to penetrate its iron hull.

Tempest manoeuvres into a position where it is actually touching *Ironteeth* before firing hundreds of cannon balls at the hapless Monitor. The Dwarf ship shakes under the impact and, as the fog of smoke clears, a gaping hole on its foredeck is all that is left of the turret.

Horns on the *Tempest* sound the charge, and heavily-armed Bretonnian warriors leap aboard the Dwarf vessel, storming through the hole made by their cannon

shells to attack the Dwarfs inside. Outnumbered, the Dwarfs put up a brave fight, but the end is inevitable. The Monitor is captured and scuttled by the bold Bretonnians, who return victorious to their own ship.

The Ironteeth is attacked from two sides and boarded.

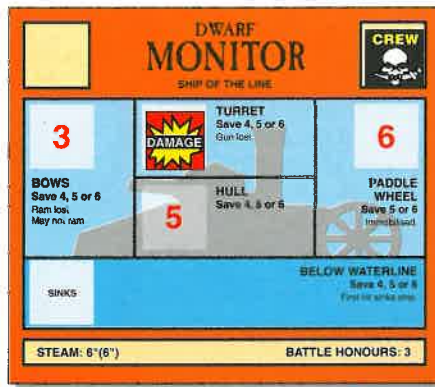

The Bretonnian Corsair Tempest and Fury pour volleys of fire into the Monitor Ironteeth

DWARF SQUADRON 3

Seeing the confusing mass of smoke, fire and debris to the fore, the Captain of the damaged Nautilus realises that he has to make an effort to save the day, even though it risks the death of all his crew. He decides to submerge and make a torpedo attack before the Bretonnians wreck any more damage on the Dwarf fleet.

Diving in a damaged Nautilus is a risky business, and the crew hold their breath as the hull creaks and groans under the pressure. Water leaks through numerous small cracks, but the Nautilus holds together, giving mute testimony to the skills of the engineers who built it.

Through the Dwarf Captain's periscope the Bretonnian Corsair *Lune* looms large before him. Holding off until the last moment — to avoid any chance of the torpedo

veering off and hitting one of the other Dwarf ships, the Nautilus moves closer. Finally the firing handle is cranked, and with a hiss of air the torpedo speeds away towards its unsuspecting target.

The first the Bretonnian Captain knows of the torpedo attack is a massive explosion which rocks his ship from stem to stern. Knowing his vessel is doomed, the Captain orders his crew to take to the lifeboats, before retiring to his cabin to await the inevitable end with honour.

| | | | |
|---|--|--|--|
| BRETONNIAN CORSAIR SHIP OF THE LINE | | | CREW |
| 4 FORE MAST Save 5 or 6 Mast lost Ship speed reduced by 3" Any further loss do not cause critical damage | 5,6 AFT MAST Save 5 or 6 Mast lost reduces speed by 3" Any further loss do not cause critical damage | HIGH | |
| 2 FORECASTLE Save 5 or 6 1 broadside cannon battery lost | 3 MAIN DECK Save 5 or 6 1 broadside cannon battery lost | LOW | |
| 4 BOWS Save 4, 5 or 6 | 5 GUN DECK Save 4, 5 or 6 1 broadside cannon battery lost | 6 STERN Save 4, 5 or 6 | BELOW WATERLINE Save 4, 5 or 6 Prop and rudder not hit, no effect. (Third hit sinks ship) |
| DAMAGE | | DAMAGE | |
| SAIL: 9"(9") | | BATTLE HONOURS: 4 | |

The Bretonnian Corsair *Lune* is torpedoed and sunk.

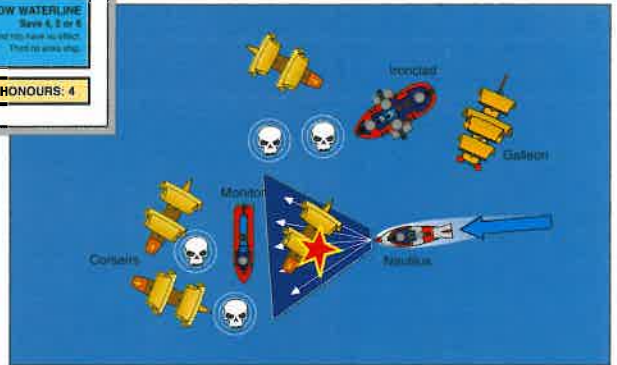

DWARF SQUADRON 4

| | | | |
|---|---|--|--|
| BRETONNIAN GALLEON MAN O' WAR | | | CREW |
| 4 FORE MAST Save 5 or 6 First hit has no effect. Second hit destroys mast. Ship speed reduced by 3" Any further loss do not cause critical damage | 5 MAIN MAST Save 5 or 6 First hit has no effect. Second hit destroys mast. Ship speed reduced by 3" Any further loss do not cause critical damage | 6 AFT MAST Save 5 or 6 First hit has no effect. Second hit destroys mast. Ship speed reduced by 3" Any further loss do not cause critical damage | HIGH |
| 2 FORECASTLE Save 4, 5 or 6 Broadside cannon battery damaged | 3 AFTCASTLE Save 4, 5 or 6 Broadside cannon battery destroyed | LOW | |
| DAMAGE BOWS Save 4, 5 or 6 | 5 GUN DECK Save 4, 5 or 6 Each hit destroys 1 broadside cannon battery | 6 STERN Save 4, 5 or 6 | BELOW WATERLINE Save 4, 5 or 6 Prop, rudder and stern not hit, no effect. Fourth hit sinks ship |
| NO EFFECT | NO EFFECT | NO EFFECT | SINKS |
| SAIL: 9"(9") | | BATTLE HONOURS: 6 | NAME: |

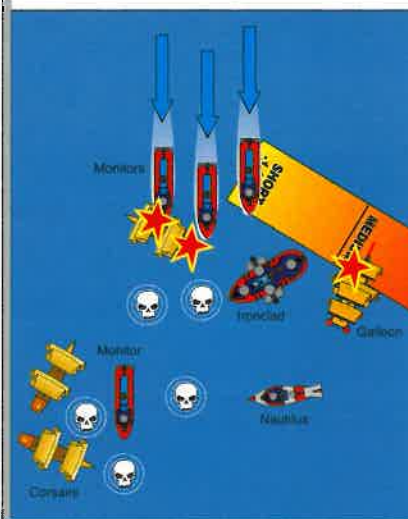

Finally, the Captain of the trailing Monitor squadron judges the time is right to attack. The Bretonnians are pre-occupied with the action around the centre of the battle, and seem to have forgotten them.

Two of the Monitors crash into the side of the Corsair *L'Espace*, but although shaken she doesn't shatter, and resists the impact of the attack.

To make matters worse for the Monitors, both their shots miss, leaving them in the unenviable position of facing an undamaged wall of heavy cannon.

The only thing left for the Dwarf fleet to do this turn is for the last Monitor to fire a shot at the Bretonnian Galleon, blowing away the top half of its foremast.

 **GAMES WORKSHOP** 
WARHAMMER
DAYS



**PAINTING
AND
MODELLING
DEMOS**

**QUIZZES!
COMPETITIONS!
PRIZES!**

Throughout the spring and summer, every Games Workshop store in the UK will be running special Warhammer days. There'll be competitions, prizes, quizzes, painting and modelling demonstrations and of course loads of games of **Warhammer**, **Warhammer 40,000** and **Space Marine** that you can join in with.

Games Workshops' expert gamers, painters and modellers will all be there, so come along and join in the fun!

WARHAMMER DAYS IN APRIL AND MAY

24th April

Cardiff and Leicester

15th May

Portsmouth and Croydon

8th May

Edinburgh and Dudley



LOOK OUT FOR FUTURE WARHAMMER DAYS AT STORES NEAR YOU

HORUS HERESY

By Jervis Johnson and Bill King

This month sees the release of *Horus Heresy*, the second game in the Jervis Johnson Wargame Series. We have asked Jervis to describe the background and development of the game, and Bill King has also written an historical overview of the campaign and its titanic battles.

Unlike most of our other games, which recreate individual battles using Citadel Miniatures to represent the armies, our Wargame Series games concentrate on entire campaigns involving hundreds, thousands or even millions of men. Such vast conflicts are impossible to recreate on the tabletop (unless your collection of Citadel Miniatures runs into thousands of models!), and so the Wargame Series games use a colourful mapboard and sets of cardboard counters to recreate the conflict.

For *Horus Heresy*, we decided to look at what is without doubt the single most important campaign in the history of the Imperium – the Battle For Earth. The game map shows the terrain over which the campaign took place, while each counter represents a unit of troops rather than an individual soldier. The scale of the map and the size of the units represented by the counters can vary. For example, in *Warmaster*, the free Wargame Series game in this issue of *White Dwarf*, the map shows Horus's spaceship and each counter represents a full company of troops. In *Horus Heresy*, on the other hand, the map shows the Emperor's Palace and the surrounding space ports and fortresses. These cover an area of several hundred square miles, and each counter represents a complete Imperial Guard army or an entire Space Marine Chapter.

Horus Heresy begins at the start of the Battle For Earth, just as Horus's invasion force lands on the planet. One player commands the Traitor forces led by Horus. Under his command are all of the units that fought in the campaign; Traitor Space Marine Chapters, foul Daemonic Hordes, enormous Chaos War Engines and much more. The other player commands the loyal Imperial forces defending the Imperial Palace, including three full Chapters of Space Marines and an equal number of Titan Legions, as well as numerous Imperial Guard armies and Tank Divisions.

The game is split into 5 turns, each of which represents about two weeks of the campaign. At the start of each turn you decide on a plan for your army by picking two strategy cards, which list your tactical options, in a similar way to *Armageddon*. If, for example, you had a 'Movement & Combat' card, you could move and then attack with your counters. Once both players have chosen their cards, they each roll a D6. Whoever scores highest wins the initiative and goes first, flipping over the top card in his stack of strategy cards and carrying out the two phases listed on the card in the order shown. His opponent then flips over his top card, and so on.

The game board is divided into a number of different sized areas and each counter is given a movement value, which shows how many areas it can move in a turn. Most units have a movement value of one, while swiftly moving units such as

Disc Riders can have a movement value as high as 4 or even more. In addition, each counter is rated for its ability to attack and defend.

For example, the 9th Terran Army (an Imperial Guard unit) has an attack value of 2 and a defence value of 4, showing that it is better on the defensive than when ordered to attack. A unit of Khorne Juggers, on the other hand, has an attack value of 6 and a defence value of 3, as befits troops that are famed for the devastating charge that they deliver! Combat is resolved by comparing the strengths of each side's counters, and then rolling a dice on the special *Combat Results Table* that is included with the game.

Due to the fact that the Chaos forces can land anywhere on the map at the start of the game, it is rare for any two games of *Horus Heresy* to be the same. During playtesting we found that most games were not decided until the fifth and final turn, making for an exciting and closely fought contest. The number of possible set-ups and strategies are endless, and ensure that what works in one game is unlikely to do so in another. Your choice of strategy, combined with the luck of the dice, will always decide the outcome of the campaign. Will you be able to emulate the Emperor and turn back the Chaos hordes to save Mankind? Or can you do better than *Warmaster Horus*, and in the process doom Mankind to eternal slavery under the dark gods of Chaos? The fate of the Imperium is in your hands...



On the thirteenth of Secundus, 30,014, the bombardment began. From orbit the Warmaster's ships laid down an unrelenting barrage of missiles and deadly energy beams. The aim was to cripple the defences around the Emperor's Palace and make possible a massive invasion of Earth. The lunar bases had already fallen and the defending fleets had been scattered. On Mars, as across the entire vast Imperium, bitter civil war raged.

On countless worlds blood-mad warriors clashed. Some had pledged loyalty to the Emperor. Others had sworn fealty to Warmaster Horus, and, through him, to the dark powers of Chaos. The Emperor's realm was in turmoil and some of the greatest battles in human history were being fought. On the hive-world of Thranx over a million warriors died in a single day on the killing fields of Perdagor. On the blazing deserts of Tallarn, at the Ka'an Salient, fifty thousand tanks clashed in the greatest armoured action of all time. During the spacedrop on Vanaheim three hive-cities were depopulated by rebel forces as a warning against resistance and still the defenders fought to the last man.

Like a cancer the Heresy infected the entire structure of the Imperium. Everywhere brave men gave up their lives to try and excise that cancer.

It was on Earth, at the very heart of humanity's realm, that the fate of the galaxy was to be decided. In those last days, the sky was black with dustclouds and the earth was split by gigantic fissures. Tectonic plates shifted under the stress of the bombardment. Mountain chains shivered and seas evaporated and became salty deserts. Rains of blood and ash dripped from the dark sky. Everywhere oracles muttered evil portents and men went mad with fear.

Hideously twisted ships full of the lost and the damned hung in orbit over the ravaged world. Shielded from the devastation by the cunningly wrought defences of the Adeptus Mechanicus a pitiful few stood ready to repel the invaders.

The embattled remnants of the Emperor's army were desperately trying to hold out until reinforcements arrived. The Emperor himself oversaw the defence of his fortress-palace, personally commanding the Adeptus Custodes, his elite guard. He was accompanied by Sanguinius, white-pinioned Primarch of the Blood Angels and his Chapter of Space Marines. In the palace grounds stood the stalwart Adeptus Arbites.

The palace was not the only bastion of resistance. There were others; each an awesome fortified city filled with dauntless soldiers. Beneath their Fortress-Monastery, grim-visaged Rogal Dorn led the stern Imperial Fists in final prayers. Within the armoured factory complexes of the Adeptus Mechanicus, tech-priests put aside their tools and girded on the fearsome weapons of their order. In the rubble of burned-out harems Primarch Jhagatai Khan mustered the White Scars, the Chapter of Space Marines he had personally instructed in the art of lightning warfare. Three full Titan legions stood ready to defend their Emperor.

As the earth shuddered under the bombardment, tank divisions roared across the tortured landscape to take up their position against the coming invasion. Brave men checked their weapons and offered up last prayers. Defence lasers swivelled to face the turbulent threatening sky. Suddenly, the night was streaked by the plasma contrails of drop-pods. Within the Emperor's halls even the Space Marines shuddered knowing that they would soon confront their lost and damned brethren. The terrifying prospect of facing those corrupt Primarchs who had sold their souls to Chaos filled every man's mind with indescribable horror and dread.

The pods touched ground and from them erupted the mightiest champions of Chaos, the renegade Space Marines of the lost Chapters. These were no longer the fine human warriors of legend but twisted creatures, bodies warped by the energies of Chaos, minds twisted by their devotion to the dark powers. If what had happened to the Space Marines was bad then what had happened to their Primarchs was worse. They had been created higher in the Emperor's esteem and had fallen further. None of their former comrades would have recognised them – they had been transformed into creatures both daemonic and exultant.

Mighty Angron bellowed orders to his blood-drinking followers, the World Eaters. Brandishing his great runesword he led them against the defenders of Eternity Wall Space Port. Around his red-armoured followers bolter shots whined. Unflinchingly they advanced, determined to spill blood for the Blood God.



At Mortarion's soft-spoken command the Death Guard emerged silently from the festering cocoons of their drop-pods and advanced on their terror-stricken foes. The dread runes on Mortarion's scythe glittered eerily in the night as he gestured for them to advance.

Magnus the Red glared triumphantly about him with his one watchful eye before ordering the mage-warriors of the Thousand Sons to cast their spells of doom. A hail of deadly bolter shells cut down dozens of the Emperor's Children. Undeterred, the wounded howled with pleasure at the experience and chanted the praises of their Primarch Fulgrim. The Renegade Space Marines surged forward to carve a path through their foes.

Perhaps some defenders went mad with fear. Perhaps the corruption of Chaos ran deeper than anyone suspected. Perhaps some were foolish enough to think that they could negotiate with the ultimate enemy. Whatever the reason one last vile treachery was to take place. Many units of the Imperial army that had pledged loyalty to the Emperor turned blasphemers even as the Traitor Space Marines made their drop. It was almost as if it were a pre-arranged signal. In one of the basest acts of betrayal in humanity's history they turned their weapons on their brother warriors and cut them down like dogs. Thus did the Lions Gate Space Port fall to the rebels. As the heretics chanted and howled their mad prayers, the air shimmered and slavering daemons emerged from the warp to spread terror and dismay.

Then indeed did it seem to the defenders that they were living in the last days of mankind. Huge bat-winged Bloodthirsters swept triumphantly across the weeping skies. Clawed Keepers of Secrets danced lasciviously on piles of corpses. Great Unclean Ones chuckled as they lumbered through the ruined streets spreading trails of filth and slime and disease. Enigmatic Lords of Change perched atop the towers and statues and supervised the coming of Chaos to the heart of the world.

Mighty ships began the descent from orbit, hoping to overwhelm the defenders by sheer weight of numbers. Unlike the drop-pods these presented fine targets for the weapons of the defenders. And thus did the battle for Earth begin in earnest.

Defence lasers blasted many renegade ships from the sky, sending thousands of tons of fused metal death raining down onto the ground below. One giant craft span out of control and crashed into a hab-unit, killing a hundred thousand people. Another was welded to the ground, disgorging its passengers into a lake of bubbling tar and plas-crete. The vessel of the Warped Dogs was vapourised and that Titan Legion's name passed into history.

As quickly as they disembarked the Traitors surged forth from the space ports to besiege the bastions of the defenders. Their first objective was to silence the defence lasers inflicting such casualties on their comrades. The rebels were met by a wave of Imperial defenders, desperate men who knew that they were giving their lives for their home and their Emperor.



In the tightly packed streets around the space ports the fighting was close and deadly. Bolters chattered and missile launchers delivered cargoes of death from building to nearby building. Traitor tanks rumbled through the avenues, turrets swivelling to bring weapons to bear on the hastily improvised barricades of their former comrades.

Soon the defenders of Eternity Wall Space Port had been swept aside by the merciless assault and the hordes of the Warmaster were in total possession of the spacefield. More and more intricately wrought drop-ships descended from orbit. They towered over the landing ground like nightmare skyscrapers. The dark runes on their sides glowed evilly in the gloom. Hundred-metre high doors opened in their kilometre-long sides. From their red depths Titans ten times the height of a man emerged. They were warped giants; the armour of their carapace fused and moulded into new shapes by the power of Chaos. Within them were men melded to their machines. Some of the hideous Titans had strange and potent weapons, others were a bizarre hybrid of the organic and the machine. Metal tentacles lashed, spiked tails whipped back and forth. Engines roared like the voices of angry beasts. Banners fluttering, the Titans of Storm Lords and the Flaming Skulls legions marched forth. At Lions Gate Space Port the traitors welcomed the towering black war engines of the Khornate host. Minotaurs and trolls and cultists seethed like angry ants around their bases.



Reinforced by this fresh wave of troops the hordes of Horus swept on, driving through the exhausted and demoralised Imperial troops to the very walls of the Emperor's palace. Khornate warriors mounted on bestial daemonic Juggers raced towards the marble and steel outer ring. Hordes of horn-headed Tzeentchian disc riders soared on the wind, bolts of mystic power erupting from their clenched fists to rake the defenders. Slaaneshi beast riders swept aside the Imperial Guard infantry and reached the Saturnine Gate.

Round the walls bitter fighting ensued as the Imperials sallied forth, trying to drive the attackers back before the main body of the assaulting troops arrived. Men died in their thousands. From pillbox emplacements in the palace walls Imperial gun crews rained death down on the relentless attackers. Again and again the streets outside the palace were swept clear of heretics. Again and again new foes stepped forward to take their place.

Now indeed it seemed the tide of battle had turned against the Emperor. The space ports were firmly in the grasp of the minions of the Warmaster. Hundreds of thousands of troops poured down from orbit. Goat-headed beastmen, gibbering mutants and hideous amorphous Chaos Spawn surged out of the dread ships. Under the banner of the great eye, the sign of Horus, the lackeys of the four Great Powers of Chaos marched united. Mounted on Rhinos, lurking within mighty Behemoths and clinging to the sides of gigantic war-engines they made their way en masse to the Emperor's palace.

Looking down on the seething sea of foulness the defenders' hearts went cold. Mingling with the daemons and the mad-eyed cultists, the trolls and the beastmen they could see heretical Space Marines and traitor Guardsmen. These were people they might have once fought alongside, who had once been as loyal to the Emperor as themselves. They looked upon a dark mirror of their souls. Down there they could see martial honour become berserk madness, human cleverness become sly treachery, hope become foulness and love become abominable lust. The brave men on the walls knew that there was no way out. Here they must stand and fight and die. There would be no mercy from those below. This was a war where there could be no honourable peace. It was destroy or be destroyed.

For a moment all was silence, then Angron strode forth. In his brazen voice he demanded that the loyalists surrender. He told them that their cause was hopeless, that they faced a foe who could not be defeated. They were cut off, outnumbered, and defending a ruler too weak to be worthy of their loyalty. In that moment the men on the walls felt their resolve weaken. Looking at the transformed face of the Primarch who had been one of the Emperor's finest warriors, they saw an invincible, relentless foe backed by a numberless horde and all the daemonic might of Chaos.

There was a clamour on the walls as Sanguinius and the Blood Angels arrived. Standing on the wall, the angel-winged man glared on Angron with angry contempt. For long moments their gazes locked. Each Primarch seemed to be measuring the other, searching for chinks in the armour, for any sign of weakness and lack of resolve. Who knows what they saw there? Perhaps they communicated telepathically, brother Primarch to brother Primarch. The truth will never be known. Eventually Angron turned and walked back to his lines. He told his troops that there would be no surrender; they should kill everyone they found within the palace. No stone should be left upon stone.

With a roar the horde advanced towards the walls. Great Lords of Battle lurched forward on iron wheels, crushing anything in their way, unloading racks of missiles and turning the area on the top of the walls into blazing storms of death. Doom burners sent tongues of superheated metal licking out at the emplacements. Molten brass filtered through the windows and scalded those inside. Multi-tracked Cauldrons of Blood squirted jets of obscene daemonic ichor onto the defenders. Enormous fleshhounds of Khorne loped forward in their wake. Titans armed with specially constructed siege weapons lumbered into position. Battle cruisers dropped megatons of explosive death onto the defenders.

Every loyal warrior knew that he was already dead; that there was no way he could survive the coming of the daemonic army. The soldiers fought with the desperate ferocity of hopeless men, firing until their weapons were empty, snatching up the bolters of the fallen, and facing monsters with the butts of their guns when all ammunition was exhausted. Three times the horde managed to scale the walls, and three times it was

driven off by the valiant efforts of Sanguinius and the Blood Angels. Warily the Primarch marshalled the defenders, rallying the broken, speaking words of comfort to the mortally wounded, fighting with cold, implacable fury when he was called upon to do so. Slowly though, despite his efforts, the Chaos forces managed to erode the defence. They seemed numberless as the grains of sand on a sea shore and Horus spent their lives carelessly.

Outside the walls Imperial forces frantically raced from their bastions to try and relieve the palace. Titan legions boldly cut their way towards the centre of the rebel army. The Whitescars harried its flanks. No attempt to break the rebel line succeeded. Breaking through that blood-mad horde was a near impossible task. All four of the daemonic Primarchs inspired their followers to feats of fiendish bravery. For every Chaos warrior who died it seemed two more stood ready to take his place.



In orbit the Warmaster watched approvingly. If the palace fell and the Emperor died loyalist legions across the galaxy would lose heart and the war would be over. Without the psychic shield of the Emperor's power, humanity would swiftly fall prey to Chaos. Horus would stand triumphant amid the rubble of humanity's greatest empire. He would become a new and angry god. If he did not win soon reinforcements would filter in from the corners of the Imperium, and his attack would falter. For the Warmaster this was the desperate ultimate gamble. Everything was staked on this attack. It had to succeed, and at that moment it looked as if it might.

Day by day the siege wore on, casualties rose from the thousands to tens of thousands to hundreds of thousands. Bodies had to be bulldozed from the accessways to the Saturnine Gate by war machines. Chaos Titans blazed at the walls, specially constructed missiles ripping great chunks from the masonry. The Titans of the Fire Wasps answered their fire with volcano cannons: The smell of burning flesh filled the air as the corpses of the dead were incinerated in funeral pyres a hundred foot high. Obscene ash parched the throats of the defenders. The World Eaters built a pyramid of scorched skulls sixty foot high in Temple Square. By night the chants of degenerate cultists echoed through the streets and daemons flitted among the ruins of Earth.

Slowly, foot by torturous foot, the defenders were forced back. The great walls of the palace were riddled with hundreds of kilometres of bulkheads and corridor. Within this maze bitter hand to hand fighting ensued till entire sections of passage were filled with bloated corpses. Feeling progress was too slow, Horus ordered the Titans of the Death's Head Legion to demolish

entire sections of the wall. Despite taking tremendous casualties the great Warlord Titans broke through, and the forces of the Warmaster flooded into the palace grounds.

While all this was taking place Jhagatai Khan had implemented a change of plan. Rather than throwing away his forces against the near invincible bulk of the main Chaos army he launched a lightning raid against Lions Gate Space Port. This night attack was spearheaded by the shaven-headed warriors of the Whitescars, who led the remnants of the 1st Tank Division and elements of the surviving Guard armies against the surprised heretics. Khan threw a defensive perimeter around the space port and held it against all counter-attacks. The flow of men and materials towards the palace was halved at a stroke.

This success gave heart to the defenders. They swiftly attempted to seize Eternity Wall Space Port but here the forces of the Warmaster were better prepared. The attackers were ambushed and driven back by traitors. Horus knew it was imperative to keep his beachhead secure. The final push on the inner palace had begun.

The battle raged across the grounds of the Inner Gardens. What had once been a vast parkland was swiftly turned into a killing ground. Men used statues for cover and monuments for bunkers. Blood swirled in the waters of the ornamental lakes. Groves of ancient redwoods burned. The smell of the burning mingled with the acrid odours of weapons and engines and death. Red-eyed, snatching sleep when they could, both sides fought a total war. Trenches were hurriedly excavated in the meadows. Snipers killed men as they tried to sip brackish water from the ruined fountains.

Both sides fought with unimaginable naked ferocity. Both sides sensed the end was near.

Eventually Sanguinius was forced to retreat to within the palace itself, personally holding the Ultimate Gate against the oncoming horde while the last of his wounded men was carried through. Just as the giant ceramite gate was about to close a Bloodthirster of Khorne leapt upon him. The daemon's huge talons closed around his throat. Sanguinius took to the air. Angel and daemon wrestled over the warring armies. Both sides halted for a moment to watch the titanic struggle. It was a conflict such as has been rarely seen; two beings of awesome power wrestled.

Sanguinius was weary and near the end of his strength and the daemon gouged great wounds in his flesh. The heretical throng roared its approval as the Primarch was cast to the ground, the impact splintering the granite. For a moment the Primarch lay still and a groan rose from the Blood Angels, the daemon stood over him and howled in exultation. Then slowly and painfully the Blood Angel rose and seized the creature, raised it high and broke its back across his knee. Then with a halo of power playing round his head he tossed its broken carcass back amid its followers. They beat their chests and rent their hair and wailed in dismay as the Ultimate Gate shut.

The great Sky Fortress bore Rogal Dorn and the remnants of the Imperial Fists to the inner palace. The loyal old general was determined to stand and die with his Emperor in the final hour. The Sky Fortress raced away from the palace in a desperate attempt to reach Jhagatai Khan and return him to the palace. It was destroyed by a blaze of fire from the Death's Heads Titan Legions. Even in death its commander wrought havoc on the enemy, bringing the crippled vehicle down into the centre of the Chaos Horde. It seemed as if a new sun was born on Earth as the plasma reactor exploded, blasting out a crater three kilometres across. Those within the palace knew they were cut off; now they were truly alone. Only a miracle could save them.

Now the final siege began. Through great breaches in the outer walls more and more armaments and reinforcements were brought to bear. The Warmaster himself prepared to teleport down to the surface and supervise the destruction of his former lord. Then a daemon from the Warp whispered to him the words that he had dreaded.

A loyalist fleet under Leman Russ and Lion'el Johnson bearing a fresh army of Space Wolves and Dark Angels was only hours away. It would take days to break humanity's last citadel, even with Horus leading his troops. It seemed that time had run out for the Warmaster, that his gamble had failed.

Horus was first among the fallen, with the power of a god and the cunning of a daemon. He resolved to try one final desperate gambit. He could still kill the Emperor. He ordered all comm-net communications blocked so that the defenders would get no word from their rescuers and then he used his psychic powers to the full to prevent the Emperor becoming aware of this. Finally he dropped the shields of his command ship. It was an invitation and a personal challenge that he knew the Emperor could not resist. He was being offered a chance finally to smite the foe who had harried him for so long.

The Emperor rose to the challenge, and he and his surviving Primarchs teleported aboard the Warmaster's battle barge. Horus used his powers to separate the Emperor from his loyal followers. The loyalists were transported to different spots within his hideously altered ship. Sanguinius he had brought directly to his throne room. In his evil cunning the Warmaster offered the Blood Angel a chance to switch sides, reasoning that the winged Primarch's followers would be useful when the Space Wolves and the Dark Angels arrived.

Sanguinius refused. Horus grew wrathful and attacked him. At the peak of his powers the Blood Angel would have been no match for the Warmaster and now, sorely wounded and weary he had no chance at all. Horus strangled him with his bare hands before the throne the Powers of Chaos had gifted him with.

The Emperor found Horus shortly after this and what happened next is the subject of legend. The two mightiest beings in the history of mankind clashed. They met blade to blade, power to power, mind to mind and tested sinew and psychic power to the ultimate.

Behind Horus was the massed power of the Chaos Gods. The Emperor stood alone and still he triumphed, although he was terribly wounded in the process.

The psychic shock wave of the Warmaster's passing rippled outward through the warp. On Earth, daemons screamed and vanished, and the rebel Primarchs stood dumbfounded. It was their leader, not their enemy's, who was dead and they knew it. With the one who had raised the banner of rebellion dead, there was nothing to hold the rebels together. They were demoralised and dismayed. When word of the oncoming Imperial fleet reached them they knew that they must flee.

Within the perimeter of Lions Gate Space Port, Jhagatai Khan and the handful of unwounded Whitescars watched in amazement as the horde halted in confusion then retreated. Angron, Fulgrim, Magnus the Red and Mortarion led their men to their ships and departed, leaving the deluded, traitorous followers of Chaos to their fate. As he stepped aboard his ship Angron turned and shook his fist at the glittering dome of the Imperial palace that had proved just out of his taloned reach. Then he shrugged; he and his fellow rebels had all eternity to seek revenge. The Battle for Earth was effectively over. The Horus Heresy was ended.

Rogal Dorn found the Emperor's broken body in the ruins of the Warmaster's throne room. Through mangled lips the Emperor whispered instructions for the creation of his golden throne. Dorn smiled, for while the Emperor still lived there was still hope. The old general returned to Earth. There was much to be done.



HORUS HERESY

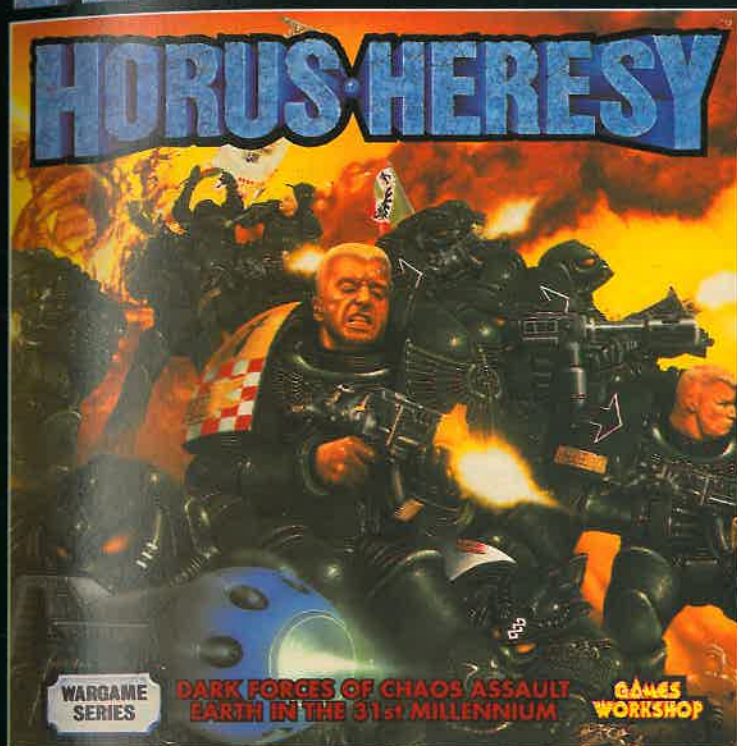

Warmaster Horus, humanity's greatest general, has been possessed by a foul daemonic creature and has turned against the Emperor of Mankind, hurling the galaxy-spanning Imperium into a ferocious civil war. The Warmaster now leads a huge rebellious army including chaos cultists and daemons, directly against the Emperor and Earth itself. Whole chapters of Space Marine warriors, humanity's supreme fighting elite, have turned against each other. The fate of the Imperium will be decided in this, the ultimate conflict – the Battle for Earth!



The Horus Heresy is a two player wargame that recreates the invasion of Earth by rebel forces. One player takes command of the invasion fleet led by Warmaster Horus and the other of the gallant defenders led by the Emperor of Mankind. The two enormous armies that took part in the campaign are represented by colourful counters that are moved and fight over a realistic map of the Emperor's Palace and the surrounding area. The winner will be the player who best uses the forces under his command to outwit his opponent's plans and out-manoeuvre his army.



Horus Heresy contains 181 double-sided, high quality counters, a full colour map of the Emperor's Palace and surrounding area, 12 special cards, 8 strategy cards, 4 set-up sheets, 2 off-world areas, 1 reference sheet, 2 six sided dice and a rule book with a full history of the war.

**WARGAME
SERIES**



**GAMES
WORKSHOP**

WARMASTER

By Jervis Johnson

This month sees the release of *Horus Heresy*, the latest in our Wargame series of battle games. The game recreates the titanic battle for Earth when Warmaster Horus led his rebellious legions of Space Marines, Titans and Daemons, directly against the Emperor and his loyal forces. At the climax of the struggle, the Emperor teleported onto Horus's battle barge in an attempt to search out and destroy Horus. As a companion to *Horus Heresy*, Jervis has created *Warmaster*, an exciting simulation of the cataclysmic conflict between the Emperor of all Mankind and Horus, humanity's greatest foe.

INTRODUCTION

Warmaster is a two player wargame that recreates the Emperor's attack on Horus's ship at the end of the Battle For Earth. At the start of the game the Imperial player has no idea where Horus is located and must search his ship to find him as quickly as possible. Many hidden perils confront the Imperial attackers, who must battle their way past traps and through ambushes as they search for the Warmaster. The Emperor does not have a moment to waste, for the longer the game goes on, the greater are the numbers of the Traitors that oppose the dwindling assault force. In a desperate race against time the Emperor must find and defeat his arch enemy or die in the attempt!



THE GAME RULES

Before you start, it's a good idea to read through these rules at least once so you get some idea of how the game works. They aren't complicated, and reading them won't take very long. If you've played *Battle For Armageddon* you will find that the rules to *Warmaster* are very similar. However, there are a number of important differences, so you should still read the rules carefully. Take care not to miss the special rules – they are very important

ASSEMBLING THE BOARD & COUNTERS

You will need to remove the board and counters from your issue of *White Dwarf* in order to play *Warmaster*. The counters need to be *carefully* cut out – make sure that you do a neat job, as it is important to the game that the counters look exactly the same when they are placed face down.

The game board shows a map of *Warmaster*, Horus's orbiting spacecraft. It is divided into a number of different sized spaces to help regulate movement. The game board also includes tracks which are used to record information needed while you are playing. Each counter is printed with a name and picture showing the unit it represents, and two numbers at the bottom. These show the counter's attack value and defence value, and the higher they are, the better!

SETTING UP

Clear a space on a table and set up the board. One player takes the Imperial counters and the other player takes the Traitor counters.

The Traitor army is set up first. You should make the Imperial player turn round or go out of the room while you are setting up the counters so that he cannot spy and get an unfair advantage. The counters that make up the Traitor army at the start of the game are black on the back with the white eye of Horus printed in the middle. Take these counters and set them up on the map, one counter per area.

The counters are set up on the map *face down* so that the Imperial player has no idea which counter is placed in which area, and they are only turned face up when the Imperial player moves a counter into the space to find out what is lurking there! The remaining Traitor counters (which have a grey back with a white skull on them) should be placed in a mug or cup. These counters are reinforcements and will be drawn at random from the cup once the game is under way.

After the Traitor player has set up, the Imperial player must sort out his army. Take the three Imperial Guard counters and put them to one side for the moment. Sort the remaining 12 counters into four stacks of three counters each. It's up to you which counters you put in each stack, just so long as you end up with 4 stacks with 3 counters in each stack. These stacks are the main Imperial assault force and they will teleport onto Horus's ship at the start of the first turn.

WINNING THE GAME

The **Traitor player** wins by killing the Emperor, and the **Imperial player** wins by killing Horus. The game ends *immediately* either Horus or the Emperor is killed. If both are killed at exactly the same time, then the game is considered a draw.

THE SEQUENCE OF PLAY

Warmaster is played in a series of game turns, each of which is divided into six phases. All activities may only take place in the correct phase and each phase must be finished before the next can be started. What you do in each phase is described below and explained in the rules that follow.

1. **IMPERIAL REINFORCEMENT PHASE:** The Imperial player takes any stacks of reinforcement counters and teleports them onto the ship.
2. **IMPERIAL MOVEMENT PHASE:** The Imperial player may move any counters he has on the ship.
3. **IMPERIAL COMBAT PHASE:** Any combat caused by the Imperial player's moves must now be resolved.
4. **TRAITOR REINFORCEMENT PHASE:** The Traitor player rolls a dice to see how many reinforcement counters he may take this turn, draws that number from the mug, and then teleports them onto the ship.
5. **TRAITOR MOVEMENT PHASE:** The Traitor player may move any face up counters he has on the ship.
6. **TRAITOR COMBAT PHASE:** Any combat caused by the Traitor player's moves must now be resolved.

REINFORCEMENTS

In a **Reinforcement Phase** you are allowed to *teleport* extra counters onto the ship. The number of counters you may teleport on board will vary depending on whether you are the Imperial or Traitor player, and is detailed in the reinforcement schedule below. In order to teleport counters to the ship you must make a special *D66* dice roll for each separate stack or counter teleporting to the ship and refer to the *Teleportation Table*. This is nowhere near as complicated as it sounds, and only requires ordinary six sided dice. Simply roll two dice one after the other, counting the first roll as tens and the second roll as units. Put the two results together to get your score. For example, if the first roll was 5 and the second roll was 3 then the score would be 53, if the first roll was 1 and the second roll was 6, then the score would be 16 and so on.

TELEPORTATION TABLE

| D66 | Result |
|-------|--|
| 11 | Disaster! A horrific teleporter accident destroys the counters being teleported. |
| 12-13 | Failure! Teleportation is delayed. The counters may attempt to teleport again in the next friendly reinforcement phase. |
| 14-56 | Success! The counters teleport to a random area on the ship. Each space on the ship is numbered. Place the counters in the space with the same number that you rolled on the dice. |
| 61-66 | Perfect! You may choose which area on the ship that the counters teleport to. The stack can go anywhere you like on the ship apart from the Engines. |

REINFORCEMENT SCHEDULE

Imperial Player Turn One: On the first turn of the game you must teleport the four stacks of counters you sorted out when setting up. The first stack you teleport *must* be the stack that includes the Emperor. These counters teleport as stacks, with all of the counters in the same stack teleporting to the same area. Do not roll for each counter individually.

Imperial Player Turn Two: On the second turn of the game you must teleport the three Imperial Guard counters to the ship. Each Imperial Guard counter teleports separately – they do *not* teleport as a stack.

Traitor Player Every Turn: Roll a D6 at the start of each and every Traitor reinforcement phase to see how many counters you receive as reinforcements: 1-2 = one counter; 3-4 = two counters; 5-6 = three counters. Select the appropriate number of counters *at random* from the mug where they were placed at the start of the game. Each Traitor counter teleports up to the ship separately – they do *not* teleport as a stack.

MOVEMENT

In a **movement phase** you are allowed to move any or all of your counters. You may move as many of your counters as you wish: all, some or none. The number of areas a counter may move depends on whether or not you control the Bridge. This represents the ability of the side that controls the Bridge to open or close blast doors in order to speed up their own movement and hinder that of the enemy. At the start of the game the Traitor player controls the Bridge. From then on the last player to have a face up counter on the Bridge controls it. We have provided a counter that says 'Imperial Control' on one side and 'Traitor Control' on the other. Place this counter on the Bridge to show who controls it. If the Bridge is destroyed, then neither player can control it and both sides' moves are limited to one area per turn.



GEOFF TAYLOR

If you control the Bridge then each of your counters may move up to three areas per turn. If you do not control the Bridge then they may only move one area. A counter may be moved in any direction or combination of directions, as long as it does not enter a Destroyed Area. If a counter enters an area occupied by an enemy counter of any type (including face down counters) then it must end its move in that space and fight the enemy counter(s) in the ensuing combat phase. Counters are moved one at a time, and you must finish a counter's move before you move another one. Once you have started to move another counter, you may not change a previous move, no matter how much you want to!

Counters which teleported to the ship in the reinforcement phase *are* allowed to move, even if the area that they teleport to contains enemy counters. However, they must stop moving as soon as they enter an area that contains one or more enemy units.

STACKING

The number of counters a player may have in an area is limited to three counters. This is called the *stacking limit* as it is the maximum number of counters you may stack one on top of the other in an area. The stacking limit only applies at the end of the movement phase, so when you teleport to the ship or while you are moving you *may* over-stack. For example, you can move a counter through an area which already has three counters in it, or you can move a counter into an area with three counters and then move one of those counters out. However, if you end up with more than three counters in an area at the end of the movement phase you must eliminate one or more counters to bring the stack within 'legal' limits. The stacking limit for an area applies to each player's counters separately, so it is possible for both players to have up to three counters in the same area.

COMBAT PHASES

In the combat phase your counters must attack any enemy counters that are in the same area as you. All of the counters that you have in an area must take part in the combat against all of the enemy counters. It's up to you in what order you make your attacks, but you must finish one attack before you are allowed to move on to the next one.

Attacks are resolved by using the Combat Results Table printed on the reference sheet. To resolve each attack you must follow this simple five step procedure:

1. The attacker adds up his counters' attack value.
2. The defender adds up his counters' defence value.
3. The two values are converted to a ratio by dividing the attacker's total by the defender's total, rounding any fractions down. This ratio determines which column is looked up on the Combat Results Table. For example, if the attacker's combat value was 10 and the defender's combat value was 5, the odds would be 10 divided 5 or 2-1. If the attacker had 9 points to the defenders 5, the odds would be 9 divided by 5. This works out at 1 and a bit to 1 and is therefore rounded down to a simple 1-1 ratio.
4. The attacker rolls a D6 and the score is cross-referenced with the odds ratio to determine the outcome of the battle.
5. Look up the result under the Combat Results Table and follow the instructions there.

DESTROYED UNITS

In many places in these rules, but most notably on the Combat Results Table, you will be told that one or more counters have been destroyed. Destroyed counters are removed from play and take no further part in the game. When there is a choice, the Imperial player decides which Imperial counters are eliminated and the Traitor player decides which Traitor counters are eliminated.

RETREATS

Several results on the Combat Results Table call for one player's counters to retreat. Retreating counters are immediately moved one area by the *opposing* player (ie: the Imperial player retreats Traitor counters and the Traitor player retreats Imperial counters). Retreating counters may not enter a destroyed area, an area where it would cause over-stacking, or an area that contains one or more enemy counters (including enemy counters that are face down). If the counters cannot retreat because *all* of the adjacent spaces are prohibited, then the counter is eliminated instead.

Sometimes a counter that has already retreated will find itself in an area that is attacked later in the same combat phase. If this happens, then any counters that have already retreated count as having a defence strength of zero and will be destroyed if forced to retreat a second time.

FACE DOWN COUNTERS

Face down counters are revealed if there is an enemy counter in the same area at the start of the combat phase. Reveal the counter before any combats are resolved, and work out the effects of any Traps, Horror or Ambush counters as and when they are revealed. With the exception of Horus, this is the only way face down counters may be revealed. The Traitor player may not reveal them voluntarily earlier in the game.

DICE RE-ROLLS

The Emperor, Horus, Sanguinius, Rogal Dorn, Angron, and Magnus the Red all entitle you to a *re-roll* if they are involved in a battle. You may use this ability to re-roll the dice if



you do not like the first result rolled, but you must accept the second dice roll and may not choose to go back to the first result if the second one is even worse! If both you and your opponent are entitled to make a re-roll in the *same* battle, then the re-rolls cancel out and the dice may not be re-rolled by either of you. **Exception:** Horus or the Emperor only lose their re-roll when battling each other – they retain their re-rolls against any other opponent.

DESIGNER'S NOTES



When Robin asked me if I could come up with a free 'mini-game' for White Dwarf, I was more than happy to oblige. The game is inspired by Adrian Smith's artwork and Bill King's short story, originally published in *Realm of Chaos: The Lost and The Damned*. What struck me as I read through Bill's story was the feeling of tension and horror as the Imperial forces searched

through the ship trying to find Horus, and it was this that I wanted to capture in the game.

I had already tried out a few ideas for a game based on the assault on Horus's battle barge when I had been working on *Horus Heresy* the new Wargame Series game that will be out soon. Although the concept hadn't proved suitable for that game, it had left me with a number of ideas that I knew I could develop into a game in their own right. Warmaster is the result.



A typical game of Warmaster will only take twenty minutes to half an hour to play, including set-up. Be warned, the outcome of the game can be rather unpredictable, with the result of the initial teleporting of Imperial forces to the ship being crucial. (During playtesting, Andy Chambers in particular had an uncanny ability to teleport Sanguinius directly into the ship's Engine or some horrible dimension in the warp, with terminal results for Sanguinius, the troops he was with, and the Imperial chances of victory!). However, because the game is quick to play, it is easy to start again if things go horribly wrong, and over the course of several games any random elements will even out and the better player should come out ahead.

I would recommend playing a series of 2-4 games, swapping sides after each game, to really get a feel for the strategy and tactics required to win. Part of the pleasure of playing a game like Warmaster is developing your own 'master plan', but to help you through your first couple of games, here are some hints and tips that you may find useful. However, bear in mind that Warmaster is above all a game of bluff and deception, and if your opponent is able to guess your plan you will almost certainly be doomed. Have fun!

TRAITOR PLAYER

In order for you to win, Horus must remain hidden for as long as possible. Resist the temptation to set him up on the Bridge or Shields, or indeed any of the other special areas, because the Imperial player is quite likely to go attack these locations early on in the game. It is also a good idea to include crew counters in 2-3 areas adjacent to Horus, so that he can retreat or move onto them once discovered and use them to reduce the odds and soak casualties if he is attacked. Remember, Horus is almost certainly doomed if he is attacked on his own! Once Horus is revealed, retreat him behind face down Trap and Horror counters to kill off Imperial troops and give yourself time to teleport more reinforcements on board. Never give up, and remember that the longer the game goes on, the greater your chance of victory!

IMPERIAL PLAYER

At the start of the game you have overwhelming force on your side, and if you can find Horus within the first couple of turns then you can probably pull off a win. Try not to get side tracked into fighting for locations such as the Shields or the Bridge when you should really be exploring the ship. Once you have tracked Horus down, go all out to engage him in combat and eliminate him. If you fail to do this quickly enough, you will find your forces dwindling while the Traitor's are increasing in strength, and at some point you will realise that you cannot hope to defeat Horus in normal combat. However, there are still a number of options that you can try even at this late stage, such as capturing the ship's Shields so that you can blast the ship with your defence lasers, or blowing up the ship's engine room. Never give up, and remember there is always a chance of victory!



GEOFF TAYLOR

WARMASTER

REFERENCE GUIDE

SEQUENCE OF PLAY

1. IMPERIAL REINFORCEMENT PHASE.
2. IMPERIAL MOVEMENT PHASE.
3. IMPERIAL COMBAT PHASE.
4. TRAITOR REINFORCEMENT PHASE.
5. TRAITOR MOVEMENT PHASE.
6. TRAITOR COMBAT PHASE.

TELEPORTATION TABLE

| D66 | Result |
|-------|--|
| 11 | Disaster! A horrific teleporter accident destroys the counters being teleported. |
| 12-13 | Failure! Teleportation is delayed. The counters may attempt to teleport again in the next friendly reinforcement phase. |
| 14-56 | Success! The counters teleport to a random area on the ship. Each space on the ship is numbered. Place the counters in the space with the same number that you rolled on the dice. |
| 61-66 | Perfect! You may choose which area on the ship that the counters teleport to. It can go anywhere you like on the ship apart from the Engines. |

SPECIAL IMPERIAL COUNTERS



The Emperor

The stack with the Emperor must be the first stack to teleport onto Horus's ship. Do *not* roll on the Teleportation Table for the Emperor's stack – the stack always teleports perfectly, just as if you had rolled a 66 on the Teleportation Table. Neither the Emperor nor any counters stacked with him are ever affected by Horror counters. Discard the counter as soon as it is revealed if the Emperor is in the same area.

If the Emperor is involved in a battle as either an attacker or defender, then the Imperial player may force a re-roll of the dice if he does not like the first result rolled on the Combat Results Table. He must accept the second dice roll if he forces a re-roll. **Exception:** If Horus is involved in the same battle then the Emperor loses his re-roll and must accept the first result rolled on the Combat Results Table.



Sanguinius

If Sanguinius is involved in a battle as either an attacker or defender, then the Imperial player may force a re-roll of the dice if he does not like the first result rolled on the Combat Results Table. He must accept the second dice roll if he forces a re-roll. **Exception:** If Horus, Angron or Magnus the Red are involved in the same battle then Sanguinius loses his re-roll and must accept the first result rolled on the Combat Results Table.

COMBAT RESULTS TABLE

| D6 | 1-3 or less | 1-2 | 1-1 | 2-1 | 3-1 or more |
|----|-------------|-----|-----|-----|-------------|
| 1 | AA | AA | AR | AR | BC |
| 2 | AA | AR | AR | BC | BC |
| 3 | AR | AR | BC | BC | DR |
| 4 | AR | BC | BC | DR | DR |
| 5 | BC | BC | DR | DR | DA |
| 6 | BC | DR | DR | DA | DA |

- AA** **Attacker Annihilated.** All attacking combat units are destroyed.
- AR** **Attacker Routed.** One attacking combat unit is destroyed. Any surviving attacking counters must retreat.
- BC** **Bloody Conflict.** One attacking *and* one defending combat unit are destroyed. You must fight another round of combat between any surviving counters. Ambushes do not count for second and subsequent rounds, but you do have to roll again to see if the Weapons Store or Engine Room suffers accidental damage. Leader re-rolls may be used again in second or subsequent rounds.
- DR** **Defender Routed.** One defending combat unit is destroyed. Any surviving defending counters must retreat.
- DA** **Defender Annihilated.** All defending combat units are destroyed.

**WHITE
DWARF**

Presents

WARMASTER



**WARGAME
SERIES**

TM

**GAMES
WORKSHOP**

WARMASTER

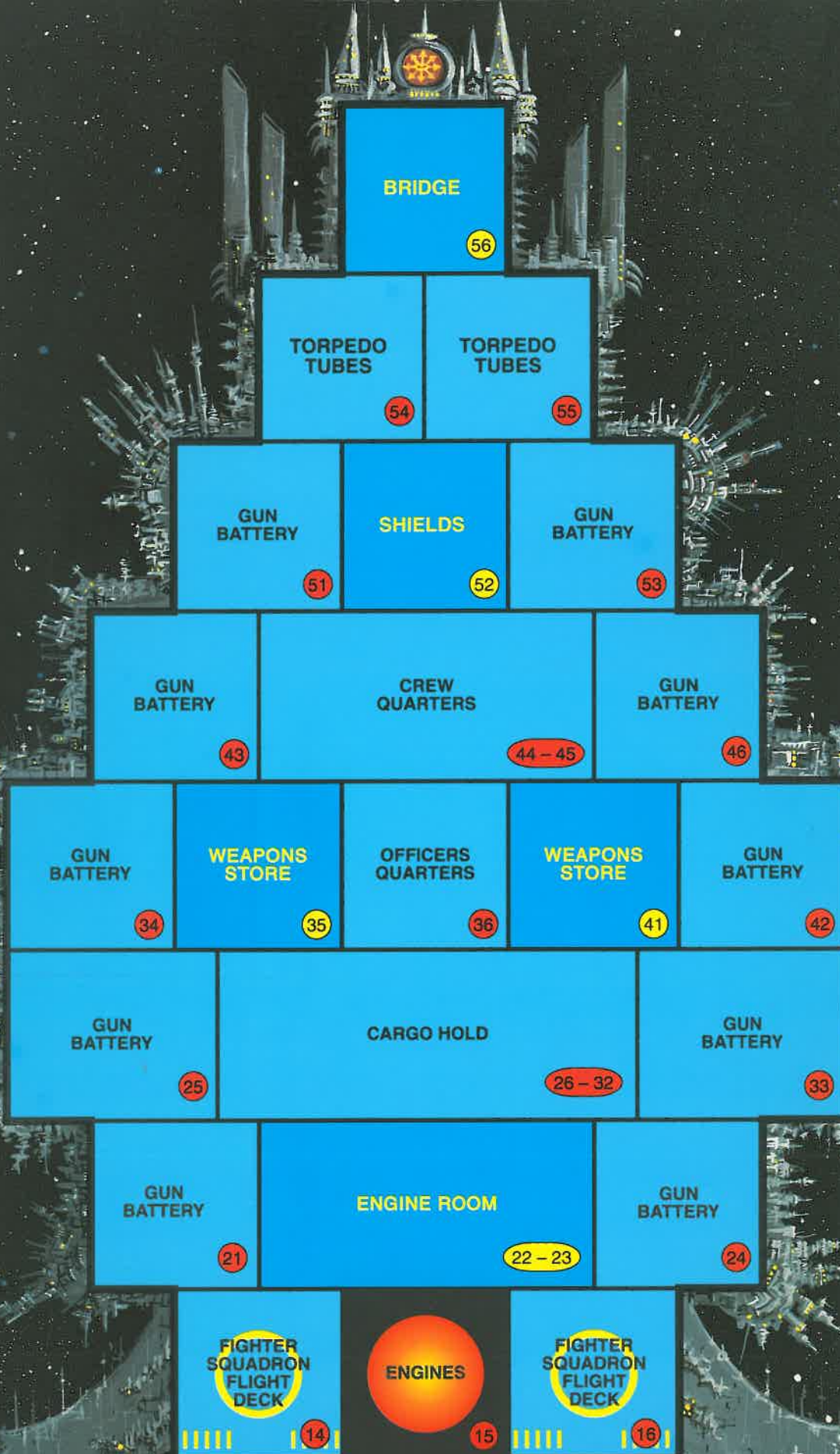

© Copyright Games Workshop Ltd 1993. All rights reserved.



WARMASTER FORCES (FRONTS)

| | |
|---|---|
| HORUS  10-8 | GREATER DAEMON DOOMBREED  ?+4 |
| CREW  0-3 | CREW  0-3 |
| CREW  0-3 | CREW  0-3 |
| CREW  0-3 | CREW  0-3 |
| CREW AMBUSH  0-3 | CREW AMBUSH  0-3 |
| HORROR  SPECIAL | HORROR  SPECIAL |
| HORROR  SPECIAL | HORROR  SPECIAL |
| HORROR  SPECIAL | HORROR  SPECIAL |
| TRAP  SPECIAL | TRAP  SPECIAL |
| TRAP  SPECIAL | TRAP  SPECIAL |
| TRAP  SPECIAL | TRAP  SPECIAL |

| | | |
|--|--|---|
| TRAITOR TERMINATORS  6-5 | TRAITOR TERMINATORS  6-5 | CHAOS SPACE MARINES  5-3 |
| CHAOS SPACE MARINES  5-3 | CHAOS SPACE MARINES  4-4 | CHAOS SPACE MARINES  4-4 |
| CHAOS SPACE MARINES  3-5 | CHAOS SPACE MARINES  3-5 | CHAOS DREADNOUGHTS  7-6 |
| CHAOS DREADNOUGHTS  7-6 | CHAOS ANDROIDS  3-3 | CHAOS CULTISTS  3-2 |
| CHAOS SQUATS  2-4 | DAEMON HORDE  ? | DAEMON HORDE  ? |
| DAEMON HORDE  ? | DAEMON HORDE  ? | DAEMON HORDE  ? |
| ANGRON  8-7 | MAGNUS THE RED  8-7 | GREATER DAEMON KRAXNAR  ?+4 |

| | |
|--|--|
| DESTROYED  AREA DESTROYED | DESTROYED  AREA DESTROYED |
| DESTROYED  AREA DESTROYED | DESTROYED  AREA DESTROYED |
| DESTROYED  AREA DESTROYED | DESTROYED  AREA DESTROYED |
| DESTROYED  AREA DESTROYED | DESTROYED  AREA DESTROYED |
| DESTROYED  AREA DESTROYED | DESTROYED  AREA DESTROYED |
| DESTROYED  AREA DESTROYED | DESTROYED  AREA DESTROYED |

| | |
|--|---|
| BATTLE  LOCATION | BRIDGE  CONTROL |
|--|---|

| | | | | |
|--|--|---|---|---|
| EMPEROR  10-9 | PRIMARCH ROGAL DORN  7-8 | PRIMARCH SANGUINIUS  8-7 | GENERAL KANE  7-6 | TERMINATORS  6-5 |
| TERMINATORS  6-5 | ASSASSINS  8-2 | DEVASTATOR COMPANY  3-5 | TACTICAL COMPANY  4-4 | TACTICAL COMPANY  4-4 |
| ASSAULT COMPANY  5-3 | ASSAULT COMPANY  5-3 | IMPERIAL GUARD  3-3 | IMPERIAL GUARD  3-3 | IMPERIAL GUARD  3-3 |

WARMASTER FORCES (BACKS)

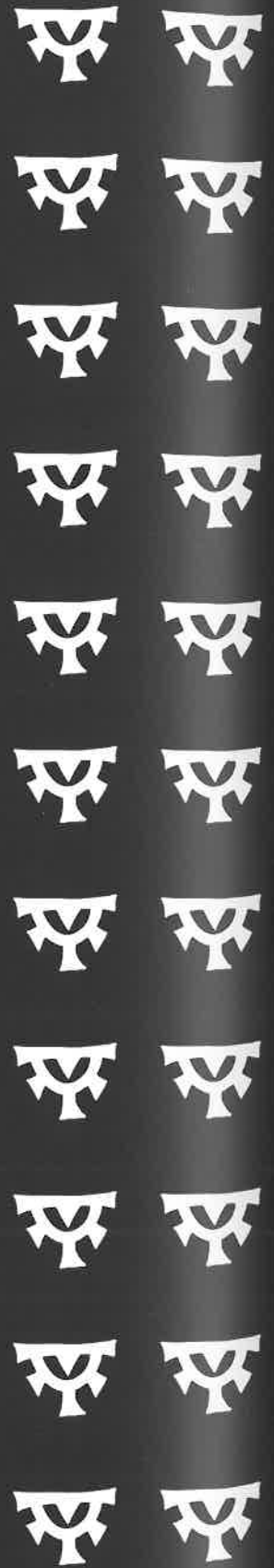

BRIDGE



CONTROL

BATTLE



LOCATION

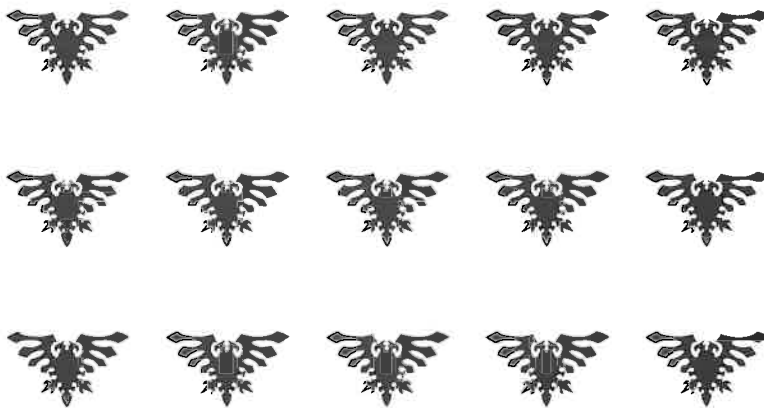



Rogal Dorn

If Rogal Dorn is involved in a battle as either an attacker or defender, then the Imperial player may force a re-roll of the dice if he does not like the first result rolled on the Combat Results Table. He must accept the second dice roll if he forces a re-roll. **Exception:** If Horus,

Angron or Magnus the Red are involved in the same battle then Rogal Dorn loses his re-roll and must accept the first result rolled on the Combat Results Table.



General Kane

Neither General Kane nor any counters stacked with him are ever affected by Trap counters. Discard the counter as soon as it is revealed if Kane is in the same area.

SPECIAL TRAITOR COUNTERS



Warmaster Horus

Horus starts the game hidden face down on the Traitor ship. However, unlike other face down counters, the Traitor player may reveal him at the start of any of his turns if he desires, turning him face up when he does so. Horus remains

face up for the rest of the game once he is revealed. In addition, if Horus is revealed by an Imperial counter finishing its move in the same area as him, he is allowed to retreat one area before the combat is resolved, thus avoiding the battle. The normal rules for retreating counters apply, except that the Traitor player is allowed to choose which area Horus retreats to. Note that this special ability only applies when Horus is revealed, it may not be used later in the game once he is face up.

If Horus is involved in a battle as either an attacker or defender, then the Traitor player may force a re-roll of the dice if he does not like the first result rolled on the Combat Results Table. He must accept the second dice roll if he forces a re-roll. **Exception:** If the Emperor is involved in the same battle then Horus loses his re-roll and must accept the first result rolled on the Combat Results Table.



Angron

If Angron is involved in a battle as either an attacker or defender, then the Traitor player may force a re-roll of the dice if he does not like the first result rolled on the Combat Results Table. He must accept the second dice roll if he forces a

re-roll. **Exception:** If the Emperor, Sanguinius or Rogal Dorn is involved in the same battle then Angron loses his re-roll and must accept the first result rolled on the Combat Results Table.



Magnus The Red

If Magnus the Red is involved in a battle as either an attacker or defender, then the Traitor player may force a re-roll of the dice if he does not like the first result rolled on the Combat Results Table. He must accept the second dice roll if he forces a re-roll. **Exception:** If the

Emperor, Sanguinius or Rogal Dorn is involved in the same battle then Magnus the Red loses his re-roll and must accept the first result rolled on the Combat Results Table.



Doombreed and Kraxnar

The combat values of Doombreed and Kraxnar are not fixed, but vary depending on the whims of the gods of Chaos. When they are involved in a battle, either as attacker or defender, roll a dice and add four to the score. The result is the counter's combat value for that battle. You must roll separately for each battle that a Greater Daemon is involved in, including succeeding rounds of combat if you roll a Bloody Conflict result on the Combat Results Table.

Daemonic Hordes

The combat values of Daemonic Hordes are not fixed, but vary depending on the whims of the gods of Chaos. When they are involved in a battle, either as attacker or defender, roll a dice. The result is the counter's combat value for that battle. You must roll separately for each battle that a Daemonic Horde is involved in, including succeeding rounds of combat in the same turn if you roll a Bloody Conflict result on the Combat Results Table.

Trap Counters

Roll a dice when the counter is revealed: 1-3= No effect; 4-6= One Imperial counter in the same area is destroyed. The Imperial player is allowed to choose which counter is eliminated if there is more than one Imperial counter in the area. Discard the Trap counter after resolving its effects.

Horror Counters

Roll a D6 for each Imperial counter in the same area as the counter. On a roll of 5 or 6 the counter is driven stark staring mad by the horrors encountered on the ship and must be removed from play (Imperial Guard are driven made on a roll of 3, 4, 5 or 6). Discard the Horror counter after resolving its effects.

Crew Counters

Crew are treated in the same way as a normal combat unit with a defence value of three. They remain in play after they have been revealed, but are never allowed to move and are eliminated if forced to retreat.

Crew Ambush! Counters

Ambush counters are treated in the same way as Crew counters, except that on the turn the counter is revealed, the combat value of it and any other Traitor counters stacked with it are doubled. This only applies to the very first round of combat when the counter is revealed. It does not apply to succeeding rounds of combat



in the same turn if you roll a Bloody Conflict result on the Combat Results Table.

SPECIAL SHIP LOCATIONS

Certain areas of the ship have special rules that apply to them. These areas are coloured bright blue and have their name written in yellow type on the game map.

The Bridge

As already described in the main rules, the player who controls the Bridge may move his counters up to three spaces, while his opponent can only move his counters one space. The Bridge is initially controlled by the Traitor player (it is Horus's ship after all!). Thereafter it is controlled by the last player to have a face up counter in the space. If the Bridge is destroyed then neither player can control it and both players' counters may only move one space per turn.

The Engine Room

Any Imperial counter may blow up the Engine Room instead of making an attack. The counter must be in the Engine Room and there may be no Traitor counters in the same space. In addition there is a risk of accidental destruction if a combat is fought in the Engine Room. Roll a D6 before resolving battles in the area; on a roll of 1, a stray shot causes an explosion which destroys the area as described below.

If the Engine Room is destroyed, any counters in the area are destroyed in the explosion (including the counter that set it off) and a Destroyed Area counter is placed in the space. Counters may not enter Destroyed Areas. With the engines dead, the barge's orbit starts to decay and it begins to burn up as it enters the Earth's atmosphere. At the start of each player's turn *one* space on the ship is burnt up and destroyed. The first area burnt up will be area 56, the next area 55, then 54 and so on. If an area is already destroyed, skip it and destroy the next area instead.

The Engines

No counter may voluntarily enter the ship's Engines. Any counters that teleport there are destroyed in nano-seconds as they materialise inside the ship's pulsing plasma reactor.

The Weapons Store

Any Imperial counter may blow up a Weapons Store instead of making an attack. The counter must be in the Weapons Store, and there may be no Traitor counters in the same space. In addition there is a risk of accidental destruction if a combat is fought in a Weapons Store. Roll a D6 before resolving battles in the area; on a roll of 1 a stray shot causes an explosion which destroys the area as described below.

If a Weapons Store is destroyed, any counters in the area are destroyed in the explosion (including the counter that set it off) and a Destroyed Area counter is placed in the space. A dice roll must then be made for each area adjacent to the Weapons Store. On a roll of 1 or 2 the area is destroyed along with any counters in it.

Shields

If the Imperial player has a counter in the Shields area at the start of his turn he may make a special *Defence Laser* attack. This attack is made in the Imperial reinforcement phase, before any reinforcements teleport to the ship. Roll on the Teleportation Table to see where the attack hits the ship. The indicated space is hit by the defence laser blast. Any counters in the space hit are destroyed and a Destroyed Area counter is placed in the space.

Destroyed Areas

No counter may voluntarily enter a Destroyed Area. Any counters that teleport to a Destroyed Area are killed in an extremely unpleasant manner when they materialise *inside* the mangled wreckage of the ship.



SOUTHEND

GAMES WORKSHOP®

GRAND OPENING SATURDAY 8th MAY

12 SOUTHCHURCH RD

TEL: 0702 461251

Doors Open 9am!

**Normal
Opening Hours**

Monday to Friday 10am – 6pm
Saturday 9.30am – 5.30pm
Games Nights Thursdays 'till 8pm



BUY ANY TWO RED DOT ITEMS AND GET ONE YELLOW DOT ITEM FREE!

Eg., Buy Warhammer 40,000 and Space Hulk and get the Warhammer 40,000 Battle Manual FREE!

BUY ANY TWO BLISTER PACKS AT £3.99 OR MORE AND GET ONE ADDITIONAL £3.99 BLISTER PACK FREE!

Offers open all day (while stocks last).

| | |
|---|---|
| <p>ONLY ONE VOUCHER PER PRODUCT REDEEMABLE AT GAMES WORKSHOP SOUTHEND 8th MAY 1993</p> <p>10 % OFF</p> <p>ANY GAMES WORKSHOP OR CITADEL PRODUCT</p> <p>NOT TO BE USED WITH ANY OTHER OFFER</p> | <p>ONLY ONE VOUCHER PER PRODUCT REDEEMABLE AT GAMES WORKSHOP SOUTHEND 8th MAY 1993</p> <p>10 % OFF</p> <p>ANY GAMES WORKSHOP OR CITADEL PRODUCT</p> <p>NOT TO BE USED WITH ANY OTHER OFFER</p> |
| <p>ONLY ONE VOUCHER PER PRODUCT REDEEMABLE AT GAMES WORKSHOP SOUTHEND 8th MAY 1993</p> <p>10 % OFF</p> <p>ANY GAMES WORKSHOP OR CITADEL PRODUCT</p> <p>NOT TO BE USED WITH ANY OTHER OFFER</p> | <p>ONLY ONE VOUCHER PER PRODUCT REDEEMABLE AT GAMES WORKSHOP SOUTHEND 8th MAY 1993</p> <p>10 % OFF</p> <p>ANY GAMES WORKSHOP OR CITADEL PRODUCT</p> <p>NOT TO BE USED WITH ANY OTHER OFFER</p> |
| <p>ONLY ONE VOUCHER PER PRODUCT REDEEMABLE AT GAMES WORKSHOP SOUTHEND 8th MAY 1993</p> <p>25 % OFF</p> <p>ANY GAMES WORKSHOP OR CITADEL PRODUCT</p> <p>NOT TO BE USED WITH ANY OTHER OFFER</p> | <p>ONLY ONE VOUCHER PER PRODUCT REDEEMABLE AT GAMES WORKSHOP SOUTHEND 8th MAY 1993</p> <p>25 % OFF</p> <p>ANY GAMES WORKSHOP OR CITADEL PRODUCT</p> <p>NOT TO BE USED WITH ANY OTHER OFFER</p> |

PLEASE NOTE: YOU CANNOT USE THE VOUCHERS WITH ANY OF THE ABOVE OFFERS OR ON MB GAMES' HEROQUEST, SPACE CRUSADE OR BATTLEMASTERS.

THE EAVY METAL REFERENCE GUIDE



Over the last few months, Games Workshop's miniature painting expert Mike McVey has been hard at work compiling notes and painting models for his definitive guide to collecting and painting Citadel Miniatures. The book is almost ready for release and so in this special preview, we've extracted a small section describing the basic techniques for painting the rank and file troops and character models for your armies.



The base colours for this Orc are Goblin Green for the flesh and Go Fasta Red for the tunic. The flesh was then shaded with Ork Flesh and highlighted with Goblin Green mixed with a little Sunburst Yellow. The tunic was shaded with red ink and then highlighted with a mix of Go Fasta Red and Sunburst Yellow. The skull on the Orc's belt was painted with Bleached Bone and then shaded with chestnut ink. Lastly the details were added such as the white teeth, red eyes and finally the shield.



On this model, the Orc flesh was taken a stage further. More highlights were applied, and Skull White was mixed into the final highlight of Goblin Green and Sunburst Yellow. The armour was glazed with yellow ink to make it brighter.



The base colours on these Savage Orcs are Goblin Green for the flesh, Snakebite Leather for the bones and a mix of Snakebite Leather and Go Fasta Red for the bow. The flesh was shaded and highlighted as shown above. The bones were then highlighted with Bleached Bone, and finally with Skull White. The bow was given a very light drybrush of Hobgoblin Orange mixed with Snakebite Leather. The tattoos were painted with Chaos Black and highlighted with Elf Grey. The warpaint on the face was painted with Blood Red and highlighted with Hobgoblin Orange.



The leopard skin pattern on this Savage Orc was achieved by starting with a white base coat. A mix of Orc Brown and Hobgoblin Orange was then added to the white, eventually fading to just Hobgoblin Orange. Then a mix of orange and brown ink was applied to the darker areas and finally the black detail was added.



These Goblins were undercoated white and the flesh was given a base coat of Goblin Green. The base coats for the other areas were Go Fasta Red for the tunic, Snakebite Leather for the boots and Bad Moon Yellow for the spear shaft. The skin was first shaded with Orc Flesh and then highlighted with Goblin Green lightened with a little Sunburst Yellow. The highlight colours for the other areas were Hobgoblin Orange for the tunic, Skull White for the spear and Orc Brown for the boots. The last step was to paint the shield and superglue it into place.



The highlights on this Goblin character were taken a little lighter by adding more yellow to the highlight mix, and using Skull White for the final highlights. The armour and weapons were given a base coat of Boltgun Metal and highlighted with Chainmail and Mithril Silver.



These Night Goblins were undercoated black, then a coat of white was painted onto all the flesh areas before the Goblin Green was painted on top. The flesh areas were undercoated white because it makes the skin appear far brighter. The axe haft was painted with Go Fasta Red and the belt was painted with Bad Moon Yellow. The flesh was then shaded with Ork Flesh and highlighted with Goblin Green mixed with a little Sunburst Yellow. The black cloak was highlighted with Elf Grey and a white moon shape was painted onto the hood. Finally, all the detail was added – the white teeth, the red eyes, and the moon on the hood.



This Goblin's hood has been painted with Bad Moon Yellow and shaded with some thinned-down orange ink. Progressively lighter highlights have been applied with some Skull White mixed into the Bad Moon Yellow. The Goblin's tongue was given a base coat of Titillating Pink and highlighted with Skull White.



These Forest Goblins were undercoated white. Their flesh was painted in the same way as the Night Goblins' shown above. The sword was painted Mithril Silver and the hand guard was painted Hawk Turquoise. The skull-shaped pommel was given a coat of Bleached Bone and was highlighted with white. The feather was painted with white and Go Fasta Red. The white area of the feather was then shaded with a very thin wash of Chaos Black and the red area was highlighted with Hobgoblin Orange. Then the warpaint was carefully applied with Moody Blue and highlighted with Enchanted Blue. The shield was painted in Sunburst Yellow, and shaded with Hobgoblin Orange before the transfer was applied.



The axe handle on this Forest Goblin was given additional patterning. Both of the patterned areas were painted white, and then thin black zig-zags were added to separate the areas of colour. The triangles were then filled in with Bad Moon Yellow and Hawk Turquoise. Both these colours were highlighted by adding white into the mix.



The base colours on this High Elf are Blood Red, Mithril Silver, Orc Brown and white. The plate mail was then washed with a thinned down mix of black and blue ink. The red on the helmet and breastplate were highlighted with Sunburst Yellow. The gloves and boots were shaded with a mix of Orc Brown and Snakebite Leather, and finally highlighted by adding a small amount of white into this mix.



The armour on this High Elf Champion was painted in the same way as the trooper's. The fine runes on the spear shaft were added in Moody Blue with a 000 brush.



The base colours for this Wood Elf are Spearstaff Brown, Woodland Green, Chaos Black, Hawk Turquoise and Blood Red. The skin was painted with Bronzed Flesh and shaded with a thin wash of chestnut ink. When dry, the highlights were added with a mix of Bronzed Flesh and Skull White. The pattern on the edge of the cloak was achieved by painting a broad band of white on first. When this was dry, small triangles of Hawk Turquoise were added over it.



The red on the cloak of this Wood Elf was painted with a base coat of Blood Red, given an ink wash of yellow mixed with red and then highlighted with yellow and white. The arrows in the ground were made from short lengths of brass wire.



These Dark Elves show just how easy it is to use the Citadel Metallic paints. The gold armour was painted with Shining Gold, which was then given a thinned-down wash of brown and yellow ink. The green helmet was painted with Glistening Green and then given a wash of thinned-down green ink. The armour was then lightly drybrushed with Shining Gold and the helmet lightly drybrushed with Glistening Green. The pale face colour was achieved by mixing a tiny amount of Ghoulish Grey to the Bronzed Flesh base colour.



The purple armour on this Dark Elf was achieved by firstly painting the areas with metallic blue. When this was dry, washes of red ink were applied over the top until the correct shade of purple was reached. The sword was painted with Shining Gold and highlighted with a mix of Shining Gold and Mithril Silver.



DWARFS

This Dwarf has been given base coats of Mithril Silver for his armour, Moody Blue and white for his tunic and Shining Gold for his helmet. His face has been painted with Bronzed Flesh and his beard given a thinned-down coat of Snakebite Leather. The beard and face were then given a wash of chestnut ink. The chainmail was washed over with black ink and when dry, carefully drybrushed with Mithril Silver. The Dwarf's helmet was given a thinned-down wash of brown and yellow ink.



This Dwarf's beard was given a base coat of Hobgoblin Orange mixed with a little Snakebite Leather. It was then shaded with chestnut ink and highlighted with a mix of Hobgoblin Orange, Snakebite Leather and finally a tiny spot of white.



THE EMPIRE

The base colours used on this Empire Halberdier are Chainmail, Shining Gold, Red Gore, Chaos Black, Ultramarine Blue and Bronzed Flesh. The gold has been shaded with a mix of brown and yellow ink. The blue was highlighted with Enchanted Blue and Skull White and the red areas were highlighted with Sunburst Yellow and Skull White. The shield was undercoated white and the right-hand half was painted yellow, overlapping the centre slightly. Then the other half was painted red. Small highlights were applied to the edge of the shield and finally, the transfer was applied in the centre.



The breastplate on this model was given a base coat of Chaos Black. The flower design was then carefully painted on with white paint. When dry, the other colours were applied over the white. To make the whole area appear hard and shiny, the breastplate was given a coat of gloss varnish.



SKELETONS

This Skeleton was given a base coat of Bleached Bone and the breastplate and sword were painted with Chainmail. Then the Skeleton was washed with a mix of chestnut and brown ink. The breastplate and sword were given a wash of chestnut and yellow ink to make them appear rusty. Highlights of Bleached Bone mixed with Skull White were then lightly drybrushed onto the Skeleton, and the teeth were picked out with pure Skull White.



The black, red and gold colour scheme works extremely well on Undead models. The deep red colour was achieved by using a mix of Chaos Black and Red Gore for the shading and a mix of Red Gore and Bad Moon Yellow for the highlights.



SKAVEN

This Skaven was given base coats of Snakebite Leather for the fur and Striking Scorpion Green for the tunic. The fur was then washed with chestnut and brown ink and then highlighted by drybrushing with Orc Brown mixed with Skull White. The tunic was then highlighted with Striking Scorpion Green mixed with Sunburst Yellow. The crossed-bones design on the shield was created by painting a black base coat, and then adding three, fairly rough white lines across the shield. These white lines were then shaped into bones by painting around them with black paint. Finally, some Bleached Bone was added to give the bones some colour.



This Skaven has a similar colour scheme to the unit model, but the painting is much more detailed. For example, the green tunic has been painted using exactly the same colours as the unit model. More highlights have been applied and greater care has been taken on each stage, creating a much smoother overall effect.



CHAOS

The flesh of this Beastman was given a base coat of Bestial Brown and the fur was painted with Terracotta. A mix of brown and chestnut ink was then applied to the whole model and left to dry. The flesh was then highlighted with Bestial Brown mixed with Skull White. The fur was drybrushed with a mix of Hobgoblin Orange and Red Gore, and the axe was given a coat of Chainmail. The horns were first painted Spearstaff Brown, then given a wash of brown and chestnut ink, and finally, highlights were applied with Bleached Bone.



The stunningly bright red armour on the Chaos Warrior was achieved by applying a base coat of Blood Red and highlighting it first with Blood Angel Orange and then Sunburst Yellow. When the highlights were dry the armour was glazed with several coats of red ink.



RIVER TROLLS

The base coat for this River Troll's skin was Striking Scorpion Green – this gives a fairly deep green that provides the shading once the highlights have been added. These are built up by adding Bilius Green to the base colour and Skull White is added for the final highlights. The lank hair was given a base coat of Space Marine Blue, shaded with Moody Blue and highlighted with Electric Blue.

SPACE WOLVES



These Space Wolves were given a base coat of Blue Grey. This was highlighted by adding Space Wolf Grey and applying it to the edges of the armour plates, more Space Wolf Grey was added for the top highlights. As these troops are from Ragnar's company, the left shoulder pad was painted Sunburst Yellow and shaded with yellow ink. When this was dry, the black wolf's head transfer was added. The right shoulder was painted Blood Red and the black triangles were added for the Grey Hunters squad markings.



The chest eagle and wolf's head on the Grey Hunter's Sergeant were given a base coat of Sunburst Yellow. When this was dry they were washed with a mix of orange and yellow ink and highlighted with Sunburst Yellow and Skull White.

ULTRAMARINES



The base coat for these Ultramarine tactical troopers was a mix of Space Marine Blue and Marine Dark Blue. They were highlighted first with Space Marine Blue and then with Space Marine Blue mixed with Enchanted Blue, and a little Skull White was added for the final highlights. The bolter casing was given a base coat of Blood Red and highlighted with Blood Angel Orange. The shoulder pad rims were painted Sunburst Yellow and highlighted with Skull White. A white tactical squad arrow was added to the right shoulder pad and the Ultramarine symbol to the left shoulder pad.



This Ultramarine Devastator was painted in exactly the same way as the tactical troopers shown left. The chest eagle and helmet decoration were given a coat of Sunburst Yellow, shaded with a wash of orange and yellow ink and highlighted with Skull White.

BLOOD ANGELS



These Blood Angels were given a base coat of Blood Angel Orange. When this was dry a very thin wash of red ink was applied for the shading. The highlights were mixed from Blood Angel Orange and Bad Moon Yellow, with Skull White added for the final highlights. The bolters were given a base coat of Chaos Black and highlighted with a mix of Chaos Black and Skull White. The red blood drop was added onto the right knee pad by painting the shape in white over a black base, then colouring the shape with Blood Red.



The armour on this Blood Angel Sergeant was painted in exactly the same way as the troopers. Notice how the shoulder pads have been reversed out, black pads with a red rim. The yellow Blood Angel symbol transfer was added when the paint was fully dry.



The skin on these Bad Moon Orks was given a base coat of Goblin Green and then shaded with a mix of Goblin Green and Ork Flesh. The tunic and hood were given a base coat of Bad Moon Yellow and highlighted with a mix of Sunburst Yellow and Skull White. To paint the patterning on the trousers, the first step was to paint a neat band of Skull White all the way down the leg. A thin zig-zag line of Blood Red was then added to create the triangle shapes, and half of these were then painted Blood Red.



The armour on these Wolf Guard was painted in exactly the same way as the armour of the Space Wolf Grey Hunters, described earlier. The Terminator symbols on the shoulder and knee pads were given a base coat of Snakebite Leather. This was then highlighted with a mix of Snakebite and Orc Brown and then with Orc Brown and Skull White. Deep shading was added with brown ink. The bolter and right shoulder and knee pads were given a base coat of Sunburst Yellow and highlighted with a mix of yellow and Skull White. The black triangles added on top of the yellow are the Wolf Guard markings.



This Imperial Guard trooper was given a base coat of Codex Grey. When it was dry, a very thin wash of Chaos Black was applied for the deep shading. The highlights were mixed from Codex Grey and Skull White, remember to make sure that the shading wash is dry before applying any of the highlights. More Skull White is added to the grey for the final highlights. The helmet was given a base coat of Blood Red and highlighted with Blood Angel Orange. The lasrifle was given a base coat of Chainmail, shaded with a wash of brown and blue ink and highlighted with Mithril Silver.



SQUATS



The flak armour on this Squat Warrior was given a base coat of Go Fasta Red and shaded with a wash of red ink. When the wash was dry, Blood Angel Orange highlights were added. The boots and gloves were given a base coat of Snakebite Leather and highlighted with Orc Brown. The helmet visor was first painted Enchanted Blue and then highlighted with Electric Blue and Skull White. The helmet and las pistol were base coated with Chainmail, shaded with a wash of brown and blue ink and highlighted with Mithril Silver.



This Squat hero's uniform was painted in exactly the same way as the trooper. Its face was given a base coat of Bronzed Flesh, shaded with Snakebite Leather and highlighted with a mix of Snakebite and Bronzed Flesh. The beard was given a coat of Codex Grey and highlighted with Skull White.

ELDAR



This Eldar Howling Banshee's body was given a base coat of Snakebite Leather and shaded with a thin wash of brown ink. The next step was to paint each of the armour plates with Bleached Bone and highlight them with Skull White. The flaming orange hair was given a base coat of Blood Angel Orange and highlighted with Skull White, when this was dry a wash of orange ink provided the shading and brightened up the white highlights. When the whole model was finished, some thin strips of paper were painted red and glued to the butt of the gun. These can be made to curl by running your thumbnail down one side.



Eldar Exarchs can be any colour you choose – we decided to paint this Howling Banshee Exarch bright red as a contrast to the basic troops. A base coat of Blood Red was highlighted with Sunburst Yellow and Skull White. When this was dry a thin glaze of Red and Yellow Ink was applied to brighten the finished effect.

GOFF ORKS



As these Goffs were going to end up almost entirely black they were given an undercoat of Chaos Black. The areas that were going to be red or flesh-coloured were then re-undercoated with Skull White to make the finish brighter. The black was highlighted with a mix of Moody Blue and Chaos Black, and Skull White was then added for the final highlights. The areas that were going to be covered in checks were painted with Skull White. A fine grid of black lines was painted on to mark out where the checks were going to go and alternate squares were then filled in with Chaos Black.



Most of the power armour on this Goff Nob was going to be black, so it was also given a Chaos Black undercoat. The red areas were given a base coat of Go Fasta Red and highlighted with Blood Angel Orange. The checks were painted in the same way as on the Goff trooper shown left.



There are basically only two areas to paint on a Genestealer – the hard carapace, which is blue, and the skin, which is purple. The base coat for the carapace is Moody Blue with a little Chaos Black and Skull White added – this produces a dark blue grey. The highlight colour is simply a mix of the base colour and Skull White, the first highlight is quite a lot lighter than the base colour to give a dramatic look.

The top highlights can be almost pure Skull White and should be applied to the very edges of the carapace. The skin is given a base coat of Worm Purple and shaded with a wash of purple ink. When this is thoroughly dry it is highlighted with a mix of Worm Purple and Skull White. The ribbing can be lightly drybrushed with a little of the highlight colour to pick out the detail.

The claws and teeth are given a base coat of Orc Brown, shaded with brown ink and highlighted with a mix of Orc Brown and Skull White. The tips of the claws are painted with a little Skull White to make them look particularly sharp and dangerous. The tongue was given a base coat of Blood Red and then highlighted with a mix of Blood Red and Sunburst Yellow.

The skin on this fourth generation hybrid is much closer to human colouring. This was achieved by mixing a little Worm Purple with Bronzed Flesh and applying as a base coat. The highlights are a mix of the base colour and more Bronzed Flesh, Skull White was added for the final highlights. The eyes were painted pure black and given a tiny white highlight to make them look dark and sinister.



Tyranids are the largest and most dangerous monsters in the Warhammer 40,000 universe. They are the warrior brothers of the Genestealers and have a great deal in common when it comes to painting. They are basically two coloured – the bright red body, and the bone-coloured carapace, hooves and claws. When assembling the Tyranid, it is best to leave the chest piece off and paint it separately. This means that you can paint all of the internal organs in bright colours, and then glue the painted chest covering into place over the top. The first stage in painting was to give the whole model a base coat of Blood Red mixed with red and brown ink, this gives a deep red that can then be highlighted. This is done by drybrushing first with Go Fasta Red and then Sunburst Yellow to pick out the individual scales. The top highlights can be painted in by hand with Sunburst Yellow and Skull White. The carapace and bone areas are given a base coat of a mix of Snakebite Leather and Bleached Bone. This is highlighted with Bleached Bone and then a mix of Bleached Bone and Skull White. The highlights look best if applied in streaks, running down the carapace and getting lighter towards the edge. The Deathspitter was given a base coat of a mix of Bronzed Flesh and Go Fasta Red, and this was then highlighted with Bronzed Flesh and Skull White. When the highlights were dry the Deathspitter was given a very thin wash of Striking Scorpion Green to give it an alien look.

OGRES

Ogres stand twice as tall as a man and are far more strongly built. They have massive well muscled frames, jutting jaws and thick bony heads.

Ogres are such good fighters that many other races attempt to recruit them into their armies, promising food or gold and whatever else the Ogres want in return for their services.

Bands of Ogre mercenaries have often fought on behalf of the Empire as well as for Orc and Goblin Chieftains. Ogres are notoriously unbothered who they fight for.



WITH AXE AND SPIKE



STANDARD BEARER



WITH TWO-HANDED MACE



WITH SPIKED CLUB



WITH MACE



MARAUDER GIANT

Giants are extremely rare in the settled parts of the Old World, having long since been hunted down and destroyed by chivalrous Bretonnian Knights and crazed Dwarf Giant Slayers. In the Northlands they are more common, because the lands are wild and untamed, and the mountains are tall, craggy, and full of the sort of caves where Trolls, Giants and other such creatures make their homes.

Most Giants live solitary lives, occasionally banding together with other Giants, Trolls, Ogres or Orcs to raid and pillage. Giants will often join up with Orc and Goblin armies for a share of the spoils and the chance to take part in a big battle.



MAN O' WAR

The Elves and the Bretonnians are arguably the two finest seafaring nations of the Old World. The Elves have deep knowledge of the sea and all its mysteries. Their graceful catamarans and Hawkships skim across the waves bringing their foes within range of their deadly Eagle Claw bolt throwers.

The Bretonnian fleet presents an inspiring sight, with their great sails billowing in the wind and ranks of mighty cannons lining the sides of the ships. They wait for a gap in the enemy lines so that they can sail in and unleash their devastating broadsides.



ELF HAWKSHIP



BRETONNIAN BUCCANEER



ELF EAGLESHIP



ELF DRAGONSHIP



BRETONNIAN GALLEON



BRETONNIAN CORSAIR

MAN O' WAR

RAGING SEA BATTLES IN THE WORLD OF WARHAMMER

The roar of cannon and the cries of mighty blood-drenched warriors echo across the seething waters. Warships crammed with fierce warriors do battle for supremacy on the high seas. As admiral of the fleet, you are responsible for the ships and crews under your command. But beware the cruel sea, as fickle ocean currents, treacherous rocks, whirlpools and the whims of the four winds may combine to betray you at the very moment of victory.

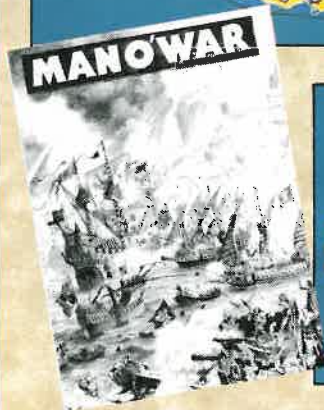

The Man O' War hobby-game system is designed so that you can open the box, assemble the components and begin playing the basic game almost immediately. The advanced rules section contains the full details of many fleets of the Warhammer World, campaign rules, scenarios, crew advancement and an exciting magic system.

As well as the Man O' War rulebook, terrain, playsheets, counters and cards, this game contains 12 plastic wargalley models – deadly ramships, bristling with cannon, which are the backbone of the Imperial fleet. And as your skill improves, so can your fleet, with the ever expanding range of Citadel Miniatures' ship models to collect and paint.

A **GAMES**®
WORKSHOP
PRODUCT

SPACE MARINE®

GARGANTS

By Andy Chambers

At the heart of the Ork expansion throughout the universe is the Waa-Ork. The Waa-Ork is a spontaneous happening which starts suddenly in obscurity and then gradually gathers momentum. More and more Ork tribes become part of the gathering strength of the Waa-Ork as the whole of Orkdom becomes agitated, disturbed and dynamic. Waa-Ork is a time of resurgence of Orkdom into the universe, a time of great migrations, wars and conquest. Orks everywhere take to the warpath and the relentless power of Ork civilisation is unleashed.

At the very core of the Waa-Ork lies the construction gigantic Titans known as Gargants. Each Gargant is a towering war machine with awesome destructive power. It is also a titanic, mechanical, fighting, fire-belching idol in the image of the

Ork gods of war. Each Gargant the Orks build is an act of worship of the primal Ork gods; they are idols of the gods that stand for all that is Orky. Gork and Mork, the Ork gods epitomise the Orkish character on a vast scale. They are big, carefree, boisterous beings that leave a trail of destruction in their wake. War, conquest, migration, endless feuds, the din of weapons and the war cries of countless Orks are but the crude games and raucous laughter of these strong, carefree gods.

Gargants are miracles of mechanical ingenuity, packed with whirring cogs and gears, wheezing pipes and pistons, dials, levers, stopcocks, gauges and no end of other mechanical devices that seem to work purely through the faith of their Mekboy inventors. Gargants carry awesome firepower, heavy cannon and giant flamethrowers are mounted in turrets on the Gargant's shoulders and often more guns are carried on the head as well. Mounted low down in the Gargant's belly is the Gutbuster mega-cannon, a gigantic weapon of massive destructive power. Gargants are protected by banks of thrumming Power Field generators and thick armour. Their heavily armoured hull is made out of all kinds of different metal and bits of armour plate scavenged from wrecked vehicles and welded or hammered into place.

A vast Krew of Orks, Gretchin and Snotlings ride into battle aboard each Gargant. The Orks fire the guns and stoke the boilers under the stern eye of the Gargant Kaptin and his Nobz. Teams of Snotlings and Gretchin 'riggers' armed with spanners and oily rags are sent frantically crawling into the cramped workings of the Gargant to fix bits and fight fires as the Gargant suffers battle damage. Though no two Gargants are identical, Ork Mekboyz commonly build one of two distinct sorts of Gargant; the short, fast Slasher Gargant and the larger, more heavily-armed Great Gargant.

In Space Marine an individual Slasher Gargant or Great Gargant can be bought as the special card for any Ork clan. The immensely proud Warboss of that particular clan will be the Gargant's Kaptin and some of his Nobz will take up the posts of Furst Mate (who shouts at the Krew) Gunboss (who shouts at the gunners) and Flagboss (who's in charge of the signal flags Gargants use in battle – as well as shouting of course!). The talented Mekboy who built the Gargant is rewarded with the post of Boss-Mek and gets to order around all the other Mekboyz onboard and shout at the riggers. These individuals all work together surprisingly smoothly to keep the Gargant stomping around and blasting away at the enemy. Because a Warboss is in command of the Gargant it can always be given orders even if there aren't any Nobz within 10cm of it. Any Orks within 10cm of a Gargant can be given orders by the Warboss.



DAVE GALLAGHER

GARGANT BIG MOBS

In the build-up to the Waa-Ork all Ork tribes are driven by the urge to build the idol-like Gargants in praise of their savage gods. Most Warbosses manage to get one or two Gargants built by industrious Mekboyz. Some of the powerful Ork Warlords can command enough resources to build many Gargants. Sometimes Ork Warbosses will join their tribes together to form an even more potent Waa-Ork. So it comes about that an Ork horde may be lucky enough to be led to war by a Gargant Big Mob.

Gargants' Big Mobs usually comprise three Gargants, either Slasher Gargants or Great Gargants or a mix of the two types. One Gargant is a frighteningly destructive creation, three is enough to send all but the bravest troops fleeing for cover. The massed firepower of a Gargant Big Mob has spelled the doom of many a battleforce under a thundering barrage of smoke and flame.

The best (in other words the biggest) Gargant in the mob is commanded by the Warlord and is known as the Boss-Gargant. The other Gargants are both commanded by the Warlords most trusted Nobz. In battle, all the Gargants in a Big Mob have to stick close together so the Nobz can see the signal flags being waved about on top of the Boss Gargant, these tell them what their orders are and where they're supposed to be going. Because of this the Gargants in a Big Mob have to be within 20cm of the Boss Gargant and able to see it in the Orders phase to be given any orders.

If one of the Gargants is too far away or can't see the Boss Gargant, the Nob in command has to guess what he's supposed to do, so roll a D6 for him. On a roll of 1 or 2 he picks first fire orders, on a 3 or 4 he picks advance orders and on a 5 or 6 he picks charge orders. Naturally, Nobz in command of Gargants consider themselves well above the rest of the Nobz, so having a Nobz stand within 10cm doesn't allow you to give them an order like most Orks - they'll take orders from the Boss Gargant and nobody else.

Note that the Boss Gargant is **not a command unit**, it must be given orders like any other unit and it can be singled out by the enemy and shot at - the banners, trophy poles and graffiti which festoon the Boss Gargant make it unmistakable! If the Boss Gargant is destroyed, all the Gargants in the Big Mob will have to roll for their orders on the next turn. At the end of the turn the next biggest Gargant will take over as Boss.

THE GREAT GARGANT DATACARD

A datacard for the Great Gargant is supplied at the end of this article. You should photocopy one of these for each Great Gargant in your army and fill it out as a permanent record of that particular Gargant. Note down the weapons fitted to the Gargant in the spaces provided along with their attack dice, to hit rolls and so on. You can also use the data card to keep a note of how many Titans the Gargant has killed and how many battles it's fought in.

POWER FIELDS

Gargants are protected by banks of power field generators. These project layers of invisible force around the Gargant which absorb the energy of shots that hit them. The Gargant has lots of power fields - one beneath the other, like the layers of an onion. When each power field absorbs a hit it is knocked down but the hit does no further damage.

Unlike Void shields power fields can't be repaired as the generators burn out when the field collapses. Gargant power fields are often unstable and flicker on and off unpredictably with accompanying showers of sparks. It's not unknown for

shots to penetrate a Gargant's shields through weak points, particularly if the Gargant is under heavy fire at the time. To represent this, roll a D6 for each shot that hits a Gargant which still has its shields up - on a 1-5 the shot hits the shields and one power field collapses as usual, on a 6 the shot penetrates the shields without knocking down any power fields, work out hit location, saving throws and damage as normal.

When Gargants go into battle they often have less than their full complement of shields. This might be because some of the generators have broken down and burnt out before the Gargant got to the battle or the Mekboyz haven't got round to fixing them after the last one. You'll need to roll dice to find out how many power fields each Gargant has before the start of the game.

Great Gargants have many banks of generators so they get a D6 plus 6, giving them between 7 and 12 power fields. Keep a note of how many power fields each Gargant has remaining on its datacard. The Mekboyz always repair the power fields on the Warlord's Boss Gargant first (if they know what's good for them) so the Boss Gargant always has the maximum number of shields at the start of a game.

BATTLE DAMAGE

Great Gargants are big and very solidly built so they can take a lot of punishment before they're destroyed. It's unlikely that a Gargant will be destroyed by a single hit, rather accumulated damage from numerous hits will gradually blow pieces off a Gargant until it's totally crippled. However, unlike Eldar and Imperial Titans, Gargants lack sophisticated auto-repair systems so they can't fix damage until after the battle.

As more and more shots slam into a Gargant its solidly welded plates start to buckle and cracks start to twist open the innards of the great metal monster. To represent the accumulated wear and tear a Gargant suffers from a sustained pounding a number of damage results add bonuses to future rolls against a particular location, increasing the chances of catastrophic damage occurring if the area is struck again. For example, on the weapon damage table a roll of 3 or more will destroy the weapon but a 1 or 2 gives a result of 'Add +1 to any future damage rolls against this location'. This means that if you hit the same weapon again and it fails its saving throw you add one to your damage roll, so this time the weapon will be destroyed on a roll of 2 or more.

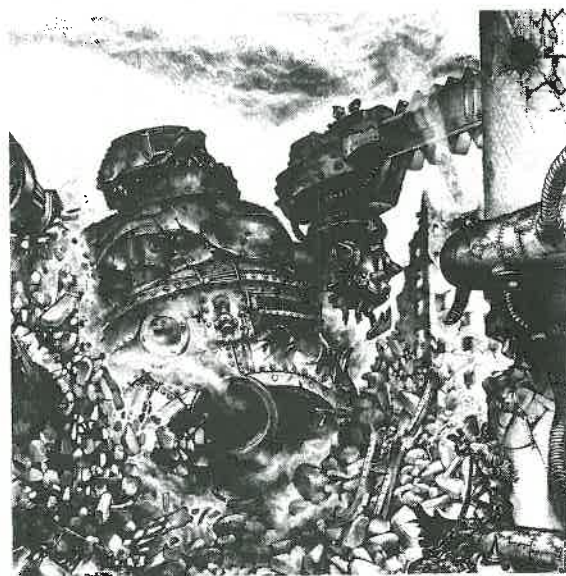

It's important to keep a note of what areas have been damaged on a Gargant — the easiest way to do it is by marking the areas hit on the Gargant's datacard in pencil or using counters. It's worth noting here that, unlike weapon locations, damage bonuses accumulated against a Gargant's hull affect the whole hull and not just the particular square hit.

FIRES

Lacking a dangerous plasma reactor to meltdown or vulnerable legs to cripple, a Great Gargant can survive almost any amount of punishment without being destroyed. When a Great Gargant finally blows it's almost always because fires have caught a hold throughout its gigantic structure and blazed out of control.

Some damage results will cause fires to break out. Teams of Gretchin and Snotlings dash through the Gargant and try to douse down fires before they become too fierce. Unfortunately, damaged areas can catch fire all too easily as explosions ignite ammunition or fuel and the fire fighters can find themselves fighting a losing battle. Keep track of the number of fires burning on a Great Gargant on its datacard. In the End phase of each turn, every Gargant which has any fires burning on it has to make a roll on the fire table, adding +1 to the dice for every fire burning in excess of one. Some particularly dangerous hits can send flames shooting through the Gargant and cause an immediate roll on the fire table.

GARGANT WEAPONS

DA GAZE OF GORK

Gork is one of the two great gods of the Orks. Gargants are gigantic representations of Gork and Mork so it is quite common for them to have specially made heads to make them look more life-like. Gargants with Gork heads are often fitted with a pair of heavy Traktor Kannon in place of their eyes so the Orks can terrify their foes with the mighty gaze of Gork.

The Traktor Kannon can fire all round because they are fitted in the head. When they shoot they fire a strong pulse of Traktor energy which slams into the target, and immobilises or crushes it.

The following special rules govern the use of Traktor Beams. Roll to hit your chosen target as with any other weapon — the gaze of Gork has 2 attack dice and a basic hit roll of 4 or more is required. If the target is hit it takes a saving with a -2 modifier. If the save is passed the target is unaffected. If the target fails its save it may be *immobilised* (in which case it cannot move, shoot or do anything else in its next turn), or *squashed* in which case it is destroyed.

Roll a D6 to determine the result and add +1 if the target has no saving throw (most infantry units, for example, have no saving throw and therefore are more likely to be squashed).

| D6 | Result |
|-----|---|
| 1-4 | IMMOBILISED – May do nothing next turn. |
| 5+ | SQUASHED – Destroyed |

An Imperial Titan's void shields do not protect it from a Traktor Beam, an Eldar Titan's holo-fields work as normal. Titans always count their highest saving throw out of all of their areas against Traktor Beams. This makes them very hard to hit effectively. If a Titan is immobilised its shields still operate but nothing else works, so they cannot repair damaged

GREAT GARGANT FIRE ARCS

Because Gargant weapons are mounted rather differently to those on Imperial or Eldar Titans they have different fire arcs, these are shown on the diagram below. The belly mount has a 90° arc of fire forward, the left and right arms have a 180° field of fire to the left and right respectively. The Gargant's head has a 360° field of fire.

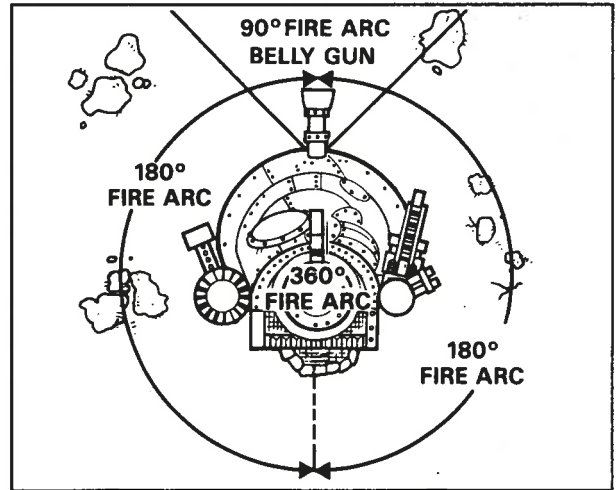

shields or locations. Other immobilised models can do nothing — they can't give orders or repair vehicles or heal wounded or use psychic powers for example. Immobilised models are exempt from formation rules until they can move again.

A Gork head also emphasises the idol-like nature of an Ork Gargant. Any Orks within 25cm of a Gargant with a Gork head are whipped into a religious frenzy and automatically pass their morale tests – no test is required for the unit. Unfortunately if the Gargant has its head blown off its very demoralising for any Orks nearby to see their Idol's head flying through the air, so all Ork units within 25cm have to take an immediate morale check.

GUTBUSTER MEGA-CANNON

The Gutbuster or belly gun is a huge cannon which protrudes from the Gargant's belly. The weapon can fire an array of ammunition. At the start of the game, the Gutbuster is loaded with one shot of the player's choice. After firing it takes a full turn to reload, and so the Gutbuster may not be fired in the next combat phase. Often gutbusters are also fitted with extra battle cannon which keep the chief gunner amused while the Boyz are sweating to reload the belly gun. The battle cannon have a range of 75cm, 3 attack dice, and hit on a 5+ with a -2 saving throw modifier. A Gargant can fire the battle cannon or the belly gun, it can't fire both in one turn. Gutbuster rounds comprise three types.

Ball rounds are like immense cannonballs. A special 3cm template is supplied for the ball round. Place the template over your target and then roll for scatter as you would for a barrage. Anything under the template is hit and makes a saving throw with a -4 modifier. The ball will then roll another 4D6cm in a straight line along the line of fire. A template which represents the rolling ball is also supplied. Place the template so that its cupped end is around the ball and align it so that it's pointing

directly away from the Gargant, then roll the dice to see how far along the template the ball rolls. Anything that is rolled over is hit automatically and must make a save with a -4 modifier, including any buildings. The ball will plough through any operating shields on a Titan that it hits, knocking them all down one after the other. Should it hit the leg of a Titan model the save is taken with a -4 save modifier.

Chainshot consists of two or more medium sized projectiles linked together by heavy chains. When it is fired the chainshot spreads out and spins like bolas. It is only used for entangling the legs of Imperial and Eldar Titans, and causes no damage to any other type of target! It will only work against Imperial Titans if they have no operating void shields at the time that it hits. When chainshot scores a hit against an eligible target it automatically causes damage to the target's legs. No hit location or saving rolls are needed, simply roll on the Leg Damage Table, adding +3 to the dice roll. For obvious reasons their must be a clear line of fire from the Gutbuster itself to the target's legs, any intervening terrain will block the shot.

High Explosive rounds are huge cannon shells packed with hundreds of pounds of explosive. They have a special 12cm diameter of effect, fully twice as large as a normal barrage attack! High Explosive is very effective against infantry and light vehicles, but not against armoured targets, so there is a +1 save. The +1 save modifier means just that — the opposing player adds +1 to the dice when he makes his armour saves.

MAGNUM MEGA-CANNON

The Magnum Mega-cannon is a monster gun which fits on the lower arm mount of the Gargant. The magnum can fire different rounds in the same way as the gutbuster, though its choice is limited to a solid armour-piercing shot or a large high explosive shell. Unlike the gutbuster the Magnum can fire every turn but you must pick which can of shell it's going to fire at the start of the turn during the orders phase.

Armour piercing shots (or Klangerz) roll one attack dice with a to hit roll of 3+ and a saving throw modifier of -3.

High Explosive shells (or Bangerz) fire a barrage template with 8 barrage points and a 0 saving throw modifier. Because Orks aren't into the fiddly bits of indirect fire high explosive shells can only be fired at targets the Gargant can see. Because this is a direct shot there is no chance of the barrage template scattering.

SUPER LIFTA-DROPPA

The Lifta-Droppa is a Mekboy invention which uses Traktor beam technology in a radically different way to a Traktor Kannon. Instead of flattening a single target with a beam of energy, the super Lifta Droppa latches onto an area of ground and pulls the lot up into the air. The immensely powerful beam lifts up trees, rocks, earth and screaming victims all at the same time. The boom carrying the projector is swung upwards and its entrapped victims swing helplessly upwards too. Then, with a little bit of jiggling of the controls, the Meks controlling the beam drop the whole lot on some unfortunates nearby.

The super Lifta-Droppa has a range of 75cm and 'fires' a barrage template. Note that unlike most barrage weapons the Lifta-Droppa must be able to see its target in order to fire at it and can never fire indirectly. Place the barrage template anywhere in sight and within range of the super Lifta-Droppa. Anything even partially under the template is hit on a roll of 4, 5 or 6 on a D6. If a target is hit it has to make a saving throw

with a -4 modifier, a failed save means the target is latched on to and lifted high up in the air. Anything which isn't latched on to or makes its armour save is lucky enough to avoid the beam and unaffected by the attack. Titans are too big to be picked up by the super Lifta Droppa as explained below.

After finding out what's caught in the beam the Ork player can designate where he wants to drop the contents of the beam within 6cm. Roll the scatter dice to see if the Mekboyz manage to get their helpless victims on target — a 'hit' indicates they're bang on target, an arrow means the template flies 2D6cm in the direction of the arrow before plummeting to the ground. The falling victims are automatically destroyed regardless of whether the Meks are on target or not. Any models underneath the template (wherever it ends up) are struck by falling debris on a roll of 4, 5 or 6 on a D6. Models hit by falling debris are automatically destroyed unless their saving throw is better than the saving throw of the biggest thing caught on the template — so for example, Land Raiders (Sv 2+) hit by debris from a template which included a Baneblade (Sv 1+) would be crushed. If a Baneblade was struck by debris from a Lifta Droppa template carrying Land Raiders it would survive.

Titans are too big and heavy to be picked up even by a super Lifta Droppa but can be hit by falling models. Titans will lose a shield if struck by a template, or suffer a hit if they have no shields left. Roll for location as normal, the location hit will suffer damage unless its saving throw is better than the biggest model on the hitting it. A building hit by a super Lifta Droppa beam or falling debris must make an unmodified saving throw and collapses into rubble if it fails.

The super Lifta-Droppa arm is cunningly constructed so that it also works as a monstrous grabber filled with whirling steel teeth. In close combat a Great Gargant armed with a super Lifta-Droppa arm can make a special grab attack if it wins. The grab attack only affects Titans and buildings. Against enemy Titans the Mekboy Gargant can grab any location shown on the hit location chart and try to tear it off. Both players roll a D6 and the Gargant adds +1. If the Gargant's score is higher than its opponents the location is torn off and suffers maximum damage as if a 6 had been rolled on the location damage chart. If the scores are equal the opponent pulls partially free of the Gargant's grasp, roll for damage normally. If the opponent rolls higher than the Gargant he wriggles completely out of the Gargant's grasp and no damage is done. A building hit by the grab attack suffers a hit with a -4 saving throw modifier.

OBSERVATION TURRET

The Observation Turret is mounted on one the upper arm positions on the Gargant. It is packed with all sorts of ranging equipment and has speaking tubes connected directly to the gunners. This enables the Gargant to add +1 to all to hit rolls against one target fired at each turn. This bonus only applies to weapons fired at that target by the Gargant.

SCORCHER TURRET

The Scorcher Turret is also mounted on one the upper arm positions on the Gargant. The scorcher fires a long gout of flame. It has a range of 35cm, 2 attack dice, and hits on a 3+. The scorcher is especially effective at winking out infantry that are in cover. To represent this ignore any modifiers for cover that would normally apply to the to hit roll.

ORK GARGANT WEAPON DATA

| Weapon | Range | Attack Dice | To Hit Roll | Target's Save Mod. | Notes |
|--------------------------------|---|------------------|--------------|--------------------|--|
| Gork Head | Any Orks within 25cm ignore morale tests. | | | | |
| Da Gaze of Gork | 50cm | 2 | 4+ | -2 | |
| Gutbuster: | | | | | |
| Ball | 100cm | Ball | 3cm Template | -4 | Ball template skids 4D6cm. |
| Chain | 75cm | 1 | 3+ | - | Only affects Titans |
| Explosive | 100cm | 8 BP's | 8 BP's | +1 | 12cm Barrage template. |
| Gutbuster Battle Cannon | 75cm | 3 | 5+ | -2 | |
| Observation Turret | Adds +1 to any to hit rolls versus <i>one</i> target. | | | | |
| Scorcher Turret | 35cm | 2 | 3+ | 0 | Ignore to hit modifiers for cover. |
| Magnum Mega-cannon | | | | | |
| Armour Piercing | 100cm | 1 | 3+ | -3 | |
| High Explosive | 75cm | 8 Barrage Points | | 0 | Fires Barrage May not fire indirect |



ORK GREAT GARGANT



ORK GOFF BANNERS



SPACE MARINE™



Warlords describes Ork and Squat forces of the 41st Millennium, and contains background, rules and army cards for using these armies in your games of Space Marine. The Orks section contains expanded details of the Ork Clans, new weapons and vehicles, the mighty Ork Gargants, and the unpredictable but deadly machines of the Ork Mekboyz. The Squat rules cover troops and special characters of the fiercely independent Squat Home Worlds such as Warlords, Living Ancestors, Warrior Brotherhoods and Guild aeronauts, plus the Squat Land Train and the gigantic Colossus. The rulebook also contains a full colour section illustrating Ork and Squat colour schemes, glyphs, banner designs, and photographs of painted miniatures.

The Warlords box also includes new card templates, Gargant data cards, Mekboy kustom repair cards and over a hundred epic army cards for the vehicles and troops described in the rule book. The contents of this product can be used in conjunction with the army cards and rules from Space Marine and all the Space Marine supplements.

**GAMES™
WORKSHOP**

**EPIC®
BATTLES**

ORK AND SQUAT WARLORDS IS NOT A COMPLETE GAME. A COPY OF SPACE MARINE IS REQUIRED TO USE THE CONTENTS OF THIS BOX

GREAT GARGANT

Close Assault Factor

+15

Movement

A Great Gargant's move is determined by its orders. These are as follows:

| Orders | Effect | Fire |
|-------------------|--|---|
| Charge | Must move between 11-15cm towards the nearest enemy formation. | The Great Gargant may not fire. |
| Advance | May move up to 10cm but this does not have to be towards the nearest enemy formation as in Charge. | The Great Gargant may fire in the Advance Fire segment. |
| First Fire | No move or turn. | The Great Gargant may fire in the First Fire segment. |

Power Fields

The Great Gargant is protected by 6+ (1D6) Power Fields.

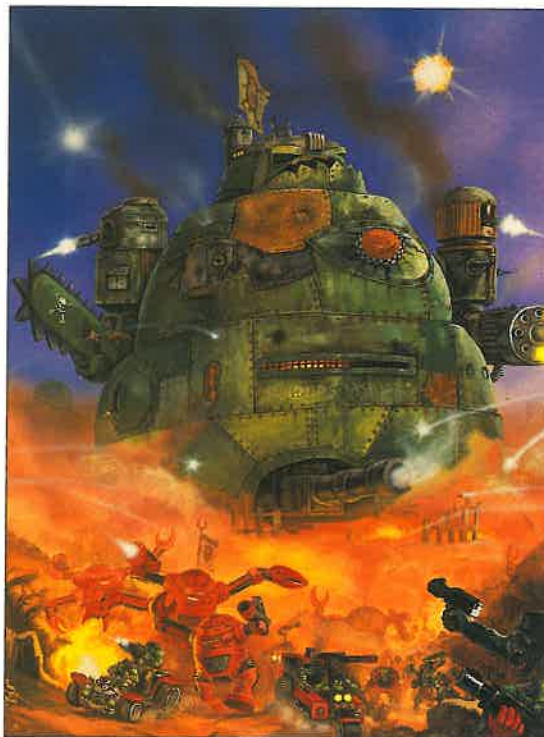

| WEAPON | RANGE | ATTACK DICE | TO HIT ROLL | TARGET'S SAVE MODIFIER | NOTES |
|--------------------------------|---|------------------|--------------|------------------------|---|
| Magnum Mega-cannon | 100cm | 1 | 3+ | -3 | Fires Barrage. May not fire indirect |
| Armour Piercing High Explosive | 75cm | 8 Barrage Points | | 0 | |
| Scorcher Turret | 35cm | 2 | 3+ | 0 | Ignore to hit modifiers for cover |
| Observation Turret | Adds +1 to any to hit rolls versus one target | | | | |
| Gork Head | Any Orks within 25cm ignore morale tests | | | | See Special rules |
| Da Gaze of Gork | 50cm | 2 | 4+ | -2 | |
| Gutbuster | | | | | |
| Ball | 100cm | Ball | 3cm Template | -4 | Ball template skids 4D6cm Only affects Titans 12cm Barrage template |
| Chain | 75cm | Chain | 3+ | 0 | |
| Explosive | 100cm | 8BP's | 8BP's | +1 | |

HIT LOCATION TEMPLATES

FRONT

| | | | | |
|--------------|------|-----------|--------|--------------|
| WEAPON | HEAD | | WEAPON | |
| 2+ | 2+ | 2+ | 2+ | 2+ |
| WEAPON MOUNT | AMMO | HULL | AMMO | WEAPON MOUNT |
| 2+ | 1+ | 3+ | 1+ | 2+ |
| WEAPON | HULL | HULL | HULL | WEAPON |
| 2+ | 3+ | 3+ | 3+ | 2+ |
| | HULL | BOILER | HULL | |
| | 3+ | 2+ | 3+ | |
| FOOT | HULL | BELLY GUN | HULL | FOOT |
| 3+ | 3+ | 3+ | 3+ | 3+ |

SIDE

| | | | |
|--------|--------------|-----------|-----------|
| WEAPON | | WEAPON | |
| 2+ | | 2+ | |
| HULL | WEAPON MOUNT | HULL | HULL |
| 3+ | 2+ | 3+ | 3+ |
| HULL | WEAPON | HULL | HULL |
| 3+ | 3+ | 3+ | 3+ |
| HULL | BOILER | HULL | HULL |
| 3+ | 3+ | 3+ | 3+ |
| HULL | FOOT | BELLY GUN | BELLY GUN |
| 3+ | 3+ | 2+ | 2+ |

REAR

| | | | | |
|--------------|------|--------|--------|--------------|
| WEAPON | HEAD | | WEAPON | |
| 2+ | 2+ | 2+ | 2+ | 2+ |
| WEAPON MOUNT | AMMO | HULL | AMMO | WEAPON MOUNT |
| 2+ | 1+ | 3+ | 1+ | 2+ |
| WEAPON | HULL | HULL | HULL | WEAPON |
| 2+ | 3+ | 3+ | 3+ | 2+ |
| | HULL | BOILER | HULL | |
| | 3+ | 3+ | 3+ | |
| FOOT | HULL | HULL | HULL | FOOT |
| 3+ | 3+ | 3+ | 3+ | 3+ |

GREAT GARGANT DAMAGE TABLES

BOILER DAMAGE TABLE - Roll D6

- 1-2 **The boiler is damaged.** Add +1 to any future rolls against the head.
- 3-4 **The boiler is hit and starts to lose pressure.** The Great Gargant's move rates are reduced by 50% from now on.
- 5-6 **The boiler is destroyed.** The Great Gargant can no longer move, and a fire is started.

FOOT DAMAGE TABLE - Roll D6

- 1-3 **The foot is damaged but carries on working normally.** Add +1 to any future damage rolls against this foot.
- 4-5 **The foot is destroyed.** If one foot is destroyed the Great Gargant is only allowed to turn in place. If both feet are destroyed the Great Gargant may not move at all.
- 6 **The foot is blown apart in a massive explosion that starts a fire.** The Great Gargant may no longer move or turn, even if the other foot is undamaged.

WEAPON DAMAGE TABLE - Roll D6

- 1-2 **The weapon is damaged but keeps on functioning.** Add +1 to any future damage rolls against this weapon.
- 3-4 **The weapon is destroyed and may not be used for the rest of the game.**
- 5-6 **The weapon is blown off the Gargant starting a fire.** The weapon lands 2D6cm away in a random direction. Any vehicles or infantry underneath it are destroyed unless they make their basic saving throw.

MAGAZINE DAMAGE TABLE - Roll D6

- 1-3 **Some ammunition explodes starting a fire and sending flames shooting through the hull.** Roll on the Fire Table immediately.
- 4-6 **The magazine detonates spectacularly, starting 1D3 fires.** Roll for damage against the weapon mount as well and apply any damage. After you have rolled for extra damage total up all the fires on the Gargant and make an immediate roll on the Fire Table.

WEAPON MOUNT DAMAGE TABLE - Roll D6

- 1-2 **The weapon mount is damaged but keeps on functioning.** Add +1 to any future damage rolls against this weapon mount.
- 3-5 **The weapon mount is badly damaged.** Roll for both of the attached weapons on the Weapon Damage Table.
- 6 **The weapon mount is blown off the Gargant starting a fire.** The attached weapons land 2D6cm away in a random direction - any vehicles or infantry underneath it are destroyed.



HEAD DAMAGE TABLE - Roll D6

- 1-2 **Several of the bridge crew are injured.** Add +1 to any future damage rolls against the head.
- 3-4 **The Kaptin is killed.** The Great Gargant must follow the same orders next turn while the bridge crew 'elect' a new Kaptin.
- 5-6 **The head is blown clean off the Great Gargant, starting a fire.** The Great Gargant must follow the same orders as it used last turn, and the Traktor Kannon mounted in the head may not be used for the remainder of the battle. All Orks within 25cm must take a morale check.
After the next turn, roll a D6 before changing the Great Gargant's orders:

| | |
|-----|----------------------------|
| 1-3 | May not change orders |
| 4-6 | May change orders normally |

HULL DAMAGE TABLE - Roll D6

- 1-5 **The hull is weakened.** Add +1 to any future rolls against the hull.
- 6 **A massive explosion rips a hole in the hull and starts a fire.**

BELLY GUN DAMAGE TABLE - Roll D6

- 1-2 **Some ammunition explodes but the Krew quickly douse it down.** Add +1 to any future rolls on this location. The battle cannon is destroyed and may no longer be used.
- 3-5 **The belly gun is destroyed and exploding ammunition starts a fire.** The gun may not be used for the remainder of the battle.
- 6 **The belly gun's magazine explodes starting 1D3 fires.** The belly gun is destroyed and the explosion rips into the boiler, so roll for damage against the boiler as well. After you have made this extra damage roll total up all the fires on the Gargant and make an immediate roll on the Fire Table.

FIRE TABLE - ROLL D6

Roll on this table as required by damage results and at the start of the end phase if any fires are burning on a Great Gargant. Add +1 to the roll for each fire burning on the Great Gargant in excess of one. Fire effects 4-7 last until the next roll is made on the Fire Table.

| Adjusted D6 Roll | Effect |
|------------------|---|
| 1-3 | A few scorched Gretchin the fires are brought under control and put out. |
| 4-5 | The fire is getting out of control. The Great Gargant may not move, but may fire normally. |
| 6 | The fire is out of control! Add one to the number of fires already burning on the Great Gargant. The Gargant may not move or fire its belly gun. Any other weapons fired are on a -1 to hit modifier due to the clouds of smoke. |
| 7 | The fire reaches the magazines! Roll on the Magazine Damage Table for each intact magazine. The Great Gargant can't move or fire its belly gun and suffers -1 on firing as in 4 above. |
| 8 | Huge internal explosions wreck the Great Gargant, destroying it and leaving a smoking, blackened heap. Any units within 2D6cm are hit by flying debris and must make an unmodified save to avoid damage. |
| 9+ | A massive explosion rips the Great Gargant apart. Remove the model from the table and replace it with a crater if you've got one. Any units within 4D6cm are hit by flying debris and must make an unmodified save to avoid damage. |

ORK GARGANT SPECIAL CARDS

SPECIAL CARD GREAT GARGANT



POINTS VALUE 850



GREAT GARGANT

A Great Gargant is a towering war machine of awesome destructive power. Shaped in the image of the Ork War Gods, it personifies the Waa-Ork.

A Great Gargant fights as a single unit which is commanded by a Warboss so it is not subject to the Ork command rule and can always be given orders. Because the Warboss is on board the Ork player can give orders to any Ork units within 10cm of the Gargant. The Great Gargant cannot be broken and always passes morale checks. Victory points are awarded to the opposing player once the Great Gargant is destroyed.

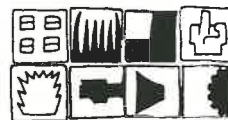

VICTORY POINTS 9

Your opponent gains 9 VPs when the Great Gargant is destroyed.

SPECIAL CARD ORK GARGANT BIG MOB

A Gargant Big Mob consists of one command unit - the Boss Gargant - and two other Gargants. The Gargants can be any mixture of Slasher Gargants or Great Gargants.



POINTS VALUE 1700



ORK GARGANT BIG MOB

In the build-up to a great Waa-Ork Mekboyz throughout Ork space enter a frenzy of Gargant construction. As a result most Warbosses will have at least one mighty Gargant to fight in the Waa-Ork. Some of the most powerful Warlords might be lucky enough to have a whole Mob of Gargants to lead their clans to war - an awesome Gargant Big Mob.

The Boss Gargant is a command unit and always has the maximum number of power fields. The other two Gargants in the Big Mob may only be given an order if the Boss Gargant is within 20cm in the orders phase, otherwise roll a D6 for the Gargants' orders : 1-2 = first fire; 3-4 = advance; 5-6 = charge.

Gargants cannot be broken and so do not need to take morale checks. Victory points are awarded to the opposing player as each Gargant is destroyed - 9VPs for a Great Gargant and 6VPs for a Slasher Gargant.

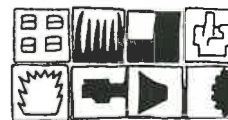

VICTORY POINTS 9 or 6

Your opponent gains 9 or 6 VPs as appropriate when each Gargant is destroyed.

GAMES WORKSHOP®

UK MAIL ORDER

OUR TELEPHONE HOTLINES ARE OPEN

9.00am – 6.30pm Monday to Friday
and 9.00am – 1.00pm on Saturdays



Man O' War is the game of raging sea battles between the great ocean-going warfleets of the Old World. Mighty warships crammed with Men, Orcs, Dwarfs, Elves and Chaos Warriors battle for supremacy on the high seas. Berserk sea monsters rear out of the watery depths, and the seas boil as mighty wizards release their powers of destruction.

MAN O' WAR™



The Man O' War boxed miniature sets are an ideal way to build up your fleets. Each box contains a single great Man O' War or a squadron of three ships of the line. A selection of ships for the Imperial, Dwarf, Bretonnian and High Elf fleets is now available.



From top to bottom:
Dwarf Nautilus,
Dwarf Monitors,
Imperial Wargalleys,
Dwarf Ironclads,
Imperial Wolfship
Squadron & Imperial Greatship.

Man O' War is a complete games system that you can use to enact sea battles in the Warhammer World. The game includes illustrated rulebook, plastic wargalley models, coloured card terrain and counters, two card decks, dice, reference sheets and a colour painting guide.

UK MAIL ORDER

Our UK Mail Order Hotlines are open six days a week, and you can pay by Visa, Access or Switch.

(0773) 713213, Monday to Friday
between 9.00am and 6.30pm
Saturdays 9.00am to 1.00pm

If you're posting your order, please send it to:

**GAMES WORKSHOP MAIL ORDER SERVICE,
CHEWTON STREET, HILLTOP,
EASTWOOD, NOTTINGHAM NG16 3HY.**

Or you can fax the order through on (0773) 530155.

WARHAMMER



| | |
|-----------------------------------|--------|
| WARHAMMER | £29.99 |
| WARHAMMER BATTLE MAGIC | £17.99 |
| WARHAMMER ARMIES – THE EMPIRE | £9.99 |
| WARHAMMER ARMIES – HIGH ELVES | £9.99 |
| WARHAMMER ARMIES – ORCS & GOBLINS | £9.99 |

OGRES & GIANTS

| | |
|----------------------------------|------------|
| NEW! OGRES | £4.99 each |
| NEW! OGRE STANDARD BEARER | £4.99 |
| MARAUDER GIANT | £19.99 |

CHAOS DWARFS

| | |
|--|------------|
| NEW! CHAOS DWARF COMMAND | £1.65 each |
| NEW! CHAOS DWARF AXEMEN | £1.35 each |
| NEW! CHAOS DWARF WITH BLUNDERBUSS | £1.35 each |
| NEW! CHAOS DWARF BULL CENTAURS | £3.99 each |
| NEW! CHAOS DWARF LORD RIDING GREAT TAURUS | £14.99 |

DWARFS

| | |
|---------------------------------|--------|
| DWARF THRONE OF POWER BOXED SET | £12.99 |
|---------------------------------|--------|

WARHAMMER PLASTIC BOXED SETS

| | |
|---|--------|
| ORCS (10 plastic Orcs) | £4.99 |
| IMPERIAL HALBERDIERS (10 plastic Imperial Halberdiers) | £4.99 |
| GOBLINS (10 plastic Goblins) | £4.99 |
| HIGH ELVES (10 plastic High Elves) | £4.99 |
| FANTASY FIGHTERS BOXED SET (An assortment of 30 plastic Citadel Miniatures) | £11.99 |
| REGIMENT OF ALTDORF (30 plastic Imperial Halberdiers) (Box includes special bonus shields and colour shield transfers not included in the £4.99 boxed set.) | £14.99 |

GOLDEN DEMON TICKETS

| | |
|-------------------------------|---------|
| TICKETS FOR GOLDEN DEMON 1993 | £5 each |
|-------------------------------|---------|

Tickets available from Games Workshop stores or post free from Games Workshop mail order.

WARHAMMER 40,000

| | |
|---------------------------------|--------|
| WARHAMMER 40,000 | £14.99 |
| WARHAMMER 40,000 VEHICLE MANUAL | £12.99 |
| WARHAMMER 40,000 BATTLE MANUAL | £11.99 |
| WARHAMMER 40,000 COMPILATION | £9.99 |
| WARHAMMER 40,000 COMPENDIUM | £11.99 |

WARHAMMER 40,000 MINIATURES

| | |
|---|------------|
| NEW! DEATHWING TERMINATORS | £2.99 each |
| NEW! DEATHWING TERMINATORS BOXED SET (Contains 5 Deathwing Terminators and a Dark Angel transfer sheet.) | £12.99 |

WARGAMES SERIES

| | |
|--------------------------|--------------|
| NEW! HORUS HERESY | please phone |
|--------------------------|--------------|

MAN O'WAR

| | |
|-----------------------|--------|
| NEW! MAN O'WAR | £24.99 |
|-----------------------|--------|

MAN O'WAR BOXED MINIATURES

IMPERIAL SHIPS

| | |
|--|-------|
| NEW! IMPERIAL GREATSHIP | £4.99 |
| NEW! IMPERIAL WOLFSHIPS (BOX OF 3) | £9.99 |
| NEW! IMPERIAL WARGALLEYS (BOX OF 3) | £4.99 |

DWARF SHIPS

| | |
|---------------------------------------|-------|
| NEW! DWARF IRONCLAD (BOX OF 3) | £9.99 |
| NEW! DWARF MONITORS (BOX OF 3) | £4.99 |
| NEW! DWARF NAUTILUS (BOX OF 3) | £4.99 |

HIGH ELF SHIPS

| | |
|---|-------|
| NEW! HIGH ELF DRAGONSHIP | £4.99 |
| NEW! HIGH ELF HAWKSHIP (BOX OF 3) | £4.99 |
| NEW! HIGH ELF EAGLESHIP (BOX OF 3) | £9.99 |

BRETONNIAN SHIPS

| | |
|--|-------|
| NEW! BRETONNIAN GALLEON | £4.99 |
| NEW! BRETONNIAN CORSAIR (BOX OF 3) | £9.99 |
| NEW! BRETONNIAN BUCCANEERS (BOX OF 3) | £4.99 |



SPACE MARINE

| | |
|--|--------|
| SPACE MARINE | £29.99 |
| ARMIES OF THE IMPERIUM (Space Marines and the Imperial Guard) | £14.99 |
| RENEGADES (Chaos and Eldar armies) | £14.99 |
| ORK & SQUAT WARLORDS | £14.99 |

GREAT GARGANT

| | |
|---------------------------|--------|
| NEW! GREAT GARGANT | £14.99 |
|---------------------------|--------|

OTHER BOARDGAMES

| | |
|------------------------------|--------|
| NEW! TALISMAN DRAGONS | £5.99 |
| NEW! TYRANID ATTACK | £24.99 |

WARHAMMER BOOKS

| | |
|--|-------|
| NEW! SPACE MARINE by Ian Watson | £3.99 |
| INQUISITOR by Ian Watson | £3.99 |
| KONRAD by David Ferring | £3.99 |
| SHADOWBREED by David Ferring | £3.99 |
| NEW! WARBLADE by David Ferring | £3.99 |
| DRACHENFELS by Jack Yeovil | £3.99 |

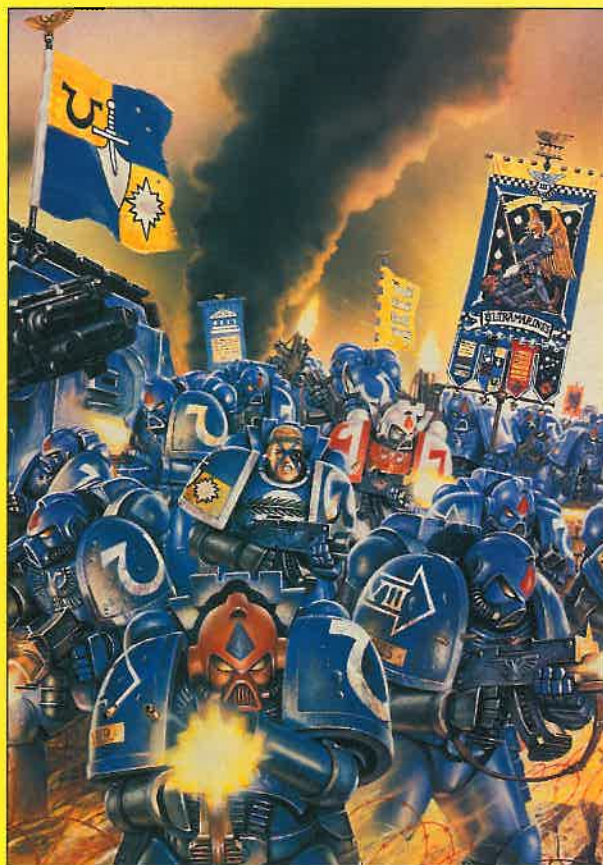

WHITE DWARF SUBSCRIPTIONS

UK, EUROPE, & THE REST OF THE WORLD

UK & BFPO: £27.50 for one year (12 issues). EUROPE: £35.

REST OF THE WORLD (excluding US and Canada): £45 for one year.

Please send payments to Games Workshop Mail Order, Chewton St, Hilltop, Eastwood, NOTTINGHAM, NG16 3HY. All payments should be in pounds sterling. Please make cheques payable to Games Workshop Ltd.

If you have a Visa, Access or Mastercard you may place your subscription by phoning our Mail Order department on 0773 713213.

USA & CANADA

USA: \$35 for one year (12 issues) / \$63 for 2 years (24 issues). (Maryland residents please add 5% state sales tax).

CANADA: \$45 for one year/ \$81 for 2 years.

Payment can be by check, US money order, Mastercard or Visa. Canadian postal money orders not accepted. Please make checks and money orders payable to Games Workshop. Payment should be sent to White Dwarf Subscriptions, 3431 C Benson Avenue, Baltimore, Maryland 21227-1072. For VISA and Mastercard orders, please telephone our Mail Order hotline on (410) 644 5699, Monday to Friday, 9am - 5pm EST. Please state which issue you would like your subscription to start with.

CORRESPONDENCE

We welcome comments about White Dwarf, Games Workshop games and Citadel Miniatures. All letters except subscriptions and Mail Order should be addressed to: The Editor, White Dwarf, Games Workshop, Howard House, 16 Castle Boulevard, Nottingham NG7 1FL.

Clearly mark your envelope with the name of the game you are writing to us about. If you want a reply you *must* enclose a self-addressed stamped envelope (overseas readers should include IRCs). We receive an enormous amount of mail. We do read every letter, but it may take a little time for us to reply to you, so please be patient!



COPYRIGHTS AND TRADEMARKS

All subject matter in White Dwarf is © Copyright Games Workshop Ltd 1993.

All artwork in Games Workshop products, and all images contained therein have been produced either in-house or as work for hire. The exclusive copyright on the artwork and the images it depicts is the copyright of Games Workshop Ltd. © Copyright Games Workshop Ltd 1993. All rights reserved.

Registered Trademarks

The following are all registered trademarks of Games Workshop Ltd.

Armageddon, Blood Bowl, Chivalry, the Citadel logo, Confrontation, Dark Future, Epic, the Games Workshop logo, Games Workshop, Realm of Chaos, Slottabase, Space Fleet, Space Marine, White Dwarf and the White Dwarf figure, Talisman, and Warhammer.

Trademarks

The following are all trademarks of Games Workshop Ltd.

Aspect Warrior, Avatar, Blood Angel, Bloodletter, Bloodthirster, Citadel, Daemonette, Dark Angels, Dark Reaper, Deathwing, Dragonmasters, Dungeonquest, Eldar, Exo Armour, Exarch, Eye of Terror, Farseer, Fire Dragon, Flesh Hound, Gargant, Genestealer, Gobbo, Great Unclean One, Gretchin, Grey Knight, Hunter Slayer, Keeper of Secrets, Khorne, Knights Panther, Leman Russ, Lichemaster, Lightning Claw, Lord of Change, Madboy, Mekboy, Mighty Empires, Nurgle, Nurgling, Ogryn, Old World, Ork, Painboy, Plaguebearer, Psyker, Ratling, Ravenwing, Skaven, Slaanesh, Slann, Snotling, Space Hulk, Space Wolf, Squat, Squig, Swooping Hawk, Striking Scorpion, Terminator, Thunder Hammer, Troll Slayer, Tyranid, Tzeentch, Ultramarines, Weirdboy, Knights of the White Wolf, Worldeater.

GW Books is a trademark of GW Books Ltd. Used with permission.

Flame is a trademark of Flame Publications Ltd. Used with permission.

Marauder Miniatures is a trademark of Marauder Miniatures Ltd. Used with permission.

Heroquest and Space Crusade are both trademarks of Milton Bradley Games. Used with permission.

CHAOS DWARFS

COMMAND FIGURES



LEADER WITH SWORD 1
75805/1

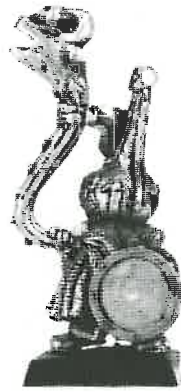

HORNBLOWER
75805/2



STANDARD BEARER 1
75805/3



LEADER WITH SWORD 2
75805/4



DRUMMER
75805/5



STANDARD BEARER 2
75805/6

AXEMEN

THESE MINIATURES ARE SUPPLIED WITH THE APPROPRIATE PLASTIC SHIELDS AS STANDARD



WITH AXE 1
75800/1

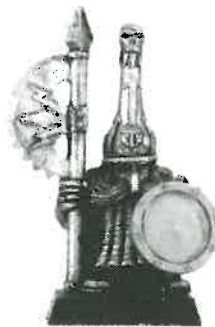

WITH AXE 2
75800/2



WITH AXE 3
75800/3



WITH AXE 4
75800/4

BLUNDERBUSSES



WITH BLUNDERBUSS 1
75810/1



WITH BLUNDERBUSS 2
75810/2



WITH BLUNDERBUSS 3
75810/3



WITH BLUNDERBUSS 4
75810/4

Designed by Alan Perry

Minatures supplied unpainted. WARNING: This product contains lead which may be harmful if chewed or swallowed. Citadel Miniatures are not recommended for children under 14 years of age.

© Copyright Games Workshop Ltd 1993. All rights reserved.



CHAOS DWARFS

BULL CENTAURS



UPPER TORSO
WITH AXE 1
75815/3



UPPER TORSO
WITH AXE 2
75815/4



UPPER TORSO
WITH AXE 3
75815/8



UPPER TORSO
WITH AXE 4
75815/9



UPPER TORSO
WITH AXE 5
75815/10



UPPER TORSO
WITH AXE 6
75815/11



LOWER TORSO
LEFT SIDE 1
75815/1



LOWER TORSO
RIGHT SIDE 1
075815/2



LOWER TORSO
RIGHT SIDE 2
75815/5



LOWER TORSO
LEFT SIDE 2
75815/6

THESE MINIATURES ARE SUPPLIED WITH THE APPROPRIATE PLASTIC SHIELDS AS STANDARD



EXAMPLES OF COMPLETED CHAOS DWARF BULL CENTAURS

Designed by Alan Perry

Minatures supplied unpainted. **WARNING.** This product contains lead which may be harmful if chewed or swallowed. Citadel Miniatures are not recommended for children under 14 years of age. © Copyright Games Workshop Ltd 1993. All rights reserved.



CHAOS DWARFS

CHAOS DWARF LORD ON GREAT TAURUS

THE COMPLETE CHAOS DWARF LORD ON TAURUS CONSISTS OF:
 1 x LORD
 1 x BACK BANNER
 1 x LEFT WING
 1 x RIGHT WING
 1 x LEFT TORSO OF TAURUS
 1 x RIGHT TORSO OF TAURUS
 1 x HEAD OF TAURUS



EXAMPLE OF COMPLETED LORD ON GREAT TAURUS



CHAOS DWARF
BACK BANNER 1
0833/7



CHAOS DWARF
LORD ON TAURUS 1
0833/1



LEFT TORSO 1
0833/4



RIGHT TORSO 1
0833/3



TAURUS HEAD 1
0833/2



LEFT WING
0833/5



RIGHT WING
0833/6

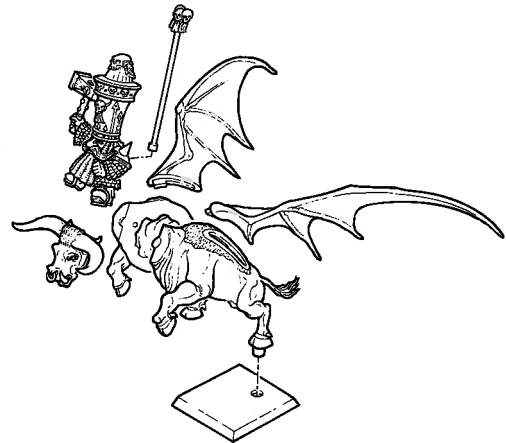

Minatures supplied unpainted. **WARNING:** This product contains lead which may be harmful if chewed or swallowed. Citadel Miniatures are not recommended for children under 14 years of age. © Copyright Games Workshop Ltd 1993. All rights reserved.



Designed by Alan Perry

OGRES

OGRES



WITH MACE
074930/3



WITH TWO HANDED MACE
074930/5



WITH AXE AND SPIKE
074930/4



WITH SPIKED CLUB
074930/6



EXAMPLE OF COMPLETED OGRE STANDARD BEARER



STANDARD
74930/2



STANDARD BEARER
74930/1

Designed by Michael Perry

Minatures supplied unpainted. WARNING. This product contains lead which may be harmful if chewed or swallowed. Citadel Miniatures are not recommended for children under 14 years of age.
© Copyright Games Workshop Ltd 1993. All rights reserved.

GIANT

GIANT



EXAMPLE OF COMPLETED GIANT

- THE COMPLETE GIANT
CONSISTS OF:**
- 1 x HEAD
 - 2 x ARMS
 - 2 x LEGS
 - 2 x TORSO PARTS
 - 1 x CLUB
 - 1 x SWORD
 - 1 x BARREL



HEAD
0829/3



GIANT'S SWORD
0829/4



ALE BARREL
0829/5



GIANT'S CLUB
0829/8

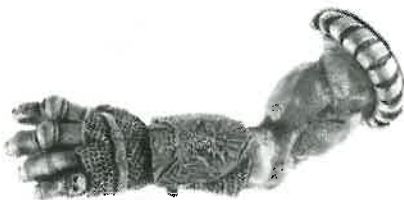

LEFT ARM
0829/10



BODY FRONT
0829/1



RIGHT ARM
0829/9



LEFT LEG
0829/6



RIGHT LEG
0829/7



BODY BACK
0829/2

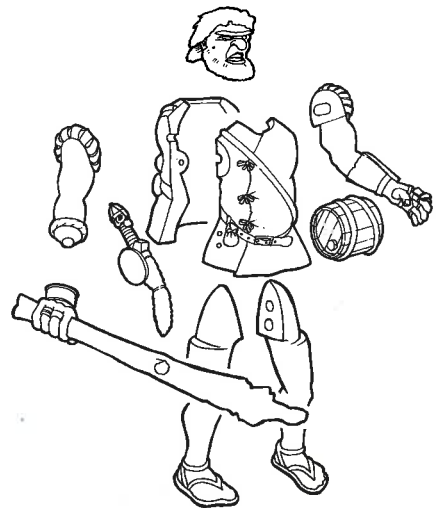

Marauder Miniatures are supplied unpainted. Banners not included.

Designed by Aly Morrison

© Copyright Marauder Miniatures Ltd, 1993. All rights reserved

Warning! These miniatures contain lead which may be harmful if chewed or swallowed. Marauder Miniatures are not recommended for children under 14 years of age.

EPIC ORK

GREAT GARGANT



EXAMPLE OF COMPLETED ORK GARGANT

THE COMPLETE ORK GREAT GARGANT CONSISTS OF:

- 3 x BODY SECTIONS
- 1 x HEAD
- 2 x FEET
- 2 x SHOULDER MOUNTS
- 1 x OBSERVATION TURRET
- 1 x SCORCHER GUN
- 1 x FURNACE DOOR
- 1 x SUPER LIFTA DROPPA
- 1 x GUTBUSTER MEGA-CANNON
- 1 x MEGA-CANNON
- 1 x BALCONY



BALCONY
076208/9



SCORCHER
TURRET
0827/14



OBSERVATION
TURRET
0827/13



MEGA-CANNON
0827/26



FURNACE DOORS
0827/22



WEAPON
MOUNT 2
0827/12



WEAPON
MOUNT 1
0827/11



SUPER LIFTA
DROPPA
0827/24

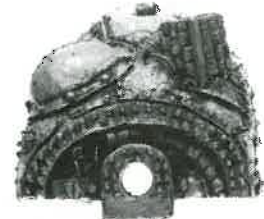

BODY SECTION 5
0827/21



FOOT
0827/10



GUTBUSTER
MEGA-CANNON
0827/25



GORK HEAD 2
0827/23

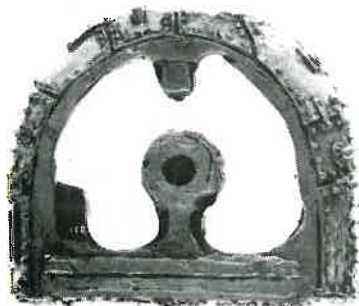

BODY SECTION 4
0827/20

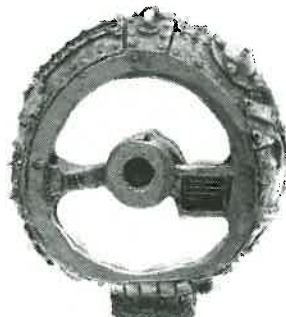

BODY SECTION 2
0827/5

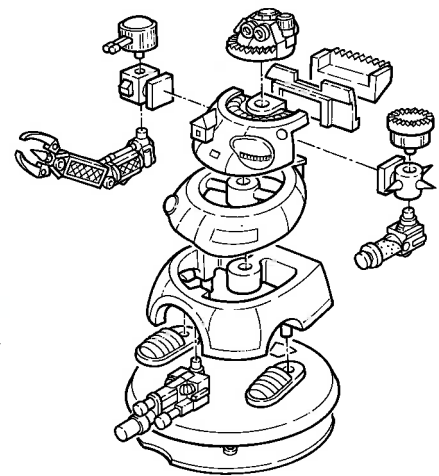

Minatures supplied unpainted. WARNING. This product contains lead which may be harmful if chewed or swallowed. Citadel Miniatures are not recommended for children under 14 years of age.
© Copyright Games Workshop Ltd 1993. All rights reserved.



Designed by Kev Adams

TERMINATORS

DEATHWING TERMINATORS

A DEATHWING TERMINATOR SQUAD MAY INCLUDE OTHER MODELS FROM OUR SPACE MARINE RANGES



DEATHWING SERGEANT
0809/7



DEATHWING TERMINATOR 1
0809/1



DEATHWING TERMINATOR 2
0809/2

LEFT ARM

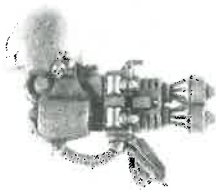

DEATHWING HEAVY FLAMER
0809/4

THE COMPLETE DEATHWING TERMINATOR CONSISTS OF:
1 x BODY
1 x LEFT ARM
1 x RIGHT ARM

(THE SERGEANT TERMINATOR IS ALSO SUPPLIED WITH
1 x BACK BANNER
1 x STORM SHIELD)

THE DEATHWING TERMINATORS ARE AVAILABLE AS A BOXED SET. THIS BOX CONSISTS OF:

- 1 x SERGEANT BODY
- 4 x TERMINATOR BODIES
- 4 x STORM BOLTERS
- 1 x HEAVY FLAMER
- 1 x BACK BANNER
- 1 x STORM SHIELD
- 1 x POWER SWORD
- 1 x CHAINFIST
- 4 x POWER GLOVE

RIGHT ARM



DEATHWING CHAIN FIST
0809/6



DEATHWING STORM BOLTER
0809/3



DEATHWING BACK BANNER
0809/10



DEATHWING STORM SHIELD
0809/9



DEATHWING POWER GLOVE
0809/5

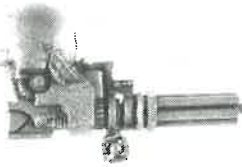

DEATHWING ASSAULT CANNON
0809/11



DEATHWING POWER SWORD
0809/8



EXAMPLES OF COMPLETED DEATHWING TERMINATORS

Designed by Jes Goodwin

Minatures supplied unpainted. WARNING: This product contains lead which may be harmful if chewed or swallowed. Citadel Miniatures are not recommended for children under 14 years of age. © Copyright Games Workshop Ltd 1993. All rights reserved.



DWARF WARSHIPS

DWARF IRONCLAD

A DWARF IRONCLAD
CONSISTS OF:
1 x HULL
1 x BRIDGE
1 x FUNNELS



EXAMPLE OF COMPLETED AND FULLY PAINTED IRONCLAD



IRONCLAD
BRIDGE
0414/3



IRONCLAD
FUNNELS
0414/2



IRONCLAD
HULL
0414/1

DWARF MONITOR

A DWARF MONITOR
CONSISTS OF:
1 x HULL
1 x BRIDGE



EXAMPLE OF COMPLETED AND
FULLY PAINTED MONITOR



MONITOR
BRIDGE
0416/5



MONITOR
HULL
0416/4

DWARF NAUTILUS



DWARF
NAUTILUS
0415/6

Designed by Norman Swales



GEOFF TAYLOR

Minatures supplied unpainted. **WARNING.** This product contains lead which may be harmful if chewed or swallowed. Citadel Miniatures are not recommended for children under 14 years of age.
© Copyright Games Workshop Ltd 1993. All rights reserved.



BRETONNIAN WARSHIPS

BRETONNIAN GALLEON

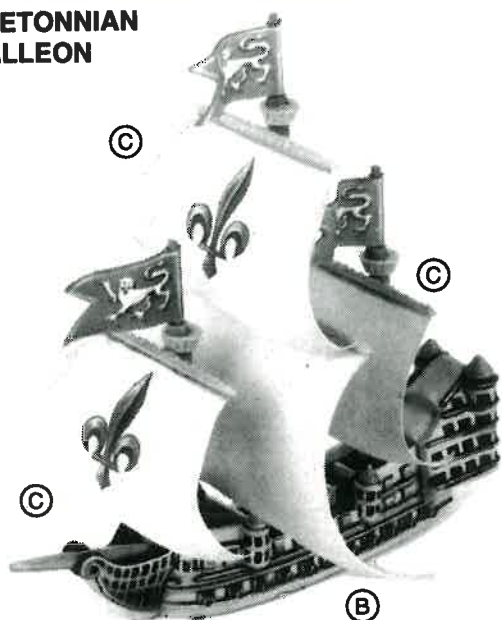

EXAMPLE OF COMPLETED AND FULLY PAINTED GALLEON

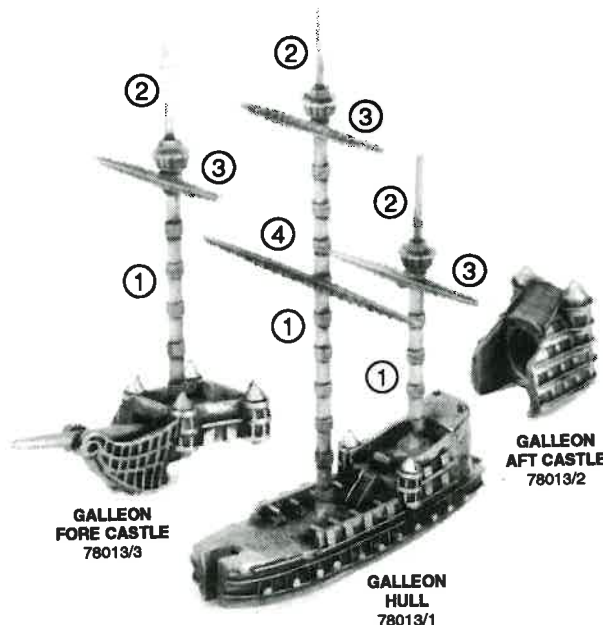

BRETONNIAN BUCCANEER

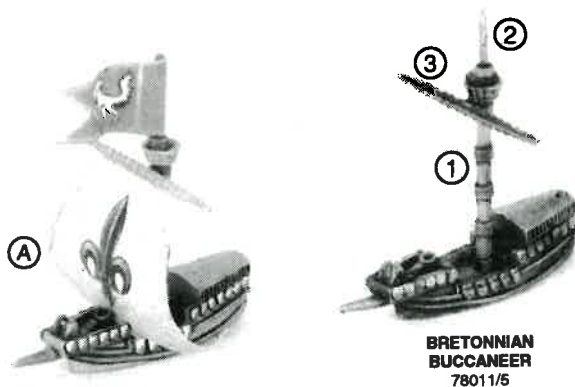

EXAMPLE OF COMPLETED AND FULLY PAINTED BUCCANEER

NOTE THAT SOME OF THESE SHIPS' MASTS HAVE BEEN SHORTENED TO MAKE THEM THE CORRECT LENGTH FOR EACH TYPE OF SHIP; REFER TO THE MAN O' WAR PAINTING GUIDE FOR MORE DETAILS ON HOW TO DO THIS.

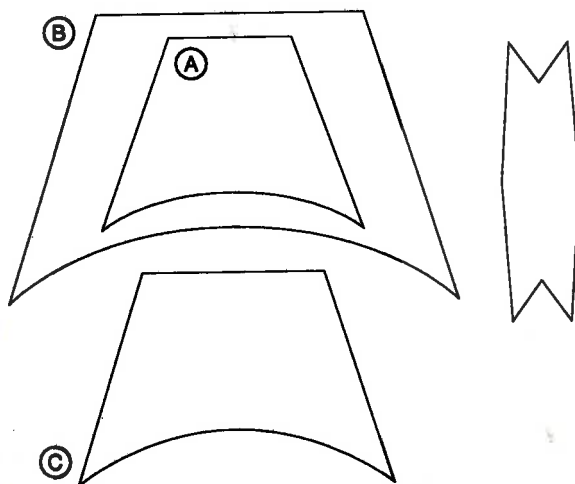

THESE SAILS AND PENNANTS MAY BE PHOTOCOPIED, CUT OUT, PAINTED AND STUCK ONTO YOUR MINIATURES. PERMISSION GRANTED TO PHOTOCOPY FOR PERSONAL USE ONLY.

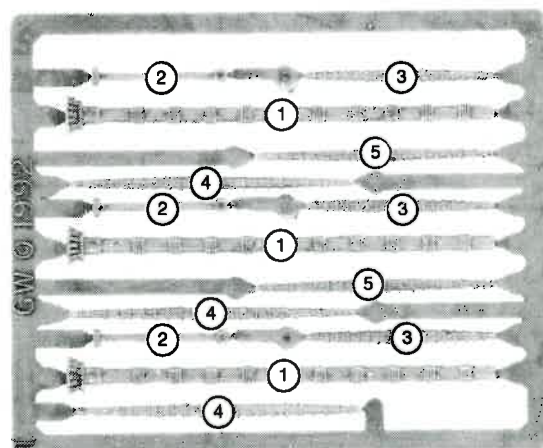

MAN O' WAR PLASTIC MAST SPRUE
MOWPLA/2

THESE MODELS ARE SUPPLIED WITH ONE OR MORE MAST SPRUES WHERE NECESSARY.

Designed by Norman Swales

Miniatures supplied unpainted. WARNING: This product contains lead which may be harmful if chewed or swallowed. Citadel Miniatures are not recommended for children under 14 years of age. © Copyright Games Workshop Ltd 1993. All rights reserved.



EMPIRE WARSHIPS

IMPERIAL WARGALLEY

EXAMPLE OF COMPLETED AND FULLY PAINTED PLASTIC WARGALLEY

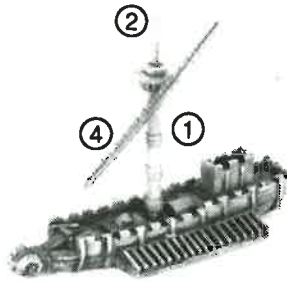
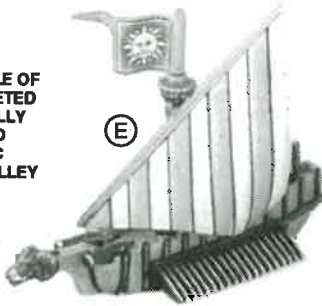

IMPERIAL WARGALLEY
0412/7

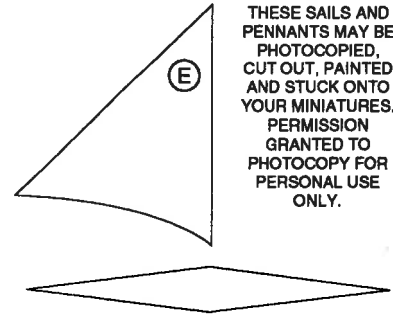

THESE SAILS AND PENNANTS MAY BE PHOTOCOPIED, CUT OUT, PAINTED AND STUCK ONTO YOUR MINIATURES. PERMISSION GRANTED TO PHOTOCOPY FOR PERSONAL USE ONLY.

PLASTIC WARGALLEY SPRUE (MOWPLA/1)

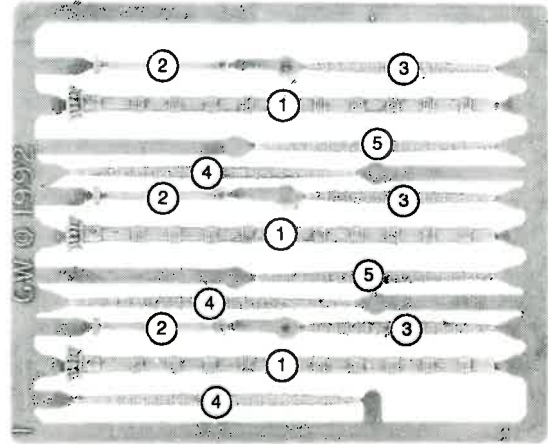
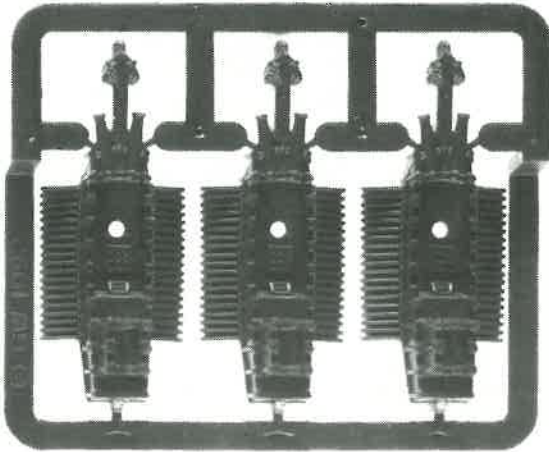

MAN O' WAR PLASTIC MAST SPRUE
MOWPLA/2

THESE MODELS ARE SUPPLIED WITH ONE OR MORE MAST SPRUES WHERE NECESSARY.

BRETONNIAN WARSHIPS

BRETONNIAN CORSAIR

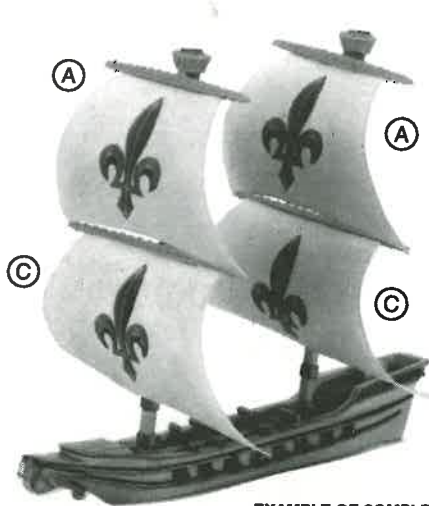

EXAMPLE OF COMPLETED AND FULLY PAINTED CORSAIR

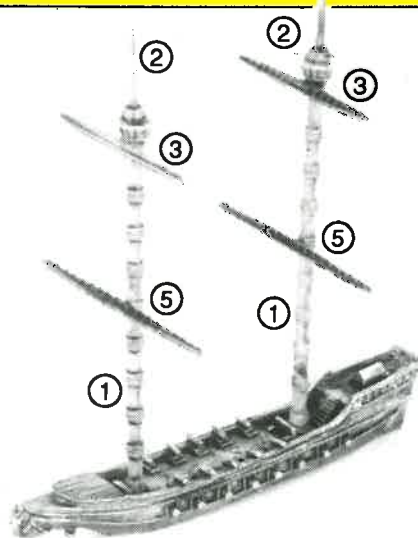

BRETONNIAN CORSAIR
78012/4

THESE SAILS AND PENNANTS MAY BE PHOTOCOPIED, CUT OUT, PAINTED AND STUCK ONTO YOUR MINIATURES. PERMISSION GRANTED TO PHOTOCOPY FOR PERSONAL USE ONLY.

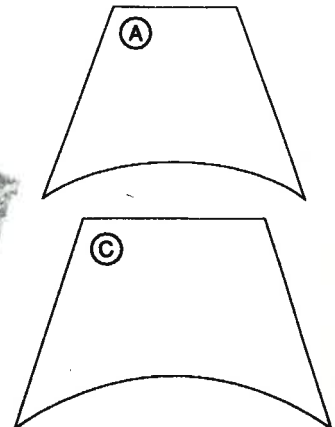

NOTE THAT SOME SHIPS' MASTS HAVE BEEN SHORTENED TO MAKE THEM THE CORRECT LENGTH FOR EACH TYPE OF SHIP; REFER TO THE MAN O' WAR PAINTING GUIDE FOR MORE DETAILS ON HOW TO DO THIS.

Designed by Norman Swales

Minatures supplied unpainted. **WARNING.** This product contains lead which may be harmful if chewed or swallowed. Citadel Miniatures are not recommended for children under 14 years of age.

© Copyright Games Workshop Ltd 1983. All rights reserved.



EMPIRE WARSHIPS

IMPERIAL GREATSHIP

AN IMPERIAL GREATSHIP CONSISTS OF:

- 1 x HULL
- 1 x AFT CASTLE
- 1 x FORE CASTLE

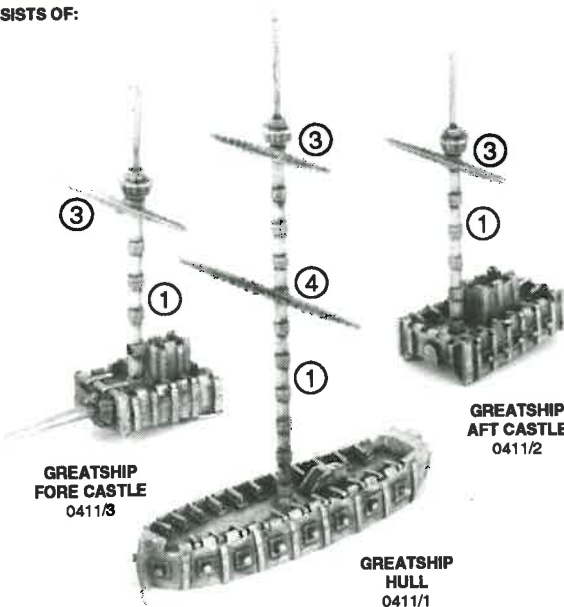
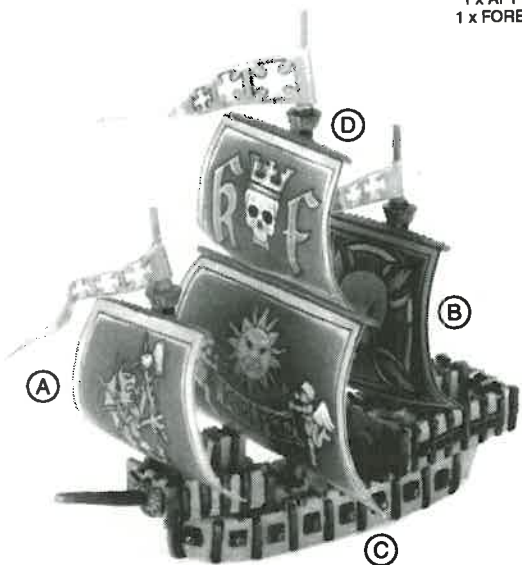

EXAMPLE OF COMPLETED AND FULLY PAINTED GREATSHIP

NOTE THAT SOME OF THESE SHIPS' MASTS HAVE BEEN SHORTENED TO MAKE THEM THE CORRECT LENGTH FOR EACH TYPE OF SHIP; REFER TO THE MAN O' WAR PAINTING GUIDE FOR MORE DETAILS ON HOW TO DO THIS.

IMPERIAL WOLFSHIP

AN IMPERIAL WOLFSHIP CONSISTS OF:

- 1 x HULL
- 1 x AFT CASTLE

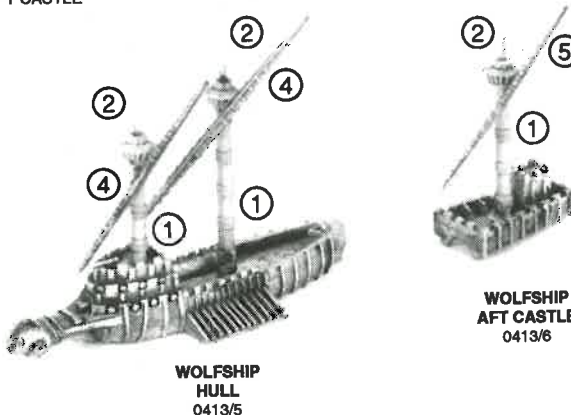
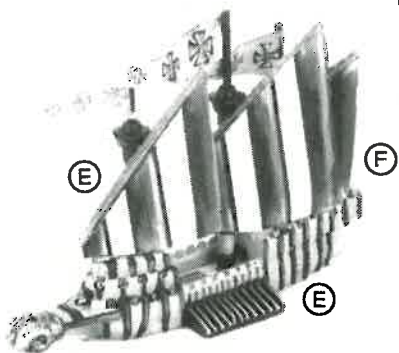

EXAMPLE OF COMPLETED AND FULLY PAINTED WOLFSHIP

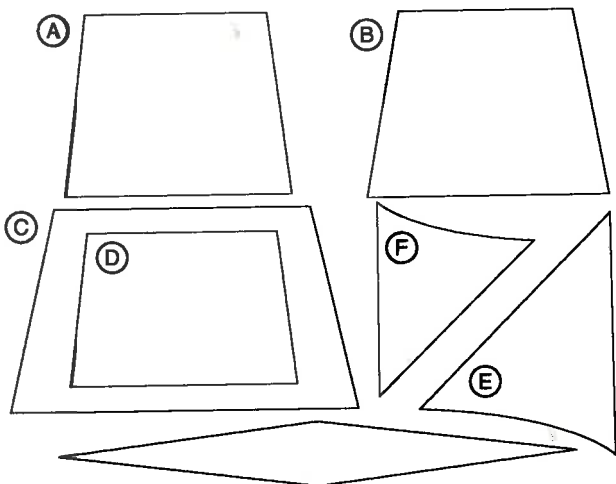

THESE SAILS AND PENNANTS MAY BE PHOTOCOPIED, CUT OUT, PAINTED AND STUCK ONTO YOUR MINIATURES. PERMISSION GRANTED TO PHOTOCOPY FOR PERSONAL USE ONLY.

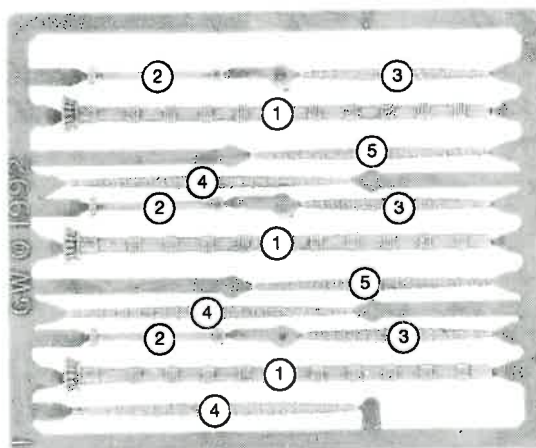

MAN O' WAR PLASTIC MAST SPRUE
MOWPLA/2

THESE MODELS ARE SUPPLIED WITH ONE OR MORE MAST SPRUES WHERE NECESSARY.

Minatures supplied unpainted. WARNING: This product contains lead which may be harmful if chewed or swallowed. Citadel Miniatures are not recommended for children under 14 years of age. © Copyright Games Workshop Ltd 1993. All rights reserved.



Designed by Norman Swales

ELF WARSHIPS

ELF DRAGONSHIP

AN ELF DRAGONSHIP
CONSISTS OF
1 x DRAGONSHIP HULL
1 x ELF BATTLE TOWER

ELF BATTLE TOWER
78001/2

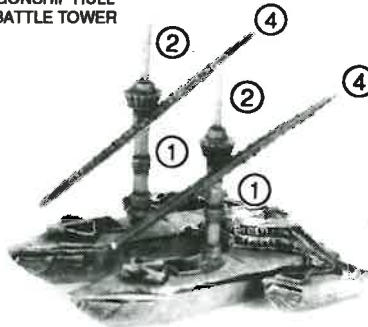
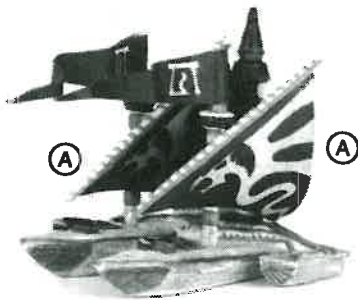

DRAGONSHIP HULL
78003/1



EXAMPLE OF COMPLETED AND FULLY PAINTED ELF DRAGONSHIP

ELF EAGLESHIP

AN ELF EAGLESHIP
CONSISTS OF
1 x EAGLESHIP HULL
1 x ELF BATTLE TOWER

ELF BATTLE TOWER
78001/2

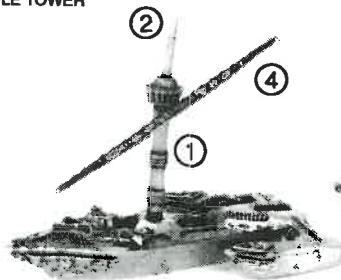
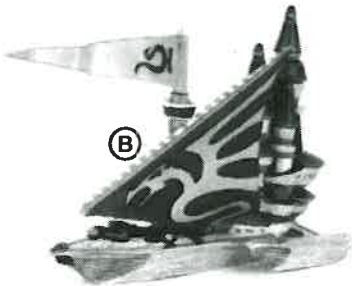

EAGLESHIP HULL
78001/1

EXAMPLE OF COMPLETED AND FULLY PAINTED ELF EAGLESHIP

ELF HAWKSHIP

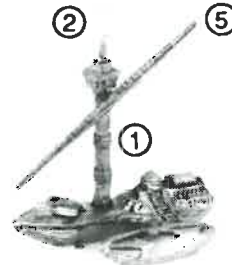

ELF HAWKSHIP
78002/1

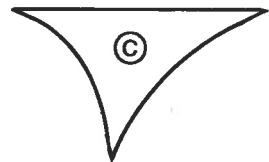

EXAMPLE OF COMPLETED AND FULLY PAINTED ELF HAWKSHIP

MASTS MAY NEED CUTTING TO THE CORRECT LENGTH FOR EACH SHIP. FULL DETAILS INCLUDED ON THE SAILS SHEET IN EACH BOX SET.

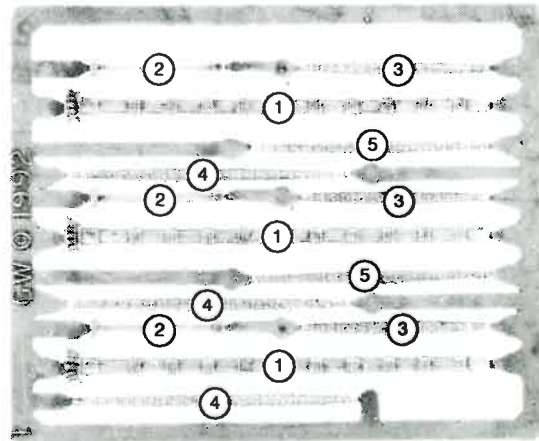
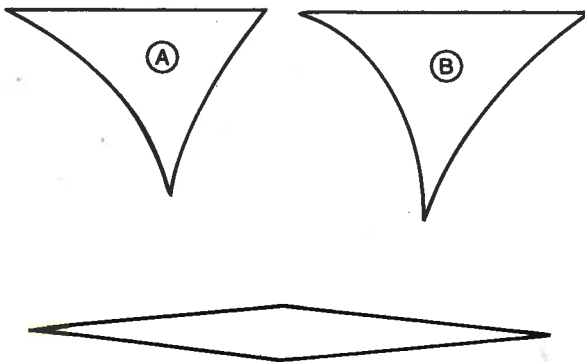

MAN O' WAR PLASTIC MAST SPRUE MOW PLA/2

THESE SAILS AND PENNANTS MAY BE PHOTOCOPIED, CUT OUT, PAINTED AND STUCK ONTO YOUR MINIATURES. PERMISSION GRANTED TO PHOTOCOPY FOR PERSONAL USE ONLY. THESE MODELS ARE SUPPLIED WITH ONE OR MORE MAST SPRUES WHERE NECESSARY

Designed by Norman Swales

Miniatures supplied unpainted. **WARNING.** This product contains lead which may be harmful if chewed or swallowed. Citadel Miniatures are not recommended for children under 14 years of age.
 © Copyright Games Workshop Ltd 1993. All rights reserved.





A HIGH ELF ARMY BATTLES AGAINST A CHAOS DWARF WARBAND