

GAMES WORKSHOP®

PRESENT THEIR MONTHLY GAMES MAGAZINE



WHITE DWARF



CITADEL™
MINIATURES

146

£1.95

\$3.95



02



9 770265 871011

METALLIC PAINT SET

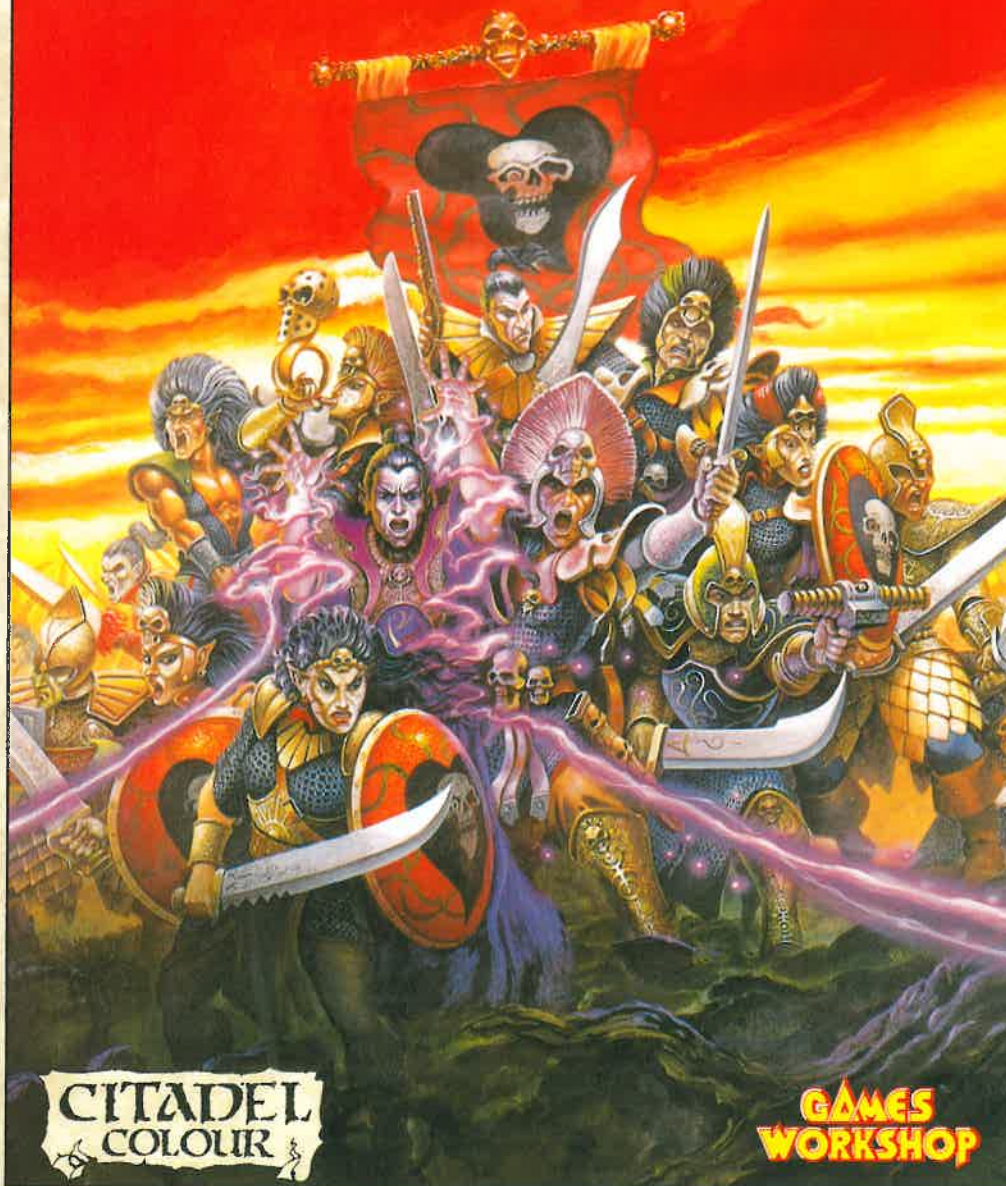

The Citadel Miniatures Metallic Paint Set contains six high quality water-based acrylic paints. They have been specially formulated to produce bright, shining metallic colours and will give a spectacular finish to any Citadel Miniature. The Paints are non-toxic and are fully intermixable with the entire range of Citadel Paints and Inks. They are ideal for both plastic and metal models.

**GAMES
WORKSHOP**



**CITADEL[®]
MINIATURES**

Editor: Robin Dews
 Published by Games Workshop Ltd
 Printed by Artisan Press Ltd, Leicester, UK.

CORRESPONDENCE

All correspondence except subscriptions and Mail Order should be addressed to *The Editor, White Dwarf, Games Workshop, Howard House, 16 Castle Boulevard, Nottingham NG7 1FL*. Clearly mark your envelope with the name of the game you're writing to us about and if you want a reply please include an ssae.

SUBSCRIPTIONS

UK and Rest of World: Please send to *White Dwarf Subscriptions, Games Workshop, Chewton Street, Hilltop, Eastwood, Notts NG18 3HY*. For Visa, Access and Mastercard orders, telephone our Mail Order Hotline on 0773 713213. A year's subscription (12 issues) is just £25 for UK and BFPD residents and £40 for the rest of the world. Postage is included in the price. Please make all payments in Pounds Sterling - make your cheque payable to *Games Workshop*.

US and CANADA: Please send to *White Dwarf Subscriptions, Games Workshop, 3431 C Benson Avenue, Baltimore, Maryland 21227-1072*. For Visa and Mastercard orders, telephone our Mail Order Hotline on (301) 644 5699. A year's subscription (12 issues) is \$35 for US residents (Maryland residents add 5% sales tax) or \$45 for Canadian residents. Postage is included in the price. Please make cheques and money orders payable to *Games Workshop*.

When you want to inform us of a change of address or subscription renewal, or if you have a query, please write to the appropriate subscription address. Make sure you tell us your name and present address (and your old address if you're moving). When you subscribe, please tell us if you're renewing an old subscription or starting a new one.

GAME SUBMISSIONS

The Editor will be pleased to accept any previously unpublished articles for inclusion in *White Dwarf*. All submissions should be typed, double-spaced with 30mm margins on one side of A4 paper, and should be accompanied by an explanatory covering letter and a stamped self-addressed envelope large enough to return the submission. Hand-written submissions will not be considered. Please clearly state on the envelope which game the submission is for - send to the Editor at the *White Dwarf* address.

ARTWORK SUBMISSIONS

We're happy to look at samples of black and white artwork but, in order to deal efficiently with such material, we require that all artwork be submitted as photocopies together with a stamped self-addressed envelope for us to reply and return to work. Please send all artwork submission to the Art Editor at the *White Dwarf* address.

ALL SUBMISSIONS

Always send a copy of your submission and keep the original - *White Dwarf* cannot take any responsibility for the safety of your submissions and regretably submissions can and do get lost or damaged. Submissions not accompanied by an SSAE will not be returned. Please allow at least 6-8 weeks for a reply.

RENEWABLE RESOURCES

White Dwarf is printed on paper from the Myllykoski Paper Mill, Finland. For every tree cut down, the mill plants two more. These are farmed trees grown specifically for paper so their use doesn't diminish the natural stock.

All Games Workshop's boxes, cards and counters are printed using 95% recycled paper.

All subject matter in *White Dwarf* is © Copyright Games Workshop Ltd. 1992

All artwork in all Games Workshop products and the images contained therein have been produced either in-house or as work for hire. The exclusive copyright on the artwork and the images it depicts is the copyright of Games Workshop Ltd. © Copyright Games Workshop Ltd 1992. All rights reserved.

Blood Bowl, Chivalry, Confrontation, Dark Future, Epic, Games Workshop Realm of Chaos, Talisman, White Dwarf and the *White Dwarf* figure and *Warhammer* are registered trademarks of Games Workshop Ltd. *Deathwing, Skottabase, Spacefleet, Space Hulk, and Space Marine* are trademarks of Games Workshop Ltd. *Scatter Dice* are UK registered design No 2017484. *Flame* is a trademark of Flame Ltd. *GW Books* is a trademarks of GW Books Ltd. All rights reserved. *Marauder* is a registered trademark of Marauder Miniatures Ltd. All rights reserved. *Flame, GW Books* and *Marauder* are all used with permission.



WHITE DWARF

CONTENTS

COVER: SPACE MARINE SCOUTS - Dave Gallagher Dave's dramatic picture captures the full fury of the Scouts' assault	
NORWICH GRAND OPENING Games Workshop has just opened a new store in Norwich. At the grand opening we're giving away a host of special discount vouchers and special offers	5
GW & CITADEL NEWS We announce the winner of the <i>White Dwarf</i> readers poll and give full dates and details of the forthcoming D-ROK "Oblivion '92" tour.	6
GOLDEN DEMON AWARDS 1992 This year's Golden Demon Awards at the Birmingham NEC are going to be Games Workshop's biggest and best convention ever. Here we provide full details of all the categories and how to enter the world's premier miniatures painting event.	8
SPACEFLEET - Andy Chambers and Andy Jones This month sees the release of a brand new range of Tyranid models for <i>Spacefleet</i> . Here we present the rules for deep space battles between the Tyranids and the Eldar or Imperium. In addition, we provide full-colour Tyranid command cards, counters and datacards for all of the new Tyranid vessels.	10
HAMMERSMITH GRAND RE-OPENING Games Workshop's Hammersmith store has been completely re-fitted and so we're holding a special grand re-opening. On the day there'll be a host of one-off bargains and you can use our special Hammersmith discount vouchers.	27
'EAVY METAL - Tim Prow Tim Prow recently brought his own personal miniature collection into the studio. We were all so impressed that we decided to give Tim his very own 'Eavy Metal special to show off his talents.	30
COVENTRY WARHAMMER DAY Mike McVey and Wayne England will be appearing at the Games Workshop Coventry store on Saturday 15th February. Mike will give his advice and tips on painting Citadel and Marauder miniatures, while Wayne will be fielding his Dwarf army and taking on all-comers in a special <i>Warhammer Fantasy Battle</i> game.	33
EMPIRE ARMY - Nigel Stillman The Empire is the largest and most powerful of the many and varied realms of the Old World. It stretches from the borders of Bretonnia in the west to the sweeping plains of Kislev in the east. We take a look at the armies of the Empire and give a detailed guide to the uniforms and banners of this mighty <i>Warhammer Fantasy Battle</i> force.	34
DREADNOUGHTS - Andy Chambers and Rick Priestly Over the next few months we're going to be previewing some sections from our forthcoming <i>Warhammer 40,000</i> vehicle guide. In this issue we take a special look at Dreadnoughts with a completely updated set of rules for movement and combat. We've also printed brand new data sheets for the Imperial, Ork, Eldar, Chaos and Tyranid Dreadnoughts that will allow you to use them with the new vehicle targeting system.	50
'EAVY METAL In our second 'Eavy Metal this month we look at some examples of Dreadnought colour schemes painted by our ever-talented miniature painting team. There is also a complete set of flags and banners that you can cut out or photocopy to add to your own models.	58
BACK COVER: An Empire force prepares to repel a massed charge by Goblin Wolf Riders. The Empire models come from the Perry twins brand new Empire range and the Goblin Wulfboyz were all painted by John Blanche.	

ADVERTS

Citadel Metallic Paint Set.....	Inside Front	Games Workshop Chester New Store.....	47
UK Games Workshop Retail.....	2	Games Workshop Retail Staff.....	47
Games Workshop US Stores.....	4	Marauder Miniatures.....	48
Golden Demon Awards.....	7	Citadel Miniatures Catalogue.....	72
White Dwarf Subscriptions.....	28	Games Workshop Mail Order.....	80
		Mighty Fortress & Warhammer Siege.....	Inside Back



Andy Chambers



Wayne England



Andy Jones



Rick Priestley



Tim Prow



Nigel Stillman

GAMES WORKSHOP®

STORES

Games Workshop Stores are much more than just places where you buy games – they are the centre of hobby gaming in your area. Many of you will have received Games Workshop games or Citadel miniatures for Christmas. If you find you're unsure about any of the game rules or want to know what extra models are available to increase the size of your force or army, please drop by or phone your local store. Our friendly staff are more than happy to help you with any questions or queries you might have about the Games Workshop world of hobby gaming. Throughout the year, there are regular activities including workshops and, demonstrations of all kinds that everyone is welcome to come along to and join in with. Drop in to or call your local Games Workshop Store for more details, plus up-to-the-minute news of any other special events.

STORE ADDRESSES

THE NORTH

NEW STORE CHESTER

112 FOREGATE ST
CHESTER
CLUB NIGHT:
THURS TILL 8.00
CONTACT: JIM
TEL: 0224 311967

HULL

30 PARAGON STREET, HULL
CLUB NIGHT:
THURS TILL 8.00
CONTACT: ALAN
TEL: 0482 589576

LEEDS

12-16 CENTRAL RD,
LEEDS, LS1 6DE
CLUB NIGHT: THURS TILL 8.00
CONTACT: PAUL
TEL: 0532 420834

LIVERPOOL

47 LORD ST,
LIVERPOOL, L1 4DJ
CLUB NIGHT:
THURS TILL 8.00
CONTACT: ROGER
TEL: 051 258 1404

MANCHESTER

UNIT 1, 3 BROWN ST,
MANCHESTER, M4 3AB
CLUB NIGHT: THURS TILL 8.00
TEL: 061 832 6863

MIDDLESBROUGH

39 DUNDAS STREET,
MIDDLESBROUGH
CLUB NIGHT:
THURS TILL 8.00
CONTACT: IAN
TEL: 0642 254091

NEWCASTLE
63 CLAYTON ST,
NEWCASTLE-UPON-TYNE
CLUB NIGHT:
THURS TILL 8.00
CONTACT: IAN
TEL: 091 232 2418

PRESTON

15 MILLER ARCADE,
PRESTON, PR1 2QA
CLUB NIGHT: THURS TILL 8.00
CONTACT: SPENCER
TEL: 0772 821855

SHEFFIELD

16 FITZWILLIAM GATE,
SHEFFIELD
CLUB NIGHT:
THURS TILL 8.00
CONTACT: DAVE
TEL: 0742 750114

YORK

26 GOODRAMGATE,
YORK, YO1 2LG
CLUB NIGHT: FRI TILL 8.00
CONTACT: EVAN
TEL: 0904 653575

EAST ANGLIA

CAMBRIDGE

4 QUAYSIDE,
(OFF BRIDGE STREET)
CAMBRIDGE
CLUB NIGHT: THURS TILL 8.00
CONTACT: DAVE
TEL: 0223 313350

NORWICH

12-14 EXCHANGE STREET,
NORWICH,
CLUB NIGHT: THURS TILL 8.00
CONTACT: JOHN
TEL: 0603 767656

MIDLANDS

NEW STORE BIRMINGHAM

116 CORPORATION ST,
BIRMINGHAM
B4 6SX
CLUB NIGHT: THURS TILL 8.00
CONTACT: TED
TEL: 021 236 7880

COVENTRY

14 CITY ARCADE, COVENTRY
CLUB NIGHT: THURS TILL 8.00
CONTACT: STUART
TEL: 0203 227311

DERBY

42 SADLER GATE,
DERBY, DE1 3NL
CLUB NIGHT: THURS TILL 8.00
CONTACT: MARK
TEL: 0332 371657

DUDLEY

KIOSK U, UPPER LEVEL,
MERRY HILL CENTRE,
BRIERLEY HILL, DUDLEY
CLUB NIGHT: THURS TILL 9.00
OPEN 10.00 TILL 8.00 MON TO FRI
9.00 TILL 7.00 SAT
CONTACT: SIMON
TEL: 0384 481818

NOTTINGHAM

34A FRIAR LANE,
NOTTINGHAM, NG1 3DU
CLUB NIGHT: THURS TILL 8.00
CONTACT: ROSS
TEL: 0602 480651

THE SOUTH

BRIGHTON

7 NILE PAVILIONS, NILE ST,
BRIGHTON, BN1 1HW
CLUB NIGHT: FRI TILL 8.00
CONTACT: CHRIS
TEL: 0273 203333

BRISTOL

13 BROAD WEIR,
BRISTOL
CLUB NIGHT: THURS TILL 8.00
CONTACT: SHANE
TEL: 0272 251533

LUTON

12 PARK ST,
LUTON, LU1 3EP
CLUB NIGHT: THURS TILL 8.00
CONTACT: GLENN
TEL: 0582 417474

MAIDSTONE

UNIT 6, 1-9 PUDDING LANE
MAIDSTONE
CLUB NIGHT: THURS TILL 8.00
CONTACT: GUY
TEL: 0622 677435

OXFORD

1A BUSH HOUSE,
NEW INN HALL STREET,
OXFORD
CLUB NIGHT: THURS TILL 8.00
CONTACT: ANDREW
TEL: 0865 242182

READING

UNIT 3, CHEAPSIDE,
READING
CLUB NIGHTS: WED AND
THURS TILL 8.00
CONTACT: BOB
TEL: 0734 598693

SOUTHAMPTON

23 EAST ST,
SOUTHAMPTON, SO1 1HG
CLUB NIGHT:
THURS TILL 8.00
CONTACT: REES
TEL: 0703 331962

TORQUAY

12 MARKET ST,
TORQUAY, TQ 1AQ
CLUB NIGHT:
THURS TILL 8.00
TEL: 0803 201036

All UK Games Workshop stores are open from 10.00am until 6.00pm Monday to Friday and from 9.30am until 5.30pm on Saturdays unless otherwise stated.

SCOTLAND

EDINBURGH
136 HIGH ST,
EDINBURGH, EH1 1QS
OPEN SUNDAY 11.00 - 5.00
CLUB NIGHT:
THURS TILL 8.00
CONTACT: MARTIN
TEL: 031 220 6540

GLASGOW
66 QUEEN ST,
GLASGOW, G1 3DS
CLUB NIGHT:
THURS TILL 8.00
CONTACT: ALISDAIR
TEL: 041 226 3762

LONDON

BECKENHAM
292-294 HIGH ST, BECKENHAM,
KENT, BR3 1DY
TEL: 081 658 8102

CENTRAL LONDON
UNIT F10,
THE PLAZA,
116-128 OXFORD ST,
LONDON, W1R 1PA
OPEN 10.00-7.00 MON TO FRI
10.00-7.00 SAT
CLUB NIGHTS: MON TO SAT
CONTACT: LANCE,
TEL: 071 436 0839

CROYDON
UNIT35, DRUMMOND CENTRE,
KEELEY ROAD, CROYDON
CLUB NIGHT: THURS TILL 8.00
CONTACT: ED, TEL: 081 680 4600

HAMMERSMITH
1 DALLING RD, HAMMERSMITH,
LONDON, W6 0JD
CLUB NIGHT: THURS TILL 8.00
CONTACT: JOE
TEL: 081 741 3445

HARROW
296 STATION RD, HARROW,
MIDDLESEX, HA1 2DX
CLUB NIGHT: MON TILL 8.00
CONTACT: JAMIE
TEL: 081 861 2350



GAMES WORKSHOP®



**USA & CANADA
RETAIL STORES**



BALTIMORE

714 YORK ROAD
TOWSON
MD21204

OPENING HOURS
MON TO SAT 11.30-7.30
SUNDAY 11.30-5.30
TUESDAY: CLOSED

CONTACT: FRANK
TEL : (410) 821 5444

COLLEGE PARK

UNIVERSITY OF MARYLAND
LEHIGH ROAD
COLLEGE PARK MD 20740

OPENING HOURS
MONDAY 11.00-7.00
TUESDAY: CLOSED
WED TO FRI 11.00-7.00
SATURDAY 11.00-8.00
SUNDAY 12.00-6.00
CLUB NIGHT: FRI TO SUN

CONTACT: JEREMY
TEL : (410) 864 5668

WASHINGTON D.C. AREA STORES



PHILADELPHIA

424 SOUTH STREET
PHILADELPHIA PA 19147

OPENING HOURS
MONDAY 11.00-7.00
TUESDAY: CLOSED
WED TO FRI 11.00-7.00
SATURDAY 11.00-9.00
SUNDAY 12.00-6.00
CLUB NIGHT: WED TO SUN

CONTACT: JOE
TEL : (215) 829 0554

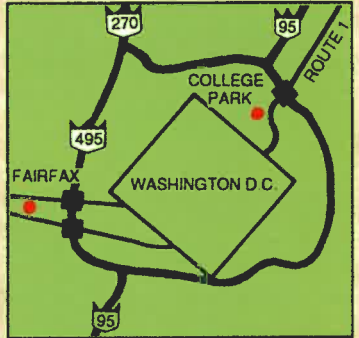



FAIRFAX

FAIR CITY MALL
9600G MAIN STREET
FAIRFAX VA 22031

OPENING HOURS
MON TO FRI 11.30-7.30
SATURDAY 11.00-9.00
SUNDAY 12.00-5.00
CLUB NIGHT: EVERY NIGHT

CONTACT: OWEN
TEL : (703) 503 9284



LOS ANGELES

313 SANTA MONICA BLVD
SANTA MONICA
CA 90404F

OPENING HOURS
MONDAY 12.00-8.00
TUESDAY: CLOSED
WED TO SUN 12.00-8.00
CLUB NIGHT: WED TO SUN

CONTACT: DAVE
TEL : (310) 395 6711



VANCOUVER

205 CARRALL STREET
VANCOUVER
BRITISH COLUMBIA
V6B 2J2

OPENING HOURS
MON TO SAT 11.00-7.00
SUNDAY 12.00-6.00
CLUB NIGHT: EVERY NIGHT

CONTACT: GEOFF
TEL : (604) 685 8823



TORONTO

331 QUEEN STREET WEST
TORONTO, ONTARIO
M5V 2A4

OPENING HOURS
MON TO SUN 10.00-7.00
CLUB NIGHT: EVERY NIGHT

CONTACT: LOGAN
TEL : (416) 595 1159



GAMES WORKSHOP®

NORWICH

GRAND OPENING SAT 22nd FEB

**12-14 EXCHANGE ST
NORWICH NR2 1AU**
Tel: 0603 767656

Opening Hours:
10.00am - 6.00pm Mon - Fri
9.30 - 5.30 Sat

Club Night Thurs till 8.00pm
CONTACT: JOHN



BUY ANY 2 RED DOT ITEMS
AND GET 1 YELLOW DOT ITEM
FREE!

EG: BUY WARHAMMER 40,000 AND
BLOOD BOWL AND GET WAAARGH THE ORKS
FREE!

BUY ANY 2 BLISTER PACKS AT £3.99
OR OVER AND GET ONE ADDITIONAL
£3.99 BLISTER PACK
FREE!

LOTS OF GAMES & ACCESSORIES
FOR £2.50 OR LESS

OFFERS LAST ALL DAY (WHILE STOCKS LAST)

PLEASE NOTE: YOU CANNOT USE THE
VOUCHERS WITH ANY OF THE ABOVE OFFERS OR
ON MB GAMES' HEROQUEST OR SPACE CRUSADE



**SPECIAL
GRAND OPENING
DISCOUNTS!**



<p>ONLY ONE VOUCHER PER PRODUCT REDEEMABLE AT GAMES WORKSHOP NORWICH SAT 22nd FEBRUARY 1992</p> <p>10 % OFF</p> <p>ANY GAMES WORKSHOP OR CITADEL PRODUCT</p> <p>NOT TO BE USED WITH ANY OTHER OFFER</p>	<p>ONLY ONE VOUCHER PER PRODUCT REDEEMABLE AT GAMES WORKSHOP NORWICH SAT 22nd FEBRUARY 1992</p> <p>10 % OFF</p> <p>ANY GAMES WORKSHOP OR CITADEL PRODUCT</p> <p>NOT TO BE USED WITH ANY OTHER OFFER</p>
<p>ONLY ONE VOUCHER PER PRODUCT REDEEMABLE AT GAMES WORKSHOP NORWICH SAT 22nd FEBRUARY 1992</p> <p>10 % OFF</p> <p>ANY GAMES WORKSHOP OR CITADEL PRODUCT</p> <p>NOT TO BE USED WITH ANY OTHER OFFER</p>	<p>ONLY ONE VOUCHER PER PRODUCT REDEEMABLE AT GAMES WORKSHOP NORWICH SAT 22nd FEBRUARY 1992</p> <p>10 % OFF</p> <p>ANY GAMES WORKSHOP OR CITADEL PRODUCT</p> <p>NOT TO BE USED WITH ANY OTHER OFFER</p>
<p>ONLY ONE VOUCHER PER PRODUCT REDEEMABLE AT GAMES WORKSHOP NORWICH SAT 22nd FEBRUARY 1992</p> <p>25 % OFF</p> <p>ANY GAMES WORKSHOP OR CITADEL PRODUCT</p> <p>NOT TO BE USED WITH ANY OTHER OFFER</p>	<p>ONLY ONE VOUCHER PER PRODUCT REDEEMABLE AT GAMES WORKSHOP NORWICH SAT 22nd FEBRUARY 1992</p> <p>25 % OFF</p> <p>ANY GAMES WORKSHOP OR CITADEL PRODUCT</p> <p>NOT TO BE USED WITH ANY OTHER OFFER</p>

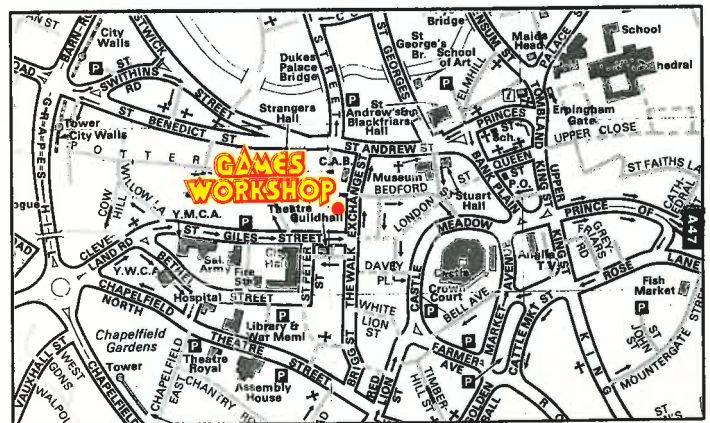

DOORS OPEN 9AM

GAMES WORKSHOP AND CITADEL NEWS

US BALTIMORE STORE MOVES

The Games Workshop store in Laurel, Maryland has moved to a new location at:

714 YORK ROAD
TOWSON, MARYLAND 21204
TEL: (410) 821 5444

US AND CANADA RETAIL STORE MAILING LIST

The Games Workshop retail stores in the United States and Canada are compiling a mailing list for all their customers. Everyone on it will receive a regular flyer outlining the store's weekly gaming events, new product information, convention news and details of on other North American Games Workshop events. To get your name on the mailing list just call up or ask any of the staff at your nearest store.



READERS POLL WINNER

The White Dwarf readers poll we published White Dwarf 143 resulted in an incredible 10,000 replies pouring into the Games Workshop office. All of the entries were put into a very large hat and one form was pulled out. The lucky winner was Sean McLaughlin from Stoke on Trent. Just before Christmas, Sean came over to Nottingham to visit Games Workshop and collect his mega prize of one copy of every Games Workshop game and book plus one of every Citadel Miniatures boxed set. Congratulations Sean.

D-ROK OBLIVION 92 TOUR

Warhammer rockers D-ROK are touring Great Britain in February and March. They are playing over 30 dates across the country so there should be a gig somewhere near you. The band will be visiting the Games Workshop stores nearest the gig venues so if you'd like to get a copy of Oblivion signed by the band or just drop by for a chat, ask your store manager for further details.



February

- 8th York – Barbican Rock Festival
- 12th Liverpool – University
- 13th Newcastle – 244 Rock Club
- 14th Workington – Carnegie Theatre
- 15th Dumfries – White Hart
- 17th Manchester – Rock World
- 18th Preston – Legends
- 19th Hull – Adelphi
- 20th Bradford – Rio
- 21st Hartlepool – Ritz

March

- 1st (Brierly Hill) Dudley – Rock Tavern
- 2nd Mansfield – Harvey's Rock Shop
- 4th Leeds – Duchess of York
- 5th Derby – Flamingo's
- 6th Nottingham – Rock City

- 7th Oxford – Fire Station
- 8th Chelmsford – Y Club
- 11th Ebbw Vale – Market Tavern
- 12th Newport – TJ's
- 13th Cardiff – Bogiez
- 14th Tony Pandy – Naval Club
- 15th New Bridge – Memorial Hall
- 18th Bristol – Fleece and Firkin
- 19th Red Ruth – London Brewhouse
- 20th Falmouth – Pirate
- 21st Newquay – Victoria Bars
- 22nd Exeter – Stocks
- 24th Bath – Joe Bananas
- 25th Brighton – Richmond
- 26th Chichester – Garfields
- 27th Eastbourne – Sherlock Holmes
- 28th Southampton – Network
- 29th Reading – Phoenix Plaza
- 30th Maidstone – Trader Jacks



NOW AVAILABLE

D-ROK POSTERS AND T-SHIRTS
ALBUM "OBLIVION" ON CD, LP AND CASSETTE.
"GET OUT OF MY WAY" ON 12" AND CD SINGLE

GAMES WORKSHOP

PRESENTS

GOLDEN DEMON REGIONAL HEATS 92



The 5th International Citadel Miniatures Painting Championships

With Golden Demon 92 approaching fast, now's the time to start painting your miniatures for the regional heats. This year's categories and closing dates for the UK are:

Single Miniature and Mounted Miniature – Saturday 29th February

Monster, Command Group and Warhammer 40,000 Vehicle – Saturday 7th March

Warhammer Fantasy Battle War Machine and Diorama – Saturday 14th March

Space Marine Battleforce, Warhammer Fantasy Battle Army and Warhammer 40,000 Army – Saturday 21st March

All US and Canadian entries must be in at your nearest Games Workshop store by Saturday 28th March

In each store there will be 10 winners, one from each category. Each regional winner goes forward to represent their store at the Grand Finals on Saturday 18th April 1992 at the Birmingham NEC.

For application forms and further details please ask at your local store.

Games Workshop and Warhammer are registered trademarks of Games Workshop Ltd. Citadel Miniatures, the Citadel Castle and Space Marine are trademarks of Games Workshop Ltd. © Copyright Games Workshop Ltd, 1992. All rights reserved.

For those of you who haven't yet started to paint your miniatures for this year's Golden Demon regional heats, here's a full list of the categories and details of where and how to enter. All entries must be either Citadel Miniatures or Marauder Miniatures (or a combination of the two) and they can be either metal or plastic. For further details of how to enter, just call into your local Games Workshop Store.

1. Single Miniature

Single Miniature means just what it says: one miniature mounted on an appropriate base, which should be no larger than 25mm square. The overall height of the model plus base must not exceed 50mm. Apart from the necessary cleaning and preparation prior to painting, the miniature must not be converted in any way.

No extra models, bits of models or bought accessories can be used as scenery on the base, though you are allowed to scratch build accessories for use on it. Just bear in mind that it's the miniature that is judged, not the base. Don't forget that you can use any of the miniatures that fit on smaller bases – Snotlings, Dwarfs, Goblins etc. Miniatures which go on 40mm x 40mm bases should be entered in the Monster category.

2. Mounted Miniature

Within the size limit of 100mm square by 125mm high, we're giving you a fairly free hand in this category. Limited conversions are allowed and it's acceptable to use a miniature not necessarily designed as a rider but which is converted into one. The same applies to the mount.

The main restriction is that only one rider and one mount are allowed on the base, and the rider must be sitting on the mount. Weapon swaps, banners, re-positioning miniatures etc are all acceptable, and machines (jet bikes for example) may be used as mounts.

3. Monster

This category includes any miniature designed to stand on a 40mm square base or larger (including Blood Bowl monsters) up to the maximum base size of 100mm x 150mm. The maximum height of the base plus model is 90mm. Only one miniature is allowed per base, with no extra model or model parts, as in the Single Miniature category. Remember that it's the miniature which is judged on the context of the base, not the other way round.

4. Command Group

This is a group of four miniatures mounted on the official sized bases for gaming to form a command group for either Warhammer Fantasy Battle or Warhammer 40,000. The miniatures may either be on foot or mounted and they must contain a general or commander, standard bearer, hero or champion and one other model of your choice. The overall height of the group must not exceed 80mm and the base size for each should be no larger than 50mm square. The miniatures can be converted.

5. Warhammer 40,000 Vehicle

This is perhaps the most difficult category to describe. The base size restriction is 200mm x 150mm with the overall height of the model (including the base) being no more than 150mm. For ease of judging, the basic vehicles are limited to any which are available from Games Workshop in the form of a plastic kit. The basic vehicle body can be



1991 1st Place Command Group – Bad Moon Orks by Barry Lees

converted and modified as much as you like, so long as it fits within the dimensions given above. Scratch-built terrain is allowed but there must be no more than 5 extra models on the base or vehicle.

6. Warhammer Fantasy Battle War Machine

The base size restriction is 100mm x 150mm with the overall height of the model (including the base) being no more than 150mm. The War Machines should be any which are available from Games Workshop in the form of a metal kit. The War Machine can be converted and modified as much as you like, so long as it fits within the dimensions given above. Scratch-built terrain is allowed.

7. Diorama

There must be at least 2 models in the diorama but there is no upper limit. The base size restrictions are 125mm x 100mm with the overall height of the model (including the base) being no more than 125mm. You are free to convert or scratch build models. Bear in mind that quantity doesn't necessarily mean quality – you don't need to cram hundreds of models onto the base. A diorama must portray a theme or an event, and this is usually best achieved with 5 or 6 miniatures at the most. Two well positioned and well painted models in the right setting can make an excellent entry – it's simply a case of applying some thought to the matter.

8. Space Marine Battleforce

This is a group of epic scale miniatures headed by a Titan or Gargant. The battleforce may be up to 1 Company plus 5 support cards and 1 special card of models and should be appropriately based. Entrants should provide a typed roster sheet detailing their battleforce.

9. Warhammer Fantasy Battle Army

The army chosen must be a practical Warhammer Fantasy Battle army of up to 1000 points. Troops should be mounted on bases for actual tabletop use – not display bases.

10. Warhammer 40,000 Army

The army chosen must be a practical Warhammer 40,000 gaming army and can be worth up to 1000 points. Troops should be mounted on bases for actual tabletop use – not display bases.

HOW TO ENTER THE REGIONAL HEATS

You may, if you wish, enter once into each of the categories. You can enter Golden Demon 1992 at any Games Workshop store in the UK, US or Canada. All you need to do is pick up an application form from your local store, fill it in and return it with your painted miniatures. All UK entries must be at your store by the following dates:

1. **Saturday 29th February:**
Single Miniature and Mounted Miniature
2. **Saturday 7th March:**
Monster, Command Group and Warhammer 40,000 Vehicle
3. **Saturday 14th March**
Warhammer Fantasy Battle War Machine and Diorama
4. **Saturday 21st March**
Space Marine Battleforce, Warhammer Fantasy Battle Army and Warhammer 40,000 Army.

ENTRY TO THE FINALS

In each store there will be 10 regional winners, one from each of the ten categories. Each regional winner goes forward to represent his store at the Grand Finals at the Birmingham NEC in April 1992.

The regional winners will also receive a Golden Demon Badge and a winners' certificate. At the finals they'll have the chance to win trophies for themselves and their store and maybe even the coveted **Golden Demon Slayer Sword**.

US AND CANADIAN GOLDEN DEMON



SATURDAY 25TH APRIL AT THE
GAMES WORKSHOP BALTIMORE STORE



HOW TO ENTER THE REGIONAL HEATS

The categories for the US and Canadian competition are exactly the same as the UK categories. You may, if you wish, enter once into each of the categories.

You must ensure that your entry is at your nearest Games Workshop store by **Saturday 28th March**.

In each store there will be 10 winning entries. All of the winning entries will be transported to the Baltimore, Maryland Games Workshop store for the finals on **25th April 1992**.

ENTRY TO THE FINALS

At the Finals, the category winners from each US and Canadian Games Workshop stores will have a chance to win trophies for themselves. The overall winner will be awarded the Golden Demon Grand Prize:

A full-size replica of Imperial Ultra Marine Commander Lord Macragge's Helmet.

SPACE FLEET™

TYRANID HIVE FLEETS

By Andy Chambers and Andy Jones

Beyond the Imperium of mankind, beyond the range of human ships and astrotelepathy lies the inconceivably vast and empty void of intergalactic space. This a realm into which few men have ventured and from which none have ever returned. It is the great barrier which divides galaxy from galaxy. Yet this great void is no longer empty. Through it moves a vast and implacable entity, a single mighty creature formed from countless billions of individual organisms, its mind the sum of all the thoughts and experiences of its component creatures. This entity, this race, is the Tyranid hive mind, and it has come from a galaxy unimaginably distant. Now its advance forces have reached the Imperium, and the fate of every living thing in the galaxy hangs in the balance.

The Tyranids have travelled to the Imperium in a vast hive fleet consisting of a great dark swarm of millions of individual space craft. Each craft is a gigantic living thing, a monstrous creature fashioned from organic tissue by means of sophisticated genetic manipulation. The journey across the void has taken eons and during that time the Tyranids have slumbered in a state of frozen hibernation. As the edge of the fleet approaches the Imperium the Tyranid Hiveships begin to stir and their inhabitants slowly awake.

The monolithic thought processes of the hive mind are still gathering pace as more Tyranids wake and recall their age-old purpose. The Tyranid hive mind hungers for fresh genetic material, gene-stocks that can be used to create new creatures and machine organisms to serve it. Humanity will be absorbed, broken into strands of DNA and used to create a new generation of Tyranid bio-technology. Could this be the doom of mankind?

THE TYRANID FLEET

The Tyranid hive fleet is controlled by one or more gigantic Hiveships which direct and control the strategy of the entire fleet by disseminating information and directives from the hive mind to the smaller craft. This means that the fleet can react very quickly to any developing situation or threat, but if the Hiveships are destroyed the whole fleet will quickly lose its cohesion and direction. To represent the advantages and disadvantages of this unique method of control, ships in the Tyranid fleet are given orders in a completely different way to Imperial or Eldar ships.

Instead of having a helm computer, the actions of a Tyranid fleet are determined by a hand of **command cards** held by the Tyranid player. Command cards affect one swarm (the Tyranid equivalent of a

squadron), allowing it to move and shoot. Some command cards allow individual ships to perform special actions such as regenerating damage.

FLEET ORGANISATION

The Hiveship starts the game positioned within 2 squares of the table edge, with the hive fleet clustered within 2 squares of it. Most fleets will only have one Hiveship, but if you are fighting particularly large battles, several different hives may be involved.

The coherency rules for Tyranid vessels in the same swarm are exactly the same as for any other squadron in Space Fleet. Some vessels do have special rules, and these are noted on their data cards.

Most of the vessels in the hive fleet are organised into swarms, the Tyranid equivalent of squadrons. The exceptions to this rule are the Hiveship itself and the Kraken, which are individual creatures and cannot be organised into units.

The following list tells you the swarm sizes of the different vessels in the hive fleet:

Vessel Type	Number per swarm	Command cards per swarm
Hiveship	1	6
Any Kraken	1	1
Dark Prowler	1-2	1
Void Fiend	1-3	1
Wardrone	1-3	1
Drone	1-9 *	0
Spore mine	Special **	0

* Drones operate in swarms of up to 9 individual drones. There can be up to 3 drones in the same square.

** Spore mines operate individually, and you can have up to 2 spore mines in the same square.

SEQUENCE OF PLAY

Because the Tyranids are so completely different to any other race in Space Fleet, the turn sequence is somewhat altered when Tyranids are being played. The revised sequence of play is shown below.

- 1 The Imperial (or Eldar) player places his orders and moves his ships, resolving any rams immediately.
- 2 The Tyranid player makes his entire move, swarm by swarm.
- 3 The Imperial (or Eldar) player completes any shooting and/or boarding. Remember that as firing is simultaneous, any ships which have been destroyed or damaged in step 2 can retaliate at this point.
- 4 Roll to see if any ships are crippled, and remove destroyed vessels from play.
- 5 The Tyranid player may now discard up to 2 cards and then replenish his hand back up to his maximum number of cards. The destruction of Tyranid swarms and vessels can reduce the Tyranid player's maximum hand of command cards during the game so it is important that he waits until the end of the turn before replenishing his hand.

TYRANID COMMAND CARDS

The Tyranid hive mind is a single co-ordinating will that directs the entire fleet. The hive mind is formed from untold billions of individual consciousnesses. Some of these minds are capable of individual thought, some can make limited decisions and others are nothing more than automatons. This ability to think and act freely varies greatly and depends on the creature's role in the hive fleet.

The more Tyranid ships present in a battle, the more attention and instructions they will receive from the hive mind. Hiveships act as special synapses and help co-ordinate the hive mind's instructions. As Tyranid ships are destroyed the hive mind becomes more 'out of touch' with the situation and the remaining ships become less effective. If a Hiveship is destroyed the remaining Tyranid ships will become confused and undirected, relying on instinct alone.

The Tyranid command cards represent the effectiveness of the hive mind during a battle. When you play a card on a swarm it represents the hive mind giving instructions to the ships. The more Tyranid ships you have, the more command cards you'll have in your hand to play. As ships are destroyed the number of cards you can hold is reduced, making the hive fleet less effective.

USING THE COMMAND CARDS

Once you have set up your fleet, shuffle the Tyranid command cards and deal your hand. You get six cards for every Hiveship in your fleet, and one for every swarm (even if the swarm consists of a single vessel).

For example, the following fleet would give the player a hand of 11 cards. The drones and spore mines do not contribute any command cards to the player's hand.

Swarm	Command cards
1 Hiveship	6
1 swarm of Dark Prowlers	1
1 swarm of Void Fiends	1
1 swarm of Wardrones	1
3 swarms of drones	0
5 spore mines	0
2 Kraken	2
TOTAL: 11	

There are two types of command cards: action cards and feature cards.

Action cards allow you to spend action points on swarms for moving, shooting and ramming. Action cards give every ship in the swarm the amount of action points indicated on the card.

Feature cards allow you to perform specific functions such as regenerating damage to a vessel. Feature cards affect only one ship.

The number of command cards which can be played on a swarm is indicated on the swarm's data card. Most swarms can have more than one card played on them in any one turn. The number of ships in the swarm *does not* affect the number of command cards you can play on it. So, for example, regardless of whether a swarm of Void Fiends contains one ship or three, the maximum number of command cards that can be played on that swarm is still two.

Note that just because a particular swarm can have three cards played on it per turn does not mean that you have to play three cards on it every turn. You may play none, one, two or three cards on it if you prefer. In fact you may choose to do nothing with the swarm for a few turns, playing no cards at all on it for a while.

Cards are always played on swarms, even cards which only affect one ship in the swarm. If you play an action card on a swarm and then play a boarding card on the swarm, the whole swarm counts as having had two cards played on it, even though the boarding card only affects one ship.

You must finish the actions for each ship before moving onto the next, and you must deal with each swarm before moving onto the next. You may never return to a ship or a swarm once you have started to play another one.

TYRANID WARDRONE

WOUNDS: 4 COMMAND CARDS: 2 POINTS: 40



WEAPON TABLE

Weapon	Arc of operation	Range
Hullgrinder	Forward	1 2 dice 1 dice
		2 2 dice 1 dice
		3-5 1 dice

SPECIAL RULES

A swarm of Wardrones can have up to two command cards played on it per turn. Each swarm of Wardrones contributes one command card to the Tyrannid player's hand.

CRITICAL WOUNDS TABLE

- 1-2 **Sensory cluster injured.** The Wardrone may only make one attack per turn.
- 3 **Hullgrinder damaged.** The Wardrone may not fire again until it is repaired by the hive.
- 4-5 **Energy cortex injured.** The Wardrone may spend a maximum of one action point on movement per turn until repaired.
- 6 **Internal damage.** Roll 1D6 extra wounds.

DOOMRIPPER KRAKEN

WOUNDS: 5 COMMAND CARDS: 3 POINTS: 60



WEAPON TABLE

Weapon	Arc of operation	Range
Power Bite	Special	Special

SPECIAL RULES

A Doomripper can have up to three command cards played on it per turn. Each Doomripper adds one command card to the Tyrannid player's hand.

To attack, a Doomripper must finish its turn in a square adjacent to a target vessel and spend one action point. Drop 3 dice in the combat tray. Choose the highest hit - this is how much damage you have inflicted on your target. If the target has no shields left on the facing being attacked, then after a successful attack the Doomripper is attached to the hull of the ship until either it or the ship is destroyed. In subsequent turns drop 3 dice in attack without having to use any cards. Any hits cause 1 point of hull damage (ignore shields), and 6's score criticals. If all dice miss, the Doomripper has lost its grip, and the ship may try to escape.

While in the grip of a Doomripper, the target vessel may function as normal. It may not attack the Doomripper in any way as it is wrapped around the ship's hull.

CRITICAL WOUNDS TABLE

- 1-2 **Sensory cluster injured.** The Doomripper may only spend one action point on attacks per turn.
- 3-4 **Respiratory vent injured.** The Doomripper suffers one wound at the start of each turn.
- 5 **Enraged.** If you have a death mission card or get one in a future turn, you must play it on the Doomripper immediately.
- 6 The Doomripper suffers 1D6 wounds from internal injuries.

TYRANID DRONE

WOUNDS: 2 COMMAND CARDS: 3 POINTS: 20



WEAPON TABLE

Weapon	Arc of operation	1	2	3
Hullgrinder	Forward arc	1 dice	1 dice	1 dice

SPECIAL RULES

A swarm of Drones can have up to three cards played on it per turn. Swarms of Drones do not contribute any command cards to the Tyrannid player's hand.

CRITICAL WOUNDS TABLE

Any critical wound will destroy a Drone.

HELLBLASTER KRAKEN

WOUNDS: 4 COMMAND CARDS: 2 POINTS: 40



WEAPON TABLE

Weapon	Arc of operation	Range
Shockram	Front three squares	1

CRITICAL WOUNDS TABLE

- 1-2 **Hive mind synapse disabled.** The Kraken grinds to a halt until repaired.
- 3-4 **Energy cortex damaged.** The Kraken may only spend one action point on movement per turn from now on.
- 5 **Discharge conduits damaged.** The Kraken may only spend one action point on attacks per turn from now on.
- 6 **Internal injuries.** The Kraken takes an extra 1D6 wounds from internal injuries.

SPECIAL RULES

A Hellblaster Kraken can have up to two cards played on it per turn. Each Hellblaster Kraken contributes one command card to the Tyrannid player's hand.

A Hellblaster can make as many attacks as you want to spend action points. If several attacks are against the same target roll all the dice together. Each successful attack does the following damage:

Score On Dice	Damage
1-2	1
3-4	2
5	3
6	Critical

The Hellblaster is almost completely sheathed in an amazingly thick shell. This shell protects it much like the armour of an Imperial Ironclad. Ignore any hits against a Hellblaster which roll a 1 or 2 in the combat tray.

The different actions you may perform must be carried out in order, see the table below.

ACTION ORDER TABLE

1.	Regenerate
2.	Move
3.	Ram
4.	Shoot
5.	Board

To perform these actions you will need to use action points (eg, for moving and shooting), or have played a feature card (eg, one that allows you to repair a ship's wounds). As you use up command cards, put them on a discard pile. Remember that once you have moved onto another swarm, you may not return to one you have already moved to play further cards on it.

You do not have to play all your command cards in one turn. There might be some particularly good cards in your hand that you want to save for a later stage of the game or you might not be able to play some cards for one reason or another.

Once you have used all the cards you want in a particular turn, and have completed all your moves for your entire hive fleet, your opponent can shoot back at you. Remember that in Space Fleet all shooting is simultaneous, so any enemy ships which you have damaged or destroyed this turn will still be able to shoot back at you.

Once your opponent has completed all his shooting, replenish your hand of cards back up to the full allowance from the deck. If you have lost ships, the number of command cards in your hand may be reduced, so check to make sure you have the right number of cards.

When you lose a Hiveship, a Kraken or a swarm, the number of command cards in your hand is reduced. If you have lost a Hiveship, reduce your hand by six cards. For each Kraken or swarm you have lost, reduce your hand by one card. Remember that spore mines and drones do not entitle you to command cards, so you do not lose command cards when they are destroyed.

This may mean that at the end of the turn you have to discard cards from your hand to bring it down to the right size. You can also opt to voluntarily discard one or two cards from your hand before you replenish your hand at the end of the turn.

The turn is now ended, and the next turn may begin with your opponent placing his orders.

ACTION CARDS

Action cards specify the number of action points which a swarm can use. For instance, a typical card may say 'ACTION POINTS 2. Each vessel in the swarm may use up to 2 action points this turn'. If the Tyranid player used this card he would be able to use up to 2 action points with each vessel in the swarm.

Action points are expended by moving and firing. A single action point allows a Tyranid ship to move one square or turn or fire a salvo with certain weapons. A Tyranid ship may perform any combination of movement and firing actions until it has used up the number of action points shown on the card. The action point costs are shown below.

ACTION POINT COST TABLE

Action	Points Cost
To move one square in the direction you are facing	1
To move one square diagonally forward	1
To change facing by 90°	1
To fire a Hullgrinder salvo or make an attack with a Kraken's natural weapons	1
To fire a Deathburner	2

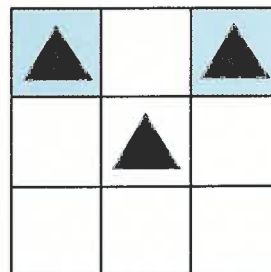

A Tyranid ship moving diagonally can move to either one of the blue positions shown. Note that the ship keeps the same facing.

EXAMPLE: Expending action points

The Tyranid player has a swarm of 2 Void Fiends. The Void Fiend data card states that up to 2 command cards per turn can be played on this swarm. The Void Fiends have not sustained any damage yet, so the Tyranid player decides to use two action point cards from his hand – an 'Action point 2' card, and an 'Action point 4' card. Used together, these two cards give each vessel in the swarm up to 6 action points each to use in this turn. Each Void Fiend can use those action points how it wants. They can go forwards 6 squares, or go forward 2 squares and fire its Hull Grinders twice for each broadside (left and right), giving a total of 4 dice rolled for the left broadside and 4 for the right. Alternatively, they could stay where they are and use all 6 actions to fire their broadsides 6 times in one direction – a 12 dice broadside from each ship in the swarm!

FEATURE CARDS

Feature cards are played on individual ships and allow you to accomplish specific tasks or make special actions. Everything you need to know is written on the card. Playing a feature card *does* count towards the total number of cards that can be played on the swarm for the turn, even though the feature card only affects one vessel in the swarm.

DAMAGING TYRANID SHIPS

Tyranid vessels do not have shields; they rely on their swift movement and armoured hides to protect them. Instead of having shield points and hull points a Tyranid vessel has a certain number of **wounds**. Each successful hit on a Tyranid vessel removes a number of wounds equal to the amount of hull points a normal ship would have suffered from the attack. Use damage counters to record the amount of wounds taken as normal. Damaged Tyranid ships never become crippled - when they reach zero wounds they are killed, and should be removed from the board.

Tyranids do not suffer critical hits in the same way as Imperial and Eldar ships. Instead they suffer critical wounds. Critical wounds cannot be repaired in the same way as other fleets repair critical damage. Instead there are special cards in the Tyranid deck which allow specific critical wounds to be healed.

BOARDING TYRANID SHIPS

Boarding Tyranid ships is an extremely risky business. On the one hand they do not have batteries of guns to destroy the boarding torpedoes as they approach, so you do not have to wait until a Tyranid vessel is crippled before boarding. However, it is never certain what you will find inside its warm fleshy caverns and tunnels. They may be empty, or swarming with death-dealing Genestealers and Tyranids.

When attempting to board a Tyranid ship the alien nature of the vessel means it is impossible to capture it, and boarding parties must find and destroy the ship's vital organs to kill it. A boarding attempt against a Tyranid vessel is carried out exactly as normal, except that a ship may board any Tyranid vessel it is adjacent to at the end of its turn. However, if the Tyranid player has a boarding card in his hand, he may use it to augment the boarding strength of his ship, adding the value on the card to his hull strength. Boarding a humble drone with 2 hull points may turn out to be a disastrous mistake if the Tyranid player has a boarding card strength 10, giving the drone a total boarding strength of 12 for that turn.

Note that for that turn only, any Tyranid vessel which has repelled boarders by using a boarding action card and which is making a counter attack, makes the counter attack at the temporarily augmented strength given by the card. At the end of the boarding action the Tyranid player discards the boarding card as usual. This action card is the only card which the Tyranid player may **use** when it is not his turn.



ROLF MOHR

Because you cannot capture a Tyranid vessel, any 'Captured' result counts as destroying the vessel. You do not get double victory points for killing a Tyranid vessel through a boarding action.

The Tyranid player is only able to attempt a boarding action if he has a boarding card in his hand. He plays the card just like any other command card on the vessel which is attempting to board. Tyranid vessels are very aggressive in their boarding actions, and are fully capable of boarding ships which are not crippled, at no penalty.

When a Tyranid ship attempts to board it must first expend the action points necessary to move into an adjacent square to its target and then play a boarding card. For that turn only the Tyranid vessel has a boarding strength equal to that on the card. Roll on the boarding table as usual, but any captured ships simply drift stricken for the rest of the game, bereft of life and rendered useless by the ravaging attack of the Genestealer and Tyranid forces raging through its empty hull.

Any ship successfully boarded by Tyranids stops in its square for the rest of the game, doing nothing. If the Imperial or Eldar player attempts to recapture the stricken vessel it has a boarding strength of 2D6 to repel the boarder - this represents the Tyranids and Genestealers still at large on the ship. If recaptured the ship counts as crippled. The Tyranid player does not receive double victory points for destroying an enemy ship in a boarding action.

TYRANID DARK PROWLER

WOUNDS: 9 COMMAND CARDS: 2 POINTS: 100



WEAPON TABLE

Weapon	Arc of operation	Range
Deathburner	Forward	7-8
Hullgrinder	Broadside	1
		3

SPECIAL RULES

A swarm of Dark Prowlers can have up to two cards played on it per turn. Each swarm of Dark Prowlers contributes one command card to the Tyranid player's hand.

CRITICAL WOUNDS TABLE

- 1 Deathburner damaged.
- 2 Respiratory vent injured. The Dark Prowler suffers one wound at the start of each turn.
- 3 Energy cortex damaged. The Dark Prowler may only spend one action point on movement per turn from now on.
- 4 Right Hullgrinder broadside injured.
- 5 Left Hullgrinder broadside injured.
- 6 Haemorrhage. The Dark Prowler suffers an extra D6 wounds.

TYRANID VOID FIEND

WOUNDS: 5 COMMAND CARDS: 2 POINTS: 60



WEAPON TABLE

Weapon	Arc of operation	Range
Hullgrinder	Broadside	1-3
Deathburner	Forward	2 dice
		4-5
		2 dice
		1 dice

SPECIAL RULES

A swarm of Void Fiends can have up to two cards played on it per turn. Each swarm of Void Fiends contributes one command card to the Tyranid player's hand.

CRITICAL WOUNDS TABLE

- 1 Deathburner damaged.
- 2 Respiratory vent injured. The Void Fiend suffers one wound at the start of each turn.
- 3 Energy cortex damaged. The Void Fiend may only spend one action point on movement per turn from now on.
- 4 Right Hullgrinder broadside injured.
- 5 Left Hullgrinder broadside injured.
- 6 Haemorrhage. The Void Fiend suffers an extra 1D6 wounds.

GAMES WORKSHOP®

**HAMMERSMITH GRAND RE-OPENING SAT 15th FEBRUARY
OF OUR NEWLY RE-FITTED STORE**

**1 DALLING ROAD
HAMMERSMITH
LONDON W5 0JD
TEL: 081 741 3445**

**Opening Hours:
10.00am - 6.00pm Mon-Fri
9.30am - 5.30am Sat
Club Night Thurs till 8.00pm**



<p>ONLY ONE VOUCHER PER PRODUCT REDEEMABLE AT GAMES WORKSHOP HAMMERSMITH 15th FEBRUARY 1992</p> <p>10% OFF</p> <p>ANY GAMES WORKSHOP OR CITADEL PRODUCT</p> <p>NOT TO BE USED WITH ANY OTHER OFFER</p>	<p>ONLY ONE VOUCHER PER PRODUCT REDEEMABLE AT GAMES WORKSHOP HAMMERSMITH 15th FEBRUARY 1992</p> <p>10% OFF</p> <p>ANY GAMES WORKSHOP OR CITADEL PRODUCT</p> <p>NOT TO BE USED WITH ANY OTHER OFFER</p>
<p>ONLY ONE VOUCHER PER PRODUCT REDEEMABLE AT GAMES WORKSHOP HAMMERSMITH 15th FEBRUARY 1992</p> <p>10% OFF</p> <p>ANY GAMES WORKSHOP OR CITADEL PRODUCT</p> <p>NOT TO BE USED WITH ANY OTHER OFFER</p>	<p>ONLY ONE VOUCHER PER PRODUCT REDEEMABLE AT GAMES WORKSHOP HAMMERSMITH 15th FEBRUARY 1992</p> <p>10% OFF</p> <p>ANY GAMES WORKSHOP OR CITADEL PRODUCT</p> <p>NOT TO BE USED WITH ANY OTHER OFFER</p>
<p>ONLY ONE VOUCHER PER PRODUCT REDEEMABLE AT GAMES WORKSHOP HAMMERSMITH 15th FEBRUARY 1992</p> <p>25% OFF</p> <p>ANY GAMES WORKSHOP OR CITADEL PRODUCT</p> <p>NOT TO BE USED WITH ANY OTHER OFFER</p>	<p>ONLY ONE VOUCHER PER PRODUCT REDEEMABLE AT GAMES WORKSHOP HAMMERSMITH 15th FEBRUARY 1992</p> <p>25% OFF</p> <p>ANY GAMES WORKSHOP OR CITADEL PRODUCT</p> <p>NOT TO BE USED WITH ANY OTHER OFFER</p>



**BUY ANY 2 RED DOT ITEMS AND GET 1 YELLOW DOT ITEM
FREE!**

**EG: BUY SPACE HULK AND
ADVANCED HEROQUEST AND GET DEATHWING
FREE!**

**BUY ANY 2 BLISTER PACKS AT £3.99
OR OVER AND GET ONE ADDITIONAL
£3.99 BLISTER PACK
FREE!**

**LOTS OF GAMES & ACCESSORIES
FOR £2.50 OR LESS**

**OFFERS LAST ALL DAY
(WHILE STOCKS LAST)**

**PLEASE NOTE: YOU CANNOT USE THE VOUCHERS WITH ANY
OF THE ABOVE OFFERS
OR ON MB GAMES' HEROQUEST AND SPACE CRUSADE**

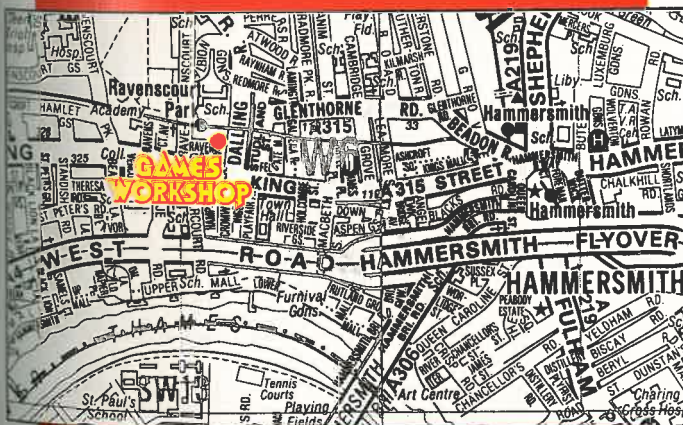

DOORS OPEN 9AM

TYRANID SPORE MINE

WOUNDS: 4 COMMAND CARDS: Special POINTS: 10



WEAPON TABLE

Weapon	Arc of operation	Range
Special	Special	Special
		6 dice

SPECIAL RULES

Spore mines move before the rest of the Hivefleet. They may not have command cards played on them, nor do they contribute any command cards towards the Tyrannid player's hand. They have one action point and may move in any direction. They may use their action point to move or explode. If they explode, consult the following table to see how many dice to roll in the combat tray, using it as explained for area effect weapons.

Wounds left	Dice rolled
1	2
2	4
3 - 4	6

Hits which score 6 do critical damage. Other hits do one point of damage.

A spore mine cannot board or be boarded. If rammed or ramming, a spore mine automatically explodes.

CRITICAL WOUNDS TABLE

Any critical wound causes a spore mine to explode

TYRANID HIVESHIP

WOUNDS: 12 COMMAND CARDS: 1 POINTS: 120



WEAPON TABLE

Weapon	Arc of operation	Range
Tentacles	Front three squares	1
Mind assault	Front three squares	5 dice
		2 dice

CRITICAL WOUNDS TABLE

1 **Tentacles injured.** The Hiveship may only make a 2 dice attack with its tentacles from now on.

2 **Energy cortex damaged.** The Hiveship may only spend one action point on movement per turn from now on.

3 **Biomass cells ruptured.** Hiveship may no longer create reinforcements.

4 **Sensory cluster injured.** The Hiveship may no longer make mind assaults.

5 **Teleporter nexus injured.** The Hiveship may no longer board other ships.

6 **Haemorrhage.** The Hiveship suffers an extra d6 wounds.

SPECIAL RULES

The Hiveship can have up to one command card played on it per turn. It contributes six command cards to the Tyrannid player's hand.

The tentacles of the Hiveship each do 1 point of damage for every hit they score.

For every successful tentacle hit the Tyrannid player makes a mind assault against the crew of the target vessel as the Norn Queen vents her wrath. Each successful mind assault does 1 automatic critical hit.

When creating reinforcements, the reinforcements arrive in any of the three squares in front of the Hiveship.

DEATHBURNER KRAKEN

WOUNDS: 8 COMMAND CARDS: 1 POINTS: 90



WEAPON TABLE

Weapon	Arc of operation	Range
Deathburner	Forward	1-9 2

SPECIAL RULES

A Deathburner Kraken can have up to one card played on it per turn. Each Deathburner Kraken contributes one command card to the Tyrand player's hand.

CRITICAL WOUNDS TABLE

- 1-2 Hive mind synapse disabled. The Kraken grinds to a halt until repaired.
- 3-4 Energy cortex damaged. The Kraken may only spend one action point on movement per turn from now on.
- 5 Deathburner damaged. Now only rolls one dice.
- 6 Internal injuries. The Kraken takes an extra 1D6 wounds from internal injuries.

RAMSMITTER KRAKEN

WOUNDS: 8 COMMAND CARDS: 3 POINTS: 90



WEAPON TABLE

Weapon	Arc of operation	Range
Boneram	Forward	1 Special 1-4

CRITICAL WOUNDS TABLE

- 1-2 Hive mind synapse disabled. The Kraken grinds to a halt until repaired.
- 3-4 Energy cortex damaged. The Kraken may only spend one action point on movement per turn from now on.
- 5 Boneram weakened. The Kraken may only spend one action point on attacks per turn from now on.
- 6 The Kraken takes an extra 1d6 wounds from internal injuries.

SPECIAL RULES

A Ramsmitter Kraken can have up to three cards played on it per turn. Each Ramsmitter Kraken contributes one command card to the Tyrand player's hand. The Boneram takes effect from an adjacent square to an enemy ship. Roll 4 dice in the ray and total any hits, then consult the following table.

Score	Ram Damage	Boarding Strength
1-4	2 points	Cannot board
5-7	4 points	8
8-10	6 points	10
11-14	8 points	12
15+	10 points	14

Note that you may only attempt to board if all of the target's shields on that facing are destroyed.

TYRANID WEAPONS

The bio-weapons used by the Tyranid hive fleets are many, varied and hideous. Huge acid-spitting cannons, infectious spores, corrosive viruses, bone-blades and massive rending jaws are just a few examples. Because of the genetically engineered nature of the Tyranid hive fleet, Tyranid vessels belonging to the same hive fleet are always immune to the effects of their own weapons.

HULLGRINDERS

Hullgrinders are a type of gigantic, ferocious insect-like creature which matures in massive brood chambers before instinctively crawling into firing sphincters. When the Tyranid fires a broadside of Hullgrinders a powerful muscle spasm ripples along the flank of the vessel as the firing sphincters hurl their deadly cargoes through the void at their targets. If a Hullgrinder hits its target, it quickly exhausts itself in a frenzied attempt to bite, tear and rend its way right through the target vessel, doing untold damage in the process.

It costs 1 action point to fire a Hullgrinder broadside, and the Tyranid ship cards tell you how many dice to roll. The dice are rolled in the combat tray as for a normal laser broadside. If a Tyranid ship spends enough action points to fire more than one broadside at a target, simply add all the dice up and roll them in the combat tray together.

EXAMPLE: BROADSIDES

A Tyranid swarm of 2 Void Fiends, each with a 2 dice Hullgrinder broadside spends 3 action points to fire three times at a nearby Imperial ship. This means the Tyranid player rolls 6 dice in the combat tray for each of the two ships in the swarm.

Every time a Hullgrinder hits its target, roll a D6:

On a score of 1-5 the Hullgrinder tears across the surface of the energy shields of the vessel, overloading the generators and draining one shield before the Hullgrinder is consumed in a brilliant flare of energy. If there are no remaining shields, then the Hullgrinder goes the surface of the ship for one hull point of damage before it dies.

On a score of 6 the Hullgrinder hurls itself straight through any remaining shields on the target vessel, and clings limpet-like to the hull, grinding its way through the target and inflicting D6 points of hull damage before it dies.

DEATHBURNER

The Deathburner is the closest the Tyranids come to a conventional missile weapon. Deep in the arming chamber of the weapon the skin is flayed off a giant acidic bio-construct creature. The resulting corrosive glob is propelled at the target vessel by a long muscular tract. When the Deathburner hits its target, it impacts against the hull or shields, showering corrosive bile for miles in all directions.

A Deathburner has a slower rate of fire than the Hullgrinder so it takes two action points to fire. The Tyranid ship cards tell you how many dice to roll in the combat tray for a Deathburner attack. If a Deathburner hits, it scores damage on the target vessel and can also damage other vessels nearby with splatters of corrosive bile. Unlike Hullgrinders, the dice for several Deathburner attacks are not added together, each shot is resolved separately.

Any Deathburner dice that hit do the amount of damage shown on the dice to the target vessel. A 6 scores six points of damage and scores a critical hit on the target vessel.

If any hits are scored roll a further 6 dice in the combat tray to show the effect of the showering acid. The 'splashes' attack an area of 9 squares in a 3 square by 3 square grid, centred on the target ship. The nine squares of the combat tray represent the nine board squares which are being showered by acid.

The square each dice lands in shows which square on the board has been hit. If a dice lands in a square representing a square on the board that contains no ship, then that dice is a miss and is ignored. Any ships hit by acid showers take one point of damage per dice which hit but do not suffer critical damage even if a six is rolled.

		▲
▲	▲	

The ship in the centre square has been hit by a Deathburner. Six more dice are then thrown in the combat tray.

HIT	MISS	HIT
MISS	HIT	MISS
HIT	MISS	HIT

If any dice land in the shaded squares, the appropriate ship takes one point of damage per dice. It doesn't matter if the square says hit or miss in it – it's the position of the square that's important. Note that the original target can be hit again by splatter dice.

THE HIVEFLEET

HIVESHIPS

Each Hiveship is a vast living organism, armoured with a leathery hide and chitinous plates hundreds of feet thick. The deep layers of fibrous dead tissue afford excellent protection from the inhospitable conditions of deep space and the warp, as well as from the weapons of hostile vessels. Constantly regenerating, repairing and growing, the Hiveships of a Tyranid fleet are almost impossible to destroy for all but the most powerful Imperial battleships.

Deep within the pulsing interior of the Hiveships are the vital organs that keep the great vessels functioning, incessantly attended to by thousands of Tyranid bio-constructs and mind slaves. Within the twisting, fleshy corridors of the Hiveship lurk massive armies of Genestealers, Tyranid warriors and worse. At the very heart of each Hiveship is the throne chamber of the Norn Queen, without whose guidance the whole fleet would founder, wither and perish. The Norn Queen's own markings appear on all her Tyranid warriors, bio-constructs and the vessels in her fleet. The bigger Tyranid fleets may display the markings of several Norn Queens.

HIVESHIP RULES

The Hiveship can have 1 card played on it per turn.

The Hiveship is the only vessel which can regenerate the fleet, creating reinforcements during the battle. These reinforcements arrive in the three squares in front of the Hiveship as shown in the diagram below.

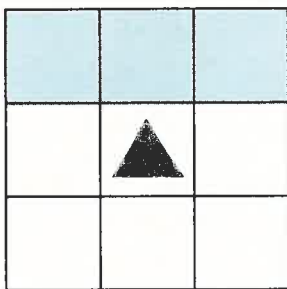

To create reinforcements in this fashion, the Tyranid player must have a reinforcement card. Every time the Hiveship attempts to generate reinforcements, it loses a wound as it channels its own genetic material into the replacements it is generating. These wounds can be regained throughout the game by playing repair cards. Each reinforcement card may only be played once in any one game. After a reinforcement card is played, take it out of the pack for the rest of the game.

The Hiveship has no long range weapons, being defended by the swarms of attendant drones and Kraken. At close range, the Hiveship is lethal, using its massive tentacles to lash its foe and venting its anger in deadly mind assaults which bring insanity or death to the puny creatures opposing it. The arc of operation of these attacks is also the three squares in front of the Hiveship (see reinforcements diagram).

Each Hiveship gives 6 command cards to the Tyranid player's hand. These cards are lost if the Hiveship is destroyed.

DRONES

The Hiveship of the Norn Queen is closely defended by a large number of drone vessels: bio-engineered defence ships which dart around the mother vessel, reacting immediately to any threat to the Hiveship. They are so frenzied in their defence of the queen that they always either beat off an attack or are destroyed totally in the attempt.

As such, no drone ships have ever been successfully boarded and the scholars of the Imperium can only guess as to what type of creatures crew them, if indeed they are crewed at all.

The Hiveship is capable of encouraging damaged drones to repair themselves almost instantaneously, and hideously damaged drones have been known to re-enter battle in a completely combat worthy state within minutes of being hit. The Hiveship can create replacement vessels by absorbing and re-forming the ruined tissue of 'dead' drones.

DRONE RULES

- Drones operate in swarms of up to 9 ships, with up to 3 drones per square.
- Critical hits on drones always destroy them.
- Drone swarms do not contribute towards any command cards to the Tyranid player's hand.

SPORE MINES

The harbinger of an approaching Tyranid fleet is usually the appearance in a planetary system of thousands of huge, floating pod-like spores. These are deadly mines, drifting in a seemingly random fashion before exploding and inflicting massive physical damage by the impact of jagged pieces of chitinous shell casing hundreds of feet across.

They also have a more insidious effect, showering their targets with a variety of virulent viruses, acids, algae and infectious parasites.

<p>ACTION POINTS</p> <p>Move the whole Hivefleet 2 actions. Play this card before any other in a turn. It does not count towards the cards played on individual swarms and is in effect a 'free' card.</p> <p>THE WHOLE FLEET</p>	<p>ACTION POINTS</p> <p>2</p> <p>Each vessel in the swarm may use up to 2 action points this turn.</p> <p>SINGLE SWARM</p>	<p>ACTION POINTS</p> <p>1</p> <p>Each vessel in the swarm may use 1 action point this turn.</p> <p>SINGLE SWARM</p>	<p>ACTION POINTS</p> <p>1</p> <p>Each vessel in the swarm may use 1 action point this turn.</p> <p>SINGLE SWARM</p>
<p>ACTION POINTS</p> <p>3</p> <p>Each vessel in the swarm may use up to 3 action points this turn.</p> <p>SINGLE SWARM</p>	<p>ACTION POINTS</p> <p>2</p> <p>Each vessel in the swarm may use up to 2 action points this turn.</p> <p>SINGLE SWARM</p>	<p>ACTION POINTS</p> <p>2</p> <p>Each vessel in the swarm may use up to 2 action points this turn.</p> <p>SINGLE SWARM</p>	<p>ACTION POINTS</p> <p>2</p> <p>Each vessel in the swarm may use up to 2 action points this turn.</p> <p>SINGLE SWARM</p>
<p>ACTION POINTS</p> <p>2</p> <p>Each vessel in the swarm may use up to 2 action points this turn.</p> <p>SINGLE SWARM</p>	<p>ACTION POINTS</p> <p>2</p> <p>Each vessel in the swarm may use up to 2 action points this turn.</p> <p>SINGLE SWARM</p>	<p>ACTION POINTS</p> <p>2</p> <p>Each vessel in the swarm may use up to 2 action points this turn.</p> <p>SINGLE SWARM</p>	<p>ACTION POINTS</p> <p>2</p> <p>Each vessel in the swarm may use up to 2 action points this turn.</p> <p>SINGLE SWARM</p>
<p>ACTION POINTS</p> <p>3</p> <p>Each vessel in the swarm may use up to 3 action points this turn.</p> <p>SINGLE SWARM</p>	<p>ACTION POINTS</p> <p>3</p> <p>Each vessel in the swarm may use up to 3 action points this turn.</p> <p>SINGLE SWARM</p>	<p>ACTION POINTS</p> <p>3</p> <p>Each vessel in the swarm may use up to 3 action points this turn.</p> <p>SINGLE SWARM</p>	<p>ACTION POINTS</p> <p>3</p> <p>Each vessel in the swarm may use up to 3 action points this turn.</p> <p>SINGLE SWARM</p>

<p>ACTION POINTS</p> <p>4</p> <p>Each vessel in the swarm may use up to 4 action points this turn.</p> <p>SINGLE SWARM</p>	<p>ACTION POINTS</p> <p>4</p> <p>Each vessel in the swarm may use up to 4 action points this turn.</p> <p>SINGLE SWARM</p>	<p>ACTION POINTS</p> <p>4</p> <p>Each vessel in the swarm may use up to 4 action points this turn.</p> <p>SINGLE SWARM</p>	<p>ACTION POINTS</p> <p>3</p> <p>Each vessel in the swarm may use up to 3 action points this turn.</p> <p>SINGLE SWARM</p>
<p>REGENERATE CRITICAL DAMAGE</p> <p>Energy Cortex regenerated</p> <p>SINGLE SHIP</p>	<p>REGENERATE CRITICAL DAMAGE</p> <p>Hive Mind Synapse regenerated</p> <p>SINGLE SHIP</p>	<p>REGENERATE CRITICAL DAMAGE</p> <p>Death Burner regenerated</p> <p>SINGLE SHIP</p>	<p>REGENERATE CRITICAL DAMAGE</p> <p>Regenerates any critical wound.</p> <p>SINGLE SHIP</p>
<p>REGENERATE CRITICAL DAMAGE</p> <p>Hull Grinder regenerated</p> <p>SINGLE SHIP</p>	<p>REGENERATE CRITICAL DAMAGE</p> <p>Respiratory Vent regenerated</p> <p>SINGLE SHIP</p>	<p>REGENERATE CRITICAL DAMAGE</p> <p>Sensory Cluster regenerated</p> <p>SINGLE SHIP</p>	<p>REGENERATE CRITICAL DAMAGE</p> <p>Regenerates any critical wound.</p> <p>SINGLE SHIP</p>

CRITICAL WOUND Hive Mind synapse damaged	CRITICAL WOUND Hive Mind synapse damaged	CRITICAL WOUND Hive Mind synapse damaged	CRITICAL WOUND Hive Mind synapse damaged	CRITICAL WOUND Hive Mind synapse damaged	CRITICAL WOUND Energy cortex. Only spend 1AP on moving	CRITICAL WOUND Energy cortex. Only spend 1AP on moving	CRITICAL WOUND Energy cortex. Only spend 1AP on moving	CRITICAL WOUND Energy cortex. Only spend 1AP on moving	CRITICAL WOUND Energy cortex. Only spend 1AP on moving
CRITICAL WOUND Death burner destroyed	CRITICAL WOUND Death burner destroyed	CRITICAL WOUND Death burner destroyed	CRITICAL WOUND Death burner destroyed	CRITICAL WOUND Death burner destroyed	CRITICAL WOUND No regeneration	CRITICAL WOUND Broadside destroyed	CRITICAL WOUND Broadside destroyed	CRITICAL WOUND Broadside destroyed	CRITICAL WOUND Broadside destroyed
CRITICAL WOUND Sensory cluster. Only attack once per turn	CRITICAL WOUND Sensory cluster. Only attack once per turn	CRITICAL WOUND Sensory cluster. Only attack once per turn	CRITICAL WOUND Sensory cluster. Only attack once per turn	CRITICAL WOUND Sensory cluster. Only attack once per turn	CRITICAL WOUND No mindshock	CRITICAL WOUND Shockram damaged	CRITICAL WOUND Boneram damaged	CRITICAL WOUND Tentacles injured	CRITICAL WOUND Tentacles injured
CRITICAL WOUND Respiratory vent - Lose 1 wound per turn	CRITICAL WOUND Respiratory vent - Lose 1 wound per turn	CRITICAL WOUND Respiratory vent - Lose 1 wound per turn	CRITICAL WOUND Respiratory vent - Lose 1 wound per turn	CRITICAL WOUND Death burner damaged	CRITICAL WOUND Death burner damaged	CRITICAL WOUND Enraged!	INFECTED	INFECTED	INFECTED

Once hit even ships caught by the very edge of the blast are almost certainly doomed as the cancerous infections quickly take hold and rapidly destroy the vessel. Spore mines are also often found drifting with the Tyranid fleet, protecting the Hiveships or breaking up enemy attacks

SPORE MINE RULES

Spore mines operate as individuals, and always move before the rest of the Tyranid hive fleet. They do not use cards to move – in fact the Tyranid player may not play any cards on spore mines at all. Instead, the spore mines have one action point per turn. They can either move one square in any direction or explode.

The only time a spore mine can move and explode is when it rams or is rammed by an enemy vessel. In this case, the enemy vessel will take any resultant damage on the facing of the ram.

When a spore mine explodes, roll a number of dice in the combat tray, in the same way as an attack by Deathburner acid showers. The amount of dice rolled for the spore mine depends on how damaged it is:

Number of remaining wounds	Dice rolled
3	6
2	4
1	2

Spore mines do not contribute any command cards to the Tyranid player's hand

BEAST-CRAFT

Tyranid Beast-craft operate in a similar fashion to the battleships of the Imperium. These are the only vessels in the Tyranid fleet capable of sustained independent operation away from the Hiveship and are sometimes used to probe ahead of the main body of the hive fleet.

Beast-craft are tough and heavily armed with Hullgrinders and Deathburners. Three broad categories have been identified so far. The largest are huge, lumbering craft known as Dark Prowlers, next largest are the Void Fiends and the third and most numerous are the Wardrones.

It has been suggested that the Beast-craft pave the way for the main fleet, and are responsible for the appearance of spore mines in a system to be conquered. They are at the same time the least frightening yet most feared of the Tyranid vessels - their appearance is perhaps the least alien and their actions the easiest to comprehend and counter, yet their precision and immensely destructive weapons render them fearful adversaries indeed.

BEAST-CRAFT RULES

Each swarm of Dark Prowlers comprises one or two vessels, while Void Fiends and Wardrones operate in swarms of up to three ships. Swarms of Beast-craft contribute one command card to the Tyranid player's hand. This card is lost if the swarm is destroyed.

KRAKEN

The Tyranids breed, grow or harness huge Kraken – vast creatures which live in the vacuum of space. There are many individual types of Kraken, each with specific horrific offensive properties. Some have huge jaws for rending the hulls of enemy ships, others spit vast globs of corrosive acids. Others have long, bone-bladed snouts to plunge deep into enemy ships where they disgorge hordes of Genestealers and Tyranid warriors. Kraken have a rudimentary intelligence and if left to their own devices away from the hive fleet they will wreak unimaginable havoc on whatever they come across.

RAMSMITER KRAKEN

Ramsmiter Kraken are huge brilliantly coloured space beasts that have been observed and recorded by the exobiologists of the Adeptus Mechanicus for many centuries. Although little is actually known about them, they appear to propel themselves across the void of deep space by using their vast cloak-like wings to draw energy from the solar wind. In the course of their evolution, the mouth and snout of these creatures has developed into an enormous iron-hard proboscis hundreds of feet long. In their natural state they gain sustenance by ramming their snouts deep into the surface crust of asteroids or moons, probing for and extracting rich deposits of minerals and ice.

Though their intelligence is questionable, Ramsmiter Kraken seem to have learned that space going vessels and isolated colonies are particularly rich sources of sustenance. Their determined assaults on human colonies are extremely rare, but devastating when they take place.

The Ramsmiter Kraken used by the Tyranids have been bio-engineered to be even more destructive than their wild cousins. They are closely controlled by the hive mind, and have been hideously altered.

Their proboscis-like rams penetrate the hulls of target vessels in search of food, and they bring a deadly trade-off in exchange for the mineral and human material sucked into the Ramsmiter's digestive tract. Each time a Ramsmiter attacks, it delivers a boarding party of Genestealers and Tyranids into the very heart of the target vessel.

The Ramsmiter can attack any of the three squares in front of it. This area is the same as the Hive ship reinforcements area.

HELLBLASTER KRAKEN

Hellblaster Kraken are thought to actually be Tyranid bio-constructs, as nothing employing such a destructive energy weapon has been reported occurring naturally. Indeed, no Hellblasters have been seen at all without the appearance of Tyranids shortly after. The Hellblaster Kraken seem to be able to recognise Tyranid vessels, as they nimbly avoid them on their headlong rush toward the enemy fleet.

Being largely made up of a huge shielded carapace, the Hellblaster is virtually unstoppable when attacking an enemy vessel. The sole objective of a Hellblaster Kraken is to contact with the hull or shields of an enemy ship and discharge a massive blast of electrostatic energy directly into its prey. The parts of the Hellblaster which are not made up of the carapace are almost entirely comprised of powerful bio-constructed high voltage electrical storage chambers.

The result of a successful Hellblaster attack is spectacular. Lethal energy seethes through the hull of the enemy ship, overloading electrical devices and burning out vast sections of its target. The generators of a well shielded vessel will groan under the strain of the attack, as the raw electricity claws, crackles and spits at the protective shields. Even if the Hellblaster is finally killed by the armament of its prey, it is very likely to have wrecked its target beyond repair.

DEATHBURNER KRAKEN

Deathburner Kraken are the most graceful-looking Kraken in the hive fleet. The sight of their great, spined wings lazily catching the solar wind as they turn towards their prey is breathtaking. The entire body section of this Kraken is a vast Deathburner cannon over a mile in length. The Deathburner Kraken is able to propel great gobbets of corrosive bile over vast reaches of space, disabling targets at a very long range, before finishing them off at its leisure.

DOOMRIPPER KRAKEN

Doomripper Kraken close with their prey before viciously attacking with grinding jaws and rending teeth. In some ways the Doomripper is even more dangerous than the Ramsmiter, as once it has successfully attached itself to its prey, it will die rather than let go. The Doomripper wraps itself around its prey, preventing the target's guns from firing at it. Unless the Doomripper itself loses its grip, the target vessel is unable to rid itself of the parasite.

KRAKEN RULES

These rules apply to species of Kraken.

- Kraken operate as individuals, not in swarms.
- Each Kraken has specific attacks, which are listed on its data card.
- Each Kraken contributes one card to the Tyranid player's hand.

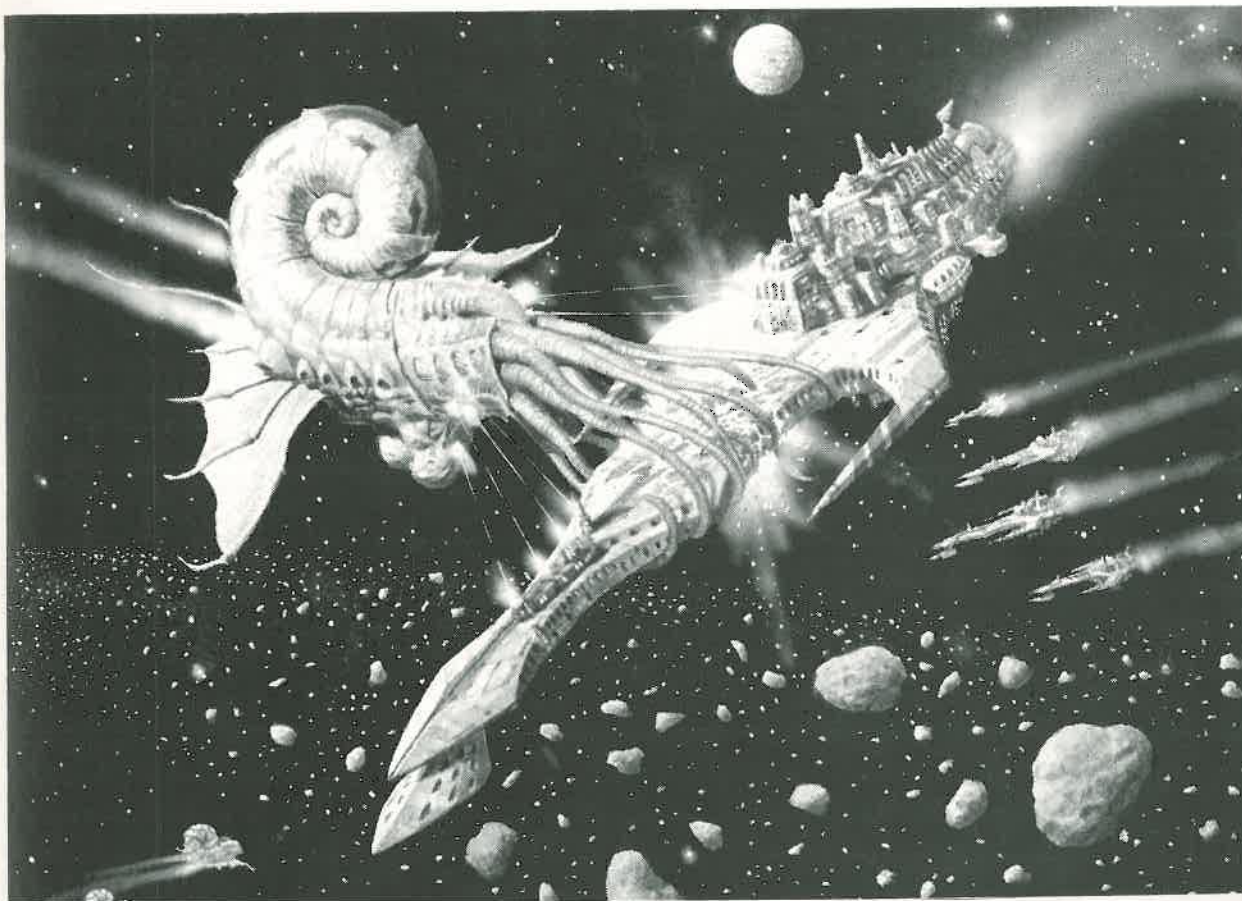

ROLF MOHR

THE TYRANID CARD DECK

As explained, the Tyranid fleet moves and fights by using a deck of command cards. At any time in the game, the Tyranid player will have a certain number of command cards, depending on how many swarms and Hiveships he has left to contribute to the hive mind. The ship data card for each type of Tyranid vessel states how many command cards can be played on a swarm of its kind each turn. The following is a listing of the command card types with explanations of how they are played.

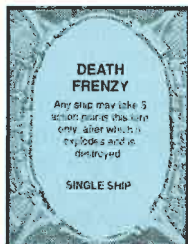

DEATH FRENZY

In times of dire threat to the hive, all Tyranid vessels are prepared to hurl themselves on the enemy in frenzied suicide missions. The death frenzy cards give any one ship a large number of action points for that turn only, after which the vessel dies, exhausted. A death frenzy card

counts towards the total that may be played on the swarm in a particular turn.

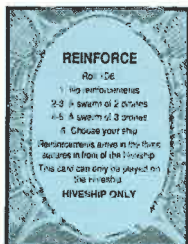

REINFORCEMENT CARDS

Reinforcement cards can only be played on the Hiveship, as she regenerates new drones, spore mines and other ships to defend the hive. Each time you play a reinforcement card, the Hiveship loses a wound before rolling a dice to see what reinforcements arrive.

The reinforcements arrive in one of the three squares in front of the Tyranid Hiveship.

Each reinforcement card can only be played once, after which it is removed from the deck for the duration of the game.

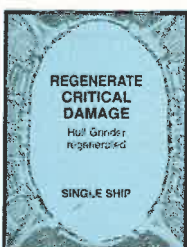

CRITICAL REPAIR CARDS

These cards are used to repair specific critical wounds on Tyranid vessels. A card affects a single vessel and does count against the number of cards which can be played on that swarm in the turn.



BOARD CARDS

These cards are the only way the Tyranid fleet may board other vessels. They can be played on any Tyranid vessel in the fleet which is adjacent to an enemy ship (crippled or not), and the ship may then attempt to board the enemy vessel with hordes of Genestealers and Tyranids. Each board card specifies

a boarding strength, and this is the boarding strength of the vessel for that whole boarding action. A card affects a single vessel, but counts towards the total that may be played on the swarm in a particular turn.

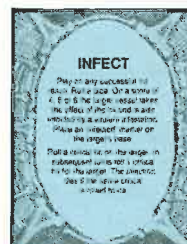

INFECT CARDS

Infect cards can be played on any successful hit against an enemy vessel. They do not have to be played through a specific vessel and are only played when a hit has been scored. They represent the deadly spores, acids and parasites of the Tyranid weapons taking hold of the enemy ship and causing extensive damage.

When you score a successful hit on an enemy vessel and score hull damage, you may play an infect card. Roll a D6. On a score of 4, 5 or 6 the target vessel is infected and immediately takes an automatic critical hit.

Place an infected marker on the base of the target vessel. In each subsequent turn, the target vessel rolls again on the critical hit chart as the infection rages through the vital sections of the ship, damaging delicate machinery and causing havoc deep in the bowels of the vessel.

The infection dies when a critical hit is rolled which the vessel has already suffered - for instance if you roll 'Engines damaged' twice. When the infection dies, remove the infection marker, which often leaves the stricken ship floating helpless in the void.

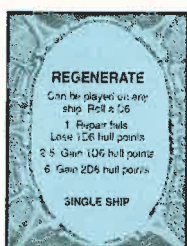

REGENERATE CARDS

These are less specific repair cards, played on a wounded vessel to encourage it to regenerate itself. Sometimes they go wrong, causing the stricken vessel to take further damage, but more often than not they repair the Tyranid ship, enabling it to get back into the

fight. A card affects a single vessel, but counts towards the total that may be played on the swarm in a particular turn.

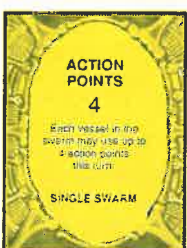

ACTION CARDS

Action cards allocate a number of action points to one or more swarms. Each vessel in that swarm may use up to that number of action points.

REINFORCE

Roll 1D6:

- 1: No reinforcements
- 2-3: A swarm of 2 drones
- 4-5: A swarm of 3 drones
- 6: Choose your ship

Reinforcements arrive in the three squares in front of the Hiveship.
This card can only be played on the Hiveship.

HIVESHIP ONLY

REINFORCE

Roll 1D6:

- 1: No reinforcements
- 2-3: A swarm of 2 drones
- 4-5: A swarm of 3 drones
- 6: Choose your ship

Reinforcements arrive in the three squares in front of the Hiveship.
This card can only be played on the Hiveship.

HIVESHIP ONLY

REINFORCE

Roll 1D6:

- 1: No reinforcements
- 2-3: A swarm of 2 drones
- 4-5: 3 Spore Mines
- 6: Choose your ship

Reinforcements arrive in the three squares in front of the Hiveship.
This card can only be played on the Hiveship.

HIVESHIP ONLY

REINFORCE

Roll 1D6:

- 1: No reinforcements
- 2-3: A swarm of 2 drones
- 4-5: 3 Spore Mines
- 6: Choose your ship

Reinforcements arrive in the three squares in front of the Hiveship.
This card can only be played on the Hiveship.

HIVESHIP ONLY

BOARD

For this turn, any one ship has a boarding strength of 9, due to hordes of frenzied Genestealers and Tyranids which are on board.

SINGLE SHIP

BOARD

For this turn, any one ship has a boarding strength of 8, due to hordes of frenzied Genestealers and Tyranids which are on board.

SINGLE SHIP

BOARD

For this turn, any one ship has a boarding strength of 10, due to hordes of frenzied Genestealers and Tyranids which are on board.

SINGLE SHIP

BOARD

For this turn, any one ship has a boarding strength of 9, due to hordes of frenzied Genestealers and Tyranids which are on board.

SINGLE SHIP

INFECT

Play on any successful 'hit' result. Roll a dice. On a score of 4, 5 or 6 the target vessel takes the effect of the hit and is also infected by a virulent infestation. Place an 'Infected' marker on the target's base.

Roll a critical hit on the target. In subsequent turns roll 1 critical hit for the target. The infection dies if the same critical is rolled twice.

INFECT

Play on any successful 'hit' result. Roll a dice. On a score of 4, 5 or 6 the target vessel takes the effect of the hit and is also infected by a virulent infestation. Place an 'Infected' marker on the target's base.

Roll a critical hit on the target. In subsequent turns roll 1 critical hit for the target. The infection dies if the same critical is rolled twice.

DEATH FRENZY

Any ship may take 5 action points this turn only, after which it explodes and is destroyed.

SINGLE SHIP

DEATH FRENZY

Any ship may take 7 action points this turn only, after which it explodes and is destroyed.

SINGLE SHIP

REGENERATE

Can be played on any ship. Roll a D6:

- 1: Repair fails. Lose 1D6 hull points
- 2-5: Gain 1D6 hull points
- 6: Gain 2D6 hull points

SINGLE SHIP

REGENERATE

Can be played on any ship. Roll a D6:

- 1: Repair fails. Lose 1D6 hull points
- 2-5: Gain 1D6 hull points
- 6: Gain 2D6 hull points

SINGLE SHIP

REGENERATE

Can be played on any ship. Roll a D6:

- 1: Repair fails. Lose 1D6 hull points
- 2-5: Gain 1D6 hull points
- 6: Gain 2D6 hull points

SINGLE SHIP

REGENERATE

Can be played on any ship. Roll a D6:

- 1: Repair fails. Lose 1D6 hull points
- 2-5: Gain 1D6 hull points
- 6: Gain 2D6 hull points

SINGLE SHIP

WHITE DWARF®

SUBSCRIPTIONS SPECIAL OFFER

For a limited period only, we are offering six free back issues to every subscriber of White Dwarf. Not only do you ensure that you get each new issue delivered direct to your door, but you can catch up on all of the great articles, rule additions and modelling tips that you may have missed! To take advantage of this amazing deal, simply complete the form below. Don't forget to tell us which issue to start your subscription with and how long you wish to subscribe for. This offer is also open to re-subscribers.



UK: SPECIAL PRICE £20.00 for 1 year (12 issues)

Please include cheque or postal order for £20.00 made payable to GAMES WORKSHOP, and send to:
 WHITE DWARF MAGAZINE SUBSCRIPTIONS, Games Workshop, Chewton Street, Hilltop, Eastwood, Notts, NG16 3HY.
 For BARCLAYCARD/VISA and ACCESS subscriptions telephone (0773) 713213 or (0773) 760462.

USA: SPECIAL PRICE \$35.00 for 1 year (12 issues) or \$63.00 for 2 years (24 issues)

The free back issues offer is only available if you order with Visa or Mastercard. We have limited copies available of White Dwarf 67 onwards, so to ensure you get the free back issues you require, please phone now on the number below.



All US subscribers will also receive a free copy of the White Dwarf Review, regular news of any special offers, and monthly updates on all the new releases from Games Workshop and Citadel Miniatures.

For VISA and MASTERCARD subscriptions telephone (301) 644 5699.

All other subscribers please include cheque or postal order for \$35.00 (Maryland residents please add 5% sales tax) made payable to GAMES WORKSHOP, and send to:

WHITE DWARF MAGAZINE SUBSCRIPTIONS, Games Workshop Inc., 3431 Benson Ave, Baltimore, Maryland 21227.

REST OF THE WORLD £40.00 for 1 year (12 issues)

Please include cheque or postal order for £40.00 made payable to GAMES WORKSHOP, and send to:
 WHITE DWARF MAGAZINE SUBSCRIPTIONS,
 Games Workshop, Chewton Street, Hilltop, Eastwood, Notts, NG16 3HY.
 For BARCLAYCARD/VISA and ACCESS subscriptions telephone (0773) 713213 or (0773) 760462.



For UK subscribers the following back issues are still available. Please select twelve issues in order of preference. For example: if issue 55 is your first choice enter a '1' in the box to the right of 55. We will endeavour to send you your first choice of six, but if an issue becomes unavailable we will send you your next highest choice.

65	<input type="checkbox"/>	69	<input type="checkbox"/>	76	<input type="checkbox"/>	87	<input type="checkbox"/>	129	<input type="checkbox"/>	133	<input type="checkbox"/>	137	<input type="checkbox"/>	141	<input type="checkbox"/>
66	<input type="checkbox"/>	70	<input type="checkbox"/>	77	<input type="checkbox"/>	89	<input type="checkbox"/>	130	<input type="checkbox"/>	134	<input type="checkbox"/>	138	<input type="checkbox"/>	142	<input type="checkbox"/>
67	<input type="checkbox"/>	72	<input type="checkbox"/>	78	<input type="checkbox"/>	109	<input type="checkbox"/>	131	<input type="checkbox"/>	135	<input type="checkbox"/>	139	<input type="checkbox"/>	143	<input type="checkbox"/>
68	<input type="checkbox"/>	75	<input type="checkbox"/>	84	<input type="checkbox"/>	110	<input type="checkbox"/>	132	<input type="checkbox"/>	136	<input type="checkbox"/>	140	<input type="checkbox"/>	144	<input type="checkbox"/>

Best Of White Dwarf Scenarios III

Please start my White Dwarf subscription with issue no: for years.

NAME

ADDRESS

POSTCODE

PLEASE DEBIT MY ACCESS/MASTERCARD/VISA NO.

NAME AND ADDRESS OF CARDHOLDER (if different from above). EXPIRY DATE

NAME

ADDRESS

POSTCODE

WHITE DWARF BACK ISSUES



Issue 75



Issue 76



Issue 77



Issue 78



Issue 84



Issue 87



Issue 89



Issue 109



Issue 110



Issue 129



Issue 130



Issue 131



Issue 132



Issue 133



Issue 134



Issue 135

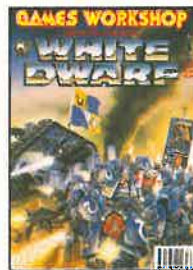

Issue 136



Issue 137



Issue 138



Issue 139



Issue 140



Issue 141



Issue 142



Issue 143



Issue 144

All the above back issues of White Dwarf and those listed with the subscription offers can also be ordered separately. Please phone Games Workshop Mail Order for more details.



TIM PROW



MINOTAUR CHAMPION



CHAMPION OF NURGLE



CONVERTED CHAOS CREATURES FROM TIM'S NURGLE WARFLEET



Although only nineteen, Tim has worked for Games Workshop as a miniature painter for almost three years. Tim was one of the top miniature painters at the Nottingham Games Workshop store and we were just so knocked out by the quality of his work that we decided we had to offer him a job. Tim is also a keen gamer who plays Warhammer Fantasy Battle, Warhammer 40,000 and Space Marine. The models on these pages all come from Tim's collection of miniatures. As you can see from the bases, some of them are display models, which sit on shelves and cabinets at his home, but most of them come from Tim's gaming armies. The models on the opposite page are taken from his Nurgle Chaos Warband. Tim also did much of the work on the Blood Angels Space Marine armies – both for Warhammer

40,000 and Space Marine – which have featured in recent White Dwarfs. In his spare time, Tim is putting the finishing touches to a huge Epic scale Chaos army. We hope to bring you some shots of this and possibly a battle report as soon as its finished.

Champion of Nurgle. This is the leader of Tim's Chaos Warband. One of the Chaos attributes he rolled up was lion's head, and so to convert the model he carefully removed the original Chaos Warrior's head and replaced it with that of a giant tiger. The join between the two pieces was concealed by adding a small quantity of modelling putty and sculpting this into a rough fur texture.

Converted Chaos Centaurs. All of these conversions are based on the body of a Citadel Chimera. This model is supplied with separate heads, so all that needed to be done to attach the new torsos was to file the area flat and drill a hole to take the fastening pin. Three of the bodies come from Chaos warriors and one is from an Orc. These were carefully cut away with a fret saw and attached to the Chimera body with superglue.

Tzeentch Disc Rider. Tim has painted the Disc Rider in bright contrasting colours, which are characteristic of all followers of the Lord of Change. He has carefully attached the disc to the base to make it appear to be skimming forwards in flight.



ELDAR HOWLING
BANSHEE EXARCH



SKAVEN POISONED
WIND GLOBADIER



CHAMPION OF TZEENTCH RIDING DISC



NURGLE BOVIGOR
BEASTMAN

The models on this page all come from Tim's collection which sits proudly on his shelves at home. The black wooden stands are a nice touch for models intended for display.



ELDAR HOWLING BANSHEE EXARCH



ULTRAMARINE CAPTAIN



THE LAST STAND

This beautifully painted diorama shows Dark Angel Marines in a last stand against the forces of Khorne. The bare headed marine is from the Dark Angels 1st Company – the Death Wing. His characteristic white armour shows the stylised homeworld icons for storm and war. The Death Wing are the Dark Angels Terminator company, so he also displays his Terminator Honours on his leg plates. Another nice touch can be seen in his damaged helmet, which he has removed and placed on the ground at his feet. The whole model has been based on a piece of slate that Tim has drybrushed with Elf Grey to enhance the contrast and bring out the texture.

GAMES WORKSHOP®

COVENTRY WARHAMMER DAY SATURDAY 15th FEBRUARY 1992

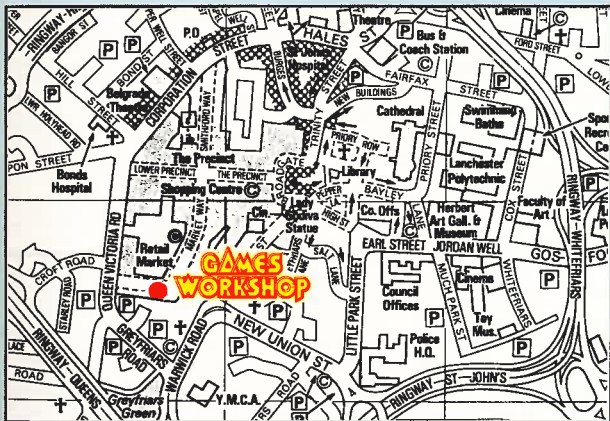

**14 CITY ARCADE
COVENTRY**

CONTACT: STUART

Opening hours:

10.00am – 6.00pm Mon – Fri

9.30 – 5.30 Saturdays

Club night: Thursdays 'till 8.00pm

Games Workshop's Mike McVey and Wayne England will be appearing at the Coventry store on Saturday 15th February 1992

Mike McVey will be passing on hints and tips for painting Citadel Miniatures at his all day painting demonstration. If you want to know how to get the best results on those special personality models or your basic troop types, come along for a chat. Mike will also be bringing the Wood Elf army that we've recently featured in the pages of White Dwarf. This is your chance to take a first hand look at Mike's spectacularly painted models.



Wayne England is one of Games Workshop's artists and his work has featured in many of our games and books.

Wayne will be fielding his superbly painted Dwarven army in the valiant defence of a small village on the edge of the Grey Mountains. Can his Dwarfs withstand an attack from the savage hordes that threaten the village?

If you've never played Warhammer Fantasy Battle before, now is your chance to learn by taking part. Bring along your own painted unit of evil or chaotic troops to join in the attack on the village. Everyone is welcome.

WARHAMMER®

FANTASY BATTLE

ARMY OF THE EMPIRE

By Nigel Stillman

The Empire is the largest and most powerful of all the many and varied realms of the Old World. It stretches from the borders of Bretonnia in the west to the sweeping plains of Kislev in the East. Its borders encompass vast forests, towering mountain ranges and wilderness regions as well as cities, farmlands and bountiful rivers. The rivers divide the Empire into natural regions and also provide the main routes for trade and communication. In the valleys of these rivers and their tributaries lie the rich farmlands and great cities of the Empire.

Although the Empire is usually referred to as if it were a single powerful realm, it is really a union of provinces and city states each of which enjoys considerable independence. Provinces are ruled by a count who maintains his own fighting forces, issues his own coinage, and levies his own taxes. In the case of city states some are ruled by popular assembly, others by hereditary councils, but they have the same status as provinces and also have their own armed forces. The rurally based provinces and cosmopolitan city states have banded together in a confederation known throughout the Old World as The Empire. Its people are united not only by a common language and way of life, but also by a complex series of trading and military treaties. The Empire has become so firmly established that individual provinces are completely

dependent upon each other to maintain prosperity and security. Despite this mutual interdependence, wars between the individual states break out all the time, but these are usually limited in scope and result from trade or boundary disputes or some such rivalry. These wars don't tend to last very long as neither side has anything to gain by involving the Empire in a conflict that might weaken its forces.

The most powerful nobles in the Empire are the Elector Counts, so called because they elect one of their number to rule over the entire Empire as Emperor. The Emperor is not just a figurehead, he formulates the foreign policy of the whole Empire and marshals its forces to war. It is also his responsibility to maintain the crack Imperial regiments of the Reiksguard as well as the Imperial artillery train. Training and equipping the Empire's regiments is a very costly affair, and producing new cannons is even more expensive. For this reason alone the Emperor is usually elected from the wealthiest province in the Empire.

The Empire is perhaps the greatest military power in the Old World. The Emperor can muster the individual provincial and city state armies into a combined force backed by the superbly trained and equipped Reiksguard, the artillery train, battle wizards from the Colleges of Magic, machines of war from the Imperial Engineers School, and allies from as far afield as Kislev, Bretonnia, and Norsca. Over the centuries the Empire's diplomats have woven a complex web of treaties and obligations. These treaties promise military support to almost every human nation in the Old World against just about every other nation. Of course these treaties also enable the Emperor to call for aid from other nations too. In practice these paper promises amount to very little, but provide a pretext for the nations of the Old World to make and break



alliances as they see fit, sending forces to support first one nation and then another. It has been known for whole nations to change sides halfway through a war, using their incomprehensible treaty agreements as a excuse for switching to the winning side. At its most extreme this can even result in two Imperial forces fighting each other, as happened during the battle of Remasalia when a combined force of Tileans and allied Empire troops found itself fighting an invading Bretonnian army accompanied by a substantial allied Empire army, more Tileans and Wood Elves. Needless to say both sides upheld tradition and fought bravely against foe and fellow countrymen alike.

THE REIKSGUARD

As we have seen the Empire's army is made up of different forces from its many contingent states. However the backbone of the Empire army is the Reiksguard, who are recruited across the Empire from amongst the elder sons of the nobility. It is a considerable honour for a family for its oldest son and heir to serve in the Reiksguard. They accompany the Emperor in war and peace, forming his personal bodyguard on the battlefield and in the course of his ceremonial duties.

The Reiksguard are much loved throughout the Empire. When a dashing young Reiksguard trooper returns to his home town on leave he is greeted by cheering citizens, and riotous celebrations carry on long into the night. The Reiksguard wear magnificent gilded armour garlanded with tall feathered crests and scarlet sashes. When they accompany the Emperor on his many ceremonial

processions they add to the splendour and magnificence of the occasion by dint of their awesome appearance and fabulously expensive armour. During the annual Imperial tournament the Reiksguard compete against each other for the honour of being closest to the Emperor. These events are a major highlight of the year attracting citizens from all over the Empire and beyond.

THE KNIGHTLY ORDERS

The Empire is a feudal society with counts, barons, and lesser nobles ruling over the many small towns and village communities of each province. When a noble assumes his title and feudal responsibilities he joins one of the Knightly Orders of the Empire. These are chivalric societies devoted to a particular deity or memory of an ancient warrior hero, but most importantly to the defence of the whole Empire against Chaos.

The orders were created many centuries ago to defend the Empire against its foes, and in particular against the perils of Chaos. Each Knightly Order has its own distinctive style of armour and often a favoured method of fighting. There are many orders throughout the Empire. Some are small and their members belong to a local community, but others are vast organisations with members throughout the land and in many principalities. Knights live perfectly normal lives tending their estates wherever they may be, but when they go to war they fight alongside other Knights from their own order, forming a separate unit on the battlefield. When two competing provinces fight each other there may well be contingents of the same Knightly Order on both



FANGORN



Knight Panther

sides, but this is an accepted practice and causes no ill will within the Knightly Orders themselves.

The largest and most important of the Knightly Orders are the White Wolves and the Knights Panther. Together these are larger than all the other orders combined, and it is a rare battle in which neither of these great orders is present. They include nobles from all over the Empire, and any noble family would be proud to boast its leader belonged to the White Wolves or the Knights Panther.

The **White Wolves** were founded in the city of Middenheim during one of the many Chaos incursions which threatened to sweep the whole Empire away. The city lay directly in the path of the advancing Chaos Hordes, and only the bravery and determination of the Knights saved the city from destruction. Riding out on their fiery war horses, bareheaded and brandishing huge clubs, the warriors met and defeated the Chaos army, saving Middenheim for the Empire, and earning themselves a place in the heroic legends of the Old World. The survivors decided to found a chivalric order sworn to fight Chaos, and they chose the name of White Wolves after the city of Middenheim, also known as the City of the White Wolf.

To this day the White Wolves still celebrate the legendary battle of Middenheim in a great annual Feast of the White Wolf held on the battlesite itself. Following the example of their forebears they maintain the tradition of fighting without a helmet, their long hair blowing behind them as they charge and making them look even more fearsome. They carry huge war clubs into battle, which they handle with great skill, striking easily to the left and right, smashing apart armour and cracking the skulls of their enemies.

The **Knights Panther** claim to be the oldest of the Knightly Orders and trace their existence back to the wars against Araby nearly a thousand years ago. During those wars Knights from all over the Old World invaded the lands of Araby, first driving them from the south of Estalia, and subsequently carrying the battle into Araby itself. The returning Knights brought back many great treasures plundered from the palaces of the Sultans of Araby, including gold and silver, precious gems, silks, furs, and exotic animals the like of which had never been seen in the Old World. Amongst these many creatures were panthers liberated from the extensive pleasure gardens of Istrabul. When the Knights paraded through the streets of the cities of the Empire many did so accompanied by one of these marvellous creatures padding beside him, led by a golden chain. This created such an abiding impression that the Knightly Order founded by these returning crusaders became known as the Knights Panther. Some of the panthers carried off by the victorious Old Worlders were eventually to become fur saddle cloths or trimming for fur cloaks, and this helped to reinforce the association. Today the original panthers and even their hides have long gone, but the memory of the Arabian wars is maintained by the Knights Panther.

Other Knightly Orders include the Knights of the Fiery Heart and the High Helms, and there are many more besides some of which boast only a handful of Knights. Not all wear a distinctive badge, some preferring to retain a slightly anonymous appearance, while others take considerable pride in their extravagant armour and

improbable plumes. As the number of Knights belonging to obscure orders is quite small they sometimes join up with other orders on the battlefield, fighting together in a colourfully varied group of Knights.

PISTOLIERS

The provinces and city states pay to maintain infantry regiments. They do not maintain cavalry as the Knightly Orders provide each province with its main cavalry force and make it unnecessary to recruit horsemen. The Knights are joined in battle by their sons including elder sons who are still too young to join the Reiksguard. The Knightly Orders themselves are only open to the title holder of the noble family, so their sons fight as Pistoliers. These horsemen are often as young as fourteen or fifteen and eager for their first taste of battle. Pistoliers wear lighter armour than their fathers and ride more lightly built, faster horses, and are armed with swords and pistols. They pick off enemy from a distance with pistols before charging into close combat, swords waving and guns firing. They have a deserved reputation as being wild, hot-blooded and reckless. When not at war they spend their time feuding and fighting duels against the unknighthed sons of neighbouring nobles.

Every Pistolier is equipped by his family and so his style of armour, the cut and colour of his clothing, and details of his weaponry vary from horseman to horseman. It is a common fashion for them to paint their armour black with contrasting silver bands, which makes Pistoliers look very distinctive. Sometimes they will wear plumes or sashes of their province colour so that they can be recognised on the battlefield.



MARTIN MCKENNA

THE STATE REGIMENTS

Every province and city state in the Empire maintains its own armed force of one or more regiments of full-time foot soldiers. These are known as state regiments. In addition the nobility and most of the land owning citizens can be called to arms in times of need. The regiments serve as the town guard, fire watch, and police force, and their duties include patrolling for insurgents, rooting out bandits, and maintaining the peace in their province. In times of war they are ready to march out to battle to defend their province against attack or to join the Imperial army under the command of their count. The part-timers or militia are only called up when they are needed. They include the Knights as well as hardy woodsmen and frontier farmers who are naturally good fighters.

Every state has its own uniform which features a colour or two contrasting colours. These colours may be combined in all kinds of different ways, often changing when troops are issued with fresh uniforms, but the same colours usually form the basis of the design. Occasionally a regiment may be issued with a differently coloured uniform either to distinguish it from other regiments belonging to that state, or because cloth of the usual colour is in short supply. By adopting these colour schemes troops from each state may be identified on the battlefield. The uniform colours of each of the regions of the Empire are shown on the chart below.

City State	Uniform Colours
Altdorf	Red and blue
Middenheim	Blue and white
Nuln	Black
Carroburg	Dark red
Talabheim	Red and white

Province	Uniform Colours
Averland	Yellow and black
Hochland	Green and red
Middenland	Blue
Nordland	Blue and yellow
Ostland	Black and white
Ostermark	Purple and yellow or Purple and white
Reikland	White
Stirland	Green and yellow
Talabecland	Red and yellow
Wissenland	Grey and white

Each province equips its soldiers from its own armouries. The type and condition of each regiment's weapons and armour therefore varies a great deal, with the wealthiest provinces providing the best equipped troops. State regiments are almost always provided with some sort of body armour. It is unusual for every trooper to be armoured in exactly the same way. In most regiments some



soldiers have breastplates, others mail armour, and a few leather tunics or even no armour at all. The favoured weapons are halberds with poorer provinces providing spearmen instead. In addition most provinces maintain small bodies of specialist troops such as hand gunners and swordsmen.

The Empire is not alone in using gunpowder weapons, but it is probably able to field more hand gunners and cannons than any other nation. This is partly due to the influence of Dwarf weaponsmiths, many of whom live in the cities of the Empire. Largely thanks to the skills and technology brought into the Empire by Dwarfs, great advances have been made in the armouries and workshops leading to the manufacture of reliable firearms and fine cannons. The communities of Dwarfs in the Empire are now so well established that they form a significant part of the citizen body, having adopted many of the social customs, styles of dress, and manners of the humans around them. Some of these Dwarfs even fight on behalf of their adopted nation.

On the battlefield the state regiments have evolved a very effective method of fighting. Each regiment can fight as a totally independent unit under its own commander just like any other unit in any army. Alternatively, some of the regiment's troops can be detached and armed in a different manner to the main body, forming smaller units which can fight in support of the larger ones. The main regiment forms up as normal and a detachment forms up near one or both flanks. Detachments often consist of hand gunners or swordsmen, and they help the main regiment by shooting at approaching enemy or by rushing out and chasing away

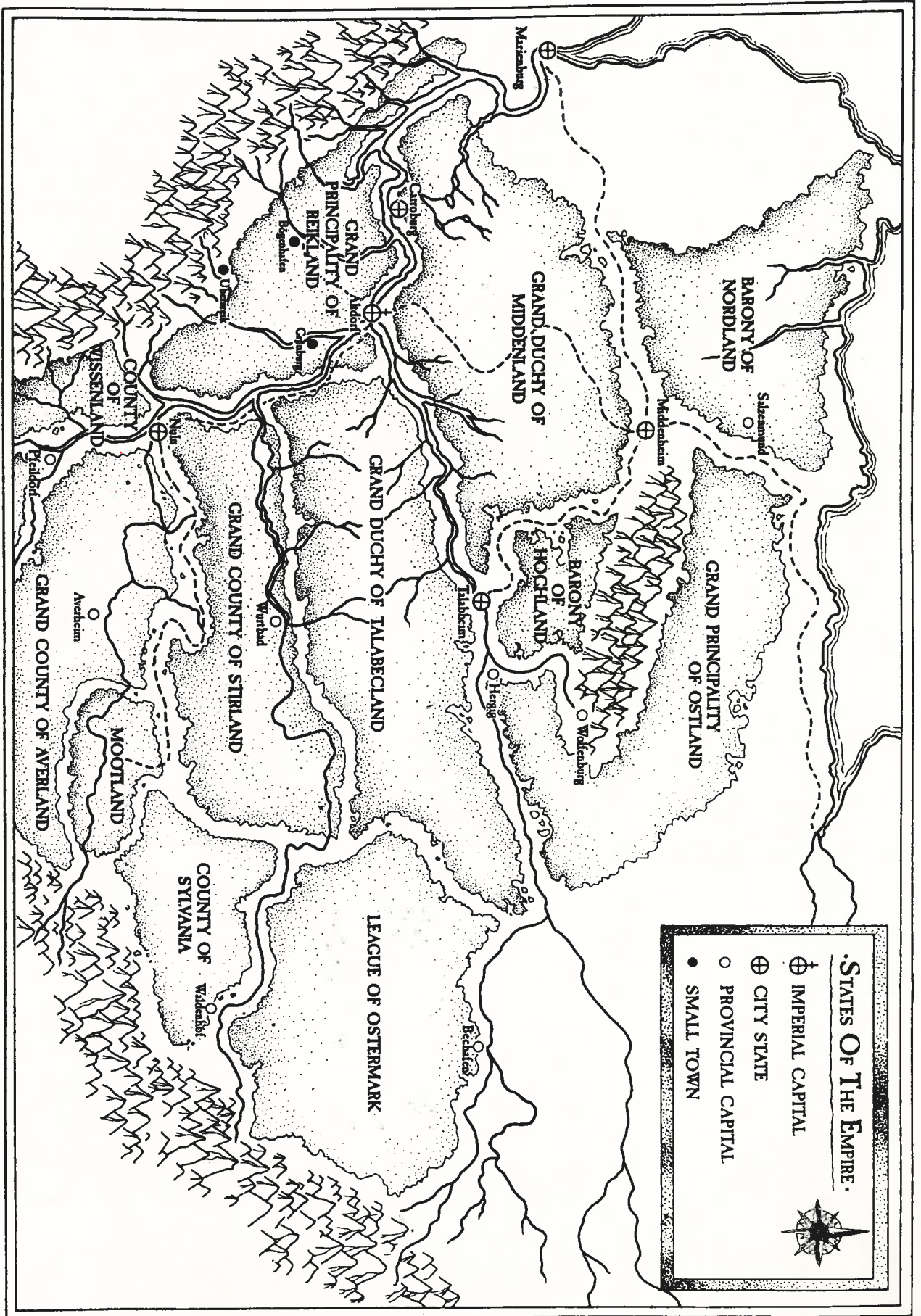

RUSSE NICHOLSON

WARRIORS OF THE EMPIRE

The Empire is a federation of states bound together by commercial interests, military treaties and a common way of life. Every city state and province in the Empire maintains its own army which it clothes in its own distinctive colours. Each state's colours serve to distinguish its troops from those of other states, enabling each contingent to be readily identified on the battlefield. A typical Empire army will usually contain infantry regiments from several states, as well as Knightly Orders and other troops. The illustrations shown here are typical examples of various troop types wearing the uniforms of different states. Obviously this does not mean that all Hochlanders are equipped exactly as shown below, or that all Stirlanders are archers as seen in our illustration.

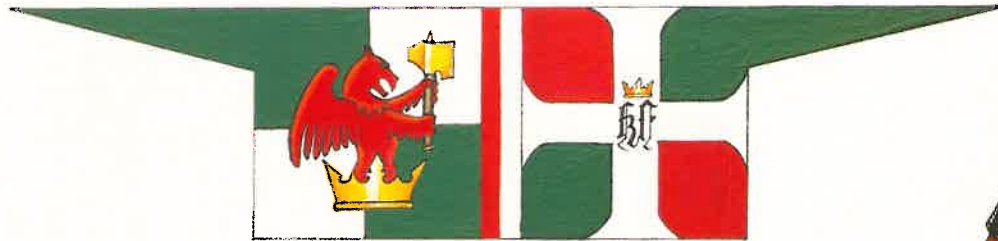

Hochland Halberdier. This trooper wears the green and red colours of Hochland. He is equipped in the most expensive manner with plate armour and plumed helmet. Halberdiers are usually deployed in small units called detachments. These guard the flanks of infantry regiments against attack, relying on their superior armour to protect them from harm. The Hochland flag also displays the state colours. Like all state regiments it bears the Imperial Griffon holding the Hammer of Sigmar on one side, whilst the other side has the state emblem. The Emperor's monogram in the centre of the Hochland cross is a special honour awarded to the Hochlanders after saving the Emperor's life in battle.

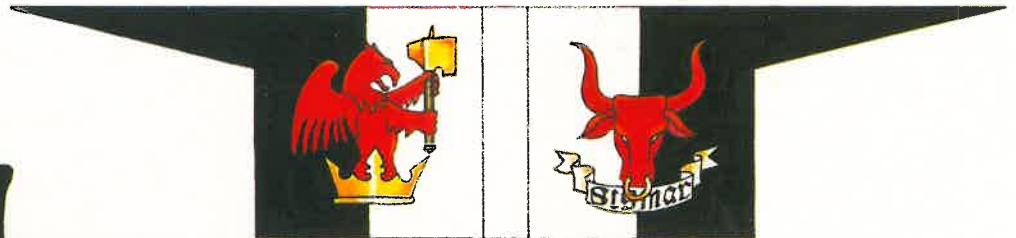

Ostland Spearman. In keeping with many Empire warriors this spearman is equipped in more modest style than the Hochlander shown above. The uniform colours of Ostland are black and white while the provincial emblem of the bull's head appears on the flag and, in this particular instance, on the spearman's shield too. This warrior's clothing demonstrates the popular quartered costume design. This design is common amongst imperial regiments but is not universal; the colours can also appear as stripes, cheques, or bands, for example.

Talabheim Swordsman. Swordsmen are organised into small detachments and deployed on the flanks of larger regiments. Their role is to harass the enemy and to protect the regiment's flanks from attack. Talabheim's city colours are red and white and its flag is shown below.

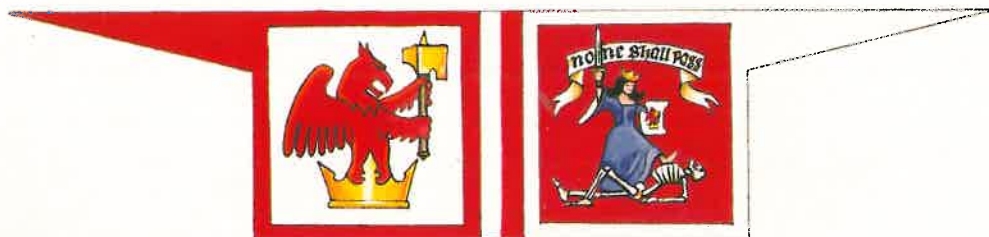

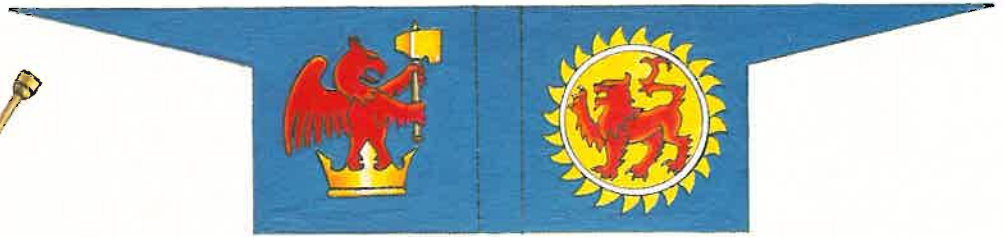

Nuln Gunner. This artilleryman is carrying a ram rod which he uses to clean out spent wadding from the barrel and to ram home a fresh charge. Gunners often wear leather jerkins like the one shown to protect their clothes from dirt and powder. The uniform colour of Nuln is a sombre black.

Stirland Bowman. This archer wears a simple style of uniform based on the day to day working clothes of rural folk. The Stirland colours of green and yellow are used in simple blocks – this is quite a common style amongst archer regiments from the provinces. These uniforms are usually made locally, so the hand-dyed colours and individual cut of the cloth vary quite a bit from region to region.



Middenheim Halberdier. This warrior wears the blue and white colours of Middenheim. When not on campaign he forms part of the city guard, patrolling the streets and guarding the gates of this important city. The city flag shows the wolf's head – emblem of the cult of Ulric and the city of Middenheim itself.

Aldorf Bowman. Archer regiments from city states are sometimes equipped more lavishly than those from the provinces as shown by this bowman. He wears the Aldorf colours of blue and red, a mail coat, breastplate, and helmet. When not on the battlefield warriors equipped in this fashion guard the city walls to deter intruders from approaching too close.

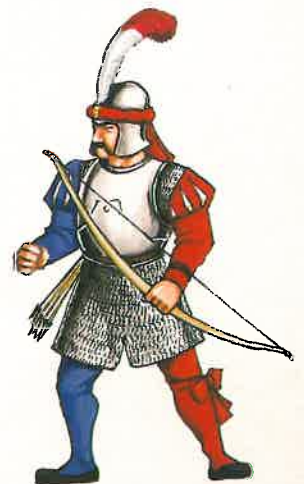
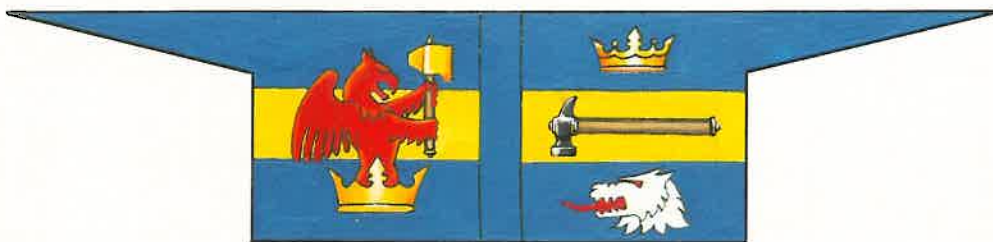

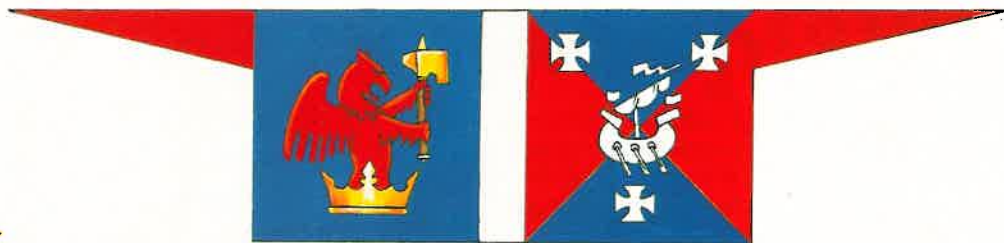

Tileans are common soldiers in the armies of the Empire. They are expert crossbowmen and their services are always in demand. This Tilean carries the crossbow which is his hallmark, and wears the blue and yellow uniform of Nordland. The accompanying flag shows the Nordland emblem.

Middenland Halberdier. This halberdier wears heavy armour of both mail and plate. The uniform colour of Middenland is blue and the provincial flag shows the White Wolf of Ulric which is associated with this part of the Empire.

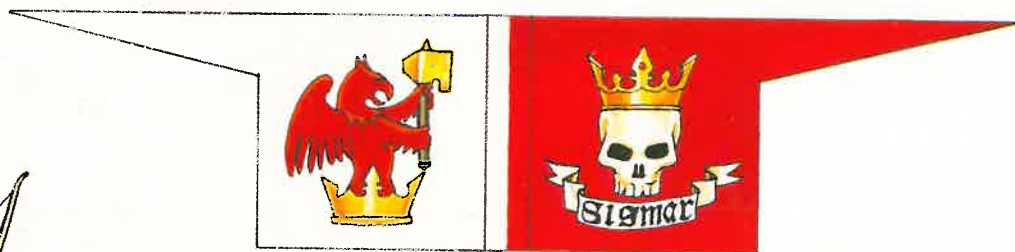

Reikland Bowman. The uniform colour of the Reikland is white or, after a few months campaigning, light grey. The Reikland is a prosperous, settled region, and the armour worn by this particular warrior would be quite common among bowmen from this area. The Reikland flag bears the legend of Sigmar – the cult of Sigmar is particularly strong in the south of the Empire.

Tilean in Averland service. This Tilean crossbowman wears the yellow and black uniform of Averland. Tileans are found in the forces of many of the city states and provinces. They are expert crossbowmen and doughty warriors. The accompanying flag shows the sun symbol of Averland.

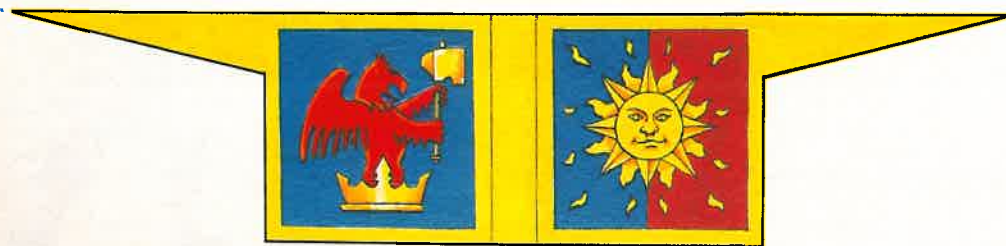



Talabecland Handgunner. The hand gun is much more common in Empire armies than in any other. This warrior carries his powder and lead shot in a leather bag slung round his waist. The uniform colours of Talabecland are red and yellow and the provincial flag is shown above.

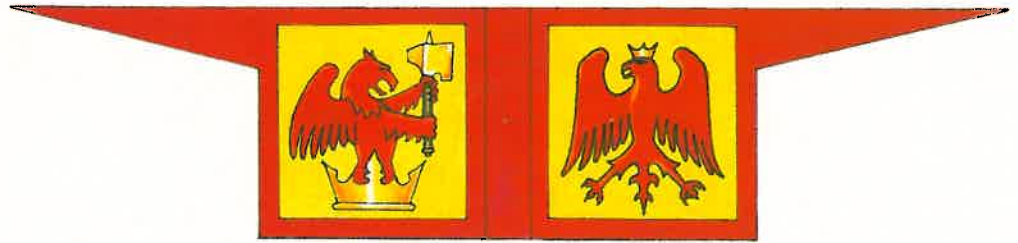

Tilean. Some Tilean bands continue to wear their own clothes and carry their own banners whilst in the service of the Empire states. This Tilean is wearing such a costume and the accompanying banner is typical of a Tilean band. Tilean flags are often striped as shown, although the stripe colours and devices vary from band to band and are made up according to the whim of its leader.

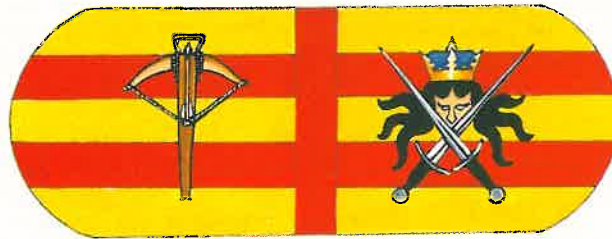

Reiksguard flag. The Reiksguard carry their own banner which is shaped differently to that of the state regiments. This bears the national emblem on one side and the Emperor's device and the Sigmar legend on the other. The device of Emperor Karl Franz is shown here, but when a new Emperor is elected the banners are altered accordingly.



Emperor's Banner. This is the personal banner of Emperor Karl Franz. This banner is carried into battle by the Emperor's personal banner bearer to demonstrate his presence on the battlefield.

Regimental Banners. The state flags shown on this and the previous page all shown the state devices. Each regiment from that state carries one of these banners, although often with slight differences in interpretation. Individual regiments are sometimes distinguished by the colour of the flag's tail piece, or alternatively by the addition of a small distinguishing symbol such as a star, crescent, crown, etc.

small units of enemy troops. This is especially useful if the regiment is being harassed by enemy skirmishers, as a detachment of swordsmen can rush out and chase the skirmishers away leaving the main body free to advance at a steadier pace. Detachments also form useful reserves, and once their parent regiment is committed they can pile into the enemy's flanks or move off to another part of the battlefield to lend a hand elsewhere. This method of fighting is so effective that most states raise bodies of troops which can be used in this way, and a state will usually send a regiment supported by one or two detachments to serve in the Imperial Army.

TILEANS

Tileans are renowned as mercenary soldiers throughout the Old World. Bands of professional fighters are always available for hire and many of the states of the Empire are more than happy to employ them. After all, hiring Tileans saves the count paying to recruit and train his own forces, and is much more convenient than maintaining a large body of home-produced troops. Mercenaries can also be dismissed once their job is done, without the danger of creating a mob of unemployed fighting men likely to turn to banditry. Tilean bands are usually provided with state uniforms so that their allegiance can be readily identified, although some bands prefer to wear their own distinctive uniforms or personal individual clothing.

The weapon closely associated with Tileans is the crossbow. The crossbow is not used as a weapon of war in the Empire, so all crossbow-armed troops are Tileans in



ANGUS NICHOLSON

the employ of one of the provinces. When the provincial army joins with others to form an Empire army these Tileans go with them, providing the Empire army with its excellent crossbowmen.

DWARFS

Dwarfs who live in the Empire are not recruited into the standing regiments but every city, village, or other community of Dwarfs is ready to send warriors when needed. These blacksmiths, wheelwrights, jewellers, and other skilled crafts-dwarfs can be called upon to provide troops for the province's defence or to fight in the Empire army. They sometimes wear state uniforms, but not all provinces are prepared to go to this expense, so many Dwarf regiments wear their own clothes or uniforms which they have devised themselves. Dwarf uniforms are inspired by the clothing styles of the Empire and are therefore bright and colourful in a manner not normally associated with the Dwarfs who live in the mountains at the World's Edge.

HALFLINGS

Halflings have lived in the rural areas of the Empire for as long as anyone can remember, but it was fifteen hundred years ago when they were granted their own province by Emperor Ludwig the Fat. This province is known as the Mootland and like all of the Empire's provinces it provides troops for the Empire's army. Halflings are not especially warlike by nature, and their state regiments are little more than a collection of country watchmen and game wardens. Even so they are willing fighters and very able bowmen. Their natural ability to infiltrate woods and move quickly through dense undergrowth means that they can accomplish tasks which would be impossible to humans.

Halflings don't always wear uniforms at all, but occasionally a community will get together and buy a particularly gaudy bolt of cloth to make into bright new uniforms. As these costumes are assembled by the Halfling's wives and sisters they usually vary, with differently coloured trims and flamboyant cuts all designed by the ambitious seamstress to show off her skills and put her neighbour's talent in the shade.

ARTILLERY

Cannons and mortars are difficult and expensive to produce and so it is the Emperor's job to make sure the Empire has enough artillery. Individual provinces can produce cannons if they like, but none are capable of making any but the smallest calibre weapons. Cannons are therefore made by the Imperial Ordnance and presented to counts throughout the Empire. These cannons are intended to be used to defend cities and towns against attack. Of course, counts sometimes end up using these weapons against each other, but technically at least they remain the property of the Emperor and can be moved or replaced at any time. When a count is called upon to bring his troops to war he also brings along any artillery that has been loaned to him.

The Empire is especially well equipped with cannons including impressive multiple barrelled weapons called organ guns or volley guns. The Empire's skills are derived

from Dwarfs fleeing from their mountain homes and settling in the cities of the Empire. Many of the Dwarfs bring unique talents, including the manufacture of gunpowder weapons and even steam powered machines (although the Dwarf Engineers Guild regards these inventions as an affront to their ancient traditions). Thanks to the Empire's massive centralised wealth and the Dwarfs' special skills the Empire has become the home to new technical innovation and experiment, which in turn has attracted Dwarf and human inventors from all over the Old World.

KISLEV ALLIED TROOPS

The realm of Kislev lies to the east of the Empire. For centuries it has been a buttress against the onslaught of Chaos from the wastes to the north. Thanks to help from the Empire, Kislev has never fallen, although many of her cities have suffered devastation at the hands of the Chaos Hordes. To this day Kislev remains a strong friend and ally of the Emperor and is always willing to send forces to help fight his wars.

Kislev is a land of dark pine forests, snow clad wilderness and wind swept steppe. The inhabitants huddle around huge log fires in timber halls protected by massive timber stockades. The present ruler of this cold and extensive realm is the sorceress Tzarina Katarina the Great, daughter of the notorious Tzar Boris Goblin Basher whose many battles in the east have expanded the Kislev empire beyond the Worlds Edge Mountains themselves.

The Tzarina is feared by all her enemies and known amongst the nomad tribes of the east as the 'Ice Queen'. Her strong will and determination to make Kislev ever more powerful are well known, although to date her ambitions have been confined to the eastlands. She will send forces to help the Emperor on his campaigns, and on occasions she has led armies herself, bringing the wild horsemen of Kislev through Imperial territory much to the consternation of local people. Infantry do not appear in these armies, although when fighting in the east the Tzarina makes use of what troops are available which may include foot troops as well as horsemen.

The Kislev forces consist of two main types of horsemen. The core of the army are its Winged Lancers: nobles who wear exotically decorated armour and carry tall lances. They have distinctive back banners adorned with feathers to give them a more terrifying appearance, which gives them their name. When they charge into battle these wings make a loud and terrifying shrieking noise as the feathers catch in the wind like the reed of a pipe.

The second type of horsemen are wild horse archers recruited from the nomadic tribes of the Kislev steppe. These expert riders are almost literally born in the saddle, and their skill with bow and sabre is legendary amongst the Old Worlders. Popular myth has it that these horsemen drink blood, eat raw flesh, and make the skulls of their fallen enemies into drinking cups - and these tales are certainly true in part. Many of these tribes tattoo their bodies or cut their hair and beards into wild shapes. This makes them look extremely frightening so that many a battle may be said to be won by reputation alone!



THE GRAND THEOGONIST

Sigmar is the legendary founder of the Empire and the patron deity of the whole nation, although many other gods are worshipped too, especially Ulric and Taal. The leader of the Sigmar cult is the Grand Theogonist: a very important individual who is regarded as the spiritual protector of the Empire and the most powerful person after the Emperor himself. The Grand Theogonist often accompanies the Emperor to war, riding on an elaborately carved ancient wagon which carries the Shrine of Sigmar and the banner from the Temple of Sigmar at Altdorf itself. This banner has never yet fallen in battle and is one of the most holy relics in the entire Empire.

As well as being the high priest of the Sigmar cult, the Grand Theogonist is also its warrior Champion! He fights from the mobile Shrine of Sigmar and carries potent magical weapons which have been contributed to the cult over the centuries. These include the fabled Silver Shield of Sigmar which wards off missiles and magic, and the Horn of Sigismund, made for the warrior-emperor Sigismund by the Dwarfs and capable of striking terror into the hearts of all who hear it.

WAR WAGONS

The Empire is home to some of the most innovative and technically able minds in the Old World. To further research and development into new weapons a college has been established in Altdorf known as the Imperial School of Engineers, in imitation of the Dwarf Engineers Guild. Many of the Imperial Engineers are Dwarfs, often imaginative Master Guildsmen whose ideas are ignored or even outlawed by the very traditionally minded Dwarf Engineers Guild. The most well known of these is the Dwarf Master Engineer Sven Hesselriesan. Sven was expelled from the Guild for his experiments with vapour

powered devices and what was regarded as an unhealthy fixation with ships. He fled to the Empire where he subsequently invented a steam powered boat before taking it and a company of adventurers into the largely unexplored western continent in search of fame and fortune.

War wagons have been developed by the Imperial Engineers to provide a mobile fire platform for hand gunners. The war wagon consists of an upright tower pulled by a fully armoured horse and crewed by a team of hand-gunners. Thanks to the war wagon's height the gunners can fire over the heads of troops below, and if it is surrounded by enemy the crew can defend themselves from behind its wooden ramparts. Other versions of the war wagon carry just one large cannon. These mobile artillery pieces are moved up into position and fired right into enemy regiments with devastating effect.

War wagons can also be formed into a defensive position called a laager - this is a circle or rough square of wagons with cannons positioned between them. This is a static defence, a wooden castle forming a solid and impenetrable barrier to enemy attack. When fighting against more mobile opponents it has been known for Imperial armies to form a gigantic laager of war wagons and cannon, with infantry regiments inside firing through gaps, and cavalry regiments inside ready to dash out and chase off any vulnerable enemy.

The Emperor has quite a few war wagons ready for battle. They are housed in the royal barracks along with the Reiksguard, and their crews are specially trained members of the Imperial Engineers. The Engineers favour a blue or blue and red costume, but individuals often dress to their own taste and no attempt is made to impose a uniform on them.

STEAM TANK

The steam tank is the invention of an extraordinary Tilean called Leonardo of Miragliano, the founder and Chief Engineer of the Imperial Engineering School until his untimely death observing the inaugural test flight of a heavier than air flying machine. The machine crashed right on top of Leonardo whereupon its alcohol powered engine exploded demolishing part of the Engineering School itself. Sadly the secret of the steam tank died with its inventor although several less than successful attempts have been made to copy the designs. Of the original twelve machines constructed by Leonardo, two exploded while being tested, one was destroyed fighting the Chaos Hordes in the northern wastes, and a fourth sank without trace while attempting to traverse a marsh during the battle of La Tour in Bretonnia. The remaining eight machines are polished and maintained by the Engineers School and occasionally receive a fresh coat of paint or new decorative iron work. However, they are not terribly reliable and it is a rare day when all eight can be persuaded to run.

As their name suggests, steam tanks are powered by a steam engine which is fed by a boiler. Young engineers are reluctant to volunteer their services as crew as the boilers are renowned for bursting apart, turning the tank into a giant pressure cooker. Steam tanks are armed with a substantial cannon. When the steam tank is fired the thunderous noise rebounds about inside it, making the

whole machine vibrate furiously and churning the stomachs and brains of the crewmen. The whole vehicle is enclosed by a mixture of steel plates and roof tiles, making it almost immune to missile fire from bows and crossbows. Even a direct hit from a cannon or stone thrower won't always destroy the steam tank, although this is the easiest way of knocking one out. The Engineers School have so far managed to recover and rebuild machines which have been destroyed in battle.

WIZARDS

The Empire is home to some of the oldest and most respected Colleges of Magic in the Old World. These institutions teach the theory and practice of magic, as first taught to humans by the great battle wizards of the High Elves during the wars against Chaos. Before this time human wizards were little more than rustic wanderers, often shunned by village people and sometimes persecuted by over-zealous authorities who were ever ready to equate magic with chaos. However, with the establishment of the Colleges of Magic all this changed, so that the profession of wizard is now quite respected. Tall towers rise high into the air where the magic tides can be tapped by the wizards, and at night the skies of many Imperial cities flash and hum with the working of spells.



The Emperor allows the Colleges to operate for a very good reason - he values their battle wizards! In return for his tolerance and patronage the Emperor receives a steady supply of wizards for his armies. Every College can provide wizards to take part in a battle, and sometimes whole units of wizards go to war, using their combined enchanting power to cast powerful battlefield spells to rend apart the foe and win the day for the Emperor.

THE BAGGAGE TRAIN

The Imperial army trails behind it a baggage train of wagons laden with food, ammunition, gunpowder, gold to pay the soldiers and of course countless civilian traders eager to sell their goods and services to the soldiers. When the army forms up for battle the baggage is left well to the rear as it very demoralising for Imperial troops to see enemy troops looting the provisions and pay chest. Powder wagons and carts carrying cannon balls are drawn up with the cannons so they can be supplied with ammunition.

GAMES WORKSHOP®

CHESTER

OPEN NOW

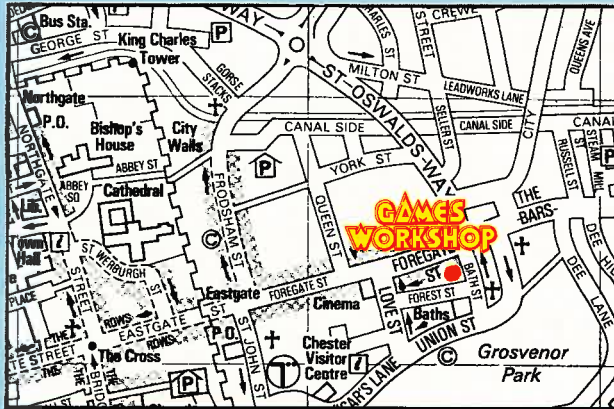

**112 FORGATE STREET
CHESTER CH1 1HB**

Tel: 0244 - 311967

OPENING TIMES
10.00 - 6.00 Mon to Fri
9.30 - 5.30 Saturday

CLUB NIGHT:
Thurs until 8.00pm

CONTACT: Jim

GAMES WORKSHOP®

TRAINEE RETAIL MANAGERS

Games Workshop are always on the lookout for enthusiastic Warhammer Fantasy Battle, Warhammer 40,000 and Space Marine gamers to be the future managers of their expanding chain of stores.

We currently have vacancies for sales assistants at the following stores:

Coventry

Oxford

Reading

Southampton

If you have an outgoing personality and would like an exciting career where you can use your knowledge and enthusiasm for



Games Workshop and Citadel Miniatures to the full, pop in and talk to the manager at any one of these stores or give the the chaps at our Retail office a call on: 0773 769731

MM15 / MM16 DWARFS

MM15/7 CLANSMEN



MM15/28



MM15/25



MM15/31



MM15/26

MM15/8 CLANSMEN



MM15/29



MM15/30



MM15/32



MM15/27

MM16/4 LONGBEARDS



MM16/16



MM16/15



MM16/18



MM16/17

MM16/5 HAMMERERS



MM16/23



MM16/25



MM16/24



MM16/26

MM16/3 IRON BREAKERS



MM16/22



MM16/21



MM16/20



MM16/19



DWARF SHIELDS 1



DWARF SHIELDS 2



All Miniatures are supplied with appropriate shields. Additional Dwarf shields may be purchased in groups of four as shown above at the cost of 15p per group.

MM15 / MM16 DWARFS
£1.00 each or £3.99 for 4

HOW TO PURCHASE YOUR MARAUDER MINIATURES

Marauder Miniatures are available from all Games Workshop stores, where you can choose your models from the wide selection in stock. Miniatures are also available from the Marauder Mail Order Service.

METHODS OF PAYMENT

You can mail order by credit card (Access or Visa), international money order or cheque drawn on a British bank. For foreign orders, please send all payments in pounds sterling. Cheques should be payable to Marauder Miniatures Limited. UK customers please do not send cash.



POSTAGE AND PACKING

The minimum mail order is for £5 with a standard charge of £1 for postage and packaging. Mail orders in the UK over £20 are post and packing free.

You should normally receive your order within 10 days but please allow up to 28 days for delivery.

TELEPHONE ORDERS

You can telephone an Access or Visa order on 0602 790200 between 9am and 5pm weekdays. Please have the cardholder present to authorise the transaction.

If you have any problems please contact us on the above number.

OVERSEAS ORDERS

The minimum mail order is £10. Please include 40% for post and packaging. We will send your order by the fastest route that the post paid allows. Please do not send currency as payment.

POST YOUR MAIL ORDERS TO

Marauder Miniatures
 The Foundry
 Mount Street, New Basford,
 Nottingham NG7 7HX

Marauder Miniatures are supplied unpainted. Banners not included.

© Copyright Marauder Miniatures Ltd, 1992. All right reserved.

Warning! These miniatures contain lead which may be harmful if chewed or swallowed. Marauder Miniatures are not recommended for children under 12 years of age.

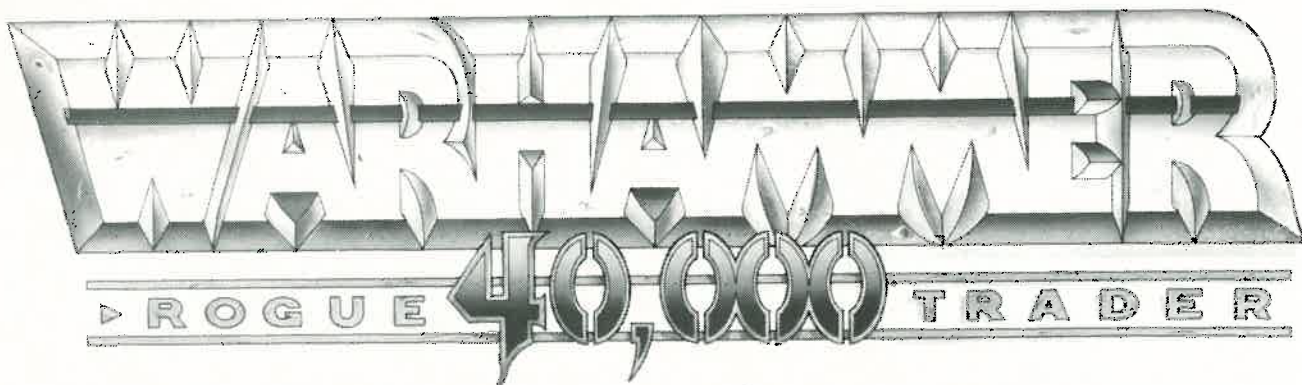

DREADNOUGHTS!

By Andy Chambers and Rick Priestley

Over the next few months we plan to preview some sections of our forthcoming **Warhammer 40,000 Vehicle Guide**, a companion volume to the **Warhammer 40,000 Weapons Guide** which will cover all the rules and data for vehicles of the 41st millennium. In this issue we will be taking a special look at **Dreadnoughts**: heavily armoured fighting machines which contain the living consciousness of a sentient mind. Dreadnoughts are a common sight on battlefields across the galaxy, being ideally suited to close support and spearheading attacks in dense terrain where their thick armour and heavy weapons are a real advantage. Employed by every race in the Warhammer 40,000 universe, Dreadnoughts form a very distinct class of war machine and as such they have their own special rules.

In White Dwarf 128 we published a completely new set of vehicle rules for Warhammer 40,000. These introduced a unique damage system which uses a cut-away style diagram of the vehicle and a clear acetate targeting grid. The Dreadnought rules also make use of the same targeting and damage system, so you will need a targeting grid to use them. Spare grids can be bought from Games Workshop stores or from Games Workshop Mail Order, see the Mail Order page for more details. If you are unable to get hold of one, we have printed a copy of the targeting grid in this article. Trace it onto tracing paper or clear plastic using fibre-tipped pens (overhead projector pens are ideal).

Dreadnoughts are huge fighting machines, most standing two or three times the height of a man. Although they could be mistaken for robots or very large fighting suits at first, they are in fact a unique symbiosis of man and machine. A Dreadnought contains a single creature whose body lies curled within its carapace and whose nervous system is directly connected to the pumps and hydraulics which form the armour's 'muscles', making it move and perform actions with the ease of a living creature. Once a living creature is interred inside Dreadnought armour it can never leave, and is destined for a life of endless battle until its walking tomb is destroyed. Dreadnoughts are complex machines, requiring special materials and skills to construct. Needless to say, the designs used by different races vary wildly in complexity and efficiency.

The Space Marine Dreadnought is possibly the most ancient design, with some machines dating back many thousands of years to the Age of Strife. These machines are revered in themselves as the art of their construction is almost lost. The Dreadnought's operator is not an ordinary Space Marine, but one of the Old Ones – a heroic Space Marine mortally wounded in battle long ago and given the singular honour of continuing to serve the Emperor as a deathless, living Dreadnought. The Old One's body lies curled in a foetal position inside the Dreadnought, with his nervous system linked directly to the machine's systems. In this way the Old One is reborn into a body of metal which becomes his sarcophagus.

Some of the Old Ones' memories may extend back tens of centuries to the founding of the Chapter and its earliest history. They are revered by the other Space Marines as potent warriors and also as ageless forebears: living embodiments of battles fought long ago. The Dreadnoughts that still survive are carefully maintained and repaired when necessary. If a Space Marine Dreadnought is destroyed in action the Space Marines will fight with righteous anger to retrieve the shell so that they may lay its occupant to rest in the Chapter's mausoleum. The Dreadnought armour itself will be repaired and prepared for another Space Marine who will become an Old One to future generations.

Chaos Dreadnoughts derive from the ancient times before the Horus Heresy when several Space Marine Chapters

betrayed the Emperor and followed the Warmaster Horus into civil war. When Horus was defeated by the Emperor the remaining Chaos Space Marine Chapters fled into the Eye of Terror where they still lurk and mount raids on the Imperium. Chaos Dreadnoughts were once much like Space Marine Dreadnoughts but over the years they have been rebuilt many times, often to mimic the shapes of daemonic beasts. Even their occupants have mutated under the warping power Chaos, fusing with their machines until their flesh pushes out through the armour and forms ridges of bone and cartilage.

Chaos Dreadnoughts now contain the barely alive remnants of great Champions of Chaos interred by their followers after they were mortally wounded. With sophisticated technologies and arcane science the Dreadnought armour prolongs the life of a Champion of Chaos so that he may continue to serve the dark gods.

Ork Dreadnoughts were conceived when the Orks first saw the heavy, armoured shapes of Space Marine Dreadnoughts striding across the battlefield with guns blazing. Ork Mekboyz were inspired by the sight and quickly set about building their own Dreadnoughts. Though the resulting metal monsters vaguely resemble Imperial Dreadnoughts their internal mechanics are typically crude and Orky.

The Ork Dreadnought is unique in that its occupant is not almost dead before he is placed inside it. A Gretchin volunteer is implanted into the Dreadnought by the combined efforts of a Painboy, a Mekboy, a hammer and some big nails. Gretchin are notoriously resilient, and the little creature usually survives the operation to wake up and find it's now got a big, strong metal body that's even more Orky than Orks!

After years of beatings and abuse from real Orks the Gretchin is understandably overjoyed at his new situation - and sometimes a little excessively ebullient, not to say destructive. But once the Mekboy and the Painboy have calmed him down the new Dreadnought becomes a fine addition to a Warband's fighting strength. Unsurprisingly, Ork Dreadnoughts always tend to be rather excitable and power crazed (sometimes they even try to boss Orks around!) and there are always plenty of Gretchin volunteers ready to be put into them.

Eldar Dreadnoughts may predate even Space Marine Dreadnoughts and are by far the most sophisticated of all kinds of Dreadnought armour. When an Eldar dies his consciousness passes into the warp where the Chaos power Slaanesh, Bane of the Eldar, waits to consume it. To avoid this fate every Eldar wears a small psychically attuned gem called a Waystone. In the event of their death the Waystone absorbs the wearer's consciousness, thereby cheating Slaanesh of his quarry - a fate literally worse than death. Waystones are gathered and implanted into the Wraithbone core of an Eldar Craftworld, releasing the Eldar spirit into the very fabric of the Craftworld. Waystones can also be implanted into machines which have a Wraithbone core, enabling the Eldar spirit to control the machine. In this way the spirits of powerful Eldar warriors are reincarnated into new robotic forms known as *Wraithguard*. One form of Wraithguard is the Eldar Dreadnought.

Eldar Dreadnoughts are by far the most elegant and agile

of all types of Dreadnought. However the consciousness of the dead Eldar is in a dream-like state and no longer perceives the material universe like a living creature, rather the spirit 'sees' the psychic flux created by the thoughts and emotions of the living. Because of this the Eldar Dreadnought responds to the emotions of living Eldar, anchoring onto their perception of the material universe to make its decisions.

The Tyranid Screamer Killer isn't technically a real Dreadnought. Rather than being a metal fighting machine containing an organic component, the Screamer Killer is an organic fighting machine with its own intelligence. The Screamer Killer is one of the largest Tyranid bio-constructed creatures, genetically engineered for combat. Compared to other creatures of its type it is fairly intelligent, and can operate a fair distance from the hive mind. Its extraordinary size, strength and toughness make the Screamer Killer more comparable to a Dreadnought than a normal creature and so we have included it in these rules.

As its great size and massive arm-claws indicate, the Screamer Killer is a deadly opponent in close combat, and it also has an extremely effective ranged attack. Rasping plates in the mouth combined with a high frequency 'scream' produced by the creature's vocal cords can fire a blast of lethal bio-electrical plasma energy. Most Screamer Killers seem to have four massive arm-claws which they use to rip apart their foes in combat and direct their deadly plasma blasts, but some have been seen with different arm combinations carrying stranger and deadlier weapons.



DREADNOUGHT DATAFAX

Dreadnoughts have a datafax record similar to the vehicle datafax. Because they have no additional crew and cannot transport troops, the record does not include these categories. However, there is an additional entry for the Dreadnought's weapon skill, initiative and close combat weapons, as Dreadnoughts have manipulative arms which can carry weapons and which enable the machine to fight in hand-to-hand combat.

MOVING DREADNOUGHTS

Dreadnoughts have legs as their motive power so they move and turn using much the same movement rules as ordinary infantry. They have a basic movement rate and can make a double-distance move if they don't fire any weapons or when they charge into close combat.

Dreadnoughts must move in a straight line in the direction they are facing but they can change their facing by up to 90 degrees at the start and the end of their movement for free. If they need to change direction *during* their movement (to manoeuvre around an obstacle for instance) each facing change of up to 90 degrees costs 1" of the Dreadnought's movement.

Dreadnoughts have been specially designed to be good at moving over difficult ground, and can move over any type of terrain except woods or deep water unhindered. They can move through woods or walk underwater along a river or sea bed at half rate. Walls over the height of the Dreadnought model's knee will stop it moving over them, but Dreadnoughts are big enough to just push their way through hedges or other light vegetation. Dreadnoughts can enter buildings if they can find a hole big enough to get in through and the model will physically fit inside.

OUT OF CONTROL

Heavy damage can destroy a Dreadnought's control systems and cause it to stagger around out of control, this is indicated on the damage charts. A Dreadnought which goes out of control is turned to face in a random direction and moved D6" in its movement phase.

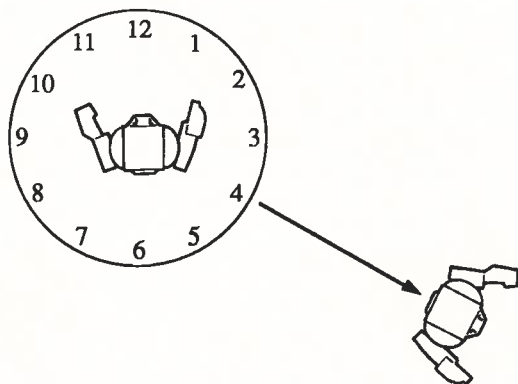

The Dreadnought is out of control. The player rolls a D12 and gets a 4. He then rolls a D6 and gets a 5. The Dreadnought is therefore moved 5" in a direction equivalent to 4 o'clock on an imaginary clockface.

CRASHES AND COLLISIONS

Dreadnoughts are designed to move more or less like living creatures. They can avoid collisions by stepping aside and can move up to and then fight enemy models in hand-to-hand combat. For these reasons Dreadnoughts are not normally affected by the collision and crash rules for vehicles given in White Dwarf 128. However, if a Dreadnought is out of control and attempts to move through another Dreadnought, vehicle, building or terrain that it cannot cross, then it is treated exactly like a vehicle and normal crash rules apply.



Collisions against vehicles, Dreadnoughts and buildings are worked out using the chart below. Cross reference the speed of the fastest vehicle or Dreadnought involved to determine the penetration value of the collision.

Speed	0-5	6-10	11-15	16-20
Penetration	D6	2D6	3D6	4D6

All vehicles, Dreadnoughts, and buildings involved in the crash are affected by the collision. Refer to the targeting diagrams for the vehicles and Dreadnoughts. Any vehicle or Dreadnought target location with equal to or less armour than the dice score is penetrated and damage is worked out as normal. Thus in a collision with a penetration value of 18 any target areas with a value of 18 or less are penetrated.

In the case of buildings, damage is worked out if the penetration equals or exceeds the building's damage value. Against uncrossable terrain, including walls, trees, and other terrain which the Dreadnought is unable to move through, work out damage in the same way. As no other vehicles are involved the speed will be the Dreadnought's own speed and only the Dreadnought will sustain damage. If it's important make a random dice roll to see if the obstacle survives.

A Dreadnought must attack foot troopers in hand-to-hand combat in order to cause damage. Its ponderous movements present no accidental threat to troops, so the machine may not harm infantry by running them down as vehicles can. Models on foot which are run over by a staggering or out of control Dreadnought must make a successful armour saving throw or they sustain D6 wounds.

Victims may attempt to dive out of the way of an out of control Dreadnought by rolling equal to or less than their initiative characteristic value on a D6. A roll of 6 always fails regardless of the model's initiative. Models diving out of the way are positioned to either side of the Dreadnought and are not harmed.

HITS AND MISSES

If the shot hits the Dreadnought then it has struck the area indicated. If the shot misses the Dreadnought outline entirely then the shot has missed. In the unlikely event of a shot landing exactly on a dividing line then randomly determine which of the two potential areas is hit. However, the final position of the shot can sometimes be modified by Target Shift as explained later.

SIDE AND REAR SHOTS

If the firer is shooting at the Dreadnought's side or rear his choice of target areas is obviously limited to what he can see. This is indicated on the targeting diagrams by the division of the front view into left and right zones.

If the firer is shooting from the left or right of the Dreadnought the cross-hairs of the grid must be centred inside the appropriate zone. Shooters firing at the rear of the Dreadnought can aim anywhere on the targeting matrix and the armour ratings of the locations on the Dreadnought are lower to represent the thinner armour protecting the Dreadnought's 'back'.

Note that although a shot may be fired from the left or right, the area actually hit may lie outside the appropriate zone. This represents the chance of a shot penetrating and going through into a section further back, or which causes internal damage affecting a more distant section. For example, a shot fired from the left of a Dreadnought may shatter a chunk of armour and send shrapnel spinning into the right arm.

The diagram below shows the positions from which a shooter is considered to be in relation to the Dreadnought. The frontal zone is a 90 degree arc extending forwards from the middle of the Dreadnought. If the shooter is within this arc the shot must be aimed at the front. Exactly the same is true of the rear except that the 90 degree arc extends backwards. Shooters firing at the side of the Dreadnought are restricted to aiming at the appropriate half of the targeting matrix.

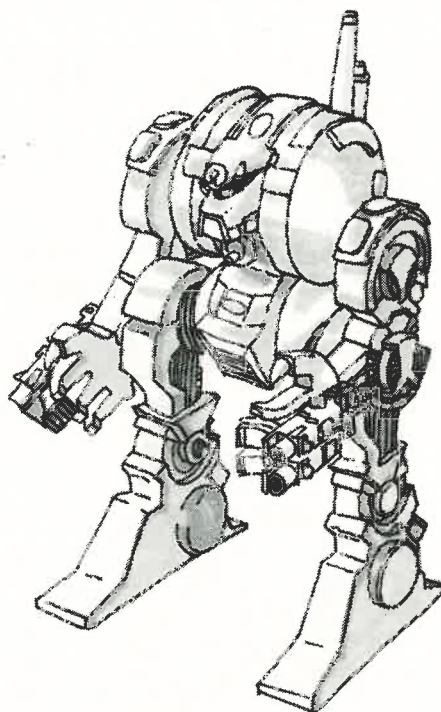
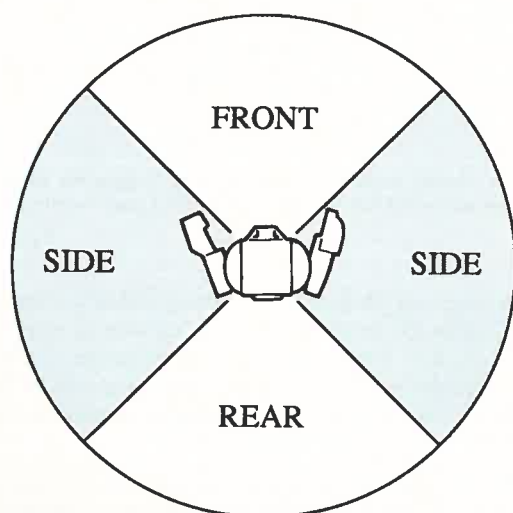

REDAW/VALLEN

TARGET SHIFT

The chance of scoring a direct hit will naturally vary slightly due to the circumstance, individual skill and the weapon used. Increased accuracy is represented by changing the position of the hit on the targeting grid - moving it vertically or horizontally by one or more grid positions. This is called the *Target Shift*. A player can always apply some, all or none of his potential Target Shift to adjust his hit location roll.

Target Shift is worked out as follows. The shooter takes his Ballistic Skill (BS) and applies Basic and Weapon 'to hit' modifiers (including any modifier for a weapon's targeter). Note that these modifiers are usually applied to the 'to hit' dice roll, but because no separate 'to hit' roll is made when shooting at a Dreadnought, the modifiers are applied to the Target Shift instead.

For example, if a firer's BS were 4 and modifiers brought this up to 5, this is the Target Shift score. If the Target Shift score is reduced to zero or less by negative modifiers for range, cover, target speed etc then proceed no further: the shot cannot be changed and has either hit the area or missed entirely as indicated originally.

Note that in the originally published vehicle rules a further D6 roll was deducted from the firer's Target Shift Score, this is no longer the case. After further playtesting, including a game where an entire Eldar Guardian squad spent three turns firing at a Land Speeder from close range and didn't hit it once, we've decided that this D6 roll makes vehicles excessively hard to hit. We would recommend that players using the advanced vehicle rules published in WD128 also dispense with the D6 modifier to the Target Shift Score.

Assuming the Target Shift Score is 1 or more the player may shift the hit by up to that number of positions on the targeting grid. The shift must be in one direction only - either vertically or horizontally (never at an angle) and must always be towards the aiming point at the centre of the grid. This represents the increased accuracy of the weapon or shooter, but because the shift must be vertical or horizontal it is still possible to miss even a large target.

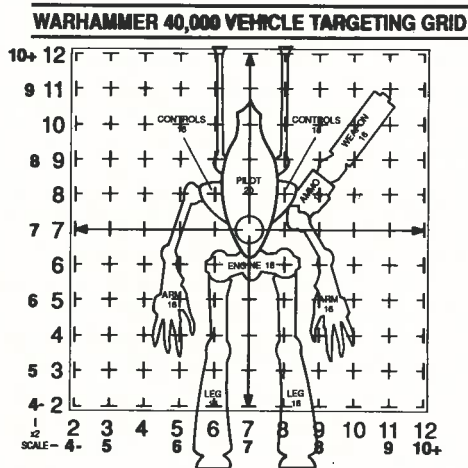

The shooter is firing a missile launcher with targeter at an Eldar Dreadnought 48" away and moving at 12" (charge rate). The shooter has a BS of 4, +1 for the targeter and -1 because of a fast target equals a total Target Shift score of 4.

The firer aims at the Dreadnought's head - a centrally placed target which maximises his chance of hitting. The rolls are 3 and 6, indicating a miss. The player can shift the hit by up to 4 spaces towards the aiming point, so he can go for either 7/6 - the engine or 3/7 - another miss! In this situation the player decides to adjust his hit position from the 3/6 to the 7/6 and attempts to knock-out the Dreadnought's engine.

AREA WEAPONS

Attacks with area weapons are handled slightly differently to normal weapons. The shooter nominates his target and makes the normal D6 based 'to hit' roll and deviation roll using the standard hit system. Once the area marker is in place on the table the targeting diagram and grid are used to locate damage if any portion of the Dreadnought model lies within the area marker.

Because of their blast area, area weapons will score several potential hits against something as large as a Dreadnought. Place the targeting grid over the diagram as usual. Then roll for one hit plus an extra hit for every full inch of the area weapon's template radius. The chart below summarises the number of rolls.

Template Radius	Number of Rolls
1" - 1 ½"	2
2" - 2 ½"	3
3"+	4

Area weapons do not receive any Target Shifts.

LINKED WEAPONS AND SUSTAINED FIRE

Linked weapons such as the twin-mounted Lascannon on the Land Raider score multiple hits. The hits from such weapons will be fairly tightly grouped, so in this case just make one roll for location on the targeting template. Both of the hits strike the same point, but roll penetration and damage separately for each hit.

Sustained or following fire weapons can hit a number of points because their rapid fire lays down a curtain shots across the target. For these weapons simply roll for the location of the hit and apply any Target Shifts to the result as normal, then make a second roll on the horizontal scale only. The weapon hits each and every target location between the two hits, including the points actually hit.

ARMOUR PENETRATION

Once it has been established that a shot has hit the target, look at the armour value of the location struck. The higher the armour value the thicker the armour and the more difficult it is to penetrate. The player tests to determine whether this armour is penetrated successfully by the shot.

Test as follows: roll a D6 and add the score to the strength of the weapon causing the hit. If the weapon normally causes a variable number of wounds (D3, D4, D6, D10, 2D6, etc) roll the dice indicated and add the score to the total as well. This is the thickness of armour penetrated. If the result is equal to or more than the armour value of the area hit, the shot has penetrated. If the result is less than the armour value the shot has not penetrated and has no further effect.

You will find a summary table of all the weapon penetration values at the end of this article, which you may find helpful.

For example: a lascannon has a strength of 9 and causes 2D6 points of damage. It will therefore penetrate $D6 + 9 + 2D6$ value of armour (a thickness between 12 and 27). The lascannon is an ideal anti-tank weapon because it can penetrate a great thickness of armour. An ordinary bolter can penetrate $D6 + 4$ value of armour (5-10) which is only likely to harm the most lightly armoured areas on a Dreadnought.



DAMAGE

If a shot penetrates the target's armour then the Dreadnought will sustain damage. In most cases the area will be destroyed, and in some cases the whole Dreadnought may be destroyed and rendered useless. Refer to the damage effect chart corresponding to the location, and roll to determine the effects of penetration.

HAND-TO-HAND COMBAT

Dreadnoughts may engage in hand-to-hand combat but some special rules do apply to them. Normally models engaged in close combat can't move away from each other, but Dreadnoughts are an exception. A Dreadnought engaged in hand-to-hand combat at the start of its turn may move during its movement phase, and so may move out of hand-to-hand combat if the player wishes, the Dreadnought just uses its strength and size to brush man-size opponents out of the way.

If the Dreadnought is fighting another model of similar size, like another Dreadnought or a Greater Daemon, it may not move away and must continue to fight just like an infantry model.

A Dreadnought fights in hand-to-hand combat using its arms and hands. The machine has the attacks, initiative and weapon skill ratings indicated on its datafax record. In most cases this is one attack with each arm plus an additional attack for kicking or crushing with its feet. These attacks are lost if the limb is damaged as indicated on the damage charts. The strength, save modifier and damage for attacks by the machine is given on the profile and represents the smashing or punching power of the Dreadnought in close combat.

If a Dreadnought is hit in hand-to-hand combat the attacker can automatically nominate which hit location he attacks. Roll for penetration and damage in the same way as for shooting.



SPECIAL HAND-TO-HAND ATTACKS

A Dreadnought in close combat may elect to forgo *all* of its normal attacks in favour of a single special attack. The player must specify that he is making a special Pound, Tear or Crush attack and then roll a single dice to hit. If the attack hits it causes the damage specified below.

The machine must have all of its arms functional in order to use a special attack. These special attacks are mostly intended to reflect the machine's awesome power when attacking other vehicles or Dreadnoughts.

POUND. May be used against any vehicle or another Dreadnought. The Dreadnought pounds with both arms against the target's armour using the might of its entire body. Choose any location on the target, and roll 6D6 to determine how much armour is penetrated. If the location is penetrated roll for damage adding +1 to your D6 dice score. Dreadnoughts can attack buildings, walls and other terrain features by pounding them. In order to do so the Dreadnought must be in contact with the scenic feature in the close combat phase. Simply add the feature's toughness and wounds together to find its armour value (see the Warhammer 40,000 rules for guidelines to the toughness and wounds of various building types). If the 6D6 penetration roll exceeds the feature's armour value a chunk about 5cm square is removed from it. If the feature is smaller than this simply remove it from the table. Otherwise mark the breach with counters, gravel, broken twigs or whatever else seems appropriate.

TEAR. May be used against any other vehicle including other Dreadnoughts. The player nominates any exterior location on the target. The Dreadnought seizes the part and attempts to tear it away. Roll 4D6 for penetration. If the location chosen is penetrated the part is torn away. Treat damage as if the player had rolled a 6 on the damage chart.

CRUSH. May be used against another Dreadnought or any single creature. The machine hugs and attempts to crush the target with both arms. The target remains caught in the crushing grip until it is either crushed or escapes - it cannot move while hugged, although it can still attack as normal. The crush attack penetrates 2D6 thickness of armour during the first round, plus an additional 2D6 points of armour during each round after that. So, during the first round the crush might penetrate 3+5=8, in the next round 2+4+ the original 8 = 14, and so on. If the 2D6 score turns up doubles the victim has struggled free without suffering any effect, otherwise the victim remains 'hugged' until the attacker lets it go.

As soon as the dice total equals or exceeds the armour value of each location, damage is caused on that location as normal. Once a location has been penetrated, it will receive damage again every hand-to-hand combat phase while the target remains hugged, or until that location is destroyed. Living creatures are automatically slain as soon as the penetration total exceeds their own toughness.

ARMOUR PENETRATION

This table summarises the armour penetration values of each weapon using the Warhammer 40,000 vehicle rules first published in White Dwarf. You can work out penetration rates for yourself using the profiles, but we thought it would be useful to have a summary. In addition to the penetration value, we've include the minimum and maximum results and the average result which you'll get with a typical dice roll. Obviously you don't need to know these values to play the game, but smart players will quickly realise the usefulness of knowing how much armour they're likely to penetrate with a shot. Remember that the more dice you roll the greater chance you have of obtaining a result close to the average score - so a lascannon with 3D6+9 is more predictable than a plasma gun with D6+7.

Weapon	Armour Penetration	Min. Result	Max. Result	Average Result	Weapon	Armour Penetration	Min. Result	Max. Result	Average Result
Autopistol	D6+3	4	9	6.5	Heavy Plasma — Varies according to power setting used				
Bolt Pistol	D6+4	5	10	7.5	Max. Power	D10+D6+10	12	26	19
Hand Flamer	D6+4	5	10	7.5	Low Energy	D4+D6+7	9	17	13
Laspistol	D6+3	4	9	6.5	Heavy Stub	D6+4	5	10	7.5
Needle Pistol	D6+3	4	9	6.5	Lascannon	3D6+9	12	27	19.5
Plasma Pistol	D6+6	7	12	9.5	Mole Mortar — Varies according to burst type				
Shuriken Pistol	D6+3	4	9	6.5	Airburst	D6+3	4	9	7.5
Stub Gun	D6+3	4	9	6.5	Surface Burst	D6+4	5	10	8.5
					Ground Burst	D6+4	5	10	8.5
Autogun	D6+3	4	9	6.5	Subterranean	D6+3	4	9	7.5
Boltgun	D6+4	5	10	7.5	Mortar — Varies according to shell type used				
Bow	D6+1	2	7	4.5	Frag Shell	D6+4	5	10	7.5
Crossbow	D6+1	2	7	4.5	Plasma Shell	D6+5	6	11	8.5
Flamer	D6+4	5	10	7.5	Missile Launcher — Varies according to type of missile fired				
Graviton Gun — Automatically penetrates the target					Krak Missile	D10+D6+8	10	24	17
Hand Bow	D6+1	2	7	4.5	Frag Missile	D6+4	5	10	7.5
Lasgun	D6+3	4	9	6.5	Melta Missile	2D6+8	10	20	15
Meltagun	2D6+8	10	20	15	Multi-laser	D6+D4+6	8	16	12
Musket	D6+3	4	9	6.5	Multimelta	D6+2D12*+8	11	38	24.5
Sniper Rifle	D6+3	4	9	6.5	Shuriken Cann.	D6+D4+5	7	15	11
Ogryn Ripper	D6+4	5	10	7.5	Cyclone Lnchr	D10+D6+8	10	24	17
Plasma Gun	D6+7	8	13	10.5					
Shot Gun	D6+4	5	10	7.5	Frag Grenade	D6+3	4	9	7.5
Shuriken Catapult	D6+4	5	10	7.5	Haywire — Automatically penetrates. See main rules.				
Storm Bolter	D6+4	5	10	7.5	Krak Grenade	2D6+6	8	18	13
					Plasma Grenade	D6+5	6	11	8.5
Assault Cannon	D6+D10+8	10	24	17	Rad Grenade	2D6+D4	3	16	9.5
Auto-Cannon	2D6+8	10	20	15	Vortex Grenade — Automatically penetrates. See main rules.				
Battle Cannon	3D6+8	11	26	18.5					
Conversion Beamer — Penetration varies with armour value					Distort Cannon — Automatically penetrates. See main rules.				
1-4 armour	D6	1	6	3.5	Scatter Laser	D6+6	7	12	9.5
5-8 armour	2D6	2	12	7	Thudd Gun	D6+6	7	12	9.5
9-11 armour	3D6	3	18	10.5	Hop-Splat				
12-14 armour	4D6	4	24	14	Ork Field Gun	D6+D4+6	8	16	14
15+ armour	5D6	5	30	17.5	Rapier Laser				
Heavy Bolter	D4+D6+5	7	15	11	Destroyer	D6+9+2D10	12	35	23.5
Heavy Flamer	D6+5	6	11	8.5	Tarantula				
					Lascannon	3D6+9	12	27	19.5

*Note that the Multimelta has a revised penetration value (2D12 not 4D6), this is because we found 4D6 gave a far too predictable result!

HEAVY METAL



Bad Moon Ork Dreadnought



Tyrannid Screamer-Killer



Blood Angel Dreadnought



Chaos Dreadnought

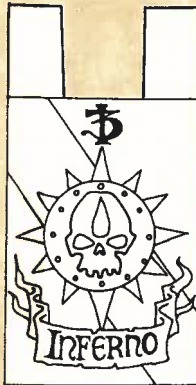
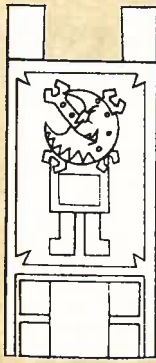

Eldar Dreadnought from the Alaitoc Craftworld

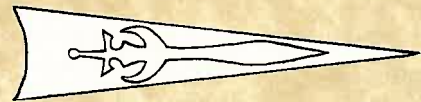

Dreadnoughts are undoubtedly the most impressive looking models in a Warhammer 40,000 force. Towering above your opponent's troops, they are the focal point of your army and therefore warrant the best paint job you can possibly give them. The models shown on these pages were painted to emphasise the enormous bulk and aggressive looks that these revered fighting machines possess.

The Ork Dreadnought has been painted in typically bright yellow Bad Moon colour scheme and the banner shows a selection of Mekboy and dreadnought glyphs. The black and white banner has some blank spaces so you can personalise your Dreadnought with your own choice of Ork glyphs.

The Tyranid Screamer-Killer was painted to emphasise the sheer power of its deadly arm-claws. They were first painted Chaos Black and then left to dry. Thinned down layers of Go-Fasta Red were gradually applied to the ends of the arm-claws. When this deep red colour had been sufficiently built up, a small highlight of Blood Angel Orange was added to the outer edges of the claws. Finally, the arm-claws were coated with a layer of gloss varnish to make them look like hardened exoskeleton.

The Blood Angel Dreadnought has a banner bearing its personal heraldry and its own name. The Dreadnought also displays chapter badges and blood drops taken from the Space Marine transfer sheet. A campaign marking has been painted on the lower leg.

The Chaos Dreadnought displays the typical red, black and brass colours of Khorne. The skull and ribbing on the carapace have been carefully picked out with Bleached Bone. The intricate banner design was created by photocopying a Khorne icon, washing over it with red ink and then highlighting it with Blood Angel Orange and Bad Moon Yellow.

The Eldar Dreadnought has been painted in Alaitoc Craftworld colours. Normally this colour scheme would be predominately blue with a yellow carapace. However, to make it stand out from the Eldar Guardian troops, we decided to reverse the colour scheme. We chose an Alaitoc rune for the banner and positioned it between the legs of the Dreadnought. Transfers were added to the Dreadnought's arms and legs and painted different colours. Finally, an infinity rune was added to the carapace as this is the standard wraithguard symbol.

SPACE MARINE DREADNOUGHT

DATA RECORD: IMP 8

The pilot of a Space Marine Dreadnought is not an ordinary Space Marine but one of the Old Ones – a Space Marine mortally wounded in battle long ago. Rather than being allowed to die he has been implanted inside the Dreadnought, his nervous system connected directly to the machine itself. The Space Marine now only exists as a tightly curled and shrivelled organic component deep inside the Dreadnought. Once installed the Space Marine can never leave the Dreadnought. He loses all sensation from his body and relies completely on the artificial senses of the machine. Dreadnoughts are often very ancient, sometimes many thousands of years old, with memories which stretch back to the early days of the Chapter's history. They are revered by the other Space Marines as potent warriors and also as living embodiments of battles fought long ago. Space Marine Dreadnoughts are armed with a variety of different weapons and operate in support or close assault roles. They are particularly valuable when fighting in close terrain where their ability to traverse obstacles makes them highly effective at rooting out the enemy.

- Type** Dreadnought
- Move** 4"
- Crew** 1 Space Marine
- Weapon** Lascannon with targeter and 90° field of fire to front.
- OR
Missile Launcher with targeter and 90° field of fire to front
- AND
1 Arm with:
Storm Bolter with targeter and 90° field of fire to front
- OR
2 Arms with:
Storm Bolter with targeter and 90° field of fire to front
- The Dreadnought fires its weapons with a BS of 5.

Close Combat The Dreadnought can attack any enemy model it is touching during the hand-to-hand combat phase. For the purposes of hand-to-hand combat, the Dreadnought has the following characteristics:

Weapon Skill	6
Strength	7
Initiative	5
Attacks	3
Saving Throw Modifier	-3
Damage	1

The Dreadnought can use the following special attacks:

- POUND
- TEAR
- CRUSH

Rear Armour: -1

PV: 150

MAIN AND ARM-MOUNTED WEAPONS – 90°

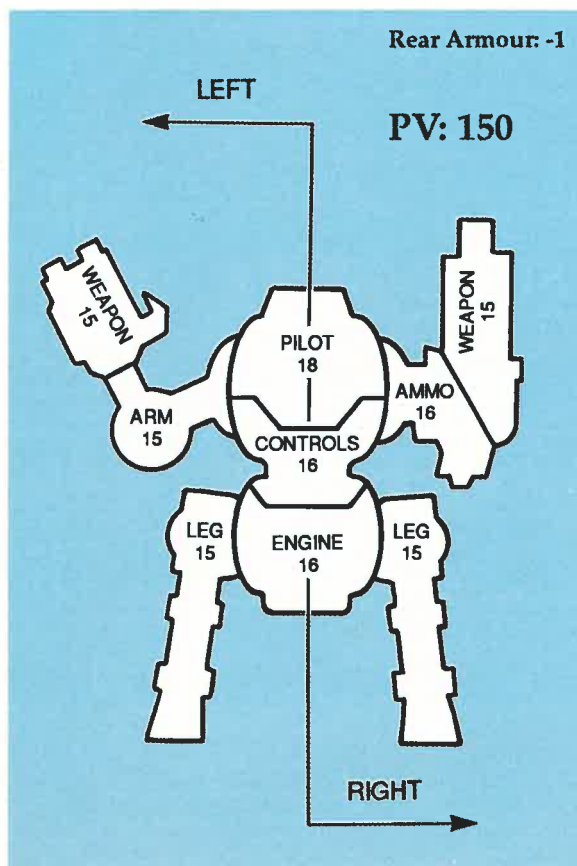
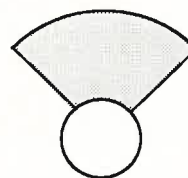

DAMAGE CHARTS

Find the chart corresponding to the location, and roll a dice to determine the effects of penetration.

PILOT

- 1-2 The pilot is mortally injured. If the Dreadnought moved in its previous turn, it will spin round to face a random direction and move D6" before coming to a halt. From now on the Dreadnought may only fire weapons or move if the owning player first rolls a 6 on a D6 at the start of his turn.
- 3-6 The pilot is slain and the machine comes to an immediate halt. The Dreadnought may do nothing for the remainder of the game and is effectively destroyed.

CONTROLS

- 1-3 The Dreadnought's control gear is destroyed and the machine comes to an immediate and permanent halt. The pilot may use emergency manual controls to fire 1 weapon during the shooting phase, but he may do nothing else.
- 4-6 The Dreadnought's control gear goes crazy and the machine moves in a dangerous and unpredictable fashion. At the start of each turn *both* sides roll a D6. The player with the highest result may move the machine that turn.

If already stationary the machine must remain that way unless the controlling player rolls a 6. Whichever side moves the machine, the other side may fire any one weapon in any way the player wishes. Other weapons may not fire and the machine may not attack in hand-to-hand combat. Although the enemy will be moving or firing, these actions still take part during the machine's own movement or shooting phase as appropriate.



ENGINE

- 1-2 The engine is badly damaged. The Dreadnought's maximum move is reduced to half rate.
- 3-4 The engine is destroyed and the Dreadnought comes to an immediate and permanent halt. It may still fire any weapons.
- 5-6 The engine is destroyed and bursts into flames. The Dreadnought is immobilised for the rest of the game and may not fire its weapons.

At the beginning of each of its following turns, the machine explodes on the D6 roll of a 6. An exploding Dreadnought causes 1 strength 10 hit with a -3 save modifier on all models within a 1D6" radius circle positioned over the centre of the machine. Damage from an exploding Dreadnought is D6.

AMMO

- 1-3 The ammunition casing is split and starts to react with the air, shells begin to burn, batteries crack and smoulder, and chemicals spill into the machine's interior. At the beginning of each of its following turns, the Dreadnought may explode. Roll a D6 - on a roll of 4, 5 or 6 the machine blows up. An exploding Dreadnought causes 1 strength 10 hit with a -3 save modifier on all models within a 1D6" radius circle positioned over the centre of the machine. Damage from an exploding Dreadnought is D6.
- 4-6 The ammunition is hit and the machine explodes instantly. An exploding Dreadnought causes 1 strength 10 hit with a -3 save modifier on all models within a 1D6" radius circle positioned over the centre of the machine. Damage from an exploding Dreadnought is D6.

WEAPON

- 1-5 The weapon is destroyed and cannot be used.
- 6 The weapon explodes, destroying it and also causing a hit on the weapon's ammo location. Work out penetration as if the weapon had hit the Dreadnought itself.

ARM

- 1-2 The Dreadnought's arm is hit and partially paralysed. Any weapon incorporated into the arm may still be used, but the arm cannot be used to fight in hand-to-hand combat. The Dreadnought's attacks characteristic is reduced by one.
- 3-6 The Dreadnought's arm is torn from the machine. Any weapon on the arm is destroyed, and the machine can no longer use the arm to attack in hand-to-hand combat. The Dreadnought's attacks characteristic is reduced by one.

LEG

- 1-2 The Dreadnought is destabilised by severe damage to one of its legs and it is immobilised for the rest of the game. If the Dreadnought moved in its previous turn it will fall over on the D6 roll of a 5 or 6. A falling Dreadnought will collapse as described for 3-4 below.
- 3-4 The Dreadnought collapses into a heap and is permanently immobilised. On the D6 roll of a 5 or 6 it collapses in such a way that 1 randomly determined weapon may still be used. Otherwise its weapons may no longer be used.
- 5-6 The Dreadnought sways for a moment and then crashes to the ground. The Dreadnought cannot move or fire for the rest of the game. Randomly determine which way the Dreadnought falls, and anything underneath it suffers a strength 6 hit with a -3 save modifier causing 1D3 damage.

CHAOS DREADNOUGHTS

DATA RECORD: CHAOS 1

A great Chaos Space Marine Champion may be fortunate enough to find himself implanted into a Dreadnought rather than die of his wounds. Just as Space Marine Dreadnoughts combine the barely living remnants of a Space Marine into a complex fighting machine, so the Chaos Dreadnought uses sophisticated technology and arcane secrets to prolong the lives of Chaos Champions in machine form.

The Chaos Dreadnoughts derive from the ancient time before the Horus Heresy, but many of these machines have mutated under the warping power of Chaos into a combination of bone, metal and living flesh. Relatively few survive and they are carefully maintained and repaired by Chaos Dwarf artificers. If a Dreadnought's occupant is killed in action the Dreadnought is recovered and refurbished to house a new Chaos Champion.

Type Dreadnought
Move 4"
Crew 1 Champion of Chaos
Weapon Heavy Plasma gun with targeter and 90° field of fire to front.
 The Dreadnought fires its weapon with a BS of 5.

Close Combat The Dreadnought can attack any enemy model it is touching during the hand-to-hand combat phase. For the purposes of hand-to-hand combat, the Dreadnought has the following characteristics:

Weapon Skill	7
Strength	8
Initiative	5
Attacks	3
Saving Throw Modifier	-5
Damage	1

The Dreadnought can use the following special attacks:

- POUND
- TEAR
- CRUSH

Rear Armour: -1

PV: 150

MAIN AND ARM-MOUNTED WEAPONS - 90°

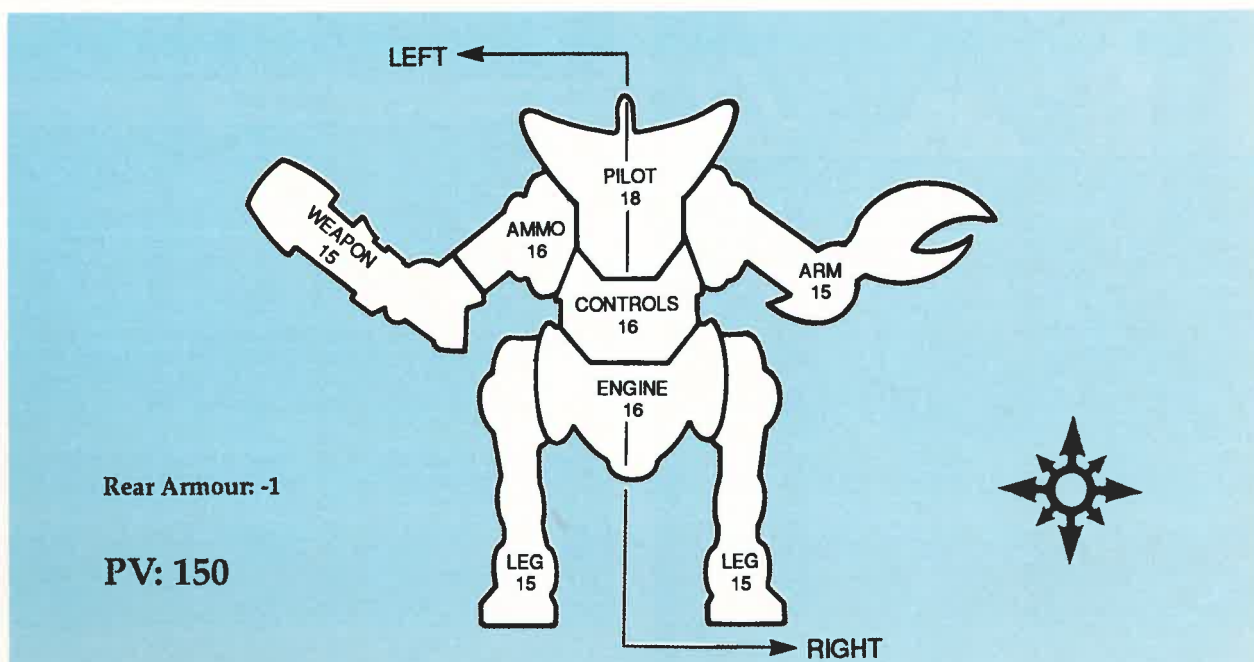
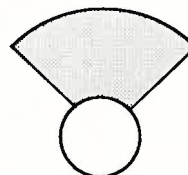

DAMAGE CHARTS

Find the chart corresponding to the location, and roll a dice to determine the effects of penetration.

PILOT

- 1-2 The pilot is mortally injured. If the Dreadnought moved in its previous turn, it will spin round to face a random direction and move D6" before coming to a halt. From now on the Dreadnought may only fire weapons or move if the owning player first rolls a 6 on a D6 at the start of his turn.
- 3-6 The pilot is slain and the machine comes to an immediate halt. The Dreadnought may do nothing for the remainder of the game and is effectively destroyed.

CONTROLS

- 1-3 The Dreadnought's control gear is destroyed and the machine comes to an immediate and permanent halt. The pilot may use emergency manual controls to fire 1 weapon during the shooting phase, but he may do nothing else.
- 4-6 The Dreadnought's control gear goes crazy and the machine moves in a dangerous and unpredictable fashion. At the start of each of its turns *both* sides roll a D6. The player with the highest result may move the machine that turn.

If already stationary the machine must remain that way unless the controlling player rolls a 6. Whichever side moves the machine, the other side may fire any one weapon in any way the player wishes. Other weapons may not fire and the machine may not attack in hand-to-hand combat. Although the enemy will be moving or firing, these actions still take part during the machine's own movement or shooting phase as appropriate.

ENGINE

- 1-2 The engine is badly damaged and the Dreadnought's maximum move is reduced to half rate.
- 3-4 The engine is destroyed and the Dreadnought comes to an immediate and permanent halt. It may still fire any weapons.
- 5-6 The engine is destroyed and bursts into flames. The Dreadnought is immobilised for the rest of the game and may not fire its weapons.

At the beginning of each of its following turns, the machine explodes on the D6 roll of a 6. An exploding Dreadnought causes 1 strength 10 hit with a -3 save modifier on all models within a 1D6" radius circle positioned over the centre of the machine. Damage from an exploding Dreadnought is D6.

AMMO

- 1-3 The ammunition casing is split and chemicals spill into the machine's interior. At the beginning of each of its following turns, the Dreadnought explodes on the D6 roll of a 4, 5 or 6. An exploding Dreadnought causes 1 strength 10 hit with a -3 save modifier on all models within a 1D6" radius circle positioned over the centre of the machine. Damage from an exploding Dreadnought is D6.
- 4-6 The ammunition is hit and the machine explodes instantly. An exploding Dreadnought causes 1 strength 10 hit with a -3 save modifier on all models within a 1D6" radius circle positioned over the centre of the machine. Damage from an exploding Dreadnought is D6.

WEAPON

- 1-5 The weapon is destroyed and cannot be used.
- 6 The weapon explodes, also causing a hit on the weapon's ammo location. Work out penetration as if the weapon had hit the Dreadnought itself.

ARM

- 1-2 The Dreadnought's arm is hit and partially paralysed. Any weapon incorporated into the arm may still be used, but the arm cannot be used to fight in hand-to-hand combat. The Dreadnought's attacks characteristic is reduced by one.
- 3-6 The Dreadnought's arm is torn from the machine. Any weapon on the arm is destroyed, and the machine cannot use the arm to attack in hand-to-hand combat. The Dreadnought's attacks characteristic is reduced by one.

LEG

- 1-2 The Dreadnought is destabilised by severe damage caused to a leg and is immobilised for the rest of the game. If the Dreadnought moved in its previous turn it will fall over on the D6 roll of a 5 or 6. A falling Dreadnought will collapse as described for 3-4 below.
- 3-4 The Dreadnought collapses into a heap and is permanently immobilised. On the D6 roll of a 5 or 6 it collapses in such a way that 1 randomly determined weapon may still be used. Otherwise no weapons may be used.
- 5-6 The Dreadnought sways for a moment and then crashes to the ground. The Dreadnought cannot move or fire for the rest of the game. Randomly determine which way the Dreadnought falls. Anything underneath it suffers a strength 6 hit with a -3 save modifier causing 1D3 damage.

ORK DREADNOUGHT

DATA RECORD: ORK 4

The Ork Dreadnought is piloted by a Gretchin which has been surgically implanted into the machine by the combined efforts of an Ork Painboy and Mekboy. Gretchin are fortunately very resilient and usually survive the operation to wake up and find itself wired into a huge metal body which is even bigger and stronger than an Ork's! This is very cheering for the Gretchin who has had to suffer years of beatings from his Ork masters, and not surprisingly the power goes to his head. For this reason Ork Dreadnoughts are often very hard to control.

In battle Ork Dreadnoughts often charge off towards the first enemy they see, bellowing loud metallic "Waaargh" noises out of their speakers. Fortunately most Ork Dreadnoughts are equipped with a couple of fearsome Power Claws so that the Gretchin can work off some of its angst in close combat and then (hopefully) settle down for the rest of the battle.

Type Dreadnought
Move 4"
Crew 1 Gretchin
Weapon Any TWO weapons chosen from the following :
 — Lascannon with a 90° field of fire to front
 — Missile Launcher with a 90° field of fire to front
 — Heavy Flamer with a 90° field of fire to front
 — Heavy Bolter with a 90° field of fire to front
 The Dreadnought fires its weapons with a BS of 4.

Close Combat Because Gretchin pilots are power crazed and eager to show off Ork Dreadnoughts must always charge into hand to hand combat the first time that the enemy are within 8".

The Dreadnought can attack any enemy model it is touching during the hand-to-hand combat phase. For the purposes of hand-to-hand combat, the Dreadnought has the following characteristics:

Weapon Skill	5
Strength	8
Initiative	4
Attacks	4
Saving Throw Modifier	-5
Damage	1

The Dreadnought can use the following special attacks:
 POUND, TEAR, CRUSH

Rear Armour: -2

PV: 125

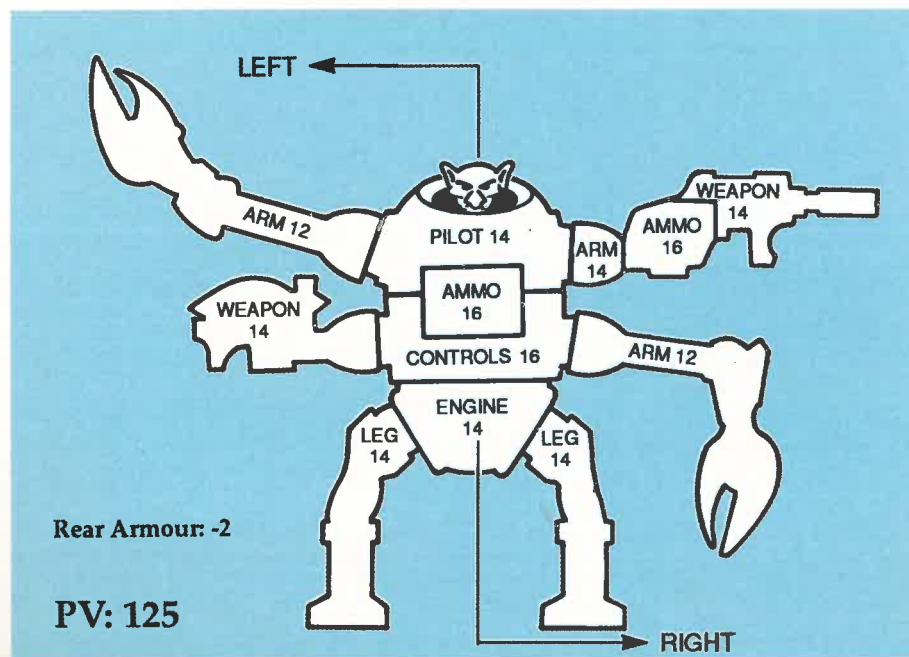

MAIN AND ARM-MOUNTED WEAPONS - 90°

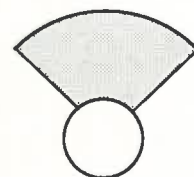

DAMAGE CHARTS

Find the chart corresponding to the location, and roll a dice to determine the effects of penetration.

PILOT

- 1-2 The Gretchin pilot suffers a massive electrical shock through his control cables, driving him half mad and sending the Dreadnought on the rampage! Move the Dreadnought D6" in a random direction in its next movement phase. It will attack anything in its path in close combat or fire its weapons at the closest target, friend or foe! The rampage will continue until the Dreadnought is destroyed or leaves the board.
- 3-6 The Gretchin pilot is slain and the machine comes to an immediate halt. The Dreadnought may do nothing for the remainder of the game and is effectively destroyed.

CONTROLS

- 1-3 The Dreadnought's control gear is smashed and the machine comes to an immediate and permanent halt. The Gretchin pilot may use emergency manual controls to fire 1 weapon during the shooting phase, though he may do nothing else.
- 4-6 The Dreadnought's control gear goes crazy and the machine moves in a dangerous and unpredictable fashion. At the start of each of its turns *both* sides roll a D6. The player with the highest result may move the machine that turn.

If already stationary the machine must remain that way unless the controlling player rolls a 6. Whichever side moves the machine, the other side may fire any one weapon in any way the player wishes. Other weapons may not fire and the machine may not attack in hand-to-hand combat. Although the enemy may be moving or firing, these actions still take part during the machine's own movement or shooting phase as appropriate.



ENGINE

- 1-3 The lines carrying fuel to the engine are smashed, and the Dreadnought's move is cut by half. Any further hits on the Dreadnought will cause the fuel to ignite and explode on a D6 roll of 5 or 6.
- 4-6 The engine is destroyed and bursts into flames. The Dreadnought is immobilised for the rest of the game and may not fire its weapons.

At the beginning of each of its following turns, the machine explodes on the D6 roll of a 4, 5 or 6. An exploding Dreadnought causes 1 strength 10 hit with a -3 save modifier on all models within a 1D6" radius circle positioned over the centre of the machine. Damage from an exploding Dreadnought is D6.

AMMO

- 1-3 The ammunition casing is split and starts to react with the air, shells begin to burn, batteries crack and smoulder, and chemicals spill into the machine's interior. At the beginning of each of its following turns, the Dreadnought explodes on the D6 roll of a 4, 5 or 6. An exploding Dreadnought causes 1 strength 10 hit with a -3 save modifier on all models within a 1D6" radius circle positioned over the centre of the machine. Damage from an exploding Dreadnought is D6.
- 4-6 The ammunition is hit and the machine explodes instantly. An exploding Dreadnought causes 1 strength 10 hit with a -3 save modifier on all models within a 1D6" radius circle positioned over the centre of the machine. Damage from an exploding Dreadnought is D6.

WEAPON

- 1-5 The weapon is destroyed and cannot be used.
- 6 The weapon explodes, destroying it and also causing a hit on the weapon's ammo location. Work out penetration as if the weapon had hit the Dreadnought itself.

ARM

- 1-2 The Dreadnought's arm is hit and partially paralysed. Any weapon incorporated into the arm may still be used, but the arm cannot be used to fight in hand-to-hand combat. The Dreadnought's attacks characteristic is reduced by one.
- 3-6 The Dreadnought's arm is torn from the machine. Any weapon on the arm is destroyed, and the machine cannot use the arm to attack in hand-to-hand combat. The Dreadnought's attacks characteristic is reduced by one.

LEG

- 1-2 The Dreadnought is destabilised by severe damage caused to one of its legs and is immobilised for the rest of the game. If the Dreadnought moved in its previous turn it will fall over on the D6 roll of a 5 or 6. A falling Dreadnought will collapse as described for 3-4 below.
- 3-4 The Dreadnought collapses into a heap and is permanently immobilised. On the D6 roll of a 5 or 6 it collapses in such a way that 1 randomly determined weapon may still be used. Otherwise the machine's weapons may no longer be used.
- 5-6 The Dreadnought sways for a moment and then crashes to the ground. The Dreadnought cannot move or fire for the rest of the game. Randomly determine which way the Dreadnought falls, and anything underneath it suffers a strength 6 hit with a -3 save modifier causing 1D3 damage.

TYRANID SCREAMER KILLER

DATA RECORD: TYR 1

The Screamer Killer is one of the larger Tyranid bio-constructs: a living engine of destruction designed for use in assaults, boarding actions and massed battles to crush enemy forces. Though less numerous than other Tyranid bio-constructs, they are almost impossible to kill and capable of immense destruction. With its huge bulk, massively armoured carapace and four gigantic claws, the Screamer Killer is an awesome foe. Because of its exceptional size and toughness the Screamer Killer is treated as a Dreadnought in all respects. At close quarters it uses its deadly claws to tear the enemy to pieces, ripping through armour with ease, and shredding flesh. The Screamer Killer's ranged attack is even more terrible. Rasping plates in the mouth, gases secreted in its lungs and a high frequency scream produced by the creature's vocal cords combine to produce ball of highly unstable bio-plasma. This forms for a split-second in front of the Screamer Killer, held in place by a flickering electrical field generated around the creature's claws, before it is belched forth to burn its path across the battlefield and explode with incandescent fury.

Type Tyranid Bio-Construct
(uses Dreadnought rules)

Move 6"

Weapon Bio-Plasma discharge with a 90° field of fire to front.
The Screamer Killer fires its plasma discharge with a BS of 4.

Range		To Hit		Str	Dam	Save
Short	Long	Short	Long			
18"	36"	+1	8	1D6	-4	

Special Rules: Move or Fire. 2" radius.

Close Combat The Screamer Killer can attack any enemy model it is touching during the hand-to-hand combat phase. For the purposes of hand-to-hand combat, the Dreadnought has the following characteristics:

Rear Armour: +0

PV: 150

Weapon Skill 6

Strength 7

Initiative 6

Attacks 4

Saving Throw Modifier -2

Damage 1

A Screamer Killer may make one of the following special attacks:

POUND
TEAR
CRUSH

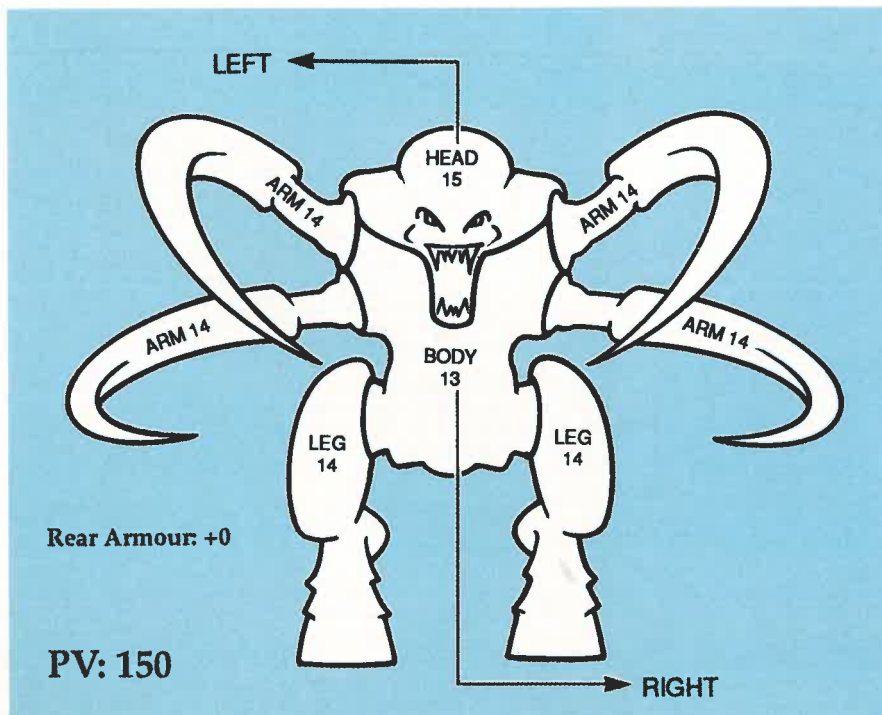

MAIN WEAPON - 90°

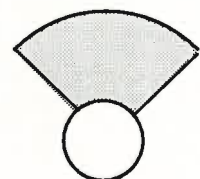

DAMAGE CHARTS

Find the chart corresponding to the location, and roll a dice to determine the effects of penetration.

LEG

- 1 The inch thick chitinous plates on the Screamer Killer's leg hold, but the force of the blow knocks it over. The Screamer Killer must spend the next move standing up, and may not use its ranged attack while it does so.
- 2 The Screamer Killer suffers a shallow leg wound. Its movement rate is halved for the rest of the game.
- 3 The Screamer Killer is knocked sprawling. It staggers D6" in a random direction, colliding with anything in its path.
- 4 The Screamer Killer's leg is badly wounded, and the creature may now only limp 1D3" per turn. If it rolls a 1 for movement it falls over as for result 1 above.
- 5 The Screamer Killer's leg is crippled. It may not move but it can still turn in place.
- 6 With a shower of ichor and gristle the leg is blown off. The Screamer Killer is completely incapacitated for the rest of the game.

ARM

- 1 The shot clips the creature's shoulder, spinning the model round 90° but having no other effect.
- 2 The arm is numbed by the shock of the impact. The Screamer Killer loses one attack until the end of next turn.
- 3 Subcutaneous storage cells and static columns are shaken up causing the Screamer Killer's bio-field to be disrupted. It may make no ranged attack next turn.
- 4 The Screamer Killer is knocked sprawling. It staggers D6" in a random direction, colliding with anything it moves into.
- 5 The Screamer Killer's arm is seriously wounded. It loses 1 from its attacks for rest of game. If 2 different arms are wounded then the Screamer Killer may use no more ranged attacks for the rest of the game.
- 6 The Screamer Killer's arm is ripped off by the hit. It loses 1 from its attacks and may use no more ranged attacks for the rest of the game.

HEAD

- 1 The creature is stunned and may do nothing in its next turn.
- 2 The Screamer Killer's domed skull deflects the blow but it is still stunned (see 1 above) and knocked over. The Screamer Killer may do nothing in its next turn and must spend its next move after that standing up. It may not use its ranged attack as it stands up.
- 3 The Screamer Killer is badly injured by the hit, but still moving! Synapse damage halves its WS, BS & I for the rest of the game.
- 4 The shot shears through the creature's spine, severing the hive mind synapse and driving it mad with pain for the few seconds before it expires. Move the Screamer Killer D6" in a random direction. It will attack anyone it moves into (including friends). Then roll a D6, on anything but a 6 the creature dies immediately. On a 6 the creature will rampage again during the next movement phase.
- 5 The hit drills the Screamer Killer neatly between the eyes and the creature drops down dead!
- 6 The Screamer Killer is struck squarely in the face and decisively blown away! It is hurled back D6" and collides with anything in the way. All opposing troops that have a LOS to this spectacular kill are immune to panic and will not rout this turn - they also give a mighty cheer! Routing troops with a LOS immediately rally.

BODY

- 1 The shot is deflected by the Screamer Killer's shoulder, spinning the model round 90° but having no other effect.
- 2 The Screamer Killer's reinforced rib cage absorbs the blow, but the force of the blow knocks it over. The Screamer Killer must spend the next move standing up, and may not use its ranged attack as it does so.
- 3 The Screamer Killer is knocked sprawling by the impact. It staggers D6" backwards, colliding with anything it moves into.
- 4 The Screamer Killer is badly injured by the hit, but is still moving! Loss of vital fluids slows the Screamer Killer to half move and also halves its WS & BS for the rest of the game.
- 5 The shot rips a gaping hole in the Screamer Killer's chest. It collapses but then starts to slowly get up! The Screamer Killer must spend the next move standing up. It may not use its ranged attack as it stands up and its WS & BS are halved for the rest of the game.
- 6 The creature is apparently mortally wounded and collapses. Roll a D6 at start of next turn. On a roll of 1-3 the Screamer Killer dies. On a roll of 4-6, treat it as seriously wounded - result 5 above.

ELDAR DREADNOUGHT

DATA RECORD: ELDAR 2

Wraithguard are cybernetic warriors inhabited and controlled by the spirits of dead Eldar heroes. Wraithguard bodies come in a variety of shapes ranging from man-sized to Dreadnoughts. Indeed, Eldar Titans are in a sense large Wraithguard themselves. The Eldar spirits are held in 'spirit stones' and interface directly into the psychic Wraithbone core of the Wraithguard suits. The spirits gradually lose their perception of the material universe in a physical respect, eventually 'seeing' purely in terms of emotions and psychic flux. Because of their increasingly psychic perception Wraithguard need to have friendly troops or psykers nearby to act as an anchor or reference point for their perception of reality, otherwise they may become confused and act randomly. Because of their nature Wraithguard make powerful opponents for daemons, being in a sense daemons of the material universe themselves.

- Type** Dreadnought
- Move** 6"
- Crew** 1 Spirit Stone
- Weapon** Distortion Cannon with 90° field of fire to front
- OR Heavy Plasma Gun with targeter and 90° field of fire to front
- OR Lascannon with targeter and 90° field of fire to front.
- OR Missile Launcher with targeter and 90° field of fire to front
- OR Scatter Laser with targeter and 90° field of fire to front
- AND 1 or 2 Arms with:
- Power Fist plus Flamer with targeter and 90° field of fire to front
- OR Power Fist plus Shuriken Catapult with targeter and 90° field of fire to front
- The Dreadnought fires its weapons with a BS of 6.

Close Combat For the purposes of hand-to-hand combat, the Dreadnought has the following characteristics:

Weapon Skill	6
Strength	7
Initiative	6
Attacks	3
Saving Throw Modifier	-3
Damage	1

The Dreadnought can use the following special attacks:

- POUND
- TEAR
- CRUSH

Rear Armour: -2

PV: 175

MAIN AND ARM-MOUNTED WEAPONS - 90°

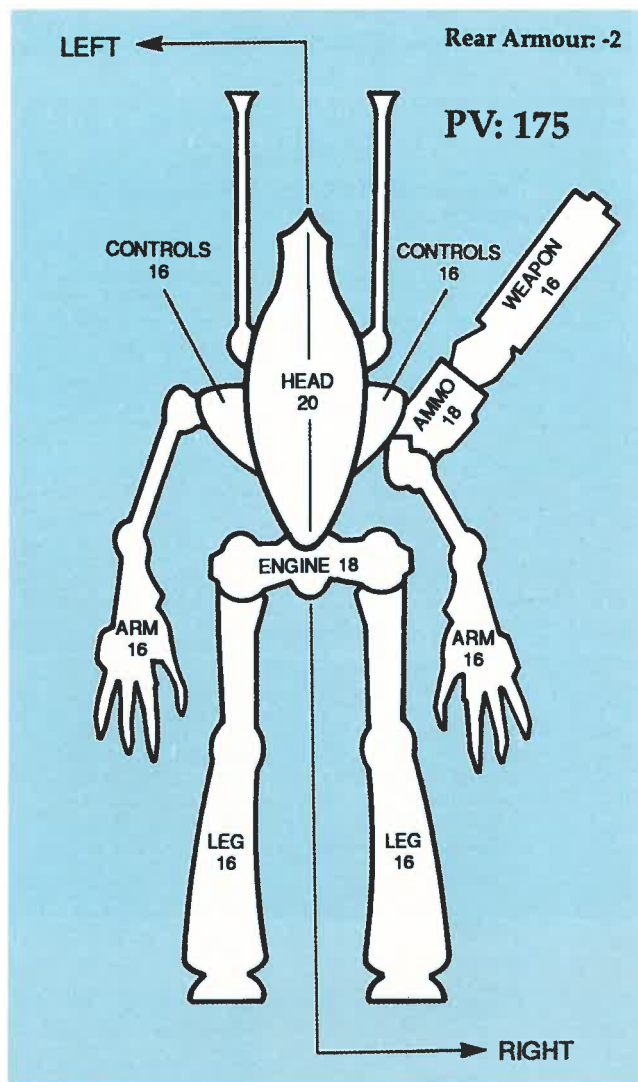
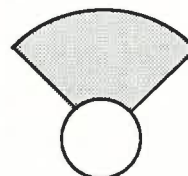

ELDAR DREADNOUGHT

CONTROLLING WRAITHGUARD

If the Wraithguard is within 8" of any Eldar model (except another Wraithguard) at the start of the turn, the Wraithguard follows the actions of the nearest Eldar unit or individual model. If two or more units or individual models are equally close, the Eldar player can choose which the Wraithguard follows.

The Wraithguard becomes psychically attuned to the unit it follows and will perform similar actions – so if the unit advances the Wraithguard will advance, if the unit fires the Wraithguard can fire and so forth.

Use the following guidelines to decide what the Wraithguard can do:

Nearest Eldar unit moves.

If the nearest Eldar unit moves, you can also move the Wraithguard. The Wraithguard doesn't have to move in the same direction as the other Eldar and you can choose to keep it stationary. The Wraithguard may charge into hand-to-hand combat with the enemy if you want.

Nearest Eldar unit moves away from the enemy.

If the nearest Eldar unit moves away from the enemy, you can either choose to move the Wraithguard away from the enemy or keep it stationary. If you move the Wraithguard it must end its move further from the enemy than it started. It doesn't have to move to the same position as the Eldar unit it mimics.

Nearest Eldar unit charges into hand-to-hand combat.

If the nearest Eldar unit charges into hand-to-hand combat, you must move the Wraithguard toward the enemy. It doesn't have to move to the same position as the Eldar unit it mimics and it doesn't have to charge into hand-to-hand combat (though it can if you want it to). It must end its move closer to the enemy than it started.

Nearest Eldar unit remains stationary.

If the nearest Eldar unit remains stationary, the Wraithguard remains stationary. You can turn it to face another direction if you want.

Nearest Eldar unit fires its weapons.

If the nearest Eldar unit fires its weapons (this includes shooting pistols in hand-to-hand combat), the Wraithguard can also shoot. It doesn't have to shoot at the same targets as the Eldar it mimics.

The Wraithguard ends its move in base-to-base contact with an enemy model.

If the Wraithguard ends its move in base-to-base contact with an enemy model it can always attack in hand-to-hand combat. It doesn't matter whether or not the Eldar it mimics are also fighting in hand-to-hand combat.

If the Wraithguard is further than 8" from the nearest Eldar model, it becomes confused unless an Eldar psyker makes a psychic link with the Wraithguard to control it. Any Eldar psyker anywhere on the board can make a psychic link with the Wraithguard provided it can see the model. The psychic link means the Eldar player can control the Wraithguard, moving and firing it how he wants regardless of what nearby Eldar units are doing. However, the psyker cannot use any other psychic powers that turn – making the psychic link prevents him using his powers.

Even if the Wraithguard is within 8" of another Eldar model, you can choose to have one of your psykers take control of the Wraithguard with a psychic link. In this case, you can move and shoot the Wraithguard however you want – it doesn't matter what the nearest Eldar unit is doing.



A psyker can only control one Wraithguard each turn but he can control different Wraithguards from turn to turn. A Wraithguard can be controlled by different psykers in different turns.

If the Wraithguard is not within 8" of another Eldar model and is not controlled by a psyker, it becomes confused. Roll a D6 at the start of the turn to see what it does:

- 1-2 The Wraithguard moves towards the nearest Eldar unit, stopping as soon as it comes within 4". If the unit shoots during this turn, the Wraithguard shoots at the same targets.
- 3 The Wraithguard stands still and shoots at the nearest enemy model.
- 4 The Wraithguard moves towards the nearest cover, stopping as soon as it is under cover. It shoots at the nearest enemy model.
- 5-6 The Wraithguard moves towards the nearest enemy model. If it reaches the model, it fights it in hand-to-hand combat. If it doesn't reach the model it shoots at it.

The only exception to this is a Wraithguard that is in base-to-base contact with an enemy model. The Wraithguard automatically attacks the model in hand-to-hand combat and doesn't have to roll as if it were confused.

DAMAGE CHARTS

Find the chart corresponding to the location, and roll a dice to determine the effects of penetration.

HEAD AND CONTROLS

- 1-3 The Wraithguard's control gear goes crazy and the machine moves in a dangerous and unpredictable fashion. At the start of each of its turns both sides roll a D6. The player with the highest result may move the machine that turn. If stationary the machine must remain so unless the controlling player rolls a 6.

Whichever side moves the machine, the other side may fire any one weapon in any way the player wishes. Other weapons may not fire and the machine may not attack in hand-to-hand combat. Although the enemy will be moving or firing, these actions still take part during the machine's own movement or shooting phase as appropriate.

- 4-5 The spirit stone is destroyed. The Wraithguard comes to an immediate halt and cannot move or fire. The sudden release of psychic energy as the spirit stone is destroyed paralyses any psyker within 18" of the Wraithguard. This affects Eldar psykers and enemy psykers equally. The psyker is rooted to the spot and cannot do anything at all. At the start of each of the psyker's following turns, roll a D6 - on a roll of 4, 5 or 6 the psyker recovers and can act as usual.
- 6 The spirit stone is destroyed. The Wraithguard comes to an immediate halt and cannot move or fire. The Eldar spirit is released and immediately consumed by Slaanesh, and the psychic shock temporarily disorients all Eldar psykers. Eldar psykers can't use any powers until the start of their turn after next.

ENGINE

- 1-2 The engine is badly damaged, and the Wraithguard's maximum move is reduced to half rate.
- 3-4 The engine is destroyed and the Wraithguard comes to an immediate and permanent halt. It may still fire any weapons.
- 5-6 The engine is destroyed and bursts into flames. If the Wraithguard is stationary it is immobilised for the rest of the game. If the Wraithguard moved in its previous turn, it will spin round to face a random direction before coming to a permanent halt. The Wraithguard may no longer fire its weapons.

At the beginning of each of its following turns, the machine explodes on the D6 roll of a 6. An exploding Wraithguard causes 1 strength 10 hit with a -3 save modifier on all models within a 1D6" radius circle positioned over the centre of the machine. Damage from an exploding Wraithguard is D6.

WEAPON

- 1-5 The weapon is destroyed and cannot be used.
- 6 The weapon explodes, destroying it and also causing a hit on the weapon's ammo location. Work out penetration as if the weapon had hit the Wraithguard itself.

AMMO

- 1-3 The ammunition casing is split and starts to react with the air, shells begin to burn, batteries crack and smoulder, and chemicals spill into the machine's interior. At the beginning of each of its following turns, the Wraithguard explodes on the D6 roll of a 4, 5 or 6. An exploding Wraithguard causes 1 strength 10 hit with a -3 save modifier on all models within a 1D6" radius circle positioned over the centre of the machine. Damage from an exploding Wraithguard is D6.
- 4-6 The ammunition is hit and the machine explodes instantly. An exploding Wraithguard causes 1 strength 10 hit with a -3 save modifier on all models within a 1D6" radius circle positioned over the centre of the machine. Damage from an exploding Wraithguard is D6.

ARM

- 1-2 The Wraithguard's arm is hit and partially paralysed. Any weapon incorporated into the arm may still be used, but the arm cannot be used to fight in hand-to-hand combat. The Wraithguard's attacks characteristic is reduced by one.
- 3-4 The Wraithguard's arm is hit and paralysed. The arm is useless. Any weapon incorporated into the arm is destroyed, and the arm may not be used to attack in hand-to-hand combat. The Wraithguard's attacks characteristic is reduced by one.
- 5-6 The Wraithguard's arm is torn from the machine. Any weapon on the arm is destroyed, and the machine cannot use the arm to attack in hand-to-hand combat. The Wraithguard's attacks characteristic is reduced by one.

LEG

- 1-2 The Wraithguard is destabilised by severe damage caused to a leg and is immobilised for the rest of the game. If the Wraithguard moved in its previous turn it will fall over on the D6 roll of a 5 or 6. A falling Wraithguard will collapse as described for 3-4 below.
- 3-4 The Wraithguard collapses into a heap and is permanently immobilised. On the D6 roll of a 5 or 6 it collapses in such a way that 1 randomly determined weapon may still be used. Otherwise the machine collapses and its weapons may no longer be used.
- 5-6 The Wraithguard sways for a moment and then crashes to the ground. The Wraithguard cannot move or fire for the rest of the game. Randomly determine which way the Wraithguard falls, anything underneath it suffers a strength 6 hit with a -3 save modifier causing 1D3 damage.

VEHICLE TURNING TEMPLATE

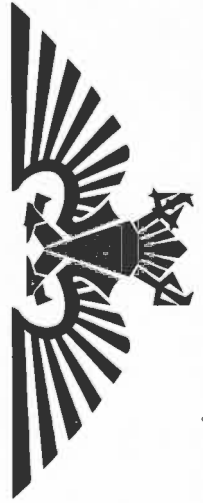
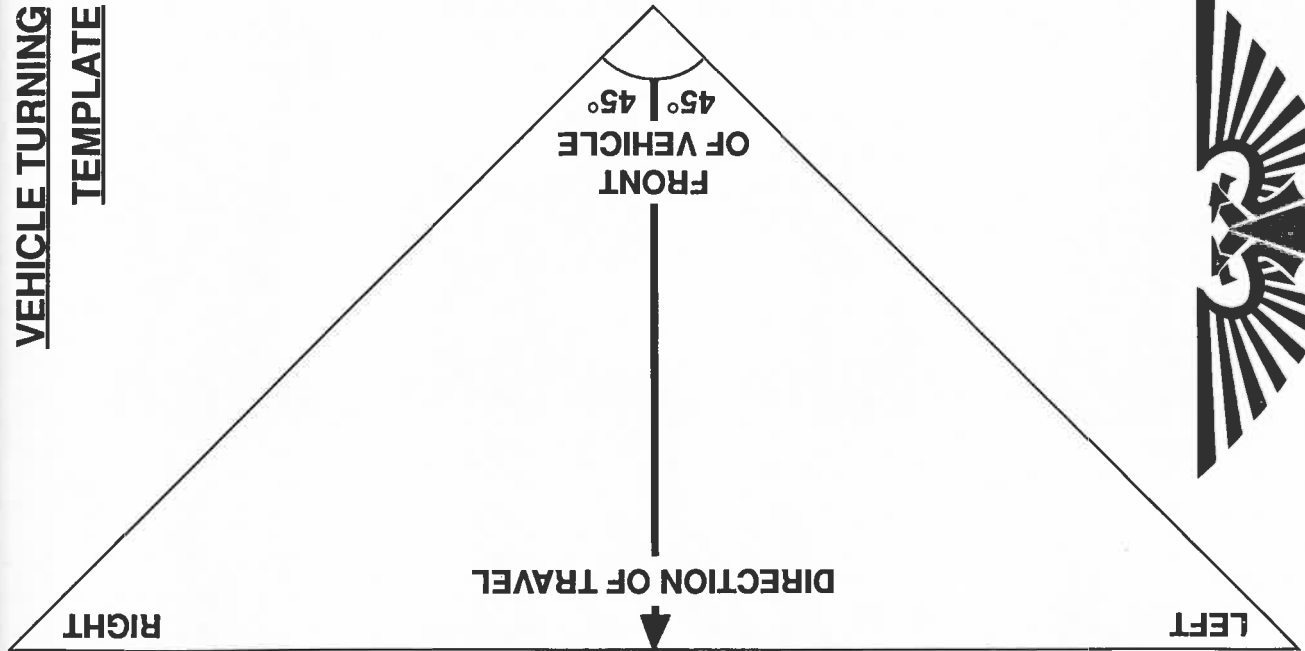

Permission to photocopy for personal use.

© Copyright Games Workshop Ltd, 1992 All rights reserved.

WARHAMMER 40,000 VEHICLE TARGETING GRID

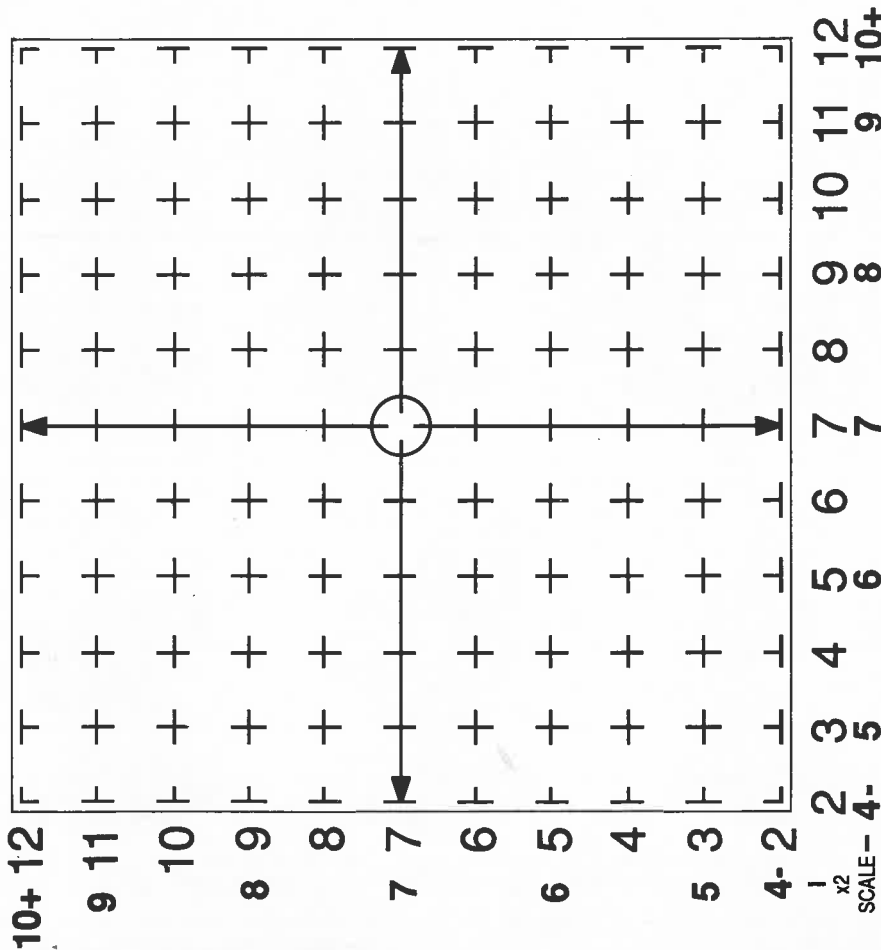

STANDARD VEHICLE HIT AND DAMAGE PROCEDURE

- Place the grid over the target's Data Record, with the centre over the point of aim.
- Roll 2D6 and find the corresponding number on the horizontal axis. The inner scale is used for all vehicles except those printed at twice size, which use the outer scale.
- Roll 2D6 and find the corresponding number on the vertical axis, using the relevant scale. The shot lands where the two numbers meet. This location may then be moved in one direction, towards the crosshairs, by a number of squares equal to the Target Shift Score:

TARGET SHIFT SCORE = BS + To Hit Modifiers - D6

- To see if the shot does damage, roll for the weapon's penetration:

PENETRATION = D6 + Weapon's Strength + Damage Dice

- If the weapon's penetration is greater than the armour value in the target area, roll on the corresponding damage chart to find the exact damage caused.

AREA EFFECT WEAPONS

- Roll a D6 to hit and a D20 for deviation using the standard hit system. If the vehicle is within the area effect marker, follow steps 1-3 and steps 5-6 from the left the following number of times:

Radius	Number
1" - 1 1/2"	2
2" - 2 1/2"	3
3"	4

One roll for Target Shift may also be made (step 4), but the value rolled applies to all rolls.

EMPIRE

EMPIRE COMMAND GROUP



HERO WITH SWORD 1
073919/6



CHAMPION WITH PISTOL
073919/4



HERO WITH HALBERD
073919/5



CAPTAIN
073919/1



HERO WITH SWORD 2
073919/7



STANDARD
073919/3



DRUMMER
073919/2



HERO WITH HAMMER
073919/8

EMPIRE FOOTSOLDIERS



SWORD 1
073906/11



SWORD 2
073906/12



SWORD 3
073906/13



SWORD 4
073906/14



SPEAR 1
073906/7



SPEAR 2
073906/8



SPEAR 3
073906/9



SPEAR 4
073906/10

EMPIRE

EMPIRE HALBERDIERS



HALBERDIER 1
073958/6



HALBERDIER 2
073958/7



HALBERDIER 3
073958/8



HALBERDIER 4
073958/9



HALBERDIER 5
073958/10



HALBERDIER 6
073958/11



HALBERDIER 7
073958/12



HALBERDIER 8
073958/13



FOOTSOLDIER 1
073906/1



FOOTSOLDIER 2
073906/2



FOOTSOLDIER 3
073906/3



FOOTSOLDIER 4
073906/4



HALBERD
073958/5



SWORD AND SHIELD
073906/5



TWO HANDED SWORD
073906/6

THESE FOOTSOLDIERS ARE SUPPLIED WITH SEPARATE PLUG-IN WEAPONS.
THE THREE MINIATURES ABOVE SHOW JUST SOME OF THE POSSIBLE COMBINATIONS.

Designed by Alan and Michael Perry

WD73

Miniatures supplied unpainted. WARNING: This product contains lead which may be harmful if chewed or swallowed. Citadel Miniatures are not recommended for children under 14 years of age. © Copyright Games Workshop Ltd. All rights reserved.

073958/01-13, 073906/01-04, 073958/05, 073906/05, 073906/06



SPACE FLEET

TYRANID HIVESHIP



THE COMPLETE TYRANID HIVESHIP CONSISTS OFF:
1 x HIVESHIP BODY
1 x HIVESHIP TENTACLES



HIVESHIP TENTACLES
077902/2



HIVESHIP BODY
077902/1



TYRANID DRONE 1
077954/1A



TYRANID DRONE 3
077954/3A



TYRANID DRONE 5
077954/2



TYRANID DRONE 2
077954/1B



TYRANID DRONE 4
077954/3B



TYRANID SPORE MINE 1
077966/1



TYRANID SPORE MINE 2
077966/2



TYRANID DARK PROWLER
077915/5



TYRANID WAR DRONE 1
077941/1



TYRANID WAR DRONE 2
077941/2



TYRANID VOID FIEND
077927/1



RAMSMITER KRAKEN
077939/1



DOOMRIPPER KRAKEN
077939/2



HELLBLASTER KRAKEN
077939/3

EPIC WAR MACHINES

THUNDERHAWK GUNSHIP



**THE COMPLETE THUNDERHAWK GUNSHIP
CONSISTS OF:**
1 x THUNDERHAWK TURRET
1 x THUNDERHAWK BODY
1 x THUNDERHAWK WINGS

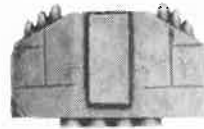

THUNDERHAWK WINGS
076078/24



THUNDERHAWK BODY
076078/23



THUNDERHAWK TURRET
076078/22



RAPIER
076078/26



TARANTULA
076078/25



Designed by Norman Swales

CHAOS DREADNOUGHT

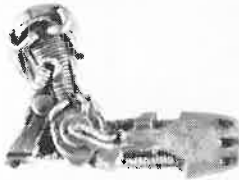

**RIGHT ARM WITH
HEAVY PLASMA GUN**
070184/18



**LEFT ARM WITH
POWER CLAW**
070184/19



**SHOULDER
JOINT**
070184/17



RIGHT LEG
070184/16



LEFT LEG
070184/15



EXAMPLE OF THE COMPLETE CHAOS DREADNOUGHT



UPPER TORSO
070184/13



LOWER TORSO
070184/14

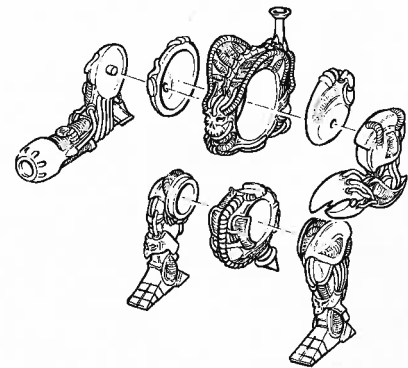

THE COMPLETE CHAOS DREADNOUGHT CONSISTS OF:
1 x UPPER TORSO
1 x LOWER TORSO
1 x RIGHT ARM WITH PLASMA GUN
1 x LEFT ARM WITH POWER CLAW
2 x SHOULDER JOINTS
1 x RIGHT LEG
1 x LEFT LEG

Designed by Alan Perry

WD75

Miniatures supplied unpainted. WARNING: This product contains lead which may be harmful if chewed or swallowed. Citadel Miniatures are not recommended for children under 14 years of age.



ORK DREADNOUGHT



UPPER TORSO SECTION
070644/1



MIDDLE TORSO SECTION
070644/2



LOWER TORSO SECTION
070644/3



LAS CANNON
RTB3/M



HEAVY PLASMA GUN
072129/5



STRAIGHT POWER CLAW ARM
070644/8



LONG LEG
070644/10



HATCH
070644/4



BANNER POLE
070644/5



HEAVY FLAMER
072129/3

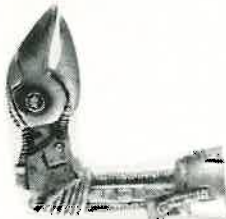

BENT POWER CLAW ARM
070644/9



LEG
070644/11



GRETCHIN PILOT
070644/6



MISSILE LAUNCHER
072129/4



WEAPON MOUNT
070644/7

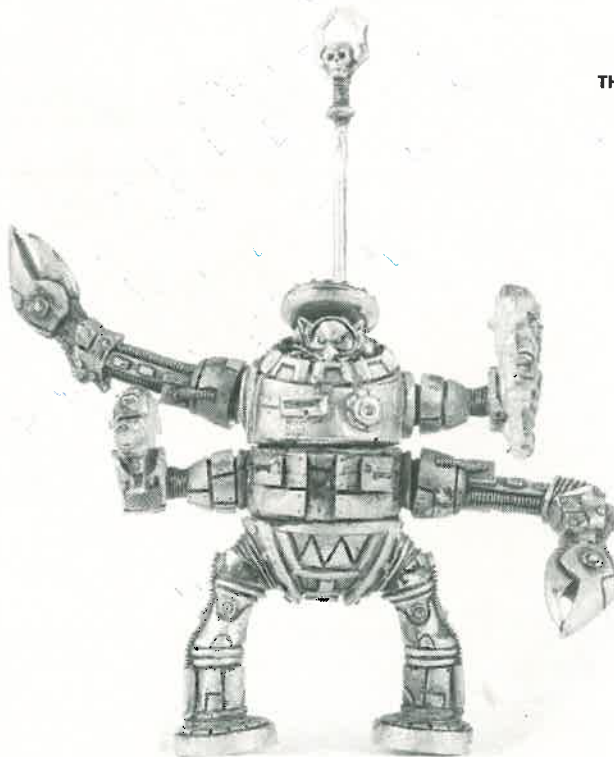

EXAMPLE OF THE COMPLETED ORK DREADNOUGHT

THE COMPLETE ORK DREADNOUGHT CONSISTS OF:

- 1 x UPPER TORSO SECTION
- 1 x MIDDLE TORSO SECTION
- 1 x LOWER TORSO SECTION
- 2 x POWER CLAW ARMS
 - 1 x GRETCHIN PILOT
 - 1 x BANNER POLE
- 2 x WEAPON MOUNTS
 - 2 x WEAPONS
 - 2 x LEGS
 - 1 x HATCH

PLEASE STATE WHICH LEGS, WEAPONS AND POWER CLAW ARMS WHEN YOU ORDER.

Designed by Kev Adams

WD76

Accessories required to assemble. WARNING: This product contains lead which may be harmful if swallowed. Citadel Miniatures are not recommended for children under 14 years of age. © Copyright Games Workshop Ltd. All rights reserved.



CITADEL MINIATURES

DREADNOUGHTS



EXAMPLE OF AN ASSEMBLED
FURIBUNDUS CLASS DESTROYER
DREADNOUGHT
(FURY)



DREADNOUGHT
BODY
07184/2

WIDE DREADNOUGHT
BODY
070184/9



MISSILE LAUNCHER ARM
070184/8

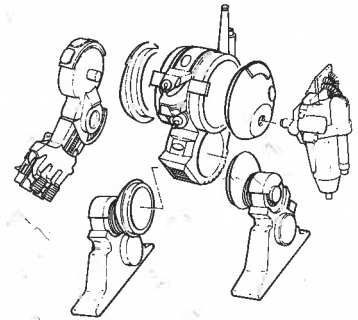

FURIBUNDUS

THIS MODEL WILL REQUIRE ASSEMBLY
AS SHOWN IN THE EXAMPLE ABOVE

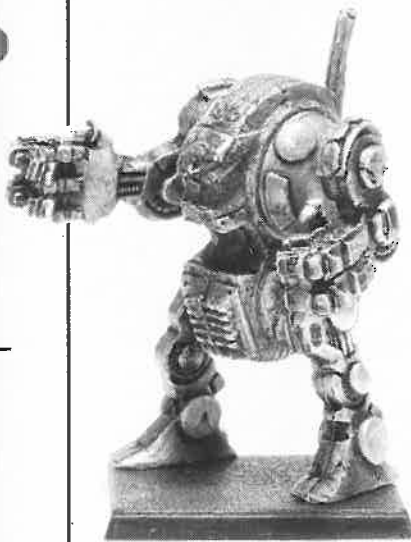

EXAMPLE OF AN ASSEMBLED
CONTEMPTOR CLASS CLOSE
ASSAULT DREADNOUGHT
(CHUCK)



SHOULDER WEAPON
MOUNT
070184/6



LAS-CANNON ARM
070184/10



RIGHT SINGLE BOLTER ARM
070184/7

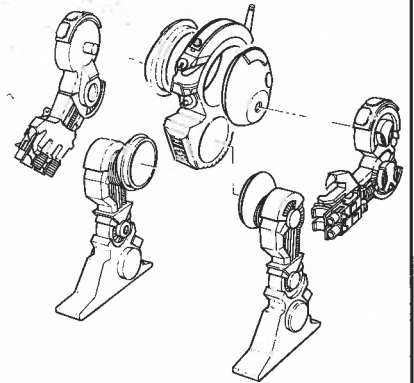

CONTEMPTOR

THIS MODEL WILL REQUIRE ASSEMBLY
AS SHOWN IN THE EXAMPLE ABOVE



RIGHT DOUBLE
BOLTER ARM
070184/1



LEFT DOUBLE
BOLTER ARM
070184/3

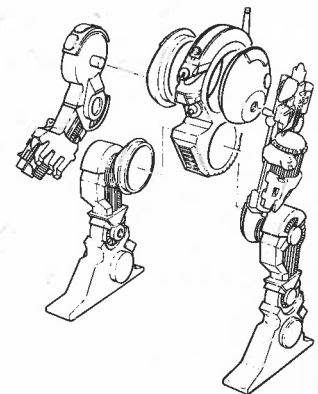

DEREDEO

THIS MODEL WILL REQUIRE ASSEMBLY
AS SHOWN IN THE EXAMPLE ABOVE



EXAMPLE OF AN ASSEMBLED
DEREDEO CLASS ATTACK SUPPORT
DREADNOUGHT
(EDDY)



RIGHT LEG
070184/12



LEFT LEG
070184/11



LONG RIGHT LEG
070184/4



LONG LEFT LEG
070184/5

THE COMPLETE DREADNOUGHT CONSISTS OF:
1 x BODY 2 x ARMS OR WEAPONS
2 x LEGS 2 x SHOULDER WEAPON MOUNTS
ALL THE ARMS, LEGS, BODIES AND WEAPONS
OF THESE MODELS ARE INTERCHANGEABLE

Designed by the Citadel Design Team

WD77

Miniatures supplied unpainted. WARNING: This product contains lead which may be harmful if chewed or swallowed. Citadel Miniatures are not recommended for children under 14 years of age. © Copyright Games Workshop Ltd. All rights reserved.



ELDAR DREADNOUGHTS



RIGHT SHURIKEN ARM
071521/4



RIGHT FLAMER ARM
071521/21



CANOPY
071521/3



EXHAUSTS
071521/2



LEFT SHURIKEN ARM
071521/9



LEFT FLAMER ARM
071521/22



RIGHT DREADNOUGHT LEG
071521/7



RIGHT CLOVEN HOOFED LEG
071521/13



TORSO
071521/1



LEFT DREADNOUGHT LEG
071521/8



LEFT CLOVEN HOOFED LEG
071521/14

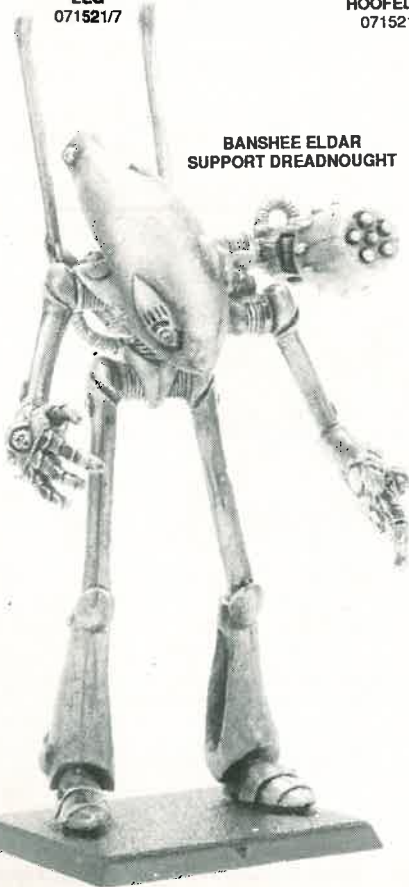

BANSHEE ELДАР SUPPORT DREADNOUGHT

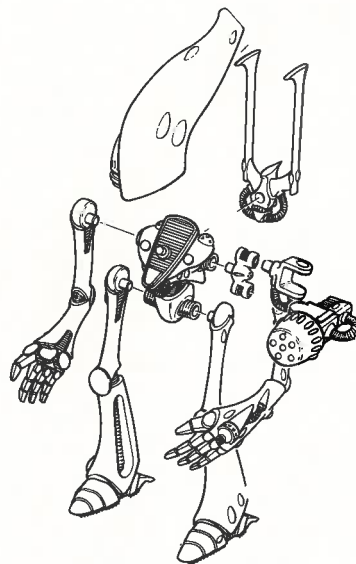

EACH ELДАР DREADNOUGHT CONSISTS OF:
 1 x TORSO 1 x CANOPY
 1 x EXHAUST 1 x RIGHT ARM
 1 x LEFT ARM 1 x RIGHT LEG
 1 x LEFT LEG 1 x WEAPON MOUNT
 1 x DUEL MOUNT 1 x HEAVY WEAPON
PLEASE STATE WHICH ITEMS YOU REQUIRE

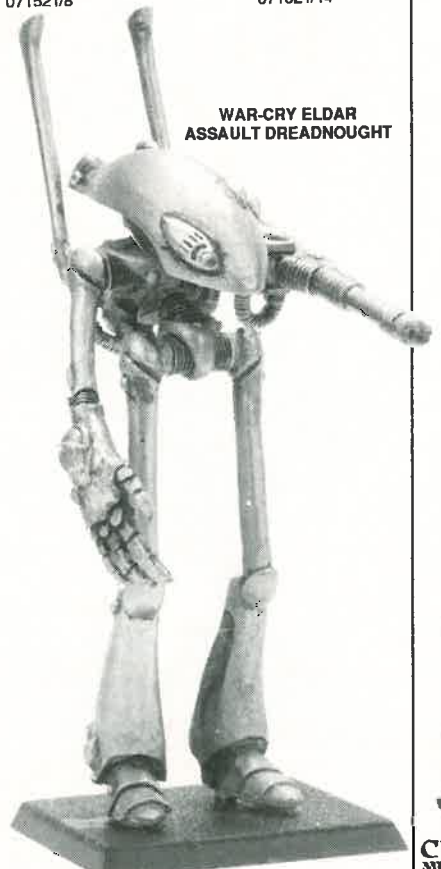

WAR-CRY ELДАР ASSAULT DREADNOUGHT



WARNING: THIS PRODUCT CONTAINS MATERIALS THAT MAY BE HARMFUL IF SWALLOWED. Citadel Miniatures are not recommended for children under 14 years of age. © Copyright Games Workshop Ltd. All rights reserved.

ELDAR DREADNOUGHTS



**EXECUTIONER CLASS
GHOST WARRIOR**
071521/17



**ASSASSIN CLASS
GHOST WARRIOR**
071521/18



**SPIRIT WARRIOR
HEAD**
071521/15

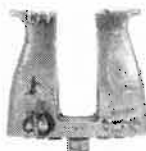

WEAPON SHIELD
071521/12



WEAPON MOUNT
071521/6



DUAL MOUNT
071521/20



D-CANNON
071617/2



LAS CANNON
071521/5



SCATTER LASER
071521/11



HEAVY PLASMA GUN
071521/16



**WAR WALKER
PILOT 1**
071521/10



**WAR WALKER
PILOT 2**
071521/10



MISSILE LAUNCHER
071521/19

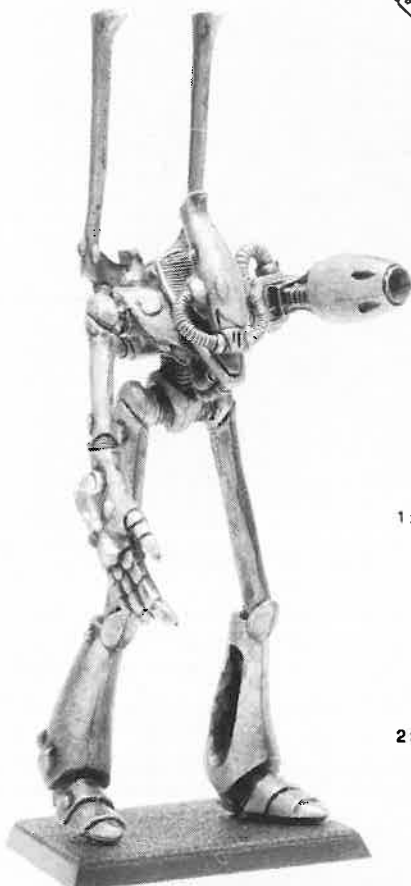
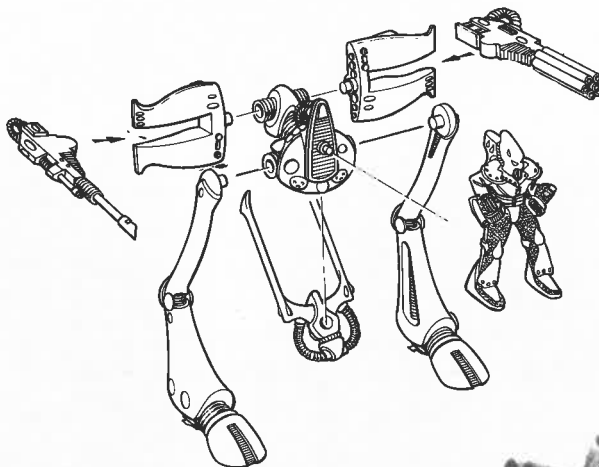

**VAMPIRE CLASS
SPIRIT-WARRIOR
WITH HEAVY PLASMA GUN**

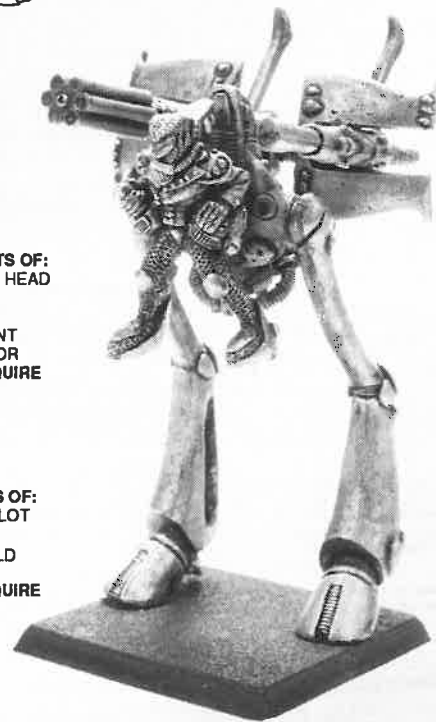

WAR WALKER

EACH ELDAR SPIRIT WARRIOR CONSISTS OF:
 1 x TORSO 1 x SPIRIT WARRIOR HEAD
 1 x LEFT ARM OR 1 x RIGHT ARM
 1 x EXHAUST1 1 x RIGHT LEG
 1 x LEFT LEG 1 x WEAPON MOUNT
 1 x HEAVY WEAPON 1 x GHOST WARRIOR
PLEASE STATE WHICH ITEMS YOU REQUIRE

EACH ELDAR WAR WALKER CONSISTS OF:
 1 x TORSO 1 x WAR WALKER PILOT
 1 x EXHAUST 1 x RIGHT LEG
 1 x LEFT LEG 2 x WEAPON SHIELD
 2 x HEAVY WEAPON
PLEASE STATE WHICH ITEMS YOU REQUIRE

Manufacturers supplied unpainted. WARNING: This product contains lead which may be harmful if swallowed. Citadel Miniatures are not recommended for children under 14 years of age.
 © Copyright Games Workshop Ltd. All rights reserved.



Designed by Jes Goodwin

MIGHTY FORTRESS™



MIGHTY FORTRESS

The Citadel Mighty Fortress is a highly detailed model, designed for use with your Warhammer Fantasy Battle and Warhammer 40,000 armies. The model is supplied as interlocking sections which allow you to create a wide range of fortifications, from lone towers and city walls, to an imposing border fortress.



WARHAMMER SIEGE

This 142 page softback book provides you with complete rules for fighting sieges on the tabletop. Warhammer Siege is the ideal companion to the Citadel Mighty Fortress and can be used in conjunction with Warhammer Fantasy Battle or Warhammer 40,000.

**GAMES
WORKSHOP**



**CITADEL
MINIATURES**

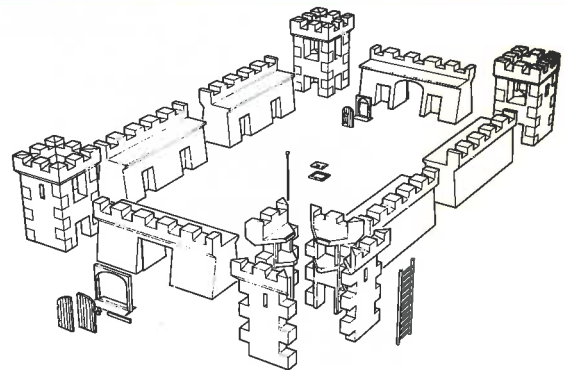

The Citadel Mighty Fortress contains four towers, 4 plain wall sections, 2 wall sections with gateways, plus gates, doors, trapdoors, ladders and other accessories, sufficient to make a fortress 28" x 18" x 7" from tower to tower.



AN EMPIRE FORCE PREPARES TO REPEL A MASSED CHARGE BY GOBLIN WOLF RIDERS

Good