

GAMES WORKSHOP

PRESENT THEIR MONTHLY GAMES MAGAZINE



WHITE DWARF



CITADEL
MINIATURES

144

£1.95

\$3.95



9 770265 871011 12

D-ROK

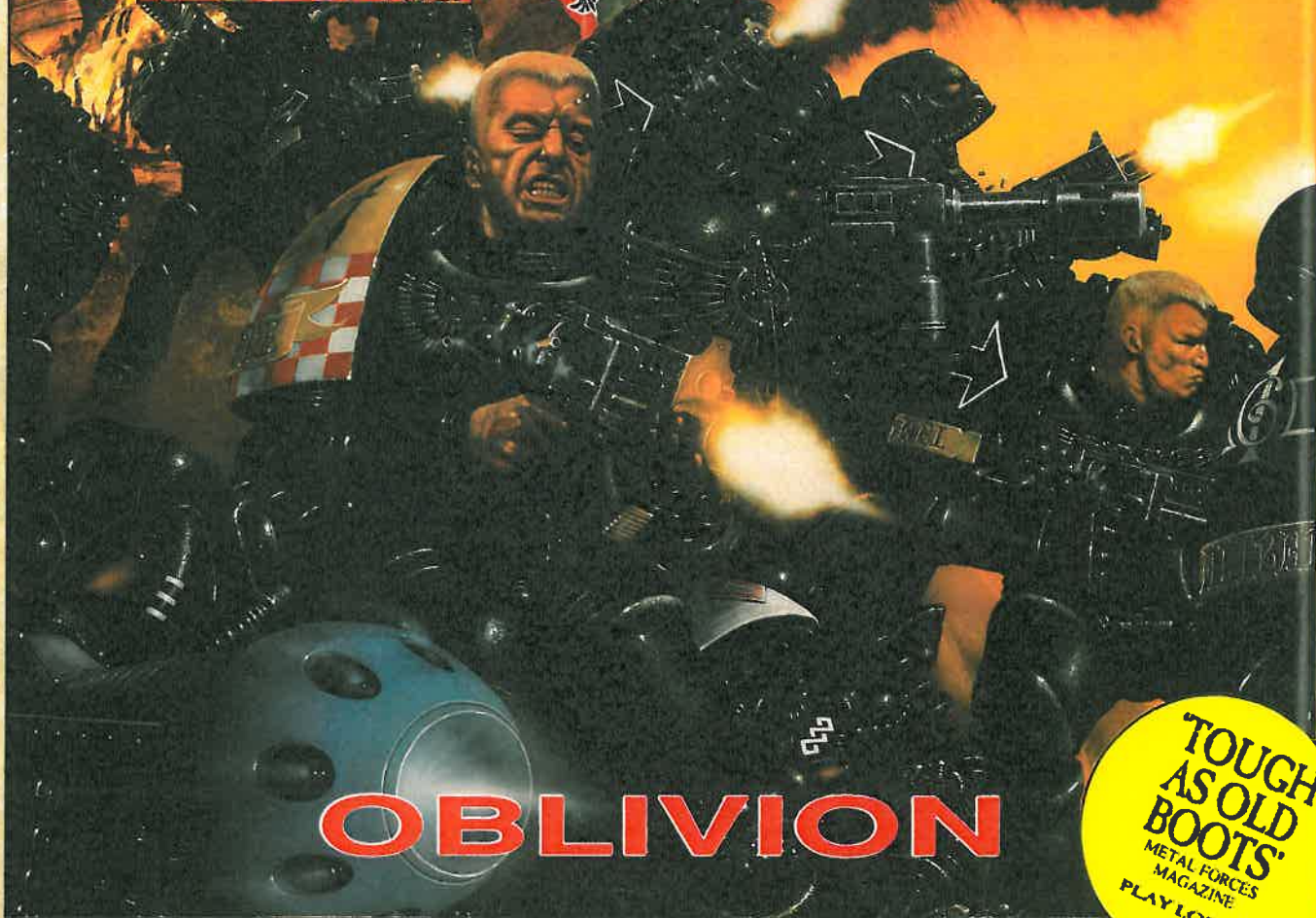

OBLIVION

**TOUGH
AS OLD
BOOTS**
METAL FORCES
MAGAZINE
PLAY LOUD!

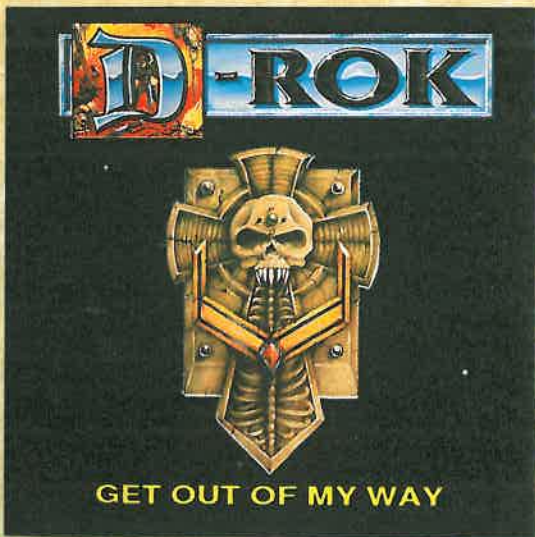

GET OUT OF MY WAY



OBLIVION - The Album

OBLIVION is the first album on the WARHAMMER record label - driving, aggressive British Rock featuring Si from the Batfish Boys and The March Violets in his new band D-ROK.

"It's a hard hitting, strict and precise Metal/Rock album with a distinctive British Sound. With the current mixing of styles, basic Metal is becoming harder and harder to find; if you feel you've been starved, then this should fill you right up" - METAL HAMMER

GET OUT OF MY WAY - The Single

"Listen to the Leaden Power of GET OUT OF MY WAY" - METAL FORCES

OBLIVION is available from the end of October on all formats, and the single GET OUT OF MY WAY is available on 12" vinyl and CD formats.

OUT NOW!

Product Code: 0959
 Ref. No: 009591
 ISSN: 0265 - 8712

Editor: Robin Dews
 Published by Games Workshop Ltd
 Printed by Artisan Press Ltd, Leicester, UK

CORRESPONDENCE

All correspondence except subscriptions and Mail Order should be addressed to *The Editor, White Dwarf, Games Workshop, Howard House, 18 Castle Boulevard, Nottingham NG7 1FL*. Clearly mark your envelope with the name of the game you're writing to us about.

SUBSCRIPTIONS

UK and Rest of World: Please send to *White Dwarf Subscriptions, Games Workshop, Chawton Street, Hilles, Essexwood, Notts NG18 3HY*. For Visa, Access and Mastercard orders, telephone our Mail Order Hotlines on 0775 713215 or 0773 760462. A year's subscription (12 issues) is just £20 for UK residents and £40 for the rest of the world. Postage is included in the price. Please make all payments in Pounds Sterling - make your cheque payable to *Games Workshop*.

US and CANADA: Please send to *White Dwarf Subscriptions, Games Workshop, 3431 Benson Avenue, Baltimore, Maryland 21227*. For Visa and Mastercard orders, telephone our Mail Order Hotline on (301) 944 5959. A year's subscription (12 issues) is \$35 for US residents (Maryland residents add 5% sales tax) or \$45 for Canadian residents. Postage is included in the price. Please make cheques and money orders payable to *Games Workshop*.

When you want to inform us of a change of address or subscription renewal, or if you have a query, please write to the appropriate subscription address. Make sure you tell us your name and present address (and your old address if you're moving). When you subscribe, please tell us if you're renewing an old subscription or starting a new one.

ADVERTISING

For details of advertising rates and copy dates, contact *White Dwarf Advertising, Games Workshop, Howard House, 18 Castle Boulevard, Nottingham NG7 1FL*.

The publishers of *White Dwarf* regret that they cannot accept responsibility for financial transactions between readers and advertisers. *White Dwarf* reserves the right to amend or reject any material submitted for publication as an advertisement.

GAME SUBMISSIONS

We're pleased to consider any previously unpublished articles for *White Dwarf*. All submissions should be typed, double-spaced with 30mm margins on one side of A4 paper, and should be accompanied by an explanatory covering letter and a stamped self-addressed envelope large enough to return the submission. Hand-written submissions will not be considered. Please clearly state on the envelope which game the submission is for - send to the Editor at the *White Dwarf* address.

ARTWORK SUBMISSIONS

We're happy to look at samples of black and white artwork but, in order to deal efficiently with such material, we require that all artwork be submitted as photocopies together with a stamped self-addressed envelope for us to reply and return to work. Please send all artwork submission to the Art Editor at the Design Studio address.

ALL SUBMISSIONS

Always send a copy of your submission and keep the original - *White Dwarf* cannot take any responsibility for the safety of your submissions and regrettably submissions can and do get lost or damaged. Submissions not accompanied by an SAE will not be returned. Please allow at least 6-8 weeks for a reply.

RENEWABLE RESOURCES

White Dwarf is printed on paper from the Myllykoski Paper Mill, Finland. For every tree cut down, the mill plants two more. These are farmed trees grown specifically for paper so their use doesn't diminish the natural stock.

All Games Workshop's boxes, cards and counters are printed using 95% recycled paper.

All subject matter in *White Dwarf* is copyright © 1991 Games Workshop Ltd. All rights reserved.

All artwork in all Games Workshop products and the images contained therein have been produced either in-house or as work for hire. The exclusive copyright on the artwork and the images it depicts is the property of Games Workshop Ltd.

Blood Bowl, Chivalry, Citadel and the Citadel Castle, Confrontation, Dark Future, Epic, Games Workshop and the Games Workshop logo, Realm of Chaos, Talleman, White Dwarf and the White Dwarf figure and Warhammer are registered trademarks of Games Workshop Ltd. *Adoptus Tibanus, Deathwing, Dungeonquest, Games Day, Games Workshop, Gamesmaster, Golden Demon Awards, Kerunch, Mighty Empires, Mighty Warriors, Slottabase, Space Fleet, Space Hulk, Space Marine, 3D Roleplay Hobby Game, Titans and Ultramarine* are trademarks of Games Workshop Ltd. *Flame* is a trademark of Flame Ltd. *GW Books* is a trademark of GW Books Ltd. *Marauder* is a registered trademark of Marauder Miniatures Ltd. *Flame, GW Books and Marauder* are used with permission.



ISSUE 144 DECEMBER 1991

AUDITED AT
73,134 COPIES
PER MONTH

WHITE DWARF

CONTENTS

COVER: CHAOS MARINES - Geoff Taylor

Geoff's stunning painting shows an assault by the World Eaters Chaos Marines of Khorne. Geoff has completely captured the feel of Chaos Marines with his vibrant colours and dynamic poses.

EPIC ASSAULT SCENARIOS - Jervis Johnson and Andy Chambers

New rules for attack and defence scenarios in *Space Marine*. Andy and Jervis have come up with an exciting system for playing large scale assaults on your tabletop. The rules introduce a brand new set of battlecards that allow you use strongpoints, bunkers, razor wire, minefields and entrenchments in your epic battles. We've also provided full colour minefield and razor wire markers to use in your games.

ELVEN LORDS - Mike McVey

Mike talks us through the latest addition to his *Warhammer Fantasy Battle* Wood Elf army in the form of a regiment of Elven Lords

MODELLING WORKSHOP - Robin Dews, Richard Helliwell and Mark Watts

Following on from the rules for assault scenarios in *Space Marine* Robin, Richard and Mark have come up with some simple techniques for building epic scale, bunkers, razor wire, minefields and entrenchments.

ARMIES OF THE IMPERIUM - Andy Chambers, Jervis Johnson and Rick Priestley

New rules and data cards for epic vehicles in *Space Marine*. These include the Eldar Wave Serpent, Warp Hunter and the Deathstalker Prism Cannon. Plus Imperial Tunnellers and the Leviathan Command Centre.

'EAZY METAL - EPIC VEHICLES AND TITANS

This month we show the new models we've added to our epic armies, painted by the Games Workshop 'Eazy Metal' team.

SPACE HULK QUESTIONS AND ANSWERS - Dean Bass

Dean replies to some of the questions he was most frequently asked about *Space Hulk* when he talked to many of you at Games Day '91

NOISE MARINES - Rick Priestley

From out of the Eye of Terror storm the dreaded Noise Marines. Rick provides the background to these Chaos Marines of Slaanesh, together with the rules for their devastating Sonic Blasters in *Warhammer 40,000*

DARK ELF ARMY - Kent Martin and Christopher Alvord

Kent Martin works for Games Workshop in the US. He's recently painted a 1000 point Dark Elf army for *Warhammer Fantasy Battle*. He takes us through the process of selecting, painting and fielding his force

WARHAMMER FANTASY BATTLE PLAYSHEET - Rick Priestley

Rick has condensed and summarised the most commonly used *Warhammer Fantasy Battle* rules onto a single, easy to use playsheet

WARDANCERS - Andy Chambers

Andy has revised and updated the Elf Wardancers in *Warhammer Fantasy Battle*

BASIC TERRAIN - Rick Priestley

Rick explains how to go about creating a basic gaming set-up. He covers the different types of materials you can use to make a gaming table and explains how to build basic hills, woods and other scenery

DWARF ARMY - Wayne England

A few months ago we gave you a sneak preview of Wayne's *Warhammer Fantasy Battle* Imperial Dwarf Army. Since then he's been busily painting more regiments and war machines

TITAN DATA SHEETS - Andy Chambers and Jervis Johnson

New data cards for the Eldar Phantom Titan, the Imperial Warhound Scout Titan and the Ork Slaughter Gargant. We include new rules for all the Eldar Titan weapons in *Space Marine*

ADVERTS

| | | | |
|-----------------------------|--------------|-----------------------------|----|
| D-Rok..... | Inside Front | Marauder Miniatures..... | 49 |
| Games Workshop Retail..... | 2 | Norwich Games Workshop..... | 57 |
| US Baltimore New Store..... | 5 | Games Workshop Staff..... | 57 |
| Space Marine..... | 23 | Epic Stompers..... | 73 |
| Golden Demon 1992..... | 39 | | |



Rick Priestley



Andy Chambers



Kent Martin



Mike McVey



Robin Dews

GAMES WORKSHOP[®]

STORES

Games Workshop Stores are much more than just places where you buy games – they are the centre of hobby gaming in your area. There are regular special events including workshops and demonstrations of all kinds that everyone is welcome to come along to and join in with. Our friendly staff are more than happy to help you with any questions or queries you have about the Games Workshop world of hobby gaming. Drop in to or call your local Games Workshop Store for more details, plus up-to-the-minute news of any other special events.

BEGINNERS' MINIATURE PAINTING

Every Games Workshop store has an area set aside for you to learn the basic techniques for painting units of Citadel and Marauder Miniatures. We supply the paints and brushes – all you need to bring along are some miniatures to paint. If you've never painted miniatures before or you've only just started, we're happy to show you how it's done. There's always a member of the staff or a local expert painter on hand to show you what you need to know and give you useful tips and advice.

BEGINNERS' GAMING SESSIONS

Newcomers to the Games Workshop hobby are more than welcome to come along to any Games Workshop store and join in with the beginners gaming sessions. Our friendly staff will be happy to give you advice on the best way to build up your own army, explain the rules and answer any questions you might have about the Games Workshop hobby. All you have to do is drop in at your local Games Workshop store and talk to a member of staff about which games you'd like to play.

STORE ADDRESSES

THE NORTH

HULL
30 PARAGON STREET, HULL
CLUB NIGHT: THURS TILL 8.00
CONTACT: ALAN
TEL: 0482 589576

LEEDS
12-16 CENTRAL RD,
LEEDS, LS1 6DE
CLUB NIGHT: WED TILL 8.00
CONTACT: PAUL
TEL: 0532 420834

LIVERPOOL
47 LORD ST,
LIVERPOOL, L1 4DJ
CLUB NIGHT: THURS TILL 8.00
CONTACT: ROGER
TEL: 051 258 1404

MANCHESTER
UNIT 1, 3 BROWN ST,
MANCHESTER, M4 3AB
CLUB NIGHT: THURS TILL 8.00
CONTACT: KARL
TEL: 061 832 6863

MIDDLESBROUGH
39 DUNDAS STREET,
MIDDLESBROUGH
CLUB NIGHT: THURS TILL 8.00
CONTACT: MARK
TEL: 0642 254091

NEWCASTLE
63 CLAYTON ST,
NEWCASTLE-UPON-TYNE
CLUB NIGHT: THURS TILL 8.00
CONTACT: IAN
TEL: 091 232 2418

PRESTON
15 MILLER ARCADE,
PRESTON, PR1 2QA
CLUB NIGHT: THURS TILL 8.00
CONTACT: SPENCER
TEL: 0772 821855

SHEFFIELD
16 FITZWILLIAM GATE,
SHEFFIELD
CLUB NIGHT: THURS TILL 8.00
CONTACT: DAVE
TEL: 0742 750114

YORK
26 GOODRAMGATE,
YORK, YO1 2LG
CLUB NIGHT: FRI TILL 8.00
CONTACT: EVAN
TEL: 0904 653576

MIDLANDS

BIRMINGHAM
519 BRIDGELINK,
BULL RING CENTRE,
BIRMINGHAM
OPEN 9.30-5.30 MON TO SAT
CONTACT: TED
TEL: 021 632 4804

COVENTRY
14 CITY ARCADE, COVENTRY
CLUB NIGHT: THURS TILL 8.00
CONTACT: STUART
TEL: 0203 227311

DERBY
42 SADLER GATE,
DERBY, DE1 3NL
CLUB NIGHT: THURS TILL 8.00
CONTACT: MARK
TEL: 0332 371657

DUDLEY
KIOSK-U, UPPER LEVEL, MERRY
HILL CENTRE,
BRIERLEY HILL, DUDLEY
CLUB NIGHT: THURS TILL 9.00
OPEN 10.00 TILL 8.00,
MON TO FRI
9.00 TILL 7.00 SAT
CONTACT: SIMON
TEL: 0384 481818

NOTTINGHAM
34A FRIAR LANE,
NOTTINGHAM,
NG1 3DU
CLUB NIGHT: THURS TILL 8.00
CONTACT: CHRIS
TEL: 0602 480651

EAST ANGLIA

CAMBRIDGE
4 QUAYSIDE,
(OFF BRIDGE STREET)
CAMBRIDGE
CLUB NIGHT: THURS TILL 8.00
CONTACT: DAVE
TEL: 0223 313350

NEW STORE

NORWICH
12-14 EXCHANGE STREET,
NORWICH,
CLUB NIGHT:
THURS TILL 8.00
CONTACT: JOHN
TEL: 0603 767656

THE SOUTH

BRIGHTON
7 NILE PAVILIONS, NILE ST,
BRIGHTON,
BN1 1HW
CLUB NIGHT: FRI TILL 8.00
CONTACT: CHRIS
TEL: 0273 203333

BRISTOL
13 BROAD WEIR,
BRISTOL
CLUB NIGHT: THURS TILL 8.00
CONTACT: SHANE
TEL: 0272 251533

LUTON
12 PARK ST,
LUTON, LU1 9EP
CLUB NIGHT: THURS TILL 8.00
TEL: 0582 417474

MAIDSTONE
UNIT 6, 1-9 PUDDING LANE
MAIDSTONE
CLUB NIGHT: THURS TILL 8.00
CONTACT: GUY
TEL: 0622 677435

OXFORD
1A BUSH HOUSE,
NEW INN HALL STREET,
OXFORD
CLUB NIGHT: THURS TILL 8.00
CONTACT: ANDREW
TEL: 0865 242182

READING
UNIT 3, CHEAPSIDE, READING
CLUB NIGHTS: WED AND
THURS TILL 8.00
CONTACT: BOB
TEL: 0734 598663

SOUTHAMPTON
23 EAST ST,
SOUTHAMPTON, SO1 1HG
CLUB NIGHT: THURS TILL 8.00
CONTACT: REES
TEL: 0703 331962

TORQUAY
12 MARKET ST,
TORQUAY, TQ 1AQ
CLUB NIGHT:
THURS TILL 8.00
CONTACT: ROB
TEL: 0803 201036

All UK Games Workshop stores are open from 10.00am until 6.00pm Monday to Friday and from 9.30am until 5.30pm on Saturdays unless otherwise stated.

SCOTLAND

EDINBURGH
136 HIGH ST,
EDINBURGH, EH1 1QS
OPEN SUNDAY 11.00 - 5.00
CLUB NIGHT:
THURS TILL 8.00
CONTACT: MARTIN
TEL: 031 220 6540

GLASGOW
66 QUEEN ST,
GLASGOW, G1 3DS
CLUB NIGHT:
THURS TILL 8.00
CONTACT: ALISDAIR
TEL: 041 226 3762

LONDON

BECKENHAM
292-294 HIGH ST, BECKENHAM,
KENT, BR3 1DY
CLUB NIGHT: THURS TILL 8.00
CONTACT: TONY,
TEL: 081 658 8102

CENTRAL LONDON
UNIT F10,
THE PLAZA,
116-128 OXFORD ST,
LONDON, W1R 1FA
OPEN 10.00-7.00 MON TO FRI
10.00-7.00 SAT
CLUB NIGHTS: MON TO SAT
CONTACT: LANCE,
TEL: 071 436 0839

CROYDON
UNITS 35, DRUMMOND CENTRE,
KEELEY ROAD, CROYDON
CLUB NIGHT: THURS TILL 8.00
CONTACT: ED, TEL: 081 680 4600

HAMMERSMITH
1 DALLING RD, HAMMERSMITH,
LONDON, W6 0JD
CLUB NIGHT: THURS TILL 8.00
CONTACT: JOE
TEL: 081 741 3445

HARROW
296 STATION RD, HARROW,
MIDDLESEX, HA1 2DX
CLUB NIGHT: MON TILL 8.00
CONTACT: JAMIE
TEL: 081 861 2350



GAMES WORKSHOP®



**USA & CANADA
RETAIL STORES**



BALTIMORE

714 YORK ROAD
TOWSON
MD21204

OPENING HOURS
MON-SAT 11.30-7.30
SUNDAY 11.30-5.30
TUESDAY-CLOSED

CONTACT: FRANK
TEL: (401) 821 5444

COLLEGE PARK

UNIVERSITY OF MARYLAND
LEHIGH ROAD
COLLEGE PARK,
MD 20740

OPENING HOURS
THURS TO SAT
11.00-7.00
SUNDAY 12.00-6.00
CLUB NIGHT:
FRI TO SUN
TEL: (301) 864 5668

PHILADELPHIA

424 SOUTH STREET
PHILADELPHIA,
PA 19147

MON/WED/THURS
11.00-6.00
TUESDAY: CLOSED
FRI/SAT 11.00-9.00
CLUB NIGHT:
WED TO SUN
CONTACT: JEREMY
TEL: (215) 829 0554

FAIRFAX

FAIR CITY MALL
9600G MAIN STREET
FAIRFAX, VA 22031

OPENING HOURS
MON TO SAT 11.00-9.00
SUNDAY: 12.00-5.00
CLUB NIGHT:
EVERY NIGHT
CONTACT: OWEN
TEL: (703) 503 9284

CALIFORNIA

313 SANTA MONICA BLVD
LOS ANGELES
CA 90404

MON 11.00-7.00 TUES:
CLOSED
WED TO SUN 11.00-7.00
CLUB NIGHT: WED TO
SUN
CONTACT: DAVE
TEL: (213) 395 6711

FAIRFAX

FAIR CITY MALL
9600G MAIN STREET
FAIRFAX, VA 22031

OPENING HOURS
MON TO SAT 11.00-9.00
SUNDAY: 12.00-5.00
CLUB NIGHT:
EVERY NIGHT
CONTACT: OWEN
TEL: (703) 503 9284

VANCOUVER

205 CARRALL STREET
VANCOUVER
BRITISH COLUMBIA
V6B 2J2
MON - SAT 11.00-7.00
SUNDAY 12.00-6.00
TUESDAY: CLOSED
CLUB NIGHT:
EVERY NIGHT
CONTACT: GEOFF
TEL: (604) 685 8823

TORONTO

331 QUEEN STREET WEST
TORONTO, ONTARIO
M5V 2A4

MON TO SAT 10.00-7.00
SUNDAY: CLOSED

CLUB NIGHT:
EVERY NIGHT
CONTACT: LOGAN
TEL: (416) 595-1159

GAMES WORKSHOP®

BALTIMORE

NEW STORE

714 YORK RD, TOWSON, MD 21204

TEL: (401) 821 5444

HOW TO GET THERE.

From the Baltimore beltway (I - 695) take York Road South (exit 26). The store is on the right-side of the road, approx 1 mile from I-695, just past Mc Donald's

OPENING TIMES

MONDAY 11.30 - 7.30
WED TO SAT 11.30 - 7.30
SUNDAY 11.30 TO 5.30
TUESDAY: CLOSED

MANAGER
FRANK BARICH



SPACE MARINE[®]

ASSAULT!

New rules for attack and defence scenarios in Space Marine

By Jervis Johnson and Andy Chambers

In the 41st millennium wars smoulder and flare across a thousand worlds in the Imperium of mankind. The vast forces of the Imperial Guard and Space Marines are in constant battle against Orks, Eldar, Chaos, rebellious humans and Squats.

Not all of these battles are fought between equally balanced forces engaging simultaneously. More often than not a battle will be fought between a vastly superior attacking force and a well dug-in, but heavily outnumbered defender. The following rules allow you to fight these desperate assaults against entrenchments and bunkers, heavily defended by wire and mine fields. Assault scenarios provide you with a new and exciting set of tactical problems to face. Can the attacker overwhelm or out-manoeuvre the cunningly-laid

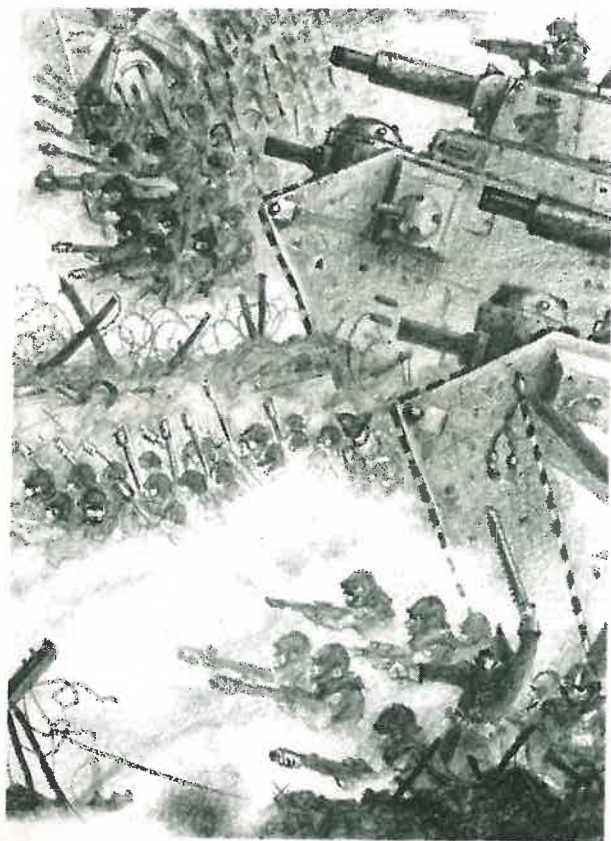

defences of the beleaguered garrison? or will the defender be able to destroy enough of the attacking hordes as they advance, to stand a chance of survival in the deadly hand-to-hand combat which follows?

When playing assault scenarios, one player is called the *attacker* and the other the *defender*. The two players have quite different forces and victory conditions. The attacker must seize a set of objectives hidden deep in the defender's half of the table without taking too many casualties in the process. The defender is heavily outnumbered and must make maximum use of cover and field fortifications to protect his meagre forces, while inflicting as many casualties on the attacker as possible.

In order to play an assault scenario, decide on a points value for the game and set up the terrain as normal. Note that you do this *before* you know who will be the attacker and who will be the defender. This encourages you to set up the terrain in a way that doesn't give an advantage to either side. After you've set up all the terrain, both players roll a D6. Whoever scores higher gets the choice of attacking or defending and the players choose their forces.

Assault scenarios introduce a new kind epic battletcard – the **fortification card**. Fortification cards allow the players to purchase entrenchments, bunkers, razor wire, minefields and strongpoints to use in their games. Both players can purchase fortification cards but in assault scenarios the following special rules apply. All of the defender's cards with the exception of fortification cards cost **double points**. This means that the defender will be outnumbered two to one or more - but he does receive a number of special advantages to even the odds in his favour!

After both player's have chosen their armies, the defender selects a table edge and sets up his forces up to halfway in from his edge of the table. Only four objective counters are used. They are all placed by the defender when he sets up his army using the normal placement rules for objective counters. This means that all four objectives will be deep in his half of the table and heavily defended, which is as it should be.

All defending units use the *hidden set-up* rules and count as *dug-in* (see below). After the defender has set up his army and objective counters, the attacker sets up

his army anywhere within 15cm of the opposite edge of the table. Because the attacker and the defender set up one after the other there is no need for either player to make a map or for you to use a screen when setting up.

The number of victory points each side needs to win is decided in the normal way. However, in the assault scenario the defender receives **double** VP's for breaking enemy units and the attacker receives **double** VP's for capturing objectives. This means that the defender must do his best to cause as many casualties to the attacker as possible, while the attacker must try his hardest to capture the objectives held by the defender.

You'll find fortification cards for bunkers, minefields, razor wire, strongpoints and entrenchments elsewhere in this issue. Note that fortification cards do not have a break point and do not give any victory points to the attacker if they are destroyed. We've also printed some cut-out minefields, razor wire and hidden set-up counters, so that you can try these rules out straight away in your own games.



HIDDEN SET UP

Defending forces invariably take great pains to conceal the disposition of their units. Both physical camouflage and powerful sensor-scramblers are used to fool the enemy. This is done to prevent the attackers using heavy artillery barrages to disrupt the defenders. It also allows the defending commander to conceal the actual composition of his force until he can unleash them to the most devastating effect.

When you use hidden set-up your units are not set up directly on the table at the start of the game. Instead you take a *hidden set-up counter* for each unit and place this on the table roughly where you want the unit to go.

You'll find a number of hidden set-up counters on the same page as the minefield and razor wire markers elsewhere in this issue. Make a note of which unit the counter represents by recording the number on the counter and the name of the unit on a piece of scrap paper. Make sure that you keep this list secret from your opponent!

As long as the unit remains hidden none of the models are put on the table and they may not be attacked in any way. Neither are they allowed to make attacks themselves. The only exception to this rule are Titans and Gargants which are far too large to be concealed.

Units can be hidden in any terrain, including in the open. Remember that the defender has had a long time

to prepare his defences and will have carefully camouflaged all of his positions, which will make his troops very hard to spot. However, if an enemy unit is within 25cm of the hidden set-up counter when it finishes its move, it is close enough to spot the hidden positions and the whole unit must be revealed at the start of the combat phase.

Hidden units count as on first fire orders, and do not need to be given any order counters. If you want to give them charge or advance orders you must reveal the whole unit in the orders phase at the time that you give them the orders. Similarly, if you want to fire with any model in a unit that is hidden, you must reveal the whole unit at the start of the combat phase before you can fire. However, you can use the hidden set-up counter as an 'observer' for indirect barrage attacks without revealing the unit.

When the unit is revealed, one model (owning player's choice) is placed at the point occupied by the counter. The remaining models may be set-up as you wish, provided normal formation rules are obeyed. You may even place the units straight into close combat if you want! The hidden set-up counter is flipped over onto its other side to show that the unit is 'dug-in'. Once revealed, a unit will be continually tracked by the commander of the attacking forces, so it is impossible for a unit to become hidden again during the course of the game.

DUG-IN COUNTERS

Defending units will also spend time fortifying their positions as much as possible. They'll not only construct bunkers and entrenchments if time permits, but will also dig fox-holes and weapon pits for individual troops and vehicles.

You will notice that the back of the hidden set-up counter says 'dug-in'. When the hidden unit is revealed, flip the counter over so that this side is showing. Having a dug-in counter means that the unit does *not* have to be given an order counter; they are treated in all ways as if they have first fire orders.

As long as the unit remains dug-in, all enemy attacks suffer a -1 to hit modifier. This modifier applies in addition to any other modifiers, so a model that is dug-in in a building or behind a fortification, for example, will be at -3 to be hit. (It may seem funny that a unit can be dug-in in a trench, but this simply represents the fact that it has spent time reinforcing their position, adding extra sandbags and so on.)

A unit can remain dug-in for as long as you like. However if you want to move any of the models in the unit you will have to give them advance or charge orders as normal, and these orders will replace the dug-in counter. Also, if the unit is forced to fall back, the fall back order counter replaces the dug-in counter.

Once a dug-in counter has been removed for any reason it is assumed that the unit has moved out of its fortified positions. This means that the dug-in counter is lost and cannot be replaced during the game.

ATTACK AND DEFENCE TACTICS IN SPACE MARINE

By Andy Chambers and Robin Dews

The aim of this article is to give Space Marine players some hints and tips on how to attack and defend fortifications on the tabletop. You might think that with minefields, razor wire and bunkers your troops would be virtually invulnerable to attack, but in fact nothing could be further from the truth.

The history of the Imperium is littered with examples of how a seemingly impregnable force, buried deep in their bunkers and fortresses, became literally buried in them by a more mobile and adventurous attacker. Or tales of huge attacking forces cut down in swathes while they struggled through a maze of minefields and razor wire to reach the enemy. So what's the best way to stop an attacking horde, or dig the defenders out of their bunkers? We've put together some useful strategies to help both attackers and defenders achieve their objectives.

DEFENCE STRATEGIES

The defending player really has his work cut out for him. If the defences are poor there is a chance that the attacker can overwhelm them with sheer weight in numbers. The defender has fixed defences on his side but the problem with fixed defences is that unless the defender manages to cover every possible line of approach, the enemy force can probe them for the inevitable weak spots.

Once the enemy has breached the defensive line the attacker's superiority in numbers can be brought to bear and the defenders will soon be overrun. This is particularly true in Space Marine where a number of specialised units such as assault squads, skimmers and tunnellers can move under, over or around your carefully prepared positions with ease.

So how do you make the most of your static defences? There are two main techniques that you can employ when you set up and man your defences. These are what's called 'defence in depth' and 'channelling'. Used in combination they provide a solid defensive structure that even the most well equipped troops will find hard to crack.

The underlying principle behind defence in depth is that by sheer weight of numbers and firepower, the attacker will always eventually overpower and break through the lines of a static defender.

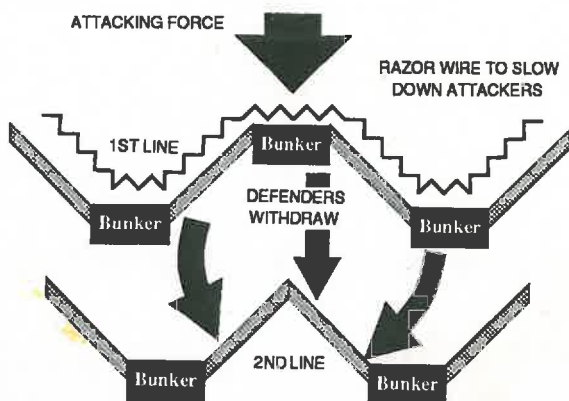

DEFENCE IN DEPTH

To counter this, the defender must construct not a single defensive line but a series of prepared positions, one behind the other. Thus as the first position gives way under the pressure of the assault, the defenders can fall back to the previously prepared next position to reinforce the defenders already waiting there.

In the case of a defence in depth, maximum use must be made of natural cover when creating the defensive lines. This is in order to cut down on the amount of bunkers and redoubts you'll need, after all some points have to be left to buy troops with! If for some reason it's not possible to create several defensive lines (such as unsuitable terrain or low points), another approach is to create a number of fortified positions or 'hedgehogs'.

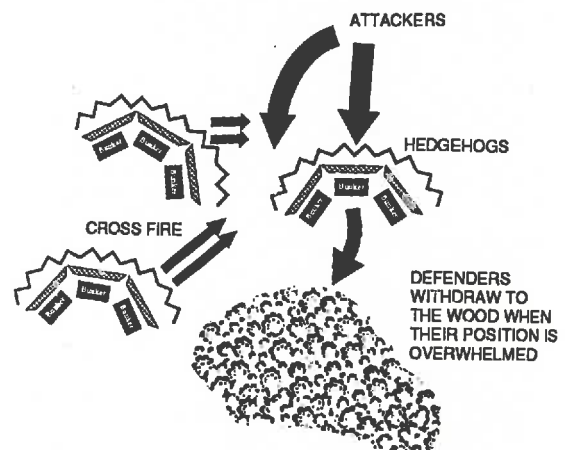

These fortified positions are placed so that an attacker going up against one will be caught in a crossfire from the others. As with defensive lines, the idea is not for each position to stand and die to the last man. If the position is in danger of being overwhelmed the surviving defenders fall back to another position. You could even build a defence around each objective marker, though you should always resist the temptation to put all your objectives in a small area as this will make life very easy for the attacker.

The idea of a defence in depth is to wear the attacker down. In each successive assault, the attacker will lose large amounts of men and equipment. Even when they eventually break through, they will have gained little advantage because they will immediately have to repeat the process against the new defensive line. Eventually the attacker will run out of reserve troops to throw into the battle and the attack will lose its momentum. At this point, the defender will be able to launch a well-timed counter attack and drive back the remaining attackers. This principle works well in Space Marine as the defending player scores double victory points for breaking attacking units.

CHANNELLING

The principle of channelling lies in allowing the attack to flow in through pre-determined and strengthened channels, and so dissipate its energy harmlessly.

SPACE MARINE FORTIFICATION CARDS

FORTIFICATION - RAZOR WIRE

This card entitles you to place razor wire entanglements up to 100cm long by 5cm wide anywhere in your set up area.



POINTS VALUE 150

Razor wire can only be crossed by units that have advance orders. Units with charge orders may not cross razor wire entanglements.

The sole exception to this is models that clear a path through difficult terrain such as Gorgons or surfaced Tunnelers. These may pass through the razor wire while on charge orders. Once these models have passed over the razor wire they leave a gap wide enough for a single infantry stand or model to pass through.

Skimmers, Titans and Gargants can pass directly over the wire and therefore ignore it.

FORTIFICATION - ENTRENCHMENTS

This card entitles you to place a set of entrenchments up to 50cm in length anywhere in your set up area.



POINTS VALUE 150

Entrenchments are battlefield fortifications designed to shield infantry against the worst effects of artillery or incoming fire. They range from hastily improvised foxholes and trenches to well prepared concrete fortifications protected by minefields and razor wire. Entrenchments provide cover with a -2 to hit modifier against any incoming fire that traces a line of sight across the front of the entrenchment. Infantry stands or models that are attacked either from the side or from behind the entrenchment do not benefit from this modifier.

To make up your data cards, first photocopy the cards on this page. Fold each card along the dotted line and glue the two halves together on the inside. You can then use these cards as normal in your Space Marine games.



Carefully remove these pages from your White Dwarf and glue them onto stiff card. You can then cut out the razor wire and minefield sections to use in your Space Marine games.



| | | | | | | | | | |
|---------------------|---------------------|---------------------|---------------------|---------------------|---------------------|---------------------|---------------------|---------------------|---------------------|
| HIDDEN SET-UP 1 | HIDDEN SET-UP 2 | HIDDEN SET-UP 3 | HIDDEN SET-UP 4 | HIDDEN SET-UP 5 | HIDDEN SET-UP 6 | HIDDEN SET-UP 7 | HIDDEN SET-UP 8 | HIDDEN SET-UP 9 | HIDDEN SET-UP 10 |
| HIDDEN SET-UP 11 | HIDDEN SET-UP 12 | HIDDEN SET-UP 13 | HIDDEN SET-UP 14 | HIDDEN SET-UP 15 | HIDDEN SET-UP 16 | HIDDEN SET-UP 17 | HIDDEN SET-UP 18 | HIDDEN SET-UP 19 | HIDDEN SET-UP 20 |
| HIDDEN SET-UP 21 | HIDDEN SET-UP 22 | HIDDEN SET-UP 23 | HIDDEN SET-UP 24 | HIDDEN SET-UP 25 | HIDDEN SET-UP 26 | HIDDEN SET-UP 27 | HIDDEN SET-UP 28 | HIDDEN SET-UP 29 | HIDDEN SET-UP 30 |
| 21 DUG-IN | 22 DUG-IN | 23 DUG-IN | 24 DUG-IN | 25 DUG-IN | 26 DUG-IN | 27 DUG-IN | 28 DUG-IN | 29 DUG-IN | 30 DUG-IN |
| 11 DUG-IN | 12 DUG-IN | 13 DUG-IN | 14 DUG-IN | 15 DUG-IN | 16 DUG-IN | 17 DUG-IN | 18 DUG-IN | 19 DUG-IN | 20 DUG-IN |
| 1 DUG-IN | 2 DUG-IN | 3 DUG-IN | 4 DUG-IN | 5 DUG-IN | 6 DUG-IN | 7 DUG-IN | 8 DUG-IN | 9 DUG-IN | 10 DUG-IN |

Hidden Set-up and Dug-in Counters

To assemble your counters, first cut carefully around the outside of the entire sheet. Crease the cut-out counters along the dotted line and thinly spread some glue onto the back of the sheet. Quickly fold the sheet in half, and when this is dry, separate the individual counters by cutting along the solid black lines. You can now use your counters in your games of Space Marine.



Minefields and Razor Wire

Carefully remove these pages from your White Dwarf and glue them onto stiff card. As soon as this is dry you can cut out the razor wire and minefield sections to use in your Space Marine games. The pieces on these pages will provide you with sufficient sections for 150 points worth of minefields and 150 points of wire.

SPACE MARINE FORTIFICATION CARDS

FORTIFICATION - MINEFIELDS

This card entitles you to place four minefields, each 12.5cm long by 5cm wide, anywhere in your set up area. The minefields are not secret and must be shown on the table. You must leave a gap of at least 5cm between each minefield.



POINTS VALUE 150

Any model that enters a minefield is immediately attacked and will be hit on a roll of 4+ with a -2 save modifier if hit. Units that start a turn in a minefield will be attacked as soon as they move. If they remain stationary they will be safe from further minefield attacks.

Minefields can attack any number of different models in a turn, but will only attack each model once. The mines spring into the air before they explode so they can hit skimmers and any location on a Titan. Mine attacks ignore power fields and void shields as they explode inside them. Choose the location on the Titan and roll the *aiming dice* as normal. The Titan is still allowed an armour saving roll on that location but with the -2 modifier.

Models that clear a path through difficult terrain such as Gorgons and surfaced Tunnellers are still attacked by mines. If they survive the attack, they leave a gap through the mines wide enough for a single infantry stand or model to pass through.

FORTIFICATION - BUNKERS

This card entitles you to place up to 5 bunkers anywhere in your set up area.



POINTS VALUE 150

Each bunker can hold up to two stands. The bunker's thick walls confer a -2 to hit modifier and a saving throw of 4+ to any stands inside it. If the model already has a saving throw, use the better of the two.

While in a bunker both of the stands have their fire arc reduced to 180° through the front of the bunker, just like a vehicle. Bunkers can be destroyed in the same way as a building, and have a saving throw of 3+ on 2D6.

To make up your data cards, first photocopy the cards on this page. Fold each card along the dotted line and glue the two halves together on the inside. You can then use these cards as normal in your Space Marine games.

Copyright © 1991 Games Workshop Ltd. All rights reserved.

Permission granted to photocopy for personal use only.

If you apply this principle to defences in Space Marine, you can see that the idea behind using minefields and razor wire is not to create a solid wall behind which your troops stand and wait, but to create channels of advance for your opponent which will lead him into your carefully prepared killing zones. The easiest way to show an example of channelling is with a diagram.

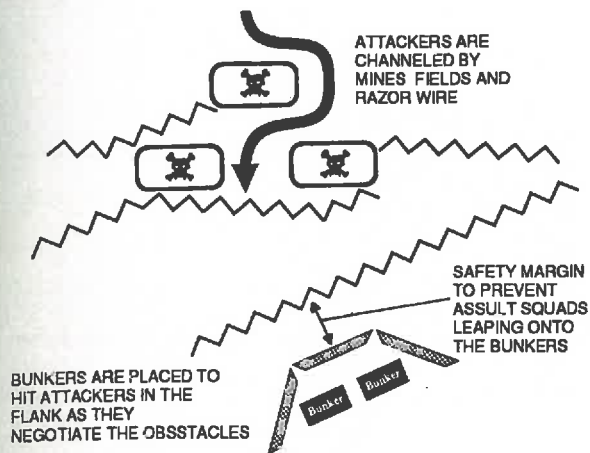

Their main effect should always be to break up the enemy formations and prevent them overpowering your own forces by sheer weight of numbers. If by the careful construction of your defences you can force your opponent to commit his forces in a piecemeal fashion, then you should be able to exchange fire with him on a shot for shot basis. So long as your troops are entrenched or in bunkers then you will definitely have the advantage.

You should be able to see how by combining these strategies of channelling and defence in depth, a small but well prepared force should always be able to see off a larger and even more heavily equipped attacker. For the defender, the key to success lies in timing and patience. Always withdraw from a position while your troops are in good order. Don't get drawn into a sustained firefight with superior forces. Be patient with your second and possibly third lines of troops. In the heat of battle, don't be tempted to rush them forward in an attempt to bolster up your front line. Let the enemy come on, conserve your strength and strike when he is exhausted and off balance.

ATTACK STRATEGIES

Now let's turn to the role of the attacker. If your opponent has followed the above guidelines and constructed a defence in depth by his positioning of bunkers, minefields and wire, just how do you penetrate and roll-up such a defence?

First of all there is the choice of what kind of forces to use. Obviously any units which are able to breach the defences are going to be essential. Tunnellers can dig under minefields and wire, enabling the attacker to get an assault force to get into close combat with the defenders. This will tie them down while the main body advances in support. Similarly, assault squads can use their jump packs to leap over obstacles and engage the enemy. Support can be provided by skimmers such as Land Speeders or Grav-tanks which are able to pass over razor wire and obstacles to engage the enemy at close quarters. Always remember however, that unless these attacks are executed on a massive scale they will need support from conventional

troops to capitalise on the break-through.

The other indispensable weapon in the arsenal of an attacker is artillery. By keeping the defenders under constant pressure with barrages of artillery you should be able to force them to abandon their front line and throw them off balance. As your infantry and vehicles move forward to engage the defenders, you should advance your barrage to bring down fire on the defender's second line and so on. This technique is known as a 'creeping barrage'.

Your artillery should target specific groups of defenders who are likely to give your advancing forces problems. Try to keep your artillery on first fire so you can hit the defender before he hits you. Then follow up with advancing fire from your assaulting troops thus keeping the defenders under extreme pressure.

One word of warning about the use of a creeping barrage. Unless your artillery is firing direct, there is the real possibility that your own fire can deviate onto your attacking units. Nothing can be more disheartening for you or more hilarious for your opponent than blasting your troops with their own supporting artillery!

Overall, as the attacker you should try to achieve the following combination of forces and strategy.

1. Locate the weak points in the enemy line where you can bring superior firepower to bear and make these the focus for your attack. If the enemy has a real strongpoint, try to think of a way to avoid it by moving round the sides and isolating his position, rather than attacking it head-on.
2. Use your artillery to batter the enemy's front line and as your forces move into combat shift the focus of the barrage onto the defender's second line or reserve forces. You should also use your artillery in an attempt to knock out any strongpoints and disrupt the movement of enemy reserves.
3. Try to move up your main force under cover until they are as close to the defenders as possible, BUT DON'T let the terrain bog you down or force you to go places where you don't want to go.
4. Make use of tunnellers and skimmers to breach the defender's lines and engage them in close combat before your main body of troops move in to mop up.
5. Don't attack piecemeal. It's fine to attack at several points at once to overstretch the defenders but ensure that attacks are co-ordinated properly.
6. If things look grim and the casualties are piling up KEEP GOING FORWARD. Unless you can capture enemy objectives you have no chance of victory.

IN CONCLUSION

Fortifications and defences provide a whole new range of tactical and strategic options for your Space Marine games.

Assault scenarios make for very tense, nail-biting games, giving players the chance to either sweep to victory with an overwhelming attacking force or to gloriously stave off the enemy horde with a heroic defence. There are no sure-fire strategies for either the defenders or the attackers, making each game a new challenge. Of all the assault scenarios we've played so far an equal amount have been won by attackers and defenders. Often the defender appears doomed to disappear under the first wave of attackers, but a cunning defender can leave the assaulting force hamstrung and out-maneuvred in the middle of his killing ground.

ELVEN LORDS

BY MIKE McVEY

Over the last couple of months everyone in the studio has been putting their efforts into the release of the new Space Marine game. For the 'Eavy Metal team there have been vast armies of epic infantry, tanks and artillery to paint, together with a host of flags, banners and colour schemes to work out. As a result, I've not had much time to spend on finishing off my Wood Elf army. I have however managed to complete the only big unit left, the Elven Lords.

ELVEN LORDS

The nine Elven Lords with their leader, a level ten Hero, is the most powerful unit in my army and I wanted them look really impressive. In Warhammer Armies, it says the regiment is comprised of the lords of Elven communities. I thought it unlikely that such renowned warriors would wear a fixed uniform, but I wanted the regiment to have a coherent feel. With this in mind, I painted each of the riders as an individual model and then developed the overall look by painting all the shields, back banners and horses in similar colours.

CONVERSIONS

To give the individual miniatures a degree of variation, I carried out minor conversion work to most of the models. The changes included head and weapon swaps, and some slight variations in lance position to increase the feeling of movement. Changing the heads and altering the position of the lance arms also allowed me to use five identical miniatures and get five seemingly individual models. I really enjoy doing this type of conversion work, I just can't seem to sit down to paint a miniature without wanting to alter it in some way!

The only miniatures to have extensive conversion work are the Champion and his war horse. The horse was taken from the Elven Attack Chariot. I chose this horse because I wanted a fairly plain model to which I could add my own saddle blanket. This was made from a flattened piece of modelling putty draped over the back of the horse and moulded into shape. I positioned the horse leaping off the front of the base. This was done to make it stand out from the rest of the models in the regiment and emphasise it as the leader.

The lance and the shield were both scratch built. The lance shaft was made from brass rod with the spear tip from another miniature pinned into place on the end. The hand guard was built up with modelling putty. The shield was cut from a piece of plasticard into the same wing shape that I've used throughout the army. I then scored the surface with a modelling knife to create the effect of wood grain.

The feathers on the shield were made from modelling putty. All you do is roll out a small piece of putty and flatten it onto a smooth surface. The feather blades are then carefully sculpted into the soft putty with a modelling knife. When the putty is completely dry, the feathers can be glued into place.

The feather back banner was made from a spare eagle wing I had in my bits box. I carefully trimmed the feathers and glued them to a length of brass rod which I'd already bent to fit the model. If you're going to have a go at bending thick wire,

you'll need to use a vice, mole grips, or two pairs of pliers to enable you to hold it securely. All the models, apart from the Champion, were pinned and glued into place on their horses before they were painted.

COLOUR SCHEMES

Even though all the miniatures are painted in their own individual colour schemes, there's still a theme running throughout the unit.

I had a clear picture of how I wanted the Champion to look. His chainmail was painted with the new gold paint from the forthcoming Citadel Metallic Paint Set and his helmet, armour and the details on his horse were painted in red, white and gold.

The detailed work on the lance was painted on with a 00 brush. First of all I painted on the thin bands of Moody Blue and then added the zig-zags of Go Fasta Red between them. The red, white and gold scheme was carried through to the feathers on the back banner, which were given a base coat of Space Wolf Grey and highlighted with Skull White before the ends were picked out with Go Fasta Red.

I wanted the rest of the models to echo the Champion's paint scheme, so I chose red, white and green as the dominant colours.

The riders were all painted in a very simple style. All areas were given a base coat, a wash and two highlights. The emphasis is on neatness and contrast between the different colours and areas of light and shade. I used black for the leather straps and most of the armour, to further emphasise these contrasts.

The horses were very quick and easy to paint. I chose piebald and skewbald colours to tie in with the general feel of the army and more specifically with the chariot horses (shown in White Dwarf 141). After giving them a white undercoat, I marked out where the patterned areas were going to be and painted them with a dark shade of the desired colour. For the skewbald horses I used a mix of Bestial Brown and Brown Ink and highlighted this with Bestial Brown and Snakebite Leather. The white areas on all the horses were shaded with Elf Grey and highlighted with Skull White. The eyes were painted black and highlighted with Moody Blue. A tiny dot of Skull White was then added to create a reflection. Any decoration was picked out in bright contrasting colours of red and gold.

SHIELDS AND BANNERS

I wanted to carry on the slightly primitive look of the army, so I gave all the troops plain wooden shields. The ones I used were from the Fantasy Regiment set and luckily we had some spare ones in the studio that I could put to good use. They were painted very simply with a white undercoat and gold rims. When this was dry, one half was painted orange and the other light grey. The orange half was given a wash of Red Ink and the grey half was highlighted with Skull White.

Finally, each of the standard troopers was given a back banner with a repeat of the Champion's wing device.



Level 10 Hero with Spell Shield



Standard Bearer



A Unit of 9 Elven Lords led by the Level 10 Hero



Mike has done extensive conversion work to both the Hero and his horse by adding a shield and feather detailing.

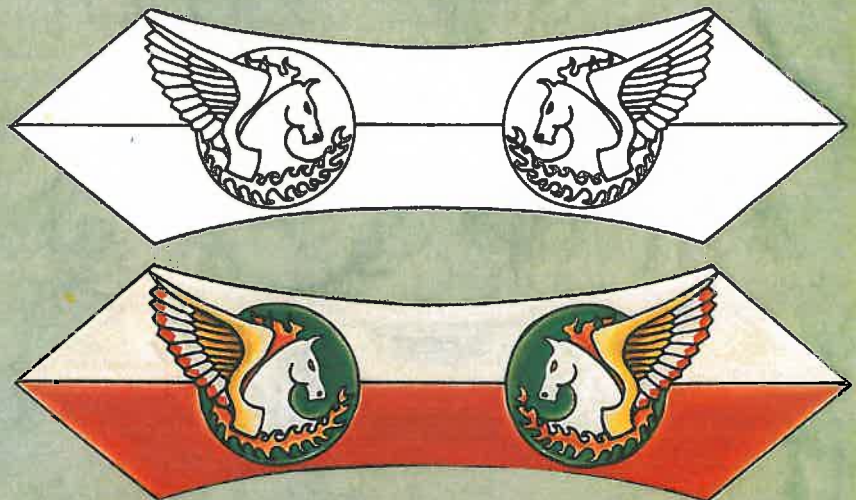

MODELLING WORKSHOP

EPIC FORTIFICATIONS

by Robin Dews, Mark Watts
and Richard Helliwell

The battlefields of the 41st Millennium are a deadly place where survival depends upon moving fast and staying low. Many varieties of battlefield fortifications have been constructed and deployed over the centuries, both to provide protection to the defending troops and to hamper and disorganise the attacking forces. In this article, we provide some techniques for constructing the most common types of fortifications and defenses for use in your Space Marine games.

Elsewhere in this issue of White Dwarf, Jervis Johnson has provided new rules for attack and defence scenarios in Space Marine. In these games, the defender can purchase a variety of battlefield fortifications – entrenchment, razor-wire, minefields, bunkers and fortresses with which to disrupt the enemy attack. In this article, we show you how to create epic scale models of these fortifications that will look great on the tabletop and add a lot of excitement to your battles.

It goes without saying, that like any other miniature, these models deserve to be assembled and painted to the best of your ability. We all know of the psychological advantage that comes from laying out a really well painted army on the tabletop. Imagine the expression on your opponent's face when he comes to plan his assault against your detailed miniature fortifications. It could well mean the difference between victory and defeat!



TRENCHES, REDOUBTS AND FORTIFICATIONS

Part of the fun of the Games Workshop hobby lies in the fact that there are as many different ways of making a model as there are modellers! The ideas and techniques in this article are just a few suggestions as to how you can set about making your own fortification models.

Trenches consist of a long channel dug into earth with barricades made from the excavated soil thrown up on both sides. They are designed to conceal groups of infantry and provide them with protection from the worst effects of barrages and other incoming fire. Trenches can vary widely, from a hastily dug hole in the ground, to a sophisticated system of strongpoints, reinforced with concrete and protected by razor wire.

Redoubts are a simpler form of battlefield defence which consist of a single barricade thrown up in front of the defending forces. Its up to you whether you want to build trenches or redoubts. For our models, we decided to build up the barricade on one side of the base only. This made it easier to place infantry stands into the fortifications and also avoided the problem of them looking unrealistically wide. It also made it easier to link the sections together and place them around woods and other terrain features. However, there's no reason why you shouldn't build up the barricades on both sides of your fortifications, it's really up to you.

After experimenting with a lot of different techniques, we came up with the idea of the concrete fortifications you can see in the photograph. We wanted to design a model that was reasonably simple to make, looked good on the tabletop and fitted in well with the gothic background and atmosphere of the Warhammer 40,000 universe.

The rules for purchasing fortifications state that for each 150 points you spend, you can place up to 50cm of fortification anywhere in your half of the table. With this in mind, we made all of our fortification sections 12.5cm long by 3cm wide. Later on we intend to make a few 6cm pieces to give us a little more flexibility with our layouts.

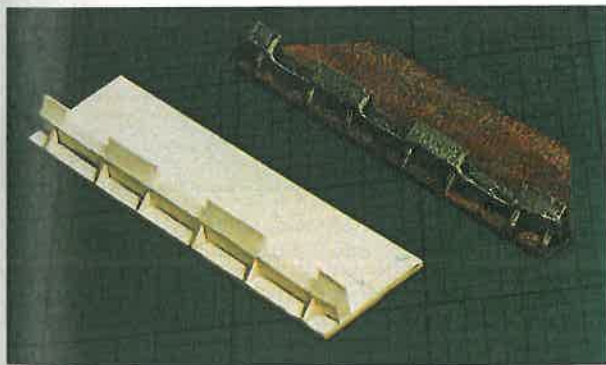

An assembled and completed fortification model

The materials we used to make the fortifications were: 5mm foamcard, cardboard or plasticard for the bases, and some bits of card for the buttresses. The models were assembled using PVA glue and a solvent based adhesive. Once they were dry, we brushed them with textured paint to conceal any gaps in the construction and give them the look of rough concrete.

We've provided full templates for the fortifications elsewhere in this article, and the construction of these is really very simple.

TOOLS AND MATERIALS

We used the following tools and materials to make our fortifications. They're all easy to buy and fairly cheap. If you have a problem finding any of these items, ask the staff at your Games Workshop store for the best place to find them locally.

Card. We used foam card for the bunkers and fortifications. This is a foam sandwich with thin card on the outside. It's available in different thicknesses but we find that the 5mm (1/4") is the most useful and works well in almost all modelling situations. Foam card is available from art shops or graphic suppliers at around £6.00 for a sheet that's approximately 800mm x 1000mm.

In place of foam card, you can use any stiff thickish cardboard. Thin card, like cereal packet card, is a bit too flimsy, but if it's all you've got you could try gluing two sheets of card together to make a stiffer, thicker card.

Mounting board or thick card for the base can be bought at most art shops for around £1.50.

Balsa wood is readily available from most model shops. We used strips of approximately 1.5mm (1/16") thick balsa wood for making the wire supports.

All-purpose glue suitable for card, plastic, balsa wood, etc.

Modelling knife with replaceable blades (remember to always work with new sharp blades, because they're much safer than blunt blades).

Packs of modelling clay can be bought in most art suppliers. Make sure you get the self-hardening variety which sets without being heated.

Steel ruler (a plastic or wooden ruler would be ruined very quickly).

Sand or flocking is easily available from DIY stores or model shops for texturing the base.

PVA glue. This is the white glue used for woodworking, available from DIY stores and hardware shops.

Masking tape or sellotape.

Emery board, fine grade sandpaper or a nail file.

Scrap pieces of balsa wood, cardboard, plastic shields and bases etc from your bits box.

SAFETY FIRST

It's worth reminding you that modelling tools can be dangerous if they're carelessly used. Remember that they're very sharp and they cut – and it's so much easier to make these models if you've still got fingers.

The most important safety rule is to make all cuts away from your fingers. It's much safer to cut through a sheet of card with several light strokes than with one heavy stroke. You're far more likely to slip when pressing too hard so you'll find that you actually get a much straighter cut with light strokes.

Always use a new blade. Sharp blades are a lot less dangerous than old blunt ones which you have to press very hard to cut through anything.

If you're unsure of what you're doing, then ask for some help, especially if you're a young modeller.

All Games Workshop stores are involved with terrain building, so if you need some advice or information on where to get materials, don't hesitate to drop in or give them a call – they'll be only too pleased to help.

MODELLING WORKSHOP

First cut the base out of fairly thick cardboard or 1mm thick plasticard. As you'll probably want to make a number of fortification sections (four 12.5cm sections will provide you with 150 points worth) its worth cutting all of these out at the same time so you can work on more than one model at once.

Take your 5mm foamcard and slice it into 10mm x 125mm lengths like those shown on the template and mark out the areas that you're going to cut out to make the battlements.

Now place your foamcard on your cutting mat or on a well protected surface and shave the foamcard at a 45° angle along the length of each strip. Don't press down too hard, and make sure your fingers are well clear of the blade as you do this. Finally, carefully cut away the marked sections to make the battlements.

Glue the foamcard to the base with the slope facing outwards. You should leave a gap of about 5mm between the foamcard and the edge of the base for the buttresses to fit into. Now cut out a number of triangular pieces (you'll need 6 for each fortification section) and carefully glue these to the front of the wall. This can be a bit fiddly as you tend to get glue all over your fingers, but I found the best way to do this was to spread the glue onto the baseboard and up the front of the wall and then press the buttress firmly into place.

You should now put the whole model on one side to dry. You can see now how it makes sense to work on a number of models at the same time so that you're not sitting around twiddling your thumbs before you can move onto the next stage.

Once your fortification models are thoroughly dry, you can move onto the final stages – texturing and painting the models.

We used textured masonry paint on our models, but thinned down all purpose filler works just as well. Have a hunt around in the garage or shed at home to see if there are materials left over from decorating before you rush out to your local DIY store to buy some. We applied the paint with an old brush and worked it carefully over the whole model and base.

PAINTING

Once this had dried, all the models were sprayed black using matt black spray paint and then drybrushed, first with Space Wolf Grey and then with Space Wolf Grey mixed with Skull White.

The bases were first painted with Snakebite Leather and when dry, we gave them a Brown ink wash. This was then highlighted by drybrushing with Snakebite Leather mixed with Orc Brown. As a final touch, we dabbed some PVA glue onto the base and sprinkled some modellers flock onto the wet glue. Then all of the edges of the base were carefully painted with Goblin Green to blend in with the colour of our gaming tables.

You'll notice that on some of the fortification sections, we've cut away the corners at an angle of approximately 45°. We did this so we could butt the pieces together at an angle and bend them around woods, buildings or other pieces of terrain.

BUNKERS

Bunkers are specially strengthened fortifications designed to protect infantry from the worst effects of bombardment and attacking fire. The new rules on assault scenarios allow

bunkers to be purchased by the defending side before the game starts. These bunkers can then be placed anywhere in the defenders half of the table.

You can make bunkers in a variety of different ways, depending upon how many you want and your level of experience and modelling skill.

Like the fortifications, we made our bunkers out of 5mm foamcard, some scraps of cardboard and a 25mm x 50mm Citadel cavalry slottabase. We wanted the bunker to fit in with the style of the fortifications so they'd look really impressive together on the tabletop.

Each bunker was really simple to build. The templates over the page give you the sizes for all the separate pieces. Depending upon which Space Marine armies you have in your collection, you might have to adjust the height of your bunkers to make sure that your infantry stands will fit inside. We made ours so that any Imperial Guard or Space Marine stands would fit inside them, but we later discovered that they only came up to chest height on an Ogryn!

First of all, you should cut out all of the parts for your model. The base and buttresses were made from plasticard or stiff cardboard and the walls were cut out from 5mm foamcard. Like the fortifications, its a good idea to work on several models at the same time, so that you can get on with the next stage of construction, while the glue or paint is drying on the other models. With this in mind, its a good idea to cut out enough pieces for several models at the same time. If you want to, you can use the 'dot-to-dot' technique we've described before for transcribing the templates onto your building materials, but to be honest, the templates for these models are so simple that you should be able to easily adapt or copy them onto your own preferred materials.

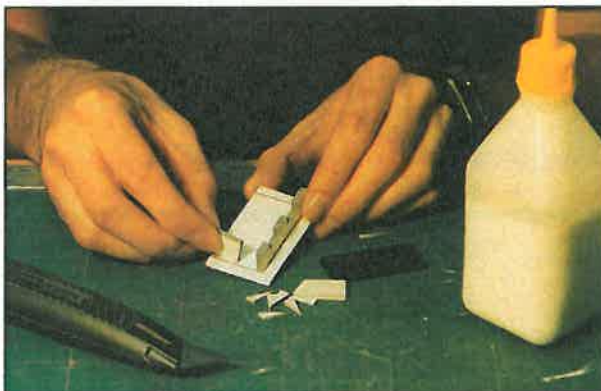

Gluing the walls to the base

First of all, glue the front of the bunker to the base. It should be located about 5mm back from the front edge. When working with foamcard, avoid using a solvent based glue as it will melt the polystyrene and cause the cardboard sandwich to collapse.

Now glue the sides of the bunker to the base. Make sure that the corners butt up neatly against the front wall. Place two epic infantry stands inside it to check they'll fit. Once you're certain you have everything in the right place, put this model on one side to dry and move onto the next one.

The next stage is to attach the buttresses. The easiest way to do this is to spread the glue onto the model and carefully push the card into place. We attached seven buttresses to each of our models – three along the front and two on each side, but you can vary this in any way you choose.

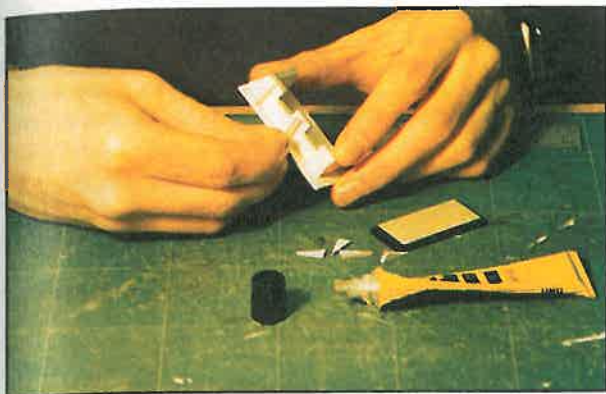

Fixing the buttresses to the bunker

The final step before texturing and painting the model is to attach the roof. We made this quite simply from a 25mm x 50mm Citadel cavalry slottabase with some masking tape stuck down on top to cover the slots.

The models that you can see in the photographs were all made by Robin, Richard and Mark and you can see how they've each added their own individual touches. One of the models has an observation turret made from several Citadel and Marauder plastic shields, another one is plain and the third has a radar dish on its roof, again constructed from a Marauder Shield.

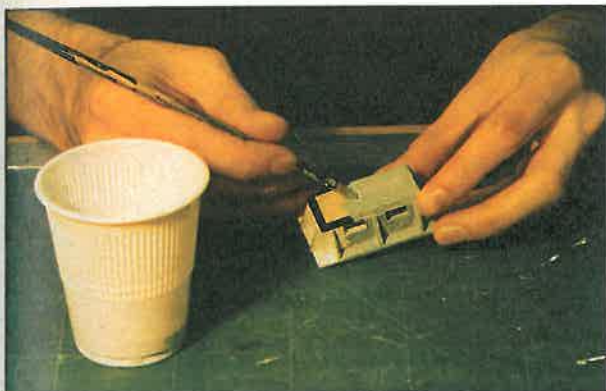

Painting the bunker with textured paint

If you want to adapt your model in this way, to make it look like a communications bunker or command centre, then you should do it at this stage. Before you paint your model, you should completely cover it with a coat of textured paint or thinned down all-purpose filler. As well as giving your model a rough surface like concrete, it also covers any rough edges or joins between the different pieces.

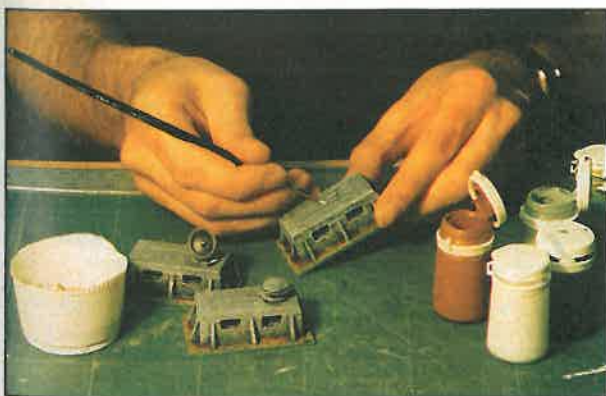

Drybrushing the model

The bunkers were painted in exactly the same way as the fortifications. First of all we gave them a coat of matt black spray paint. Each bunker was then drybrushed, first of all with Space Wolf Grey. Increasing amounts of Skull White were then added to this colour and brushed onto the model, until the last highlights were drybrushed on with almost pure Skull White. On the bunker with the observation turret, the turret itself was given a final drybrush with Mithril Silver to give it a metallic look.

There are loads of different ways in which you can construct bunkers for your games and I'm sure that once you've built a few models with the techniques shown here, you'll want to design your own.

The bunkers that we built were all designed to take two infantry stands, but there's no reason why you shouldn't construct emplacements for your tanks or artillery, or combine a number of bunkers and fortifications to make a mini-fortress.

RAZOR WIRE

The third type of defensive fortification we modelled for our Space Marine games was razor wire. As you can see from the new rules, placing razor wire in front of your units prevents the enemy from attacking you in close combat. This is because you can only move into hand-to-hand combat if you have charge orders and neither infantry nor vehicles are allowed to use charge orders to cross razor wire.

In this copy of White Dwarf, we've provided you with several photographs of one of our razor wire sections that you can cut out and stick onto card. These will enable you to try out the rules and use these sections in your games. However, many of you will want to construct your own razor wire to go with the fortifications and bunkers.

We've made our razor wire using the kind of aluminium mesh used for filling holes in car bodies. This is available from shops like Halfords or garages and costs about £1.00 for a large sheet. This should be more than enough to make all the wire you'll need for your games.



We made our razor wire, by first of all, modelling a wire base and then attaching rolled up coils of aluminium mesh to it. If you look at the Epic fortifications cards elsewhere in this issue, you'll see that you can buy up to 100cm of razor wire for 150 points. We constructed our wire sections in 12.5cm lengths, but you should feel free to build yours to go with whatever terrain you have in your collection.

The wire base was made by cutting out a piece of plasticard or cardboard to the appropriate size. We preferred to use plasticard for these models, because cardboard has a tendency to warp when it is coated with textured paint or all-purpose filler.



Texturing the base and fixing the wire supports

Cover the base with a liberal coat of textured paint or all-purpose filler and leave it for five or ten minutes until it begins to harden. While you're waiting, take some balsa wood, matches or cocktail sticks and cut them into small sections with your modelling knife. Now press these pieces of wood into the still soft texture on the base. You should aim to get two or three rows of wire on each base, so place the wire supports about 10-15mm apart in long rows like fence posts. Don't worry if some of them tilt over at odd angles or fall over altogether. You can see from our models that once they are painted and the wire has been added, the random effect will make your model look even more realistic. Once you've got the all of the wire supports in place, put the section on one side to dry, and move onto the next piece.



Painting and drybrushing the base

As soon as all the bases were dry, they were prepared for painting. As with all the models featured in this article we started off by spraying them with matt black car paint. This not only provides a good surface on which to paint, but also helps to create areas of dark shadow on the models which really brings them alive. This is particularly important when modelling in this small scale, when all you are really going to see from a distance on the tabletop is the contrast between the shadows and the highlights. After the basecoat, we gave the whole model a coat of Snakebite Leather. This was followed by a wash of Brown ink and the wire supports were drybrushed with Spearstaff Brown. The base and the wire supports were finally drybrushed with Orc Brown mixed with Skull White and some Goblin Green was spattered onto the base. If you want, you can also dab some PVA onto the base and then sprinkle it with modellers flock. Once finished, you should place your wire bases on one side to dry thoroughly, preferably overnight.

To make your wire, cut long strips of car body mesh and then bend them round a tube to produce the coils. You can cut the mesh very easily using a modelling knife. Slice the mesh diagonally, cutting two strands at a time. The barbs created by the cut ends of the mesh make for a very realistic effect.

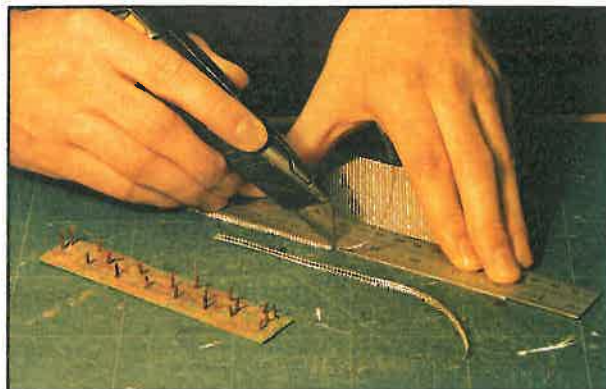

Cutting the razor wire strands

I used the tube from the inside of a plastic ball point pen to bend the mesh around, but there's no reason why you shouldn't make your coils larger or smaller than this by using a thicker or thinner tube. It's really a matter of personal taste and what tools and equipment you have to hand.

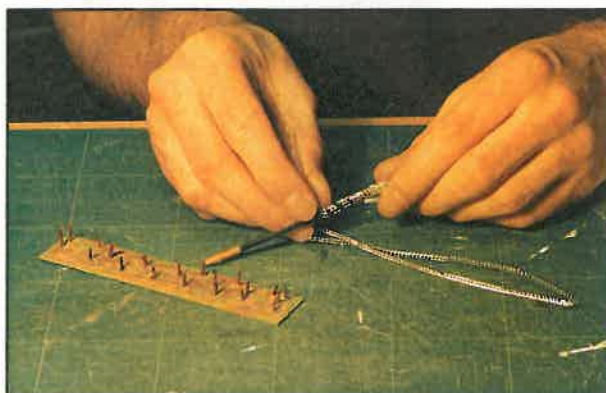

Rolling the mesh into coils

Before attaching the wire to the base, we sprayed it with matt black paint. Once you've stuck it down onto the base you can drybrush it with Mithril Silver. It may seem a bit strange to spray silver mesh black, only to drybrush it silver again, but you'll find that if you don't paint your wire in this way it looks too shiny on the tabletop – a bit like cut aluminium mesh in fact – so we think it's well worth the extra effort.



Attaching the coiled mesh to the support

With any modelling project, you can go on adding detail almost indefinitely. For example, a thin wash of Chestnut ink will make the wire look old and rusty. Once a section has thoroughly dried, you can add further detail by adding tiny blobs of PVA glue and dipping this into coarse sand. The sand can then be painted and drybrushed to look like areas of stones or gravel.

MINEFIELDS

The final scenic model we want to deal with is minefields. These were very easy and a lot of fun to make. First of all we cut the card bases into 125mm by 5mm sections. Making them in this way allows you to be a bit more flexible with your layouts on the table. Using this size, you'll be able to put two sections together to run around a wood, or follow the contour line around a hill (Note however, that in the rules for minefields, each 25cm section must be separated from the next minefield by at least 10cm of open ground.)

The craters were made by rolling out some DAS modelling clay or epoxy modelling putty and bending it round to make a small ring. This was then stuck down gently onto the card and the edges carefully smoothed down with the end of a matchstick. We particularly like to use matchsticks for our modelling work, because their rough ends give a coarse texture to the putty. If you can't get hold of any DAS or modelling putty, then plastiscene will do just as well, but as it doesn't dry hard, you'll have to handle your finished model just a bit more carefully.

Once the putty had hardened we carefully painted the craters with Snakebite Leather, gave them a quick wash with brown ink and when this was dry highlighted them by drybrushing with Spearstaff Brown and finally with Bleached Bone. We then spattered the base with Woodland Green and put the whole thing on one side to dry.

Because Robin's Imperial Guard army plays lots of games against Space Marines, he decided to place a wrecked Rhino on to one of his minefield sections. He took a plastic Rhino from the Space Marine set and carefully shaved away one of the sides with a modelling knife to make it look as if it had hit a mine and had its track blown off. You could do exactly the same thing with an Ork Battlewagon, or Eldar Gravtanks. It's these kind of touches make all the difference to the look of a scenic model.

The models in this article are all simply designed, the materials are cheap and they are great fun to make. Best of all is the fact that you can use them all straight away in your games of Space Marine, by using the Epic Fortification Battle cards that we've printed elsewhere in this issue.

We hope that the techniques have also given you lots of ideas of your own. The Bunkers and fortifications are particularly Imperial looking and it would be really fun to see what kind of models an Ork Warboss would come up with for his Boyz.

The final model on the fortification cards is the Stronghold and we've already got some great ideas for building these which we'll bring you in the next Modelling Workshop.

Epic Fortifications – Stronghold Card

You can use this card together with the others printed elsewhere in this issue to purchase Strongholds and Fortresses for use in your games of Space Marine

POINTS VALUE 150



This card enables you to place a single Stronghold or Fortress up to 15cm square, anywhere in your set up area.

FORTIFICATION – STRONGHOLD

The stronghold is essentially a large building and all of the rules that attach to buildings also apply to it. The thick walls of a Stronghold confer a 4+ saving throw to any model completely inside it. In addition, any models inside a Stronghold receive the benefit of the -2 to hit modifier shown on the terrain effects table for being inside a building.

Strongholds can be destroyed in the same way as a normal building and have a saving throw of 2+ on 2D6

The points cost for a Stronghold includes one super heavy defence turret, which can be fitted with any weapon that can be attached to a Titan (with the exception of plasma weapons, which require the Titan's plasma reactor in order to be used). The turret may be attacked separately, in which case it should be treated as an armoured vehicle with a saving throw of +1

SPACE MARINE ENTRENCHMENT TEMPLATE

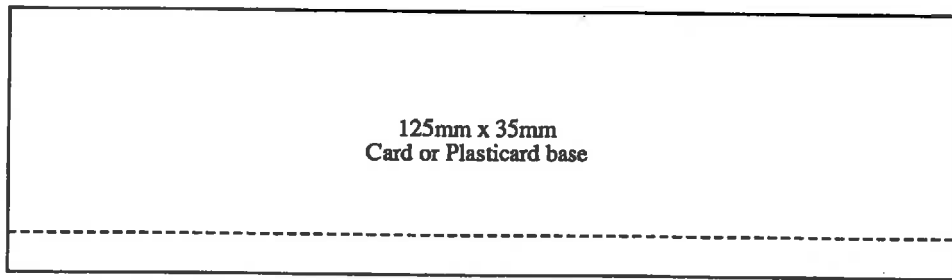

125mm x 10mm
5mm Foamcard



Wall Buttresses

SPACE MARINE BUNKER TEMPLATE

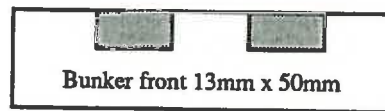
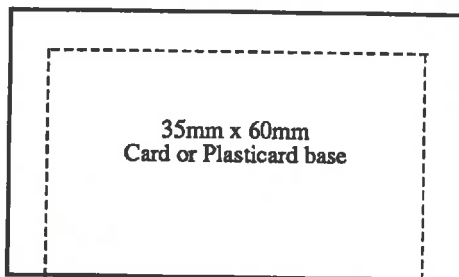

Buttresses

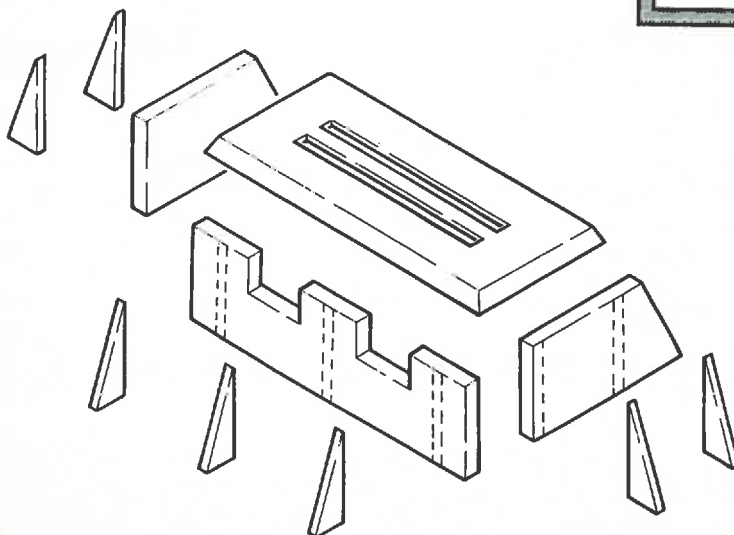

SPACE MARINE BUNKERS AND ENTRENCHMENTS

Photocopy or cut out the templates and place them on top of your foamcard or cardboard. Press a compass point or needle through the corners of the templates so that shapes are transferred onto your material. Remove the template and join up the dots. You can now cut the shapes out of your card or foamcard.

Both of the model templates shown on this page can be readily adapted to suit your own Epic army.

SPACE MARINE



EPIC CONFLICT IN THE WAR-TORN UNIVERSE OF THE 41ST MILLENNIUM

Space Marine is the game of epic battles in the war torn universe of the 41st Millennium, where mighty warriors clash in an apocalyptic conflict which will decide the fate of the galaxy.

As the commander of a conquering army, you rely on tactical skill to outmanoeuvre and outfight your opponent. You must work out the best time to launch an attack, how you can exploit terrain to give troops cover, and whether buildings, high ground or other features are worth capturing. Ultimate victory belongs to the top general, the boldest stratagem and the bravest warriors!

The game rules cover all the Eldar, Ork and Space Marine models in the Space Marine game box - plus a variety of models from Citadel Miniatures' Epic scale range. This completely new and original game system is easy to learn and fast and exciting to play.



SPACE MARINE CONTAINS: Over 500 plastic Epic scale Citadel Miniatures, including 12 Land Raiders, 24 Rhinos, 240 Space Marines, 12 Eldar Grav Tanks, 120 Eldar Guardians, 18 Ork Battlewagons and 180 Ork Boyz. 1 plastic Warlord Titan, 1 Warlord Titan playsheet and 2 reference charts. 10 full-colour card buildings with plastic roofs, 107 order counters, 9 rubble counters, 16 objective counters, 4 barrage markers, 1 vortex template and 57 epic army cards. 2 six-sided dice, 1 scatter dice, 2 aim dice and a 64 page rulebook.

**GAMES
WORKSHOP**

SPACE MARINE



EPIC FORCES



New rules and data cards for epic vehicles including the Eldar Wave Serpent, Warp Hunter and Deathstalker Prism Cannon featured in last month's White Dwarf. Plus Imperial Tunnellers and the Leviathan command centre.

By Jervis Johnson, Rick Priestley and Andy Chambers

WARP HUNTER

The Warp Hunter is a weird and immensely powerful weapon from the armoury of the Eldar Craftworlds. Its huge warp cannon bores a hole through the fabric of reality, creating a whirling black hole into warp space. Anything engulfed by the hole is sucked through into the dark dimension of the warp and destroyed. Those lucky enough to avoid the full power of the warp hole are cast aside and scattered around the battlefield. Due to the fickle nature of the warp the cannon isn't very accurate, so it is impossible to be exactly sure where the warp hole will open. Because of this the Warp Hunter is most effective when fired against massed ranks of enemy infantry or advancing armoured formations.

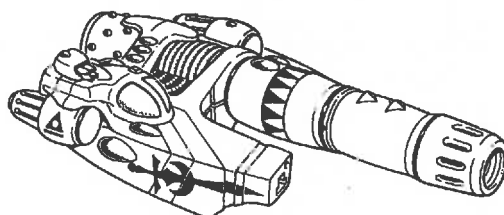

A barrage marker is used to represent the warp hole. The cannon can only shoot at a target point it can see, so take the barrage marker and place its centre over the proposed target. Roll the scatter dice and if the result is an arrow reposition the template 2D6cm in the direction shown. Now roll the scatter dice again and if the result is an arrow reposition the template once more. Because the Warp Hunter rolls twice for scatter it can sometimes miss its target by as much as 24cm, although this is unlikely. Each model under the barrage marker is affected by the warp hole and may be sucked into the warp and destroyed or, if

it is more fortunate, thrown violently aside by the unimaginable energies of the warp. Roll a scatter dice for each target. On the roll of a cross hair the target is sucked into the warp and destroyed with no saving throw allowed, except as noted below. On the roll of an arrow the target is thrown D6cm in the direction shown and may not move, shoot, or do anything else that turn.

Buildings cannot be sucked into the warp hole as they are too large, but any building hit by a Warp Hunter will be torn apart and may collapse. The building is allowed its basic saving roll, and if successful its structural integrity is maintained and the building remains standing.

Titans, Gargants, and any super-heavy tanks with either intact void or power fields automatically avoid destruction thanks to their shields. The warp hole is slightly displaced by the presence of active shields so the target is never sucked into the warp but is scattered D6cm in a random direction instead.

The Warp Hunter has anti-gravity motors which allow it to make 'pop-up' attacks as described for skimmers.

| | Move | Saving Throw | CAF | Weapons | Range | Attack Dice | Roll to Hit | Target's Save Mod. | Notes |
|-------------|------|--------------|-----|-------------|-------|---------------|-------------|--------------------|-------|
| Warp Hunter | 25cm | 3+ | +1 | Warp cannon | 75cm | Special rules | | Scatters twice | |

WAVE SERPENT

The Wave Serpent's unusually-shaped hull contains a gigantic warp energy generator which powers an impenetrable field called a warp wave. This protective field may also be used offensively. A burst of energy can send the warp wave shooting forwards, scattering or consuming everything in its path before it disappears into the ether.

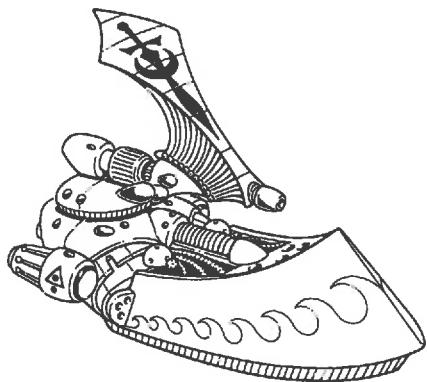

To use the Wave Serpent you will need to make a special warp wave template. This is a V shaped piece of card as shown below. You will need a template for every Wave Serpent model you have.

The template is positioned directly in front of the Wave Serpent model to represent the warp wave. As the Wave Serpent moves the warp wave moves as well. It does not affect scenery, but any troops, vehicles, or other targets which the template moves over are pushed aside by the warp wave and may do nothing else that turn. The models are moved to the trailing edge of the warp wave and any order counters are removed to show they can do nothing that turn. The warp wave is completely impenetrable by any kind of weapon or psychic attack and is impossible to move through. This means that it also acts as an effective shield and a barrier to movement, allowing troops to shelter behind it.

Buildings cannot be pushed aside as they are too large, but any building in the path of the warp wave will be torn apart and may collapse. The building is allowed its basic saving roll, and if successful its structural integrity is unaffected and it remains standing. Any models inside the building are also unaffected so long as it survives.

The Wave Serpent may also use its warp wave as a weapon, but this means it will lose the benefit of its shield for that turn. To do this the Wave Serpent expends a single burst of energy and the warp wave shoots forwards 2D6 x 10cm then dissipates and the template is removed.

The warp wave doesn't fire like a normal weapon, instead it is used in the orders phase before any order counters are placed. Determine how far the warp wave moves and move the template straight ahead this distance. Any models it moves over are pushed out of the way exactly as described above and may do nothing for the rest of the turn. In addition, the force of the warp wave causes a hit on any model pushed aside on the D6 roll of a 4, 5 or 6. The warp wave regenerates over the turn and is replaced at the beginning of the following turn.

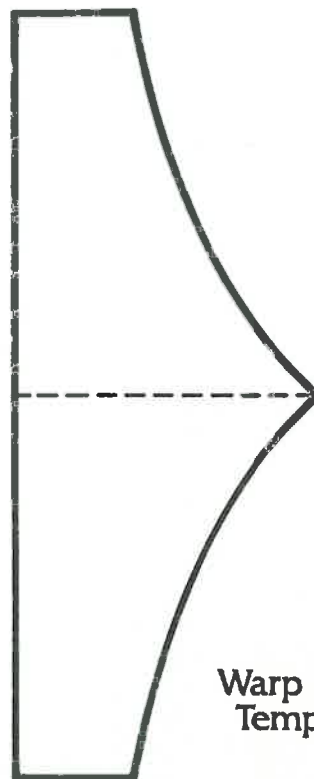

Warp Wave Template

Photocopy the Warp Wave template and stick it on to thin card. Then carefully cut around it and fold in half along the dotted line. To complete the template, open it out until the card makes a 90° angle.

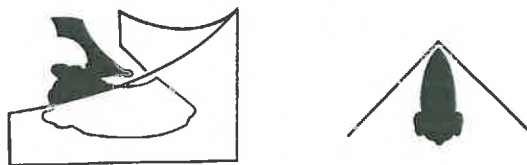

Position the Warp Wave template in front of the Wave Serpent

| | Move | Saving Throw | CAF | Weapons | Range | Attack Dice | Roll to Hit | Target's Save Mod. | Notes |
|--------------|------|--------------|-----|-----------|----------|-------------|-------------|--------------------|-------|
| Wave Serpent | 25cm | 3+ | +1 | Warp wave | 2D6 x 10 | - | 4+ | - | |

DEATHSTALKER PRISM CANNON

The Eldar are a highly advanced race whose technology often baffles and astounds human observers, and the Deathstalker with its warp-powered Prism Cannon is a typical example of this.

The Prism Cannon uses a specially shaped crystal to contain a warp energy field. A shot from the cannon unleashes the energy of the warp, creating a pinpoint beam of darkness that can pierce the toughest armour and slice through buildings and troopers with almost equal ease. The crystal at the rear of the weapon has the ability to trap and focus the beam from another Prism Cannon, increasing its own power considerably. Several Deathstalkers can exploit this by forming a chain, each Prism Cannon firing at its neighbour, combining their energy into a single powerful final burst. This has a further advantage in that only one Deathstalker need expose itself directly to enemy fire.

To fire a single Deathstalker at an enemy target proceed as normal. The range, score required to hit, and other details are given on the data exactly as with any other weapon.

If you wish to use a Deathstalker to boost another Deathstalker's fire then roll to hit at the second cannon just as if it were an enemy target. This second Deathstalker may fire at a third cannon, and if it hits then both its own hit and that of the first cannon are transferred to the third. There is no limit to the number of Deathstalkers that can combine their fire in this way. It is also possible for several Deathstalkers to transfer their fire directly to a single cannon without firing through each other.

When a Deathstalker fires and hits an enemy it causes 1 hit **plus** all the hits transferred to it, and the target must take a separate saving throw against each hit. Most targets are destroyed if any hit successfully penetrates its armour. In the case of Titans and other large machines which can sustain several hits then the appropriate amount of

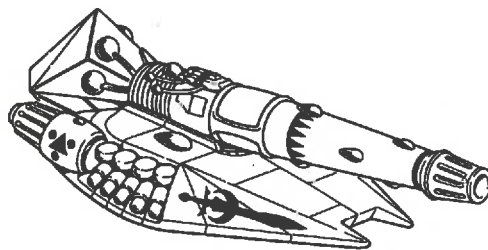

damage is recorded just as if it had been hit by a number of different weapons. The accumulated energy flares into the warp and dissipates at the end of each turn, so hits cannot be retained in a Deathstalker from turn to turn.

Each Deathstalker is a separate unit. Normally you nominate and fire one unit at a time, but in the case of Prism Cannons you can immediately fire once a hit has been transferred. For example, Prism Cannon 1 fires at Prism Cannon 2 and scores a hit, so Prism Cannon 2 may now fire immediately, whether at an enemy or a third Prism Cannon. This is an exception to the normal play sequence and allows a Prism Cannon with advance orders to fire in the advance fire segment. A Prism Cannon with charge orders cannot shoot, however, so it cannot be used to transfer hits. Once a Prism Cannon has shot it may not shoot again that turn, even if it shoots in the first fire segment and has advance fire orders. Turn over or remove the order counter to show that the Prism Cannon has taken its shot that turn.

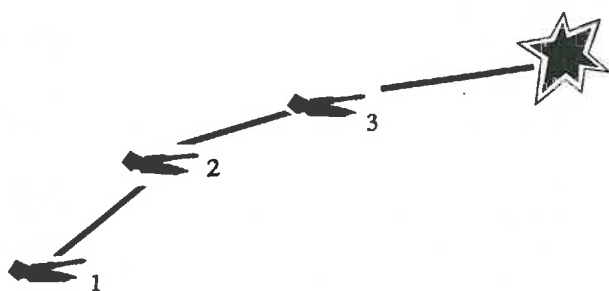

Deathstalker 1 fires at Deathstalker 2 which in turn fires at Deathstalker 3 and the combined fire power of all three Prism Cannons hits the target.

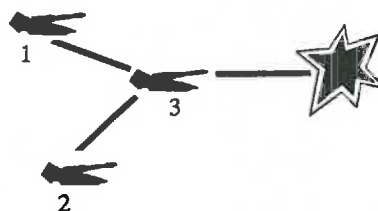

Deathstalker 1 and Deathstalker 2 both fire at Deathstalker 3 and the combined fire power of all three Prism Cannons hits the target.

| | Move | Saving Throw | CAF | Weapons | Range | Attack Dice | Roll to Hit | Target's Save Mod. | Notes |
|---------------------------|------|--------------|-----|--------------|-------|-------------|-------------|--------------------|--------------|
| Deathstalker Prism Cannon | 25cm | 3+ | +1 | Prism cannon | 75cm | 1 | 3+ | -2 | Special rule |

HELLBORE

The Hellbore is the largest of the tunnelling troop transporters known collectively as tunnellers or miners. These subterranean machines tunnel their way underground, bypassing enemy troops and fortifications and emerging behind the lines. Tunnellers can move over the ground surface as well as underground, but as they only move slowly overland it is usual to move them to battlefields on huge transporter vehicles.

At the start of the game any tunneller models are positioned on their transports along with the rest of the army. The tunnellers themselves are assumed to be underground from the beginning of the game, and the transports are left on the table. Although transporters don't have weapons and cannot move, they continue to act as guidance stations for the tunnellers. It is possible for the enemy to force a tunneller off-course by destroying its guiding transport vehicle as described later.

A Hellbore may attempt to surface at any time during its side's movement. Roll a D6, and on the score of a 1 the Hellbore has struck a rocky obstruction and cannot emerge that turn. On the score of 2 or more the Hellbore breaks through to the surface. It does not move further during the turn it emerges above ground, but can move along the surface from the next turn. If the Hellbore's transporter can be seen from the point where the Hellbore intends to emerge proceed as follows. First nominate where you want to surface and then roll the scatter dice. If you roll a hit symbol then you have emerged on target. If you roll an arrow you have missed your aiming point and instead emerge D6 x 5cm away in the direction indicated. This means you can end up anywhere between 5cm and 30cm from your chosen point. If the transporter cannot be seen from the place where you want it to emerge, or if the transporter is destroyed, then roll the scatter dice in the same way but the distance will be D6 x 10cm for misses.

Troops may not disembark on the turn that the Hellbore emerges but may do so in the following or any subsequent turn. Position order counters to remind you to disembark in the movement phase. The usual rules for boarding and leaving transport vehicles apply - the infantry move is reduced in proportion to the vehicle's movement. Note that as there are 3 platoons on board the Hellbore you must issue 3 sets of orders if you want them all to disembark.

The Hellbore may move along the surface of the ground, ploughing a deep furrow in its wake. It always moves in a straight line directly forwards up to 15cm.

No orders are ever given for the Hellbore because it is an HQ unit. Note that it cannot double up its move with a charge order; tunnellers have a maximum move of 15cm and can never move faster. Once the Hellbore has completed its move for the turn the player may turn it round by up to 45° so that it can move in a slightly different direction when it moves next turn. This is the only way to turn a tunneller and, as you can imagine, it

makes them rather cumbersome. For this reason it is better to keep them underground until you really want them to emerge, rather than surfacing early and relying on slow and awkward overland movement. A Hellbore can move through woods, trenches, foxholes, rocks and other broken ground without slowing down, but marshes, rivers and other bodies of water are impassable once the tunneller has surfaced. Nothing, not even marshes and water, can stop a tunneller that is burrowing underground.

A Hellbore can emerge under a building or plough straight through one if moving overland. This is a bit reckless as the building can collapse as a result and there is a possibility that the tunneller may be crushed by tons of plummeting rubble. To see if the building survives, roll its basic saving throw. If this is failed the building collapses and any troops inside are killed. If the building does collapse, the Hellbore may be trapped and destroyed. Roll a D6, and on the score of 6 the Hellbore is crushed by tons of debris and destroyed along with any troops still inside. Smaller tunnellers are crushed on the score of a 5 or 6 in the case of Moles and 4, 5 or 6 in the case of Termites.

The Hellbore is so huge that it is almost unstoppable in close combat, grinding infantry and lighter vehicles into the ground as it advances! To represent this the Hellbore can't be brought to a halt by lighter troops who engage it in close combat, it can only be pinned by Titans or by a super-heavy tank. If infantry or lighter tanks engage the Hellbore in close combat it can simply move past them in the next movement phase, scattering them out of the way as it does so.

A Hellbore is available as a company card complete with three platoons of tactical guards. Unlike most company cards you are restricted in the various support cards you can include with it. Obviously you can't sensibly place subterranean troops and other troops in the same chain of command as one or the other will inevitably end up stranded. Therefore, you can only include Moles or Termites as support units for Hellbores.

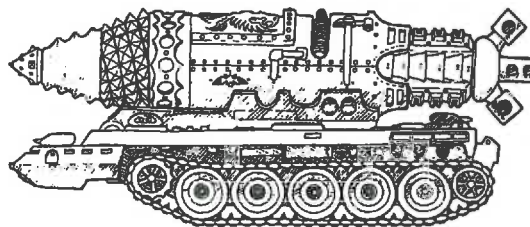

| | Move | Saving Throw | CAF | Weapons | Range | Attack Dice | Roll to Hit | Target's Save Mod. | Notes |
|-------------|------|--------------|-----|---------|-------|-------------|-------------|--------------------|--------------------|
| Hellbore | 15cm | 1+ | +12 | None | | | | | Carries 30 stands. |
| Transporter | Max. | - | 0 | None | | | | | |

THE MOLE

The Mole is the intermediate sized tunneller, carrying a single platoon of Imperial Guard tactical troops. The same rules apply as described for the Hellbore except that the Mole is trapped under a falling building on the roll of a 5 or 6 rather than just a 6. Unlike a Hellbore, The Mole can be engaged in close combat in the same way as any other vehicle.

All Moles carry special communication equipment which allows them to relay orders to the troops they carry. So long as a platoon is within 25cm of the Mole it can maintain direct communications with its regimental headquarters and can therefore be given orders. However, the Mole does not count as a command unit itself, it only acts as a relay between the regimental HQ and the platoon. The platoon may also be given orders by its own company HQ exactly as with other units.

Moles are available as company cards and support units including a platoon of ten tactical guards. You can include Moles as support units for any company you like – they don't have to be placed under the command of a Hellbore Company, though you can do this if you prefer.

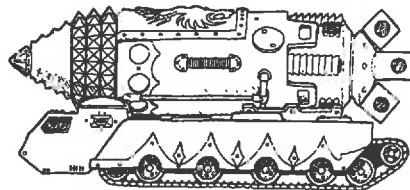

| | Move | Saving Throw | CAF | Weapons | Range | Attack Dice | Roll to Hit | Target's Save Mod. | Notes |
|------|------|--------------|-----|---------|-------|-------------|-------------|--------------------|-------------------|
| Mole | 15cm | 3+ | +3 | None | | | | | Carries 10 stands |

THE TERMITE

The Termite is the smallest of the tunnellers. It carries 2 stands and is organised into squadrons of 3 carrying a special Imperial Guard Termite unit of 6 tactical stands. The same rules apply as for Moles and Hellbores except that the Termite is trapped under a falling building on the D6 roll of a 4, 5 or 6. Unlike a Hellbore, the Termite can be engaged in close combat in the same way as any other vehicle.

Termite squadrons all use the same tunnel, each following behind the other and branching to the surface only at the last moment. Establish where the first Termite surfaces as described for the Hellbore and then place the remaining two Termites anywhere you wish within 6cm. This allows the platoon to maintain its formation.

In a squadron the first Termite carries the section HQ and also special communication equipment which allows it to relay orders to its platoon. So long as the platoon is within 25cm of the first Termite it can maintain direct communications with its regimental headquarters and can therefore be given orders. However, the Termite does not count as a command unit itself, it only acts as a relay

between the regimental HQ and the platoon. The platoon may also be given orders by its own company HQ exactly as with other units.

You can include Termites as support units for any company you like, so you don't have to place them under the command of a Hellbore, although you can if you wish.

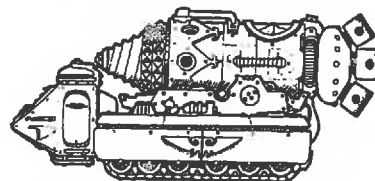

| | Move | Saving Throw | CAF | Weapons | Range | Attack Dice | Roll to Hit | Target's Save Mod. | Notes |
|---------|------|--------------|-----|---------|-------|-------------|-------------|--------------------|------------------|
| Termite | 15cm | 4+ | +1 | None | | | | | Carries 2 stands |



DROP PODS

Drop pods are pod-shaped landing craft which are launched from orbiting spaceships, fall through the atmosphere, and land on the battlefield. They can carry Space Marines or robotic weapon systems designed to clear a landing area or support foot troops.

The Space Marines use three kinds of drop pod: the Assault Pod, which carries two Space Marine stands; the Deathwind Pod, which carries a multiple bomb launcher; and the Support Pod, which contains a turret-mounted heavy plasma gun. Deathwind and support pods are robotic and have no living crew.

Before the game begins allot a number to each drop pod, and note down which numbers correspond to Deathwind, Support and troop carrying Assault Pods.

You can decide to bring pods down in any turn - but you must note in which turn they are going to land *before* the game begins. For each pod note down whether you want the pod to arrive with the first wave (the first turn), the second wave (second turn), third wave (third turn) and so on.

Drop pods land on the table during the orders phase after orders have been placed but before they are revealed to the other player. Determine where pods land using the special drop markers. These are supplied with the epic army cards for the drop pods and consist of small numbered cards which correspond to the numbered pods.

Place all the markers for pods landing that turn on a burst template, and hold it about 30-40cm above any part of the table. Invert the template sharply so that the markers fall on the table, and place a closed pod model where every marker lands. Don't remove the markers yet as you will need to refer to the number when the pod opens.

A pod is destroyed if it lands off the table, in terrain which is impassable to vehicles or on a Titan. Titans or buildings that are hit by a pod take a hit with a -3 saving throw modifier. If a pod lands on top of any other troops they are destroyed.

Enemy troops with first fire orders may fire on drop pods as they fall from the sky. This is an exception to the normal turn sequence. Instead of firing in the combat phase, troops fire at the end of the order phase after orders have been revealed. Because the pods are falling through the sky, firers ignore any intervening terrain that might block their sight. Any troops that fire in this way are not allowed to fire again during the turn.

Once the pods have landed explosive locking bolts fire and the petal-like sides unfold, releasing the troops within. Unfortunately, the extreme heat of the journey through the atmosphere often fuses the pod's outer surface and prevents it opening.

Test to open each pod as follows: at the end of the orders phase roll a D6 - on the roll of a 3, 4, 5 or 6 the pod opens. If it doesn't open, then test in the orders phase of each

following turn until it does. Once the pod has opened troops may disembark or weapons can fire as described below. Until the pod opens it is a sitting target.



Deathwind Pod. As soon as the pod opens the missile launcher inside is triggered. This is an exception to the normal turn sequence, as firing occurs at the end of the orders phase. The launcher rotates at speed, scattering missiles in every direction. Any troop stand or vehicle within 10cm of the pod is hit on the D6 roll of a 4 or more and must make its save to avoid destruction. As Titans are bigger they roll 3 dice, and suffer a hit on each roll of a 4 or more. The Deathwind is a one shot weapon - once it has fired it has no further effect.

Assault Pod. As soon as the pod opens place the troops it carries next to it. Troops emerging from a pod automatically have advance orders and move normally in the movement phase.

Support Pod. The Support Pod carries a plasma gun which can be fired normally in the combat phase once the pod has opened. There is no need to put an order counter down for Support Pods - they always fire in the first fire segment.

A pod can be fired at while it is on the ground both before and after it has opened.

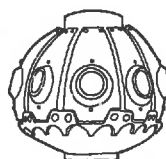

Closed Pod

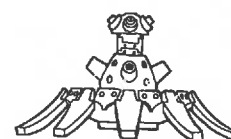

Deathwind

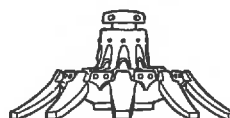

Assault Pod



Support Pod

| | Move | Saving Throw | CAF | Weapons | Range | Attack Dice | Roll to Hit | Target's Save Mod. | Notes |
|-------------|---------|--------------|-----|---------------|-------|-------------|-------------|--------------------|------------------|
| Assault Pod | Special | 4+ | 0 | None | | | | | Carries 2 stands |
| Support Pod | Special | 4+ | 0 | Plasma Cannon | 75cm | 1 | 5+ | -2 | |
| Deathwind | Special | 4+ | 0 | Bombs | 10cm | Special | 4+ | | Special rules |

THE LEVIATHAN

The Leviathan super-heavy command centres form the mobile headquarters of an Imperial Guard regiment. Each contains extensive communications and surveillance gear used to co-ordinate the regiment in action, including spy satellite link-ups, lines to orbiting spacecraft, control gear for tiny flying spy robots, and direct links to each company HQ unit. Inside are the regiment's senior officers, its Guard colonel and his staff, plus a considerable fighting crew to man the many weapons. This awesome vehicle is made by the Squats and supplied to the Imperial Guard as part of the mutual exchange of materials between the Squat Homeworlds and the Imperium. Every regiment has several Leviathans, any of which can command the entire regiment if necessary.

The immense weight and size of the Leviathan means it is very slow, and its move rate is therefore 10cm. This is its maximum move rate; the Leviathan cannot double this move if given charge orders. This doesn't really pose a problem as the command centre is unlikely to venture too near the enemy lines except in a dire emergency.

Because of its very thick and efficient armour the Leviathan has an armour saving throw of 1 on a D6. This applies all the way round including the sides and rear, so attackers do not get the usual bonus for side and rear shots. Needless to say, this means that most shots will simply bounce off unless the weapon has a save modifier of at least -1.

The Leviathan also has four void shields, which work in the same way as a Titan's. This means that it can sustain a number of hits without taking damage.

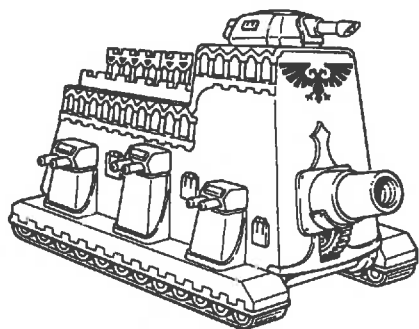

The super-heavy Leviathan is so massive that it cannot be easily brought into close combat. To represent this the Leviathan can't be pinned in close combat by lighter troops; it can only be pinned by Titans or other vehicles which are described in the rules as super-heavy. Super heavy vehicles include all Imperial super-heavy tanks (Shadow Sword, Baneblade, Storm Hammer) Ork Battle Fortresses (Giblet Grinda and Skull Hamma) and Squat Land Trains. If infantry or lighter vehicles engage the Leviathan in close combat it is not pinned and can simply move past them in the next turn, scattering opponents out of the way as it does so.

The Leviathan bristles with deadly weapons including the vast and highly destructive Doomsday Cannon mounted on its prow. This fires a barrage with a barrage points value of 3 plus the roll of a D6, so the score varies between 4 and 9. The Doomsday Cannon may fire to the Leviathan's front as normal. Because of its mobile turrets and the arrangement of its other weapons these may be fired all round.

The Leviathan can carry a complete infantry company of Imperial Guard including its company HQ unit complete with vehicles (up to 30 stands + HQ unit). Troops can be allocated to the Leviathan before the game begins. They are not obliged to stay with the command centre but can disembark and fight as normal.

The Leviathan may be included in your army as a special card representing the regiment's battlefield headquarters. The regimental HQ can issue orders to company HQ units over the entire battlefield and it can be imagined sending orders to troops further along the battlefield as well. If the Leviathan is destroyed the whole force is in deep trouble! You won't be able to give orders to any troops next turn because the chain of command will be broken at its very first link. Company commanders will find all their communications go dead, no information about the battle will reach them, and they will receive no instructions regarding objectives or movements. From the following turn orders may be given normally as another regimental HQ further behind the lines is assumed to take over.

The Leviathan does not need to be given orders. It automatically fires as if on first fire orders and can move up to 10cm. Because it is so huge, the special rules restricting firing at command units do not apply to the Leviathan. It may be fired at by any enemy that can see it just like any other target.

You can include several Leviathans in your force if you wish, assuming of course that you have sufficient points to pay for them. In this case your regimental headquarters is automatically assumed to be divided between the Leviathans. The vehicles may move and fight individually and do not form a unit as such. The loss of one of several Leviathans will not affect your chain of command so long as there is at least one left intact.

| Troop Type | Move | Saving Throw | CAF | Weapons | Range | Attack Dice | Roll to Hit | Target's Save Mod. | Notes |
|------------|--------------|----------------|-----|--------------|-------|-------------------|-------------|--------------------|--|
| Leviathan | 10cm Max. | 1 all round | 12 | Lascannons | 75cm | 6 | 5+ | -1 | May carry Imperial Guard company. 4 void shields. |
| | | | | Battlecannon | 75cm | 1 | 5+ | -2 | |
| | | | | Bolters | 15cm | 12 | 6+ | 0 | |
| | | | | Doomsday C'n | 200cm | D6+3 Barrage Pnts | | -3 | |

WARP HUNTER SQUADRON

The Warp Hunter Squadron consists of 2 Warp Hunters.



POINTS VALUE 100

BREAK POINT 2: The squadron is broken once it has lost 1 Warp Hunter. Once broken, it must take a morale check.

MORALE VALUE 3: Warp Hunters must roll 3 or more on a D6 to pass their morale check.



VICTORY POINTS 1

Your opponent gains 1 VP when this unit is broken.

WAVE SERPENT SQUADRON

The Wave Serpent Squadron consists of 2 Wave Serpents.



POINTS VALUE 150

BREAK POINT 2: The squadron is broken once it has lost 1 Wave Serpent. Once broken, it must take a morale check.

MORALE VALUE 3: Wave Serpents must roll 3 or more on a D6 to pass their morale check.



VICTORY POINTS 2

Your opponent gains 2 VPs when this unit is broken.

DEATHSTALKER PRISM CANNON

Deathstalkers fight independently, so each Deathstalker is a discrete unit.



POINTS VALUE 50

As a single vehicle, the Deathstalker cannot be broken. Victory points are awarded once it has been destroyed.

MORALE VALUE 3: A Deathstalker must roll 3 or more on a D6 to pass its morale check. The Deathstalker cannot be broken, but morale may still be necessary for daemonic attack or other special cases.



VICTORY POINTS 1

Your opponent gains 1 VP when this unit is broken.

IMPERIAL GUARD HELLBORE COMPANY

An Imperial Guard Hellbore Company consists of 1 Hellbore which is also the company HQ, plus a tactical company of Imperial Guard. The tactical company is composed of 3 tactical platoons. Each platoon includes its own section HQ stand as normal.

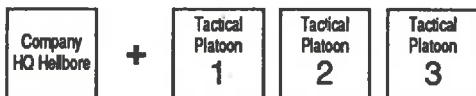

POINTS VALUE 1000

IMPERIAL GUARD HELLBORE COMPANY

SPECIAL RULE: If you choose a Hellbore Company you can only allocate Moles or Termites as support units.

BREAK POINT 16: The Hellbore Company is broken once it has lost 16 models (either troop stands or Hellbore). When the company is broken, each platoon must take an individual morale check.

MORALE VALUE 4: Imperial Guard have a morale value of 4, and must roll 4 or more on a D6 to pass their morale check.

For a platoon to receive orders its section HQ stand must be within 25cm of the Hellbore at the start of the orders phase. The same also applies to any support units allocated to the company. If troops are unable to receive orders they cannot move but may fire in the advancing fire segment of the combat phase in the same way as other troops with no orders.

The Hellbore forms the company HQ and does not need to be given orders. It always moves at up to 15cm and cannot double its move by means of a charge order. The rule restricting fire on command units does not apply as the Hellbore is so large, and it may be shot at like any other target.

VICTORY POINTS 10

Your opponent gains 10 VPs when this company is broken.

SPECIAL CARD

LEVIATHAN

Super Heavy Command Centre

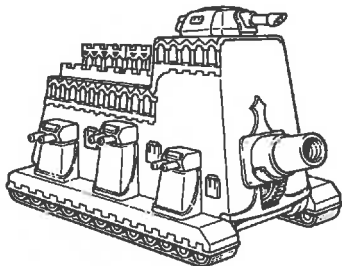

| M | Save | CAF | Weapons | Range | Attack Dice | Roll to Hit | Target's Save Mod. |
|------|------|-----|--------------|-------|-------------|-------------|--------------------|
| 10cm | 1 | 14 | Lascannons | 75cm | 6 | 5+ | -1 |
| | | | Battlécannon | 75cm | 1 | 5+ | -2 |
| | | | Doomsday C'n | 200cm | D6+3 | Barrage | -3 |
| | | | Bolters | 15cm | 12 | 6+ | 0 |

POINTS VALUE 350

LEVIATHAN

The Leviathan super-heavy command centre forms a focal point for all communications and tactical coordination for the Imperial Guard regiment. It is crammed with monitoring and communications gear; and is where the regiment's top commanders evolve and execute their battle plans.

You do not need to give orders for the Leviathan – it always has first fire orders and can move up to 10cm (with reductions in terrain in the same way as other vehicles). The Leviathan can only be pinned in close combat by other super-heavy tanks or Titans. If all the Leviathans in your force are destroyed, your chain of command is severed at the top and you may not issue any orders in the next turn while regimental command is re-established by other forces behind the battle lines.

The Leviathan can fire its weapons all round except for the Doomsday Cannon which can only fire into the front arc as normal.

VOID SHIELDS: The Leviathan has 4 void shields.

BREAK POINT: As a single model the Leviathan cannot be broken.

MORALE VALUE: The Leviathan never needs to check morale.

VICTORY POINTS 4

Your opponent gains 4 VPs when the Capitol Imperialis is destroyed.

SPECIAL CARD

DROP PODS

This consists of 10 assault drop pods, 3 support drop pods and 3 Deathwind drop pods.



POINTS VALUE FREE

DROP PODS

The drop pod card allows you to replace the Rhinos of 1 entire Space Marine company with assault drop pods in preparation for a drop. In addition, 3 support and 3 Deathwind drop pods are included to clear the ground and provide cover. Pods do not count as casualties and are not considered part of the units they deliver to the battlefield. The break point of the unit remains the same – the extra value reflects their role as fast assault troops who know they keep their nerve to survive.



VICTORY POINTS 0

To make up your data cards, first photocopy the cards on this page. Fold each card along the dotted line and glue the two halves together on the inside. You can then use these cards as normal in your Space Marine games.

IMPERIAL GUARD MOLE

A Mole transports an entire platoon of 10 tactical Imperial Guard, including a section HQ.



POINTS VALUE 250

The section HQ must remain within 25cm of its company HQ unit or Mole to receive orders. Place this card with its company HQ card to show its chain of command.

BREAK POINT 6: The Mole platoon is broken once it has lost 6 models, either Guard troop stands or the Mole.

MORALE VALUE 4: Imperial Guard must roll 4 or more on a D6 to pass their morale check.

Moles never move faster than 15cm. They cannot double their speed by means of a charge order.

VICTORY POINTS 3

Your opponent gains 3 VPs when this unit is broken.

IMPERIAL GUARD TERMITE UNIT

The Termite Unit consists of 3 Termites each carrying 2 tactical Imperial Guard stands. One stand in the unit forms the section HQ.



POINTS VALUE 150

The unit must remain within 25cm of its company HQ unit or lead Termite to receive orders. Place this card with its company HQ card to show its chain of command.

BREAK POINT 5: The Termite assault unit is broken once it has lost 5 models, either Guard troop stands or Termites.

MORALE VALUE 4: Imperial Guard must roll 4 or more on a D6 to pass their morale check.

Termites never move faster than 15cm. They cannot double their speed by means of a charge order.

VICTORY POINTS 2

Your opponent gains 2 VPs when this unit is broken.

IMPERIAL GUARD MOLE COMPANY

An Imperial Guard Mole Company consists of 1 HQ section with a Termite, plus three tactical platoons of Imperial Guard each with a Mole. Each platoon consists of ten tactical stands and includes a section HQ.

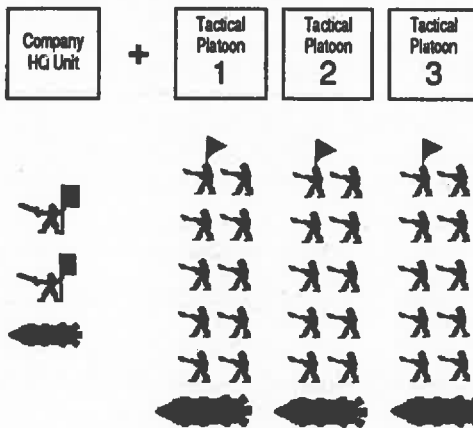

POINTS VALUE 1000

IMPERIAL GUARD MOLE COMPANY

SPECIAL RULE: If you choose a Mole Company you may only include Moles or Termites as support units.

BREAK POINT 18: The Mole Company is broken once it has lost 18 models, either troop stands, Moles, or the Termite. When the company is broken each platoon must take an individual morale check.

MORALE VALUE 4: Imperial Guard have a morale value of 4 and must roll 4 or more on a D6 to pass their morale check.

A platoon may receive orders if it is within 25cm of its Mole. Otherwise a platoon must be within 25cm of the HQ Termite at the start of the orders phase to receive orders. The same also applies to any support units allocated to the company. If troops are unable to receive orders they cannot move but may fire in the advancing fire segment of the combat phase in the same way as other troops with no orders.

Neither Moles nor Termites ever move faster than 15cm. They cannot double their speed by means of a charge order.

VICTORY POINTS 10

Your opponent gains 10 VPs when this company is broken.

To make up your data cards, first photocopy the cards on this page. Fold each card along the dotted line and glue the two halves together on the inside. You can then use these cards as normal in your Space Marine games.

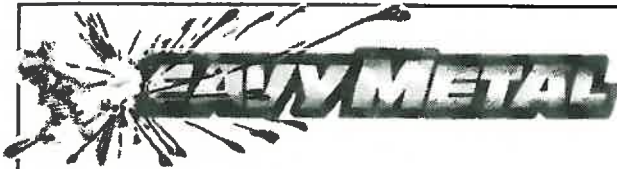

This month's 'Eavy Metal takes a look at the most recent additions to the studio Imperial Guard army - a Hellbore, a squadron of Termites and the Leviathan. We've also just finished painting the two Warhounds and the Slasher Gargant.

IMPERIAL GUARD ARMY

Last month's White Dwarf included extracts from the Codex Astartes showing details of how Imperial vehicles are painted and camouflaged.

The Hellbore and Termites are both types of tunnelling troop carriers designed to penetrate deep into enemy territory before surfacing and deploying their men. They are an extremely effective way of outflanking enemy fortifications and mine fields.

The Hellbore is a huge vehicle capable of carrying an entire company of troops. It displays its company colours on both the tunneller itself and on the carrying vehicle. Both parts of the Hellbore are painted in Apocalypse Red, one of the core vehicle colours recommended in the Codex Astartes and a mix of Blood Red and Blood Angel Orange. This was highlighted with Bad Moon Yellow and the fine details were picked out in Shining Gold.

The Leviathan is the mobile Regimental HQ and so is the centre piece of our Imperial Guard army. We wanted to make it really stand out and look spectacular on the gaming table and so decided to paint it a bright golden yellow colour. The base colour was a mix of Sunburst Yellow and Blood Angel Orange. When this was dry, the model was shaded by giving it a thin wash of yellow ink with a spot of brown ink mixed in. The highlights were achieved by adding Skull White to Sunburst Yellow and painting this onto all of the raised areas. To finish off the model, Imperial eagle transfers were applied to the outside weapon towers and a laurel wreath was painted onto the central panel.

All Imperial Guard regiments are recruited from single worlds. The studio army is the 12th Necromundan Regiment and the Leviathan proudly displays their regimental banner. Every vehicle in our Imperial Guard Army displays a campaign symbol in the form of a yellow triangle. This can be clearly seen on the side of the Hellbore and its transport vehicle.

Elsewhere in this issue of White Dwarf are data cards and damage tables for the Eldar Phantom, Slasher Gargant and Warhound Titans. Shown here is the Slasher Gargant we painted for our Epic Goff army and two Warhounds for our Imperial army.

SLASHER GARGANT

Despite its seemingly complex paint scheme the Slasher was in fact quite quick and easy to paint. Nearly all the complex designs are actually transfers, and checks are very easy to do once you've mastered the basic technique.

The model was first of all given a black undercoat. The entire miniature was then drybrushed to create the highlights starting by adding just a spot of Skull White to Chaos Black. As you build up the highlights add more white to the black paint and use slightly lighter brush strokes. Because the Gargant was going to be quite heavily decorated, we could use a more basic style of highlighting.

Once the highlights were dry all of the metal areas were drybrushed with Tin Bitz and then Chainmail.

The next stage was to decide which parts of the miniature were going to be a light colour and paint these Skull White. This is because light colours will show up far better on a white background rather than painting them directly onto the black basecoat. It is also a good idea to paint small white squares where you want the transfers to be applied, these can then be painted in bright colours so that the transfers are well defined.

All of the red parts, including the red and black checked areas were painted Go Fasta Red and highlighted with Blood Angel Orange. The head was given a base coat of Ork Flesh Green and highlighted with Striking Scorpion Green and Skull White. The lower jaw was painted black and the teeth were picked out with Skull White.

When you paint checks it's best to paint the lightest colour on first. In the case of the checks on this Slasher, we used either white or red as the base colour. The next step is to very carefully paint on a grid of thin vertical and horizontal black lines. Take your time when you are doing this, don't make the lines too close together or the checks will start to merge. When you've finished the grid, all you have to do is fill in every other square with Chaos Black.

WARHOUNDS

The two Warhounds are part of the Iron Skulls Imperial Titan Order. The main colours for Iron Skull Titans are red, gold and yellow, the Warhounds have been painted mainly red with gold metal work and yellow decoration.

Even though each Titan is an individual with its own personal colour scheme, we painted the Warhounds in closely linked styles to visually tie them together. Each of the Titans has a split-colour scheme on the carapace, one half is red and the other is patterned - black and yellow stripes on one Warhound and black and white chevrons on the other. The weapon banners that the two miniatures display reflect these patterns.



Imperial Guard Hellbore – shown aboard its huge transport vehicle



*Leviathan
Imperial Guard mobile Regimental HQ*



Termite Assault Unit



Permission to photocopy for personal use.
Copyright © 1991 Games Workshop Ltd.
All rights reserved.

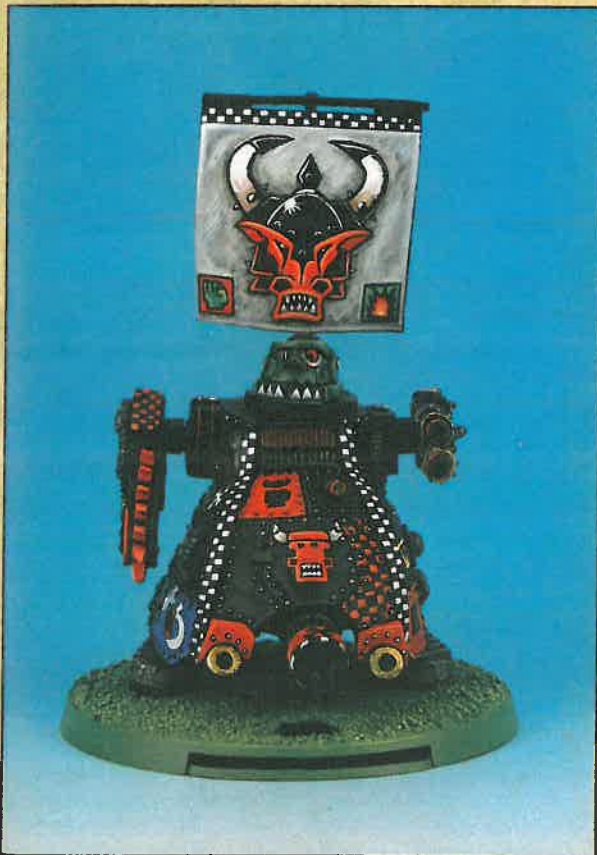

Goff Clan Slasha Gargant



Two Warhounds from the Iron Skulls Titan Order

SPACE HULK™

QUESTIONS AND ANSWERS

BY DEAN BASS

At Games Day 1991 I had a great time chatting to my fellow Space Hulk gamers and answering their questions and queries about the game. Most people commented on how useful they had found the Questions and Answers article by Simon Forrest in White Dwarf 142 and so I decided to do something along the same lines. The following rules cover the most commonly asked questions at Games Day 1991.

FIRING ON FRIENDLY TROOPS

QUESTION: Can you fire on your own Space Marines to gain an advantage?

As we've pointed out previously in Simon's article and in Space Hulk Campaigns, a Space Marine would never even consider firing at a Genestealer if it meant destroying another Brother Marine. However, it's worth pointing out that this rule does not apply to Genestealers. They'll sacrifice themselves without hesitation, for the survival of the brood.



MOVE AND FIRE

QUESTION: Does the 'move and fire' rule also apply to turning ninety degrees and firing?

The answer is yes. Turning ninety degrees and firing can be done as one action and costs 1AP.

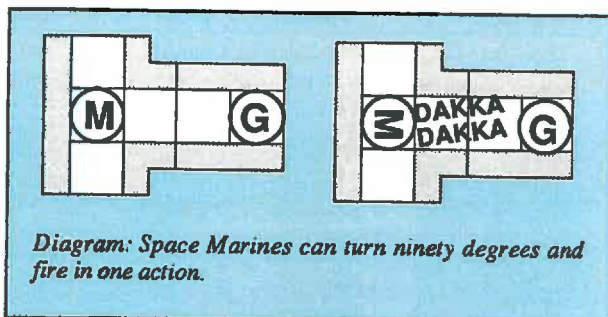

This brings to mind another interesting rules query.

QUESTION: Can a move and shoot action be used to fire on a target that wasn't in line of sight at the beginning of the action?

The answer to this is also yes as the diagrams below demonstrate.

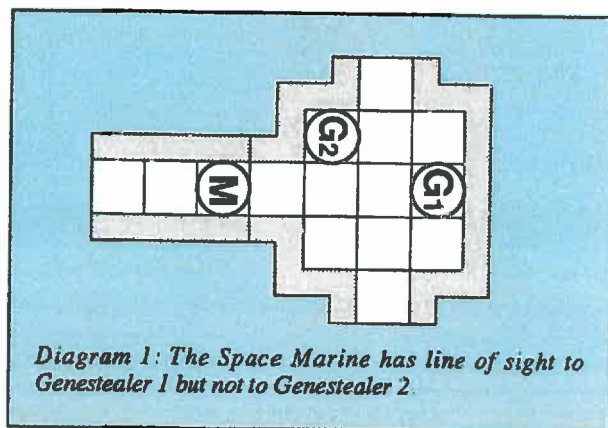

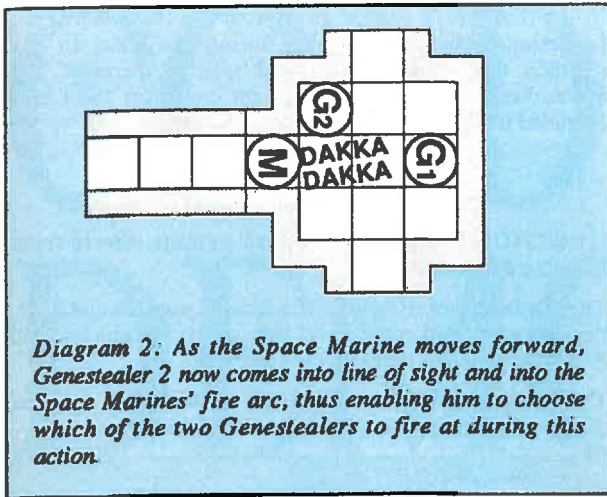

OVERWATCH AND PITFALLS

QUESTION: Can a Space Marine cover a Pitfall by being on overwatch?

The answer is yes. He can cover a pitfall whilst on overwatch whether he's on the ground or on the floor above.

In the diagram below, we've shown the squares to which a Space Marine only has line of sight (LOS) and those squares to which he has a fire arc. Remember that a Space Marine on overwatch must fire as soon as he sees a target in any square marked as a fire arc, whether the target is above or below.

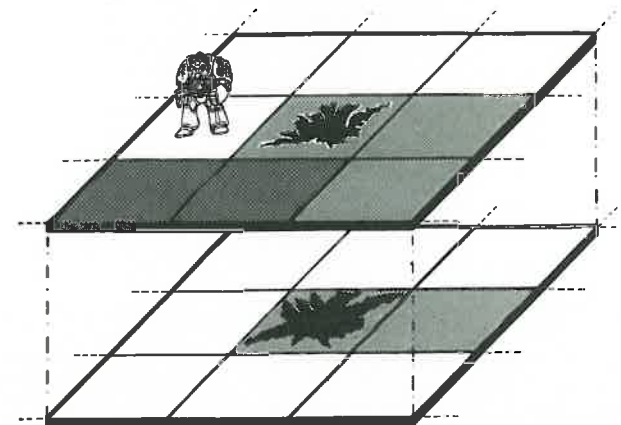
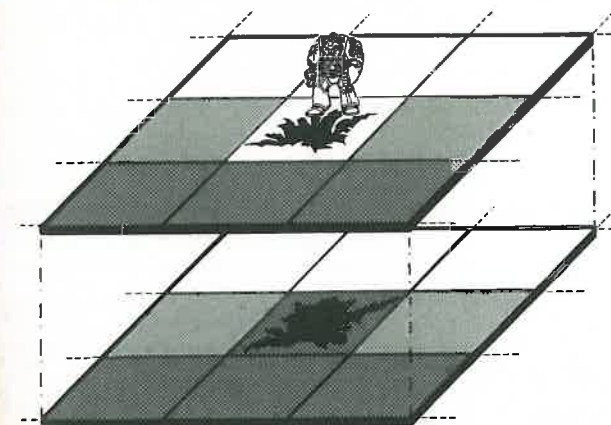
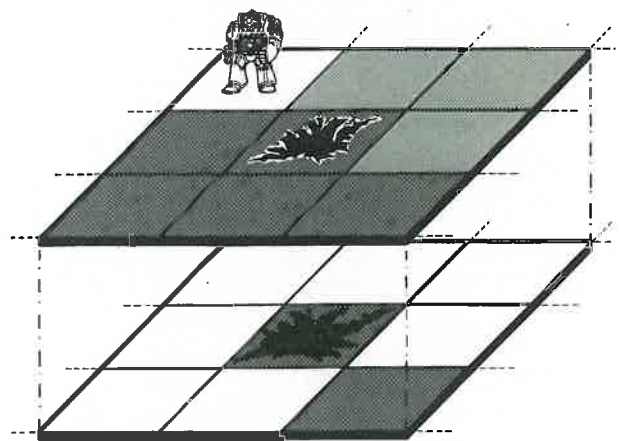
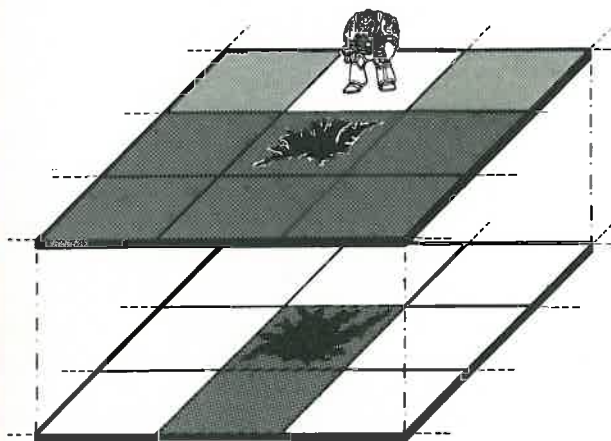

FIRE ARC 

L.O.S. ONLY 

OFF-BOARD BLIP CONVERSION

QUESTION: How do I avoid losing Genestealers after being forced to convert blips into tight spaces?

I was often asked this question at Games Day. People have said that they've been losing models because they kept getting spotted by the Space Marines before they could get to a room to convert.

Don't forget that blips can convert before they come onto the board. Instead of the Blip moving on at the entry point, the individual models move on one by one. This may mean congested corridors later on, but it puts an enormous amount of pressure on the Space Marine player when he sees hordes of Genestealers advancing towards them.

PSYCHIC CARDS

QUESTION: How many psychic cards are drawn each turn?

A lot of people seem to be confused about this. The Genestealer player has a hand of four psychic cards unless there is a Magus or Patriarch in play. If there's a Magus in play, the hand is increased by one to five cards and if there's a Patriarch in play, the hand is increased by two to six cards. If there's a Magus and a Patriarch in play at the same time, the hand is increased to six cards not seven.

At the start of each turn, one card may be discarded and one is picked up again to bring the hand back up to its full size. A single card may always be discarded and picked up each turn, even if there's no Hybrid psyker in play to take advantage of the psychic cards available.



MARK GIBBONS

The size of the Space Marine psychic card hand is two cards plus one extra card for each Librarian in play. At the start of his turn the Space Marine player replaces any cards he's used in his previous turn. He may also pick up two additional cards. He must then discard any two cards from his hand, to bring it back to the correct number.

For example: The Space Marine player has three Librarians in play. At the start of the game he picks up his first two cards and one more for each Librarian, giving him his total hand of five cards. The Space Marine player then completes his first turn, but doesn't use any psychic cards. At the start of his next turn, he can only pick up two more cards, even though he has three Librarians in play. He must then discard any two psychic cards from his hand, to bring his total back down to his maximum hand of five cards.

If the Space Marine player had used one of his psychic cards during his first turn, he would have ended up with four cards at the start of the next one, thus enabling him to pick up three more cards. After discarding any two from his hand of seven cards, he would have brought his total back down to five.

If a Space Marine Librarian is killed, the size of the psychic card hand is decreased by one card at the start of the Space Marine players' next turn.

For example: The Space Marine player has three Librarians and five psychic cards. During his turn, one of his Librarians is killed. If he has not used any of his existing five cards, his 'pick-up' next turn is two cards. After picking this up, he's now got seven psychic cards. He discards whichever three he likes, leaving himself with four cards; two cards plus one for each Librarian in play.

In the Sentinel V campaign in Space Hulk Campaigns, Librarians actually enter play during the game. In this situation, the players card hand and 'pick-up' increases. The Space Marine player cannot count cards for the Chief Librarian until he enters play.

MIASMA AND BLAST

QUESTION: Does Miasma block psychic effects from entering a section?

The answer is yes. However, if a Blast is used on an object, the object in question can travel through the Miasma and will destroy any models it hits on the other side.

This is because the Blast acts firstly on the object and after that it is a purely physical force not affected by Miasma.

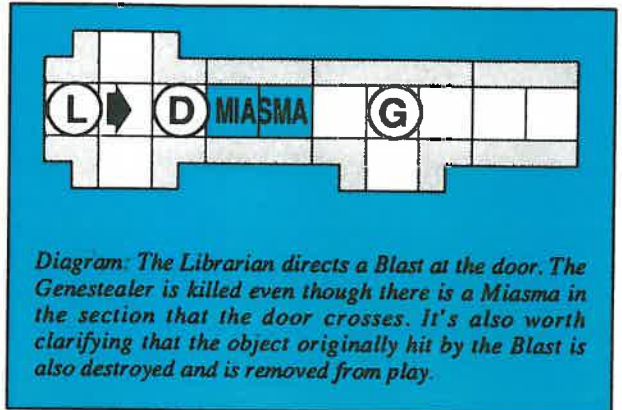

MOVEMENT AND PSYCHIC EFFECTS

QUESTION: can a Space Marine Librarian enter a Hellfire if he has an Aura?

The answer is no. Hellfire, Vortex and Stasis all block movement into a section. Only a model already in the section who survives the attack can move in that section. This is also true of Flamer hits and the first turn of a Melta Bomb hit.

PRESCIENCE

Through talking with many players, we've noticed that Prescience is a very under used psychic card. In actual fact, in the right circumstances it can change the course of a game. A Librarian on overwatch under the effect of Prescience needs a 5 or a 6 on either die to kill a Purestrain Genestealer, rather than the usual 6.

AMBUSH COUNTERS

QUESTION: When an ambush counter is spotted by a Space Marine and forced to convert, can the Genestealers continue to advance?

The answer is yes. Unlike normal Blip conversion, if an ambush counter enters a Space Marines line of sight it does not lose the rest of its AP's. If the Blip turns out to be a Genestealer it can carry on with any AP's it has left.

In some of the missions in Space Hulk Campaigns we've used ambush counters to represent Hybrid Psykers or even Magi rather than just Purestrain Genestealers. However, the rules in Deathwing still apply.

GOLDEN '92 DEMON 92

THE 5TH ANNUAL CITADEL MINIATURES PAINTING CHAMPIONSHIPS

NEC BIRMINGHAM, SATURDAY 18TH APRIL 1992

Golden Demon 1992 is world's premier Citadel Miniatures painting event. Each year, thousands of enthusiastic gamers, miniature painters and modellers assemble under one roof to see the very best painted miniatures in the world. The overall winner will carry away the coveted Golden Demon Slayer Sword.

Over the years, the Golden Demon Awards have grown in size and attracted a huge following. As a result, this year we've decided to move the competition from the Derby Assembly Rooms to the NEC in Birmingham.



This new venue will give us more space and better facilities than ever before.

As well as all the wonderfully painted Citadel Miniatures on display, there'll be fantastic demonstration and participation games, stunning displays of the finest fantasy artwork and the Games Workshop, Citadel Miniatures and Marauder Miniatures retail stands. There'll also be stands manned by Games Workshop Games designers and artists who'll be ready to answer any questions you have about the Games Workshop hobby.

Look out for more details about how to enter in future editions of White Dwarf.

1991 Golden Demon Slayer Sword winner - Paul Robins' Marauder Giant.

WARHAMMER

▶ ROGUE 40,000 TRADER

NOISE MARINES

BY RICK PRIESTLEY

There is a part of the galaxy known as the Eye of Terror which is shunned by spacecraft and avoided even by the bravest of travellers. It is a place where time and space have little meaning, where the physical universe breaks down and intermixes with the psychic universe, the Realm of Chaos.



Noise Marine painted by Tim Prow

Planets do exist in the Eye of Terror, though they are nothing like those in the material universe. The worlds in the Eye of Terror are self-contained universes where the laws of time and space depend upon the whims of the Daemon Princes that rule over them: where skies of fire light lakes of boiling blood, and a thousand other unimaginable perversities of nature flash into existence and pass away each day.

Upon one such world, ruled over by a Great Daemon Prince whose name is represented only by a scream of utter abandon, stands the colossal fortress of the Noise Marines. This bizarre and unique fellowship of Space Marines honour Slaanesh the Lord of Pleasure. They scour the galaxy, bringing death and destruction to all,

squeezing each planet dry and throwing it aside before moving on to the next succulent prize, never stopping to measure the loss of blood.

The Noise Marines were once loyal Space Marines sent to battle against a distant threat, not well understood at the time, but which proved to be nothing less than the advancing hordes of Slaanesh, Lord of Pleasure and Great Power of Chaos. They were not killed on that long forgotten battlefield, but suffered a fate far worse – they were horribly altered by the mutating power of Chaos. Their Space Marine senses, already honed by careful genetic engineering, were worked on by further magic, overturning the Imperium's work and creating a new creature known as the Noise Marine.

A Noise Marine's hearing is a thousand times keener than a normal Space Marine's and can distinguish between the subtlest difference in pitch and volume. In itself, this ability would not serve to corrupt such a steadfast servant of humanity as a Space Marine, but the Noise Marine's sense of sound affects his whole mind, causing extreme emotional reactions that make all other sensations pale and worthless. The louder and more discordant the noise the more extreme the emotional reaction provoked, and the more tawdry and vile seems the everyday sensation of life. Eventually only the din of battle and heightened screams of fear can stir the Noise Marine. His mind ceases to reason and becomes a mere receptacle for sensations ignited by the music of the apocalypse and the screams of the dying as they dance upon the path of destruction.

Noise Marines wear Space Marine type power armour with a crested helmet. The armour is painted in a bold colour or style, as the Noise Marines' senses are so distorted by their mutation that only the most extravagant colours and patterns register on their minds. The weapon carried by the Noise Marines is the Sonic Blaster, a device which can unleash destructive sound waves capable of tearing solid

objects apart. The Sonic Blaster can be used in such a way that its harmonic frequencies interfere directly with the nervous systems of living creatures, causing them to lose control of their bodies as their muscles go into violent spasm. The destructive effect of the Sonic Blaster depends upon the skill of the Noise Marine using it, as the weapon is played as an instrument, rather than simply fired. In the hands of a Master a single discordant blast at high volume causes massive sensory overload and a violent death as the target explodes into a thousand fragments.

A squad of Noise Marine consists of 6 individuals each armed with a Sonic Blaster. The squad leader is especially powerful and is known as a Master. Squads of Noise Marines may be incorporated into any Chaos force for Warhammer 40,000, not just Slaanesh armies. A Noise Marine Master may be incorporated into any Chaos army as an individual Champion. Masters may also be used as the basis of a Chaos Champion and Renegade warband created using the Realm of Chaos system described in *Slaves to Darkness*.

*We're so loud you wanna die
Go forth and amplify*

Here come the Noise Marines

Lyrics by D-Rok, from the album 'Oblivion'
© 1991 Warhammer Records Ltd

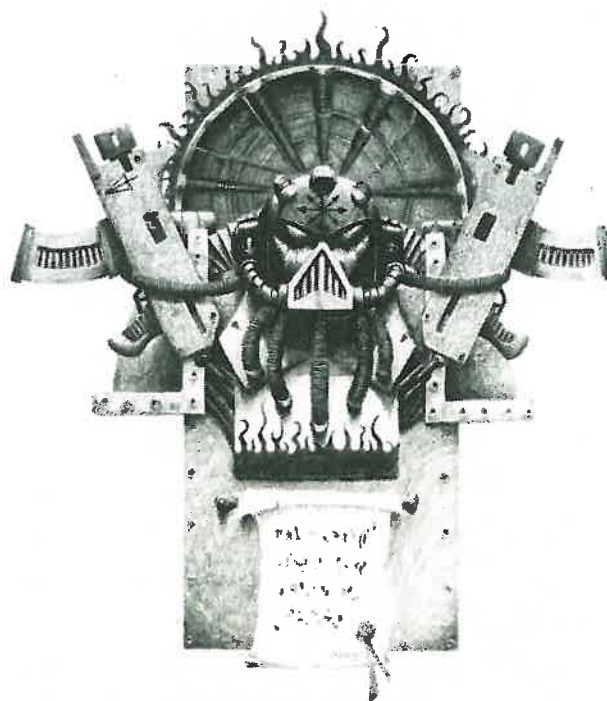

NOISE MARINES

| | M | WS | BS | S | T | W | I | A | Ld | Int | CI | WP |
|--------------|---|----|----|---|---|---|---|---|----|-----|----|----|
| Noise Marine | 4 | 4 | 4 | 4 | 4 | 1 | 4 | 1 | 10 | 10 | 10 | 10 |
| Master | 4 | 4 | 4 | 6 | 4 | 4 | 4 | 4 | 10 | 10 | 10 | 10 |

| | |
|-----------------|--|
| MAXIMUM IN ARMY | UNLIMITED |
| POINTS COST | 200 PER SQUAD OF 6 INCLUDING 1 MASTER 100 FOR MASTER ON HIS OWN |
| EQUIPMENT | POWER ARMOUR - Saves on a D6 roll of 4+ SONIC BLASTER - See special rules |

CHAOS ATTRIBUTES

Up to D6-3. All the Noise Marines in the unit can be given up to the number of attributes rolled - they can always be given less if you prefer. All Marines in the unit can be given the same attributes, or you can roll individually for their number and type.

SPECIAL RULES

Noise Marines emit a constant psychic cacophony of babbling, screaming, braying and other disorienting noises which confuse any psykers within 24". If a living psyker within this distance attempts to use his powers he is

overwhelmed by the noise and turned into a mindless gibbering hulk on the D6 roll of a 5 or 6. On the roll of a 4 he is unable to use his powers that turn but is unharmed. Only on a roll of 1, 2 or 3 can he overcome the seductive psychic harmonies and use his powers as normal. Daemons are not affected by this and quite enjoy the noise, particularly Greater Daemons of Nurgle, who are inclined to hum along in a cheerful manner.

A Sonic Blaster has a range of 24" and has the same strength value as the Noise Marine using it - this is 4 for Noise Marines and 6 for Masters. All armour saving rolls are reduced by -2 if struck by a Sonic Blaster.

In the hands of a Master (but not a Noise Marine) the Sonic Blaster has following fire, but he may forgo to use this and instead shoot a single power blast with a strength of 6+D6 (up to a maximum value of 10) causing D6 wounds and penetrating armour automatically.

Once the Master has slain an enemy or destroyed a vehicle using a power blast he must test to see if he is struck by feedback, overloading his heightened senses and sending him into rapturous unconsciousness. Roll a D6, and on the roll of a 6 the Master is knocked to the ground, ears bleeding, eyes bulging, and his mouth contorted into a fixed blood stained grin. He remains unable to do anything until the player rolls a further 6 at the start of a subsequent turn when he recovers sufficiently to continue fighting as normal. While unconscious the Master may be carried by another model at half movement rate. The burdened model may not shoot or fight while carrying the Master.



DARK ELF ARMY

By Kent Martin and Christopher Alvord

Kent Martin is an enthusiastic Warhammer player who works for Games Workshop in their Baltimore area stores. Kent has just started to build up a Dark Elf army for Warhammer Fantasy Battle, and when we were shown some photographs of his painted units, we were so impressed that we decided to feature them in White Dwarf. Kent also agreed to set down his thoughts on why he decided to choose Dark Elves for his army and how he set about organising his forces.



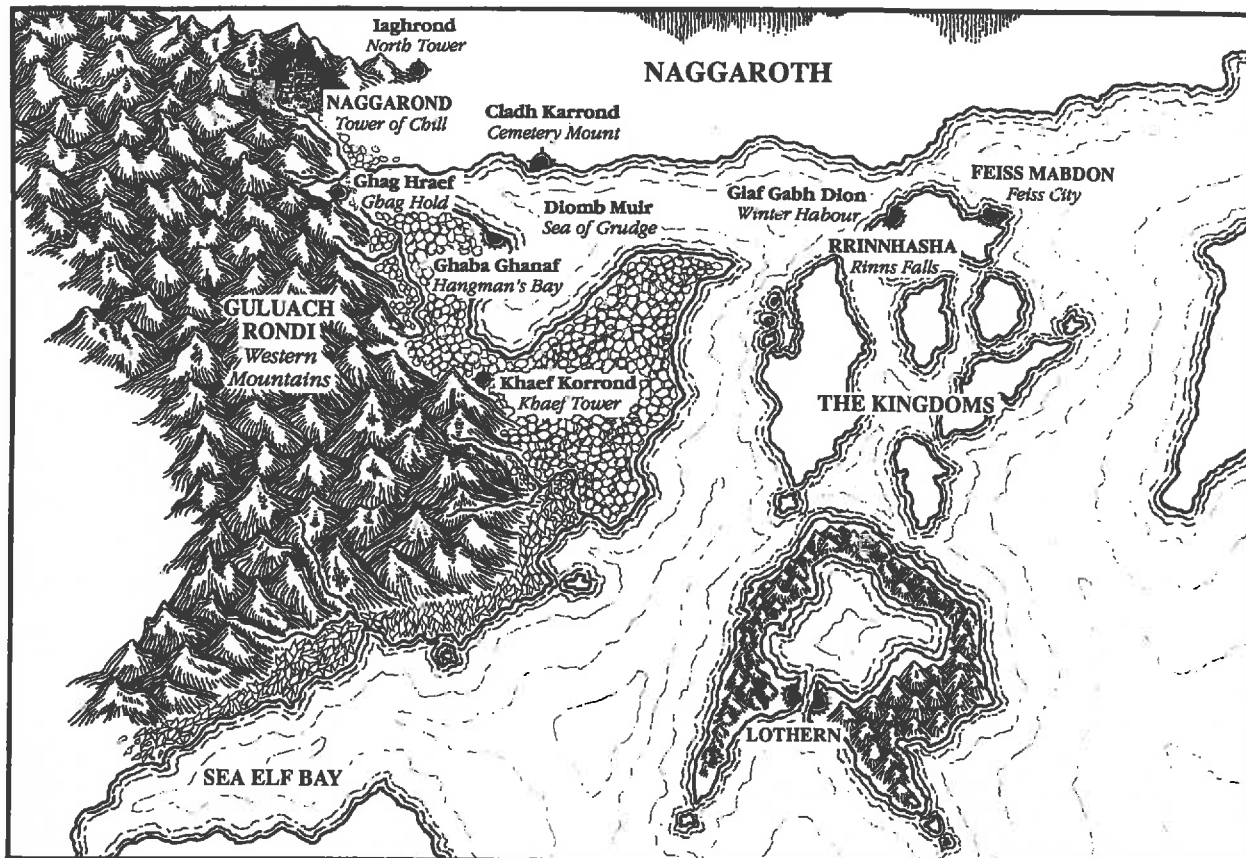

For some time now, I'd been thinking about collecting a Warhammer Fantasy Battle army. Until recently my main interest has been Warhammer 40,000, and I've been kept more than busy putting together my Dark Angels army, assembling vehicles and building terrain. However, having watched several games of Warhammer Fantasy Battle in progress, my imagination was captured by the image of my own mighty host sweeping forward to glorious victory

After speaking with some Fantasy Battle players and reading the recent White Dwarf articles, I decided that the best way forward would be to start off by assembling a modest 1000 point force. I'd be able to put this together without too much trouble, and once I'd started playing and become more familiar with the basic rules and tactics, I would have a much better idea about how to go about expanding my army.

Since I wasn't an experienced Fantasy Battle player, my choice of army wasn't really based on gaming tactics but on the miniatures themselves. The armour, weapons and poses of the Dark Elf miniatures have always made them one of my favourite ranges and so I decided that they were the army for me. Besides, there were far too many High Elf armies out there that could stand a good beating – which would be particularly galling at the hands of Dark Elves!

ARMY BACKGROUND

Before I began selecting individual characters and units I wanted to get a real feel for the Dark Elves, so I read all the background material I could find in the Warhammer rule books, GW novels and White Dwarf

articles. This gave me a much better idea of how Dark Elves fitted into the Warhammer world and enabled me to build-up an authentic background for my force.

I decided that my army general Darsis Death Dealer had been a senior officer in Naggaroth's army. He tired of the political tensions between the *Dru Perim* and the *Kryrnaa Khanas* and chose to flee south from Cladh Karrond. A strong leader with a reputation as a fierce warrior, Darsis quickly attracted a group of loyal supporters who were prepared to throw in their lot with him. He and his band of followers are now marauding along the southern coast of Naggaroth, raiding ships and coastal settlements. As word of his exploits and daring spread, ever more disaffected or mercenary forces are being drawn to his camp. When he has sufficient strength, Darsis plans to set sail for the Old World, for better spoils, conquest, and glory.

BASIC TROOPS

The army lists in Warhammer Armies are all based upon 3000 point armies. Like me, many people prefer to start by collecting a 1000 or 2000 point army first so that they can develop their collection of models over a period of time. This has the advantage of reducing the number of compulsory troops required so you can make your initial purchases more interesting and varied. Collecting a smaller army simply means that you reduce all the compulsory minimums and maximums of everything by two thirds for a 1000 point force or by a third for a 2000 point force. When reducing the army size in this way, minimum and maximum regiment sizes are also reduced by two thirds or a third to a



Dark Elf Warriors with their battle standard

minimum regiment size of five models. As I was going to start by building up a 1000 point warband, I reduced all of the compulsory troop types by two thirds which left me plenty of points for characters, additional units and equipment upgrades.

First of all came the compulsory troops – Warriors, Crossbowmen and Witch elves. I picked a unit of fifteen Warriors armed with hand weapons, light armour and shields and also included a standard bearer with these troops. I then selected a unit of ten Crossbowmen with their basic equipment of crossbow and hand weapon and light armour. Finally, I added ten Witch Elves with hand weapons and light armour. I particularly like the Witch Elf models, and so for an additional four points per model gave them all

additional hand weapons and made them even more deadly by giving them poisoned attacks.

I'd already made up my mind about the characters I wanted in my army, and so having chosen all of my compulsory troop types – and used up almost half of my 1000 points – I looked through the lists for one more unit to add to my warband.

Although tempted by a War Alter and its attendant Witch Elves, I really love the Cold One models and the idea of their fanatical riders burning out their nasal membranes in order to be able to ride and control their mounts. I therefore opted for a unit of five Doomdrakes for 175 points. The War Alter will have to wait until later.

CHARACTERS

In keeping with the unit's history, I wanted to include at least three character models: Darsis Death Dealer the army general, his trusted henchman Vok Rezhnek and the wizard Tarnig Delzus.

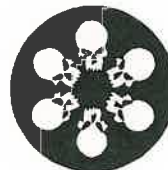

I decided a level 15 Hero would be high enough for my general. I mounted him on a Cold One to increase his mobility and enable him to lead the Doomdrake unit. To give him an edge in combat I also equipped him with a magical parasitic blade.



Dark Elf Wizard Tarnig Delzus, General Darsis Death Dealer and level 5 Hero Vok Rezhnek

Vok Rezhnek is one of Darsis's most loyal followers, having been with him since they left Cladh Karrond. I wanted him to lead the unit of Warriors and so I made Vok a level 5 Hero. I equipped him with a crossbow – a characteristic Dark Elf weapon – and to further enhance his fighting ability, I also bought him a magical Arcane arrow.

Regardless of its size, I felt that no Dark Elf army would be complete without a wizard of some kind. Unfortunately, the points values of Dark Elf wizards are rather high compared to other races. I wanted a level 2 Wizard but had to settle with making Tarnig level 1 instead. When I expand my army I intend to bolster its magical strength.

PAINTING

Most of the models were painted with the standard base coat - ink wash - dry brush technique. Don't forget that when you are doing this you must leave the paint to dry thoroughly between each of the coats, especially between the ink wash and drybrush. The only areas that were not painted with these techniques were the armour and the flesh tones. The flesh areas on the models were painted with a mix of 4 parts Bronzed Flesh, 2 parts Swamp Brown, 1 part Blood Angel Orange and 1 part Snakebite Leather. I made up a bottle of this colour and used it for the whole army so they were all the same shade. For the highlights, I added Skull White to the base colour and applied this to the raised areas such as the nose, chin and brows.



Dark Elf Crossbowmen

The most important thing to remember when you are painting miniatures for an army is that it is mass effect, not individual brilliance that you are trying to achieve. Even though the rank and file models are not highlighted or shaded to display standard, because they are painted neatly they have turned out really well. This meant that I could spend more time on painting up my character models to a really high finish.

With most of the miniatures I wanted the armour on the Warriors and the Crossbowmen to have a strange, dark look. First of all I gave the armoured areas a thin wash of Chaos Black and then painted the armour plates with a mix of Mithril Silver and Green Ink. I then carefully shaded these areas to give definition to the individual armour plates. I achieved a similar effect on the Doomdrakes, but this time mixed Blue ink with the Mithril Silver to create a shimmering blue colour.

The Cold Ones were painted Sunburst Yellow and then given a Green ink wash. Finally, they were drybrushed with Bilius Green. This gives them their startling green reptilian look.



Doomdrakes mounted on Cold Ones

I wanted the unit of Witch Elves to have real presence, so I painted them in two strongly contrasting colours, red and black. I painted the swords Go Fasta Red and highlighted them with Hobgoblin Orange. I think this works really well, and the regiment was finished off by giving all of the models jet black hair.



Witch Elves

TACTICS

The main features of a Dark Elf army are that it is fast – with an unarmoured movement rate of 5" per turn for all unmounted troop types, and it is deadly – all the basic troop types having a WS of 4. These two factors together influence the way that the army is handled on the tabletop. It really is not a lot of use waiting around for the enemy to come to you. Dark Elves love to lunge forward into the fray, closing with the enemy and cutting them down in a swathe of blood.

The largest unit in my army is the Warriors, led by Vok Rezhnek. This unit will form my main attack regiment, moving forward to engage the enemy in hand-to-hand combat. It was for this reason that I also spent the points on a unit standard for these troops. Most of the time they will be fighting in two ranks of eight models and that +1 bonus for the standard combined with their high WS should give them the edge against most opponents.

DARK ELF ARMY

The high ballistic skill of the Dark Elf crossbowmen means that I could keep this unit small while still retaining their effectiveness. Their long range weapons and hard hitting power (especially against armoured troops) will allow them to give covering fire to my Warriors and keep any marauding enemy units at bay.

No other unit better exemplifies the Dark Elves than the Witch Elves – a unit of frenzied female Dark Elves is not to be taken lightly! When I paid the points for these models, I couldn't resist giving them additional hand weapons and poisoned attacks. This combination will provide a really nasty surprise for any of my opponents on their first encounter, and hopefully a healthy respect from then on.

With its performance on the battlefield firmly in mind, I wanted a formation that could act as a mobile reserve. A unit that could quickly move to support any weakness in my line, or advance forward to exploit any gaps in the enemy's formation. For this purpose, a regiment of Doomdrakes is ideal, their speed and formidable fighting power enable them to operate in both of these roles. The Doomdrake models are also very exciting, and truly characteristic of a Dark Elf army.

SUMMING UP

I'm really happy with the way this small army has turned out. In my first few games, I've positioned the Crossbowmen well forward at the start of the battle, allowing them to pour a hail of crossbow bolts into the enemy. If the enemy has had missile troops in his army, then I've charged forward with the Warriors and Witch Elves to cut them down in hand-to hand combat. If my opponent has very few or no missile troops, then I've ordered my whole force to hold steady until the crossbows have "softened them up" before committing my main force. Although I'm often tempted to charge forward with Darsis and the Doomdrakes – if only for the look of terror on my opponents face! – experience has taught me to be patient and wait until the optimum moment to launch an attack. In two turns, they can cover almost three feet on the tabletop, manoeuvring rapidly around my opponents flanks or charging forward to support the Warriors in their frontal assault.



The next step is to expand my army by a further 1000 points. One of the great things about building up your army in this way, is that you can get it painted and into action straight away. As I mentioned earlier I can't wait to get a War Alter painted up and ready to charge forward alongside the Warriors and Witch Elves. Its +1 bonus to their combat resolution score will be really useful. I also intend to add two or three Repeating Bolt Throwers to my army to put paid to those units of Wood Elf archers that I keep encountering.



DARK ELF WARBAND

CHARACTER MODELS

| | |
|--|---------|
| Darsis Death Dealer – Level 15 Hero | 189 pts |
| Heavy armour, Shield, Magic sword - Parasitic Blade, Mount - Cold One | |
| Tarnig Delzus - Level 10 Wizard | 118 pts |
| Hand weapon | |
| Vok Rezhnek - Level 5 Hero | 75 pts |
| Light armour, Double-handed weapon, Crossbow, Magic missile - Arcane Arrow | |

RANK & FILE

| | |
|---|---------|
| Warriors (15) | 176 pts |
| Light armour, Shield, Hand weapon, includes Standard bearer | |
| Crossbowmen (10) | 130 pts |
| Light armour, Crossbow, Hand weapon | |
| Witch Elves (10) | 140 pts |
| Light armour, 2 Hand weapons, Poisoned attacks | |
| Doomdrakes (5) | 175 pts |
| Light armour, Shield, Hand weapon | |

TOTAL COST: 1003 pts

WARHAMMER FANTASY BATTLE PLAYSHEET

TURN SEQUENCE

1. MOVEMENT
2. SHOOTING
3. HAND-TO-HAND
4. RESERVES
5. MAGIC
6. RALLY

MOVEMENT

Movement over difficult ground is at half rate. Movement over an obstacle takes up half the total move allowance that turn.

A unit is permitted one free simple manoeuvre during its movement or reserve phase as long as its formation is not divided by an obstacle. A unit cannot change formation if it is on difficult ground. Any other manoeuvre must be preceded by a successful Ld test (2D6). A failed test brings a unit to an immediate halt except during a charge as noted below.

Simple manoeuvre

Formation change (4 models)
Turn of 90 or 180 degrees
Wheel

Complex Manoeuvre

Moving backwards at half rate
Wheeling backwards at half rate
Wheel from centre at half rate

SINGLE FILE FORMATIONS

Single file formations ignore difficult ground. Obstacles impose a 1/4 move penalty. They cannot charge. They must run away from a charge. They may make snaking moves.

RESERVES

A unit may not reserve move if it is within 4' of enemy troops at the start of the reserve phase. A unit may not approach within 4' of enemy during the reserve phase. Otherwise a unit may reserve move except in the cases outlined below. A moving unit approaching within 4' of enemy ends its move immediately.

A unit may not reserve move if:

1. The unit is engaged in hand-to-hand combat.
2. The unit is Routing or Pursuing.
3. The unit is within 4' of any routing troops.
4. The unit failed a manoeuvre test for a complex manoeuvre in its movement phase.
5. The unit is flying.
6. The unit comprises of vehicles, heavy chariots, engines.
7. The unit is on difficult ground or its formation is divided by an obstacle.
8. Troops in the unit have fired crossbows, arquebus, or blunderbusses, in the shooting phase

CHARGING

Charges must be declared before other movement. Only models which charge may approach within 1' of enemy troops. Charging troops double their movement rate. Charging troops failing a manoeuvre do not halt, but continue to charge and become unformed. Charging troops may not attempt to manoeuvre within 4' of their enemy other than to wheel to bring them within 22.5 degrees of their target's facing (if they do this all charging bonuses are lost).

SHOOTING

TO HIT

| BS | 1 | 2 | 3 | 4 | 5 | 6 | 7 | 8 | 9 | 10 |
|----|---|---|---|---|---|---|---|----|----|----|
| D6 | 6 | 5 | 4 | 3 | 2 | 1 | 0 | -1 | -2 | -3 |

- +1 Large Target - such as a wagon, building or anything greater than 10' tall
- 1 Shooter Moved - if the shooter moved in his movement phase
- 1 Rapidly Moving Target - a target which moved more than 6" in its reserve phase
- 1 Firing at a Charging Enemy - if you are standing and firing against a charger
- 1 Firing at over half your maximum range
- 1 Target is behind soft cover - such as a hedge or wood
- 2 Target is behind hard cover - such as a wall or building

SAVING THROW

| Armour | Without Shield | With Shield | Mounted without shield | Mounted with shield |
|--------|----------------|-------------|------------------------|---------------------|
| None | None | 6 | 6 | 5 or 6 |
| Light | 6 | 5 or 6 | 5 or 6 | 4, 5 or 6 |
| Heavy | 5 or 6 | 4, 5 or 6 | 4, 5 or 6 | 3, 4, 5 or 6 |

STAND AND FIRE

A missile unit may only attempt to stand and fire against a unit charging from over half its charge move away. A Ld test is necessary for success.

HAND-TO-HAND

During hand to hand combat a model may make as many attacks as shown on its profile (if a close combat weapon is carried in each hand, then the model may make as many attacks as shown with each weapon. For example, if A=2 the model could make 4 attacks if it has a weapon in both hands).

Procedure

- 1 Attack in initiative order - all models in contact may fight
- 2 Roll to hit - routing models are hit automatically
- 3 Roll to damage
- 4 Determine amount of damage where appropriate
- 5 Make any permitted saves
- 6 Once all models engaged have fought establish results of combat

TO HIT

Roll one D6 for each attack. Compare the attacker's WS with the defender's WS to find the basic score needed to hit. A dice roll of a 1 is always a miss irrespective of any modifiers.

| Attacker's WS | Defender's Weapon Skill | | | | | | | | | |
|---------------|-------------------------|---|---|---|----|----|----|----|----|----|
| | 1 | 2 | 3 | 4 | 5 | 6 | 7 | 8 | 9 | 10 |
| 1 | 5 | 5 | 6 | 6 | +4 | +4 | +5 | +5 | +6 | +6 |
| 2 | 4 | 5 | 5 | 6 | 6 | +4 | +4 | +5 | +5 | +6 |
| 3 | 4 | 4 | 5 | 5 | 6 | 6 | +4 | +4 | +5 | +5 |
| 4 | 3 | 4 | 4 | 5 | 5 | 6 | 6 | +4 | +4 | +5 |
| 5 | 3 | 3 | 4 | 4 | 5 | 5 | 6 | 6 | +4 | +4 |
| 6 | 2 | 3 | 3 | 4 | 4 | 5 | 5 | 6 | 6 | +4 |
| 7 | 2 | 2 | 3 | 3 | 4 | 4 | 5 | 5 | 6 | 6 |
| 8 | 2 | 2 | 2 | 3 | 3 | 4 | 4 | 5 | 5 | 6 |
| 9 | 2 | 2 | 2 | 2 | 3 | 3 | 4 | 4 | 5 | 5 |
| 10 | 2 | 2 | 2 | 2 | 2 | 3 | 3 | 4 | 4 | 5 |

- +1 Charging - this bonus is lost if the charger changes formation during the charge. The bonus is also lost if the unit attempts a wheel within the last 4'. Unformed units receive no charge bonus.
- +1 Following Up - if the unit won the previous round of combat
- +1 Higher Ground - positioned on a higher slope, stair or rampart
- 1 Defenders behind hedge, stakes, prepared defences, etc.

DAMAGE

Roll to determine if damage is caused. Compare the weapon's strength with the toughness of the target.

| Attacker's Strength | Target Toughness | | | | | | | | | |
|---------------------|------------------|---|---|---|---|---|---|---|---|----|
| | 1 | 2 | 3 | 4 | 5 | 6 | 7 | 8 | 9 | 10 |
| 1 | 4 | 5 | 6 | 6 | - | - | - | - | - | - |
| 2 | 3 | 4 | 5 | 6 | 6 | - | - | - | - | - |
| 3 | 2 | 3 | 4 | 5 | 6 | 6 | - | - | - | - |
| 4 | 2 | 2 | 3 | 4 | 5 | 6 | 6 | - | - | - |
| 5 | 2 | 2 | 2 | 3 | 4 | 5 | 6 | 6 | - | - |
| 6 | 2 | 2 | 2 | 2 | 3 | 4 | 5 | 6 | 6 | - |
| 7 | 2 | 2 | 2 | 2 | 2 | 3 | 4 | 5 | 6 | 6 |
| 8 | 2 | 2 | 2 | 2 | 2 | 2 | 3 | 4 | 5 | 6 |
| 9 | 2 | 2 | 2 | 2 | 2 | 2 | 2 | 3 | 4 | 5 |
| 10 | 2 | 2 | 2 | 2 | 2 | 2 | 2 | 2 | 3 | 4 |

COMBAT RESULTS

Each side adds up the number of wounds inflicted on the enemy - wounds which have been saved are not counted, only those actually inflicted. Then add the following.

Charged that turn +1

Followed up last turn +1

Unit Standard +1

Army Standard with unit +1

Each rank behind 1st +1

(up to +3, must be at least 4 models engaged)

The side with the highest score is the winner. Losing units must take a rout test if they have suffered 25% or more of their original strength as casualties in the battle to date. Unless routed the losers are retreated 2'. This is called a push back. Winners follow up losers who have been pushed back and models are moved back into base contact. The winner may expand his formation by 4 models or wrap round as he follows up (see p 132 of WFB).

ROUTS

A unit must test for rout if:

1. A unit has lost 25% of its **original** strength and is beaten in hand to hand combat Test before making the push back.
2. A unit suffers 25% or more of its **current** numerical strength to missile fire/magic during a single turn.

Roll 2D6 against Ld. If the score is equal to or less than the unit's Ld the test is passed with no further effect. Otherwise the unit is routed. As soon as a unit routs it is turned directly away from its enemy and moved immediately at double pace away from them. The winning side strikes free hacks as the routers turn away - free hacks automatically hit and any saving throw from shields is discounted as the enemy have their backs turned.

During the initial rout out of combat routers move directly back through any friends blocking their path, however if there is a gap of 2' or more within their path they will funnel through this instead. If there is no such gap the routers will burst through the friendly formation. Friends who have been burst through in this way may not move in their following movement phase as they need time to recover their formation.

Following the initial rout move, routing units are moved in their own movement phase at double rate towards the nearest table edge and may do nothing else. No penalties are imposed for manoeuvres. If routers leave the table edge they are removed from play.

A routing unit may not rally in the turn in which it has routed. After the initial rout turn the routing unit may attempt to rally in its rally phase. Routers may not rally if they are engaged in combat by pursuers or other enemy. Routers may not rally if nearer to enemy than friends or within fear range of a fear causing monster.

GENERALS AND STANDARDS

A unit whose leader is within 12' of the general may take any rout or rally test: on his Ld characteristic value.

A unit within 12' of the Army Standard may retake a failed rout test. A routing unit within 12' of the Army Standard may add +1 to its rally test. An Army Standard adds a further +1 to a unit's Combat Result if fighting in the front rank - ie +2 if the unit also has its own standard.

PURSUIT

If all of a unit's hand-to-hand combat opponents rout the unit normally pursues. Pursuers follow the routers during the initial rout move, and strike a second free hack if still in contact at the end of it. Pursuers may test to avoid pursuit when their enemy first rout. Test against Ld - if successful the unit does not have to pursue and proceeds without further restriction.

After the initial rout from combat, pursuers move in the router's movement phase following the path of the routing unit. Pursuers in contact with routers during the hand-to-hand combat phase strike further free hacks. Pursuers who wish to do so can test to end pursuit as the routers move away in their movement phase. Take a 2D6 test against Ld - if this is passed the pursuit is ended and the unit immediately halts unformed (see **UNFORMED**).

Pursuers unable to move quickly enough to catch their routing enemy move as far as they can in the initial rout and then halt unformed until the end of their following movement phase.

If pursuers wipe out routers then they also halt unformed until the end of their following movement phase.

If pursuers chase routers off table then they halt unformed at the table edge until the end of their following movement phase.

If pursuers are engaged by fresh enemy they immediately cease pursuit and fight normally but if pushed back in the first round of combat they are automatically routed.

UNFORMED

A unit becomes unformed if:

1. It charges and fails to contact an enemy.
2. It attempts and fails a manoeuvre during a charge (no further manoeuvres may be attempted but the unit completes its charge and may automatically wheel to bring itself with 22.5 degrees of the enemy's facing).
3. It charges and contacts an enemy formation at an angle of more than 22.5 degrees.
4. A unit ends pursuit of a routed enemy, or ceases to pursue because routing enemy are slain, leave the table edge, or move out of reach.

An unformed unit must spend its entire following movement phase stationary after which it is reformed. Alternatively it may retire remaining unformed. Unformed units receive all charges at the halt. An unformed charging unit loses all of its charge bonuses. Unformed units receive a penalty of -1 Ld, Int, CI and WP. An unformed unit which is pushed back in hand-to-hand combat is routed. An unformed unit not pushed back in hand-to-hand combat reforms automatically.

FRENZY

Troops who are subject to frenzy must take a 2D6 test against their CI when they charge. The unit's leader may apply his CI bonus to either increase or decrease the units chance of going into frenzy. If the CI test is failed then the unit is in frenzy for as long as they remain in base-to-base contact with the enemy. The following rules apply to frenzied troops;

Frenzied models gain +1 on all to hit, wound and saving rolls.

Frenzied troops must always follow up and pursue enemy troops.

Frenzied troops are immune to all psychology and rout tests while they remain in frenzy.

FEAR

A 2D6 test is taken against the unit's cool if:

1. Wishing to charge a feared enemy - if failed the unit spends the turn stationary.
2. Charged by feared enemy - if this test is failed the unit is routed.
3. Wishing to shoot at a feared enemy who is within his own charge distance - if failed the unit may not shoot that turn.

A unit pushed back by enemy that it fears is automatically routed.

HATRED

A unit which hates an enemy within charge distance at the start of its movement phase must charge unless it successfully takes and passes a 2D6 test against its CI.

A unit which hates an enemy unit within its missile range during the shooting phase must fire at it unless it successfully takes and passes a 2D6 test against its CI.

A unit fighting a hated enemy in hand-to-hand combat may add +1 to all its to hit rolls and +1 to any rout test.

If a hated enemy routs, the unit must always pursue and must continue to pursue until the enemy unit is either destroyed or leaves the table, or if the unit is charged by other enemy while pursuing.

PANIC

A unit must take a 2D6 panic test against its CI if:

1. It is within 4' of friendly routers at the start of its turn.
2. It is within 12' of a friendly unit which routs from hand to hand combat (+1 may be added to the unit's CI if it outnumbered the routers by 4 to 1 or more).
3. It is charged in the side or rear - unless the unit has stomp attacks.
4. Character leaves the unit while it is engaged in combat.
5. It is charged while its formation is divided by a wall or hedge.

STUPIDITY

Troops who are stupid must take a 2D6 test against their CI at the start of each of their turns. If this is failed then the unit strikes only half its total number of blows in hand-to-hand combat. If not engaged in combat the unit may not fire missiles or use magic, and moves in a random direction as described on p 74 of WFB.

IMPERIAL HERO RIDING GIANT PEGASUS

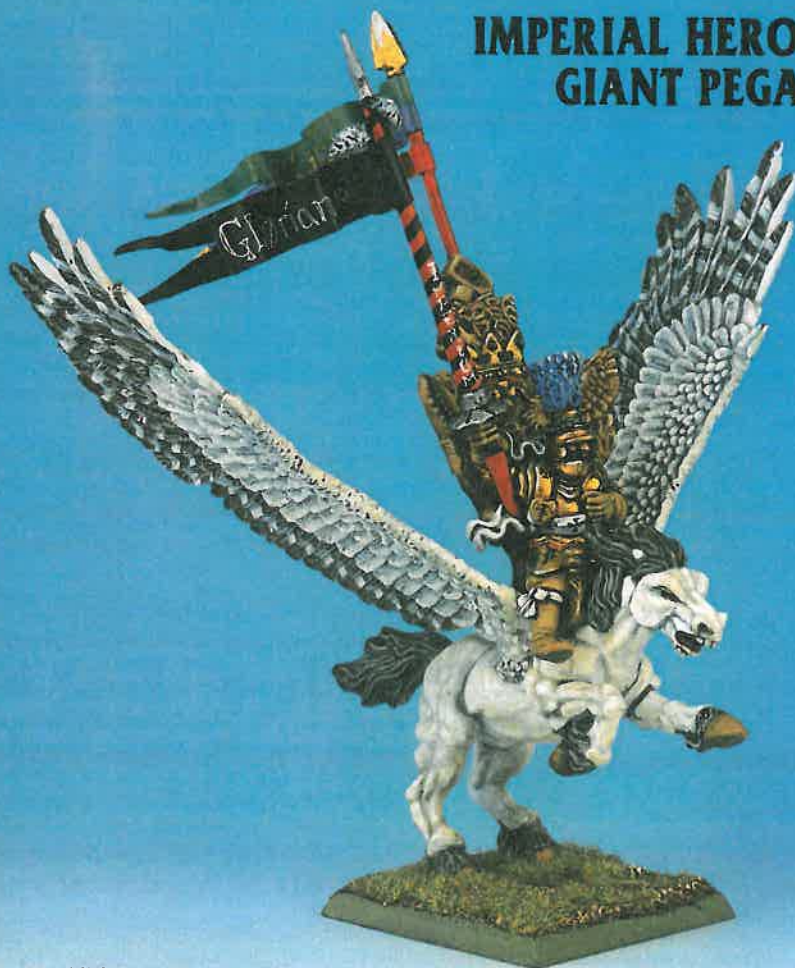

Miniature supplied unpainted.

HOW TO PURCHASE MARAUDER MINIATURES

Marauder Miniatures are available from all Games Workshop Stores, where you can choose your models from the wide selection in stock. Miniatures are also available from the Marauder Mail Order service.

METHODS OF PAYMENT

You can Mail Order by credit card (Access or Visa), International money order or cheque drawn on a British bank. For foreign orders, please send all payments in pounds sterling. Cheques should be made payable to Marauder Miniatures Limited. UK customers please do not send cash.

POSTAGE AND PACKING

The minimum mail order is £5 with a standard charge of £1 for postage and packaging. Mail Orders in the UK over £20 are post and packing free. You should normally receive your order within 10 days, but please allow up to 28 days for delivery.

TELEPHONE ORDERS

You can telephone an Access or Visa order on 0902 790200 between 9am and 5pm weekdays. Please have the cardholder present to authorise the transaction. If you have any problems, please contact us on the above number.

OVERSEAS ORDERS

The minimum overseas mail order is £10. Please include 40% for post and packaging. We'll send your order by the fastest route that the postage paid allows. Please don't send currency as payment.

Post your Mail Orders to

**Marauder Miniatures
The Foundry
Mount Street, New Basford,
Nottingham NG7 7HX**

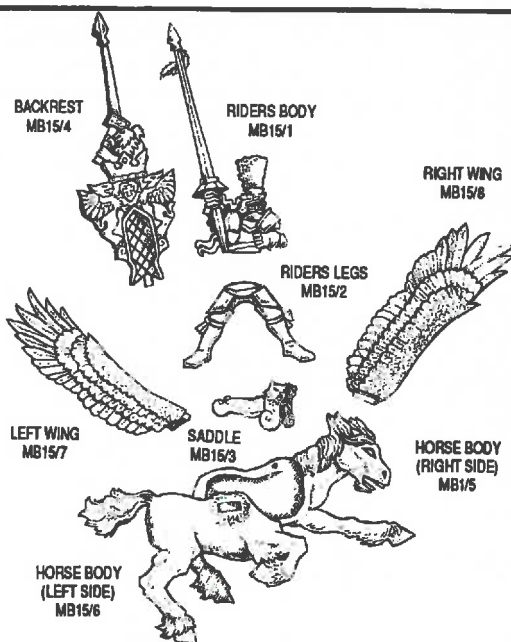

All parts of the Marauder Pegasus are available separately from Mail Order.

MB15

**IMPERIAL
HERO
AND
PEGASUS**

£9.99

**RIGHT WING
MB15/8
£1.75**

**LEFT WING
MB15/7
£1.75**

**HORSE BODY
(LEFT SIDE)
MB15/6
£2.00**

**HORSE BODY
(RIGHT SIDE)
MB15/5
£2.00**

**RIDERS BODY
MB15/1
£0.75**

**RIDERS LEGS
MB15/2
£0.75**

**BACKREST
MB15/4
£1.25**

**SADDLE
MB15/3
£0.75**



ELVEN WARDANCERS

BY ANDY CHAMBERS

Elves are one of the most popular army choices for Warhammer Fantasy Battle, and many players have written to us asking questions about the Elven Wardancer rules in Warhammer Armies. To answer these questions and to clear up any remaining queries, Andy Chambers has taken a new look at Wardancers and here we present his updated and expanded rules.



Wardancers are a unique form of Warrior-Troubadour who have dedicated themselves to the pursuit of the Elven art form known simply as 'The Dance'. Wardancers are some of the most agile and athletic members of a nimble race who have honed their martial skills into a swift and deadly art.

SPECIAL RULES

1. Wardancers ignore movement penalties for armour. Because of the need to be unencumbered as they 'perform' Wardancers may not wear heavy armour, though light armour and shields may be used without restrictions.
2. Wardancers fight in troupes of 5-10 models. These troupes behave in exactly the same way as Scouts (see Warhammer Fantasy Battle p100-101) except they ignore the normal restrictions on weapons and armour suffered by Scouts and Skirmishers.
3. Wardancers suffer no penalties when engaged from the flank or rear. They do not have to take a panic test and may turn any previously unengaged models to fight normally.
4. By means of bounding leaps and back-flips Wardancers may freely move through friendly units with no movement penalty to the Wardancers or the friendly unit, even if charging. Wardancers may also leap over or side-

step through an enemy unit that's only a single rank deep without becoming engaged in close combat with them. The enemy troops are too surprised by this feat to strike at the Wardancers as they pass. Obviously, ditches, walls, hedges and streams offer no obstacles to such huge athletic ability and may be moved over freely if they are less than 3" high or 2" wide.

5. By using colourful insults and particularly cutting social remarks, a troupe of Wardancers may irritate an enemy unit into charging them. The enemy unit is tested for at the beginning of the enemy turn. The enemy must begin the turn within charge reach of the Wardancer troupe and may make a test against their CI to resist the taunting. Berserkers and troops subject to frenzy must charge immediately.
6. In close combat a Wardancer troupe may use one of the special abilities listed below each turn. In all cases the Wardancer models are left in place regardless of the feats they are performing. Enemy models may strike back against Wardancer models in base-to-base contact.

The Whirling Death

The Wardancers' leaping combat roils faster and faster as they work themselves into a frenzied bloodlust. The Wardancers count as in frenzy until the end of the combat. They may double their attacks for the first turn of frenzy only. The troupe must continue attacking the enemy unit until all its members are dead. They cannot use any other special abilities while they are frenzied. The Wardancers will always follow up and pursue and may even pursue the enemy off the table altogether.

The Woven Mist

Through hypnotic song and gesture, the Wardancers delude and confuse their opponents, making them sluggish and clumsy. The opposing unit may test against its WP to resist the effects of the Woven Mist – a failure indicates they are affected and suffer -1 on their to hit rolls for that turn. While their foes are affected the Wardancers gain +1 on their to hit and wound rolls. A successful WP test indicates that the enemy are not confused and there is no effect. If the Wardancers use this ability for more than one turn, the enemy unit test against WP each turn

The Shadows Coll

By dodging and weaving, fighting purely defensively and making no effort to attack back, the Wardancers hold their opponents to a stand-off. This ability may only be used upon opponents which have a Weapon Skill of 4 or less and causes the combat to be drawn for that turn with no blows being struck by either side. This feat may only be performed for a maximum of three turns in the same combat.

The Storm of Blades

In an acrobatic display of their prowess, the Wardancers whirl around individuals in the opposing ranks, slashing at them in a continuous flow of violence. The troupe may use this feat to direct their close combat attacks against specific individuals in the enemy front rank. A maximum of six attacks may be made against one model. More than one model can be attacked in this way.

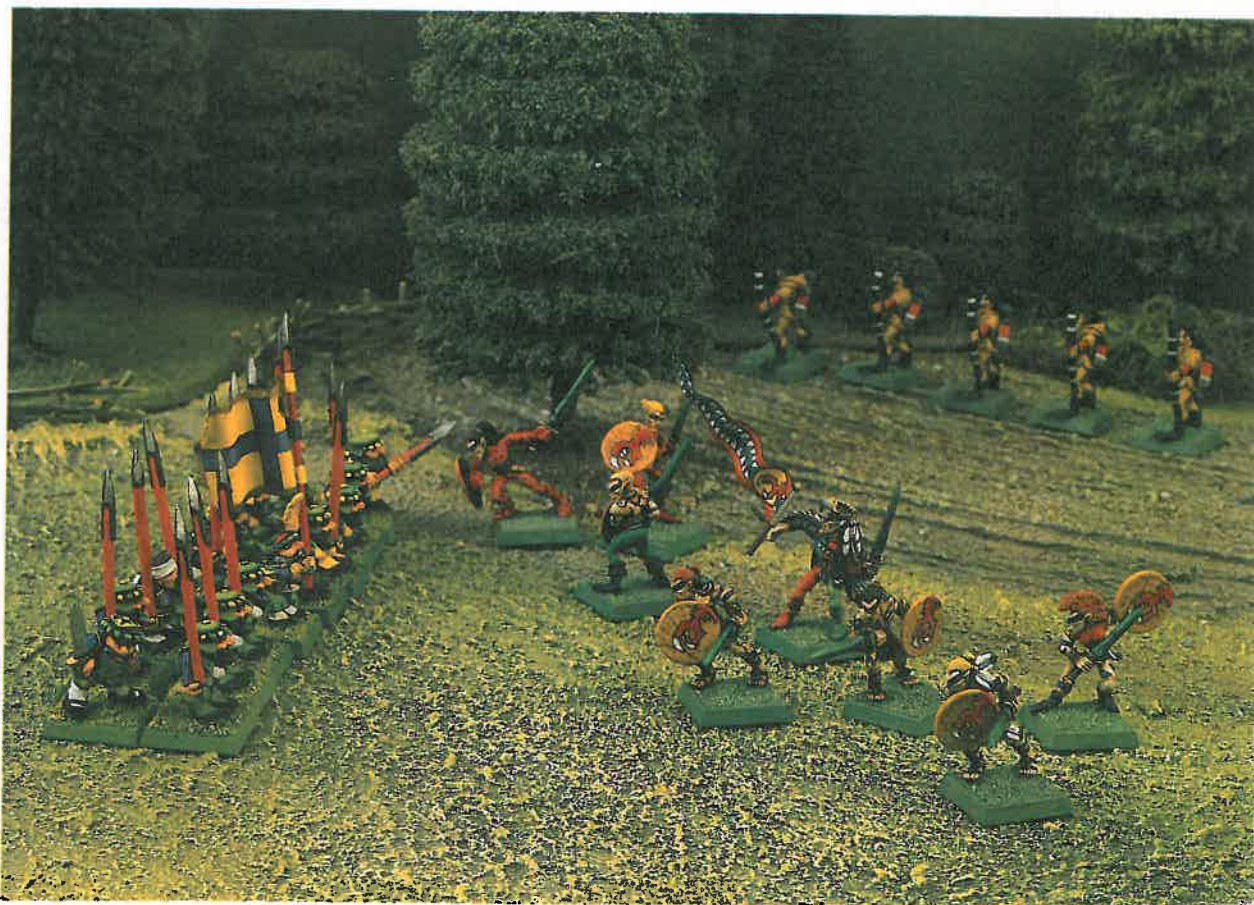

WARDANCERS ATTACK A UNIT OF DWARFS

BASIC GAMING TERRAIN

by Rick Priestley

We get lots of letters at the Studio asking about the terrain and other tabletop features shown in the photographs in *White Dwarf*. We also know from talking to people at Games Day and the Golden Demon Awards, that many of you are a bit unsure about how to go about setting up and organising terrain for your games. We decided to ask Rick to have a think about this and set his thoughts down on paper.

One of the questions I'm most frequently asked, is how the gaming terrain we show in *White Dwarf* is made? Many of my interrogators are young gamers who are keen to start work on their own set-up, while the more experienced are interested in finding out how we made particular features or achieved a certain effect. As all of our Games Workshop studio staff are veteran gamers we tend to take the terrain and scenery for granted and assume that everybody understands exactly what's required. Of course, this isn't really true at all, so I thought it was about time we introduced our current gaming set up in rather more detail. If you are an experienced gamer and scenery maker then you've probably already sorted yourself out a permanent wargames set up with all the scenery you need. If you haven't quite got round to making your set-up, but you've been thinking of making a start, then I think you'll find some useful tips in what follows.

I think most gamers start to collect armies without giving any real thought as to where or how they are going to field their growing forces. In practice this doesn't matter because you can play a game of *Warhammer Fantasy Battle*, *Warhammer 40,000*, or *Space Marine Epic Battles* on any reasonably sized flat surface. If you're able to use the dining room or kitchen table then these will serve well, so long as you put a thick cloth over the top to protect the surface from scratches. If you don't have the use of a table or you've built up a collection that is so large your table is no longer big enough, then you can always resort to using the floor as a battlefield. By moving the furniture to the edges of the room you will have more space than you'll ever get from a specially-built gaming table! It is perfectly possible to fight a game outside on the lawn or patio if the weather's good, but as it rarely is only occasional games can be conducted in this way unless you have a large conservatory or a covered patio.



Bretonnian Knights and Skeleton Cavalry charge across a wooded valley

BASIC TERRAIN

Whether you decide to adopt the family table or the floor as your battlefield it is a good idea to lay a fairly thick (preferably green) cloth or blanket over your playing surface. Apart from protecting the table from damage as mentioned above, it also makes an attractive surface for the battle. By positioning books under the cloth you can create hills and gulleys to fight over. Woods, ploughed fields, marshes, and areas of rocky ground can be represented by a piece of card or carpet tile cut into an appropriate shape and coloured in a suitable fashion such as green for woods or marsh, brown for fields, and grey for rocks. By placing a little lichen or a model tree onto the wood area you can emphasise that the card represents a wood, while some gravel chippings or small pieces of stone on a rocky area will help to further indicate the terrain. Small pieces of stone can be also arranged into a row to make a wall. This sort of arrangement is easy for even the absolute beginner and will serve experienced gamers perfectly well. However, it's natural that as your model collection grows you'll probably want to make scenery and possibly a gaming board too.

HILLS

You don't need a wargames table before you start to make scenery. A piece of scenery will work just as well on a bare table or floor, it can be placed on top of your cloth battlefield, and naturally it'll sit happily on a purpose built table too. The most useful items, and therefore the first pieces you'll probably want to make, are hills.

Hills make a flat area look more appealing, introduce blind spots as well as high points which overlook the battlefield, and because of the slopes, they make good firing positions for regiments of archers. I've always found the most practical way of representing hills is to make them 'stepped' like a ziggurat, with two levels. You don't have to have more than one level at all, the hill will work just as well if it is a single level, but somehow hills just don't seem like hills unless they have a bit more height! If the hill is fairly large three levels can be used, but as a rule two levels is plenty. The reason for making hills in steps is so that Warhammer regiments can move over them without all the models falling over. This means that the flat areas should always be wide enough to take at least a 25mm base. If you make the flat areas too narrow then you'll find them impossible to position models on, which is very irritating indeed.



Cutting the hill shape out of polystyrene

Flat sheets of polystyrene are the most convenient materials to make your hill from. Ordinary ceiling tiles will do, or you can get insulating polystyrene sheets from most DIY stores. An alternative to polystyrene is cork tiles of the kind used to line

walls and floors; these are quite cheap and a little heavier. At the studio we buy large sheets of thick insulating polystyrene. We prefer our hills to be quite tall because this helps give a sense of height to our photographs, but there is no reason why you can't use a thinner polystyrene sheet and correspondingly lower hills. If you want to create more height and you've only got thin sheets of polystyrene simply glue two or more sheets together.



Sticking the pieces together with PVA glue

To cut polystyrene into shape use a craft knife or a fine toothed saw such as a coping saw, fretsaw or a hacksaw blade. Whatever you use make sure you take extreme care not to cut yourself as polystyrene is very soft and cuts easily. As you cut the polystyrene angle the blade so that you cut at approximately 45° to create a slope. You'll find as you cut the material individual beads will go all over the place, so it's best to do any cutting in a shed or garage and have a vacuum cleaner handy. You can tidy up roughly cut areas of polystyrene by sanding them flat. The best way to do this is to use a flexible sanding block with a gentle circular motion to avoid breaking up the surface. It is possible to buy a special polystyrene cutting tool which uses a heated wire to melt through the material. These are a bit hard to find but you may be lucky enough to discover a craft or model shop which has some.



Covering the hill with textured paint of thin Polyfilla

Cut out some roughly circular or oval shapes and glue them together, small pieces onto large, to make hills of various shapes and heights. We use PVA wood glue for this as most other glues melt polystyrene. PVA is also sold as school glue and modelling glue; this is all basically the same stuff and perfectly suitable. DIY shops, home decorators, most model shops, and Early Learning Centres all sell PVA in one guise or another. PVA will also stick cork tile although you could also use ordinary contact adhesive for this too.



Painting the hill to match the gaming table

Polystyrene can be painted with ordinary green emulsion paint. Citadel Colour is fine too, but you'll need an awful lot to cover even a small hill and this is rather a waste of fine-quality paint where cheap emulsion will do equally well. You will probably be able to find a suitable standard colour, but if not most large DIY stores can mix a colour for you on the spot. The colour is up to you really – there is no reason why you should use one shade of green rather than another. One of our tables at the Games Workshop Studio is painted an identical shade of Goblin Green, which is the colour we use for all our model bases. Cork is more difficult to paint directly and you will find it necessary to undercoat it first using a white car undercoat spray.

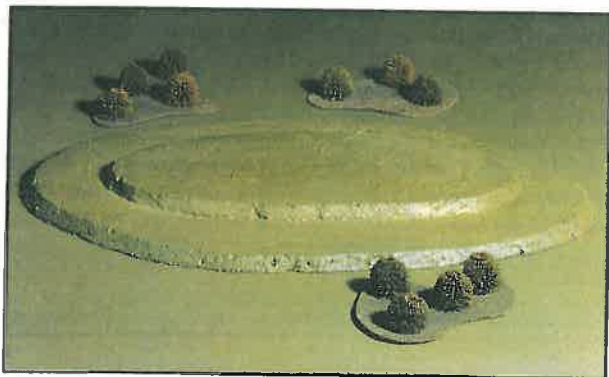

The finished hill on the tabletop

As a final note on hills, some gamers like to apply a textured paint to polystyrene before painting it green. Textured paint is sold to paint onto house walls and ceilings to cover up imperfections. This covers the surface and helps disguise the polystyrene beads producing a neat finish and a slightly harder wearing surface.

Another technique is to cover the entire hill with green scenic flock. This produces a rough textured finish which looks good but is actually very hard to move models on (it's like moving over sand paper!).

We use flocked hills at the Games Workshop because they photograph much better than plain hills. Our flocked hills were first painted brown to provide a good dark background which helps produce that velvety pile look. Once dry the hill is placed on a sheet of newspaper, the surface covered in watered down PVA glue and green flock is sprinkled all over. After a few minutes the excess flock is shaken off, the process repeated if there are any bald bits, and the hill is complete.

WOODS

You don't need hundreds of model trees to make a wood, just one or two will do fine and won't break the bank either. Woods are almost as useful as hills, providing cover to infantry and presenting barriers to mounted troops and vehicles. Just one or maybe two woods will be enough to make the game interesting without slowing down the pace of play.



The small trees mounted on plywood bases make suitable Epic scale woods

A wood is best represented by a piece of circular card about 6 to 8 inches across, painted green with a few tree models placed on top. You can fix the trees into place if you like, but it's easier to move models through the wood if the trees can be rearranged to accommodate them. Games Workshop shops sell excellent model trees in assorted styles and sizes but these do need to be firmly fixed into place with modelling putty or provided with a proper individual base. We use the Citadel metal tree bases which are nice and heavy but, being metal castings, add to the cost of the tree. I've used plastiscene to fix trees in place on occasions. An inexpensive and effective way of making trees stand up is to take a small round piece of card and drill a hole through it, glue the wire tree trunk into this, and then glue small stones around the trunk to hold the whole thing together and provide weight. Such a tree can also be used on its own as a purely decorative piece of scenery.



A selection of woods suitable for Warhammer Fantasy Battle and Warhammer 40,000 gaming

Our studio woods are actually made from plywood rather than card because we found that card warps under the hot photography lights. Plywood or hardboard can certainly be used and are more robust than card, but are much harder to cut out and obviously a bit more expensive too. Our own woods are flocked in the same way as the hills so that they look good in photos but this isn't really necessary. You can go a bit further and glue scenic undergrowth to the card or wood base

to produce a more tangled appearance. You could use lichen for example, or wire wool teased into shape and flocked over to make bushes and low trees. You can even add in small stones to represent boulders, but the more of this sort of thing you do the harder it is to position troops inside the wood. For this reason we favour the rather plain style you see in our photographs, but it's really for you to decide for yourself.

HEDGES

Hedges and walls provide defensive cover for troops. In Warhammer Fantasy Battle the odd hedge can be used to anchor your battle line. In Warhammer 40,000 small pieces of scrub offer cover against deadly long range weapons and are far more important tactically. You can make a hedge very easily by using lichen to make a line or to create scattered areas of scrub. You can use pieces of stone in the same way to produce scattered areas of boulders or crude stone walls. This is a perfectly acceptable solution, although you'll find lichen gets tatty quite quickly. At the Games Workshop Studio our scenery has to stand up to quite a bit of wear and tear and it has to look good in photographs.



Scratch built hedges from the Studio collection

We therefore made up the sections of hedge you'll see in our photographs. These have wooden or card bases and are made from wire wool which is covered with PVA glue and flock to produce a realistic hedge. However, these are not quite as hard wearing as we'd hoped as the wire tends to tease out. Rather than describe how we made out hedges in detail we'll leave that to another day along with other modelling scenery projects.

OTHER SCENERY

Buildings, marshes, rivers, bridges and other special pieces of scenery require a little more work. These are really modelling projects for those who enjoy modelling for its own sake. Modelling projects of this kind are often described in White Dwarf's Modelling Workshop. An occasional game with a river or a small village makes an interesting change from battles fought over open landscapes, but all too often you'll find the game gets bogged down by just too much scenery. Rivers are notorious for this: the practical effect of putting a river on your table is to make your battlefield smaller because nobody is going to cross the river if they can avoid it. I've also seen players religiously put whole units into buildings just because they were there, affording my glorious conquering hordes of Orks plenty of opportunity to avoid them and stomp all over their mates in the open. So all this scenery can be regarded as secondary to hills and woods and certainly not essential to the game.

THE WARGAMES TABLE

Very few gamers are fortunate enough to have a whole room to devote to their hobby, where a permanent table can be installed and battles left undisturbed for weeks on end. Most gamers, however, will soon want to move their games from the floor or kitchen table, where the demands of the rest of the family often take precedence and ensure that games will be at best short and often undecided. The answer is to create your own gaming table. A gaming table is just a flat surface on which you can place scenery and models. You might have seen carefully sculptured battlefields complete with permanently fixed woodlands, modelled fields, villages, and waterways carved into the base board. These are special show pieces which take many months to make and which look great on public display but are totally impractical to fight a real game on! To fight a game you need a flat, even surface that you can comfortably push models along.

The first thing to consider is where are you going to fight your game. Can you set-up in a spare room or will you be sharing a room that's also used by the rest of the family. How about a garage, outhouse or loft? In most cases gamers choose to play games in their bedroom. The size and shape of your room will obviously dictate the size of your gaming table. There's no point in having a table that's so big you can't get round it conveniently. Equally important, you'll have to store your table somewhere when it's not in use. If your table is a flat board you can probably stand it behind a wardrobe or beside your bed, but obviously you have to make sure that there is enough space. Most board material come in a sheet 8' x 4', and most modern houses have ceilings about 8' high, so there's just about room to stand the board upright against a wall. If you need to cut a few inches off the length of your table so that it can be stored more easily then this is no great loss. A board 6' x 4' is sufficiently large for a game if space is limited.

The next thing to consider is how are you going to set the table up. It's not really practical to make legs for your table unless you know what you're doing and you also have the space to store the finished result. In fact if you have this much space then your best option is to go to an auction and buy trestle tables or canteen tables, you can often find these or similar large tables quite cheaply second hand. Another option if you are blessed with the space is a table tennis table. However, the most practical option by far is to buy a flat sheet of board which will serve as your table and to place it on top of something to raise it from the floor. The obvious solution if your games room is also your bedroom is to put the board on top of your bed. This will be stable enough so long as you are careful. You may also be able to support the table edges using stools or chairs. Alternatively, you can put your board down on top of a smaller table, making sure you cover the table with a thick blanket first to protect it from scratches.

Another way of supporting the board is to buy a couple of cheap paste tables. You can even put these side by side and use them as the actual playing surface if you want, although there will be a small gap down the middle. The disadvantage of paste-tables is they are quite flimsy, and you'll need to bolt, clamp or in some way fix them together to stop them wobbling about. Paste tables can be bought for well under £10 each and they do fold down, but you will have to make sure they are the same size when you buy them as they tend to be all different heights and sizes.

The gaming table itself is a board painted with green paint or stained with a green wood stain to produce a flat battlefield. A single piece of board as large as 8' x 4' is actually quite hard

to move about, especially if you have to carry it upstairs, so bear this in mind when you decide what type and size of board to get. Some gamers resort to sawing their boards into two or more sections to make them more manageable. You can actually buy the boards as 4' x 4' or 2' x 2' sections if you want. This does make the board harder to support and there is a tendency for the two halves of the battlefield to part company at a vital point in the conflict.

Before you decide what sort of board to buy take a trip down to your local DIY superstore. You'll find several kinds of board on sale, usually hidden down at the end together with all the builders supplies. There are several kinds of wood-based board which are available either plain or with a special kitchen-top style laminated surface. Amongst the cheapest type of board is chipboard, which is made from compacted woodchips and glue pressed into flat sheets. Chipboard is probably the most common material used by games clubs to make boards, but it is very heavy, not entirely rigid and the edges tend to break apart.



8'x4' Plywood, Chipboard and Polystyrene gaming surfaces

Block board is made from lengths of wood planed to the same thickness and surfaced with a plywood facing sheet. This has the advantage of being rigid as well as lighter than chipboard but it is also fiendishly expensive - about two to three times as much as chipboard. At the time of writing a sheet of 8' x 4' blockboard cost about £30 while 1/2" thick chipboard of the same size was about £9 and 3/4" £13.

Fibre board is a very dense and extremely heavy board which I've no experience of using but which looks suitable if you can manage the weight! This'll cost you about £20 for an 8' x 4' sheet.

Plywood consists of several thin sheets of wood glued together to form a flexible and hard wearing board. You can get plywood in various thicknesses and the thicker boards are obviously heavier and more expensive. Plywood is not rigid enough on its own, so you'll need to make a wooden frame to stiffen it. The same goes for hardboard which is probably the cheapest of the lot at about £5, although with the cost of a frame this could be more expensive than a chipboard table.

To make a frame you need a few basic wood working skills or a cooperative friend or relative who doesn't mind helping out. Screw or nail timber lengths all round the board edge and across the centre and fasten them to each other with screws and plastic chipboard connectors or metal brackets. Of all these options the easiest and one of the cheapest is a sheet of chipboard, so it's no wonder this is also the most common type of games table.

You can also use a big sheet of insulating polystyrene to make your table. Polystyrene is very light of course, but it's also rather delicate. I once lost a sheet getting it out of a van. The wind caught it and clean snapped the sheet in two! You'll also find polystyrene isn't very hard wearing: bits will get knocked off the corners, holes will appear on the surface and generally it gets tatty very quickly. We use polystyrene sheets at the studio because they are light and we can move them about from our Games room to the adjacent camera area. We put a thick layer of tape all round the edges to protect them, but even so they soon get damaged. Polystyrene is probably ideal if you don't mind repainting it every so often and replacing it eventually. You can recycle old boards by breaking up the polystyrene to make new hills or dramatic model terrain such as soaring cliffs and craggy rock outcrops.

Whatever type of table you choose it can be painted with green emulsion paint in the same way as the hills described earlier. A wooden table can be stained with a green wood stain if you prefer. Alternatively, having provided a large flat surface, you can lay a green cloth over it and use this as your battlefield. Some gamers like to paint their tables with a textured flexible paint of the kind sold to cover walls and ceilings. The trouble with this is it makes it impossible to slide models along the surface, so movement is slowed down to a snail's pace while every model is moved individually. You can get round this by deploying your regiments onto a separate square of card or wood - a movement tray as this is called - so the whole regiment can be moved at once. It's more convenient to use a ruler behind a unit to push the models into place, and for this you'll need a flat finish.

The only case where it probably is best to apply a textured paint is if you are using polystyrene boards where the paint forms a more resilient surface and helps to stop the boards getting tatty. At the studio we have actually flocked some of our polystyrene boards, first painting the surface brown and then covering with flock in the same way as described for the hills. This looks good in photos in *White Dwarf* but it's quite awkward to move models over as the surface is like sandpaper! We also have plain green untextured wooden tables but these don't look very attractive in photographs so we tend not to show them, though we much prefer these for actually fighting over.



Andy and Jervis enjoy a game of Warhammer Fantasy Battle on one of the Studio gaming tables

As a final thought, I ought to mention doors. If you can find a source of cheap interior doors these make perfectly good tables although you'll need to put two together to get a good width!

GAMES WORKSHOP[®]

NORWICH

OPEN NOW

**12-14 EXCHANGE
STREET
NORWICH
NR2 1AU**
Tel: 0603 767656

OPENING TIMES:
10am - 6pm Mon to Fri
9.30 - 5.30 Sat
CLUB NIGHT: THURS UNTIL 8.00 pm

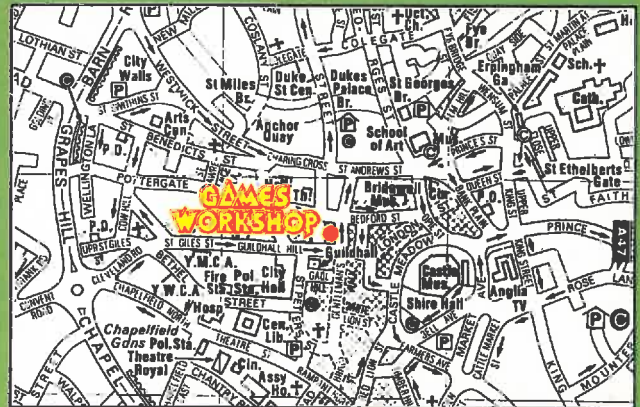

GAMES WORKSHOP[®]

RETAIL STAFF

Games Workshop Retail are always on the look out for energetic, enthusiastic and experienced Warhammer gamers to work in our stores. We need staff who know and understand what our customers want, because they're in the same hobby themselves. Staff who can show new customers how to play Games Workshop games, teach them how to paint miniatures, and help them choose and collect their very first army.

Previous retail experience is not essential. Its much more important to us that you have a friendly outgoing personality and really enjoy the Games Workshop world of hobby games.

Just ask any of our staff and they'll tell you what a rewarding experience it is to see a newcomer's face light up as you reveal a whole new world of hobby gaming to them.

We're opening up more Games Workshop stores all the time, so career prospects are excellent. If you're good at your job, you could soon be managing your own shop!

If you'd like to work for Games Workshop, and think you're the sort of person we're looking for to work in our stores, why not apply?

For a job application form, either see your local Games Workshop store manager or ring the chaps in the Retail Office on 0773 769731.





WAYNE ENGLAND'S DWARF ARMY

A few months ago, we featured a selection of miniatures from Wayne England's Warhammer Fantasy Battle Imperial Dwarf army. Since then Wayne has managed to find time in his busy work schedule to produce two more major units, three artillery pieces and two character models.

Wayne works at the studio as an artist producing black and white and colour illustrations for many of our products. He's an experienced gamer and has been playing Warhammer Fantasy Battle and Warhammer 40,000 for many years. As well as his Imperial Dwarf army, Wayne has an Undead army and an Ultramarine army. He also paints Citadel and Marauder Miniatures for display.

Dwarfs work in human cities as Smith's, Wheelwrights, Jewellers and in other trades where their skillful hands and keen minds make them supreme. As a result, the designs of Imperial Dwarf uniforms and banners have been greatly influenced by their human counterparts. To reflect this,

Wayne has painted all of his units in a simple two-colour uniform, in the manner of many Empire city-state troops. This makes them look colourful and vibrant. As blue is the colour of the royal household, any of the troops or Champions connected with it display the blue colour somewhere on their clothing. As you can see from the photographs, you'll see that Wayne has done two banners for each unit. Of course, it isn't necessary to have two banners but Wayne enjoys painting them so much he has included two standard bearers in each of his units – on the tabletop one of them is simply treated as a normal warrior so there is no unfair advantage. One banner matches the colours of the unit and the other is a blue army banner.



A unit of 19 Dwarf Clansmen lead by a level 10 Hero



A unit of 19 dwarf Warriors lead by a level 5 Hero

PREPARATION

Wayne used a mix of Citadel and Marauder Miniatures, all of which are superb models and can of course, be used alongside each other. The casting process leaves mould lines and a certain amount of flash on each model. The first thing he did was carefully remove all these rough edges with a craft knife and a fine needle file. A thin undercoat of Chaos Black was then applied to the miniatures. Wayne prefers to use a black undercoat rather than the more usual white. At first this may seem rather odd, but a black undercoat can be used to create areas of deep shadow and contrast as the other colours are applied and this suits Wayne's painting style very well.

Dwarfs tend to have a lot of armour, and using a black undercoat can also save a great deal of painting time. When the undercoat was dry, all of the armoured areas were drybrushed with Chainmail and then Mithril Silver. Even at this stage the miniatures were starting to come to life. All the unarmoured areas of the miniatures were then re-undercoated with Skull White. This is to ensure clean, bright colours.

Wayne painted his dwarfs' faces with a warm, ruddy skin tone. To achieve this he used a mix of Bronzed Flesh, Hobgoblin Orange and Skull White. This was applied to all areas of flesh and highlighted by adding more Skull White to the base colour. To create stronger contrast, the faces were all carefully shaded around the edges. The eyes were painted black before a thin line of white was added inside. The pupils were dotted in with Chaos Black.

All the beards are black so all that had to be done to highlight them was to give them a light drybrush with Elf Grey.

DWARF CLANSMAN

Dwarf Clansman are good solid dependable troops. Wayne has chosen to give this unit a level 10 leader and a magical instrument to make the unit even more potent. The simple two-colour scheme is repeated throughout all the units. In the case of the Clansman he has chosen black and white.

After the armour had been drybrushed, half of the surcoat and all the areas of flesh were painted with Skull White. Then the black half of the surcoat and the beards were highlighted by drybrushing them with Elf Grey. After this, the white half was shaded with a thin wash of Elf Grey. This just left the faces of the basic troops to be painted.



*Bardin Orc-Render
Level 10 Hero*

The hero was painted in exactly the same way as the rank and file except for the crest on his helm and some detail on the hammer which was picked out in Shining Gold.

All the shields were painted Skull White before the boar transfer was applied. Using this transfer as the unit symbol ties the troops together very effectively and links them strongly to the champion, who displays a boar crest on his helm.

DWARF WARRIORS

Even though this unit of Dwarf Warriors has no metal armour, Wayne also gave these troops a black undercoat. This makes the painting a little harder than it would be if he had undercoated with white, but the final effect is worth it because it creates a strong contrast.

All of the green clothing was given a base coat of Orc Flesh Green. This was highlighted up to a bright green by adding progressively larger quantities of Striking Scorpion Green to the base colour. The final highlights are Bilious Green which are carefully applied to the highest areas.

The parts of the miniatures that were going to be brighter colours, such as yellow and flesh, were then painted white before the base colour was applied because a black base colour would make the models look dull.

DWARF ARMY

Wayne was very careful to leave a thin line of black between the different colours to ensure greater definition. The yellow areas were given a base coat of Spearstaff Brown and highlighted with Sunburst Yellow and Skull White.

The basic yellow and green colour scheme of this unit was further enhanced by painting the pikes bright red. This dramatic contrast makes the miniatures stand out on the gaming table. The tips of the pikes were left black and then painted with Mithril Silver.



*Brokk Thingrim
Level 5 Hero*

The hero was painted in the same way as the rest of the troops in the unit. Wayne first painted the helmet Chainmail and then picked out the detail in Shining Gold. The split sleeves were painted blue to show his connection with the royal household.

WAR ENGINE BATTERY

For some heavy support for his foot troops, Wayne has painted an artillery battery consisting of Bolt Thrower, a Cannon and a Flame Cannon. The two-colour scheme used on all his troops has also been used on the war engines and crew.

The Cannon has been given a bright green and yellow colour scheme, matching the unit of Warriors. The wood was painted yellow and green to match the livery of the Dwarf Warriors. Sunburst Yellow was mixed with small amounts of Yellow and Brown Ink and painted on over white. Adding the ink to the paint makes the mix fairly thin so you'll find it runs into the wood grain of the model and creates shading. When it was dry, a light drybrush of Sunburst Yellow and Skull White was added for the highlights.

The mantlet is a pivoting wooden screen that is closed to protect the gunners and the cannon whilst it's being re-loaded. When it is loaded, the screen is swung open and the gun fired. The yellow and green colour scheme has been continued on the mantlet and a transfer has been added to the front face for a unit symbol. The metallic parts of the gun were painted with chainmail and drybrushed with Mithril Silver for the highlights.



Cannon

The Flame Cannon and crew have a blue and white colour scheme. Matching the colour schemes of the crew and the cannon helps to give a coherent look to the unit. The blue areas were given a base coat of Moody blue and highlighted with Enchanted Blue. The white areas were first painted Elf Grey and then highlighted with Skull White.



Flame Cannon

As a contrast to the other two artillery pieces, the Bolt Thrower was painted to look like natural wood. It was given a black undercoat and then the metal areas were drybrushed with Chainmail and Mithril Silver. The wood effect was created very simply by lightly drybrushing Bestial Brown over the black. When this was dry, a wash of Brown Ink was applied to re-define the grain of the wood.



Bolt Thrower

CHARACTER MODELS

Wayne has also painted up two powerful Character models for his ever expanding Dwarf army- Brokk Gromson, a level 20 hero and Dimzad Dwinbar, a level 15 wizard.



*Lord Gromson
Level 20 Hero*

Brokk Gromson is a mighty individual character who is made even more powerful by the addition of a magic axe with the 'Trance' ability.

As with the rest of the troops, he was given a black undercoat. The slashed sleeves were painted Skull White and Blood Red. The studs were first painted Chaos Black and dotted with Shining Gold. Again, Wayne has painted parts of this character blue to connect him with the royal household.



*Dimzad Dwinbar
Level 15 Wizard*

More subdued, natural colours are required for dwarf wizards so this was one of the few models that Wayne undercoated with white. The robes were painted with Orc Brown, highlighted with Skull White and edged with Blood Red. The hat was painted Terracotta and highlighted by adding Sunburst Yellow.

Wayne's army is still in development. He has got at least two more large units planned, one of which will be crossbowmen. He has also got some exciting plans for a special conversion for the army general which we'll show you as soon as it's completed.

WAYNE ENGLAND'S DWARF ARMY

CHARACTERS

| | |
|--|---------|
| Lord Gromson (Lvl 20 Hero) Double handed weapon, Magic Blade (<i>Trance</i>) Light armour, crossbow | 225 pts |
| Bardln Orc-render (Lvl 10 Hero) Light armour, shield, magic Blade (<i>bane blade</i>) | 121 pts |
| Prince Kargrim (Lvl 10 Hero) Heavy armour, shield | 92 pts |
| Grom Thingrim (Lvl 5 Hero) Light armour, pistol | 52 pts |
| Dimzad Dwinbar (Lvl 15 Wizard) | 203 pts |

TOTAL ON CHARACTER SO FAR = 693pts

RANK AND FILE

| | |
|---|---------|
| 19 Longbeards, Heavy armour, hand weapon, shield, musician, standard bearer (<i>war banner</i>) | 319 pts |
| 19 Clansman, Light armour, shield, hand weapon, Musician (<i>magic instrument-battlecry</i>) standard bearer | 277 pts |
| 19 Warriors, Light armour, pikes, hand weapons, musician, standard bearer | 231 pts |

WAR ENGINES

| | |
|--|----------------|
| bolt thrower, Light armour for crew | 60 pts |
| cannon, Light armour for crew | 75 pts |
| flame cannon, Light armour for crew | 125 pts |
| TOTAL RANK AND FILE SO FAR = | 1087pts |

ARMY TOTAL SO FAR = 1780pts

SPACE MARINE™

We've been working away to complete our range of Space Marine data cards for all the available Titan models. This month we finish off with the Eldar Phantom Titan, the Imperial Warhound Scout Titan and the Ork Slasher Gargant. Additional rules are included to cover the potent weaponry of the Eldar Phantom and its unique defensive Holo Fields.

ELDAR TITANS

Eldar Titans are very different to those used by the Imperium. Tall and slender, they move with an smooth agility and grace unachievable by human Titans. They benefit not only from the experience of their crews (which are brought up with Titans from birth) but from the collective consciousness of a large Spirit-stone which contains the souls of numerous dead Eldar. Phantom Titans are built around a Wraithbone core which permits the spirits contained within it to flow freely through the whole construct. This gives the Eldar Titan a consciousness of its own which, combined with its living crew, makes the Phantom such a deadly fighting machine.

ELDAR HOLO FIELDS

Certain Eldar vehicles and troops use a sophisticated system of defensive screens called Holo Fields. The most well-known users of the holo field are Eldar Phantom Titans. Holo fields are not designed to block, absorb and shunt aside attacks like Imperial void shields and Ork power fields, instead the Holo field confuses enemy location and targeting systems by diffracting the subject's image. When a unit protected by a holo field moves, its image seems to explode into a storm of multi-coloured shards. The faster it moves, the more scattered the image becomes. When it stops the cloud appears to coalesce into a solid shape again. Thus the holo field is well suited to the Eldar precepts of speed and mobility over armour and firepower.



Any unit protected by a holo field receives an additional saving throw against a hit. Because the holo field disrupts targeting more if the subject is moving the saving throw varies according to what orders the subject is on, making it better on charge orders than first fire for instance. The table below summarises what saving throws the subject has on different orders. The saving throw is tied only to the units orders and not to the actual distance the model moves.

This extra save is taken first and is not modified by the attacking weapon's armour saving throw modifier; being able to punch through heavy armour is no help if the target isn't where its supposed to be. On the other hand, the holo field is useless against area effect weapons which don't have to rely on pin-point accuracy, and so the save does not apply against hits from barrages, or any other attack that uses a template of any kind.

| Orders | Saving Throw |
|------------|--------------|
| First Fire | 4+ |
| Advance | 3+ |
| Charge | 2+ |

ELDAR TITAN WEAPONS

POWER FIST

The Eldar Power Fist is identical in most ways to the power fist mounted on Imperial Titans. In close combat the gigantic armoured fist can be used to rip pieces off enemy Titans or crush buildings like paper. The Eldar Power Fist is also enhanced with the addition of a battery of Shuriken Cannon in the fingers and 'knuckles' which give it a potent ranged capability as well. In the combat phase the power fist can be used either in close combat or as a ranged weapon. It may not be used as both in the same turn.

If a Phantom with a Power Fist wins a close combat with an enemy Titan it can make a special grab attack instead of rolling normal damage. The Phantom can grab any location on the hit template and try to rip it away. Both players roll a D6 and the Phantom adds +1. If the Phantom's score is higher than the defender's the location is wrenched off and suffers maximum damage. If the scores are equal the defender wriggles partially out of the Phantom's grasp and damage on the location is resolved with a D6 roll as normal. If the defender's score is higher than the Phantom's it manages to slip completely out of the Phantom's grip and suffers no damage. A building attacked with the Power Fist is hit automatically and must roll a saving throw with a -4 modifier or be destroyed.

| Name | Range | Attack Dice | To Hit Roll | Save Mod |
|------------|-------|-------------|-------------|----------|
| Power Fist | 50cm | 4 | 4+ | -1 |

Notes: May be used in close combat.

HEAT LANCE

The Heat Lance is a special Eldar Titan weapon. It operates by setting up an electromagnetic 'tube' between the weapon and its target and then launching a high-power bolt of fissile energy along it. The effects are akin to the awesome destructiveness of Melta and Plasma weapons but far more devastating by virtue of being more tightly controlled. At longer ranges the carrier field is unable to contain the shot and the Heat Lance loses some of its lethality. The ability of the Heat lance to literally punch through the heaviest armour at close range makes it a highly favoured weapon.

Anything hit by a Heat Lance at up to 25cm range must make a saving throw with a -5 modifier. A massive +5 is added to damage rolls against Titans hit by a Heat Lance at up to 25cm range. For each 25cm of range the Heat Lance's saving throw modifier and damage bonus is reduced by two, so a target hit at a range of 50cm would suffer a -3 saving throw modifier and a +3 on damage rolls. This is summarised on the weapon chart

| Name | Range | Attack Dice | To Hit Roll | Save Mod | Damage Bonus |
|------------|------------|-------------|-------------|----------|--------------|
| Heat Lance | Up to 25cm | 1 | 2+ | -5 | +5 |
| | 26-50cm | 1 | 3+ | -3 | +3 |
| | 51-75cm | 1 | 4+ | -1 | +1 |

THE PSYCHIC LANCE

Eldar Titans may be armed with the Psychic lance, a weapon created by the Eldar Knight clans which 'fires' a burst of psychic energy directed through a long crystalline rod. The resonances set up in the crystal create a beam of directed psychic energy which will brainwipe anything in the area of effect. The Psychic lance is a much feared weapon - it makes a mockery of even the heaviest armour and shields as it passes straight through such physical obstructions and leaves its victims drooling idiots without even control of their bodily functions.

When using the psychic lance take a barrage template and place it anywhere within the LOS and range of the firing Titan. Anything completely under the template will be hit on a D6 roll of 5 or 6. The effects of a hit from a Psychic lance vary greatly depending on the victim. It will automatically wipe the brains of any infantry stand or vehicle regardless of its armour saving throw, as the lance beam passes straight through it. Robots and robotically controlled equipment (such as Tarantulas) are immune to the effects of the lance. Units which have a 'psychic saving throw', such as Grey Knights, receive their psychic save against the lance's effects as normal. Daemons which are hit are instantly cast back into the warp without any saving throw as the brain of their host body is destroyed. A Titan hit by the Psychic lance rolls for damage once on the head damage table.

| Name | Range | Attack Dice | To Hit Roll | Save Mod |
|---------------|-------|-------------|-------------------|----------|
| Psychic Lance | 50cm | special | - see rules above | |

Notes: Uses Barrage template. No armour save possible. Hits destroy daemons automatically

TREMOR-CANNON

The Tremor-Cannon is a much larger version of the weapon mounted on the Vibro-Cannon anti-grav platform. The Tremor-Cannon is so powerful that it does not have to operate in a battery, just one of these weapons can cause enemy troops to literally shake themselves apart! Tremor-Cannon operate on a ranged induction field principle, using a fluctuating electromagnetic field to set up a resonant vibration in the target's atomic structure. The Tremor-Cannon is fired into the ground to produce a 'quake' effect some distance away. As the Tremor-Cannon is kept focussed the tremors in the area become more and more intense with attendant secondary explosions and thermal effects eventually culminating in the whole area liquifying as its atomic structure breaks down.

When you shoot a Tremor-Cannon draw an imaginary line between the weapon and the target. The ground along this line is ripped up just as if a giant plough had driven a furrow through the ground. Any building along the line is hit automatically and is destroyed unless it can make its saving throw with a -2 modifier. Roll a D6 for any troop stand, vehicle or Titan that lies along the line, and on a roll of 5 or 6 it is so badly shaken that it takes a hit. The nominated target takes a hit on a roll of 3 or more. Note that the Tremor-Cannon's field passes straight through Titan shields and hits the Titan without effecting the shields in any way.

Any troop stand or vehicle that is hit must make its saving throw with a -2 modifier or be destroyed. Since Tremor-Cannon transmit shockwaves along the ground, only the bottom part of a Titan - or anything else with a hit location template - will be affected. To represent this, if you hit a Titan you must pick a hit location that is on the bottom row of the its hit location template.

| Name | Range | Attack Dice | To Hit Roll | Save Mod |
|---------------|-------|-------------|-------------|----------|
| Tremor-Cannon | 100cm | Special | Special | -2 |

Notes: Target hit on 3+, intervening models on 5+.

DISTORTION CANNON

The powerful Eldar Distortion cannon bores a hole through the fabric of reality, creating a whirling black hole into warp space. Anything engulfed by the hole is sucked through into the warp and destroyed. Those lucky enough to avoid the full power of the warp hole are cast aside and scattered around the battlefield. Due to the constantly changing flux of the warp it's impossible to be sure precisely where the warp hole will open. Because of this the Distortion cannon is most effective when used against densely packed enemy formations.

A barrage template is used to represent the warp hole. The cannon can only shoot at a target point it can see, so take the barrage marker and place it with its centre over the proposed target anywhere in LOS and range of the firing Titan. Roll the scatter dice and if the result is an arrow reposition the template 2D6cm in the direction shown. Now roll the scatter dice again and if the result is an arrow reposition the template once more. Because you roll twice for scatter with the Distortion cannon it can sometimes miss its target by as much as 24cm. Then roll a scatter dice for each model at least half under the template. On the roll of a cross hair the target is sucked into the warp and destroyed with no saving throw. On the roll of an arrow the target is thrown D6cm in the direction shown and may not move, shoot, or do anything else that turn.

TITAN WEAPONS

Buildings cannot be sucked into the warp whole as they are simply too large, however any building hit by a Distortion cannon will be severely damaged and may collapse. The building is allowed its basic saving roll, and if successful its structural integrity is unaffected and the building still stands. Any models inside the building are also unaffected so long as it survives.

Titans, Gargants, and any super-heavy tanks with either intact void or power fields automatically avoid destruction thanks to their shields. The warp hole is slightly displaced by the presence of active shields and so the target is never sucked into the warp but is scattered D6cm in a random direction instead.

| Name | Range | Attack Dice | To Hit Roll | Save Mod |
|--------------------------|-------|-------------|-------------------|----------|
| Distortion Cannon | 75cm | Special | - see rules above | |

Notes: Uses barrage template, Scatters Twice

PULSAR

The Pulsar, is used exclusively by the Eldar. It is a highly sophisticated laser cannon and amply demonstrates the Eldar's consummate skill in constructing laser weapons. The Pulsar fires short volleys of extremely powerful laser energy, each pulse of energy in the volley being separated by a few milliseconds from the next one.

The Pulsar can be fired in two ways. When fired at a single target the Pulsar will be held steady so that as many pulses as possible will hit the target, while against a more numerous foe the Pulsar can be moved slightly to spread the pulses over an area in an attempt to hit more than one target.

When you fire the Pulsar you must declare which way you will use it. If you fire against a single target, roll to hit just once. If you score a hit, roll the D6 again. The result is the number of pulses from the volley that hit the target. Each pulse must be saved against separately. If you decide to fire at a group of targets, take the barrage template and place it over any target point within the Pulsar's LOS and range. Roll once to hit any model under the template.

| Name | Range | Attack Dice | To Hit Roll | Save Mod |
|---------------|-------|-------------|-------------|----------|
| Pulsar | 100cm | 1 | 2+ | -2 |

Notes: Target must save D6 times. May fire a barrage instead.

WING WEAPONS

Eldar Phantoms have two small weapon mounts, one on each shoulder. They are commonly referred to as wing weapons because they are connected to the holo-field generator 'wings' on the Phantom's back. They are used to house secondary weapons, usually a small battery of lascannon on one shoulder for use against vehicles and a set of missile launchers on the other for bombarding infantry. You may choose to have either type of battery in each mount, and can have two batteries of the same type if you want.

| Name | Range | Attack Dice | To Hit Roll | Save Mod |
|------------------------------|-------|-------------|-------------|----------|
| Lascannon Wing | 75cm | 2 | 3+ | -2 |
| Missile Launcher Wing | 100cm | 4 BPs | - | -0 |

ELDAR TITAN WEAPONS SUMMARY

| Name | Range | Attack Dice | To Hit Roll | Save Mod | Damage Bonus | Notes |
|------------------------------|------------|-------------|-------------|----------|--------------|--|
| Heat Lance | Up to 25cm | 1 | 2+ | -5 | +5 | |
| | 26-50cm | 1 | 3+ | -3 | +3 | |
| | 51-75cm | 1 | 4+ | -1 | +1 | |
| Pulsar | 100cm | 1 | 2+ | -2 | - | Target must save D6 times. May fire a barrage instead. |
| Tremor-Cannon | 100cm | Special | Special | -2 | - | Target hit on 3+, intervening models on 5+. |
| Distortion Cannon | 75cm | Special | Special | Special | Special | Uses barrage template, Scatters Twice |
| Psychic Lance | 50cm | Special | Special | Special | - | Uses Barrage template. No armour save possible. Hits destroy daemons automatically |
| Power Fist | 50cm | 4 | 4+ | -1 | - | May be used in close combat. |
| Lascannon Wing | 75cm | 2 | 3+ | -2 | - | |
| Missile Launcher Wing | 100cm | 4 BPs | - | 0 | - | Uses barrage template |

ELDAR PHANTOM TITAN

| | |
|--|-----------------------------|
| Move | Close Assault Factor |
| 20cm | +12 |
| <p>The Phantom Titan is protected by a Holo field and mounts 2 Eldar Titan Weapons plus 2 Wing weapons (see Special rules). Note down the details for the weapons mounted on your Titan model in the spaces given below.</p> <p>The Phantom is very fast and agile so unlike other Titans it can move in any direction it wants to when it moves.</p> | |
| Holo Field Saving Throws | |
| Orders | Saving Throw |
| First Fire | 4+ |
| Advance | 3+ |
| Charge | 2+ |
| <p>Holo field saving throws are unaffected by the attackers save modifier. Barrages ignore Holo Fields.</p> | |

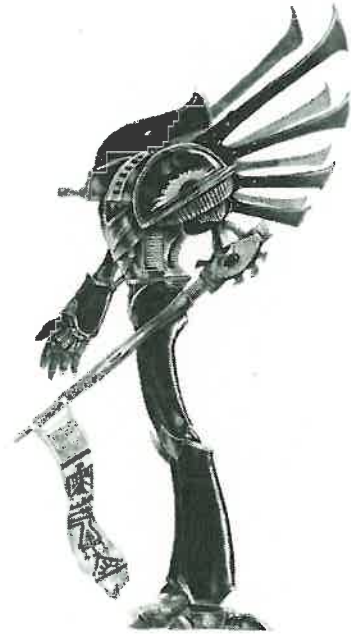

| WEAPON | RANGE | ATTACK DICE | TO HIT ROLL | TARGET'S SAVE MODIFIER | NOTES |
|--------|-------|-------------|-------------|------------------------|-------|
| | | | | | |
| | | | | | |
| | | | | | |
| | | | | | |
| | | | | | |

HIT LOCATION TEMPLATES

FRONT

| | | | |
|-------------|---------|-------------|--------|
| WING | | WING | |
| 3+ | | 3+ | |
| WING WEAPON | HEAD | WING WEAPON | |
| 2+ | 1+ | 2+ | |
| WEAPON | REACTOR | WEAPON | |
| 2+ | 1+ | 2+ | |
| WEAPON | LEG | LEG | WEAPON |
| 2+ | 2+ | 2+ | 2+ |
| | LEG | | |
| | 1+ | | |
| | LEG | | |
| | 1+ | | |

SIDE

| | |
|-------------|--------|
| WING | |
| 3+ | |
| WING WEAPON | HEAD |
| 3+ | 1+ |
| WEAPON | WEAPON |
| 2+ | 2+ |
| LEG | |
| 2+ | |
| LEG | |
| 1+ | |
| LEG | |
| 1+ | |

REAR

| | | | |
|-------------|---------|-------------|--------|
| WING | | WING | |
| 3+ | | 3+ | |
| WING WEAPON | HEAD | WING WEAPON | |
| 3+ | 2+ | 3+ | |
| WEAPON | REACTOR | WEAPON | |
| 2+ | 3+ | 2+ | |
| WEAPON | LEG | LEG | WEAPON |
| 2+ | 2+ | 2+ | 2+ |
| | LEG | | |
| | 1+ | | |
| | LEG | | |
| | 1+ | | |

ELDAR TITAN DAMAGE TABLES

WING DAMAGE TABLE - Roll D6

- 1-3 The Wing has been damaged. The Titans Holo Fields will not work until it is repaired by rolling 4+ on a D6 in the end phase.
- 4-5 The Wing is destroyed and the Titans Holo Fields stop working for the rest of the game.
- 6 The Wing is blown clean off the Titan and lands 2D6cm in a random direction. Anything the wing lands on must make a saving throw or be destroyed. The Titans Holo Fields stop working for the rest of the game.

WING WEAPON DAMAGE TABLE - Roll D6

- 1-3 Roll on the Wing damage table.
- 4-6 Roll on the Weapon damage table.

HEAD DAMAGE TABLE - Roll D6

- 1-2 The Titan's mind impulse units have been damaged. Until the damage is repaired the Titan's CAF is halved, and it may only move or fire if you first roll a 4+ on 1D6 (roll the D6 just before you move or fire).
- 3 The shot punches through to the bridge, killing vital crew members. The Titan's CAF is halved for the rest of the game.
- 4 The shot rips through the head and causes an explosion in the crew compartment, injuring several of the crew. The Titan's CAF is halved for the rest of the game, and it may only move or fire if you first roll a 4+ on 1D6 (roll the D6 just before you move or fire).
- 5-6 The shot rips through the head and crew compartment, and triggers massive internal explosions within the Titan. The Titan crashes to the ground as a result of this spectacular KO! Decide randomly which way the Titan falls, and place it on its side lying in that direction. Any vehicles or stands units that are fallen on are destroyed.

LEG DAMAGE TABLE - Roll D6

- 1-2 The leg is damaged, forcing the Titan to walk with a pronounced limp. The Titan's move rates are halved and it may not enter difficult terrain.
- 3-4 The Titan's leg has suffered extensive damage, and it is very likely that it will give way if the Titan attempts to move. Roll a D6 in each ensuing repair phase, subtracting 2 from the roll if the Titan has charge orders, or 1 from the roll if it has advance orders. On a roll of 0 or less the leg snaps
If the leg snaps the Titan will crash to the ground and is destroyed. Decide randomly which way the Titan falls, and place it on its side lying in that direction. Any vehicles or stands fallen on are destroyed.
- 5 The Titan is completely crippled by the damage to its legs. It may not move or turn for the rest of the game.
- 6 The leg is blown apart and the Titan collapses to the ground. Decide randomly which way the Titan falls, and place it on its side lying in that direction. Any vehicles or stands fallen on are destroyed.

REACTOR DAMAGE TABLE - Roll D6

- 1-2 The Titan's plasma reactor has been breached and shuts down. The Titan grinds to a halt and may not move or fire until the damage is repaired. No other damage may be repaired until the plasma reactor comes back on line.
- 3-4 The Titan's plasma reactor has been breached and the crew desperately struggle to keep the damage under control. Attempt to repair the damage in the next repair phase. If you fail there is a reactor meltdown and the Titan is destroyed (see the next result for the effects of a meltdown). If you succeed the reactor comes back on line and the Titan may move and fire as normal.
- 5-6 The Titan's plasma reactor has been destroyed, and the Titan is vapourised in a spectacular meltdown. The Titan is removed from play (replace it with a model crater if you've got one). All units within 3D6 cms suffer an automatic hit, and must make an unmodified save to avoid damage.

WEAPON DAMAGE TABLE - Roll D6

- 1-2 The weapon has been damaged by the attack, and may not be used again until it is repaired.
- 3-4 The weapon has been destroyed and may not be used again in this battle.
- 5 The weapon is blown clean off the Titan and scatters 2D6cm in a random direction. Any vehicles or stands underneath the point where it lands are destroyed.
- 6 The weapon is blown off the Titan as above, but there is also a flashback to Titan's hull. Roll a D6 to see what was affected by the flashback:

| | |
|-----|---------|
| 1-2 | Wing |
| 3-4 | Reactor |
| 5-6 | Head |

 Then roll the D6 again and refer to the appropriate Damage Table to find out what damage is caused.

HIT LOCATION

HIT LOCATION/SHOOTING

Roll to hit the Titan as normal. If you hit, refer to the location templates overleaf. Nominate the target area. Roll the pair of aim dice and move the location hit as indicated up, down, left or right. If the shot lands in a location area take any appropriate save. If the save fails refer to the appropriate damage table. If your shot lands on an empty square or outside the grid it has missed.

CLOSE COMBAT

If beaten in close combat the enemy chooses a location and damage is worked out from the appropriate damage table. Shields have no effect in close combat and saving throws are ignored.

SLASHER GARGANT

| | | |
|---|--|--|
| Close Assault Factor | | |
| +12 | | |
| Movement | | |
| A Slasher's move is determined by its orders. These are as follows. | | |
| Orders | Effect | Fire |
| Charge | Must move between . 13-18 cm towards the nearest enemy formation. | The Slasher may not fire |
| Advance | May move up to 12cm but this does not have to be towards the nearest enemy formation as in Charge. | The Slasher may fire in the advance fire segment |
| First Fire | No move or turn | The Slasher may fire in the first fire segment. |
| Power Fields | | |
| The Slasher is protected by 3+ (1D3) Power Fields | | |



| WEAPON | RANGE | ATTACK DICE | TO HIT ROLL | TARGET'S SAVE MODIFIER | NOTES |
|--------|-------|-------------|-------------|------------------------|-------|
| | | | | | |
| | | | | | |
| | | | | | |
| | | | | | |

HIT LOCATION TEMPLATES

FRONT

| | | | | |
|--------|------|------------|--------|--------|
| | | HEAD 2+ | | |
| WEAPON | AMMO | HULL | AMMO | WEAPON |
| 2+ | 1+ | 3+ | 1+ | 2+ |
| | | HULL | BOILER | HULL |
| | | 3+ | 2+ | 3+ |
| FOOT | HULL | BELLY GUN | HULL | FOOT |
| 3+ | 3+ | 2+ | 3+ | 3+ |

SIDE

| | | | | |
|--|--|------------|--------|-----------|
| | | HEAD 2+ | | |
| | | 2+ | | |
| | | HULL | WEAPON | WEAPON |
| | | 3+ | 2+ | 3+ |
| | | HULL | BOILER | HULL |
| | | 3+ | 3+ | 3+ |
| | | HULL | FOOT | BELLY GUN |
| | | 3+ | 3+ | 2+ |

REAR

| | | | | |
|--------|------|------------|--------|--------|
| | | HEAD 2+ | | |
| | | 2+ | | |
| WEAPON | AMMO | HULL | AMMO | WEAPON |
| 2+ | 3+ | 3+ | 3+ | 2+ |
| | | HULL | BOILER | HULL |
| | | 3+ | 3+ | 3+ |
| FOOT | HULL | AMMO | HULL | FOOT |
| 3+ | 3+ | 3+ | 3+ | 3+ |

ORK SLASHER DAMAGE TABLES

BOILER DAMAGE TABLE - Roll D6

- 1-2 The boiler is damaged. Add +1 to any future rolls on this location.
- 3-4 The boiler is hit and starts to lose pressure. The Slashers move rates are reduced by 50% from now on.
- 5-6 The boiler is destroyed. The Slasher can no longer move, and a fire is started.

FOOT DAMAGE TABLE - Roll D6

- 1-3 The foot is damaged but carries on working normally. Add +1 to any future rolls on this location.
- 4-5 The foot is destroyed. If one foot is destroyed the Slasher is only allowed to turn in place. If both feet are destroyed the Slasher may not move at all.
- 6 The foot is blown apart in a massive explosion that starts a fire. The Slasher may no longer move or turn, even if the other foot is undamaged.

BELLY GUN DAMAGE TABLE - Roll D6

- 1-2 Some ammunition explodes but the Krew quickly douse it down. Add +1 to any future rolls on this location.
- 3-4 The gun is destroyed and may not be used for the remainder of the battle.
- 5 The gun is destroyed and exploding ammunition starts fire. The gun may not be used for the remainder of the battle.
- 6 The belly gun's magazine explodes starting a fire. The belly gun is destroyed, and each adjacent location must roll for damage on the following table:

| | |
|-----|------------------------------------|
| 1-3 | No Effect |
| 4-6 | Roll on the Locations Damage Table |

HULL DAMAGE TABLE - Roll D6

- 1-5 The hull is weakened, add +1 to any future rolls on this location.
- 6 A massive explosion rips a huge hole in the hull and starts a fire.

WEAPON DAMAGE TABLE - Roll D6

- 1-2 The weapon is damaged but keeps on functioning. Add +1 to any future rolls on this location.
- 3-4 The weapon is destroyed and may not be used for the rest of the game.
- 5-6 The weapon is blown off the Slasher, starting a fire. The weapon lands 2D6cm away in a random direction - any vehicles or infantry underneath it are destroyed unless they make their basic saving throw.

HEAD DAMAGE TABLE - Roll D6

- 1-2 Several of the bridge crew are injured. Add +1 to any future damage rolls on this location.
- 3 The Kaptin is killed. The Slasher must follow the same orders next turn while the bridge crew 'elect' a new Kaptin.
- 4-5 The head is destroyed. The Slasher must follow the same orders as it used last turn, and any weapons mounted in the head may not be used for the remainder of the battle. After the next turn, roll a D6 before changing the Slasher's orders:

| | |
|-----|----------------------------|
| 1-3 | May not change orders |
| 4-6 | May change orders normally |
- 6 The head is blown clean off the Slasher, starting a fire. The Slasher must follow the same orders as it used last turn, and any weapons mounted in the head may not be used for the remainder of the battle.

After the next turn, roll a D6 before changing the Slasher's orders:

| | |
|-----|----------------------------|
| 1-3 | May not change orders |
| 4-6 | May change orders normally |

MAGAZINE DAMAGE TABLE - Roll D6

- 1 Some ammunition explodes. Add +1 to any future damage rolls on this location.
- 2-3 A large explosion starts a fire.
- 4-6 The magazine detonates spectacularly, starting a fire. Each adjacent location must roll for damage on the following table:

| | |
|-----|------------------------------------|
| 1-3 | No Effect |
| 4-6 | Roll on the locations damage table |

FIRE TABLE - ROLL D6

Roll on this table at the start of the end phase if any fires are burning on a Slasher. Add +1 to the roll for each fire burning on the Slasher in excess of one.

| Adjusted D6 Roll | Effect |
|------------------|--|
| 1 | With a few scorched Gretchin the fires are brought under control and put out. |
| 2-3 | The fire is getting out of control. The Slasher is not allowed to move next turn, but may fire normally. |
| 4 | The fire is out of control! Add one to the number of fires already burning on the Slasher. The Slasher may not move or fire its belly gun next turn, and any other weapons fired are on a -1 to hit modifier due to the clouds of smoke. |
| 5 | The fire reaches the magazines! Roll on the Magazine damage table for each intact magazine, the Slasher also can't move or fire its belly gun and suffers -1 on firing as in 4 above. |
| 6 | Huge internal explosions wreck the Slasher, destroying it and leaving a smoking, blackened heap. Any units within 2D6cm are hit by flying debris and must make an unmodified save to avoid damage. |
| 7+ | A massive explosion rips the Slasher apart. Remove the model from the table and replace it with a crater if you've got one. Any units within 4D6cm are hit by flying debris and must make an unmodified save to avoid damage. |

WARHOUND TITAN

| | |
|-------------|-----------------------------|
| Move | Close Assault Factor |
| 25cm | +8 |

The Warhound Titan has 2 Void Shields and capacity to mount 2 Weapons
 Note down the details for the weapons mounted on your Titan model in the spaces given below.
 A Warhound cannot mount either a Plasma Cannon or Plasma Destructor as it unable to provide enough power for these weapons. It can mount a Plasma Blastgun.
 Warhound Titans are very agile and unlike the Warlord and Reaver Titan they can make as many turns as they like when they move.
 When a Warhound Titan is on charge orders opponents have a -1 to hit modifier because the Warhound can quickly dodge incoming shots
 Record shield loss using markers on the Warhound Titan's base

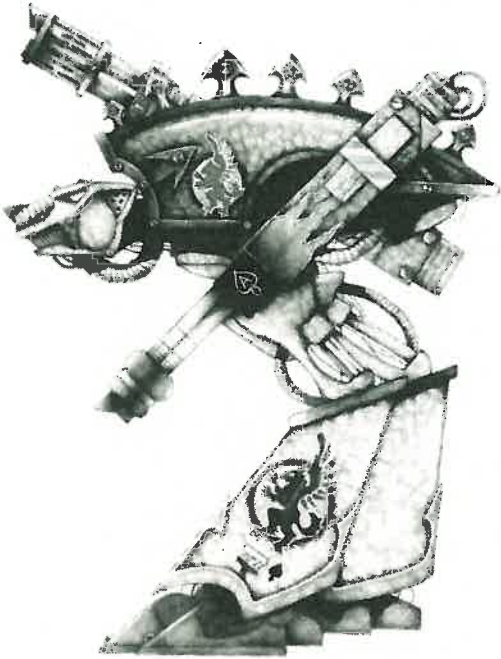

| WEAPON | RANGE | ATTACK DICE | TO HIT ROLL | TARGET'S SAVE MODIFIER | NOTES |
|--------|-------|-------------|-------------|------------------------|-------|
| | | | | | |
| | | | | | |

HIT LOCATION TEMPLATES

FRONT

SIDE

REAR

IMPERIAL TITAN DAMAGE TABLES

CARAPACE DAMAGE TABLE - Roll D6

- 1-2 The Titan's void shield generators are damaged, and shut down temporarily. Until the void shield generators are repaired they may not be used.
- 3-4 The Titan's void shield generators shut down and may not be used any further in the game.
- 5 The Titan's void shields are in danger of overloading and you must shut them down before they explode! Roll a D6 - on a 5 or 6 the shields are safely shut down. On a 1-4 the shields explode as described below.
- 6 The Titan's void shields overload and explode causing massive internal damage. The Titan is destroyed but remains standing. Any units within 2D6cm are hit by flying debris and must make an unmodified save to avoid damage.

REACTOR DAMAGE TABLE - Roll D6

- 1-2 The Titan's plasma reactor has been breached and shuts down. The Titan grinds to a halt and may not move or fire until the damage is repaired. No other damage may be repaired until the plasma reactor comes back on line.
- 3-4 The Titan's plasma reactor has been breached and the crew desperately struggle to keep the damage under control. Attempt to repair the damage in the next repair phase. If you fail there is a reactor meltdown and the Titan is destroyed (see the next result for the effects of a meltdown). If you succeed the reactor comes back on line and the Titan may move and fire as normal.
- 5-6 The Titan's plasma reactor has been destroyed, and the Titan is vaporised in a spectacular meltdown. The Titan is removed from play (replace it with a model crater if you've got one). All units within 3D6 cms suffer an automatic hit, and must make an unmodified save to avoid damage.

HEAD DAMAGE TABLE - Roll D6

- 1-2 The Titan's mind impulse units have been damaged. Until the damage is repaired the Titan's CAF is halved, and it may only move or fire if you first roll a 4+ on 1D6 (roll the D6 just before you move or fire).
- 3 The shot punches through to the bridge, killing vital crew members. The Titan's CAF is halved for the rest of the game.
- 4 The shot rips through the head and causes an explosion in the crew compartment, injuring several of the crew. The Titan's CAF is halved for the rest of the game, and it may only move or fire if you first roll a 4+ on 1D6 (roll the D6 just before you move or fire).
- 5-6 The shot rips through the head and crew compartment, and triggers massive internal explosions within the Titan. The Titan crashes to the ground as a result of this spectacular KO! Decide randomly which way the Titan falls, and place it on its side lying in that direction. Any vehicles or stands units that are fallen on are destroyed.

WEAPON DAMAGE TABLE - Roll D6

- 1-2 The weapon has been damaged by the attack, and may not be used again until it is repaired.
- 3-4 The weapon has been destroyed and may not be used again in this battle.
- 5 The weapon is blown clean off the Titan and scatters 2D6cm in a random direction. Any vehicles or stands underneath the point where it lands are destroyed.
- 6 The weapon is blown off the Titan as above, but there is also a flashback to Titan's hull. Roll a D6 to see what was affected by the flashback:

| | |
|-----|----------|
| 1-2 | Carapace |
| 3-4 | Reactor |
| 5-6 | Head |

 Then roll the D6 again and refer to the appropriate Damage Table to find out what damage is caused.

LEG DAMAGE TABLE - Roll D6

- 1-2 The leg is damaged, forcing the Titan to walk with a pronounced limp. The Titan's move rates are halved and it may not enter difficult terrain.
- 3-4 The Titan's leg has suffered extensive damage, and it is very likely that it will give way if the Titan attempts to move. Roll a D6 in each ensuing repair phase, subtracting 2 from the roll if the Titan has charge orders, or 1 from the roll if it has advance orders. On a roll of 0 or less the leg snaps. If the leg snaps the Titan will crash to the ground and is destroyed. Decide randomly which way the Titan falls, and place it on its side lying in that direction. Any vehicles or stands fallen on are destroyed.
- 5 The Titan is completely crippled by the damage to its legs. It may not move or turn for the rest of the game.
- 6 The leg is blown apart and the Titan collapses to the ground. Decide randomly which way the Titan falls, and place it on its side lying in that direction. Any vehicles or stands fallen on are destroyed.

HIT LOCATION

HIT LOCATION/SHOOTING

Roll to hit the Titan as normal. If you hit, refer to the location templates overleaf. Nominate the target area. Roll the pair of aim dice and move the location hit as indicated up, down, left or right. If the shot lands in a location area take any appropriate save. If the save fails refer to the appropriate damage table. If your shot lands on an empty square or outside the grid it has missed.

CLOSE COMBAT

If beaten in close combat the enemy chooses a location and damage is worked out from the appropriate damage table. Shields have no effect in close combat and saving throws are ignored.

SPECIAL CARD

2 WARHOUND SCOUT TITANS

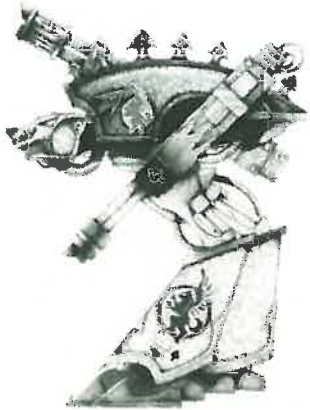

**POINTS VALUE 500
FOR TWO WARHOUNDS**

WARHOUND TITANS

Warhound Scout Titans are the eyes and ears of the Titan Legions. Fast and agile, they perform dangerous reconnaissance missions and raids behind enemy lines. Each Titan fights as a single unit which cannot be broken and so they do not need to take morale checks. Victory points are awarded to the opposing player as soon as one of the Titans is destroyed.



VICTORY POINTS 5

Victory points are awarded once one Warhound is destroyed.

SPECIAL CARD

PHANTOM TITAN



POINTS VALUE 600

PHANTOM TITAN

The Phantom Titan is the most potent weapon of war employed by the Eldar Craftworlds. It fights as a single unit which cannot be broken and so does not need to take a morale check. Victory points are awarded to the opposing player once the Titan is destroyed.



VICTORY POINTS 6

Victory points are awarded once the Titan is destroyed.

To make up your data cards, first photocopy the cards on this page. Fold each card along the dotted line and glue the two halves together on the inside. You can then use these cards as normal in your Space Marine games.

Copyright © 1991 Games Workshop Ltd. All rights reserved.

Permission granted to photocopy for personal use only.

SPECIAL CARD

SLASHER GARGANT



POINTS VALUE 600

SLASHER GARGANT

The Slasher Gargant is commonly built by Ork Warlords who don't have the time or the resources to build a full scale Great Gargant. However, they are still much revered by Orks as representations of the Ork gods and many Evil Sunz prefer them because of their greater speed. A Slasher Gargant fights as a single unit which cannot be broken and so does not need to take a morale check. Victory points are awarded to the opposing player once the Slasher is destroyed.



VICTORY POINTS 6

Victory points are awarded once the Gargant is destroyed.

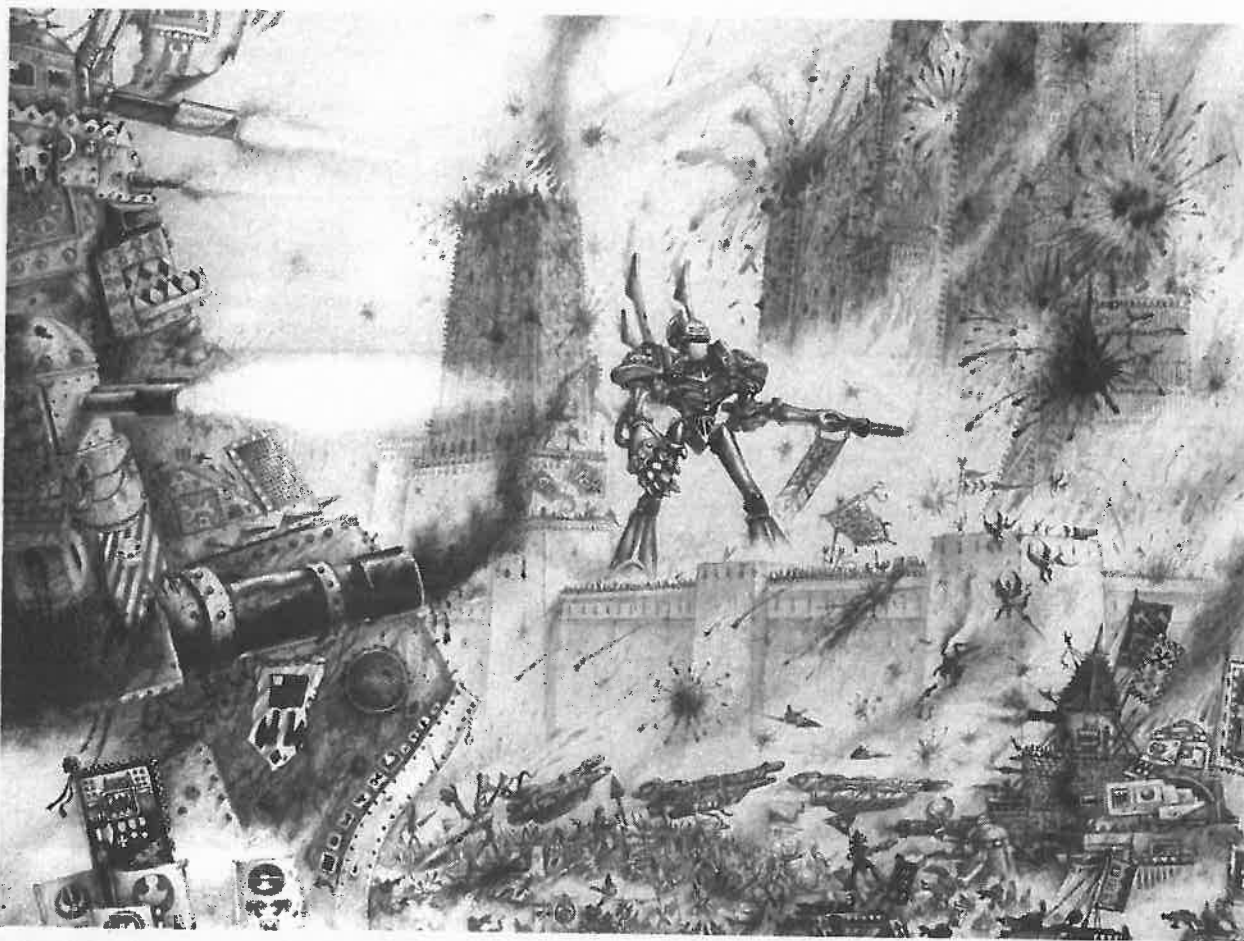

JOHN BLANCHE

To make up your data cards, first photocopy the cards on this page. Fold each card along the dotted line and glue the two halves together on the inside. You can then use these cards as normal in your Space Marine games.

Copyright © 1991 Games Workshop Ltd. All rights reserved.

Permission granted to photocopy for personal use only.

SPACE MARINE™

EPIC STOMPERS



SPACE
MARINE™

ELДАР, ОРК, МАРИНЕ АНД ЧАОС ДРЕАДНОУГХТС ФОР УСЕ ВИТХ СПАСЕ МАРИНЕ

WARHAMMER
40,000™

EPIC STOMPERS SPRUE 101557

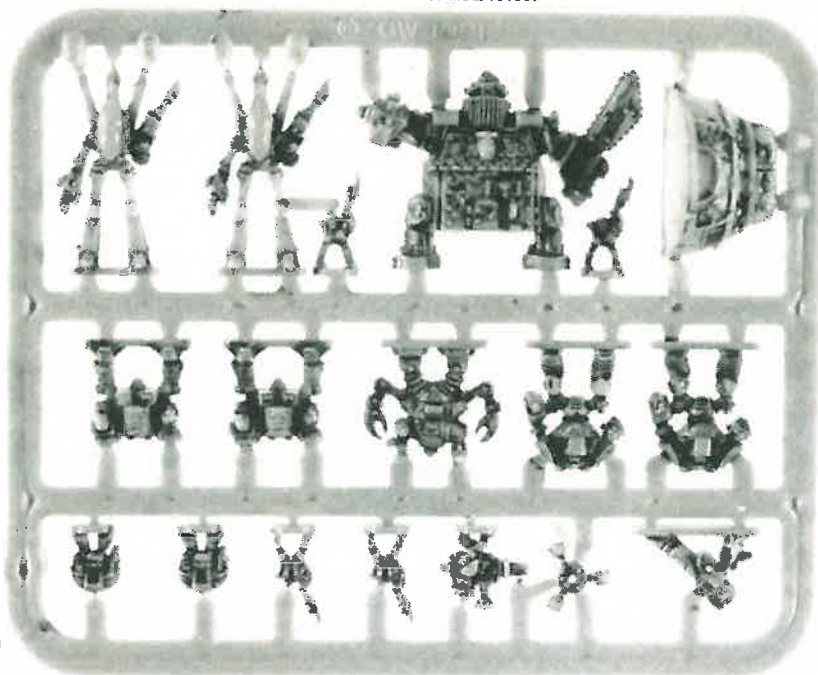

The Epic Stompers box set contains 6 sprues of highly detailed plastic miniatures for the Space Marine game.

Each box contains:

- 6 Ork Stompers
- 12 Eldar Dreadnoughts
- 6 Ork Dreadnoughts
- 24 Chaos Androids
- 12 Marine Dreadnoughts
- 6 Ork Shokk Attack Guns
- 12 Chaos Dreadnoughts
- 12 Marines in Terminator Armour
- 6 Mole Mortars

GAMES
WORKSHOP®

CITADEL
MINIATURES®

Not suitable for children under 10. For more information on our products, visit our website at www.games-workshop.com

GAMES WORKSHOP® MAIL ORDER PRICE LIST

| DESCRIPTION | UK PRICE | DESCRIPTION | UK PRICE |
|--------------------------------------|--------------------------|---------------------|-----------------|
| SPACE MARINE | £24.99 GAME | ELDAR DEATHSTALKER | £3.99 FOR 2 |
| DRAGON MASTERS | £19.99 GAME | PRISM CANNON | £0.75 EACH |
| D-ROK "GET OUT OF MY WAY" 12" SINGLE | £3.99 | ELDAR WARP HUNTER | £3.99 FOR 2 |
| D-ROK "GET OUT OF MY WAY" CD SINGLE | £3.99 | WAR HOUNDS | £4.99 FOR 2 |
| D-ROK "OBLIVION" ALBUM | £6.99 | HEAD AND TORSO | £1.00 EACH |
| D-ROK "OBLIVION" TAPE | £6.99 | CONNECTING RING | £0.30 EACH |
| D-ROK "OBLIVION" CD | £10.99 | LEGS | £1.00 EACH |
| NOISE MARINE | £3.99 FOR 2 | WEAPONS | £0.65 EACH |
| ORKS | | HELLBORE | £11.99 COMPLETE |
| SUPER CYBOAR | £5.99 COMPLETE | TRANSPORTER CHASSIS | £4.00 EACH |
| SUPER CYBOAR RIGHT SIDE | £2.00 EACH | BORE HEAD | £1.50 EACH |
| SUPER CYBOAR LEFT SIDE | £2.00 EACH | PROPULSION JET | £1.00 EACH |
| SUPER CYBOAR HEAD | £0.75 EACH | BORE SIDE 1 | £1.50 EACH |
| SNAKEBITE WARBOSS BODY | £1.50 EACH | BORE SIDE 2 | £1.50 EACH |
| SNAKEBITE WARBOSS LEGS | £1.00 EACH | LAUNCHING RAMP | £1.50 EACH |
| BIONIK BOYZ | £3.99 FOR ANY 3 COMPLETE | HYDRAULIC PISTON | £1.00 EACH |
| BODIES | £0.80 EACH | PLASTIC TRACKS | £1.00 PER SPRUE |
| LEGS | £0.80 EACH | SLASHER GARGANT | £6.99 COMPLETE |
| ORK WEAPONS | | WEAPONS | £0.65 EACH |
| HEAVY WEAPONS | £3.99 FOR ANY 3 | HEADS | £0.65 EACH |
| EAVY STUBBA | £0.80 EACH | BELLY GUN | £1.00 EACH |
| EAVY STUBBA JUICE BOXES | £0.80 EACH | FRONT | £1.00 EACH |
| KUSTOM WEAPONS | £3.99 FOR ANY 6 | BACK | £1.00 EACH |
| STORMBOY JUMP-PACK | £3.99 FOR 3 | SIDES | £1.50 EACH |
| EPIC WAR MACHINES | | ELDAR TITANS | £4.99 COMPLETE |
| IMPERIAL LEVIATHAN | £5.99 COMPLETE | LAS CANNON WING | £1.00 EACH |
| LEVIATHAN RIGHT SIDE | £3.00 EACH | MULTI LAUNCHER WING | £1.00 EACH |
| LEVIATHAN LEFT SIDE | £3.00 EACH | HEAD 1 | £0.75 EACH |
| DOOMSDAY CANNON | £0.50 EACH | HEAD 2 | £0.75 EACH |
| LEVIATHAN TOWER | £0.75 EACH | LEGS | £1.50 EACH |
| LEVIATHAN TURRET | £0.50 EACH | FOOT | £0.30 EACH |
| ELDAR WAVE SERPENT | £3.99 FOR 2 | SHOULDERS | £0.50 EACH |
| WAVE SERPENT HULL | £1.50 EACH | TORSO | £1.00 EACH |
| WARP ENERGY GENERATOR | £0.75 EACH | WEAPONS | £1.00 EACH |

ALL MODELS SUBJECT TO AVAILABILITY

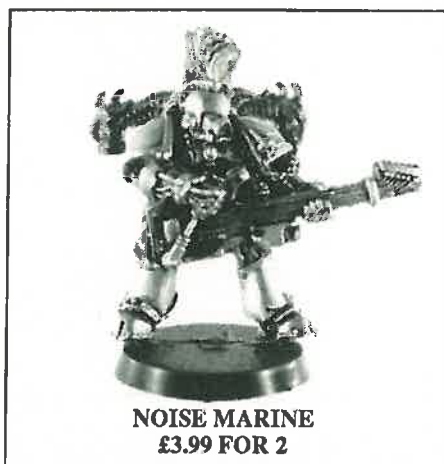

NOISE MARINE
£3.99 FOR 2

| ORDER FORM | | |
|--------------------------------|-------------------------------|----------------------------|
| CODE / DESCRIPTION | QTY | TOTAL PRICE |
| | | |
| | | |
| | | |
| | | |
| | | |
| | | |
| | | |
| | | |
| TOTAL: | POSTAGE & PACKING: | (TOTAL + P&P) = |
| NAME AND ADDRESS: | | |
| | | |

HOW TO ORDER CITADEL MINIATURES

We strongly recommend that you phone in your orders. You'll be talking directly to the Mail Order specialist who'll actually be packing and despatching your order. He'll be able to tell you exactly what is and isn't available, and suggest alternatives in the case of any problems. He will also be able to tell you about any new models that have become available since last issue, and any special offers we may be running on old, discontinued or overstocked items.

If it's simply not possible for you to order by phone then it doesn't matter too much. All you have to do is tell us the name (if available) and code. Be as explicit as you can when writing out your descriptions of the models you want. This is particularly important if you want to order a particular combination of parts for a multi-part kit. We recommend using block capitals to avoid confusion!

ALTERNATIVES

You should always let us have a list of alternatives when ordering by post. Even if you make an order by phone. It is wise to give a few alternatives. The only reason we won't be able to supply you with a model is if it has been discontinued and the mould is no longer available on the factory floor. Normally speaking we manage to supply 95% of all orders. Our staff will be happy to suggest viable alternatives for any models which are out-of-stock or no longer produced.

DESPATCH AND DELIVERY

We always try to despatch your orders within 2 days of receipt, quite often we get them out the same day. Remember that parcels take longer than letters, but you should, in general, get your order back within 10 days. We do occasionally get behind, but this usually only happens when we hold a large sale with lots of irresistible offers, and at Christmas.

FOREIGN ORDERS

We are very happy indeed to supply foreign orders through our UK Mail Order Department.

POSTAGE & PACKING

Total up your order and add the following postage & packaging costs:

UK & BFPO. add £2.50

Overseas (including Eire): add 40%. If you pay by credit card, P&P will be charged at cost.

METHODS OF PAYMENT

You can pay by cheque or postal order. Alternatively, we take Access and Visa cards - write with your order, and include the card number, the cardholder's name and signature, the card expiry date, and your name and address. Better still, phone our Mail Order Helpline to place an immediate order - make sure you have your Access or Visa card with you when you phone.

UK MAIL ORDER

Our UK Mail Order Helpline are open for your orders from 9.00am to 6.30pm on weekdays. The numbers to ring are (0773) 760462 or (0773) 713213

If you're writing in with your order, send it to:

GAMES WORKSHOP MAIL ORDER SERVICE,
CHEWTON STREET, HILLTOP,
EASTWOOD,
NOTTINGHAM NG16 3HY

Or you can fax the order through on
(0773) 530155



US MAIL ORDER

For US telephone orders (Visa and MasterCard only) ring (301) 644 5699, Monday through Friday between 9.00am and 5.00pm EST. Or you can post orders to:

GAMES WORKSHOP MAIL ORDER SERVICE,
3431 C BENSON AVENUE,
BALTIMORE, MARYLAND 21227-1072

Please add \$3.00 postage and handling. Maryland residents add 5% sales tax, residents in Virginia add 4.5% sales tax, residents in California add 8.25% sales tax and residents in Pennsylvania add 6% sales tax. Write for free catalogue.

Cash, COD, and Canadian Postal Money orders are not accepted. Minimum order is \$20.00 and postage will be free if your order is over \$120.00.

You can also fax Access and Visa miniatures orders direct to the US on (301) 242-1839. Please remember to include the card number, the cardholder's name and signature, the card expiry date and your name and address. Handling will be charged at 40% or cost, whichever is cheaper.

CANADIAN MAIL ORDER

For Canadian telephone credit card orders (Visa and Mastercard only), ring (416) 595 1159. Monday to Saturday between 11.00am and 8.00 pm EST.

Postage and handling will be charged at cost. Please note that we are taking telephone credit card orders only. For postal orders, please contact our US Mail Order Service.

SLASHA GARGANT



EXAMPLE OF THE COMPLETED SLASHA GARGANT

THE COMPLETE SLASHA GARGANT CONSISTS OF:

- 1 x FRONT
- 1 x BACK
- 1 x RIGHT SIDE
- 1 x LEFT SIDE
- 1 x HEAD
- 1 x BELLY GUN
- 2 x WEAPONS

PLEASE STATE WHICH ITEMS YOU REQUIRE WHEN ORDERING



RIPPER FIST
076211/6



BATTLE CANNONS
076211/7



HEAD 1
076211/5



BELLY GUN
076211/8



DEATH CANNON
076211/10



CLUSTER BUSTER
076211/11



HEAD 2
076211/9



FRONT
076211/4



BACK
076211/3



RIGHT SIDE
076211/2



LEFT SIDE
076211/1

© Copyright Games Workshop Ltd. All rights reserved.



CITADEL
MINIATURES

Designed by Kev Adams

EPIC WAR MACHINES

IMPERIAL LEVIATHAN

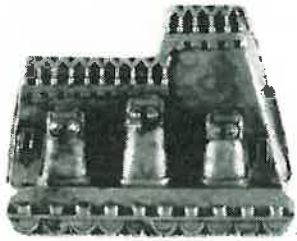

LEVIATHAN RIGHT SIDE
076113/2

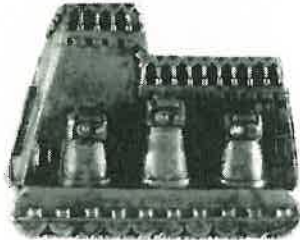

LEVIATHAN LEFT SIDE
076113/1



DOOMSDAY CANNON
076113/3



LEVIATHAN TOWER
076113/5



LEVIATHAN TURRET
076113/4

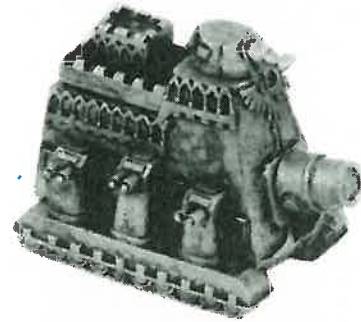

THE COMPLETE LEVIATHAN CONSISTS OF:
1 x LEVIATHAN RIGHT SIDE
1 x LEVIATHAN LEFT SIDE
1 x DOOMSDAY CANNON
1 x LEVIATHAN TURRET
1 x LEVIATHAN TOWER

ELDAR WAVE SERPENT



WAVE SERPENT HULL
076429/6



WARP ENERGY GENERATOR
076429/7

THE COMPLETE ELDAR WAVE SERPENT CONSISTS OF:
1 x WAVE SERPENT HULL
1 x WARP ENERGY GENERATOR



ELDAR DEATHSTALKER

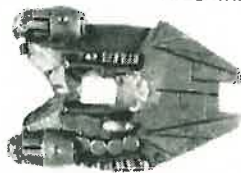

DEATHSTALKER / DOOM WEAVER HULL
076429/4



PRISM CANNON
076429/7

THE COMPLETE ELDAR DEATHSTALKER CONSISTS OF:
1 x DEATHSTALKER / DOOM WEAVER HULL
1 x PRISM CANNON

ELDAR WARP HUNTER



WARP HUNTER
076429/3



© Copyright Games Workshop Ltd. All Rights Reserved



Designed by Norman Swales with Jes Goodwin

WAR HOUNDS



INFERNO GUN
076015/5



VULCAN MAGA-BOLTER
076015/8



MULTIPLE ROCKET LAUNCHER
076015/14



TURBO-LASER DESTROYER
076015/4



PLASMA BLASTGUN
076015/6



HEAD AND TORSO
076015/2

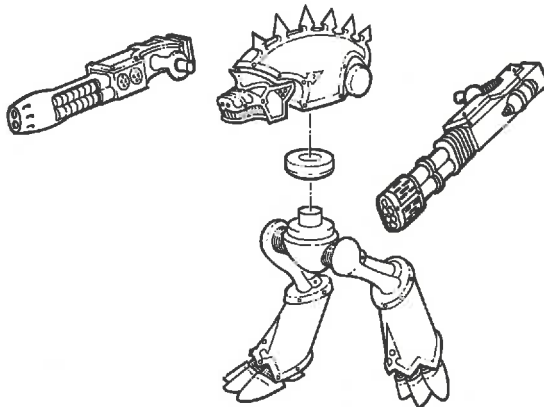

CONNECTING RING
076015/3

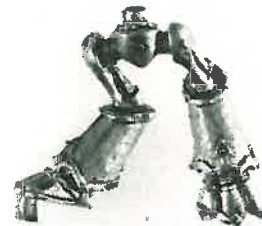

LEGS
076015/1

EACH COMPLETE WAR HOUND CONSISTS OF:

- 1 x LEGS
- 1 x HEAD AND TORSO
- 1 x CONNECTING RING
- 2 x WEAPONS

PLEASE STATE WHICH WEAPONS YOU REQUIRE WHEN ORDERING.



THESE ARE EXAMPLES OF COMPLETE WAR HOUNDS

Designed by Jes Goodwin

Manufactures supplied unpainted. W/A FINING. This product contains lead which may be harmful if chewed or swallowed. Citadel Miniatures are not recommended for children under 14 years of age.

Copyright Games Workshop Ltd. All rights reserved.



HELLBORE

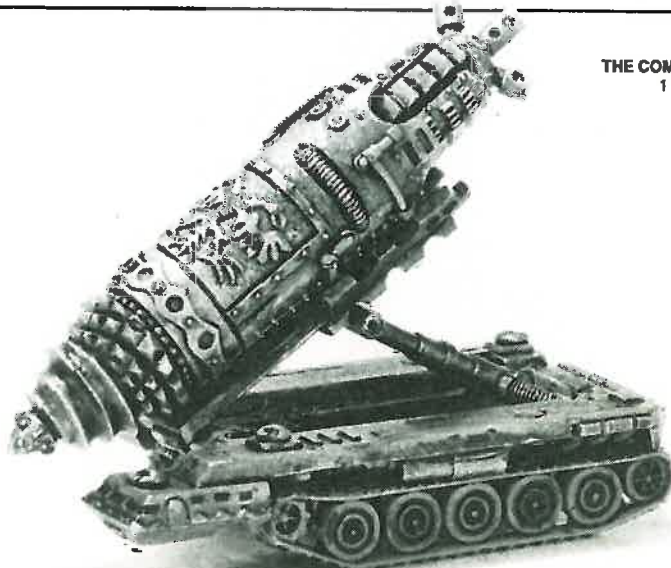

- THE COMPLETE HELLBORE CONSISTS OF:**
- 1 x TRANSPORTER CHASSIS
 - 1 x BORE HEAD
 - 1 x PROPULSION JET
 - 1 x BORE SIDE 1
 - 1 x BORE SIDE 2
 - 1 x LAUNCHING RAMP
 - 1 x HYDRAULIC PISTON
 - 1 x TRACK SPRUE

THIS IS AN ASSEMBLED HELLBORE

THIS MODEL WILL REQUIRE ASSEMBLY AS SHOWN IN THE EXAMPLE ON THE RIGHT

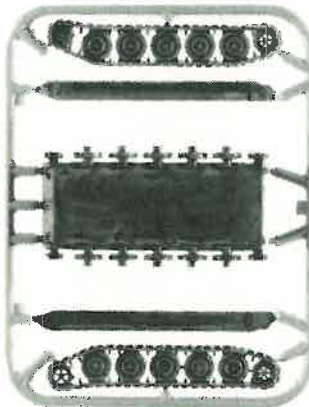

TRACKS SPRUE
(SHOWN AT 50%)
102543

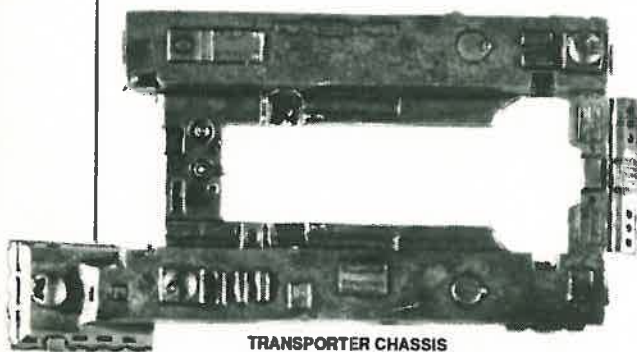
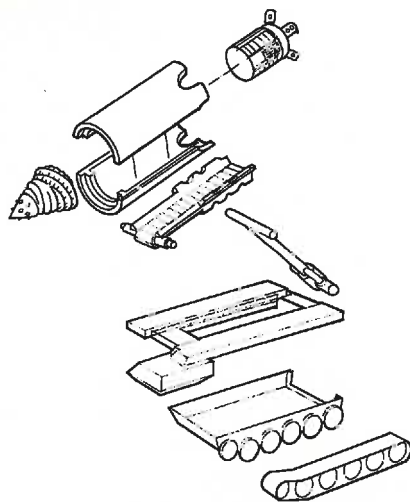

TRANSPORTER CHASSIS
076080/1



BORE HEAD
076080/6

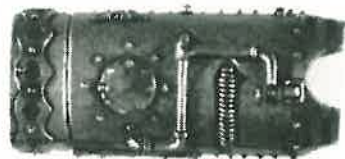

BORE SIDE 1
076080/3



PROPULSION JET
076080/7



BORE SIDE 2
076080/4

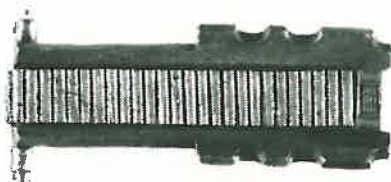

LAUNCHING RAMP
076080/2



HYDRAULIC PISTON
076080/5



CITADEL
MINIATURES

Designed by the Citadel Design Team

ELDAR TITANS



LAS CANNON WING
076404/2



MULTI LAUNCHER WING
076404/3



HEAD 1
076404/12



HEAD 2
076404/8

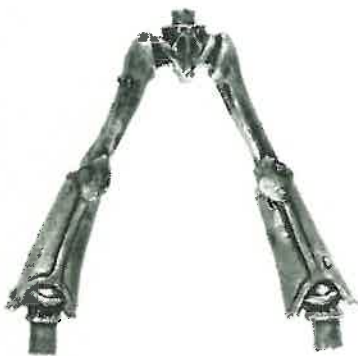

LEGS
076404/1



FOOT
076404/7



SHOULDER 1
076404/5



TORSO
076404/4



SHOULDER 2
076404/6



HEAT LANCE
076404/16



PSY CANNON
076404/15



PULSE LASER
076404/9



D-CANNON
076404/10



V-CANNON
076404/13



POWER FIST
076404/11

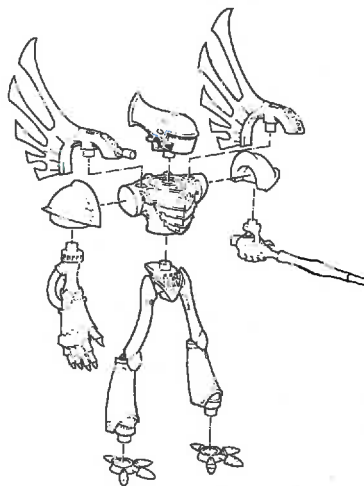

EACH COMPLETE ELDAR TITAN CONSISTS OF:

- 2 x WINGS
- 1 x LEGS
- 1 x TORSO
- 1 x HEAD
- 2 x FEET
- 2 x SHOULDERS
- 2 x WEAPONS

PLEASE STATE WHICH ITEMS YOU REQUIRE WHEN YOU ORDER

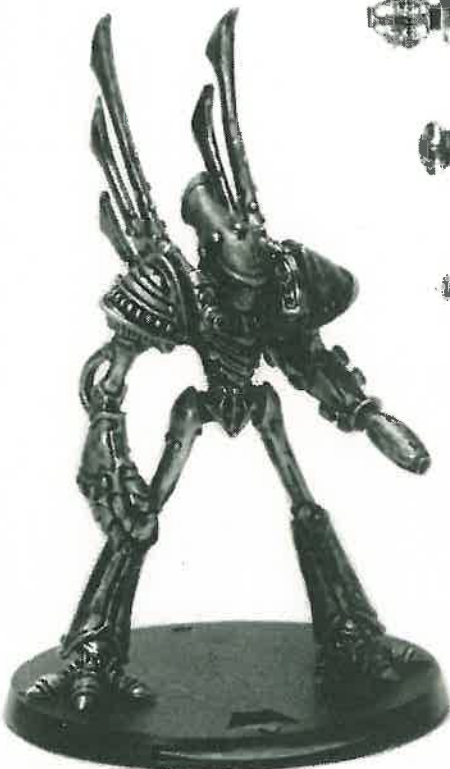

EXAMPLE OF THE COMPLETE ELDAR TITAN

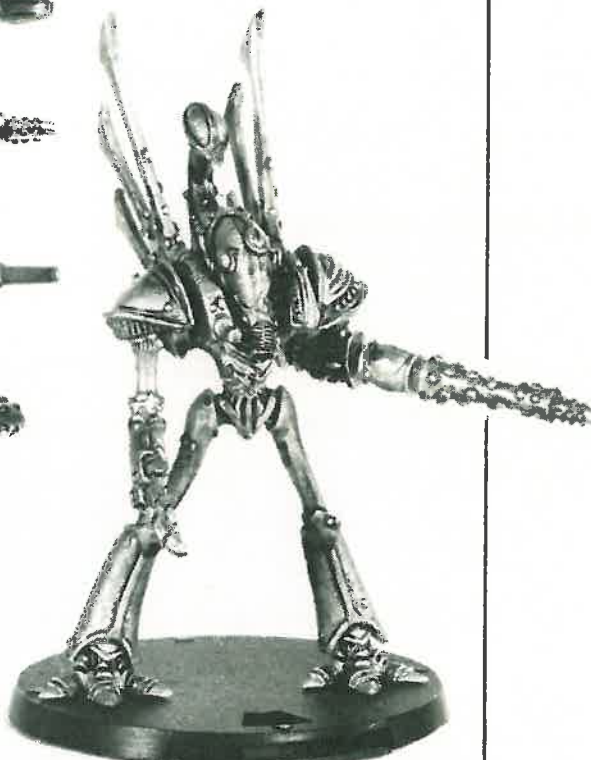

EXAMPLE OF THE COMPLETE ELDAR TITAN

Designed by Jes Goodwin

Minatures supplied unpainted. WARNING: This product contains lead which may be harmful if chewed or swallowed. Citadel Minatures are not recommended for children under 14 years of age.

© Copyright Games Workshop Ltd. All rights reserved.

Minatures supplied unpainted. WARNING: This product contains lead which may be harmful if chewed or swallowed. Citadel Minatures are not recommended for children under 14 years of age.

© Copyright Games Workshop Ltd. All rights reserved.

ORKS

SUPER CYBOAR

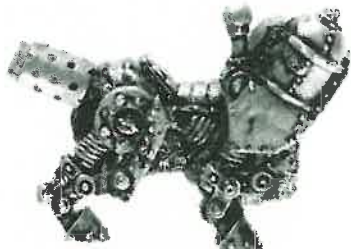

SUPER CYBOAR RIGHT SIDE
070779/4



SUPER CYBOAR HEAD
070779/5

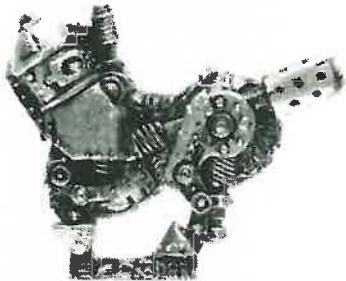

SUPER CYBOAR LEFT SIDE
070779/3



SNAKEBITE WARBOSS BODY
070779/1



SNAKEBITE WARBOSS LEGS
070779/2



THE COMPLETE SUPER CYBOAR CONSISTS OF:
 1 x SUPER CYBOAR RIGHT SIDE
 1 x SUPER CYBOAR LEFT SIDE
 1 x SUPER CYBOAR HEAD
 1 x SNAKEBITE WARBOSS BODY
 1 x SNAKEBITE WARBOSS LEGS
 1 x ORK ARMS SPRUE
 1 x ORK WEAPONS SPRUE

BIONIK BOYZ

EACH COMPLETE BIONIK BOY CONSISTS OF:
 1 x BODY
 1 x LEGS
 1 x ORK ARMS SPRUE
 1 x ORK WEAPONS SPRUE

BODIES

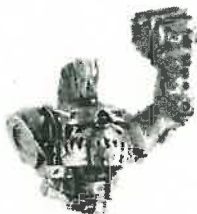

POWER GLOVE
070755/1



BOY 1
070755/4



FREEBOOTER BOY
070755/7



BOY 2
070755/2



BOY 3
070755/3



TARGETER EYE
070755/6



BOY 4
070755/5

LEGS



BIONIK LEGS
070755/11



GYRO-STABILISED MONOWHEEL
070755/13



TELESCOPIC LEGS
070755/10



PEG LEG
070755/9



NOBZ LEGS
070755/12



BOYZ LEGS
070755/8



EXAMPLES OF THE COMPLETED MODELS



ORK WEAPONS

HEAVY WEAPONS

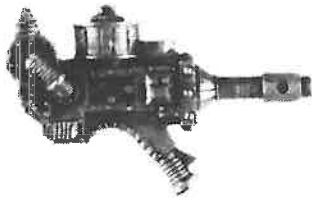

AUTO KANNON
070534/1



EAVY BOLTA
070534/3

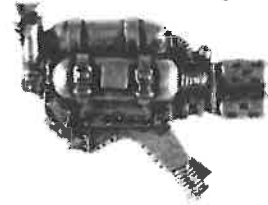

MULTI MELTA
070534/2



EAVY LASKANNON
070534/6



EAVY STUBBA JUICE BOXES
070534/5

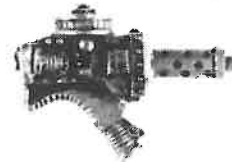

EAVY STUBBA
070534/4

KUSTOM WEAPONS

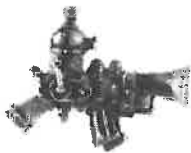

BLUNDERBUS BOLTA BOLTA
070767/4

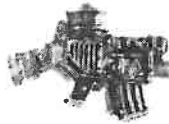

AUTOKANNON BOLTA BOLTA
070767/3



MISSILE LAUNCHA LASGUN FLAMA
070767/1



STORMBOY JUMP-PACK
070781/1



BOLTA LASGUN STUBBA STUBBA
070767/2



FLAMA LASGUN BOLTA
070767/6



SHOTGUN STUBBA BOLTA
070767/5

THE COMPLETE EAVY STUBBA CONSISTS OF:
1 x EAVY STUBBA
1 x EAVY STUBBA JUICE BOXES



EXAMPLES OF ORKS WITH THE HEAVY AND KUSTOM WEAPONS

Designed by Kev Adams

Manufacture supplied unpainted. Manufacture. This product contains lead which may be harmful if chewed or swallowed. Citadel Miniatures are not recommended for children under 14 years of age.
 © Copyright Games Workshop Ltd. All rights reserved.



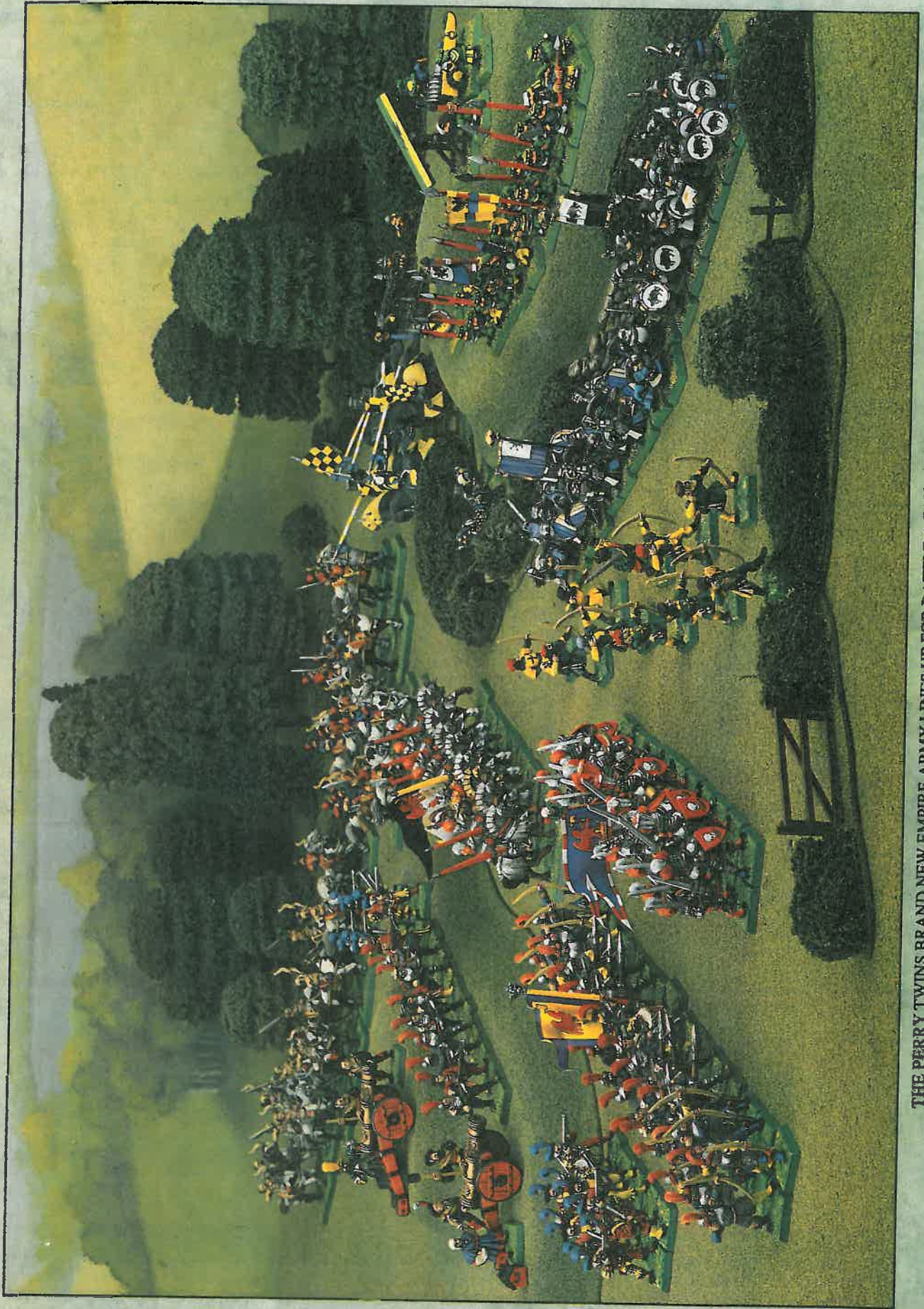

THE PERRY TWINS BRAND NEW EMPIRE ARMY LINES UP FOR BATTLE AGAINST WAYNE ENGLAND'S DWARFS.