

GAMES WORKSHOP

PRESENT THEIR MONTHLY GAMES MAGAZINE

WHITE DWARF

132

£1.50

\$3.95

AUSTRALIA

\$6.50

WEST GERMANY

DM 7,80



CITADEL
MINIATURES



US EDITION

12



0 83746 78081 8

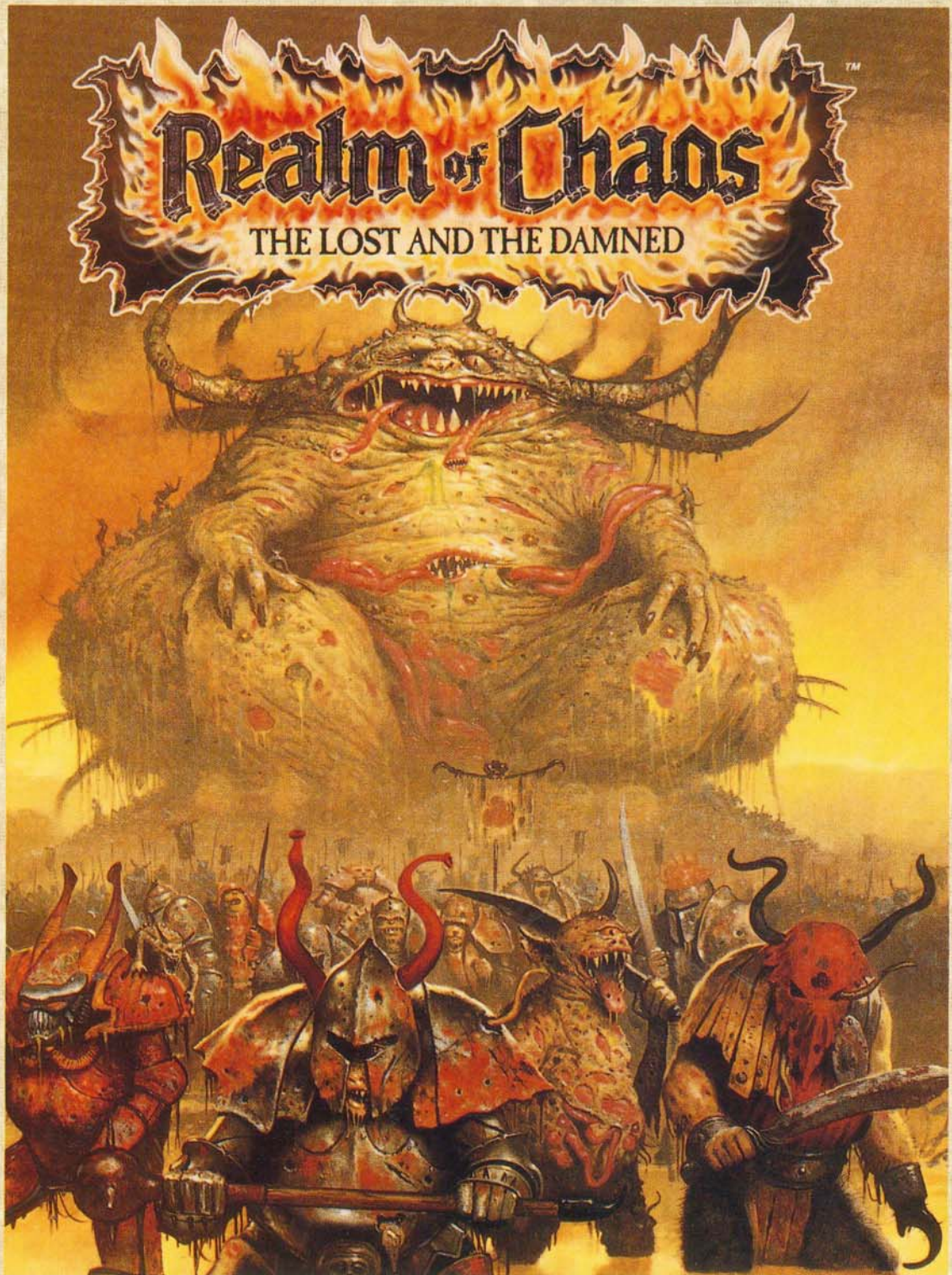

REALM OF CHAOS – a world of arcane horror for players of Warhammer Fantasy Battle and Warhammer 40,000.

The Lost and the Damned

Full Rules for the Chaos Powers Nurgle and Tzeentch
Extensive Narrative Campaign Section
The Dark Tongue and Runes of Chaos
Lesser Powers of Chaos and Creating Independent Daemons
Full Colour 'Eavy Metal
Chaos Warbands and Champions of Chaos
Beastmen, Centaurs, Minotaurs and Dragon Ogres
Chaos in the Warhammer 40,000 Universe
The Chaos Armies of Nurgle and Tzeentch
Daemon Legions of Chaos and Chaos Renegades

**GAMES
WORKSHOP**



**CITADEL™
MINIATURES**

Product Code: 0947
 Ref. No: 00947g
 ISSN: 0265 - 8712

Editor: Simon Forrest
 Published by Games Workshop Ltd

PRODUCED BY
 THE GAMES WORKSHOP
 DESIGN STUDIO

Printed by Artisan Press Ltd, Leicester, UK.
 All correspondence except subscriptions and Mail Order should be addressed to: *White Dwarf, Games Workshop Design Studio, Enfield Chambers, 14-16 Low Pavement, Nottingham NG1 7DL.*

SUBSCRIPTIONS

Please send and make remittance to: *Games Workshop, Chewton Street, Hilltop, Eastwood, Notts NG16 3HY.* Telephone (0773) 713213 or 760462. *White Dwarf* is published monthly. Annual subscription rates are: UK - £18.00; Europe £36.00; other overseas surface - £36.00; other overseas airmail - £54.00. Please make all payments in Pounds Sterling.

US/CANADA - check or money order - \$35.00 for US residents (Maryland residents add 5% sales tax); \$45.00 - Canadian residents. Cheques made payable to **GAMES WORKSHOP** and sent to **WHITE DWARF MAGAZINE SUBSCRIPTIONS**, Games Workshop Inc., 3431 Benson Ave, Baltimore, Maryland 21227. For **VISA** and **MASTERCARD** subscriptions telephone (301) 644 5699.

When you want to inform us of a change of address or subscription renewal, or if you have a query, please write to the appropriate subscription address and make sure that you tell us your name and present address (and your old address if you are moving). When you subscribe, please tell us whether you are renewing an old subscription or starting a new one.

ADVERTISING

For details of advertising rates and copy dates, contact Steve How at Games Workshop Design Studio, Enfield Chambers, 14-16 Low Pavement, Nottingham, NG1 7DL.

The publishers of *White Dwarf* regret they cannot accept responsibility for financial transactions between readers and advertisers. *White Dwarf* reserves the right to amend or reject any material submitted for publication as an advertisement.

CONTRIBUTIONS

The Editor will be pleased to accept any previously unpublished articles for inclusion in *White Dwarf*. All submissions should be typed, double-spaced with 30mm margins, on one side of A4 paper only, and should be accompanied by an explanatory covering letter and a stamped self-addressed envelope large enough to return the submission. Hand-written submissions will not be considered. Please state clearly on the envelope which game the submission is for.

ARTWORK SUBMISSIONS

We are happy to look at samples of black and white artwork but, in order to deal efficiently with such material, we require that all artwork be submitted as photocopies together with a stamped self-addressed envelope in order for us to reply and return the artwork. Please address all artwork to the Art Editor at the Design Studio address.

For both articles and artwork, please allow at least 6-8 weeks for a reply.

RENEWABLE RESOURCES

White Dwarf is printed on paper from the Myllykoiski Paper Mill, Finland. For every tree cut down, the mill plants two more. These are farmed trees grown specifically for this purpose and their use in no way diminishes the natural stock.

All Games Workshop's boxes, cards and counters are printed using 95% recycled paper.

All subject matter in *White Dwarf* is copyright Games Workshop Ltd.

All artwork in all Games Workshop products and the images contained therein have been produced either in-house or as work for hire. The exclusive copyright on the artwork and the images it depicts is the copyright of Games Workshop Ltd. Copyright © 1990 Games Workshop Ltd. All rights reserved.

Games Workshop and the *Games Workshop* logo, *Citadel Miniatures* and the *Citadel Miniatures* logo, *Warhammer 40,000*, *Epic*, *Adeptus Titanicus*, *Titanus*, *3D Roleplay Hobby Game*, *Talisman*, *Space Marine*, *Space Hulk*, *Advanced Heroquest*, *Mighty Empires*, *Chivalry*, *Confrontation*, *Games Day* and *Golden Demon Awards* are trademarks of Games Workshop Ltd. *White Dwarf* and the *White Dwarf* figure, *Blood Bowl*, *Warhammer*, *Realm of Chaos* and *Dark Future* are registered trademarks owned by Games Workshop. *Marauder* is a trademark owned by Marauder Miniatures Ltd; *Flame* is a trademark owned by Flame Ltd; the *GW Books* logo is a trademark owned by GW Books Ltd - all used with permission.

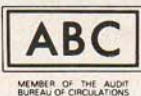

ISSUE 132 DECEMBER 1990

AUDITED AT
 66,257 COPIES
 PER MONTH

WHITE DWARF

CONTENTS

COVER: STORM WARRIORS - <i>Fangorn</i> Fangorn's picture of Dark Elves is the cover to our forthcoming Warhammer Fantasy novel, <i>Storm Warriors</i> by Brian Craig	
GAMES WORKSHOP GAMES CLUBS We take a look at the Games Clubs which are run in all our stores, plus a full listing of Games Workshop stores in the UK and US	2
GAMES WORKSHOP AND CITADEL NEWS News of imminent releases and forthcoming events	4
NEW GAMES WORKSHOP STORES Addresses for five new Games Workshop stores	5
MODELLING WORKSHOP: HILLS AND MINES - <i>Dave Andrews & Phil Lewis</i> Templates and simple modelling instructions for hills, mine-shafts, shacks and ore trucks	6
EPIC REALM OF CHAOS - <i>Andy Chambers</i> Following on from last month's Epic Chaos army list, rules for summoning Daemons onto <i>Space Marine</i> battlefields, with stats for Daemon Princes and Greater and Lesser Daemons of the four Great Chaos Powers	12
CONFRONTATION: CREATING A GANG - <i>Bryan Ansell, Rick Priestley and Nigel Stillman</i> Rules and tables for generating gangs from the hiveworld of Necromunda, with charts for rolling up equipment, skills and followers	23
'EAVY METAL - TYRANIDS AND SPACE MARINE SCOUTS Tyranid Warriors, Genestealers and Space Marine Scouts painted by the 'Eavy Metal team	34
ADVANCED SPACE CRUSADE: IMPERIAL GUARD - <i>Jervis Johnson</i> Full rules and force list for including the Imperial Guard in your games of <i>Advanced Space Crusade</i> , either as a stand-alone force or as part of your <i>Space Marine</i> force	36
MIGHTY EMPIRES: NECROPOLISES - <i>Rick Priestley</i> Expansion rules for <i>Mighty Empires</i> allowing the exploration and plundering of ancient Necropolises, plus a page of extra tiles to cut out	43
MODELLING WORKSHOP: BANEBLADE - <i>Tony Cottrell and Rick Priestley</i> Full instructions and templates for scratch-building the impressive Baneblade tank plus the Baneblade data sheet for the new <i>Warhammer 40,000</i> vehicle system	47
ILLUMINATIONS: STEPHEN TAPPIN Here's just a sample of the brilliant artwork by Games Workshop artist, Stephen Tappin - you'll find more of his excellent work in our latest books such as the second volume of <i>Realm of Chaos, The Lost and the Damned</i>	58
'EAVY METAL - MEKANIACS, STUART WILLIS AND SPACE CRUSADE Three pages of Citadel Miniatures: Ork Meks, a selection from guest painter Stuart Willis, and the Citadel Miniatures from MB Games' <i>Space Crusade</i> . Plus an in-depth look at painting techniques for this month's miniatures by <i>Mike McVey</i>	61
IRONSTONE PASS A dangerous <i>Warhammer Fantasy Roleplay</i> encounter for mountain journeys that can either be played as part of the <i>Doomstones</i> campaign or as a stand-alone road encounter	66
BACK COVER: ORKS AND ELДАР DIORAMA A splendid diorama showing Orks of the Goff clan fighting Eldar Aspect Warriors and Guardians led by their Avatar - painted by the 'Eavy Metal team	

ADVERTS

The Lost and the Damned.....	Inside Front	Truckers and Wings.....	75
Games Workshop Toronto.....	11	PhoneQuest.....	75
Raven Armoury.....	22	Games Workshop Illustrators.....	75
Advanced Space Crusade.....	41	Games Workshop Mail Order Service.....	76
Flame Publications: Career Opportunities.....	42	Citadel Miniatures Catalogue.....	77
GW Books: Inquisitor & Deathwing.....	46	Flame: Death Rock & Dwarf Wars.....	Inside Back
Marauder Miniatures.....	57		



Bryan Ansell Andy Chambers Tony Cottrell Jervis Johnson Rick Priestley Nigel Stillman

GAMES WORKSHOP™

GAMES CLUBS

Games Workshop stores are more than just the place to buy the exciting range of Games Workshop games and Citadel Miniatures. Each Games Workshop store runs its own weekly Games Club and other exciting events, making it the centre for the gaming hobby in your area.

Games Club Activities

Playing and Learning Games

The Club takes place at least one night a week as shown in the list of stores opposite. It's the ideal place to learn a Games Workshop game you've just bought or are considering buying. Our friendly staff are all experts on our games and are more than happy to teach you how to play any of them. Each of the shops also has its own armies, so if you're short of an opponent you can always ask a member of staff for a game.



League Games

The Club is the focus for the Games Workshop Gaming Leagues which build to an exciting climax at Games Day each year. There is a special League noticeboard where challenges, reports and other messages can be pinned up and perused, the League tables themselves are also displayed here. You can come in and see your current League standing, arrange games for the next week and perhaps even play a game or two. And, of course, the staff are only too happy to explain how the Leagues work, help you arrange games and so on.



Meeting Other Gamers

The Club is the ideal place to meet fellow gamers and make new friends who are interested in your hobby.



EAVY METAL TOUR

MINIATURE PAINTING DEMONSTRATIONS



Tim

Tim Prow will be visiting the Newcastle store on the 8th of December to demonstrate his painting talents as featured in every month's Eavy Metal pages. He'll be showing you how to paint some of the new releases from Citadel Miniatures and giving you advice on all aspects of miniature painting and converting. If you want some help with your models, bring them along on the day and Tim will give you hints and tips on ways of improving your results, whatever your standard.

Painting and Modelling Clinics

If you need any help or advice on painting Citadel Miniatures or modelling anything from games terrain to Warhammer 40,000 vehicles, there's always someone at your Games Workshop Games Club who can help. All the shops also run occasional clinics where you can bring in your army and paint it with expert tuition. And, of course, various members of Games Workshop's 'Eavy Metal team turn up from time to time to give demonstrations of the fine art of miniature painting. Every month, the 'Eavy Metal Tour box gives details of forthcoming painting demonstrations (see previous page).

All the shops have a selection of gaming terrain built by the shop staff especially for the use of Club members. The staff will help you with advice on building terrain as well as running regular sessions to build new boards for the Club.

The above activities don't just take place on the Club night. Each shop runs a series of special events on Saturdays and

there are usually tables and terrain available all week for you to game on.

So, don't miss out – check out your local Games Workshop store for the best in hobby gaming.



RETAIL STORES

If you want to know what's going on at your local Games Workshop store, drop in and check the notice board or ask any of the staff who'll be happy to fill in the details and chat about games and Citadel Miniatures. If you can't make it in, give the store a call and ask when the next event is taking place. There's something happening most Saturdays at all the stores – and don't forget the evening Gaming Clubs when the shop will be open till 8.00pm.

LONDON

BECKENHAM

292-294 HIGH ST, BECKENHAM,
KENT, BR3 1DY
CLUB NIGHT: THURSDAY
CONTACT: PAUL
TEL: 081 658 8102

HAMMERSMITH

(NEAR RAVENSCOURT PARK TUBE
STATION)
1 DALLING RD, HAMMERSMITH,
LONDON, W6 0JD
CLUB NIGHT: THURSDAY
CONTACT: JOE
TEL: 081 741 3445

HARROW

296 STATION RD, HARROW,
MIDDLESEX, HA1 2DX
CLUB NIGHT: MONDAY
CONTACT: DAVE
TEL: 081 861 2350

PLAZA

UNIT F10, THE PLAZA, 116-128
OXFORD ST, LONDON, W1R 1PA
CLUB NIGHTS: MONDAY TO FRIDAY
CONTACT: PHIL
TEL: 071 436 0639

THE NORTH

LEEDS

12-16 CENTRAL RD, LEEDS, LS1 6DE
CLUB NIGHT: WEDNESDAY
CONTACT: DARYN
TEL: 0532 420834

LIVERPOOL

23 BOLD ST, LIVERPOOL, L1 4DJ
CLUB NIGHT: THURSDAY
CONTACT: STEVE
TEL: 051 708 6087

MANCHESTER

UNIT 1, 3 BROWN ST, MANCHESTER,
M4 3AB
CLUB NIGHT: THURSDAY
CONTACT: KARL
TEL: 061 832 6863

NEWCASTLE

63 CLAYTON ST, NEWCASTLE-
UPON-TYNE,
NE1 5PY
CLUB NIGHT: THURSDAY
CONTACT: IAN
TEL: 091 232 2418

PRESTON

15 MILLER ARCADE,
PRESTON,
PR1 2QA
CLUB NIGHT: THURSDAY
CONTACT: SPENCER
TEL: 0772 821855

SHEFFIELD

16 FITZWILLIAM GATE,
SHEFFIELD,
CLUB NIGHT: THURSDAY AND
SUNDAY
CONTACT: RICK
TEL: 0742 750114

YORK

26 GOODRAMGATE,
YORK, YO1 2LG
CLUB NIGHT: FRIDAY
CONTACT: EVAN
TEL: 0904 653575

THE SOUTH

BRIGHTON

7 NILE PAVILIONS, NILE ST,
BRIGHTON,
BN1 1HW,
CLUB NIGHT: FRIDAY
CONTACT: CHRIS
TEL: 0273 203333

BRISTOL

13 BROAD WEIR,
BRISTOL
CLUB NIGHT: THURSDAY
CONTACT: SHANE
TEL: 0272 251533

CROYDON

UNIT 35, DRUMMOND CENTRE,
KEELEY RD
CLUB NIGHT: MONDAY TO FRIDAY
CONTACT: TOM ROACH

LUTON

12 PARK ST, LUTON,
LU1 3EP
CLUB NIGHT: MONDAY TO FRIDAY
CONTACT: LANCE
TEL: 0582 417474

MAIDSTONE

UNIT 6, 1-9 PUDDING LANE
MAIDSTONE
CLUB NIGHTS: MONDAY TO FRIDAY
CONTACT: GUY
TEL: 0622 677435

OXFORD

1A BYSH HOUSE,
NEW INN HALL STREET,
OXFORD
CLUB NIGHT: MONDAY TO FRIDAY
CONTACT: STEVE RAY
OPENING SOON

READING

UNIT 3, CHEAPSIDE,
READING
CLUB NIGHT: WEDNESDAY
AND THURSDAY
CONTACT: RICHARD
TEL: 0734 598693

SOUTHAMPTON

26 EAST ST,
SOUTHAMPTON, SO1 1HG
CLUB NIGHT: THURSDAY
CONTACT: CHRIS
TEL: 0703 331962

TORQUAY

12 MARKET ST,
TORQUAY, TQ 1AQ
CLUB NIGHT: TUESDAY
AND THURSDAY
CONTACT: STEVE
TEL: 0803 201036

MIDLANDS

BIRMINGHAM

519 BRIDGELINK,
BULL RING CENTRE,
BIRMINGHAM
CONTACT: TED
TEL: 021 632 4804

DERBY

42 SADLER GATE
DERBY, DE1 3NL
CLUB NIGHT: THURSDAY
CONTACT: DOMINIC
TEL: 0332 371657

DUDLEY

KIOSK U, UPPER LEVEL,
MERRY HILL CENTRE,
BRIERLEY HILL, DUDLEY
CLUB NIGHTS: MONDAY TO FRIDAY
CONTACT: SIMON
TEL: 0384 481818

HULL

31 PARAGON ST, HULL
CLUB NIGHT: MONDAY TO FRIDAY
CONTACT: TIM CHEETHAM
OPENING SOON

NOTTINGHAM

34A FRIAR LANE,
NOTTINGHAM, NG1 3DU
CLUB NIGHT: THURSDAY
CONTACT: PAUL
TEL: 0602 480651

SCOTLAND

EDINBURGH

136 HIGH ST, EDINBURGH, EH1 1QS
CLUB NIGHT: THURSDAY
CONTACT: MARK
TEL: 031 220 6540

GLASGOW

66 QUEEN ST, GLASGOW, G1 3DS
CLUB NIGHT: THURSDAY
CONTACT: ALISDAIR
TEL: 041 226 3762

USA

CALIFORNIA

313 SANTA MONICA BOULEVARD,
SANTA MONICA, CA 90404
CLUB NIGHT: MONDAY TO FRIDAY
CONTACT: COLIN
TEL: (213) 395 6711

FAIRFAX

FAIR CITY MALL, 9600G
MAIN STREET, FAIRFAX, VA 22031
CLUB NIGHT: MONDAY TO FRIDAY
CONTACT: JAVIER
TEL: (703) 503 9284

COLLEGE PARK

UNIVERSITY OF MARYLAND,
LEHIGH ROAD, COLLEGE PARK,
MD 20740
CLUB NIGHT: MONDAY TO FRIDAY
CONTACT: FRANK
TEL: (301) 864 5668

PHILADELPHIA

424 SOUTH STREET, PHILADELPHIA,
PA 19147
CLUB NIGHT: MONDAY TO FRIDAY
CONTACT: OWEN
TEL: (215) 829 0554

LAUREL

LAUREL CENTER MALL,
14858 BALTIMORE-WASHINGTON
BOULEVARD, LAUREL,
MD 20707
CLUB NIGHT: MONDAY TO FRIDAY
CONTACT: TIM
TEL: (301) 490 8853

GAMES WORKSHOP AND CITADEL™ NEWS

READERS POLL - UK WINNER

Our Nottingham and Baltimore offices have been inundated with replies to the Readers Poll from White Dwarf 130. At the last count, the Mail Order Trolls were buried under more than 15,000 replies!

We'll let you in on the results at a later date when we've had time to analyse them. At the time of writing, there are still 3 weeks to the closing date for US entries so we can't yet announce the winner of the Mega Prize Draw in the USA.

In the UK, however, all the replies were crammed into one mammoth heap and the lucky winner's entry plucked out. Anthony Riddell from Tayport in Scotland wins a complete collection of every Games Workshop boxed game, rulebook, game supplement, novel and artbook still in print, plus a copy of every boxed set of Citadel Miniatures in production!

IN THE WORKS

To support the release of *Advanced Space Crusade*, we're currently planning a boxed set of plastic Citadel Miniatures, tentatively entitled *Terminators and Tyranids*. The precise contents have yet to be finalised but will include Purestrain and Hybrid Genestealers, Tyranid Warriors, Terminators, Terminator Librarians and Space Marine Scouts. More details as soon as we've got them.

The plastics department are also beavering away on the all-new Epic Chaos Horde and Epic Eldar Warhost sets. The Chaos box will include something like 100 Chaos Renegades, 50 Chaos Squats, 50 Beastmen, 30 Slaaneshi Riders, 30 Khornate Juggernauts, 30 Tzeentchian Disc Riders, 10 Minotaurs, 10 Trolls and 10 Chaos Champions.

The Eldar box should contain approximately 100 Aspect Warriors, 20 Harlequins, 50 Guardians, 30 Jet Bikes, 20 Exarchs, 20 Wraith Guard, 20 Scouts, 10 2-seater Jet Bikes, 10 Warlocks, 10 Standard Bearers, 10 Vibro-Cannon and 10 Field Guns and Gunners.

Andy Chambers is working on the relevant army lists, while the Citadel design team are busy making additional metal models - from Daemons to vehicles.



D-ROK recording *Get Outta My Way!* at the Slaughterhouse recording studio. From left to right: Simon D (vocals), Brian May (guest guitar), Chi (guitar) and Al (drums).

A further plastic set of Epic scale models in intended to feature such goodies as Imperial, Ork, Chaos and Eldar Dreadnoughts, Eldar War Walkers, Ork Shokk Attack Guns and even some mega Ork Stompa.

Nearing production are sets of Eldar arms and weapons to complement the existing metal range for Warhammer 40,000, while, further into the future, a set of Epic Scale Tyranids, Genestealers and bio-constructs is also planned.

GW BOOKS

The boys in Brighton have now sent David Ferring's *Shadowbreed* off to print - this is the sequel to *Konrad* and part 2 of the epic *Warblade* trilogy. Next in line is Jack Yeovil's *Krokodil Tears* - book 2 in the *Daemon Download* cycle - closely followed by *Storm Warriors*, the concluding tale from Brian Craig's Orfeo. Meanwhile, we wait with bated breath for the delivery of the sequel to *Inquisitor* from Ian Watson.

FLAME PUBLICATIONS

There's a whole stack of Warhammer Fantasy Roleplay products in the pipeline from Flame. *Dwarf Wars* is to be followed by a miscellany of short adventures and rules material (new magic items and so on), the *WFRP Companion*. After that, editor Mike Brunton is planning to release *Castle Drachenfels* giving WFRP characters a chance to explore Jack Yeovil's horrifying settings for themselves. There's also a detailed campaign setting with a series of mini-adventures, currently entitled *Death's Dark Shadow*. Flame publications are also looking for new staff to join the team in an editorial and/or production capacity. Check out the advert elsewhere in this issue.

GAMES WORKSHOP TORONTO

As you can see from details elsewhere in this issue, the first Canadian Games Workshop store has opened in Toronto. The address and phone number are:

331 Queen Street West
Toronto, Ontario M5V 2A4
Tel: (461) 595-1159

WARHAMMER RECORDS

The first album on the new Warhammer record label has been recorded and mixed and the master tapes delivered to the Design Studio.

D-ROK, formerly *Crash & Burn* (and they promise not to change their name again before the album is released) have recorded a dozen tracks which tell the story of the infamous Noise Marines.

With an early New Year release date, the working title for the album is so far a choice of one of these four:

D-ROK VOL-1
40K OBLIVION

If you have a strong favourite from the above names, why not drop a line to Andy Jones at the Design Studio.



WARHAMMER PIN BADGES

We will soon have some full-colour Warhammer pin badges available. The price isn't decided yet but they'll be a strictly limited edition so keep an eye out for them in your local Games Workshop store.

RETAIL SPOTLIGHT

FIVE NEW **GAMES WORKSHOP** STORES OPENING SOON

GAMES WORKSHOP LUTON

12 PARK STREET, LUTON, LU1 3EP

OPEN 11.00am - 8.00pm
CLUB NIGHT: EVERY NIGHT
CONTACT: LANCE FIELDING
TEL: (0582) 417474

OPEN NOW

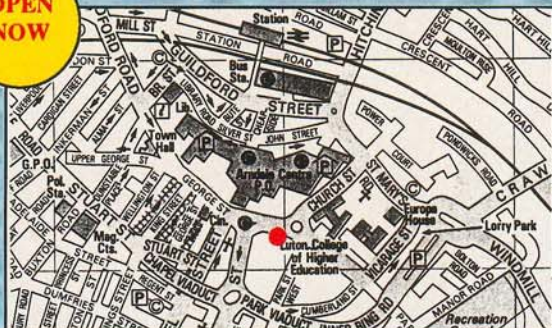

GAMES WORKSHOP SHEFFIELD

(MOVING TO A NEW SHOP JUST AROUND THE CORNER)

16 FITZWILLIAM GATE, SHEFFIELD

OPEN 11.00am - 8.00pm
CLUB NIGHT: EVERY NIGHT
CONTACT: RICHARD GRANT
TEL: (0742) 750114

GAMES WORKSHOP HULL

31 PARAGON STREET, HULL

OPEN 11.00am - 8.00pm
CLUB NIGHT: EVERY NIGHT
CONTACT: TIM CHEETHAM
TEL: (0773) 769731

OPEN SOON



OPEN SOON



GAMES WORKSHOP CROYDON

UNIT 35 DRUMMOND CENTRE, KEELEY RD. CROYDON

OPEN 11.00am - 8.00pm
CLUB NIGHT: EVERY NIGHT
CONTACT: TOM ROCHE
TEL: (0773) 769731

OPEN SOON



GAMES WORKSHOP OXFORD

1 BUSH HOUSE, NEW INN HALL STREET, OXFORD

OPEN 11.00am - 8.00pm
CLUB NIGHT: EVERY NIGHT
CONTACT: STEVE RAY
TEL: (0773) 769731

OPEN NOW



RETAIL SPOTLIGHT

MODELLING WORKSHOP

HILLS AND MINES

BY DAVE ANDREWS AND PHIL LEWIS

Following on from last month's Town House article, Phil and Dave demonstrate how to build hills and mines for Warhammer Fantasy Battle and Warhammer 40,000. If you're an inexperienced modeller and you want some help with any of the techniques described, or if you want to know where to get hold of the tools and materials you'll need, call in to your local Games Workshop store and they'll be more than happy to advise you.

GETTING STARTED

If you're not an experienced modeller, have a go at making a couple of small hills first as they're quick and easy to make and will help you get used to working with polystyrene. You'll need polystyrene tiles about 1" thick, but if you can't find any of this thickness in DIY shops then just use ordinary ceiling tiles and stick them together with PVA glue or polystyrene tile adhesive. Three or four should be high enough to make a hill. Remember that if your hill is too high then your miniatures won't stand up on the slopes, so check when you've completed stage 3 by placing a miniature on all sides. Make sure you work outside or have got a large, well-covered work surface because cutting and sanding polystyrene is a very messy job!

HILLS

- 1) Draw the shape of the hill on top of the polystyrene.
- 2) Cut the shape out roughly using a serrated knife (warning: knives are dangerous — always cut away from your fingers).

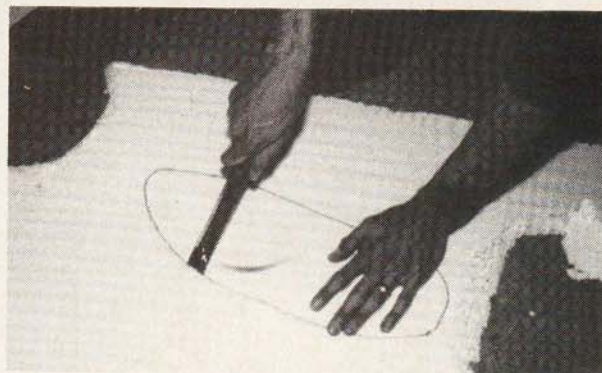

Stage 2. Cutting out the basic shape

- 3) Using the serrated knife, carefully cut away the edges of the hill to create the sloped sides. Make sure that you don't cut the sides too steep or your miniatures will keep falling over.
- 4) Carefully round off the crest of the hill using the serrated knife.



Completed diorama showing mine entrance and shacks



Stage 3. Cutting away the edges

- 5) Using coarse and then medium grade sandpaper, gently sand the hill until smooth.



Stage 5. Sanding the hillsides smooth

- 6) A base should be added to the hill to prevent it being damaged. Glue the hill to a piece of card with PVA glue, then apply a weight to the top of the hill (a couple of large books will do). This prevents the card from warping. Leave this overnight to dry.
- 7) When its dry, trim the card around the edge of the base using a modelling knife or scissors.
- 8) The hill can now be coated with textured wall covering, such as Polyripple or Supatex (both are described as having a flexible self texturing finish). This is best applied with a 1" or 2" decorating brush and will create a slightly textured finish. If extra texture is required, sprinkle a little sand on the wet hill. Allow this stage to dry thoroughly.
- 9) Paint the hill a suitable shade of green with a decorating brush. When dry, this can be lightly drybrushed with a lighter green or yellow if desired.

SAFETY FIRST

- It's worth reminding you that modelling tools can be dangerous if they're used carelessly. Remember, they're sharp and they cut – and it's so much easier to make these buildings if you've still got fingers!

The most important safety rule is: **make all cuts away from your fingers.** It's also much safer to cut through a sheet of card or polystyrene with several lighter strokes than with one heavy stroke. You're far more likely to slip when pressing too hard so you'll find that you actually get a much straighter cut with lighter strokes.

Always use a new sharp blade – sharp blades are a lot less dangerous than old blunt blades which you have to press very hard to cut through anything.

If you're unsure of what you're doing, then ask for some help, especially if you're a young modeller.

TOOLS AND MATERIALS

All-purpose glue or epoxy gel suitable for card, plastic, balsa wood etc (use PVA woodwork glue for the polystyrene as other glues have a tendency to melt the surface).

Modelling knife with replaceable blades (remember to always work with new sharp blades – these are much safer than blunt blades).

Sandpaper: coarse and medium grain.

Medium-sized knife with serrated edge for example a bread knife. Also, if you are a young modeller, ask your parents to help you with the cutting.

Scissors, especially if you're cutting thicker card.

Steel ruler (a plastic or wooden ruler will be ruined in a very short time) and set square.

Cutting surface, for example a piece of thick card, hardboard or a cutting mat (available from art shops or graphic suppliers but quite an expensive item) – the main thing is to make sure that you don't end up digging great chunks out of your best dining room table.

1" expanded polystyrene sheet from building suppliers (alternatively several polystyrene tiles stuck together)

Stiff cardboard available from artshops.

Textured wall covering (such as Polyripple etc) which can be bought from most DIY shops.

Coral sand from pet shops.

The two other main materials are thin cardboard (the card from cereal packets is just right) and balsa wood offcuts that are available in small packs from model shops.

ROCKY AREAS

Rocky areas can be represented by roughly cutting the polystyrene. The surface should be coated with PVA and then coral sand and small rocks added to the surface. When this is thoroughly dry, paint it dark brown or grey and dry brush.

MINE

- 1) Make a basic hill as described earlier. However, before adding the base, cut a tunnel into the hill about 50mm wide and 150mm long.
- 2) Now add the base, but extend it a few inches beyond the mouth of the tunnel.

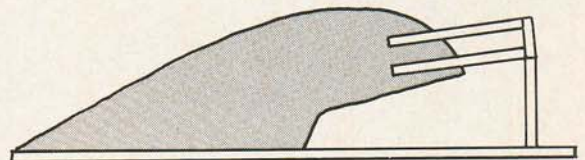

Cross section of hill showing tunnel length

HILLS & MINES

3) Texture the hill (but not the base) as previously described. Rocks can be added using pebbles from the garden secured in place with a little filler.

4) While the hill is drying you can begin to build the covered entrance to the mine. Firstly, construct the end frame using the template provided. Cut out strips of balsa wood about 5mm square, place them onto the template and cut them to shape. Glue the pieces together and then leave to dry.

Cut three lengths of balsa 5mm square and about 50mm long.

Glue the ends of the lengths onto the end frame. Now leave it to dry.

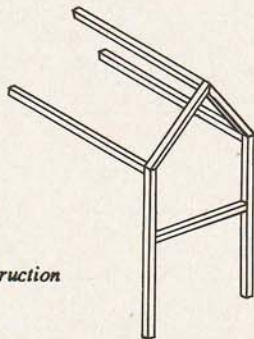

End frame basic construction

5) If you wish to add the rails, first make a dozen sleepers about 3mm by 30mm from a balsa sheet. Make the rails by cutting two strips of balsa about 2mm square. Stick the sleepers onto the base at regular intervals leading out from the tunnel. The rails can then be stuck to the sleepers leaving a gap of about 6-10mm between them.

6) Now for the covered entrance to the mouth of the tunnel. The three beams can be pushed slightly into the polystyrene hill and secured with a blob of PVA glue. The feet of the end-frame can be glued to the base.

7) Cut the two basic roof pieces out of thin card. These should be 40mm wide, but the length will vary on how you have constructed your model. Don't worry if there are any gaps. You may find it easier to make the roof in several pieces.

Once the basic roof is stuck in place, tile the roof as we described for the houses (see White Dwarf 131) or, use one of the methods described later. Roughly-cut planks of balsa can be stuck to the upper half of the end-frame.

8) The buffer stop is simply a square of foam board covered with small balsa planks and topped with a few small stones.

The truck was made from artists card. Templates are given, so just photocopy and stick to card. Cut out and assemble as shown in the diagram. The wheels are made from thin card using a hole punch. The centres are made from thin slices of round sprue. Rivets can be added by a small blob of PVA glue applied with a cocktail stick. Remember to make sure the trucks will fit on the rails

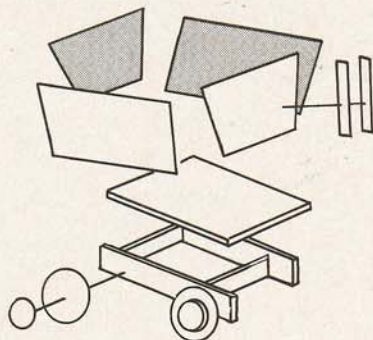

Exploded diagram of truck

9) Lastly, texture the base using PVA glue. The moss and sand were bought from a railway model shop and stuck on with PVA glue.

10) Now that it's finished you can paint it. Firstly, paint the inside of the tunnel black. Any woodwork can be undercoated black and drybrushed brown then grey. The hill should be painted to fit with your wargames board/playing surface. The rocks and ground were undercoated mid-brown then drybrushed with light ochre.

SHACKS

These are really simple to make. Basically, a shack is a cardboard box covered in balsa scraps. This project is ideal for using up those leftovers from your bits box.

1) Transfer the templates to foam board by using the same technique described in the last two White Dwarfs.

Assemble the pieces and stick to a card base as shown in the diagram. The planking is made from cutting a sheet of balsa wood into thin strips about 3-4mm wide. Stick these to the outsides of the shack with multi-purpose glue. Leave spaces for the window and door as shown on the templates.

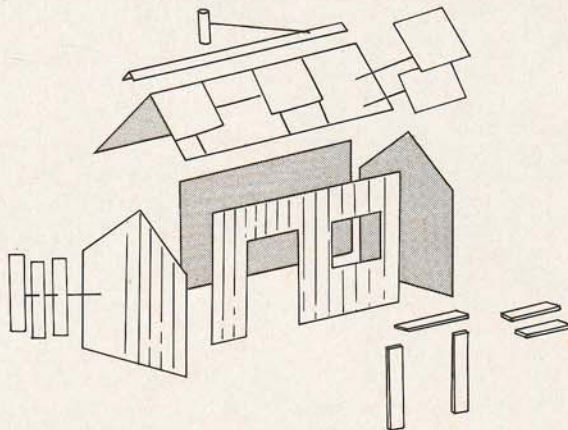

Exploded diagram of shack with tile roof

If you wish, you can make a window and a door frame from balsa wood or just paint them onto the card.

The roof is covered with small irregular shaped pieces of thin card. The ridge is covered with a thin card strip and folded.

The chimney is made from a small piece of plastic pipe (from a paint brush) pushed through the roof and secured with modelling putty.

2) Cut out the pieces and assemble as shown.

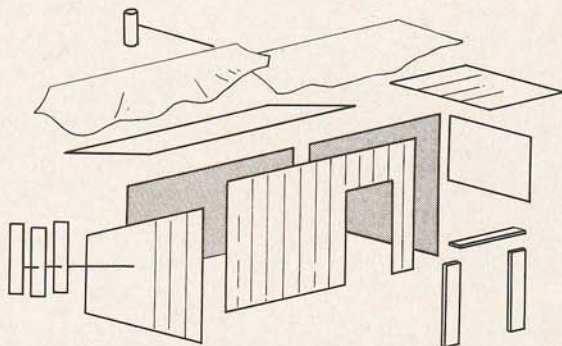

Exploded diagram of shack with canvas roof

The building is planked like the shack described above. However, the door should be cut out. The roof could be made as the first example, but ours has been given a canvas roof.

Roll out a thin sheet of self-hardening clay (such as DAS Pronto) slightly larger than the roof. This should be done on a smooth surface (like an old magazine). When the clay has just started to harden, peel it off and cut it to shape with scissors. You then drape it over the roof and form folds in it as necessary. Add a few small stones to the roof.

The crates were made from spare Rhino parts, but any equipment such as barrels or spare weapons would do. Other details can be added using parts from your bits box or model railway kits etc. Little touches like this will make a building look lived in and more realistic.

TEMPLATES FOR CANVAS ROOFED SHACK

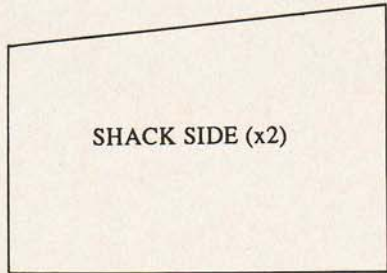

SHACK SIDE (x2)

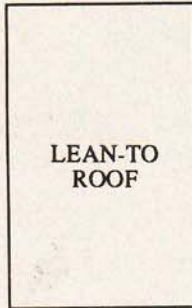

LEAN-TO ROOF

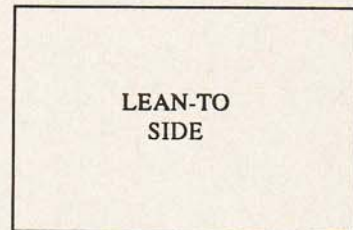
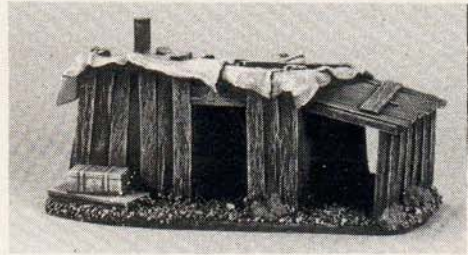

LEAN-TO SIDE

TEMPLATES FOR MINE ENTRANCE

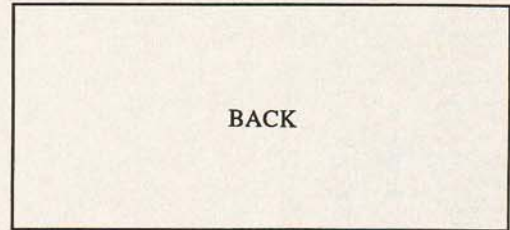
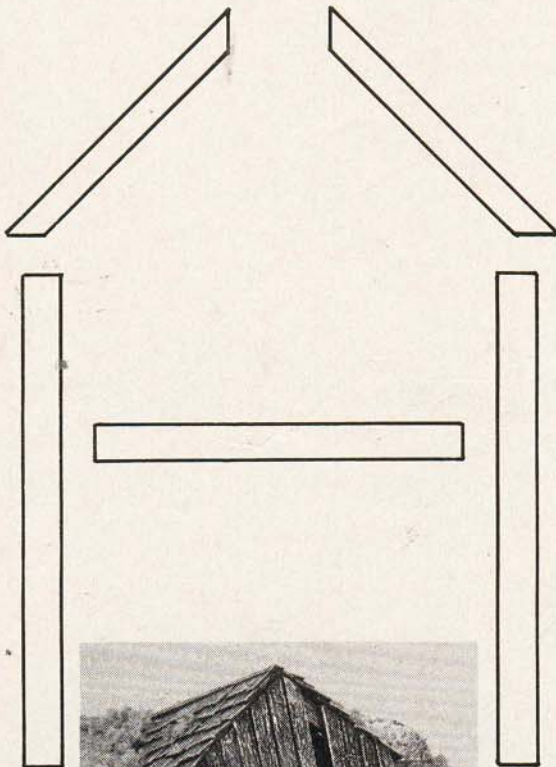

BACK

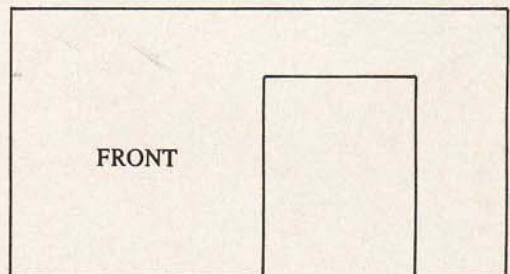

FRONT

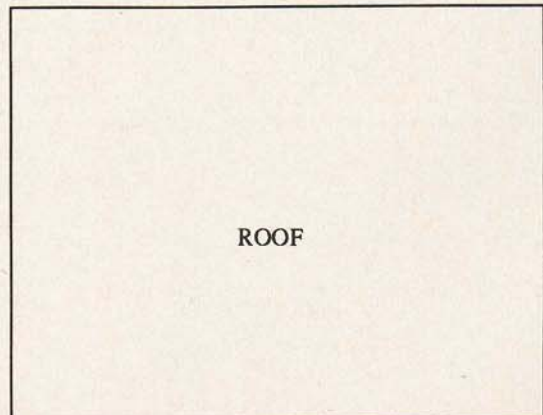

ROOF

TEMPLATES FOR TRUCK

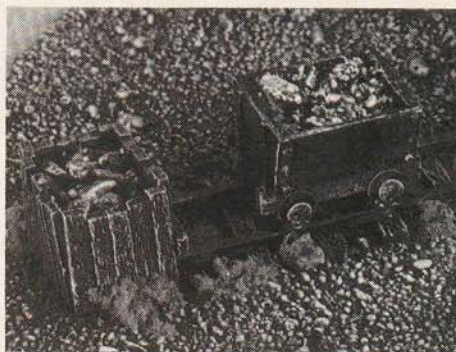
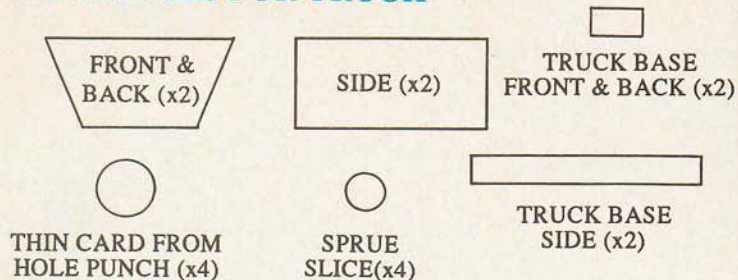

TEMPLATES FOR TILED SHACK

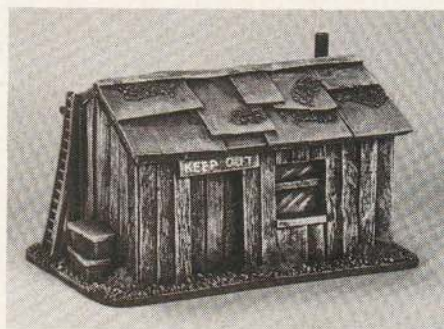
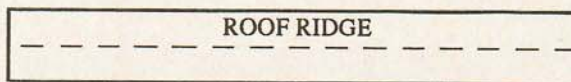
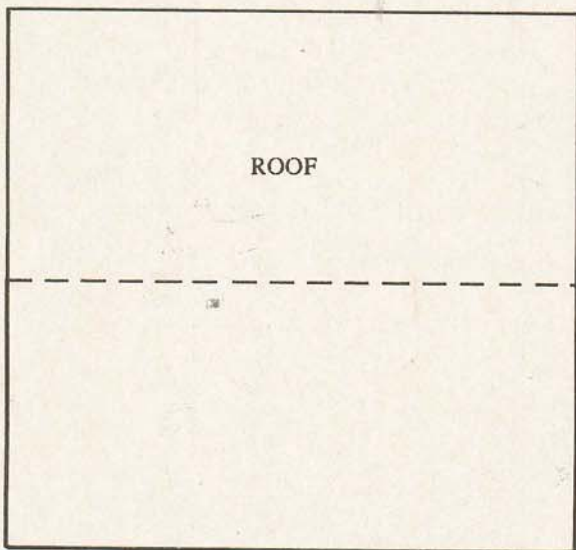
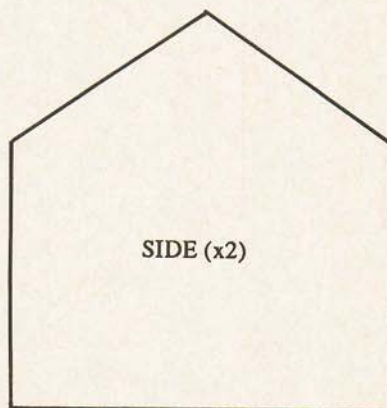
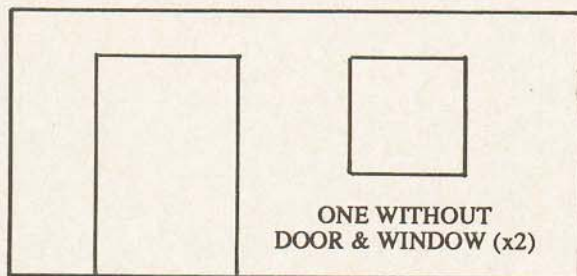

All the Games Workshop stores are becoming involved with every aspect of terrain building, so if you need some advice or information on where to get materials, or you just want to share ideas about making terrain, don't hesitate to drop in or give them a call – they'll be only too pleased to help.

Happy modelling.



Phill Lewis



David Andrews

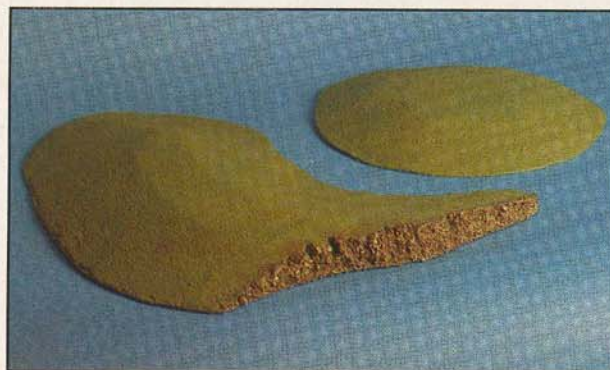

A couple of examples of the many variations of hills you can make

GAMES WORKSHOP™

TORONTO

331 QUEEN ST WEST, TORONTO
ONTARIO M5V 2A4

PHONE (416) 595-1159 FAX (416) 595-1709

NOW OPEN

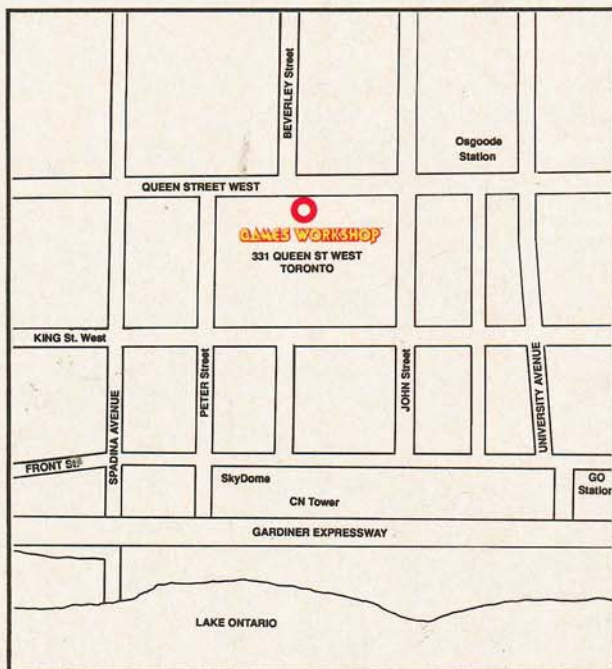

Our latest Games Workshop store and the first in Canada is now open. Come along for all the new releases from Games Workshop and Citadel Miniatures and to see what's happening at the store.

Opening Times: Monday to Saturday: 11am - 9pm
Sundays: 11am - 5pm

Contact: Mike Cheney

HOW TO FIND THE STORE

From the 401, take the Don Valley Parkway south to the Gardiner Expressway.

From the Gardiner Expressway or Lakeshore, take Spadina Avenue north to Queen Street West then turn right. We are on the second block east of Spadina on the south side.

From the GO station, take the University Avenue Subway line to the Osgoode Station. The store is three blocks west of University Avenue on the south side.

FORTHCOMING EVENTS

Saturday December 1st: Warhammer 40,000. A massive battle between Orks and Marines. In front of the two armies are a large group of Ogryns just begging to be recruited. Who will succeed in convincing them to join their force?

Saturday December 8th: Warhammer Fantasy Battle. Bring along a force consisting of 500 points of Citadel Miniatures and prove your unit's mettle at the Battle of Castle Burke.

Saturday December 15th: Painting Clinic. Come along and pick up tips on painting the Space Marine Scouts and Tyranid Warriors from Advanced Space Crusade.

Saturday December 22nd: Advanced Space Crusade. Test yourself against the best competition Toronto can offer.

Saturday December 29th: Mega-Bowl Knockout. An action-packed day of Blood Bowl excitement. In order to take part you should register your team at the store by the 22nd Dec.



SPACE MARINE™

EPIC REALM OF CHAOS

DAEMONS AND THEIR CONJURATION

BY ANDY CHAMBERS

The second part of the Epic Chaos army list for use with the forthcoming plastic boxed set of Epic Chaos miniatures and the range of metal miniatures. This article covers the rules for summoning Daemons to the battlefield with the stats for the Greater and Lesser Daemons of the four Great Powers and Daemon Princes.

Daemons are created by a Chaos Power out of the very fabric of Chaos. The Daemon embodies specific aspects of the Power's own traits and abilities. Daemons are really part of a Chaos Power but they have their own consciousness and powers and to all intents and purposes are independent and fully conscious creatures. They depend upon the Chaos Power for their existence, leading to competition between rival Daemons for their master's favours.

Each of the four Great Powers has his own hierarchy of Daemons. There are also Daemons which owe nothing to these Chaos Powers and whose existence reflects the waking dreams of a still immature Power. Such Daemons are inclined to be variable in appearance and not always consistent. Other Daemons owe nothing to any power. Their consciousness is due to some other factor, such as the persistence of a particularly strong-willed and idiosyncratic shadow-self.

GREATER AND LESSER DAEMONS

Daemons are divided into two categories in Epic scale: **Greater Daemons** and **Lesser Daemons**. The chart below details exactly what falls into each category:

GREATER DAEMONS

Bloodthirsters – Khorne
Keepers of Secrets – Slaanesh
Great Unclean Ones – Nurgle
Lords of Change – Tzeentch
Daemon Princes

LESSER DAEMONS

Bloodletters – Khorne
Fleshhounds – Khorne
Daemonettes – Slaanesh
Fiends – Slaanesh
Plague Bearers – Nurgle
Beasts of Nurgle – Nurgle
Pink Horrors – Tzeentch
Blue Horrors – Tzeentch
Flamers – Tzeentch

Throughout the following rules, references are made to Greater or Lesser Daemons and it's important to know which are which. Though the actual characteristics of different Daemons may vary enormously, the distinction between Greater and Lesser Daemons is broader than that between master and slaves – this is fully reflected in the rules that follow.

SUMMONING

Daemons can be summoned by covens, Greater Daemons and Daemon Princes. Summonation can take place both before and during a battle.

SUMMONING COSTS

The statistics given for Daemons of the various Chaos Powers includes a summoning cost. A Daemon's **summoning cost** is a rating of how hard that particular entity is to bring through into the material universe. Lesser Daemons always appear in packs equal to the sacred number of their native Power, so the summoning cost stated in the statistics of Lesser Daemons is for a whole pack, not an individual Lesser Daemon.

Obviously only Daemons of the summoner's own patron Power may be summoned – those who follow Chaos Undivided may attempt to summon only Independent Daemon Princes.



KEVIN WALKER

PRE BATTLE SUMMONING

A Chaos player can summon Daemons before a battle by sacrificing points equal to the summoning cost of the Daemons he requires and rolling for their appearance. The player is limited to one pre-battle summoning attempt for each coven, Greater Daemon and Daemon Prince in his battleforce.

Greater Daemons and Daemon Princes will not lower themselves to request aid from equals so they may only summon lesser Daemons – covens will happily abase themselves so may attempt to summon Greater Demons, Daemon Princes or Lesser Daemons.

Once the Chaos player has decided on what Daemons his force is going to summon, he should note this down and then roll 1D6 for each pack of Lesser Daemons and each individual Greater Daemon or Daemon Prince, adding +1 to his roll if his forces for the battle include a War Temple:

- 1-2 The summoning is a failure and the requested Daemon or Daemons do not appear.
- 3-6 The Daemon or Daemons appear and are available to be used in the battle.

SUMMONING IN BATTLE

Summoning attempts can be made in battle, though it is risky and time-consuming. The summoning begins with the preparation of an area where the summoner will stand to make his attempt. This must be carefully drawn out with numerous runes and devices while incenses and powders are burnt to prepare a temporary gate through which the Daemon or Daemons can appear.

To start preparing the the summoning area, in the orders phase the stand or model which intends to perform the rite has the **summoning template** placed underneath its current position instead of an order counter. From now on the model or stand is preparing the area. If the summoner is moved for any reason or forced to make a saving throw, the whole summoning attempt is ruined and the template removed.

The presence of a War Temple of the appropriate Power can enhance the chances of success substantially. A War Temple may participate in the summoning process as long as it stays stationary and in base-to-base contact with the summoning template from when it is first laid until the completion of the rites.

In each end phase after the template has been placed, roll 1D3+1 and add the indicated number of **summoning counters** to the arrow points on the template. Once all eight points are filled, the summoner can intone the final chant and open the gate.

More than one attempt at summoning taking place in a relatively close proximity, such as on the same battlefield, makes the preparation more difficult – deduct -1 from the roll for each extra summoning area being prepared at the same time.

Once all of the arrow points on the template have been filled, the summoner may begin the final chants on the following turn. In the orders phase of the turn he must state what type of Daemon or Daemons he intends to summon and in the end phase he may roll to see if it/they appear. The suffering and dying energy of departing souls acts as a magnet to Daemons so the more destruction wrought on this final turn of summoning the better.

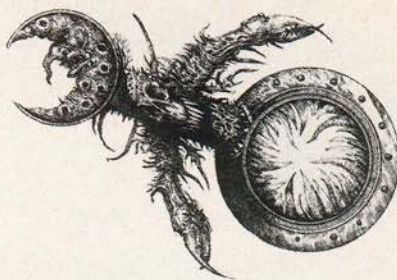

Roll 1D6 and apply the following modifiers before consulting the table below:

- +1 If a Greater Daemon is making the summoning.
- +2 If a War Temple is participating in the summoning.
- + a number equal to the bonus indicated on the chart below according to the number of units killed this turn and the summoning cost of the Daemon:

Units Killed	Summoning Cost of Daemon									
	100	200	300	400	500	600	700	800	900	1000
1-3	+1	0	0	0	0	0	0	0	0	0
4-6	+1	+1	+1	0	0	0	0	0	0	0
7-10	+1	+1	+1	+1	0	0	0	0	0	0
11-14	+2	+1	+1	+1	+1	+1	0	0	0	0
15-18	+3	+2	+1	+1	+1	+1	+1	0	0	0
19-21	+4	+3	+2	+1	+1	+1	+1	+1	+1	0
22+	+5	+4	+3	+2	+1	+1	+1	+1	+1	+1

RESULTS

- 7+ With a crack like thunder the gate opens. The summoning is successful and the Daemon or Daemons requested appear anywhere within 10cm of the summoner. Remove the summoning template.
- 6 Eerie lights swirl and the air howls with power – but not enough! The summoner can abandon his attempts or try again next turn.
- 4-5 An unearthly wind blasts across the area, destroying the carefully laid symbols and sending candles guttering. Remove 1D3 counters from the template – the summoner may replace the counters on following turns using the rules given above before attempting another summoning or abandon the summoning altogether.
- 2-3 The Chaos Power barely notices this feeble attempt to draw its attention and slaps it away as a man would a fly. The template is removed – the summoner must make a saving throw to survive or be destroyed by the vague annoyance of his patron Power.
- 1 With a crack like thunder the gate opens. The summoning is successful – after a fashion. The summoner has seriously fouled up and his attempts have been noticed by an opposing Chaos Power! The equivalent Daemon or Daemons of an opposing Power appear anywhere within 10cm of the summoner, under the control of the opposing player. Remove the summoning template.



FORMATIONS

Greater Daemons are always treated as individuals for the purposes of orders, movement and so on. Lesser Daemons are organised into detachments consisting of a number of Daemons of the same type. A detachment of Lesser Daemons will contain a number of Daemons equal to the sacred number of its native Power: nine for Tzeentch, eight for Khorne, seven for Nurgle and six for Slaanesh. A detachment of Lesser Daemons follows the same orders, is moved at the same time etc – just like any normal detachment.

Lesser Daemons must remain reasonably close to each other to resist the destabilisation they invariably suffer when removed from the warp for any period of time, though inevitably instability eventually draws Daemons back into the warp. At the end of each movement phase it is necessary to check that all the Lesser Daemons in each detachment are in formation.

To count as in formation, all the Daemons in a detachment must be within their sacred number in centimetres of a central point. Any Daemons in the detachment which are further than their sacred number from the designated point must take an immediate instability test. A different point may be chosen for each detachment.

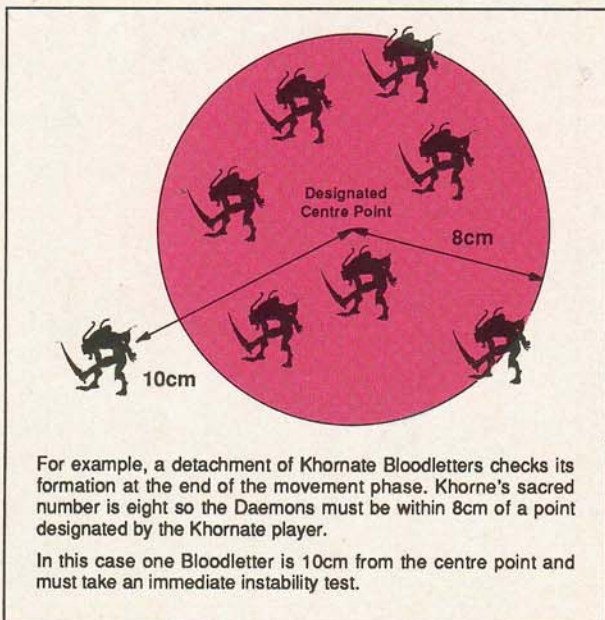

SEQUENCE OF PLAY

Daemons are creatures with an alternate perspective on events – the warping power of Chaos means they view the present, the future and the past with varying clarity.

To reflect this, Daemons are free to pick at what point in a particular segment of a phase they wish to act. So a Daemon with charge orders would still have to be moved in the charge segment of the movement phase but it could be moved in the Titan part or the vehicle part of the phase at the option of the controlling player.

ORDERS

An order counter must be given to each Greater Daemon and each detachment of Lesser Daemons in the orders phase. Greater Daemons may opt to change their orders once all other orders have been revealed. If there are Greater Daemons or Eldar Titans on both sides of the conflict players should alternate changing their orders where necessary.

Greater and Lesser Daemons receive the same number of turns as vehicles. Their charge and advance rates are listed in the individual Daemon statistics.

THE INSTABILITY TEST

The material universe is like a waterless desert to Daemons, mostly lacking the invigorating power of Chaos. Though Daemons take great pleasure in wreaking havoc in the material universe, it is only a matter of time before their strength weakens and they are drawn back into the warp.

Combat and hits by the particularly powerful weapons employed on the battlefields of the Imperium increase the stress on a Daemon's continuity and may cause it to be sucked back into the heart of Chaos.

Whenever a Daemon is required to take an **instability test**, roll 1D6 and consult the table below:

- 1-2 The Daemon is sucked back into the warp, remove the model from play.
- 3-4 The Daemon is weakened momentarily and staggers back. Immediately move the Daemon an advance move towards its own base line. If the Daemon is in close combat, it is dissipated into the warp – remove the model from play.
- 5-6 The Daemon is able to restabilise its form and remain in play.

Dice Roll Modifiers

- +1 If within 24cm of a War Temple of the Daemon's Power.

Some Daemons are able to **regenerate**. If a Daemon can regenerate you shouldn't remove it from play as the result of an instability test. Instead lay the model on its side and leave it in place until the next repair phase. Then roll a D6 for the Daemon. On a 1-4 the Daemon fails to regenerate and is removed from play altogether; on a 5 or 6 the Daemon climbs back to its feet and is returned to play.

While they are attempting to regenerate, Daemons have a CAF of 0.

PANIC TESTS

Daemons radiate an aura of indescribable terror. Mortals minds fill with dread at the very approach of such creatures and the gibbering mask of insanity stalks the battlefield at their heels.

Nearly all Daemons cause **panic** when they engage an enemy in close combat or even at a distance. Exact details of the panic caused by different Daemons is included in their descriptions. Daemons themselves are completely immune to panic.

DAEMONS IN COMBAT

THE DAEMONIC SAVING THROW

Whenever a Daemon takes damage for any reason, it receives a saving throw. Daemonic saving throws are not normally modified so it doesn't matter whether the Daemon took a hit from bolter fire or a defence laser, it still receives an unmodified saving throw. Certain things like attacks from other Daemons or Psykers can modify a Daemon's saving throw – where this the case, it will be noted in the statistics of that particular creature or weapon.

If a Daemon fails its saving throw it is forced to take an immediate instability test. The saving throws for individual types of Daemons are noted in their statistics.

DAEMONIC ABILITIES

Daemons may have a number of **Daemonic abilities** representing their various arcane or supernatural powers. Most Daemonic abilities are as natural to the Daemon as walking and so can be used in all situations.

Other abilities represent the knowledge of actual spells and give a choice of abilities each turn – these abilities cannot be used if the Daemon is in close combat. From this choice of abilities, each Daemon or detachment of Lesser Daemons can pick one ability each turn – if you want, different Daemons and detachments can pick different abilities.

Objects covered by void shields or power fields are protected against Daemonic abilities and are unaffected by them. Any Titan or Gargant has a saving throw of 2+ against Daemonic abilities.

RANGED COMBAT

Daemons can be fired on with technological weapons. This is resolved using the standard Epic rules. Greater Daemons are treated as vehicle/Titan targets; Lesser Daemons are treated as light vehicles. Any hit against a Daemon with a technological weapon forces it to make an immediate Daemonic saving throw and take an instability test if it fails to make it's save.

Some Daemonic abilities are resolved as ranged combat, in which case they are used in the segment of the combat phase appropriate to the Daemon's orders, unless specified otherwise.

CLOSE COMBAT

Most Daemons rely on close combat to destroy their opponents – they favour rending, chomping and slashing the poor fools they catch so that they can feel them die.

Close combat involving Daemons fighting each other, infantry or vehicles are handled normally using the close combat rules in *Space Marine*. Each Daemon's CAF is stated in its statistics.



PAUL CAMPBELL

Vehicles or infantry which lose a close combat against Daemons are destroyed without a saving throw; secondary attackers will need to make a saving throw to survive if they lost the combat by five or more points. Daemons beaten in close combat by other Daemons deduct -2 from their normal Daemonic saving throw

Greater Daemons in close combat against Titans are treated as Titans themselves, having 1D3 improvised attacks. Lesser Daemons in close combat against Titans roll 1D6 each – add their CAF to the roll and consult the table below:

- 11+ The Daemon is able to inflict serious damage to the Titan. Apply one random critical hit against the Titan.
- 8-10 The Daemon hurls itself against the Titan, inflicting minor damage before being driven back. The Titan takes one random superficial hit and the Daemon must make a saving throw or suffer an instability test.
- 1-7 The Daemon is smashed down the Titan and must take an immediate instability test

STOMPS AND RAMS

Lesser Daemons cannot be rammed (they're agile enough to step aside) so any attacks made on them in the movement phase must be overruns. These are conducted as per the normal rules.

Greater Daemons can be rammed but not overrun. Any ramming attempt against a Greater Daemon is treated in the exactly the same way as a ram against a Titan – any damage inflicted forces the Daemon to take an instability test.

Daemons cannot stomp or ram opponents, though any Daemon with a split CAF characteristic can overrun infantry and light vehicles.

KHORNE

BLOODTHIRSTERS GREATER DAEMONS

Bloodthirsters are the most favoured of Khorne's Daemonic servants and only the mightiest of his Daemon Princes and Champions can one day aspire to join their ranks. Once aroused, their bloodlust and ferocity are almost unimaginable to a mortal. They have a powerful sense of martial honour and pride. Bloodthirsters are utterly fearless and will not hesitate to fight anything. In battle they rely purely on their own prowess, eschewing the aid of allies or slaves and always leading from the front.

Move	Save	CAF	Cost
16/32	3+	+10/+14	700

Notes: can fly (counts as skimmer). Hates followers and creatures of Slaanesh. Regenerates.

DAEMONIC ABILITIES

Bloodthirsters are terrifying to behold, a veritable embodiment of whirling death. They cause panic in opponents within 12cm.

Khorne loathes magic – Bloodthirsters receive a +1 bonus on saves against Daemonic abilities.

The fury of the Bloodthirsters' attacks mean that any instability tests they inflict on Daemonic opponents have an additional -1 modifier.



TONY ACKLAND

BLOODLETTERS LESSER DAEMONS

Most of Khorne's Daemonic ranks are filled by the Bloodletters. They act as his huntsmen and his foot soldiers. Bloodletters may eventually reach the status of Bloodthirsters if they display the right amount of skill and *ve. ve.* Few succeed on this path, however, quickly becoming engrossed in the dark, howling battle lust which typifies the Lesser Daemons of Khorne.

Move	Save	CAF	Cost
10/20	4+	+5	500

Notes: hates followers and creatures of Slaanesh. Regenerates.

DAEMONIC ABILITIES

Bloodletters cause panic in opponents within 6cm.

Khorne loathes magic – Bloodletters receive a +1 bonus on saves against Daemonic abilities.

Bloodletters can spit poison. This has the effect of a ranged attack effective only against light vehicles and infantry – range 10cm, hit roll 5+, save modifier -1.



TONY ACKLAND

FLESHHOUNDS LESSER DAEMONS

Fleshhounds are the terrible hunting beasts of Khorne. Faultless trackers and merciless in the chase, the Fleshhounds make implacable foes. Those marked as quarry for the Hounds are doomed to be run to ground and torn to shreds beneath their red, dripping fangs.

Move	Save	CAF	Cost
20/34	5+	+4	400

DAEMONIC ABILITIES

Khorne loathes magic – Fleshhounds receive a +1 bonus on saves against Daemonic abilities.

Fleshhounds receive an additional +1 to their CAF when charging.

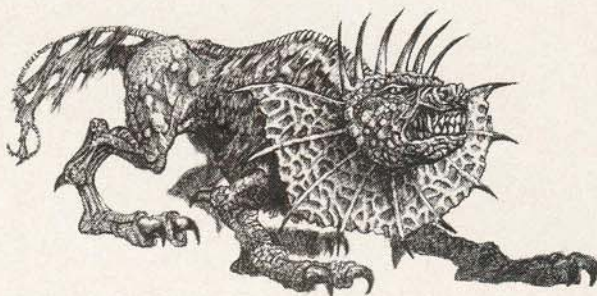

TONY ACKLAND

SLAANESH

KEEPERS OF SECRETS GREATER DAEMONS

Keepers of Secrets are the most powerful and brutal of Slaanesh's Daemons. They take sadistic pleasure in murder and torture so are ideal for leading the forces of the Lord of Pleasure to war. Each Keeper has a deep and abiding understanding of the ebb and flow of the warp, and takes particular pleasure in summoning and banishing Lesser Daemons, revelling in its position of power over others.

Move	Save	CAF	Cost
12/24	4+	+11	700

Notes: hates followers and creatures of Khorne.

DAEMONIC ABILITIES

Keepers of Secrets cause panic in opponents within 12cm.

Keepers of Secrets understand magic intimately – they receive a +1 bonus on saves against Daemonic abilities.

Keepers of Secrets use magic with glee during battles – each turn a single ability from the following list can be used:

- 1) Invoke +1 on its own attempts to prepare a summoning template or actually summon Lesser Daemons of Slaanesh.
- 2) Automatically force one detachment of Lesser Daemons within 24cm to make instability tests in the end phase.
- 3) Summon a raging storm in the orders phase of the turn. This inflicts a -1 penalty on all firing that turn.



TONY ACKLAND

DAEMONETTES LESSER DAEMONS

The Daemonettes are the most numerous of Slaanesh's Daemonic followers and serve his desires in many ways. Daemonettes have a perverse beauty, unnatural and disturbing. Though they are fearsome fighters in their own right, each Daemonette also knows a little of the forbidden arts and will not hesitate to use its power.

Move	Save	CAF	Cost
10/20	4+	+4	500

Notes: hates followers and creatures of Khorne.

DAEMONIC ABILITIES

Daemonettes cause panic in close combat opponents when they charge.

Daemonettes understand magic well – they receive a +1 bonus on saves against Daemonic abilities.

Daemonettes can always evoke a strange aura of lust and loathing with their perverse beauty such that they can fascinate a single detachment within 18cm if they remain stationary with no orders from the orders phase. The fascinated detachment cannot move or fire until the Daemonettes are destroyed, move or are engaged in close combat. (Note this ability is totally ineffective against followers of Khorne or Daemons of any sort.)

Daemonettes evoke the powers of magic whenever possible during battles. Each turn a detachment of Daemonettes can use a single ability from the following list. These are cast in the appropriate fire phase for their orders unless specified otherwise.

- 1) Force one Lesser Daemon within 12cm to take an immediate instability test in the end phase of the turn.
- 2) Add +1 to all Slaaneshi panic tests and morale checks within 12cm for the turn.



TONY ACKLAND

FIENDS LESSER DAEMONS

Fiends are unnatural mixtures of scorpion, reptile and human. With an insect-quick scuttling gait they pursue those who would flee the Lord of Pleasure's embrace and seek to overcome their prey with their soporific musk.

Move	Save	CAF	Cost
12/24	5+	+2	200

DAEMONIC ABILITIES

Units fighting Fiends reduce their CAF by -1.

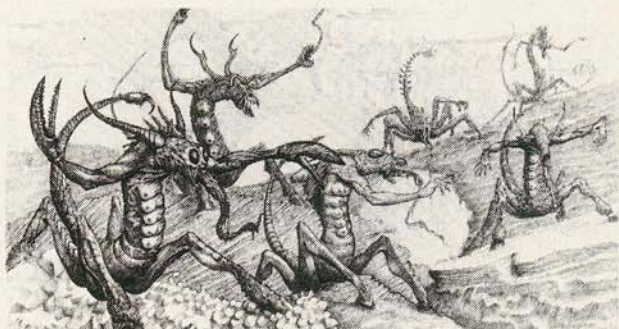

TONY ACKLAND

TZEENTCH

LORDS OF CHANGE GREATER DAEMONS

The Lords of Change share some of the subtle cunning and wisdom of Tzeentch himself, master of plots and intrigue. Like Tzeentch, the Lords of Change delight in bringing order to ruin so that all may be reshaped and directed to a new path before that too is changed again. The gaze of a Lord of Change is said to reach into the very soul of those it touches, deep into the unspoken fears and hopes each mortal carries with them. It is always the Lord of Change's greatest pleasure to raise a mortal past the heights of his wildest dreams or dash him down to the lowest pit of despair, for nothing can be more despised than the stability and comforts so ardently desired by mortal kind.



Move	Save	CAF	Cost
12/36	3+	+11	800

Notes: can fly (counts as skimmer). Hates followers and creatures of Nurgle.

DAEMONIC ABILITIES

Lords of Change cause panic in opponents within 12cm.

Tzeentch is the master of magic in all its forms. The Lords of Change, as Tzeentch's most favoured servants, enjoy an unparalleled knowledge of the Arcane. Each turn, a Lord of Change can use a single ability from the following list. These are cast in the appropriate fire phase for their orders unless specified otherwise.

- 1) Invoke the Firestorm of Tzeentch. The Daemon may place a 6cm burst template anywhere within 12cm. Units caught underneath the template must make an unmodified saving throw to survive. Any units which fail their save are replaced with Pink Horrors. The Horrors may not move on the turn following their creation.
- 2) Project a blast of magical fire up to 36cm which will hit automatically, causing a critical on a 4+ or a saving throw modifier of -1 against light vehicles and infantry.
- 3) The Daemon can gaze upon a detachment within 24cm in the orders phase and force them to take an immediate morale check.
- 4) A Lord of Change can force a detachment of Lesser Daemons or a single Greater Daemon within 36cm to take an instability test in the end phase of the turn.

FLAMERS LESSER DAEMONS

Like Pink and Blue Horrors, Flamers are creations of magic, soft bodied and almost transparent. Flamers move with surprising speed, leaping forward in great bounds. They attack with magical flames which they spit from orifices at the end of their trunk-like arms.

Move	Save	CAF	Cost
18/36	4+	+5	700

Notes: none.

DAEMONIC ABILITIES

Flamers cause panic in enemy units when they engage them in close combat.

Flamers have two ranged attacks each. These are only effective against infantry and light vehicle targets, having a range of 12cm and requiring a 4+ to hit with a saving throw modifier of 0.

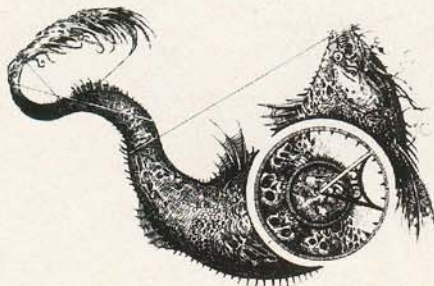

PINK HORRORS

LESSER DAEMONS

Pink Horrors are created from the raw stuff of magic as slaves for Tzeentch. On the battlefield they blur into multi-coloured masses of magic, cackling and braying like lunatics as they stream forward at Tzeentch's bidding. Worst of all, when they are struck down the magic of their nature splits into two halves forming into slouching, grumbling Blue Horrors to continue their work.

Move	Save	CAF	Cost
12/18	5+	+4	900

Notes: hates followers and creatures of Nurgle.



DAEMONIC ABILITIES

Pink Horrors cause panic in opponents when they charge into close combat.

Pink Horrors do not take an instability test the first time they fail their saving throw. Instead they collapse immediately and are replaced by two Blue Horrors with the following statistics:

Move	Save	CAF	Cost
12/18	5+	+2	-

When Blue Horrors fail saving throws they take instability checks as usual and are removed if indicated. They are not replaced with further Daemons.

Pink and Blue Horrors are created almost entirely from magic and during battles their progress can be marked by the crackle and flash of energy as they fight. Each turn a detachment of Pink and/or Blue Horrors can use a single ability from the following list. These are cast in the appropriate fire phase for their orders unless specified otherwise.

- 1) Streamers of magic swell and whirl faster and faster. This spell is cast in the orders phase and lasts the whole turn. The detachment may move at twice their normal speed.
- 2) The Horrors raise their spindly arms to direct blast after blast of pink fire at their foes. This gives each Horror in the detachment a ranged attack with a range of 24cm, which hits on 5+, causing a critical hit on 6 or a save modifier of 0.
- 3) The Horrors weave protective strands of power around themselves increasing their saving throw to 4+.

DAEMON PRINCES

GREATER DAEMONS

Daemon Princes may be selected as battle leaders or horde commanders in a Chaos horde regardless of the horde's patron Power. Daemon Princes may be summoned by any coven. Greater Daemons and Daemon Princes will not deign to attempt to summon entities as powerful as themselves.

Daemon Princes are Chaos Champions which have succeeded in their quest for ultimate power and ascended into the ranks of Daemonhood. Daemon Princes can either be the servants of one of the four Great Powers of Chaos who have gained Daemonhood with the aid of their patron, followers of another patron, or exceptionally powerful individuals who make their own path in Chaos Undivided.

Though he may be a servant of a greater Power than himself, a Daemon Prince is an individual with his own character, powers and appearance. Most Daemon Princes tend toward the archetypal look of Daemons: horns, tail and batlike wings are in evidence, with various mutations. They are always large and very powerful, both in the arcane arts and in battle.

Type	Move	Save	CAF	Cost	Notes
I	8/16	4+	+3/+7	400	
II	10/20*	4+	+8	500	3
III	12/18	3+*	+4/+9	600	
IV	16/24	3+	+9	700	2,3
V	14/28*	4+*	+10	800	1,4
VI	12/36*	3+	+5/+10	900	1,2,3,4

Notes: Princes with movement rates marked * can fly (count as skimmer). Princes with saving throws marked * regenerate.

DAEMONIC ABILITIES

Daemon Princes cause panic in opponents within 12cm. They are themselves immune to panic.

Some Daemon Princes have a deep and abiding knowledge of the Arcane. These are marked with one or more numbers in the notes section of their characteristics. Each number equates to a single ability from the following list. The Daemon can use one of its Daemonic magic abilities each turn. These are cast in the appropriate fire phase for their orders unless specified otherwise.

- 1) The Daemon may invoke a raging maelstrom of flames – place a 6cm burst template anywhere within 12cm. Any unit caught underneath the template must make an unmodified saving throw to survive the blazing gout of warp energy.
- 2) The Daemon can project a blast of magical fire up to 36cm which will hit automatically, causing a critical on a 4+ or a saving throw modifier of -1 against light vehicles and infantry.
- 3) The Daemon can gaze upon a detachment within 24cm in the orders phase and force them to take a morale check.
- 4) The Daemon can force a detachment of Lesser Daemons within 24cm to take an instability test in the end phase of the turn.

Daemon Princes which serve Khorne cannot use their magic. Instead increase their CAF by +1 for each ability lost. Khornate Daemon Princes can always overrun using half their CAF unlike other Daemon Princes who may only overrun if their characteristics indicate they can.



NURGLE

GREAT UNCLEAN ONES GREATER DAEMONS

Whereas most Greater Daemons are actually servants and slaves of their Power, those of Nurgle are more akin to facsimiles of Nurgle himself both in terms of appearance and personality. Indeed the followers of Nurgle frequently refer to Great Unclean Ones as Father Nurgle – which gives an indication of the relation between Daemon and underling. Nurgle's followers are treated with a gregarious and even sentimental nature by Great Unclean Ones, who seem to take a noticeable pride in their behaviour and achievements. All Greater Daemons of Nurgle seem to have boundless energy and drive, constantly working to extend the process of rot and decay, thoughtlessly for their own comfort while places still remain uncorrupted.

Move	Save	CAF	Cost
12/18	3+	+9/+13	700

Notes: hates followers and creatures of Tzeentch.

DAEMONIC ABILITIES

Great Unclean Ones cause panic in opponents within 12cm.

Great Unclean Ones are great masters of magic – each turn a Great Unclean One can use a single ability from the following list. These are cast in the appropriate fire phase for its orders unless specified otherwise.

- 1) Launch a stream of filth and corruption against its foes. Use the Gargant grape shot template to mark the area effected by the stream. Any unit caught underneath the template must make an unmodified saving throw to survive.
- 2) Project an aura of pestilence which halves the CAF value of all units within 12cm which are not followers of Nurgle.
- 3) Send followers and Lesser Daemons of Nurgle within 24cm into a whirling Dance of Death. It must declare this use in the orders phase of the turn. The affected units must charge (even if they don't have charge orders) and enter close combat if possible. While in the Dance of Death, units are immune to panic.



STEPHEN TAPPIN

PLAGUEBEARERS LESSER DAEMONS

Plaguebearers are created from the dying soul stuff of victims of Nurgle's greatest contagion, Nurgle's Rot. Nurgle's Rot is unusual in that it affects not only the body but the soul of the victim too. Those falling prey to its influence become Nurgle's servants. Plaguebearers are doomed to the impossible task of keeping account of the innumerable plagues, contagions and infections throughout the universe, counting and recounting in a fruitless attempt to impose order on a meaningless and chaotic existence.

Move	Save	CAF	Cost
8/16	4+	+4	500

Notes: hates followers and creatures of Tzeentch.

DAEMONIC ABILITIES

Plaguebearers cause panic in opponents when they charge into close combat.

Plaguebearers are surrounded by clouds of flies which swarm over their opponents in close combat, inflicting a -1 CAF modifier.

The unholy Plague Swords borne by Plaguebearers inflict an additional -1 on all Daemonic saving throws made against Plaguebearers in close combat.

Plaguebearers will use magic on occasion during battles. Each turn a detachment of Plaguebearers can use a single ability from the following list. These are cast in the appropriate fire phase for their orders unless specified otherwise.

- 1) Raise any units destroyed within 12cm as an undead counter – see *Artifact Weapons: Plague Wains* for more details.
- 2) They may set up a sonorous chanting in the orders phase of the turn which will force a single detachment within 24cm onto no orders if it fails its saving throw.
- 3) Invoke a Plague Wind which affects the area of 6cm burst template. Any units caught underneath the template must make a saving throw to survive. Maximum range for the Plague Wind is 30cm.



ADRIAN SMITH

BEASTS OF NURGLE

LESSER DAEMONS

Beasts of Nurgle have a fearsome appearance: a slug-like body topped by a fringe of fat writhing tentacles which constantly ooze slimy secretions. This is belied by their apparently friendly and energetic character as they bound from one group of newcomers to the next, excitedly licking at their new friends and leaving little puddles of caustic slime behind them. The touch of the Beast of Nurgle is deadly to mortals, though they do not appreciate this and only register vague disappointment as each new playmate quickly becomes still and boring.

Move	Save	CAF	Cost
6/12	3+	+1D6	400

Notes: none.

DAEMONIC ABILITIES

Beasts are immune to panic except when attacked by fire (not plasma, not lasers, not meltas – just fire) which causes an automatic panic test.



STEPHEN TAPPIN

NURGLINGS

LESSER DAEMONS

Nurglings are Nurgle's favoured little helpers. Each one is a tiny facsimile of Nurgle or a Great Unclean One. Nurglings are excitable and energetic, like malicious school children, though their vicious sense of humour and sharp fangs make them quite nasty for all their small size.

The Nurglings encountered on the battlefield are mostly in great swarms which have bred together on the Nurgle Renegades' space hulk. They form carpet-like masses to overwhelm the foe with numbers while more adventurous individuals sneak off to inflict boils and diseases on their own. Quite often Nurglings will remain behind on a planet which has been raided to cause trouble for years to come.

Move	Save	CAF	Cost
8/16	5+	+2	100

Notes: Regenerates (this doesn't represent the actual Nurglings regenerating, rather it shows the tendency for the nurglings to get scattered by a hit and then gradually scramble back together). Nurglings have no Daemonic Abilities.



ADRIAN SMITH

SUMMONING TEMPLATE: Photocopy the summoning template and the eight summoning counters, stick them to stiff card and cut them out. You place the counters on the arrow points as the summoning progresses. Once all eight counters have been placed, the final chants begin on the next turn.

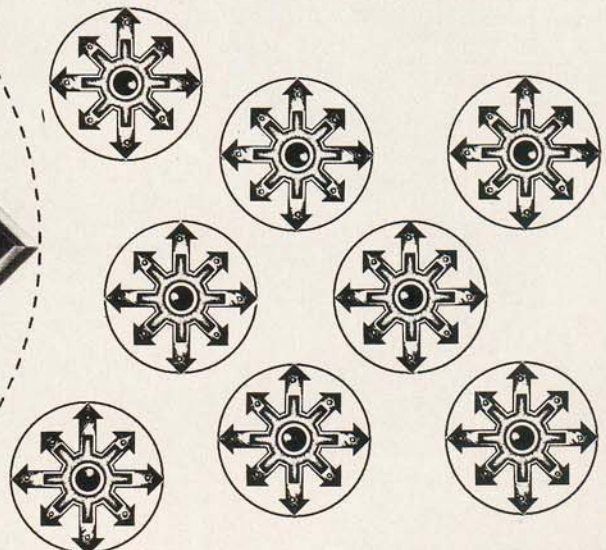
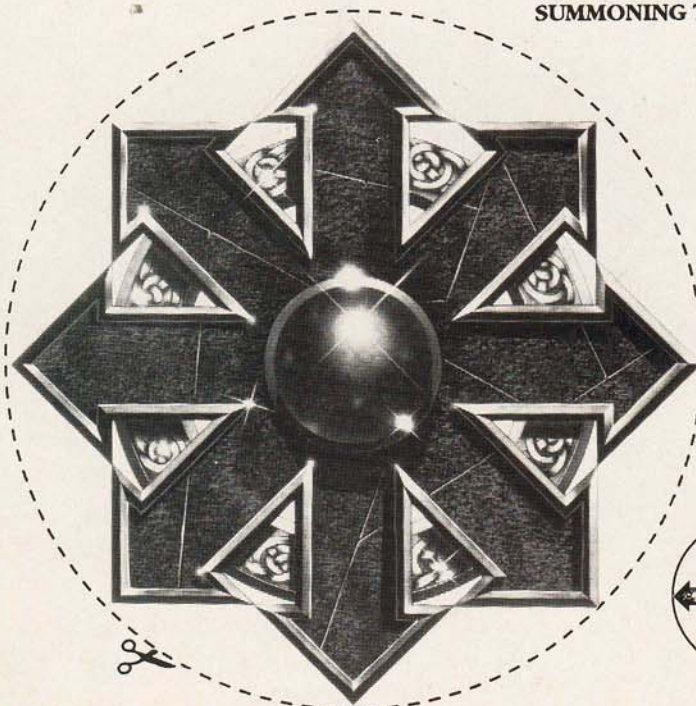

Copyright © 1990 Games Workshop Ltd. All Rights Reserved.

Permission to photocopy for personal use.



Raven
Armoury

There can be only one.

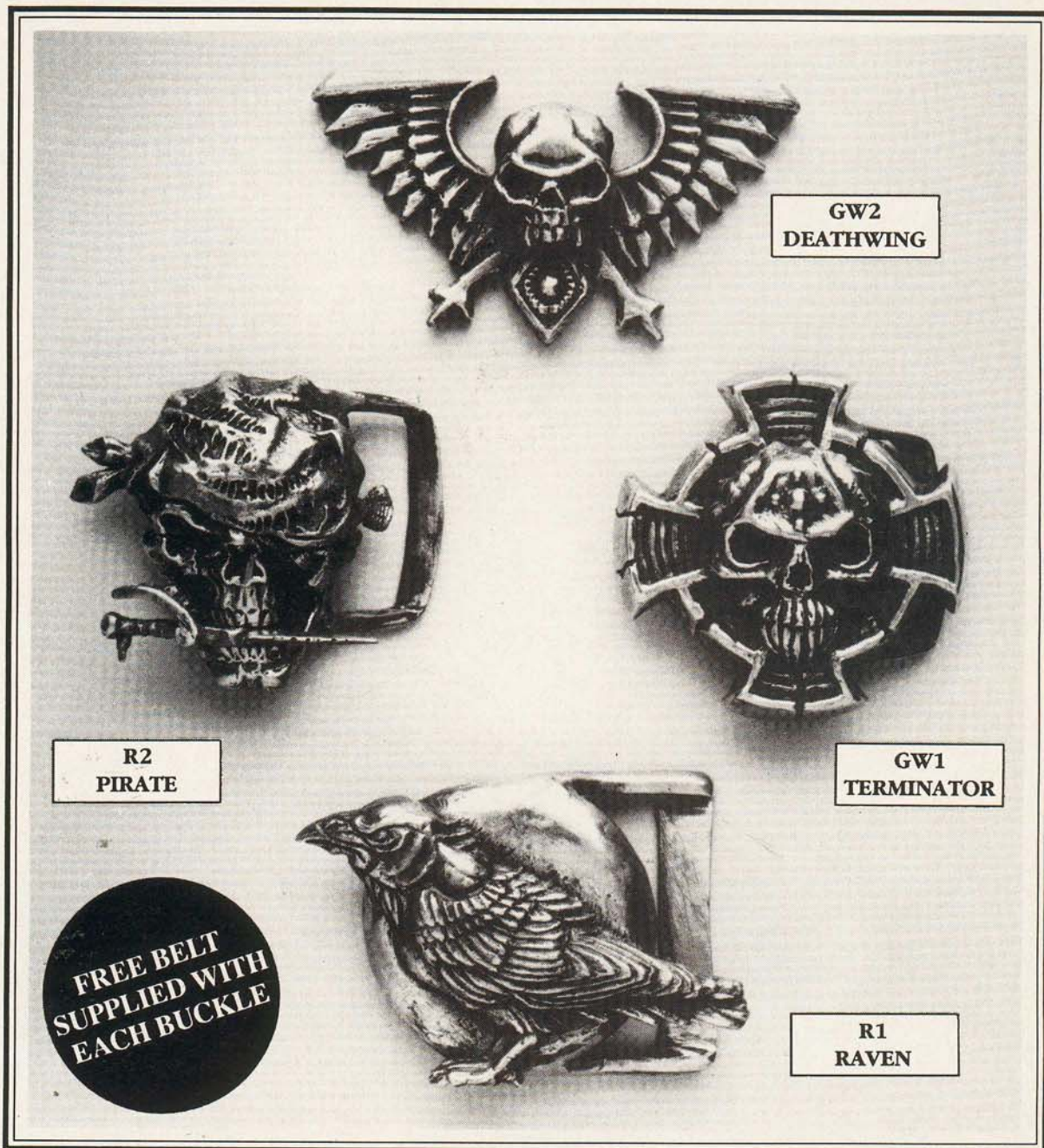

HAND CRAFTED TRADITIONALLY CAST BELT BUCKLES IN SOLID BRASS

- GW1 Terminator.....for 1½" belt £19.99
- GW2 Deathwing.....for 1½" belt £19.99
- R1 Ravenfor 2" Belt £19.99
- R2 Pirate with dagger.....for 1½" belt £21.50
- R3 Pirate without dagger (*not illustrated*)for 1½" belt £19.50
- Raven Armoury T-Shirt(S,M,L,XL) £5.95
- Belt 1½" black leather(S,M,L) £3.99
- Sword belt 2"(S,M,L) £7.99

Forge & Showroom
Handleys Farm,
Dunmow Road,
Thaxted, Essex
Tel: 037184 486



All prices include Postage and Packing & VAT (U.K. only). For overseas orders add 10% of value for delivery.

Terminator and Deathwing buckles © Games Workshop 1990 Raven & Pirate Buckles © Raven Armoury.

CONFRONTATION

THE GANGS

On Necromunda every clan, no matter how large or how small, has gang fighters who protect the clan's territory and attempt to expand its borders into areas controlled by its rivals. Not all of Necromunda's gangs come from these clans however. Amongst the outcasts and mutants of the undercity warfare is a matter of dire necessity and everyone has to be a fighter if they are to survive. Even beyond the hives, in the barren wastes, the Nomads are always prepared to protect their trading caravans from marauders.

Whatever strata of Necromundan society they come from, fighters organise themselves into units called gangs. A single clan living in just one spire of one hive may have hundreds of associated gangs, and there are thousands of clans on Necromunda as well as many gangs not formally associated with clans. There are many different types of gang, some accepting a fairly formal role as protectors of their clan's territories while others head off to the remote and dangerous undercity in search of fame and fortune. The success of a gang establishes the right of its members to become leaders of their own families and take a part in the administration of their clan's business. Clan leaders and important families are all headed by the most successful gang leaders of their generation.

As a player you start off at the bottom of the Necromundan social pile by representing a small gang without influence or power. If you're lucky you'll grow to become a force to be reckoned with. On the other hand if you're unlucky or careless you'll be ground into the dirt by your rivals. On Necromunda only exceptional people get lucky and the rest are swept from the path of power! Fortunately, as a player you can always start again with a fresh gang and another chance.

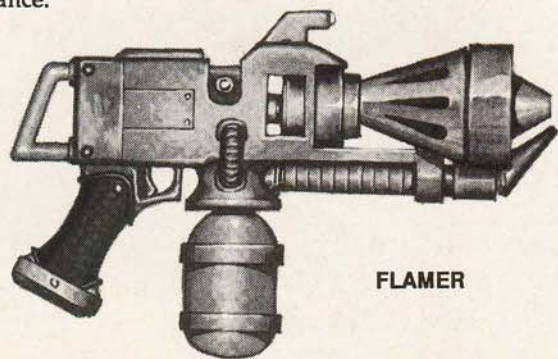

FLAMER

We have described several different types of gangs that can be generated and developed in Confrontation. There are many other types of gangs as well as some which are unique and don't really conform to a type as such. As your gang gains new members and grows, it will naturally develop its own distinct idiosyncracies which will characterise it and make it wholly your own.

THE GANG LEADER

Each player represents a whole gang as an entity including its leader and the ordinary gang members. If the leader is slain another gang member takes over, and the gang lives on led by this character. However, the player should think of himself as the gang's leader, and the rest of the gang as his followers. If the leader is slain and a new leader takes over, and the player then assumes the role of the new leader. To begin with players may undergo several changes of personae as their gang leaders fall in combat. A leader who survives many encounters will become less vulnerable in combat as he becomes more experienced and battle-hardened.

Players will naturally grow to identify strongly with their gang's leader. The passing of a favoured leader is something of a set-back for a player irrespective of the fortunes of the gang as a whole. As the gang undergoes a succession of leaders, its past history will become increasingly colourful and interesting. Most players get quite attached to their gang, and enjoy inventing all sorts of extraneous detail and history about it.

THE GANG

The gangs we are discussing probably have around a dozen members in all. Although a great clan may have many thousands of gang fighters these are always divided into quite small gang units. It is not unknown for gangs belonging to a single clan to combine in order to meet a large threat from another clan, but most encounters involve battles between individual gangs. The complex environment of the hive makes this inevitable. It is easier for close-knit gangs to fight and survive in the labyrinthine corridors. Undercity gangs

and armed bands of other outcasts are almost always small and independent - mainly because they trust no-one else.

There will be older henchmen and raw recruits as well as ordinary gang fighters among ordinary gang members. All gang leaders rely upon trusted henchmen: responsible older gang members who help to keep the youngsters in line, and who will take over if the leader is killed. Some henchmen get out of line themselves, and try to take over the gang by supplanting the leader. Although rivals, henchmen and leaders are just as likely to be close comrades.

Gang recruits are drawn from the level of society where the gang operates. Most of the gangs from the factory and lower hab layers absorb their recruits from the tough young bucks of the worker and tech classes. Down in the undercity, gangs find their recruits in the city-scum that drift down from the layers above. Even the highest levels of society has its gangs, drawn from young adventurers or older para-militarists. While youth of the elite and tech classes have the choice of joining a gang, few of the other classes have any option. Running with a gang is a normal part of the Necromundan life cycle. In the undercity, shanties or ash wastes, it is the only way to survive.

Not everyone is automatically accepted into a gang. The prospective recruit must usually pass some sort of test or initiation. In the upper hab layers money or social position may be enough to ensure acceptance. In the lower levels a recruit frequently has to prove his worth, often by fighting other prospective recruits or gang members.

Every gang has its own way of weeding out the weak and stupid. Many of the undercity gangs will only accept a new recruit once he has successfully scragged an enemy by tearing off an ear, part of his scalp or some other grisly bit of anatomy. This trophy is proudly worn about the neck as a sign of gang membership.

As a gang grows in power and reputation, new recruits will be attracted to its ranks and it will grow bigger. The charisma of a gang's leader may be sufficient to attract more recruits than it needs. Conversely, the bad reputation of some gang leaders may be enough to drive recruits away and into the arms of other gangs.

Although a typical gang will often be a relatively small and close knit fighting unit, some of the tasks the gang wishes to take on may be too big to handle on their own. For big actions, all the gangs in a clan may be mobilised or several gangs of different clans or types may form a temporary alliance. A typical example of this occurred when several Undercity gangs made a concerted raid into the Akritas clan territory in Trazior hive. The Akritas clan mobilised its gangs to fight alongside each other to repel the raiders. One gang held them up in the narrow twists while runners went out to gather gangs from neighbouring clans. They came in from all sides and the invaders were wiped out.

Other good examples of gang co-operation can be found in the mass bounty hunts that take place now and again in Trazior and in most hives on Necromunda. A bounty is declared for any mutants, psykers or other

miscreants slain or captured. Then several interested gangs, and maybe even a squad of Judges, will muster together and make a mass foray into the undercity. Once inside, the gangs may split up, but it is often safer for them if they collaborate among themselves. The only way the victims can be sure to survive is to co-operate with each other against the bounty hunters.

It will be obvious to players that any existing gang can be used in alliance with other gangs or even with Imperial forces such as Judges or Space Marines. As well as the regular skirmishes involving up to a dozen characters on each side there will be a few larger engagements with perhaps 30 or more on each side.

Haro and Rest ran through the twisted alleys of the undercity, gliding through the shadows. One ran ahead, and when he was satisfied the way was safe, he would silently sign his friend forward, and the process was repeated, each taking turns to run onward while the other stayed behind to cover.

They were both sixteen, second cousins, and determined to prove their worthiness to join the Red Spiders gang. As proof of the youths' survival and combat skills, Stallek, the gang leader, had set them the task of going down to the undercity and bringing back a Scavvy scrag - any body part would do. Not any Scavvy scrag, but from the Black Rag gang, notorious for their savagery and zealous protection of their territory. For weapons, they were allowed a knife each - only when they had proven themselves would they be outfitted from the gang's stash. As their task was a dangerous one, they and another youth, Andra, had been sent together, as a team.

Haro and Rest worked well together: Haro being naturally adept at leadership, and Rest happy to accept his authority. Andra, though a year older, had proved clumsy and indecisive. He had fallen off a thin communications tube they had been using as an improvised bridge.

Haro was on point when he detected the sounds of distant gunfire. He signed his friend forward.

'There's fighting ahead!' he whispered to Rest. 'We haven't time to bypass it, let's sneak up and see what's going on. Maybe we can get past without too much trouble.'

The dark, narrow alley they were travelling down opened up into a larger, better illuminated space. At this distance they couldn't see what was happening, but the characteristic explosive sound of las pistol fire was unmistakable. Moving with more caution now, they edged stealthily towards the exit of the alley. When they peered round the corner, they saw a large vaulted chamber, once proudly decorated, now in an advanced state of disrepair. From a walkway suspended high across the room a gang of clan fighters was firing at a band of Scavvies on the floor.

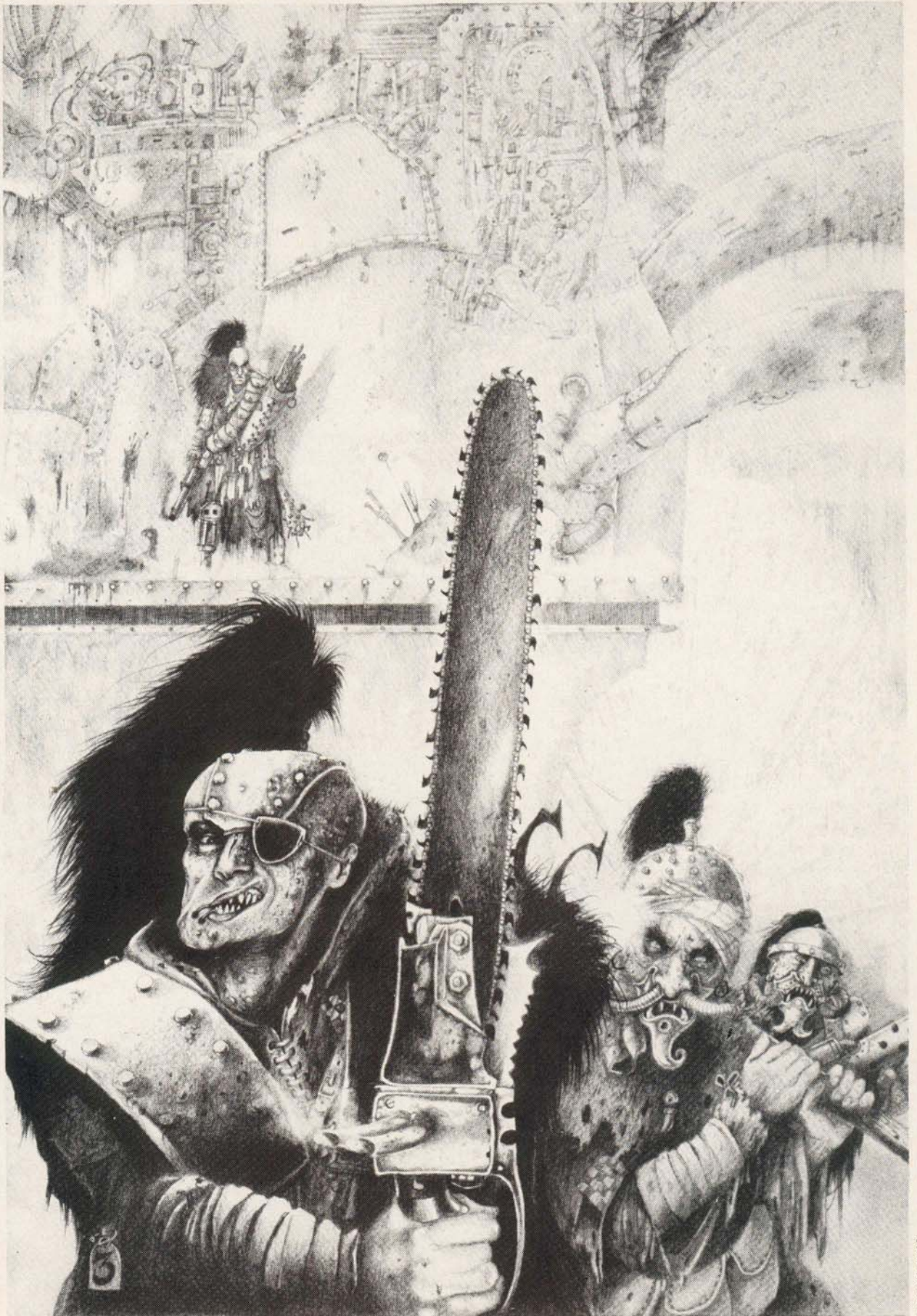

JOHN BLANCHE

CREATING A GANG

In Confrontation each player represents a gang led by a charismatic leader. To create your own gang together with its leader you generate the type of gang, its leader, the number of members it has, the personal fighting skills of each member, and their weaponry and other equipment. This section of Confrontation explains how to generate your gang. As you go along you will need to record details of your gang, stash, and other pertinent details. Make sure you have paper and pencil handy to record the information as you generate it.

GANG GENERATION SUMMARY

1. Randomly determine which type of gang you are going to control by rolling on the Gang Determination Chart. Alternatively players may choose to represent Clan gangs, the most common type of gang in the Necromundan hives.
2. Generate the gang leader's prestige and determine the number of additional gang members by cross-referencing this score on the Gang Members Chart.
3. Roll on the Prestige and Status Table to generate prestige points for each additional member of the gang. The same dice roll is also used to determine their status: Raw Recruit, Hardened Gang Fighter or Henchman.
4. Determine the profile of each gang member by rolling for Initiative, Weapon Skill and Ballistic Skill on the Profile Generation Chart. Use the Gang Modifiers Chart to modify each individual profile.
5. Generate weapons and equipment for each member of the gang by rolling on the appropriate Equipment Chart. For each ranged weapon, roll determine how many shots it has remaining in the magazine. Generate the gang's stash by rolling on the Stash Chart.
6. Determine the amount of credits the gang has in their stash by rolling on the Credit Table.
7. Determine whether any of the gang members have any special skills by rolling on the Skill Generation Chart.
8. Establish if characters with high prestige have Caryatids.
9. Organise the gang by exchanging weapons, ammunition and equipment between members and consigning unused equipment to the gang's stash. Make sure that you have recorded all the details generated so far, and especially that you have noted down details of each gang member's armament. Equipment and credits stashed by the gang must be noted separately - stash is not carried into action and so is not available during the game itself.

CHOOSING A GANG

There are two ways of selecting which sort of gang you want. The first is to choose a Clan gang, which is the most common kind of gang. The second is to randomly determine the type of gang using the chart below. This second method introduces some less common but more interesting gangs, but still allows for the possibility of generating a Clan gang. Clan gangs are an accepted part of life on the hive world and can operate overtly. Psyker gangs on the other hand are relatively rare and very secretive.

THE TYPE OF GANG

To randomly generate a gang use the chart below. Roll a D6 - a score of 3 or 4 indicates that you have a clan gang, scores of 1 or 2, or 5 or 6 indicate that you should roll again. Your second D6 roll will either give you a gang type or a third dice roll which will determine your gang. So, an initial roll of 5 indicates that you should roll again, if this roll is 3 you have generated an undercity gang.

GANG DETERMINATION CHART

1st Roll	2nd Roll	3rd Roll	Gang Type	
1-2	1-3	1	Psyker Gang	
		2	Mutant Gang	
		3-6	Scavvy Gang	
	4-6		Nomad Gang	
3-4			Clan Gang	
5-6	1-3		Undercity Gang	
		4-5	1-3	Brat Gang
			4-6	Tech Gang
	6		Venators	

THE SIZE OF THE GANG

Once you have established the type of gang you have you are ready to determine how many fighters it contains. First generate the prestige value of the gang's leader: 6 plus the score of a D6 (6+D6).

Prestige is important because it defines the level of respect and authority the leader commands; the higher a leader's prestige the better leader he is and the more followers he is likely to have. To determine the initial number of followers in the gang roll a D6 and read the score against the leader's prestige on the Gang Members Chart on the opposite page.

For example a leader with 7 prestige points rolling a 6 will start with 5 followers (therefore the total number of fighters in the gang including the leader will be 6).

GANG MEMBERS CHART

D6	Leader's Prestige Value					
	7	8	9	10	11	12
1	3	3	4	4	5	5
2	3	4	4	5	5	6
3	4	4	5	5	6	6
4	4	5	5	6	6	6
5	5	5	6	6	6	7
6	5	6	6	6	7	7

The leader starts off with the number of followers indicated on the chart, which may be less than his prestige points total. Henceforth the prestige value of the leader determines the maximum number of followers he can lead.

For example, a leader with a prestige value of 12 can have up to 12 followers in his gang, a leader with a prestige value of 8 can have up to 8 followers, and so on. A gang may always include fewer members than its leader's prestige value would permit, but it never contains more. Once the gang has fought a battle there will be an opportunity to recruit more followers. The prestige value of the leader may also fall or rise depending upon his success in battle.

GENERATING FOLLOWERS

Now you have determined the number of followers in your gang it is necessary to establish the personal prestige value of each of them. Just like your leader, every gang member has his own prestige value which reflects his combat experience and hence his position within the gang. For each follower roll a D6 to determine his prestige value. Individuals with a low value (1 or 2) are raw recruits, those with an average value (3 or 4) are hardened gang fighters, while those with a high value (5 or 6) are the most experienced fighters of all: henchmen.

PRESTIGE AND STATUS TABLE

D6 Prestige Value	Gang Member
1-2	Raw Recruit
3-4	Hardened Gang Fighter
5-6	Henchman

PROFILES

Each character in the gang will differ from every other. Some will be good hand-to-hand fighters, others will be good marksmen, and some may be good all-round fighters while others are generally inexperienced. A character's fighting prowess is defined by his profile. The profile consists of three characteristics; Initiative, Weapon Skill and Ballistic Skill. Each of these characteristics is expressed by a number - the higher the

number the more accomplished that individual is within the field of expertise

Initiative defines the character's reactions, agility and awareness on the battlefield. Characters with high initiative are quick-witted and have speedy reactions, those with low initiative are slow witted, a bit clumsy or maybe just inexperienced.

Weapon skill defines the character's prowess in hand to hand combat. A character with high weapon skill is an experienced and probably savage hand-to-hand fighter, those with low weapon-skill are inexperienced or lack aggression.

Ballistic skill defines the character's ability to shoot or throw a weapon accurately. Characters with high ballistic skill are skilled marksmen; those with low ballistic skills are relatively poor shots.

GENERATING PROFILES

To generate the profiles of your gang members consult the chart below. As you can see there is a column for the gang's leader, and a corresponding column for Henchmen, Hardened Gang Fighters and Raw Recruits.

Start by generating the gang leader: his initiative equals the score of a D6 plus 8 (D6+8), his weapon skill equals the total score of four D6's multiplied by 10, and his ballistic skill equals the total score of five D6's multiplied by 10. Once you have generated the profile for your leader work through each gang member in turn rolling dice as indicated.

PROFILE GENERATION CHART

GANG FIGHTER	CHARACTERISTIC		
	INITIATIVE	WEAPON SKILL	BALLISTIC SKILL
LEADER	D6+8	4D6x10	5D6x10
HENCHMAN	D6+6	3D6x10	4D6x10
HARDENED GANG FIGHTER	D6+4	2D6x10	3D6x10
RAW RECRUIT	D6+2	D6x10	2D6x10

Example 1. A gang leader's initiative is D6+8 - rolling a 4 his initiative would be 4+8 = 12. His weapon skill is 4D6x10 - rolling a 1, 3, 5 and 5 his WS would be 14x10 = 140. His ballistic skill is 5D6x10 - rolling 2, 2, 4, 5 and 6 his BS would be 19x10=190.

Example 2. A Henchman's initiative is D6+6 - rolling a 5 his initiative would be 5+6 =11. His weapon skill is 3D6x10 - rolling a 2, 3 and 6 his WS would be 11x10 = 110. His ballistic skill is 4D6x10 - rolling a 4, 4, 5 and 6 his BS would be 19x10 = 190.

Example 3. A Raw Recruit's initiative is only D6+2 - rolling a 3 his initiative would be 5. His weapon skill is D6x10 - rolling a 4 his WS would be 4x10=40. His ballistic skill is 2D6x10 - rolling a 2 and 4 his BS would be 6x10=60.

Note that it is perfectly possible to have a Raw Recruit with a characteristic higher than that of a Hardened Gang Fighter, Henchman, or even (in extreme cases) the gang leader himself. This is perfectly acceptable, representing talented young individuals with specific natural abilities and lacking only experience. Obviously the more experienced gang members will tend to have the higher overall characteristic values, even though talented young bucks may, in some cases, be better.

GANG TYPE VARIATIONS

As indicated already there are different types of gang on the hive world, composed of very different kinds of people. Each type of gang tends to consist of individuals with slightly different combinations of talents and abilities. This is naturally reflected in their characteristic values.

For example, the savage Scavvies tend to be good at hand-to-hand fighting, but are often poor shots since they are less likely to use sophisticated ranged weapons and find them difficult to operate as their hands are rather gnarled and covered in sores and scabs. Nomads tend to be very quick-witted due to the hardships of life

Hiding behind a fallen length of corrugated ventilation ducting, Haro and Rest could watch the conflict unseen by the battling gangs. The chamber was illuminated by fibre-optic cables set into the walls, but in the undercity their power supply was weak and erratic, and the ceiling and far corners of the chambers were lost in shadow.

Haro counted six or seven clan fighters crouching on the walkway, all clad in sleeveless black tunics, dark trousers and boots. They wore their black hair swept back from the forehead, secured at the nape of their neck in a knot. The leader was taller and older than the others, hard featured, with a luminous red tattoo of a serpent coiling round his upper arms. He used a lasgun while the rest of the gang fired laspistols.

By contrast to the discipline of the clan fighters, the Scavvies scuttled backwards and forwards without any apparent coordination. They too were all dressed in a similar fashion, if their ragged black wrappings could be termed clothes. They ran from cover to cover, trying to find good vantage points to fire their stub guns up at the walkway. They were appalling shots, and the bullets flew wide of the walkway, ricocheting off the walls and metal tubing in flashes of white and orange sparks.

One of the Scavvies ran for the shelter of a collapsed doorway and was hit by the clan fighters' laspistol fire before he could reach it. His body was blasted apart in an explosion of noise and smoke.

Rest, whose knowledge of local clans and gangs was encyclopaedic, identified the gang on the walkway as the Blood Serpents, and the Scavvies as the Black

in the ash wastes and this is reflected by their higher than average initiative values.

Every type of gang is unique in some way. Clan gangs are good all round with no drastic weaknesses or strengths. To represent the differences between gang modifiers are applied to the profiles of the gang.

These modifiers are applied to the characteristic scores of the relevant gang type. Note that there are two kinds of modifier indicated on the chart. The first kind is simply an overall penalty or bonus which is applied to the initiative, for example +1, -2, etc. This initiative modifier is simply added to or subtracted from the individual's characteristic value.

A Scavvy Gang leader who generates an initiative of 12 adds +3 to his score making a total value of 15 for example. The second type of modifier applies to WS and BS and is made to each D6 dice rolled. For example, for members of a Tech Gang -1 is subtracted from each D6 dice rolled for WS, so a Henchman rolling 4, 5 and 5 actually scores 3, 4 and 4 making a total of 11 giving a final value of $11 \times 10 = 110$.

An Undercity Gang Henchman, on the other hand, adds +1 to each D6 dice rolled so his score of 4, 5 and 5 becomes 5, 6 and 6 = 17 giving a final score of $17 \times 10 = 170$. These differences reflect the individual

Rag gang. While they had been fortunate enough to find members of the gang they were looking for, they were now posed with the problem of how to obtain their trophy. If they revealed themselves they would bring down the wrath of both feuding gangs.

The walls of the chamber were patchworked with carved panels and utilitarian ducts and vents, and, unseen by the Serpents, two Scavvies were climbing up the walls directly beneath the walkway. Moving through the gloom, they looked like huge spiders.

The conflict reached an impasse; the Scavvies still left alive sticking to their cover, refusing to be drawn out. The Serpents not willing to abandon their commanding position and let the Scavvies escape.

The leader of the Serpents signalled his gang to hit the deck, then tossed something small and round down to the floor below. The frag grenade exploded with a blasting roar, spewing hot fragments of metal through the chamber. The ventilation ducting shook and groaned in the blast, but held firm, protecting Haro and Rest from the flying shards of metal. The Scavvies weren't so lucky - their bodies were thrown into the air and thudded down, broken, to the ground. Blood, flesh and metal sprayed everywhere. None of the Scavvies in the chamber was left alive.

The Serpents were on their way down to loot the Scavvy bodies; it was too dangerous for Haro and Rest to stay. As they turned back down the alley, a lone Scavvy detached itself from the shadows to block their way. While they had been watching the fight, Haro and Rest had themselves been under the surveillance of a Black Rag out-watcher.

strengths and weaknesses of different types of gang.

While some gangs might appear to be at a disadvantage (such as Brats who suffer a -1 per D6 to WS and BS) bear in mind that they may have other advantages such as wealth or access to exotic weapons and equipment.

GANG MODIFIERS CHART

Gang Type	I	WS	BS	Comments
Clan Gang	-	-	-	Good all round
Undercity Gang	+1	+1 per D6	-	Quick and savage
Nomad Gang	+3	-	-	Very quick witted
Scavvy Gang	+1	+1 per D6-1 per D6	-	Savage fighters but poor shots
Mutant Gang	Profile may be modified by mutations		-	Vary from as discussed later
Tech Gang	-2	-1 per D6	-	Cautious and reliant on technology
Psyker Gang	-	-	-	Rely on Psionics
Brat Gang	-1	-1 per D6	-	Rely on exotic weaponry
Venators	+1	-	-	Bounty hunters with specialist equipment

GENERATING EQUIPMENT

Gang fighters are useless without weapons. Most gang fighters start out with stolen or home-made weaponry or with weapons which are relatively common on the hive world. More exotic weapons are costly and often hard to obtain. As well as weapons there are other kinds of equipment which are useful in combat such as armour, communications gear, and combat drugs.

Weapons and other equipment are described in detail in the *Armoury* section - here we are concerned only with determining the type and quantity of equipment which the gang has. The gang's initial equipment is generated randomly, more equipment can be bought by trading or obtained by raiding as explained later.

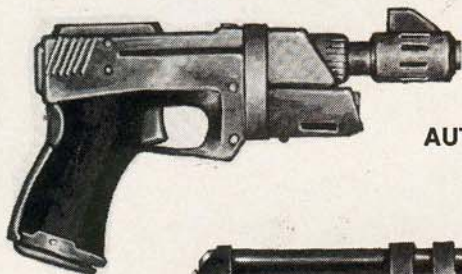

AUTO PISTOL



LAS PISTOL

Generate the equipment for each gang member in turn, starting with the gang's leader as its most prestigious fighter. First refer to the Leader Equipment Chart. As indicated on the chart 4 dice rolls are allowed - each dice result will generate a piece of equipment. If you roll a duplicate result you have the option to keep it or reverse the dice score to give an alternative. For example, a roll of 57 becomes an optional roll of 75. This reversing of the dice score is only an option for a duplicate result.

Note down each character's equipment as you generate it. Some equipment can be pooled or redistributed throughout the gang as described later, so it is a good idea to use scrap paper to note down the equipment generated at this stage.

Without hesitation, Haro and Rest flung themselves straight at the Scavvy, giving him no time to raise and fire his stub gun. Underneath the filthy wrappings the Scavvy was supple and wiry, strong enough to hold off both the youths. He was more savage than anyone they had ever fought before, attacking with great ferocity.

Even at the odds of two to one, Haro and Rest were having to fight for their lives. Backing under the Scavvy's blows, Rest tripped over a piece of debris and fell to the floor, pulling his opponent down on top of him. The Scavvy redoubled his efforts, slicing at him with a vicious dirty knife, slashing him on the face and shoulders. Haro had avoided being pulled to the floor, and was trying to attack the Scavvy from the rear, only to be smashed aside by a powerful blow.

Face to face with the Scavvy Rest could see the inflamed sores and pustules that covered his skin, smell the foulness of his breath. His blackened teeth had been filed into points, and tufts of coarse hair sprouted from his neck and ears. Rest couldn't hold out much longer. He couldn't attack effectively because he was too busy trying to stop the Scavvy from strangling him. The disgusting face bore down, blotting out everything else, then there was a loud crack, a flash, and the Scavvy's body jerked up and down on top of him.

At the last moment, Haro had managed to retrieve the Scavvy's stub gun and shoot it through the head. He pried the Scavvy's hands away from Rest's throat, and pulled his friend out from under its limp body. Rest's head swam from the shot, and he staunched the painful flesh wounds the Scavvy had inflicted upon him. He was proud to have received his first real combat scars.

They were still in danger, so it was important to leave quickly. Haro cut off one of the Scavvy's thumbs, taking care to leave the wrappings intact. They took the Scavvy's knife and stub gun for the gang stash, small trophies of their achievement. Their scrag procured, all they had to do now was get safely back to Red Spider territory.

LEADER'S INITIAL EQUIPMENT

The leader is entitled to 4 or 3 rolls from the chart as indicated below. Cross reference the dice score to the type of gang. The type of gang influences the kinds of equipment the leader has.

D100	CLAN	TECH	VENATORS	SCAVVIES, NOMADS PSYKERS, MUTANTS UNDERCITY GANGS
<i>Rolls</i>	4	4	4	3
0-5	Sword	Stub Gun	Las Pistol	Sword
6-10	Handbow	Shotgun	Las Pistol	Sword
11-15	Stub Gun	Shotgun	Las Pistol	Handbow
16-20	Stub Gun	Autogun	Bolt Pistol	Handbow
21-25	Shotgun	Las Pistol	Bolt Pistol	Handbow
26-30	Shotgun	Las Pistol	Lasgun	Stub Gun
31-35	Autogun	Bolt Pistol	Lasgun	Stub Gun
36-40	Autogun	Bolt Pistol	Powersword	Shotgun
41-45	Las Pistol	Lasgun	Powersword	Shotgun
46-50	Las Pistol	Lasgun	Bolt Gun	Autogun
51-55	Bolt Pistol	Powersword	Bolt Gun	Autogun
56-60	Bolt Pistol	Powersword	Hand Flamer	Las Pistol
61-65	Lasgun	Bolt Gun	Plasma Pistol	Las Pistol
66-70	Lasgun	Bolt Gun	Plasma Pistol	Bolt Pistol
71-75	Powersword	Hand flamer	Auto Pistol	Lasgun
76-80	Boltgun	Plasma Pistol	Needle Pistol	Powersword
81-85	Hand Flamer	Auto Pistol	Web Gun	Boltgun
86-90	Plasma Pistol	Chainsword	Needle Gun	Hand Flamer
91	Auto Pistol	Respirator	Needle Gun	Plasma Pistol
92	Auto Pistol	Respirator	Needle Gun	Plasma Pistol
93	Auto Pistol	Communicator	Needle Gun	Auto Pistol
94	Auto Pistol	Communicator	Needle Gun	Shield
95	Respirator	Flak Armour	Needle Gun	Shield
96	Shield	Flak Armour	Respirator	Shield
97	Flak body armour	Helmet	Flak body armour	Shield
98	Helmet + communicator and photo visor	Helmet + communicator and photo visor	Helmet + communicator and photo visor	Shield
99	Chainsword	Mesh body armour	Chainsword	Respirator
100	Mesh body armour	Mesh body armour	Mesh body armour	Flak body armour

HENCHMAN AND HARDENED GANG FIGHTER INITIAL EQUIPMENT

Henchmen and Hardened Gang Fighters are entitled to either 3 or 2 rolls as indicated below. Cross reference the dice score to the type of gang - the type of gang influences the kinds of equipment the character has.

D100	CLAN	TECH	VENATORS	SCAVVIES, NOMADS PSYKERS, MUTANTS UNDERCITY GANGS
<i>Rolls</i>	Henchman 3 Hardened Fighter 2	3	3	Henchman 3 Hardened Fighter 2
0-5	Sword	Sword	Autogun	Sword
6-10	Sword	Handbow	Las Pistol	Sword
11-15	Handbow	Stub Gun	Las Pistol	Sword
16-20	Handbow	Shotgun	Bolt Pistol	Handbow
21-25	Stub Gun	Autogun	Bolt Pistol	Handbow
26-30	Stub Gun	Las Pistol	Lasgun	Handbow
31-35	Shotgun	Las Pistol	Lasgun	Stub Gun
36-40	Shotgun	Bolt Pistol	Powersword	Stub Gun
41-45	Autogun	Bolt Pistol	Needle Pistol	Shotgun
46-50	Autogun	Lasgun	Needle Pistol	Shotgun
51-55	Las Pistol	Lasgun	Web Gun	Autogun
56-60	Las Pistol	Powersword	Web Gun	Autogun
61-65	Bolt Pistol	Powersword	Needle Gun	Las Pistol
66-70	Bolt Pistol	Bolt Gun	Needle Gun	Las Pistol
71-75	Lasgun	Bolt Gun	Needle Gun	Bolt Pistol
76-80	Powersword	Hand Flamer	Bolt Gun	Lasgun
81-85	Bolt Gun	Hand Flamer	Bolt Gun	Powersword
86-90	Hand Flamer	Plasma Pistol	Hand Flamer	Bolt Gun
91	Plasma Pistol	Auto Pistol	Plasma Pistol	Hand Flamer
92	Plasma Pistol	Auto Pistol	Plasma Pistol	Hand Flamer
93	Plasma Pistol	Auto Pistol	Plasma Pistol	Plasma Pistol
94	Plasma Pistol	Auto Pistol	Plasma Pistol	Auto Pistol
95	Plasma Pistol	Auto Pistol	Plasma Pistol	Respirator
96	Auto Pistol	Chainsword	Auto Pistol	Shield
97	Auto Pistol	Respirator	Auto Pistol	Shield
98	Respirator	Flak body armour	Respirator	Shield
99	Shield	Flak body armour	Flak body armour	Shield
100	Flak body armour	Communicator	Communicator	Shield

RAW RECRUITS INITIAL EQUIPMENT

Raw Recruits are entitled to either 1 or 2 rolls as indicated below. Cross reference the dice score to the type of gang - the type of gang influences the kinds of equipment the character has.

D100	CLAN	TECH	VENATORS	SCAVVIES, NOMADS PSYKERS, MUTANTS UNDERCITY GANGS
<i>Rolls</i>	<i>1</i>	<i>2</i>	<i>2</i>	<i>1</i>
0-5	Sword	Sword	Sword	Improvised weapon
6-10	Sword	Sword	Sword	Improvised weapon
11-15	Sword	Sword	Handbow	Improvised weapon
16-20	Sword	Handbow	Handbow	Improvised weapon
21-25	Handbow	Handbow	Stub Gun	Improvised weapon
26-30	Handbow	Handbow	Stub Gun	Sword
31-35	Handbow	Stub Gun	Shotgun	Sword
36-40	Handbow	Stub Gun	Shotgun	Handbow
41-45	Stub Gun	Stub Gun	Autogun	Handbow
46-50	Stub Gun	Shotgun	Autogun	Handbow
51-55	Stub gun	Shotgun	Las Pistol	Stub Gun
56-60	Shotgun	Autogun	Las Pistol	Stub Gun
61-65	Shotgun	Autogun	Las Pistol	Shotgun
66-70	Las Pistol	Autogun	Needle Pistol	Shotgun
71-75	Autogun	Las Pistol	Needle Pistol	Autogun
76-80	Las Pistol	Las Pistol	Bolt Pistol	Autogun
81-85	Las Pistol	Las Pistol	Lasgun	Las Pistol
86-90	Bolt Pistol	Bolt Pistol	Web Gun	Bolt Pistol
91	Bolt Pistol	Bolt Pistol	Needle Gun	Lasgun
92	Bolt Pistol	Bolt Pistol	Needle Gun	Lasgun
93	Lasgun	Bolt Pistol	Needle Gun	Lasgun
94	Lasgun	Bolt Pistol	Needle Gun	Shield
95	Lasgun	Lasgun	Needle Gun	Shield
96	Lasgun	Lasgun	Needle Gun	Shield
97	Respirator	Lasgun	Needle Gun	Shield
98	Shield	Lasgun	Needle Gun	Shield
99	Shield	Respirator	Respirator	Shield
100	Shield	Communicator	Communicator	Shield

STASH

All gangs acquire extra equipment, weapons, and ammunition which it could not hope to carry with it all the time. This equipment, called stash, is kept in some safe location known only to the gang leader and his most trusted henchmen.

When new members are recruited they are equipped from the stash, which also forms a reserve of weapons and ammunition which can be used to equip gang members or to trade. When equipment is captured or traded it may be added to the stash. Players keep a record of their gang's stash, preferably on a separate sheet of paper, and can use it as they see fit.

The Stash Chart (see over the page) is used to determine a gang's initial stockpile of stash. Where the chart specifies a type of ammunition the number following is the number of rounds or shots. For example Conventional Ammo (50) is 50 rounds of conventional ammunition, Power Pack (50 points) is a power pack with 50 power points of charge, a Flamer Canister (5) is a canister of flamer ammunition sufficient for 5 shots, and so on. In the case of combat stimulants a roll indicates one dose of one randomly generated type. Ammunition is often harder to come by than weapons, and a gang's stash represents its own secure source of supply. Ammunition may be pooled and shared out among gang members as the player wishes.

CASH

On the hive world wealth is measured in currency units called credits. Among the hive world gangs items are often bartered or exchanged for other items of equivalent value in credits, so credits provide a standard of relative value. A gang's stockpile of credits is kept with the gang's stash in whatever safe location the gang prefers.

The initial wealth of the gang is randomly generated by a D10xD10 roll with suitable modifiers for the gang type. The result indicates the number of credits available to the gang. For example the first roll on the D10 gives a score of 5 and the second roll a score of 7 the initial wealth available to the gang is thus 35 credits.

CREDIT TABLE

	Credits
Clan Gang	D10xD10+25
Undercity Gang	D10xD10
Nomad Gang	D10xD10-50
Scavvy Gang	1D10
Mutant Gang	D10xD10-25
Techno Gang	D10xD10+100
Psyker Gang	D10xD10
Brat Gang	D10xD10+50
Vigilantes	D10xD10+50

STASH CHART

D100	CLAN	TECH	VENATORS	SCAVVIES, NOMADS PSYKERS, MUTANTS UNDERCITY GANGS
Rolls	6	7	7	4
0-5	Conventional Ammo (50)	Conventional Ammo (50)	Conventional Ammo (50)	Conventional Ammo (50)
6-10	Conventional Ammo (50)	Conventional Ammo (50)	Conventional Ammo (50)	Conventional Ammo (50)
11-15	Conventional Ammo (50)	Conventional Ammo (50)	Conventional Ammo (50)	Conventional Ammo (50)
16-20	Conventional Ammo (50)	Conventional Ammo (50)	Power Pack (50 points)	Conventional Ammo (50)
21-25	Conventional Ammo (50)	Power Pack (50 points)	Power Pack (50 points)	Power Pack (50 points)
26-30	Conventional Ammo (50)	Power Pack (50 points)	Power Pack (50 points)	Power Pack (50 points)
31-35	Power Pack (50 points)	Power Pack (50 points)	Power Pack (50 points)	Power Pack (50 points)
36-40	Power Pack (50 points)	Power Pack (50 points)	Power Pack (50 points)	Power Pack (50 points)
41-45	Power Pack (50 points)	Power Pack (50 points)	Handbow Ammo (50)	Power Pack (50 points)
46-50	Power Pack (50 points)	Power Pack (50 points)	Flamer Canister (5)	Power Pack (50 points)
51-55	Power Pack (50 points)	Handbow Ammo (50)	Flamer Canister (5)	Handbow Ammo (50)
56-60	Power Pack (50 points)	Handbow Ammo (50)	Flamer Canister (5)	Handbow Ammo (50)
61-65	Handbow Ammo (50)	Bolt Ammo (15)	Flamer Canister (5)	Handbow Ammo (50)
66-70	Handbow Ammo (50)	Bolt Ammo (15)	Web Chemical Canister	Handbow Ammo (50)
71-75	Bolt Ammo (15)	Flamer Canister (5)	Web Chemical Canister	Handbow Ammo (50)
76-80	Bolt Ammo (15)	Combat Stimulant	Needle Chemical Canister	Bolt Ammo (15)
81-85	Flamer Canister (5)	D6 Frag Grenades	Needle Chemical Canister	Bolt Ammo (15)
86-90	Combat Stimulant	D6 Frag Grenades	Needle Chemical Canister	Flamer Canister (5)
91	D6 Frag Grenade	1 Krak Grenade	D6 Frag Grenades	Combat Stimulant
92	D6 Frag Grenade	1 Krak Grenade	D6 Frag Grenades	Combat Stimulant
93	D6 Frag Grenade	1 Krak Grenade	D6 Frag Grenades	Combat Stimulant
94	D6 Frag Grenade	D6 Smoke Grenades	D6 Frag Grenades	Combat Stimulant
95	D6 Frag Grenade	D6 Smoke Grenades	D6 Frag Grenades	Combat Stimulant
96	1 Krak Grenade	D6 Smoke Grenades	D6 Stumm Grenades	D6 Frag Grenades
97	1 Krak Grenade	1 Stumm Grenade	D6 Stumm Grenades	D6 Frag Grenades
98	1 Krak Grenade	1 Stumm Grenade	D6 Stumm Grenades	D6 Frag Grenades
99	1 Krak Grenade	1 Stumm Grenade	D6 Stumm Grenades	D6 Frag Grenades
100	Medi-Pack	Medi Pack	D6 Stumm Grenades	D6 Frag Grenades

SKILLS

Gang fighters lead tough lives and if they survive long enough, may acquire certain special skills as a result of their experience in gang warfare. For example, a character may earn a reputation as a sniper or a dealer, or he might be considered so cool and daring that he has 'nerves of steel'. The range of skills are fully defined later. For the initial generation of the gang, only the leader and henchmen are considered likely to have already acquired such a skill, although as the gang develops other characters may also acquire skills as they become more experienced.

Roll a D100 on the Skill Generation Chart to determine whether the leader and any henchmen in the gang start off with a skill and if so, what that skill may be. Roll once for the leader on the D100 score column for Leader, then roll for each henchman on the D100 column for henchman.

SKILL GENERATION CHART

D100	SKILL	
LEADER	HENCHMAN	
1-20	1-50	No Skill
21-28	51-55	Sixth Sense
29-36	56-60	Nerves of Steel
37-44	61-65	Ambidextrous
45-52	66-70	Sniper
53-60	71-75	Medic
61-68	76-80	Rogue
69-76	81-85	Dealer
77-84	86-90	Fast Draw
85-92	91-95	Lightning Reactions
93-100	96-00	Fighter

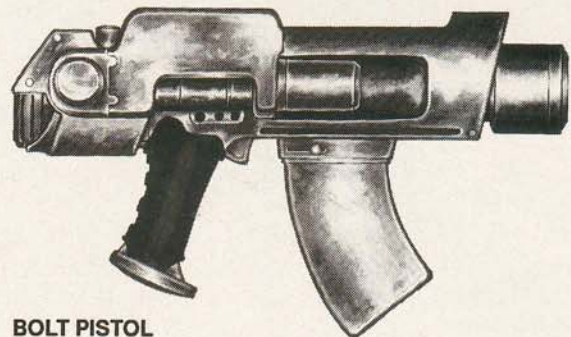

BOLT PISTOL

AMBIDEXTROUS

A character who is ambidextrous ignores the shooting penalty for firing with the left hand, and the hand-to-hand combat roll penalty for using a weapon in the left hand. The character is in effect neither right nor left handed, but can use both hands equally well. Although characters who are naturally right or left handed cannot literally become ambidextrous, we assume they gain this ability as a result of experience and practice.

DEALER

The character has good contacts with other gangs or the better traders. If a gang includes a character with dealer skill, it will be easier to get hold of rarer weapons. When rolling to determine whether a weapon or item of equipment is available, the gang may add +10% to its chance of success.

FAST DRAW

The character can draw and fire a pistol with super-human speed and accuracy. This could be the result of intensive combat experience, long practice, or simply an innate ability. The character may draw and fire a pistol as 1 action. He may also draw and fire a pistol when snap firing, in which case the character misses his next turn as normal, but counts his full chance of hitting. A normal snap firing shot is at half the normal chance of hitting (see *Snap Firing*).

FIGHTER

The character is a ruthless, highly efficient hand-to-hand fighter. In hand-to-hand combat double his combat dice roll. This applies in addition to any multiplier for fighting defensively. For example, the character may fight defensively and multiply his dice roll by 4. If the character is wearing power or exo-armor the additional Fighter multiplier is ignored. The weight and encumbrance of the armour cancels out the ability conferred by the skill.

LIGHTNING REACTIONS

The character has naturally fast reactions. If he shares an initiative score with another character, he takes precedence in the turn sequence. If two or more characters have the same initiative and Lightning Reactions dice for precedence as normal. If the character is called upon to make a reaction roll his chance of success is increased from the normal 30% to 60%.

MEDIC

This skill is fairly self explanatory. The character is either a trained medic, has practical experience, or is just unusually gifted. The presence of a medic in the gang means a wounded character is more likely to recover after the encounter. When rolling on the Wound Recovery Chart add +1 to the score. This is additional to any bonus for a Medi-kit. Note that a character can never use his healing powers on himself. If a medic is seriously wounded during a game he cannot use his power to help other wounded characters recover.

NERVES OF STEEL

If a character has Nerves of Steel he may ignore duckback results if he wishes. He never panics if covered by a web.

ROGUE

This character is a natural loner. He doesn't mind joining up with a gang, but he knows he can get by on his own if he needs to. A character with Rogue skill can act independently of a gang group on the tabletop and does not have to belong to a gang group as the other gang members do.

SIXTH SENSE

Sixth Sense isn't really a special power, it just reflects the fact that the character's normal senses and mind are especially sharp. To his comrades his uncanny ability to 'feel' he is being watched seems almost magical. If the character approaches hidden mines, concealed enemy,

or unseen danger of any type there is a 75% chance that he will be aware of the danger.

If a GM is available he will make the roll secretly. Otherwise the player can make the roll at the beginning of his turn, the opposing player must then be honest about any hidden dangers. The Sixth Sense ability detects any hidden danger within 10 metres (5") of the character, and to any enemy model aiming at him from any distance.

SNIPER

The Sniper skill can only be used by characters who have a BS of 150 or more. If a character gains the skill but does not have a BS high enough to use it, the skill is recorded and comes into play when the BS reaches 150.

A character with this skill may use it when firing a single aimed shot. The chance of hitting your target is not increased, but the sniper may add or subtract up to 10 from the hit location table of his victims. A sniper is therefore far more likely to hit a vital spot compared to an ordinary character.

CARYATIDS

Caryatids are small blue, winged, humanoid creatures which inhabit the hives of Necromunda. They are mildly psychic creatures and tend to attach themselves to charismatic individuals and are considered a sign of good fortune. They are also useful since they can psychically penetrate the minds of others and recognise malintent against their adopted human.

Successful gang leaders and even henchmen often have Caryatids in attendance. Any character generated with a prestige rating of 12 or more, or whose prestige reaches 12 as a result of experience gained in play, tests to determine if they have been adopted by a Caryatid. There is a 50% chance that a Caryatid will latch onto the character. Once a character's prestige reaches 12 then every time his prestige goes up 1 level he also tests to see if another Caryatid appears - the chance is once again 50%. This means that a character with a very high prestige level may have several Caryatids in his retinue.



EAZY METAL

The markings on Tyranids and their bio-constructed creatures are a result of their genetic cloning by the Norn-Queen. Genestealers, of course, reproduce by using humans and other races as hosts, but their race memory often leads them to use Norn-Queen patterns as the basis for their coven warpaint.



Third Generation Hybrid with autocannon.



Fourth generation Hybrid with bolter.



Purestrain Genestealer

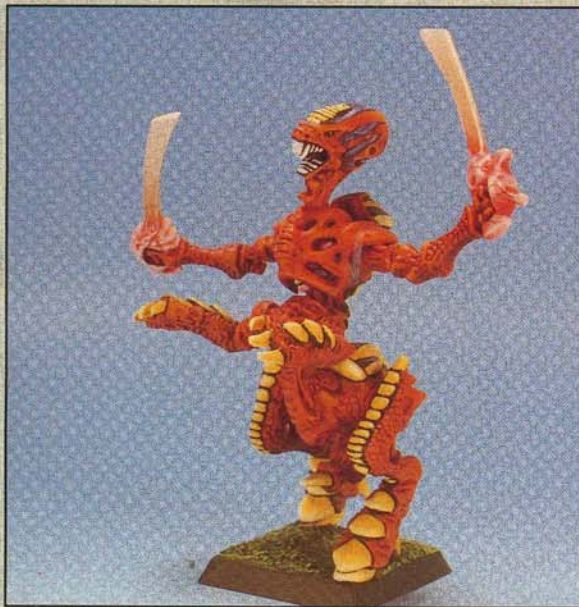

Tyranid Warrior with two Boneswords.



Tyranid Warrior with two Boneswords.



Tyranid Warrior with Deathspitter.



Tyranid Warrior with Deathspitter.

SPACE MARINE SCOUTS



A Scythes of the Emperor Scout with combat knife and laser-sighted bolt pistol.



An Ultramarine Scout armed with combat knife and bolt pistol.

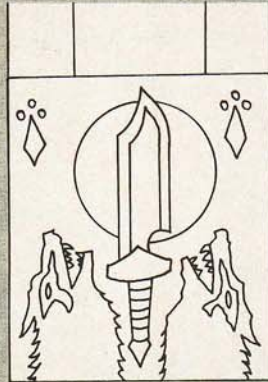

SPACE WOLVES

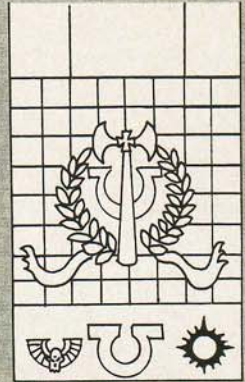

ULTRAMARINES

The back banners carried by the Space Wolves and Ultramarine Sergeants shown in the photos below are reproduced here for you to photocopy, colour and use on your own models



This Veteran Blood Angel Scout Sergeant has both campaign markings and honours on his legs



A Scythes of the Emperor Scout armed with combat knife and heavy bolter.



A Dark Angel Scout armed with bolt pistol and combat knife.



Four Space Wolves Scouts with their Veteran Space Marine Sergeant from the 1st Squad (shown by the black breast plate with a white triangle) of the Scout Company.



These Ultramarine Scouts belong to the 8th Squad of the Scout Company, as shown by the device on their breast plates. Their Veteran Space Marine Sergeant displays his campaign markings and honour badges on his backbanner and legs.

ADVANCED SPACE CRUSADE IMPERIAL GUARD

BY JERVIS JOHNSON

The Imperial Guard make up the vast bulk of the Imperial military machine. Regiments are recruited from the Imperium's millions of worlds, forming a huge force of Humans and Abhumans.

This article contains rules for using the Imperial Guard in your games of Advanced Space Crusade with a complete Imperial Guard force list. You can either launch assaults using only the Imperial Guard, or you can include them as part of your Space Marine force.

Each regiment in the Imperial Guard is raised from a single homeworld, and the Imperial Guard trooper regards himself as belonging first and foremost to his regiment ahead of family and planet of birth. Regiments are divided into companies, which vary widely in their size and composition, and then into platoons made up of a number of Imperial Guard squads led by a group of officers and a command section.

When it recruits a regiment, the Imperial Guard creams off the elite of the homeworld's Planetary Defence Force. Regimental quotas are normally set for each generation but, in times of great need, the Administratum may require a planet to supply many regiments from a single generation. The Horus Heresy was one such time of need – the attack of Hive Fleet Kraken is an equal threat to the safety of the Imperium.

It is considered a great honour to be chosen for recruitment into the Imperial Guard and many young hopefuls flock to the Planetary Defence Force in the hope of being found worthy of the Guard. Methods of recruitment vary according to the world involved. On hive worlds such as Necromunda, it is common to draft entire street gangs into the Planetary Defence Force, the gang leaders becoming officers. The most successful gangs become platoons or even whole companies in the Imperial Guard.

On feral and medieval worlds, the Planetary Defence Force is recruited from the warrior caste by a series ordeals and given names such as the Knights of the Star Lord or the Eagle Warriors. The greatest of these, chosen again by trial, may join the Warriors from the Stars when their great ships come out of the sky.

Particularly on feral worlds and amongst hive world gangs, the taking of scalps, ears and other trophies is encouraged as an index of martial prowess. On Necromunda, for example, many gangs take the smallest finger of the right hand as a trophy. Trophies are all-important proof of martial prowess and thus of worthiness to join the Imperial Guard

When they join the Imperial Guard, recruits are already partially trained by virtue of their service with the Planetary Defence Forces. Advanced weapons training and various drills take place during the long voyage from the regiment's homeworld to their posting. By the time an Imperial Guard regiment arrives at its destination, it is a highly-trained and cohesive force, ready for almost any eventuality.

A successful regiment can look forward to being granted the overlordship of the planet to which they are posted. If the planet remains peaceful and meets its quotas, the regimental commander may in time be rewarded with the title of Imperial Commander and governorship of the planet and – substantial land grants may be made to Guard veterans who retire from active service due to old age.

In due course, the regiment will become a hereditary nobility, almost indistinguishable from the native population. The descendants of the first garrison may well be recruited, first into the Planetary Defence Force and then into the Imperial Guard regiments that are raised from the planet.

Although many of the boarding actions performed against Tyranid ships are made by the Space Marines, the Imperial Guard have their part to play. Imperial Guard squads may be temporarily attached to Space Marine assault groups, even to the extent that the number of Imperial Guardsmen greatly outnumber the Space Marines in the force (although the Space Marines are, of course, still in command).

The Imperial Guard also provide boarding parties on the Imperial Navy patrol craft that orbit the regiment's homeworld, in which case Imperial Guardsmen will make up the entire force.

The following new rules allow you to add the Imperial Guard to your games of Advanced Space Crusade and recreate another facet of the Imperium's desperate struggle against Hive Fleet Kraken.

LAUNCHING AN ASSAULT

The Imperial Guard use very similar tactics to the Space Marines when assaulting a Tyranid spaceship, advancing on three lines of attack in order to locate and destroy the ship's vital organs. When playing with an assault force of Imperial Guard, you therefore use the Strategic Display exactly the same as if you were playing a Space Marine force. Deployment, exploration and battles are also handled in the same way.

The only exceptions to the normal rules for playing with Space Marines are given below. They recreate the different squad and platoon organisation of the Imperial Guard and the weapons they carry that aren't normally carried by Space Marines.

IMPERIAL GUARD OFFICERS

The Imperial Guard has a rigid command structure. Platoons are led by officers, chosen because they were the leaders of the warband or gang that was originally recruited into the Guard. In overall command of a platoon is usually a **Captain**, who is supported by several **Lieutenants**. If their officer is killed, an Imperial Guard squad tends to go to ground, tenaciously defending the territory it has captured but failing to carry out any direct offensive actions.

Included in the category of Imperial Guard officers are **Commissars**. It is the Commissars who increase the troops' awareness of Imperial ideals, disseminate the wisdom of the Imperium to the ranks and maintain discipline. They are also perfectly capable of taking charge of Imperial Guard squads and leading them into battle.

Number of Officers

An Imperial Guard force always includes one **Captain** – it can't include more than one. The **Captain** is attached to a command section at all times.

An Imperial Guard force may also include up to one **Commissar** and any number of **Lieutenants**. **Commissars** and **Lieutenants** don't have to be attached to command sections.

Note that **Sergeants**, **Medics** and **Orderlies** are not officers.

Command Sections

An Imperial Guard force always includes at least one command section – this is the one the **Captain** is attached to.

You can include as many more command sections as you want, provided each one has a **Lieutenant** and/or a **Commissar** attached to it.

Officers attached to command sections aren't represented by a separate squad counter – simply record the officer's characteristics on your roster as part of the section. As long as every command section has an officer, you can have extra officers that aren't attached to command sections and have their own squad counters.



Lasgun



KEVIN WALKER

Promoting Sergeants

If all the officers in an Imperial Guard force are killed, you can pick one **Sergeant** and give him a field promotion to the brevet rank of **Lieutenant**. This represents the most senior **Sergeant** taking temporary command of the Guardsmen. Obviously, the **Sergeant's** characteristics aren't changed – just make a note on the roster that he's been promoted.

If the newly-promoted brevet **Lieutenant** is killed, you can pick another **Sergeant** to promote. If there are no **Sergeants** remaining alive, the **Guardsmen** are left without orders and immediately begin to retreat – the Imperial Guard player loses the game.

Officers and Exploring

Officers affect the ability of Imperial Guard squads to deploy, explore and fight in battles. In order for Imperial Guard squads to do any of these things, there must be an officer in the same box (recon squad, assault forces or reserves) on the Strategic Display.

If any box doesn't have an officer in it, the Imperial Guard forces represented by the counters in that box can't do anything that turn – they can't move to another box, turn over exploration cards or take part in a battle.

Note that an officer which is represented by a separate counter doesn't have to move with the squads when they redeploy – he can stay in the same box. If he's attached to a squad (such as the **Captain** attached to a command section), he always moves with the squad.

Because of their importance in exploring the ship, you should include quite a few officers in your force. For most games you'll need a minimum of 7 officers (one for each box on the Strategic Display) – it often helps to have 8, 9 or even more!

IMPERIAL GUARD SQUADS

Because of its enormous size, the Imperial Guard is an incredibly diverse organisation. To define every variation of troop organisation and equipment would fill the pages of *White Dwarf* for years to come, so we must confine ourselves to standard issue equipment and common troop types.

Most Imperial Guardsmen wear flak armour and the most common weapons used are the lasgun and laspistol. Although not quite as effective as boltguns, laser weapons are easy to manufacture, rarely need to be reloaded and are almost impossible to break, making them the ideal weapon for the Imperial Guard. Squads also carry heavier weapons to lay down supporting fire, such as lascannon and grenade launchers.

Like the Space Marines, Imperial Guard squads are organised into different types of squad, each of which fulfills a different battlefield role. The squads most commonly used in assaulting Tyranid spacecraft are **tactical squads** and **assault squads**. Tactical squads are the standard Imperial Guard squad type, flexible enough to fight in most circumstances. Assault Squads are armed with laspistols and plasma guns in order to fight the enemy at close quarters.

Recon

Because an Imperial Guard squad needs an officer in command to be able to explore, you can put two squad counters into the recon box on the Strategic Display, provided one is a squad of troopers and the other is an officer. Alternatively, of course, you can use a squad that has an officer permanently attached (in which case, you can only have one counter in the recon box).

Ambushes

As Imperial Guard squads have 10 men, the set up for an ambush can become unrealistically crowded. To stop this happening, you only set up 5 men on the central board section. Any remaining members of the recon squad must be set up on board section one (the board section that leads to the Imperial Guard entry/exit area).

ABHUMANS

Imperial Guard forces may include squads of **Beastmen** or **Ogryns**, creatures of mutated human stock. Beastmen are noted for their aggression and determination, and their fierce devotion to the Imperial cult, hoping to atone for their sin of being born mutants. Ogryns are large, powerfully-built Abhumans, valuable because of their strength, bravery and unflinching loyalty to both the Imperium and their fellow troopers.

Neither of these races is noted for their intelligence and to reflect this they may only be given an extra action if they are within 6 squares of the Packmaster or Leader of their squad or any Imperial Guard officer.

EXTRA ACTIONS

When using an Imperial Guard force, subtract -2 from the dice when you roll for extra actions. This modifier is increased to -4 if the Captain in command of the force has been killed.

Officers and Sergeants that are involved in the battle give bonuses to extra action rolls which may offset this penalty.

CHOOSING AN IMPERIAL GUARD FORCE

If you choose to field an Imperial Guard force you can use any of the units shown on the Imperial Guard force list.

Use the Force Points Table just as if you were choosing a Space Marine force – the same maximum number of force points and required number of victory points apply.

Once you've chosen your force, record it on the force roster as usual, using the squad counters you'd normally use for Space Marines.

To summarise the restrictions for different troop types mentioned already:

Troop Type	Minimum	Maximum
Captain	1	1
Lieutenant	0	any
Commissar	0	1
Command Section	1	any
All other types	any	any

IMPERIAL GUARD IN SPACE MARINE FORCES

If you're picking a Space Marine force, you can include Imperial Guard units. The types of units you may choose are limited, as Space Marines won't serve alongside the tainted Abhuman units that are included as part of the Imperial Guard.

When an Imperial Guard force is part of a Space Marine force, any Space Marine officer or squad can command the Guardsmen. Imperial Guard squads can redeploy, explore and fight battles provided an Imperial Guard officer or any Space Marines are in the same box on the Strategic Display.

Because they're under the command of the Space Marines, you don't have to pick an Imperial Guard Captain and command section, though you can include them if you want. For Imperial Guard attached to Space Marine forces, the restrictions on troop types are:

Troop Type	Minimum	Maximum
Captain	0	1
Lieutenant	0	any
Commissar	0	1
Command Section	0	any
Beastmen and Ogryns	0	0
All other types	any	any

When you're fighting a battle with a combined Space Marine and Imperial Guard force, you also ignore the normal penalty that the Imperial Guard suffer when rolling for extra actions – the Guardsmen are inspired by fighting alongside humanity's elite warriors.

GAME VARIANTS

You can use Imperial Guard squads as Tyranid mind slaves. If they're mind slaves, you don't have to worry about officers and command squads – just use whatever squads or officers you want at the points listed and allocate a mind slave counter to each squad or officer. The Mind-Slaver totally controls the Guardsmen so ignore all penalties and bonuses for extra action rolls – officers don't get any fate points.

NEW WEAPONS

The Imperial Guard regularly use a number of weapons not normally employed by Space Marines, namely lascannon, grenade launchers and bomb harnesses.

Special rules for these weapons are included below.

LASCANNON

Lascannon are extremely powerful weapons, primarily designed for use against heavily-armoured targets. The laser energy they release impacts with explosive force, literally disintegrating a target. With a to hit roll of 1D+9, even the most heavily-armed targets stand no chance against a well-aimed shot from a lascannon.

BOMB HARNESS

Penal Battalions contain troops in the service of the Imperium who have committed capital crimes. The troops sentenced to penal battalions are there for life – with one very important exception. Penal Battalion troopers may volunteer for service as **Human Bombs**.

This is not as terminal as it may sound – a percentage of bomb harnesses are designed not to go off and any trooper who survives the the battle is freed from the Penal Battalion. This is a way for the Penal Battalion troopers to escape their sentence with integrity or at least to die with honour in the service of their Emperor.

You may include Penal Battalion Human Bombs in your force at a cost of 10 points each. Any Human Bombs you purchase are attached to a command section and are treated as part of the command section for the rest of the game.

Human Bombs move and attack normally. They don't have any ranged weapons and can only attack in close combat or by detonating their bomb harness. The Human Bomb may attempt to detonate a bomb harness at any time instead of moving one square – it doesn't matter what action has been chosen, just so long as the model has a square of movement left in its action. Bomb harnesses may not be detonated as a reaction.

Roll a D12 when you detonate the bomb harness. On a roll of 1 or 2, the harness is a dud and doesn't explode – the Human Bomb is unharmed. On a roll of 3-12, the harness explodes. If the Human Bomb is killed by an enemy ranged attack or in close combat, roll to see if the harness explodes just as if it had been detonated by the model.

If the harness was a dud, the Penal Battalion trooper is a free man and attempts to head back to the Entry Points board section. You can move the model normally, except you can't move it into a square adjacent to an enemy model. You can't make a close combat attack with the model but it can defend if attacked in close combat. If the trooper makes it to the Entry Points he's removed from play and takes no further part in the game.

If the harness explodes, the Human Bomb is killed. Any model in an adjacent square is attacked with a to hit roll of 1D+3 and models within 2 squares (provided there's not an intervening blocked square) are attacked with a to hit roll of 1D+1.

GRENADE LAUNCHERS

Grenade launchers are capable of firing most of the grenades used by Imperial troops. Their range is restricted when fired inside a ship, as it's impossible to lob the grenades in the standard manner used with this weapon.

The grenade launcher is a single-shot weapon, and must be reloaded after each use. The type of grenade being used is specified when the launcher is loaded. Photocopy the frag and blind grenade counters we've provided and stick them to sturdy card. At the start of a battle, take the appropriate counter and place it by the model. When the grenade launcher is fired, use the counter to indicate the grenade's target square and then discard it. When the grenade launcher is reloaded, choose which grenade type is being loaded and place the appropriate counter by the model again. Even if the weapon hasn't been fired, you can change from one ammo type to another with a reload action – just swap the grenade counters to show the new ammo type.

You don't move grenades from a grenade launcher one square for bounce – just pick a target square within the firer's line of sight, fire arc and range and scatter the grenade from that point.



ADVANCED SPACE CRUSADE ERRATA

Unfortunately, the first few rulebooks printed for Advanced Space Crusade have a number of errors. The necessary corrections are listed below with our apologies.

On the Space Marine force list, the heavy plasma gun carried by the Space Marine tactical squad is actually a plasma gun. The gun's characteristics are unchanged but the Space Marine is manoeuvrable (delete the U in the manoeuvrability column). The heavy plasma gun description on page 49 actually refers to the plasma gun.

Also on the force list, note 4 for the Space Marine assault squad is wrong. Space Marines can't fire both weapons simultaneously – they fire one or other weapon, not both!

On the Tyranid force list, the weapon characteristics for the Genestealer Hybrid with laspistol are wrong: the range should read 8 for snap fire and 16 for aimed fire. The Hybrid with plasma gun can't snap fire – delete the snap fire range and to hit roll.

On page 45, some of the strangers' stats are wrong: the Squat and Eldar weapon characteristics should both read 12 for snap fire range, 1D for snap fire to hit roll, 24 for aimed fire range and 1D+2 for aimed fire to hit roll; the Imperial Guardsman should read 7 for exposed armour rating and 9 for in cover armour rating; the Ogryn should read 6 for movement, 5 for reaction, 12 for both armour ratings and 1D+7 for close combat to hit roll.

Finally, the rules for frag grenades on page 51 give the wrong to hit rolls. A frag grenade attacks targets in the square where it lands with a to hit roll of 1D+3, and targets in adjacent squares with 1D+1.

IMPERIAL GUARD FORCE LIST

IMPERIAL GUARD OFFICERS

20 POINTS EACH

Name	Movement		Reaction	Armour		Weapons	Ammo	Target	Snap Fire		Aimed Fire		Close Combat	
	Speed	Man.		Exposed	In Cover				Range	To Hit	Range	To Hit	To Hit	Parry
Guard Captain ¹	4	-	10	8	10	Laspistol & Chainsword	U	-	8	1D	16	1D+2	2D+3	P
Lieutenant ²	4	-	8	7	9	Laspistol & Chainsword	U	-	8	1D	16	1D+2	2D+1	P
Commissar ³	4	-	10	7	9	Laspistol & Chainsword	U	-	8	1D	16	1D+2	2D+3	P

Notes: 1) Captain has 1 fate point - adds +2 to Imperial Guard's roll for extra actions. 3) Commissar has 1 fate point - adds +2 to Imperial Guard's roll for extra actions.
2) Lieutenant adds +1 to Imperial Guard's roll for extra actions. (Force must include 1 Captain, plus up to 1 Commissar and any number of Lieutenants).

IMPERIAL GUARD COMMAND SECTION

150 POINTS FOR 1 MEDIC, 1 SERGEANT, 1 ORDERLY AND 2 GUARDSMEN WITH LASCANNON

Name	Movement		Reaction	Armour		Weapons	Ammo	Target	Snap Fire		Aimed Fire		Close Combat	
	Speed	Man.		Exposed	In Cover				Range	To Hit	Range	To Hit	To Hit	Parry
Medic ¹	4	-	9	7	10	Laspistol	U	-	8	1D	16	1D+2	1D+3	-
Sergeant ²	4	-	8	7	9	Laspistol & Chainsword	U	-	8	1D	16	1D+2	2D+1	P
Orderly	4	-	7	7	9	Laspistol	U	-	8	1D	16	1D+1	1D	-
Guardsmen	4	U	7	7	9	Lascannon ³	U	-	-	-	U	1D+9	1D-1	-

Notes: Each Imperial Guard force includes 1 to any number of command sections. 1) Medic has 1 fate point.
Each command section must be led by an officer. 2) Sergeant adds +1 to Imperial Guard's roll for extra actions.
All Guardsmen are equipped with frag grenades. 3) Targets attacked by a lascannon may make a reaction roll to dive prone.

IMPERIAL GUARD TACTICAL SQUAD

150 POINTS FOR 1 SERGEANT, 1 GUARDSMAN WITH LASCANNON, 1 GUARDSMAN WITH GRENADE LAUNCHER AND 7 GUARDSMEN WITH LASGUNS

Name	Movement		Reaction	Armour		Weapons	Ammo	Target	Snap Fire		Aimed Fire		Close Combat	
	Speed	Man.		Exposed	In Cover				Range	To Hit	Range	To Hit	To Hit	Parry
Sergeant ¹	4	-	8	7	9	Laspistol & Chainsword	U	-	8	1D	16	1D+2	2D+1	P
Guardsmen	4	-	7	7	9	Grenade Launcher	S	A ²	8	*2	16	*2	1D	-
Guardsmen	4	U	7	7	9	Lascannon ³	U	-	-	-	U	1D+9	1D-1	-
Guardsmen	4	-	7	7	9	Lasgun	U	-	12	1D	24	1D+2	1D	-

Notes: All Guardsmen are equipped with frag grenades. 2) Area effect and roll to hit depend on type of grenade: fires frag or blind.
1) Sergeant adds +1 to Imperial Guard's roll for extra actions. 3) Targets attacked by a lascannon may make a reaction roll to dive prone.

IMPERIAL GUARD ASSAULT SQUAD

150 POINTS FOR SERGEANT, 2 GUARDSMEN WITH PLASMA GUNS AND 7 GUARDSMEN WITH LASPISTOLS

Name	Movement		Reaction	Armour		Weapons	Ammo	Target	Snap Fire		Aimed Fire		Close Combat	
	Speed	Man.		Exposed	In Cover				Range	To Hit	Range	To Hit	To Hit	Parry
Sergeant ¹	4	-	8	7	9	Laspistol & Chainsword	U	-	8	1D	16	1D+2	2D+1	P
Guardsmen	4	-	7	7	9	Plasma Gun	S	A ²	-	-	8 ²	1D+4	1D	-
Guardsmen	4	-	7	7	9	2 Laspistols	U	-	12	1D	24	1D+2	2D	-

Notes: All Guardsmen are equipped with frag and blind grenades. 2) Use plasma bolt template - place the template pointing from model's square and within its fire arc - any square half or more under the template is attacked.
1) Sergeant adds +1 to Imperial Guard's roll for extra actions.

BEASTMAN ATTACK SQUAD

100 POINTS FOR 1 PACKMASTER AND 9 BEASTMEN

Name	Movement		Reaction	Armour		Weapons	Ammo	Target	Snap Fire		Aimed Fire		Close Combat	
	Speed	Man.		Exposed	In Cover				Range	To Hit	Range	To Hit	To Hit	Parry
Packmaster	5	-	8	9	10	Power Sword & Hand Flamer	2	-	4	1D+2 ¹	-	-	1D+4	P
Beastman ²	5	-	7	9	10	Hand Weapons	-	-	-	-	-	-	2D+2	-

Notes: 1) Roll to hit against exposed armour rating, even if target is in cover or prone. 2) May only take extra action if within 6 squares of Packmaster or officer.

OGRYN SQUAD

150 POINTS FOR 1 LEADER AND 4 OGRYNS

Name	Movement		Reaction	Armour		Weapons	Ammo	Target	Snap Fire		Aimed Fire		Close Combat	
	Speed	Man.		Exposed	In Cover				Range	To Hit	Range	To Hit	To Hit	Parry
Leader	6	U	6	12	12	Ripper Gun	2	-	4	3D+1	-	-	1D+7	-
Ogryn ¹	6	U	5	12	12	Hand Weapons	-	-	-	-	-	-	1D+7	-

Notes: 1) May only take extra action if within 6 squares of Leader or officer.

IMPERIAL GUARD PENAL BATTALION

10 POINTS FOR 1 HUMAN BOMB

Name	Movement		Reaction	Armour		Weapons	Ammo	Target	Snap Fire		Aimed Fire		Close Combat	
	Speed	Man.		Exposed	In Cover				Range	To Hit	Range	To Hit	To Hit	Parry
Human Bomb	4	-	7	7	9	Bomb Harness	-	-	-	-	-	-	1D	-

Notes: Bomb may be set off using any action, instead of moving one square - roll 1D12 - on a score of 1 or 2 bomb is a dud; 3+ bomb explodes - if bomb explodes, Human Bomb is killed, adjacent squares attacked at 1D+3, targets within 2 squares at 1D+1 - roll to see if Human Bomb explodes if killed by shooting or close combat.

ADVANCED SPACE CRUSADE

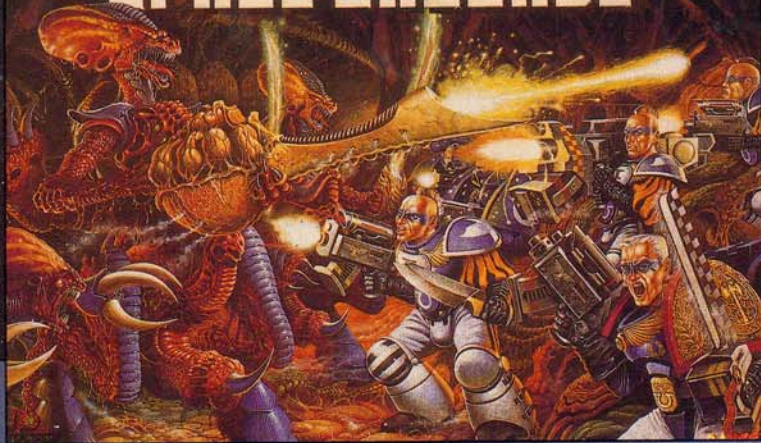

Recreate the ultimate struggle between the noble defenders of humanity and the alien hordes of the Tyranids.

Board the immense living bio-construct ships of Hive Fleet Kraken, explore the intestinal labyrinths within, and do battle with the terrifying warriors of the Hive Mind.



Models are unpainted and require assembly with glue (not supplied)

The Advanced Space Crusade game boards jigsaw together in a variety of layouts to represent the innards of a huge Tyranid spacecraft. One player controls the Space Marine Scouts who explore the living vessel, penetrate its most important organs and attempt to destroy the entire ship by sabotaging vital organic devices. The attacking forces must be chosen and deployed with extreme care. Recon Squads lead the way through slime-coated passages, constantly at risk from Tyranid ambushes. Behind them come the Assault Forces, hopefully ready to deal with whatever defences await.

The other player represents the Tyranids who must try to stop the Scouts by deploying Tyranid Warriors from the defence of one part of the ship to another, waylaying and slaying the Scouts if they can. Great cunning must be used to avoid spreading the defence too thin, or concentrating it too tightly – either way can spell defeat.

Ship exploration is handled by an ingenious system of encounter cards, evoking the tension of hunting through the bewildering interior of a Tyranid vessel, as well as ensuring that no two games are ever quite the same.

Advanced Space Crusade has been designed so that collectors of Citadel Miniatures can use the Warhammer 40,000 models they already own. For example, the Space Marine player's force can include Imperial Guard Troopers, Space Marines, and/or Terminators. The Tyranid player can use any of the monstrous bio-constructed creatures, such as Genestealers, Zoats, and indeed the whole host of Tyranid models from Citadel Miniatures.



CITADEL
MINIATURES

Advanced Space Crusade contains: 21 Citadel Miniatures (6 Tyranid Warriors, 15 Space Marine Scouts - including 3 with heavy bolters and 3 Veteran Sergeants); 6 interlocking, colour board sections; 6 colour overlays representing the Tyranid ship's vital organs; Space Marine player's Strategic Display; Tyranid player's Hive Network; hidden set-up counters and tiles; weapon markers and area effect templates; 16 doors and bases; 36 exploration cards; 24 Space Marine force counters; 24 alien blips; fully detailed rules and background book.

GAMES
WORKSHOP

WARHAMMER FANTASY ROLE PLAY

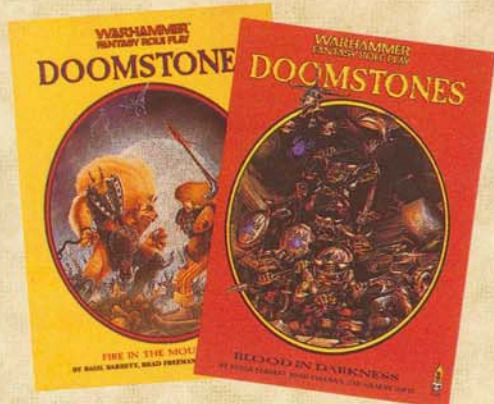

FIRE IN THE MOUNTAINS £7.99 BLOOD IN DARKNESS £6.99

"The Orc Hordes surround us, their number is many. We sense the presence of a mighty artefact. Please send us aid. The thing they have must not remain with them, nor must our secrets fall into their foul hands."

A mysterious message sends the adventurers off on a hundred year old trail into the Vaults Mountains. Their objective: find one of the Doomstones, a long-lost artefact. Finding what proves to be only the first Doomstone is the least of the adventurers' problems. Along the way, they'll have to defeat a long-dead Orc sorcerer-chieftain and stay off the dinner menu at an Ogre shrine... Each adventure includes player handouts and a model of a Doomstone crystal for you to build. The campaign is continued in *Death Rock*, also available now!

LICHEMASTER £7.99

"I am the means of your vengeance, Heinrich Kemmler. I am your greatest desire. You want to be strong, do you not? You want to be avenged?"

High in the Grey Mountains, chance brings the meeting of a madman and a Daemon. And thanks to that meeting, an army of the Undead is gathering among the high peaks. In an isolated monastery, one senior monk suspects the truth. But when - and where - will the Undead appear? How can they be stopped? *Lichemaster* is a 104 page adventure including handouts, and sample adventurers.

WFRP CHARACTER PACK £4.99

50 WFRP character sheets, plus an all-new 16-page booklet detailing the Graf Manfred - a large city inn and adventuring base, complete with 22 ready-to-use NPCs and adventure outlines to get you started.

MAIL ORDER

Make cheques payable to **Flame Publications**. Please make all payments in Pounds Sterling. Handling charges on UK, Eire and BFPO orders: add £2.50 for all orders. Overseas airmail: minimum order £5.00, add 40% for handling (minimum £2.50). Telephone orders direct to us on (0602) 500459, Monday-Friday 10 am-5 pm. Or send SSAE to the address below for Mail Order details. In the USA contact Games Workshop US Mail Order.

FLAME

PUBLICATIONS
3 DERBY TERRACE DERBY ROAD NOTTINGHAM NG7 1ND



"If you can't recognise a good manuscript when you see one, spot the deliberate (ahem) mistakes in a piece of text, write up an NPC at the drop of a hat, lay out a page (with a little help from the computer), know about most things in WFRP from Alchemists to Zoats, do about 1001 other things (at the same time) and make a good cup of coffee then we don't want to hear from you. But if you can..."

...there's a job for you at Flame Publications. We produce Warhammer Fantasy Roleplay material under licence from Games Workshop.

We are looking for people to work at Flame. There's no job description or title. We're too small for that kind of formality - if something needs doing, you'll be expected to help do it... There's an interesting, creative and utterly unpredictable job waiting for the right person.

If this sounds good, you might want to know more. A professional attitude counts for a lot. A good knowledge of Warhammer Fantasy Roleplay counts for more. Then you should have a good command of English, plus a willingness to learn. If you know one end of a mouse from the other and have experience of Macintosh-based DTP systems (or 'traditional' publishing experience), that won't hurt your chances either. It might sound like a tall order and you're right, it is - Flame is a small operation and needs commitment.

For further details, write to Mike Brunton at the address below. Please enclose a CV and details of your gaming experience.

Flame Publications
3 Derby Terrace
Derby Road
Nottingham NG7 1ND



MIGHTY EMPIRES™

This month we continue with new rules for the Necropolis: a Wilderness Location available shortly as a metal model. We have also taken the opportunity to print some extra map tiles from the original artwork, adding some solid blue tiles which will enable you to fill in odd sea areas should you wish. These tiles may be cut out, mounted onto suitable card, and included in the existing packs.

WILDERNESS LOCATIONS

Until we have designed sufficient new models and published rules for all wilderness locations, players may prefer to use an alternative method of determining locations to that given in WD131. This method allows you to use the models that you already have and ignores results which are as yet undescribed. When you explore a tile, instead of rolling on the Exploration Chart, make an initial D100 roll to determine whether a location is present or not - there is a 50% chance of finding a location. If you do find a location, rather than use the chart to determine what you have found, line up the models you own and dice randomly between them to see which is discovered. You can draw up a chart listing your collection, if you prefer. Of course, this method will tend to populate the landscape with whatever models you choose to collect - so the final balance of location types is determined by you. You can always agree or randomly determine a limit on the number of each location at the start of the game.

NECROPOLIS

A Necropolis is a city of the dead consisting of thousands of tombs, built one on top of another. There are many Necropolises throughout the world: some are very large and imposing but others are quite small and well hidden. They were built hundreds if not thousands of years ago by a forgotten race of humans whose treasures, wealth, and magical artifacts can still be found buried inside their tombs. Most necropolises have long since been plundered by tomb robbers, and the tombs themselves dismantled and destroyed by people who didn't like the idea of living next to a haunted city of the dead. All that remains of these looted and broken Necropolises are rubble strewn mounds of earth. Intact Necropolises are much harder to find, but as armies march through unexplored wilderness they sometimes come across these crumbling structures.

If a force moves into a tile containing a Necropolis the player may choose to send searchers inside to explore the ruins. Necropolises may contain treasure or magical artifacts, but they can also contain unforeseen dangers. Some of these are material and commonplace, such as bands of cut-throat plunderers, giant carnivorous tomb-rats, gigantic poisonous insects, rock-falls, and tunnel collapses. There is also the possibility of getting lost and

slowly starving to death among the labyrinthine tombs of the dead. However, these perils are nothing compared to the unparalleled consequence of disturbing a destructive force of Undead. When deciding whether to explore a Necropolis the player must balance the inherent dangers against the potential gain. A player is in no way obliged to search a Necropolis just because a force is in the tile. Should the player decide to search the Necropolis roll 2D6 and consult the Necropolis Search Chart to find what the searchers uncover.

A force which is in a Necropolis tile at the start of its turn can choose to remain stationary and search the Necropolis instead of scouting or moving. It is therefore possible for a force to search a Necropolis for several turns if the player wishes. The more time is spent searching the ruined tombs the more likely something dangerous is disturbed. To represent this increasing danger the player adds +1 to his dice roll for every turn spent searching. Thus a force entering a tile rolls 2D6, where as a force which entered in the previous turn rolls 2D6+1, and 2D6+2 in the following turn.

UNDEAD FORCES & NECROPOLISES

Due to the powerful magical field radiating from the Necropolis an undead force does not suffer from magical instability if it is in a Necropolis map tile regardless of how many banners occupy the tile.

An undead player may search a Necropolis in the same way as any other player, but any search dice roll may be re-rolled once if the player does not like the first result. The player is obliged to stand by the second dice roll even if the result is worse than the first!

Rather than search the Necropolis an undead force may attempt to summon reinforcements from the dead. The player rolls a D6 to determine if he is successful.

D6	Result
1-2	The dead refuse to awake - no reinforcements are gained.
3-4	D6x50 points of undead arise and join the player's force.
5-6	2D6x50 points of undead arise and join the player's force.

Reinforcements are added to the player's force. Players with tabletop forces may choose troops from the Warhammer Armies Undead list. Where the player finds it necessary to create new banners due to maximum point and unit values, remember that undead banners must be led by a Liche, Necromancer or Vampire.

NECROPOLIS SEARCH CHART - Roll 2D6

- 2 **Fabulous Treasure.** The searchers uncover a fabulously rich tomb containing jewels, gold coins, and countless other treasures. The treasure is added to the force's baggage train and may be added to the Empire's coffers on the army's return to Winter Quarters. Should the force carrying the treasure be destroyed by an enemy force the treasure is captured along with other baggage. If the army is destroyed in some other way the treasure is lost. Make note of which particular banner is carrying the treasure. The treasure is worth 3D6 Crowns added to the Empire's revenue.
- 3 **Hero's Tomb.** The searchers find the tomb of a long dead hero. The hero's war gear includes a magical weapon worth D6x20 points and magical armour worth D6x20 points. Players with tabletop armies may select items to the value indicated from Warhammer Armies. Other players add the value indicated to their banner.
- 4 **Necropolis Map.** The searchers find a carved slab upon which is inscribed a map of the necropolis. A copy of the map is made and returned to the army's camp. Although of no value in itself the map enables searchers to find their way into and out of the necropolis. During subsequent searches the player may add or subtract 1 from the Search Chart dice score, enabling searchers to avoid the worst perils and, hopefully, to find the most valuable treasures.
- 5 **Vast Hoard.** The searchers discover a hoard of gold and silver in a deep vault in the depths of the necropolis. The tunnel entrance is narrow and unsafe, but the quantity of treasure is virtually without limit. The player rolls a D6, if the score is a 6 the tunnel collapses and the treasure is sealed up forever. If the tunnel does not collapse the player may remove D3 Crowns of treasure. The searchers may continue to return to the hoard in following turns by-passing the normal 2D6 search roll. Every time the player attempts to remove treasure from the Vast Hoard a test must be made to determine if the vault collapses. Once the vault has collapsed no further treasure may be removed. Treasure is carried in the force's baggage train and added to the Empire's revenue in the same way as the *Fabulous Treasure* described above.
- 6 **Cursed Treasure.** The searchers find a sealed tomb containing gold and silver objects of ancient and mysterious origin. This treasure is worth D6 Crowns and may be added to the baggage train and carried to the Empire's coffers as described for *Fabulous Treasure*. However, the tomb was cursed and a strange sickness descends upon the force. The force loses D10x10 points of troops at the start of every following turn. The only way to lift the curse is to leave the map tile containing the Necropolis; once the force has left the tile the curse is lifted. Players with tabletop armies must remove casualties in the form of character models where possible.
- 7 **Return Empty Handed.** Several tombs are plundered but most have been robbed in the distant past and the remainder contain nothing of value or interest. The searchers return to camp empty handed but grateful to be alive and unharmed.
- 8 **Massive Collapse.** A large section of the Necropolis collapses, trapping or slaying many searchers and driving the rest away empty handed. The force loses D6x20 points of troops. Where tabletop armies are used casualties are chosen by the player in the same way as casualties suffered by subsistence shortfall.
- 9 **Haunting Terror.** The search party returns to camp in a state of abject terror, reporting tales of haunted tombs, frenzied zombies, and other horrors. The searchers refuse to re-enter the tombs and the entire army becomes so restless and agitated that the force is compelled to retreat from the tile in exactly the same way as if it had been beaten in battle.
- 10 **Necromancer's Tomb.** A search party stumbles through a secret door. As they grope their way along the dark and filthy passageway they realise they are in the tomb of a Necromancer, and that the recesses and anterooms to either side contain hundreds of dead warriors. Fortunately the skeleton army appears completely inert, and the party succeeds in entering the throne room of the Necromancer himself. The throne room contains endless riches and magical

treasures, but to touch any of them would be to risk awakening the Necromancer. The tomb robbers are now faced with an uneasy choice. If the player decides to remove an item from the tomb he rolls a dice on the chart below. If the dice scores between 1 and 5 the party removes the item or items indicated. The player may now elect to leave the chamber or take another item. The player continues in this way until a 6 is rolled when the Necromancer is woken up. He instantly destroys the search party and reclaims any treasures they have already removed. Rousing his army of undead skeleton warriors from their deathly slumbers, the Necromancer leads his horde out of the Necropolis and attacks the player's forces as described for 12 below.

D6 Result

- 1 A magical weapon worth D6x50 points
- 2 One or more suits of magical armour worth D6x50 points
- 3 Magical standards or instruments worth D6x50 points
- 4 Magical scrolls worth D6x50 points
- 5 A magical ring worth D6x50 points
- 6 The Necromancer wakes!

Players with tabletop armies may select appropriate magical weapons, armour, etc from Warhammer Armies. Other players add the value indicated to their banner.

- 11 **Tomb Rats.** The searchers stumble upon a palatial cavern housing untold millions of carnivorous tomb rats. The rats flood from the tomb devouring the searchers and immediately head towards army itself. The great swarm of rodents envelops the entire army, over-running the encampment and consuming everything in its path. Each banner in the force loses D6x50 points of troops and the entire force must retreat out of the tile as if it had been beaten in battle. If unable to retreat the force loses a further D6x50 points of troops before the rats finally stop attacking. In addition the force loses all of its baggage including prisoners, captured standards, captured war machines and anything else held with the baggage train.
- 12 **Eruption of the Undead.** The searchers stumble across the tomb of a long dead Necromancer and inadvertently rouse him. The Necromancer leads his horde of undead warriors out of the Necropolis and attacks the player's forces. The resulting battle may be resolved by the Mighty Empires battle rules or by a tabletop game using Warhammer Fantasy Battle. The Necromancer's force consists of 4D6x200 points of troops and is represented by one or more metal Undead Banner models (a banner represents between 500 and 1500 points of troops). If a tabletop battle is to be fought then the undead army can be chosen by another player from the Warhammer Armies Undead list. If the undead force is beaten or the battle is drawn the entire undead force is removed from the tile, the Necromancer and his army returning to the necropolis. In the event of a draw or Necromancer victory the player's force is retreated exactly as after a normal battle.

If the Undead win then the undead force is not removed but remains in play and continues to move around the map each turn. At the start of each campaign turn, and before any of the players have their own turns, the Necromancer's force is moved one tile in a random direction. The force does not have to scout, but it is susceptible to the magical instability rule for undead (on the roll of a 6 the force suffers normal subsistence shortfall). As the undead move into undefended settlements they automatically raze them. Independent settlements must be fought in exactly the same way as normal as these settlements may in fact harbour small armies. Every time the undead force razes a village or fortress it grows in size by D6x20 points as the local inhabitants join its ranks. Every time the force razes a city it grows in size by D6x100 points. If the undead move into a tile containing a player's forces a battle or siege is fought as normal. The undead force continues rampaging through the countryside in this way until it is destroyed or leaves the map area altogether.

20 large round shields 2 small

MODELLING WORKSHOP

BANEBLADE

BY TONY COTTRELL

Something a little bit more adventurous for this month's Modelling Workshop – scratch building a Baneblade tank for Warhammer 40,000. This isn't as difficult as it first appears but it's probably best to have tried at least a couple of the conversions presented in previous articles before attempting this project.

The Baneblade is one of the Imperial Guard's most formidable vehicles – a huge tank armed with two battlecannon, three lascannon and seven heavy bolters.

Tony's really gone to town on this scratch-built model which offers a serious challenge to your modelling skills. As you can see from the photos of the finished Baneblade, it makes a truly magnificent model, well worth the effort.

We haven't included templates for the fiddly bits like small inspection plates, rivets and so forth. Once you've finished the basic model, you can add these if you want – take a look at the photos and diagrams for examples.

If you're a less experienced modeller, don't feel you have to add every detail to your Baneblade.

Using the templates and instructions we've given here you should be able to put together an exciting model that's well within your own abilities.

GENERAL NOTES ON CONSTRUCTION

Most of the parts for the tank are made from plastic card. Alternatively, you can use thin, sturdy cardboard.

You'll need to photocopy or cut out the pages with the templates and stick them to your plastic card.

Some of the templates are used for more than one piece – the template number will have x2, x3 or whatever written next to it.

A few of the templates overlap to save space – either make more than one copy of these or copy them onto tracing paper so that you can cut both templates out.

Use a sharp knife to cut the shapes out of your plastic card – it's safer and more accurate to use several lighter cuts than to push really hard and try to cut through in one go. Remember that you should always cut away from your fingers.

When you've cut the parts out of the plastic card, remove the templates.

As well as your modelling knife, you'll need some fine sandpaper, a small hacksaw (for cutting the brass tubing) and a hole-punch (the type usually used for punching holes in paper).

Although most of the parts of this model are scratch built, you'll also need a few parts from Citadel's Predator Tank kit. If you haven't got the spare Predator parts, it's fairly easy to scratch-build the pieces you need to add the finishing touches to your model.

In the instructions, the numbers preceded by a P refer to Predator kit parts (see the Predator assembly instructions) and those preceded by a B refer to parts you'll need to make specifically for this model. BT parts are for the tracks, BH for the hull, BE for the engine and BR for the turrets.

Plastic parts should be stuck using polystyrene cement, card and balsa parts using contact adhesive, and metal parts using superglue or two-part epoxy glue.



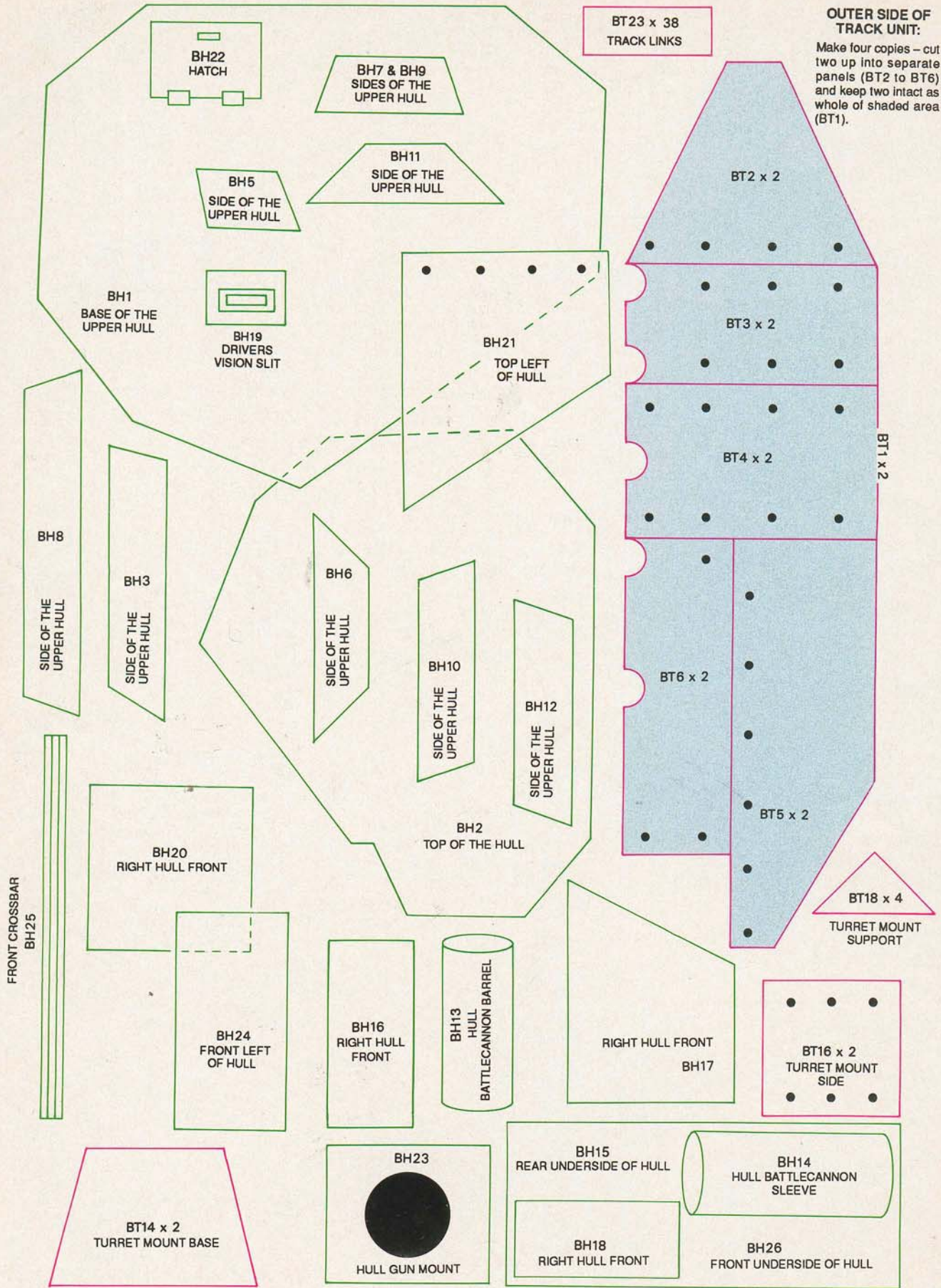

Any gaps that occur during assembly can be easily filled with plastic model filler. Because of the complexity of the model, you'll find you have to do a fair amount of trimming and sanding of pieces and filling of gaps as you go along.

To strengthen the construction of parts of the Baneblade you'll need to use small triangular brackets made from plastic card or cardboard – the diagram below shows you how to fit a strengthening bracket.

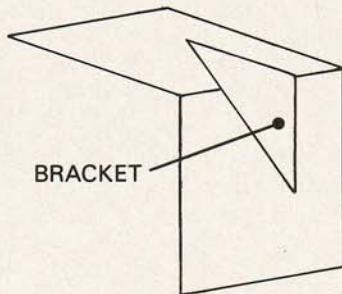

There are diagrams and photos of the completed model to show you how it all goes together – take a look at these as you read the instructions.

You'll need to have a little patience when building a Baneblade. Always leave time for parts to dry before moving on to the next section. This isn't a model you can build in half an hour like many kits. However, when you've finished it you should get a great sense of achievement and a splendid centerpiece for your Imperial army.

PART 1: TRACK UNITS MAKING THE PARTS

All parts are made from 0.03" thick plastic card or thin cardboard with the exception of the following:

The turret mount supports (BT18) are made from 0.08" thick plastic card or thick cardboard.

The tracks (BT22) are made from very thin plastic card or thin cardboard. Cut two strips 24mm wide to the desired length.

The axles (BT19 x 20) are made from 1" long pieces of 5/8" wide balsa wood doweling.

The wheels (BT21) are large Citadel round shields.

The heavy bolters (BT24) are cut from Citadel plastic bolters from either the vehicle or the miniature kits.

First cut out four outer track unit sides (BT1), then cut two of these up to make two each of the outer track unit panels (BT2-BT6). These parts should have their edges and corners rounded by sanding. Similarly cut out four track unit tops (BT8), then cut two up to make two each of the track unit top panels (BT9-BT13).

The heavy bolter ports (BT25) are small circles of thin card which can be cut out using a hole-punch.

CONSTRUCTION

Follow this sequence for both track units.

1) Glue the track unit panels (BT2, BT3, BT4, BT5 and BT6) to the outer side of the track unit (BT1).

2) Glue the top panels (BT9, BT10, BT11, BT12 and BT13) to the track unit top (BT8).

3) Glue the outer side of the track unit (BT1) and the track unit top (BT7) to the inner side of the track unit (BT8).

4) Glue the turret mount base, sides and support (BT14, BT15, BT16, BT17 and BT18) to the track unit.

5) Glue the wheels (BT21) to the axles (BT19). The first two axles on each unit should be capped by wheels at both ends because you can see them from the front. Therefore, the axles for these need to be slightly shorter.

6) Glue a round slotta base (BT20) to each end of the rear axle to make the drive wheel – use the uncut type of slottabase.

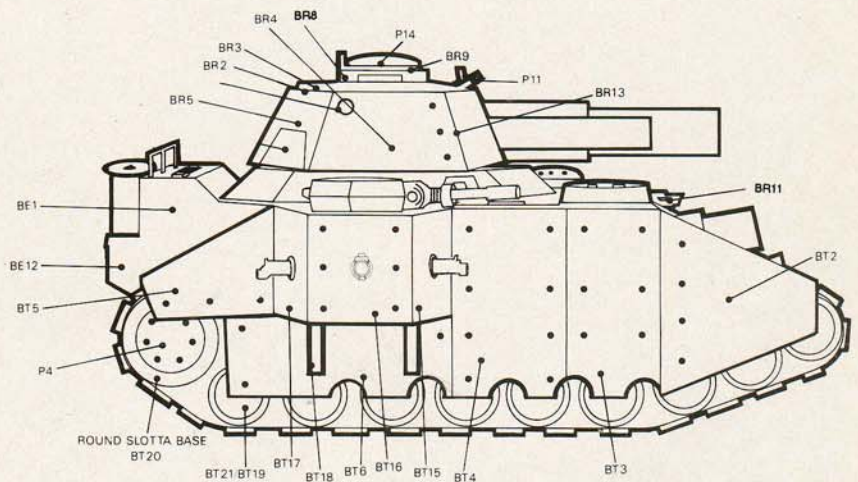

BANNER OF STAR COMPANY,
AQUITAINE REGIMENT,
IMPERIAL GUARD

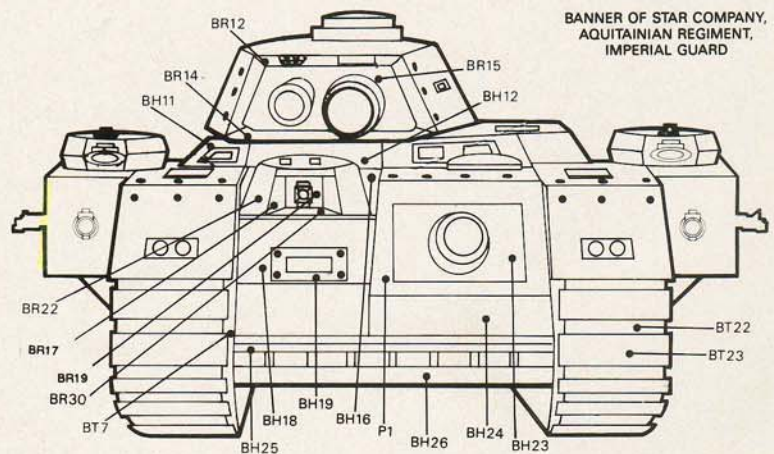



TOP OF TRACK UNIT:

Make four copies - cut two up into separate panels (BT9 to BT13) and keep two intact as the whole of the shaded area (BT8). Note that you'll have to flip over one track top and one set of panels so that you can make the right-hand track unit (the one shown here makes the left-hand track unit).

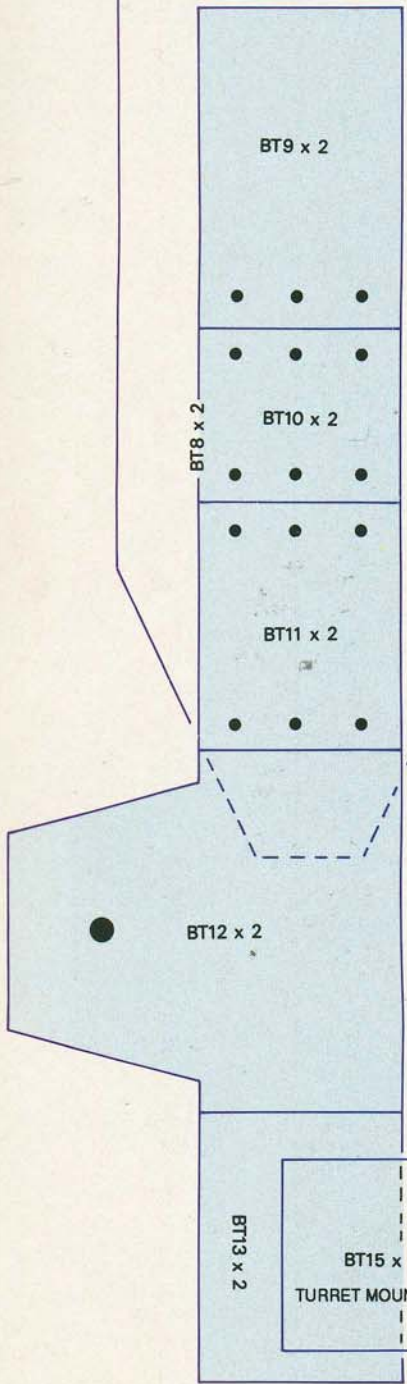

ENGINE GRILL



ENGINE GRILL PLATE

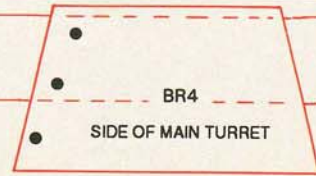
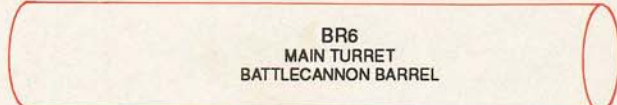
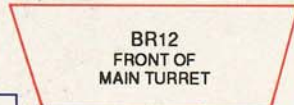
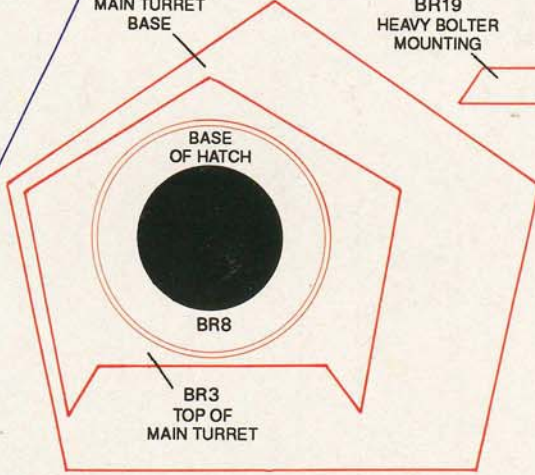
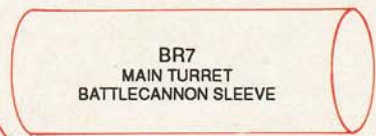
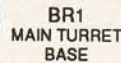
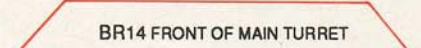
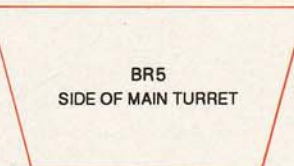
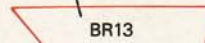
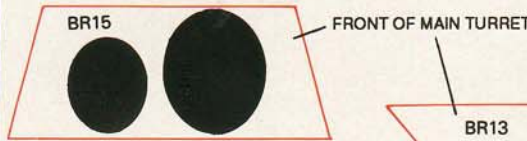
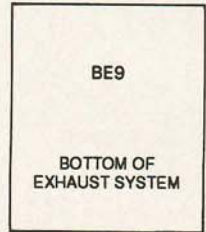
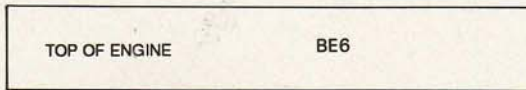
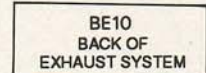
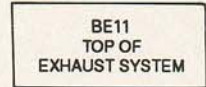
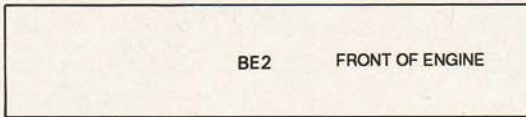
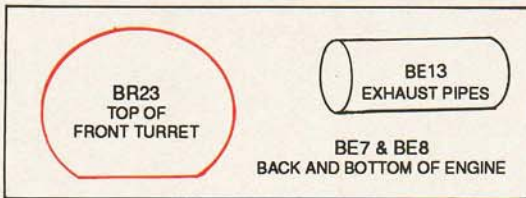
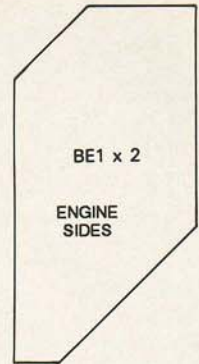

- 7) Glue the hub (P4) to the drive wheel.
- 8) Glue all the wheels to the track unit.
- 9) Bend the track (BT22) round the wheels and into the track unit at each end and glue in place.
- 10) Glue the track links (BT23) to the track. Space these out evenly along the exposed length of the track – you'll need 19 for each track.
- 11) Glue the heavy bolters (BT24) to the heavy bolter ports (BT25) and then glue these to the side turrets.
- 12) Glue the headlights (P12) to the track unit.

PART 2: HULL MAKING THE PARTS

All parts are made from 0.03" plastic card or thin cardboard with the exception of the following:

The left hull top (BH21) is made from 0.06" thick plastic card or thick cardboard.

The driver's vision slit (BH19) is cut from the Predator hatch (P6).

The front crossbar (BH25) is cut from a length of Predator sprue.

The base of the front hatch (BH4) is a large Citadel round shield.

The battlecannon barrel (BH13) and sleeve (BH14) are cut from brass tubing.

- 6) Glue the front crossbar (BH25) and the front underside of the hull (BH26) between the track units.
- 7) Glue the Eagle plate (P24 slightly trimmed) to the front left of the hull (BH24) and the driver's vision slit (BH19) to the right-hand side of the hull front (BH18).
- 8) Glue the rear underside of the hull (BH15) to the back of the upper hull base (BH1) and between the track units.
- 9) To fill in the space at the rear of the hull, glue two small wedges of card between the base of the upper hull (BH1), the track units and the rear underside of the hull (BH15).

10) Glue together two slottabases. Any of the small types will do. Repeat twice so you have three pairs of bases.

11) Glue the pairs of slotta bases to the upper hull base (BH1) – these are going to support the top of the hull (BH2) so position them accordingly.

12) Glue the top of the hull (BH2) on top of these bases.

13) Glue the sides of the upper hull (BH3, BH5, BH6, BH7, BH8, BH9, BH10, BH11 and BH12) between the base and the top (BH1 and BH2).

14) Glue the hatch (BH22) to the hull top (BH2). The handle and hinges are made from small bits of plastic card and sprue.

15) To fit the battlecannon barrel (BH13) into the barrel sleeve (BH14), wind sticky tape around the end of the barrel until it fits snugly into the sleeve and then glue it in place.

16) Glue the gun into the hull gun mount (BH23).

17) Add the dozer blade (P10) to the front underside of the hull (BH26).

PART 3: ENGINE MAKING THE PARTS

All parts are made from 0.03" plastic card or thin cardboard with the exception of the following:

The engine grill (BE5) is a type of wire mesh that is used to repair car bodies and is available from motorist's shops. Alternatively model shops sell wire mesh but this tends to be more expensive.

The lights (BE15 and BE16) are cut from the Predator tail-light strip (P9).

The grab rail (BE4) is made by cutting the ends from the Predator grab rails (P19).

The exhaust pipes (BE13) are made from plastic tubing. Alternatively you can use the barrel of a pen. One side of each tube should be sanded slightly flat.

The tops of the exhaust pipes (BE14) are small Citadel round shields.

CONSTRUCTION

- 1) Glue the base of the upper hull (BH1) to the top of the track units.
- 2) Glue the left-hand sloping hull front (P1) to the left track unit and the base of the upper hull.
- 3) Glue the four parts that make up the right-hand hull front (BH16, BH17, BH18 and BH20) between the right track unit and the left hull.
- 4) Glue the top of the left-hand side of the hull (BH21) to the top of P1, the hull gun mount (BH23) to the inside of P1 and the front left of the hull (BH24) to the front of P1.
- 5) Glue the base of the hatch (BH4) and the top of the hatch (P14 with the rim on the underside trimmed off), to the top of the hull on the left (BH21).



CONSTRUCTION

- 1) Glue the front, top, back and bottom of the engine (BE2, BE6, BE7 and BE8) to the engine sides (BE1).
- 2) Glue the engine grill (BE5) to the top of the engine (BE6) and then glue the engine grill plate (BE3) on top of this.
- 3) Glue the bottom, back, top and sides of the exhaust system together (BE9, BE10, BE11 and BE12).
- 4) Glue the exhaust system to the engine and glue the engine to the back of the hull (BH15).

- 5) Glue on the exhaust pipe (BE13 and BE14).

PART 4: TURRETS MAKING THE PARTS

All parts are made from 0.03" thick plastic card or thin cardboard with the exception of the following:

The top of the turret (BR3) is made from 0.08" thick plastic card or thicker cardboard.

The base of the hatch (BR8) is a round slottabase of the uncut type. If you want to have the hatch open, cut out the centre of the base.

The middle of the hatch (BR9) is a large Citadel round shield. Again the centre will need to be removed if you want the hatch in the open position.

The main turret lascannon barrel (BR10) is made from plastic tubing or a round-barrelled pen.

The battlecannon barrel and sleeve (BR31 and BR32) are made from brass tubing.

The two side turret lascannon (BR20) are constructed from the Predator lascannon (P26) with their back sections cut off.

The pegs that allow the turret to rotate (BR21) are made from round spruce or plastic rod.

The front turret (BR22) is made from a Citadel display base with a section cut out of it.

The heavy bolter (BR11) for the front turret is a Citadel plastic heavy bolter with the back part and the magazine removed.

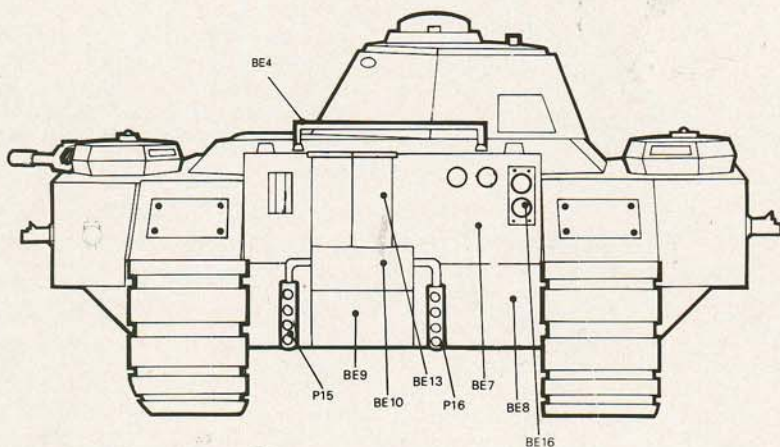

CONSTRUCTION

MAIN TURRET

- 1) Glue a Citadel display base and a small slottabase together and glue these to the turret base (BR1) – they're going to support the roof of the turret.
- 2) Glue the roof of the turret (BR2) to the top of these bases.
- 3) Glue the sides of the turret (BR4 and BR5) between the base and the top (BR1 and BR2).
- 4) Glue parts BR12, BR13, BR14 and BR15 together to make up the front of the turret.
- 5) Glue the top of the turret (BR3) to the roof (BR2).
- 6) Glue the hatch (made from parts BR8, BR9, P11 and P14) to the turret.
- 7) Wind sticky tape around the battlecannon barrel (BR6) until it fits snugly into the cannon sleeve (BR7) then glue in place.
- 8) Glue the battlecannon and the lascannon (BR10) into the front of the turret (BR15)
- 9) Glue the peg (BR21) to the centre of the underside of the turret.

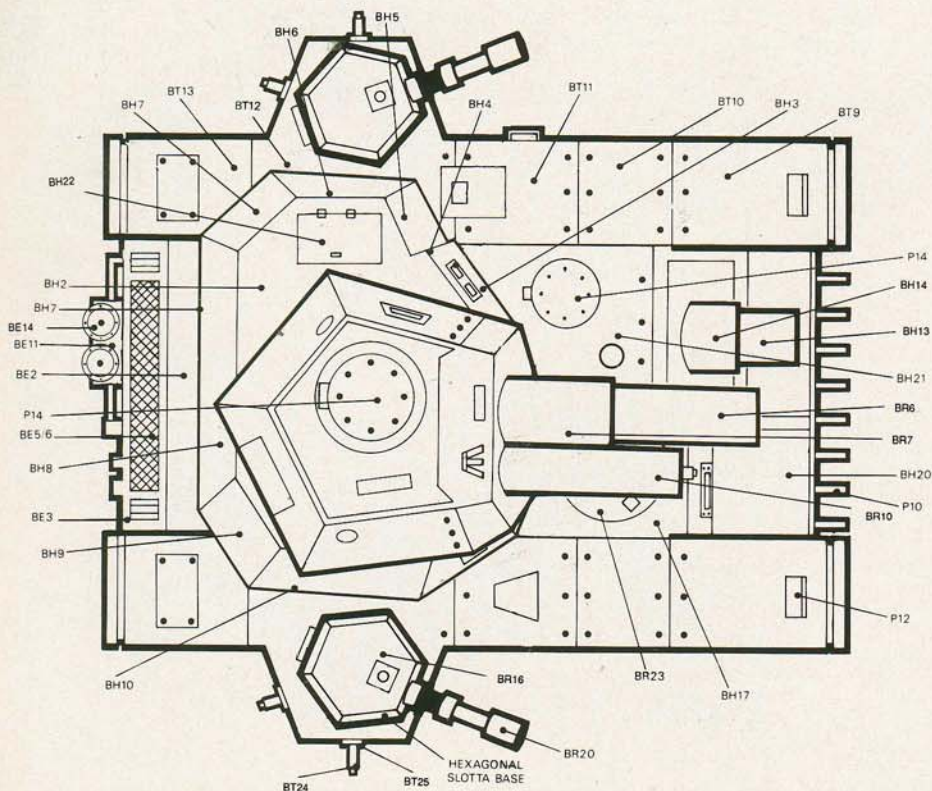

SIDE TURRETS

- 1) Glue the two hexagonal slottabases together and glue BR16 on top.
- 2) Glue the lascannon (BR20) to the turret.
- 3) Glue the peg (BR21) to the centre of the underside of the turret.
- 4) Repeat for the other turret.

FRONT TURRET

- 1) Glue the heavy bolter mounting (BR17, BR18 and BR19) into the front of the display base that makes up the main body of the turret (BR22).
- 2) Glue the heavy bolter (BR11) to the front of the turret.
- 3) Glue the top of the turret (BR23) to the top of the display base (BR22).

ADDING DETAIL TO THE FINISHED MODEL

The model can be greatly enhanced by the application of some extra detail.

Rivets

Rivets can be added to the armour plating by carefully slicing up sections of thin plastic rod or sprue and sticking the resulting small discs to the tank.

These are best picked up and positioned using the point of a modelling knife.

After the rivets have dried on the model, a light sanding will round the edges slightly.

Crew

If you wish to have a crewman in the turret, an Imperial Guard officer makes an excellent commander. The bottom half of the miniature should be sawn off just below the waist and the plastic arms repositioned.

Binoculars can be made from the ends of two plastic lasgun barrels.

Other Details

If you look closely at the diagrams and photographs, you'll notice all sorts of extra details that I've added to my Baneblade.

A ladder on the side of the tank can be added using the grab handles from Citadel vehicle kits.

An aerial can be made using a short length of thin, fairly stiff wire such as fuse wire.

It's easy to enhance the look of your model by using the odds and ends that you have in your bits box like spare pieces of plastic sprue and offcuts of card. These can be added as flanges, inspection plates, viewing ports and so forth.

PAINTING THE MODEL

It's a good idea to add one or more large banners to your Baneblade. These huge tanks are often the HQ vehicles for an Imperial Guard company and may fly the company's battle colours, listing the company's honours and victories. We've included an example of a banner for the Star Company of the 8th Aquitainian Regiment. Your Baneblade should obviously fly the colours of your own company or regiment of Imperial Guard.

Undercoat the model with either grey primer or a mix of Elf Grey and Chaos Black. Paint on the highlights by drybrushing with a very large brush – ideally a 1/2" wedge (available from art shops). The highlights should be built up slowly by adding Skull White to Chaos Black and lightly drybrushing over the whole tank. Eventually, you can build the highlights up to pure Skull White.

Black Ink can be blended into the recesses to add definition. Paint the small guns Chaos Black and then drybrush with Chainmail followed by Mithril Silver. A wash of Brown and Black Ink is put over each of the rivets for a rusty effect.

Finally, you can add extra details, such as kill markings on the guns (painted as rings on the barrels) and various Imperial Guard badges and slogans.



BANEBLADE

DATA RECORD: IMP6

The Baneblade heavy battle tank is one of the heaviest and best armed battle tanks in the Imperial Guard's extensive arsenal. It carries a main armament of turret-mounted battle cannon with a co-axial mounted lascannon and a further hull-mounted battle cannon. The main turreted lascannon is surrounded by an armoured sheath, which makes it look like a small battle cannon. Twin side sponsons each carry a turreted lascannon and three heavy bolters. A further heavy bolter is mounted in a hull turret. The Baneblade is best suited to open but solid ground and action among low cover which it can drive through or over. Its armour and size make it largely invulnerable to most infantry weapons, but it can be disabled by fire directed towards its more lightly protected tracks and rear armoured sections.

Type	Track
Fast Speed	12
Combat Speed	8
Slow Speed	4
Crew	1 Driver
	1 Hull Gunner
	2 Sponson operators
	(not shown on diagram)
	1 Turret Gunner/Commander

Weapons In the main turret: Battlecannon and Lascannon with 360° arc.

In the hull: Battlecannon with 90° arc to the front.

On each side sponson: 1 Lascannon with 180° arc to the side. Also 3 heavy bolt guns each covering a 60° arc as shown in the diagram.

In the front turret a heavy bolt gun with a 90° field of fire to the front.

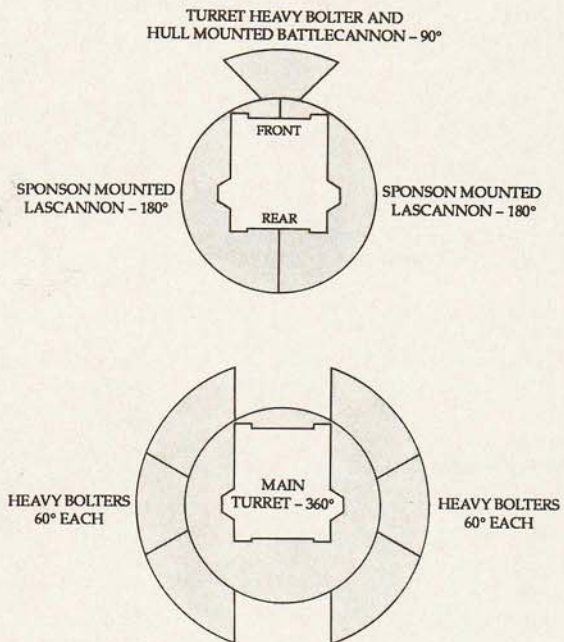

Battlecannons are larger versions of autocannons which fire a massive shell. These shells are stored behind the driver in the area indicated on the targeting diagram. Imperial Battlecannons can fire normal high explosive shot with the effects shown on the profile below - these shells are called Blast Shells. Alternatively, special Tank Buster ammunition can be loaded. Tank Buster shells are designed so that their entire explosive force is directed into the target. They have no effect area but add an extra D6 to their armour penetration score instead (ie 4D6+8 in total rather than 3D6+8).

Short Range	Long Range	To Hit S L	Strength	Damage	Save Mod.	Special
0-20"	20-72"	8	2D6	-3	Vehicle mounted only	Area 2" radius

Because of its size and weight a Baneblade may move over low (up to 2 metres high) obstacles without penalty at slow or combat speed. At slow speed it can move straight through woods if the trees are less than 10 metres tall, flattening them and creating a clear path behind it equivalent to its own width.

If involved in a collision with a vehicle which has no armour ratings higher than 18, the Baneblade suffers potential damage in only one location rather than in all locations as normal. In this respect it is rather like any

other vehicle which collides with a bike, but because of its bulk it is able to withstand collisions much more easily. A Baneblade cannot be damaged by a bike or trike collision regardless of how fast the bike is going. See WD 128 for full vehicle rules including the rules for collisions.

The Baneblade has three special target locations: the Side Sponsons, the Shells and the Turret Control. These each have their own special damage effect charts and these are given on the following page.

The Side Sponsons are armoured projections containing a manned weapon station which controls the turreted lascannon at the top and the three heavy bolters at the sides. Although he is not shown on the diagram there is a crewman operating each sponson. Due to the automated nature of the sponson armament this man can fire all four weapons at once if necessary. However, his function cannot be taken over by another crewman if he is killed. The Shell area is where the Battle Cannon shells are stored. Although this is well protected should it be hit the results will be very spectacular! The remaining ammo areas represent batteries for the laser armament. The Turret Control area is the motor and controls which turn the main turret. If this area is hit the turret may become useless depriving the Baneblade of its main armament.

BANEBLADE

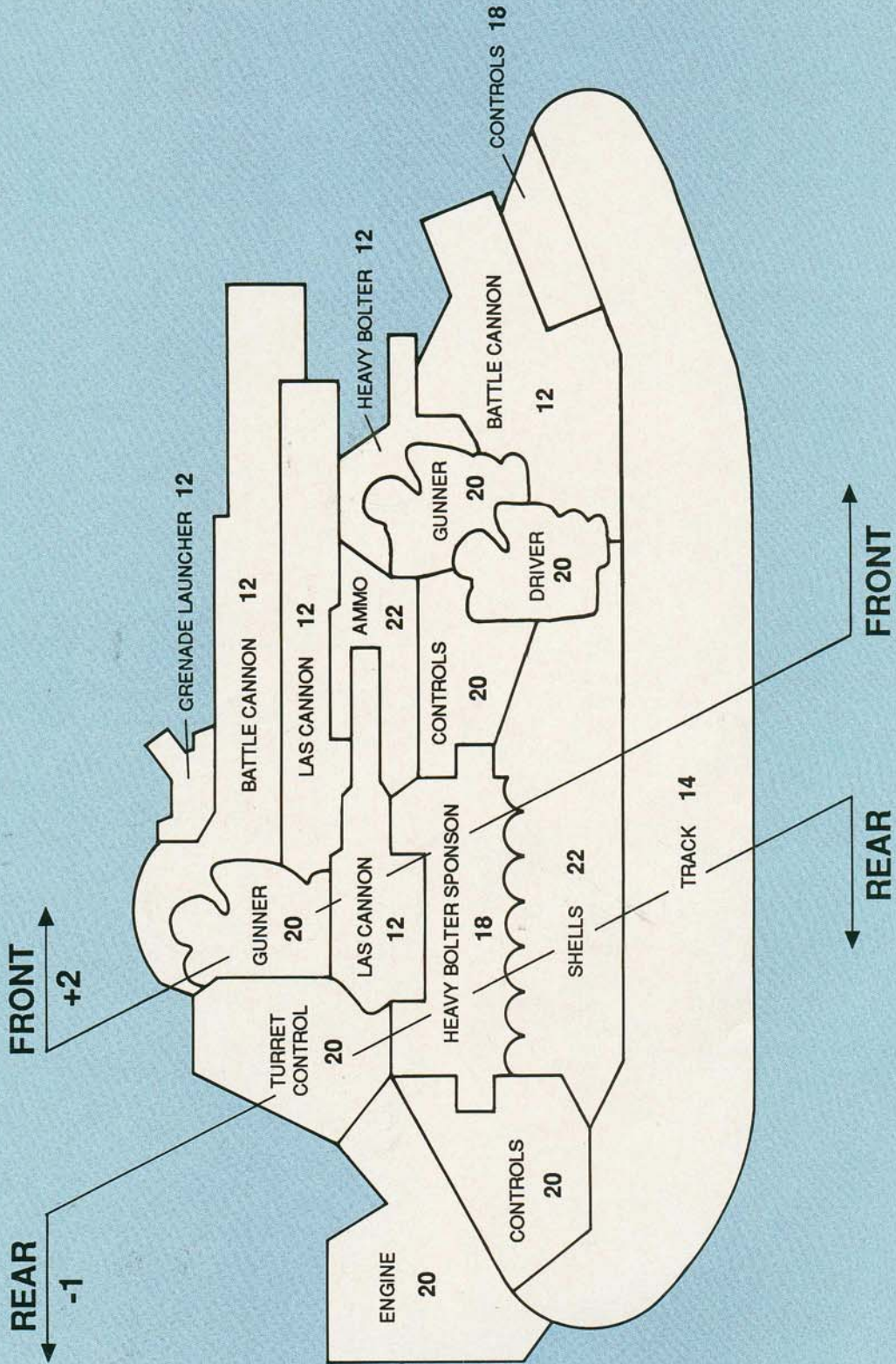

BANEBLADE DAMAGE EFFECT CHARTS

TURRET CONTROLS

The motor and various other controls which allow the turret to turn are situated in an armoured compartment at the rear of the turret itself. Should this be hit and penetrated roll a D6.

D6 Result

- 1 **Motor.** The turret motor is damaged so that it can only turn the turret very slowly. From now on the turret weapons may only fire within a 45° arc of the direction they are pointing in. If the player wishes to rotate the turret roll a D6. On roll of a 4, 5 or 6 the turret may rotate up to 90°, but may not be rotated further until the player's next turn. On the roll of a 1, 2 or 3 the turret jams solid for the rest of the game.
- 2 **Rotates.** The turret rotates to face a random direction - use a D12 nominating one direction as 12 o'clock. The turret is now jammed facing that direction.
- 3-6 **The entire turret is dislocated from its turning gear making it impossible to alter the turret's position and causing the guns to bear upwards or downwards in a useless fashion. Neither of the turret weapons may be used from now on.**

SHELLS

The Blast Shells and Tank Buster shells are kept in a special armoured compartment. Should this be penetrated the Baneblade is likely to be torn apart by the resulting explosion.

D6 Result

- 1 The explosion is contained by the Baneblade's phenomenal armour. The Baneblade and all its entire crew are destroyed, but with no further effect.
- 2-6 The Baneblade explodes with an 18" radius from the vehicle centre. All models within 12" of the centre sustain 1 strength 10 hit causing 2D6 wounds. Models further than 12" from the blast sustain 1 strength 10 hit causing D6 wounds.

SPONSONS

The Baneblade has two side-mounted sponsons which may be struck and damaged separately. Hits from the left affect the left sponson, hits from the right the right sponson, hits from directly in front or to the rear may be randomised.

D6 Result

- 1-2 **Mechanism Hit.** The automatic mechanism which allows the crewman to use all four weapons at once is destroyed. From now on the sponson may fire only one of its four weapons, ie one of the heavy bolters or the lascannon.
- 3-4 **Crewman Hit.** The crewman operating the sponson is allowed his normal armour saving throw modified by the normal armour modifier for the penetrating weapon. Crewmen wear flak armour as standard with a save of 6. If he saves he is unharmed and the sponson is unaffected. If he is slain the sponson is useless. No other crewman can take over his duties as the sponson is an enclosed compartment entered from the outside of the Baneblade.
- 5-6 **Mechanism Destroyed.** The sponson automatic mechanism is destroyed. The heavy bolters and the lascannon turret all shut down and cannot be used from now on.





3 Derby Terrace,
Derby Road,
Nottingham
NG7 1ND

EACH MOUNTED CHAOS WARRIOR IS SUPPLIED WITH ONE BODY (ARMED WITH LANCE, WARHAMMER, AXE OR SWORD) AND ONE SET OF LEGS (A, B OR C) AND A HORSE

HOW TO MAIL ORDER PLEASE SEND ORDERS TO: MARAUDER MINIATURES, MAIL ORDER, 3 DERBY TERRACE, DERBY ROAD, NOTTINGHAM, NG7 1ND. MAKE CHEQUES PAYABLE TO MARAUDER MINIATURES LTD

POSTAGE AND PACKING: UK EIRE AND BEFO ADD £1.00 FOR ORDERS UNDER £20.00. OVER £20.00 POST FREE

OVERSEAS AIRMAIL: MINIMUM ORDER £5.00 ADD 40% FOR CARRIAGE



HOW TO TELEPHONE ORDER: BARCLAYCARD, VISA AND ACCESS



SIMPLY TELEPHONE YOUR ORDERS DIRECT TO US ON (0602) 474875 MONDAY TO FRIDAY 9.00AM TO 5.00PM

MM92 MOUNTED CHAOS WARRIORS £3.50 EACH

MM73/5 SHADOWS DARK ELF SCOUTS 5 FOR £2.99

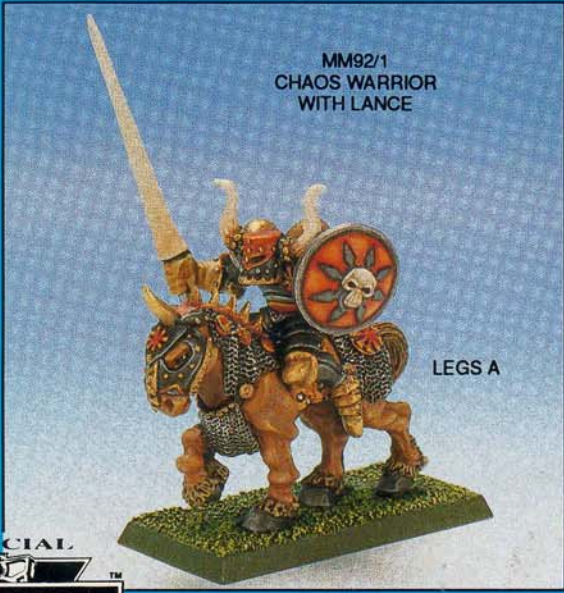

MM92/1
CHAOS WARRIOR
WITH LANCE

LEGS A

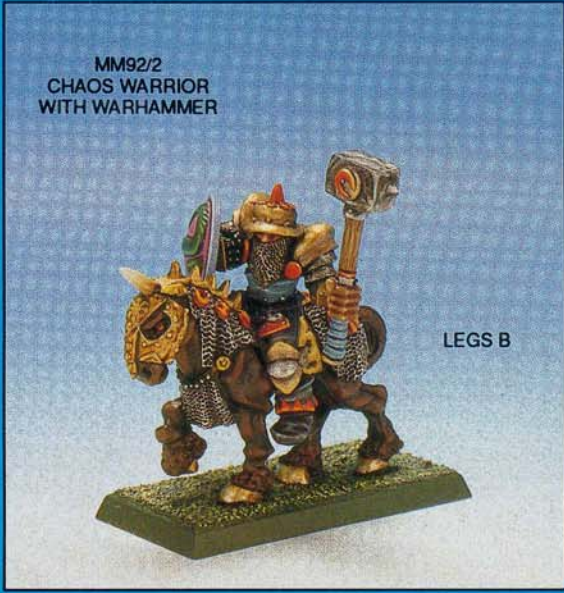

MM92/2
CHAOS WARRIOR
WITH WARHAMMER

LEGS B

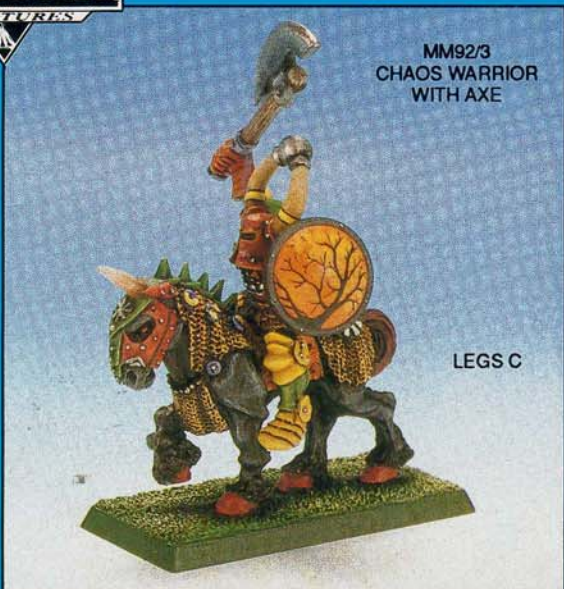

MM92/3
CHAOS WARRIOR
WITH AXE

LEGS C

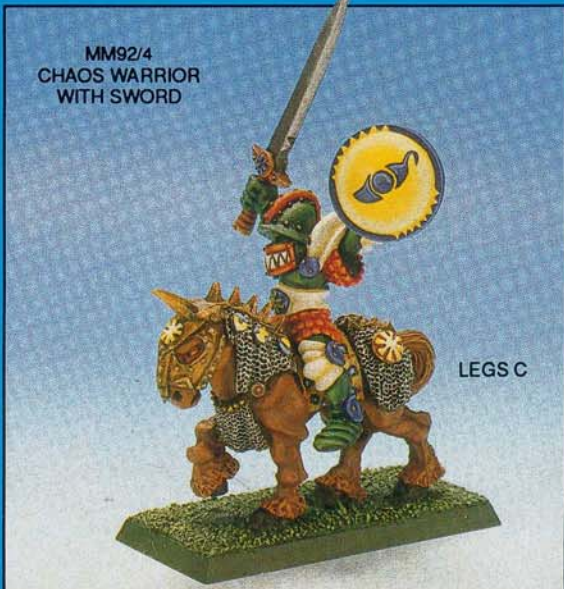

MM92/4
CHAOS WARRIOR
WITH SWORD

LEGS C

MM 73/5 SHADOWS - DARK ELF SCOUTS

Miniature C may be supplied with a repeating crossbow as shown below, or a standard crossbow from code MM 70 Marauder Dark Elves in White Dwarf 114, page 17



A

B

C

D

E

This product contains lead which may be harmful if chewed or swallowed. Marauder Miniatures are not recommended for children under 14 years of age.



ILLUMINATIONS



STEPHEN TAPPIN



Many many moons ago, in *White Dwarf 93*, we featured some of Stephen's work. I commented that he would be a major force in the future. At the time, he was working at the Design Studio during student vacation. Now he's back at the Studio as a full-time artist producing illustrations for all our major projects. His work is primarily executed in quality artists' pencils on CS2 artboard with the larger pieces being up to A3 in size. Stephen lists his main influences as Terry Gilliam and Ridley Scott from the film world, Alan Lee, Brian Froud, Arthur Rackham, John Waterhouse, N C Wyeth and Albrecht Durer as artists, and Kate Bush and the Waterboys in music.

John Blanche



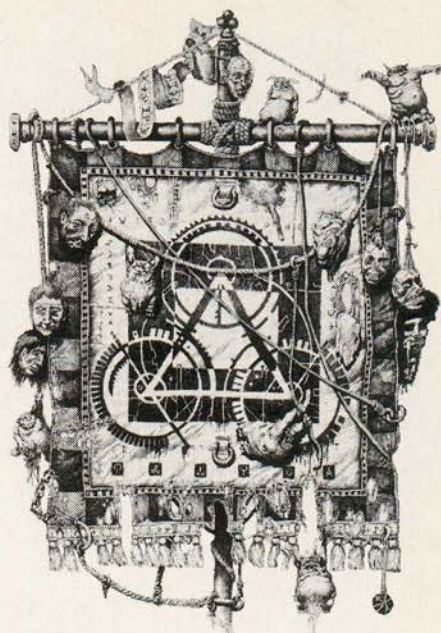
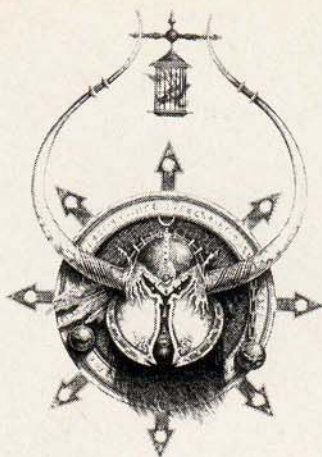
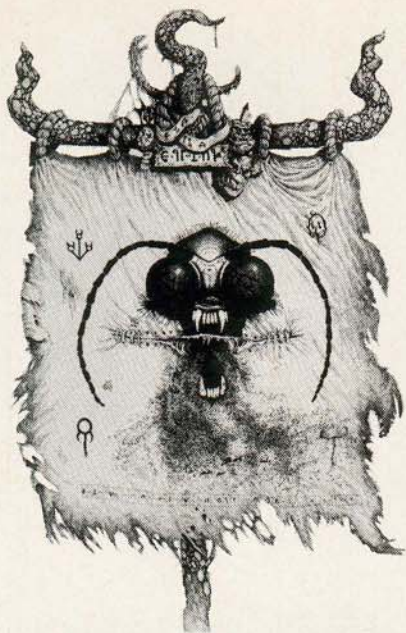

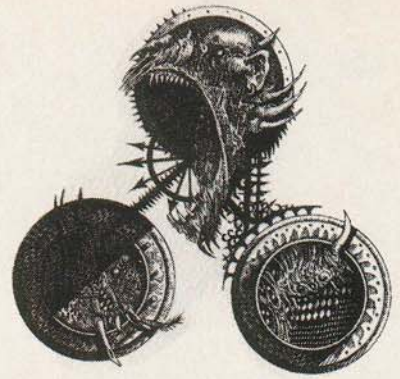

MEKANIAKS



As with all Oddboyz, Meks often carry back banners as advertisements for their services. The three Orks above all have their own back banners, while the Gretchin carries an especially large banner for his Mek master. They're all in the style of their particular clan: the Goff's banner is surrounded by checks and the Evil Sunz and Blood-Axe Meks' banners have the clan symbols and Mek glyph.



Snake-Bite Mek covered with typical Snake-Bite tattoos representing coiled snakes.



Bad Moon Mekboy dressed in the bright extravagant style that the Bad Moon clan favour.



Blood-Axe Mekaniak equipped with bolter and heavy duty pliers.



This remarkable Mek vehicle is a complex conversion by Tim Prow. In best Mekaniak style, he's used parts from anything he could get his hands on: Robot legs, Titan laser...



The black and red flames displayed on this Mekaniak's clothing and warpaint are a favourite device of the Bad Moon clan.



Evil Sunz Mekaniak with Shokk Attack Gun. This incredible weapon has been made from all the paraphernalia and spare parts that he was able to salvage. It has been painted red in true Evil Sunz fashion and marked with the Mek's own symbol.

STUART WILLIS

Stuart and his work will already be familiar to regular customers at Games Workshop Dudley, where he's been working since joining the company. The models shown here have all been painted during the few weeks he's spent at the Design Studio learning some expert techniques with the 'Eavy Metal team.



This Bad Moon Nob proudly displays his clan's crest on his helm.



This Eldar Scout bears the heart symbol of the Beil Tan Craftworld on his forehead.



Dark Angel Deathwing Terminator with storm bolter (inset: Homeworld name totem - Weasel).



Grey Knight Terminator armed with a Nemesis Force Sword.



A Celestial wizard in the colours of his college.



Fire Dragon Exarch armed with firepike.



Dark Angel Deathwing Terminator Captain (inset: Homeworld name totem - Eagle-Wing).



Dark Angel Deathwing Terminator with flamer and power fist.



Chaos Hound with Scorpion Tail mutation from Marauder Miniatures.



Dark Angel Deathwing Terminator with assault cannon (inset: Homeworld name totem - Lame-Bear).



Dark Angel Deathwing Terminator Librarian



This stunning conversion shows a Tyrannid Warrior with Boneswords defending itself against a surprise attack

HEAVY METAL



An Ork of the Evil Sunz Clan.



Gretchin servant with blunderbuss. His markings signify he belongs to an Evil Sunz Runtherd



Marine Captain Elziah of the Blood Angels, shown in his personalised white armour.



Chaos Dreadnought equipped with missile launcher and autocannon.



Chaos Android with the eight pointed Chaos star on forehead.



Marine Captain Zekial of the Blood Angels, here equipped with a heavy bolter.



These Blood Angel Space Marines bear the winged blood drop symbol of their chapter on their left shoulder pad, while the yellow arrow on their right shoulder pad show that they are Tactical Marines. From left to right they are armed with bolter, missile launcher, flamer and autocannon.



These Chaos Marines are equipped with bolters and power axes. Their power armour is black, red and gold, typical of followers of the Chaos Power Khorne.

EAVY METAL

PRESENTED BY JOHN BLANCHE



This month's 'Eavy Metal is dominated by the appearance of the brand new plastic Tyranid Warriors. These bizarre alien creatures are at least twice the height of humans and are equipped with fearsome natural weaponry such as long rending claws and an evil looking sting. On top of this, they are armed with either a pair of Boneswords or the grotesque organic heavy weapon, the Deathspitter. Also featured this month are Space Marine Scouts, part of the front-line defence against the Tyranid threat. The squads are lead by Veteran Sergeants, another of the new plastics from Advanced Space Crusade.

One of Kev Adams' most impressive models to date is the amazing Shokk Attack Gun featured on the page of Mekaniaks. To help you with your Meks, we've included a few sample Mekaniak banners for you to photocopy and cut out.

The most exciting miniatures in development at the Studio are the Space Marine Captains in Artificer suits that Jes Goodwin's working on. These include miniatures that are specific to particular chapters and others that can be used with all chapters. Jes has sculpted the armour on some of these models in Artificer suits with truly breath-taking detail.

Hope you enjoy this month's 'Eavy Metal. See you next issue.

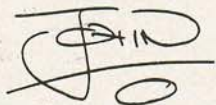

TYRANIDS AND GENESTEALERS

The most exciting thing to hit the painting department for quite some time are the amazing Tyranid Warriors featured in this month's issue.

Tyranid Warriors, like all Tyranid creatures, are produced by the Norn-Queens that are found inside vast chambers on the largest Tyranid spacecraft. Each of the many Norn-Queens within Hive Fleet Kraken imparts a particular skin pattern to the creatures it produces, from Tyranid Warriors to less sophisticated bio-constructs. The pattern is an algal symbiote that makes it possible to identify which Norn-Queen generated a creature. These patterns enable the hive mind to moderate and control its populations to a remarkable degree. Outwardly identical creatures with subtly different genes can be directly compared and the least efficient variants expunged from future populations by the speedy relaying of accurate production instructions to the appropriate Norn-Queen.

The colours of the various patterns as they appear on Tyranid Warriors change with the Warriors' general colouring which in turn alters with age. Adult Tyranid Warriors are basically bright red with pale yellow bony plates and blue markings. As they get older, these colours gradually change – the red areas get darker and deeper, the yellow areas first get paler, turning white, and then acquire an ever-stronger blue tinge, while the markings change from blue through green to yellow. Once a Tyranid has reached a certain age, however, its coloration

remains fairly stable – a dark, burgundy with blue plates and yellow markings – although it does start to fade with time so that truly ancient Tyranids have a pale, almost bleached appearance, reminiscent of the colour of dried cuttlefish.

The four Tyranid Warriors shown on the page are examples taken from the life cycle of a Tyranid. Top right shows a newly-adult Tyranid Warrior, the rest are taken from later stages of its life. There are two main colours on each of the models shown – one colour appears on the softer fleshy areas and another on the hard chitinous carapace. Dividing the body into two distinct colours gives the miniature an uncluttered appearance and makes it very quick and simple to paint.

Large and scaly models such as Tyranid Warriors (and Dragons, for example) present their own particular painting challenges but there are some techniques which make painting these models considerable easier.

With models that have a large amount of surface detail the ideal technique to use is drybrushing. If care is taken, a miniature can be painted very quickly and effectively this way. Here's a quick re-cap to remind you of the golden rules of drybrushing.

Stage 1: the base coat should be watered down until it's quite thin; this is so that it doesn't fill in areas when it's dry and obscure any detail. It also means that the white undercoat shows through the paint and makes the result far brighter.

You can paint the base coat on in quite a dark colour or apply an ink wash to provide the deep shading; either way, you should do this early on so that you can build up the highlights over the top.

Stage 2: when lightening the colours it's best to take it in gentle stages – don't try to get results too fast. Mix up the first highlight so that it's just a little lighter than the base colour. When you've applied this, you'll not see much of a result, but don't worry – the highlights soon show as they become lighter. Just keep on building them up with gentle drybrushing.

Stage 3: The final highlights can be added with either a very light drybrush of Skull White or by painting on small flecks of the highlight colour on the most prominent areas. When the highlights are dry, you may wish to get rid of some of the rough appearance that's caused by drybrushing. The best way to do this is by applying a thin ink wash of the appropriate colour; this redefines the deep shading and smooths out the highlights.

You should always do all the drybrushing on a miniature before anything else, starting with the largest areas first. This is because you may inadvertently get some of the colour that you are drybrushing onto other areas. Leave all the flat colour and detail until last.

The youngest Tyranid Warrior is given a base coat of Blood Angel Orange on the skin and this is shaded with a wash of Red and Orange Ink. When the shading wash is completely dry, the highlights are built up by adding Bad Moon Yellow to the base mix and drybrushing it on. The carapace areas are given a base coat of Sunburst Yellow shaded with a mix of Yellow and Brown Ink applied in a thin wash.

As the Tyranid Warrior gets older, its skin turns a deeper shade of red. This can be easily achieved by deepening the colour of the shading wash or by applying several washes instead of one.

The carapace first gets lighter, right through to white and then darker, deepening down through light to dark blue. When the Tyranid Warrior is very old, the whole body colour starts to get paler until it's almost fully white and resembles an old, dried cuttlefish.

The markings on the head and carapace are symbiotic algae, imparted to the Tyranid by the huge Norn-Queens. Each Norn-Queen imparts its colour scheme to every creature it produces – all the Tyranid Warriors, Grabber-Slashers and Hunter-Slayers produced by the same Norn-Queen, for example, have exactly the same pattern of markings. The easiest way to paint these markings onto the miniatures is to very carefully mark them out with a hard pencil and then paint them on in the appropriate colours.

STUART WILLIS



Stuart joined us from the Dudley Games Workshop store to join the 'Eavy Metal team for a month's intensive painting.

On his Terminators, Stuart has opted for the tribal markings of the Deathwing's homeworld rather than the Space Marine Codex versions. He's also developed a very quick way of painting the basic armour colour. The first step is to

undercoat all of the miniatures white – as the desired end effect is white, this means that a lot of the work is already done. The next step is to apply a thin wash of Brown and Yellow Ink – this defines the shape and gives deep shading. Skull White is then blended into the brown for the final highlights.

Eaglewing took far longer to paint than the rest of the miniatures due to the complexity of his personal heraldry. The areas where the badges were to be painted were left plain white and the designs were carefully drawn out with a pencil. The colours were then filled in and the pencil lines were reinforced with Black Ink.

Stuart painted the Grey Knight Terminator in a mixture of greys and metallics. The fluted areas of armour were given a base coat of a mix of Shining Gold and Brown Ink. When this is highlighted with Shining Gold and Mithril Silver, it gives a really good bronze effect.

If you live in the Dudley area and have any questions about miniature painting, then Stuart's your man.

MEKANIAKS

The Shokk Attack Gun was a real challenge to paint: the amount of detail is truly amazing. Tim decided that the best way to tackle it was to paint the gun separately from the Mek that's carrying it. He did this by gluing the gun onto the end of an old paint brush so that he could hold it. A base coat of Go Fasta Red was highlighted with Blood Angel Orange and Bad Moon Yellow. A few glyphs on the flat areas of the gun help to give it some extra interest.

Models like this Shokk Attack Gun offer a perfect opportunity for conversion and personalisation. No two Mekaniaks make these weapons the same. The addition of more detail or salvaged parts can be limitless – with the Orks, it really is a case of anything goes.

We've included three Mekaniak banners on this page: one for the Snake-Bite clan, one for the Bad Moon clan and one that's suitable for any clan. All you have to do is photocopy them, cut them out and paint them. We've left two of them with blank spaces so that you can fill in the glyphs that you want – there's a list of Ork glyphs in Waaargh the Orks. The banner poles on our models have been scratch-built out of pieces of brass wire but a straightened paper clip will do just as well. The ones here are all fairly plain but you can add all sorts of paraphernalia as trophies and decoration – all Orks love to boast of their prestige and prowess in this way.

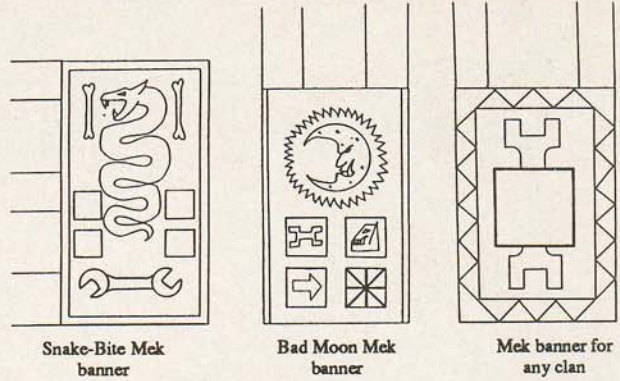

Tim's Mek vehicle conversion is based on the legs from an Imperial Robot. The top half of an Ork Nob was pinned and glued into place after the surface had been filed flat so that the parts fitted flush. Tim used parts from a wide variety of models that were in his bits box, including the laser off a Reaver Titan. All of the pieces on a conversion as complex as this must be pinned and glued for strength. If the parts are really large then you need to use some kind of two-part epoxy glue – superglue isn't strong enough.

The Snake-Bite Mek with the spade is a very simple conversion by Ivan. All he had to do was cut the original weapon out of the model's hand with a pair of sharp wire cutters and clean up the joint with a flat needle file. The spade is one of the many accessories off the Ork Battlewagon kit – this was simply cut in two and one half glued to either side of the hand.

SPACE CRUSADE

Also in this issue, we've got painted prototypes of the Citadel Miniatures that are included in MB Games' Space Crusade. All of these miniatures were painted by Tim and myself in the correct colour schemes for Space Marines and the forces of Chaos.

Tim painted all of the Blood Angel Tactical Marines at the same time. When you're planning a group of miniatures that are basically the same, working on them together is much faster than painting them one at a time. They were all undercoated white and given a base coat of Terracotta; they were then highlighted up by adding more and more Blood Angel Orange to the base colour with each successive coat.

Hope that you've enjoyed this month's offering.



Mike

Mike
MWJ



Ivan



Dale



Tim

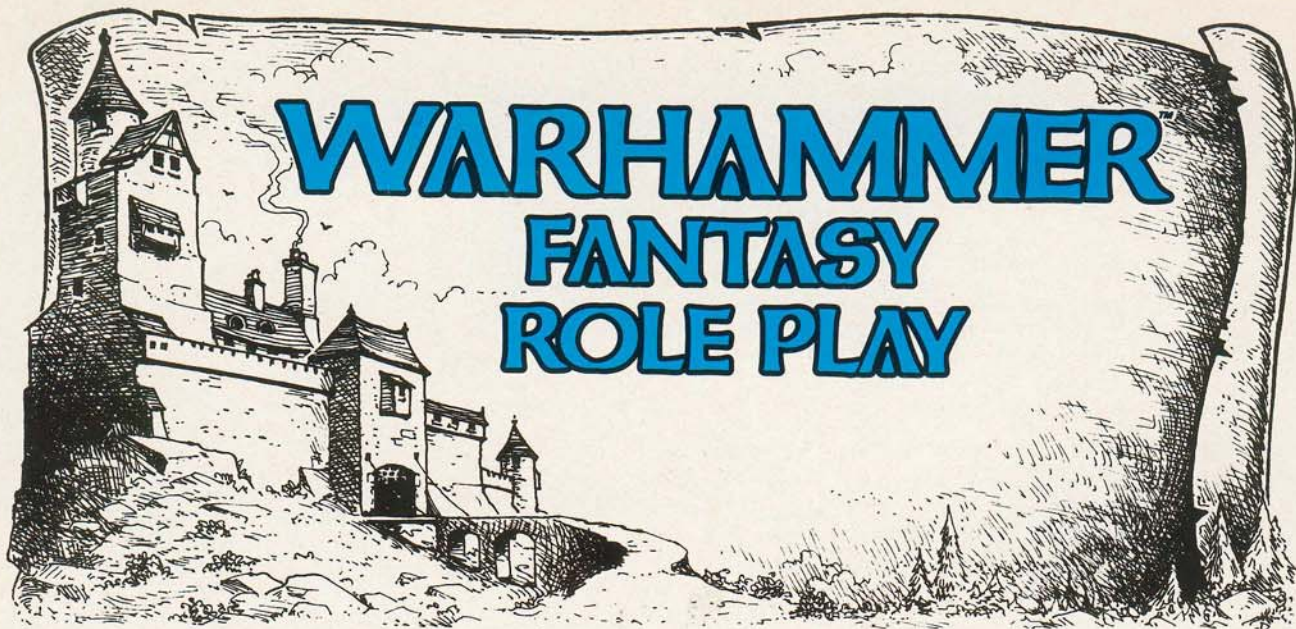

WARHAMMER FANTASY ROLE PLAY

THIS month we visit *Ironstone Pass* and present an encounter for mountain journeys that can turn very nasty for a group of unwary or careless adventurers!

This is a short incident that you can spring on your adventurers at some point during the *Doomstones Campaign*. All four of the *Doomstones* adventures involve quite a bit of hazardous travelling along mountain passes - Werner Silbermann and his allies are an excellent extra hazard for the adventurers. We would suggest, however, that you don't use *Ironstone Pass* if the party has already lost some of its members to other perils - this could be the final straw!

You can, of course, run *Ironstone Pass* as a stand-alone road encounter whenever you need something to spice up a mountain crossing. If your adventurers aren't crossing the *Vaults*, just change the place names given here to something a little more suitable. And remember that it doesn't have to be the height of winter when they make the crossing - bad weather comes earlier, hits harder and stays longer in mountains.

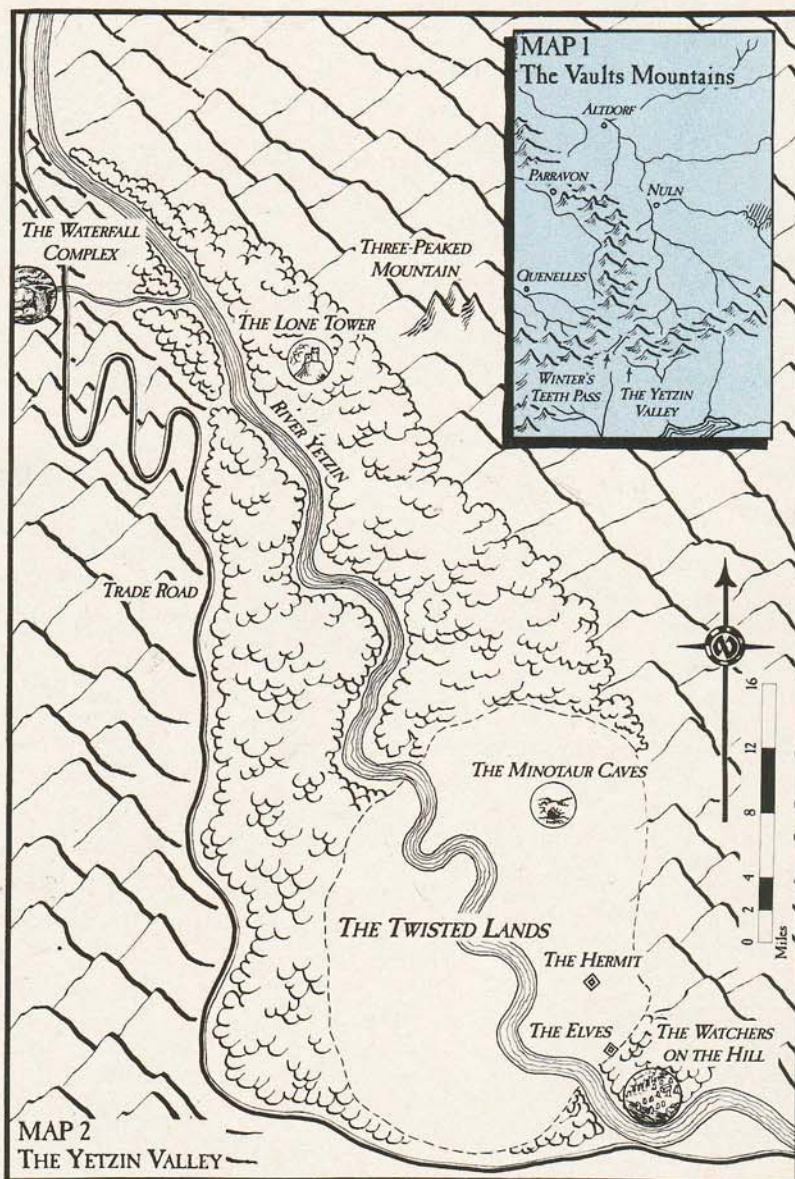

IRONSTONE PASS

This encounter is designed for characters in their second or third careers; ideally, a party should have 15-20 careers between them, and access to at least level 1 magic. The adventurers should be travelling in a remote mountain area, which requires them to traverse a little-used high pass.

WERNER'S TALE

Werner Silbermann was a young and fairly successful wizard in the city of Nuln when he became a werewolf in an experiment that went dreadfully wrong. For the next few years he drifted from place to place, always moving on to avoid being recognised for what he was and hunted down. As the years went by, he came to terms with his condition, and learned to control it to an extent.

One harsh winter found him wandering through the forest which fringed the western foothills of the Worlds Edge mountains. It had been almost a week since he had eaten, and hunger and exhaustion caught up with him. He collapsed at the base of a tree, resigning himself to death.

He regained his senses to find himself surrounded by a pack of wolves. Too weak to move, he closed his eyes and waited for death. He heard the soft footfall of a wolf approaching him, felt its breath on his neck – and then it began to lick his face. It was almost as if the wolves were aware of his true were-nature, and had accepted him as one of their own.

Werner gratefully accepted the hospitality of the wolf-pack, and lived among them as a wolf for almost a year. He became their leader, and for once he was happy to have the choice of forms, to be a wolf with swift legs, a keen nose, a warm coat, and deadly-sharp teeth.

The next winter was even harsher than the last, and the hunting was predictably poor. As the pack ranged wider and wider in search of prey, they came across a trade road, which led from The Empire across the Winter's Teeth pass to the Vaults and on to the Border Princes. The Human part of Werner's brain told him that this was the answer – he established a lair in dense cover near the road, and posted lookouts to bring news of an approaching caravan.



Tony Ackland

Werner's first attack was a success. In a well-laid ambush, the wolves took two guards and a wagon driver, and disappeared into the forest before the survivors could react. The wolves fed well that day, and over the following months tales began to be told of the 'Daemon Wolves' of Wissenland.

Soldiers and Rangers were sent out from Pfeildorf, to scour the forests and hunt the wolves down. They returned with the carcasses of almost a hundred wolves, but the attacks continued. The stories grew wilder, giving the Daemon Wolves the ability to walk through solid rock, making weapons pass harmlessly through their bodies. Wissenland was gripped with near-hysteria.

One fateful day, the pack ambushed a caravan in a narrow pass to the east of Winter's Teeth. Werner had chosen the site so that the narrow passage would hamper the caravan guards, enabling the wolves to strike and escape without meeting serious resistance. The attack went exactly as planned until an unexpected rearguard appeared, trapping the wolves between two forces. The wolves fought with savage desperation, but their doom seemed certain.

Suddenly, one of the wagons erupted in flame – the main body of the caravan broke as panicking merchants and guards fled along the pass. The dead rose up, shambling past the wolves to attack their living comrades. Over the screams and snarls of the battle, laughter rang out – the clear, savage laughter of an elf-woman who had appeared beside the burning wagon.

The battle turned into a rout, and soon the woman was the only living thing in the pass which stood on two legs. The wolves were wary of her, but she petted them as they fed on the dead horses and guards. Still chuckling quietly, she approached the wolf which was Werner, and he knew that she saw him for what he was.

That day, a strange alliance was born. The elf-woman was Syrillia, an outcast from the dark city of Feiss Mabdon who had travelled widely in search of knowledge and adventure. The wolves withdrew to their current lair – an abandoned mine which had given the Ironstone Pass its name – and Syrillia and Werner sat talking and plotting far into the night.

Spring and summer came and went, and by the time winter closed the higher passes, the two allies had turned Ironstone Pass into a death-trap. The few travellers who came that way were easily overpowered, providing riches as well as food. Meanwhile, the two spellcasters grew in power, trading spells and amassing magical equipment from those they robbed.

As the adventurers make their way through the mountains, they will have to cross through Ironstone Pass, and survive an attack which is capable of wiping out forces many times their strength. The two allies have found that groups of adventurers can be a rich source of unusual treasures.

MAP KEY

The map shows the layout of Ironstone Pass. This can be a good action to play out with miniatures and *Dungeon Floor Plans*, if you wish.

1. Snow Trap

The adventurers approach the pass from this direction. Beneath a crust of soft snow, the ground drops away vertically by 5 feet. Unless they are probing the snow in front of them, the lead characters are taken completely by surprise, and drop 4ft into the soft snow. Characters on horseback must make a successful **I** test (*Ride Horse* +10, *Trick Riding* +10) to stay mounted.

Characters in the deep snow may only move at one-quarter of their *cautious* rate until they are clear of it. They may perform no actions other than parrying and trying to get clear, and may not dodge or cast spells. Creatures attacking characters mired in the deep snow do so with a +10 **WS/BS** bonus.

2. Wolf Lair

This is where the wolves spend their time until an attack starts. The entrance is covered by a *Camouflage Area* spell (see Appendix 1), making it difficult to see from the outside. The inner chamber is used by cubs and nursing mothers – there are four females and seven cubs here, which will not take part in the attack. The entrance to the lair is two feet high and six feet wide, while that to the nursery chamber is two feet high and two feet wide. The female wolves will fight to the death to protect their cubs, and are *frenzied* while doing so.

3. Mine Entrance

The original iron doors which sealed the mine entrance are still in place, but the area behind them has been blocked by a rockfall. The doors themselves are **T 6 D 20**, but even if they can be broken down, it is impossible to proceed any further beyond them.

4. Undead Pen

This small cavern has been altered to serve as a holding pen for the undead forces commanded by Syrillia. When an attack is not in progress, all the undead will be in this cavern, in an inactive state.

5. Entrance

As you will see in the section on *Staging the Encounter*, victims are intended to find this lightly-concealed entrance. A loose rock standing at the side of the pass (**I** +20 to find it – make the roll secretly for any character who goes within 2 yards)

has a space behind it. The rock takes a combined *Strength* of 10 to move, revealing a passage 4ft high and 5ft wide.

6. Killing Zone

Characters who survive the ambush outside and discover the entrance at 5 will find themselves in this chamber. It is here that surviving victims are scrutinised to decide who merits further investigation, and who should be killed out of hand. The concealed door at 6a has a spyhole which facilitates this process.

7. Living Quarters

The *Lesser Eidolon* spell in the passage to 6 projects the illusion of a deep chasm 20ft wide, with spikes at the bottom and a drawbridge sealing the rest of the passage.

The chamber is the main living quarters for Werner and Syrillia. A couple of piles of silks and cushions, looted from various caravans, serve as makeshift beds. In the centre of the chamber is an ash-filled fire-pit, and against the far wall stands a small shrine, with three Human hearts slowly rotting in top of it. A successful *Int* test (*Theology* +10) will identify the shrine as being dedicated to Kháine, the Lord of Murder.

If the beds are searched thoroughly, the one near-

est the entrance will be found to have three books buried under the assortment of cloth. These are spell books looted from spellcasters who have fallen prey to the death-trap. Each book has a number of pages missing (the spells Werner was unable to learn – he tends to be impatient about these things), but their contents are as follows:

Book 1

Petty

Magic Flame, Magic Lock, Sounds, Zone of Warmth.

Battle 1

Immunity from Poison, Strength of Combat.

Battle 2

Aura of Protection.

Battle 3

Arrow Invulnerability.

Book 2

Petty

Gift of Tongues, Glowing Light, Magic Lock, Protection from Rain, Sleep.

Book 3

Illusion 1

Assume Illusionary Appearance, Bewilder Foe, Camouflage Area.*

Illusion 2

Illusionary Woods, Lesser Eidolon.*

Book 4

Battle 1

Cause Animosity, Immunity from Poison.

Battle 2

Cause Frenzy, Cause Panic.

The spells marked with an asterisk (*) are new, and are explained in the section on *New Magic* at the end of this book.

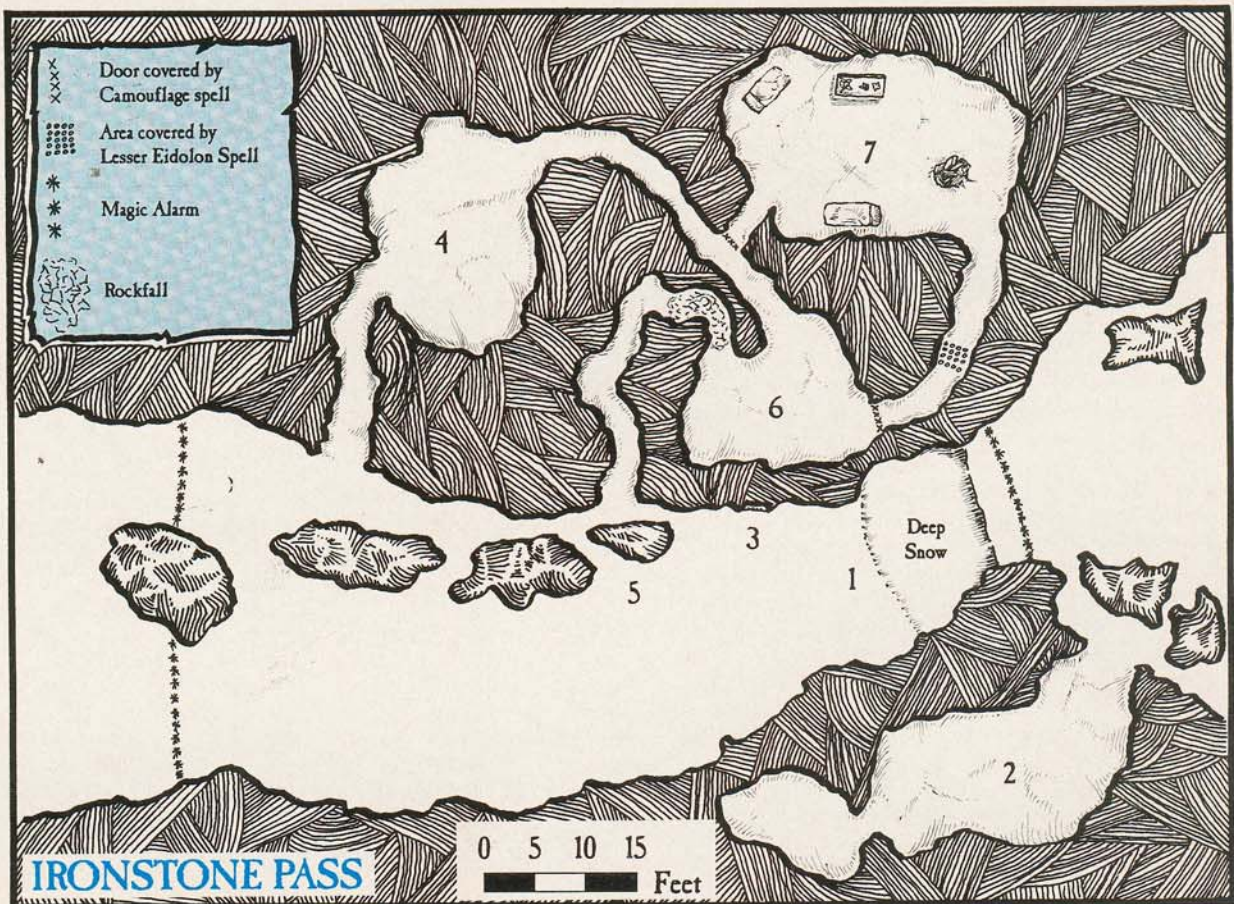

The fire-pit has a loose slab at the bottom, which lifts up to reveal a cache of treasure. There is 13 GC, 4/6 in assorted coin (10 GC, 30 SS, 414 BP), a silver statuette of Myrmidia worth 30 GC, and two small rubies worth 5 GC each.

STAGING THE ENCOUNTER

Magic Alarm spells have been placed at the points marked on the map. When Werner becomes aware of victims entering the trap, he casts a *Aura of Protection* and *Arrow Invulnerability* on himself, and then proceeds to area 7 to watch 6 through the eyeslit in 6a. He uses his Lesser Earthstone to summon a small Earth Elemental, and orders it to wait in the rock of the ceiling of area 6, ready to trigger a rockfall on his command.

Meanwhile, Syrillia goes to area 4 and casts *Raise Dead* on the bodies stored there, preparing the undead for battle with *Stop Instability*.

The adventurers' first intimation of danger is when they encounter the hidden drop at 1. As soon as the first characters drop in the deep snow, the wolves come pouring out of their lair at the rate of D4+1 per round until all 14 are in the fray. This forces the adventurers forward, further into the pass. As they get level with area 5, the undead come out of area 4, sealing the other end of the pass. The two forces close in, and the adventurers are forced closer to 5. The door is found, and the adventurers take shelter in the caves.

Once in the caves, the adventurers are herded into area 6. Werner orders the Earth Elemental to cause a rockfall in the area shaded on the map, sealing off the escape route to 5. Treat the resulting shower of rock fragments as an *Assault of Stones* spell. At the same time, the undead have returned to area 4 and make their way along the passage to 6, with Syrillia behind them. She casts *Illusionary Enemy* to make the numbers of undead look more fearful, and takes on a *Ghostly Appearance* to disguise her presence among them. The undead stand shoulder-to-shoulder, blocking the passage to 4 but making not move to attack.

There follows a pause. The adventurers are trapped, with a rockfall sealing the exit to 5, undead blocking the exit to 4, and an illusion hiding the exits to 7. Werner and Syrillia examine the adventurers from their hiding-places, weighing up whether or not they are "interesting".

Any use of spells or magic items, displays of unusual fighting ability or imaginative responses to their predicament will qualify the adventurers as "interesting". This means that, rather than killing them as quickly and effectively as possible (*Fire Ball* spells, a more serious rockfall, etc), the two will try to dispose of the adventurers without damaging any equipment they might have.

The following paragraphs deal with the various methods that will be tried to this end by Werner and Syrillia. The text below takes no account of what the adventurers themselves might be doing at the time, because the options are too numerous – you'll have to react to this as you see fit, bearing in mind the overall plan of the two evil spellcasters and the forces at their command.

The adventurers certainly shouldn't just sit there and wait for the next thing to happen to them, so be sure that you allow them full freedom of action – within the restrictions of their present situation, of course!

Subduing the Adventurers

The first move to subdue the adventurers comes in the form of a *Marsh Lights* spell. A single globe of light appears in the centre of area 6, and begins to move in a rhythmic pattern – Werner is trying to use this as the object for his *Hypnotism* skill. Characters whose players state that they are looking away from the light are not affected, but others must make a **WP** test (with a +10 bonus owing to the unorthodox manner in which Werner is using hypnotism) or lapse into a trance. Each unaffected character may try to rouse one entranced character per round, by shouting, slapping and the like – this gives the entranced character another **WP** test (unmodified) to snap out of the trance.

If all the adventurers end up in a trance, the fight is more or less over – they will wake up in the dark, on an unfamiliar part of the mountain, stripped of all valuables and magical items and the poorer by a fate point each. And they should think themselves lucky at that – it's only the fate point apiece that kept them from being wolf food.

However, it is fairly unlikely that all the adventurers will succumb at once, and after an entertaining few minutes they should all be staring steadfastly away from the bobbing light, refusing to be hypnotised. So Werner will have to try something else.

The next move will be to cast a *Steal Mind* spell as the likeliest-looking character. A spellcaster will be the first target, especially one who has been using magic to resist the scheme so far. If the first target is affected, Werner will repeat the treatment on a second, and so on round the party. If it proves possible to subdue the whole party this way, they will be stripped and dumped as above; if not, Werner will proceed to Plan C.

Plan C is a *Universal Confusion* spell, cast on the entire party. Note that a **WP** test is permitted to resist the spell's effects. As soon as the spell is cast, the undead will move into the room with the intention of mobbing the adventurers and pinning them to the walls. If the adventurers haven't been able to do anything positive about their situation so far, now is their chance for an epic battle, bunched together and fighting off hordes of undead as the corpses pile up all around them!

THE ADVENTURERS STRIKE BACK

It is very unlikely that the adventurers will fall prey to Werner's attempts to subdue them – such methods might work well enough on terrified merchants and unimaginative mercenaries, but a band of seasoned adventurers should be able to stand up to his methods, and even mount a counter-attack.

There seem to be three main options open to the adventurers once they are herded into area 6: blasting their way out through the undead, finding the secret door to 7, or somehow getting out through the rockfall to 5. Of course, imaginative players might well come up with other plans, and you'll have to react to these on behalf of Werner and Syrilla.

Digging Out

The rockfall triggered by Werner's Earth Elemental covers the area shaded on the map, and will take 40 character/minutes to clear manually (Werner has the Earth Elemental put things back after an attack), with a maximum of two characters being able to work clearing the rockfall at any one time.

Unless the adventurers have some magical means of tunnelling their way out at speed, this is probably the least useful option; it will take some time, and Werner will certainly notice and have time to react. The adventurers will have about a turn's worth of digging before Werner reacts with the *Universal Confusion* plus undead option.

Blasting Out

In this instance, blasting their way out is not so bad an idea – especially if the adventurers have the Crystal of Fire to help them. The first time the adventurers use the Crystal, the Earth Elemental will vanish in terror, so Werner can't cause another cave-in.

Although there seem to be an awful lot of undead, remember that part of this is due to Syrilla's *Illusionary Enemy* spell. A good, solid barrage of *Fire Ball* or *Blast* spells should clear a few of them away from the mouth of the passage to 4, enabling the adventurers to get a bridgehead in the passage and start pushing. Once in the passage, the adventurers will be out of Werner's line of sight from his spyhole in the concealed door, so he will no longer be able to cast spells at them. And, having a healthy regard for his own skin, he will certainly not come out from his hiding-place just to get a better shot.

The Zombies, of course, can be forced to leave combat if they lose a round of combat and fail a **Ld** test, and this will play havoc with the undead

in such a confined space, as Zombies try to go one way and Skeletons try to go the other – and all the while the adventurers will be taking free blows at retreating backs.

As soon as things begin to look complicated in the passage, Syrilla will retreat to area 4, ordering the undead to stage a fighting retreat. What she does next will depend on how healthy her forces are looking – if you'll pardon the expression. If she thinks she can win the fight by pulling back to 4 and luring the adventurers into the chamber where the undead can use their superior numbers to advantage, she will do so. If, on the other hand, the adventurers are felling undead right and left like ninepins, she will adopt a more subtle tactic. Leaving the undead to block the adventurers for as long as they can, she will retreat to area 4, drop her *Ghostly Appearance*, and do her best to look like a prisoner by tearing her clothes and scratching her face and arms. The adventurers will find her, huddled in a corner and apparently terrified, when they enter area 4.

She will claim to be a wizard's apprentice, held prisoner by the undead since her master was killed in a similar ambush. "*They're keeping me for something HORRIBLE, I just KNOW it!*" she will wail in feigned hysteria. There's a good chance that the adventurers will decide to rescue her, unless one or more characters saw through her *Ghostly Appearance* during the fight in the corridor. A character with *Magical Awareness* skill is permitted an **Int** test to notice that her magical aura seems somewhat more powerful than one would expect from a mere apprentice.

Assuming that the adventurers accept her story and take her along with them, she will try to get away from them on the following night, stealing what she can. If she sees the Crystal of Fire in action, she will probably sneak off, return to the pass, put together as many undead as she can, and attack the party repeatedly with the aim of winning this fabulous treasure. The journey through the mountains could turn into a running battle, fighting off undead every inch of the way!

Finding the Door

If the adventurers penetrate the illusion covering the door at 6a, the door becomes obvious. It is bolted on the other side (**T** 4, **D** 14), and Werner will be long gone by the time the adventurers break it down. One character at a time can try to break the door down; the rest will be needed to fight off the undead, who will pour into the chamber at this point.

Werner will rush into area 7, relying on the illusion of the chasm and portcullis to slow the adventurers down a little. He will grab his spell book and go via the passage to 4 and out of the complex, hiding the book under a rock in the pass, changing to wolf form and leading his wolves in a full retreat into the mountains. Syrilla will have to fend for herself – she may try to wipe the

adventurers out in area 7, under her idol of Khaine, by swamping them with undead, she may play the prisoner and hope for better luck another day, or she may simply run for it, leaving the undead to fight a rearguard and buy her time to escape.

Changing Sides

Syrillia is growing tired of Werner's company, and is thinking of taking him for everything he's got and moving on; although Werner doesn't know it, she is by far the superior spellcaster, especially now that he has trained her to level 3 Illusionist. You might decide that if the adventurers are doing a very impressive job against Werner, and if they haven't yet come into conflict with Syrillia, then she may decide to join them. If you like rolling dice, you might give her a "Whimsy" test of 30%, modified by up to +/-30 according to how she rates the adventurers' performance.

If Syrillia decides to abandon Werner at this point, a number of spectacular things will happen. First, the undead will crumble to the floor as she unleashes an *Annihilate Undead* spell from behind them. Then, she will march into the chamber, revealing the concealed door with a *Banish Illusion*, followed by a *Lightning Bolt* to demolish it and a *Steal Mind* (augmented with 9 magic points from one of her *Jewels of Power*) at Werner. If the spell gets him, she marches up and cuts his throat - otherwise, she pumps *Fire Balls* into his fleeing back. He could ruin everything if he got the chance to talk.

Introducing herself to the adventurers as Larithriel Oakshadow from the Loren Forest, Syrillia then explains that Werner had been holding her prisoner under the influence of powerful soporific drugs, but the adventurers' arrival delayed the next dose long enough for her to regain her senses, get free and take her revenge. She will offer to join the adventurers for up to 2 weeks - "the least I can do in thanks" - but her main motive is to find out what magical equipment they have and strip them of it if possible.

PROFILES

14 Pack Wolves

M WS BS S T W I A Dex Ld Int Cl WPFel
9 33 0 2 2 5 30 1 - 10 10 14 14 -

Special Rules: Bite attack, 20% chance of causing infected wounds. Fear fire.

12 Zombies

M WS BS S T W I A Dex Ld Int Cl WPFel
4 25 0 3 3 5 10 1 10 10 14 14 14 -

Special Rules: Subject to *instability*. Subject to *stupidity* unless controlled. Ld test to keep fighting when losing combat. Cause *fear* in living creatures they attack. Immune to psychological effects. Hits have a 20% chance of causing *Tomb Rot*; hits which do not cause *Tomb Rot* have a 50% chance of causing *infected wounds*.

16 Skeletons

M WS BS S T W I A Dex Ld Int Cl WPFel
4 25 17 3 3 5 20 1 18 18 18 18 -

Special Rules: Subject to *instability*. Subject to *stupidity* unless controlled. My not be forced to leave combat. Cause *fear* in living creatures. Immune to psychological effects. Hits have a 35% chance of causing *infected wounds*.

Werner Silbermann, Level 3 Illusionist/Werewolf

Human Form

M WS BS S T W I A Dex Ld Int Cl WPFel
4 38 35 4 4 10 43 1 53 56 63 51 58 33

Special Rules: Subject to *frenzy*; make a **WP** test or change to wolf form until *frenzy* subsides, when another **WP** test is necessary to change back to Human form.

Werner has learnt to control his condition to some extent, so he has a +10 bonus to these tests.

Skills: Arcane Language - Magick; Cast Spells - see below; Charm Animal - wolves only; Evaluate; Herb Lore; Hypnotise; Identify Plants; Identify Undead; Magical Awareness; Magical Sense; Meditation; Read/Write; Rune Lore; Scroll Lore; Secret Language - Classical.

Spells: 37 Magic Points

Petty	<i>Gift of Tongues, Glowing Light, Magic Alarm, Magic Flame, Magic Lock, Marsh Lights, Protection from Rain, Sleep, Sounds, Zone of Warmth</i>
Battle 1	<i>Cause Animosity, Fire Ball, Immunity from Poison, Steal Mind, Strength of Combat</i>
Battle 2	<i>Aura of Protection, Cause Frenzy, Cause Panic</i>
Battle 3	<i>Arrow Invulnerability</i>
Illusion 1	<i>Assume Illusionary Appearance, Bewilder Foe, Camouflage Area*, Cloak Activity</i>
Illusion 2	<i>Banish Illusion, Ghostly Appearance, Illusionary Woods, Lesser Eidolon*</i>
Illusion 3	<i>Illusionary Enemy; Illusion of Mighty Appearance, Universal Confusion</i>

* These are new spells - see *New Magic* at the back of this book.

Possessions: dagger (I +20, D -2, P -20); magical sword (WS +10); *Robe of Toughness* +2; *Jewel of Power* (energy - 8 magic points); *Amulet of Coal* (2 Fire Ball spells, cast at level 2); *Potion of Healing* (3 doses); *Ring of Protection* vs goblinoids; *Lesser Earthstone* (see *New Magic*); spell book.

Wolf Form

M WS BS S T W I A Dex Ld Int Cl WPFel
9 41 0 3 3 5 30 1 - 10 14 14 14 -

Special Rules: Bite attack; 20% chance of causing infected wounds.

Syrillia, Dark Elf Level 3 Necromancer/Level 3 Illusionist

M WS BS S T W I A Dex Ld Int Cl WPFel
4 48 44 3 4 10 83 1 79 63 88 80 63 45

Special Rules: Syrillia's disabilities are *Cadaverous Appearance*, *Animal Aversion* and *Strength Loss*. All are at stage 1.

Skills: Acting; Ambidextrous; Arcane Language - Magick; Cast Spells - see below; Charm; Daemon Lore; Evaluate; Flee!; Herb Lore; Hypnotise; Identify Plants; Identify Undead; Immunity to Disease; Magical Awareness; Magical Sense; Meditation; *Night Vision* 30 yards; Read/Write - Tar-Eltharin, Old Worlder; Rune Lore; Scroll Lore; Secret Language - Classical; Seduction; Speak Additional Language - Old Worlder.

Spells: 47 Magic Points

Petty	<i>Curse, Gift of Tongues, Glowing Light, Magic Alarm, Magic Flame, Magic Lock, Marsh Lights, Protection from Rain, Reinforce Door, Sleep, Sounds, Zone of Silence, Zone of Warmth</i>
Battle 1	<i>Cause Animosity, Fire Ball, Flight, Immunity from Poison, Steal Mind, Strength of Combat</i>
Battle 2	<i>Cause Frenzy, Cause Hatred, Cause Panic</i>
Battle 3	<i>Arrow Invulnerability, Cause Cowardly Flight, Cause Fear, Cause Stupidity</i>
Illusion 1	<i>Assume Illusionary Appearance, Bewilder Foe</i>
Illusion 2	<i>Banish Illusion, Ghostly Appearance</i>
Illusion 3	<i>Illusionary Enemy</i>
Necromantic 1	<i>Destroy Undead, Hand of Death, Summon Skeletons, Zone of Life</i>
Necromantic 2	<i>Control Undead, Extend Control, Hand of Dust, Stop Instability</i>
Necromantic 3	<i>Annihilate Undead, Raise Dead</i>

Possessions: dagger (I +20, D -2, P -20); *Jewel of Power* (energy - 6 magic points); *Jewel of Power* (energy - 9 magic points); *Jewel of Power* (spell - *Lightning Bolt*, cast at level 3); *Amulet of Righteous Silver*; *Ring of Protection* vs non-ethereal Undead; *Amulet Ring - Thrice-Blessed Copper*; spell book.



Tony Ackland

Gorr'ummraorr, size 3 Earth Elemental

M WS BS S T W I A Dex Ld Int Cl WPFel
3 27 27 3 3 27 27 3 27 27 27 27 27

Special Rules: Gorr'ummraorr is bound to Werner's *Lesser Earthstone* - see the section on *New Magic* for the relevant rules.

NEW ILLUSION MAGIC

Camouflage Area

Spell Level: 1
Magic Points: 4
Range: Touch
Duration: until dispelled
Ingredients: 1 pint of Chameleoleech blood

This spell can affect an area up to 10 feet in each dimension. It has the effect of concealing anything within that area - doors, treasure chests and the like - and making the area look just like the rest of the space in which it is situated.

The main purpose of this illusion is to discourage anyone from searching the area thoroughly, and characters searching the area covered by this illusion will see through it on a successful **Int** test (Illusionists +10 per level). This test is modified by the caster's level as normal.

Lesser Eidolon

Spell Level: 2
Magic Points: 6
Range: Touch
Duration: until dispelled
Ingredients: model of desired terrain

This spell creates illusionary terrain within a 10 foot cube. The terrain can be anything desired by

the caster, but the illusion may not include a representation of anything living or anything which moves. No other illusion may be cast in the same area - if this happens, both illusions are dispelled.

Characters viewing the illusion from a distance of 24 yards or less may make an **Int** test to see through it. This test is modified by the caster's level as normal.

NEW MAGIC ITEMS

Lesser Earthstone

This item is a fist-sized lump of granite, irregularly shaped and carved with runes pertaining to the element of earth. A character with *Magical Sense* skill who examines the stone will recognise its affiliation with the magic of earth on a successful **Int** test.

A small Earth Elemental is magically bound to the stone, and may be summoned by the stone's holder once per day. This costs the holder 2 magic points, which means that the user must be a spellcaster - users without MPs will be ignored. Once summoned, the Elemental may be ordered to perform three tasks. Orders may be given one at a time or all together; in the latter case, the character must specify the order in which the tasks are to be performed, or the Elemental will choose (select randomly).

It is not certain that the Elemental will perform all the tasks demanded of it. The first task will always be carried out, but the second task has a 60% chance of being done - on a D100 roll of 61 or more the Elemental vanishes back whence it came and may not be summoned again for a full day. The third task has only a 30% chance of being carried out.

Note that the Earthstone's Elemental may not be ordered to do things which are beyond its abilities, or which would result in its destruction. If given such orders, the Elemental will vanish and may not be summoned again until next day. ■■

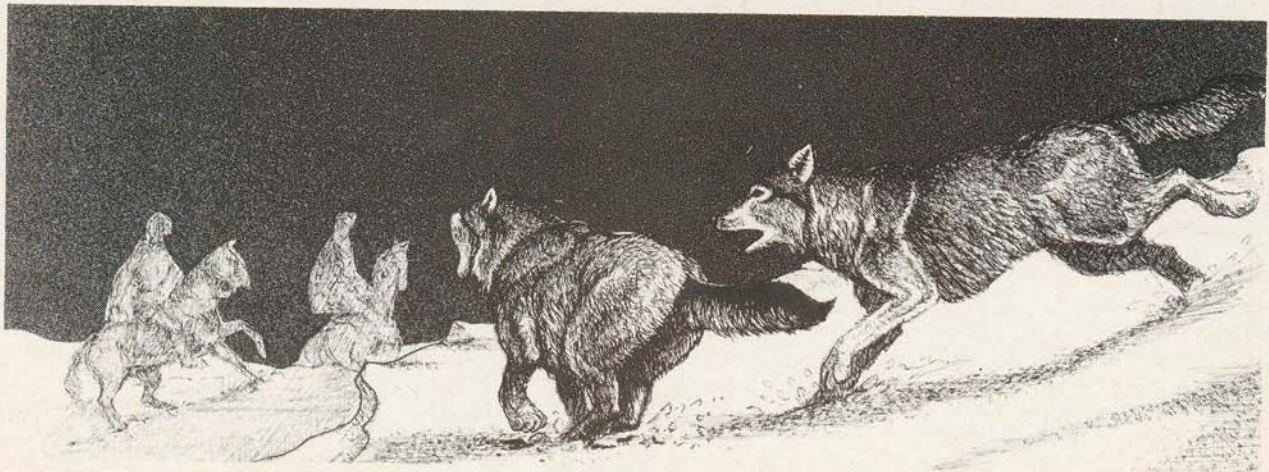

Tony Ackland

GAMES™ WORKSHOP

ILLUSTRATORS

We're looking for artists capable of illustrating:

Plans, Maps & Technical Cutaways

such as those in this issue's Ironstone Pass and Modelling Workshops. This is freelance work and you'll have to be able to meet fairly short deadlines.

If you think you can draw maps and/or technical illustrations to a high standard, please send some samples of your work and a letter outlining your age and occupation to:

Steve How
Games Workshop Design Studio
Enfield Chambers
14-16 Low Pavement
Nottingham

Please note that samples cannot be returned – only send copies.

IN PAPERBACK...IN HARDCOVER....INVENTIVE...
INGENIOUS...INCREDIBLE...

TRUCKERS

The first part of
the nome trilogy
now in
paperback. 

WINGS

The hilarious third
and final part of
the nome trilogy.
In Doubleday
hardcover. 

The wonderful world of the nomes.
For readers of all sIzEs

THE IRONSTONE QUEST

THE ADVENTURE LINE

Enter five fantastic worlds of high adventure created
by the Master of Role-playing Fantasy - Joe Dever

ALIEN INTRUDER

Starring Tom Baker



Time and place:
2754 AD - Deep Space

Your identity:
Federation Patrol Leader

Your quest:
Hunt down and destroy the
killer intruder - before it kills
you!

NINJA

Time and place:
1530 AD - Nippon

Your identity:
Ninja warrior: Samurai Toda Clan

Your quest:
Recover your clan's most precious
relic - the
Toda
Katana



THE FORBIDDEN TOWER

Time and place:
MS 5056 - World of Magnamund

Your identity:
Lone Wolf: the last Kai Master
of Sommerlund

Your quest:
Discover the identity of He who
commands the Forbidden Tower

Lone  Wolf



THE LATEST GREAT ADVENTURE
IN THE LONE WOLF SAGA

TOMB OF THE SPHINX



Time and place:
1934 AD - Cairo

Your identity:
Sir Edward Mainwaring:
archaeologist

Your quest:
To find the legendary 'Eye of
Set'

VAMPIRE HUNTER



Time and place:
1995 AD - Los Angeles

Your identity:
Dr Marc Steiner: paranormal
investigator

Your quest:
To hunt down and destroy the
vampire that is terrorizing
Mammoth
Studios



DEATH OR GLORY? – THE CHOICE IS YOURS!

 0898 555 525 

C & E GROUP, PO BOX 120, HENLEY-ON-THAMES, OXON

Calls cost 33p (off peak) and 44p (standard peak) per minute inc VAT

GAMES WORKSHOP™

MAIL ORDER

Games Workshop and Citadel Mail Order is not just a packing and despatch service. The friendly staff who man the Mail Order phones are all keen hobby enthusiasts who will be more than happy to give you help and advice with your purchases of miniatures and games

PRICE LIST			
CODE	DESCRIPTION	UK PRICE	US PRICE
0071584	Eldar Guardians	£2.99 for any 5	\$7.50 for any 5
070620	Ork Mekboyz	£2.99 for any 3	\$7.50 for any 3
070683/1	Ork Freebooterz Nob	£1.99 each	
070683	Ork Freebooterz	£2.99 for any 2	\$7.50 for any 2
072596	Purestrains Genestealer	£2.99 for any 2	\$7.50 for any 2
072557	Genestealer Hybrids	£2.99 for any 3	\$7.50 for any 3
	Genestealer Patriarch Set:		
072583	Genestealer Patriarch and Magus Advisor	£5.99 for the set	\$14.95
072583/7	Magus advisor	£0.60 each	
072583/5	Patriarch Body	£2.00 each	
072583/6	Patriarch Back	£0.50 each	
072583/1	Throne Back	£1.50 each	
072583/3	Throne Right Side	£0.50 each	
072583/4	Throne Left Side	£0.50 each	
072583/2	Throne Seat	£0.50 each	
	Plastic Arms and Weapons	£0.50 each	

THE MINIATURES ABOVE ARE ALL SUPPLIED WITH THE APPROPRIATE PLASTIC ARMS AND WEAPONS

ORDER FORM

CODE / DESCRIPTION	QTY	TOTAL PRICE
TOTAL:	POSTAGE & PACKING:	GRAND TOTAL (TOTAL + P&P) =
NAME AND ADDRESS:		
.....		

HOW TO ORDER CITADEL MINIATURES

We strongly recommend that you 'phone in your orders. You'll be talking directly to the Mail Order specialist who'll actually be packing and despatching your order. He'll be able to tell you exactly what is and isn't available, and suggest alternatives in the case of any problems. He will also be able to tell you about any new models that have become available since last issue, and any special offers we may be running on old, discontinued or overstocked items.

If it's simply not possible for you to order by phone then it doesn't matter too much. All you have to do is tell us the name (if available) and code. Be as explicit as you can when writing out your descriptions of the models you want. This is particularly important if you want to order a particular combination of parts for a multi-part kit. We recommend using block capitals to avoid confusion!

Alternatives

You should always let us have a list of alternatives when ordering by post. Even if you make an order by phone, it is wise to give a few alternatives. The only reason we won't be able to supply you with a model is if it has been discontinued and the mould is no longer available on the factory floor. Normally speaking we manage to supply 95% of all orders. Our staff will be happy to suggest viable alternatives for any models which are out-of-stock or no longer produced.

Despatch and Delivery

We always try to despatch your orders within 2 days of receipt, quite often we get them out the same day. Remember that parcels take longer than letters, but you should, in general, get your order back within 10 days. We do occasionally get behind, but this usually only happens when we hold a large sale with lots of irresistible offers, and at Christmas.

Please, please, please do NOT send in orders which you expect in time for Christmas any later than the last week-end in November!

Foreign Orders

We are very happy indeed to supply foreign orders through our UK Mail Order Department.

Postage & Packing

Total up your order and add the following postage & packaging costs:

UK & BFPO: add £2.50

Overseas (including Eire): add 40%. If you pay by credit card, P&P will be charged at cost.

METHODS OF PAYMENT

You can pay by cheque or postal order. Alternatively, we take Access and Visa cards - write with your order, and include the card number, the cardholder's name and signature, the card expiry date, and your name and address. Better still, phone our Mail Order Hotlines to place an immediate order - make sure you have your Access or Visa card with you when you phone.

UK MAIL ORDER

Our UK Mail Order Hotlines are open for your orders from 8.30am to 6.30pm on weekdays. The numbers to ring are (0773) 760462 or (0773) 713213

If you're writing in with your order, send it to:



GAMES WORKSHOP MAIL ORDER SERVICE,
CHEWTON STREET, HILLTOP,
EASTWOOD,
NOTTINGHAM NG16 3HY



Or you can fax the order through on (0773) 530155

US MAIL ORDER

For US telephone orders (Visa and MasterCard only) ring (301) 644 5699, Monday through Friday between 9.00am and 5.00pm EST.

Or you can post orders to:

GAMES WORKSHOP MAIL ORDER SERVICE,
3431 BENSON AVENUE,
BALTIMORE,
MARYLAND 21227

Please add \$3.00 postage and handling. Maryland residents add 5% sales tax, residents in Virginia add 4.5% sales tax. Write for free catalogue.

You can also fax Access and Visa miniatures orders direct to the UK on 01144 773 530155. Please remember to include the card number, the cardholder's name and signature, the card expiry date and your name and address. Handling will be charged at 40% or cost, whichever is cheaper.

PLASTIC ARMS AND WEAPONS

ORK WEAPONS



- 4 BOLTERS
- 4 BOLT PISTOLS
- 1 PLASMA GUN
- 1 CHAIN SWORD

ORK HEAVY WEAPONS

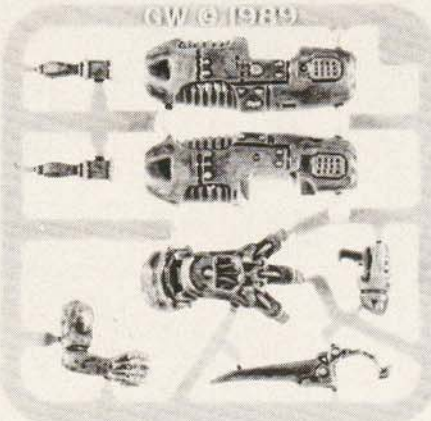

- 1 HEAVY PLASMA GUN
- 1 POWER CLAW
- 2 STIK BOMBS
- 1 PLASMA PISTOL
- 1 POWER SWORD

CHAOS HEAVY WEAPONS

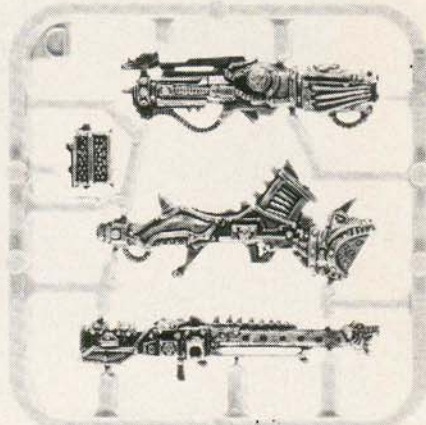

- 1 CONVERSION BEAMER
- 1 MISSILE LAUNCHER
- 1 AUTO CANNON WITH MAGAZINE

HEAVY LASER

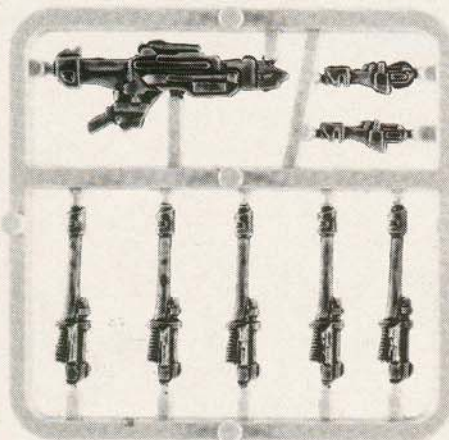

- 1 HEAVY LASER
- 2 LAS PISTOLS
- 5 LAS GUNS

HEAVY BOLTER

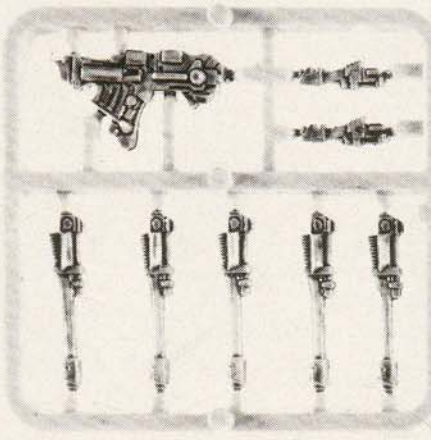

- 1 HEAVY BOLTER
- 2 LAS PISTOLS
- 5 LAS GUNS

HAND WEAPONS

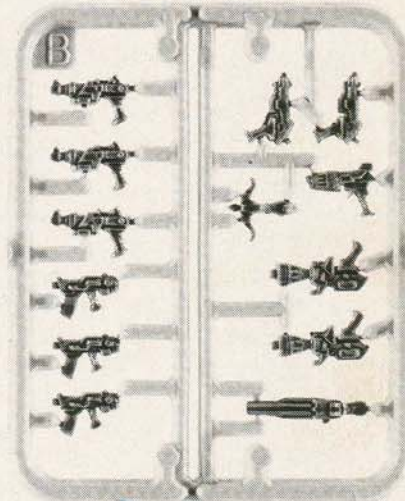

- 3 AUTO PISTOLS
- 3 BOLT PISTOLS
- 2 HAND FLAMERS
- 2 STUB GUNS
- 1 HAND CROSSBOW
- 1 SAWN OFF SHOTGUN
- 1 PLASMA PISTOL

GENESTEALER ARMS



ORK ARMS

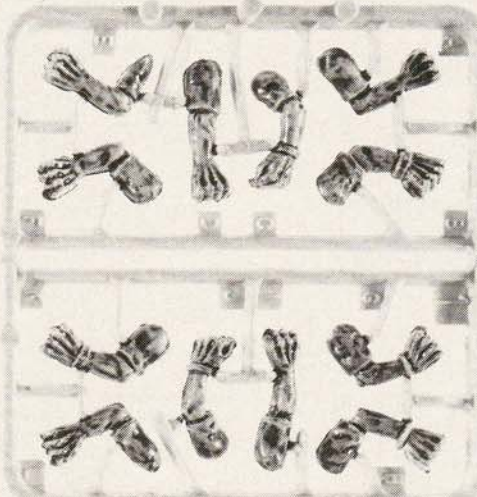

HUMAN ARMS

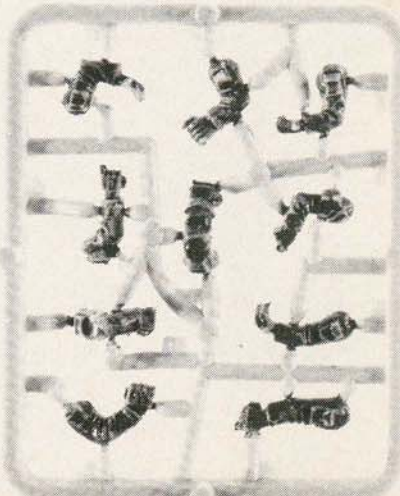

THE ABOVE ARMS AND WEAPONS WERE ORIGINALLY MADE WITH SPECIFIC RANGES IN MIND, BUT THEY ARE OF SUCH A DESIGN THAT IF YOU WISH, ANY COMBINATION OF ARM, WEAPON AND MINIATURE CAN BE PUT TOGETHER. THESE ARMS AND WEAPONS CAN BE PURCHASED SEPARATELY THROUGH MAIL ORDER

Miniatures supplied unpainted. WARNING! This product contains lead which may be hazardous if chewed or swallowed. Citadel Miniatures are not recommended for children under 14 years of age.

GENESTEALER HYBRIDS



HYBRID 1
072557/6



HYBRID 2
072557/10



HYBRID 3
072557/12



HYBRID 4
072557/13



HYBRID 5
072557/14

GENESTEALER MAGUS
WITH LAS PISTOL AND
COMMUNICATOR
072557/7



HYBRID 7
072557/16



HYBRID 8
072557/17



HYBRID 9
072557/18



HYBRID 10
072557/19



HYBRID 11
072557/20



HYBRID 12
072557/21



HYBRID 13
072557/22



HYBRID 14
072557/23



HYBRID 15
072557/28



HYBRID 16
072557/27



HYBRID 17
072557/25



HYBRID 18
072557/24



HYBRID 19
072557/29

ALL THE HYBRIDS FROM 3 TO 20 ARE SUPPLIED COMPLETE WITH PLASTIC ARMS AND WEAPONS. THE MINIATURES ABOVE ARE EXAMPLES OF JUST SOME OF THE COMBINATIONS YOU CAN CREATE. BY USING THE APPROPRIATE COMBINATIONS OF ARMS AND WEAPONS, YOU CAN MAKE TWO, THREE OR FOUR-ARMED GENESTEALER HYBRIDS TO REPRESENT WHICHEVER GENERATIONS YOU WANT.



HYBRID 20
072557/26

Minifigures supplied unpainted. **WARNING!** This product contains lead which may be harmful if swallowed. Citadel Miniatures are not recommended for children under 14 years of age.



GENESTEALER PATRIARCH



MAGUS ADVISOR
072583/7

THRONED
GENESTEALER
PATRIARCH

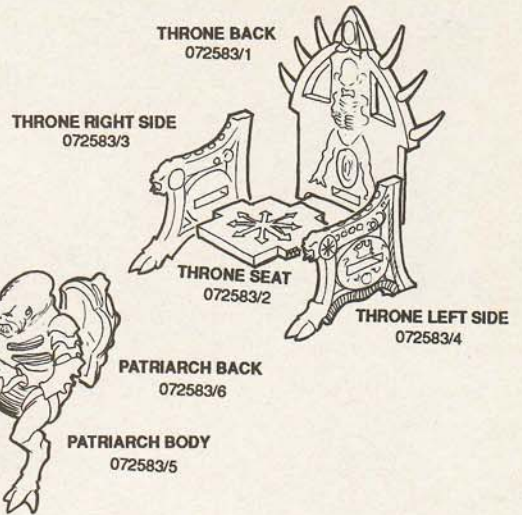

THRONE BACK
072583/1

THRONE RIGHT SIDE
072583/3

THRONE SEAT
072583/2

THRONE LEFT SIDE
072583/4

PATRIARCH BACK
072583/6

PATRIARCH BODY
072583/5

GENESTEALERS



PURESTRAIN
GENESTEALER 1
072596/10



PURESTRAIN
GENESTEALER 2
072596/11



PURESTRAIN
GENESTEALER 3
072596/12

THESE MINIATURES ARE SUPPLIED WITH PLASTIC ARMS

ELDAR GUARDIANS



CLOSE COMBAT GUARDIAN
WITH POWER SWORD
AND LAS PISTOL
071584/2



GUARDIAN WITH LAS GUN 1
071584/3



BATTLE GUARDIAN
WITH SHURIKEN
CATAPULT 1
071584/4



BATTLE GUARDIAN
WITH SHURIKEN
CATAPULT 2
071584/1



GUARDIAN WITH LAS GUN 2
071584/5

Copyright © 1990 Games Workshop Ltd. All rights reserved.

Minatures supplied unpainted. WARNING! This product contains lead which may be hazardous if chewed or swallowed. Citadel Miniatures are not recommended for children under 14 years of age.



MEKBOYZ



MEKBOY WITH
GRENADE LAUNCHER
070620/1

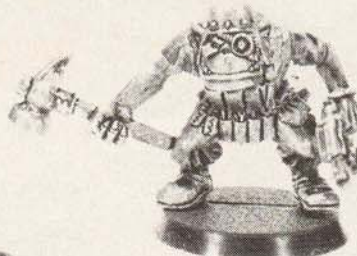

MEKBOY WITH BIG HAMMER
070620/19



MEKBOY WITH WRENCH
070620/2



MEKBOY WITH FLAME
THROWER
070620/20



MEKBOY WITH CUTTERS
070620/3

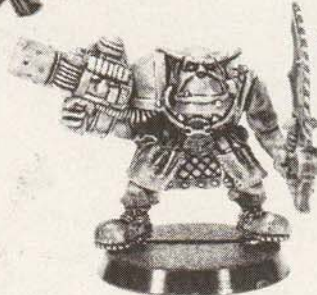

MEKBOY WITH
GRENADE LAUNCHER
070620/21

FREEBOOTERZ

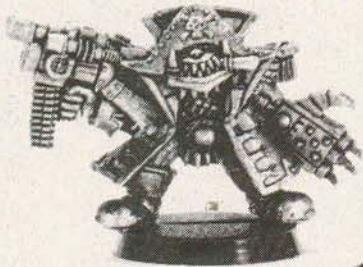

NOB WITH POWER CLAW
AND KUSTOM WEAPON
070683/1



RENEGADE MEK
WITH KUSTOM WEAPON
070683/2



BAD DOC WITH
POWER CLAW
070683/3



FREEBOOTER BOY 1
070683/4



FREEBOOTER BOY 2
070683/5



ORK KAPTAIN
070683/6



ORK PIRATE WITH
CYBORG BODY
070683/7



FREEBOOTER
STORMBOY
070683/8

ALL THE ORKS ABOVE (EXCEPT THE NOB AND PIRATE),
ARE SUPPLIED COMPLETE WITH PLASTIC ARMS AND
WEAPONS. THE MINIATURES ABOVE ARE EXAMPLES OF
JUST SOME OF THE COMBINATIONS YOU CAN CREATE.

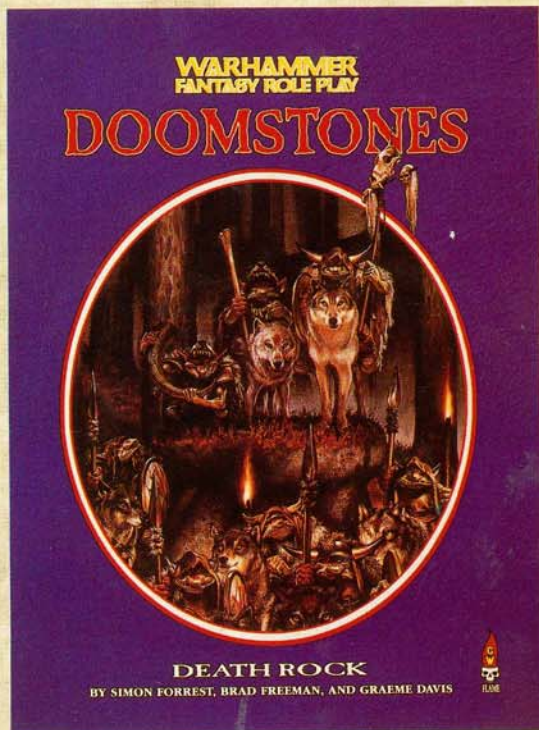

WARHAMMER FANTASY ROLE PLAY

DEATH ROCK

The Orcs of the Bloodaxe Alliance once again threaten the Yetzin Valley. Their target is the monastery of Eyrie where, long ago, the Dwarf-mage Yazeran fled with the fabled Crystal of Air.

The adventurers must reach the monastery and find the Crystal before Orc army, driven on by its mutant master, attacks Eyrie. The only problem – apart from 600 or so bloodthirsty Orcs – is solving a little puzzle that Yazeran left behind...

Death Rock is the third part of the *Doomstones Campaign* for WFRP, an 88-page book including handouts, sample characters and a model of the Crystal of Air.

Available now for £6.99 from Games Workshop stores. Mail Order: make cheques payable to Flame Publications. Please make all payments in Pounds Sterling. Handling charges on UK, Eire and BFPO orders: add £2.50 for all orders. Overseas airmail: minimum order £5.00, add 40% for handling (minimum £2.50). Telephone orders direct to us on (0602) 500459, Monday-Friday 10 am-5 pm. Or send SSAE to Flame Publications, 3 Derby Terrace, Derby Road, Nottingham, NG7 1ND, for Mail Order details. In the USA contact Games Workshop US Mail Order.



Coming Soon!

WARHAMMER FANTASY ROLE PLAY

DWARF WARS

Civil war is brewing among the Dwarven kingdoms of the southern World's Edge. A lost Dwarfhold has been found: Kadar-Gravning, the Hold of Hargrim, a Dwarf-King without equal. To the Dwarfs of the World's Edge, there is no greater symbol of rulership than Hargrim's Crown. He who owns the Crown is the true King, and when war comes, he that has the Crown will surely prevail...

But finding the Crown won't be easy. Kadar-Gravning was sacked a century ago by Orcs. Large parts of the Hold are in ruins; the Royal Tombs are ringed by deadly traps. And whoever reaches the Hold first can be sure that the enemy is not far behind.

And while the Dwarfs fight each other, a small group of adventurers are making for Kadar-Gravning for reasons of their own...

Dwarf Wars is a 104 page stand-alone adventure or can be used as the fourth part of the *Doomstones Campaign*.

Available soon from Games Workshop stores, or by Mail Order direct from Flame Publications.

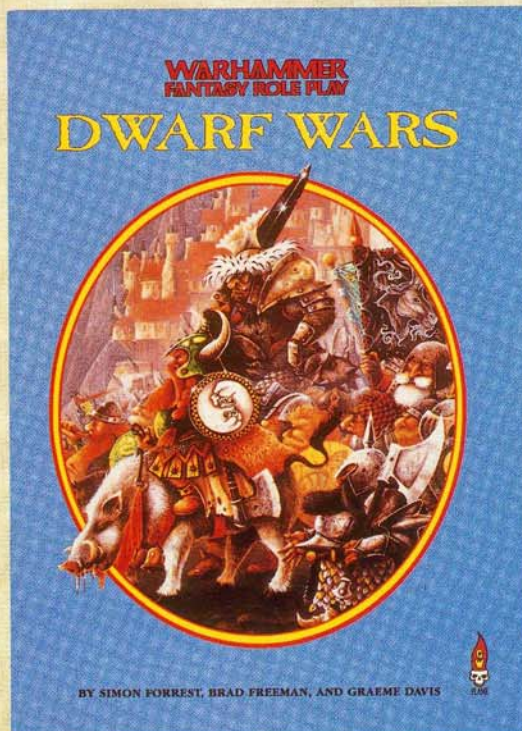



The Avatar leads his forces of Aspect Warriors and Guardians in an ambush on an Ork convoy of Golfs