

GAMES WORKSHOP

PRESENT THEIR MONTHLY GAMES MAGAZINE



CITADEL
MINIATURES

WHITE DWARF

128

£1.50

\$3.95

AUSTRALIA

\$6.50

WEST GERMANY

DM 5.95

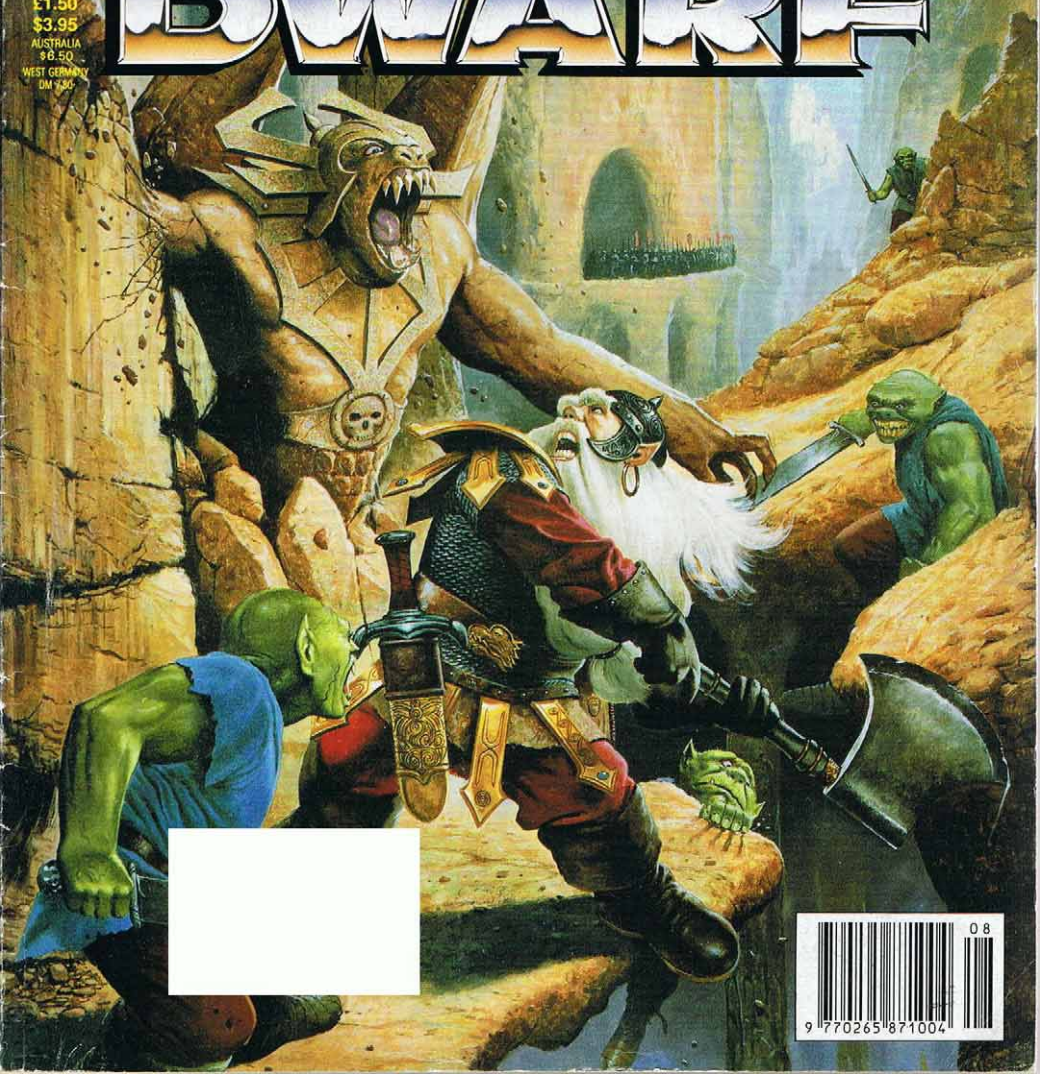

9 770265 871004

08

GW

DARK FUTURE™

...SO AVAILABLE
THROUGH W.H. SMITH
AND OTHER LEADING
BOOKSHOPS

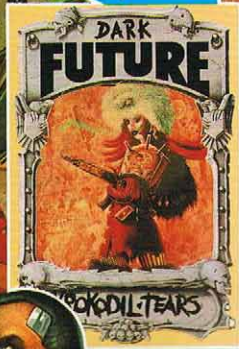
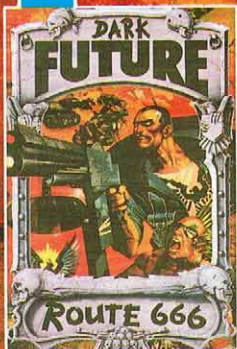

“Arcane cybergoth fiction, set in the nightmare world of the near future.”

The earth is ravaged by catastrophic climactic changes. The world's economies, civilizations, and even the laws of nature are on the brink of collapse. North America is a sand-blasted battlefield between tribalistic gangcunts and a new breed of legalised killer - the Sanctioned Operative.

THE DEMONS ARE BACK.

Games Workshop Mail Order,
Chewton Street, Hilltop, Eastwood,
Nottingham, NG10 3HY

GW Books,
34 West Street, Brighton,
East Sussex, BN1 2RE

Games Workshop Inc.,
3431 Bennoch Avenue,
Baltimore, MD 21227

Copyright © 1990 Games Workshop Ltd. All rights reserved.

Product Code: 0943
Ref No: 00943
ISSN: 0265 - 8712

Editor: Simon Forrest
Published by Games Workshop Ltd

**PRODUCED BY
THE GAMES WORKSHOP
DESIGN STUDIO**

Printed by Artisan Press Ltd, Leicester, UK.
All correspondence except subscriptions and Mail Order should be addressed to: *White Dwarf*, Games Workshop Design Studio, Enfield Chambers, 14-16 Low Pavement, Nottingham NG1 7DL.

SUBSCRIPTIONS

Please send and make remittance to: Games Workshop, Chewton Down, Hilltop, Eastwood, Nottingham NG16 2NR, Telephone 0773 733231 or 760432. *White Dwarf* is published monthly. Annual subscription rates are: UK - £18.00, Europe £36.00, other overseas surface - £38.00, other overseas airmail - £54.00. Please make all payments in Pounds Sterling.

US-CANADA - check or money order - \$35.00 for US residents (Maryland readers add 5% sales tax), \$45.00 for Canadian residents. Cheques made payable to GAMES WORKSHOP and sent to WHITE DWARF MAGAZINE SUBSCRIPTIONS, Games Workshop Inc., 3431 Benson Ave, Baltimore, Maryland 21227. For VISA and MASTERCARD subscriptions telephone (301) 644 5699.

When you want to inform us of a change of address or subscription renewal, or if you have a query, please write to the appropriate subscription address and make sure that you tell us your name and present address (and your old address if you are moving). When you subscribe, please tell us whether you are renewing an old subscription or starting a new one.

ADVERTISING

For details of advertising rates and copy dates, contact Steve How at Games Workshop Design Studio, Enfield Chambers, 14-16 Low Pavement, Nottingham, NG1 7DL.

The publishers of *White Dwarf* regret they cannot accept responsibility for lost or stolen transactions between readers and advertisers. *White Dwarf* reserves the right to amend or reject any material submitted for publication as an advertisement.

CONTRIBUTIONS

The Editor will be pleased to accept any previously unpublished articles for inclusion in *White Dwarf*. All submissions should be typed double spaced with 30mm margins, on one side of A4 paper only, and should be accompanied by an explanatory covering letter and a stamped self-addressed envelope large enough to return the submission. Hand-written submissions will not be considered. Please state clearly on the envelope which game the submission is for.

ARTWORK SUBMISSIONS

We are happy to look at samples of black and white artwork but, in order to deal efficiently with such material, we require that all artwork be submitted as photocopies together with a stamped self-addressed envelope in order for us to reply and return the artwork. Please address all artwork to the Editor at the Design Studio address. For both articles and artwork, please allow at least 6-8 weeks for a reply.

RENEWABLE RESOURCES

White Dwarf is printed on paper from the Mylyskivi Paper Mill, Finland. For every tree cut down, the mill plants two more. These are farmed trees grown specifically for this purpose and their use in no way diminishes the natural stock.

All Games Workshop's boxes, cards and counters are printed using 95% recycled paper.

All subject matter in *White Dwarf* is copyright Games Workshop Limited.

All artwork in all Games Workshop products and the images contained therein have been produced either in-house or as work for hire. The exclusive copyright in the artwork and the images it depicts is the property of Games Workshop Ltd. Copyright © 1990 Games Workshop Ltd. All rights reserved.

Games Workshop and the Games Workshop logo, Citadel Miniatures and the Citadel Miniatures logo, *White Dwarf* and the *White Dwarf* figure, Warhammer, Warhammer 40,000, Realm of Chaos, Epic, Dark Future, Blood Bowl, Advanced Tactics, Titans, 3D Roleplay Hobby Games, Tallman, Space Marine, Space Hulk, Advanced Horrologer, Games Day and Golden Demon Awards are trademarks of Games Workshop Limited. *Blood Bowl* and the Realm of Chaos logo is a registered trademark owned by Games Workshop Limited. Maelstrom is a trademark owned by Maelstrom Miniatures Limited. Flame is a trademark owned by Flame Limited. The GW Books logo is a trademark owned by GW Books Limited - all used with permission.

ABC

MEMBER OF THE
BUNDS OF PUBLISHERS

ISSUE 128 AUGUST 1990

AUDITED AT
58,597 COPIES
PER MONTH

WHITE DWARF CONTENTS

COVER: KELLAR'S KEEP - Les Edwards

Les' picture from the cover of MB Games' first HeroQuest supplement Artwork © 1990 Milton Bradley Limited. Used by permission

RETAIL SPOTLIGHT: BRIGHTON, SOUTHAMPTON AND TORQUAY

Details of events on the South Coast and a full listing of Games Workshop stores in the UK and US

GAMES WORKSHOP STORE NEWS

What's on where around the country - news of special events in all our stores

GAMES WORKSHOP AND CITADEL NEWS

Info on the latest releases and plans in the pipeline

'EAVY METAL

New models painted by the Studio staff, some more Terminators from Frances Eilvyd, plus David Soper's Nurgle Predator, winner of the 1990 Golden Demon Slayer Sword

MARIENBURG - Graeme Davis and Richard Laing

We take a second visit to Poison Square in this continuing series about our Warhammer Fantasy Roleplay city and discover Kluger's Emporium, Wilhelm Rotkopf the Alchemist and Lisette's Leather Goods

ORK FREEBOOTERZ - John Blanche

John gives us a sneak preview of his sketches for Citadel Miniature's new range of Warhammer 40,000 Ork Freebooterz

WARHAMMER 40,000 VEHICLES - Rick Priestley

The first part of a new and improved vehicles system for Warhammer 40,000, giving you the rules plus data sheets for two Ork Battlewagons, the Rhino and the Predator. This month's special free insert is the vehicle targeting grid to accompany this article

'EAVY METAL: BATTLEWAGONS - Ivan Bartlett and Dale Hurst

Two of the new plastic Battlewagon kits painted with Goff and Snake-Bite colour schemes

MODELLING WORKSHOP: BATTLEWAGON WITH BLITZKANON

Tony Cottrell tells you how to do a simple conversion on your Ork Battlewagon to arm the model with a blitzkanon for Warhammer 40,000, plus a Bad Moon Battlewagon painted by Ivan Bartlett

'EAVY METAL - Mike McVoy

Mike takes you through the painting details for this month's miniatures, with expert hints and tips on how to achieve great results with your models

EPIC ORKS ARMY LIST - Andy Chambers

How to design an Ork horde for fighting Space Marine battles, with rules for new infantry, vehicles and Gargants; counters and templates for creating your own horde; and a fully-worked-out sample army - Burzuruk's Bad Boyz

'EAVY METAL: WAA-WAZROKK

A ready-made Warhammer 40,000 Ork warband chosen by Nigel Stillman - two pages of painted miniatures from the Studio staff, plus a special Mail Order offer for the entire warband!

BACK COVER: 'EAVY METAL: NURGLE WAR ALTAR - Ivan Bartlett

Ivan Bartlett's superb scratch-built Nurgle War Altar surrounded by other minions of the Plague Lord

ADVERTS

Dark Future Books.....	Inside Front	White Dwarf Subscriptions.....	70
Games Workshop Staff.....	5	Mail Order.....	75
Games Day 1990.....	7	Citadel Catalogue.....	76
Games Workshop Philadelphia.....	19	Independent Specialist Stockists.....	80
Marauder Miniatures.....	48	War of Wizards.....	Inside Back



John Blanche



Andy Chambers



Graeme Davis



Rick Priestley



Nigel Stillman



Steve Tappin

GAMES WORKSHOP™

With summer upon us, we take a look at the South Coast this month, featuring the Games Workshop stores in Brighton, Southampton and Torquay. If you're a regular gamer at the stores, take a look at what's coming your way. And if you're down south for your holidays in August, why not drop into the nearest store – you'll be more than welcome and it'll give you a chance to play against some fresh opponents.

BRIGHTON



Space Hulk Marathon Knockout

Saturday 4th August: bring along your squad of painted Terminators for an enormous battle on a 10' x 3' layout of a derelict hulk in warp-space. Can you claim ultimate victory at the end of the day?

August Gaming Day

Friday 10th August: a special all-day mini-Games Day will be held at Mangleton in Brighton, with demonstration and participation games, miniature painting workshops and more. Everyone's welcome – if you want to come along, contact the store for more details.

Painting Demonstration by Ivan Bartleet

Saturday 11th August: see 'Eavy Metal Tour box for details.

Epic Bring'n'Battle

Friday 17th August: bring along painted forces chosen from one of the Epic army lists in White Dwarf of up to 1500 points and help defend the fortress against Nell's Ork invasion force. Contact Nell for further details.

Quest for the Amulet of Feral Winter

Saturday 18th August: a 'Warhammer Fantasy Battle bring'n' battle in which you get a chance to take on Chris' Chaos Dwarfs in a deadly quest. If you've got a painted WFB army and you'd like to play, contact Chris for details.



Chris Cooper

Chris is a keen Warhammer Fantasy Battle gamer, fielding a Chaos Dwarf army. He also has an Epic Ork army and is the resident miniature painting expert. If you'd like some useful tips on painting your models, Chris will be running painting classes on Wednesdays throughout August.



Tracie Fleming

TC is Brighton's WFRP expert, so if you'd like some advice on rules, creating an adventure or would like to part in one of the games she's running, just pop in the store and ask her for more info.



Neil Condren

Neil is the Warhammer 40,000 and Epic Ork Clan Master and will not only be happy to give you help with fighting in the universe of the 41st Millennium, but will gladly take on anyone who fancies their chances against his Orks.

SOUTHAMPTON

Warhammer Fantasy Roleplay Week

Tuesday 7th to Friday 10th August: Quentin will be running a series of short Warhammer Fantasy Roleplay adventures for beginners throughout the week. If you've not played WFRP before and you'd like to take part, register at the shop before Friday 3rd August.

Painting Demonstration by Dale Hurst

Saturday 11th August: See 'Eavy Metal Tour box for details.

Warhammer 40,000 Roleplay Special

Tuesday 28th to Friday 31st August: We'll be running a manic series of short adventures in the Warhammer 40,000 universe using a specially-written set of WH40K roleplaying rules. If you'd like to be a death-dealing, bolter-wielding mercenary for the week, see Chris before Friday 24th August for full details of how to join up.

Chris Cutting

Chris is a very keen Warhammer 40,000 and Space Hulk player and fields a WH40K Imperial Guard army as well as Squats and Space Marines – drop into the shop and challenge him to a game if you dare!



Jason Harris

As well as fielding his Tzeentchian forces, Jason is Southampton's resident miniature painting expert – he's always willing to help you with the art of wielding a paint brush. If you want, bring along your miniatures and Jason will give you some hands-on advice.



Quentin Berry

Quentin is the store's WFRP expert and is also the proud general of a Warhammer 40,000 army of World Eater Renegades. Talk to Quentin if you want advice on either system, or fancy your chances against his army.



'EAVY METAL TOUR

MINIATURE PAINTING DEMONSTRATIONS

Ivan Bartleet, Dale Hurst and Tim Prow will be visiting the Brighton, Southampton and Torquay stores during July and August to demonstrate their talents as featured in every month's 'Eavy Metal pages. They'll be showing you how to paint some of the new releases from Citadel Miniatures and giving you advice on all aspects of miniature painting and converting.

If you want some help with your models, bring them along on the day and the lads will give you some hints and tips on ways of improving your results whatever your standard.



Ivan



Dale



Tim

TORQUAY

Painting Demonstration by Tim Prow
Saturday 28th July: See 'Eavy Metal Tour box for details.

Epic Space Marine Battles

Throughout August, we'll be running a series of battles on our newly-built Epic scale oil refinery. Come along and play in a game where Imperial and Rebel forces are in desperate battle - bring a force of painted miniatures chosen from one of the Epic army lists in White Dwarf. Call the store for more details.

Epic Vehicles Painting Competition

Also throughout the month, we'll be running a special miniature painting competition. If you think you can paint the best Epic scale miniature on the South Coast, then get your entry to the shop by Friday 31st August. Drop in or call for more details.



Guy Carpenter

Guy is an avid enthusiast of Warhammer 40,000 and Space Marine, but he's best known for his superb Warhammer 40,000 vehicle conversions, many of which have appeared in White Dwarf. If you need any expert tips on modelling and painting, Guy's your man.



Brian Hoare

Brian is always happy to give advice on any Games Workshop game, whether you want to know about the rules or could do with a bit of help on choosing your armies. He fields a Dark Elf army and is open to any and all challenges.



**GAMES WORKSHOP
BRIGHTON**
7 NILE PAVILIONS,
NILE ST, BRIGHTON,
BN1 1HW.
CONTACT: CHRIS
TEL: 0273 203333



**GAMES WORKSHOP
SOUTHAMPTON**
23 EAST ST,
SOUTHAMPTON,
SO1 1HG.
CONTACT: CHRIS
TEL: 0703 331962



**GAMES WORKSHOP
TORQUAY**
12 MARKET ST,
TORQUAY, TO1 1AQ.
CONTACT: GUY
TEL: 0803 201036

RETAIL STORES

If you want to know what's going on at your local Games Workshop store, drop in and check the notice board or ask any of the staff who'll be happy to fill in the details and chat about games and Citadel Miniatures. If you can't make it in, give the store a call and ask when the next event is taking place. There's something happening most Saturdays at all the stores - and don't forget the evening Gaming Clubs during the week.

LONDON

**GAMES WORKSHOP
BECKENHAM**
236-234 HIGH ST, BECKENHAM,
KENT, BR6 1DY
CONTACT: PAUL
TEL: 081 658 8102

**GAMES WORKSHOP
HAMMERSMITH**
(NEAR RAVENSCOURT PARK TUBE
STATION)
1 DALLING RD, HAMMERSMITH,
LONDON, W6 0JD
CONTACT: PETE
TEL: 081 741 3445

**GAMES WORKSHOP
HARROW**
236 STATION RD, HARROW,
MIDDLESEX, HA1 2DX
CONTACT: DAVE
TEL: 081 861 2380

**GAMES WORKSHOP
OXFORD STREET**
UNIT F10, THE PLAZA, 116-128
OXFORD ST, LONDON, W1R 1PA
CONTACT: PHIL
TEL: 071 436 0839

THE SOUTH

**GAMES WORKSHOP
BRIGHTON**
7 NILE PAVILIONS, NILE ST,
BRIGHTON,
BN1 1HW. CONTACT: CHRIS
TEL: 0273 203333

**GAMES WORKSHOP
BRISTOL**
13 BROAD WEIR, BRISTOL
CONTACT: SHANE
TEL: 0272 261533

**GAMES WORKSHOP
READING**
UNIT 3, CHEAPSIDE, READING
CONTACT: RICHARD
TEL: 0734 596693

**GAMES WORKSHOP
SOUTHAMPTON**
22 EAST ST, SOUTHAMPTON, SO1 1HG
CONTACT: CHRIS
TEL: 0703 331962

**GAMES WORKSHOP
TORQUAY**
12 MARKET ST, TORQUAY, TO1 1AQ
CONTACT: GUY
TEL: 0803 201036

MIDLANDS

**GAMES WORKSHOP
BIRMINGHAM**
519 BRIDGELINK, BULL RING
CENTRE, BIRMINGHAM
CONTACT: TED
TEL: 021 632 4904

**GAMES WORKSHOP
DERBY**
42 SADLER GATE, DERBY, DE1 3NL
CONTACT: DOMINIC
TEL: 0332 371687

**GAMES WORKSHOP
DUDLEY**
KOSK U, UPPER LEVEL, MERRY HILL
CENTRE, BRIERLEY HILL, DUDLEY
CONTACT: SIMON
TEL: 0284 481 6118

**GAMES WORKSHOP
NOTTINGHAM**
304 FRIAR LANE, NOTTINGHAM,
NG1 3DU
CONTACT: KARL
TEL: 0602 480651

THE NORTH

**GAMES WORKSHOP
LEEDS**
12-16 CENTRAL RD, LEEDS,
LS1 6DE
CONTACT: DARYN
TEL: 0332 420034

**GAMES WORKSHOP
LIVERPOOL**
28 BOXL ST, LIVERPOOL, L1 4DJ
CONTACT: STEVE
TEL: 051 708 6087

**GAMES WORKSHOP
MANCHESTER**
UNIT 1, 3 BROWN ST,
MANCHESTER, M4 3AB
CONTACT: KARL
TEL: 061 832 6863

**GAMES WORKSHOP
NEWCASTLE**
83 CLAYTON ST, NEWCASTLE,
LONDON-TYNE, NE1 5PY
CONTACT: IAN
TEL: 091 232 2418

**GAMES WORKSHOP
PRESTON**
15 MILLER ARCADE, PRESTON,
PR1 3QA
CONTACT: IAN
TEL: 0772 21855

**GAMES WORKSHOP
SHEFFIELD**
85 THE MOOR, SHEFFIELD, S1 4PG
CONTACT: RICHARD
TEL: 0742 760114

**GAMES WORKSHOP
YORK**
26 GOODRAMGATE, YORK, YO1 2LG
CONTACT: EVAN
TEL: 0904 653575

SCOTLAND

**GAMES WORKSHOP
EDINBURGH**
136 HIGH ST, EDINBURGH
CONTACT: MARK
TEL: 031 220 6540

**GAMES WORKSHOP
GLASGOW**
66 QUEEN ST, GLASGOW, G1 3DS
CONTACT: ALISTAIR
TEL: 041 226 9192

USA

**GAMES WORKSHOP
FAIRFAX**
FAIR CITY MALL, 9600 MAIN
STREET, FAIRFAX, VA 22031
CONTACT: TOM
TEL: (703) 893 9284

**GAMES WORKSHOP
MARYLAND**
UNIVERSITY OF MARYLAND,
LEHIGH ROAD, COLLEGE PARK,
MD 20740
TEL: (301) 864 5668

**GAMES WORKSHOP
PHILADELPHIA**
424 SOUTH STREET,
PHILADELPHIA, PA 19147
CONTACT: OWEN
TEL: (215) 829 0554

**GAMES WORKSHOP
WASHINGTON/
BALTIMORE**
LAUREL CENTER MALL, 14658
BALTIMORE-WASHINGTON BLVD,
LAUREL, MD 20707
CONTACT: TIM
TEL: (301) 490 8663

GAMES WORKSHOP™

RETAIL STORE NEWS

GAMES WORKSHOP MAIDSTONE

OPENING SOON
UNIT 6
1-9 PUDDING LANE
MAIDSTONE

Look out for opening details in White Dwarf

GAMES WORKSHOP 1990 GAMING LEAGUES

The new Gaming Leagues are now running at your local Games Workshop store. There are Leagues for Warhammer Fantasy Battle, Warhammer 40,000, Blood Bowl, Space Hulk and Space Marine. If you're interested in joining the Leagues, pop in to your local store for further details and pick up a rules booklet.

WARHAMMER CLUBS

We're in the process of setting up a network of new Warhammer Clubs throughout the country for players of all Games Workshop games.

If you'd like to join your local club or even help us run one (perhaps you know of a suitable venue?), contact your local Games Workshop store – they'll give you all the details.

EVENTS FOR AUGUST

There are always exciting events going on at your local games Workshop store, including Games Clubs, gaming demonstrations and participations, painting and modelling workshops, and auctions.

On these pages, we've only got room to give details of a few of the special events, so the only way to avoid missing out is to drop in to your local Games Workshop store and ask what's planned for the following weeks. If you can't get in to the shop on a regular basis, ring up and find out when there's something special happening. Keep in touch, because new events are announced all the time.

BECKENHAM

GAMES CLUB THURSDAY EVENINGS
SPACE MARINE PARTICIPATION GAME
Come down on **Saturday 25th August** and join in the special re-enactment of the battle at the end of the Honor Heresy between forces of the Emperor and Warmaster Horus. Contact Paul for details.

BIRMINGHAM

LEAGUE PAINTING COMPETITIONS
Each Saturday in August there'll be a competition to find the best painted force in Birmingham's Gaming Leagues. Dates are:

- 4th Space Hulk
- 11th Warhammer 40,000/Space Marine
- 18th Blood Bowl
- 25th Warhammer Fantasy Battle

BRISTOL

**GAMES CLUBS THURSDAY AND
FRIDAY EVENINGS**

SPACE MARINE MONTH
A series of events on Saturdays for Space Marine, including the following:

- 4th Designing and painting Epic forces
- 11th Making scenery for Epic battles
- 18th Space Marine participation battle
- 25th Space Marine participation battle

Contact the store for more details.



DERBY

GAMES CLUB THURSDAY EVENINGS
BLOOD BOWL MONTH
Every Saturday during August, there'll be a Megabowl Speed Tournament in the store. First to a Touchdown wins League points, and there'll be prizes for the fastest Touchdown on the day.

On Saturday 2nd August, Adrian Wild will be running a Blood Bowl painting demonstration alongside the tournament so make sure you're at the shop on the 2nd

DUDLEY

GAMES CLUB EVERY EVENING
CHAOS WARBANDS

Can your Chaos Champion lead his warband to victory and be first to claim the ultimate prize of Daemnohood. If you're interested in playing in our Chaos warband campaign running throughout August, contact Stuart at the store.

EDINBURGH

GAMES CLUB THURSDAY EVENINGS
Each week during August there'll be a different miniature painting competition. Judging will be on Saturdays with entries in by the previous Wednesday. The dates and classes are as follows:

Judging		Entries
4th	Warhammer 40,000	1st
11th	Warhammer Fantasy Battle	8th
18th	Space Hulk	15th
25th	Vehicles	22nd

GLASGOW

GAMES CLUB THURSDAY EVENINGS
DWARF DAMBUSTERS

On Saturday 18th August, there'll be a participation game where you control a flight of Dwarf grycopters attempting to bomb a dam and drown the Orc army. The Orcs will, of course, be trying to stop you using archers, bolt throwers and stone throwers! If you'd like to play, contact Alasdair at the store.

HAMMERSMITH

GAMES CLUB THURSDAY EVENING
The Hammersmith staff challenge anyone to a game of Warhammer Fantasy Battle, Warhammer 40,000, Space Hulk, Blood Bowl or Space Marine. There's also a whole series of events planned in the shop for August, so pop in and see Pete for details.

HARROW

GAMES CLUB MONDAY EVENINGS
DEATHQUEST
A Space Hulk bring'n'battle on **Saturday 18th August**. Bring down your basic Terminator squads and battle against other Marines – but watch out for those Stealer. See Dave for details.

LEEDS

GAMES CLUB WEDNESDAY EVENINGS
SPACE ORK SPECIAL
Following a Space Ork painting clinic on **Saturday 18th**, there'll be a Warhammer 40,000 Space Ork participation game on **Saturday 25th**. If you'd like to play, turn up with your painted Space Orks ready to take on Paul Hudson's Fire Legion Space Marines.

LIVERPOOL

GAMES CLUB THURSDAY EVENINGS
ELDAR PAINTING COMPETITION
To enter the competition, bring in your single miniature by **Thursday 23rd August**. There are two age groups: up to 14 and 15 and over. Entries will be judged on **Saturday 25th August** – contact Will for details.

MANCHESTER

GAMES CLUB THURSDAY EVENINGS
ELDAR VS MARINE BRING'N'BATTLE
Bring down either a painted squad of Aspect Warriors or a squad of Marines on **Saturday 11th August** if you'd like to join in. There'll be a prize for the best Eldar and Marine forces. Contact Karl for further details.

NEWCASTLE

GAMES CLUB THURSDAY EVENINGS

BATTLE FOR THE HOMEWORLD

There'll be a Space Hulk participation game on Saturday 11th August. The Marines have returned to their homeworld, only to discover unwanted guests: Genestealers have invaded the planet. Can the Marines purge their world of the aliens? Come along at 1.00pm and find out - better still, help to decide the outcome by taking control of a squad of Terminators. Contact Ian for further details.

NOTTINGHAM

GAMES CLUB THURSDAY EVENINGS

WARHAMMER GAMES CLUB

This club playing Warhammer Fantasy Battle, Warhammer 40,000, Space Marine, Space Hulk and Blood Bowl is now running at a city-centre venue on Wednesday nights, 7-10.30pm - contact the shop for more info.



SUMMER SEMINARS

During the coming month, the Games Workshop game designers will be giving a series of special Saturday seminars where you can learn about the new exciting products on the way and ask questions about the rules.

- 4th Warhammer Fantasy Roleplay - Mike Brunton and Graeme Davis
- 11th 'Eavy Metal - Phil Lewis and Mike McVey
- 18th Blood Bowl - Jervis Johnson

PLAZA OXFORD STREET

GAMES CLUB EVERY EVENING

WAAARGH! PARTICIPATION GAME

A squad of the Emperor's finest have grabbed a Weirdboy and are heading back to their shuttle. But the shuttle engine won't start and the Ork horde is getting nearer. One tribe may get lucky and snatch the Weirdboy back but the Imperial mothership in orbit will try to prevent this. Bring down 120 points of Orks on Saturday 11th August if you'd like to play. Contact Phil for info.

PRESTON

GAMES CLUBS THURSDAY EVENINGS

EPIC PAINTING COMPETITION

Design a colour scheme for your own Epic battleforce, paint up the appropriate miniatures, write a short history and background on the force and enter it into the special competition at Preston by 1st September. Contact Ian for further details.

READING

GAMES CLUB THURSDAY EVENINGS

WARHAMMER 40,000 CAMPAIGN

Throughout August you can join in a Warhammer 40,000 campaign where each player controls a band of mercenaries out to make a quick profit at whatever cost. For more details, contact Richard.



SHEFFIELD

GAMES CLUB THURSDAY EVENINGS AND NOW SUNDAY AFTERNOONS

BATTLE OF HAVRON II

The civil war on Havron II has escalated. The houses of Dibran and Kijlian have been destroyed and an alliance between Kranston and Mayrock houses looks set to conquer the world. You can take part in the battle to decide the future of the planet in a game of Space Marine using Imperial Knights. If you'd like to play, just turn up at the store on Saturday 4th August - everything's provided.

SOUTHAMPTON

WARHAMMER GAMES CLUB

Now running at a venue in the city on Sundays is a Games Club for all Games Workshop gamers. Contact the shop for more info.

YORK

GAMES CLUB FRIDAY

SPACE HULK BRING'N' BATTLE

Bring down your painted basic Terminator squad on Saturday 18th August and join in Tim Kirk's devious special mission. If you'd like to play, register at the store before the 18th.

GAMES WORKSHOP

GAMES PRODUCTION STAFF

Games Workshop currently has a number of vacancies at its busy Design Studio in the centre of Nottingham. This is where White Dwarf and all our games are designed, written, edited, illustrated and prepared for printing.

We are currently reorganising the Studio into self-contained design cells, each with the staff and hardware to perform all the tasks involved.

We are looking for committed and enthusiastic individuals who are already immersed in the world of hobby gaming and who are intimately familiar with one or more of Games Workshop's games systems and the associated range of Citadel Miniatures.

The right attitude is far more important than publishing experience, but familiarity with Apple Macintosh DTP and a facility with English could be an advantage.

The successful applicants will find themselves in a hard-working team, dedicated to the creation and production of the finest hobby games material in the world.

For further details, please write in the first instance to Simon Forrest at the address below. Be sure to enclose a brief CV and details of your gaming background.

Games Workshop Design Studio, Enfield Chambers
14-16 Low Pavement, Nottingham NG1 7DL

UK STAFF RECRUITMENT

RETAIL MANAGERS

Games Workshop is not just concerned with the design and production of games, novels and miniatures. Our expanding chain of retail stores plays a vital role in the company's continued success and we need experienced Warhammer gamers to fill positions as Retail Managers.

Games Workshop stores are more than mere retail outlets: our retail managers must take the responsibility for creating regional hobby centres. Our stores should be places where newcomers and old hands alike can participate in and contribute to the world of Games Workshop hobby games.

The successful applicant must therefore have a good working knowledge of Games Workshop games and Citadel Miniatures. It's not enough to be a keen miniature painter who has seen a couple of our games being played.

Previous retail experience would be useful but is not essential as comprehensive training will be given at our Head Office and Design Studio in Nottingham. You must, however, be willing to relocate to anywhere in Britain.

If you fulfill these requirements and would enjoy a career with excellent prospects for the right person, please Clive Thompson at our retail department on 0773 769731 for further details.

GAMES WORKSHOP AND CITADEL NEWS

GOLDEN DEMON USA

We'd like to congratulate all those who entered Golden Demon through our US stores on the standard of painting we saw. There's obviously a lot of painting talent in the US and we'd like to see an ever-increasing number of US entries in future years.

The US winners of Golden Demon 1990 were:

Single Miniature: Drew Price - Great Avatar

Mounted Miniature: Barry Belbin - Tzeentchian Champion on horse

Monster: Barry Belbin - Daemon of Tzeentch
Standard Bearer: Dave Brooks - Champion of Tzeentch

Vignette: George Murdaugh - Minotaur Lord
Epic Scale Vignette: Wayne King - Titan Hunter

Single Titan: Dave Brooks - Reaver
Vehicle: Tory DeStromp - Nurgie Rhino

GAMES WORKSHOP WORLDWIDE

We've been snowed under by replies from overseas retailers and gaming enthusiasts following our call to those who'd like to work with us setting up shops and gaming clubs or translating our books and games. Thanks to everyone who got in touch - we'll be replying very soon. If you haven't sent us a letter and you're interested in working with GW overseas, please send write with a full CV to Andy Jones at the Design Studio - see page 5 of White Dwarf 125 for full details.



Games Workshop Ultra leading upwind



Ian Abbinnett



Alan Cowsill

WARHAMMER COMIC

Ian Abbinnett and Alan Cowsill have just joined the Design Studio as editors for the Warhammer Comic, which is now proceeding apace. Ian and Alan have published their own comic, *Stormwatcher*, and have written strips for *Revolver* and *Starblazer* - they currently write the Ricky Kilbane strip for *Deadline*.

Both are big Space Hulk and Blood Bowl fans and were attracted to Games Workshop by the chance to work with some of our artists and writers. As well as GW's own artists, they list comic artists like Brett Wing, Matt Wagner, John Bolton, Simon Bisle, Frank Miller, Glen Fabry and Steve Dillon amongst their favourites.

GAMES WORKSHOP ULTRA

What's 30 feet long, zooms along at 25 knots downwind and occasionally jetsons Ian Livingstone and eight other crazed yachtsmen into the cold sea? The answer is Games Workshop Ultra - a radical yacht that sails at nerving speeds. The crew sit out on racks and fight to control the huge sails - if they get it wrong, the boat capsizes. In short, Ultras are fast and dangerous

Ian's Games Workshop Ultra recently won the historic first race. It's racing again in front of the TV cameras in July and August. Watching Ultras race is really exciting and some of the incidents are spectacular. Anybody wanting to watch the race, meet Ian and cheer on the Games Workshop Ultra Race Team, here's the programme:

July 20-22: Ocean Village,
Southampton

July 27-29: World Championships,
Port Pennennis,
Falmouth

August 3-5: Royal Western Yacht
Club, Plymouth

More details can be obtained from Games Workshop stores in Brighton, Southampton and Plymouth, where Games Workshop Ultra Race Team T-shirts will be on sale.

CRASH & BURN

Games Workshop enthusiasts *Crash & Burn* (who used to be *Batfish*) have just gone into The Slaughterhouse to start recording the first album on the new Warhammer record label. The band play powerful heavy metal blues and the album will contain tracks like *Stealer's Kiss* and *Inquisitor Thrax*.



Simon Denbigh

Recording with *Crash & Burn* will be Brian May of Queen. Brian, a GW fan himself, liked what he heard of *Crash & Burn's* music so much that he offered to come along to the band's recording sessions and play guitar on some of the tracks. We can't wait to hear the results - watch this space for more news of the album.



Brian May



Bolt Thrower - Realm of Chaos picture disc

BOLT THROWER

Bolt Thrower are beginning work on their second album in collaboration with Games Workshop, currently under the working title of *Warmaster*.

Meanwhile, there's a special limited edition picture disc of Bolt Thrower's first album, *Realm of Chaos*. This is on sale in Games Workshop stores now and features John Sibbick's splendid Warhammer 40,000 cover on one side and a picture of the band on the other.

WARHAMMER RECORDS

If you're in a professional rock band and you're into games Workshop imagery, we'd like to hear from you. Send a demo tape and photos to Andy Jones at the Design Studio. Thanks to all the bands who've already sent us their demos - we're listening to them with great interest.

GAMES DAY GAMING LEAGUE CHAMPIONSHIPS 90

ASSEMBLY ROOMS, DERBY, 10am - 6pm SAT 15th SEPTEMBER

PRIORITY ENTRY TICKETS AVAILABLE NOW £2.00 IN ADVANCE FROM GAMES WORKSHOP STORES, INDEPENDENT SPECIALIST STOCKISTS AND GAMES WORKSHOP MAIL ORDER (0773 760462 OR 0773 713213)
NON-TICKET HOLDERS ENTRY ON THE DAY £3.00, AFTER 1pm ONLY



THE FINALS OF THE 1ST NATIONAL GAMING LEAGUE CHAMPIONSHIPS

- Grand finals for the Space Hulk, Warhammer Fantasy Battle, Warhammer 40,000, and Blood Bowl leagues
- Grand finals of the Space Marine Epic gaming league
 - Advanced Heroquest Tournament
- All league matches will be played on fully-terrained tables with buildings and landscape by Games Workshop's own modelling experts
- Citadel Miniature painting displays by the 'Eavy Metal team
 - Magnificent Games Workshop art displays
- All the latest releases from Games Workshop and Citadel Miniatures
- Seminars, live re-enactments, bring 'n' battle, demonstration and participation games
 - Many other exciting events to be announced
- Coaches to Games Day will be running from all Games Workshop shops - see your local manager for details

**GAMES
WORKSHOP**

**CITADEL
MINIATURES**

HEAVY METAL

This month we are featuring some of the latest releases from the Citadel Design team; including Orks, Eldar and Harpies. Also shown this month are a couple of Frances Ellyard's Terminators from her extensive collection, and the winner from the 1990 Golden Demon Slayer Sword; Dave Soper's Predator.



A SQUAD OF FIRE DRAGON ASPECT WARRIORS.
EACH MODEL IN THIS SQUAD HAS BEEN GIVEN A BANNER.



WARBOSS FROM THE
BLOOD AXE CLAN



BLOOD AXE MEKANIAK WITH
BOLTER AND FLAME THROWER

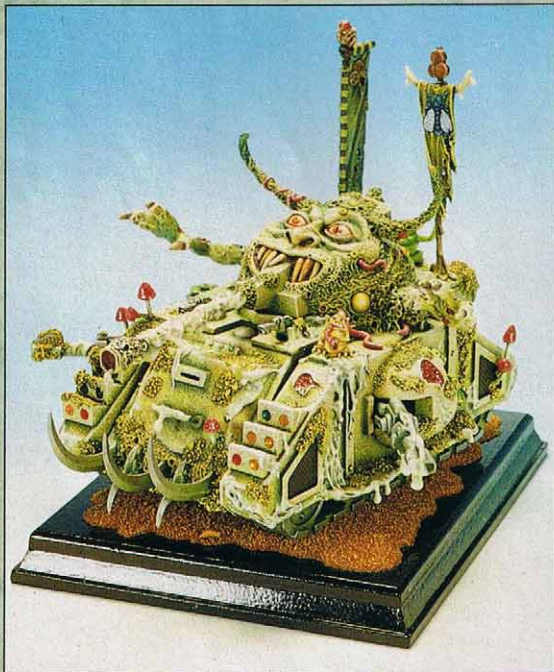

THE WINNER OF THE 1990 GOLDEN DEMON AWARDS.
A NURGLE PREDATOR BY DAVID SOPER.



GREY KNIGHT TERMINATOR BY
FRANCES ELLYARD

HEAVY METAL



BAD MOON ORK BOY WITH
HEAVY BOLTER



GRETCHIN WITH SHOTGUN
AND AMMO BOX



GRETCHIN WITH
BLUNDERBUSS



HARPY



GREY KNIGHT TERMINATOR
BY FRANCES ELDYARD



ELDAR WARLOCK WITH
WITCH BLADE



ELDAR GUARDIAN WITH
SHURIKEN CATAPULT



HARPY



SEA ELF REPEATING CROSSBOW AND CREW



ELDAR GUARDIAN FROM
THE BIELTAN
CRAFTWORLD



ORK BOSS FROM THE
SNAKE-BITE CLAN



GOFF BOSS WITH KUSTOM
BIONIC ARM



DEATHWING LIBRARIAN WITH
STORM BOLTER AND POWER AXE



DEATHSKULL ORK BOY



GOFF ORK BOY



Welcome, once more, to Marienburg, and our second visit to Potion Square.

This time we'll browse around Kluger's Emporium – a treasure trove of rare, interesting and curious items, where almost anything can be bought or sold; the alchemical workshops of Wilhelm Rotkopf, (both by Richard Laing), and meet one of the city's foremost alchemists – a useful acquaintance indeed. Finally, there is the mysterious Lisette, a dealer in leather who is more than she seems. (written by Graeme Davis, from the *Wolf Riders* short story *The Tilean Rat* by Sandy Mitchell).

This time, we've introduced a new, formalised way of presenting NPCs. Each minor NPC is itemised into five standard paragraphs:

Appearance, which is the initial impression anyone meeting them would get – eg tall blond Elf, pale-faced, unkempt;

Personality, their manner and behaviour patterns – eg kind, but slightly forgetful;

Motivations, the NPCs aims and desires – eg to have fun, and control the pipeweed trade;

Catchphrases, some sample speech for GMs – eg "I 'ad a baff last mon!"; and...

People, who the NPC knows, and what kind of a relationship exists – eg hates Agnetha Zeetrouw (SB7a), scared of and respects Big Piet (SR5b).

Minor NPCs are, of course, fully defined in WFRP rules terms as well.

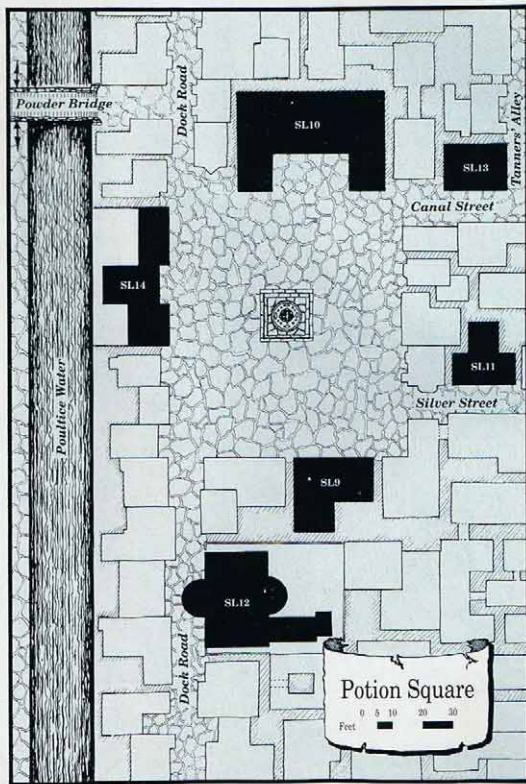

KLUGER'S EMPORIUM SL11

Just off the south side of Potion Square, on Silver Street, a grimy and barely readable sign hangs outside a tall, narrow building. Upon close inspection, it reads *Kluger's Emporium - Antiques and Curios*. A small, filthy window reveals nothing of the inside.

As the door opens, it squeaks on its hinges and rings a tiny-sounding bell. It takes a few second for the visitor's eyes to become accustomed to the near-darkness. Near the door lies an enormous ginger cat. Small, grime-encrusted oil lamps serve only to throw weird shadows from the jumbled heaps of books, pieces of armour, pots, and other miscellaneous objects that throb threateningly over the visitor - perhaps the slightest sound or movement might start an avalanche!

The wooden floor creaks beneath underfoot, and the boards are so badly warped that crossing the darkened room is an unnerving experience. Even the shop's wooden desk has clearly seen better days. An oil lamp casts a fitful light on the open book which rests there, and on the indeterminate shape which sits reading it. A chair scrapes, and the figure rises. "Good day to you," says a strong voice, "looking for anything in particular?"

Common Knowledge

"Whose Emporium? Never heard of it."

"You never know what you'll find at Kluger's. I don't think even he knows what he's got."

"Watch out for that cat of his. It knows more than a cat ought to know, if you take my meaning."

"The Bretonnian crown jewels could be hidden in that junk and no-one would ever find them - and maybe they are!"

Hans Kluger (SL11a), Fence, ex-Thief, ex-Racketeer



Hans is short, middle-aged, and surprisingly neat and clean - a sharp contrast with his environment. He has grey hair, but his hairline has receded beyond the top of his skull, so that at first he appears to be completely

"Hmmm. I saw something of the sort, only a couple of years ago. Over here, I think - ah, yes. Is this the kind of thing?"

"A pleasure to meet you. It's always gratifying to be recommended by a - ah - regular customer."

"Perhaps this will do..."

"Hmmm. I have to confess, I'm not sure about this piece. Very distinctive, you see. Obviously made for the tastes of one person. Very difficult to find a buyer for something like that. Still - shall we say twenty-five?"

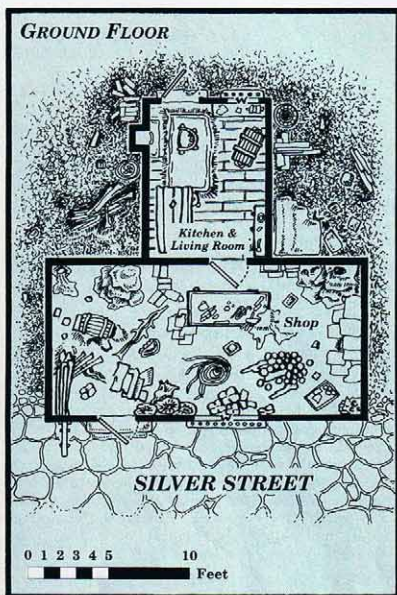

bald. His grey eyes hardly ever seem to blink, and he always looks straight into the eyes of the person whom he is addressing. He is normally dressed in clean, if crumpled, middle-class clothes, typically a green doublet, a white linen shirt and brown breeches.

Despite the almost insane jumble inside his shop, Hans can find anything in a matter of seconds. Anyone else might spend days and never find what they were looking for. Hans is unfailingly polite, well-spoken, and talkative, but whenever he is nervous or annoyed he clenches and unclenches his fists. He is particularly fascinated by the nonhuman races, and will talk for hours about nonhuman art and antiquities. He is a superstitious character, and fears magic of all sorts.

Hans is one of the most successful fences in the city. He took the shop over from his father, who died in jail 30 years ago, awaiting trial for a murder he did not commit. Officially, he hanged himself in his cell, but Hans has his own opinions. His father's death has left him with a deep grudge against the law and its minions, which occasionally shows through his politeness.

Through his father's shadier dealings, Hans grew up with extensive contacts in Marienburg's underworld. Many of his childhood friends are now among the most respected and feared of the city's criminal fraternity. Lea-Jan Cobbuis (SR05a) is a kind of unofficial uncle to Hans, whose business is carried on with his permission.

Marienburg

He also has dealings with Ruud Vilager (SR27a), Jochen Kaaimans (SR10a) at Haagen's Wharf, Jan Omkoop (SH03f) of the Excise and the smuggler Thijs Modgekker (SR12a), when he needs to send a consignment out of Marienburg. He also does occasional legitimate business with Neugierde's of Middenheim.

M WS BS S T W I A Dex Ld Int Cl WP Fel
4 59 36 4 4 9 58 1 52 41 39 45 41 50

Age: 56

Alignment: Neutral (Ranald)

Skills: Concealment Urban; Disarm; Disguise; Dodge Blow; Evaluate; Haggle; Lip Reading; Magical Sense; Palm Object; Read/Write; Secret Language – Classical, Thieves' Tongue; Secret signs – Thieves'; Silent Move Urban; Shadowing; Specialist Weapon – Fist Weapons, Fencing Sword; Spot Traps; Street Fighting; Strike to Stun; Super Numerate.

Possessions: dagger (I +20, D -2, P -20); rapier sword-cane (I +20, D -1).

Jascha the Cat (SL11b)

Jascha is a large ginger cat, who usually lies on the floor halfway between the door and his master's desk, visible only by the glinting of his eyes. He has never been known to move out of the way for a customer, but will sometimes show an interest in goods which are being discussed. As well as being a pet and a mouser, Jascha serves Hans as a kind of security device. Many regular customers are habitually hooded, masked or otherwise disguised, so Hans does not know their faces. But he knows Jascha's reaction to all of them, and more than that this has helped him penetrate an imposture by 'undesirables' – as he calls the servants of the law.

M WS BS S T W I A Dex Ld Int Cl WP Fel
5 23 0 1 2 3 40 1 0 20 12 35 20 0

Skills: Acrobatics; Dodge Blow; Strike to Injure.

Trading at Kluger's Emporium

Hans will buy or sell just about anything. If strangers want his services as a fence, they must make the first move themselves. You should be careful about how this is played; direct or clumsy approaches will result in Hans doing a very good imitation of an outraged honest trader. "What manner of dealer do you take me for?" he will thunder. If in doubt, make a secret Fel test for the character who is doing most of the talking, allowing a +10 bonus for each Rogue career completed by that character, +10 for thinking of using *Secret Language – Thieves*, and up to +/-20 for how well you think the player is handling things.

Hans will buy items up to 10 Guilders in value without question. When offered more valuable goods, he will ask for some proof of ownership – "without wishing to cause offence, of course, but one has to be careful." If he is satisfied, he will offer up to 75% of the item's value. If he believes that an item was stolen, he will offer 30-60% of its value, depending on his degree of acquaintance with the customer. He can be bargained up to 150% of his original offer, but no further.

Only the smaller, cheaper stolen items are actually out in the shop. Valuable and bulky items are kept in the cellar, behind a stout padlocked trapdoor (T 4, D 10, CR 30). Such items rarely stay on the premises for more than a couple of days; Hans generally has a buyer lined up. Particularly 'hot' items are shipped out of town to contacts in The Empire, Bretonnia and Kislev.

If the adventurers want to buy something specific, you should assign an "illegal availability rating" to the item and follow the standard availability procedure in the *WRP* rulebook, treating Kluger's Emporium as a city with 1000 inhabitants. Depending on the rarity of the item sought, Hans will take several days and a few dozen Guilders before the sale can be completed.

For a fee, Hans will keep an item 'to be called for'. This fee ranges from 3 Guilders per day to 20 or more, depending on the item's value and the status of the person from whom it was stolen. For example, an expensive ring slipped from an artisan's fat finger might be worth 5-6 Gu per day; if the owner had been the head of a powerful merchant family, it might cost 9-10 Gu per day to store. A wizard's ring, even if it is not magical, might cost 20 Gu per day, due to Hans' distrust of magic.

Making Contact

The adventurers might not find Kluger's at all unless they are looking for it. If they intend to do business there, then a recommendation is the most valuable thing they can take with them.

Beggars – always the eyes and ears of the underworld – might let slip that Kluger's is the place to find anything you want and sell anything you don't. Ingrid, the barmaid at the Pelican's Perch (SB12c) may recommend Kluger's as she overhears a lot of gossip. Granny Hetta (SB26a) uses Kluger – although she is cautious in her dealings with him. Jochen Kaaimans (SR10a) might also point adventurers toward Kluger's – but only if offered a suitable bribe. Lisette (SL 13) will send enquirers to Kluger's, once she has consulted the Guild about them. Adventurers who can tell Hans that one of his trusted contacts recommended him will be more likely to get a favourable reception.

Alternatively, the adventurers might overhear a conversation in the Pelican's Perch with a reference to 'the stuff Paal left at Kluger's', they might find themselves trying to track down a stolen item, or being used as go-betweens in negotiations for the recovery of something valuable. Shadowing a contact after a meeting might lead to Kluger's.

A Useful Acquaintance

Hans Kluger can be very useful to a group of adventurers. As well as buying and selling goods, he might be persuaded – for a suitable fee – to teach skills and train characters for career changes. Offers of money, new contacts, new goods and permanent custom will all help sway him. Of course, he can only teach skills he has and train for entry into careers he has followed. The monetary charge will be modest – 3-4 Gu per hour for skill training and 20 Gu or so per day for career training – but Hans will also ask for favours and services now and again.

Once the adventurers have got to know him, Hans can be used as a lead-in to several adventures. For example, in a simple adventure they might have to acquire a certain item which Hans has been asked to obtain. Or Hans might have been receiving blackmail threats. The only clue is the instructions for delivering the money. Who is the blackmail? A rival fence? Someone Hans crossed in business? A racketeer trying to take over part of Suiddock? The possibilities are endless.

A more complex adventure might start when a contact Hans expected four days ago still hasn't shown up. The item in question is a talisman from Araby which is said to carry a curse. Hans wants to get rid of it, and fears for the life of his contact – this may be one of the rare occasions when he lets slip a customer's identity. Why is he late? Has he fallen prey to the curse? Have Arabian assassins struck him down? Are they now converging on Kluger's? Or is the contact fuming beside a broken coach between here and Middenheim?

WILHELM ROTKOPF,

ALCHEMIST SL12



Just off Potion Square on Dock Road is a curious house on the east side of the street. The two-storey building is not of unusual size for the area, but at the top is a small turret which leans over so much that passers-by glance uneasily at it, especially when there are high winds. The turret casts a long shadow over the road for most of the day.

This is the house of Wilhelm Rotkopf, the Master Alchemist, although there are some who claim that this is the least of his accomplishments.

The two-storey tower contains a small alchemical laboratory and an observatory. There is a secret laboratory in the cellar, used for Wilhelm's less respectable activities. The entrance is via a trapdoor which is hidden under a coat-stand in the hall (T 2, D 4, CR 30).

It's unlikely that adventurers will be able to deal directly with Wilhelm; most people have to go through his journeyman, Floris Rijppen. In the normal course of a day's business, only important or influential customers talk directly to Rotkopf.

His other assistants can be seen coming and going at all sorts of times. They help by making sure the place is tidy, stirring mixtures on the quarter hour every quarter hour, and doing the hundred and one jobs that a Master Alchemist shouldn't have to do for himself.

Common Knowledge

"You want alchemical bits and pieces, Rotkopf's your man. A bit pricey, of course, but you get what you pay for. He's got a house just off Potion Square. Great big place, it is, with plenty of servants and a tower that looks like it's going to come down any minute."

"Rotkopf? Professional clever-dick if you ask me. But his journeyman's soft as new butter."

"He's had a full life, that one, and it's getting fuller by the minute. I don't know how he fits it all in. There he is, one of the best alchemists in Marienburg, sitting on half a dozen boards and committees, and he's always got one of his people running back and forth to the orphanage or the temple or one of the saabones, doing mixtures and odd jobs for them like he'd only just set up his practice. Up all night with his telescope looking at the stars. I don't know when he sleeps – or maybe he doesn't. I don't know what he's got that keeps him going, but I wouldn't mind some for myself."

"He's got hidden depths, that one, you mark my words. Them as look most respectable on the surface always have their secrets. I'm not making any accusations – not a word of it, and if any man says otherwise he's a liar. But he has some strange visitors after dark when he's looking through his telescope, and that's the truth. Not to mention some of the strange folk he employs – that there Dwarf's an odd one for a start... and then there's that kid..."

Wilhelm Rotkopf (SL12a), Alchemist, ex-Pro prospector, ex-Tomb Robber

"Let's see now – calcination for three days, then fix in the tincture of mercury and sublime with three parts lead and one part bone. I wonder if the small cohobation chamber is clean. Oh! You're still here! I'm so sorry, I'd forgotten all about you. Just give me two minutes to get this over to the orphanage, then I promise you'll have my undivided attention. Floris! Floris!"

"Best if you came back in the morning. I've got a committee tomorrow afternoon, and the night-time is rather precious to me at this time of year. Do you have any interest in astronomy? It should be good and clear tonight..."

Wilhelm is in his mid-forties, but looks older. He is about 5ft 10in tall, with slightly curly, unkempt ginger-brown hair. His slightly hooked nose is set between brown eyes which squint slightly. Wilhelm dresses in expensive but practical clothes, but whenever he goes out he wears the same tatty brown cloak, wrapped closely around him. He walks quickly, with his head bent towards the ground, and always seems to be in a hurry. His voice is soft and his speech is rapid; he has a habit of muttering to himself – usually incomprehensible formulae and astronomical data.

Wilhelm was apprenticed at the age of 9 to an old and eccentric alchemist by the name of Helmut Schwarzbauch. Helmut died before Wilhelm's training was complete, and Wilhelm – to his parents' despair – went to seek his fortune as a prospector in the Middle Mountains gold rush of 2497. Failure as a prospector led him to join a band of adventurers in the mountains; after they stumbled upon an ancient dwarven tomb, Wilhelm turned to tomb-robbing as a profession. When he reached the wisdom of middle age, however, he decided to abandon this dangerous life and resume his training as an alchemist. He had saved enough to travel to Middenheim and study under the famous master alchemist Josef Schmidtturm.

Like many Suiddockers – even on comparatively prosperous Luydenhoek – Wilhelm has no respect for the minions of the law, although he never expresses this too openly. He is not afraid of stepping slightly outside the law if it is in the interests of his research to do so.

Wilhelm is knowledgeable in many subjects, and besides his alchemy he pursues astronomy, cryptography and

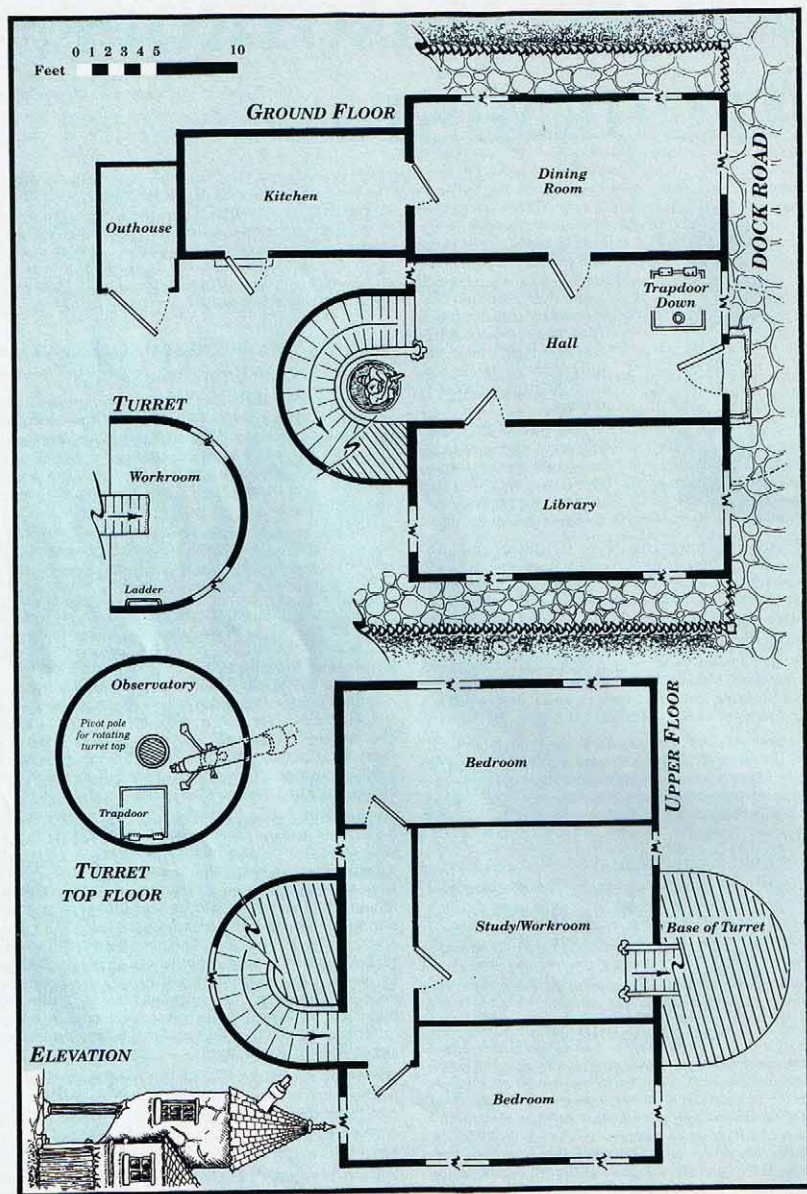

heraldry as hobbies, helped at times by Thadrin Thadrinson, once an associate, now a permanent guest. Wilhelm has an extensive library on these subjects, as well as a small observatory in the tower of his house. He is also interested in mutants and the nature of mutation, and will pay highly for a mutant corpse. He and Sister Marianne (SL14a) are not yet aware of each others' differing interests in this regard, but two such close neighbours dabbling in this forbidden area could spin off all sorts of adventures.

Wilhelm is a prominent member of the Wizards' and Alchemists' Guild (C22), and one of his secrets is that he is a member of the High Council. He also acts as a consultant to the Board of Trade Equity (SH3) and the Council on matters involving alchemical and magical materials. He is a pillar of the local community, and regarded as a good neighbour by everyone on Potion Square. He and Jan van Arzenei (SL9a) do a thriving two-way trade in ingredients and preparations, and occasionally he will be prevailed upon to supply medicinal mixtures for the Home for Foundlings (SL14) and the Edelmoed Temple (SL10). Many of the better-off physicians on Leech Street also rely on him for medicinal supplies and preparations.

He does occasional (and highly secret) business with Jeremias Qualk (SL15a) and with Hans Kluger (SL11a) when he needs rare or illegal ingredients for a process.

M WS BS S T W I A Dex Ld Int Cl WP Fel
4 49 33 4 4 9 62 1 47 41 64 45 46 34

Age: 46

Alignment: Neutral (no particular deity)

Skills: Arcane Language – Magick; Astronomy; Brewing; Carpentry; Cartography; Cast Spells – see below; Chemistry; Concealment Urban; Cryptography; Evaluate; Heraldry; Herb Lore; Magic Sense; Manufacture Potions; Orientation; Prepare Poison; Meditation; Metallurgy; Read/Write; Secret Signs – Thieves; Scroll Lore; Spot Trap; Silent Move Urban.

Possessions: sword; dagger (I +20, D -2, P -20); guild symbol on chain

Spells: 25 Magic Points

Petty *Gift of Tongues, Magic Alarm, Sounds, Zone of Cold, Zone of Silence.*

Battle 1 *Aura of Resistance, Cure Light, Flight, Strength of Combat.*

Battle 2 *Zone of Sanctuary.*

TRAINING

Despite the fact that he always seems to have a hundred and one things to do, Wilhelm may agree to train adventurers in any of his skills, charging about 7 GC per hour (3 GC per hour for Astronomy, Heraldry and Cryptography, his three hobbies). He will also train suitably-qualified applicants to enter alchemical careers up to level 2; this will take a week and cost 100 GC.

He will never waive a fee – he believes in payment equalling value, and vice-versa – but he might accept payment in kind. For example, there are many adventures to be had in trying to obtain exotic ingredients for his experiments, or learned (and perhaps forbidden) tomes which he has learned have come to Marienburg.

Absolute commitment is required, and the applicant must make a successful Fel test to convince Wilhelm of his dedication. Like many experts, Wilhelm has a habit of talking down to those who seek instruction from him, but he is a good and conscientious teacher.

A new apprentice is also expected to carry out his share of menial duties around Wilhelm's laboratory. These duties take D3 hours per day, and this time must be paid for in full – fetching and carrying are vital parts of the learning experience!

Of course, Wilhelm's servants can be persuaded to do these tasks for a small consideration, usually D3 shillings per hour. This is a small price to pay for the freedom from (expensive) drudgery.

ROTKOPF'S SERVANTS

Floris Rijgpen (SL12b), Alchemist, ex-Alchemist's Apprentice

- Spotty, red-headed 24-year old; wears journeyman's clothing with Guild badge on the left breast.
- Easy going, polite, has a natural talent for business and his studies; likes gambling, sometimes to excess.
- To get on and 'inherit' Master Rothkopf's business.
- "I'm afraid Master Wilhelm is rather busy at the moment... Can I help?"
- Knows most people in the area and 'in the craft'; friendly with Jan van Arzenei (SL9a); thinks that he is in love with Lotte Wald (SL18b), the co-owner of The Long Dragon; occasionally visits Monnik's pit fighter school (SR30) on his days off; owes 250 Gu to Frans Makreel the moneylender (SL29a).

M WS BS S T W I A Dex Ld Int Cl WP Fel
3 25 34 2 2 6 50 1 43 24 39 24 43 43

Skills: Brewing; Cast Spells – see below; Chemistry; Evaluate; Read/Write.

Spells: 8 Magic Points

Petty *Gift of Tongues, Magic Alarm.*

Possessions: good quality clothing, dagger (I +10, D -2, P -20); thick wadge of appalling love poetry; 2D6 Guilders (50%) or pennies (50%), depending on his luck.

Jacob Boerenstand (SL12c), Artisan, ex-Artisan's Apprentice

- Red-nosed and ruddy-cheeked middle-aged man with broad-shoulders and powerful hands; wears leather apron, worn out with long use.
- Practical; respectful of his 'betters'; slow thinking, but gets to the heart of an idea or problem in the end; very proud of his skills; tries hard to be a 'good' follower of Shallya.
- Wants to get the job done as quickly as possible, but torn by a desire to build elaborate bits of alchemical glassware – whether they are needed or not!
- "Wellllll... end of the week do you?" and "Leave it with me, I've got just the thing for that somewhere..."
- Deeply respectful to Brother Marijkus (SL10a), SisterWilhelmina (SL10b) and Sister Marianne (SL14a); occasionally has (legitimate) dealings Hans Kluger (SL11a); a regular at The Long Dragon (SL18); disapproves strongly of Floris' gambling (see above).

Marienburg

M WS BS S T W I A Dex Ld Int Cl WP Fel
3 25 34 3* 3† 8 50 1 43 24 39 24 43 43

Skills: Chemistry; Drive Cart; Evaluate; Secret Signs – Artisan; Very Resilient; Very Strong*.

Possessions: Iron shod walking stick (I -10, D -2, P +10); glass-blower's tools; leather apron; glass amulet with engraved dove on chain; D6 shillings.

Anatol (SL12d), Alchemist's Apprentice, ex-Pickpocket, ex-Seaman

- Small, rather smelly 10-year old with lank hair and a pronounced limp; always in need of at least one good scrubbing (and probably two).
- Nervous around adults and water; very conscientious in his pot-watching and fetching duties.
- To keep on the good side of Wilhelm and avoid baths!
- "I *ad a baff last week – an' I didn't needs it!*" and "I'm *tryin' to 'member all them al-chemy-memikal words!*"
- Slightly scared of Rotkopf (SL12a); very scared of Gunther and Anders Grimm (SL14b&c); absolutely terrified of Sister Marianne (SL14a) and the thought that he might end up in her orphanage! When he's not working, Anatol sees a lot of what goes on in the area; anyone who treats him kindly will make a friend – and gain an extra pair of eyes!

M WS BS S T W I A Dex Ld Int Cl WP Fel
3 21 35 2 2 3 25 1 38 21 45 23 39 25

Skills: Flee!; Palm Object; Read; Write; Swim.

Possessions: hidden dagger (I +10, D -2, P -20); dead spider in small box; 2 pennies; piece of stolen cake.

Thadrin Thadrinson (SL12e), Explorer, ex-Scholar, ex-Scribe

- Ancient Dwarf; impossibly neat at all times, as though he has just been laundered and pressed.
- Fussy, pedantic and precise; intolerant of 'fuzzy thinking'; very knowledgeable; quirky and capable of great kindness, but has a slightly cruel streak which he uses on those he considers his inferiors; vaguely cross that his life is done with so much still to see...

- To know more... and finally learn the secrets of the heavens (whatever that may be).
- "Hmmpf. I learnt that 75 years ago."; "And I learnt that 100 years ago!" and "Try the infusion of brimstone... a sure solution to any intractable problem and stain." Advising people to try sulphuric acid as a stain remover is Thadrin's idea of a joke.
- Knows and is, known by only Dwarfs beyond the walls of Rotkopf's premises; respects Rotkopf (SL12a) for the man's learning, but expects to be listened to, especially in business matters; ignores everybody else until they ask him a question and then his response is determined by the relative stupidity of the speaker.

M WS BS S T W I A Dex Ld Int Cl WP Fel
3 41 45 3 4 12 20 1 24 58 59 68 81 24

Skills: Arcane Language – Magick; Astronomy; Cartography; Drive Cart; Evaluate; History; Identify Plant; Law; Linguistics; Numismatics; Orientation; Read/Write – Old Worlder, Khazalid; Rune Lore; Secret Language – Classical; Speak Additional Language – Old Worlder, Elthárin.

Possessions: maps and star charts; pistol (R 8/16/50, ES 3, Rld 2); powder and shot for 10 firings; 4D6 Gu at all times (privately wealthy from his investments).

Janna Mossfoot (SL12f), Servant

- Young-ish, remarkably thin Halfling – always seems to be eating or talking about food!
- Greedy, but sees no reason why everybody shouldn't eat as well and as much as she does.
- Janna's motives are simple: eating, drinking and more of the same.
- "This one's called 'Death by Marzipan!'" and "Yummy!"
- Likes the orphans (SL14d etc) because they appreciate her cooking; knows the ins-and-outs of the families along Halfling Row (C60 onwards).

M WS BS S T W I A Dex Ld Int Cl WP Fel
4 24 26 2 2 5 45 1 41 26 35 25 32 49

Skills: Dodge Blow; Cook; Etiquette.

Possessions: Rolling pin (I -10, D -2, P +10); two or three 'snacks'; 3D6 shillings.

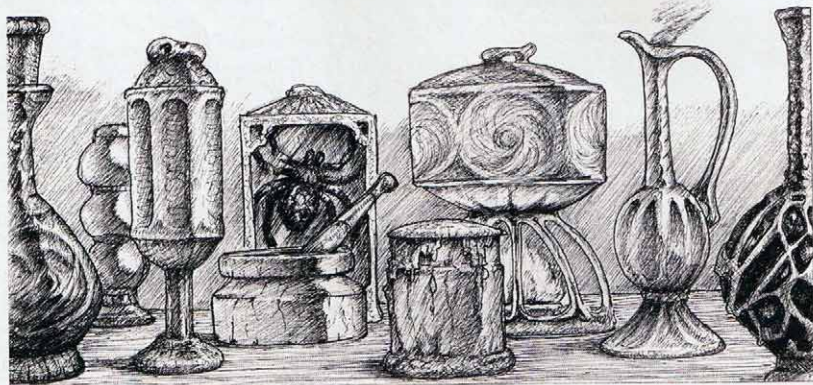

LISETTE'S LEATHER

GOODS SL13

Canal Street is one of the darker, narrower side-streets leading off from Potion Square. A little way from the square, on the north side of the street, stands a small, neat shop with a sign in the shape of a cowhide.

Neatly arranged in the windows are leather goods of all kinds, from pieces of leather armour to leather tankards and jugs. Behind them, in the shop, can be seen stacks of cured hides and piles of finished garments and other leather goods.

Lisette is well-known as a dealer in hides and leather goods - she is a merchant rather than an artisan, and specialises in buying and selling rather than in actually working leather. It is no accident that her shop is close to Tanner's Alley.

In some quarters, there are darker rumours about this particular leather-merchant. It is whispered in some quarters of the Suiddock that Lisette is well-connected in the underworld organisation known simply as The Guild; some people assert - though never in her hearing - that she holds a very high position in that shadowy brotherhood. It certainly seems to be the case that things said to her have a way of getting back to them.

Common Knowledge

"Anything you want in leather, Lisette can supply it, or point you at a leatherworker who can. Take care with her, though - she doesn't suffer fools. You'll see what I mean."

"She knows her business, all right. Don't waste your time wandering up and down Tanner's Alley and around Shoemaker's Square, just go straight to Lisette. Don't waste her time, though. She hates having her time wasted."

"Now you know me. I've no axe to grind against women. But that one's different. Something about her - she can scare you half to death without saying a word and without getting out of her chair. They say she's a dagger for the Guild, and all I can say is I don't want to find out."

"She's a strange one. There must be more to her than the leather trade. She's got too much about her to be happy buying and selling hides all her life. Of course there are rumours - the wagging tongues will tell you she's an assassin, a witch, and half a dozen other things. Myself, when I see her I just talk about leather."

"Don't cross that one. There's something about her. Can't put my finger on it, but it's there."

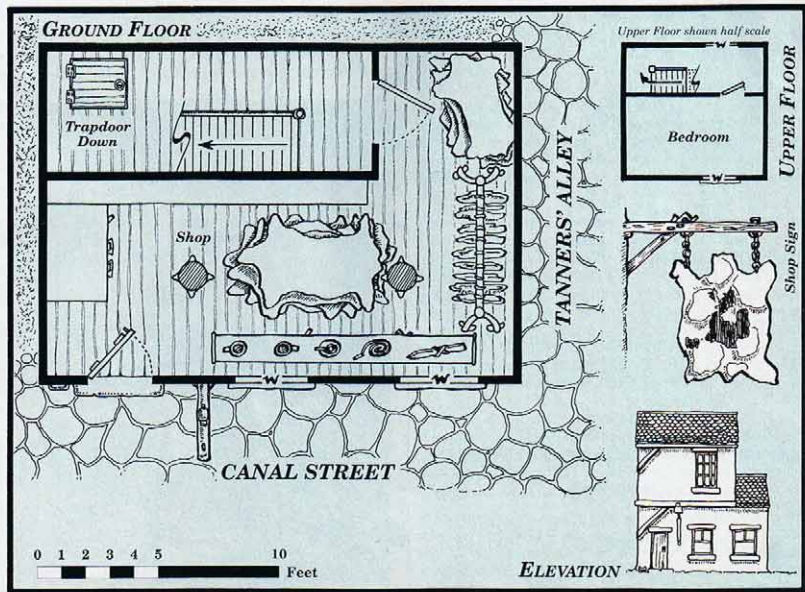

Lisette Leerer, Assassin (SL13a), ex-Bounty Hunter, ex-Bodyguard, ex-Racketeer, ex-Thief, ex-Trader



"If you've come here to buy or sell, do it. If not, you're wasting your time and mine."

"I never discuss my business arrangements."

"Who told you that?"

Lisette is a tall, slim woman in her twenties, with dark hair and eyes. Her face, while attractive, almost never betrays any expression, and many people find her impassive face and steady eyes intimidating.

She always favours black clothes of soft, high-quality leather, and always has a slim, silver-handled stiletto hanging from her belt.

She is softly spoken and blunt, never wasting words or movement. Everything about her says that she would be a very bad person to cross. Stories are still told about the out-of-town merchant who made unwelcome advances to her once – no-one saw her touch him, but he was unconscious for almost an hour.

On the surface, Lisette is no more than a trader in skins and leather goods who can handle herself better than many of the self-styled 'hard men' of the docklands. Many of the merchants and leatherworkers of Marienburg know and respect her for her efficient, hard-dealing business practice and the quality of the goods she deals in. But in some parts of the city, rumours are whispered about another life. It is said that she is a member of 'the Guild we don't talk about', and a high-placed one at that. Such things are whispered fearfully, with many glances over both shoulders, for the Guild has an eye in every house, an ear in every wall, and a harsh way with informers.

Apart from her business dealings, Lisette keeps very much to herself. She has a nodding acquaintance with her neighbours in Potion Square, and makes a regular donation to the Home for Foundlings (SL14) – as much to prevent Sister Marianne from constantly badgering her as for any other reason. She will occasionally slip almost unseen into the Pelican's Perch (SB7), and spend some time in a curtained booth with Lea-Jan Cobbius (SR5a) or Pieter de Groot (SR5b), but she has no connection with the Worshipful Guild of Stevedores and Teamsters. She has also been seen in the Moonbeam Inn (SS16), and those with an eye for such things might remark that her visits always take place shortly after a back-room meeting of the Knights of Purity (C38). Once every three or four days, Granny Hetta (SB26a) will visit Lisette's shop, although she clearly can't afford to buy.

Although finding proof will be an almost impossible task – and a highly dangerous one – Lisette is a senior member of the underworld body known simply as the Guild (SB34). She keeps all her dealings well-hidden, and works as a mixture of intelligence officer and

enforcer, relaying information to The Guild and delivering warnings to those who displease it.

Rogue characters who disturb the everyday running of the seamier side of the Suiddock – robbing premises or persons who are under the protection of The Guild, for instance, or discovering and attempting to foil Guild operations – may get a visit from Lisette, masked and dressed in a black cloak. She will issue a warning and deliver terms for restitution, normally giving the offenders two days to comply. Rogue characters will be instructed to go to one of the Guild meeting-places – generally the back room of the Lighthouse Inn (SR9) – and say that she sent them. According to how the adventurers play it, this could be a valuable introduction to the Guild and the start of a series of illegal missions, or it could be the beginning of a lifetime of harassment until the adventurers comply, leave Marienburg or get killed.

Age: 26

Alignment: Neutral (Ranald)

M	WS	BS	S	T	W	I	A	Dex	Ld	Int	Cl	WP	Fel
4	64	66	4	5*	13	78*	4	59	47	50	55	51	46

Skills: Ambidextrous; Concealment Urban; Disarm; Evaluate; Follow Trail; Haggle; Law; Lightning Reflexes*; Magical Sense; Marksmanship; Numismatics; Prepare Poisons; Read/Write; Scale Sheer Surface; Secret Language – Thieves' Tongue; Secret Signs – Thieves'; Shadowing; Silent Move Urban; Specialist Weapon – Blowpipe, Fencing Sword; Fist Weapons, Prying Weapons, Throwing Knife; Street Fighting; Strike Mighty Blow; Strike to Stun; Very Resilient*.

Possessions: leather jack and leggings (01 AP, everywhere except head); knuckle-dusters; rapier (I +20, D -1); stiletto (I +20, D -2, P -20); blade venom concealed in left heel (Manbane, 3 doses, 2 applications); *Amulet of Iron* (WP +20 vs spells and magical effects). ■■



GAMES WORKSHOP

PHILADELPHIA

424 SOUTH STREET
PHILADELPHIA, PA 19147
PHONE (215) 829-0554 FAX (215) 829-0561

NOW OPEN

Our newest US Games Workshop store is now open. Come along for all the latest releases from Games Workshop and Citadel Miniatures, and see what's happening at the store.

Opening Hours: not finalized as we went to press
– please call for more information.

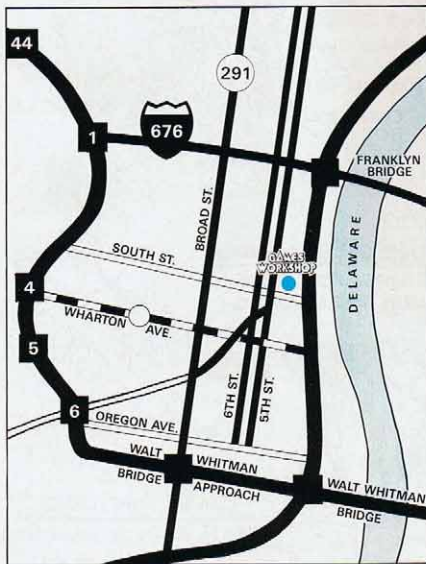

Here's a provisional schedule of events for August and September – call the manager, **Owen Branham**, at the store for full details of how you can join in and up-to-the-minute news of all the other events we're planning.

AUGUST

- | | |
|----------|--------------------------|
| Sat 11th | Epic Space Marine |
| Sat 18th | Warhammer Fantasy Battle |
| Sat 25th | Space Hulk |

SEPTEMBER

- | | |
|----------|--------------------------|
| Sat 1st | Warhammer 40,000 |
| Sat 8th | Warhammer Fantasy Battle |
| Sat 15th | Epic Space Marine |

FREEBOOTERZ

MERCENARY RENEGADE PIRATES

- ORK MINIATURE CONCEPTS



THE JOLLY ORK



GRETCHIN BANDIT



FLASH GIT

HIGHLY SUCCESSFUL
MERCENARY - BIONICS
- MEK WEAPONS
- LOTS OF TEETH
- COMMISSAR
STYLE COAT

FREEBOOTER ORK BOYZ

USE PLASTIC ARMS

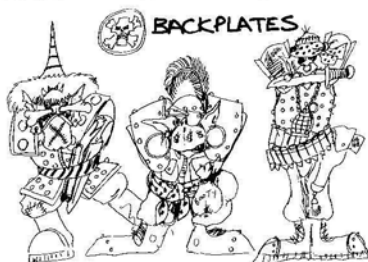

BACKPLATES

RENEGADE MEK

PLASTIC
ARM

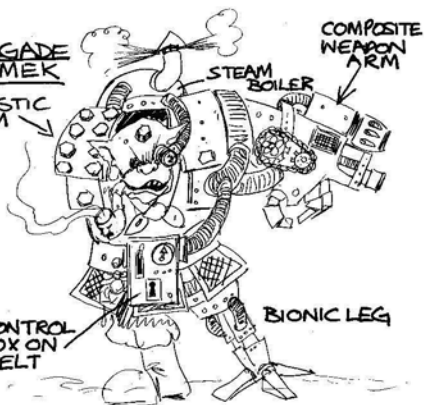

COMPOSITE
WEAPON
ARM

STEAM
BOILER

BIONIC LEG

CONTROL
BOX ON
BELT

YOUNG BUT
DELIBERATELY
FIERCESOME
MILITERISTIC
POSE



PLASTIC
ARMS

BIG
SHINY
BOOTS

KHORNE CULT
STORMBOY

RENEGADE MINDER

THUGS FOR HIRE
HUNTER SQUIGS



PLASTIC
ARM

THEY PAINT THEM RED SO THEY
RUN FASTER!!

WARHEAD
RENEGADE
WEIRDBOY
DERANGED
& AGGRESSIVE
NO MINDERS



FEATHER
SQUIG

RENEGADE NOB



MUTATION
CRAB CLAW



CHAOS RENEGADE
ORK CHAMPION

BAD DOC
RENEGADE PAINBOY

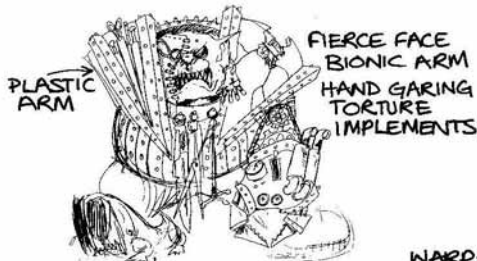

WARHEAD
DAEMON
POSSESSED
WEIRDBOY



VAMPIRE
SQUIGS

WARHEAD
RENEGADE WEIRDBOY
DERANGED & FIERCE
SQUIGS ON BELT

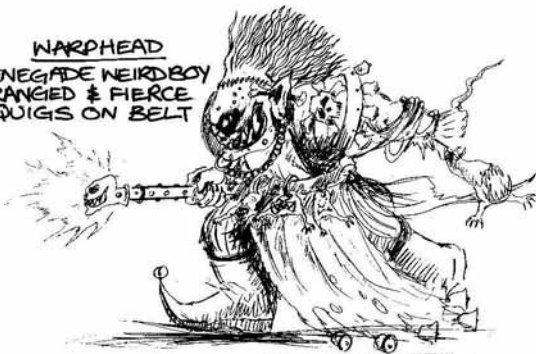

GRETCHIN BANDIT
SHOTGUN & BIG KNIFE

DESIGNS NOT TO SCALE

SD 1990
WD21

WARHAMMER 40,000

New Rules for Vehicles in Warhammer 40,000 by Rick Priestley

Vehicle models for Warhammer 40,000 have been appearing at regular intervals over the last few years and, as a result, have become an integral and important part of the game. We have been aware for some time that the existing rules tend to play down the effect of vehicles on the tabletop, and prove rather complex when more than 2 or 3 vehicles are in play on each side. These new vehicle rules entirely replace the old ones, enabling players to field more vehicles more effectively and at a cheaper points cost. In this White Dwarf we present the new rules and the clear acetate template that goes with them.

THE NEW SYSTEM

Right from the start it was decided to take a different approach to the original vehicle system which appeared in Warhammer 40,000; rules which had been rendered largely redundant by the current model range. We tried out various ideas, but eventually settled on a concept favoured by Bryan Ansell, which envisaged that every type of vehicle would be represented by a cutaway diagram showing the internal layout of engine, crew, tracks, and so forth. Shots could be worked out by drawing a grid around the diagram so that you could roll dice to see where a shot strikes.

The Cutaway Diagrams

A few mock ups of vehicle diagrams were constructed, with the internal areas divided up to represent major internal systems. One immediate advantage was that each area could be given a different armour thickness. This was particularly apt for open vehicles such as Land Speeders and Bikes where hits could fall on the crewman or the vehicle's body. This was a nice feature and one we decided ought to be retained.

We soon realised we had the core of a good system, but constructing grids over the cutaway diagrams proved rather difficult as the vehicles were all sorts of shapes and sizes, and varying the grid size to fit the vehicle shapes affected the probabilities of hitting. After all, although the chance of hitting a big vehicle should be greater than the chance of hitting a small one, the chance of hitting a single spot on a target of any size should be exactly the same. Initially we numbered the grid 1-100 across the horizontal and vertical and players nominated their aiming point by writing down two sets of numbers. It worked, but was awkward, and slowed down the pace of the game.

The Template

The obvious solution was to remove the grid from the cutaway diagram and put it on a separate standard size

plastic template, which could be positioned to cover any target area on the vehicle. The immediate advantage was that we could do away with the tedious business of nominating coordinates and rolling separate dice to determine the accuracy of the shot. Deciding where you were going to aim was a simple matter of positioning the central cross hairs of the template. All the player had to do was roll 2D6 for the vertical and horizontal axes to discover exactly where his shot landed. As the most common result on 2D6 is 7 (1 in 6 chance) this gave a natural balance towards the centre of the grid. This built-in bias provided a natural basic hit probability of a direct hit - 1 in 36 in fact. The chances of scoring a hit somewhere near your aiming point depended entirely on the size of the vehicle.

Number Crunching

We then needed to check out the basic hit probability we had created. To test the system we drew up an outline diagram of a human and tried superimposing our template over it - we then had to work out the probability of scoring a hit as compared to the actual chance of hitting using the normal 'to hit' system. We found that it was definitely harder to hit the human-sized target using our template. This was surprising as our test games had seemed if anything to be faster and more realistic. Still, we would have to redress the balance one way or another.

Fine Tuning

Early versions of the new rules were sent out to playtesting groups, who reported back with their comments and suggestions. One of the biggest bugbears was how to take into account the normal 'to hit' modifiers and the variable Ballistic Skills of different shooters. This was eventually achieved by altering the position of the hit by a simple formula which allowed characters with a high WS to adjust their chance of hitting. The same system could also slightly increase the average chance of hitting, thereby solving the problem of low hit probability which the two 2D6 dice rolls generated. The result is the completely new game system printed on the following pages.

More Developments

The new vehicle system has other uses as well - the new armour penetration rules will be used as the basis for a new Dreadnought system and possibly for new buildings rules. In addition, powerfields are going to be given an armour rating like vehicle armour. All of this, together with new rules for grenades, an updated weapons and equipment section, new psionic rules, and more information on Eldar, Orks, and Space Marines are planned for inclusion in future White Dwarfs.

WARHAMMER 40,000 VEHICLES

Vehicles are an important part of the Warhammer 40,000 game, whether simple transports, fast assault bikes, or lumbering heavy tanks bristling with weaponry. The fighting forces of the Imperium, Orks, Squat Homeworlds and the Eldar all have their own unique design philosophy which determines the appearance and tactical role of their fighting vehicles. All of these widely differing vehicles are covered by these rules, although further special rules apply to the most unusual of them.

VEHICLE DATA RECORD

The details of every vehicle's armament, movement and defensive capabilities are included on a single sheet of paper called a *Data Record*. The most important aspect of the Data Record is the targeting diagram which is used to determine whether and where shots hit the vehicle and if any hits penetrate its armour.

Every vehicle has its own Data Record in the format shown below - this example is the Data Record for the Imperial Predator. The Datafex records for other vehicles are given in a complete section after the rules. Further additions to the Data Records will be printed in White Dwarf magazine as new models are added to the Warhammer 40,000 range.

PREDATOR
DATA RECORD INFO

The Predator Heavy Tank is well armed and armoured on the medium of conventional armoured fighting vehicles. It is based on the 50-ton centurion chassis but has improved armour as well as additional armament. Although slow and cumbersome, the solid fighting vehicle can normally compare well for reasons of power and heavy armour. On the battlefield Predator units provide the mighty punch that set up an enemy attack dead in its tracks, and which can equally easily burst through the enemy lines and allow withdrawal by lighter, faster units. It carries one 120mm gun mounted on each side - plus an anti-aircraft in a well-protected turret.

Type:	Tank
Price/Point:	12
Center Speed:	12
Max Speed:	16
Chase:	1
Transport:	1
Weapons:	1 x 120mm main gun (range and 120 degree field of fire) 1 x 120mm anti-aircraft 1 x Laser with 100 degree field of fire 1 x Laser with 100 degree field of fire 1 x Laser with 100 degree field of fire

The double turret can be operated to aim at the same target. Roll once to hit, twice to kill on both sides.

120°

120°

180°

180°

180°

180°

180°

180°

IMPERIAL PREDATOR
DATA RECORD

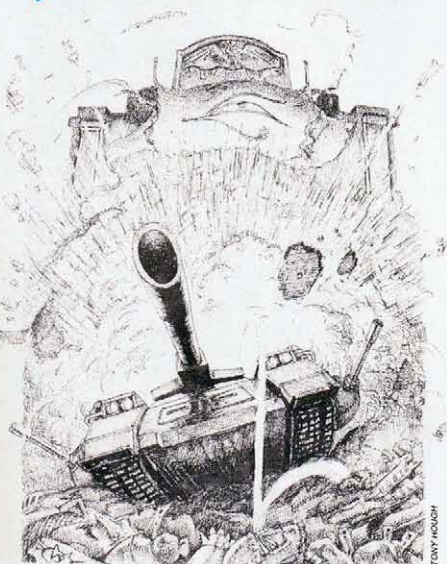

VEHICLE MOVEMENT

A player may move his vehicle models during the movement phase of his turn at the same time as foot troopers and other forces. There is no particular need to move vehicles either before or after infantry, the choice is up to the player.

Unlike a human or other living creature, a vehicle has three different move rates: *fast*, *combat speed*, and *slow*. These move rates are indicated on the Data Record. In each case the number shown is the greatest distance that the vehicle can move at that rate. For example, a Predator which moves 12" is travelling at combat speed, a Predator which moves more than 12" is travelling at fast speed.

The fastest a vehicle can travel is its maximum fast move rate. For example, the Imperial Predator has a maximum speed of 16".

Vehicles can move quickly compared to troops on foot, but if they are to shoot weapons accurately and negotiate corners or obstacles they will need to moderate their speed. For this reason, players will probably want to move vehicles at combat speed when fighting - hence the description 'combat speed', this being the move rate most appropriate for combat. Even at combat speed a vehicle is travelling relatively quickly, and will have to reduce its speed to slow rate in order to negotiate corners or tricky obstacles.

TURNING VEHICLES

Vehicles normally travel directly forwards in a straight line. Changes in direction are accomplished by means of turns of 45 degrees or more.

A vehicle travelling at fast speed may make one turn of up to 45 degrees during its move. This turn may be to the right or left, and may be made at the start of the move, at the end, or at any point in between.

A vehicle travelling at combat speed may make up to two turns during its move. Each turn may be of up to 45 degrees. The two turns may be combined into a single turn of 90 degrees if required.

A vehicle travelling at slow speed may make any number of unrestricted turns during its move. Each turn can be up to 360 degrees.

MEASURING TURNS

The diagram below illustrates a turning template used to measure 45 degree angles left or right. An acetate plastic turn template is provided on the transparent insert. You can copy this onto a piece of card if you prefer, or use a protractor. However, it is often easier not to use the template but to estimate the turn and ask your opponent to approve the move.

It is actually quite simple to estimate 45 degrees by eye, and the template can still be used if your opponent prefers. Generally speaking, we have found it is only necessary to use the template in situations where the exact position of the model is vital to the outcome of the game. The template is placed in front of the vehicle with the direction arrow pointing the same way as the vehicle - the vehicle is then turned up to 45 degrees either to the left or right.

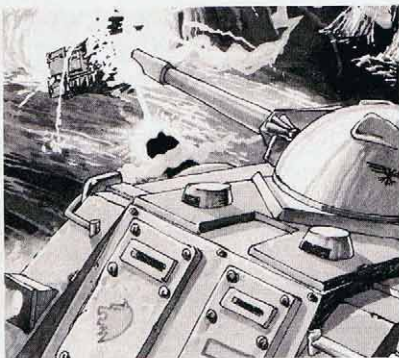
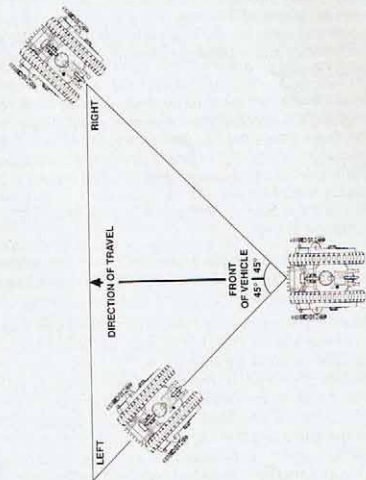

KEVIN WALKER

BOARDING AND LEAVING

Some vehicles are capable of carrying troops in addition to their normal crews. The number of troops a vehicle can carry is indicated on its Data Record under the entry for transport. This shows the number of human-sized or smaller troops that can be transported in the vehicle and includes Humans, Squats, Ratlings, Orks, Eldar, and so on. Ogryns, Marines in Terminator Armour and other equivalently-sized creatures take up the same space as 2 smaller humanoids.

Any number of models may enter or leave a vehicle during a turn, up to the total number of models that can be transported within it. Models leaving a vehicle which is not moving during the turn are positioned within 2" of its sides or rear and may make a normal move immediately. Models leaving a moving vehicle are placed directly behind the vehicle's line of travel and may make a normal move immediately. Normal unit coherency must be maintained between the troops leaving the vehicle and any remaining inside.

Models may board a stationary vehicle if they are within 2" of its side or rear after they have made a normal move. Models may also board a moving vehicle if their normal move takes them across the path taken by the vehicle during its own move. Although this means that a trooper may theoretically only reach the position of a vehicle once the vehicle has itself moved off, this doesn't matter as it is assumed the individual runs a little faster in order to catch up and clamber inside.

If a vehicle is moving up to 10", then troops may leave or board it without risk. If a vehicle is moving more than 10" then each model boarding or leaving sustains an automatic hit with the strength shown on the chart below. Any model suffering damage is allowed its normal saving throw and sustains 1 wound if this is failed.

BOARDING/LEAVING A SPEEDING VEHICLE CHART

VEHICLE MOVES	0-10"	11	12	13	14	15	16	17	18	19	20+
STRENGTH OF HIT	None	1	2	3	4	5	6	7	8	9	10

MOTIVE TYPES

The Data Record gives the general motive type of the vehicle - whether it has wheels, legs, gravitic reaction engines or tracks. Some motive types also reflect the vehicle's size or design, such as bikes and jet bikes.

Walkers. Walkers are vehicles with legs, either two legs like humans or more. They can cross all linear obstacles (hedges/walls/ditches/etc) without penalty, and can move unhindered over any terrain type other than woods and deep water. Walkers can only move through woods at slow speed. They cannot move over deep water at all, but may cross shallow streams and fords without penalty.

Tracked. Tracked vehicles have caterpillar tracks like tanks. They can move unhindered over most terrain, but cannot move through wood at all. A tracked vehicle moving through a bog or other loose swampy ground at combat or fast speed risks becoming stuck. On the D6 roll of a 6 the vehicle becomes stuck fast in the bog for the remainder of the game and cannot move at all. A tracked vehicle may move over linear obstacles at slow speed without incurring any penalty - at faster speeds it will crash and incur damage like any other vehicle. Tracked vehicles cannot move over deep water, but can traverse streams and fords without penalty.

Wheeled. Wheeled vehicles have large rugged wheels designed for off-road as well as normal urban use. They cannot cross over difficult or very difficult ground at combat or fast speed. A wheeled vehicle cannot move through a wood at all and may not cross a linear obstacle of any kind.



KEVIN WALKER



KEVIN WALKER

Grav. These vehicles are powered by gravitic reaction motors which allow the vehicle to float a foot or so above the ground surface. A grav vehicle may cross linear obstacles at slow speed without incurring any penalty - at faster speeds it will crash and take damage like any other vehicle. Grav vehicles may not enter woods at all. They may move unhindered over bogs, loose ground and water as the solidity of the ground below them makes no difference to the gravitic drive.

Bikes. Bikes and the larger three wheeled trikes are wheeled vehicles which usually have a single rider. They are very much like contemporary motor cycles and trikes. A bike cannot cross a linear obstacle of any kind - if it attempts to do so it will crash. Bikes may cross difficult or very difficult ground, including woods, at slow speed only - at faster speeds they crash and incur damage. They may not cross water other than shallow streams and fords. Bikes may also attempt special skid turns as described below.

Jet Bikes. Jet Bikes are similar in appearance to ordinary bikes but have no wheels. They are powered by gravitic reaction motors as well as compact jet engines. They can fly as well as move over the ground surface in the same way as grav vehicles. Because jet bikes ride over the ground they can cross over terrain without penalty. However, they cannot move through, or land in, a wood, but must fly over it.

FLYING VEHICLES

As mentioned in the description of jet bikes, some vehicles can fly through the air. The rules for flight are not covered here and players are referred to the main rules.

BIKE SKID TURNS

A bike travelling at slow speed can make as many turns as the player wishes, but when travelling at faster speeds bikes are limited to one or two turns exactly like other vehicles. However, bikes are also allowed to make additional turns of up to 45 degrees called *skid turns*. Skid turns therefore allow a bike to change direction several times even while travelling at high speed. These manoeuvres are quite dangerous and call for extra skill on the part of the rider. The biker revs his engine and swings his machine round in a controlled skid, dipping low to the ground to balance the machine. This is a spectacular manoeuvre - all the more so when it goes wrong!

A bike wishing to make a skid turn must take a *skid test*. A bike may attempt as many skid turns as the player wishes - a separate test is made for each. Skid turns can be made immediately after normal turns or after each other, allowing the biker to turn 90 degrees or more. Of course, the greater the change in direction the more tests the biker will have to take and the greater the chance of crashing. To determine if the skid turn is completed successfully roll a D6, reference the score with the vehicle's speed and read the final result.

Bike Speed	Result	
Combat	Fast	
-	1	The bike crashes and is destroyed together with its rider. The flaming wreck travels straight forward for the remainder of its maximum fast move, and then explodes with an area radius of 1" causing a strength 4 hit on any target within the effect area. If the bike hits something before its move is complete, work out normal collision damage and then the bike explodes.
1	2	The biker skilfully guides his protesting machine in the desired direction, but is too preoccupied to do anything else this turn. No weapons may be fired from the bike this turn, including any fired by a passenger (who is more interested in holding on than shooting).
2-3	3-4	The biker skilfully guides his protesting machine in the desired direction, but is too preoccupied to do anything else this turn. The rider may not fire any weapons, including bike weapons, this turn. A passenger or side car crewman may shoot as normal.
4+	5+	The biker successfully completes the manoeuvre.

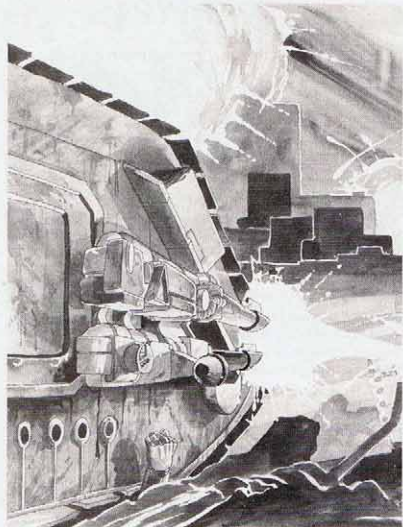

VEHICLE ARMAMENT

During the shooting phase any vehicle crewman can fire one of the vehicle's weapons. It does not matter if the crewman is the driver, as the driver can also operate one weapon. Weapons may be fired within the shooting arc as shown on the small shooting arc diagram on the vehicle's Data Record.

Note that some weapons are rigged up to fire in tandem - two or more combined weapons are operated by a single action and fire together at the same target. Although a combined weapon actually consists of two or more weapons it is considered to be a single weapon when it is fired - only a single crewman is therefore required to fire a combined weapon.

SHOOTING FROM A VEHICLE

If a vehicle is transporting troops in addition to its own crew, these may shoot weapons from the vehicle during their shooting phase. If the vehicle is open topped (such as the Ork Battle Wagon) then all the models inside may shoot so long as they don't fire over the heads of other troops in the vehicle (apart from the driver - who is sensible enough to keep his head down).

If the vehicle is enclosed the maximum number of models that can shoot out depends on the positions of doors and hatches. As these can vary a great deal no specific rules are given to cover firing from specific vehicles. However, players can assume that an access hatch or door is large enough to permit two models to fire through, while a firing slit or view port is large enough to permit one model to fire through.

SHOOTING AT VEHICLES

A model can shoot at an enemy vehicle if it has a line of sight to it in the same way as when firing at another trooper model. Because vehicles are very much larger than ordinary troops, linear obstacles and other low cover do not block the line of sight either to or from them. In other words, an Imperial Land Raider is just too big to hide behind a hedge!

The exception is any sort of bike or trike, where normal line of sight rules continue to apply because bikes are relatively small and low.

PROCEDURE TO HIT

When shooting at a vehicle the normal 'to hit' procedure is not used. Instead the firer uses the special gun sight template shown below.

The gun sight represents the shooter's view of his target either directly over the gun sights, through a separate targeting device, or via a head-up display projected into his helmet visor. The cross-hairs in the middle of the gun sight show the point of aim. The shooter refers to the vehicle's Data Record, which includes its own unique targeting diagram. This illustrates the side view of the vehicle divided up to show its internal as well as its external parts. Each area is labelled and has its own armour rating shown as a number. The higher the number the thicker the armour protecting that area.

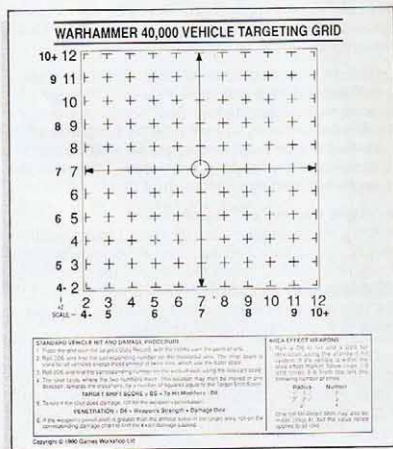

To make the gun sight template easier to use we suggest you mount it on a thin piece of card or a sheet of paper with a hole cut in the centre, 102mm wide by 103mm deep, so that the targeting diagram can only be seen through the grid itself. This makes it easier to distinguish the numbers along the edge of the grid, as well as allowing you to see at a glance which areas of the vehicle you may be able to hit.

To shoot at the vehicle, the player takes the transparent gun sight and places it with the central cross-hairs on his chosen point of aim. The firer then rolls 2D6 and finds the corresponding number along the bottom of the gun sight. The firer then rolls 2D6 and finds the corresponding number along the side of the gun sight. The shot lands where the two numbers meet.

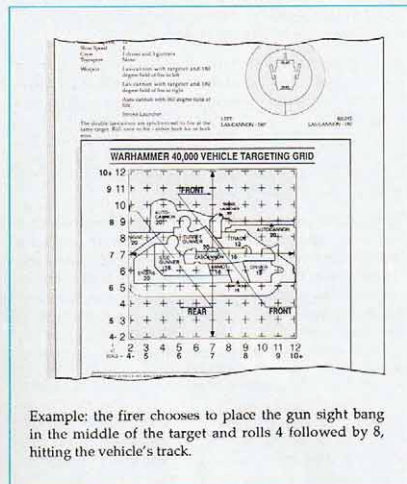

The shooter may position the target grid anywhere he likes (although see Front and Rear Shot for further details). Where you choose to aim will depend on your weapon, the armour thickness, and how lucky you feel! A fairly central location gives you the best chance of hitting, but may be heavily armoured and difficult or even impossible to penetrate.

Sometimes it is better to place the centre of the target grid over a more lightly armoured peripheral area. Only experience will tell you what is the best position to aim for.

HITS AND MISSES

If the shot hits the vehicle then it has struck the area indicated. If the shot misses the vehicle outline entirely then the shot has missed. In the unlikely event of a shot landing exactly on a dividing line then randomly determine which of the two potential areas is hit. However, the final position of the shot can sometimes be modified by Target Shift as explained later.



FRONT AND REAR SHOTS

If the firer is shooting at the vehicle's front or rear his choice of target areas is obviously limited to what he can see. This is indicated on the targeting diagrams by the front and rear zones.

If the firer is shooting from the front of the vehicle the cross-hairs of the gun sight must be centred inside the frontal zone. Similarly, if firing from the rear the cross-hairs must be centred in the rear zone.

Note that although a shot may be fired from the front or rear, the area hit may lie outside the front/rear zone. This represents the chance of a shot penetrating and going through into a section further back, or which causes internal damage affecting a more distant section. For example, a hole blown in the rear of a vehicle may shatter the armour and send shrapnel spinning into the driver's compartment at the front.

The diagram below shows the positions from which a shooter is considered to be in front of or behind a vehicle. The frontal zone is a 90 degree arc extending forwards from the middle of the vehicle. If the shooter is within this arc the shot must be aimed at the front. Exactly the same is true of the rear except that the 90 degree arc extends backwards. Shooters firing at the side of the vehicle can aim anywhere on the targeting matrix.

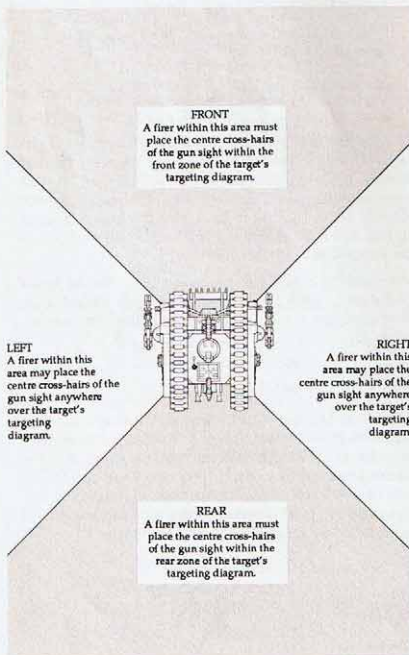

NEW WALKER

TARGET SHIFT

The chance of scoring a direct hit will naturally vary slightly due to the circumstance, individual skill and the weapon used. Increased accuracy is represented by changing the position of the hit on the gun sight template - moving it vertically or horizontally by one or more grid positions. This is called the *Target Shift*. A player can always apply Target Shift if he wants but he does not have to do so - he may be content with a hit on another area.

Target Shift is worked out as follows. The shooter takes his Ballistic Skill (BS) and applies Basic and Weapon 'to hit' modifiers (including any modifier for a weapon's targeter). Note that these modifiers are usually applied to the 'to hit' dice roll, but because no separate 'to hit' roll is made when shooting at a vehicle, the modifiers are applied to the Target Shift instead.

The player then rolls a D6 and deducts the score from the total. For example, if his BS were 4 and modifiers brought this up to 5, and he rolled a D6 score of 3, his final score is 5-3 = 2. This is the Target Shift Score. If the Target Shift Score is zero or less then proceed no further - the shot cannot be changed and has either hit the area or missed entirely as indicated originally.

$$\text{TARGET SHIFT} = \text{BS} + \text{TO HIT MODIFIERS} - \text{D6}$$

Assuming the Target Shift Score is 1 or more the player may shift the hit by up to that number of positions on the gun sight template. The shift must be in one direction only - either vertically or horizontally (never at an angle) and must always be towards the aiming point at the centre of the gun sight. This represents the increased accuracy of the weapon or shooter - but because the shift must be vertical or horizontal it is still possible to miss even a large target.

Example. The shooter is firing a missile launcher with targeter at a Predator 48" away and moving at 16" (maximum rate). The shooter has a BS of 4, +1 for the targeter and -1 because of a fast target equals a total of 4. The D6 score is a 3, so the player can shift his shot by 4-3 = 1 position.

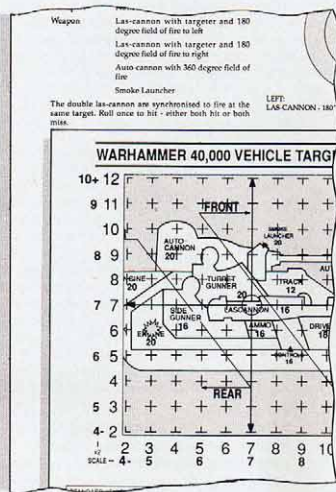

The firer aims for the Predator's lascannon - a centrally placed target which maximises his chance of hitting. The gun sight rolls are 3 and 6, indicating a hit in the engine. The player can shift the hit by 1 space towards the aiming point, so he can go for either 4/6 (side gunner) or 3/7 (engine). In this situation the player might decide to adjust his hit position from the well protected engine to the slightly more vulnerable gunner.

ENLARGED SCALE TARGET MATRIX

If you look at the Data Record of a small vehicle you will see that the targeting diagram has been reproduced at approximately twice its actual dimensions. This allows us to show the vehicle and its target areas at a reasonable size. To compensate for this change in scale, the firer uses the special outside column of the gun sight template marked x2. This is numbered from 4 or less (4-) to 10 to more (10+). The gun sight is used in the normal way: any result of 4 or less is read along the 4-line, and result of 10 or more is read along the 10+ line.

When using the enlarged scale, the Target Shift works in exactly the same way as for other hits. The target shifts follow the grid pattern on the gun sight template not the dice roll numbers - a shift of one position is still a shift of one grid space, not from one dice roll number to the next.

AREA WEAPONS

Area and other special weapons are discussed in detail later. However, players might like to know the general procedure at this point. The shooter nominates his target and makes the normal D6 based 'to hit' roll and deviation roll using the standard hit system. Once the area marker is in place on the table the targeting diagram and gun sight are used to locate damage if any portion of the vehicle model lies within the area marker.

ARMOUR PENETRATION

Once it has been established that a shot has hit the target, note the armour value of the location struck. The higher the armour value the thicker the armour and the more difficult it is to penetrate. The player tests to determine whether this armour is penetrated successfully by the shot.

$$\text{PENETRATION} = \text{D6} + \text{STRENGTH} + \text{VARIABLE DAMAGE}$$

Test as follows: roll a D6 and add the score to the strength of the weapon causing the hit. If the weapon normally causes a variable number of wounds (D3, D4, D6, D10, 2D6, etc) roll the dice indicated and add the score to the total as well. This is the thickness of armour penetrated. If the result is equal to or more than the armour value of the area hit, the shot has penetrated. If the result is less than the armour value the shot has not penetrated and has no further effect.

Example: A lascannon has a strength of 9 and causes 2D6 points of damage. It will therefore penetrate $\text{D6} + 9 + 2\text{D6}$ value of armour (a thickness between 12 and 27). The lascannon is an ideal anti-tank weapon because it can penetrate a great thickness of armour. An ordinary bolter can penetrate $\text{D6} + 4$ value of armour (5-10) which is only likely to harm the lightest types of vehicle or exposed crewmen

DAMAGE

If a shot penetrates the target's armour then the vehicle will sustain damage. In most cases the area will be destroyed, and in some cases the whole vehicle may be destroyed and rendered useless. Refer to the damage effect chart corresponding to the location, and roll to determine the effects of penetration.



DAMAGE EFFECT CHARTS

DRIVER

- D6 Result**
- 1-2 Driver is Hit.**
The driver is allowed his normal saving throw modified by the normal armour modifier for the penetrating weapon. If this is successful he is unharmed. If he does not save then he sustains the number of wounds normally caused by the penetrating weapon. This may or may not be sufficient to slay the driver depending on how many wounds he can withstand and how much damage the weapon causes. If the driver is slain but the vehicle has other crew, one of these may take over the controls immediately. Otherwise, if the vehicle is moving at slow speed it will move out of control in its next turn and then stop (rules governing out of control vehicles are given later). If travelling faster, the vehicle moves out of control for the remainder of the game or until it hits terrain it cannot cross, collides with another vehicle or building, or until it leaves the game table.
- 3-4 Driver is Hit.**
The driver is allowed his normal saving throw modified by the normal armour modifier for the penetrating weapon. If this is successful he is unharmed. If he does not save then he sustains the number of wounds normally caused by the penetrating weapon. This may or may not be sufficient to slay the driver depending on how many wounds he can withstand and how much damage the weapon causes. If the driver is slain and the vehicle has other crew, one of these may take over the controls at the start of any following turn on the D6 roll of a 4, 5 or 6. A crewman attempting to take the controls and failing, may not do anything else in the turn. If the vehicle is stationary when hit it will remain stationary until a crewman installs himself as its driver. If moving when hit, the vehicle moves out of control until a new driver is installed, hits terrain it cannot cross, collides with another vehicle or building, or until it leaves the game table.
- 5-6 Driver is Hit.**
The driver is allowed his normal saving throw modified by the normal armour modifier for the penetrating weapon. If this is successful he is unharmed. If he does not save then he sustains the number of wounds normally caused by the penetrating weapon. This may or may not be sufficient to slay the driver depending on how many wounds he can withstand and how much damage the weapon causes. In addition, part of the driver's controls are also damaged so that the vehicle becomes undrivable regardless of whether the driver is slain. If the vehicle is stationary when hit it will remain stationary. Otherwise it will continue to move out of control for the remainder of the game, until it hits terrain it cannot cross, collides with another vehicle or building, or until it leaves the game table. Once halted it is permanently immobilised.

CREWMAN

Some crewmen operate weapons and are indicated on the targeting diagrams as 'Gunnery'. If a vehicle has guns either side (Predator and Land Raider for example) it is the Gunner on the side presented to the firer that is hit. Where either might be hit, roll randomly to determine which it is - for example if a Predator or Land Raider is struck from the front or rear.

- D6 Result**
- 1-2 Crewman Hit.**
The crewman is allowed his normal saving throw modified by the normal armour modifier for the penetrating weapon. If this is successful he is unharmed. If he does not save then he sustains the number of wounds normally caused by the penetrating weapon. This may or may not be sufficient to slay the driver depending on how many wounds he can withstand and how much damage the weapon causes. Once the crewman is slain, he can no longer operate a weapon or other item of equipment. However, if the vehicle has several crew, another may take over the dead crewman's functions by forsaking his own. The player may choose which weapon/item of equipment to leave unused.
- 3-4 Crewman Hit.**
The crewman is allowed his normal saving throw modified by the normal armour modifier for the penetrating weapon. If this is successful he is unharmed. If he does not save then he sustains the number of wounds normally caused by the penetrating weapon. This may or may not be sufficient to slay the driver depending on how many wounds he can withstand and how much damage the weapon causes. Once the crewman is slain, he can no longer operate a weapon or other item of equipment. If the vehicle has other crew one of these may take over the dead man's function at the beginning of the player's turn on the D6 roll of a 4, 5 or 6. A crewman attempting to take over from another and failing may not do anything else that turn.
- 5-6 Crewman Hit.**
The crewman is allowed his normal saving throw modified by the normal armour modifier for the penetrating weapon. If this is successful he is unharmed. If he does not save then he sustains the number of wounds normally caused by the penetrating weapon. This may or may not be sufficient to slay the driver depending on how many wounds he can withstand and how much damage the weapon causes. Regardless of whether the crewman survives, the piece of equipment he is operating is so badly damaged by the hit that it can no longer be used.



WEAPON

If the vehicle has left and right hand weapons (for example a Predator or Land Raider) the side presented to the firer is hit. If either side might be hit roll randomly to determine which it is.

D6 Result

- 1 The weapon is jammed or partially damaged and cannot be used until it has been repaired. A crewman may successfully repair the weapon by rolling a 4, 5 or 6 at the start of his turn. A crewman who attempts a repair cannot do anything else and the weapon cannot be fired in the same turn that it is repaired. Only one crewman may attempt to repair a weapon at once.
- 2-5 The weapon is destroyed and can no longer be used.
- 6 The weapon explodes and is destroyed. The explosion also causes a randomly located hit on the vehicle. Use the vehicle's target diagram and reroll any result which would otherwise indicate a miss. Because the weapon explodes inside the vehicle there is no need to roll for penetration, simply roll for damage on the area affected.

ENGINE

D6 Result

- 1-2 **Engine is Destroyed**
The vehicle comes to an immediate halt and remains immobilised for the remainder of the game.
- 3-4 **Engine is Destroyed.**
If moving when hit the vehicle moves out of control in its next turn and then comes to a permanent halt. If stationary when hit the vehicle is halted for the rest of the game as for 1 above.
- 5 **Engine is Destroyed.**
If moving when hit the vehicle ceases to move forward but spins round to face a random direction (nominate one direction as 12 o'clock and roll a D12 - the result shows the direction faced relative to a clock face). The vehicle is then halted for the rest of the game. If stationary when hit the vehicle is halted for the rest of the game as for 1 above.
- 6 **Engine is Destroyed and Bursts into Flames.**
If the vehicle is stationary when hit it is halted for the rest of the game. If moving it ceases to move forward but spins round to face a random direction and then comes to a halt as for 5 above. At the beginning of each of its following turns a D6 is rolled and the vehicle explodes on a roll of a 6. An exploding vehicle causes 1 strength 10 hit on all models within a 3" radius circle positioned over the centre of the vehicle. Exploding vehicles cause D6 wounds on any targets damaged by the blast.

CONTROLS

D6 Result

- 1-2 **Vehicle's Control Gear is Destroyed.**
The vehicle is brought to a halt and may not move for the rest of the game. All onboard systems are rendered useless but weapons may be fired and doors opened manually. When firing weapons note that turrets may not turn and targeter devices are rendered inoperative.
- 3-4 **Vehicle's Control Gear is Destroyed.**
The vehicle is brought to a halt and may not move for the rest of the game. All onboard systems are rendered useless and all doors jam shut. Models inside a totally enclosed vehicle are trapped. Weapons may be fired, although turrets may not turn and targeter devices will not operate.
- 5-6 **Vehicle's Control Gear Goes Crazy.**
The vehicle moves in a dangerous and unpredictable fashion. At the beginning of each of the vehicle's subsequent movement phases the opposing players each roll a D6. The player with the highest result may move the vehicle that turn. If the player who is to move the vehicle has rolled 1-5 the vehicle must move at the same speed rate as in the previous turn. If the player rolls a 6 he can change the speed rate but cannot bring the vehicle to a halt. Otherwise the vehicle is moved in any way the controlling player wishes. If stationary when hit the vehicle must remain stationary unless a player rolls a 6, in which case he can increase the speed and get the vehicle started. Whichever player moves the vehicle, his opponent may fire any one of its weapons during the shooting phase. Other weapons on the vehicle may not fire at all. Although the enemy player will be moving or firing the vehicle, these actions still take part during the vehicle's own movement or shooting phase - not during the enemy player's turn.

AMMO

D6 Result

- 1-5 **Ammunition is Hit and Vehicle Explodes**
An exploding vehicle automatically causes 1 strength 10 hit on all models within a 3" radius circle positioned over the centre of the vehicle. Exploding vehicles cause D6 wounds on any targets damaged by the blast.
- 6 **Ammunition Casing is Split**
Ammunition starts to react dangerously with the air, and chemicals spill into the vehicle's interior. At the beginning of each of its following turns, the vehicle will explode on the D6 roll of a 4, 5 or 6. An exploding vehicle automatically causes 1 strength 10 hit on all models within a 3" radius circle positioned over the centre of the vehicle. Exploding vehicles cause D6 wounds on any targets damaged by the blast.

WHEEL

D6 Result

- 1-2 The wheel and mountings are badly buckled. From now on the vehicle's maximum speed is reduced to its slow rate only.
- 3-4 If the vehicle is stationary when hit it is permanently halted. If moving the vehicle goes out of control for the rest of the game, or until it hits terrain it cannot cross, collides with another vehicle or building, or leaves the game table. Once brought to a halt it cannot move for the rest of the game.
- 5-6 If the vehicle is stationary it is permanently halted. If moving it will cease to move forward and spin round to face a random direction (roll a D12 with straight ahead as 12 o'clock). Once halted it cannot move for the rest of the game.



JETS

D6 Result

- 1-2 **Gravitic Jets Fail.**
If already stationary the vehicle is permanently halted. If moving it will move at slow rate next turn and then come to a permanent halt.
- 3-4 **Gravitic Jets Fail.**
If already stationary the vehicle is permanently halted. If moving at slow rate it comes to an immediate stop and is halted for the remainder of the game. If moving faster than slow rate it will move at its maximum slow rate next movement phase and then come to a permanent halt facing in a random direction at the end of the phase.
- 5-6 **Gravitic Jets Overload and Fail.**
If moving when hit the vehicle is thrown 2D6" in a random direction and ends its movement facing in a random direction. If the vehicle collides with terrain, vehicles or other models, work out damage as for a normal collision with the vehicle's speed equal to the 2D6 distance roll. If stationary when hit the vehicle may not move for the rest of the game.

TRANSPORT

D6 Result

- 1-2 Any models carried in the transport section of the vehicle are allowed their normal saving throw modified by the normal armour modifier for the penetrating weapon. If this is successful the model is unharmed. If models do not save then they sustain the number of wounds normally caused by the penetrating weapon. This may or may not be sufficient to slay the occupants depending on how many wounds they can withstand and how much damage the weapon causes. Where a unit consists of troops each of whom have several wounds, calculate the total number of wounds caused and then remove the number of whole models corresponding to that number of wounds - this saves recording odd wounds on a large number of models. Record any wounds on individual character models separately.
- 3-4 Any models carried in the transport section of the vehicle are allowed their normal saving throw modified by the normal armour modifier for the penetrating weapon. If this is successful the model is unharmed. If models do not save then they sustain the number of wounds normally caused by the penetrating weapon. This may or may not be sufficient to slay the occupants depending on how many wounds they can withstand and how much damage the weapon causes. Where a unit consists of troops each of whom have several wounds, calculate the total number of wounds caused and then remove the number of whole models corresponding to that number of wounds - this saves recording odd wounds on a large number of models. Record wounds on individual character models separately. Any surviving models must leave the vehicle during their following turn. They will disembark regardless of the vehicle's speed and of any concern for their own safety.
- 5-6 Any models carried in the transport section of the vehicle sustain the number of wounds normally caused by the penetrating weapon. This may or may not be sufficient to slay the occupants depending on how many wounds they can withstand and how much damage the weapon causes. No saving throw is permitted for armour. Where a unit consists of troops each of whom have several wounds, calculate the total number of wounds caused and then remove the number of whole models corresponding to that number of wounds - this saves recording odd wounds on a large number of models. Record any wounds on individual character models separately.



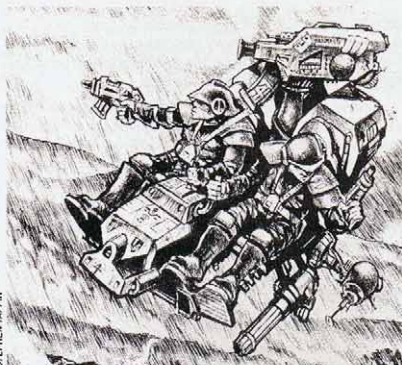

LEG

D6 Result

- 1-2 The vehicle is destabilized by the loss or severe damage caused to a limb. The vehicle is permanently halted. If moving when hit it stops and falls over on the D6 roll of a 5 or 6. A falling vehicle will collapse as described for 3-4 below.
- 3-4 The vehicle collapses into a heap and may not move for the remainder of the game. On the D6 roll of a 5 or 6 the vehicle collapses in such a way that 1 randomly determined weapon may still be used. Otherwise the vehicle's weapons may not be used for the rest of the game.
- 5-6 The vehicle collapses into a heap and may not move for the remainder of the game. Its weapons are broken or fall in such a way that they may not be fired for the rest of the game.

TRACK

D6 Result

- 1-2 The vehicle is brought to a permanent halt. If moving when hit, the vehicle immediately turns 45 degrees towards the damaged side before it comes to a halt. The vehicle may not move for the rest of the game, but may turn to face any direction during its movement phase so long as one track remains functional.
- 3-4 The vehicle is brought to a permanent halt. If moving when hit, the vehicle turns 45 degrees towards its damaged side before it comes to a halt. The vehicle may not move nor turn once it has halted.
- 5-6 If moving when hit, the vehicle moves out of control in its following turn, and then comes to a permanent halt. If halted when hit it will remain halted for the rest of the game.

MULTIPLE HITS ON A LOCATION

Once an area has been destroyed, a crewman killed, or a weapon destroyed, subsequent hits in that area are not re-rolled and cannot cause damage. The energy of the hit is absorbed by the existing wreckage and surrounding superstructure.

OUT OF CONTROL

The damage charts indicate situations where vehicles go out of control when hit. Note that only a vehicle which moved in its previous turn can go out of control, stationary vehicles never go out of control.

Vehicles moving out of control are moved before other models at the start of their side's movement phase. A vehicle which goes out of control is moved 2D6" but no faster than its maximum speed. The vehicle moves straight ahead or towards the right or left as shown on the diagram below. Roll a D6 to determine direction and move the vehicle in its movement phase.

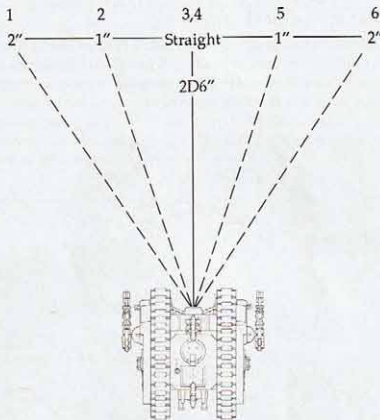

Some damage results specify that vehicles move out of control for 1 turn and then come to a halt. Other results specify that vehicles move out of control for the remainder of the game, or until the vehicle is brought to a halt by a collision. In the case of a slain driver, it may be possible for another crew member to restore control as explained on the damage result table.

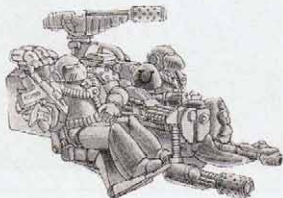

COLLISIONS

If a vehicle moves into another vehicle, dreadnought, building, terrain or obstacles that it cannot cross, this results in a collision. Where a vehicle collides with another vehicle, building or dreadnought, both may suffer damage.

Collisions against other vehicles, dreadnoughts and buildings are worked out using the chart below. Cross reference the speed of the fastest vehicle involved to determine the penetration value of the collision.

Speed	0-5	6-10	11-15	16-20	21+
Penetration	D6	2D6	3D6	4D6	5D6

All vehicles, dreadnoughts, and buildings involved in the crash are affected by the collision. Refer to the targeting diagrams for the vehicles and dreadnoughts. Any vehicle or dreadnought target location with equal to or less armour than the dice score is penetrated and damage is worked out as normal. Thus - in a collision with a penetration value of 18 any target areas with a value of 18 or less are penetrated.

A bike or trike which crashes into a larger vehicle is an exception, as it will only cause damage on one location, randomised from all those that have an armour value equal to or less than the penetration score. In the case of buildings, damage is worked out if the penetration equals or exceeds the building's damage value. Against uncrossable terrain, including walls, trees, and other

terrain which the vehicle is unable to cross, work out damage in the same way. As no other vehicles are involved the speed will be the vehicle's own speed and only the vehicle will sustain damage.

A vehicle, other than a bike or trike, which is travelling at slow or combat speed may run into foot trooper models without suffering damage. Bikes/trikes and all vehicles moving at fast speed will suffer a randomly located hit with 2D6 armour penetration if they run into foot trooper models during their movement.

Models which are run over must make a successful armour saving throw or they sustain D6 wounds.

Victims may attempt to dive out of the way of oncoming vehicles by rolling equal to or less than their initiative characteristic value on a D6. A roll of a 6 always fails regardless of the model's initiative. Models diving out of the way are positioned to either side of the vehicle and are not harmed.

VEHICLES IN CLOSE COMBAT

Vehicles cannot engage in hand-to-hand combat as such, but enemy models may attack any vehicle they are touching during the hand-to-hand combat phase. This is not a proper hand-to-hand combat engagement and does not restrict movement of either the vehicle or the attacker in their subsequent movement phases.

A model which is touching a vehicle automatically hits so no 'to hit' roll is necessary. The attacker chooses the location struck - but this must be an exterior feature of the vehicle, such as a track or weapon.

If the vehicle is not fully enclosed, the attacker may choose crew, controls or other exposed locations. However, a vehicle's ammunition reserve and fuel supply is never considered to be exposed - even should this appear to be the case on the model itself.

Armour penetration and damage effects are worked out exactly as already described for shooting.

HITS FROM AREA WEAPONS

When shooting against a vehicle with an area effect weapon, the area marker is positioned on the gaming table exactly as when firing at other targets. The player rolls a D6 to hit and positions the area template on the table. If no part of the vehicle lies within the template the shot has missed the vehicle and cannot affect it. If any part of the vehicle lies within the template then refer to the Data Record and the targeting diagram.

An area weapon spreads its blast or hail of shot over an area, and so may affect several different locations on the targeting diagram.

The gun sight is placed on the targeting diagram. If the centre of the area marker lies in the vehicle's frontal arc then the player must place the cross-hairs within the frontal zone. If the centre of the area marker lies within the rear arc then the player must place the cross-hairs within the rear zone. If the centre lies anywhere else, including on the vehicle itself, the gun sight can be positioned anywhere on the diagram.



Roll to establish where the shot strikes the target using the gun sight. First roll 2D6 along the bottom, and then along the side to establish if and where the shot hits. However, instead of rolling just once, roll once plus once more for every inch of the template radius. The chart below summarises the number of rolls.

Template Radius	Number of rolls
1" - 1 1/2"	2
2" - 2 1/2"	3
3	4

A single D6 roll may be made to establish Target Shift, in which case the same dice result stands for all rolls. Once you have established which parts of the vehicle have been hit determine damage as normal. Note that shots may still miss the vehicle outline on the diagram in which case they have no effect even though the area template lies over the vehicle - the blast has simply passed very close without actually hitting the vehicle.

HITS FROM GAS WEAPONS

There is no need to determine where gas clouds strike a vehicle. Any exposed crew members are automatically hit and sustain damage exactly like foot troopers. Gas weapons are otherwise unable to affect vehicles.

HITS FROM STASIS/TANGLEFOOT

If the vehicle model is touched by the grenade template then it is affected. No roll is made on the targeting diagram.

HITS FROM VORTEX GRENADES

Vortex grenades destroy everything they touch. If the centre of the vortex marker passes over the vehicle then it is destroyed and removed from play. If 50% or more of the vehicle is covered by the vortex marker then it is also destroyed, regardless of whether the centre passes over it.

Otherwise, if the vehicle is touched by the vortex, but the centre does not pass over it and less than 50% is covered by the vortex, roll for damage as follows.

Place the gun sight over the targeting diagram as normal and roll 2D6 - read the result along the bottom of the gun sight.

If the vortex is approaching from the front then all areas to the front of that point are hit. If the vortex is approaching from the rear all areas to the rear are hit. If the vortex is coming from the side, all areas 1 either side of the point are hit (eg roll 7 and all areas 5 through 8 are hit). Everything hit by a vortex is destroyed.

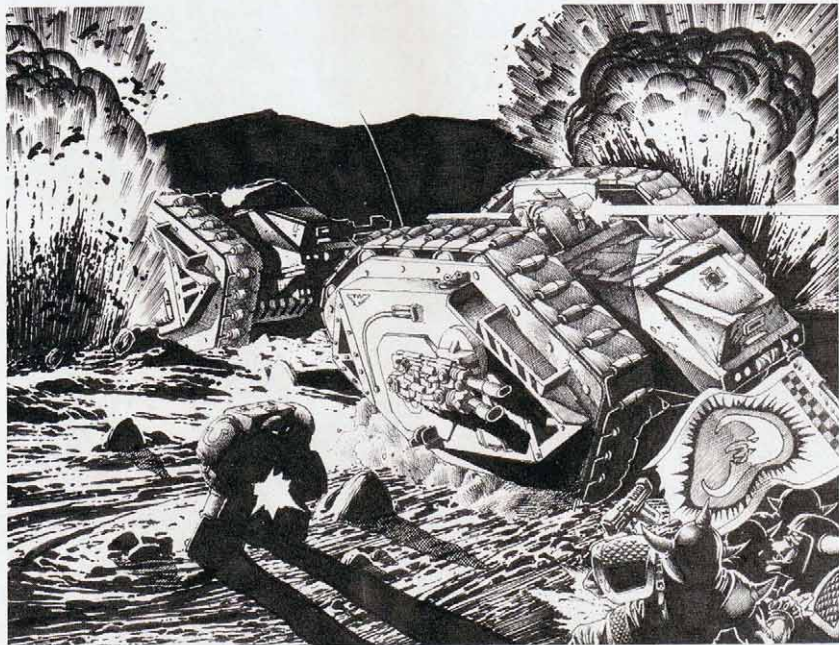

On the next few pages you'll find the first few Data Records; more will appear in future months.

ORK BATTLE WAGON

The Battle Wagon is an extremely common type of large vehicle. Its design, like that of War Buggies and most other Ork vehicles conforms to one or other of the traditional types known throughout Orkdom and copied by Mekboyz for many generations.

Battle Wagons are large vehicles designed to carry a whole fighting mob of Orks including any Gretchin and Snotling servants that accompany it. It is possible to squash an almost unlimited number of these underlings into the Battle Wagon, and any that can't fit inside will be quite happy to hang on to the bodywork or grab hold of the vehicle's flagpole.

As these vehicles are large, heavy and prestigious, it follows that they usually belong to the most important Ork families. In battle they might be ridden by the family leaders or Nobs, or they might be commanded by one of the various types of Oddboy. A family might also entrust its Ork Boyz with the Battle Wagon if their Nob wants to fight elsewhere. An Ork Warboss might decide to mount himself and his entire retinue in a Battle Wagon, or even several Battle Wagons if his retinue is suitably large and impressive.

Battle Wagons are provided with flagpoles so that the Ork who owns it can display his personal banner or his clan banner in an appropriately prominent position.

Mekboyz sometimes build a Battle Wagon for their own use but not all Mekboyz favour this form of transportation. Some Mekboyz prefer smaller and lighter vehicles for their personal use, favouring the exhilaration and speed of the War Buggies or Bikes rather than the ponderous invincibility of the Battle Wagon. The Battle Wagon is not an especially fast vehicle, but it is heavy and just about impregnable. Its only points of weakness are the Orks inside, who generally fail to keep their heads down behind the thick armoured plates.

The armament and other specific details of the Battle Wagon's construction vary a great deal from one vehicle to the next, so that some individual Battle Wagons are completely covered with extra turrets, covered awnings, new decks welded on top, and other features which either the Mekboy who made it or the Ork who owns it considered completely essential at the time. Weapons are a case in point. As Battle Wagons are mostly owned by Ork families it is armed with weapons belonging to that family - and these will naturally vary a great deal. Because of this tremendous variation no weapons have been included on the diagram. Where weapons are carried they will be operated by individual Orks, and any casualties amongst the Orks inside can be randomised amongst all those inside. A Battle Wagon can be used to tow a piece of Ork artillery such as the Hop-Splat field gun, the crew for the weapon can ride inside the Battle Wagon.

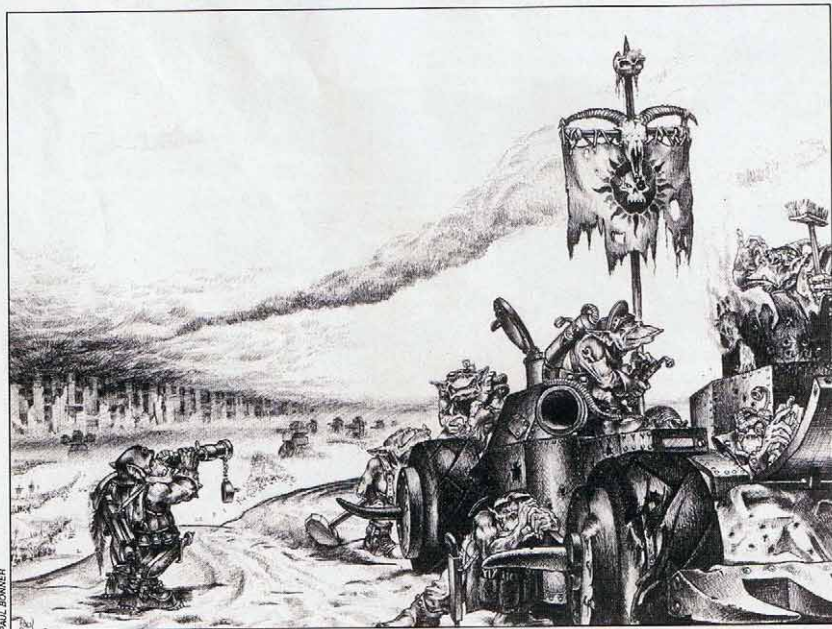

ORK BATTLE WAGON

DATA RECORD: ORK-1

Battle Wagons are large vehicles designed to carry a whole fighting mob of Orks plus their attendants. Weapons vary, as each Ork will outfit his Battle Wagon differently.

Type Wheel
Fast Speed 20
Combat Speed 14
Slow Speed 6
Crew 1 driver

Transport There is no limit on the number of Orks or servants that may be placed inside the vehicle, other than the actual number of models which you can fit inside. This will vary depending on which models you choose and how many you are able to squash in or on the Battle Wagon. Any models which fall off during the game are adjudged to have actually fallen off... so players who feel capable of fitting dozens of Orks in their Battle Wagons should watch out!

Weapons No specific weapons are included as the Battle Wagon may be used to mount any of the weapons owned by the Ork family. The weapon models must be placed inside the Battle Wagon together with their crew and the same comments apply regarding models which fall off as to other Ork models. Weapons can be fastened on to more permanent mounts on the Battle Wagon if you wish.

Points Value The Battle Wagon has a points value of 150.

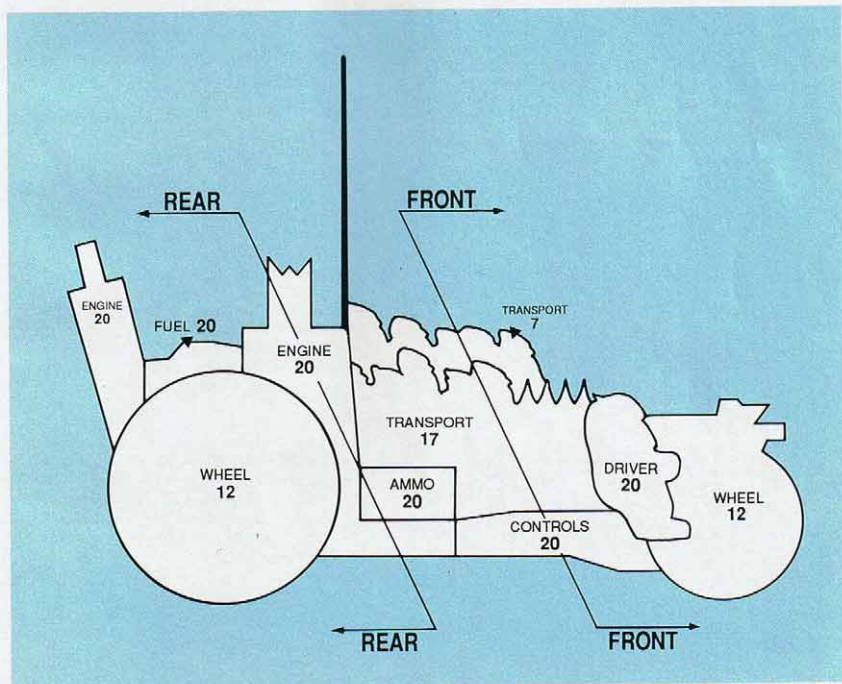

ORK FUEL TANK HITS

DATA RECORD: ORK-1

Ork vehicles are powered by a unique blend of squig and fungus derived gases. Every Mekboy favours his own mixture which is engineered not only to provide a volatile combustible fuel but also to enhance the sound of the engine and characterise the smell of its belching exhaust.

The speed of an Ork vehicle is regulated by a valve mechanism - the driver opens the valve to let more fuel into the engine so that the vehicle goes faster, by closing the valve the engine and the vehicle both slow down. Because of the extremely volatile and often unpredictable nature of the fuel, a hit on the fuel tank or delivery system can lead to the vehicle going out of control, spewing fuel in all directions or simply exploding. For this reason Ork vehicles have a special target location for their fuel tanks and any penetrating hits on this tank are resolved by means of the special Ork Fuel Tank hits table.

ORK FUEL TANK HITS TABLE

D6 Result

- 1-2 **Control Valve Smashed**
The controlling valve is smashed and the vehicle continues to travel at the same speed for the rest of the game. The vehicle can still be steered normally but the driver has no control over the speed. If the vehicle leaves the table it does not return.
- 3-4 **Tank Bursts**
The fuel tank is ruptured and clouds of volatile fuel spew out over the vehicle. The vehicle will explode on the D6 roll of a 4, 5 or 6 made at the beginning of its subsequent turns. If the vehicle explodes it will erupt into a ball of fire with a radius of 2" - the vehicle and all of its crew are completely destroyed. Any other models inside the fire ball will take a single strength 5 hit and D4 wounds with normal saves applying.

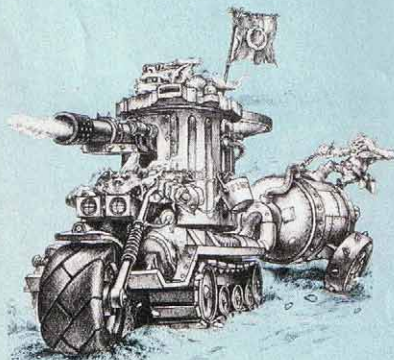

D6 Result

- 5 **Fuel Tank Ruptures**
A corrosive cloud forms centred around the vehicle. All crew immediately jump off regardless of the vehicle's speed. Place a 2" radius wad of cotton wool over the vehicle - any models inside this area sustain a single strength 5 hit due to corrosion, normal saving throws apply. This gas cloud remains in place when the vehicle moves, and stays on the table until it disperses as explained below. In its own turn the vehicle continues to move out of control as it has no driver.
- As the vehicle moves it trails a corrosive cloud behind it - to represent this you will need more cotton wool to represent the trail of gas. Once the vehicle has moved place another 2" radius wad over its final position. Now fill in the space between the two gas areas with a 4" wide trail of gas creating a trail which follows the path of the vehicle.
- Any models covered by the gas trail suffer a single strength 5 hit from the corrosive effects of the fuel vapour. Once the vehicle has moved and casualties have been worked out roll a D6 and remove that number of inches of gas cloud from the rear of the trail - in this way the cloud always disperses gradually from the rear and will eventually disappear. Whilst it persists the cloud blocks line of sight in exactly the same way as smoke.
- 6 **Fuel Tank Explodes**
The vehicle is destroyed and its crew crisped. Place a 2" radius area marker over the vehicle. Any models inside the fire ball will take a single strength 5 hit and D4 wounds where appropriate with normal saves applying.

RHINO

DATA RECORD: IMP1

The Rhino is designed to carry troops into forward fighting zones. It can deploy its troops very quickly, and can continue to offer battlefield support with its turreted bolter armament.

The vehicle forms a standard part of the Imperial Guard's armoury, and has seen wide service throughout the war zones of the Imperium. It shares a common chassis assembly with the Predator but is less heavily armoured and it is not really intended to operate against enemy armoured formations. Possibly its most useful weaponry is its smoke launcher which can be used to lay down covering clouds of smoke so that troops can advance without being seen.

Type	Track
Fast Speed	20
Combat Speed	14
Slow Speed	6
Crew	1 driver
Transport	10
Weapon	Double bolter with 360 degree field of fire
	Smoke Launcher

The double bolter is synchronised to fire at the same target. Roll once to hit - either both hit or both miss.

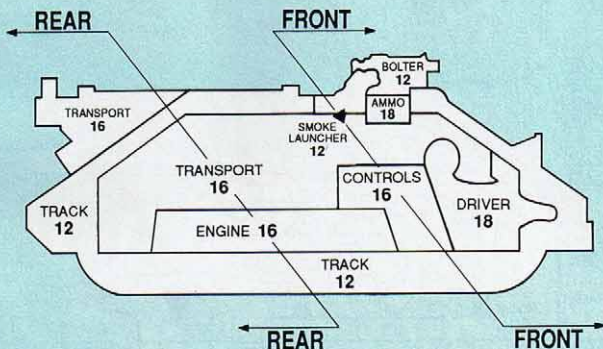
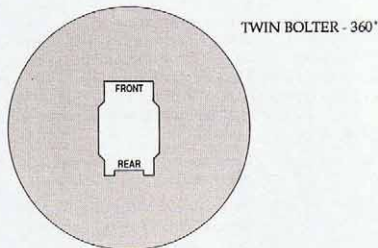

PREDATOR

DATA RECORD: IMP2

The Predator Assault Tank is well armed and armoured in the tradition of conventional armoured fighting vehicles. It is based on the Rhino armoured carrier, but has improved armour as well as additional armament. Although slow and ponderous, few other fighting vehicles can seriously compete with its massive fire power and heavy armour.

On the battlefield Predator units provide the mighty punch that can stop an enemy assault dead in its tracks, and which can equally easily burst through the enemy lines and allow infiltration by lighter, faster units. It carries two las-cannons, one mounted on each side, plus an auto-cannon in a well armoured turret.

Type	Track
Fast Speed	16
Combat Speed	12
Slow Speed	4
Crew	1 driver and 3 gunners
Transport	None
Weapon	Las-cannon with targeter and 180 degree field of fire to left Las-cannon with targeter and 180 degree field of fire to right Auto-cannon with 360 degree field of fire Smoke Launcher

The double las-cannon are synchronised to fire at the same target. Roll once to hit - either both hit or both miss.

AUTO-CANNON - 360°

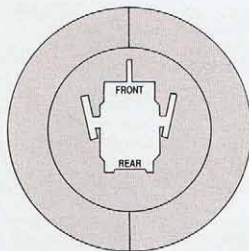

LEFT:
LAS-CANNON - 180°

RIGHT:
LAS-CANNON - 180°

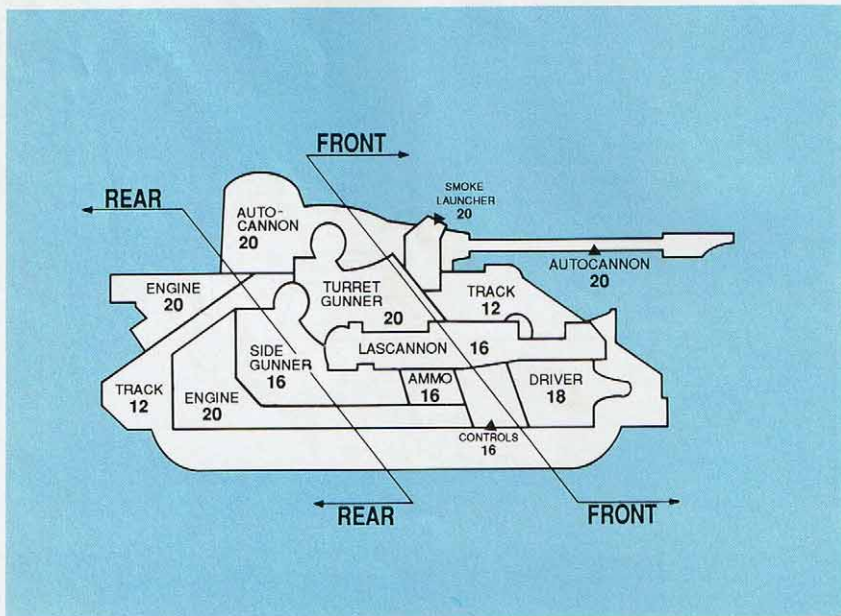

BATTLEWAGON BLITZKANON

DATA RECORD: ORK1a

Ork Battlewagons vary tremendously in details of their construction, and it is quite possible that there are no two alike in all Orkdom. Some have considerably more superstructure or even several decks, while others sport turrets concealing weapons. This offers tremendous scope for the modeller, whether expert or novice. Individually modelled Battlewagons can also be kitted out with new and different weaponry, which makes them different and interesting on the games table. A Battlewagon can carry any heavy weapons generated for the army's Nobs, and can in theory carry as many weapons as you can cram on board (the Ork Army Lists place a limit of 6 weapons in total - but the Battlewagon can carry more so long as they are represented by models). The Nob whose family owns the Battlewagon and weapons does not need to ride in the Battlewagon himself but he can, of course, do so if he wishes. The Battlewagon version shown here has a Kustom Kombi weapon made from three Auto-cannons fastened together! This was invented by the talented Ork Mek Tony Cottrell, who calls his creation a Blitzkanon. Tony's conversion of the basic Battlewagon appears elsewhere in this issue of White Dwarf. As Tony has gone to all the trouble of providing a special weapon for his Battlewagon we have decided to work out a special Data Record for it. You can do this for your own conversions if you like, or you can use the standard Data Record and targeting diagram and randomise any hits on the crew between crew members and any weapons mounted on the Battlewagon.

Type	Wheel
Fast Speed	20
Combat Speed	14
Slow Speed	6
Crew	1 driver
Transport	As many Orks and their servants as you can get inside!
Weapons	Triple Auto-cannon affectionately known as the Blitzkanon. The three barrels fire as a single weapon and either all three miss or all three hit.

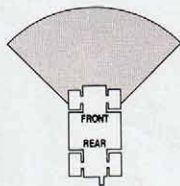

BLITZKANON - 90°

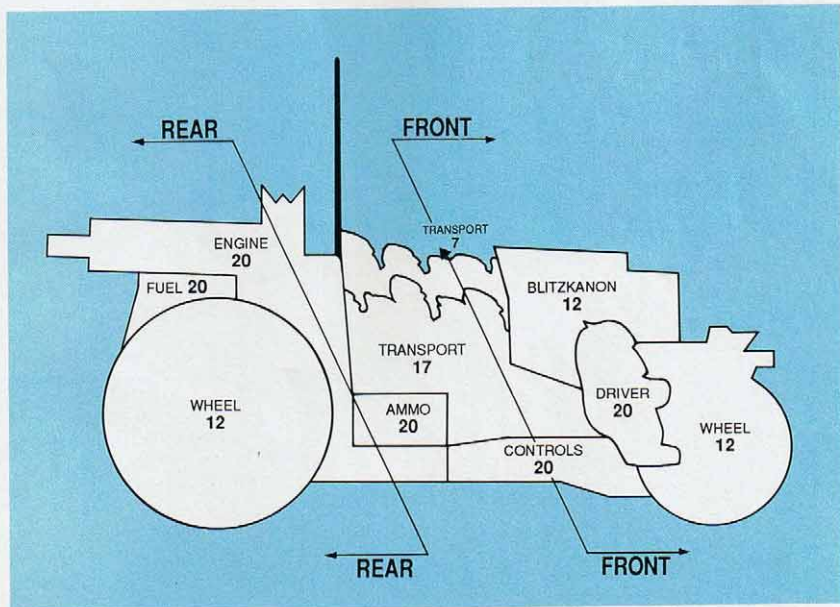

ORK BATTLEWAGONS

GOFFS

Waaargh the Goffs! The Snotling and Gretchin attendants hang on for dear life as the Goffs, mightiest of Orks, roar into battle. This stunning piece of modelling and painting was executed by the Studio's own Goff Warboss, Dale Hurst. Dale has armed his battlewagon crew with various Ork hardware and custom weapons and supplemented them with Gretchin and Snotling attendants. Most of these attendants are from Citadel's range of Blood Bowl Players and Hooligans, painted in the familiar blacks and checks of the Goffs. After the wagon had been painted, Dale festooned it with glyphs, trophies, streamers and banners.



FRONT VIEW EMPHASISING THE MASSES FIRE POWER



THE CLAN SYMBOL AND GLYPHS WERE PHOTOCOPIED FROM WAAARGH THE ORKS. THEY WERE THEN PAINTED AND GLUED TO THE SIDE PANELS

SNAKE-BITES

Ivan's Snake-Bite Battlewagon beautifully captures the feral nature of the clan. Skulls hang from the mast, a huge horned skull is roped to the front and Marine helmets impaled on spears act as a grim reminder to the Emperor's elite forces.

The brightly-coloured banners, bunting and streamers were all painted on paper before they were attached to the wagon, as were the crew.

Brilliant patterning and pictograms have been used to decorate the body-work and contrast well with the rusty, mud-stained wheels.



THE ROPE AND DECORATIVE TASSELS ON THE SIDE WERE MADE FROM TWISTED WIRE AND MODELLING PUTTY



ORKS AND SNOTTLINGS ALIKE HANG ON FOR DEAR LIFE! IVAN HAS PAINTED THE CLAN SYMBOL ON THE SIDE TO LOOK LIKE IT HAS BEEN MADE FROM BONE

MODELLING WORKSHOP

ORK BATTLEWAGON CONVERSION

by Tony Cottrell

This is the first of a series of conversions using Citadel's new Ork Battlewagon. Here we look at how to make a Battlewagon with a BLITZKANON. This is a simple conversion, well within the capabilities of anyone who's made a plastic kit before.

Besides the Ork Battlewagon kit, all you'll need to make the blitzkanon is a biro (the type with a hexagonal barrel) and a small sheet of plastic card (0.04" thickness) or thin cardboard. You'll also need the following tools: a sharp knife, a steel ruler and some fine sand paper.

In the instructions, the parts preceded by a G refer to parts specially made for this model, details of which are given below. The other numbers refer to parts from the Battlewagon kit - these numbers are the same as those in the Battlewagon instruction leaflet.

MAKING THE NEW PARTS

The **armoured bitz** (G1), **back bitz** (G2) and **kanon holda** (G4) can be made from either plastic card or thin cardboard. Lightly glue the templates provided to your card and, using the templates as a guide, cut out the shapes with a sharp knife.

Remember, if you're cutting anything with a modelling knife, always work with a sharp blade and make sure you cut away from your fingers. You'll find the steel ruler helpful for cutting straight lines.

If you are using plastic card you'll just need to score it, then bend it and it'll break down the cut. The hole in the kanon holda (G4) can be drilled with the end of the knife.

The **kanon barrels** (G3) are made from the barrel of a biro. Cut the barrel into three equal lengths by scoring with the knife and then snapping.

The above plastic parts can have their edges smoothed using the sandpaper.

The **kanon rachits** (G5) are round plastic shields.

ASSEMBLY

1. Assemble the Battlewagon as normal but leave off the wheel guards (10, 11), fighting compartment sides (27, 28), spiked railings (26) and lights (30).
2. Glue the three kanon barrels (G3) together.
3. To make the side bitz, remove the ends of the struts on the wheel guards (10, 11) and glue them to the kanon barrels.

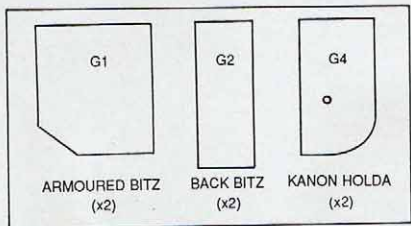

4. For the **kanon kovers**, glue the spare wheel plates (8) to the top of the kanon barrels.
5. To make the **kanon rachits**, glue the shields (G5) onto the bolts on the sides of the kanon - these are for aiming the kanon. Small handles from a plastic rod can be added if you want.
6. You make the **bullit stoppa** by gluing the compartment sides (27, 28) to the front of the kanon. You'll need to remove a small part of the lip on these to improve the fit.
7. Glue the kanon holdas (G4) to the sides of the kanon barrels so that the front bolts go through the holes.
8. Glue the complete blitzkanon into the front of the fighting compartment.
9. Glue the armoured bitz and back bitz (G1 and G2) to the edges of the chassis.
10. You can add extra detail like rivets by using a thin plastic rod. Just slice the rod into small discs, then add a small drop of liquid polystyrene cement to the place where you want the rivet. Now position the disc onto the model by picking it up using the point of a sharp knife. When the rivets have dried, smooth them off by gently sanding.

THE COMPLETED MODEL

Rules and datasheet for the Battlewagon with blitzkanon are given in the new Warhammer 40,000 vehicle rules. Painting guidelines can be found in 'Eavy Metal, along with hints and tips for painting your unconverted Battlewagons.

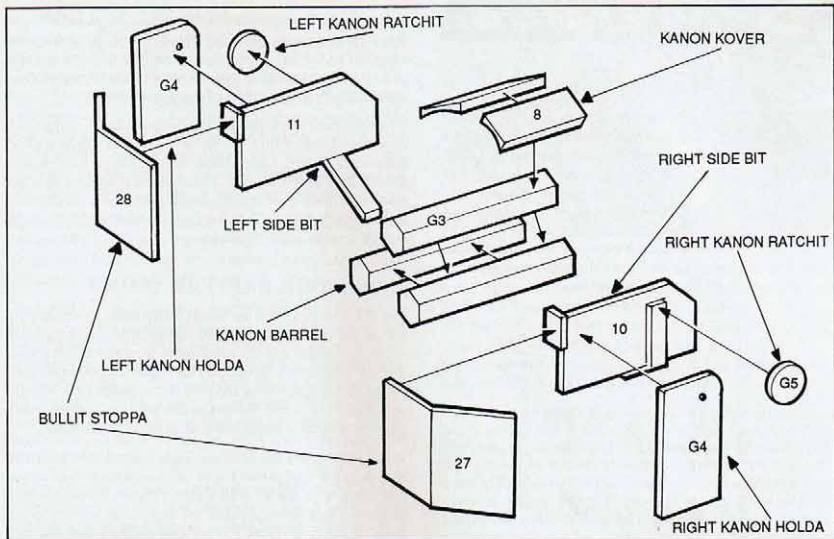

EVIL METAL

PRESENTED BY JOHN BLANCHE



Welcome to this month's 'Evay Metal. In this issue we're featuring Orks fairly heavily, with a sample Evil Sunz army, some of the most recent releases and two of the stunning newplastic Battlewagons painted by Ivan and Dale, plus Tony Cottrell's Battlewagon conversion with blitzkanon.

Along with the Orks, we also have the latest masterpieces from the Studio staff. Hope you enjoy them.

EVIL SUNZ ARMY

Waa-Wazrokk is a thousand point army ideal for a single evening's wargaming. It consists mainly of plastic Ork miniatures with a few metal specialists and vehicles. The army is lead by the Evil Sunz Warboss, Wazrokk, and his personal retinue: 5 Bosses, a Painboy, a Mekaniak, a Runtherd and a Weirdboy. All these miniatures have been painted in the bright reds that are typical of the Evil Sunz.

The quickest and easiest way to get a really bright red is to use a base coat of Blood Red and highlight with Blood Angel Orange and Sunburst Yellow. When this is dry, you can put on some deep shading, especially round the edges of the red areas, to provide definition. A thin wash of ink is the easiest way – Red is best, with just a tiny spot of Brown to deepen it.

The spectacular Boss-pole was designed and painted by Dale. He first sketched it out on paper, then drew it up neatly and painted it in. We've made it easier for you and provided a simple black and white drawing for you to photocopy – all you have to do is colour it in!

The whole of the army was painted with uniformity in mind, so that all the miniatures look like a coherent group. This is something that only requires a little thought but can make all the difference to the appearance of your army. Look at the Boyz Mobz for instance. They have all been painted with very similar warpaint and decoration on their clothing; this helps to identify them immediately.

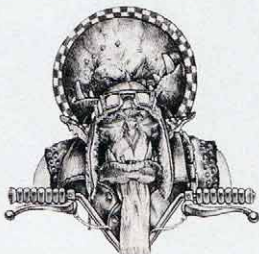

Paul Bunker

The army also includes a Mob of Bad Moon Boyz and a single Boss. These represent the Bad Moon traders that have been admitted to the Evil Sunz camp. The Boyz Mob has been painted in the extravagant colours and patterns typical of their clan: bright yellow with black flames is a favourite.

When painting black flames, always paint and highlight the background colour first; in this case, we used a base coat of Spearstaff Brown, highlighted with Sunburst Yellow and Skull White. A thin wash of Yellow Ink was applied over the areas when they were dry, brightening the whole area up and removing any chalky effect that may have resulted from using too much white in the highlights.

ORK BATTLEWAGONS

The Ork Battlewagon is the latest Citadel multi-part plastic kit and, in our opinion, the best yet. Assembly is simplicity itself – just follow the step-by-step instructions and construction diagram that come with the kit. Polystyrene cement is the best sort of glue to use, ideally the kind that comes in a pot with its own application brush. Be careful that you don't use too much glue when sticking pieces together as this can melt detail.

The Battlewagons that Ivan and Dale painted were both test models of the final plastic kit, so there are a number of pieces that come with the kit which aren't shown on our painted versions. The amount of detail and accessories you get on the sprue is amazing. There's every type of Orky tool that you could wish to adorn your Battlewagon with: spanners, hammers, bone saws, oil cans, drills – every time you look something new appears.

The best way to paint large vehicles is to leave the crew out and paint them separately. Dale undercoated his Goff Battlewagon with black spray instead of the normal white. He then drybrushed on the highlights with a large brush, adding Skull White to Chaos Black as the highlights got lighter. Any decoration that he wanted was added last; the black and white checks were painted on with a fine brush.

One of the most attractive features of Ivan's Battlewagon is the bunting running around the top of the mast. This is supported by two plastic Elf spears glued to the front of the bodywork. The hands were carefully removed from the spears with a sharp modelling knife.

The individual pieces of bunting are just small squares of paper with a glyph drawn on each. Ivan drew them all out together on a sheet of paper, painted them in and then cut them out and attached them to the twisted wire support. We've provided copies of Ivan and Dale's banners for you to photocopy and colour in.

Also featured in this month's 'Evay Metal is a Battlewagon conversion by Tony Cottrell, painted by Ivan. The rusty metal effect on the wheels was achieved by a fairly slow but very effective technique. Ivan painted on a base coat of Chainmail which he left to dry. He then drybrushed this with Bestial Brown and gave it a wash of Brown and Orange Inks. When this was dry, he drybrushed it up again with Chainmail and Mithril Silver. A final wash of Brown and Orange Inks finished the effect off.

The yellow areas were given a base coat of Spearstaff Brown and highlighted up with Sunburst Yellow and Skull White. When this was thoroughly dry, Ivan painted on flames with Chaos Black.

NEW RELEASES

The two pages of Studio staff work shows some of the latest Ork and Eldar miniatures as well some new fantasy releases. Also shown is the winner of the 1990 Golden Demon Slayer Sword, Dave Soper's amazing Nurgle Predator. Dave started working on this piece last October and only just finished it in time – that gives you some idea of how much work he's put into it! We'll be doing a special feature on Dave's work in this year's Fantasy Miniatures book, along with all the best of the 1990 Golden Demon entries, so watch out for it.

The Sea Elf repeating crossbow and the Gretchin crew were designed by the newest member of the Citadel Miniatures design team, Colin Dixon, who is currently working on some stunning fantasy Dwarfs.

The squad of Fire Dragon Aspect Warriors was painted by Tim. Each of the miniatures has been painted identically but two of them are from the latest release, in an aggressive fighting pose. He painted the Eldar Guardian from the Biel-Tan Craftworld in startling, bright colours. He used a base coat of Ultramarine, highlighted with Enchanted Blue and Electric Blue. He gave the helmet a base coat of Sunburst Yellow, highlighted with Skull White; the stripes were then painted on with Chaos Black.

Two of Frances Ellyard's Terminators armed with Nemesis force weapons are also featured on this page. They've been painted to fit in with the rest of her Terminator force in a distinctive green and white colouring. Frances used a base coat of Goblin Green, highlighted with Bilious Green and shaded with a mixture of Goblin Green and Moody Blue.

MARAUDER MINIATURES

This month's Marauder pages feature some of their very latest releases. The Wyvern was painted by Dale. He used a base coat of Goblin Green, highlighted with Bilious Green and Bronzed Flesh. A shading wash of Green Ink helped to pick out the definition.

Tim painted the Chimera. He tried to get a different effect on each of the three heads; the naturalistic finish on these is contrasted sharply by the bright red on the wings. He gave the lion's head a base coat of Orc Brown, which was then given a



Paul Campbell

wash of Brown and Yellow Ink and highlighted with Spearstaff Brown and Skull White. He painted the boar's head and the rest of the body with a mix of Bestial Brown and Chaos Black which he highlighted with Bestial Brown. The eagle's head is Orc Brown, highlighted with Skull White and then carefully flecked with Swamp Brown.

The skin on the Black Orcs was painted with deep rather than dark tones in mind. A base coat of Woodland Green and Chaos Black was highlighted with Woodland Green and then Goblin Green.

NURGLE WAR ALTAR

The diorama on the back cover features Ivan's Nurgle War Altar accompanied by an Honour Guard of Nurgle Chaos Champions – a spectacular sight, I'm sure you'll agree. The War Altar itself took Ivan over five months to complete, working in the evenings and over weekends. The basic frame was constructed out of thick wire and was built up with carbody filler before the final detail was added in modelling putty. We've shown the War Altar before in issue 125 and you'll find more details on its construction in that month's 'Eavy Metal' – it's such a superb model that we couldn't resist including it again in this diorama setting.

Apologies to Adrian Wink and Steve Wingate for a mix up on last month's Golden Demon Winners page. The Nurgling standard bearer was in fact by Steve and not Adrian; sorry about that.

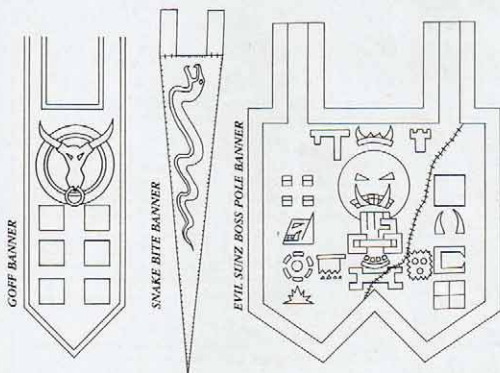

Mike
Murray



Mike



Ivan



Dale



Tim

MARAUDER™ MINIATURES



**MB08
ORC WAR
WYVERN
£6.99**

When ordering this miniature, please specify whether you would like the Shaman or the Champion.



SHAMAN



CHAMPION



**MM44/2
CHIMERA
£3.50**

When ordering this miniature, please specify one of head A or B, one of head C or D and one of the four tails.

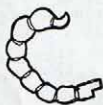

SCORPION TAIL A



LIZARD TAIL B

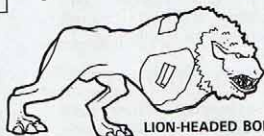

LION-HEADED BODY



EAGLE HEAD D



LION TAIL C



TENTACLE TAIL D



GIANT RAT
HEAD A



BOAR HEAD B



RAM HEAD C

HOW TO ORDER MARAUDER MINIATURES

PICK YOUR BLISTERS: Write to us telling us exactly what you wish to order. Each blister has its own individual number in the box with its photo so remember to quote this with your order.

PICK YOUR MODELS: In many cases, there are several different models in a blister, or several variations of the same model possible. You can pick specific models or choose the selection of parts when you order - just add the relevant letter or letters for the models or parts to the blister code when you write to us.

When you are ordering individual models and parts of models, make it really clear exactly what you're after - write your order clearly in capital letters so there can be no mistake.

METHODS OF PAYMENT: You can order by credit card (Access or Visa), international money order or by a cheque drawn on a British bank. For foreign orders, please send all payment in pounds sterling and made payable to Marauder Miniatures Limited. The minimum order is £10 and please include 40% for postage and packaging. We will send your order by the fastest route that the postage paid allows.

Please do not send currency as payment for your order. U.K. customers please do not send cash for your order.

TELEPHONE ORDERS: You may telephone an order using access or visa on 0602 474875 between 9.00am and 5.00pm on weekdays only. Please have the cardholder present to give authorization to the transaction.

If you have any problems please contact us on the above number.

POSTAGE AND PACKAGING: The minimum order is for £5 with a standard charge of £1 for postage and packaging. Orders in the U.K. over £20 do not have a postage and packaging charge. Please allow 28 days for delivery but normally you should receive your order within 10 days.

POST YOUR ORDERS TO: Marauder Miniatures, 3 Derby Terrace, Derby Road, Nottingham, NG7 1ND.



© Derby Terrace,
Derby Road,
Nottingham,
NG7 1NL
Tel: (0602) 474875

MM27 GIANT BLACK ORCS



**MM27
GIANT
BLACK
ORCS**
£2.99
FOR 2

MM73/5 DARK ELF ASSASSINS



**MM73/5
DARK
ELF
ASSASSINS**
£2.99
FOR 5
60p
FOR 1

MB08 ORC WAR WYVERN

This miniature is supplied with a choice of riders. Please specify if you would like the Champion or the Shaman.



**MB08
ORC
WAR
WYVERN**
£6.99

MM44/2 CHIMERA

This miniature is supplied with a choice of heads and tails, see facing page for details.



**MM44/2
CHIMERA**
£3.50



MARAUDER MINIATURES ARE SUPPLIED UNPAINTED

Copyright © 1990 Marauder Miniatures Ltd. All rights reserved.

OFFICIAL WARHAMMER MINIATURES PRODUCED UNDER LICENCE FROM GAMES WORKSHOP LTD, NOTTINGHAM, ENGLAND.

SPACE MARINE

ORKS

HOW TO DESIGN AN ORK HORDE IN EPIC SCALE BY ANDY CHAMBERS

Orks are the most warlike and prolific race known to man. Their unique brand of Kultur is brought to the rest of galaxy on the great tidal wave of Orkiness known as the Waa-Ork. The Waa-Ork begins with the spontaneous gathering of Orks around construction sites of Gargants, the gigantic machine-idols of the Orks which epitomise the crude, powerful Orkish gods. As the construction of the Gargants nears completion the whole of Orkdom reaches a fever pitch of armament and preparation until the Gargants finally waddle forth, belching fire and smoke to signal the beginning of a new Waa-Ork.

Orks are the largest and strongest members of the Orkoid race, which also includes the smaller Gretchin and diminutive Snotlings as related sub-species. The Orks naturally form a warrior elite and use the smaller Grots 'n' Snots as servants and slaves.

The Gretchin use their sly cunning to make sure their roles are as comfortable as possible by making themselves indispensable to the Orks who tend to be lazy and forgetful when there isn't a war on. The Snotlings are tiny and of very limited intellect and so end up doing all the jobs the Orks won't do and the Gretchins wriggle out of, like collecting and tending fungus in the Ork cesspits.

The Orks themselves are warriors (**Da Boyz**) or nobles (**Nobz**) for the main part. Some, however, are born into stranger lifestyles as **Oddboyz**. Oddboyz are Orks who for one reason or another pursue a role within Ork society which isn't purely involved in fighting (though they do come to battles, of course) – that's why they're Oddboyz.

The most commonly known Oddboyz are **Mekaniaks**, also known as **Mekboyz** or **Meks**. Meks are the Ork engineers who build and maintain the bewildering array of vehicles, weapons, spacecraft and machinery used by Orks. Mekboyz are great innovators and inventors but seldom plan their creations before they begin; rather they take an idea from something they've seen or heard about and construct it, kustomisin' it in typically Orky fashion with additional bolts and spiky bits as they go along.

Meks have an instinctive talent with machines and their unlikely creations often work surprisingly well, though it must be said there are often some spectacular accidents and malfunctions. Mekboyz have a particular affinity for force fields and matter transmission devices – they particularly enjoy the crackling power and deep thrum of power fields, tractor beams and similar devices. In this area they have produced machines whose effects defy explanation even by the Adeptus Mechanicus, giving rise to the theory that the Orkoid race is the degenerate survivor of a much older, more advanced civilisation and that the Meks are simply recreating half-forgotten achievements of this lost race.

Other types of Oddboy include **Painboyz** and **Weirdboyz**. **Painboyz** specialize in patching up wounded Orks and fitting bionik bits built with the aid of Meks. **Painboyz** also co-operate with Meks to create Ork Dread-noughts and Cyboars (Cyborg Boars ridden into battle). **Weirdboyz** are rare psychic Orks who act as channels for the psychic power generated by Orks in battle.

Another common type of Ork often seen in battle are **Madboyz**. **Madboyz** are deranged Orks who suffer a wide range of manias – not that this makes them any less useful on the battlefield as they have a habit of doing just the right thing at the right time (and occasionally the wrong thing at altogether the wrong time). Nonetheless, the **Madboyz'** fearlessness and manic strength make them a great asset.

Orks don't have a strict military organization; they fight and raid in relatively small groups known as **warbands**. Warbands are composed of a number of **mobz**, each usually containing 10-40 Ork warriors on foot or a lesser number of Orks in vehicles. Each warband is led by a **Warboss** who keeps the mobz together through a mixture of strength and Orky cunning – Warbosses are not trained to lead, they are simply Orks who have demonstrated that they have the right amount of Orkiness to impress their troops.

Any large group of Orks is known as a **tribe**. A tribe may be nomadic or settled on a single world or continent. Some tribes are small empires in their own right – others are migrating groups of pirates and raiders aboard space hulks.

Most Orks have itchy feet and are often inclined to move from place to place, especially during the Waa-Ork. When Orks go to war or join a Waa-Ork, the biggest Boss in the tribe just tells the other Warbosses to bring along Da Boyz and they get on with the important considerations, like killing things, without worrying about how long for or where.

The biggest Ork boss in a tribe is known as the **Warlord** and the warbands he brings together are collectively known as an **Ork horde**. The Warlord rules the tribe

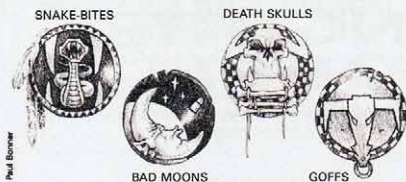

during quiet periods, dispensing the rather rough and ready Ork version of justice and collecting tribute from subjugated worlds. During wars, the Warlord is leader for the whole Ork horde and makes all the big decisions like where to attack and how to do it.

In the time of the Waa-Ork, the Warlord takes to the field in his own Boss Gargant at the head of the Gargant mob. A particularly wealthy or powerful Warlord may convince another Warlord to join the tribe and bring his own Gargants to join the mob to form a Gargant Bigmob.

The Warlord is always open to a ritual challenge from any Ork in the tribe to a pit-fight for supremacy – this means that there is seldom any serious dissension in the tribe as the Warlord has proved his right to rule by demonstrating his Orkish qualities of strength and fighting prowess.

Unlike more conventional armies, an Ork horde has no pyramid type organization to it. The Warlord just gets his Warbosses together, tells them what to do, and then leaves them to get on with it. This means the horde doesn't hold any equipment at higher command levels to be distributed to mobs as needed and doesn't move troops, weapons or equipment around between warbands; Warbosses don't believe in sharing.

Throughout Orkdom there are numerous clans. Each clan has a particular approach to Orkiness all of its own. Members of different clans mix freely within tribes, though some clans get along better than others, most tribes have at least some members from every clan. The Warlord tends to favour Warbosses from his own clan and in turn they favour their own clan members within the warband.

Each clan has its own traditions and ideas of how to fight. This is reflected by the way the Warbosses gather particular things in their own warband. The Evil Sunz clan, for example, are obsessed with speed, so an Evil Sunz Warboss will have as many vehicles in his warband as he can lay his hands on. There are six major clans in Orkdom and innumerable splinter clans. The six principle clans are described below.

Goffs

The Goffs have a strong military aristocracy of Nobz in the clan and by far the most warlike attitude of all the clans in this warlike race. Goffs favour black and see any other colour as weedy. Their warriors are hardened veterans who believe that any fighting should be done at close quarters, preferably close enough to settle it with a good hefty belt! Goff warbands always have plenty of Boyz and Nobz in them, and the Goffs also have the largest numbers of Stormboyz (Ultra-militaristic Orks who go to the unOrky lengths of drilling and wearing uniforms).

Bad Moons

The Bad Moons are noted for their wealth and flamboyance, favouring yellow and black as their clan colours. Because they are so wealthy, the Bad Moons can afford to equip themselves well and have a lot of Nobz and well-armed Boyz in their warbands.

Death Skulls

The Death Skulls are renowned as thieves and looters, a reputation which attracts many mischievous Gretchin. Blue is considered a sacred colour by the Death Skull clan and they often use blue warpaint on their faces and posteriors to attract the Orkish gods and bring them luck.

Evil Sunz

Evil Sunz Orks are obsessed with the cult of speed and have a lot of vehicles. Orks maintain that *red wunz go fasta*, so the Evil Sunz ritually paint their vehicles red and wear as much red as they can lay their hands on. The Evil Sunz have a good aptitude for mechanics and technology and consequently have lots of Mekboyz.

Snake-Bites

The Snake-Bites are the wildest Ork clan. They believe strongly in traditional Orkish values and are proud of their ancient roots. Snake-Bites still maintain large stables of Boars and Cyboars to ride into battle, and Snake-Bite warbands often contain a lot of Wildboyz (young Orks who are being introduced to Ork Kultur) and Madboyz.

Blood-Axes

The Blood-Axes were a very powerful clan who got ideas above their station before getting overthrown by the other clans in a vicious interclan war known as Da Big Party. Now the Blood-Axes are notorious trouble makers and are suspected of dealing with Humans in exchange for wealth. Other Orks point to the Blood-Axes' predilection for combat fatigues and camouflage patterns as proof of Human influence. This means no other clans will fight under a Blood-Axe Warlord, generally regarding them as *stinkin' 'oomie-lovin' gitz*.



DESIGNING THE ORK HORDE

As mentioned above, each Ork horde consists of a number of warbands. You design each warband by attaching **mob counters** to a **warband template**, both provided with these rules. Later on you'll find a sample horde – you may find it helpful to look at this now and refer to it as you read through what follows.

ORGANIZATION TEMPLATES

An organization template is a representation of the forces available in part of an Ork horde. Each space on the template represents a single mob, which can be Boyz, Buggies or whatever – it all depends on the Warboss in control and what you want to go in his warband. The Ork army list tells you exactly what mobs you can place in what warbands. For now you just need to remember that each space can take one mob counter. There are two types of template: the **warband template** and the **Gargant mob template**. Each Ork horde has ten warbands and at least one Gargant mob.

The warband template has a box to contain a counter representing the Warboss and four extra boxes to contain the mob counters. The warband can have more boxes if you want but all of them must be filled when you design the warband. The Gargant mob template has a box for the Warlord's Boss Gargant and five other mob boxes. You do not have to use all the boxes on the Gargant mob template

but if you want to add more boxes you must have one less warband for each extra Gargant.

MOB COUNTERS

Later in this article, you'll find a page of counters. Photocopy these and stick them onto a sheet of stiff card before cutting them out. You'll probably need to photocopy several sheets of counters to have enough to fill out the whole horde.

Each mob counter represents troops or vehicles which are present in a warband. Mob counters are different to the detachment counters used in the Imperial Guard and Marine army lists because they don't represent independent detachments. Instead, they show what's in each warband. In a battle, the warband acts as a single detachment for all intents and purposes with all the mobs in it following the same orders (for more details see the Special Rules section later).

The mob counters have an illustration of the mob type they represent as a guide to enable you to quickly pick out the right counters when you're designing your horde. At the bottom of the counter is the battle rating for the mob. Note that this is the BR for the whole mob, not its individual elements. The army list tells you exactly how many infantry stands or vehicles are in each mob.



Gul Boyz (Grubnaz' Death Boyz) or **Burzuruk'** Bad Boyz are examples of typical names. You can either think up a name for your Warboss or generate one from the tables in Waaargh the Orks.

Number of Mekaniaks: write in here the number of Mekaniaks in the warband – see the Special Rules section for details.

Warboss Box: fix a clan glyph counter here to show what clan the Warboss is from.

Mob Boxes: you can place one mob counter in each box. You may increase the number of mob boxes if you wish by drawing more boxes below the template or sticking several templates together but remember when you fill out the template every box must be used.

Warboss Retinue: the Warboss can be represented either by a Warboss stand or an extra vehicle of a type present in one of the warband's mobs. Write here how the Warboss is to be represented on tabletop.

Warband Battle Rating: add up the total battle ratings of all the mobs you've chosen to be in the warband and write it in here.

Back Plate: draw the warband's back plate symbol in the circular space. This is usually a variant on the clan glyph of the Warboss. The back plate symbol is also used on vehicles and banners to mark them as belonging to the warband – keep yours reasonably simple so that you can paint it on your models.

Warband's Name: the warband's name is usually derived from the name of the Warboss with the addition of a few choice words saying how powerful and dangerous the warband is – Grubnaz' Warboss's Name.



Tribal Name: write the tribal name in here. Tribes are often named after their Warlord with additional honorifics; a good example is Waa-Grashkul Okai (We are Grashkul's Killers)

Warlord's Name: you can make up your Warlord's name or generate it using the tables in the back of Waaargh the Orks.

Warlord's Boss Gargant: place a Gargant counter for the Warlord's Gargant here (it must be the most expensive Gargant in the mob) and name it. Gargant names are fairly long and as destructive as possible: Stompsmasher, Deithlumpa and Bigripper are excellently Orky Gargant names.

Total Horde Battle Rating: write in the battle rating of the entire horde here, including the rating of the Gargant mob.

Gargant Boxes: you can place one Gargant counter in each of the five Gargant boxes on the template. You don't have to fill all the Gargant boxes on the template if you don't want to. You can increase the number of Gargant boxes on the template if you want – each extra Gargant box decreases the number of warbands you may have in the horde by one.

Tribal Symbol: place the tribal symbol of the horde in the empty square. This is usually a variant on the Warlord's clan symbol, plus some Ork runes or glyphs declaring the Warlord's victories.

Gargant Mob Battle Rating: total up the value of the whole Gargant mob and write it in here.

FILLING THE ORGANIZATION TEMPLATES

There are certain restrictions on what you can place in each warband dictated by what clan the Warboss belongs to. Since the Warlord decides who's going to be his Warbosses, the first thing you have to do is decide which clan the Warlord is from so you can find out what Warbosses he has.

Once you've decided which clan the Warlord comes from, look down the left-hand column on the table below until you find it. By moving across the table you can see what dice you must roll to find out the numbers of Warbosses he can have from each other clan. As you'll see from the table, a Warlord can always have as many Warbosses from his own clan as he likes.

WARLORD'S CLAN	NUMBER OF WARBOSSSES					
	Goffs	Bad Moons	Death Skulls	Evil Sunz	Snake-Bites	Blood-Axes
Goffs	*	1D6-2	1D3	1D3	1D3	1D3
Bad Moons	1D3	*	1D3-1	1D6-2	1D3	1D3
Death Skulls	1D3	1D6-2	*	1D3-1	1D3	1D3-1
Evil Sunz	1D3	1D6-2	1D3-1	*	1D3-1	1D3-1
Snake-Bites	1D3-1	1D3	1D3	1D3-1	*	1D3-1
Blood-Axes	0	0	0	0	0	*

* The Warlord may have as many Warbosses from this clan as he wishes.

As you can see, some clans get along better than others and consequently draw more Warbosses from the ones they get along with best. The finely-balanced inter-relationships of the Ork clans are rather complex and best not examined here. However, Orks are a practical race if nothing else and when it comes to the end of the day, if the Warlord doesn't like the Warbosses he's got then he changes them! Hence the Warlord doesn't have to use all the Warbosses from other clans if he doesn't want to, replacing them instead with more Warbosses from his own clan. There are ten warbands in a horde and each one must be commanded by a Warboss.

Once you've sorted out your Warbosses, you can start filling in the warband templates. Generally it's best to take each one in turn and complete the whole warband before beginning the next one. You may find it useful to fill in a few standard warbands for the different clans and then work on variants of those rather than trying to design each warband completely from scratch. If you want the horde to represent a tribe which isn't fighting during a Waa-Ork, the Warlord will command a warband at least twice the size of any other in the horde instead of a Gargant mob.

USING THE ARMY LIST

Before starting to design the horde, photocopy enough templates and counter sheets to design plenty of warbands and Gargant mobs. You'll find it easier to handle the counters and templates if you glue them to thin card before you cut them out. Place an appropriate clan counter in the space provided on the warband templates and the Gargant mob template.

When you're ready, look at the army list to find what you can place in each warband. The army list is divided into a box for each type of mob. Each box starts by telling you the general type of the mob and the minimum and maximum numbers of mobs of that type which can be chosen for a warband according to what clan the Warboss is from (don't worry – it's not as tricky as it sounds). For



convenience, there's a reference sheet at the start of the lists which tabulates each clan's minimums and maximums for all the different troop types.

Also in the box are copies of some of the mob counters on the sheet; these are to show you what specific mob types are available. The bottom of the box tells you how many vehicles or infantry stands each counter represents.

The Warlord's Gargant mob is simply filled in by picking out the correct counters for the Gargants you want in the mob. When you've filled in the Gargant mob template and the 10 warband templates to your satisfaction, note the total battle rating of each warband and the Gargant mob. Then name the horde and record its total battle rating, glue down the templates onto a single large piece of paper, and photocopy it to get a permanent record.

USING THE HORDE

When you play a game using Orks, take along a predesigned horde to use as your force. If you intend to play a large game, you can use more than one horde with your opponent's consent. Generally you should use one Ork horde for each regiment or war host in an opponent's battleforce. When you know how many points you're using, select exactly what forces you're going to field from the horde, subject to the following restrictions;

- 1 Warbands must be used in full and may not be split up.
- 2 If you use Gargants, the Warlord and his Boss Gargant must be used. If you use more than 6 Gargants you may split them up into two mobs with 6 in one and the rest in the other.
- 3 You may spend up to 25% of your points on barrage support counters but not support missiles (see Space Marine rulebook).

ALLIES

Ork warbands may be used as allied formations by any Traitor or Chaos force. When acting as allies, warbands must be used in full and cannot be split up. An Ork horde can only have allied non-Ork formations attached if they are drawn from Chaos: the Waa-Ork is an elemental force of Orkines and allegiances with non-Ork races do not matter one jot to the Orks once they've begun the Waa – it's Orks against the galaxy and the galaxy better look out!

SPECIAL RULES

WARBANDS AND WARBOSSSES

On the battlefield, a Warboss controls his warband through a combination of flag-waving Gretchin and shouting very loudly (Orks do have communicators but tend to forget about them in the excitement of battle). If the mobs in a warband get too far away from the Warboss they may get confused as to what he wants them to do and try to guess (usually wrongly). To reflect this, a warband operates like a single very large detachment with the following formation restrictions.

- 1 A mob must keep all its stands or vehicles within 30cm of the Warboss at all times. If any of the mob's stands is beyond command range in the orders phase of a turn, the whole mob counts as **out of command** for that turn (see below).
- 2 A warband is given one order counter in the orders phase of the turn. All mobs within command range of the Warboss are on those orders for the turn.
- 3 The Warboss may give a different order counter to one mob in the warband on turns when the Ork player is first player.
- 4 Stormboyz Korps have their own Kommander and so are independent of the warband and may always be given different orders. Madboyz use the random orders system in Codex Titanicus, so they always act independently. In small games, you might like to try using the full Madboyz rules in

WD126 with suitable adaptations but stick with the Codex rules for larger battles.

- 5 All infantry stands or vehicles in each mob must stay within 6cm of at least one other vehicle or stand from the same mob, forming an unbroken chain through the whole mob. If this is not the case, in the orders phase of the turn that mob must be given advance orders and must reform so that every unit is within 6cm of one other.
- 6 If a mob from another warband approaches within 6cm of a mob, both mobs become so distracted jeering, showing off and throwing bits of offal at each other that they suffer an additional -1 modifier for firing for that turn. You'll find it useful to paint warbands in different clan colour schemes and with different banners and markings to help identify them while you're playing.

BEING OUT OF COMMAND

Stormboyz and Madboyz mobs suffer no detrimental effects from being out of command. All other mobs which are out of command in the orders phase must roll a D6 to determine their orders for the turn.

D6 Roll	Orders
1-2	Charge
3-4	First Fire
5-6	Player's Choice

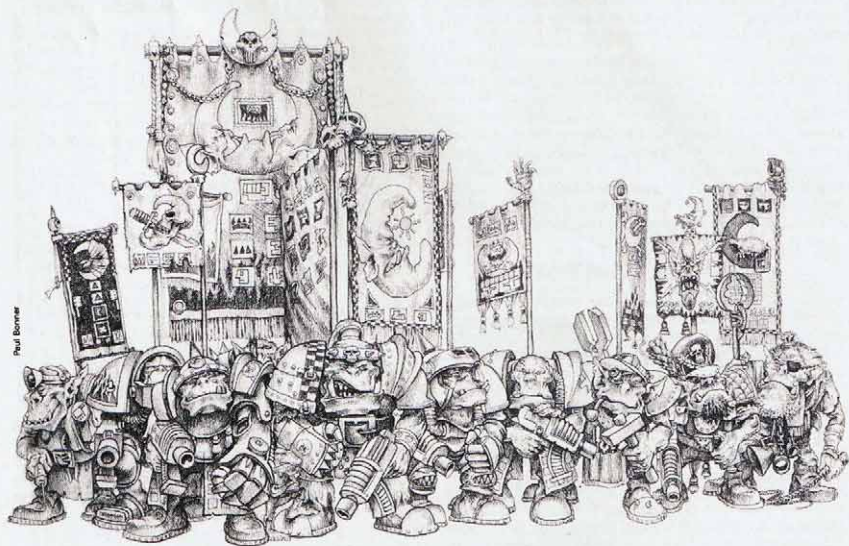

THE WARBOSS

The Warboss is the leader of the warband, usually selected on the basis of how good a mate to the Warlord he is or how loud he can shout. The Warboss is normally represented by an infantry stand, usually having the stats given in Codex Titanicus, though he can be represented by any other type of infantry stand present in his warband – a Warboss who had Boarboyz in his warband could be represented by an extra Boarboyz stand, for example. If the warband contains any vehicles, the Warboss can be represented by an extra vehicle of the same type as any present in the warband (note that in this case, the Warboss must stay on board his vehicle and may not disembark). Either of these ways, the Warboss costs no points to field. Alternatively, the Warboss may be mounted in his own Stomper (see New Infantry and Vehicles) at a cost of 100 points.

Regardless of how the Warboss is represented, he may only be fired at if he is the closest available infantry or vehicle target (as appropriate) to the enemy – the smoke and confusion of battle make it virtually impossible to single the Warboss out from amongst his fellows. If the Warboss is killed, all infantry mobs in his warband must take a morale test in each orders phase to determine their orders for the turn; vehicle mobs count as being out of command for the rest of the battle. Note that Stormboyz Korps are unaffected by the loss of the Warboss as long as they still have their own Kommander.

THE WARLORD

The Warlord is the top Ork in the horde and he commands the meanest, shootiest and just plain biggest thing he can find – the Boss Gargant. Because the Warlord has instructed his Warbosses in Da Plan before the battle begins, he can concentrate on commanding the Gargant mob without having to worry about Da Boyz. Da Boyz, on the other hand, draw great confidence from having something as shooty as the Boss Gargant around. The following special rules apply to the Warlord.

- 1 The Warlord in a Waa-Ork is always the Boss Gargant Kaptin (see Codex Titanicus). Otherwise he can be represented by an infantry stand or vehicle just like a Warboss if the horde doesn't have a Gargant mob
- 2 The Boss Gargant is always the most expensive Gargant in the mob – the Warlord isn't going to have anyone upstaging him on the battlefield.
- 3 The Boss Gargant can be singled out as a target by the enemy: the banners, trophy poles and graffiti that cover the Boss Gargant make it hard to miss!
- 4 Though the Warlord cannot take command of warbands, any morale checks made by the Orks gain a +2 modifier when the Boss Gargant is within 48cm as long as it's still firing ('cos if it's still shootin', s'alright, innit).

MEKANIAKS

The Mekboyz are what keeps an Ork horde on the move. Without them to maintain their vehicles, the Boyz quickly find themselves walking everywhere. This is partly why Meks are the most commonly-seen Oddboyz on the battlefield. As well as having to fix Wartraks and

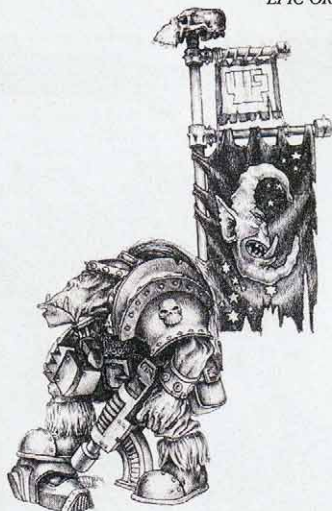

Battlewagons all the way to the battlefield, Meks are fascinated by the power and energy of a battle and spend many happy hours scavenging around wreckage for things to put in their bitz-box and use on future projects.

Mekaniaks often take along their new inventions and buggies to test out in the field. Though they tend to get distracted from fixing things while they attend to their latest creations, Warbosses still encourage Meks to bring along these frighteningly-powerful devices, one of which, the Traktor Beam, is detailed later in these rules. We'll be giving you more information on Mekianik weapons and vehicles soon.

The number of Mekaniaks a warband contains is important in two respects. First, certain special mobs, known collectively as **Oddbitz**, can only be used if there are enough Meks to look after them and either run them directly or maintain them. Second, the number of Meks in a warband will influence how prone the warband's vehicles are to breaking down.

Each warband receives 1D3 Meks modified by the clan the Warboss belongs to, as follows:

Clan	Modifier
Bad Moons	+2
Evil Sunz	+1
Blood-Axes	+1
All others	+0

Write down the number of Meks in a warband in the space provided on the template.

Gargants receive much loving care and attention from their Boss-Meks but are still prone to suffering malfunctions at awkward times. You should roll for each Gargant in the Gargant mob separately using the Malfunctions system to represent the Gargant's state of repair and note down the result on the Gargant's roster sheet. The Warlord's Boss Gargant always receives the maximum possible attention so treat his state of repair as being the best possible.

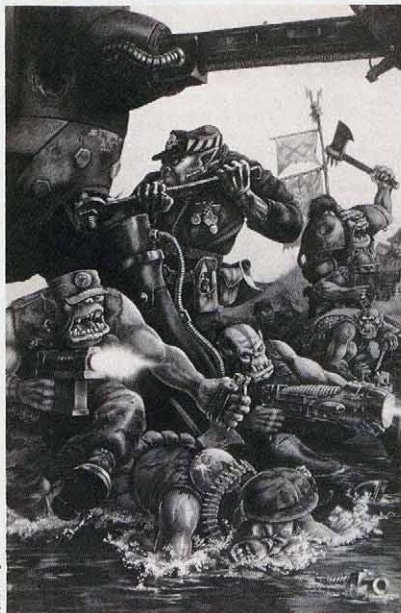

David Gallagher

MALFUNCTIONS

Vehicles break down and weapons jam in all armies, not just in Ork hordes. However, the Mekaniaks' total and gleeful disregard for reliability and safety as important design features of their vehicles means that when the inevitable happens and something Orky goes wrong, it really goes wrong!

To represent the chances of things going seriously wrong at a bad time, the Orks' opponent is given a number of **malfunction counters** at the start of the game. The opposing player may randomly draw one malfunction counter for every 1000 points the Ork player is using in a battle.

There are two types of malfunction counter: **movement malfunctions** and **fire malfunctions**. A movement malfunction may be played in the orders phase of the turn on any Ork vehicle or Gargant. A fire malfunction counter may be played on any Ork vehicle or Gargant in the combat phase after the Ork player has announced his targets but before he rolls to hit.

A maximum of one malfunction counter (whether it's a movement or fire malfunction counter) may be played against a particular Gargant or vehicle in a game.

Vehicles receive a saving throw against the malfunction on a D6, succeeding if they roll equal to or less than the number of Meks in their warband at the start of the game – the Meks obviously saw this one coming and fixed it before the battle.

Gargants receive a saving throw against malfunctions on a D6, succeeding if they roll equal to or less than their state

of repair number. Gargant saving rolls are modified by +1 for each unit of Riggers lost and by +2 if the Boss-Mek has been killed.

Failure to save means the Gargant or vehicle has to make a roll on the appropriate malfunction table immediately. Gargants are more sturdily built than most Ork vehicles so they get a -1 modifier when rolling on the malfunction tables. Wartraks and Warbikes suffer a +1 modifier when rolling for malfunctions.

A fire malfunction will affect only one randomly-determined weapon location on a Gargant. Gargants may repair movement malfunctions.

Leave the malfunction counter next to the unit affected by it and make a note of the malfunction afflicting it. Each malfunction counter may only be played once, after which it is discarded.

If a vehicle mob is split up by one of its number suffering from a movement malfunction, the remainder of the mob can treat the missing vehicle as destroyed and avoid the need to reform.

FIRE MALFUNCTION TABLE

- 1 **No Effect.**
- 2 **Misfire:** all firing and damage rolls suffer an additional -1 modifier this turn.
- 3 **Wildfire:** all firing by the affected vehicle suffers a -1 to hit modifier this turn but receives a +1 damage modifier. After firing, make a second fire malfunction roll with a +1 modifier – treat Wildfire and Misfire results as a jam instead.
- 4 **Jam:** the affected vehicle may not fire in this turn or the following turn.
- 5 **Wildfire:** as above but the second malfunction roll receives a +2.
- 6 **Kaboom!** the vehicle is destroyed in a cataclysmic explosion as its ammo explodes. If the vehicle was armed with any weapons with a burst (B), place the template over the vehicle and roll to hit any targets touched by the template as from a normal hit by the weapon. Gargants check for a flashback to the magazine as usual.

MOVEMENT MALFUNCTION TABLE

- 1 **No Effect.**
- 2 **Bitz Drop Off:** the vehicle is immobilized for the remainder of the battle.
- 3 **Steering Damaged:** the vehicle may not turn for the remainder of the battle.
- 4 **Throttle Stuck:** the vehicle must be given charge orders each turn from now on. It must move at its full charge rate every turn for the remainder of the battle.
- 5 **Out of Control:** the vehicle careers off at its advance rate in a direction randomly determined by using the burst template. Resolve any rams and overruns the vehicle makes as usual. If the vehicle enters impassable terrain, it is destroyed. Gargants are treated as out of command until repaired – determine what turns are made where randomly.
- 6 **Smash:** the vehicle crashes and is destroyed.

THE KULT OF SPEED

Orks like going fast – rapid, bumpy movement directly stimulates part of the pleasure centre in their brains. Some Orks actually get addicted to going fast and find it very hard to stop. This predilection for screaming around the place on bikes, buggies and wagons has actually built up into a kult in some Ork tribes, though certain clans seem more taken with the idea than others. In battles, speed kultists often get so carried away hurtling towards the enemy that they keep on going, over and through their opponents before disappearing off towards the horizon.

Every vehicle mob with charge orders must roll a D6 in the end phase to determine if they can bring themselves to slow down on the following turn. Add +1 to the dice roll if the mob are from an Evil Sunz warband. On a modified result of 6 or more that mob must be given charge orders in the following turn regardless of what orders the rest of the warband has.

For a mob that has been overcome by the need for speed, check again in the following end phases, but this time use the additional modifier of -1 per vehicle lost from the mob. A modified score of 3 or more indicates the mob stays on charge orders; any other result means the mob has come to its senses and may now be ordered normally (though they may well be out of command by now).

MERCENARIES

Most Ork Warbosses happily employ Ogryn mercenaries when they can find them. Orks and Ogryns generally get along well and have a similar outlook on life. Ogryn mobs

act as part of the warband just like any other mob. Blood-Axe Warbosses will actually stoop low enough to use Human mercenaries and advisors, much to the disgust of other Orks.

In the army list, you'll find that Blood-Axe Warbosses can use Imperial Guard tactical and support detachments if they wish – these aren't actually Guard troops, rather they represent outlaws, pirates and mercenaries who are despicable enough to fight for the Orks (sometimes disguised Imperial Guard do fight alongside the Orks, but only when it's in the Imperium's best interests to have them do so). Mercenary Human detachments have their own command stands so they may act independently of the warband they're attached to, just like Stormboyz.

CAPTURED EQUIPMENT

Orks also use Imperial equipment which has either been salvaged by Mekks or built as tribute by subjugated worlds. Though the rules and statistics for equipment of this type are the same as for their Human equivalents don't be fooled into thinking that the equipment itself is identical: after a few weeks in Orkish hands, most things get customised with the addition of banners, trophies and spiky bits. After a few more weeks, they become impossible to recognise as ever having been anything other than Ork-built.

So don't try to con your opponent that those Codex grey Rapiers really belong to the Orks – if you're going to use captured equipment, add some pennants, build on some spikes, paint them in clan colours (and rust) – in short, make them Orky.



NEW INFANTRY AND VEHICLES

Note that you don't have to be using the Ork army list to gain access to these new types of infantry, vehicles and Gargants not covered in Codex Titanicus.

WILDBOYZ

Wildboyz are immature feral Orks, new to the marvels of Ork Kultur. Though they haven't really got the hang of using bolters and stikkbomz, they're willing to have a go at the enemy with swords, axes and anything else to hand. A Warboss often brings some of his Wildboyz along to a battle so they can have some fun and get a bit of experience at the same time. A Nob is always put in charge of each group of five Wildboyz to make sure they don't do anything too impetuous.

BOARBOYZ

Boarboyz, unsurprisingly enough, are Boyz riding Boars - not just any old bad-tempered, vicious and thick-skinned Boars but specially-adapted and cybernetically-altered bad-tempered, vicious and thick-skinned **Cyboars**. Cyboars have their particularly Orkish qualities augmented through the joint efforts of Painboyz and Mekaniaks with additions like razor-sharp steel tusks, carapace armour and chemical booster implants. Because of these chemical boosters, a Boarboyz stand which charges has its CAF increased to +4 for that turn.



GRETCHIN

Ork warbands always have large numbers of non-combatant Gretchin and Snottlings with them who carry messages to the mobs, cheer the Boyz on in battle or help out the Mekks and other Oddboyz. But all Gretchin dream of being great warriors like their larger cousins, the Orks. To this end, some scrimp and save enough to afford to buy a few weapons so they can fight in battles too! Generally, the best they can afford are rickety old blunderbusses - these aren't the most sophisticated weapons, but they're big and noisy and therefore hold a lot of appeal for small and weedy Gretchin. Most Warbosses let their Gretchin fight if they want to, though some tend to use them for the most dangerous jobs like mine-clearing or skirmishing (i.e. putting them at the front so they get shot at first).

Gretchin Blunderbuss

The **Gretchin blunderbuss** is a primitive muzzle-loading weapon which, though short-ranged and relatively low-powered, is nonetheless potent because of the wide spread of shot it delivers.

INFANTRY TARGETS WEAPONS TABLE

	Range		To Hit	Roll	Save
	Short	Long			
Blunderbuss	special	-	6+	-	0

When a stand of Gretchin fire their blunderbusses, you should take the Gargant grapeshot template and place it so that its narrow end is touching the Gretchin stand with the cone centered on the closest enemy stand. Roll to hit any targets touched by the template.

BOYZ

Finally, a word regarding Boyz to dispel any confusion about them. In the army list section you'll find there are two types of Boyz mobs you can use. The counter illustrations show an Ork with a heavy weapon on one and an Ork with a bolter on the other. When Da Boyz come along to a battle, each household has to send at least five Boyz and a heavy weapon; these are the Boyz shown on the first counter and each stand in the mob has a heavy weapon (use the stats for Boyz with a heavy plasma gun for these stands). If a household wants to send more Boyz (either because the looting is going to be good or because the Warlord sez so), they don't bring any more heavy weapons because the Nobz have snaffled them all. The extra Boyz get put into separate mobs - these are the mobs shown by the second kind of counter. When you come to select mobs for your warbands, you can only take one mob of Boyz without heavy weapons for every mob of Boyz with heavy weapons.

STATS FOR NEW INFANTRY STANDS

Type	Speed	Save	CAF	Weapons		BR
				Basic	Support	
Wildboyz	8/16	5+	+2	None	Melta-Gun	15
Boarboyz	20/30	4+	+3	Bolters	None	60
Gretchin	8/16	6+	0	Blunderbuss	None	15
Boyz	8/16	5+	+1	Bolters	Heavy Plasma Gun	50
Boyz	8/16	5+	+1	Bolters	None	20

TRAKTOR BEAM

The **traktor beam**, mounted on a **Traktor Buggy**, is a battlefield version of a weapon commonly used by Ork spaceships. It operates by latching a force field onto the target and then contracting the field to rip chunks off, causing much destruction to those nearby from flying debris (and much hilarity amongst the crew).

The traktor beam is particularly devastating against infantry as it sweeps men off their feet and scatters them across the battlefield like windblown leaves, much to the amusement of the traktor beam crews. The traktor beam can also be used on a wide setting to pin an enemy vehicle or infantry squad in place beneath the force field, a useful if somewhat less popular option.

VEHICLE AND TITAN TARGETS

	Range		To Hit Roll		Critical Roll
	Short	Long	Short	Long	
Traktor Beam					
narrow beam	30cm	60cm	3+	5+	5+
wide beam	60cm	-	3+	-	NA

INFANTRY TARGETS

	Range		To Hit Roll		Save Mod
	Short	Long	Short	Long	
Traktor Beam					
narrow beam	-	60cm	-	5+	-2
wide beam	-	60cm	-	4+	NA

The traktor beam needs to be firmly braced before use and so may only be used on first fire orders. It receives no +1 bonus for having first fire orders and may not snap fire. Follow the to hit and damage procedure as usual, but the traktor beam cannot damage void shields or power fields.

Traktor beams fire on two settings: **narrow beam** and **wide beam**. You must specify before you fire which setting the traktor beam is on for that turn.

Narrow Beam

If a vehicle target is destroyed by a traktor beam on a narrow setting, multiply the number rolled for the critical hit roll (including AR modifiers) by 2 and move the model that distance in centimetres directly towards the source of the traktor beam. Any infantry or vehicles caught in the path of the flying debris count as being overrun or rammed by the destroyed vehicle as appropriate (note that it is possible that the wreckage will smash into the Traktor Buggy). Once all the attacks have been resolved, remove the destroyed model as normal.

Wide Beam

Targets hit by a traktor beam on a wide setting may not fire for the remainder of the turn and are immobilized until the combat phase of the next turn unless the traktor beam is subsequently destroyed or does not have first fire orders that turn. Traktor beams on a wide setting cannot affect Titans or Gargants.

Traktor Buggy

The traktor beam is carried into battle mounted on a **Traktor Buggy**. The Traktor Buggy is a converted War Buggy with additional armour and a traktor beam mounted as main armament.

Name	Speed	Save	CAF	AR	Weapons	BR
Traktor Buggy	12/18	5+	0/3	+1	Traktor Beam	65

Remarks: the Traktor Buggy is a light vehicle.



David Gallagher

STOMPERS

Stompers are smaller versions of Great Gargants. They are built by apprentice Mekboyz as their first big project or by aging Meks who no longer have the influence or the energy to build a full-size Gargant. Often a Warboss will scrape together enough teef to get a Stomper built for him to use as a personal mount or even to create his own Stomper mob! Warbosses are very keen on Stompers, not only because ownership of a mob of Stompers puts them a cut above the other Warbosses, but also because it allows them to possess their very own idol of the Ork wargods.

Stompers carry a crew of 6-10 Orks and mount various weapon combinations plus a number of power fields. Regardless of the actual weapons on a Stomper model, the following stats apply equally to all variants.

Name	Speed	Save	CAF	AR	Weapons	BR
Stompers	8/16	2+	+6/+3	0	see below	200

Weapons: battlencannon (2), autocannon (1x/2), bolters (1x/4).

Remarks: a Stomper has two power fields.



Wayne England



	Belly Mount	Arms		Power Fields	AR	BR
		Left	Right			
Slasher	Gut Buster	2/0/B	2/0/B	6	0	600

Note: The arm mounts may be fitted with twin battlecannon.

Special Rules

Slasher type Gargants follow all the standard rules for Great Gargants given in Codex Titanicus, with the following amendments.

- 1 Slasher Gargants roll a D6 to find out how many power fields they have operating at the start of a battle. Slasher Boss Gargants always have all six power fields operating without having to roll – the Warlord makes sure his fields get fixed first!
- 2 Because of the cramped conditions on board, Slasher Gargants can only carry a limited amount of ammunition for the belly gun. Before starting play you should write on the Gargant's roster sheet how many rounds of what types it is carrying, up to a maximum of ten in total.
- 3 If the Slasher runs out of ammo during a battle, it can still suffer a flashback to the magazine – there is still plenty of ammunition for other weapons lying around in the magazine to cause explosions. Taking on more ammo for the belly gun is a long, laborious process which cannot be carried out during a battle.
- 4 Though Slasher Gargants move using the same rules as Great Gargants, their slightly lower center of gravity and more efficient engines mean they can get up a greater lick of speed and turn slightly tighter than their larger brethren.

SLASHER GARGANTS

Though not as large as the Crusher and Smasher Gargants, collectively known as the **Great Gargants**, Slasher Gargants are every bit as fearsome. Just like Great Gargants, a Slasher Gargant has a crew of Orks and Gretchin which keeps it running – stoking the boiler, aiming the guns and so on. The crew's efforts are directed by the Gargant's Kaptin who has a number of officers to keep an eye on what the crew are up to.

Slasher Gargants are protected by six banks of power fields and have three weapon mounts: left and right arm plus a belly mount. So far, only variants with a Gut Buster mega-cannon in the belly position have been sighted, but logic dictates that versions mounting Snappers and head turrets must exist or are forming in the minds of Meks across Orkdom. Slashers are quicker and easier to build than Great Gargants, making them a popular choice for Meks with limited facilities, like Freebooterz.

Speed	Min Move	Max Move	To Hit Modifier
Full Speed	10cm	18cm	-2
Battle Speed	1cm	12cm	-1
Stop	0cm	0cm	0
Backward	1cm	6cm	-1

Note: a Gargant may not move less than its minimum move distance.

Direction	Number Of Turns	Direction
Port	Up to 3 x 45° turns	Left only
Starboard	Up to 3 x 45° turns	Right only
Ahead	Up to 1 x 45° turn	Left or right

- 5 Slasher Gargants are not quite as thick-skinned and heavily-constructed as Great Gargants. When rolling for level of damage versus Slashers add a +1 modifier to the roll. Note that this is not an AR modifier and only applies to rolls for the level of damage.
- 6 You can create a roster sheet for Slasher Gargants by taking a standard Great Gargant roster sheet (there's one supplied in Codex Titanicus) and altering it as follows:
 - 1 Cross out the head turret and upper left and right turrets. The belly gun will be hit on 1-2, the left arm on a 3-4, the right arm on a 5-6.
 - 2 Shade in the last two numbers on the power fields track so that it shows a maximum of six power fields.
 - 3 Reduce the number of Boyz squads on board to three and reduce the number of Gunners to two.

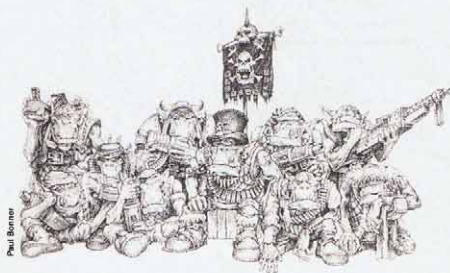

ORK ARMY LIST

Each box in the army list has three sections.

Number Available

At the top of the box it tells you the minimum and maximum numbers of mobs of that can be chosen for each warband according to what clan the Warboss is from. There's a key to the clan symbols used at the start of the list. For example, in the Bikeboyz box, under the symbol for an Evil Sunz Warboss it has 1-4 – this means that an Evil Sunz Warboss must have at least one mob of Bikeboyz in his warband and can have a maximum of four Bikeboyz mobs. These could be chosen as any combination of Warbike and Wartrak mobs – say one Wartrak mob and three Warbike mobs. The symbol for *All Others* means all clans not covered by their own symbols, including the smaller splinter clans. For example, in the Madboyz box, the Snake-Bites and Death Skulls can have up to four Madboyz mobs – everyone else gets up to one.

Counters

Below the number available is an example of the counter types that represent the mobs in this box. These counters are the same as those on the page you photocopy. They give the mob type, the battle rating for the whole mob, and have an illustration on them for easy identification. You may find it helpful to place your counters in these spaces to have them readily available as you fill out the templates.

Units In Detachment

Below the counter illustration is a list of the number and type of the vehicles or infantry stands in the mob. To continue our example, a Bikeboyz mob comprises five

vehicles of the type shown on the counter. You can't mix different types of vehicles in a mob even if they appear in the same box. So, for instance, in a Bikeboyz mob you could have five Wartraks or five Warbikes, but you couldn't have two Wartraks and three Warbikes or any other combination of different vehicles in one mob.

Warband Mobz Quick Reference Table

The Ork army list is quite large and it can be difficult to remember what compulsory mobs you have to take. To make things easier, we've condensed all the minimums and maximums for each kind of mob on to one table.

	Goffs	Bad Moons	Death Skulls	Evil Sunz	Snake-Bites	Blood-Axes
Boyz	2-9	2-6	0-6	0-4	1-4	1-5
Nobz	1-3	1-4	0-3	0-2	0-1	0-1
Madboyz	0-1	0-1	0-4	0-1	0-4	0-1
Stormboyz	0-4	0-1	0-1	0-1	0	0-1
Wildboyz	0-1	0-1	0-1	0-1	0-4	0-1
Gretchin	0-1	0-2	0-4	0-1	0-1	0-1
Boarboyz	0	0	0	0	1-4	0
Ogryns	0-1	0-2	0-1	0-1	0-1	0-1
Oomies	0	0	0	0	0	0-1
Bikeboyz	0-2	0-3	0-3	1-4	0-1	0-2
Battlebuggies	0-2	0-3	0-2	1-4	0-2	0-2
Oddbitz	0-2	0-2	0-3	0-2	0-3	0-2
Battlewagons	0-2	0-4	0-2	1-4	0-2	0-3



David Gallagher

ORK ARMY LIST



GOFFS



BAD MOONS



DEATH SKULLS



EVIL SUNZ



SNAKE-BITES



BLOOD-AXES



ALL OTHERS

DA BOYZ



2-9



2-6



0-6



0-4



1-4



1-5

BOYZ



150

8 BOYZ STANDS

BOYZ



150

4 BOYZ STANDS

One Boyz Mob without heavy weapons may be chosen for each Boyz Mob with heavy weapons

STORMBOYZ KORPS



0-4



0



0-1

STORMBOYZ



250

4 STORMBOYZ STANDS
AND 1 KOMMANDER

DA NOBZ



1-3



1-4



0-2



0-3



0-1



0-1

NOBZ



150

2 NOBZ STANDS

WILDBOYZ



0-4



0-1

WILDBOYZ



50

4 WILBOYZ STANDS

MADBOYZ



0-4



0-4



0-1

MADBOYZ



100

4 MADBOYZ STANDS

GRETCHIN MOBZ



0-2



0-4



0-1

GRETCHIN



50

4 GRETCHIN STANDS

BOARBOYZ

1-4



0

BOARBOYZ



100

2 BOARBOYZ STANDS

MERCENARY OGRYNS

0-2



0-1

OGRYN



100

2 OGRYN STANDS

MERCENARY 'OOMIES

0-1



0

TACTICAL



300

SUPPORT



300

See Imperial Guard Army List and Special Rules

BIKEBOYZ

0-2



0-3



0-3



1-4



0-1



0-2

WARTRAK



200

5 WARTRAKS

WARBIKE



250

5 WARBIKES

BATTLEBUGGIES

0-3



1-4



0-2

WAR BUGGY



150

5 WARBUGGIES

ODDBITZ

0-3



0-3



0-2

ONSLAUGHTER



250

5 ONSLAUGHTERS

KILLER



100

5 KILLERS

LAND RAIDER



400

2 LAND RAIDERS

RHINO



150

4 RHINOS

ROBOT



150

5 ROBOTS

RAPIER



250

5 RAPIERS

TARANTULA



250

5 TARANTULAS

MOLE MORTAR



250

5 MOLE MORTARS

THUDD GUN



250

5 THUDD GUNS

FIELD GUN



100

5 ORK FIELD GUNS

TRAKTOR BUGGY



300

5 TRAKTOR BUGGIES

STOMPER



200

1-6 STOMPERS

Each Oddbitz Mob needs a Mekaniak to command it. Reduce the number of Meks in the Warband by one for each Oddbitz Mob chosen. Stompers come in Mobs of one to six; the battle rating of the Mob is the amount on the counter times the number of Stompers in the Mob.

BATTLEWAGONS



0-4



1-4



0-3



0-2

BATTLEWAGON



250

BOWELBURNA



300

GOBSMASHA



250

5 BATTLEWAGONS 3 BOWELBURNAS 3 GOBSMASHAS

BRAINCRUSHA



650

GIBLETGRINDA



1000

GUTRIPPA



300

3 BRAINCRUSHAS 3 GIBLETGRINDAS 3 GUTRIPPAS

BONECRUNCHA



300

SPLEENRIPPA



300

SKULLHAMMA



750

3 BONECRUNCHAS 3 SPLEENRIPPAS 3 SKULLHAMMAS

WARBAND TEMPLATE

WARBAND



Warband Name

MOB
I

Number of
Mekanlaks

MOB
II

WARBOSS

MOB
III

Warboss
Retinue

MOB
IIII

Warband
Battle Rating

DA GARGANT MOB



1-6

SMASHER



1000

SMASHER



900

1 SMASHER WITH
HEAD TURRET

1 SMASHER WITHOUT
HEAD TURRET

CRUSHER



900

CRUSHER



800

1 CRUSHER WITH
HEAD TURRET

1 CRUSHER
WITHOUT
HEAD TURRET

SLASHER



600

1 SLASHER

GARGANT MOB TEMPLATE

GARGANT MOB

TRIBAL NAME

Warlord's
Name

**WARLORD'S
BOSS
GARGANT**

Total Horde
Battle Rating

Name

GARGANT
II

GARGANT
I

GARGANT
III

Name

Name

Name

GARGANT
IIII

TRIBAL SYMBOL

































































































GARGANT
++++

Name

TRIBAL SYMBOL

Name

GARGANT MOB BATTLE RATING

 150	 150	 150	 150	 150	 150	 150	 150
 150	 150	 150	 150	 100	 250	 250	 150
 150	 150	 150	 150	 300	 300	 150	 150
 150	 150	 150	 150	 250	 250	 150	 150
 250	 250	 250	 100	 300	 300	 1000	 1000
 100	 100	 50	 50	 650	 650	 750	 750
 300	 300	 300	 300	 300	 300	 300	 300
 300	 300	 200	 200	 300	 300	 300	 300
 250	 250	 250	 250	 50	 50	 100	 150
 100	 100	 250	 250	 100	 200	 200	 200
 100	 100	 600	 200	 250	 400		
 1000	 900	 900	 800				

BURZURUK'S BAD BOYZ

SAMPLE ORK HORDE

I'm going to go through the design of an Ork horde step by step and explain the process for choosing the horde and the decisions I make as I go along. This is only the way I would approach choosing a horde so you shouldn't assume I'm making all the right choices for the perfect Ork horde – the object of this sample horde is to demonstrate how to use the lists and supply a usable Ork horde in case you don't have the time to create your own

The first thing I have to do is think about what clan the Warlord will come from. I want to go for screaming hordes of Boyz as the mainstay of my force, though I'd like to have a fair number of bikes and vehicles as well and a lot of Mekaniaks would be nice – lots of everything in fact! The other thing I have to take into account is the way I'm going to paint them, so clan colours are important (after all, the Gargants are going to end up in clan colours).

After much agonising, I settle on Goffs for the Warlord's clan, though Bad Moons and Evil Sunz were both tempting options from the criteria of good clan colours and either having lots of Mekks or hordes of vehicles. I settled on the Goffs because they get along reasonably well with most of the other clans (Evil Sunz in particular, so I can still have lots of vehicle in some warbands) and they go in for screaming hordes of Boyz in a big way. Last and most important, their clan colours are black which may be a little drab compared to the Bad Moons or Evil Sunz but is easy to paint and can always be relied on to look good.



Paul Boomer

Once I've settled on my Warlord's clan, I move onto rolling for his Warbosses. I get D3 for Evil Sunz and Death Skulls which come up 3 and 1 respectively, which is splendid – plenty of vehicles to be had there. Blood-Axes and Snake-Bites supply D3-1 Warbosses each; I get none from the Blood-Axes (gitz!) and one from the Snake-Bites. Lastly I get D6-2 from the Bad Moons, which gives me 2 Bad Moon Warbosses.

So I end up with three Goff warbands, three Evil Sunz warbands, two Bad Moons warbands, one Death Skull warband and one Snake-Bite warband – a nice mix overall with a bit of everything (except Blood-Axes, the gitz). Now I can get on with designing the warbands individually and I'll come back to doing the Warlord's Gargant mob later.

I'll start by designing a standard Goff warband and a standard Evil Sunz warband and then do the rest of the warbands before doing the other two Goff and Evil Sunz warbands. This way, I can shape my forces so their roles in battle compliment each other rather than duplicating each other's efforts or getting in the way. Each warband has to be employed pretty much as a single unit, so it needs to be heavily slanted towards doing one job very well – like storming the enemy positions, giving support fire or sweeping round the enemy flanks.

I'll start off with the Goff warband, **Nazgrond Nashtul**. This will be a standard warband so I stick to the compulsory Boyz and Nobz – I pick one mob of Boyz with heavy weapons and one without to get the necessary numbers to make the warband suitably imposing on the table. For the final mob in the warband (I'm keeping to the basic four mobs to keep the cost of the warband down), I pick a Stormboyz Korps; Stormboyz are very useful for splitting off from the main body of the warband to do specific tasks or just to lay down covering fire while the rest of the warband keep charging.

I can only have a Warboss on foot as there are no vehicles in the warband but that's just fine – it's a pretty tough stand to stick in the centre of the warband and it's totally free! The total BR for the whole warband is 700 points which is reasonable but I'll need some cheaper warbands in the horde, something to bear in mind later.

The Evil Sunz warband, **Ashakkul Tarak**, I want to be reasonably cheap and fast so I can deploy them out on a flank to swing round the enemy and envelop one side. With the Evil Sunz at the wheel there's a chance they'll go crazy and charge off of their own accord so I may as well try to take advantage of this by not making this warband a supporting group but making them numerous enough to get away with charging off on their own.

I've got quite a few of the mobs already taken up with compulsory Bikes, Buggies and Battlewagons (I go for Bowlburna types because they're fast and have a battlecannon armament) so I take another Bike mob to pad out the warband's numbers further and leave it at that. I place the Warboss in a Bowlburna because it'd be useless having him on foot and a Warbike would be too vulnerable. The total cost of the Ashakkul Tarak comes to 900 points which is a bit steep but the warband does comprise 19 fast vehicles, so they may well come as a nasty shock to somebody.

BURZURUK'S BAD BOYZ

WARBAND

Warband Name: **NOVELBUNA** (Icon: Cow) Number of Members: **THREE**

WAR BUGGY (Icon: Buggy) 150

WARBE (Icon: Sun) 250

Warband Brawler: **NOVELBUNA** (Icon: Brawler) 200

WARTRAK (Icon: Truck) 200

Warband Battle Rating: **400**

GARGANT MOB

TRIAL NAME: **BURZURUK'S BAD BOYZ**

Warband's Name: **SMASHER** (Icon: Smasher) Total Herds Battle Rating: **4000**

Name: **SMASHER**

SMASHER (Icon: Smasher) 1000

SMASHER (Icon: Smasher) 900

CRUSHER (Icon: Crusher) 800

Name: **SMASHER**

SLASHER (Icon: Slasher) 600

SLASHER (Icon: Slasher) 600

Name: **SMASHER**

GARGANT MOB BATTLE RATING: **4400**

WARBAND

Warband Name: **BATTLEWAGON** (Icon: Wagon) Number of Members: **THREE**

WAR BUGGY (Icon: Buggy) 150

Warband Brawler: **FOOT** (Icon: Foot) 200

BATTLEWAGON (Icon: Wagon) 200

Warband Battle Rating: **700**

WARBAND

Warband Name: **BOYZ** (Icon: Boyz) Number of Members: **THREE**

BOYZ (Icon: Boyz) 150

BOYZ (Icon: Bull) 150

BOYZ (Icon: Boyz) 150

Warband Brawler: **FOOT** (Icon: Foot) 150

BOYZ (Icon: Boyz) 150

Warband Battle Rating: **1500**

STORMBOYZ (Icon: Storm) 250

NOBZ (Icon: Nobz) 150

STORMBOYZ (Icon: Storm) 250

STORMBOYZ (Icon: Storm) 250

NOBZ (Icon: Nobz) 150

NOBZ (Icon: Nobz) 150

BOYZ (Icon: Boyz) 150

BOYZ (Icon: Boyz) 150

STOMPBOYZ (Icon: Stomp) 300

STOMPBOYZ (Icon: Stomp) 200

WARBAND

Warband Name: **KILLER** (Icon: Killer) Number of Members: **ONE**

BOYZ (Icon: Boyz) 150

Warband Brawler: **STOMPER** (Icon: Stomper) 150

KILLER (Icon: Killer) 100

BOYZ (Icon: Boyz) 150

Warband Battle Rating: **1500**

WARBAND

Warband Name: **NOBZ** (Icon: Nobz) Number of Members: **FOUR**

BOYZ (Icon: Boyz) 150

BOYZ (Icon: Bull) 150

BOYZ (Icon: Boyz) 150

Warband Brawler: **SMASHBOYZ** (Icon: Smash) 250

NOBZ (Icon: Nobz) 150

Warband Battle Rating: **1500**

SMASHBOYZ (Icon: Smash) 250

BOYZ (Icon: Boyz) 150

WILDBOYZ (Icon: Wild) 50

WARBAND

Warband Name: **GRETCHINS** (Icon: Gretchins) Number of Members: **THREE**

GRETCHINS (Icon: Gretchins) 50

GRETCHINS (Icon: Gretchins) 50

GRETCHINS (Icon: Gretchins) 50

Warband Brawler: **FOOT** (Icon: Foot) 50

GRETCHINS (Icon: Gretchins) 50

Warband Battle Rating: **400**

WARBAND

Warband Name: **BOYZ** (Icon: Boyz) Number of Members: **THREE**

BOYZ (Icon: Boyz) 150

BOYZ (Icon: Bull) 150

STORMBOYZ (Icon: Storm) 250

Warband Brawler: **FOOT** (Icon: Foot) 150

NOBZ (Icon: Nobz) 150

Warband Battle Rating: **700**

WARBAND

Warband Name: **WARBEKE** (Icon: Warbeke) Number of Members: **THREE**

WAR BUGGY (Icon: Buggy) 150

WARBEKE (Icon: Warbeke) 250

Warband Brawler: **SKILLMAMA** (Icon: Skill) 250

WARBEKE (Icon: Warbeke) 250

WARBEKE (Icon: Warbeke) 250

Warband Battle Rating: **2000**

WARBEKE (Icon: Warbeke) 250

SONORONKA (Icon: Sonor) 300

BOARBOYZ (Icon: Boar) 100

WARBAND

Warband Name: **BOARBOYZ** (Icon: Boar) Number of Members: **THREE**

WARBUG (Icon: Warbug) 150

BOARBOYZ (Icon: Boar) 150

BOARBOYZ (Icon: Boar) 150

Warband Brawler: **BOAK BOYZ** (Icon: Boak) 150

BOYZ (Icon: Boyz) 150

Warband Battle Rating: **500**

WARBAND

Warband Name: **BOYZ** (Icon: Boyz) Number of Members: **THREE**

BOYZ (Icon: Boyz) 150

BOYZ (Icon: Bull) 150

BOYZ (Icon: Boyz) 150

Warband Brawler: **FOOT** (Icon: Foot) 150

NOBZ (Icon: Nobz) 150

Warband Battle Rating: **600**



Next I do the two Bad Moons warbands, Fatlob Kushuk and Gok Lard, one of which I want to act as a fire support group and the other as a heavy assault group. **Fatlob Kushuk** is going to be the support warband, so I pick both compulsory Boyz mobs as ones with heavy weapons. The Nobz are compulsory but they've got missile launchers so are quite welcome as well.

To give the warband the mobility it needs to get into a good firing position, I take a Battlewagon mob – I'll have to be careful about not getting caught with the Boyz on board the wagons when the shooting starts. To give them some real shooty value at long range, I also take a mob of Braincrushas and put the Warboss in a Braincrusha as well. Total cost for the Fatlob Kushuk is 1350 points – when I use these I'll have to make sure the enemy is kept nice and busy while they move into position or it could cost me dearly, but their firepower will be essential for pinning down the enemy.

Gok Lard is a heavy assault group intend to go and mix it up front where the action is. After placing my compulsorys (again I go for one mob of Boyz without heavy weapons to get the numbers in the warband up nice and cheaply), I take two extra Nobz mobs, another Boyz mob with heavy weapons, a Traktor Buggy mob and a Killer Dreadnought mob. I've gone for a lot of Nobz because their saving throw is better than normal and their CAF is good enough to take on most opponents. After some deliberation, I also put in a mob of three Stompers and put the Warboss in a fourth Stomper.

This warband is intended for going over the top and storming enemy positions – they have enough heavy weapons to lay down some withering fire before they attack and the traktor beams will come in very handy for harassing the opposing units. Hopefully the Stompers can provide some lasting covering fire with the protection of their power fields to keep them in action. Gok Lard is 1900 points but should be well worth it in any reasonably big battle.

Finally, before moving back to do the rest of the Goff and Evil Sunz warbands, I'll do the Snake-Bite and Death Skulls warbands, Gurukz Snortaz and Burzwomba Snaga. I want both of these warbands to be cheap enough to fill the gaps when I pick a force for battle.

As their name suggests, **Gurukz Snortaz** have got a lot of Boarboyz, including their Warboss and just one Boyz mob. Boarboyz are good and hard and have the speed to charge someone's flank or to get into close combat pretty quick. It doesn't matter if the Boyz get left behind – they'll either

charge or first fire which is just fine. The Snortaz come to just 550 points and will be great fun to use, so I'm quite pleased with them.

Burzwomba Snaga are going to be a cheap skirmish screen to soak up fire and distract the enemy from my real intentions and that means just one thing – Gretchin! I take the maximum number of Gretchin I can have, plus some Wildboyz to add a real threat against anyone who fancies trying to get into close combat. I also take a Boyz mob with heavy weapons so the warband has some long range bite. Obviously I take the Warboss on foot. Burzwomba Snaga is wonderfully cheap, only 400 points, so it'll be ideal for blundering around in front of the enemy and getting killed until they get to a decent vantage point to get on first fire orders.

The next to tackle are the two remaining Goff warbands, Kargak Ratglob and Wargnash Maguk. **Kargak Ratglob** is a rich Warboss – he's got lots of Boyz with heavy weapons. This warband is another group for moving into range and blasting the opposition for a while before sticking the boot in. I keep the warband down to minimum size and plump for three Boyz mobs with heavy weapons plus the Nobz. Again the Warboss is on foot and again the warband comes out nice and cheap at 600 points.

Wargnash Maguk is going to be a really big one, so I take four Boyz mobs, two with heavy weapons and two without. Next I place in the compulsory Nobz mob and take three Stormboyz Korps so the warband has some independent firepower groups attached to it. The Warboss is on foot and the total for the warband comes to 1500 points for 39 infantry stands making the Maguk a good intimidating warband which is actually quite flexible because of all the Stormboyz in it.

Now I come to the two Evil Sunz warbands, the first of which, **Mushuk Kezek**, I want to make a cheaper flanking group. I keep to minimum warband size and take Battlewagons so I can carry a Boyz mob and the Warboss, whom I opt to keep on foot this time. The idea of this warband is that they sweep round the flank and drop off the Warboss and the Boyz who provide covering fire while the vehicles speed off to the enemy's rear. I expect this warband to suffer heavy casualties but for 750 points they're worth it for the distraction value.

Skebek Luzurk is going to be a really big warband with lots of vehicles so they can run straight over part of the enemy line. I take an extra mob of Warbikes to add to the compulsory Bikeboyz mob (which are also Warbikes) and I take Spleenrippa Battlewagons and an extra mob of

Bonecrunchas for their good overrun factor. Finally I take a mob of Skullhammas and put the Warboss in one as well so I have something really hard in the warband to give it a bit more weight. Skebek Luzruk is the most expensive warband so far at 2000 points so it can only really be of any use in a large battle – but the possibility of cramming them in on a smaller game might be fun.

Last of all I do the Gargant mob. I'm going to stick with having six Gargants because I don't want to lose any warbands and six should be plenty anyway. The main function my Gargants will serve is long-range support and neutralizing enemy Titans so I want at least some of them to be dead shooty. With this in mind, I put the Warlord (Burzuruk himself) and one of his henchmen in Smasher Great Gargants with head turrets and I take another Smasher type without a head turret for something slightly cheaper. I take one Crusher Great Gargant without a head turret for getting in close and squashing things. Finally, I take two Slasher Gargants for cheaper options to use in battles where I want Great Gargants but can't afford the points or I want several Gargants to use at once.

The total for Burzuruk's Bad Boyz is 15,500 points so I doubt I'll be using the whole horde in a hurry! There are some things I haven't even touched on in this horde, like captured Imperial stuff, various Oddbizz and mercenaries which would all be good fun to use. I'll probably include some extra things like that once I've played with this horde for a while and got a feel for it.

TACTICS

Orks are harder to use in battle than you'd think. Just steaming towards the enemy doesn't generally work – unless you've got totally overwhelming numbers like three to one or better, things tend to get wiped out faster than they can move up as they close within range of the enemy.

The answer is to make sure you soften the enemy up before hand with off-table barrages and direct fire, then charge in to mop up the survivors before they get away or reorganise. You have to be careful not to get bogged down in a firefight with enemy forces who are better armed than you; if you do, manoeuvre into a position where your opponent has to destroy your cheap skirmishing type units before he can attack the good stuff.

Don't forget that when firing at infantry you have to target the closest enemy stands first. Use this to your advantage by deploying cheaper troops at the front of the warband and placing the better stuff progressively further back.

Think about how you actually place infantry stands – you can avoid getting too badly chewed up by burst weapons by maintaining decent spacing. Similarly, place cheap warbands directly in front of the enemy, preferably in cover so they'll last longer, and let them get shot at – this will force the enemy to stay in position to keep firing at you effectively or force him to move and hopefully create a gap you can exploit.

Vehicles in an Ork horde are rather unreliable but are generally pretty fast with reasonably good armament. Exploit this by flinging them out wide of the frontline and probing at the enemy's flanks and try to find a weak point to break through. At worst, you'll pin the enemy down and possibly force him to pull stuff out of the line to bolster up his flanks. At best, you'll manage to break through and cause him no end of trouble rampaging around his rear. Stompers are worth a mention in their own right because

they're ideal for supporting infantry warbands – they've got a good armament and good survivability and if they're moving as part of a warband that's on foot their slow movement rate is no problem.

Gargants are big chunks of firepower and good value for points – they can generally absorb lots of damage before going up and they carry more guns than their Imperial or Eldar equivalents. Smasher Gargants generally do well to stop moving as soon as they get within range of the enemy and pound them to bits before moving closer. The same holds true for Slasher type Gargants as well. In general, Crusher Gargants should only be used when enemy Titans are expected and you need to close the distance and engage the Titans in close combat or bring the Snapper's multi-melta into range as quickly as possible.

Another point to remember is that, whatever happens, you'll generally outnumber your opponent in terms of how much stuff you've got on the table – press your advantage home once you've softened him up and keep him on the run.

The most important decision you'll have to make in a battle is when to close in – too early and you'll just get blown to pieces, too late and you'll have lost too much of your force to make it. Don't be overly worried about mobs getting outside the command range of the Warboss – they won't generally do anything too disastrous, particularly if they're infantry. In fact it can often be a good idea to let some mobs split off and do their own thing.

Most important of all is to remember that you're Orks and Orks never taste defeat – they just get beaten off and come back later when nobody's looking!



WHITE DWARF

SUBSCRIPTIONS SPECIAL OFFER

The next 12 issues for only £15! Plus six back issues FREE!

For a limited period only, we are offering six free back issues to every subscriber of White Dwarf. Not only that, but we are also reducing the United Kingdoms subscription price from £18 to £15. To take advantage of this amazing deal, simply complete the form below. Don't forget to tell us which issue to start your subscription with and how long you wish to subscribe for.



UK: SPECIAL PRICE £15.00

Please include cheque or postal order for £15.00 made payable to GAMES WORKSHOP, and send to:

WHITE DWARF MAGAZINE SUBSCRIPTIONS, Games Workshop, Chewton Street, Hilltop, Eastwood, Notts, NG16 3HY.

For BARCLAYCARD/VISA and ACCESS subscriptions telephone (0773) 713213 or (0773) 760462.



USA \$35.00 CANADA \$45.00

Please include cheque or postal order for \$35.00 or \$45.00 (Maryland residents please add 5% sales tax) made payable to GAMES WORKSHOP, and send to:

WHITE DWARF MAGAZINE SUBSCRIPTIONS, Games Workshop Inc., 3431 Benson Ave, Baltimore, Maryland 21227.

For VISA and MASTERCARD subscriptions telephone (301) 644 5699.

EUROPE £36.00

REST OF THE WORLD £54.00

Please include cheque or postal order for £36.00 or £54.00 made payable to GAMES WORKSHOP, and send to:

WHITE DWARF MAGAZINE SUBSCRIPTIONS, Games Workshop, Chewton Street, Hilltop, Eastwood, Notts, NG16 3HY.

For BARCLAYCARD/VISA and ACCESS subscriptions telephone (0773) 713213 or (0773) 760462.

Plus six free back issues of your choice. Please select twelve issues in order of preference. For example: if issue 55 is your first choice enter a '1' in the box to the right of 55. We will endeavour to send you your first choice of six.

From the following issues.

50	<input type="checkbox"/>	51	<input type="checkbox"/>	54	<input type="checkbox"/>	55	<input type="checkbox"/>	65	<input type="checkbox"/>	66	<input type="checkbox"/>
67	<input type="checkbox"/>	68	<input type="checkbox"/>	69	<input type="checkbox"/>	75	<input type="checkbox"/>	78	<input type="checkbox"/>	81	<input type="checkbox"/>
84	<input type="checkbox"/>	87	<input type="checkbox"/>	88	<input type="checkbox"/>	89	<input type="checkbox"/>	99	<input type="checkbox"/>	109	<input type="checkbox"/>
111	<input type="checkbox"/>	112	<input type="checkbox"/>	119	<input type="checkbox"/>	125	<input type="checkbox"/>	126	<input type="checkbox"/>	127	<input type="checkbox"/>

Best of White Dwarf Scenarios III

Best of White Dwarf Articles III

Please start my White Dwarf subscription with issue no: for years.

NAME

ADDRESS

POSTCODE/ZIP

PLEASE DEBIT MY ACCESS/MASTERCARD/VISA NO.

NAME AND ADDRESS OF CARDHOLDER (if different from above)

EXPIRY DATE

NAME

ADDRESS

POSTCODE/ZIP

* The special price of £15 for a year's subscription applies until further notice. Back issues are subject to availability and only while stocks last.



Issue 50 75p



Issue 51 75p



Issue 54 85p



Issue 55 85p



Issue 65 95p



Issue 66 95p



Issue 67 95p



Issue 68 95p



Issue 69 95p



Issue 75 95p



Issue 78 95p



Issue 81 95p



Issue 84 95p



Issue 87 95p



Issue 88 95p



Issue 89 95p



Issue 99 £1.25



Issue 109 £1.50



Issue 111 £1.50



Issue 112 £1.50



Issue 119 £1.50



Issue 125 £1.50



Issue 126 £1.50

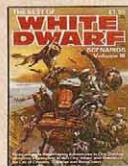

Best Of WD Scenarios III £1.95



Issue 127 £1.50



Best Of WD Articles III £2.50

You can also order separately, any of the White Dwarf's shown above

EVIL SUNZ ARMY

Here it is! Waa-Wazrokk's fast-growing warband ready to leave some treadmarks on the first unlucky enemies to get in their way. Specially painted in the glowering reds of the Evil Sunz and the blacks and yellows of their compadres from the Bad Moons these superb miniatures show Waa-Wazrokk's boyz in all their glory. In a special once-in-a-lifetime offer we give you the opportunity to purchase all the miniatures necessary to make up Waa-Wazrokk's official warband from Games Workshop Mail Order. All you have to do is assemble and paint them yourself....



BADNICK - EVIL SUN PAINBOY WITH BONE SAW AND BOLTER



UZTEEF - BAD MOON BOSS



GRIMGOB - EVIL SUNZ WEIRDBOY AND TWO MINDERS



SNOTSOG - EVIL SUNZ RUNTHERD



EVIL-SUNZ BOYZ MOB ARMED WITH BOLT PISTOLS AND HEAVY PLASMA GUN



BAD MOON BOYZ MOB ARMED WITH BOLTERS AND HEAVY PLASMA GUNS



EVIL SUNZ BIG-MOB ARMED WITH BOLTERS AND HEAVY PLASMA GUNS



WAZROKK, EVIL SUNZ WARBOSS,
LEADER OF THE ARMY.



BOSS-NOBZ MOB - THIS CONSISTS OF FIVE NOBZ FROM THE BOSS CLAN, EACH WEARS A BACKBANNER TO DENOTE HIS STATUS. ONE OF THE NOBZ CARRIES THE BOSS-POLE.



GRIMGOR WEIRDBOY
FROM THE WAR-BOSS
RETINUE



WAZGOR - MEKBOY
FROM THE WAR-BOSS
RETINUE



GUITROT - PAINBOY FROM THE
WARBOSS RETINUE



DUFFBAG - EVIL SUNZ
RUNTIERD FROM THE
WARBOSS RETINUE



TWO EVIL SUNZ MEKANIAKS CREWING THEIR
OWN PERSONAL WAR BUGGY



BOSS CLAN NOBZ MOB - THREE EVIL SUNZ BOSSES MOUNTED ON
WAR BIKES



WAA-WAZROKK

Wazrokk has big planz. He wants his Boyz to be known across the galaxy as the tuffest, 'ardest, shootiest Boyz there is. And once Waa-Wazrokk's on the move, nuffink's gonna get in its way!

Wazrokk is rapidly coming over to the idea of attacking his enemies hard and fast. Speed is the essence of warfare, or so the Meks keep telling him. So far the tribe is only partly motorized, but one day Wazrokk hopes to capture more vehicles and get the Meks to make some 'specials' – a couple of kustomised Battlewagons is just what he needs.

Some of the Nobz have already gone over to the speed cult and got themselves shiny new snazzy warbikes. Wazrokk intends to use them as the spearhead of his warband, to cut a swathe through the ranks of his enemies, which are many. A couple of Meks (also speed cultists) have got together and made an impressive warbuggy, and Wazrokk is frantically saving up teef to get one for himself.

With this end in mind, Wazrokk has let a family of Bad Moon traders into the tribal settlement, so that these wheeler-dealers will bring in some more teef, which he can then get off them by charging extortionate fares for rides on his personal fun fair. Bad Moons tend to spend teef as fast as they can grow them.

If trouble starts before Wazrokk's ambitious mechanised column takes shape, he plans to use his speed freaks on their vehicles to outflank the enemy or charge straight at them (a job which speed cultists are best for), supported by the firepower of his foot-slogging infantry Mobz.

MAIL ORDER SPECIAL OFFER

WAA-WAZROKK COMPLETE FOR £33.00

You get 41 miniatures and 4 vehicles:

1 Warboss	2 Runtherdz
8 Bosses*	2 Weirdboyz
(including 3 warbikes)	2 Minderz *
1 Bad Moon Boss	20 Boyz *
3 Mekaniaks	1 Warbuggy
2 Painboyz	

5 sprues of plastic weapons, including heavy weapons
(* plastic miniatures – others are metal)

See the Games Workshop Mail Order page for details of how to order.

WAA-WAZROKK EVIL SUNZ WARBAD

1002 POINTS

WARBOSS RETINUE – 221 POINTS

WARBOSS	power armour, boltgun, knife
5 BOSSES	flak armour, boltgun, knife
MEKANIAK	flak armour, boltgun, knife
PAINBOYZ	flak armour, boltgun, knife
RUNTHERD	flak armour, boltgun, knife
WEIRDBOY	flak armour, boltgun, knife

EVIL SUNZ NOBZ – 285 POINTS

3 BOSSES	flak armour, boltgun, knife
3 WARBIKES	

NOBZ – 21 POINTS

1 BAD MOONS BOSS	power armour, boltgun, knife
------------------	------------------------------

EVIL SUNZ ODDBOYZ – 155 POINTS

MEKANIAK	flak armour, boltgun, knife
MEKANIAK	flak armour, boltgun, knife
PAINBOYZ	flak armour, boltgun, knife
RUNTHERD	flak armour, boltgun, knife
WEIRDBOY	flak armour, boltgun, knife
2 MINDERZ	flak armour, boltgun, knife
WAR BUGGY	to mount the 2 Mekaniaks

EVIL SUNZ BIGMOB – 130 POINTS

8 BOYZ	flak armour, boltgun, knife
2 BOYZ	flak armour, boltgun, knife, heavy bolters

EVIL SUNZ MOB – 105 POINTS

4 BOYZ	flak armour, boltgun, knife
1 BOY	flak armour, boltgun, knife, missile launcher, frag missiles, melta missiles

BAD MOONS BOYZMOB – 85 POINTS

3 BOYZ	flak armour, boltgun, knife, frag stikkbombz
2 BOY	flak armour, boltgun, knife, grenade launchers, frag stikkbombz

RTB12 IMPERIAL RHINO

DESIGNED BY THE CITADEL MINIATURES DESIGN TEAM

MODEL REQUIRES ASSEMBLY



This highly detailed kit comes complete with multi-purpose body sections, optional hatches, open or closed crew compartments, separate Commander's hatches (with boltguns), engine exhausts, smoke and grenade launchers, spiked ram attachment, and external accessories such as light fittings and handrails. Each Rhino can be built in a variety of ways - reflecting the multiplicity of roles filled by this mighty machine.

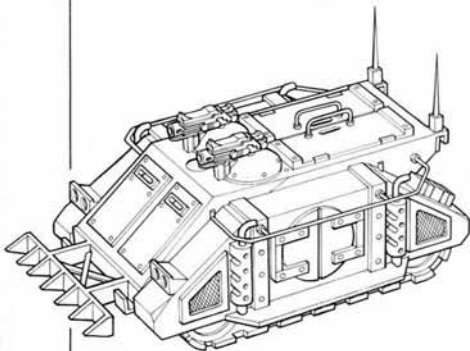

MODEL SUPPLIED UNPAINTED

Copyright © 1990 Games Workshop Ltd. All rights reserved.

WD76

Miniatures supplied unpainted. **WARNING!** This product contains lead which may be harmful if chewed or swallowed. Citadel Miniatures are not recommended for children under 14 years of age.

CITADEL
MINIATURES

RTB08

IMPERIAL PREDATOR

DESIGNED BY THE CITADEL MINIATURES DESIGN TEAM

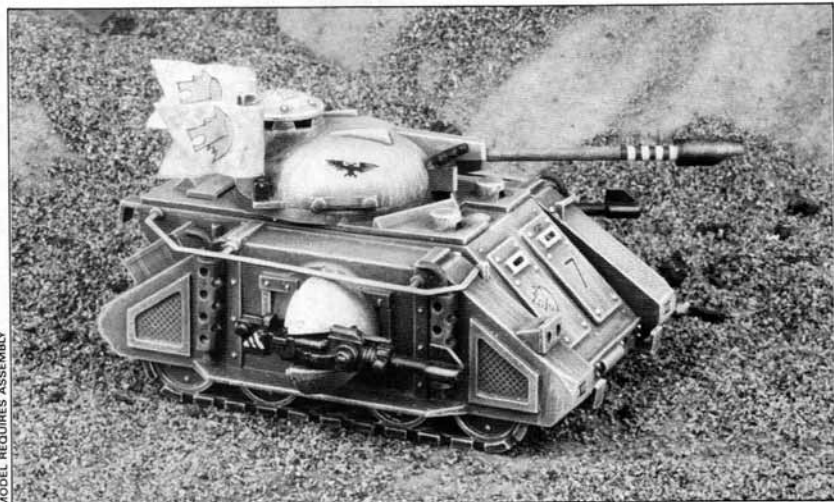

MODEL REQUIRES ASSEMBLY

The Predator is the Imperium's Assault Tank combining highly effective firepower with mobility. Designed around the standard Rhino APC chassis, the Predator is armed with a pair of las-cannon and a turret-mounted auto-cannon. It is widely used by both the Space Marines and the Imperial Guard as an assault vehicle, breaking through enemy lines at the head of advancing troops or moving rapidly across the battlefield using its heavy firepower to stop the enemy dead. The Predator is a detailed hard plastic kit.

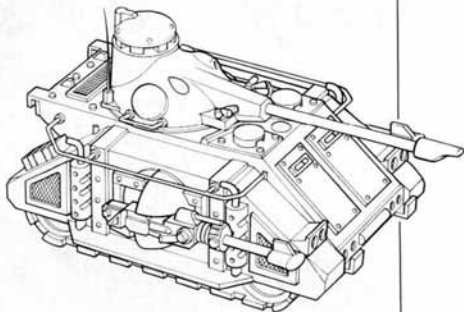

MODEL SUPPLIED UNPAINTED

Miniatures supplied unpainted. **WARNING!** This product contains lead which may be harmful if chewed or swallowed. Citadel Miniatures are not recommended for children under 14 years of age.



CITADEL
MINIATURES

Copyright © 1990 Games Workshop Ltd. All rights reserved.

WD77

072789

ORK BATTLEWAGONS

DESIGNED BY KEV ADAMS

072789/1

SKULLHAMMA BATTLEWAGON



072789/5

BRAINCRUSHA BATTLEWAGONS



072789/2

BONECRUNCHA BATTLEWAGONS



072789/6

GIBLETGRINDA BATTLEWAGON



072789/3

SPLEENRENDA BATTLEWAGONS



072789/7

GOBSMASHA BATTLEWAGONS



072789/4

GUTRIPPA BATTLEWAGONS



072789/8

BOWELBURNA BATTLEWAGONS



Figures supplied unpainted. WARNING! This product contains lead which may be harmful if chewed or swallowed. Citadel Miniatures are not recommended for children under 14 years of age.

072824 ORK GREAT GARGANT

DESIGNED BY KEV ADAMS

The Ork Great Gargant is supplied with a choice of heads. Please specify whether you would like the Gork head (supplied with head turret), the Gun head, or the Mork head. Refer to the assembly diagram below for details.



072824



MODEL REQUIRES ASSEMBLY

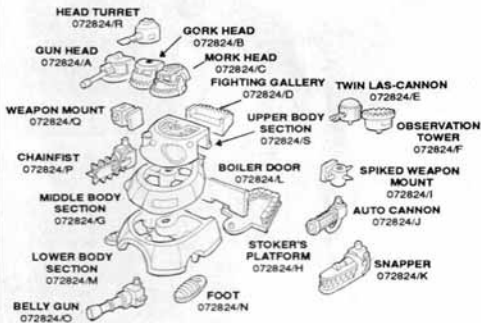

EPIC SCALE RELEASES

Epic Ork Invasion (£7.99/\$16.95) contains over 300 detailed Epic scale 6mm plastic Citadel Miniatures including Nobz, Madboyz, Heavy Weapons, War Buggies, Boarboyz and Ork Tractor Beams.



Ork Horde (£7.99/\$14.95) contains over 230 detailed Epic scale 6mm plastic Citadel Miniatures including 200 Ork Warriors and 30 Battlewagons with separate rotating turrets mounting an auto-cannon and heavy bolter.



GAMES WORKSHOP™

INDEPENDENT SPECIALIST STOCKISTS

IN THE US

ARLINGTON HTS – GAMERS PARADISE
445 EAST PALATINE RD, ARLINGTON HTS,
IL 60004, TEL: (708) 577 7586

BURBANK – THE LAST GRENADIER
335 N. SAN FERNANDO BLVD, BURBANK,
CA 91502, TEL: (818) 848 9144

CHICAGO – GAMERS PARADISE
2826 N. CLARK ST, CHICAGO, IL 60657,
TEL: (312) 549 1833

CHICAGO RIDGE – GAMERS PARADISE
CHICAGO RIDGE MALL, CHICAGO RIDGE,
IL 60415, TEL: (708) 499 9121

DEERFIELD – GAMERS PARADISE
142 S. WAUKEGAN, DEERFIELD, IL 60015,
TEL: (708) 498 0170

HAMPTON – ATOMIC COMICS EMPORIUM
59 WEST MERCURY BOULEVARD,
HAMPTON, VA 23669, CONTACT: JIM
DESTROMP, TEL: (804) 723 5003

NEW JERSEY – THE GAME ROOM
201 WOODBRIDGE CENTER,
WOODBRIDGE, NEW JERSEY, CONTACT:
MICHELLE, TEL: (201) 636 1111

**NEW YORK – JIM HANLEY'S
UNIVERSE**
35 NEW DORP LANE, STATEN ISLAND,
NEW YORK, CONTACT: RITCH,
TEL: (718) 351 6299

NORRIDGE – GAMERS PARADISE
4138A N. HARLEMAVE, NORRIDGE,
IL 60634, TEL: (708) 456 1422

ORLAND PARK – GAMERS PARADISE
1435 ORLAND PARK PL, ORLAND PARK,
IL 60462, TEL: (708) 460 8477

SCHENECTADY – ARMADILLO GAMES
2230 BROADWAY, SCHENECTADY,
NY 12306, CONTACT: KEITH HOUGHTON,
TEL: (518) 377 8134

STEVENSVILLE – THE BLADE
1731 JOHN BEERS ROAD, STEVENSVILLE,
MI 48127, TEL: (616) 428 3356

VILLA PARK – GAMERS PARADISE
NORTH PARK MALL, 270 W. NORTH
AVENUE, VILLA PARK, IL 60181,
TEL: (708) 279 1212

IN GREAT BRITAIN

BOURNEMOUTH – WONDERWORLD
803 CHRISTCHURCH ROAD, BOSCOMBE,
BOURNEMOUTH, DORSET, OWNER:
DAVE HERN, TEL: 0202 422964

CARDIFF – ENCOUNTER GAMES
7 HIGH STREET ARCADE, CARDIFF,
OWNER: ROGER HARRIS,
TEL: 0222 221159

**Saturday 11th August
TERMINATOR FORCE
PAINTING DEMO**

Mark Gibbons, Gold and Silver Winner
at the 1990 Golden Demon Awards and
artist featured in the *Drawing and
Genestealer* books, will be sharing his
tips on painting units of Terminators.

CHESTER – TOPPERS OF CHESTER
24 WATERGATE STREET, CHESTER,
CH1 2LA, OWNER: ROD LAWSON,
TEL: 0244 328802

COLCHESTER – GAMES AND PUZZLES
SIR ISAACS WALK, COLCHESTER,
ESSEX, OWNER: RON LINGUARD,
TEL: 0206 574781

CORNWALL – TRURO MICRO
UNIT 1, BRIDGE HOUSE, NEW BRIDGE
STREET, TRURO, CORNWALL,
TEL: 0872 40043

IPSWICH – WAR AND PEACE
8 UPPER ORWELL STREET, IPSWICH,
SUFFOLK, MANAGER: DAVE QUINTON,
TEL: 258356

LEICESTER – ANOTHER WORLD
22 SILVER STREET, LEICESTER,
TEL: 0533 515266

LINCOLN – ASHLEYS
9-10 MINI MARKET, LINCOLN,
TEL: 0522 520168

NORTHAMPTON – A. WATTS
80-82 ABBINGTON STREET,
NORTHAMPTON, CONTACT: TOM
HEBBLEWHITE, TEL: 0604 21809

**ORPINGTON – COMPUTER &
LEISURE CENTRE**
117 HIGH STREET, ORPINGTON, KENT,
CONTACT: JOHN LEVEL, TEL: 0689 21101

**PORTSMOUTH – SOUTHSEA
MODELS & GAMES**
69 ALBERT ROAD, SOUTHSEA,
PORTSMOUTH, OWNER: MARSHALL
MCCOMBIE, TEL: 0705 733208

STOKE-ON-TRENT – FANTASY WORLD
10 MARKET SQUARE ARCADE,
HASNLEY, STOKE-ON-TRENT,
TEL: 0782 279294

SWINDON – SPOT ON MODELS
43 HAVELOCK STREET, SWINDON,
WILTSHIRE, PROPRIETOR: CHRIS
HEXT, TEL: 0793 617302

WOLVERHAMPTON – ROLE'N'PLAY
4 BROAD STREET, WOLVERHAMPTON,
CONTACT: NEIL PAYNE, TEL: 0902 310027

IN EUROPE

MARSEILLE – DRAGON D'IVOIRE
64 RUE ST. SUFFREN, 13006,
MARSEILLE, FRANCE

PARIS – STRATEJEUX
13 RUE DE POIRIER-DE-NARCAY, 75014,
PARIS (METRO PORTE D'ORLEANS),
MGR: PIERRE MICHAUD, TEL: (1) 45 45 87

TOULOUSE – JEUX DE MONDE
PASSAGE ST. JEROME, 14 RUE MAURICE
FONVIEL, 31000, TOULOUSE, FRANCE

KOBENHAVN-K – FANTASK
STK PEDERSSTRAEDE 18, DK, 1453,
DENMARK, TEL: (DENMARK) 33 11 85 38

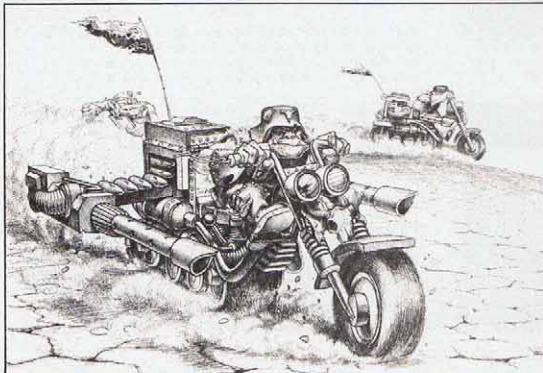

WAR OF WIZARDS

A TELEPHONE GAME OF
SPELL COMBAT
by Ian Livingstone
DIAL 0898 10 10 66



Have you the skills of sorcery, power and cunning to earn you the status of Grand Wizard? Find out as you ascend Yaztromo's tower and face his formidable school of wizards in dazzling spell combat.

Advance a level with every victory, gaining new spells as you go, until finally you face the ultimate battle with Zagor, the Legendary Warlock of Firetop Mountain. The select few who defeat Zagor and make

it to Grand Wizard, will receive a scroll, printed in gold leaf, personally signed by Ian Livingstone.

They will also have a chance to win the £100 monthly prize.

Prepare to cast your first spell and dial 0898 10 10 66 now!

HINTS ON PLAY: Your attack spells are *Acid Storm*, *Warpaint* (stronger but may backfire) and *Elements* (strongest) but will require it successfully defended. These are defended by *Shield*, *Shield* and *Screen* spells.



THIS STUNNING SCRATCH-BUILD WAS ALTOGETHER A MAGNIFICENT CENTRE PIECE FOR THIS NICKEL ARMY