

• EPIC CHAOS! • NECROMUNDA EVENTS CARDS • KISLEV ARMY LIST CONCLUDES • NEW WHQUEST CHARACTER •



THE CITADEL[®] JOURNAL[™]

ISSUE **16**

£4.00

**4 EXTRA
FULL-COLOUR
PAGES IN THIS
ISSUE!**

**GAMES
WORKSHOP[®]**



• WARHAMMER TACTICS • 40K ARID WORLDS • MORE CONVERSIONS! • WARHAMMER GOBLIN JESTERS •

BAD, BAD GIRLS...

By Matthew Houghton

Matthew competed in the recent Grand Tournament which took place at Leicester University. His excellent Escher gang took our fancy so much that we just had to show you some of the dozens of converted models that make up the biggest gang we have ever seen! Matthew beat off some pretty stiff opposition to take the coveted 'Best Painted Gang' award at the Tournament.



Tallarn Desert Raiders clash with Eldar Scouts on the sands of the Desert World, Snibston IV

Da Bunker
Boyz



PAUL SAWYER
'DA 'EAD-ITTER'

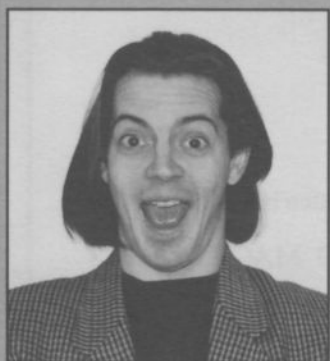

ALEX SCOTT

COPYRIGHTS AND TRADEMARKS

All subject matter in The Citadel Journal is © Copyright Games Workshop Ltd 1996.

All artwork in all Games Workshop products, and all images contained therein have been produced either in-house or as work for hire. The exclusive copyright in the artwork and the images it depicts is the property of Games Workshop Ltd. © Copyright Games Workshop Ltd 1996. All rights reserved.

Registered Trademarks belonging to Games Workshop

Armageddon, Blood Bowl, Chivalry, Citadel, the Citadel castle, Confrontation, Dark Angels, Dark Future, Deathwing, Dungeonquest, Eldar, Eldar Attack, Epic, Flame logo, GW books logo, Games Workshop, the Games Workshop logo, Genestealer, 'Eavy Metal, Marauder, Slottabase, Space Fleet, Space Marine, Talisman, Tyranid, Warhammer, White Dwarf and the White Dwarf figure.

Trademarks

The following are all trademarks of Games Workshop Ltd:

Aspect Warrior, Avatar, Blood Angels, Bloodletter, Bloodthirster, Daemnette, Dark Reaper, Exo-Armour, Exarch, Eye of Terror, Farseer, Fire Dragon, Flesh Hound, Freebooter, Gargant, Gobbo, Great Unclean One, Gretchin, Grey Knight, Hunter-Slayer, Keeper of Secrets, Khorne, Knights Panther, Leman Russ, Lichemaster, Lightning Claw, Lord of Change, Madboy, Mekboy, Mighty Empires, Nurgle, Nurgling, Ogryn, Old World, Ork, Painboy, Plaguebearer, Psyker, Ratling, Ravenwing, Skaven, Slaanesh, Slann, Snotland, Space Hulk, Space Wolves, Squat, Squig, Swooping Hawk, Striking Scorpion, Terminator, Thunder Hammer, Troll Slayer, Tyranids, Tzeentch, Ultramarines, Warmaster, Weirdboy, Knights of the White Wolf, Worldcater.

Scatter dice are UK registered design No. 2017484.

Product Code: 96016

THE CITADEL JOURNAL™ CONTENTS



Ex-Blood Bowl Player *Jason Hill* 3
You wouldn't think that a testosterone-crazed psychotic would feel at home in a dungeon would you?

Fiction *Andrew Rostron* 7
An aggressive but dour Dwarf. No stereotyping there then...



The everchanging faces of Chaos *David Cain* 9
Regular (*well, regular at the bar anyway!* - Ed) contributor, David, brings dire news of the imminent appearance of the devastating warp Palaces of Tzeentch.



Sandstorm! *J. Michael Tisdal* 13
Dunes, wadi's, oases and some other stuff that you'd find in the desert (if you wanted to...)

Waaaagh! Dakka! Dakka! *Jason Clark* 37
No self-respecting Greenskin should miss this.



The Designer's Cut *David Moretti and Co.* 18
David and a couple of other blokes you probably have'n't heard of present Necromunda Event cards.



Warhammer Armies: Kislev *Tuomas Pirinen* 19
The end is here! We're all doomed! Doomed I tell you!

Ha! There's only eight of them! *Tim Richardson* 31
Warhammer psychology - or is it...

Spell, Dispel, Spell, Dispel... *Tim Richardson* 36
It's that bloke Richardson again!

Goblin Jesters 43
If you think Jeremy Beadle gets up your nose wait until you see these little @*%\$#@*!

Thorns in the side *Aleksandr Plusowski* 47
One of our most prolific contributors gets a whole lot off his chest.

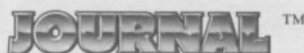

Liber Illuminatus *Martin Hanford* 24
After weeks of sending in pieces of his artwork Martin finally gets to share his work with you lot.

Dok Butcha's Konvershun Klinik 26
Da Dok, as promised last month, brings you Ewen Little's AFV conversions.

Surfer's Paradise 29
More stuff from the WWW (*no, not the American Wrestlers - Ed*)

BLAH! BLAH! BLAH! BLAH! BLAH! BLAH!

More tosh from
that fat bloke...

O kay! Okay! So we might just have made a couple of errors in last issue's Kislev army list. Even so, it surely doesn't warrant Tuomas leaving a moose head in my bed as a warning to get it right this issue...

Well you'll be glad to know that I'm not going to bang on and on for a complete page this issue (I'll save it for next issue, heh! heh!). I have gone somewhat towards appeasing our Finnish friend by giving you the following errata. Until next issue.

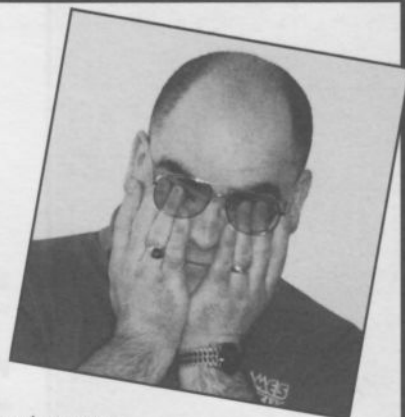

Paul

Kislevite Errata (Issue 15)

BEARS

Here are the correct profiles and rules for all the different bears that can be included in the Imperial Army of Kislev:

PROFILE	M	WS	BS	S	T	W	I	A	Ld
Bear	4	3	0	5	5	2	3	2	6
War Bear	5	4	0	5	5	2	4	2	6
Great Bear	5	5	0	6	5	3	4	3	6
Father Bear	6	6	0	6	5	3	5	4	8

BEARS

If all the Sibiryan Beast-tamers have been killed, the bears will move towards the nearest table edge and flee from the field as soon as possible.

WAR BEARS

These are the steeds of the Sons of Ursa. They do **not** cause fear. A champion may ride a War Bear at the cost of +32 points if he is leading a regiment of the Sons of Ursa. If the rider of the War Bear is killed, it continues to fight and move with the regiment as normal.

GREAT BEAR

Causes *fear*.

FATHER BEAR

Causes *fear*. May only be ridden by Boris Ursa.

REGIMENTS AND MAGIC ITEMS

Winged Lancers are equipped with a lance, shield, light armour and ride warhorses.

The Holy Axe of Miska and *the Holy Icon of Miska* are **Kislevites only** items.

Hun champions cost 42 points, are subject to *Frenzy*, and may only be included in Hun regiments.

Cossacks, including their Champions, *bate* Beastmen, Chaos Warriors and Chaos Knights and Trolls, as well as Chaos Champions and Sorcerers and all Beastman Characters including Shamans.

Tuomas

PLEASE WRITE TO US!

SUBMISSIONS

We are always looking for new articles, conversions, artwork, etc. and so we are giving you the chance to send in that exciting idea you have been meaning to start work on for ages.....

All submissions should be typed (where possible) or written in **legible** handwriting AND include all relevant rules, conversion ideas, etc. We would also like you to playtest them before you send them in as this often changes the content of an article. Submissions should be sent to the address below.

All material submitted to us for publication is only accepted on the assumption that the copyright in it is, by the very act of submission, unconditionally assigned by the author as beneficial owner and with full title guarantee to Games Workshop Limited. We also retain the right to edit and/or amend all material as we see fit. So, if you do not wish to assign copyright in this way, please do not send us your submission. We're afraid we cannot work in any other way!

CORRESPONDENCE

We love receiving your comments, ideas and articles for The Citadel Journal, Games Workshop games and any other aspects of the hobby so if you have anything you want to share with either us or the gaming fraternity at large send us a letter!

All letters except subscriptions and Mail Order should be addressed to the address below

Clearly mark your envelope with the name of the game you are writing to us about. If you want a reply you must enclose a self-addressed stamped envelope (overseas readers should include IRCs). We receive an enormous amount of mail and do read every letter, but it may take a little time for us to reply to you, so please be patient!

**THE JOURNAL BUNKER, GAMES WORKSHOP LTD,
CHEWTON STREET, EASTWOOD, NOTTS. NG16 3HY**

Warhammer Quest®

EX-BLOOD BOWL PLAYER

By Jason Hill

Who could possibly have more barely controlled aggression and be capable of wreaking havoc in a dungeon? The Ex-Blood Bowl player is well equipped for a hearty session of Hack 'n' Slash and so Jason has kindly sent us rules for adapting this psychopath for use in your games of Warhammer Quest!

STARTING AS AN EX-BLOOD BOWL PLAYER.

The profile of an Ex-Blood Bowl player is as follows:

Wounds	1D6+8	Toughness	3(4)
Move	4	Initiative	3
Weapon Skill	3	Attacks	1
Ballistic Skill	5+	Pinning Roll	4+
Strength	4(5)		

WOUNDS

The Ex-Blood Bowl player starts off with 1D6+8 Wounds. Remember that when rolling Wounds, if you roll a 1, you may re-roll the dice, but if you roll a 1 a second time, you must keep it.

EQUIPMENT

The Ex-Blood bowl player starts the game with the Gat-ork-ade Bottle Equipment card and the Spiked Shoulder Pads Equipment card.

GAT-ORK-ADE BOTTLE

The Gat-ork-ade Bottle may be used once per game to have one of the following effects:

- Restore the Ex-Blood bowl Player to full health.
- Give the Ex-Blood Bowl Player a +2 Str.ength for one entire combat.
- Double the Ex-Blood Bowl Player's move for one turn.

Blitzing through the throng of Ork warriors, the Ex-Blood Bowl player sows confusion amongst the greenskins allowing his fellow adventurers to maximise their attacks.

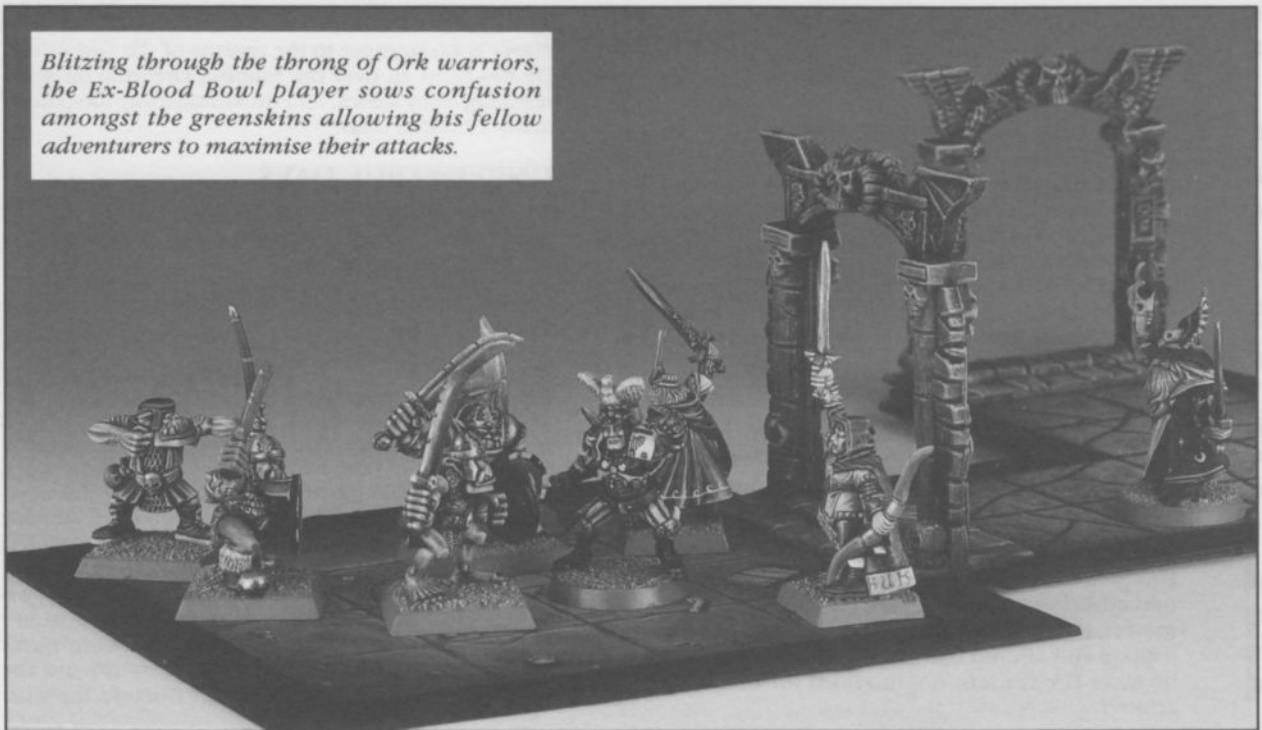

Every time the Bottle is used roll aD6. On the roll of a 2-6, no effect; on the roll of a 1 however, the bottle runs out and is useless from now on.

WEAPONS

The Ex-Blood Bowl Player starts the game with the Spiked Shoulder Pads Equipment card. This allows him to make a special *Running Blitz* attack. He may move and attack, then continue moving and attack again. He may continue to do this as long as he moves in a straight line and doesn't run out of movement points. He may use all of his natural attacks on each enemy attacked, but gets no "deathblows". While doing a *Running Blitz*, the Ex-Blood Bowl Player can not be pinned.

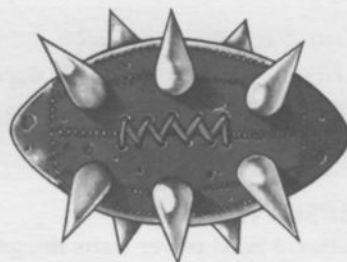

The Ex-Blood Bowl Player may not use any weapons, except his Spiked Shoulder Pads and anything he buys from the *Foot Locker*.

ARMOUR

The Ex-Blood Bowl Player wears Blood Bowl armour which gives him a +1 Toughness. He may wear no other form of armour. This armour can not be sold.

EX-BLOOD BOWL PLAYERS IN AN ADVENTURE.

SPECIAL EX-BLOOD BOWL PLAYER SKILLS

Powerful Strike

The Ex-Blood Bowl Player is trained to strike powerful blows with his bare hands (in a Blood bowl arena, that's all you've got). This ability gives the Ex-Blood Bowl Player a +1 Strength, but because he has fought with his bare hands all his life, he really doesn't know the first thing about using any other weapon (besides, it's just not his style). because of this, the Ex-Blood bowl may not use any weapons, except his Spiked Shoulder pads and anything he buys from the *Foot Locker*.

Follow Up

Anytime the Ex-Blood Bowl Player kills an enemy, he may forego a "deathblow" to *Follow Up* during a *Running Blitz* action.

Push It

The ex-Blood Bowl player may *Push It* after he completes his full move, allowing him to move up to two additional spaces. For each additional square moved, he must roll a D6. On the roll of a 1, he has tripped and injured himself. This ends his move, and he takes D3 wounds, not modified for toughness or armour.

EX-BLOOD BOWL PLAYERS AND TREASURE

Treat the Ex-Blood Bowl Player exactly like a Barbarian. If a Barbarian can use a particular piece of treasure or equipment, so can the Ex-Blood Bowl player. Do not forget about his weapon and armour restrictions though.

ADVANCED RULES.

The rules in this section are used in conjunction with the Roleplaying game. They explain all about taking you ex-Blood Bowl player through the Battle-levels, visiting settlements and gaining skills.

EX-BLOOD BOWL PLAYERS IN SETTLEMENTS

While at any settlement, the Ex-Blood Bowl Player may visit the Temple, Alchemist, Gambling House, Fighting School, Foot Locker, and all the shops (New rules for the *Foot Locker* can be found below). He may also visit the Alehouse (roll 2D6+1). On the roll of a 13, you join in a bet on a current Blood Bowl game going on in town. You may bet up to 300 gold on the game. After deciding on an amount to bet, roll a D6 on the following chart:

D6	Result
1-2	The team you bet on loses miserably, You lose all the gold you bet.
3-4	The team you bet on wins and you double your money.
5-6	The team you bet on wins and you decide to bet again. Roll again to see what the outcome of your next bet is (counting a 5-6 as a draw-no win, no loss). You must then bet and roll again (the second and subsequent bets must be at least 50 gold each).

As a hardened Blood Bowl Star, the Ex-Blood Bowl Player is no stranger to the taverns of the Old World. He has been all over the Empire; cheering on wins, drinking away losses, and drowning away the pain of many a broken limb.

UNEVENTFUL DAYS

An uneventful day is a rare occurrence in the life of a rough and tumble Blood Bowl Player (especially one that's not out on the pitch).

If an Uneventful Day is rolled, roll again on the following chart:

D6	Result
1-2	You are recognised on the street as an Ex-Blood Bowl Player, roll another D6 to see the crowd's reaction: <ul style="list-style-type: none"> 1-2 The crowd boos and hisses, (obviously fans of the last team you beat) quickly forming a mob. They chase you all the way to the edge of the settlement, but you narrowly escape by ducking down a back alley. You had better never show your face around these parts again. You must immediately leave the settlement and wait outside for your companions.

- 3-4 Your fans cheer as they see you and quickly swarm around to get your autograph. In all the confusion, you may have a fan shower you with money or get your pocket picked. Roll a D6-3 x10. This is how much gold you gain/lose (a positive number means you gained that much while a negative number means you lost that much). A result of zero means that the audience is honest, they're just not taken with you.
- 5-6 A crowd of your best fans quickly gather, showering you with gold. You get D6x50 gold.
- 3-4 Your old team is in town for a big match against the Orkland Raiders. They quickly convince you to join them once more, "for old times sake". Roll a further D6 to see the outcome of the game:
 - 1 You are badly injured in the game, losing one Wound permanently and spending the next D6 days in the local infirmary. You do not have to roll events for these bed-ridden days (although you do have to pay living expenses).
 - 2-3 Your team loses and you go out to the local tavern with your Blood Bowl Chums to drink away the loss. You spend D6x20 gold, drinking away this horrible defeat.
 - 4-5 Your team wins with you back to lead them, and as you bid your old team mates farewell once more, they give you a cut of the winnings. You get D6x20 gold.
 - 6 Your team makes quick work of the Orcs, and you get back to the dug out early, so one of your old Blitzter friends shows you some new moves. Now, once per adventure, you may use a special feint move to distract your opponents. When used, all enemy models adjacent to you lose all of their attacks on you this turn. If you roll this result a second or subsequent time, just add one to your Wounds characteristic permanently instead.
- 5-6 It truly is an uneventful day.

THE FOOTE LOCKER

The *Foote Locker* is a special location for the Ex-Blood Bowl Player only. To find it, you must roll a 7 in a town or city, just like any other special location. Below is a list of items that may be purchased by the Ex-Blood Bowl Player.

With the exception of the *Athletic Bandages*, you may never have more than one of the following items at any one time. There is also no need to roll for availability for any of the items below as *The Foote Locker* is always well stocked. These items may only be used for and on the Ex-Blood Bowl Player.

Gat-Ork-Ade Bottle150 gold
As above.



Spiked Football1000 gold
The Spiked Football allows the Ex-Blood Bowl Player one ranged attack per combat (as you throw the ball at something). You can throw the ball up to 6 squares away. To hit, you must roll equal to or greater than the number of squares the target is away (counting the target's square, but not your own). The ball does D6+8 damage to whatever it strikes, modified as usual. The ball is automatically recovered at the end of every battle (once all the monsters on the board have been defeated), in the next Exploration Phase.

Spiked Cleets500 gold
These special boots give the Ex-Blood Bowl Player an additional kick attack every turn, rolling to hit with a -1, and causing normal damage (D6+ strength). Note: no character may ever wear more than one pair of boots at a time.

Athletic Bandages200 gold
These may be used at any time to restore D6 wounds to the Ex-Blood Bowl Player (never above his starting wounds). These bandages never go bad like the normal bandages.

Blood Bowl Armour (Replacement)250 gold
As Above.

Spiked Shoulder Pads250 gold
As Above

TRAINING

The Ex-Blood Bowl Player may train in any settlement.

SKILLS

EX-BLOOD BOWL STAR PLAYER

Roll 2D6 on the following table to determine which skill is learned.

2 Dirty Player

In the game of Blood Bowl, There are no such things as "Morals".

The player may now strike one *dirty blow* a turn, making one of his attacks unmodified by toughness or armour. He must declare which attack is the *dirty blow* before rolling to hit. (Note: this does not give the player an extra attack, it only modifies an existing one).

3 Dodge

After playing Blood Bowl for many years, a player learns to see blows coming. His injuries can be sbrugged as little more than a flesh wound.

Every hit that the Ex-Blood Bowl Player receives from now on, is reduced by one point of damage.

6 Heroic Leap

To escape serious injuries on the Blood Bowl field, many players learn to leap and bound across the field in an attempt to avoid being tackled.

You may now leap over any square, landing in the square on the other side. This leap costs 2 squares of movement, but lets you leap over intervening models. You may leap in any of the four compass directions as well as diagonally.

7 Mighty Blow

Anytime the Ex-Blood Bowl Player rolls a natural 6 to hit from now on, you may roll an extra dice damage as well.

8 Lucky

This is not a skill persay, the fighter is just remarkably lucky.

The Ex-Blood Bowl Player gains 1 Luck Point permanently.

10 Fearsome

Blood Bowl Players are infamous for their bad attitudes and burly physiques.

All monsters that don't cause Fear or Terror are now -1 to hit you.

11 Reaction Strike

It takes quick reflexes to stay alive on the astro-granite of a Blood Bowl field. They're not too bad to have in a dungeon either.

Every time new monsters are placed on the board, roll a D6 for the Ex-Blood Bowl Player. On the roll of a 3-6 he may make an immediate, single attack on any monster just placed adjacent to him (with death blows, etc. as usual). On the roll of a 1-2, even he is caught off guard, and gets no benefits.

12 Da Cunnin' Plan

You are an expert strategist when it comes to game plans. You know every play in the book (as well as many that aren't).

At the start of any **one** Battle per adventure, you may choose to use your plan. You recognise your enemy's tactics and call out coded instructions to your fellow warriors. Any

one turn during that battle, the warriors may take an extra Warriors Phase (two in a row; one normal, then one extra). All of the warriors must take this phase together

Battle Level	Gold	Title	Weapon Skill	Ballistic Skill	Strength	Damage Dice	Toughness	Wounds	Initiative	Attacks	Luck	Will-Power	Escape Pinning	Skills
1	0	Rookie	3	5+	4	1	3	1D6+8	3	1	0	3	4+	0
2	2,000	Lineman	3	5+	4	1	3	2D6+8	3	1	1	3	4+	1
3	4,000	Lineman	4	5+	4	2	3	3D6+8	4	1	1	3	4+	2
4	8,000	Lineman	4	5+	4	2	4	4D6+8	4	2	2	3	4+	3
5	12,000	Blitzer	5	5+	4	2	4	5D6+8	5	2	2	4	3+	4
6	18,000	Blitzer	5	5+	5	2	4	6D6+8	5	3	3	4	3+	4
7	24,000	Blitzer	5	5+	5	2	4	7D6+8	5	3	3	4	3+	5
8	32,000	Blitzer	6	5+	5	3	4	8D6+8	6	3	3	4	3+	6
9	45,000	Star Player	6	5+	5	3	4	9D6+8	6	4	4	4	3+	6
10	50,000	Star Player	6	5+	5	3	4	10D6+8	6	4	4	4	3+	7

Warhammer Quest®

The Kislev Arms was one of the more reputable and popular taverns in the city of Kislev, having managed to avoid the worst of the thugs and other generally bad folk who tended to cling to the outskirts of the towns, the dark alleys and back street taverns and clubs. Tonight was a usual night and the owner and bartender Thomas Crabbe was making his usual living selling his ale and ever popular Bugman's XXXXXX Brew. There were the usual customers and rumour-mongers and the fair share of new adventurers telling of their heroics and fortune.

Somebody kicked the door open and strode in proudly. A tall and haughty elf guffawed at the sight of the little man. This little person was in fact a dwarf, going by the name of Gunbad Ironhand. He walked forward majestically and planted his huge rune axe on the wooden floor, resting his hand on the hilt. Everyone stared in awe at the majestic, strange character and there were even a few gasps and low whistles.

The only item of clothing he wore was a pair of green and blue vertical striped breeches. Expensive gold bracelet's and bangles adorned his weather beaten, muscle bound body. His left ear was laced with ruby and emerald and sapphire rings and the other with one small brass ring. A beard and moustache were plaited into long lengths, all dyed bright orange, each of the several plaits being a metre or more in length, draping down over his strong chest and muscular stomach. His hair, for the most part was stiffened with fat and dyed a very bright orange, sprouting a good foot and a half up from his scalp. Behind his mohican were three plaits leading down over the tough hide of his back, which were also dyed orange and seemingly a different beard was bound into each, one grey, one black and one brown. Each of his numerous plaits was held together by a small circlet of gold.

It was dark outside and a storm was brewing. As Gunbad stood in the middle of the room, tense, a gust of wind blew in through the open door and whipping up the plaits at the back of his head with it as it swept around the room. The chuckles coming from the elf were silenced by a flash of lightning and a roll of thunder, illuminating the figure and revealing his body to be covered with sacred war and battle tattoo's.

"My name," he announced, "is Gunbad Ironhand. I am a Trollslayer. I swore to protect my family from whatever danger was to befall them. One night I was helping to protect Karak Azul from a swarming green horde of goblins. While I was out fighting, my home was attacked

by Skaven." He slammed his axe into the floor with a mighty sweep. "I almost disembowelled myself when I returned to find my house ransacked and my father, mother and desperately ill brother devoured by the foul vermin. Near them was my cousin's axe, he had fled with terror into the mountains and was never seen again. He probably killed himself in shame and disgrace of his act of disloyalty and desertion. From then, I swore the slayer oath and travelled here to Kislev on my way to the Hell Pit. A month today it will be the first anniversary of my family's death and I intend to arrive at the Hell Pit that very day and exact my vengeance upon any living enemy of mine who dwells there, be it Skaven, Orcish or other. Now, will anyone travel with me into the depths of that foul dungeon, for assistance to me or other reasons?"

"Aye!" called out a stout dwarf, holding aloft a mug of Bugman's. "I will. My name is Gorak Dawi. I come from Karaz-a-Karak and I am a brave and doughty warrior. It would be an honour to fight with such great heroes as yourselves and will always help a cousin-in-arms in need of it," he announced. "I will come, whether you want me or no."

"I do, cousin Gorak, I do," replied Gunbad. "Come with me then and anyone else who so wants."



The haughty elf stood up and declared "I am Aliae Torhelm, one of the sons of Tiranoc, an Elf Ranger Mage. You, little man, may find me useful and life saving on your quest, if somewhat of a posh, commenting nuisance, in your opinion. I do agree to fighting at your side, because I share your hate of the vermin you talk of. Together, the three of us and any more who care to join us, will fare pretty well but your distaste for armour or protection may cause a minor problem. Yes, I have decided to grace your obsessed if rather dishonourable presence!"

"Welcome friend," replied Gunbad grudgingly, "but don't get too mouthy for yourself or you'll get the axe, literally." As he said this, the elf laughed and was once again silent.

Warhammer Quest®

"A dwarf, another dwarf and a puny elf" mused a huge oaf of a human barbarian while the shocked elf made a comment about him to his neighbour, "I may be able to assist you in your adventures. I am quite learned in the ways and doings of Skaven..."

"Traitor," murmured Gunbad.

"Through loathing and detestation rather than admiration, *actually* I know the typical layouts of such hell-holes and my fighting skills are quite up to scratch. So, if you will," he coughed, "I will come and lend whatever aid and advice I can. Magnus the Great at your service."

"Very well Magnus, you will join us and that makes the party four with no offers," he replied and added, under his breath, "great as in ego size, no doubt," and aloud again, "we leave at daybreak tomorrow." And with that he walked upstairs, followed by the others, shortly after downing their beverages.

Gorak was clad in a fine suit of Gromril armour which could sustain many a blow which could cleave through lesser armour. This rested on top of a red leather jerkin and he wore dark leather breeches. His cheeks were ruddy and his face boasted an average-sized dark brown beard and moustache. Lastly he wore a fur hood which draped part way down the back of his splendid suit of armour, which was covered by a majestic red cloak, adorned with runes.

The elf wore splendid silks from one of the few noble houses occupied by elves in the Old World, probably at great expense. He wore a light green silken shirt with gold trimming and middle blue silk breeches. At his back a long turquoise cloak covered the length of his body and he wore deep black, shiny leather boots. He wore a suit of scale-mail armour which glistened a mithril tint and probably had magical properties. In his hands he carried a marvellous sapphire crown with a silver head band on it and a bright emerald encrusted in the front. This would usually be worn atop his golden locks of hair and long thin pale elven face.

Lastly, was Magnus the so-called Great. The only item of clothing he wore was a fur loin-cloth held in place by a gold-studded leather belt. He did, however have many pieces of jewellery ranging from a grand necklace of ivory and bronze and a bronze circlet around his head and forehead, to small golden trinkets and bracelets and the like. Around his left ankle was a small silver chain with a small ruby attached to the end of it. He had longish, light brown unkempt hair which stopped at about his shoulders and had a few bone beads entwined in it.

The group arose early the next morning and got dressed and prepared themselves, paid their bills and set off together, eager to find adventure and glory or revenge. But, just as Gunbad was about to follow his companions out of the door, there came a guttural grunt from a dark corner of the room.

"Wait!" came the voice.

"WHAT!" screamed Gunbad, "Nobody! Nobody orders me to do anyth..." The stranger walked out of the shadows. "except in special circumstances, of course..." added Gunbad, gently.

The owner of the voice was an extremely large, violent looking humanoid. It was not possible to define the speaker's race, for he wore a large and heavy, splendid suit of plate armour. The splendid helmet was adorned with a pair of ivory horns and gave the character a menacing look. In one hand he bore a huge axe, even bigger than the one Gunbad possessed. Gunbad looked to the ground, kicking the floor and cursing in shame. The axe's blade was embossed with strange and mystical runes, unknown and unrecognised to Gunbad and the handle was carved with many skulls.

"You are heading to the Hell Pit." growled the stranger, and Gunbad nodded, "you do not know of the daemons and evils which may lay beyond the simple Skaven inhabitants. There are many dark secrets and rumours surrounding the mysteries and untold tales of the abominable place. I WILL come, for you WILL need me."

He glared at the elf, who was about to raise an argument, raised his axe and cut through the nearest drinking table. He cleaved the table exactly in two and swung through to the stone floor, causing a great many sparks. This was all too much for the stout-natured butcher sitting at the table, who fainted and his thinner companion began to slap him in the face to bring him round. The dwarf, Gorak about to ask the yet unanswered question also received a glare. How he achieved the effect, even through his armour was a mystery to anyone.

"I am known, commonly, as The Un-named One, fearsome warrior and skillful with the axe. Sit and eat at my expense, my friends. We leave at noon," announced the warrior. The party did as requested, but asked no questions, for fear of the answers.

By Andrew Rostron



THE EVERCHANGING FACE OF CHAOS

by David Cain

With the relatively recent arrival of the Nurgle War Machines and the Slaaneshi Knights, David and his games club feel that the Warp-laden forces of Tzeentch are under utilised and in his opinion over pointed (especially Silver Towers and Firelords). In addition they think that the Man O'War Tzeentch Bane Tower just begs to be used in games of Epic!

WARP PALACES - GREATER DAEMONS OF TZEENTCH

The Armies of Tzeentch, Changer of Ways

The Chaos God Tzeentch is the Lord of Fortune and Chance. His tainted followers delight in bringing ruin to the Imperium of mankind and seeing the well established order created by centuries of the Emperor's rule gradually eroded.

However, Tzeentch is also the unrivalled Master of Mental energy and of Magic and by manipulating

these aspects he is able to stabilise the gateways that exist between warp space and the material universe such as the Eye of Terror. Such rifts in the fabric of space allow Chaos warbands and daemonic incursions to terrorise the hapless citizens of the Imperium.

Tzeentch's schemes are often unfathomable but war and strife are vital machinations of change so the followers of this dark power are frequently found in the heart of battle.

An enigmatic Warp Palace supported by the sorcerous forces of Tzeentch clash with Eldar defenders

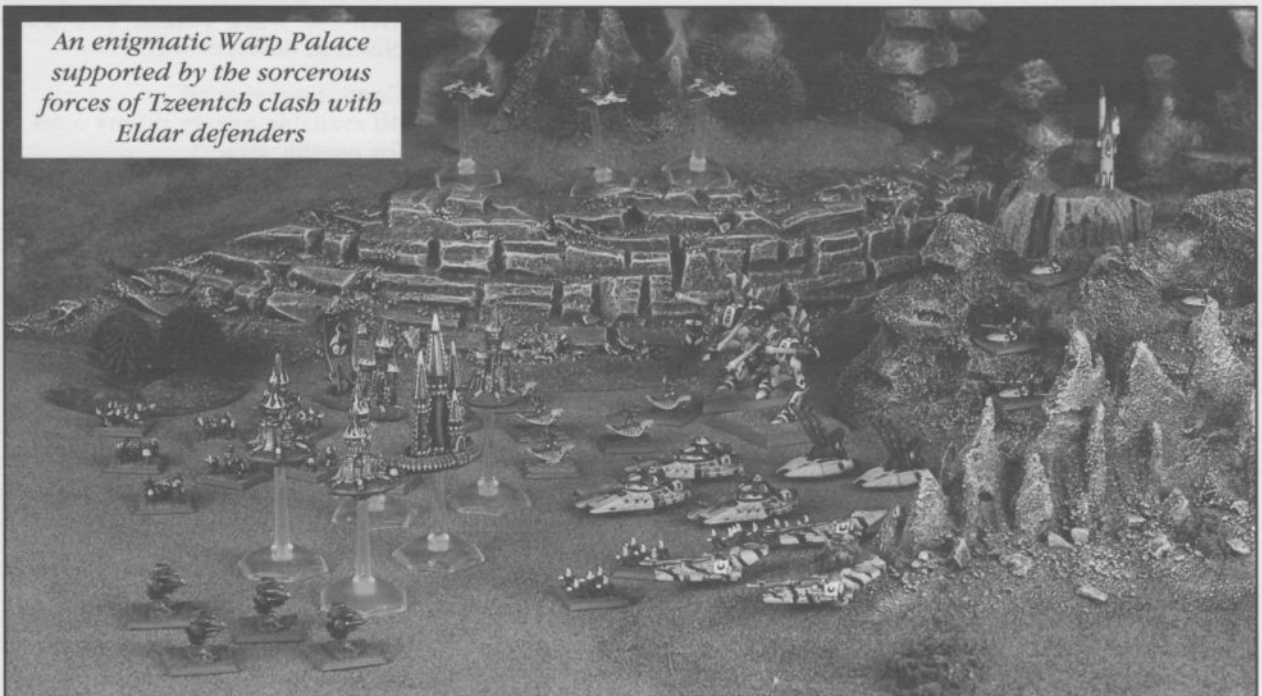

The Warp Palaces of Tzeentch

The dreaded Warp Palaces of Tzeentch resemble huge baroque fortresses or bastions mounted upon a colossal hovering disk. Fluctuating sparks of Warp energy flare out from the turrets and crenellations and the air crackles with the aura of magical energy. In this manner it resembles the more commonly encountered Silver Towers of Tzeentch, but does, in fact, dwarf even these feared engines of Chaos.

The Warp Palaces are constructed in a manner far beyond the comprehension of even the most learned of the Adeptus Mechanicus Tech-Priests. These floating monstrosities are known to appear above the battlefields of the 41st millennium drawing upon a raw power that is unimaginable to other machines and daemon engines.

Occasionally the Warp Palace will sit motionless in the midst of its enemies, strafing ground targets with its various destructive forms of attack. At other times it will simply disappear with a sonic boom and a cascade of lightning bolts only to reappear again at the opposite flank of the battlefield in the blink of an eye. However, the Warp Palace is not just a nightmare union of metal and ferocious firepower. At the core of each Warp Palace lies the essence of a Changer of Ways - a Greater Daemon of Tzeentch.

The Greater Daemon rules (found in the Renegades supplement) apply in full and the Warp Palace is presented in a similar fashion to a Greater Daemon card and must be accompanied by between three to five minion cards. However, unlike normal Greater Daemons the Warp Palace must be given orders as usual.

Since the Warp Palace is so adept at focusing warp energy you may add four Chaos cards to your hand if your force includes at least one of these Greater Daemons. You may expend such cards to keep it functioning if it should be destroyed. Like the Khornate Lord of Battle and the pustulent Plague Tower you cannot enhance the performance of the Warp Palace by playing Chaos cards on them. In addition, the ability to channel warp power gives the Warp Palace a Psychic saving throw of 3+. This save is present even if the Warp Palace fails to accumulate any warp energy points for the turn (see below).

The Warp Palace is classified as a flyer.

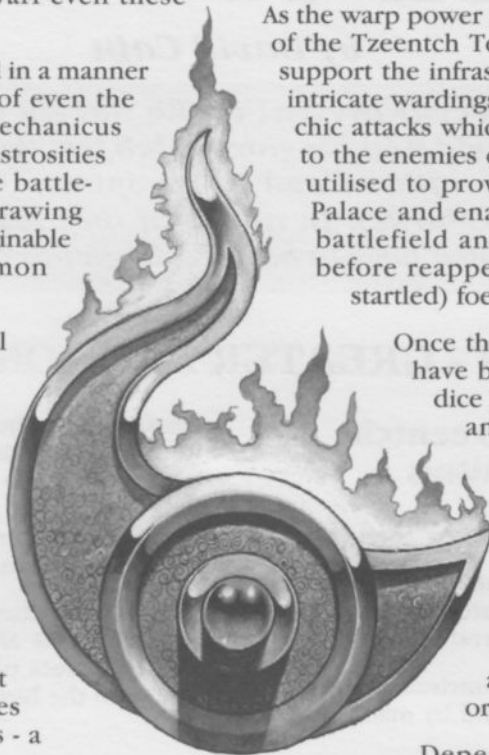

Warp Energy

Each Warp Palace is filled with powerful Psykers and chanting neophytes who act in unison to generate a focal point for warp power. It is the nature of such power that it ebbs and flows, sometimes reaching awesome proportions while at others, hardly enough is available to utilise even the most minor of psychic disciplines.

As the warp power is absorbed by the exhortations of the Tzeentch Techno-Magi, it is channelled to support the infrastructure of the Palace through intricate wardings and sigils and to energise psychic attacks which bring death and destruction to the enemies of Tzeentch. This power is also utilised to provide the motive power for the Palace and enables it to disappear from the battlefield and travel through warp space before reappearing above it's (presumably startled) foes.

Once the order counters of both sides have been revealed, roll an artillery dice (the one marked 2, 4, 6, 8, 10 and Misfire) to determine how many warp energy points have been absorbed this turn. a 'Misfire' roll indicates that there is only enough energy to sufficiently preserve the integrity of the Palace itself and that there are no energy points available to power movement or psychic attacks.

Depending on the order counter placed from the Warp Palace the warp energy can be utilised in different ways:

- FIRST FIRE:** Cannot move at all.
All available energy points used for psychic attacks.
Conventional weapons shoot in the First Fire segment.
- ADVANCE FIRE:** Half available energy used for movement.
Half available energy used for psychic attacks.
Conventional weapons shoot in the Advance Fire segment.
- CHARGE:** All available energy points used for movement.
May not shoot or utilise psychic abilities.

Warp Palace Movement

Each point of warp energy used for movement allows the Warp Palace to move 10cm. If there is no warp energy available (ie 'Misfire' rolled on artillery dice) it cannot move at all.

Because the Warp Palace disappears and moves through warp space, snap fire weapons cannot target the Warp Palace during the movement phase. As the Warp Palace is classed to be a flyer it follows all the special rules for flyers as detailed on page 23 of the Titan Legions rulebook.

Psychic Attacks

Each of the following psychic powers can be used in the psychic phase if there are sufficient warp energy points available. A power may be used more than once per turn if desired. If there is no warp energy available no powers may be used. Targets benefit from psychic saves (where applicable) as usual. All psychic attacks have a 360° fire arc.

Psychic Shield1 warp energy point

Select one model or unit within 75cm (not Titans or Legion minion cards). The targetted model/unit now benefits from a 3+ saving throw until the start of the Chaos players next turn.

Fortune of Tzeentch.....2 warp energy points

Select one model or unit within 75cm (not Titans or Legion minion cards). The targetted model /unit gains a 4+ unmodifiable saving throw until the start of the Chaos players next turn. This save is in addition to any normal save the recipient is entitled to.

Blue Fire of Tzeentch2 warp energy points

A bolt of blue psychic energy flares out from the Warp Palace. The bolt has a range of 35cm, 1 attack dice and hits on a 4+. The targets saving throw is reduced by -2.



Tzeentchian Warp Palaces can be devastating opponents that are difficult to pin down as they flit across the battlefield

Tzeentch's Firestorm.....3 warp energy points

A maelstrom of fiery warp energy is produced by the Warp Palace. A standard barrage template is placed within a range of 35cm. Anything under the template (completely or partially) is hit on a 4+ and there is no save modifier.

Roll a D6 for every stand or model destroyed. if a 6 is rolled then a stand of Pink Horrors is created in place of the casualty. The Pink Horrors created follow the normal rules for such Daemons but no victory points are awarded for them when they are destroyed.

Note:

The Blue Fire of Tzeentch, Pink Fire of Tzeentch and Tzeentch's Firestorm are all classed as being akin to shooting attacks and as such the target must be visible to the Warp Palace. Normal saving throws are taken (modified where stated above) as well as psychic saves. However, due to the psychic nature of these attacks the target does not receive any benefit from being in cover.

Pink Fire of Tzeentch4 warp energy points

A bolt of pink psychic energy flares out from the Warp Palace. The bolt has a range of 50cm, 1 attack dice and hits on a 3+. The targets saving throw is reduced by -4.

Troop Type	Move	Saving Throw	CAF	Weapons	Range	Attack Dice	Roll to Hit	Target's Save Mod.	Notes
Warp Palace of Tzeentch	Special	2+ all round	+8	Cannon Bolters	50cm 15cm	2 5	5+ 6+	-1 0	Flyer. 3+ psychic save Psychic attacks

GAMING CONTACTS

This is a new feature that has been suggested by countless readers over the past few months. The aim of this section is to put players or clubs of Games Workshop gamers in touch with others of a similar inclination.

If you are a member of such a gaming group and would like to advertise your group, find new friends with which to play our games or even advertise tournaments you need to let us know the following details:

The name, address and catchment area of the club, a contact name and address (and telephone number if you wish), usual meeting times and which games you usually play.

CENTRAL WARGAMES

ADDRESS: Carronshore Community Centre
Carronshore, Falkirk,
TIMES: 5pm to 11pm Saturday nights
CONTACT: David Gillan,
23, Westerton Terrace,
Carronshore, Falkirk,
Scotland
Telephone: 01324 - 554350
GAMES: All Games Workshop games.

THE ORIGINAL WORKSOP WARGAMES SOCIETY

ADDRESS: 70, Lowtown Street,
Worksop, Notts S80 2JR
TELEPHONE: 01909 - 486187
GAMES: All Games Workshop games
(plus a few others!).

PHOENIX MODELLING & WARGAMING CLUB (LIVERPOOL)

ADDRESS: c/o 58, Frank Street,
Widnes,
Cheshire WA8 0AH
CONTACT: Ron Foster
GAMES: Warhammer Fantasy Battle,
Warhammer 40,000, Epic,
Space Hulk, Blood Bowl, plus
many period wargames and
board games.

BARNSELY ROLE PLAYERS SOCIETY

ADDRESS: 9 Hindle Street,
Barnsley
CONTACT: David Watson
GAMES: Talisman, Judge Dredd (RPG &
board game), MERP,
Warhammer Role Play,
Chainsaw Warrior.

Calling all Epic players!

Epic Space Marine players desperately wanted for one-off or league/campaign games in Sileby, Thurmaston and Leicester areas.

Current armies include:

1 Eldar Host, 1 Squat army,
2 Ork Hordes, 1 Tyranid
Swarm, 1 Chaos Horde,
3 Imperium armies.

Contact Lee on 01509 - 815296
for details or leave a message on
the answering machine

**NOTE: we are only providing this page as a noticeboard for players and can make no promises that these clubs exist, or continue to exist, at the addresses given.
There is no connection between these clubs and Games Workshop Ltd.**



SANDSTORM!

Arid Terrain rules

by J. Michael Tisdell

ARID TERRAIN RULES

There are over a million inhabitable worlds in the Imperium. Many more exist outside the Emperor's domain. The varieties of these planets are almost endless. From the steamy jungles of Catachan to the icy wastes of Valhalla, the forces of the Imperium have had to struggle in many different environments. The basic terrain rules in the Warhammer 40,000 Rulebook are general enough to cover most of the terrain types encountered.

This article presents optional rules which provide a structure for fighting battles in Arid or Desert regions. They are based on the basic terrain rules provided in the Warhammer 40,000 Rulebook but add the unique character of the arid wastes.

ARID FEATURES

Most arid regions are composed of flat, rocky ground. There are rarely any large terrain features other than sand dunes. What features there are, are small and low to the ground. This doesn't mean, however, that units remain in line of sight, it just means that you have to change the way you think about cover.

Below is a list of the various terrain types found in arid regions and the rules governing them. References are made to the terrain types found in the Warhammer 40,000 Rulebook. A chart is provided at the end of this article for ease of reference.

Note that the following terrain does not exist in arid or desert regions:

1. Woods or forest
2. Rivers or streams
3. Jungles

Other terrain features, such as hills and buildings often do exist in arid or desert regions. Use the rules from the Warhammer 40,000 Rulebook for these terrain features.

OPEN GROUND

Open ground is considered open terrain except that no in-ground fortifications are allowed due to the shifting sands and fluctuating state of the land-



scape. In-ground fortifications include trenches, emplacements, and concealed bunkers.

ROUGH GROUND

Large areas of deserts are littered with obstacles such as scrub bushes or strewn with rocks, such areas are for the purpose of gaming referred to as rough ground. For movement purposes rough ground counts as open terrain. To take account of the many small scrub bushes and rocky outcrops troops are allowed to hide in rough ground.

WADIS

A wadi is a gully formed by the infrequent rain storms that hit arid regions. Unlike other gullies, wadis usually have very steep sides and are treated as difficult terrain for units crossing it and as open

SANDSTORM! - Arid Terrain rules

terrain for units moving along it. Units already in a wadi may hide from those outside. Units in a wadi receive hard cover bonuses when fired on by those outside of it. Units receive no cover bonuses when fired on by other units inside the wadi. Units in a wadi may not hide from opponents in the same wadi. Units hidden in a wadi may move along it and remain hidden from those outside of it.

OASIS

An oasis is usually a clump of vegetation which surrounds a permanent or semi-permanent water source. The vegetation around the water source consists of a few shallow rooted trees, like palms, and small thorny bushes, such as the Joshua Tree. For game purposes treat the oasis like a small wood. Figures within one inch of the edge of the oasis may fire out and be fired upon. The oasis provides soft cover for these units. Deeper than one inch into the oasis, troops cannot see out nor can they be seen. An oasis is considered difficult terrain for those moving through it.

ROCKY OUTCROPS

Rocky outcrops appear quite frequently in some arid regions. These are formed from very hard rock that has been constantly blasted by the very strong winds typical in these areas. As a result these outcrops often take on an outlandish shape. Rocky outcrops count as very difficult terrain and provide hard cover for troops hiding behind them.

DUNES

Sand can pile up into dunes of varying height. Wheeled vehicles treat dunes as Very Difficult Terrain. All other units treat dunes as Difficult Terrain. Units may hide in or behind dunes. No ground fortifications may be constructed in or behind dunes. Buildings do not exist in dunes. Although most dunes are isolated terrain types in an arid region on certain arid planets, the sand has accumulated to such a depth that no other surface feature is visible. Such deep accumulations, sometimes on the order of hundreds of feet, are called dune seas. An interesting possibility would be to

play a game where almost all the Terrain was counted as a "dune sea" such an inhospitable planet would have small islands of rock on which the combatants would fight. Unfortunately there is not enough space to go and explore this idea in this article but I hope it provides you with food for thought.

SANGARS

Since troops are unable to dig trenches or foxholes, they usually pile rocks into low walls behind which they hide. Such fortifications are called sangars. Units may hide behind sangars and receive hard cover bonuses when attacked across the front of a sangar. Units in one of these terrain features receive no bonus when attacked from behind the wall. Sangars may be purchased at a cost of 10 points per 2" length. They have an armour value of 15. If a shot penetrates the sangar, it is destroyed and removed from play.



SANDSTORM! - Arid Terrain rules

ARID CONDITIONS

Weather in arid and desert regions is hot and dry. The effects of this on game mechanics are small. It is assumed that all vehicles and troops have been prepared for fighting in arid conditions, so rules for mechanical failure/heat exhaustion are not included. However, there are some climatic conditions that do effect game play: wind and dust.

WIND

The wind is always blowing in arid regions. Sometimes it is a mild breeze and at others, a blinding sandstorm. It is assumed that games do not take place during a sand storm, so the rules that follow account only for strong breezes. In arid regions, vision is hampered by dust kicked up by the breezes and by the haze coming off the hot ground. To account for this, a -1 to hit modifier is made for shooting at short range, with a -2 modifier for long range.

Example: an Eldar Guardian fires with a lasgun at an Ork 23 inches away he will need a 6 to hit. This is because of the -2 modifier for firing at long range in arid terrain.

DUST

Arid regions are very dusty. Wheeled, tracked, hover, and skimmer vehicles which move in an Arid region kick up a cloud of dust. Walking vehicles, such as Dreadnoughts, only produce a dust cloud when they run or charge.

For game purposes, this cloud of dust is as wide as the vehicle and extends behind it from its final position back to its starting position. The dust cloud is 12" high and remains in place until the start of that player's next turn

Example: a Space Wolf Land Raider moves 12" from left to right this turn. The Land Raider leaves a dust cloud behind it as wide as the vehicle and 12" long. This cloud persists until the start of the next Space Wolf turn.

Units within 1" of the edge of a dust cloud may fire at targets outside of it with a -1 to hit penalty. Units



outside a dust cloud may fire into it at targets within 1" of the edge of it with a -1 to hit penalty. Units may not see through a dust cloud and, therefore, any weapon which requires a line of sight may not fire through a dust cloud although they may shoot at targets that are within 1" of the edge of a dust cloud.

ARID TERRAIN TACTICAL NOTES

Arid terrain provides novel challenges for those used to fighting in temperate terrain. There is a noticeable lack of upright terrain behind which to hide troops. In fact, there are no trees or bushes behind which to hide. What few large rocks there are, are usually fiercely guarded by your enemies. At first it appears the game will be over quickly. Whoever goes first will annihilate his opponent with long range weapons. However the astute commander will notice two things:

1. Almost all arid terrain provides enough cover in which to hide troops.
2. The haze and dust makes any long range sniping more difficult. For both sides.

SANDSTORM! - Arid Terrain rules

To survive in the desert the cunning general makes every use of what terrain is around. You should place the majority of your troops in hiding. When you move, be sure to advance from one hiding spot to another. If you have access to blind or smoke grenades, use them to cover your advance. Probably the most effective cover can be found in the rare rocky outcrops. Not only does this hide troops it provides hard cover. Few other natural terrain features do this. For this reason alone, pay special attention to rocky areas. Use them as hard cover for troops with indirect fire weapons, such as mortars.

Wadis, like rocky outcrops, provide hard cover. They are amongst the best defensive terrain in arid regions. Units hidden in a wadi are safe from attack

while advancing along it. Wadis which are parallel to the line of attack function as natural trenches whilst those at angles to the line of attack provide protected avenues for troop advancement.

The desert is a place where, because of the flatness of the terrain, vehicles assume a dominant position on the battlefield. Consequently anti-tank artillery becomes more important than anti-personnel. A las-cannon is of more use in arid terrain than a scatter laser.

Though vastly different from the normal temperate terrain usually used in Warhammer 40,000 games, these arid terrain rules provide a challenging environment in which to fight battles of the 40th millennium.

Arid Terrain Chart

Terrain	Type	Cover	Hide	To Hit	Special Rules
Dunes	Very Difficult	Hard	Yes	-	No Fortifications
Haze	Climate	None	No	-1/-2	Short/Long Range
Oasis	Difficult	Soft	Yes	-1	Treat as Woods
Open	Open	None	No	0	
Rocky Outcrop	Very Difficult	Hard	Yes	-2	
Sangar	Fortification	Hard	Yes	-2	Armour Value of 15
Wadi	Difficult	Hard	Yes	0	

These additional Strategy cards can be photocopied and added to your existing deck of strategy cards. They should help to give your games of WH40K a suitably parched atmosphere. Alternatively you can use them on their own to produce a deck of entirely Arid terrain strategy cards.

FLASH FLOOD

Play this card at any time. All troops in wadis are caught in a sudden raging torrent as a flash flood strikes. All troops (including friendly models) are effected. Vehicles in wadis will go out of control on a roll of 5-6. Troops must role their strength or under on 1D6 to avoid drowning. i.e. all models that fail suffer one wound.

STRATEGY



STRATEGY

SANDSTORM! - Arid Terrain rules

**DESERT
RAIDERS**

A single enemy unit is chosen as the target of indigenous raiders, or perhaps they are attacked by one of the planets many vicious predators. Play this card immediately, the attack is resolved by 1d6 strength 4 hits with a -2 armour save.

STRATEGY



STRATEGY

**POISONED
WATER SUPPLY**

An advance party of your army has successfully poisoned the enemies water supply. Play this card immediately, for the first turn all enemy troops movement is halved. This takes into account the debilitating effects of consuming the poisoned water. Other than this there are no other effects.

STRATEGY



STRATEGY

MIRAGE

The holder of this card sets up as normal. However, once he has set up and has seen his opponent's set-up the holder may reposition any one unit or character within his deployment zone. This represents the enemy commander being fooled by a mirage.

STRATEGY



STRATEGY



THE DESIGNERS CUT

with Andy Chambers, Jervis Johnson and David Moretti

With the release of Outlanders you can now play Necromunda with the annoying intervention of vicious Genestealers, various beastly monsters and dozens of other deadly denizens - but, you do need to play the game with your campaign Arbitrator and what if he can't make it to the game, or you aren't even playing in a campaign? Well we have just the thing for you - Necromunda event cards (*because that's the generous kind of people we are!* - Ed).

David Moretti from Rome sent us his ideas for using event card in Necromunda and we really liked them. When we mentioned this great idea to Jervis and Andy they said they'd had the same idea for Necromunda about a year ago when playtesting first began. The events deck was going to be a major part of the game. Unfortunately we couldn't physically fit anything else into the boxed set which meant the idea had to be dropped. However Jervis and Andy's work on the cards has not gone to waste as we combine David's work with that of our Games Designers to produce a deck of cards which will make your games of Necromunda even more exciting (*yes, I know it's hard to believe but it's true!* - Ed). David is currently working on several projects at the moment and has promised to share the details of his excellent Space Marine chapter - The Imperial Falcons - with us as soon as he completes the background....

How to use the cards

At the beginning of each game, after having decided which scenario is going to be played, each player takes D3 cards from the Necromunda event deck and keeps them secret from their opponent until the card is played. Each card has a full explanation of its use and effect upon the game.

After the title of each event card is an indication as to when the card can be played. The three different categories of card are 'Before', 'After' and 'Event'. The exact duration of the event card is given with the rules on the card.

Before: The card is played immediately after it is drawn and its effects will generally last for the entire game.

After: The card will be played at the end of the game and its effects will usually alter the post battle sequence.

Event: The card may be played at a specific moment and causes something to happen, an event. Usually the effects of this card are resolved instantly.

Note: For some cards you will have to note down where on the table they are. For example the dangerous walkway card needs a walkway somewhere on the table noted down to prove the walkway is dangerous and may collapse. Make notes such as this after all terrain has been placed but before the gangs deploy for battle.

To use the events for Necromunda you will need to make up the deck of cards supplied on the covers of this issue. You can easily do this by photocopying these pages or cutting the cards out.



WARHAMMER®

KISLEV

The claws of the Great Bear

by Tuomas Pirinen

And so the curtain draws to a close on the Kislev army list. The Journal will just not be the same without Tuomas's list (still it helped to get him a job on White Dwarf!). However, we do have all sorts of goodies lined up for you! I could not possibly tell you what is in store except that it isn't an Albion army list, a Border Princes army list, a new Epic Marines chapter or even bucket loads of characters and scenarios for Warhammer Quest. Or is it....

SPECIAL CHARACTERS

This section describes some specific individuals from Kislev's history. You may include these individuals in your army by paying the appropriate points cost. Although the list includes characters who could never have met in reality, you can include them in the same army if you wish to do so. However, you may only have one General, so you will be unable to use certain characters together.

Tzarina Katarin,
Ice Queen of Kislev200 Pts
 +100 Pts Fearfrost

MAGIC SPELLS: Katarin is a level 3 Ice Mage. She may cast spells in the normal manner as described in Warhammer Battle Magic.

The Tzarina Katarin is the current ruler of the people of Kislev, having succeeded to the throne on the death of her father, the Tzar Bokha. She is the most powerful magician ever to wear the crown of Kislev and her aloof majesty and inscrutable disposition have caused many to refer to her as the Ice Queen of Kislev. The Tzarina is so suffused with magic that even her flesh is cold and pale, and her limbs are long and lean like icicles. Her hair glistens with frost, and ice crystals sparkle on her lofty crown.

Your army may include Tzarina Katarin. If so, she will always be the general of the army and thus replace the normal general. She is a level 3 Wizard (an Ice Lady), and is dealt three spells from the Ice Magic deck at the start of each battle.

Profile	M	WS	BS	S	T	W	I	A	LD
Tzarina	4	4	3	3	3	3	5	3	10
Warhorse	8	3	0	3	3	1	3	1	5

WEAPONS/ARMOUR: The Tzarina carries the magical weapon Fearfrost and rides a Warhorse.

MAGIC ITEMS: The Tzarina may carry up to three magic items including the magic sword Fearfrost. Other magic items may be selected from Battle Magic, Arcane Magic, Chronicles of War or the Kislevite magic items (see last issue) as usual.





Prince Ivan Radinov, Captain of the Gryphon Legion110 Pts +60 Pts Sword of Heroes

Ivan Radinov is the younger brother of the ruling Tzarina Katarin. While his sister oversees Kislev with icy efficiency, Ivan spends his time on daring adventures. He is nominally the Cavalry Commander of the Gryphon Legion, but he rarely spends much time in their barracks headquarters, located in Altdorf. He prefers his freedom and dangerous lifestyle, but when a real threat emerges and his beloved sister is in danger, Ivan leads the grim knights of the Gryphon Legion in defence of Mother Kislev.

Your army may include Prince Ivan if it includes a unit of Gryphon Legion.

Profile	M	WS	BS	S	T	W	I	A	LD
Ivan	4	6	5	4	4	2	5	3	9
Silverhoof	10	4	0	4	3	1	4	2	5

WEAPONS/ARMOUR: Prince Ivan wears heavy armour, carries a shield and rides his barded Warhorse, Silverhoof, which he acquired from Koshei the Immortal. He is armed with a sword and spear.

MAGIC ITEMS: Prince Ivan may carry up to two magic items including the Sword of Heroes. Other magic items may be selected from Battle Magic, Arcane Magic, Chronicles of War or the Kislevite magic items (see last issue) as usual.

SPECIAL RULES

NATURAL HERO: Ivan will always try to save those in danger. Whenever a character model within 4" of Ivan is killed, roll a D6. On a roll of 5+, Ivan saves the individual at the last moment by means of wit, cunning, swordplay and unrivalled bravado. The character is restored to one wound (although all the wounds caused still count towards combat resolution). If the D6 roll is a 1, Ivan fails spectacularly! He is then so overcome with grief that he may do nothing except defend himself during the next turn, whether it is his own turn or that of the enemy.

Tzar Saltan of Praag110 Pts +45 Pts Black Blade

Tzar Saltan is the bitter ruler of Praag, the city overrun by the armies of Chaos during the last great incursion. Every day is torture for him, for his city is a constant reminder of the horrors suffered by the Kislevites. Whenever Tzar Saltan hears of a Chaos Warband polluting the sacred soil of Kislev he becomes a figure with the wrath of a storm. He gathers his warriors and, with grim determination, attacks the minions of evil, the only joy that is left to him.

Your army may be led by Tzar Saltan, though he does not have to be the General. If used as a General, he replaces the Lord or Khan-Queen described in the main army list. Saltan may also be included as an independent Hero.



Profile	M	WS	BS	S	T	W	I	A	LD
Saltan	4	5	5	4	5	3	5	3	9
Warhorse	8	3	0	3	3	1	3	1	5

WEAPONS/ARMOUR: Tzar Saltan wears heavy armour, carries a shield and rides a barded Warhorse. He is armed with the Black Blade.

MAGIC ITEMS: Tzar Saltan may carry up to two magic items including the Black Blade. Other magic items may be selected from Battle Magic, Arcane Magic, Chronicles of War or the Kislevite magic items (see last issue) as usual.

SPECIAL RULES

HATRED: Saltan is subject to *Hatred* when fighting Trolls, Beastmen or Warriors of Chaos. When fighting against a unit of Chaos troops, Tzar Saltan will always issue a challenge to any characters in the unit. If challenged by a Chaos character, he must accept. When fighting against Chaos characters in a challenge, Saltan gets a +1 bonus to his Strength.

PSYCHOLOGY: Tzar Saltan has lived in Praag long enough that he is quite immune *Fear*, *Terror* and *Panic*. He must still take break tests as normal.

Stepan Rasin,

Clanchief of the Cossacks143 Pts

Stepan Rasin is the young and rash Clanchief of the Cossacks. He is a stubborn man who refuses to give up. If he sees a mountain he feels he must climb it. If there is a task or a test that seems impossible, Stepan will not rest until he has completed it. While this attitude has earned him the respect and admiration of his fellow Cossacks, it has also endangered his life more than once. Fortunately, it seems that luck is with him and success has always been his to claim. Stepan's exploits include such feats as climbing the Cliff of Harkov that stands in the middle of the River Urskoy, slaying the Chaos Champion Akrim the Fell and riding through the insanely dangerous marches of Zaborota. During his adventures, Stepan has become an outstanding warrior and a great archer.

No one in Kislev would challenge him to a riding contest. In wartime he leads the brave Cossacks in daring skirmishes and bold charges and he is one of the most trusted subjects of Tzarina Katarin.

Your army may include Clanchief Stepan Rasin if it includes at least one regiment of Cossacks. Stepan Rasin may not be the General of the Army.

Profile	M	WS	BS	S	T	W	I	A	LD
Stepan	4	6	6	4	4	3	6	4	9
Warhorse	8	3	0	3	3	1	3	1	5

WEAPONS/ARMOUR: Stepan Rasin rides a Warhorse and wears a suit of light armour. He is armed with a sword, spear and a longbow.

MAGIC ITEMS: Stepan Rasin may carry up to three magic items. These may be selected from Battle Magic, Arcane Magic, Chronicles of War or the Kislevite magic items (see last issue) as usual.

SPECIAL RULES

HATRED: Like all Cossacks, Stepan hates Beastmen, Trolls and Warriors of Chaos. This includes any Beastmen characters and Chaos Champions and Chaos Sorcerers.

LUCK: Stepan Rasin is an unbelievably lucky man. He is therefore allowed to re-roll any dice roll he makes. He may make up to three re-rolls during the battle. He may attempt to re-roll any single roll only once.

HORSEMANSHIP: Stepan is a master rider and suffers no movement penalties for difficult terrain or obstacles.

Ilja of Murova102 Pts

If you ask an inhabitant of the Taiga who is the strongest man in the land, you will invariably get the same answer, Ilja of Murova. This grim and skilled hunter has won every contest of strength in Kislev during the last twenty years. Once, by the personal request of the Tzarina, he wrestled a great grizzly bear unarmed and emerged victorious. Ilja of Murova is a bear of a man, standing well over seven feet tall. His hair is already showing signs of greying, but he has lost nothing of his skill with the bow or axe. His arms and shoulders are as mighty as ever, and no one, even amongst the Sibirians, dare to challenge him to a contest of power. There are even those who believe that Ilja has been blessed by the gods with the spirit of a Great Bear. Ilja hunts alone, for the prey he searches is far too dangerous. He openly challenges the creatures of Chaos and the Beastman Warbands, bringing their hides to the feet of the Tzarina in the yearly Summer Fair. In wartime Ilja is always the first man to stand beside the ruler of Kislev, and his awesome strength is welcomed by all.

Your army may include Ilja of Murova if it also includes at least one regiment of Sibirian troops. Ilja may not be your General.

Profile	M	WS	BS	S	T	W	I	A	LD
Ilja	4	5	5	5	4	2	5	3	8





WEAPONS/ARMOUR: Ilja of Murova carries a two-handed axe, longbow and a sword. He wears light armour.

MAGIC ITEMS: Ilja of Murova may carry up to one magic item. This may be selected from Battle Magic, Arcane Magic, Chronicles of War or the Kislevite magic items (see last issue) as usual.

SPECIAL RULES

SIBYRIAN: Ilja is a Sibirian, and may be placed on the table after all the other troops have been deployed. He may be placed anywhere on the battlefield, except within the enemy deployment zone or within the sight of enemy troops.

STRENGTH OF THE GREAT BEAR: If Ilja hits with all three of his attacks then he may opt to do one mighty strike attack instead. This is worked out at +3 to his Strength and does D4 damage. These rules do not apply if Ilja is using a magic weapon.

HUGELY RESILIENT: Ilya is almost literally a bear of a man and therefore is able to take far more punishment than a normal man. To represent this, whenever he is reduced to zero wounds roll a D6. On a 1-3 he is killed as normal, but on a 4-6 the fact that Ilja should be dead does not register in his battle-crazed mind and completely ignores the injury. Return Ilja to 1 wound.

Igor the Terrible108 Pts
+100 Pts Bloodedge

Igor the Terrible is a dark legend amongst the Kislevites. He was perhaps the most feared Tzar of all time, for his great intelligence and courage were tainted by an unreasoning rage. He ordered the infamous beheading of the members of the Boyar family of Melnikovs, destroying almost every single member of that family, because he had a dream that a young man name Melnikov toppled his Kingdom. The taxes he assessed the poor people of Kislev were enormous and were ruthlessly collected by his cruel servants. Thousands died during his regime. Igor, however, was a mighty warrior and was never defeated in battle. He united the Kislev as we know it now, and formed a strong monarchy which endures to this day. He was a great military innovator and without his organisation of the army, Kislev might today be a part of the Realm of Chaos.

Your army may include Igor the Terrible as an independent character if you wish. He cannot be your General because once the fighting starts, he is far too busy slaying his enemies and has no time to lead the army!

Profile	M	WS	BS	S	T	W	I	A	LD
Igor	4	6	6	4	4	3	6	4	9

WEAPONS/ARMOUR: Igor the Terrible wears a suit of heavy armour. He is armed with a sword and an additional hand weapon.

MAY RIDE: Igor may ride a barded Warhorse (+7 Pts) or a Monster (see the separate Monster list for points).

MAGIC ITEMS: Igor the Terrible may carry up to three magic items including the famed sword Bloodedge. Other magic items may be selected from Battle Magic, Arcane Magic, Chronicles of War or the Kislevite magic items (see last issue) as usual.

SPECIAL RULES

HATRED: Igor is subject to *Hatred* against all human enemies.

Miska the Slaughterer315 Pts
+100 Pts Fearfrost

Miska the Slaughterer is the most famous of the Khan-Queens of Kislev. She was the daughter of Boris Ursa, the legendary Forever Tzar of Kislev. Her innumerable hordes of Gospodars, Tartars, Cossacks and Huns almost overran the Empire. Such was her power as a warrior that only the combined armies of the Empire, Bretonnia and Dwarfs managed to stop her and even then she was not defeated. The battle ended in a bloody stalemate. Miska drew her hordes back to the North and founded Kislev in the regions she had conquered from the Dwarfs and the men of the Empire. The people of Kislev remember her with pride and affection and she is sainted by the church of Kislev. Miska sported wild black hair and filed her teeth as her savage forefathers before her. She was a master of both magic and arms, and perhaps the greatest single warrior ever to lead an army.

Your army may include Miska the Slaughterer. If you choose to include her she will be your General and replace the General described in the main army list.

Profile	M	WS	BS	S	T	W	I	A	LD
Miska	4	6	5	4	4	3	6	4	9

WEAPONS/ARMOUR: Miska the Slaughterer carries the magic sword Fearfrost.

MAY RIDE: Miska the Slaughterer may ride a Warhorse (+3 Pts).

MAGIC ITEMS: Miska the Slaughterer may carry up to three magic items including the magic sword Fearfrost. Other magic items may be selected from Battle Magic, Arcane Magic, Chronicles of War or the Kislevite magic items (see last issue) as usual.

MAGIC SPELLS: Miska is a level 3 Ice Mage. She may cast spells in the normal manner as described in Warhammer Battle Magic. Miska uses Ice Magic spells.

SPECIAL RULES

FRENZIED: Miska the Slaughterer is a manic warrior-queen and is affected by the rules for *Frenzy* as described in the Warhammer rulebook.

Baba Yaga310 Pts
 +150 Pts Chicken Legged Hut

Deep in the birch forests in the heartland of Kislev lives Baba Yaga, meagre as a skeleton, stronger than iron and more powerful than any other witch. Her crooked hut stands on chicken legs of bronze and the fence around it is built from the bones of humans and beastmen. Skulls perched atop the spikes of this gruesome construction glow with a eerie light when darkness falls.

Baba Yaga lives a solitary life, caring little for the fate of Tzars or of Kingdoms. However, her power is still tied to the land and when Kislev is threatened, Baba Yaga will rouse and cast great enchantments over her house. The magical construction takes a life of its own and carries its mistress into battle, crushing those who would threaten the power of Baba Yaga.

Profile	M	WS	BS	S	T	W	I	A	LD
Baba Yaga	4	4	3	4	4	4	6	3	9

WEAPONS/ARMOUR: Baba Yaga carries a crooked staff she uses as a hand weapon. She rides into battle on her Chicken-Legged Hut. Rules for the Hut are included below.

MAGIC ITEMS: Baba Yaga may carry up to three magic items. These magic items may be selected from Battle Magic, Arcane Magic, Chronicles of War or the Kislevite magic items (see last issue) as usual.

MAGIC SPELLS: Baba Yaga is a level 4 Wizard. She may cast spells in the normal manner as described in Warhammer Battle Magic. She may choose spells from either Ice Magic or the Dark Magic decks.

The Chicken Legged Hut

The Chicken-Legged Hut is believed to be merely a legend by most Kislevites. However, the Witch Baba Yaga knows the ancient formula for bringing a hut alive. Occasionally she rides her sinister Chicken-Legged Hut to battle to protect her homeland of Kislev from those who would destroy it and, ultimately, her source of power.

MOVEMENT

The Chicken-Legged Hut moves in exactly the same way as a large monster. To summarise, it moves independently in the same way as an individual character model, cannot make a march move, and is obviously unaffected by penalties for wheeling and turning as such manoeuvres are unnecessary.

FIGHTING THE CHICKEN-LEGGED HUT

The Chicken-Legged Hut has the following profile:

Profile	M	WS	BS	S	T	W	I	A	LD
Hut	7	5	0	6	7	4	3	3	-

The Chicken-Legged Hut fights in hand to hand combat in the same way as a large monster. It counts as a large target for the purposes of shooting. Hits from shooting and hand to hand combat are randomly allocated between the Hut and Baba Yaga as shown on the chart below. For each hit scored roll a separate die and resolve damage against the target that has been hit.

Shooting

1. Baba Yaga
- 2-6. Hut

Hand to Hand

- 1-3. Baba Yaga
- 4-6. Hut

If the Hut is targeted by a stone thrower, spell, or any other attack which has a template to represent its effect, it is possible to hit the Hut or Baba Yaga depending on the position of the template. Position the template normally. The Hut and Baba Yaga are treated as separate targets, just like single models in an ordinary unit, and are potentially hit if the actual models are within the template area.

If Baba Yaga is killed, roll on the Monster Reaction table.

CHICKEN-LEGGED HUT ATTACK

When the Chicken-Legged Hut charges it automatically causes D6 S7 hits. These hits are made before the attacks from either side. Note that hits are inflicted automatically, there is no need to make rolls to hit. The additional Strength represents the large mass of the Hut ploughing into its foe.

Baba Yaga may fight against any enemy in contact with the Hut, whether to its front, sides or rear. She strikes blows in normal Initiative order and attacks first during a charge, exactly like other warriors.

SPECIAL RULES

PSYCHOLOGY: The Hut and Baba Yaga are not affected by *Panic*, *Fear*, *Terror* or any of the psychology rules. In addition, the Chicken-Legged Hut causes *Fear* as described in the Warhammer rulebook.

COMBAT: The Chicken-Legged Hut will fight on in hand to hand combat regardless of circumstances. It need never take a break test, never flees and will fight to the death even if repeatedly beaten by its opponents.

Liber Illuminatus

Martin Hanford

Martin, from Ledbury in Hertfordshire, has been playing Games Workshop games for about eleven years. He started on the long road to Daemonhood by playing *Warrior Knights*, *Battlecars*, *Judge Dredd* and *Talisman*.

Martin is a keen fan of *Space Hulk* who seems to be constantly painting new armies for our main games since most of his armies have been borrowed by his friends and large chunks of them have yet to find their way back to him!

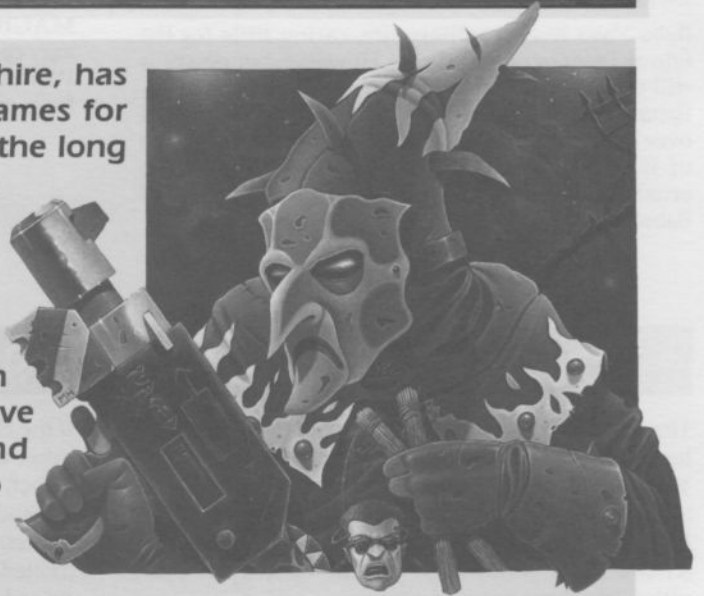



Martin's influences artistically are Rodney Matthews, Moebius, Gary Chalk, Carlos Esquerra (2000AD) but strangely not Neil Buchanan of 'Art Attack'! When not painting or drawing he usually plays guitar or deafens himself with British and Polish (!!!!!!! - Ed) thrash

We really like Martin's unique 'stipple-dot' effect and the dark brooding atmosphere he gets into all of his work. Every month we seem to receive another consignment of artwork from Martin and each time we are stunned by the contents! Keep your eyes open as we will hopefully be bringing you more of Martin's work in the near future.

Here at the Bunker we have a particularly soft spot for the glum looking the Space Marine on the opposite page. We've christened him 'Brother No-Mates'!



Welkum to Dok Butcha's
Konverzhun Klinik!

Da Dok is really looking forward to this issue because he's going to be cutting up all sorts of Humie vehicles! As promised last issue we show you how to make one of Ewen Little's excellent Armoured Fighting Vehicles! We are assured by Ewen, that this conversion is, "quite simple" - although we found it more than a bit challenging (that means it's a git to make! - Ed).

If you have any other great ideas for conversions send them to:

Da Journal Bunker,
Games Workshop Ltd.,
Chewton St.,
Eastwood,
Notts. NG16 3HY

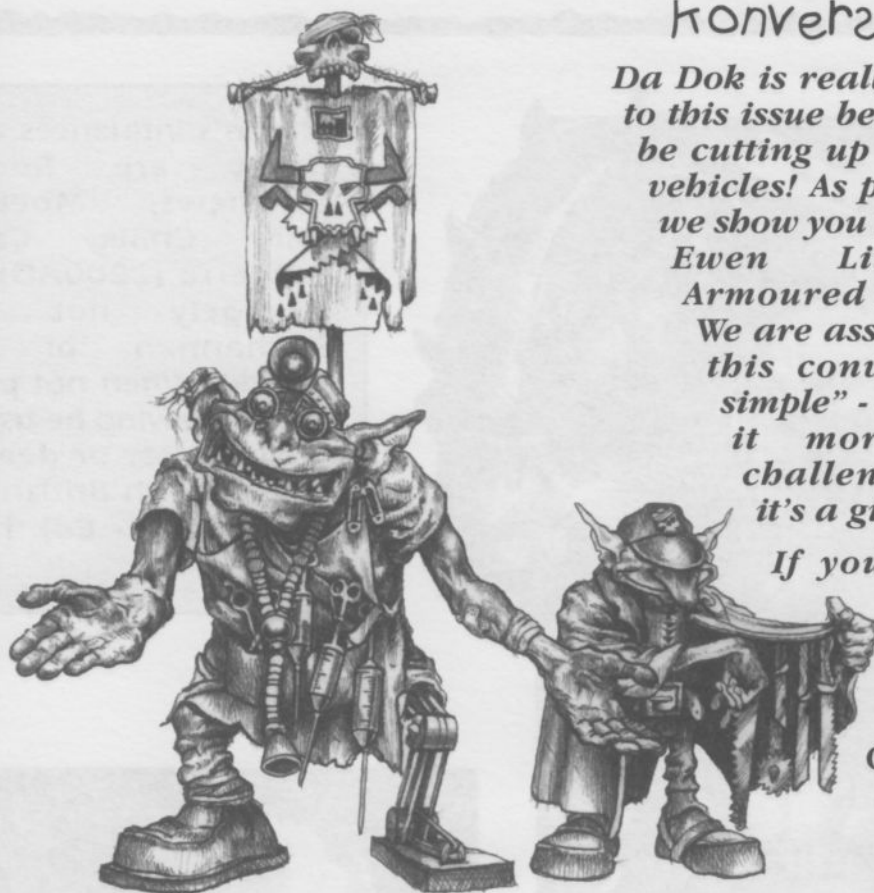

CENTAUR & MINOTAUR AFVS

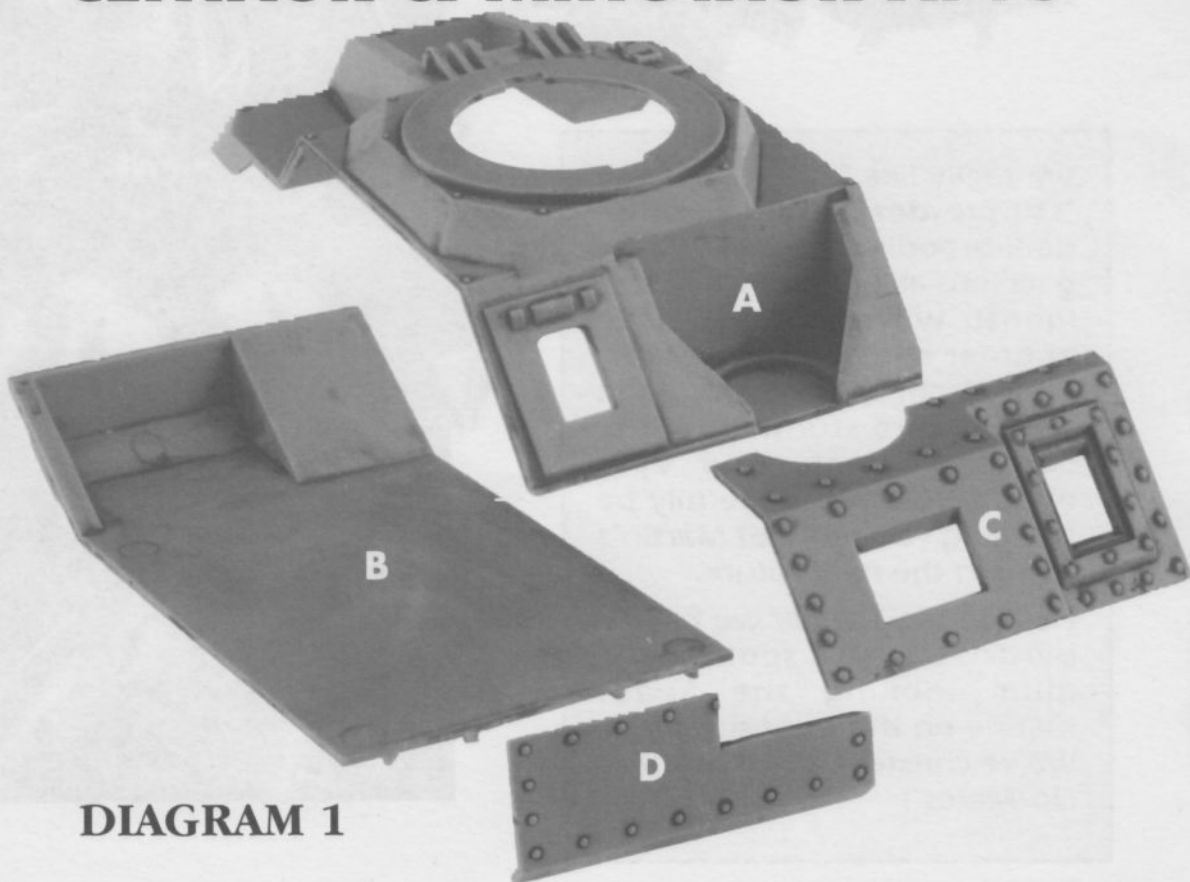

DIAGRAM 1

DIAGRAM 2

At the heart of this conversion is a hull constructed from various Leman Russ and Chimera parts, as well as side panels cut from plasti-card. Accurate modelling of this hull is vital to the successful completion of this model. Diagram 1 shows the four main components needed and how they should be assembled. These components are labelled (A-D) and instructions on modelling each of these components are given below

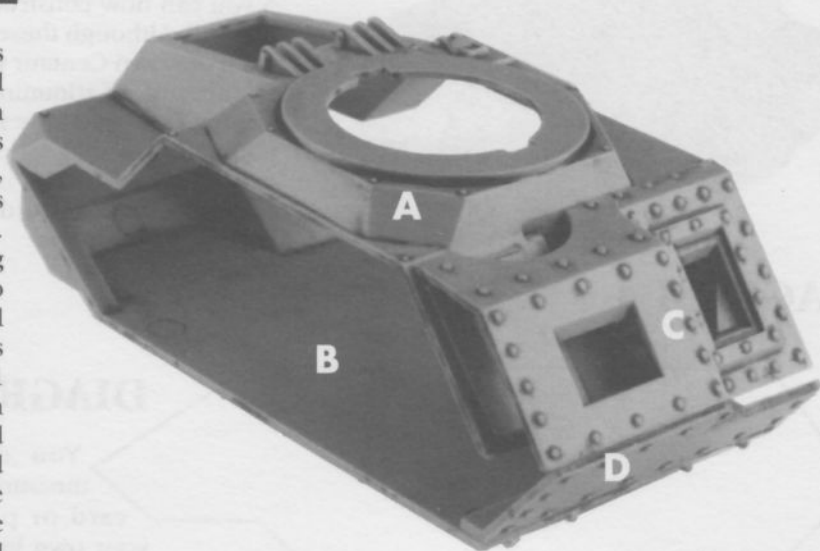
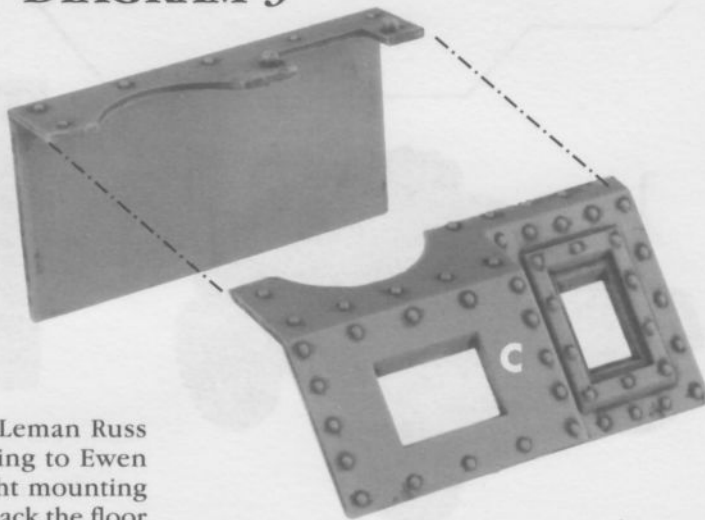

DIAGRAM 3

A The first major component of your kit is the Leman Russ upper chassis B3. You should use a modelling knife to remove the lower back section to the angled corners. *(I am assured by Ewen that the correct name for this should be Hip ends, but I think he's making it up as he goes along! - Ed.)*



B The next essential part is Leman Russ lower chassis B22. According to Ewen you should remove the light mounting and locating lugs and trim back the floor by about 3mm. With pieces B22 and B3 reversed and stuck together you have the basis of the hull.

C The front of the hull is constructed from the Chimera driver's section B3. This piece must be cut in half along the rivet lines. See diagram 3. This will leave a semi-circular hole that must later be filled with plasti-card.

D Chimera part B4 forms the final part of the Chimera hull. As shown in the diagrams a small rectangle needs to be removed from this piece to allow an accurate match. Removing this small rectangle creates a gap that can clearly be seen in diagram 2



IF YOU WANT TO HAVE A GO AT MAKING ONE OF THESE STUNNING VEHICLES ALL YOU HAVE TO DO IS GIVE DA BOYZ AT MAIL ORDER A CALL ON 01773-713213!

DOOR BUTCHA'S RKLINIR

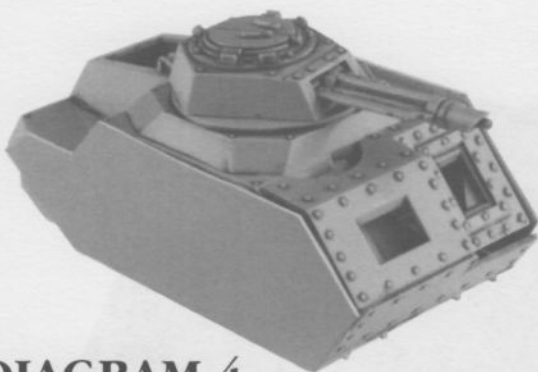

DIAGRAM 4

Using the templates shown in diagrams 4 & 5 you can now construct the side panels of the hull. Although these templates are taken from our own Centaur you may have to do a fair amount of trimming to get them to fit. Having assembled the hull of your Centaur you can now add on extra details, as you can see the turret is simply that of a Chimera and should be assembled in exactly the same way.

DOK BUTCHA'S KLINIK



DIAGRAM 5

You can photocopy or measure this template onto card or plasticard to create your own hull side panels. Bear in mind that you may have to do a fair amount of trimming to get a good match.



DIAGRAM 6

Diagram 6 shows the rear view of the Centaur, this view clearly demonstrates the lowered rear section of the Lemman Russ upper chassis B22. It also shows the exhaust pipe which replaces the head light mounts on the real Lemman Russ model.



DIAGRAM 7

The mud guards for the wheel were produced from plasti-card. The wheels for this kit were found in Ewen's bitz box and any large wheels will do. As you can see from the insert above the Minotaur turret is constructed from various pieces of Citadel vehicles. Other than the turret the construction process for the Minotaur is exactly the same as the Centaur.



DIAGRAM 8

The Minotaur turret is similar to that of the Centaur but other components are also used. At the rear is the backpack from the Griffon spotter. Exhaust tubes from a Whirlwind and radar dishes from various Epic vehicles make up the main sensors. These components are mounted on the mantlet from a Demolisher. In pride of place within the turret is one of the great new Commissar models, which was simply sawn in two and pinned in place.

Surfer's Paradise!

This issue's snippets from 'the Net' are John Haire's ideas for making the Firebase and Bastion models even better and should appeal to novice and expert modellers alike. On a lighter note a few of you thought that with the recent Olympics held in Atlanta you would join in the Olympic spirit with 'The 40K Olympics'!

Terrain Master

I love the new Firebase and Bastion models and have a few tips on how to make them better...

- Try spraying the model with black spray which is held a few metres away. The airborne spray will drift down onto the model to tone down the vividness of the blue of the Firebase. Instead of misting the model with black spray paint, why not try a misting of matt varnish? It would prevent obscuring the details already on the model.
- You can also make physical enhancements to the models when constructing them. I cut all of the vision slits from the card sections. I also cut out the vents and glued wire mesh in their place.
- I would highly recommend carefully selecting the bulkheads you will use. I own the Necromunda boxed set, so I had plenty of bulkheads to choose from. I recommend using the bulkheads with hatches in any place that seems like it should have a door, like the small boxy room behind the launch pad of the Firebase and on all levels of the Bastion. And when making the Bastion, be careful to use the solid bulkheads for the tower sections that will be hidden from view.
- You can add depth to the models by using a layering technique. For instance, you could carefully cut out a hatch and then use the cut-out as a template to make a twin hatch out of thick card. Glue the twins together with the original hatch on top. Then replace the new, thicker hatch on the model (*you could also use extra hatches from our tank kits which are oddly enough available from Mail Order UK. Right, that's my sales pitch for this issue! - Ed*).
- If you're really sick, like me, you could add a lighting system to your models. I've added a series of red-domed lights to my Firebase and internal lights to my Bastion. It all looks very cool! I use 12V lights from Radio Shack (*most electronics shops will do: Tandy, etc. - Ed*) and a lantern battery. With careful planning, the internal wiring can be invisible and the wires leading to the battery (mine is enclosed in a custom made shack) can be masked

with rows of hedges, etc. (*For those of you with access to the Necromunda boxed set or scenery pack you could quite easily use the small stand alone pieces of scenery to mask your battery pack as this will fit in quite easily with the atmosphere of the 41st millennium - Ed*) My next task is to figure out a way of making the firebase landing lights blink in a landing pattern!

- Before assembling the models, paint the bulkheads black and drybrush them with Bolt Gun metal or Chainmail or whatever. Of course the more advanced (patient) painter could try to paint the bulkheads to match the blue of the Firebase or the stone-grey of the Bastion, but who has that much time on their hands? You might also want to snip the connecting grooves off the top bulkhead in any given stack. It really helps in positioning models. You should also base your models. This will add stability and allow you to do things like speckle the surrounding area with spent shells, dead bodies, vegetation, trees, stones, or whatever takes your fancy.
- If you haven't figured it out from the above, I highly recommend gluing your models together. Sure it makes them a bitch to travel with, but they will hold up better and you don't have to waste time putting them together when you could be gaming!

John Haire



The 40K Olympics

Anyone think that a 40K Olympics would be neat? Every race could enter a team and participate in a variety of events such as...

The 500 metre Rhino Sprint

Each team piles a squad of 'volunteers' into a Rhino APC, which they must then drive across the board without getting splattered by the opposing teams' heavy weapons elements. A Rhino that explodes but lands across the finish line counts as completing the course.

Individual Freestyle Slaughter

Each team may choose one champion and arm them however they wish. The champions are then deposited on a featureless plain along with 400 Gretchin. The champion who can kill the most Gretchin without getting killed by one of the opposing contestants is the winner. Contestants killed by other contestants are disqualified. Contestants killed by the Gretchin will have the rest of their team fed to the official Olympic mascot: Kirby the Carnifex.

The 400 metre Break

An individual event, the competitors line up, without weapons or armour of any kind, and then are introduced to a largish group of Flesh-hounds (at least twice the number of competitors). Anyone who can make it to the safety of the well armed Imperial Bastion 400 metres away advances to the next round. The last one alive wins.

Grot-Shooting

Also an individual event, the competitors are armed with a standard Bolter. Their skill as a marksman is assessed as live Snotlings are catapulted through the air. All competitors compete simultaneously. Note that a 1 Grot penalty is assessed for shooting other competitors.

Snot-putt

Yet another individual event, this constitutes seeing who can throw the squirming Snotling the farthest.

Synchronised Teleporting

A squad of 5 must teleport to various places on the battlefield without getting blown to bits by random heavy weapons fire. Also, if a member of the squad becomes possessed, or sucked into the warp, or similar nasty stuff, then the team must attempt to finish the course with their new team member.

Snotling Shooting

Each participant must take a basic lasgun as weaponry. They shout "Pull!" and a snotling is catapulted over their heads on one of several trajectories by a customised Squig Catapult. The competition is round robin elimination (or if the participant is shot by another competitor).

No Seer runes or Imperial Tarots are allowed near the event. This is to prevent cheating (or re-rolls)

Yachting

Each team starts with a small sailing craft and 1000pts worth of crew. They must finish a course loaded with mines, sea creatures and all of the other craft. Each team must finish with a boat, but not necessarily the one they started with.

20th Century Yachting rules apply (that is if the Adeptus Arbites catch a team cheating). Violators will be disintegrated.

This is not a best of seven event. This is a winner takes all event. One race decides the medal standings.

Boarding another boat is within the rules and actively encouraged. If repairs are needed during the race, another team's boat is always near... The other boat may not be too happy when you come calling for spare parts! Boats can always be lashed together to form 'Sailing Hulks'.

*Various depraved individuals
who need to get out more*



WARHAMMER®

HA! THERE'S ONLY EIGHT OF THEM!

By *Tim Richardson*



17 year old Tim is a student who has been enjoying Games Workshop games for around 5 years. He commands a 10,000 point Epic Ork force and a 5,000 point Undead horde. This article was inspired by a battle in which a Wraith Champion held up a Dwarf General for the duration of the conflict. Later this issue we have another of Tim's articles entitled "Spell, Dispel..." which was written after another game against a Dwarf army in which he didn't get the chance to cast one spell!

Q You control a High Elf army which includes Prince Imrik. You are facing an Undead army, and it is your turn. Imrik is flying high and you decide to charge with him, after all why not? Your opponent has two units:

A: 30 Wights with a Vampire Lord, Army Standard and Wight champion.

B: 8 Skeletons with a Standard and Wraith champion.

Who do you charge - A or B?

Option B: Wrong, the Wraith has the Talisman of Ravensdark and so Imrik can no longer attack but the Dragon still can. The Wraith will then challenge Imrik - what do you do? Accept - in which case you cannot harm the Wraith and will lose the combat by at least two (Standard & rank bonus). You could decline, in which case neither Imrik nor the Dragon can attack and you will again lose the combat by at least two - either way it is a no win situation....





"HUMAN" PSYCHOLOGY IN WARHAMMER

Many people don't realise it but there are in fact two different types of psychology in Warhammer Fantasy Battle. We all know and love (or hate?) the first type: frenzy, fear, terror etc. but there is also another type that is not so widely known. "Human" psychology is on a higher level to that used by the miniatures - it's based around getting your opponent to do what you want them to do by leaving weak looking units (or bait) for them to charge, then revealing later they are in fact much harder than they appear. As in the example above using Imrik, this tactic works very well against flyers but it does have other uses as well. To use this tactic properly you will need to have one or more specially kitted out units to use as bait, a good example is the unit of skeletons (who are specially made to take out flyers) but they would be of little use against a unit of 30 dwarf clansmen! When creating these specialised units try to predict what you are trying to lure in, as your bait will often be of little or no use against a different type of unit.

The main thing to remember though is that you must make the unit look vulnerable without it being too obvious - for example: putting a unit of 4 goblins and a champion out on the side of the board by themselves will look decidedly suspect.

After you have chosen your bait, both it's role and it's composition you must then decide where to place it to make it look as vulnerable as possible, without making it look like an obvious trap! Quite often, slightly to the side and behind another unit works well if you are hunting flying

creatures, but a more centralised roll will probably work better on ground based troops.

To summarise the main points:

- Decide what type of troop you are attempting to snare.
- Decide what troops & magic items you need to achieve this.
- Decide where to set up,. Remember, "make it look weak, but not too weak!"

Just as a final point it is possible to use the opposite of these tactics to keep your opponent away from certain units by making them look harder than they are - one of the best ways to do this is to "play on" certain troop types reputations - for example Minotaurs have a fearsome reputation and rightly so too!



THE CITADEL

JOURNAL

ARCHIVING SERVICE

Due to an ever increasing number of enquiries regarding issues of the Citadel Journal which are no longer available we are pleased to announce the arrival of the 'JOURNAL ARCHIVING SERVICE'.

Over the next three pages you will find a complete listing for all the articles that have been published in Journals 1-11. These are now available as photocopies which come in a dust-proof plastic wallet sent to you by First class post. So, if you are kicking yourself for missing the rules for the Undead Plague cart, Epic Ork Cyber-wyverns or even the Space Marine Drop Pods in Warhammer 40,000 all you have to do is simply give the Ladz at Mail Order a call on 01773-713213.

CITADEL JOURNAL 1

- WARHAMMER: HELBLASTER WAGON**£2.50
Rules for this new weapon and how to build your own Wagon.
- WARHAMMER: WAGONS ROLL!**£2.50
A Warhammer scenario using the new Helblaster Wagon.
- WARHAMMER: WEATHER CONDITIONS**£2.50
A new and comprehensive system for introducing random weather conditions into your battles.
- SPACE HULK: UNSEEN ENEMY**£2.50
New set up rules for Space Hulk
- SPACE HULK: SUPPLY LINES**£2.50
A thrilling scenario using the new Unseen enemy rules.
- EPIC: RANDOM ARMIES**£2.50
Random army selection and two new scenarios.
- EPIC: IMPERIAL & ELДАР KNIGHTS**£2.50
All new rules for these Imperial and Eldar machines.
- MAN O' WAR: BLOOD AND IRON**£2.50
Dwarf Runesmiths and Master Engineers in Man O' War.

CITADEL JOURNAL 2

- WARHAMMER: WEATHER MAGIC**£2.50
New spells for controlling the forces of nature.
- WARHAMMER: KNIGHT'S OBJECTIVES**£2.50
Knights form one of the most potent units on the table, unless of course they're getting distracted by damsels in distress or fulfilling some blood oath.
- SPACE HULK: HARLEQUINS**£2.50
What better to combat those dreaded Genestealers.
- EPIC: STORM THE BREACH**£2.50
Full urban combat rules for battles in anything from Plasma Power Stations to Gothic Shopping Malls.
- WH40K: WOLF LORD KVALNIR SILVERCLAW**...£2.50
All new Space Wolf characters plus modelling guide.
- MAN O' WAR: WIND AND WAVE**£2.50
High Elf Man O' War Magic rules.

CITADEL JOURNAL 3

- WH40K: ASSAULT**£2.50
First of a two part article, detailing using trenches, emplacements, concealed bunkers, etc. in WH40K.
- WH40K: YRRTHILIEN MOURNSONG**£2.50
New Eldar Jetbike character plus modelling guide.
- SPACE HULK: THE SILENT VOYAGER**£2.50
Campaign between Chaos' Emperor's Children and Space Wolves.
- EPIC: INNER FORCE**£2.50
Full psychic combat rules for fighting Epic battles in both the real universe and deadly Warp space.
- MAN O' WAR: CURSED OF NAGGAROTH**£2.50
Dark Elf Man O' War Magic rules.
- WARHAMMER: PLAGUE CART**£1.00
Plague and pestilence in the Warhammer World.
- MIGHTY EMPIRES: FORGOTTEN LANDS**.....£2.50
New terrain tiles, rules expansions and increased diplomacy!





CITADEL JOURNAL 4

- WH40K: ASSAULT II**£2.50
Concluding part, covering Battle Towers and Strongholds.
- WH40K: TINBOYZ**£1.00
Mekanikal madness with these Orky invensbuns.
- EPIC: THE POWER WITHIN**£2.50
Expanded psychic rules for Rune Priests, Adeptus Psykers and Chaos Magi.
- EPIC: SNAKEBITE CYBER-WYVERNS**£2.50
Huge, green and scaly with wings and big guns! A must for all Ork players.
- WARHAMMER: SIEGE**£2.50
Introduction to the forthcoming Seige system.
- WARHAMMER: FOR THE LOVE OF GOLD**£1.00
Details for mercenaries in the Old world.

- MIGHTY EMPIRES:
 BLIMEY! WHO PUT THAT THERE?**£2.50
Expand your scope of wilderness locations from dark, malevolent tombs to Mystic fountains.

CITADEL JOURNAL 5

- WARHAMMER: SEIGE II**£2.50
Knock, knock! Who's there? Seige Towers, battering rams, mantles, and a whole assortment of goodies to take your enemies castle with.
- MIGHTY EMPIRES:
 GREAT WALLS & FRONTIER FORTRESS**£1.00
Full rules for building mighty walls to protect your frontiers.
- EPIC: SPECIAL CHARACTERS**£2.50
Mad Doc Grotznik, Enjuneer Bignailz, Blood Axe Kommandos, Ork Warpbeadz and Squat Ancestral Lords.
- SPACE HULK: ELДАР**£2.50
Aspect Warriors, Exarcbs, Wraithguard and Warlocks.
- MAN O' WAR: WE ARE SAILIN'**£2.50
Brand new rules for marauding Orcs on the High Seas!

CITADEL JOURNAL 6

- WARHAMMER: DRAGONS**£1.00
New rules for Dragons (breath weapons and spell casting!)
- WARHAMMER: ARMIES: NORSE**£2.50
The first of a three part delve into the realms of Norse. Full Bestiary for the hordes of Norsca.
- WARHAMMER: MEETING ENGAGEMENT**£1.00
A simple article allowing you a different approach to games of Warhammer.
- WH40K: DEATH FROM THE SKIES**£2.50
Full rules and modelling guide for using WH40K Drop Pods.
- MAN O' WAR: FLEETS OF THE DAMNED**£2.50
Full rules for Undead fleets, including rules for Screaming Skull Catapults and Necromantic magic.

CITADEL JOURNAL 7

- WARHAMMER ARMIES: NORSE**£2.50
The second part of 'The Norse' kicks off with the Army List.
- WARHAMMER: OGRE MERCENARIES**£2.50
Well 'ard Ogre Mercenaries and their captain Old Funder.
- WARHAMMER: BETWEEN THE LINES**£2.50
Expanded skirmish rules as well as a special character.
- SPACE HULK: DESIGNERS CUT**.....£2.50
New weapon rules along with 4 complete new missions!
- WH40K: TANKFEST 40,000**£2.50
Expanded rules giving vehicles greater depth with rules for the mighty Baneblade and awesome Shadow Sword in WH40K.
- WH40K: SPACE WOLF TANKS**£2.50
Making and converting your own vehicles for WH40K.
- BLOOD BOWL: PICK 'N' MIX**£1.00
Using mixed teams, including team lists for the famous Underworld Creepers and a shaky alliance between Skaven and Goblins.

CITADEL JOURNAL 8

- WARHAMMER ARMIES:
 NORSE WAR MAMMOTHS**£2.50
Full rules to include these huge war-beasts in your Norse army.
- WARHAMMER ARMIES:
 NORSE CHARACTERS**£2.50
...and Norse special characters to boot.
- WARHAMMER: HERO CARDS**£2.50
Want more characters? Make your own with these ready-made Hero cards.
- WH40K: GOFFIK ROKKERZ**£1.00
Who's best? Who's better?
- WH40K: SQUIG BOMMERZ**£1.00
Kamikaze squigs!
- WH40K: ELДАР SCOUT WALKERS**£2.50
How to build and use these walkers in your WH40K games.
- WH40K: EVIL SUNZ GOBSMASHA**£2.50
Abandon road! Da Evil Sunz use these for Orky driving lessons!
- BLOOD BOWL: HE PLAYS LIKE A DAEMON**£2.50
Full rules for using Daemons (!) on the Blood Bowl pitch.

CITADEL JOURNAL 9

WARHAMMER: BARBARIAN MERCENARIES£1.00

An old favourite from our Quest games in Warhammer.

WARHAMMER: ENCHANTED SCENERY£2.50

Scenery covered in magic and all things sorcerous!

WH40K: PEGASUS£2.50

A new Amphibious Assault Vehicle based on the Chimera.

WH40K: ROGUE TRADERS£2.50

A complete new army list for armies of the Imperium.

WH40K: VENGEANCE CAVE£2.50

A new scenario featuring Eldar and Ultramarines.

EPIC: LEGIONS OF CHAOS£2.50

New Cbaos titans with added Daemonic powers, includes a modelling guide.

EPIC: GOFFIK ROKKERZ£2.50

Lets rokke!!!!

MAN O' WAR: NECROMANTIC MAGIC£2.50

Final article on the Undead Fleet with some nasty spells.

BLOOD BOWL: NEW STAR PLAYERS£2.50

Valen Swift, Erik Kantona, Jobo Hairyfoot, etc.

CITADEL JOURNAL 10

EPIC: LEGIONS OF CHAOS..... £2.50

Daemon Titan abomination for all beretics.

EPIC/WH40K: MEGA WARS (Part 1)..... £2.50

Campaign system for use with Epic & Warhammer 40K armies.

WH40K: DEATH FROM THE SKIES..... £2.50

Rules for Thunderhawk Gunsbips in WH40K.

WH40K: GRETCHIN ROCKET BOYZ..... £1.00

New Mekboy creations to bring more havoc to 40K Ork armies.

WH40K: ADAPTING THE MECHANIC STUFF..... £2.50

Do your own play testing with these new vehicle rules.

BLOOD BOWL: IT'S NOT JUST THE CROWD THAT GOES BERSERK..... £1.00

You've waited for so long, so here they are - Blood Bowl Norse.

COACHING IN BLOOD BOWL..... £1.00

Learn new skills from the coaches.

WARHAMMER: HALFLING MERCENARIES..... £2.50

Halflings get a new identity in Warhammer.



CITADEL JOURNAL 11

EPIC: CHARACTERS..... £2.50

Eldar Warp Spiders, Legions of the Damned Space Marines and new Imperial Guard characters to lead your troops.

EPIC/WH40K: MEGA WARS (Part 2)..... £2.50

Advanced rules to expand your campaigns, including rules for scenarios, fortifications, Psykers and much more.

WH40K: ASSAULT CHIMERAS..... £2.50

Devastating Imperial Guard vehicles to conquer your foes with.

ADAPTING THE MECHANIC STUFF, PART 2..... £2.50

All new movement rules for vehicles in WH40K.

SQUIGS IN BLOOD BOWL..... £2.50

Squigs in Blood Bowl! Surely they'll just eat the ball.

WARHAMMER: I'LL BITE YOUR KNEECAPS OFF!... £2.50

A Vampire scenario to get your teeth into!

CITADEL JOURNAL 12

STILL AVAILABLE!..... £3.99

CITADEL JOURNAL 13

STILL AVAILABLE!..... £4.00

CITADEL JOURNAL 14

STILL AVAILABLE!..... £4.00

WARHAMMER[®]

Spell, Dispel, Spell, Dispel, Spell, Dis.....

by *Tim Richardson*

Ever played with a High Elf army and had your 900 point super general killed by a blood crazed champion of Khorne with the SWORD OF TECLIS? Ever played against a large army of Dwarfs and found that NOTHING happens in the magic phase? If so then read on....

These rules are purely optional and don't have to be used - they just make Warhammer games a little bit more fun at times...

Option 1: Arbaal who? Never heard of ya...

The first option is to play without any special characters at all - yes that's right, no Nagash, Felix, Tyrion or anybody. This option makes games just that little bit more interesting as the role of characters is reduced somewhat and it also gets round those silly situations where a long dead character (ie. Magnus The Pious) fights one of today's heroes (ie. Felix)

Option 2: Curse of years, Valaya, Raise dead, Valaya, Hand of dust, Va...

The second option is to limit the amount of dispels in a game - yup, no Valaya etc. I have found that the best way to play this is to limit the total magic level of each side to a relatively low number (for example 5) and then restrict each player's access to any dispels, other than those in the magic deck. I also take out Total power from the deck as this makes things rather unfair when you are playing with limited dispels.

Earlier on I said to limit the Magic Level and, if this only incorporated wizards it would have little

effect as players would take lots of magic banners etc. Instead, for this reason I have counted any item or spell that can normally be dispelled as a magic level.

Therefore it is possible to have in a game with magic level 5:

- A single level 5 wizard
- A level 3 wizard, the Banner of Wrath and the Blasted Standard (not being held by the wizard obviously).
- Or many other combinations

The only other point to make is that it is still possible to buy items which dispel by their nature, but they would lose that ability - for instance Nagash's armour would no longer protect him from spells.

Option 3 "I'll shoot Dieter Helsnicht with my Staff of Flaming Death"

The third option is to play the game without using any magic item cards that have been printed in a Warhammer army book that your army does not come from. This only applies to cards that are printed in books not things like the Black Amulet, Amulet of fire or Death Sword and not familiars. (apart from Chaos ones) which have not had their cards printed in the relevant books. This stops those silly times when your General/Wizard, whatever gets killed by an opponent with the same weapon as him.

As I said these rules are totally optional and you may feel they are a little unfair on some armies - in this case don't use them as there is no point playing a game if you aren't going to enjoy it!

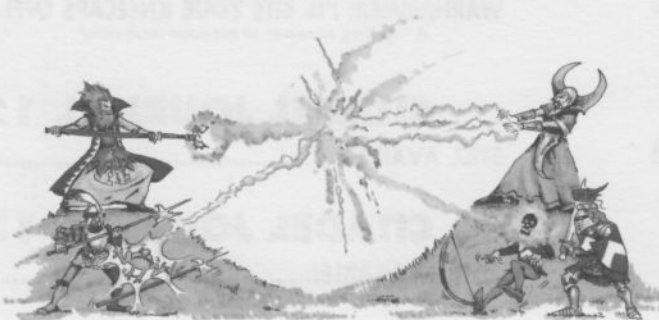



Waaaaaagh! Dakka! Dakka! Dakka!

by Jason Clark

Looking for an army to play in 40K? Need a change because you cannot seem to win enough? Play the Orks! Many people write articles about playing Orks. Yet, here is a 2,00 point army that can win even if you have terrible luck....

WEER DA BOYZ

Most people buy and select armies in 500 point blocks. Nonsense. You end up with a patchwork of disjuncted pieces. Army selection in 40K is really a case of looking at the whole army. Each piece of your army must strengthen and complement the others. A whole army approach will win if you keep in mind three conditions: firepower, missions, and limiting victory points. the Orks are one of the few races that can achieve all three.

Start with your Boyz. you need at least 500 points of them. Do not go too far over 500 points because regular Boyz are not that useful. The preferred clan is Bloodaxe. The Blood Axe boyz have the big guns; they allow you to choose Imperial vehicles. Even without targetters, Imperial vehicles are very useful against some races; they can withstand terrible amounts of damage and will often come as a surprise in a first time engagement.

Purchase nine Blood Axe boyz with bolters and have another boy bear a Heavy bolter. Lead these boyz with a nob equipped with a Plasma gun, Powerfist and eavy armour. The nob is useful for more than just his leadership. He can snipe at specific targets and can use his powerfist to bash any vehicle that gets too close to your lines. This mob including the nob costs 175 points. If all 11

Orks are killed, your opponent will receive two measly victory points; and they have toughness 4! But be tactically wise, a suicidal infantry charge has no place in this army. Put them on overwatch and in cover. Then stay put. Their role is defensive so pick your targets wisely.



Waaaaaagh! Dakka! Dakka! Dakka!

Next choose a Nobz mob with heavy weapons. While it is better to go with a mixture of big guns, four nobz armed even with Lascannons costs only 2 victory points and they hit large targets ie tanks on a 2+. Once again this mob yields only 2 victory points to your opponent if they are all killed. Use caution though; to keep your firepower throughout the game, make sure these boyz are not the closest unit to the enemy.



DA LITTLE RUNTS

After two mobz of boyz pick your gretchin. Choose between ten and twenty of these little soldiers depending on the enemy. If you pick more than twenty, the unit will cost over 100 points and they lose their victory point effectiveness. Like any good Ork Warlord, throw those Gretchin out as a screen for the enemy to shoot at the whole game. Do not worry about cover. Your opponent has to kill them all just to get one victory point so casualties are unimportant.

Cousins of the Gretchin, the snotlings make up the next choice. Select six and only six bases of snotlings for thirty points. Victory points explain why you choose only six bases of snotlings. A shock attack team counts as a squad. by choosing only six bases of snotlings, you keep the cost of the team under 100 points. Therefore, your opponent must kill all of the squad including these snotlings with three wounds, to score one victory point.

You can keep picking boyz but for now, save some points for optional troops. Optional troops help tailor your army to the enemy. With a mobile, fire-power based army, the Orks can take on anybody, but Orks unlike most races have specific equipment for specific enemies. If you allow points for this equipment and wargear, you will be better served in the long run. Keep these points in the back of your mind and move down the army list to the next category.



DA BIG SHOOTAZ

The army selection continues as the choices move on to support. Choose two Dreadnoughts. One has a Lascannon, Heavy Bolter, and Ablative armour and the other is armed with an Assault cannon, Heavy Bolter, Search Light, and Ablative armour. Both of these machines cost 160 points



apiece. Your Ork Dreadnoughts have anti-vehicle and anti-personnel capabilities and they are difficult to destroy for two victory points. (*I presume Jason is using the rules for converting vehicles from Dark Millennium.* - Ed.)

Following the Dreadnoughts the most important unit in your army is your vehicle squadron. A quality standard squadron costs 400 points. Four hundred points is a good deal of points, but vehicle squadrons have much to say for themselves. Picture five Warbikes with dual linked Autocannons, a Warbuggy with Multi-Melta, a Wartrak with a Lascannon, and a Scorcher rolling towards the enemy. Even though they are worth four victory points they are much harder to destroy than a normal 400 point squad. Move them at combat speed to get the negative modifiers on your opponent's to hit dice and stick one bike out in a shoot me kind of way. That bike becomes a fire magnet because your opponent has to shoot the closest vehicle. So you lose one vehicle every turn while your other vehicles are safe including your dreadnoughts giving fire support.

Watch out! Don't use your vehicles in a flank attack! Your Dreadnoughts can hold the flanks while your vehicles zoom up the middle. Flank

Waaaaaagh! Dakka! Dakka! Dakka!

attacks cut down the firepower of your squadron, and will be a waste of 20% of your points. Zip them up the middle and blast away. Even with bad luck you should be able to cause a high amount of damage each turn.



LOOK AT THE SIZE OF THAT BIG NOB!

The last core of points are spent on characters. Forget Ghazghkull Thraka; he costs too many points which you could use elsewhere and will not really help you. The extra fifty points that you save buys many useful weapons and you can tailor a cheaper Warboss to your needs.

You can use a Warboss equipped with: a Cyborg body, a Powerfist, a Spike arm, a Sword, a

Gyrostabilised Monowheel, and a Plasma Gun. Your Warboss was born to kill. Early in the game take a shot with your Plasma gun, then CHARGE! Think about this a 16" charge move, 8 weapon skill on the charge, four attacks, a parry and an armour value of 15. Now you are ready to take on enemy characters and all for 130 points!

Almost as important as your Warboss are your Mekaniaks and Runtherdz. You need a Mekaniak for your vehicles and a Runtherd for any artillery. Add the two characters together and you have a Shokk Attack team. Shokk Attack teams are great. They cost next to nothing; they can kill anything on the table ; and they scare the willies out of your opponents. A Mekaniak with a Shokk attack gun and a refractor field costs 48 points. Characters under 50 points are included in the squad total. For 96 points including the Runtherd and those six

bases of snotlings you get a powerful heavy weapon and your opponent has to kill all of the team to get a single victory point.

Another Character selection is painboy. You must have the Painboy for the dreadnoughts; so give him a vaccine squig. Viruses are the bane of any un-armoured army but the Orks have an answer for every contingency. With the Squig, all your boyz are protected from the virus and you can even use virus grenades against the Imperial Guard if you want. Note though, the vaccine squig brings the cost of the Painboy to 68 points. He is a cheap victory point so hide him well.

For the sheer Waaagh Power choose a Warphead. Never choice a Weird boy, they are too fragile and give away victory points. A Warphead costs a lot of points but he can be very destructive. Set him up and keep him with in twelve inches of your Blood axe boyz to get an extra Warp Card. During the game you might need to inch him towards the enemy lines as the most destructive powers have short range. That's OK. As long as there is no hand to hand you cannot head bang. If any of your boyz are about to enter hand to hand combat, run away from large groups of Orks. Even if your Warphead is killed you have so many guns it does not matter.



Waaaaaagh! Dakka! Dakka! Dakka!

Likewise, do not choose a standard bearer. With the exception of the Gretchin, so few of your squads will break. If you do select one, make it an unequipped Gretchin Standard Bearer. He costs 35 points and is worth no victory points

With all those Orks and big guns chosen you only have a few hundred points left. As was mentioned above base these selections on the army you will fight. Below is a quick reference list.

DA PAFETIK HUMIES (IMPERIAL GUARD)

- 1 Choose Blood axe Kommandos with Power Axes and a Kaptin with a devastating grenade (Haywire or Virus). Go for the command Squads and vehicles!
- 2 Choose a pair of Squig catapults at 40 points apiece. Buzzer Squigs stay on the board even if they miss and they can't hurt you.
- 3 Make sure your Warp head takes a Sniffer Squig. Get Da Krunch and Squish as psychic

powers. Assassins can't dodge Squish, and they will be trapped far away from you because of the Sniffer Squig.

DA PANZEE POINTY EREZ (ELDAR)

- 1 Choose another mob of boyz and mount them in a Rhino (remember you have Blood Axe Boyz). The Rhino will keep them safe from those awful Warp spiders and can be shielded from heavy weapons fire by your vehicle squadron.
- 2 Choose pulsa Rokkits. While they are one shot weapons they cause an automatic leg wound on walkers and dreadnoughts and they knock down and pin those super mobile troops for a round or two.

NASTY SPIKY THINGS (TYRANIDS)

- 1 Do not pick a Warhead. He will not be much use.
- 2 Take another mob of Evil Sunz on bikes. They are immune to psychology and carry big sustained fire guns.



Waaaaaagh! Dakka! Dakka! Dakka!

- 3 Buy a Tank. Put a Kustom Force Field and Ablative Armour on it. A Demolisher so armed costs 255 points with Heavy Bolters.
- 4 Pulsa Rokkits and Squig Catapults will slow down their attack. Well placed Pulsaz will allow you to hammer them on the first turn, then hammer them on the second before they move! Now that's Ork power!
- 5 Choose a Death Skulls mob of five armed with Heavy Stubbers. These boyz cost less than 100 points and can have ten sustained fire dice.

DEDD ARD HUMIES (MARINES)

- 1 Add a Sniffer Squig to your Warphead.
- 2 Use Pulsa Rokkits. Pulsa's hurt their dreadnoughts and Devastator squads.
- 3 Take additional boyz armed with close combat weapons to fight off those Assault Troops.

THERE'S SOME MORE BOYZ! LETS SORT EM OWT! (SOME ONE ELSE'S ORKS)

- 1 Change your Warboss to Nazdreg for those additional strategy cards. You want Brilliant Strategy or Traitor. Getting the first turn is important here.
- 2 Use Pulsa Rokkits on their vehicle squadrons and dreadnoughts. Their dreadnoughts will take a leg wound go out of control and hit each other, rocks and trees.
- 3 Take those additional boyz in a Rhino again to even up the numbers. Run them over.

SOM KLEVER TAKTIKS

The Orks now have an offensive and defensive force. Your army will have the fire power to succeed at any mission and they will be very stingy when it comes to giving up victory points. But you are not finished, the final consideration for an Ork army is the mission. The Orks are very lucky indeed because they only have four possible missions. Each mission requires special tactics but here is a brief summary.

If your mission is Dawn Raid, use your vehicle squadron to smash apart their lines. Remember the targeting the closest vehicle rules. If you use the squadron correctly, your enemy will be hard pressed to destroy all eight of your vehi-



Waaaaaagh! Dakka! Dakka! Dakka!

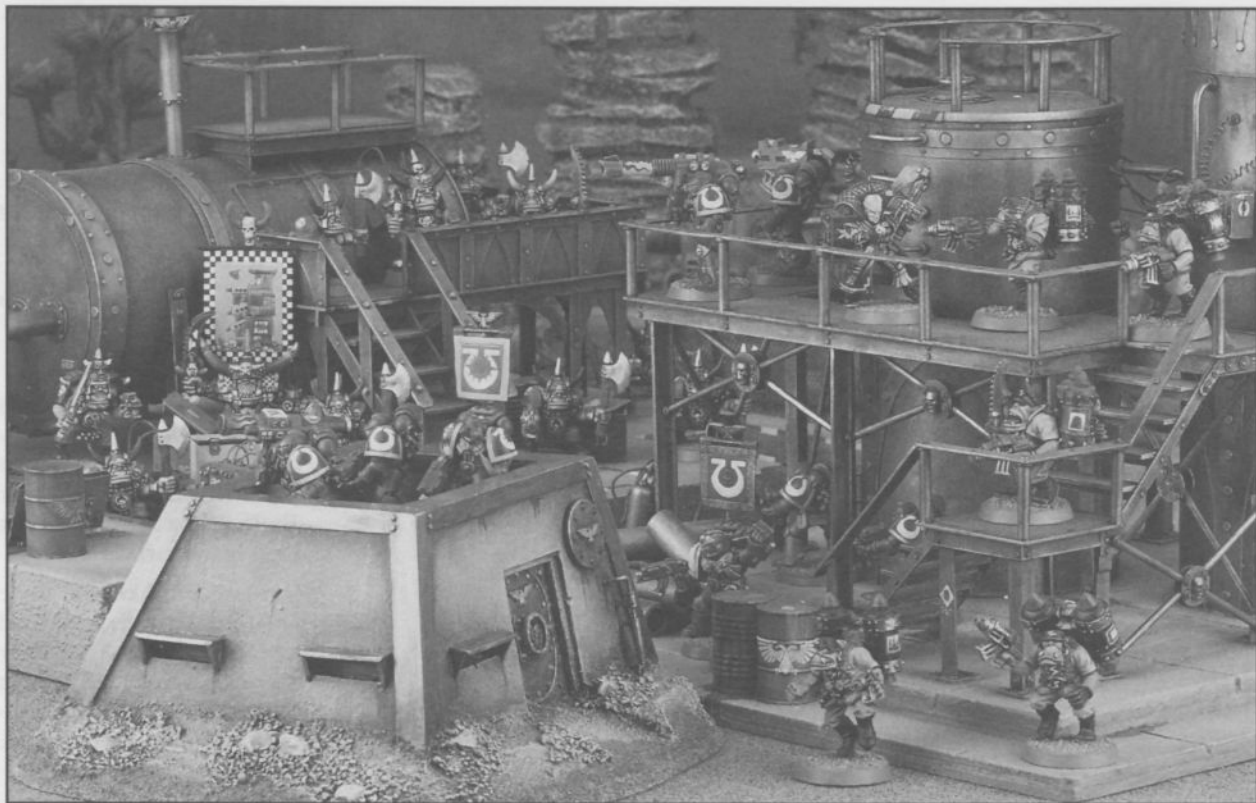

cles in four turns. Remember you only need one undamaged vehicle to survive. Use your dreadnoughts to shoot up threats on the flanks while the rest of your army supports the attack.

Vehicle squadrons help in Take and Hold as well. This time use those vehicles as a screen for your dreadnoughts. On the first two turns use a dreadnought to shoot up the enemy then run it towards the objective. While the enemy is shooting their heavy weapons at the light vehicles your dreadnought can gain the objective unmolested. Most armies will be hard pushed to remove the dreadnought in one turn.

Guerrilla War is always a tough mission. You probably gain the fewest points for this mission but you still achieve some. Use your Warboss and any other characters to do most of the fighting. Remember that 16" charge move. Dreadnoughts can also beat up any infantry that get too close.

Engage and Destroy is probably the best mission for any Ork army. Don't sit back with those vehicles though. Play Engage and Destroy aggressively like Dawn Raid. All of your Heavy Weapons fire will really dishearten many commanders.

The Orks can be the most powerful army in 40k. As their commander you have an army that is

cheap fast and shooty. With the army that has been selected you can out gun the Imperial Guard and out manoeuvre the Eldar. Points, both victory and selection, are important when choosing a force so keep them in mind. Do not be afraid to lose some troops; by the end of turn four, you should really cause some carnage. May the enemy always question if you miss!



WARHAMMER®

GOBLIN JESTERS! (or 'How to annoy absolutely everyone)

by Greg Prince

Inspired by the havoc wreaked by 'Gubbins the Jester' (from the 'Lair of the Orc Lord' scenario pack) in a game of Warhammer Quest, Greg thought how useful a Goblin Jester would be on the battlefield. The look on your opponents face when he discovers his prized Chaos Knights need 5's to hit a unit of Gobbo's is hilarious...

The greenskinned races are common throughout the Old World, and it is a well known fact that Goblins in particular, are downright pests. Sneaky, sly, but above all cowardly, Goblins are one of the most annoying races in the Warhammer world (as any band of brave adventures will testify) and are about as much use on a battlefield as a wet sponge (although as cannon fodder they do have some uses!). However there exists a strange sub-group of these creatures in Goblin society that are so crazed (possibly through some genetic fault) they devote their entire lives to generally making a nuisance of themselves, getting in the way of their larger cousins, the Orcs, and upsetting the normal daily

routine of entire tribes of greenskins who look upon them as amusing pets running around the place in highly conspicuous, brightly coloured clothing, whooping hysterically as they go. Other more sanely minded greenskins have dubbed these unusual Goblins "Jesters".

Jesters are rarely seen on the battlefield, not because of their relatively small numbers but because they are normally too busy frantically zipping about the tribes lair or encampment in such a hyperactive fit that they fail to notice the rest of the tribe has marched off to war. Strangely enough when these creatures finally reach a battlefield they enjoy themselves immensely as they view the opportunity to annoy someone new (the enemy) as particularly challenging. The problem is though, left to their own devices the Jesters would run around the field of battle desperately annoying whatever unit they first encountered.

However, it was not long before Goblin Bosses learnt that by chaining the delirious little chap to themselves they could drag the Jesters wherever they wanted.

The first Goblin to attempt this was a member of the Rotting Nose tribe of the lands around the Border Princes and known as Skabby to his associates. At first the results of this experiment were very successful as the mad little greenskin so enraged their human opponents that their attacks became wilder and less controlled with anger, allowing for the first time in the tribes history for a Goblin unit to rout their opponents by attacking while the Jester occupied the attention of the humans. However it



was not long before the down side of the move made itself felt, and indeed was the cause of Skabby's demise. His entire unit became so paralysed with laughter at the Jesters antics they failed to notice the vengeful human cavalry looming on their flanks.

Many Goblin Bosses have since followed his example (and most have probably met a similar end), but the temptation to include a Jester in a Goblin unit often proves too much for a greenskin leader.

Jesters on the Battlefield

Any Orc and Goblin army may include up to one Goblin Jester in their force if the army also includes at least one unit of Goblins (not Night, Forest or mounted Goblins such as Wolf riders) with a character of at least Boss level for the Jester to accompany (the Jester effectively replaces one of the characters magic items). So a Boss could have a Jester or a Magic item, A Big Boss could have one of each and so on.

A Goblin Jester costs 40 points to include in the army which goes towards the character points allowance and they have the following stats:

	M	WS	BS	S	T	W	I	A	LD
Goblin Jester	4	2	3	3	3	1	2	?	?

Goblin Jesters do not make attacks as such and have no Ld value as they are chained to the character so go pretty much wherever he goes. Jesters must be placed in the front row of a unit and adjacent to the character, effectively replacing a model in the rank. When the unit containing the Jester charges, or is charged in hand to hand combat then each turn, before

any blows are struck, roll a dice and consult the "You Annoying Little *&£*&\$" table below

As Jesters are so energetic in battle it is almost impossible to hit the blighter with their weapons. If an enemy character wants to do so he must first roll a 6 on one die before rolling to hit. Otherwise the only way Jesters are removed is if the character is killed. It is assumed the Jester wanders off the battlefield.

Goblins are always encouraged by the presence of a Jester so a further +1 is added to the units overall Ld value (including that of any Characters). Orc characters will tolerate Jesters but the deeply serious Black Orcs consider Jesters to be the bane of their lives and will attempt to kill any that want to join their unit. Therefore any Goblin unit which includes a Black Orc character may not be allocated a Jester.

On the downside however, Goblins are always distracted by Jesters so every turn the unit is not in close combat and passes it's animosity test roll one D6. On the roll of a 1 the unit is rapt with laughter so may do nothing for the rest of the turn.

Allies: As the number of these weird creatures is extremely limited, if the Orc force is being chosen as part of an allied contingent by another force (eg. Chaos Dwarfs can ally with the greenskins) then the force may not include a Jester. This also represents the fact that any Warlord lucky enough to 'own' a Jester would certainly not squander his potential by sending him out to fight for another force (albeit as allies) and would much rather keep one to use for a more important battle (i.e. one where lots of his Orcs beat up lots of other people on their own).



YOU ANNOYING LITTLE *&3*&\$!

1, OH DEAR!

The Jester seems to have become rather confused in the heat of battle and is leaping about and getting completely in the way of the Jester's own unit! As a result of this, all attacks made by the Greenskin unit this turn suffer a -2 to hit rolls (this may not however, result in rolls requiring 7+ to hit unless there are other modifiers, magical or otherwise effecting the unit. In this case use the following rules to make a 7+ to hit roll, first roll your attack dice and any which score a 6 you reroll. If, the second time the dice rolls 4+ then you have hit.)

For example, Goblins with a WS of 2 require 5+ to hit a WS of 9. This would result in a 7+ to hit roll, but this would be modified down to 6+ unless the enemy has a magic item or special ability that afflicted extra modifiers which would combine with the Jesters roll to make the 7+ roll no matter how many extra modifiers are added. 8+ or 9+ rolls are not allowed because even 7+ rolls are extremely difficult to make and there is no such thing as an impossible to hit roll.

2, OOOPS!!!

The Jester is continually harassing the character adjacent to him so all attacks made by that character suffer a -2 to hit modifier (also see above)

3-4, NOTHING HAPPENS.

No one is particularly impressed with the Jester's antics so the little green chap sulks uncontrollably until next turn and there are no resultant effects.

5, WHAT THE @*&%3@*&@!

The Jester begins to jump up and down and laugh in the face of the nearest character model (not standards or musicians) in the opposing unit who suffers a -2 to hit roll penalty on all attacks this turn. If the unit has no characters (unlikely) the nearest model to the Jester is affected.

6, YOU ANNOYING LITTLE *\$**&!!!

The Jester performs an amazing display of acrobatics while hollering insults at the top of his squeaky voice which thoroughly distracts the entire front rank of the enemy unit which suffers -2 to it's hit rolls this turn.

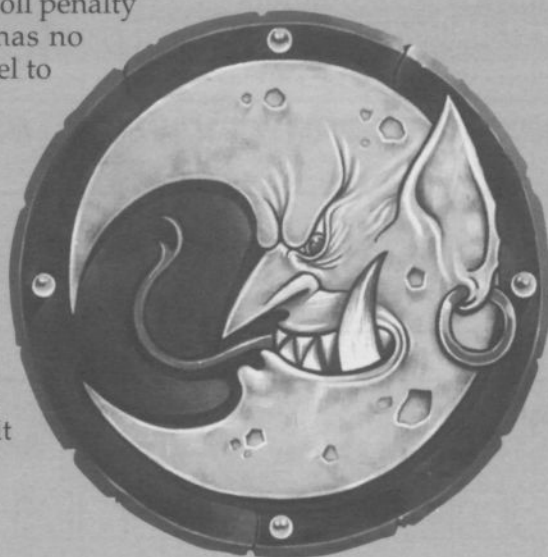

WE'LL GIVE YOU THE GARGANTUAN CITADEL MINIATURES ANNUAL 1995/96 FREE WHEN YOU SUBSCRIBE TO THE CITADEL JOURNAL!

THIS OFFER APPLIES TO NEW SUBSCRIBERS, RE-SUBSCRIBERS AND THOSE OF YOU WISHING TO EXTEND AN EXISTING SUBSCRIPTION. WE'LL DELIVER THE NEXT 5 ISSUES PLUS THE 1995/96 CITADEL MINIATURES ANNUAL DIRECT TO YOUR DOOR FOR JUST:

£20.00 (UK & BFPO)

£30.00 (Overseas)

To take advantage of this offer simply call us now on: 01773-713213 (Credit card only by phone) or complete the form below and return it to us as quickly as possible.

If you are a new subscriber your subscription will start with the next issue published. Unfortunately we cannot include back copies in subscriptions as they are in such limited supply.

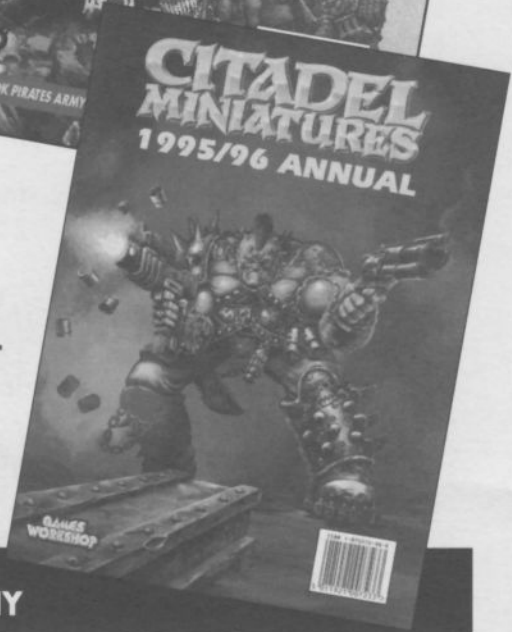
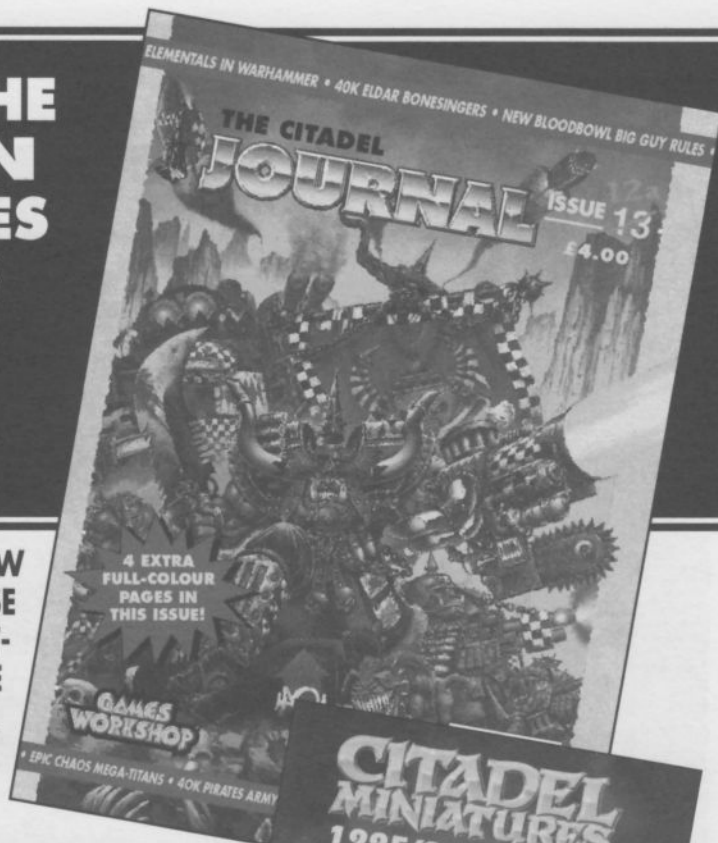

**Games Workshop Mail Order,
Chewton Street, Hilltop, Eastwood, Notts. NG16 3HY**

PLEASE START MY JOURNAL SUBSCRIPTION WITH NUMBER _____ AND SEND ME MY FREE 1995/96 CITADEL ANNUAL

Name: _____

Address: _____

Country: _____ Post Code: _____

Telephone: _____

I am paying by:

Cheque Postal Order Visa Access/Mastercard Switch

Card No.

Switch Card Issue No. _____ Card Expiry Date _____

Cardholder Name _____ Cardholder Signature _____

Cardholder Address _____

WARHAMMER®

THORNS IN THE SIDE

by Aleksandr Plusowski

Every experienced Warhammer player has undoubtedly felt a great deal of agitation in at least one battle when his carefully constructed strategy, or the abilities of his special troops are compromised by individual enemy upstarts who are not found in the front rank, but behind the battle lines, directing events while drinking their tea! Aleksandr explains how to plot the downfall of those annoying wizards, runesmiths and necromancers who, while not directly involved in the fighting, play an important part in hindering the efforts of the other player, while increasing the advantage for their own troops. They are a thorn in the side of their opponent, and while no doubt many of you have found intricate and elaborate ways of achieving their demise, here are some basic ones for those players who start chewing their models out of frustration...

The Arch-Enemy

There are three main categories of annoying cretins who are constantly asking for a beating...

1) Empire wizard lords (especially the Supreme Patriarch)

These wizards, while being poor fighters and survivors in combat are heavy on the magic that can alter the course of battle within a bat of an eyelid. The supreme Patriarch is especially a prime target, because of the staff of Volans, which effectively means he can sit playing chess on the edge of the field, while meteors the size of Wembley stadium fall from the sky on a regular basis - and there is nothing you can do about them! Likewise, Grey wizards who casually lift characters 36" away and flick them to the other side of the field, there are numerous examples. These wizards also have the irritating ability of darting around the field themselves; they get bored of the view or wish to escape certain death from a volley of arrows.

2) Elven Mages

Again, they are not too good at fighting or surviving but their spells are worth their weight in gold. A good general fighting a magical army such as the undead would like to retain those drain magic and assault of stone spells for as long as possible. This involves the Elven wizard fleeing about on a horse or some other agile device, taking cover in forests and rarely straying into the charge range of an irritated Bloodthirster. It is very frustrating for the opponent to have to keep chasing this bag-o-tricks across the battle field while his units are burning up and mountains are crushing his rearguard.

3) Necromancers

They are a real pain! Although more proficient at fighting than ordinary wizards they are still delicate

in combat, and the death of a necromancer holding a powerful spell such as raise dead or Vanhels can be a great loss to the undead army and could even cost them the battle. Bad luck may force this situation upon an undead player, who shuttles through the Necromancer rather than lich. With the dark mist (as





well as colour and dark) at their disposal, these Necromancers are going to move around quickly and evade volleys from cannons or flying hammers.

And of course, war machines are always an irritation for the enemy, especially if they are accurate, multi-shot engines which are capable of mass devastation within a single turn such as the bolt thrower which cleaves through units as if they were butter (especially undead, Skaven and Goblins).

So what are the solutions to these hair-tearing agitators? Read on...

Fight Fire with Fire.

Wizards are often best ousted with magic. The magical repertoire of most armies allows for at least one spell capable of reducing a single target to ashes. The Skaven have excelled in this, being able to increase the range of their spells by an infinite amount, providing they have the power. Chaos are also excellent at destroying (eg. incandescent assassin), while gold tops the league with the longest ranged spell - the Gleaming Arrow that rockets 72" across the board, likely to kill a low level Necromancer or seriously injure a wizard lord. (A more interesting version of this is the Goblin Doomdiver).

Should the elven wizard seek cover within a forest to cast drain magic, deprive him of this scenery, transmute it or even better create a blazing inferno with Scorch and combine it with a restraining spell. Within a few turns, the Elven wizard will resemble the texture of Brazilian coffee.

Alternatively, if your Vampire Lord has Witchflight, why not visit the irritating bugger yourself and shove couple of axes down his throat. Amusing spells such as the Traitor of Tarn or Madness allow you to march the offending item out of cover and dance a jig in a clearing, a perfect target for your war machines, spells, charging units etc.

Vanhels and The Bridge of Shadows can transport deadly units across the field, and drop them en par with the Vampire Lord using Witchflight, right next to the wizard. Those mummies which seemed so, so far away, are suddenly tapping him on the shoulder. Undead cavalry are the best, for they can ignore terrain penalties, and with a charge of 16", they should reach quite far, even without help from Vanhels.

The best way to destroy a target in this way is to set it as your personal objective and set aside a unit or character to do the honours.

Death from the Skies

Flying creatures are excellent at moving across the field quickly together with the characters they bear. Thus Arkhan and his chariot, an Elven hero upon a Dragon and even a lone Manticore will make short work out of a small wizard or Necromancer.

My favourite combination is found with Chaos... A Chaos Lord of Tzeentch mounted on a Flying Disc, armed with a double-handed weapon, the Helm of

Many Eyes and a few extra Chaos Rewards that add fighting bonuses makes a perfect assassin. He can swoop down from the sky and hack the target to death before he can draw his blade in anger. The target may even flee before combat begins. The Chaos Hero is not likely to be killed or even wounded in this fashion and so can be re-used (recycled) to take out other potential targets, such as war machines. Against Skaven, combat may actually never occur...



These combinations are sneaky, but reflect the need to remove annoying upstarts. Nagash surrounded by a horde of Tomb Guardians (see Journal #13) on the other hand is a different matter entirely and here a Gleaming Arrow would not get you very far.

Hack 'em, Shoot 'em...

Natural assassins can be sought, both the Skaven and Dark Elves have specialists at maiming Warhammer personalities and they should be used. Remember that chasing an individual with a unit is much harder than chasing an individual with another individual.

Against the Empire, the Screaming Skull chucker is a delight. It is useful to aim at artillery units who cannot take advantage of leadership bonuses within the main units. They will flee (if you are lucky) and so might wizards in near proximity to them. Placing characters near the edge of the battlelines is a risky business, and most individual irritants usually hide at the back of units or within forests.

Other war machines can also be put to great use against individuals. Gyrocopters rendered invisible by runes can sneak up upon their target and fry him in a single sheet of steam.

These characters are not always present in every battle, but if you play large battles of 6,000 points or more, then they may prove a menace if the opponent splits his magical arsenal among a group of wizards. Even an Empire wizard lord would not be seen fighting in the front rank with a Vampire Count. The value of spell-casters is compromised by the lack of fighting skills and so the player will tend (in large battles where both sides have strong leading characters) to find refuge for their mounted wizard lord, either in a forest, behind a house, or in the back of a heavily armoured unit. Regardless of his cover, the bulls eye will remain firmly between his eyes!



Disheartened (Before)

The enemy gang has been beaten by yours several times in the past and is not as confident as usual. All of their fighters have -1 to Leadership tests and bottle tests for this game.



Slippery Surface (Before)

You must play this card after the buildings have been placed but before the gangs deploy. The surfaces of all the buildings and walkways are wet from humidity and moss. Any models which run or charge while on a building or walkway must make an Initiative test. If the fighter fails the test then he slips over and might fall over the edge of the building.



Bounty Hunter (Before)

A Bounty Hunter is after a dangerous outlaw who he believes is fighting with the gang you are about to face. The Bounty Hunter promises you half the reward money for the outlaw if you help him capture the renegade. The Bounty Hunter joins your gang for one game free of charge. Randomly determine one member of the enemies gang. If the Bounty Hunter captures him then split his reward money in half and add the amount to your stash (see Outlanders for details of outlaw rewards).



Toxic Waste (Event)

Play this card when you make a ranged attack on a model but miss. The attack hits a toxic waste pipe just above the target, and highly corrosive waste cascades all over the target. The model immediately takes D3 Strength 4 hits with no armour saving throw allowed.



Loot (Before)

Take D6 loot counters and place them according to the rules given for the Scavengers scenario. The loot is worth D6x5 credits each. Note that there are no monsters in this particular game.



Honour Debt (Before)

A Ratskin scout or an Underhive Scum owes a debt of honour to your gang leader and chooses to pay it now. For this game you can add a Ratskin Scout or an Underhive scum to your game without paying the hire fee. After the game is over the honour debt will be paid and the hired gun will leave unless you decide to pay his hire fee.



Sickening Fungus (Event)

When you draw this card note down a single building level on the table which is infested by a fungus formation. Any fighter who walks in or across the building must make a Toughness test on a D6. If the model fails the test he suffers one wound which cannot be saved by armour saving throws or any other way.



Genestealer! (Event)

This card must be played at the end of your turn. A Genestealer enters play from the middle of a table edge of your choice (either left or right edges, it may not appear behind the enemy gang). The Genestealer will move towards the nearest model and attack it if the creature reaches them. You move the Genestealer at the end of both players turns, but remember the Genestealer will go for one of your men if they are closer. See the Outlanders bestiary for the profile and rules on Genestealers.



Blood Feud (Before)

"... And this makes four scalps!"

This fight is a blood feud. Any model taken Out of Action in hand to hand combat by your men will confer an additional D6 Experience Points to that fighter.



Unsafe Ladder (Event)

Play this card when an opposing model climbs a ladder. A rung gives way and the model falls back down to the ground, from the top of the ladder. Check to see if the model is injured using the normal rules.



Treasure Stash (Before)

The gang which wins this fight will find a great pile of valuable treasure close to the location of the fight. The winning gang adds 2D6x10 credits to its income.



Shakedown (Before)

The opposing gang has been stopped by an Adeptus Arbites patrol and D3 randomly determined members of the gang have been taken in for questioning. These models must miss the fight.



Wandering Doc (After)

A wandering doctor takes care of all the seriously wounded members of your gang for a small fee of 20 credits. Each member of your gang who must roll on the serious injury table can make two rolls and choose whichever result you prefer. Ratskin Scouts roll three times.



Live wire (Event)

Play this card on an enemy model that has just suffered a flesh wound or been taken down or out. As the model staggers back and collapses it trips on to a live cable. With a blinding flash thousands of volts of electrical energy course through the model, killing it instantly.



Out of Ammo (Event)

Play this card after your opponent makes an attack. The weapon they have used runs out of ammo, no matter what their to hit roll was and no ammo roll is required.



Giant Rat (Event)

Play this card in the close combat phase on a model that is NOT engaged in hand to hand combat. The model has disturbed a Necromundan Giant Rat, which attacks. See Outlanders for the full rules on Giant Rats. The Giant Rat will run off once the combat is resolved.



Dangerous Walkway (Event)

The player who draws this card secretly notes down any walkway on the table as dangerous. During the game, when a miniature moves over the walkway, you may declare that it is dangerous - roll a D6 and add the models Toughness to the result. Add a further +1 if the model is carrying a special or heavy weapon.

If the total is 8 or less then the walkway holds. If the final result is 9 or more, the walkway collapses and any miniatures standing on it will fall with it. Miniatures on the walkway take a hit in the same way as falling models. The walkway will drop straight down and any models fully or partially under the walkway must make an Initiative test to escape the falling debris. Any models which fail this test will be injured automatically no matter how many wounds they may have. Roll a dice to determine whether they are Man Out or Man Down, etc. The walkway is removed from play.



Aim High (Event)

If the enemy's Leader is taken Man Down or Out of Action, the fighter causing the wound gains an additional 10 Experience Points.

The card is discarded after the opposing gang's Leader is forced Man Down or Out of Action.



Secret Target (Before)

At the beginning of the fight, before placing the gangs, secretly note down the name of an enemy fighter. The first time that fighter is hit and wounded during the game, the fighter causing the hit gains an additional D6 Experience Points.

Keep this card until the target model is shot and wounded and then discard this card.



Poison cloud (Event)

You must play this card at the beginning of your turn. Declare a table edge of your choice. D3 Hallucinogen gas clouds move on 2D6" from the table edge in a direction of your choice. Follow the usual rules for Hallucinogen grenades.



Lucky Find (After)

A ganger, sent in search of rare trade, has a bit of luck. Along the way he finds, between a mass of debris and waste objects, a single useful item which he brings back instead. The ganger does not contribute to the number of rare items found in the post battle sequence but roll a D6 on the Rare trade chart. The ganger has acquired that item totally free of charge.



Race against time (Before)

Each member of your gang will gain additional Experience Points at the end of the fight if you win the race against time. If you beat your opponent in 1 turn you will gain an additional 5 Experience Points per fighter taking part. If you beat the enemy gang in 2 turns you gain 4 Experience Points, this is then reduced to 3 points in your third turn and so on. If after your fifth turn you have not beaten off the enemy then you have lost the race against time and gain no additional Experience Points.



Archeotech (After)

Your Leader happens to know of an archeotech board not so far away. You can send a ganger to search that territory instead of collecting income or searching for rare trade. The ganger collects 2D6x10 credits from the territory before underhive settlers move in and claim it as their own. This income is added to the gang's income total before profits are worked out.



Scout (After)

At the end of the game you may select one of your gangers to be sent in search of new territories, instead of collecting income or searching for rare trade.

Randomly determine a new territory from the territory table. If the D66 roll comes up a double then the ganger does not find a new territory and returns empty-handed. If the dice roll is not a double then you may add a new territory to your existing territories and this can be worked after your next fight.

SPIKED SHOULDER PADS

This allows the Ex-Blood Bowl Player to make a special Running Blitz attack. He may Move and attack, then continue moving and attack again. He may continue to do this as long as he moves in a straight line and doesn't run out of movement points. He may use all of his natural attacks on each enemy attacked, but gets no "deathblows". While doing a *Running Blitz*, the Ex-Blood Bowl

GAT-ORK-ADE BOTTLE

Can be used once per game to have one of the following effects:

- Restore the Ex-Blood Bowl player to full health.
- Give the Ex-Blood Bowl player +2 Str. for one turn.
- Double the Ex-Blood Bowl Player's move for one turn.



EQUIPMENT

EQUIPMENT

GREATER DAEMON

Warp Palace of Tzeentch

The Warp Palace is classified as a flyer and follows all the rules for such craft.

The Warp Palace has a psychic saving throw of 3+.

WARP ENERGY

Roll an artillery dice to determine how much power is accumulated per turn. Power can be used for movement or psychic attacks.



VICTORY POINTS 4

Your opponent gains 4 VPs when the Daemon is destroyed

GREATER DAEMON

Warp Palace of Tzeentch

The Warp Palace resembles a massive floating fortress atop a colossal flying disk



POINTS VALUE 400



EX-BB PLAYER ADVANCED PROFILES

Battle Level 6 Wounds: 6D6+9 Wpn./Bal. Skill: 5/3+
Strength/Dice: 4/2 Toughness: 4 (5)
Initiative: 5 Attacks: 3

ENEMY'S WS	1	2	3	4	5	6	7	8	9	10	Luck:	2	
TO HIT	2	2	3	3	4	4	4	4	4	4	Willpower:	4	
SKILLS: 4												Pinning:	5+

Battle Level 7 Wounds: 7D6+9 Wpn./Bal. Skill: 5/3+
Strength/Dice: 4/2 Toughness: 4 (5)
Initiative: 5 Attacks: 3

ENEMY'S WS	1	2	3	4	5	6	7	8	9	10	Luck:	3	
TO HIT	2	2	3	3	4	4	4	4	4	4	Willpower:	4	
SKILLS: 5												Pinning:	5+

Battle Level 8 Wounds: 8D6+9 Wpn./Bal. Skill: 6/3+
Strength/Dice: 4/2 Toughness: 4 (5)
Initiative: 5 Attacks: 4

ENEMY'S WS	1	2	3	4	5	6	7	8	9	10	Luck:	3	
TO HIT	2	2	3	3	3	4	4	4	4	4	Willpower:	4	
SKILLS: 6												Pinning:	5+

At Battle-level 8 a Barbarian gets +2 on his Berserk dice roll

Battle Level 9 Wounds: 9D6+9 Wpn./Bal. Skill: 6/2+
Strength/Dice: 4/3 Toughness: 4 (5)
Initiative: 6 Attacks: 4

ENEMY'S WS	1	2	3	4	5	6	7	8	9	10	Luck:	3	
TO HIT	2	2	3	3	3	4	4	4	4	4	Willpower:	4	
SKILLS: 6												Pinning:	5+

Battle Level 10 Wounds: 10D6+9 Wpn./Bal. Skill: 6/2+
Strength/Dice: 4/3 Toughness: 4 (5)
Initiative: 6 Attacks: 4

ENEMY'S WS	1	2	3	4	5	6	7	8	9	10	Luck:	3	
TO HIT	2	2	3	3	3	4	4	4	4	4	Willpower:	4	
SKILLS: 7												Pinning:	5+

THE EX-BLOOD BOWL PLAYER

Across the Known World a game is played pitting teams from all races against each other. This game is BLOOD BOWL. It was designed to solve disputes between armies or nations without always going to war. Only the toughest individuals make it at playing Blood Bowl, in fact the only difference between open warfare and Blood bowl is that in Blood bowl the players are supposed to try to score points with a ball. Everyone in the Old World likes a bit of Blood Bowl, even it is only to support their races greatest team in the Super Bowl.

Many people find it strange to find a Blood Bowl player in the middle of a dungeon beating seven shades of @*%\$ out of orcs, but players do occasionally retire having survived playing the greatest game ever, and usually have nothing better to do, or if between leagues what better way to earn money and keep up on the practice.

Being used the open astrogranite field, Blood Bowl players do occasionally have to get used to the confines of the maze of a dungeon, and they never seem to be able to handle a sword or any other conventional weapon. However, even with these disadvantages, they can find uses for all of the skills that they are used to, Minotaurs never expect a Human to charge in him with only his shoulder, and there has been many a confused monster after they have been hit with a Blood Bowl ball.

EX-BLOOD BOWL PLAYER

Wounds: 1D6+8
Move: 4
Weapon Skill: 3
Ballistic Skill: 5+
Strength: 4 (5)
Toughness: 3 (4)
Initiative: 3
Attacks: 1



Equipment: Lantern.

Weapon: Spiked Shoulder Pad (see card).

Armour: Blood Bowl Armour, giving him +1 Toughness.

Pinning: Breaks from pinning on a roll of 4+.

Special Rules

Powerful Strike: This ability gives the Ex-BB Player a +1 Strength when he fights with bare hands or Spiked Shoulder Pads.

Follow Up: Anytime the Ex-BB Player kills an enemy, he may forego a "deathblow" to Follow Up and move into the monster's square.

Push It: The Ex-BB Player may Push It after he completes his full move, allowing him to move up to two additional spaces. For each additional square moved, he must roll a D6. On the roll of a 1, he has tripped and injured himself. This ends his move, and he takes D3 wounds, not modified for toughness or armour.

ENEMY'S WS	1	2	3	4	5	6	7	8	9	10
TO HIT FOE	2	3	4	4	4	4	5	5	5	6

EX-BLOOD BOWL PLAYER ADVANCED PROFILES

Battle Level 2 Wounds: 2D6+8 Wpn./Bal. Skill: 3/5+
Strength/Dice: 4/1 Toughness: 3 (4)
Initiative: 3 Attacks: 1

ENEMY'S WS	1	2	3	4	5	6	7	8	9	10	Luck:	1	
TO HIT	2	3	4	4	4	4	5	5	5	6	Willpower:	3	
SKILLS: 0												Pinning:	4+

Battle Level 3 Wounds: 3D6+9 Wpn./Bal. Skill: 4/5+
Strength/Dice: 4/2 Toughness: 3 (4)
Initiative: 4 Attacks: 2

ENEMY'S WS	1	2	3	4	5	6	7	8	9	10	Luck:	1	
TO HIT	2	3	3	4	4	4	4	4	5	5	Willpower:	3	
SKILLS: 1												Pinning:	4+

Battle Level 4 Wounds: 4D6+9 Wpn./Bal. Skill: 4/5+
Strength/Dice: 4/2 Toughness: 4 (5)
Initiative: 4 Attacks: 2

ENEMY'S WS	1	2	3	4	5	6	7	8	9	10	Luck:	2	
TO HIT	2	3	3	4	4	4	4	4	5	5	Willpower:	3	
SKILLS: 2												Pinning:	4+

At Battle-level 4 a Barbarian gets +1 on his Berserk dice roll

Battle Level 5 Wounds: 5D6+9 Wpn./Bal. Skill: 5/5+
Strength/Dice: 4/2 Toughness: 4 (5)
Initiative: 5 Attacks: 2

ENEMY'S WS	1	2	3	4	5	6	7	8	9	10	Luck:	2	
TO HIT	2	2	3	3	4	4	4	4	4	4	Willpower:	4	
SKILLS: 3												Pinning:	3+

MAGIC WEAPON 45 POINTS

THE BLACK BLADE

The Black Blade is a scimitar of unknown metal, but its potency in combat cannot be denied.

The Black Blade emits black clouds around its wielder, giving a -1 modifier on any to hit rolls by his opponents. In addition, it increases the wielder's strength by 1 point.

TSARSALTIAN ONLY

MAGIC WEAPON 100 POINTS

BLOODEGE

This is the dreaded magic sword that Koshet the Immortal made to be the bane of the Goblinoïds. Unfortunately, it passes some of the madness of its maker to its user, making him thirst for the blood of his enemies.

Any enemy models within 3 inches of the Bloodedge suffer 1 wound on the roll of 4+ in the beginning of any magic phase as small wounds and bleeding cuts appear in their flesh. These wounds can be saved by armour as normal, without any reduction in the armour save roll. It has no effect on Undead, Daemons or any non-living creature. Bloodedge confers a -2 armour save modifier when used in normal combat. It gives a +1 to wound against Orcs and Goblins.

IGOR THE TERRIBLE ONLY

MAGIC ITEM



MAGIC ITEM

MAGIC ITEM



MAGIC ITEM



A mischievous Gobbo Jester wreaks havoc amongst the ranks of the Witch Elves