

# Frontier Explorer



Issue 18  
Fall 2016

TSC Magdalena - SC-181 Courier

Posita and Negato  
The Gypsy Moons

Atlantic Class Freighter

A Change in Orbit

Atlas Manufacturing  
Corporation "Comet"

**Spaceship. Spaceship.  
Spaceship!**



## CONTENTS

Top 10 Small Party Ships of Science Fiction ..... 1  
*What ship would like to be adventuring on?*

**Ships of the Frontier: TSC Magdalina - SC-181 Courier** ..... 3  
*A small, fast, and armed courier ship for getting quickly around the Frontier.*

**Posita and Negato The Gypsy Moons**..... 5  
*A strange pair of worlds with a pair of dralasite derivative races.*

**Atlantic Class Freighter** ..... 8  
*An updated version of the venerable Pacific Class freighter made famous by the events of the Drammune Run.*

**Using the Varda in Star Frontiers** ..... 12  
*A look at how the Varda concept from Battle Beyond the Stars might fit into a Star Frontiers campaign*

**A Change in Orbit** ..... 14  
*A more accurate representation of planetary orbits and stats for all the planets of the Frontier*

**Titan Rising: Z299**..... 29  
*The story continues in episode 11*

**Atlas Manufacturing Corporation "Comet"** ..... 31  
*A research vessel with a built in lander for going planet-side*

**Bandoliers From Bandits**..... 37  
*Another look at the Yazirian Disk Grenade and related equipment.*

**New Era Commercial Survey Module: CMS-GPS..** 38  
*A survey cargo container designed to be carried and transported by standard freighters*

**The Miniature Lossodragon**..... 41  
*A rare, "tamed" miniature lossodragon give Jurak Hangna a bit of a scare (and stirs a bit of jealousy)*

**Alternate Movement Rules for Knight Hawks** ..... 44  
*A new system for handling movement and turning for the KH board game that's a bit more realistic*

**Grimz Guide Comic** .....back cover  
*Do you really want to open that door?*

## FEATURES

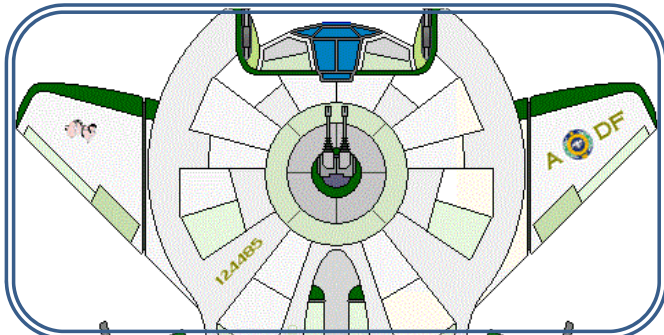

**SHIPS OF THE FRONTIER: TSC MAGDALINA – SC-181 COURIER** .....3

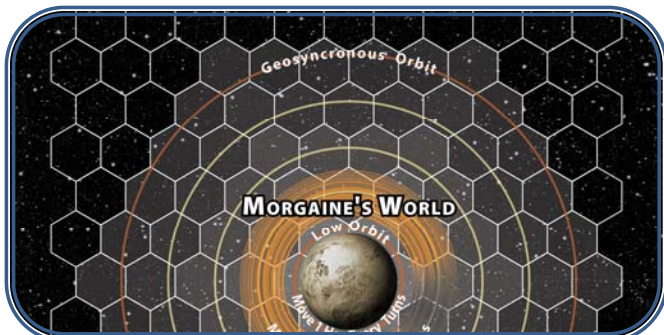

**A CHANGE IN ORBIT**..... 14

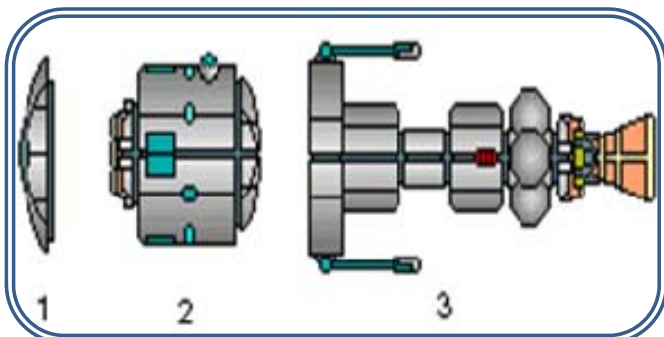

**ATLAS MANUFACTURING CORPORATION "COMET"** .....31

## FROM THE EDITORS

Welcome back explorers!

It's the spaceship issue! Over the past few issues there have been several spaceship deck plans submitted for publication that didn't make it into the earlier issues and a great project related to planetary orbits that was being worked on so I decided that it was time for an issue dedicated to ships and Knight Hawks mechanics. This issue ended up with four new ship specifications plus a couple of optional rules related to the Knight Hawks board game in addition to several of our regular features.

I'm looking to have the next issue focus on a return to Voltornus, Planet of Mystery. We have a number of Voltornus related items in the queue for publication that an issue with that topic as the focus is warranted. If you have material for this iconic setting, feel free send it in and we'll get it into the next issue. We'd love to see what you've done.

The big news item for this issue is that I received permission from Wizards of the Coast to produce the 35<sup>th</sup> Anniversary Commemorative patch. This will be a three inch diameter circular patch based on the 35<sup>th</sup> Anniversary Logo which is in turned modeled on the 30<sup>th</sup> Anniversary logo and patch we created five years ago. Next year is the 35<sup>th</sup> Anniversary of Star Frontiers and we want to have these patches available by the beginning of the year.



In order to meet that goal, I'll be placing the order to actually have the patches produced in mid-November so get your pre-order or request in now to guarantee there are enough for you. You can find details in the sidebar on page 36 and also on the web at <http://starfrontiers.info/patch2017.html>.

On a personal note, this issue is the last one that I worked on while completing my Masters of Library Science degree. I took the end of program exam while I was working on the editing for this issue. I'm now done (and just awaiting the results). With that part of my life behind me, I hope to have more time to dedicate to the magazine and other game related items.

I hope you enjoy this issue and find a use for all the great material it contains. And remember, always keep exploring!

- Tom Stephens  
Senior Editor

## PRODUCTION CREDITS



**Cover Art:** Sathar Attack by Scott Mulder

**Back cover comic:** Scott Mulder

**Banner Logo Image:** NASA

**Editors:** Tom Stephens, Tom Verreault, Eric Winsor

**Layout:** Tom Stephens

**Full Cover Quote:**

*Spaceship. Spaceship. Spaceship!*

- Benny – *The LEGO Movie*

<http://frontierexplorer.org>

[@FrontierExpMag](https://twitter.com/FrontierExpMag)

<https://patreon.com/FrontierExplorer>

**Legal** – The Frontier Explorer is not affiliated with, endorsed, sponsored, or specifically approved by Wizards of the Coast LLC. The Frontier Explorer may use the trademarks and other intellectual property of Wizards of the Coast LLC, which is permitted under Wizards' Fan Site Policy.

Random Thoughts

# TOP 10 SMALL PARTY SHIPS OF SCIENCE FICTION

Tom Verreault

This being a RPG fan magazine we're limiting our best star ships list to only those ships that would be ideal for a prototypical RPG party of player characters. Fighters and shuttles are excluded as well as large ships.

The three criteria used to judge ships are coolness, versatility and realism. Coolness because RPG players crave a cool ship for their character's to fly around the universe in. Versatility for the sake of the in game characters and finally realism as a nod to one of the Star Frontiers setting's cornerstones.

## AND NOW IN REVERSE ORDER...

10. **Jupiter 2** from "Lost in Space" comes in at number 10. It lacks in coolness being the equivalent of an RV that you had to ride around the universe with your parents in. Realism lacked but it was versatile enough to rocket the Robinson family across TV screens for 3 seasons and 84 episodes.



9. The **Palomino** from Disney's "The Black Hole" is next. It scores high marks for realism. Its utilitarian look and its brief appearance on screen sap any chance at this ship being judged cool.

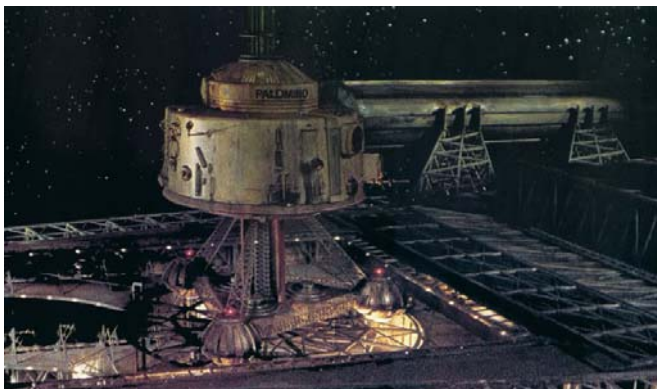

8. **Luna** from "Destination Moon" (1950) was a classic rocket design and the first realistic depiction of space travel and inspired rocket ships for a decade or more. The ship loses in versatility since the crew were almost forced to leave a man behind on the moon to lighten the ship so it could achieve escape velocity from a low gravity body like the moon!



7. The **Runabouts** from "Deep Space 9" were much more than shuttle craft sporting transporters. It was a plain versatile craft but lacking in coolness and realism. They rate low on the list in part for the fact that they were replaced with a proper warship in later seasons.



6. The **Starbug** from "Red Dwarf" is like an ugly dog that's so homely it comes off as cute. It would not have been considered for the list being the shuttle for the Red Dwarf except that the Red Dwarf was stolen and the crew made do with the Starbug for two seasons.



5. The **Eagle** from "Space 1999" scores good marks for coolness, realism and versatility. It might have rated better if it was a more capable vessel not being limited to operations around low gravity bodies.



4. **Serenity** from "Firefly" and "Serenity" scores well for coolness and versatility but lacked in realism. It unfortunately was the victim of early cancellation.



3. The **Osprey** from the "Star Frontiers" RPG comes in at number 3 scoring high marks for realism, coolness and good makes for versatility. Its sleek design screams cool and its weaponry packs a punch that lets bigger ships know they were kissed. It was the workhorse of Frontier militias and Space Fleet. Like Serenity it was a victim of early cancelation making it a bit obscure.



2. The **Klingon Bird of Prey** from "Star Trek" has been seen countless times in TV & movies. A scout and patrol craft workhorse of the Klingon Empire, it sports impressive fire power and a cloaking device. Its very

design screams predator and menace causing this ship to break the coolness meter.



1. The **Millennium Falcon** from "Star Wars" tops the list. If the Bird of Prey broke the coolness meter the Falcon breaks the versatility meter. It has smuggled heroes, out run Star Destroyers, led fighter attacks, and was used to outwit the imperial navy while entertaining and inspiring legions of fans. Like the Bird of Prey, it was not the most realistic. However, it did max the coolness meter. Of all the ships on the list it's the only one that can do a unit of distance as if it's a unit of time, "...did the Kessel Run in 12 parsecs". That's mad cool and gets the Falcon the top spot.



## HONORABLE MENTION

Eagle 5 from "Space Balls" gets an honorable mention. The movie was a parody and not to be taken seriously. In contrast to Jupiter 2 that we panned as a RV in space the Eagle 5 is literally a Winnebago in space. It does not rate well for realism, versatility, or coolness but it did rate high for fun.



Starships

# SHIPS OF THE FRONTIER: TSC MAGDALINA - SC-101 COURIER

Richard "Shadow Shack" Rose

## DESCRIPTION

The SS Magdalena is a decommissioned courier vessel acquired by her current owner via government auction. She is a relic dating back a century before the UPF and has been retrofitted numerous times. Ironically she was absorbed by the same government that initially commissioned the ship as the result of chartered debt, utilized for government business, and subsequently retired & decommissioned. She now operates as a privateer under the Palean government.

The ship has an aerodynamic/streamlined hull and is atmospheric capable. If the forward firing pod laser system were removed, performance could be restored back to the stock ADF:4/MR:4 ratings. However the current crew justifies the slight loss of maneuverability as a good trade-off for more firepower, more so in light of the fact that cargo capacity could not be increased by ditching the weapon system.

## KH STATS

**HS:** 2 **HP:** 12 **Powerplant:** 2 Atomic A  
**ADF:** 4 **MR:** 3 **DCR:** 30 **Crew:** up to 4  
**Armament:** Pod Laser, Pod Laser Turret  
**Defenses:** RH  
**Communication/Detection:** SubSpace Radio, Radar, Intercom  
**Misc. Equipment:** streamlined, light hull armor  
**Cargo Capacity:** Port & Starboard 0.5u holds (1u total)  
**Crew Accomodations:** 2 dbl bunks  
**Passenger Accomodations:** n/a  
**Ship's Vehicles:** 0  
**Computer:** Alarm (2), Analysis (4), Astrogation (4), Commerce (1), Communication (1), Damage Control (2), Drive (4), Industry (1), Information Storage (1), Laser Battery (1), Laser Cannon (1), Life Support, cap:4 (1) x2, Maintenance (2)

## DECKS

The upper/fore deck is the Bridge Deck. The helm, poised 90° above the astrogation/mainframe computer center and accessible via a ladder extending above the

dorsal side of the hatch, has three command chairs but can typically be operated alone via the center seat.

The Recreation Deck is outfitted with an autocooker/refrigeration unit, dining area, hygiene facilities, holo-entertainment, gunnery station, and outer hull hatch & airlock. Port and starboard hold bay doors flank the ventral side, the holds extend fore & aft (up and down) and the bay doors are the only access. The central ladderwell extends up and down the entire ship, with manual hatches closing off/securing each deck.

The Crew Deck has four folding bunks along with personal effects storage areas and a lengthy desk/table area.

The Engineering Deck houses access to the twin atomic drives along with a workshop area, life support equipment, recharging equipment for powerpacks & parabatteries, and an engineer station to monitor maintenance & overhauls. Floor panels can be removed to access additional equipment that wouldn't fit on the deck such as the power relay station and internal power generator. A decontamination station is in the central ladderwell/airlock access to the deck.

FE

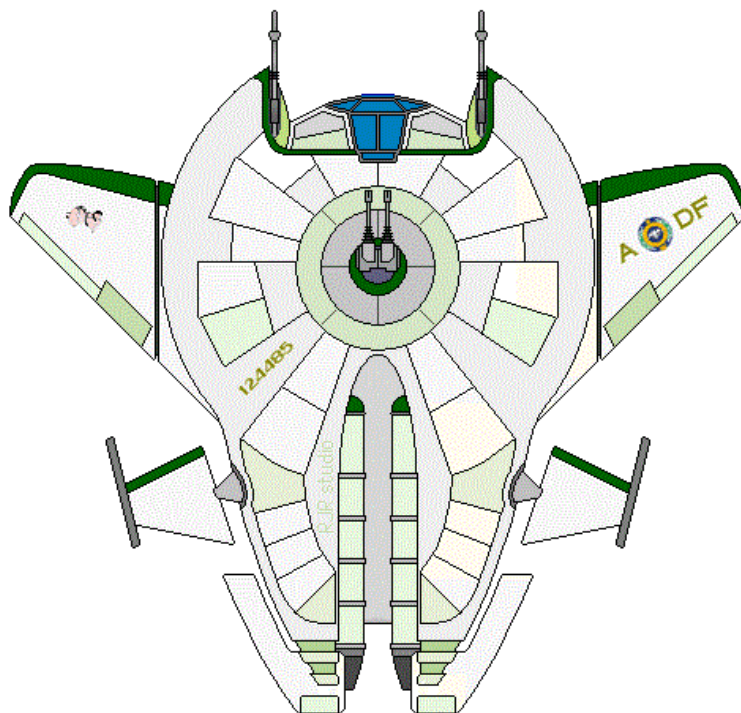

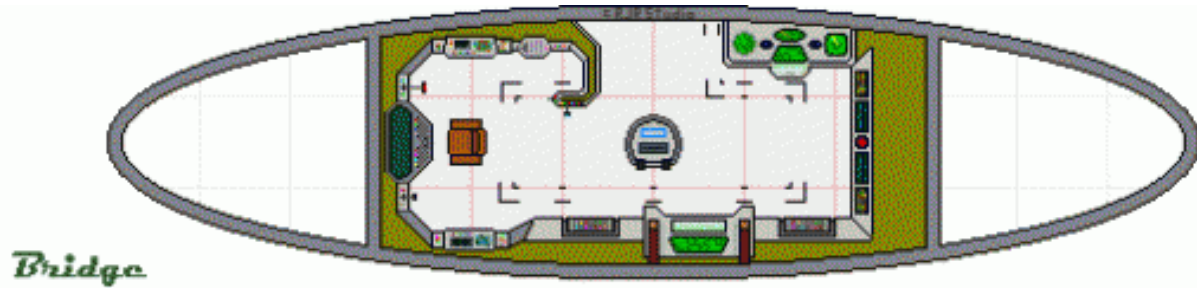

*Bridge*

 *TSC Magdalina*



deck is inverted 90°

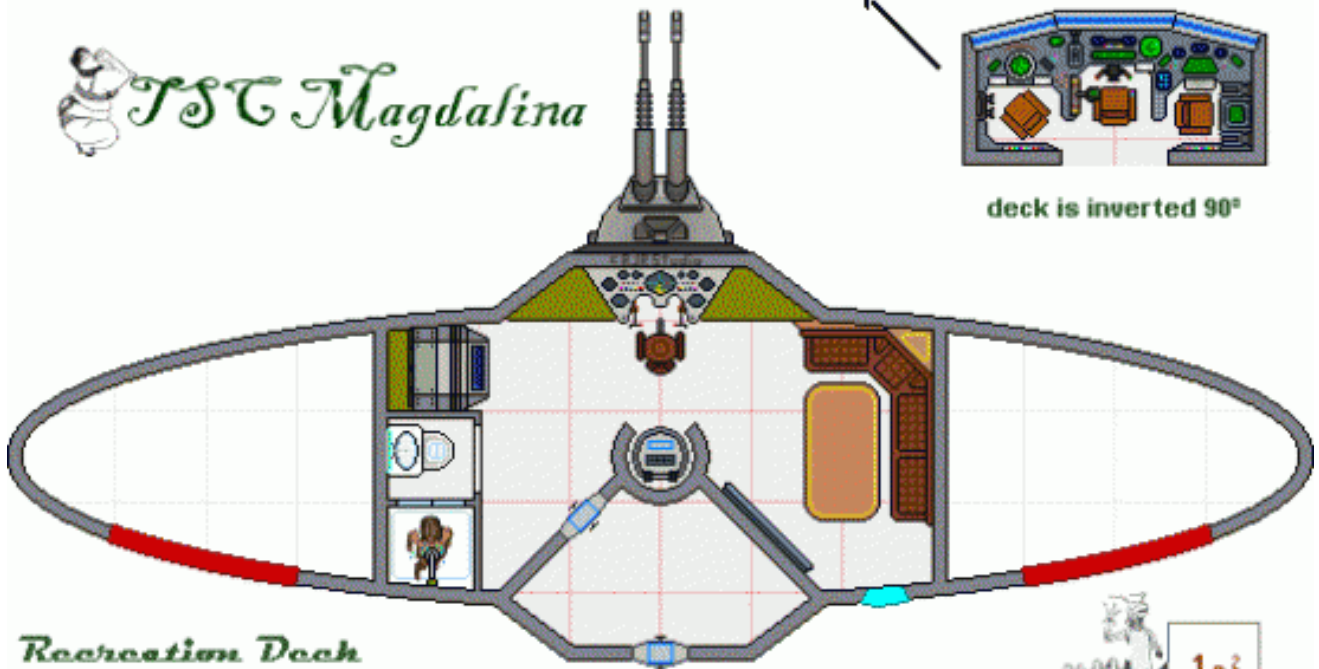

*Recreation Deck*

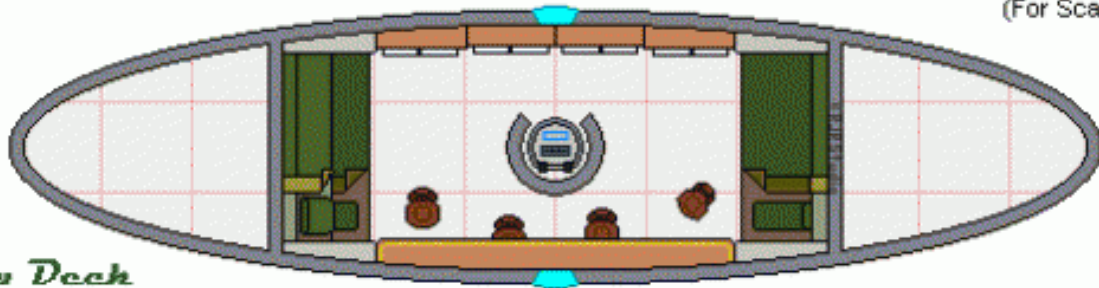

*Crew Deck*

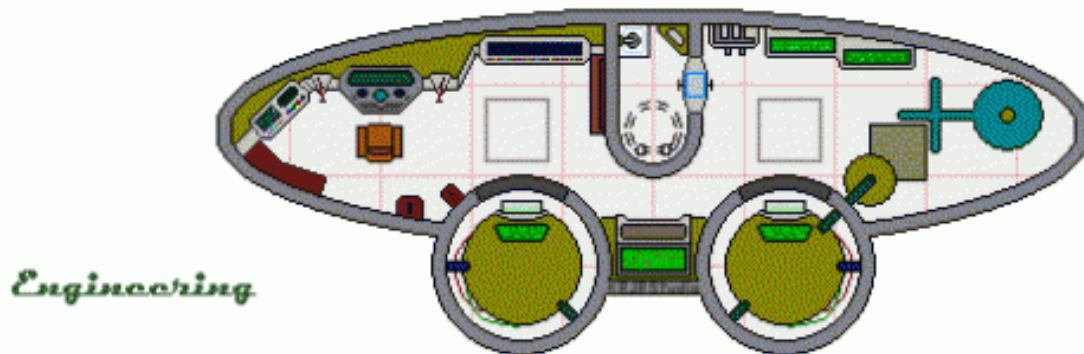

*Engineering*

Starships

# POSITA AND NEGATO: THE GYPSY MOONS

Laura Mumma

These planetoids and their races were inspired from the Rocky Jones Space Rangers series “Gypsy Moon/Rocky’s Odyssey” and “Crash of Moons”. A dash of Star Trek episode “Let That Be Your Last Battlefield” (the color scheme of the races) with a dash of FarScape mainly the Interon scream was also barrowed. Special thanks to Malcadon, Shadow Shack, jedion357, iggy and all the folks from [www.starfrontiers.us](http://www.starfrontiers.us).

*"Those twin planets are like trillion-ton balls adrift in space, having testicular torsion on a cosmic level! We hope you off-worlders have a good large pair like them 'cuz you'll need them just to live here! If you wish to visit, you better leave your pretty pink purse at home, 'cuz we don't accommodate to tourists!"*

-- Gypsy Moon Travel Brochure by Malcadon Travel Agency

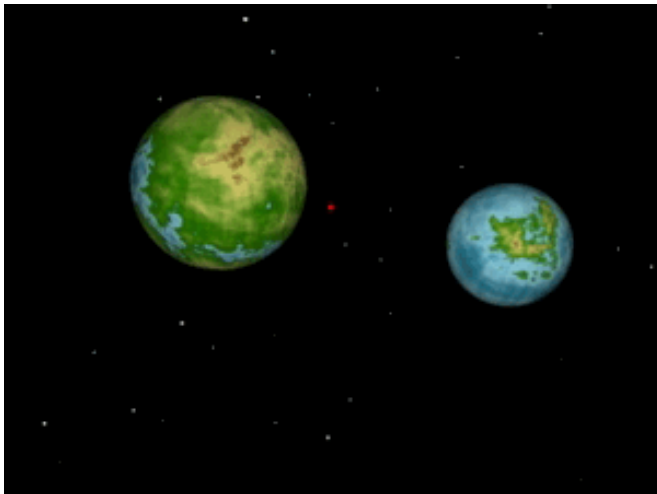

## POSITA AND NEGATO

### ENVIRONMENT

Posita and Negato are two dwarf planets that were discovered orbiting each other. Posita and Negato are exactly 3218 kilometers in diameter. The planetoids are exactly the same size and mass. The planetoids are tidally locked and their rotation rate is exactly equal to their orbital period, so one half of each planetoid faces the other permanently, while they mutually rotate together in space creating day and night as they rotate around “the heart”. The mutual rotation creates 1G of gravity on each planetoid.

The planetoids are connected by an atmosphere chain or belt. Within the chain lightning storms rage, gravity and turbulence and areas of extreme weather exist such as vortexes and hail, sudden heat spikes or cold drops. Naturally the side of the planetoids that face each other is the less pleasant side with volcanic action and terrible weather.

The sides of the dwarf worlds facing out to space are the more pleasant sides and during the night on each planetoid spectacular light shows in the atmospheres can occur. Note that terrible storms (just not as bad as the constant activity on the other side) can happen on the pleasant side of the planetoids as well. Both planetoids have very arid environments with extreme hot and cold temperatures (but survivable extremes with the right training and technology.)

Though it is possible for two objects to orbit, it should be noted that the two objects having the same size and mass and the existence of both having an atmosphere that is connected by a “belt” or “chain” is just not normal or natural. If anyone actually stays long enough to solve this mystery they will discover “the Heart of Electro” which is in the middle of the chain and somehow artificially keeps the whole thing working.

### INHABITANTS

The two planetoids both have life. Two closely related races of beings that appear to be Dralasite off-shoots inhabit both Posita and Negato. Both races have a color mutation that makes one half of their body white and the other half a dark charcoal grey to black, their veins that meet at the eyespots are bluish. Positans are dark on the right side and Negatons are dark on the left side. However this is not the only difference between both races, each race possesses specialized organs that give them special abilities. Positans can admit an electric-magnetic shock, which can stun, be used to kill or save another’s life, and erase memories while Negatons can create sound waves that can disorient, stun, kill, hypnotize and some individuals can melt metal when they scream. Naturally both races have developed technology that takes advantage of these natural abilities and enhances it.

Both populations will relate that thousands of years ago (they are very vague on how many thousands) they believe their ancestors were one united people and that while working to harness a new power technology Electro



was destroyed, split asunder. Somehow some of their ancestors survived on both sides of the planet at the polar extremes and thus Posita and Negato were formed. Both Posita and Negato have other life, much of it created out of the few organisms that survived the cataclysm. Both Positans and Negatons for many generations had no idea anyone but they had survived. The two groups evolved along separate lines of evolution.

Each group has developed a much more restrictive and controlled societies than one sees in Frontier Dralasite society. Both cultures use the same symbol of electric bolts for their national symbols Negatos use a light bolt on a dark background while Postia use a dark bolt on a light background.



The Posita/Negato sense of humor is dark, sadistic, and slap stick. Debates on humor might involve the discussions on how to kill or torture someone the funniest way possible.

Both societies are very capitalistic, opportunistic, status driven, and slavery is part of their social norm. Both cultures are experts at Bio-Chemical methods of modifying life forms, which was a necessity for their survival.

Both cultures believe they are the superior surviving gene pools of the ancestors, and do not believe in mixing and blame each other for Electro's demise. They will each claim they were the true controller race and the other race was a servitor or slave race. Any mis-colored bud (solid black or white or checkered bud) is "bonsai" (kept small and bio-chemically neutered) and used as slaves and servants. The idea that their ancestors may have been one color (white, black or grey), checkered or some other combination is objectionable to most members of these two societies. Inverted colored buds are raised to be spies by their governments, and are taught it is the only way to redeem their genetic flaw.

Both races can transverse the belt, but did not have space travel when first encountered by space explorers. Since they now know there are other races both governments are now dedicating a lot of research towards developing space travel and considerable energy to attracting trade partners and gaining new technology.

A constant state of war has existed for generations between Negato and Posita. Negato in the past has attacked and enslaved Posita and though Posita is now free, Posita wishes to return the favor. Both races blame each other for the destruction of Electro. It should be noted that the oldest buildings on both Negato and Posita are exactly the same, in the relative same locations and built out of alloy materials that are unique and cannot be made with the resources on these planetoids and both have the same ancient symbols.

## PHYSICAL ABILITIES OF INHABITANTS

The abilities and biology of the Negato and Posita races is the same as a standard Dralasite except that instead of Lie Detection they possess the following:

### POSITANS

Positans are dark on the right side.

#### BIOELECTRIC ABILITY

All Positans have the ability to generate bioelectric energy from a specialized organ. All Positans start with a 5% chance to do the following: Stun a creature unconscious for d100 turns, cause damage 1d10 points, attempt to bioelectrically resuscitate another, interrupt nerve signals to relieve pain, or erase another person's memory.

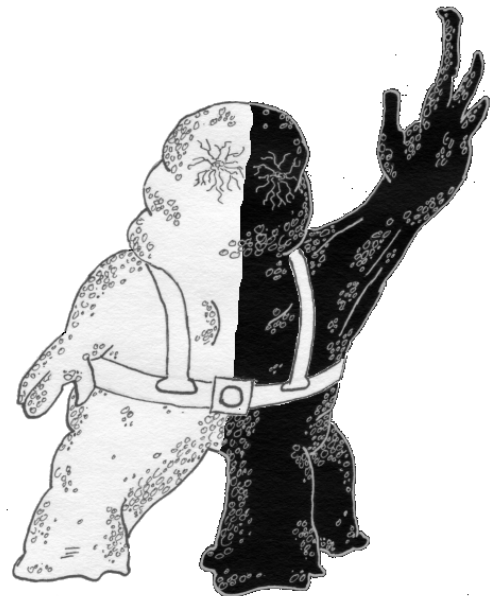

### NEGATONS

Negatons are dark on the left side.

#### SONIC ABILITY

Using a special organ Negatons can create sound waves that can disorient, stun, kill, hypnotize and some individuals can melt metal when they scream.

All Negatons start with a 5% chance using their Sonic Ability to stun a creature unconscious for d100 turns, use sound to disorient other species for d100 turns, cause damage 1d10, attempt to hypnotize using sound (requires a Logic check), and melt metal (scream).

## MYSTERY POWER STATION

Posita and Negato are actually a huge power station device in essence designed to power something, the real question is what? If anyone can ever stay long enough to study the “Heart of Electro” they will figure out the planetoids and the Heart are a power station. They will be able to determine it was no accident Electro was split in two and in essence reformed into two planets. The ancestors of the current population may have been used as slaves to create it but were not expected to live once the station was activated (what the power station was built to power is another mystery). A device in the middle of the atmosphere chain keeps the planetoids locked in orbit and allows for the shared atmosphere.

## BACKGROUND & ADVENTURE POSSIBILITIES

This double planet has some potential:

1. It is cruising through space like in Crash of the Moons:
  - a. Basically it's not an out of control wandering planet but a ship.
  - b. It is a wandering planet not controllable
2. Is not wandering through space but has a set orbit in a system.
3. Is not in a system but has a set orbit relative to something else.
4. Two weird cultures and possibly stopping them fighting (the PCs will need a motivating factor to be peacemakers).
5. Investigating the weird astrophysics could lead to wanting to know what required so much power that a planet or two planetoids were turned into a power station and is that a threat to the UPF or game changing tech? Possible ideas are it is powering an ancient artifact now out of alignment with it: a weapon? A new FTL tech? A non-lethal defense? A matter transmitter on a huge scale? A communications array? A giant computer? Who really built it?
6. Were the Dralosite ancestors placed on it after its creation or before? Are they actually power station employee descendants who forgot that their less than pleasant planet was planned not an accident? Where they a slave race that revolted and killed their masters? Or are they the descendants of master builders?

## SUPPORT THE FRONTIER EXPLORER VIA PATREON



Do you enjoy the Frontier Explorer? Would you like to help support the production of the magazine and improve it? If so consider supporting our Patreon campaign (<https://www.patreon.com/FrontierExplorer>).

We love making the magazine and will continue to do so regardless of the outcome of this endeavor. However, the production and maintenance of the magazine and website have costs and that's where you can help.

In addition to just our deep felt thanks, there are perks to patronage. Depending on the level of support you get access to supporter only forum on the website, e-mailed a copy of the magazine in advance of its public release, early access to the articles for up-coming issues, and at the highest level, a print copy of each issue you support. In addition, supporters will be listed on the magazine's website and at some levels here in the magazine itself.

The patrons that helped support this issue of the magazine are:

- At the **Frontiersman** Level – Akerraren, Ivan Begley, Erik, David Kester, and Nox SanJuan
- At the **Scout** Level – Andrew Moore, Miska Fredman, and Tevel Drinkwater
- At the **Explorer** Level – Shane Winter, Joe Johnson, and Tom
- At the **Space Ranger** Level – Richard Farris, Scott Holliday, and Kenneth Reising
- At the **Station Master** Level - Pagan

I want to say thanks to our patrons for their contributions.

The money raised will be used to improve both the [Frontier Explorer](#) and [Star Frontiersman](#) magazines in various ways including improved web hosting, improved software and hardware for production, website upgrades and improvements with the magazine itself.

We'd love to have your support to help make the magazines the best that they can be. Jump on over to the Patreon site (<https://www.patreon.com/FrontierExplorer>), read all the details, and consider becoming a patron.

Starships

# ATLANTIC CLASS FREIGHTER

Richard "Shadow Shack" Rose

Trans Travel's TT5050 is a newer offering for independent haulers, she made her debut in f.y. 61 as a 20th anniversary of Trans Travel's Pacific release. Much like its sibling Pacific class freighter, the overall design makes it optimum for a wide variety of roles beyond cargo hauling, a crew can make additional income via the trio of passenger cabins as well as offering courier duties to local governments. Without drives the Atlantic measures 105 meters in length and 18 meters at its widest point (the hold). The deck arrangement is simple and straight forward, separating various duties efficiently enough. Many owners are quick to modify the basic design both during the construction phase and after acquisition. The optional Pan Galactic "Eureka" drive adds an extra 100,000Cr per drive and increases the MR to 4. Like the Pacific, a laser battery may be added with no performance penalties.

The Atlantic hasn't caught on in terms of popularity, at least not compared to the original Pacific design from which it was cloned and reduced in size from. The additional drive and software required to operate it boosts the price above that of the Pacific and it carries less cargo. However, the higher performance is worth it to those willing to pay the price, more so with the optional Eureka drives which elevates it to scout ship performance in a freighter package (adding 100,000Cr per drive and an ADF:5).

Used samples can be had for 15 to 50% of new price, depending on condition & upkeep...but tend to be rare compared to the more frequent Pacific class samples out there.

## KH STATS

**HS:** 5 **HP:** 25 **PowerPlant:** 4 Atomic B

**ADF:** 4 **MR:** 3 **DCR:**35 **Crew:** up to 8

**Armament:** none (LB available at no penalty)

**Defenses:** none (RH available)

**Communications/Detection:** SubSpace Radio, Radar, Intercom (3 master panels, speaker/mike in each station/cabin/chamber)

**Misc Equipment:** Cargo Arm, Universal AirDock

**Computer** (LVL: 4 fp: 167 SP: 100)

Alarm (4), Analysis (4), Astrogation (4), Commerce (1), Communication (1), Damage Control (4), Drive - Atomic B (5), Industry (1), Information Storage (1), Life Support cap:16 (1), Maintenance (4)

**Cargo Capacity:** 5

**Crew Accommodations:** Captain's Suite (double occupancy possible), Crew Cabin w/2 triple bunks

**Passenger Accommodations:** 1 First Class Cabin, 2 Journey Class Cabins (all double occupancy)

**Ship's Vehicles:** lifeboat, 2 workpods

**Base Price:** 2,489,400Cr --- does not include fuel, spacesuits, weapons/defenses, or toolkits

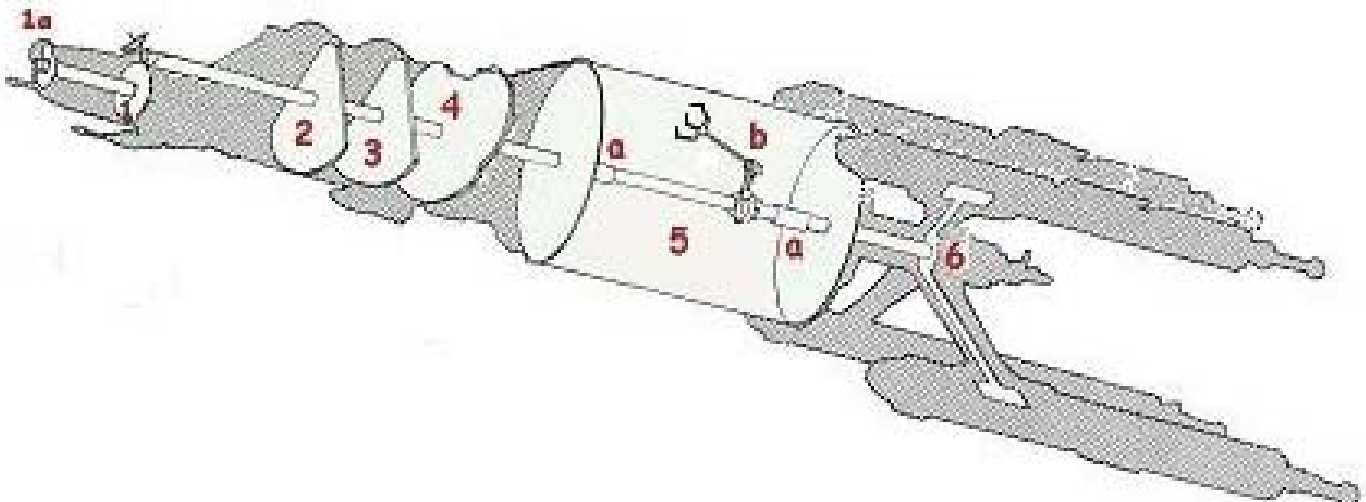

Deck arrangement for the Atlantic Class Freighter

## DECK PLANS

### DECK 1A – FLYING BRIDGE

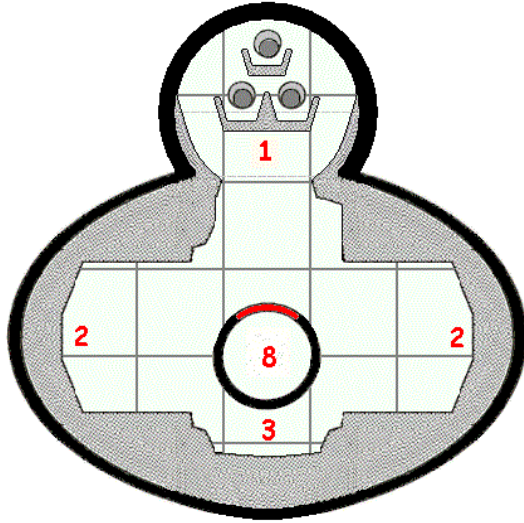

1. Flying Bridge w/positions for Pilot, copilot or computer operator, and Engineer - gimbal allows "star fighter" flight stance
2. Hydroponics
3. Avionics
8. Elevator to main bridge

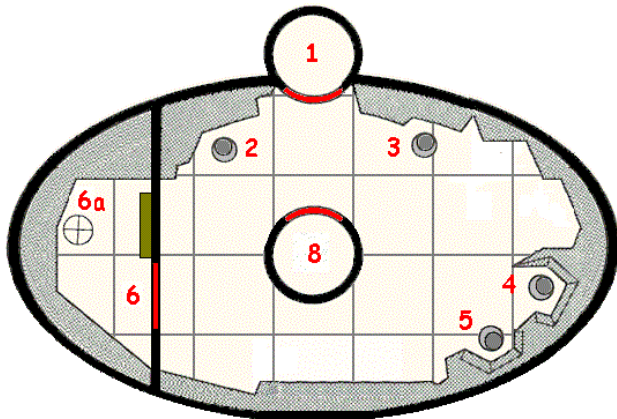

### DECK 1 – MAIN BRIDGE

1. Main Elevator
2. Astrogator station
3. Chief Engineer station
4. Helm, position for pilot
5. Helm, position for optional copilot

6. Computer Room, 6a is a maintenance shaft. Small arms storage nearby
7. Optional Laser Battery, where applicable
8. Elevator to Flying Bridge

### DECK 2 – CREW QUARTERS

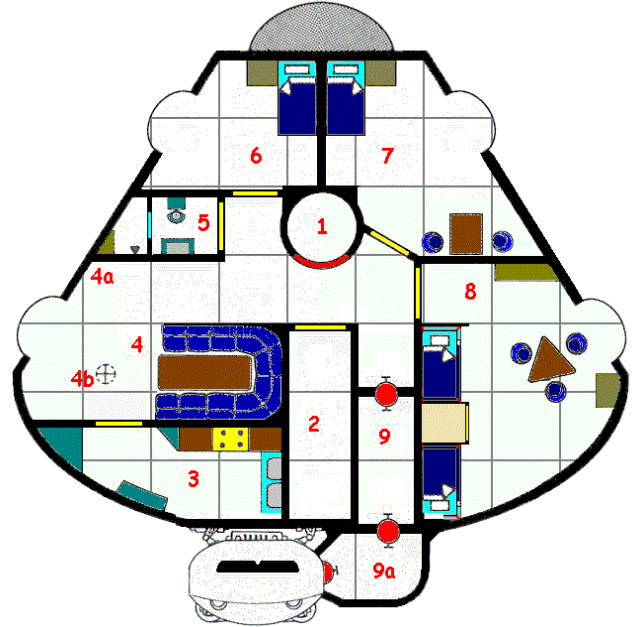

1. Elevator
2. Storage Area
3. Galley
4. Common Area, 4a is the holo-entertainment console, 4b ceiling hatch to computer maintenance shaft
5. Fresher/sanitation
6. Pilot's cabin
7. Captain's cabin & office
8. Crew Cabin w/2 double bunks
9. Inner airlock, 9a airlock to lifeboat

### DECK 3 – PASSENGER DECK

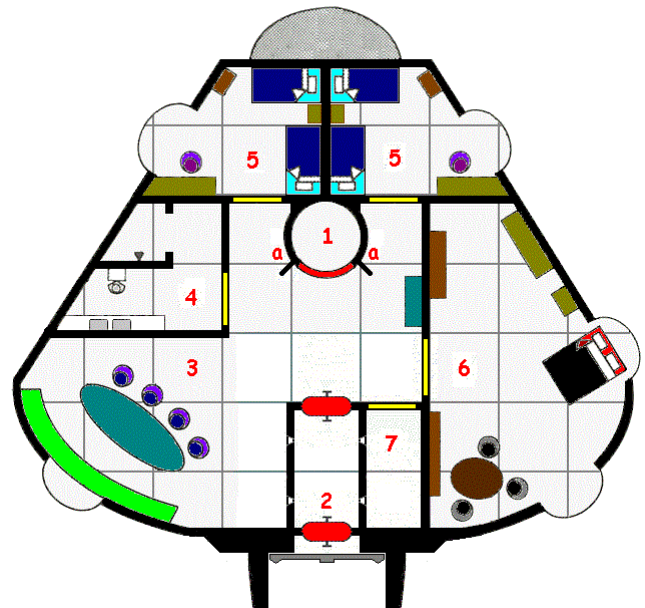

1. Elevator, a – heavy weapon mounts
2. Airlock w/Universal Docking Collar and gunports
3. Common Area
4. Fresher/sanitation
5. Journey Class Cabin
6. First Class Cabin
7. Storage closet

### DECK 4 – ENGINEERING

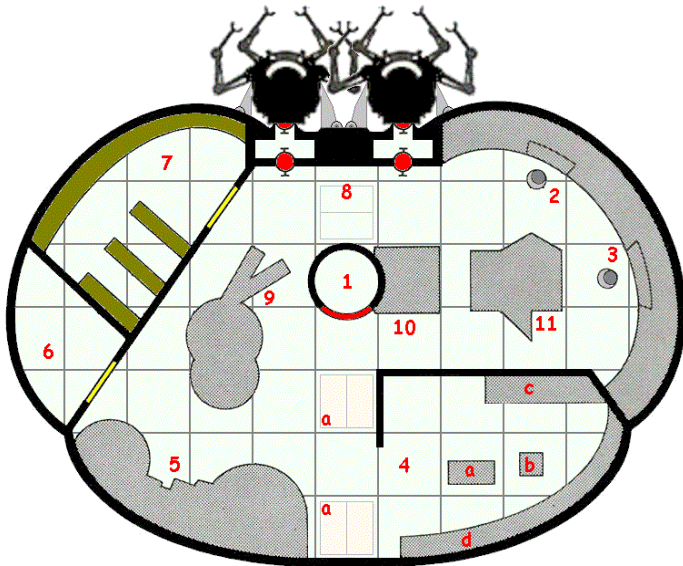

1. Elevator
2. Engineer's Station (half of overhaul time spent here)
3. Freight Handler Station
4. Workshop - 4a is a laser/lathe. 4b is a laser drill press, 4c is a workbench w/tool storage, 4d is a foundry
5. Life Support unit, 5a floor access to water purification plant and water tanks
6. Misc Storage
7. Parts Storage
8. Workpod Airlock pens & floor access to hydroponics
9. optional back up LS unit (not standard equipment)
10. Power Relay Station
11. Generator

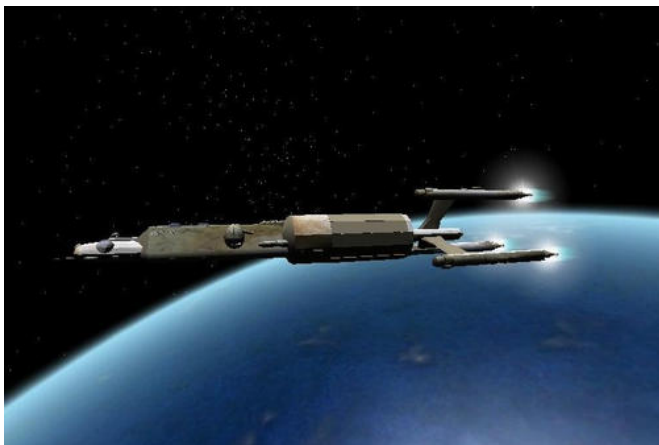

### DECK 5 – CARGO HOLD

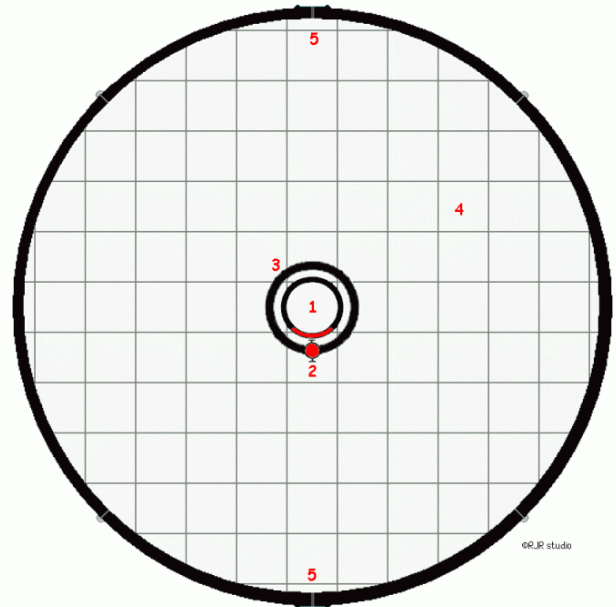

1. Elevator
2. Airlock
3. Cargo Arm tracks
4. Hold
5. Bay Doors

### DECK 6 – ENGINE ROOM

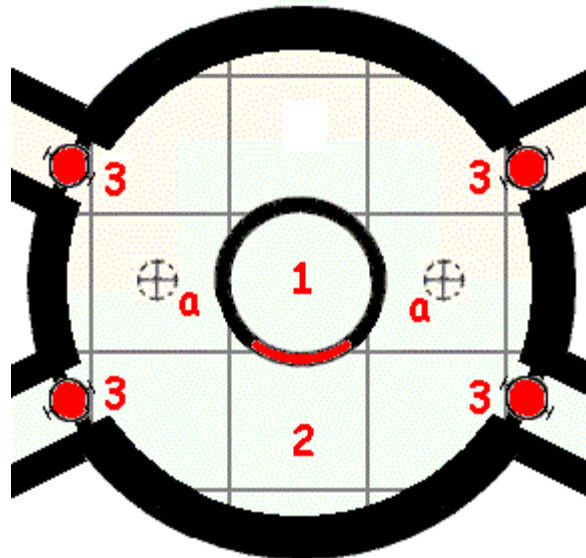

1. Elevator
2. Monitor Panels, 2a is a ceiling access way to the aft maneuver jet banks above
3. Airlock/Decontamination Chambers, access to engines

Half of overhaul time spent within engine room and drive access ways.

**DON'T GET CAUGHT UNPLUGGED!**

With StarPlay's Risto series chrono-coms, you'll never be disconnected again. With all the standard features you expect and Starplay's ever-growing library of profits for fun and productivity you'll never ask for another chrono-com again!



Quick, easy access to all StarPlay InfoTainNet data content & connectivity

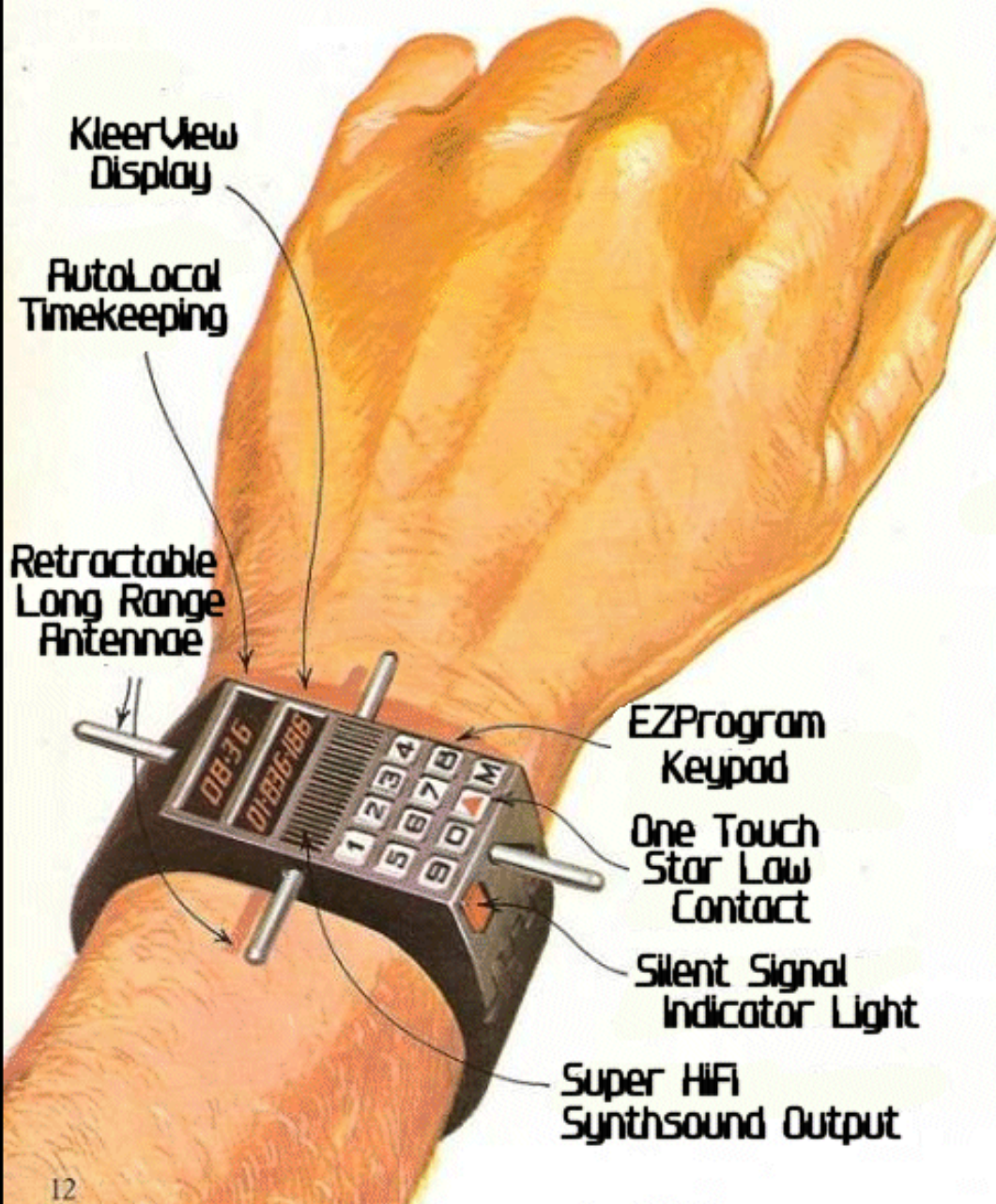

▲ StarPlay's EZSynch Protocols Keep you up to the minute with your home, office and ship based computing systems.



▲ Any World, Any Weather You can depend on a StarPlay Chrono-com. Available at a fine retail outlet on your world

Philosophies of the Frontier

# USING THE VARDA IN STAR FRONTIERS

Tom Verreault

Made three years after Star Wars at a fraction of the budget, *Battle Beyond the Stars* is a Roger Corman classic that has developed a cult following. While low budget it is acclaimed for the score by James Horner (Star Trek II Wrath of Kahn & Aliens), art direction & special effects by James Cameron (Avatar & Titanic), and the pervading moral philosophy that grounds the movie called The Varda. Finally, this movie, while pandering to sex appeal in the form of St. Exmin's sexy outfits and a star ship sporting what for all intents and purposes looked like boobs, it elevated the role of women to full-fledged participants in this action movie in a way not seen in Magnificent Seven or the Seven Samurai on which the story is based.



The connection to Star Frontiers while perhaps unintentional runs deep. Both were conceived as Westerns in space. The Valkyrie are brash and pushy with a philosophy after the heart of any yazirian, "I am from a warrior race. We exist for battle. Our Creed is to live fast, fight well, and have a beautiful ending." The Varda comes off as the philosophical debating of dralasites. Space Cowboy's ship appears as a dirtier beat up pickup truck version of the large and small freighters in the Knight Hawks box set and it even lands tail first!

Compared to the Force in Star Wars the Varda has depth and texture and presents as a well-rounded philosophy. For this reason it is ideal to use in a sci-fi RPG setting especially one populated with a whole species of philosophy loving aliens (the dralasites).

It should be noted that the movie uses the word law in one place and rule in another to describe the Varda's strictures. In other places characters simply say, "the Varda teaches". Aside from one statement about the first law there is no analog to the Ten Commandments. Some of the teachings come off as proverbs so it's easy to imagine the Varda as a robust philosophy with rules (laws), proverbs, and teachings. I've collected quotes from the movie and

arranged them with limited editing to present some as rules, others as teachings and some as proverbs. Not all of the quotes were explicitly said to be part of the Varda but they fit the general theme and felt like a Vardic teaching.

The scope of this work is to present a suggested philosophy that will fit a sci-fi setting. The laws can be formalized and expanded. Use the Varda as a base and modify it to suit your individual game or character. The name Varda does not even need be retained though if it isn't I would suggest "Akira" as a nod to Akira Kurosawa (Seven Samurai).

## THE RULES OF THE VARDA

The first law of the Varda is to use greater force against itself.

Prey on no one.

That which is not organic must not harm that which is.

Only take a life to save a life.

## THE WAY (OR TEACHINGS) OF THE VARDA

Every form has its function. (Note: throughout the movie the word form is used for living sapient beings or species and this made a lot of sense since there were a plethora of sapient species flying around in space).

To live by the Varda is not to fight.

The way of the Varda is concerned with balance in all things.

## WISDOM OF THE VARDA

Trust first and judge later.

Swift rain is little rain.

No form ends until all the lives that it touched are ended, until all the good that it has done is gone.

To fight creatures of violence you must use creatures of violence.

While life exists the possibilities are unlimited. (Note this statement was by one of the facets of the alien hive mind and not presented as a teaching of the Varda but it feels right for inclusion).

## FINAL THOUGHTS

The people of Akir were peaceful pacifists because of their moral code. However, when confronted with wanton violence and destruction the same moral code guides them to choose self-defense, "to take a life to save a life". Thus they were not strict pacifists and for that reason the Varda works as a potential philosophy in both an action/adventure movie and in a role playing game with a strong action element. In the real world many people live a similar code of not looking for violence but willing to step up to save a life. This makes the Varda a credo that many can identify with.

## OTHER GEMS FROM THE MOVIE

### ST. EXMIN AND THE CREED OF THE VALKYRIE

"I am from a warrior race. We exist for battle. Our creed is to live fast, fight well, and have a beautiful ending."

The character of St. Exmin's is brash, pushy and irritating. In her culture young Valkyrie leave home and seek out battle to prove themselves. She sees the plight of the Akira as just such an opportunity and yet her bravado turns off the main character.



A referee might have fun introducing a young yazirian who has left his colony to seek out battle and prove himself. The yazirian stereotype of brash pushiness can be played up and the need to prove himself while generally annoying the player characters till they let him join the group can be overstated. He may need a "fast ship" to follow the PCs around until they let him join the party. This can be a small fast

runabout with a poor excuse for weapons or simply a hovercycle as the situation warrants. Finally a more yazirian version of the Valkyrie Creed would end with, "and have an ending worthy of song."

### SPACE COWBOY, HIS BELT BUCKLE, & SHIP

Despite the unimaginative name of Space Cowboy the George Peppard character was immensely memorable. He was a good ole boy & cowboy and you knew this because of the Confederate flag on the ship's hull. He was a

fan/expert of Western movies and reveled in the clichés even shouting at one point during a battle, "Remember the Alamo!" He was pure fun and willing to help by donating his cargo (weapons) and expertise (apparently ground combat) because his buyers were wiped out by Sador (the bad guy). Well that and a budding love interest among the Akira.

Change the name from Space Cowboy to the equally cliché and unimaginative 'Tex' and you have a non-player character that can provide some aid to the PCs in an environment where pirates or corporate mercenaries are set up as foils.

Space Cowboy's ship is easily represented in Star Frontiers with the small freighter from the KHs box set. It should be old and have a few quirks and unexplained noises. Dixie comes to mind as a possible ship name.

### THE BARTENDER BELT BUCKLE

Originally marketed by a subsidiary of Star Play Enterprises as a clothing accessory the belt buckle has been discontinued for years. It did not originally sell well but it has developed a bit of a cult following among ne'er-do-wells across the Frontier. New and used ones routinely turn up for sale with Capellen Free Merchants and in curio shops.

The belt buckle is actually a whole belt that includes a 12 SEU micro-disk for power. The belt contains tubing that holds water and alcohol while the buckle has a miniature refrigeration unit that makes ice from its supply of water. It makes 2 small cubes every 30 minutes and can dispense 5 alcoholic drinks before requiring a refill. The micro disk will operate the belt for two weeks (GST). The belt buckle has three buttons that dispense alcohol (scotch is popular), water, and ice.

Original cost new was 30 Cr. but the value can be triple to quadruple depending on condition due to demand. Weight is negligible.

### THE AKIRAN VILLAGE

The look of the village on Akira looks like something dralasites would build. It's ideal for use as a photo reference for such a community.

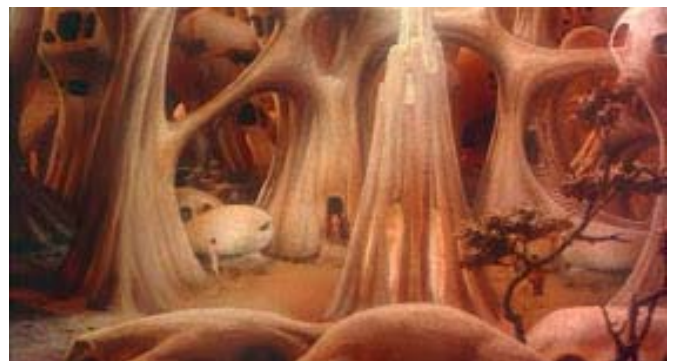



## Optional Rules

# A CHANGE IN ORBIT

Shane Winter

The problem with most space combat games, and Knight Hawks is no exception, is the lack of variety. Most scenarios consist of a blank star field, with the occasional planet thrown in. The same planet, every time. It gets a bit stale after a while. The terrain needs to be varied sometimes, even if it is only visually. So what can be done to make planets different?

You can address the different sizes of planets, which pretty much lets you choose between a planet that takes up one hex or seven ( unless you use a gas giant; more on that later). More interestingly, you can add the gravity well of the planet.

What does this give you? Most obviously, it allows you to model how multiple stations at different orbits move. But how do you calculate what those rates should be?

The big thing you need to know is the mass of the planet. If we know the mass (in kilograms, represented by  $m$ ), we can use the following formula to calculate the orbital speed necessary for a given orbital distance:

$$v = \sqrt{\frac{Gm}{r}}$$

where  $v$  equals velocity,  $G$  equals the gravitational constant of  $6.674 \times 10^{-11} \text{ Nm}^2/\text{kg}^2$ , and  $r$  equals the radius being orbited at (in meters).

Unfortunately, the mass of any planet cannot be found anywhere in the canon information. For most of the planets, the only information we are given is surface gravity and day length (the modules do give the radius of the planets involved). Given the gravity of a planet, and a few educated guesses on the density of a world, however, we can work out a mass and radius.

Earth's density is estimated to be is  $5.514 \text{ g/cm}^3$ . The three other terrestrial planets in the solar system, Mercury, Venus, and Mars have estimated densities of  $5.427 \text{ g/cm}^3$ ,  $5.243 \text{ g/cm}^3$ , and  $3.933 \text{ g/cm}^3$ , respectively. These estimates can be also used to infer details of a planet's inner structure. Lower densities of terrestrial planets would be an indicator of more silicates, while higher densities would indicate a richer metal content.

With this in mind, we can make an educated guess about the densities of some of the Frontier planets. If they are mining colonies, they should be denser, and mainly

agricultural worlds are less dense than average. I tried to vary between 5 and 10 percent in either direction.

By way of example, let's take Pale and New Pale in the Truane's Star System. Pale is listed as a resource planet, whereas New Pale is an agricultural world. It makes sense that Pale's density would probably be on the higher side of our earth norm, whereas New Pale would be on the lower side. Accordingly, when I went to create orbital data for the planets, I assigned Pale a density of 1.04 earths, and New Pale a density of .95 earths.

Gas giants have a lower mean density than terrestrial planets, but are handled in the same way as terrestrial planets. The gas giants of our own solar system range from  $1.638 \text{ g/cm}^3$  at the high end with Neptune to  $0.687 \text{ g/cm}^3$  at the low end with Saturn (Jupiter and Uranus have masses of  $1.326 \text{ g/cm}^3$  and  $1.27 \text{ g/cm}^3$ , respectively). Like the terrestrials, you can make some general observation; the higher the density, the more likely there are volatile ices, such as ammonia, methane, or water.

Armed with a density, let's take the following equation, used to determine gravity (which we already know for most Frontier planets), and rearrange it so as that we can determine the planets radius:

$$g = \frac{Gm}{r^2} \longrightarrow r = \sqrt{\frac{Gm}{g}}$$

where  $r$  is the radius we are looking for,  $G$  is our gravitational constant again,  $g$  is the planet's surface gravity (in  $\text{m/s}^2$ ), and  $m$  is once again the mass of the planet.

As you can see, we are still missing the mass of the planet, but not to worry. We just learned how to make a guess at a planets density. We can rearrange the following equation to determine density to determine mass instead:

$$d = \frac{m}{V} \longrightarrow m = d \cdot V$$

where  $d$  is density,  $m$  is once again mass, and  $V$  is volume.

Now, we all learned in school that the volume of a sphere (or planet in this case) is calculated as follows:

$$V = \frac{4}{3}\pi r^3$$

Frontier Explorer

Now if we plug the volume of a sphere in to our mass equation:

$$m = \frac{4}{3} \pi r^3 \rho$$

We then plug our "new" mass equation back into our equation to determine the radius of a planet to give us:

$$r = \frac{3g}{4\pi dG}$$

So now we have a radius and a gravity, to get our mass, we again rearrange our gravity equation to give us the mass of the planet:

$$g = \frac{GM}{r^2} \rightarrow m = \frac{gr^2}{G}$$

Armed with all of this, we can find out a lot about our planet. To determine the velocity needed to orbit at a distance of 2 hexes around Clarion, we plug in our Constant G, the mass of Clarion (5.0 x 10<sup>24</sup> kg) and the orbital distance of 20,000 km (20,000,000 m) for the radius:

$$v = \sqrt{\frac{6.674 \times 10^{-11} \cdot 5.0 \times 10^{24}}{20,000,000}}$$

giving us a speed of 4,084 m/s, or 2,450 km per 10 minute turn. Which means that it takes 4 turns to move 1 hex (10,000 km) when orbiting at a distance of 2 hexes.

If you wish to figure at what distance geosynchronous orbit is (which might be important for an orbital station), just use the following formula:

$$r = \sqrt[3]{\frac{t^2 Gm}{4\pi^2}}$$

## THE TABLE

So that you don't have to calculate all of this information yourself, orbital information has been compiled for known planets of the Frontier. Radius and Geosynchronous Orbit is given in km, and mass and density are given in units of earths. Low orbit is defined as 1,000 km above the planetary surface. The numbers in the low column and hex column (1 hex, 2 hex, etc.), show how many turns it takes to move 1 hex at that orbital distance.

## ORBITAL IMAGES

On the pages following the table, are a sample of planetary orbital templates. These are designed to be printed and place directly on the Knight Hawks map for use in your game. The orbital speeds for the various orbits are depicted directly on the templates.

**FE**

**Editor's Note:** Not all of the templates could fit into this issue of the Frontier Explorer. To get them on, go to Maps section of the website to grab a zip file containing all of the planetary templates as well as a giant 4 page one for the gas giant Venturi.

If you have the print edition of the magazine, the templates on the following pages have been arranged such that they take up the three center sheets of the issue and can be easily removed simply by opening the staples, removing the sheets and reclosing the staple binding.

System/Planet	Grav (g)	Day (hrs)	Radius (km)	Mass (earth)	Density (earth)	Geosync (km)	Low	1 Hex	2 Hex	3 Hex	4 Hex	5 Hex
Araks Hentz	.7	25	4,325	.32	1.05	29,756	3	5	7	8	9	10
Athor Yast	1.0	15	7,208	1.28	.9	33,512	2	2	3	4	5	5
Belnafaer Venturi	1.0	10	64,500	102.5	.1	110,230						
Cassidine Rupert's Hole Triad	.9 1.1	20 30	6,146 6,796	.84 1.25	.95 1.05	35,244 52,802	2 2	3 2	4 3	5 4	6 5	6 5
Dixon's Star Laco	1.4	60		2.25	1.1	101,915	2	2	2	3	4	4
Dramune Inner Reach Outer Reach	.8 1.0	20 30	4,446 6,523	.39 1.05	1.16 .98	27,422 55,155	3 2	4 3	6 4	7 4	8 5	9 6

System/Planet	Grav (g)	Day (hrs)	Radius (km)	Mass (earth)	Density (earth)	Geosync (km)	Low	1 Hex	2 Hex	3 Hex	4 Hex	5 Hex
<b>Fromeltar</b>												
Groth	1.2	45	8,555	2.16	.91	83,036	2	2	3	3	4	4
Terledrom	1.0	60	6,553	1.06	.99	79,247	2	3	4	4	5	6
<b>Gruna Goru</b>												
Hargut	1.0	20	5,947	.96	1.2	36,864	2	3	4	5	5	6
<b>K'aken-Kar</b>												
Ken'zah Kit	.9	25	6,869	1.05	.85	44,045	2	3	4	4	5	6
<b>Kizk'-Kar</b>												
Zik-kit	1.0	65	6,007	.89	1.08	78,880	2	3	4	5	6	6
<b>K'tsa-Kar</b>												
Kawdl-Kit												
<b>Liberty</b>												
Snowball	.924	32	6,000	.82	.98	47865	2	3	4	5	6	7
<b>Madderly's Star</b>												
Kdikit	1.0	30	6,758	1.13	.96	50,957	2	2	4	4	5	6
<b>Prenglar</b>												
Gran Quivera	1.0	15	6,238	.96	1.04	30,433	2	3	3	4	5	6
Morgaine's World	1.5	40	10,243	3.88	.95	93,244	1	1	1	2	2	3
<b>Rhianna</b>												
Alcazzar	.81	10,000	4,916	.48	1.05	1,847,127	3	4	5	7	8	9
<b>Scree Fron</b>												
Histran	.6	25	4,185	.26	.93	27,654	4	5	7	9	10	12
Hakosoar	.9	50	6,019	.80	.97	64,025	2	3	4	5	6	7
<b>Sundown</b>												
Starmist	21	.93	6,558	.99	.92	38,436	2	3	4	5	5	6
<b>Theseus</b>												
Minotaur	1.2	15	7,485	1.66	1.04	36,520	2	2	3	4	4	5
<b>Tristkar</b>												
Kraatar	.6	18	4,900	.35	.78	24,677	3	4	6	8	9	10
<b>Timeon</b>												
Lossend	.7	70	4,883	.41	.93	64,094	3	4	6	7	8	9
<b>Truane's Star</b>												
Pale	.9	55	6,502	.67	1.04	64,258	3	3	5	6	6	7
New Pale	1.4	20	9,560	3.15	.95	54,824	2	2	2	3	3	3
<b>Waller Nexus</b>												
Mahg Mar	.98	23.95	6,175	.92	1.01	41,018	2	3	4	5	6	6
<b>White Light</b>												
Gollywog	1.0	50	5,840	.84	1.09	65,000	2	3	4	5	6	6
<b>Zebulon</b>												
Volturnus	1.0	24	6,478	1.03	.99	42,637	2	3	4	5	5	6

# CLARION



Low Orbit

Move 1 Hex Every 2 Turns

Move 1 Hex Every 4 Turns

Move 1 Hex Every 5 Turns

Move 1 Hex Every 6 Turns

Move 1 Hex Every 6 Turns

Geosynchronous Orbit

# GRAN QUIVERA

Low Orbit

MOVE 1 Hex Every 2 Turns

MOVE 1 Hex Every 3 Turns

MOVE 1 Hex Every 4 Turns

MOVE 1 Hex Every 5 Turns

MOVE 1 Hex Every 6 Turns

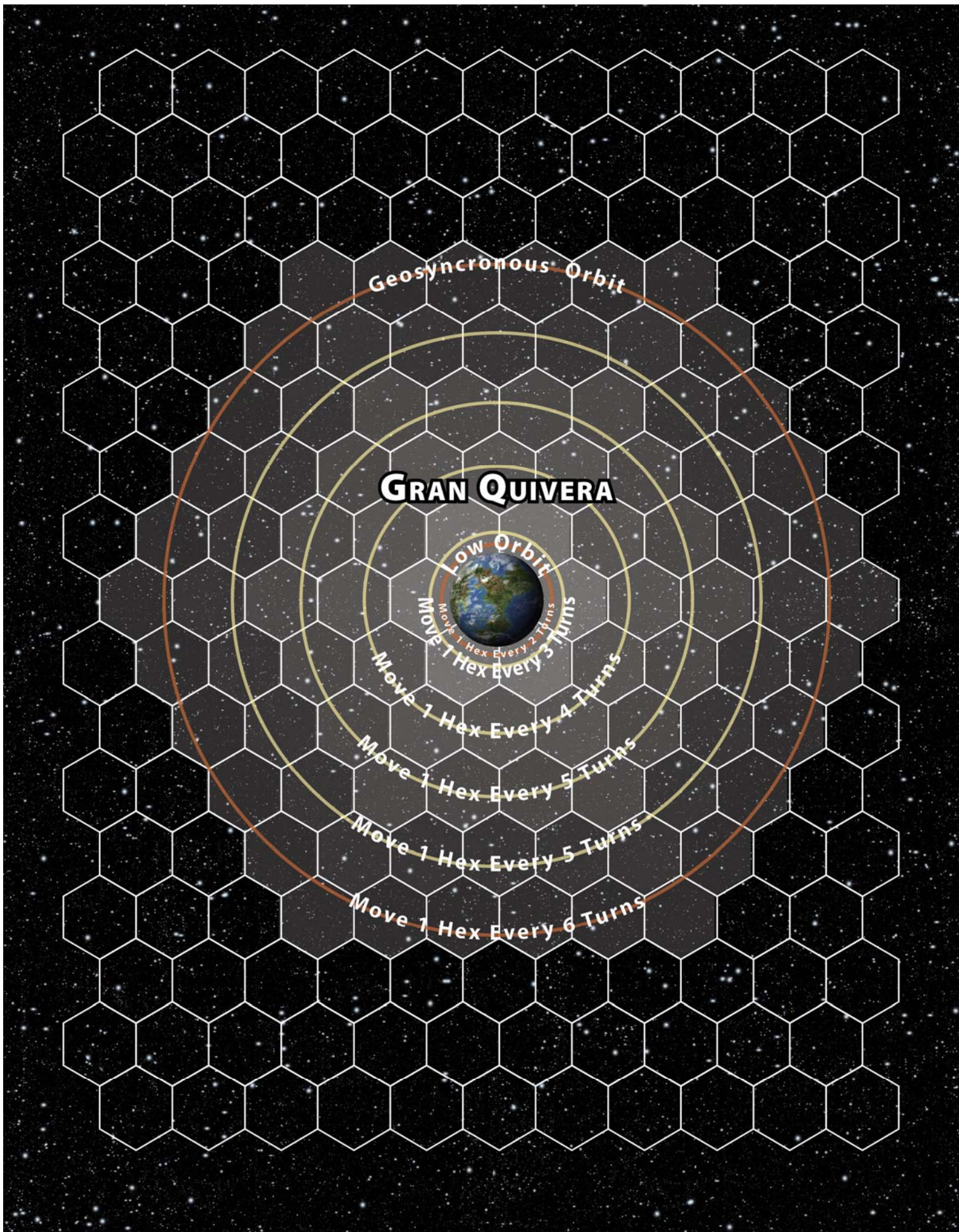

# LACO



Low Orbit  
Move 1 Hex Every 2 Turns

Move 1 Hex Every 3 Turns

Move 1 Hex Every 3 Turns

Move 1 Hex Every 4 Turns

Move 1 Hex Every 4 Turns

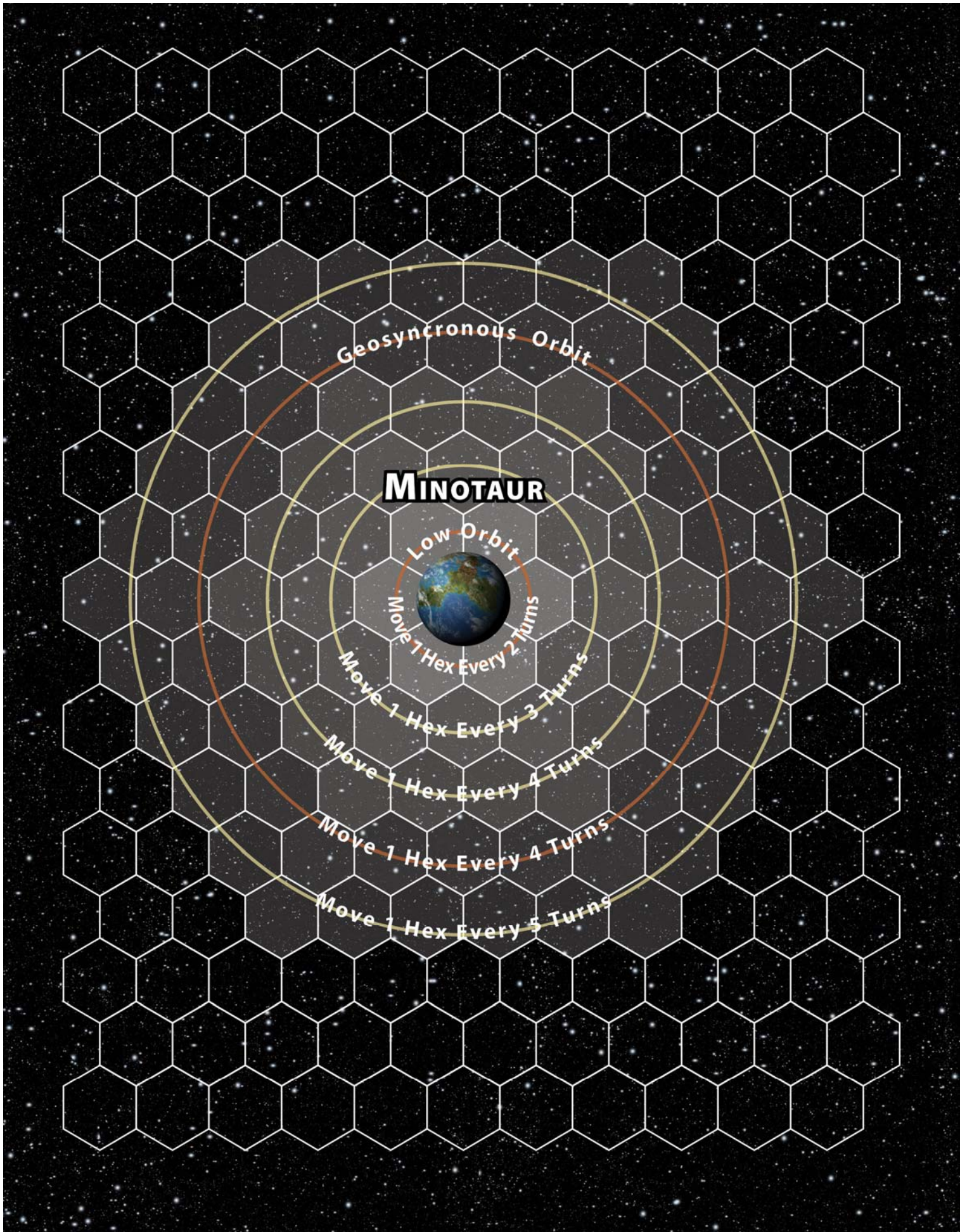

# MORGAINE'S WORLD

Geosynchronous Orbit

Low Orbit

Move 1 Hex Every 1 Turn

Move 1 Hex Every 2 Turns

Move 1 Hex Every 2 Turns

Move 1 Hex Every 2 Turns

Move 1 Hex Every 3 Turns

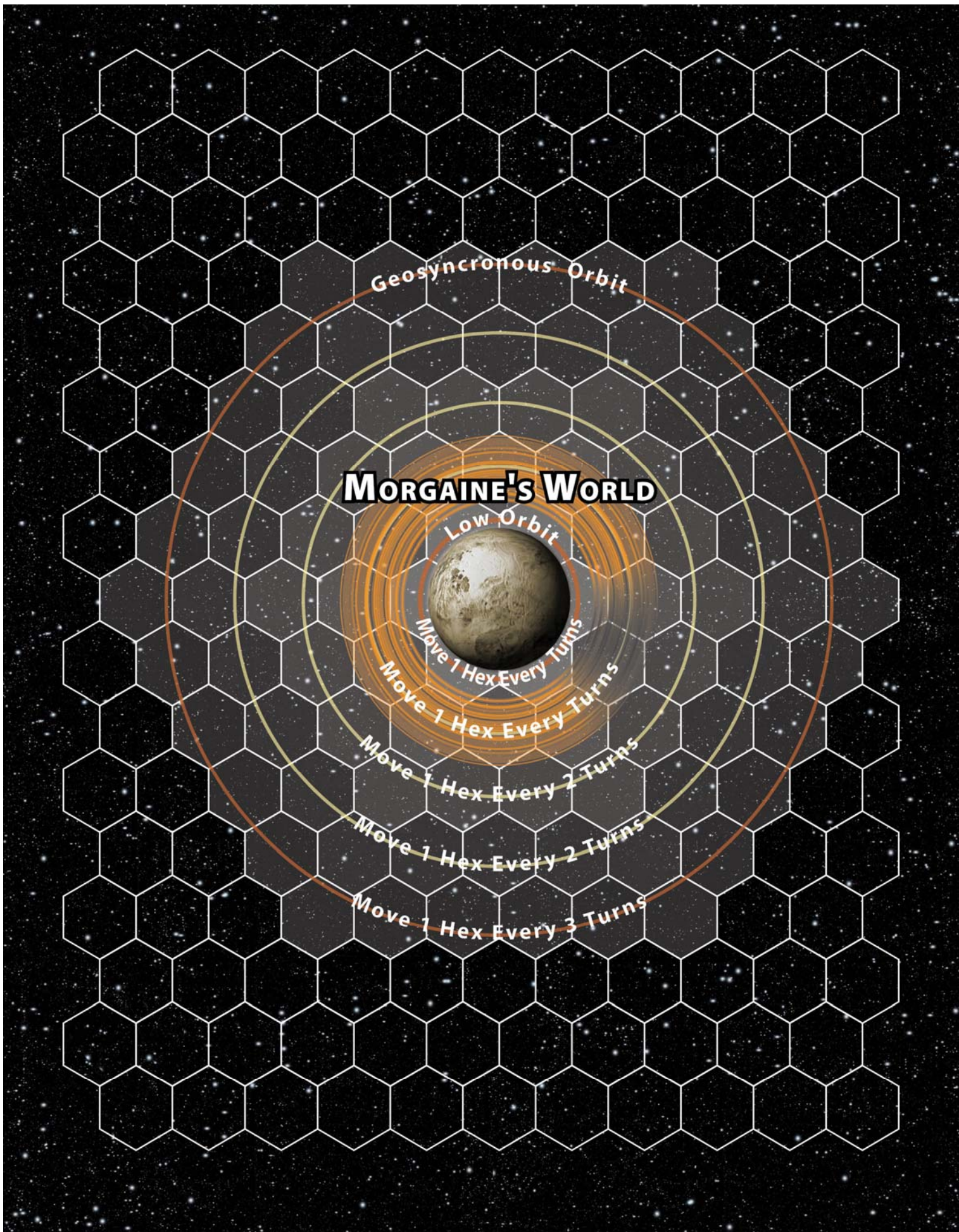



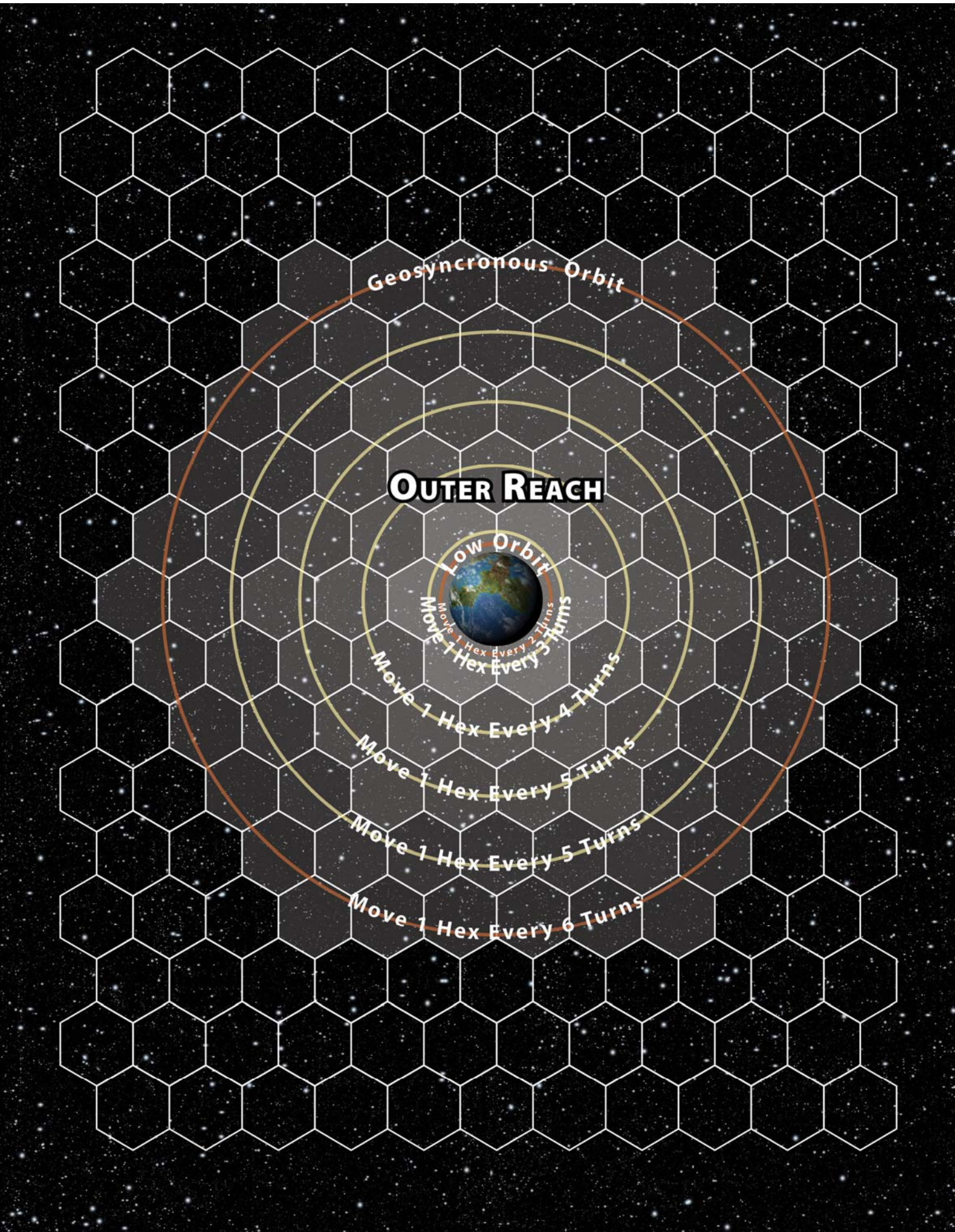

# OUTER REACH

Low Orbit

Move 1 Hex every 2 Turns

Move 1 Hex Every 3 Turns

Move 1 Hex Every 4 Turns

Move 1 Hex Every 5 Turns

Move 1 Hex Every 6 Turns

Geosynchronous Orbit

# TERLEDROM

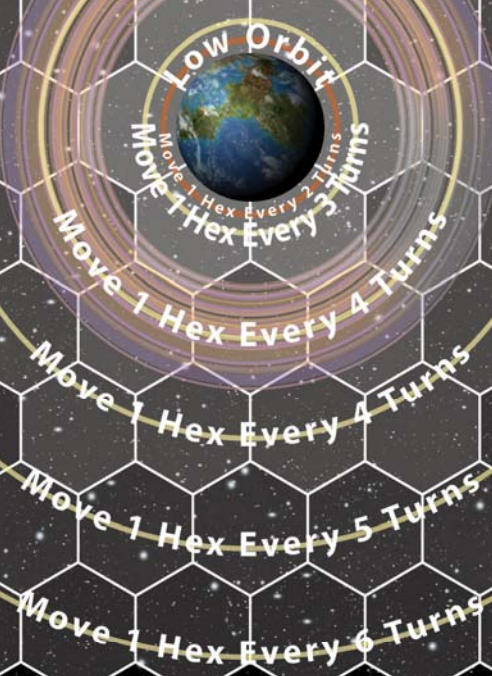

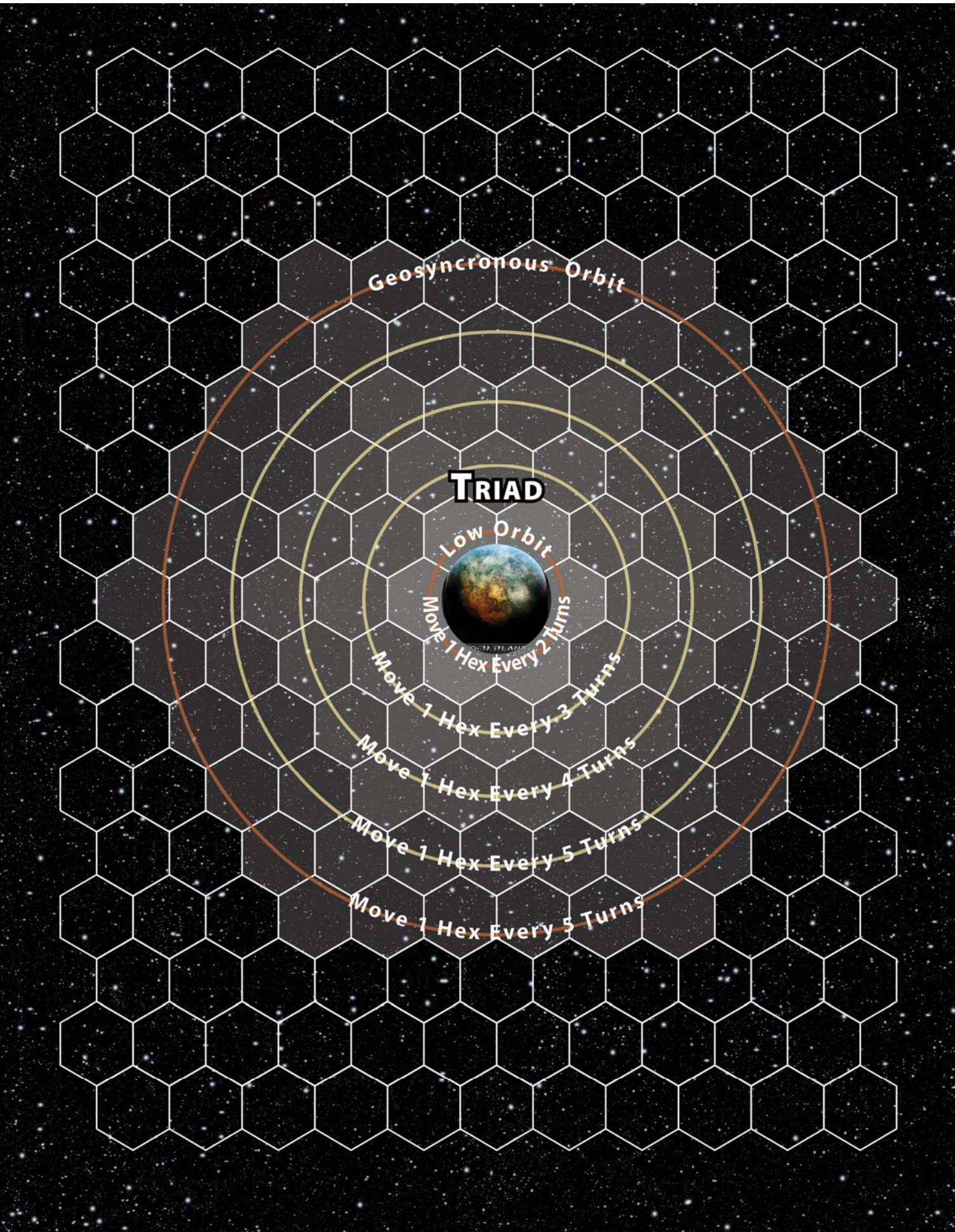

# VOLTURNUS



Low Orbit

Move 1 Hex Every 2 Turns

Move 1 Hex Every 4 Turns

Move 1 Hex Every 4 Turns

Move 1 Hex Every 5 Turns

Lulu Orbit / Geosynchronous Orbit

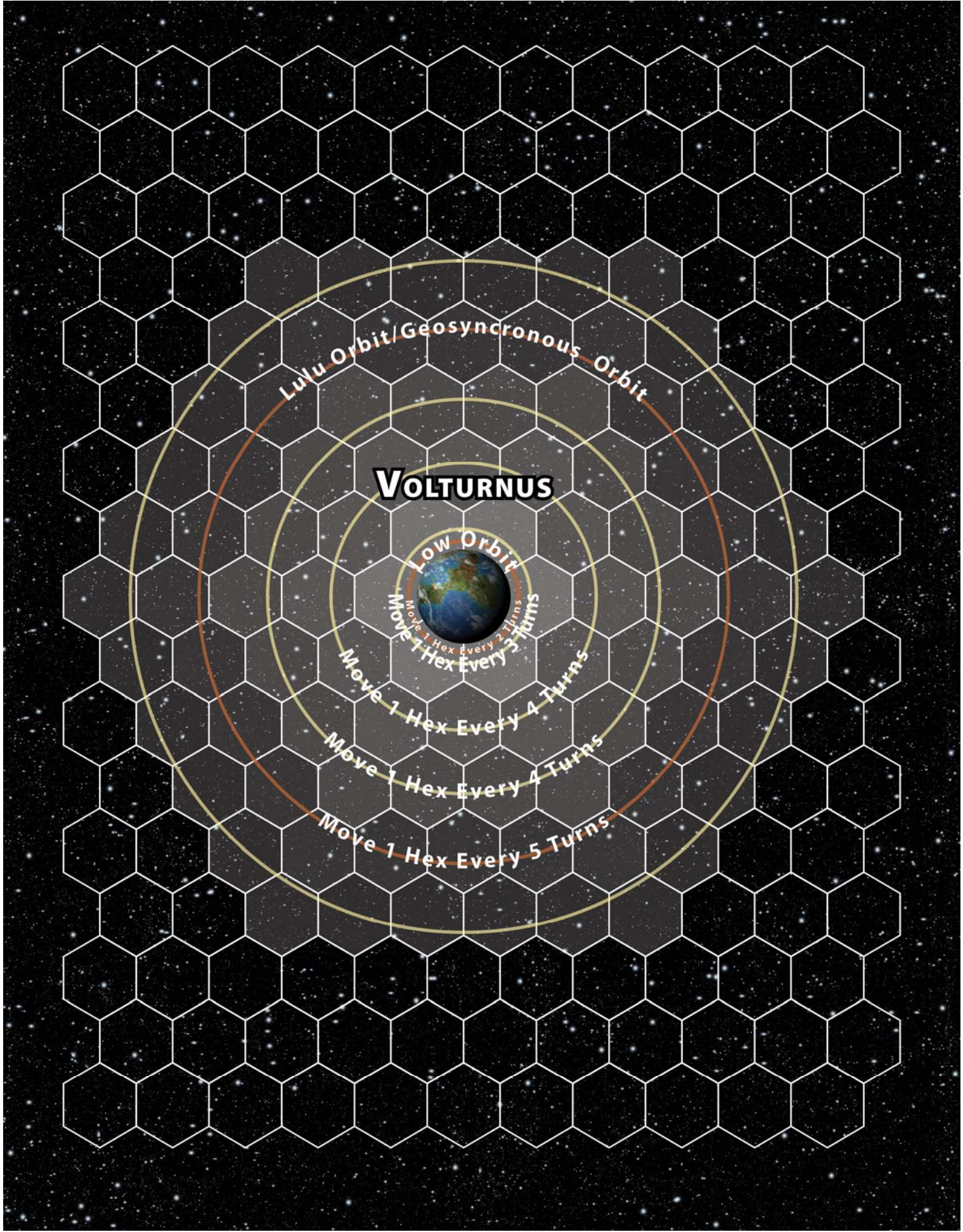

# ZIK-KIT



Move 1 Hex Every 4 Turns

Move 1 Hex Every 5 Turns

Move 1 Hex Every 6 Turns

Move 1 Hex Every 6 Turns

# HAKOSOAR



Low Orbit

Move 1 Hex Every 2 Turns

Move 1 Hex Every 3 Turns

Move 1 Hex Every 4 Turns

Move 1 Hex Every 5 Turns

Move 1 Hex Every 6 Turns

# PALE



Low Orbit  
Move 1 Hex Every 3 Turns

Move 1 Hex Every 5 Turns

Move 1 Hex Every 6 Turns

Move 1 Hex Every 6 Turns

# TITAN RISING: 2299

## EPIISODE #11.0: "EXPOSURE"

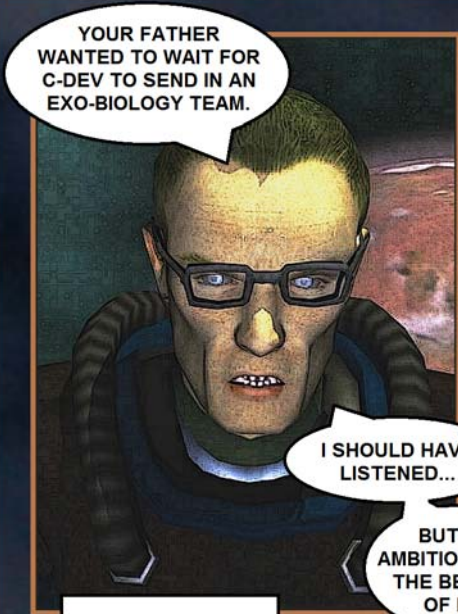

YOUR FATHER WANTED TO WAIT FOR C-DEV TO SEND IN AN EXO-BIOLOGY TEAM.

I SHOULD HAVE LISTENED...

BUT MY AMBITIONS GOT THE BETTER OF ME.

THE ALIEN SHIP WAS MASSIVE...



DOESN'T LOOK LIKE ANYONE'S AT HOME.

WE SHOULD TAKE A LOOK AROUND.

'EXPOSURE FOR A FIND LIKE THIS IS A CAREER CHANGER.

IT'S YOUR CALL CAPTAIN DENTAK BUT I WOULD WAIT FOR THE EXO'S.



I'VE NEVER SEEN ANYTHING LIKE THIS...

IT'S AMAZING, THERE DOESN'T APPEAR TO BE ANY KIND OF MACHINERY.

JUST ENDLESS ROWS OF THESE STRANGE POD STRUCTURES.

...AND HAUNTING.



FLYNN, TAKE A LOOK AT THIS...

LOOKS LIKE SOME KIND OF HULL BREACH?

YEP, IT SURE DOES...

AND A NASTY ONE AT THAT!

WHAT A MESS, LOOKS LIKE IT'S TORN INSIDE OUT.



WITHOUT WARNING THE BREACH ERUPTED WITH A DENSE MIST THAT FILLED THE CORRIDOR.

**LOOK OUT!**

**WOOOSH!**

COMPLETELY COVERING OUR ENVIRONMENTAL SUITS WITH AN UNKNOWN SUBSTANCE.

AFTER THE INCIDENT YOUR FATHER AND I EVACUATED THE ALIEN SHIP.

THE RETURN TRIP IN THE SCOUT ROVER SEEMED TO TAKE FOREVER.

SCOUT ONE TO C-DEV EXPLORER!

SCOUT ONE TO C-DEV EXPLORER!

COME IN C-DEV EXPLORER!

WE ARE DECLARING A MEDICAL EMERGENCY!

SCOUT ONE, THIS IS EXPLORER, WHAT IS THE NATURE OF THE EMERGENCY?

SPECIALIST FO, THIS IS CAPTAIN CHARLES DENTAK...

WE'VE COME INTO CONTACT WITH AN UNKNOWN SUBSTANCE...

THE C-DEV EXPLORER'S F.T.L. TECH ANSWERED OUR DISTRESS CALL.

WE NEED IMMEDIATE DECONTAMINATION AND MEDICAL TREATMENT.

CAPTAIN DENTAK, THIS IS SPECIALIST FO...

IF YOU'VE HAD AN EXPOSURE INCIDENT WE HAVE TO FOLLOW QUARANTINE...

C-DEV PROTOCOL STRICTLY PROHIBITS THE CREW FROM ALLOWING A POSSIBLE CONTAMINANT ONTO THE SHIP.

YOU AND CREWMAN FLYNN WILL HAVE TO BE QUARANTINED UNTIL THE EXO'S ARRIVE.

**TO BE CONTINUED...**

Starships

# ATLAS MANUFACTURING CORPORATION "COMET"

Martin Derryberry

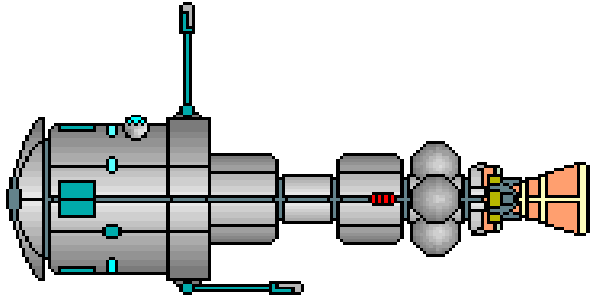

The Comet was built for the Truane's Star Department of Commerce (DoC). The DoC wanted to set up a research station and stake a claim on Volturnus after hearing that several major Corporations were interesting in opening Volturnus system for colonization and resource mining.

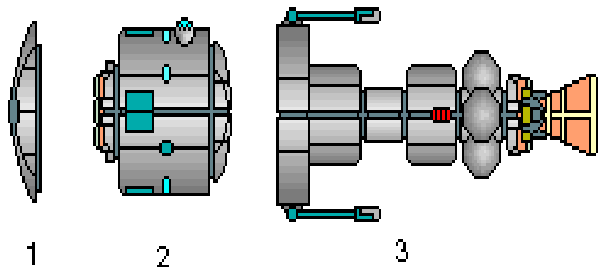

DoC requirements call for a ship that could transport a 4 man crew and setup a research station on the planet. Atlas (AMC) came up with the solution that was both cost effective and easy to construct. The ship consists of three part. (1) Heat / Meteorite shield, (2) Lander and (3) Drive Assemble.

The shield allow AMC to use less expensive heat resistant material in the construction of the lander. The use of Ion Engine also reduced cost since it carries only enough fuel for two, 14 light year jumps.

The lander with heat shield would do a ballistic reentry into the atmosphere. Once it reached the higher atmosphere, two parachutes would deploy slowing the craft even further, then eject the heat shield. When the ship got to within 300 meters of the surface, the parachute would be released and the rocket motors would fire easing the craft rest of the way down to the surface.

The Drive Assembly would remain in orbit acting as a mapping satellite until it was time to depart.

To return to orbit, the lander would fire up its chemical rocket engines and blast off. Once in orbit, it would dock with the Drive Assemble and return to Truane's Star.

## LANDER LAYOUT

The ship is somewhat unconventional. The lander's deck orientation is opposite of the direction of thrust. Crews complained about being strapped into their seats on the bridge for the 5 hours it took to reach maximum speed and during deceleration.

In case of emergencies each deck can be sealed off by a sliding hatch located in the floor and ceiling of each deck.

## HEAT/METEORITE SHIELD

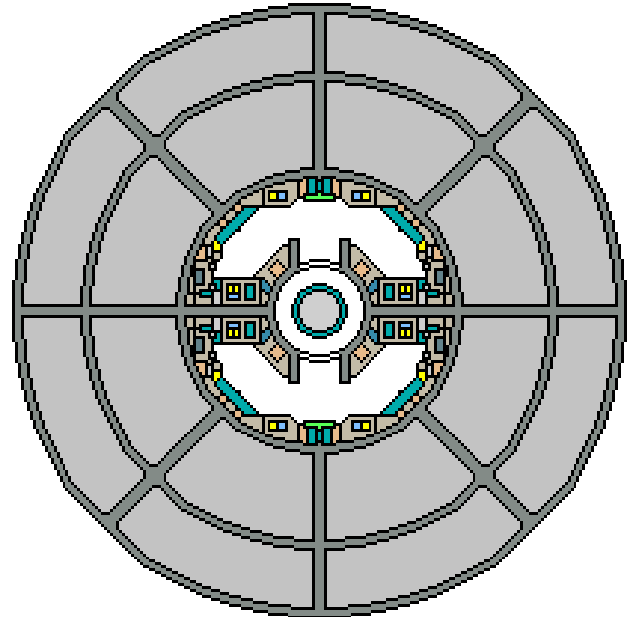

Made from a heat resistance material the shield provides protection for the lander during reentry. The shield is coated with an Ablative armor which protects the shield during space flight and micro meteorite strikes. This was thought to be essential since system wasn't mapped and the chances of such strikes were high.

There is a small compartment that houses sensing equipment for the shield and a 1,000 kilometer radar system.

The shield is attached to lander by six explosive bolts. The heat shield cannot be reattached to the lander after it has been discarded. Nor can the parachutes be used as well.

## DECK 1

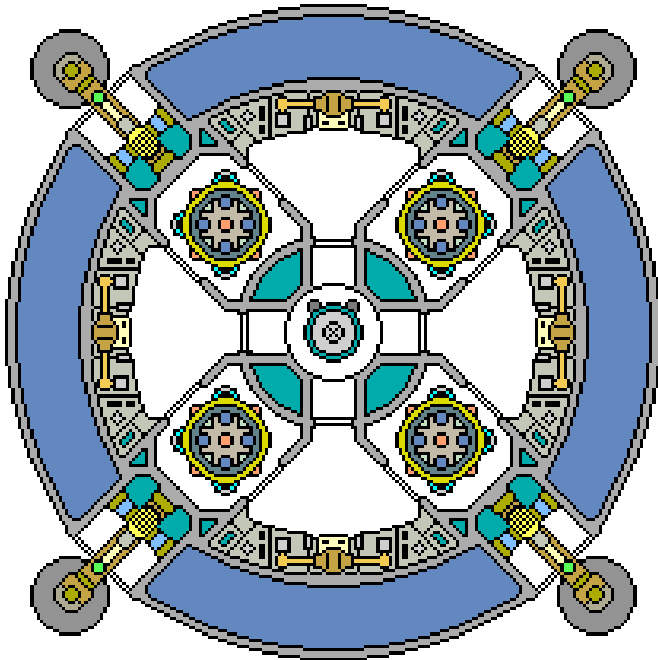

This deck houses the four rocket motor, landing gear and fuel tanks. Four maintenance areas are provide to work on the engines and inspect the power and fuels systems. Each room has two inspection hatches for engines.

At the bottom of the access tube is a hatch used to gain access to the avionics bay on the heat shield. The hatch is locked when nobody is working in the bay. After the heat Shield has been jettisoned. The hatch will not open unless there is a command from the bridge. The hatch cannot be opened from the outside.

The lander sits one meter off the ground (it will auto-level itself) and the hatch at the bottom becomes useless on rough terrain.

## DECK 2

1. **Galley / Lounge:** (1) the dining area seats four. It has a full kitchen (1a) and (1b) lounge with entertainment system.

2. **Storage Locker:** Spare parts and personal gear that can't be stowed in the room are placed here.

3. **Airlock with extendable Lock:** The airlock allows access to the interior of the ship. The cabinet in the room houses tools and safety equipment used during spacewalks. The Comet is equipped with an extendable lock for docking with other spacecraft (3a). After entering the ship, personal must pass through this room. The room houses space suits, EVA equipment, and the airlock control panel.

Access to the ground is done using a ladder built into the hull. A small retractable crane is mounted above the airlock. It can only lift 250 kilograms. The Airlock has a Level 3 Security Lock.

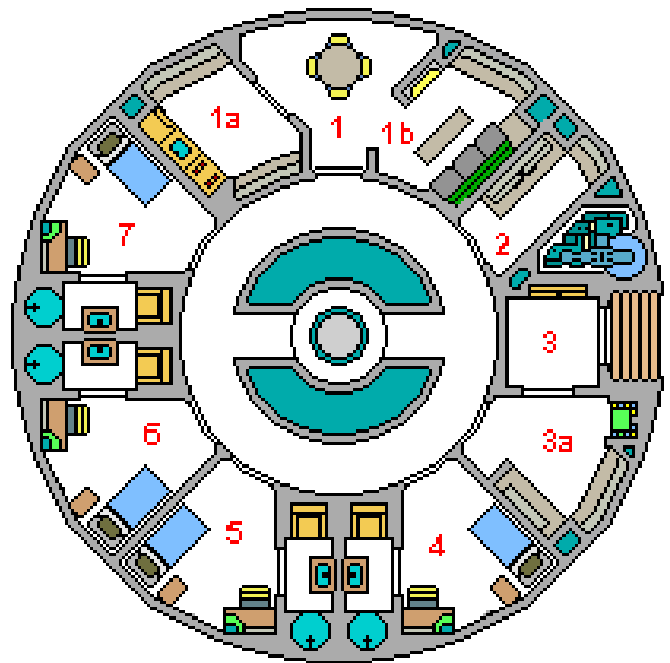

4-7 **Quarters:** These are the crew's quarters. They are single occupancy staterooms. Each room contains one beds, one nightstand, a desk, and a full bath. Above and below each bed are storage areas and compartments for personal belongings. On the desk is a small workstation used to watch vids, games or read messages from home. (Should be treated as a home computer, Level 1.) They are not connected to the ship's network but can receive and send messages via the ship's communication array.

## DECK 3

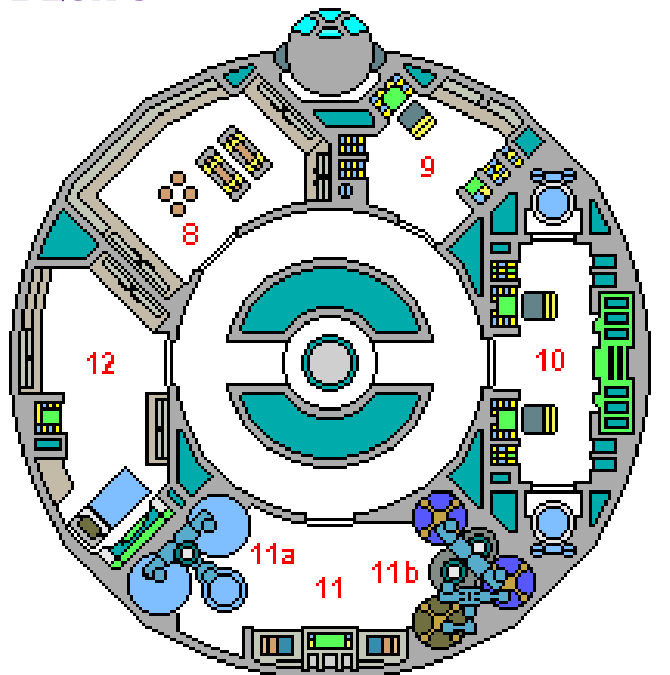

8. **Cargo Hold:** This room is storage for the expedition, food, equipment and samples collected during the mission.

## Frontier Explorer

9. **Telescope:** The telescope is a multispectrum type used for mapping planets, asteroids, and solar systems. Other uses include; meteorological studies, astronomy and gas analysis. It can also run an astronavigation program.

10. **Analysis Lab:** The lab is for general analysis of mineral and organic material. The sample analysis unit (bright green in the center), at the top and bottom are two isolation chambers and to either side of the door are the workstations for the lab.

11. **Life support:** This room houses the ship's life support system. It has a standard 20 ship days or 400 hours operational life and handles as many as eight personnel. Once on the planet's surface, the system cleans the air coming into the ship. Water brought in from the planet surface can also be filtered as well. Filters can be changed and cleaned by the ship's crew.

11a. **Atmospheric Scrubbers:** This maintains the ship's atmosphere for 20 ship days or 400 hours. Recharging this unit can only be done at a spaceport

11b. **Water Purification Plant:** This unit cleans and sanitizes the water used in the container during its mission. Recharging this unit can only be done at a spaceport.

12. **First Aid Station:** This is simply a first aid station for the ship. It contain one life support bed, several supply lockers, and cabinets mounted in the walls. A small work station is provided to allow the Med Tech to monitor patients. A single work station allows a medic to scan an individual lying on the Med Bed. It cannot diagnose diseases or illness. It only aids the medic in treatment. (+ 30% to medical skills)

## DECK 4

13. **Electronics' Bay:** This room houses the equipment that connects the bridge to the rest of the ship as well as the electrical system.

14a/14b. **Nav Array:** The Nav-Array is a multi-spectrum device. The device has the following items built in: A radio telescope, Doppler radar, multi-frequency radio scanner, and a full spectrum optical system. The array is mainly used to do a rapid assessment of a solar system or planet. It also has the ability to detect other ships in the area. Its intended purpose is to reduce the strain on the astronavigation equipment.

The Nav-Array can chart a system in about 30 hours and do a planetary survey from orbit in 20 hours. In each case, the Array provides a detailed map of the system or planet they are in orbit around. The multi spectrum optical system allows the crew to determine the composition of a planet's atmosphere at great distances. Since the system operates separately from Astronavigation, the survey takes place during calculations for the next jump.

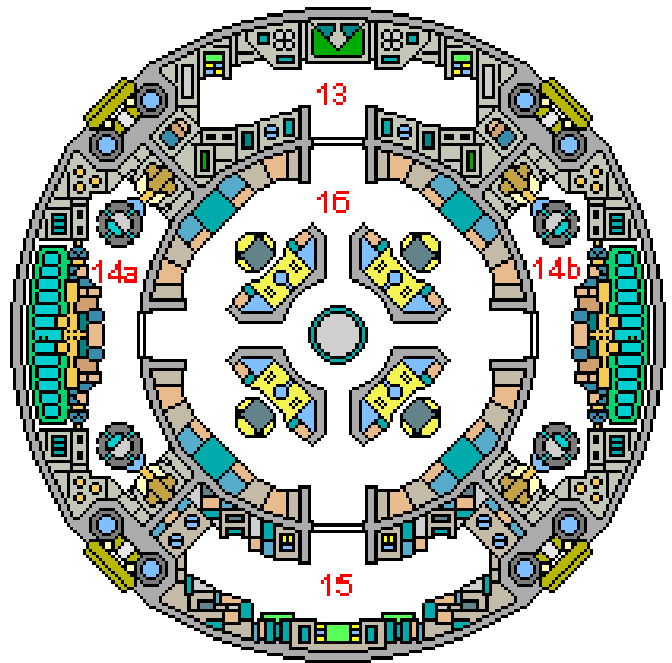

Under normal circumstances in a well-known system, the crew can detect any ship within a 500,000 kilometer range. The Array adds 15% to the player's chances of detecting a ship within an unknown system at a range of 300,000 kilometers. It also removes the -5% per light year penalty from Charting New Routes Skill since the Astronavigation systems can be committed to plotting the new course.

When the heat shield is attached, the ship has a blind spot directly to the front (See Deck 1 for limitations).

15. **Ship's Computer:** This room contains the Computer.

16. **Bridge:** The bridge has four work stations: Pilot, Co-pilot/Astronavigation, Captain and Engineer.

Steering thrusters mounted every 45 degrees on this deck provide for course correction during landing. When mated to the Drive Assemble, they help maneuver the ship.

## DECK 5

17/17a. **Electronics' Bay:** This room controls the transfer of power from the Drive Assembly to the Lander, as well as the network systems which allow the Lander to communicate commands to the Drive Assembly. There is an iris hatch atop the central access tube. It can be opened only with authorization from the Bridge. When docked with the Drive, it allows access to the assembly. It is also there to remove the parachute cables, if the need arise.

18/18a. **Mooring System:** This simple system allows the Lander to dock with the Drive Assembly. All the pilot has to do is align it with the corresponding mooring system on the assembly. The ports in this compartment are used to connect the Lander's systems with the assembly. Access to the compartment requires the removal of an access hatch on the hull.

atmosphere. Again this was a cost cutting measure by AMC.

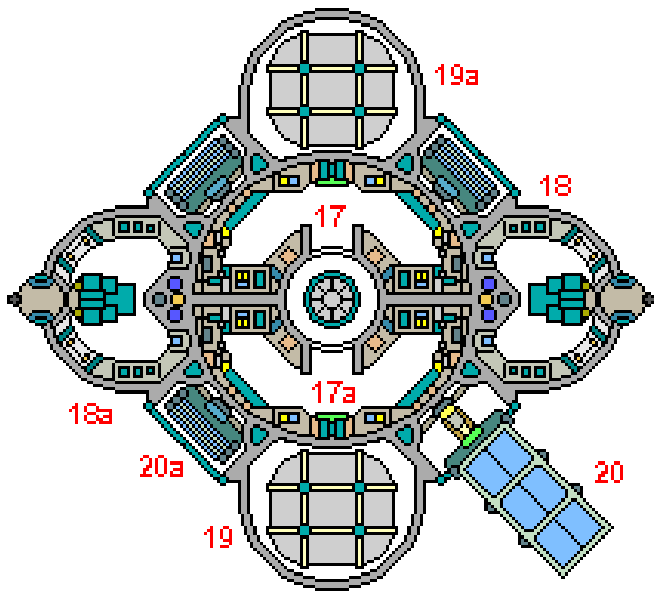

19/19a. **Parachute bay:** There are two large parachutes in these bays. They aid in the landing of the craft on the planet surface or in emergencies.

20/20a. **Solar Panels:** The solar panels provide power to the lander after it is on the planet's surface. The panels are able to track the sun's movement to provide the most power. The panels cannot be deploy while docked with the Drive Assembly. 20 shows the panel deployed, while 20a shows it in stowed.

Mooring anchors are not shown.

## DRIVE ASSEMBLY

The Drive Assembly is treated as a separate craft. Its whole purpose is to get the lander to Volturnus. After that, it stays in orbit around the planet until it's time to leave.

While the Assembly is in orbit, its sensors will collect data on the planet and solar system. It will then be downloaded only after the Lander has returned to the Assembly and they are ready to return. This is due to an encryption security program.

The mooring anchors (there are 6 of them) and the locking mechanisms on the Assembly are not strong enough for radical maneuvers such as those made in combat. If the ship is reused these moorings and locks must be inspected and replaced as need.

There is only enough fuel onboard to make two trips in this ship. This was a cost cutting measure used by Atlas. Its maximum range is 14 light years one way, that's if you plan on returning to the point of origin. In theory, it can travel 28 light years one way without refueling.

There is no atmosphere in the drive assembly. Spacesuits are required, unless the commander has decided to use the Lander's life support system to flood the assembly with

## DECK 1

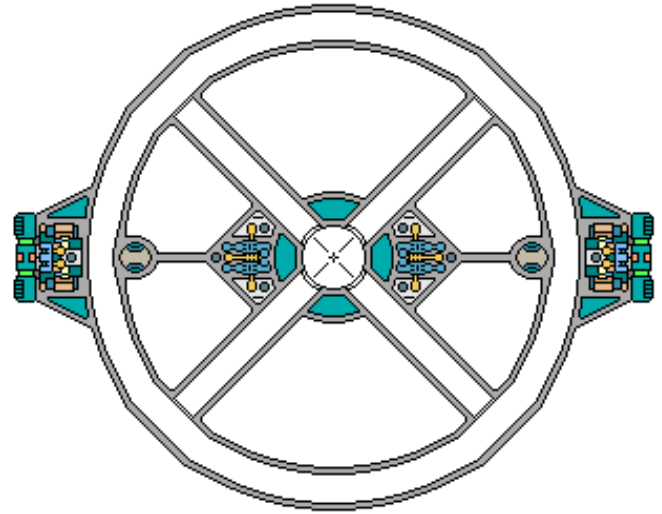

The dock ring (mooring clamps not shown) allows access to the antennae, inspection ports, the mooring pins, and power and computer couplers. They must be check for proper alignment and that all clamps are secure before switching power over to, and taking control of, the Drive Assemble. (Engineer Skill minus 2d10 minutes).

## DECK 2

This deck houses the engineering controls for the ship. Once the Lander is attached, the Drive Assembly systems are monitored from these station (work station left and right (light green are the monitors)). Four parabatteries add an additional 20 hours of emergency power to the Lander.

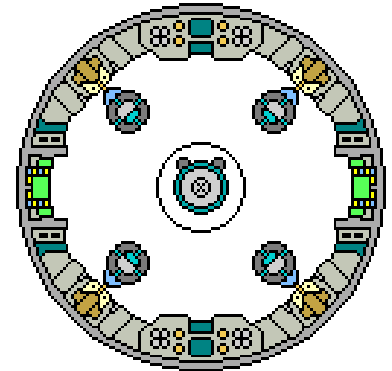

When the Drive Assembly is separated from the Lander, they act as backup power for the Assembly. The hatch on this deck is considered a Level 5 lock (center of the deck).

## DECK 3

This deck contains the computers and planetary mapping arrays. There are two computers on this deck (top and bottom) one is used to store data for the mapping array (right and left) while the other is the

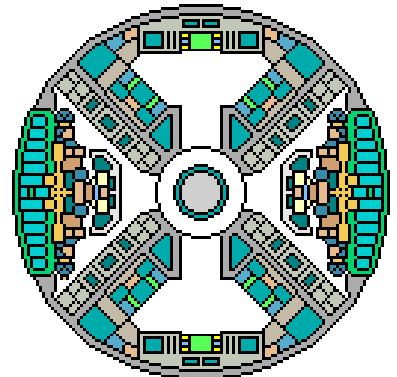

## Frontier Explorer

engineering computer.

The arrays are the same as 14a and 14b.

The computers have a double security lock out. One is a password and the other are the mooring pins. If the lander is not docked with the assembly the computers are inactive. Activation of the Drive Assemble and these computers without the Lander should be seen as formable task (-60 percent).

### DECK 4

This deck contains the electro-mechanic equipment that controls and transfers the power from the atomic reactor. There is an iris value lock on this deck that blocks access to the reactor decks below (treat as a Level 5 lock).

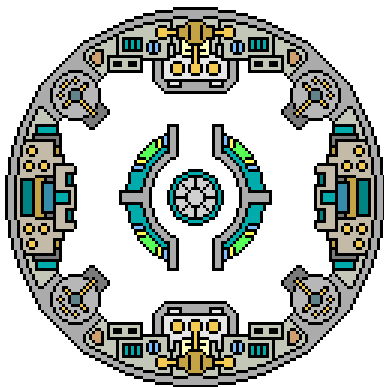

### DECK 5

This deck is an access tube which connects the engineering section to the reactor decks. It is a six meter long tube with access panels lining the entire length. Behind these panels are electric and control cables which control and transfer power from the reactor to the rest of the assembly.

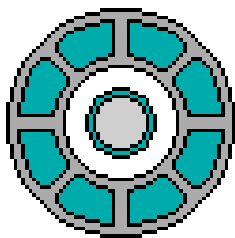

### DECK 6

This deck houses the equipment that monitors and controls the reactor. No radiation suits are required on this level. Monitoring of the reactor is done on Deck 2 of the Drive Assembly or from the bridge of the Lander.

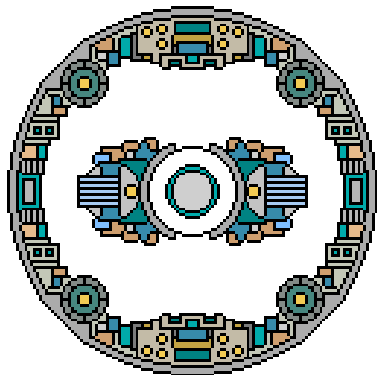

The reactor can be manually shut down from this level. (engineering level minus 2d10 minutes).

### DECK 7

This deck is six meters tall and houses the reactor which powers the ship. At the top and bottom are the power relays which transfer power to the rest of the ship. To the

right and left are the heat exchangers for the reactor and in the center is the reactor itself.

The reactor is intend to operate for two years without refueling. Refueling the reactor needs to be done at a specialized center.

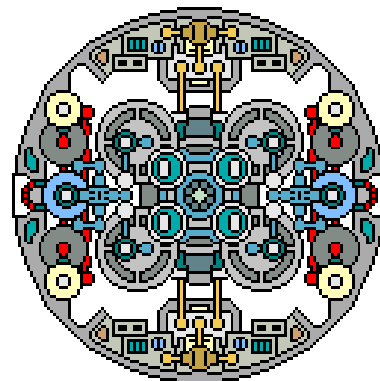

When the Lander is detached from the Drive Assembly, the reactor automatically is set to idle providing just enough power to keep the internal system running and the mapping arrays operational.

This depiction shows the fuel tanks. Already stated, it contains enough fuel for 28 light year's worth of travel one way. These tanks can be refueled at any station which services Ion Engines. These tanks are designed to hold only Hydrogen.

This depiction shows the main Ion engine and its maneuvering thrusters.

## APPENDIX 1: DESIGNER'S NOTE

I watch too many science shows and try to depict my ships with some resemblance to real world Ideas. There is also a precedent for this in Star Frontiers, Eleanor Moraes. As stated in Face of the Enemy SFKH3, the Moraes has a supply ship orbiting Mahg Mar, which it can dock with and attach landers.

## APPENDIX 2: GM NOTE

In the Alpha Dawn Rulebook PDF, there is a mention of the survey team sent to Volturnus nine months prior to the adventure starting. This would be their ship. Since no one is sure what happened to them, this could lead to an adventure all by itself or precursor to the events to come.

## PLAYER DISORIENTATION DUE TO THE DESIGN

The lander is backwards to the direction of travel. It is therefore necessary for the crew to remain strapped in during the initial 5 hour run up to maximum speed. They will feel as if they are being pulled upward during this time. Once the engines are cut off, the lander has no gravity.

Since the Lander is constructed to work as an operational planetary base, the weightless environment will need getting use to since the decks orientation is pointed towards the ground. Rules for zero-gravity should apply.

Roll (2d10)	Possible Outcomes
1-3	Sathar discover them in the system and have taken them prisoner. They destroy the Drive Assembly and Lander. They are now agents of the Sathar.
4-8	Pirates attack them and they are killed. The lander has been turned into their headquarters or outpost and reactor from the Drive assembly has been (with great effort) scavenged to power their base.
9-13	They landed on the planet without incident and were later killed by the natives or taken prisoner by the Pirates.
14-17	They landed on the planet and realize something has gone wrong but are unable to return to Truane's Star. They either died or have gone native leaving the lander in order to find food and water.
18-19	They crashed on the planet and there are no survivors.
20	They discovered something in the system which prompted them to travel further into the unknown.

### OTHER POSSIBLE SCENARIOS

The lander if intact, could provide them with shelter and a base of operations. It could also have much needed supplies.

It may also give the players a way of leaving the planet. This can be explained as the Drive Assembly was set in a long elliptical orbit which passes by the planet once every three months. The Pirates and the Sathar are aware of the Drive assembly but since it is no threat, they have done nothing to it. And with the security systems in place. The undamaged Drive Assembly has not been breached. Then again, it could be booby trapped as well.

Another scenario is that the ship can be used in other adventures. The ship can be used as a follow up ship, like the Alpha Scout or the Eleanor Moraes, in order to stake a claim to the world or just general exploration. The ships major drawback will always be its fuel and the lack of armament. It is a vehicle used to get players from point A to B and provide a base of operations, nothing more.

## APPENDIX 3: STAGING GROUND: VOLTURNUS

This replaces the base described by Mister Putman in his PDF. To me this makes sense considering a four man team was sent to the planet. The ship has all the requirements to do the survey housed in one nice neat

package. It also provides a clue to how the Pirates are laundering their mining operation. Atlas or another corporation used the initial survey information gathered by the team to setup the operation on Volturnus. It also explains why there was no follow up mission until the PCs get involved.

Looking at the team list, we have two members from the Truane's Star government, a professor and a navigator from Atlas. Either one of them was bribed or the entire team was working for the corporation in the first place. Another possibility is one of them is working for the pirates.

We should also consider that the pirates are probably mercenaries sent there to establish the mining camp and protect the interests of the corporation. This would explain why they are well armed and well supplied. It also explains how they are introducing the mined materials into the economy without suspicion.

**FE**

## 35<sup>TH</sup> ANNIVERSARY COMMEMORATIVE PATCH

We received permission from Wizards of the Coast to produce a limited edition 35<sup>th</sup> Anniversary Commemorative patch. The patch will be based on the 35<sup>th</sup> Anniversary Logo. The logo, along with the patch design are shown below.



If you are interested in ordering one or more of these patches you have two options. To pre-order the patch, go to <http://starfrontiers.info/patch2017.html> and you will find a PayPal button allowing you pre-order the patches. If you don't want to order via PayPal, or don't want to pre-order, you can simply send an e-mail to [patches@frontierexplorer.org](mailto:patches@frontierexplorer.org) and let us know how many you would be interested in.

The order to produce the patches will be placed in mid-November once we have an idea of how many will be needed. If you want to guarantee that there is a patch for you when they come in, please express your interest in one of the above methods. We can only produce a limited number and once they're gone...

Equipment

# BANDOLIERS FROM BANDITS

Tom Verreault

Hezred “Wolfen” Arsclan presented the image of an old and feeble yazirian. He leaned on a walking stick, his mane was graying and his movements were those of the old and lame. This had emboldened a group of three local toughs to try some smash and grab of cargo clearly visible beyond the open cargo ramp.

Unfortunately for them, Hezred’s years of tactical training and strict martial arts regime meant he was not the feeble watch keeper he appeared. The young punks had threatened and blustered but Hezred had simply stared them down from the top of the ramp. The moment had come when they were either going to make a move or walk away and he had told them to walk away.

The rash leader produced a disk grenade from a bandolier but his throw was hesitant. The default setting for such weapons allowed for them to be bounced off a hard surface like a human Frisbee or a yazirian zamira. Hezred made two quick strides and snatched the thrown weapon from the air before it could bounce, spun on one leg, and sent it on a blazing return arc amongst the tightly grouped attackers.

After the grenade exploded he was suddenly among them with the walking stick and beat the three opponents into submission or unconsciousness. He relieved them of their weapons, tied them up with ion bonding tape dumped, and dumped them in a garbage dumpster.

Later, when the ship returned to Faire, he visited the Minzii Market and bought a case of assorted grenades to restock the disk grenade bandolier he had taken as a trophy. After all, one never knew when one would encounter opponents that had their act together and having the extra bang could come in handy.

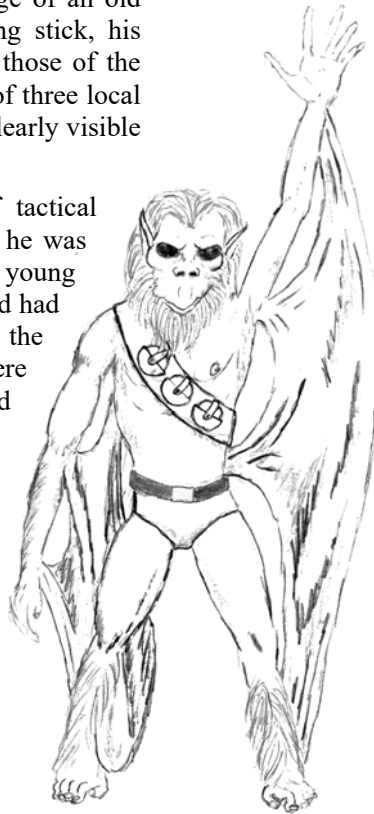

## STANDARD EQUIPMENT BANDOLIER

The standard equipment bandolier has 8 pouches. A thrown grenade, 2 ammo clips, a gas mask, or other small items will fill 1 pouch. Grenades carried in a bandolier are treated as a pistol in a holster for initiative rolls.

Cost: 20 Cr Wt.: n/a

## YAZIRIAN DISK GRENADE BANDOLIER

This bandolier is designed to hold 6 disk grenades and 2 solvaway vials. Characters drawing and throwing a grenade in the first turn of combat suffer the same -2 IM penalty as a character drawing a pistol from a holster.

Cost: 20 Cr Wt.: n/a

## GRENADE RIFLE BANDOLIER

This bandolier is designed to hold 12 grenade rifle rounds and 4 solvaway vials.

Cost: 25 Cr Wt.: n/a

*NOTE: Star Frontiersman #5 detailed the Yazirian Disk Grenade but this was simply the disk version of the fragmentation grenade. What follows is simply stats for a wider variety of disk grenade types. Rules for using disk grenades are not reprinted from [Star Frontiersman #5](#) but can be found in that issue.*

**FE**

Grenade Type	Cost	Damage	Rate	Defense	PB	S	M	L	E
Doze	13 Cr	Sleep	1	STA check	0-5	6-15	16-25	26-50	51-75
Fragmentation	25 Cr	8d10	1	RS check	0-5	6-15	16-25	26-50	51-75
Incendiary	25 Cr	1d10 + 1d3x3 turns	1	RS check	0-5	6-15	16-25	26-50	51-75
Poison	25 Cr	S5/T10	1	STA check	0-5	6-15	16-25	26-50	51-75
Smoke	25 Cr	-10 to hit	1	IR Goggles	0-5	6-15	16-25	26-50	51-75
Tangler	30 Cr	Entanglement	1	RS check	0-5	6-15	16-25	26-50	51-75



Starships

# NEW ERA COMMERCIAL SURVEY MODULE: CSM-GP5

Martin Derryberry

The CSM-GP5 is a converted 16 meter diameter cargo container used by the mining industry to do general surveys of asteroid belts and planets. The design allows companies and corporations to easily transport using existing fighters throughout known space.

The CSM-GP5 has a crew of eight and weighs approximately 3,000 tons. The container has a crew of 8, level 4 computer, a science lab, and a powerful multispectrum optical telescope. The design allows the container to be connect to stations or ships with a specially design cargo rack. The container can also act as a stand-alone platform where samples can be examined.

## DECK 1

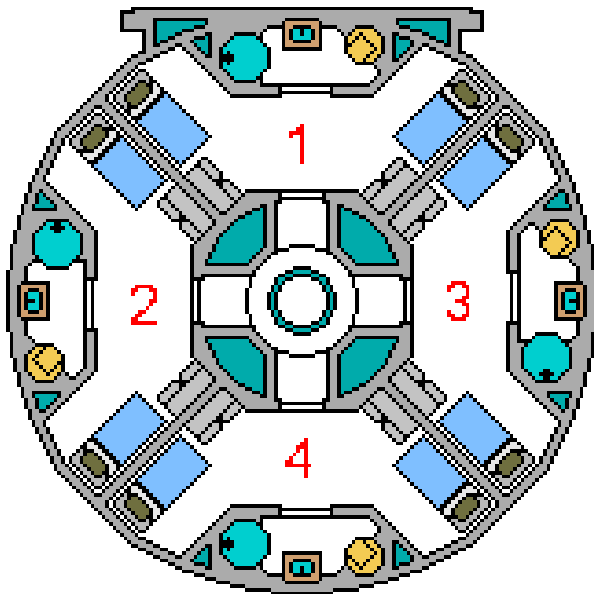

1-4: These are the **crews' quarters**. They are double occupancy staterooms. Each room contains, two beds, two wall lockers and a full bath. Above and below each bed are storage areas and compartments for personal belongings. A small monitor is mounting over the head of the bed so people can watch their favorite vids and receive personal mail from home. (Should be treated as a home computer. Level 1)

## DECK 2

5: **The ship's computer**. The computer is level 4. The computer runs and records most of the systems on board. The computer is tailored for analysis of chemical compounds and mineral resources.

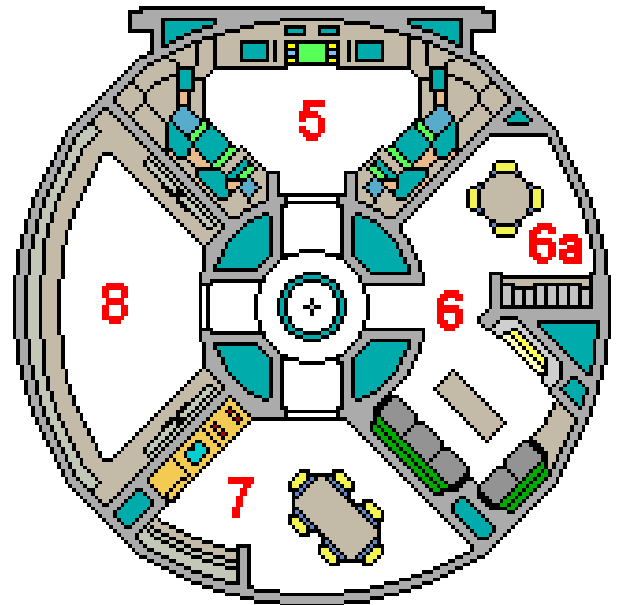

6: **The Lounge**: The crew can sit here and watch vids as a group or just relax. This area is also used as the briefing room.

6a: This small area contains a table for playing cards and a library.

7: **Galley**: Contains a full kitchen and a table that seats six.

8: **Food storage**: The food is either dehydrated, canned or concentrated. There is enough food to last 20 ship days.

## DECK 3

10: **Airlock**: The airlock is a safety precaution as well as used to load and unload the crews. The air lock control is on the right as you enter. To the left, is the control panel which activates the module. The airlock can only accommodate one being at a time.

On ships or stations with specially equipped cargo rails this airlock allows access to the ship. On TT-456s and NT- 1000 access to the ship is done by a spacewalk to the ship's airlock.

11: **Med Bay**: This is simply a first aid station for the ship, it contains two life support beds and two small supply lockers. A small work station is provided to allow the med tech to monitor patients.

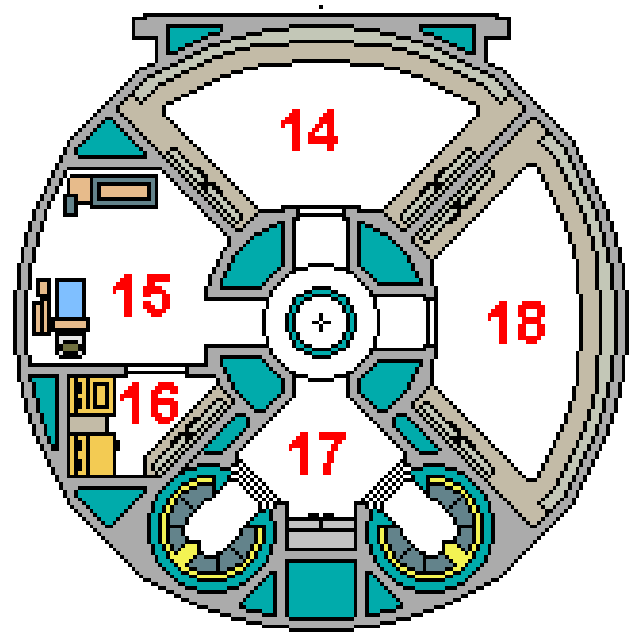
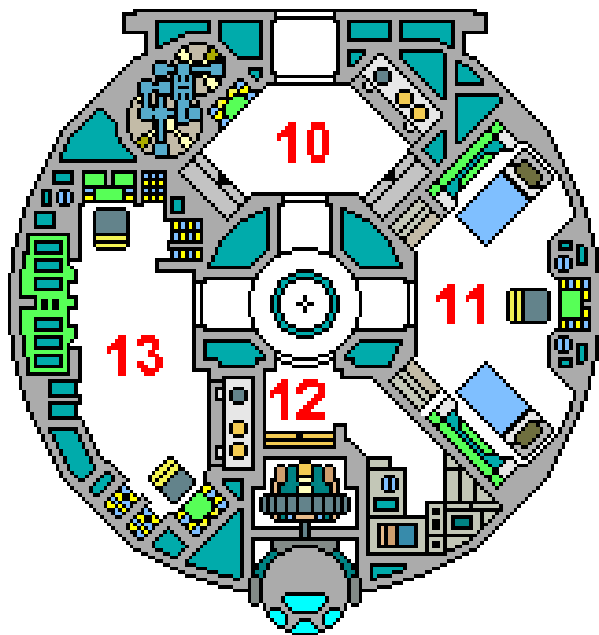

12: **Electronic Bay:** This room contains the electronics needed to run the telescope. A wall locker at the entrance contains an electronic toolkit.

13: **Analysis Lab:** The lab is for general analysis of mineral and organic material. The controls for the sample analysis unit (bright green in the center) are at the top of the room, at the bottom are the controls for the telescope. The station allows the operator to map a planet or asteroid, do limited meteorological studies, and analysis of gases using its multispectral telescope. The station has a very limited mapping capability concerning solar systems and by no means can it be used as an astronavigation program.

## DECK 4

14: **Specimen Storage:** Samples of minerals and organic material are stored here for further examination at a research facility.

15: **Gymnasium.**

16: **Laundry.**

17: **Escape pods:** There are 2 escape capsules here, each seats 4. Once launched they cannot return to the container due to the explosive bolts and charges that launch them. Between the two escape capsules is a locker with extra provisions. Under each seat in the escape capsules is a survival kit.

18: **Stores:** This compartment contain spare parts, chemicals need to run the Analysis unit in Room 13, and personal equipment which cannot be store in their staterooms.

19: **Electrical Control Panel:** This group of equipment allows the pod to transfer power from the ship to the container.

19a: **Atmospheric Scrubbers:** This maintains the ship's atmosphere for 20 ship days or 400 hours. Recharging this unit can only be done at a spaceport

19b: **Water purification plant:** This unit cleans and sanitizes the water used in the container during its mission. Recharging this unit can only be done at a spaceport

20: **Battery Room / Solar Panels:** There are 3 batteries in this room which provide 15 hours of emergency power, in case the container is separated from the ship. The solar panels are there in case of emergency as well. When both are deployed, they provide enough power to run the systems on the container and charge the batteries.

## APPENDIX 1: EQUIPMENT

### DUTY UNIFORM

The duty uniform is a light weight space suit meant to be worn when onboard a spaceship. The suit is equipped with a temporary pull out clear plastic helmet that is pulled over the head and worn until a real helmet can be located. The atmosphere is stored in two flex tanks located in the chest and will last for 2 hours. The suit provides some protection from shrapnel and should be treated as Kevlar armor. When mated with a helmet and backpack system, the suit will act as a spacesuit. The suit doesn't do well in corrosive atmospheres. Cost: 1000 Credits.

### ESCAPE CAPSULES

Their life support system last for 7 ship days or 140 hours. They are capable of planetary reentry and use a parachute to land. They can make slight course adjustments in order to land on the nearest planet. An emergency beacon begins to broadcast as soon as the capsule leaves the ship. The signal will broadcast for 7 ship days. They cannot

outrun other ships or evade incoming fire. Cost: 50,000 Credits.

Capsule Survival Gear located under a hatch in the floor. List of items:

- 1 Atmospheric condenser for extracting water from the atmosphere (fills four canteens)
- 1 Food Processor.
- 3 Man Tent
- 1 Emergency radio
- 1 Recharging System with two external ports. (solar powered or hand cranked)
- 1 Shock fence (covers 10 by 10 meter area.) 4 emitters with 10 charges each. 40 Survival Rations
- 2 Survival Rifles (10 shot Rifle with 3 clips and a built in single shot shotgun with 10 rounds.)

If the equipment is divided up between the survivors, it can be easy carried between the 4 of them.

Personal Survival Kits are located under each of the seats. List of items:

- 1 Backpack
- 1 Compass
- 1 Collapsible Shove (Does Club Damage)
- 1 First Aid Kit: 3 bandages, antibiotic spray and 1 autojector antitoxin.
- 1 Flashlight, recharge by built in hand crank.
- 1 Lighter
- 1 Personal Emergency Beacon
- 1 Poncho
- 1 Sleeping bag
- 3 Signal Flare
- 1 Survival Knife (Does Knife Damage)
- 7 Survival rations.
- 1 Water Purification Canteen, with 7 filters.

## APPENDIX 2: GAME MASTER'S NOTES

The container is on loan from United Resources Corporation to the Truane's Star Department of Commerce (DoC) for this mission. As with all government contracts, it went to lowest bidder. Therefore these are some of the considerations you should make during the 5 day journey to Zebulon system.

### PIRATE ATTACK

To impress on the Player the need to hit the escape capsules and get off the ship. There is a loud bang and the explosion above their head. The radiation warning goes off, meaning there is a large scale radiation leak somewhere. After leaving the ship they will see that the number one engine has plowed into the shuttle container causing the contamination.

Roll (d10)	Results
1-3	The container is in great shape and everything is stowed correctly and everything is in running order. The players will spend the next 5 days bored out of their skulls.
4-7	The storage rooms are a mess and need 5d10 hours to organize but everything is in running order. The computer is a mess and needs 1d10 hours to organize and make sure it is running properly.
8-10	The necessary supplies were piled into the storage room without any thought. Minor repairs are need on the Telescope and Analysis Unit, each will take 6d10 to sort out. The computer is a complete mess and there are files missing. Mapping Volturnus will be impossible.

## AFTER THE PLAYERS LAND ON VOLTURNUS

Their mission to survey the planet and system was to last 18 days (2 days less than the maximum of the CSM-GP5 life support system out of safety concerns.) Therefore, they are under the assumption that rescue is 21 to 24 days away. The GM should impress this upon them.

Second, the destruction of the cargo ship that brought them here by pirates should be of grave concern considering there is an emergency beacon blasting away on their escape capsule. They will not be able to do anything until after they have landed. They have 10 minutes after they land to disable it or the rirates will have their location. Roll a D10, if it 8 or higher pirates will know their general location and send out a search party. This can be offset, however because there are a number of pods coming down (2 from the container and 2 from the ship.)

### CAPTAIN OHED EPPS

If the Captain survives (50/50 chance), he will not be too pleased to see the characters and blames them for the destruction of his ship. His smuggling days and dealing with the underworld may lead him and his crew to side with the pirates or attack the group for the above reason.

## IF THE PLAYERS BOTCH THE ADVENTURE

Allow the players to struggle it out for 22 Days before a Truane's Star Defense Force cruiser shows and rescues them...

# THE MINIATURE LOSSODRAGON

Eric Winsor

Grakta beings of the Frontier. Joy and happiness to you from the home tree this new season. In honor of the life of the trees that all yazirians celebrate at the start of a new season we at the Jurak Hangna Foundation wish to celebrate the budding spring of Hakosoar and the new year by showcasing a wonderful creature of the trees our dear friend and life ally named Hako brought along with him from his recent travels on Lossend. Hako as ever is in good health and cheer and an honor to his clan. He has shared with us many great tales of his most recent travels across the Frontier. We congratulate him for his successes on Terledrom and Triad and appreciate the tokens of success he presented us. We will see to it that they receive a clan hall place of honor. Good luck friend on your continued journeys and thanks for sharing your miniature lossodragon with us.

## GREAT THINGS COME IN SMALL PACKAGES

Hako always drops in unexpectedly and his work does not let him stay long. Dwain and I were out in the open preserve tending to a sick fieldbear when Hako suddenly strolled out from the treeline with a miniature lossodragon riding on his shoulder. He casually commented that he had just finished wrapping up a business deal in Hyyay and had a few gifts to drop off and a celebratory dinner to share before leaving the planet to push out of Scree From the next day. Dwain and I nodded mindless agreement and thanks but were hopelessly obsessed with the miniature lossodragon. The creature did not belong peacefully resting on his shoulder. Lossodragons are known as dangerous carnivores that have never been domesticated. The miniature lossodragons of the great northern forests share equally in this well established reputation as menacing predators who are fearless of all creatures and the core four. How did Hako manage to get one as a companion animal?

Hako divined our source of distraction and grinned with satisfaction at his exploit then goaded us back to our duties hurrying us along so that we might get back for dinner and stories of his travels. This was undoubtedly a planned moment for Hako, landing his hoverbike in the trees and sneaking in to surprise us with his new pet. I commented about his sneaking in and he responded that he had landed in the trees to avoid startling the fieldbear. Neither Dwain nor I bought that explanation but it was true that the fieldbear was becoming agitated by the

presence of the lossodragon. Eventually Hako had to take the lossodragon back into the trees out of sight and tie its leash to the handlebars of the hoverbike. Taking the creature out of sight also removed our distraction from work and inspired us to work faster so that we might get to meet the creature first hand. Hako wandered back to his hoverbike to spare us further distraction.



Miniature Lossodragon by Eric Winsor

## MEETING STADAKH

Dwain and I hurried through the remaining treatment of the fieldbear needed while Hako put together this nice little sketch of himself and the dragon on his bodycomp tablet. Hako was just finishing up the coloring as Dwain and I found our way through the trees to the small clearing he had parked his hoverbike at. The lossodragon was perched with his four feet across the length of the handlebars playing his wings in the wind. Hako was resting up against the passenger backrest tablet in hand smiling as he worked. He gestured toward the lossodragon and announced, "Meet Stadakh!"

Dwain approached slowly and Stadakh watched him intently. Dwain started to reach toward the creature gauging Stadakh's acceptance of himself. Suddenly

Stadakh snapped at Dwain's hand and Dwain expertly jerked his hand as quickly away to safety. Hako chuckled with pleasure and explained, "He guards me as his own. He will only let one whom I command handle him." Then he spoke the command, "Gra-gapa!" and told Dwain to reach forward once more. Dwain steadied himself and put forth his hand toward Stadakh's wing. Stadakh kept his eyes on Dwain but let his fingers touch him. Dwain started soft then slowly began to stroke Stadakh's wing. Stadakh responded by stretching his wings out and allowing Dwain to pet and scratch slowly toward his back while Hako and I exchanged clan greetings. To Hako's surprise Dwain soon had Stadakh in his arms and was whispering to him softly while stroking his head. I had my chance to return Hako's chuckle at Hako's surprised expression. Hako nodded gallantly back at me.

I reached over to touch Stadakh myself and Stadakh hissed at me. Hako chuckled again at me and commanded Stadakh, "Gra-gapa!" as he gestured for me to touch Stadakh freely. Stadakh obeyed. The lossodragon skin is soft supple leather with fine hair a few millimeters long.

We had dinner that night at one of the back country tree homes. Tik joined us and brought live feed for Stadakh from the JHF provisions. We got to see firsthand the hunting capabilities of a lossodragon. Hako had Dwain loose one of the feed animals into the brush on the ground bellow and return to the tree home above. Hako then brought Stadakh forth set him on a branch and removed the hood from his eyes. "Gataka" he spoke softly and Stadakh scanned the ground bellow for a moment, caught a brief rustle of the animal in the brush below and dove swiftly down onto it snatching it in his four paws. There was a brief struggle and Stadakh crushed the creature's head in his mouth. Stadakh then began clawing and climbing his way back up to the tree house and dropped the prey at Hako's feet. Hako patted his head and commanded Stadakh to eat his prey. Stadakh grabbed up his kill and jumped back up to a tree branch to consume it. The display of lossodragon skill and Hako's training was very impressive. Our questions started immediately.

## HOW TO TRAIN YOUR LOSSODRAGON

Miniature lossodragons imprint on the first creature they see at birth. They will be loyal to this creature for the duration of their lives. The only known way to tame one is to obtain it right after the mother gives birth to her two or three pups. Lossodragons, both miniature and full-sized are mammalian and always have at least two pups at birth. Miniature lossodragon pups are about seven centimeters long at birth and their tails are not yet developed. Hako obtained his lossodragon when he accompanied a Lossend game warden to the site of a miniature lossodragon that had been hit by a ground cycle

and had not been able to recover from its injuries before giving birth. Hako was working part time for the Lossend Game Department as a volunteer lending his medical expertise. Stadakh's twin died at the veterinary clinic shortly after arrival. The game warden recognized that Stadakh had imprinted on Hako and arranged for Hako to obtain official registration for permanent care of the pup. This led to Hako staying on Lossend for an extended period after his business contracts were fulfilled which allowed Hako time to raise and train Stadakh under the supervision of the game warden and his staff in their pioneer work taming orphaned lossodragons.

Lossend law is that only orphaned miniature lossodragons may be adopted and only if they demonstrate that they have imprinted on the prospective owner. Miniature lossodragons that have not imprinted on their owners are very wild and dangerous to their owners and any others around. The law requires that non-imprinted miniature lossodragons be reintroduced to the wild or kept in zoos and preserves with professional handlers. Those owners for whom the miniature lossodragons do imprint on them must go through a Lossend Game Department training and certification program to master handling and training their miniature lossodragon. Miniature lossodragons are not a pet or domesticated animal. The ownership and handling of the animals is more like falconry of the largest human birds of prey. The miniature lossodragon is still wild but tamed to the imprinted owner. Mistreatment of the animal risks defensive attacks of lethal potential and abandonment by the miniature lossodragon.

Hako spent six months raising Stadakh to be large enough to glide and fly. Lossodragons do not fly by flapping their wings like birds. Rather they glide and ride air currents. They can gain a little lift to aid in jumping and use this to jump to higher branches of trees by pulsing their wings in conjunction with jumping from their strong four legs. Once they can glide earnest hunting training begins. This they would normally learn from their mothers but as orphans they must learn this from their imprint owners. Day after day Hako and Stadakh practiced together seeking and pouncing upon prey. As a yazirian Hako had the added benefit that he knew himself how to glide and fall upon prey. Hako and Stadakh glided together and pounced together. Hako took to riding a hoverbike so that he could stay aloft as long as Stadakh had instinctively learned when he discovered air currents and up drafts.

In addition to hunting training there are many commands practiced and mastered. Unlike the birds of falconry, lossodragons are capable of recognizing one and two word commands and their owner's voices. Training is done with food reinforcement and praise while the pups are young and continued usage throughout adulthood. Owning a miniature lossodragon is a lifelong job of continued practice to keep the animal trained and tame.

Hako has trained Stadakh to sit, wait, come, sleep, guard, hiss an alarm, stand, spread wings, perch, obey another, hunt, attack, retrieve, and roll up into a ball. All are done by command and a select few are only from Hako's voice. All of the commands are in Yazirian but a few essential ones like sit and wait are also known in Pan-Gal so that Hako can command Stadakh to obey another person he has designated. The obey command is a finicky command as Stadakh tends to only obey the designated person until that person leaves and then Hako has to command him to obey again. He says that long term exposure does help as a few of the game wardens he trained with enjoy long term obedience from Stadakh due to familiarity.

Hako says that ownership brings with it a bit of extra burden when traveling because he has to produce licenses when passing through customs and immigration. Also not every venue is comfortable with Stadakh riding on his shoulder in the open, it scares beings of all races. He has trained Stadakh to ride in a backpack on occasions where open view is a problem and he will do it for an hour or so before rebelling. Stadakh can be left alone caged or leashed around the waist or ankle. However, this can't be for much more than a day's work period or Stadakh gets restless and wild. Maintaining the imprint bond requires that the two remain together as often as possible. Mature lossodragons naturally tend toward independence though miniature lossodragons congregate in small gangs for protection and hunting advantage from time to time.

The big trick, Hako says, is to manage the lossodragon's tail. There are three spiked claws at the end of the tail that it uses to thrash and jab at prey. However, if you hold the end of the tail and control it, you can keep psychological control over the lossodragon. Where the tail spikes go, the lossodragon goes. Dwain took notice of this as Hako always holds Stadakh's tail spikes when he wants to maintain firm control over him. Dwain questioned Hako on this and Hako confirmed Dwain's observations. Dwain himself was even able to maintain better control over Stadakh when holding him by the tail spikes and

exercising his skills and years of experience as a xenological expert at animal handling. However, don't bank on catching a lossodragon by the tail and suddenly being its master. The animals are still wild and an imprint bond is essential.

Hako also explained that the lossodragon tail is always growing throughout the life of a lossodragon. A miniature lossodragon will reach full size in two years like Stadakh but the tail continues to grow new vertebra each year, continually pushing the tail spike forward. Full lossodragons take about five years to reach full size. Thus the tail is not included when measuring a lossodragon. Proper lossodragon measurement is from the crown of the head to the base of the pelvis.

## MINI LOSSODRAGONS IN THE WILD

Wild lossodragons stay with their mother to learn to hunt and glide until they are nearly a year old. Initially the mother will kill prey and regurgitate the meat for the pups to eat. Within a few weeks the pups are large enough to pull meat from dead prey themselves and then the mother will bring kills back to her hide for the pups to claw and bite at themselves. Later as the pups learn to climb and glide the mother takes them on hunts until they can hunt on their own. After a few weeks of successful solo hunting the mother abandons her offspring if they don't abandon her first.

Miniature lossodragons live principally in the high trees of Lossend. They are most common in the great northern forests. They tend to claim a large tree as their own and defend it from other miniature lossodragons through displays of force and occasional fights to first blood. Yet when food is scarce or large prey are the required source of food, three or four miniature lossodragons will gang together to hunt until the need for support is satisfied and independence again reasserts in their nature. This gang behavior also manifests when large predators threaten them. Principle among their predators are full size lossodragons who have wandered upon miniature lossodragon territory.

Lossodragons attack by pouncing followed by gripping with two claws and piercing with the other two. They also use their wing claws to rake their victims. The tail spikes are used to thrash and jab especially for midair attacks.

## GM NOTES

Full size lossodragons have only been known to imprint on a few occasions and those animal are in the possession of the Wiggling Brothers Circus. Wiggling Brothers spent a lot of money to attract the imprinted lossodragons and their owners to join the circus.

Lossodragon		
<b>TYPE:</b>	Carnivorous	
<b>SIZE:</b>	Miniature: 55cm	Full Size: 2m
<b>NUMBER:</b>	1-4	1
<b>MOVE (walk-run):</b>	10-15 m/turn	10 - 12 m/turn
<b>MOVE (flying):</b>	Very Fast (diving)	
<b>IM/RS:</b>	6/60	6/55
<b>STAMINA:</b>	35	125
<b>ATTACK:</b>	55 (ground), 70 (air)	
<b>DAMAGE:</b>	2d10	4d10
<b>SPECIAL ATTACK:</b>	Tail spike, dive knockout (1-35)	
<b>SPECIAL DEFENSE:</b>	NA	
<b>NATIVE WORLD(S):</b>	Lossend	

Optional Rules

# ALTERNATE MOVEMENT RULES FOR KNIGHT HAWKS

Tom Stephens

**Author's Note:** I don't remember in which of the threads on starfrontiers.us this came up but I described this alternate rule there and it was suggested that I write it up for the magazine. So here it is. It definitely alters some of the ways you think about movement and tactics in a Knight Hawks game. Enjoy.

When Douglas Niles wrote the Knight Hawks rules, he had just finished creating a World War Two naval combat game and much of the feel of that style of combat carried over to the Knight Hawks combat system. It's actually something about the system that I like. In fact, right about the time I got my copy of Knight Hawks I had written up a WWII era naval combat game myself. I still have it, written out in pencil on three-hole punched paper in a binder on the shelf behind me. However, naval warfare is a bit different than combat in space.

If you want to go as realistic as possible (or as possible as can be done on a 2D map), take a look at the Vector Movement article we published a long time ago in issue 11 of the Star Frontiersman. It actually recreates quite accurately the true motion of ships in space. We're not going for that full treatment here but rather a small tweak to the standard Knight Hawks rules in regards to turning your ship.

One of the biggest issues I always had with the Knight Hawks rules was how the small ships could pop a 180 degree turn in a single combat turn on a two hex radius curve regardless of their speed. In real life, the faster you are going the larger that turn radius would have to be or you'd have to come to a complete stop, turn the ship around, and head back the other direction. The possibilities in the KH rules are very cinematic but not very realistic.

So assuming you want a touch more realism in your game, how do you address this? By default, you can make one hex-face turn for each hex you enter until you've used up your current Maneuver Rating (MR) for the turn independent of current speed. This means that a ship with MR of 4 could make four quick turns in the first four hexes it entered whether it was moving four hexes per turn or forty.

This optional rule would limit how often you could make a turn based on your speed, thus simulating the larger turning radius that would really be the case in real life.

## NEW MOVEMENT RULE

The rule is actually very simple. If you are stopped, you can still make as many hexside facing changes as you desire, just like in the standard rules. If you are moving, the number of hexes you must travel before you can make a turn is given by the following relation rounded down to the nearest integer with a minimum of 1.

$$\text{Minimum Travel Distance} = \frac{1}{(MR + 1)}$$

So if your MR is one, you would have to move half your current speed before you could turn, if you're MR is 2, you'd have to move 1/3 your current speed before your first turn, and then that much again before using your second MR point, and so forth. You can always move farther before turning but you have to move that minimum distance after the turn before making another turn.

The table at the bottom of the page gives some sample values of the minimum turn distance for various MR ratings and speeds.

**MINIMUM TRAVEL DISTANCE FOR A GIVEN SPEED AND MR**

MR	Current Ship Speed															
	1-3	4-5	6-7	8	9	10-11	12-13	14	15	16-17	18-19	20	25	30	35	40
1	1	2	3	4	4	5	6	7	7	8	9	10	12	15	17	20
2	1	1	2	2	3	3	4	4	5	5	6	6	8	10	11	13
3	1	1	1	2	2	2	3	3	3	4	4	5	6	7	8	10
4	1	1	1	1	1	2	2	2	3	3	3	4	5	6	7	8
5	1	1	1	1	1	1	2	2	2	2	3	3	4	5	5	6

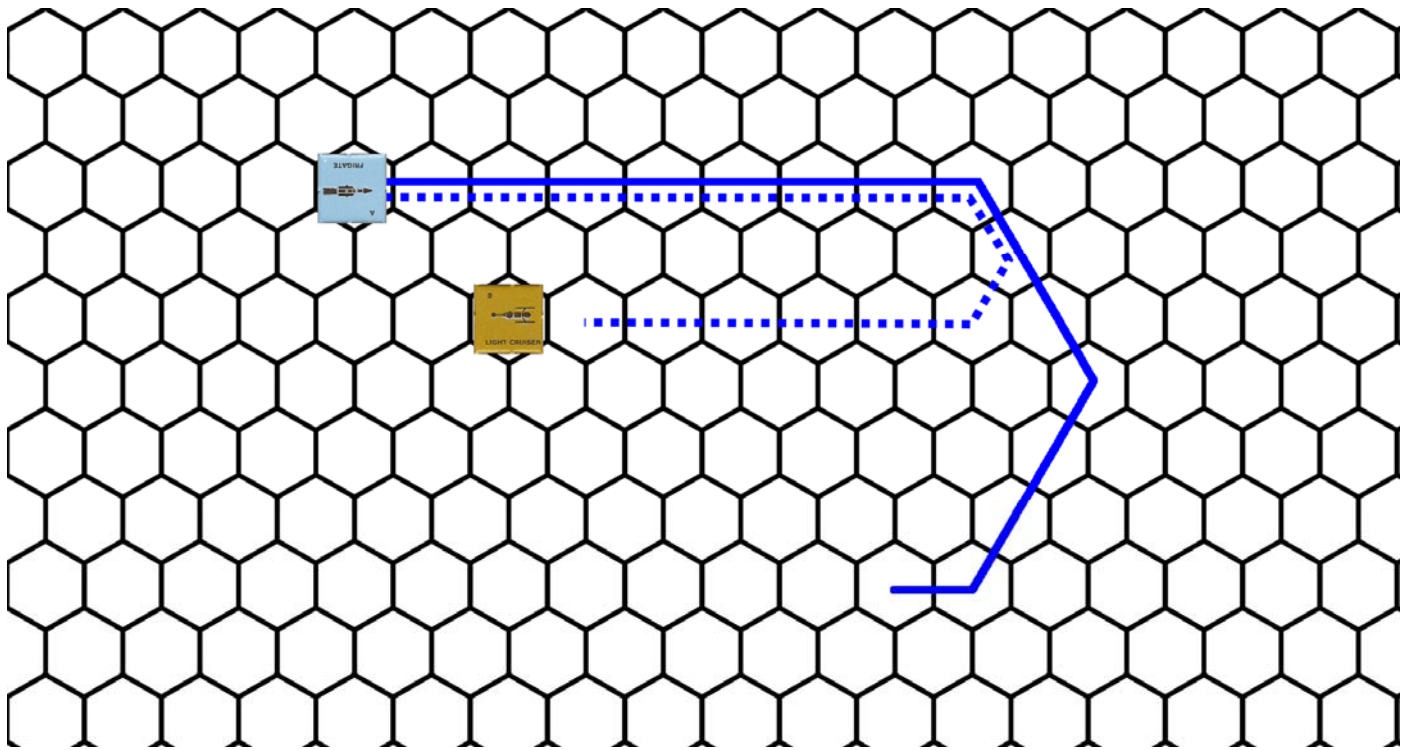

### SOME EXAMPLES

In the image above, UPF frigate A, racing to intercept the Sathar light cruiser (B) is moving at a speed of 15 and overshoots his target and needs to turn around. Using the standard rules, it could turn using the dotted blue path. With this new rule, given that the frigate is moving at a speed of 15 and has a MR of 4, it must move at least 3 hexes before turning. Thus it must follow the solid blue path shown.

In the image below, the Sathar destroyer is moving at a speed of 11 hexes. Undamaged it has a MR of 3 and at that speed could turn once every 2 hexes (following the dotted blue path). Unfortunately for the destroyer, it took a hit from an assault scout's assault rockets last turn which knocked its MR down to 1. Even slowing down at its max acceleration (ADF 3) it will still be traveling 8 hexes per turn and must move 4 hexes before turning (the solid blue path) and will smash into the planet.

**FE**

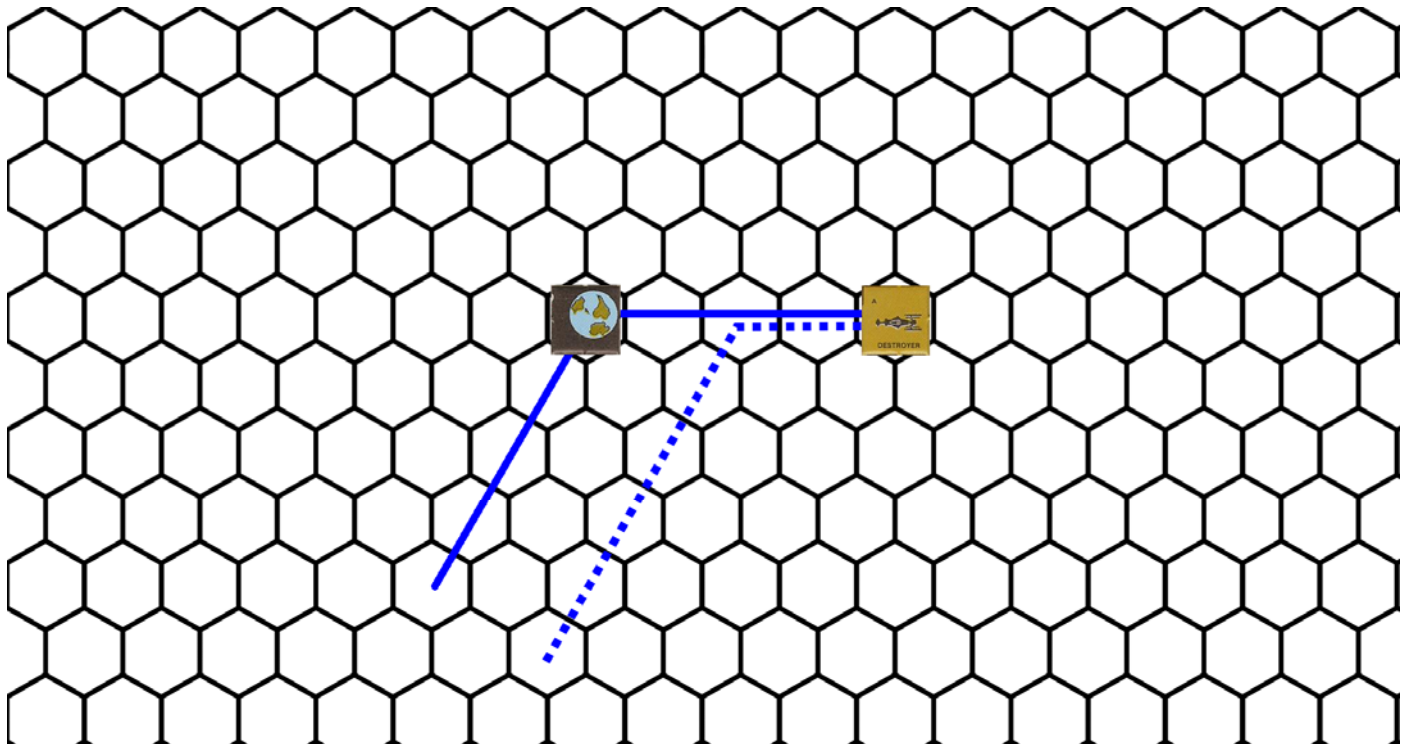





# GRYMZ

GUIDE TO INTERGALACTIC CONQUEST



## LESSON #18: VISITORS?

