

# Frontier Explorer

Issue 9  
Summer 2014

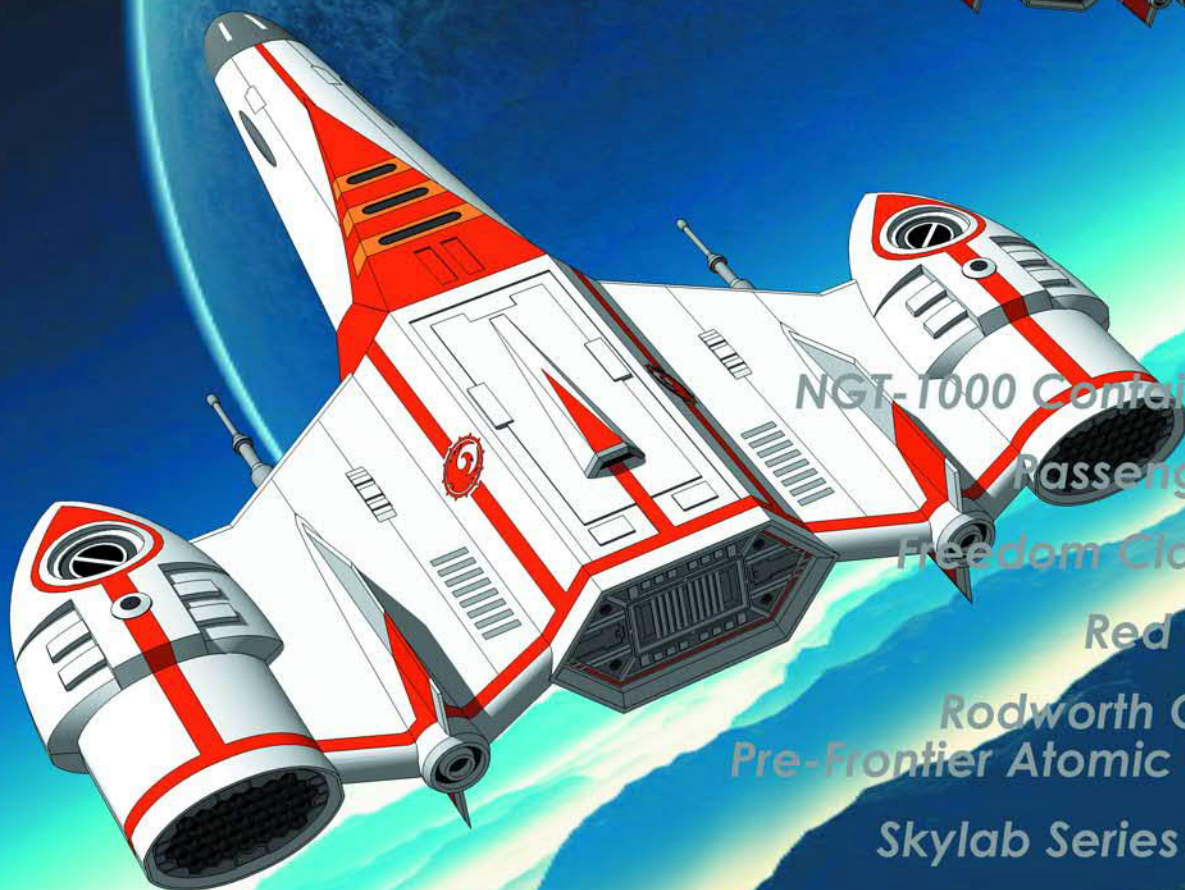

NGT-1000 Container Ship

Passenger Liner

Freedom Class Ships

Red Thunder

Rodworth Guide to  
Pre-Frontier Atomic Rockets

Skylab Series Stations

... a spaceship without an  
operating manual



## FEATURES



**SCREE FRON** ..... 4

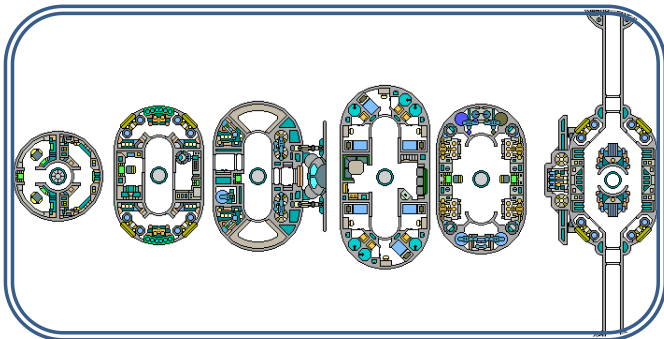

**NGT-1000 CONTAINER SHIP** ..... 10

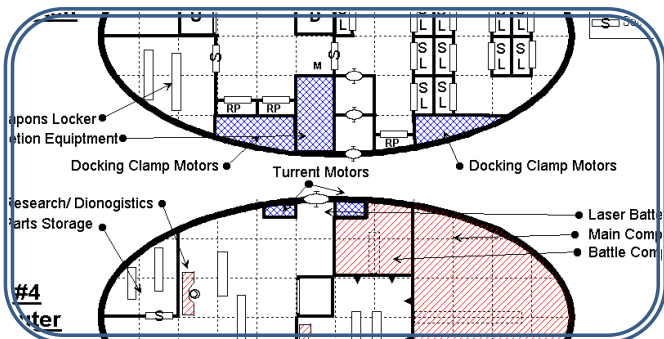

**RED THUNDER** ..... 23

## CONTENTS

The Legend of Adha and the Brother Hunters ..... 1  
*A bit of Yazirian cultural history*

Scree Fron ..... 4  
*System brief and background information on the Scree Fron system*

NGT-1000 Container Ship..... 10  
*A new cargo vessel in the space lanes.*

Passenger Liner ..... 12  
*A small, simple system ship for getting between worlds in systems with multiple inhabited planets.*

Passage to Scree Fron ..... 16  
*Battle pirates and evil Mechanons in the Scree Fron system*

Freedom Class Ships ..... 18  
*An early Frontier design that can still be seen in service in the space lanes near you.*

Titan Rising Z299..... 20  
*The next installment in the new Titian Rising comic*

In the Minzii Marketplace..... 22  
*New equipment available from the CFM*

Red Thunder ..... 23  
*A Streeel Corporation exploration vessel and associated lander module.*

Rodworth Guide to Pre-Frontier Atomic Rockets.. 34  
*A guide to the designs of early atomic rockets*

The Minotaur Sealion ..... 37  
*Dwain finds yet another dangerous aquatic creature to play with.*

Skylab Series Stations ..... 40  
*Some basic research stations available in the Frontier*

Grymz Guide Comic ..... back cover  
*Never make assumptions.*

## FROM THE EDITORS

Welcome back explorers!

This issue is full of starships. Some are new designs sent to us from our contributors and others have been rescued from lost Star Frontiers websites now only found in the [Internet Archive](#). Regardless, this issue provides a wide variety of new ships that can be used in any science fiction campaign.

Two of those ships, the Passenger Liner and the Red Thunder were designed by Joseph Meagher and rescued out of the archive. These deck plans are quite wonderful and we simply couldn't let them be lost. In fact, it was these two sets of plans that inspired me to make this a spaceship themed issue, just so I had a good reason to publish them. Joseph, if you're out there, well done and drop us a line.

This issue also continues with several regular features including new articles in the Jurak Hangna and Alex Stone series. We also get a new system brief, this time on an out of the way system Scree Fron to provide more information and background on that less used system.

I want to give a big thank you to all our contributors. The Frontier Explorer wouldn't be nearly as rich or varied without all of the great submissions we get. If you've contributed in the past or to this issue, thank you for your support. If you haven't ever contributed, please feel free to do so. We don't bite. In fact we do everything we can to get community submissions published as quickly as possible.

I also want to say thank you to our readers. Thank you for reading and making the Frontier Explorer as successful as it is. While we'd probably keep putting out issues even if no one was reading it, the fact that you are, and the number of readers keeps growing with every issues, is very satisfying and helps to keep us motivated. So share the word and let your friends know about us as well.

Finally, we'd love some feedback. What do you like about the magazine? What don't you like? Is there any thing you'd like to see more or less of in future issues? Feel free to let us know your thoughts. Drop us a line at [editors@frontierexplorer.org](mailto:editors@frontierexplorer.org). Or you can follow us on Twitter ([@FrontierExpMag](#)) and contact us that way as well.

As always have fun and keep exploring!

- Tom Stephens  
Senior Editor

## PRODUCTION CREDITS



**Cover Art:** [Assault Scout](#) model and background selection by [Jay Thrumen](#). Image composition by Frontier Explorer staff.

**Back cover comic:** AZ\_Gamer

**Banner Logo Image:** NASA

**Editors:** Tom Stephens, Tom Verreault, William Douglass, Eric Winsor

**Layout:** Tom Stephens, Eric Winsor

**Full Cover Quote:** *The Earth is like a spaceship that didn't come with an operating manual.*

- R. Buckminster Fuller

<http://frontierexplorer.org>

[@FrontierExpMag](#)

**Legal** – The Frontier Explorer is not affiliated with, endorsed, sponsored, or specifically approved by Wizards of the Coast LLC. The Frontier Explorer may use the trademarks and other intellectual property of Wizards of the Coast LLC, which is permitted under Wizards' Fan Site Policy.

# ADHA AND THE BROTHER HUNTERS

Eric Winsor

I know some readers might be expecting to hear about my trip from Boneyard Station and a dralasite named Plicka. Be assured that the story is coming. However, I learned a yazirian legend from Cletus that the editors of Frontier Explorer find useful for this issue. I have done quite a bit of research on this yazirain legend and am honored to present to you, translated into PanGal for the first time, the Legend of the Brother Hunters, The Legend of Adha.

## NAMES OF THE CHARACTERS

Infi - Thoughtful brother

Inti - Cautious brother

Ingi – Peace-making younger brother

Adha – Female of beauty, wisdom, and honor

Okor - The murderer

## THE LEGEND

In the days of the first clan, yazirians only killed animals. The hunters stalked the forests and killed all kinds of beasts. Of all the beasts the lask was the most prized meat, sweet and savory, blessed by the creators. When the lask was hard to find the hunters would trap fowls of all kinds, climbing to the highest branches of the trees. They sought bogah as they scampered through the high branches seeking nuts, lopah clawing insects from the bark, or peegat among the pools of rain water in the clefts of great branches. Then the hunters stalked the dropah as they circled and stalked the animals in their packs or the sorga in their great family herds jumping from limb to limb way up high. Finally they would seek the dark shadows on the forest floor and brave catching a plaat.

When the plaat, sorga, dropah, peegat, lopah, bogah, and fowls of all kinds were hard to find the clan gathered nuts, fruits, and leaf food. Yazirians have always distasted a diet with only leaf foods. These times were hard and followed the seasons. The clan learned that each hunting season would be followed by a time of scarcity as the game migrated to other forests where the fruits and food of the animals were renewed. The hunters followed the animals and in time learned the pattern of migration. Each forest held a great tree that the creators provided for the clan to make their home.

One day a hunter was perched at the top of the great tree eating lask meat and enjoying the sun when the speaker called for all of the clan to gather. The hunter was named Infi and he was a silent one who often pondered the creations of the world. Infi glided down, branch to branch, to the heart of the great tree and gathered beside his litter mate Inti. Inti was born after Infi and so the speaker always gave voice to Infi first. Inti never questioned this practice because he was a patient hunter who relied mostly on traps and waiting. Inti typically brought the least meat back to the clan of all hunters. The clan did not begrudge Inti this practice as he hunted every day. The clan never let members go hungry.

The speaker counseled with the hunters about the migrating animals. The time was soon upon the clan to travel to the next great tree in the circle of clan trees. The speaker felt that the clan should move early this season. He had observed the meekla flying sooner than usual. Where the meekla flew the lask followed, where the lask went the bogah followed, where the bogah followed, the lopah went ahead, where the lopah foraged ahead, the peegat gathered behind, where the peegat gathered the dropah stalked, where the dropah stalked the sorga scavenged, where the sorga scavenged the plaat drove them on. Thus had the creators decreed that all the game would migrate and so to must the yazirains obey and follow.

When the speaker gave voice to Infi to speak, Infi counseled that a group of hunters should go ahead to the next great tree to prepare for the clan, the mothers, and the pups. All the other hunters began talking among themselves and started nodding agreement. There was much conversation and counseling among brothers, mother, fathers, son, daughters, and mates. Most were not ready to move their pups such a long distance. There was not enough food stored for the trip and stopping to hunt would put the pups in danger while camped among the lower trees. Fears of plaat striking the young in the night were strongly voiced. A group that moved ahead of the clan to the next great tree could start hunting and bring fresh meat back to the traveling clan. The clan would then be ready to swiftly journey to the next tree with the hunters free to protect the young. Infi was chosen to lead the group of hunters to the next great tree.

Inti spent the next few days anxiously awaiting Infi's departure. Inti desired the beautiful and graceful Adha who Infi was openly seeking by public gifts of meat to her

mother. Adha was a granddaughter of the clan speaker and her father had been a great hunter who was killed by a great wild beast. Even one of the great wild beast that the creators had put into the forests to guard the home forests until the day the yazirians mastered the savage within and rose above the great wild beasts of the forests. Adha's mother was birthing her first litter and the great wild beast caught the scent. Her father fought the beast to protect her mother and died killing the beast. Adha was very favored by the clan because her father's spirit and courage was a companion with her. She wore the prized pelt of the beast each night to the clan gathering to keep warm. Often she would sit in front of Infi and allow him to slide his toes under the edges to get warmth. Inti knew it was only a short time before Infi would win Adha as mate so he saw Infi's journey as a chance to win Adha away before Infi returned a hero.

The day after Infi departed Inti began making public meat offerings to Adha's mother. All of the clan took notice. Even Infi and Inti's younger litter mate, Ingi the blind took notice. Ingi was born blind and became a hunter of stealth and observation. He learned as a hanger to catch zeedahn flying from their nests by the sound they made when taking flight. Ingi would crawl stealthily along a branch with hanging zeedahn nests and slowly drape his patagium down to net the zeedahn so he could quickly grab them. He was also a keen observer of his brothers and took it as his duty to ensure there was peace and justice between them. He knew that Adha had chosen Infi in her heart for she often confided in him.

Four days after Infi had left, Ingi determined that the right moment to confront Inti had arrived so he followed Inti on a round of his traps. When Inti came to one of his traps, he found it held a lopah caught by a hind leg and hanging from the branch. This was a good live capture and Inti was rewarded by a fresh kill. Ingi offered to carry the animal for Inti and they shared in joyful conversations. Then Ingi asked Inti if he would take prey of his brother's zamra and claim it as snared in his trap. Inti immediately replied that it would be dishonorable and that he would never claim another's kill as his own, especially his elder brother and litter mate. So Ingi then asked why Inti was trying to snare Adha when Infi's zamra was imbedded in her heart. Inti stopped and turned to Ingi and grasped him by the shoulder, a sign Ingi had challenged his honor. Ingi faced toward his brother and spoke calmly.

"When you take this lopah to Adha's mother, ask Adha for her zamra to dress the meat. When you are cutting the meat examine her zamra on all sides. You will find Infi's markings carved among her own. Adha has been doing this since Infi was sent ahead to the next great tree. She does this while sitting in Infi's thinking spot at the top of the great tree."

Inti removed his hand from Ingi and took the lopah from his back. The two returned to the great tree and climbed

to Adha's hut. Ingi held back at a crossing of branches while Inti bade for entry and was brought inside the hut. The lopah was presented and accepted. Inti asked for Adha's zamra and began dressing the lopah. He cut and as he did so turned the blade from side to side examining the markings. Cut among her markings she had added the markings of Infi's zamra. Inti knew at this moment that she was bound from within to Infi and he would never be able to change that. He presented the meat to Adha's mother and returned to Ingi below. Inti thanked his brother for protecting his honor and returned to the trail of his traps. He did not bring any more meat offerings to Adha's mother.

Okor was a strong hunter and often brought large kills to the great tree. He hunted with a band of fierce yazirians who sought the largest and most dangerous beasts. The clan welcomed the exotic meats Okor's band brought. The tales they told of the hunts were the greatest told at the clan gatherings and meals. Many young hunters admired Okor. Most wise hunters feared Okor. What none yet realized was that Okor not only stalked the prey of the forest, he stalked within his clan. He desired to be speaker and chief of the clan. When Infi left he thought he had a chance to bag Adha and the status she would give him in the clan. He had not expected Inti to seek Adha after Infi left. He held back and watched and waited for the right time to act. Okor noticed immediately when Inti stopped bringing meat offerings.

Adha climbed to the top of the great tree every morning after Infi left. She found his thinking spot and the lask meat Infi had left in the sunny branches. Each day Adha sat thinking of Infi and nibbling at his meat. She brought herbs and salts to flavor the meat as it aged. She desired to cook the meat to make it last. She missed Infi and his meat comforted her soul. However, a fire this high up would endanger the great tree and was forbidden. The branches were thin and leaves were many, there was much food for fire in Infi's thinking spot. Then she noticed how hot the sun was at noon day and thought to cook the meat by the sun. She sliced the lask into thin strips and hung them in the sun covered with the herbs and salts. She called the meat lask-ga because it held the soul of the sun and filled her soul with warm thoughts of Infi.

Several days after Inti quit offering to Adha's mother, Okor followed Adha to the top of the great tree. Adha was eating a piece of sun dried lask meat when Okor climbed up beside her. She greeted him with proper honors and offered him a piece of the lask meat calling it lask-ga. Okor declared his intention to make Adha his mate. Adha declined and moved to glide down to the voices of the clan far below. Okor blocked Adha's descent and forced his desire. Adha fought back and fled. Okor tracked her to a far tree and slew Adha in his rage. He then hid his crime by putting her body inside a hollow of an old tree.

Three days went by and Adha's mother was searching for her daughter. The speaker organized a search and all of the clan worried for her loss. The elderly watched the hangers as every remaining clan member worked out in a circle searching high and low. Okor himself searched the old tree towards the rising of the sun where plaat were known to hide. He brought back two plaat he killed and pulled a bracelet known to be Adha's from the stomach of one of the beasts as he butchered it before the clan. The speaker took the carcasses of the two plaat and cast them down to the forest floor for the sorga to devour. The day came for the clan to leave the great tree and travel to the next great tree and all left in sadness.

Half way through the journey the clan met with Infi and the advance hunters. They brought food for the mothers and the young hangers. Inti greeted Infi with Ingi at his side. He shared the news of Adha's loss and comforted his brother. Okor greeted Infi and expressed his condolences. He offered Infi some dried lask meat to calm his loss. Ingi smelled the seasoned meat and asked Okor if he had lask-ga to share. Okor replied that he had an extra to share. Ingi then asked who told him the name of this new seasoned meat. Okor became silent and could not answer. Ingi then took his brothers away and privately told them how he had spent time with Adha sharing lask-ga as she awaited Infi's return at his thoughtful spot. They took the matter to the speaker who summoned Okor to an answering, but Okor fled with those hunters loyal to him. The speaker dispatched Infi and Inti and five other hunters to track Okor and his band and bring them back as Okor must answer the questions of the clan about Adha.

They tracked the band back to the great tree and a battle ensued. Hunter fought against hunter and Okor's band was subdued but Okor fled alone. Infi and Inti followed and captured Okor late in the night. They brought him bound back to the speaker and Okor was made to answer. He confessed that he had pressed Adha to be his mate and that she had fought him. He then confessed that he had raged and killed Adha and hid her body in a hollow of the old tree toward the rising of the sun. Inti went into a rage and tried to kill Okor but Ingi stopped him. Ingi advised that it was not good for clan members to kill each other and that rather Okor should be banished among the great wild beasts that the creators might see to his death. The speaker agreed and banished Okor. To this pronouncement Infi swore an oath before the whole clan that Okor would forever be his enemy for life. He then took to a time of great silence.

Okor was escorted to the forests of the great wild beast by the hunters of the band. His zamra was taken and cast into a raging river and he was given only a sharpened stick to hunt with. As the hunters left Okor in the wild forest he called back to them, "You have taken my zamra, you have taken my band, I am no longer of your clan.

Brothers of my hunting band, join my clan!" The hunters marched home with heavy hearts. They told the speaker what Okor had said and he declared that if the creators willed that he live then let it be so. The next morning many of Okor's hunting band were gone with their mates and children.

Some ancients say that Okor survived and that his hunting band became his clan. Others say that the creators guided a great wild beast to Okor in the night and the beast devoured him. Legends say that his band of hunters wandered many moons searching for Okor and became lost. What is known is that no clan in history claims lineage from Okor or his hunting band. However there are legends that say that Okor's hunters raided the early clans in the generations after Infi, Inti, and Ingi.

As for the tree that Adha as buried in, Infi, Inti, and Ingi searched out Adha's resting place and made it a central place along the circle of great clan trees they followed. They patched the hollow and tended the wounds of the old tree. With their care the old tree became a great tree and a gathering place for the clans in the days of the ancients. No tree was taller or more beautiful. The fruit of the tree was sweet and fragrant. Beast from all around came to eat of the fruit and the hunting during the clan gatherings at Adha's tree was like in the home forest of the creators. Never was claw raised against claw between yazirians gathered in Adha's tree, so beautiful and sacred was the tree to all yazirians.

In time great yazirain females who have come to exemplify the beauty, wisdom, and honor demonstrated by Adha have borne here name as a title bestowed by the eldest female of their clans. Cletus shared this legend with me as he told me of his mother Adha Corda. Adha Corda of Clan Ma-Zeedahn I am honored to have met your son Cletus.

## EDITOR'S NOTES

Ma-Zeedahn translates to *catches zeedahn* in PanGal. Clan Ma-Zeedahn once held a relic, the story of Adha and the Brother Hunters that was carved into a giant piece of clan tree wood. The writing was in ancient yazirian hieroglyphs and depicted Adha's tree. Legend says that Adha's tree was struck many times by lightning and burned. Clan Ma-Zeedahn's eldest ancestor cut the unburned remnant of the tree and carved the legend into it to preserve the memory of Adha's tree. The relic always served as the sunrise wall in the chief clan hall of Ma-Zeedahn. They brought the relic to Hentz at the beginning of the exodus where it was lost. Clan Ma-Zeedahn suspects it was taken by the Family of One. Clan Ma-Zaadahn left Araks and pioneered the founding of Scree Fron and Hakosoar in protest.

## System Brief

# SCREE FRON

Tom Verreault

## A SYSTEM ON THE EDGE OF THE FRONTIER

“Where are you from?”

“Scree Fron”

“Scree what? Never heard of it.”

As far as star systems go in the Star Frontiers game, Scree Fron never seemed that interesting to me. Dixon’s Star had the Tetrarch pyramids, White Light had the Royal Marines, Hentz had the Family of One’s version of the Vatican, and Prenglar had the headquarters of Star Law; so what was there to Scree Fron? It had the headquarters of the mega corporation Universal Households which was concerned with setting fashion trends and selling home goods. Despite that and the corporation’s name being commonly shortened to UniHo, which sounded dirty in a juvenile sort of way, it never caught my interest.

That is until I was inspired by the landscape of the Meteora Mountains in Greece. These mountains are steep spires of rock, often shrouded in fog and many of which are topped with centuries old monasteries or convents. I immediately thought of the somewhat religious yazirians of the Frontier sector and past internet discussions about establishing yazirian monasteries on a few planets of the Frontier.

Naturally, yazirians building on a spire of rock probably have gliding at the back of their mind since it’s a species ability they are all born with. Thus choosing a planet for such a monastery would mean looking for one with a low gravity to make the most of the gliding angle. Low and behold there was Histran in the Scree Fron system with gravity of 0.6, an outpost population level, and a planetary economy somehow centered on education, it seemed tailor

made to be the location of a monastery.

## THE CANONICAL MATERIAL

Scree Fron is an orange red star. The following table is compiled from both the Alpha Dawn rules and Zebulon’s Guide:

In the Zebulon’s Guide we also discover that **Hakosoar** is headquarters for Universal Households, the apparel, household furnishing, and housing mega corp. UniHo developed the city of Hyyay as its operations base.

**Histran** is the location of the UPF outpost that keeps an eye on the Mechan system, the Lesser Morass, and that sector of the Vast Expanse.

## UNIVERSAL HOUSEHOLDS

UniHo specializes in three distinct areas: textiles and clothing, household furnishings, and buildings. Their synthetic apparel resists grime and wear and is inexpensive. Therefore UniHo made sure it controls the fashion industry; though made to last longer, their clothing goes out of style yearly. UniHo furnishings are usually made of plastic or plasteel and are modular in design. Any piece of valuable furniture, such as real wood pieces, are made by a sub-contractor. UniHo buildings are pre-fab dwelling, offices, industrial, and professional facilities, and so forth. Specialty buildings are expansive and are designed and constructed by architectural engineers.

*Headquarters: Hyyay, Hakosoar Chief Executive: K’an Ku (vrusk) Subsidiaries: Two massive ones: Planetary Structures Inc., and Kotiz Fashions Inc.*

## TIMELINE ENTRIES

94PF – Scree Fron system discovered by Yazirians

Planet	Prevalent Species	Population	Economy	Gravity	Day	Space Stations	Moons & Uses
Haksoar	Yazirian	Light	Ag & Industry	0.9	50	None	5
Histran	Yazirian	Outpost	n/a	0.6	25	None	7
Post Zebulon's Guide							
Hakosoar	Yazirian	Moderate	Ag & Industry	0.9	50	None	Inti (Research), Infi (Resource mining), Ingi, Adha, Okor
Histran	Yazirian	Outpost	Education	0.6	25	None	Designated A thru G

## Frontier Explorer

32-26PF – Thirty-two exploration vessels are lost trying to map the Lesser Morass. Only the area between Scree Fron and Zebulon is mapped.

70FY – The Mechanon civilization on Volturnus undergoes an upheaval. The majority of peaceful Mechanons migrate into the undeveloped space between Scree Fron and Dixon's Star.

There is no space going militia listed for Scree Fron in the Knight Hawks campaign game.

## MAKING SOME ASSUMPTIONS

I generally treat differences in the planetary catalogs of Alpha Dawn and Zeb's Guide as simply changes that have happened over time and this usually reconciles any differences between the two. Thus the planet Hakosoar has undergone population growth where the Light population entry would be for early in its history circa the First Sathar War and Moderate population is most likely for post Second Sathar War.

# UNIVERSAL HOUSEHOLDS

Universal Households (UniHo) is an oddity. It is a mega corp headquartered on a yazirian world, presumably staffed with a majority of yazirians, and yet it had a vrusk CEO. Not all vrusk fit into the vrusk trade house system and many leave to pursue an individual life elsewhere. K'an Ku is most likely one of these vrusk and most likely came to Hakosoar after its colonization, probably attracted by tax incentives designed to bring outside investment. He's built a flourishing fashion empire which appeals to his natural artistic impulses and has managed to do this in cooperation with the Star Play mega corp, avoiding competition with them over broadcasting rights and infrastructure. He's become a student of yazirian culture, a philanthropist, and a cultural icon of the Frontier at large making him much beloved of his employees and the population in general on Hakosoar.

Histran is a UPF outpost with a stated mission that requires the involvement of both Star Law and Space Fleet but could also require the presence of the UPF's scout service. For this reason I tend to simply make it a UPF base with contingents of whatever government service needs to be there; Star Law, Space Fleet, Medical Services Organization, a scout service and etc. The base is called Histran Base and the commander has always been appointed from Space Fleet which is a very large component of the base. After a plague entered the Frontier from Starmist, the Medical Services Organization established a research lab at Histran Base in part because of its remoteness.



There is a substantial Space Fleet patrol group stationed here. The flagship of which is nothing smaller than a cruiser. The rest of the group is made up of 2-4 frigates and 4-6 assault scouts plus support vessels.

Scree Fron has had a long association with exploration. First of all, it's a gateway for the UPF to monitor the Starmist system and no doubt many an exploration expedition to there has been routed through Scree Fron. Then there is the matter of 32 exploration vessels lost while trying to map the area of the Lesser Morass which indicates that there had to be a larger number of vessels operating as explorers for those maps to have been made. Scree Fron is the logical last port of call for all these vessels and it had to have been a major base of operation for this activity. Star Law would have mounted exploration expeditions from Histran to monitor the migrating mechanons and locate their new home planet as well.

The economy is dominated by UniHo. The lion share of all industry on Hakosoar is due to UniHo and these products ship throughout the Frontier sector. The agricultural side of the economy grows yazirian food stuffs which primarily ship to Hentz and Hargut, tying Hakosoar to these planets economically. Because of that the government of Hakosoar avoids getting involved in the antagonism between Hentz and Yast even though it has more sympathy for Yast.

## HOLES IN THE DATA

Two of the five moons of Hakosoar were named in Zebs, Inti and Infi. The reason is that these two are part of the local economy while the other three are not. The naming pattern can be continued with names like Inki, Ingi, and Inni. The moons of Histran were designated A-G which



are the first 7 letters of the English alphabet. I would propose using the first 7 letters of the Greek alphabet especially in light of the long history or using the Greek alphabet in Star Frontiers; Alpha, Beta, Gamma, Delta, Epsilon, Zeta and Eta.

There are at least two unmarked jump routes to this system, Starmist and Mechan. Space Fleet and Star Law have simply chosen not to make these public. It's entirely possible that pirate bands might have charted the route from Zebulon as an escape route. This route became less popular as the importance of the system rose and the Space Fleet presence grew.

## A PLACE FOR ADVENTURE

A Star Law campaign has many possibilities. Star Law would want to keep tabs on the migrating mechanons and mount some exploration missions to locate their new home world of Mechan. Delegates from Mechan travelling to Prenglar seeking recognition of the mechanons by the UPF would have a layover at Scree Fron. While on layover a cell of hostile mechanons or sathar agents might hatch a plot to assassinate or subvert the mechanon diplomat. Finally, the StarMist system which was the setting of one of the published modules is closely monitored by Star Law due to the activity of the sathar there.

A Knight Hawks campaign is always possible with sathar or pirates showing up. Hostile mechanon could pose a threat in space fielding heavy mechanon fighters or even base carriers or alternatively friendly mechanons could be joining with Space Fleet units.

### **HEAVY MECHANON FIGHTER**

**HS:** 2 **HP:** 15 **DCR:** 30

**ADF:** 3 **MR:** 4

**Weapons:** PL x2(linked and FF), AR (x2) but uses the FF firing arc to the rear of the ship

**Defenses:** reflective hull

### **MECHANON BASE CARRIER**

**HS:** 18 **HP:** 100 **DCR:** 200

**ADF:** 2 **MR:** 1

**Weapons:** LB x2, PB x1, EB x3, RB x4, 8 heavy mechanon fighters

**Defenses:** reflective hull, ICM x10, MS x2.

An exploration campaign would be ideal based in Scree Fron. The player characters could be in the employ of either the government or private sector. The published modules: Sundown on Starmist and Bugs in the System, would easily fit into or support this campaign which is a plus. Charting new jump routes is one possible lucrative activity with the possibility of creating new routes to Zebulon or Capella as well as to the host of unexplored systems in the area. The campaign can go into uncharted space beyond the Great Expanse to the west and south of Scree Fron as well. A government sponsored exploration



Scott Mulder

mission could use an assault scout and PCs could be from multiple agencies with a doctor scientist from the MSO, ship's crew from Space Fleet, security officer from Star Law or Ground Fleet, a scout service officer and perhaps a transfer from the Royal Marines. A private sector exploration team could have any and all backgrounds and would be more concerned with charting jump routes for the purpose of selling the route information.

## SYSTEM BRIEF

Screen Fron, orange-red star

### **HAKOSOAR**

The colony of Hakosoar began as an agricultural colony servicing the needs of the planet Hentz. Its ecosystem was ideal for raising many yazirian food animals since the planet was at the inner edge of the goldilocks zone.

Its Council of Clans was determined to expand its economy by building infrastructure to support industry and courted outside investment. This is what brought K'an Ku (a vrusk) to Hakosoar. He had become enamored with the fashion industry while visiting worlds like Gran Quivera and Cassidine. His desire was to clothe and furnish the Frontier with the most beautiful of fashions and objects and to create repeat sales through manipulation of styles causing last year's fashions to be out of style. The established vrusk trade houses could not comprehend the vision he had for the fashion and home furnishing industries so he founded Universal Households at Hakosoar. UniHo works closely with Star Play in the effort to manipulate styles and fashion trends across the Frontier.

UniHo founded and is headquartered at Hyyay, Hakosoar's largest city and center of industry. The company maintains a cargo facility star port for the export

## Frontier Explorer

of its goods from Hyyay. The latest in modular housing, vehicle garages, and science labs designed for base operations is now being marketed to exploration expeditions directly from a show room at this landing field.

The next largest city and capitol of the planet is Hako's Landing. It is the seat of the Council of Clans on Hakosoar and the location of the Spirit of Exploration. The city has a full service star port and much of the agricultural goods from Hakosoar are exported through this port.

The Spirit of Exploration is a monument and museum dedicated to explorers and scout service personnel who braved the unknown beyond the system. The monument is dedicated to the crews of the 32 vessels lost mapping the Lesser Morass. The museum has the most extensive collection of ship's and personal logs connected to exploration. Its archive is regularly consulted by researchers and academics from all over the Frontier.

The Colonel R.A. Chisholm Depot is a Ground Fleet depot storing equipment in stasis and supporting a training cadre in this sector of the Frontier. The depot is named for a hero of the First Sathar War who commanded yazirian raised units in the battle for the planet Pale.

The major cities of Hako's Landing and Hyyay are protected by limited planetary batteries of ICM missiles and laser batteries. These measures only protect the cities from direct bombardment and it would be entirely too easy for an invader to land troops beyond the reach of the defense emplacements. Hakosoar's economy was too marginal in the beginning to support a space based defense force and later Space Fleet began maintaining a strong presence in the system. The Space Fleet patrol group is usually a flagship of cruiser size or larger, 3-4 frigates, 4-6 assault scouts and support vessels.

## HISTRAN

Histran is a cold and somewhat barren world, though it is inhabitable. Its orbit is at the outer edge of the habitable zone for this star system. Its earliest inhabitants were yazirian monks who carved mountain top monasteries from its rugged terrain.

Later a small outpost called Iko's Landing was established at the best landing site for ships with people desiring to reach one of the monasteries. Iko's Landing was always little more than a bar and few structures until the UPF established a military outpost nearby. Now Iko's Landing has grown to support off duty troops and some trade from the monasteries.

Histran Base is a UPF base commanded by a Space Fleet officer but staffed with contingents from many government agencies. The Star Law contingent monitors the Mechan and the Starmist systems. Space Fleet monitors for sathar activity in the areas as well as patrols the Vast Expanse close to the Frontier sector. After a plague made its way into the Frontier from Starmist, the Medical Services Organization established a major bio lab here to research infectious diseases. There are also a couple other military contractor operated laboratories doing classified work here as well. The UPF's scout service operates out of Histran Base working closely with Space Fleet.

## **AMMUR KA ZOUL & MUR KA ZOUL**

*(Monastery of the Scroll and Monks of the Scroll respectively)*

Ammur ka Zoul is the largest monastery on Histran. Its monks follow the Oneness Faith paying lip service to the Family of One but their practice resembles that of the Oneness Faith prior to the Star Exodus and the usurpation of control of the Oneness Faith by clan Anglan of Hentz. The mission of the monastery is the preservation and study of Yazirian Literature from before the Star Exodus. It's unknown how the monks came to be in possession of the largest archive of original documents from the planet Yazira but it is rumored that the archive was originally the library of the Imperial Warhon of Yazira.

In pursuit of their mission, the monks send scribes throughout the yazirian colonies to compile copies of every clan's history, honor code, and songs. Most of this work is preserved in digital formats and the computer archive at the monastery has grown quite large as well. This "missionary" work has had the effect of drawing new members into the order from all colonies and all social strata of yazirian society and for this reason the monastery has shown continual increase in members.



Some have speculated that the monastery is potentially a cadre with an agenda of its own besides what is known but few have had the energy to suspect the monks of anything other than good intentions.

## CULTURAL PERSPECTIVES

While system briefs are written for game referees, cultural perspectives are written for players. This document is about advising a player on how to establish his character as having Scree Fron as his home system.

### HAKOSOAR

Hakosoar is by default the capitol planet of the Scree Fron System. Its population is growing and progressive. The presence of the Universal Households Corporation with its focus on manipulating fashion and style trends across the Frontier makes the population in general very cosmopolitan despite the system being “on the edge of the Frontier”. Because the fashions of the moment go out of style within a year, the yazirians of Hakosoar have been branded the “clothes horses” of yazirian society. Of course the constant push to buy the latest fashions is good for the flow of money but does pool a significant portion of it in the accounts of UniHo. The rural clans are less influenced by the ever changing trends in fashion and style though only by a slight degree.

There has been a trend toward urbanization in cities like Hako’s Landing and Hyyay, but the agricultural segments of the economy are not diminishing as much as was expected due to the clan organization of yazirian society.



[The Smile](#) by [BlackDonner](#)

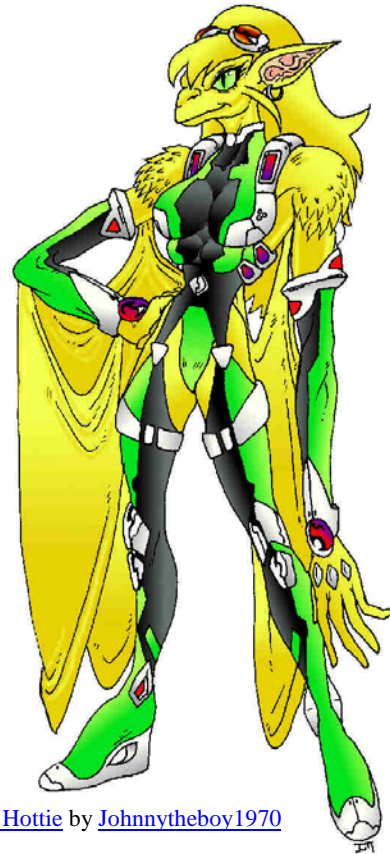

[Yazirian Hottie](#) by [Johnnytheboy1970](#)

Farms are owned by clans and the communal ethic remains strong, preventing a degrading of the social fabric with clans expanding their holdings as the clan grows. Automation is limited in the agricultural segment of the economy although some of the smaller clans have adopted some.

Military service on Hakosoar is limited to the Hakosoar Defense Force and its reserve division. The actual standing army is limited but maintains the planetary defense batteries (ICM and laser batteries) that would prevent the direct attack of the major cities. There is a reserve force of part time warriors that drills four days out of forty.

Hakosoar has had a long association with exploration and various scout services. Many a Hakosoar citizen were part of the crews on the vessels sent out to explore this region of space and thus a significant proportion of the lost crews were also Hakosoaran. The heroic cultural epic of Hakosoar is that of an intrepid explorer braving the unknown blackness of space which is ironic given their reputation for being concerned with being fashionable and in style. They are brave, inquisitive, and willing to challenge the unknown and possibly the most stylish explorers in space.

Oneness faith is very popular on Hakosoar but the Family of One is not to the same degree. The Family of One disdains the preoccupation of Hakosoar with fashion and

## Frontier Explorer

style since it controls its own society by requiring everyone to wear uniforms denoting occupation and social status. The relationship between Hakosoar and the Family of One has been rocky in the past when the Family of One employed virtual gun boat diplomacy to intervene in Hakosoaran society on the side of a clan closely allied with the clan controlling the Family of One.

### **CONCERNING MATTERS OF RACE**

Hakosoar is a yazirian colony though other members of the “core four” races have certainly immigrated to the colony. To a certain degree the presence of Ground Fleet, Space Fleet, Star Law, the MSO, and other research labs in the system has aided with non-yazirians settling here although they remain the minority. If your character is not a yazirian, adjust the following perspectives to fit your species in particular.

### **PLAYER CHARACTERS FROM URBAN ENVIRONMENTS**

These characters come from clans that connected in some way to the industry supporting the UniHo Corporation. They do not have to have been employed directly by UniHo but they have benefitted from the business UniHo brings to the economy. They are very cosmopolitan and style conscious. They tend to have technological skills and a broad working knowledge of popular culture across the Frontier. Those from Hyyay are more likely to have worked directly for UniHo while those from Hako’s Landing may have been in government service, other industry, or the food packing industry.

### **PLAYER CHARACTERS FROM RURAL ENVIRONMENTS**

These characters come from clans employed in agriculture and ranching industries. To a smaller degree they are less concerned with fashion and style though these concerns still permeate the whole of society. They will typically have tough work clothes for daily work and stylish ones for days off. They tend to have environmental, science, and animal handling skills.

### **PLAYER CHARACTERS WITH A MILITARY ORIENTATION**

These characters have a high likelihood of having served a term with the reserve or possibly the regular Hakosoar Defense Force. This is not guaranteed as there are plenty of corporate and police security positions available on Hakosoar.

### **CHARACTERS FROM HAKOSOAR**

All characters coming from Hakosoar, may upgrade any skienisuit they receive at character creation from military to civilian for free. The standard rule for player character finances is that half is spent for living expenses but a character from Halosoar *should* spend an extra 10% of his income for clothing and stylish home goods.

Urban Hakosoarans are adept at shopping for clothing and save 10% on the cost of defensive suits and may make a LOG check to remember important elements of popular culture from across the Frontier.

Rural Hakosoarans are familiar with animals. They may ride a common mount animal automatically and gain a +5% bonus to any ability or skill check involving an animal.

### **HISTRAN**

Histran has remained an outpost since the system was colonized. The population is very limited but it is still possible for a character to have come from here.

Iko’s Landing is the one civilian settlement and the people here are hardy and employed in service industries catering to the local military outpost and the few needs of the monasteries on Histran. They are tough and resourceful and start play with a bonus of 3 points to either STA or INT.

A character could also come from one of the monasteries but in general he will need to be from someplace else before and a player should have an idea of where that is. Most monasteries allow members to leave the order if they feel called to. A player character with a monastic background will be a devotee of the Oneness faith though not necessarily a devotee of the Family of One. He can have any PSA or skill set but he leaves the monastery with the ability to read both ancient and modern yazirian dialects as well as level 1 in theology skill. Note this skill can be improved as an “in PSA military skill” if using the Alpha Dawn rules or as appropriate for the fan created skill system like “A Skilled Frontier” in [Star Frontiersman #9](#).

A character detailed to the UPF outpost on Histran will have no cultural ties to the Scree Fron system unless he was originally born here. A referee may provide a free piece of equipment over and above any starting equipment to a character that has finished his term of service and decided to remain in the Scree Fron system.

**FE**

The logo for Universal Households features the word "UNIVERSAL" in a large, bold, sans-serif font. The letter 'I' is replaced by a silhouette of a person in a dress. The letter 'A' is replaced by a silhouette of a refrigerator. The word "HOUSEHOLDS" is written below "UNIVERSAL" in a smaller, bold, sans-serif font. The letter 'H' is replaced by a silhouette of a house.

**Editor’s Note:** This Universal Households logo was conceived by my son (Thomas Stephens) by substituting the I, E, and A with, respectively, a dress, refrigerator, and house to represent the three areas of UniHo’s focus: fashion, appliances & furniture, and buildings. I did the final drawing of his concept. Feel free to use this logo in your campaigns.

## Spaceships

# NGT-1000 CONTAINER SHIP

M. Derryberry

NexGen Technologies released their version of the TT-456 six years after the ship became a success. Within a year Trans Travel, filed a lawsuit claiming copyright infringement on their design. The following court battle was relatively short and the court ruled in favor of NexGen because of major differences within the design.

The primary differences in the design were the two-man bridge and the extensive use of computers to monitor ship systems and for navigation. The crew size was also reduced to six. Though the NGT-1000 looks very much like the TT-456 in shape and size, they can be distinguished by the engine pylons. Where the TT-456 is curved, the pylons on the NGT-1000 are straight and shorter than the Trans Travel model.

Even after they won their court case, few companies saw the need to replace their TT-456 with NexGen ship. NGT-1000 lower cost per ship did however allow startup companies and independent traders to gain a foothold into the starship market. This can be seen on any given day by the numbers of TT-456s delivering cargo to orbiting stations. For every four Trans Travel ships there is one NexGen ship.

Frontier Transport Corporation (FTC) is the only major company to operate solely with the NGT-1000 as its primary ship in the UPF. FTC has tailored its operations around the ship and has grown significantly in the past few years. This steady expansion into trade is rooted in the fact they are the only company to have a 99% on time delivery rating.

The performance and reliability of the NGT-1000 is on par with TT-456.

## GENERAL OVERVIEW

The ship's decks are connected by a center shaft. Each deck can be shut off from the rest by sliding hatches located in the floor between decks.

The crew quarters are considered luxurious compared to the TT-456 since they house only one crew member. Each stateroom has its own shower and toilet. Storage for the crew's personal belongings is above and below the bunks in small storage units and cabinets. The stateroom also has a small desk for personal papers.

The crew works in 2 shifts of three (Standard 20 hour ship day applies). A pilot and co-pilot on the bridge and one

monitoring the engines and ship's systems on the engineering deck.

The ship lacks a workpod and repairs must be made by the crew taking a spacewalk. They must also rely on work pods from the station they are delivering cargo to in order to move the cargo containers to their assigned berth.

## DECK PLANS

### BRIDGE DECK

The Bridge Deck is divided in two, the upper half is the cockpit and the lower half is the avionics' bay. The cockpit contains two seats for the pilot and co-pilot. A third work station is supplied as an auxiliary station. The person using this station must stand since no chair has been provided.

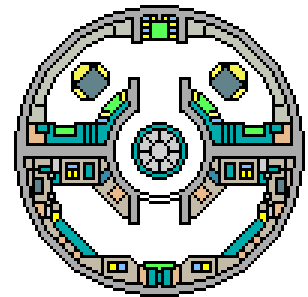

### FLIGHT DECK

This deck has four areas. The port and starboard are for the maneuvering thrusters and navigation array. The top compartment

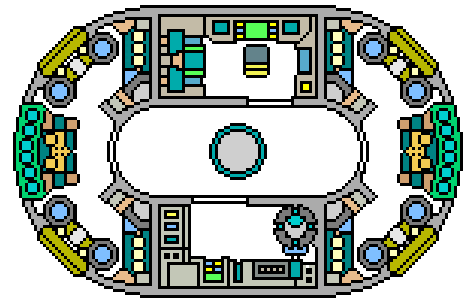

is the ship's computer which has a work station for uploading and download computer programs. The lower compartment is the backup power supply for the Bridge and Flight deck. The backup power supply last for 20 hours.

### ENTRY DECK

This deck has four compartments. The port and starboard sides are storage rooms for provisions and spare equipment. The room at the top is the entry hatch. The airlock has a double security door and space for two people to exit the ship at a time. The lower room is where

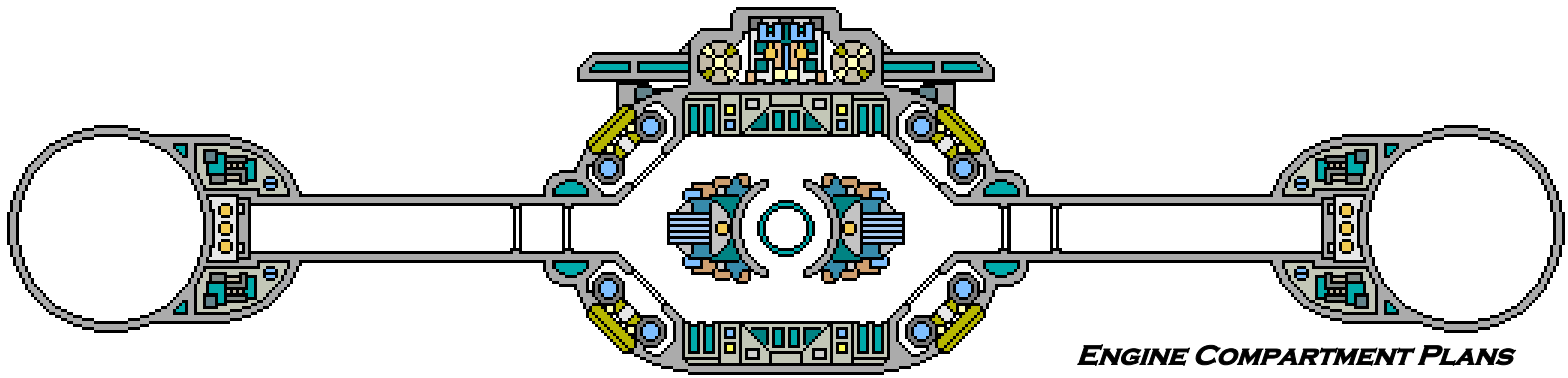

**ENGINE COMPARTMENT PLANS**

the ship's boat is moored. Access to the ship's boat is gained by extending the collapsible docking ring. The boat is held in place by two mooring clamps. A control panel next to the security doors of the airlock controls both the airlock and ship's boat mooring system. There are two bays on this deck as well which house the umbilical

connections and data ports while the ship is moored in port. They are located on the top port and starboard side.

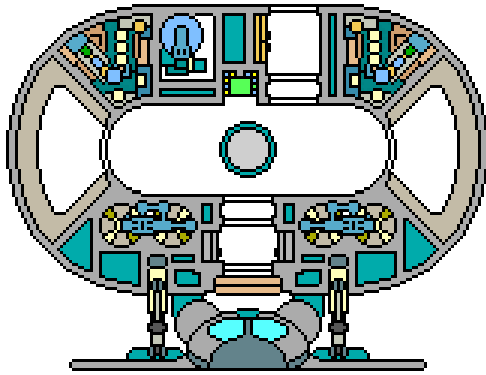

Access to these areas is from hatches located on the outside of the ship.

**CREW DECK**

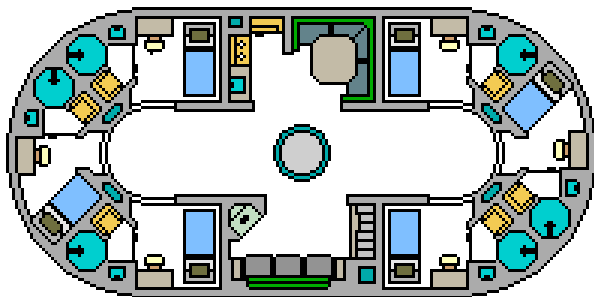

The Crew Deck consists of six staterooms a lounge and galley. The staterooms are located on either side of this deck, one for each crew member. At the top is the galley and at the bottom is the lounge.

**ENGINEERING DECK**

This consists of three compartments. Portside compartment contains the oxygen replenishers while the starboard side contains the water treatment unit. The

larger compartment in the center is engineering. Controls for life support, power and engines are

located here. There are two work stations which provide control of the ship's systems.

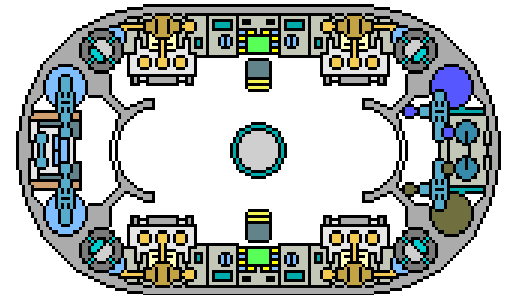

**ENGINE COMPARTMENT**

At the top of this deck is the equipment that controls the cargo rail. Controls for the rails are located on the bridge and accessed through the auxiliary workstation. Aft maneuver thrusters are located here as well. The center compartment is equipped with systems used to monitor the engines. Pylon access is to either side of the room. At the end of each access tube is a control panel which monitors the atomic engine and regulates the power supply.

**STANDARD CARGO CONTAINER AND MOORING CLAMPS**

This depiction shows the mooring clamps on the cargo rail and how they would grasp the container's cargo rails.

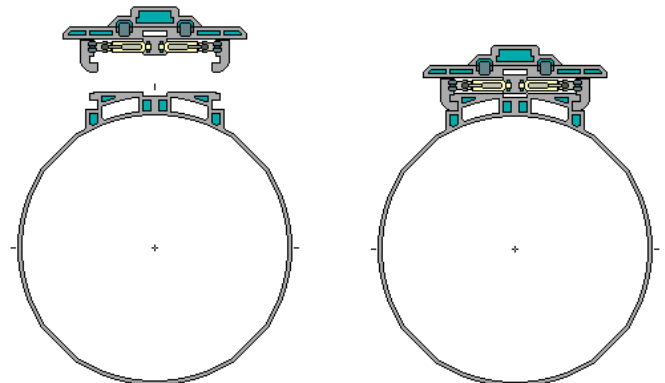

## Spaceships

# PASSENGER LINER

Joseph Meager

**Editor's Note:** The Passenger Liner was designed by Joseph Meager. The deck plans were recovered from an internet archive and are presented here with an eye to preserving an excellent set of deck plans. We have been unable to discover if a write up on the Passenger ever existed so the following write up is presented as background on the ship and is the work of the FE editors, not Joseph.

Also note that there are actually 6 decks, not 5. There is an extra passenger deck in the plans that is not shown in the cross section and the final engineering deck is mislabeled as deck 5 instead of deck 6.

The Passenger Class system liner is both system ship and cargo pod. It was designed to fill the niche of an inexpensive system passenger liner for star systems with multiple inhabited planets in relatively close proximity like Prenglar, Cassidine, Truane's Star, Dramune, Fromeltar, Pan-Gal, Scree Fron, Solar Minor, and Zebulon. The ability to be carried as a cargo pod by freighters designed for that has ensured its use everywhere in the Frontier and Rim.

The ship has sub decks that aid in maintenance. These sub decks are located under decks 1-5. They are essentially open crawl spaces laced with power runs, air vents and plumbing connections. Movement speed within this area is at ½ walking and the area has numerous obstructions in the form of elevator shafts and life support machinery. Should combat occur in this space all targets of shooting count as having soft cover for ranges of ½ the decks diameter or less and hard cover for over half the deck's diameter.

## KNIGHT HAWK'S STATISTICS

Assuming that the crawl spaces are about 2 meters tall and the decks themselves are 3 meters tall, this makes the main body of this ship about 30 meters long. Assuming the scale on the deck plans is 1 square = 2 meters (this makes the rooms the right size for Journey class accommodations), the ship is 16 meters in diameter for a total volume of about 6,000 cubic meters. Based on the Hull Size numbers from page 11 of the Campaign Book, this makes the ship come in as a small hull size 4 vessel, about 30% smaller than average. The referee could easily



**Editor's Note:** One of the goals of the Frontier Explorer is to bring to light old material that has faded off the internet due to the shutdown of older Star Frontiers websites. As such we are always keeping our eyes out for material in the Internet Archive (<http://archive.org>). The "Blast From The Past" logo is something we're introducing to help call out these articles and highlight work that may have been otherwise lost. Look for this logo to appear in this and future issues of the Frontier Explorer.

add in two or three more decks and still be sitting at a typical hull size 4 ship's volume.

As shown in the deck plans, the ship has the following KH statistics:

**HS:** 4    **HP:** 20    **DCR:** 32

**ADF:** 1    **MR:** 4

**Engines:** One Chemical, Class A

**Life Support Capacity**

**Primary:** 35    **Backup:** 35

**Accommodations:** 6 First Class, 6 Journey Class, 12 Econo Class (1/2 Journey) + 4 crew at Econo levels

**Computer: Level:** 3    **FP:** 32

**Programs:** Drive 1 (3), Life Support 1 (3), Alarm 1 (1), Computer Lockout 3 (4), Damage Control 1 (2), Astrogation 2 (6), Information Storage 3 (8), Communication 1 (3), Maintenance 1 (2)

**Other Equipment:** System Ship Astrogation package, videocom radio, radar, subspace radio, Intercom with 2 master panels and 25 standard stations, 26 portholes, Type 4 Generator/Reactor (backup power)

**Cost:** 424,650 cr.

FE

# PASSENGER DECKS 1&2

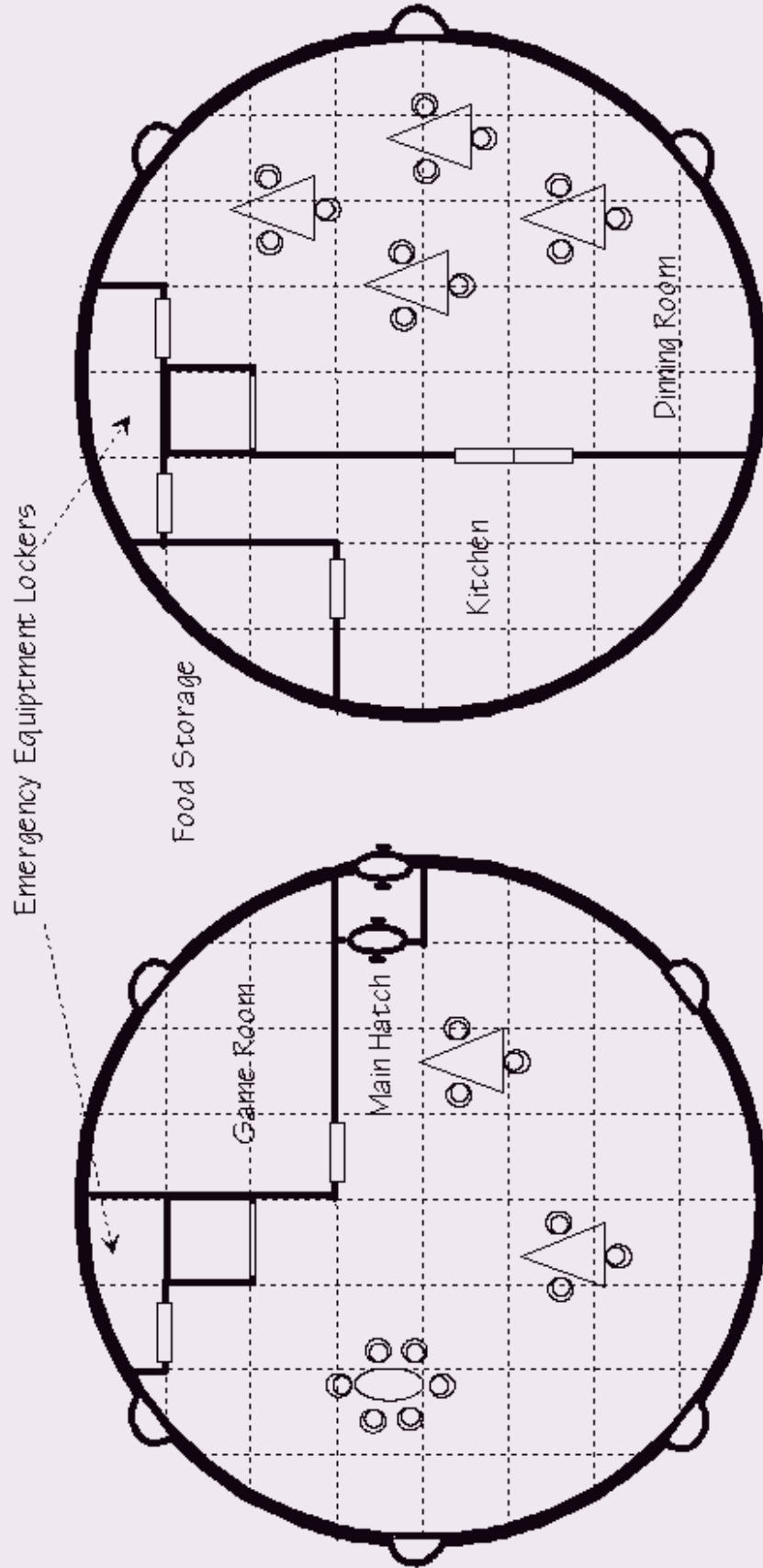

**DECK #2**  
**GALLEY**

**DECK #1**  
**OBSERVATION**



# PASSENGER: DECK 3, 4, 5

## SLEEPING QUARTERS:

Key:

- A - Elevator
- B - Econo Cabin (Sleeps Two)
- C - Standard Cabin
- D - First Class Cabin

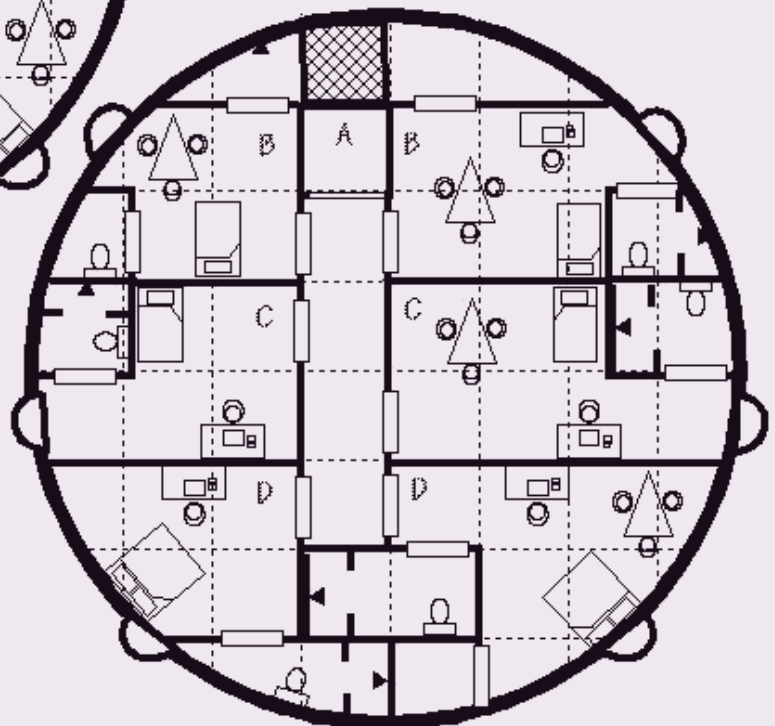
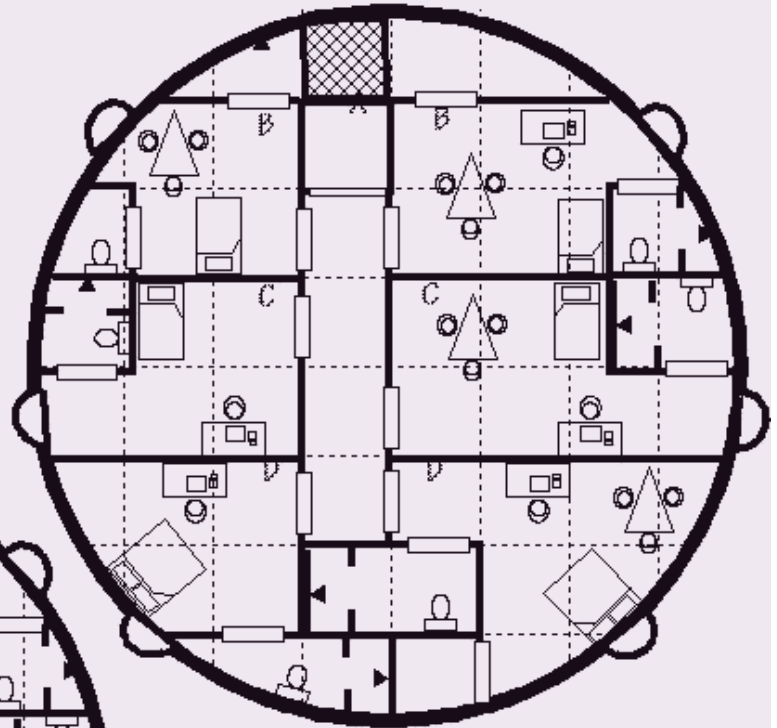
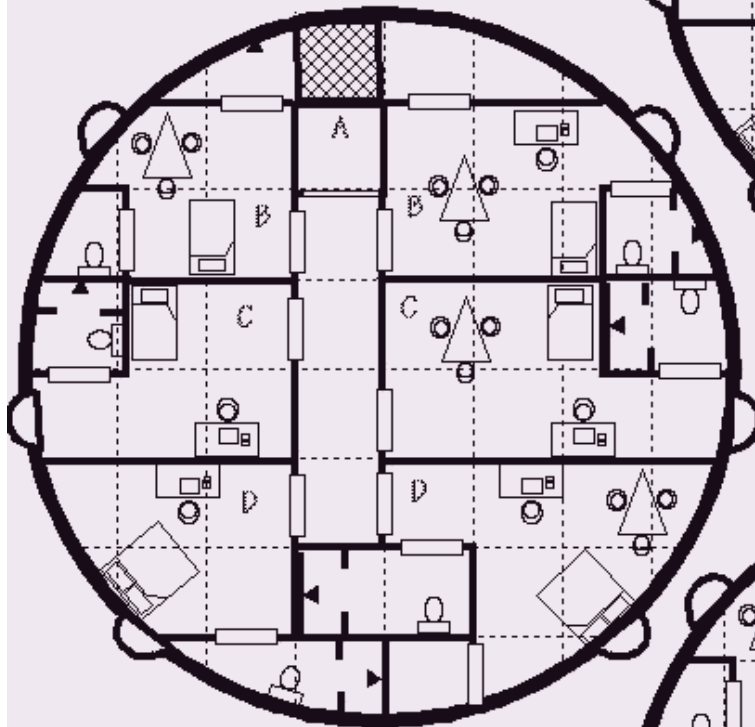

**Note:** Each room has access to their own bathroom.

Emergency Power and Backup Life Support is located behind the elevator. Access to them are by means of a panel at the back of the elevator.

# DECK LAYOUT:



# PASSENGER: DECK #5

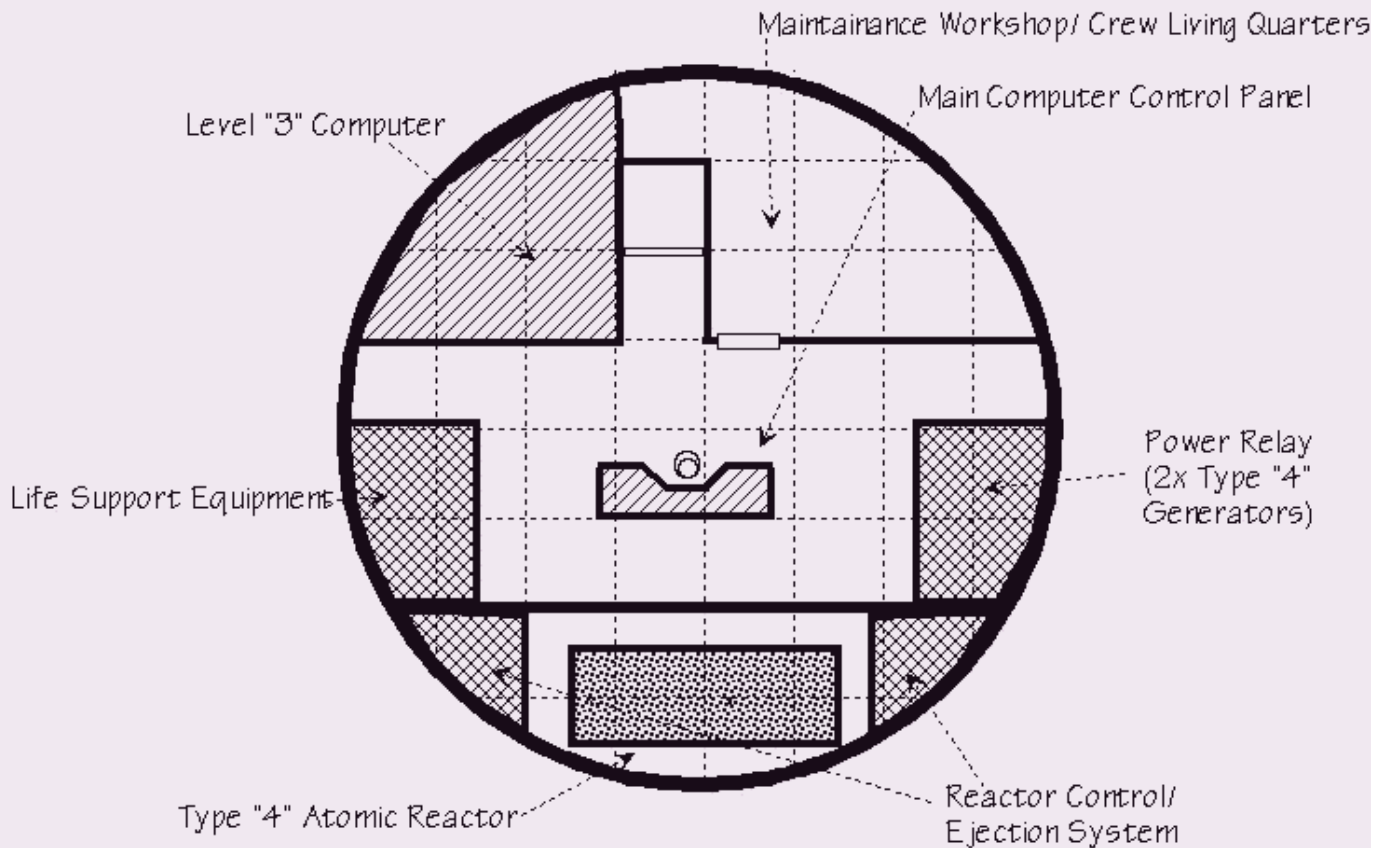

## ENGINEERING & MAINTAINANCE DECK:

Knight Hawks Encounters

# PASSAGE TO SCREE FRON

Tom Verrault

Space Fleet has long realized that there is a charted jump route between Scree Fron and Volturnus. Evidence suggests that both pirate elements and the mechanons are using this jump route. It has become a priority to obtain the data on this route for the United Planetary Federation and its forces.

## PIRATE INTERCEPT

A pair of pirate vessels were driven out of Athor and authorities in Prenglar, Hentz, and Scree Fron were alerted via subspace radio to be on the lookout. The commander of Histran Base, knowing that pirates have been eluding him by using the secret jump route to Volturnus, has dispatched his available vessels to attempt an intercept reasoning that they might try to evade capture through Scree Fron.

## SCENARIO RULES

The advanced damage table should be used as a pirate ship reduced to 0 ADF can be presumed captured at the end of the scenario. The UPF player has a chance of one assault scout showing up to join the battle. At the end of each turn the UPF player rolls d100 and the chance is equal to the turn times 10%, thus in the third turn the chance is 30% or less. Only one assault scout will arrive during the battle.

## SETUP

The UPF player chooses either a frigate and an assault scout or three assault scouts for the intercept. The ships are set up anywhere on the map as long as they are 20 hexes apart. The pirate player gets two privateers (see below) and dices for the side of the map they both start on (1d6: 1-2 one long side, 3 a short side, 4-5 the other long side, 6 a short side) and sets them up 20 hexes apart. The UPF player has a speed of 0 and the pirate player has a speed of 12. Pirate player must travel to the exact opposite side of the map and exit it without an enemy vessel within 20 hexes. If he does this he is judged to have escaped.

## VICTORY CONDITIONS

The UPF player's goal is to capture jump route charts and thus he wins a partial victory for stopping one pirate vessel without completely destroying it and a major victory for stopping both without completely destroying one vessel.

If there are only two players the pirate player wins a partial victory if one vessel gets away and a major victory if both vessels escape.

If there are 3 players then two players take a single pirate vessel each and victory is figured separately for each. A pirate player that escapes wins a major victory and has no concern for what happens to the other pirate vessel.

If the pirate player(s) destroys all of the UPF vessels without having his ships crippled he/they win a total victory.

## PIRATE VESSELS

The pirate player(s) may choose 1 yacht (Imp, Nova or Astro-Blaster III classes) and 1 privateer (Lightspeed Lady or Moonbright Stinger classes). Note these yachts and privateers come from Dragon #88 "Yachts and Privateers Return" by Douglas Niles.

**Imp Class:** HS 4, HP 20, ADF 3, MR 4, DCR 32, Weapons: laser battery, AR (X3), Defenses reflective hull.

**Nova Class:** HS 5, HP 25, ADF 2, MR 2, DCR 35, Weapons: laser battery, rocket battery, laser cannon, Defenses reflective hull.

**Astro-Blaster III Class:** HS 6, HP 30, ADF 1, MR 3, DCR 38, Weapons: laser battery, electron beam battery, Defenses: reflective hull, 4 interceptor missiles.

**Lightspeed Lady Class:** HS 4, HP 20, ADF 4, MR 4, DCR 32, Weapons: laser battery, AR (X3), Defenses reflective hull.

**Moonbright Stinger Class:** HS 9, HP 45, ADF 3, MR 2, DCR 45, Weapons: laser cannon, seeker missile launcher (X2), electron beam battery, Defenses reflective hull, 6 interceptor missiles.

## CONTINUING THE ACTION

A referee may develop an Alpha Dawn style sequel to the above battle with a Space Fleet boarding party entering a captured pirate vessel and clearing it of pirates, dealing with battle damage, and hacking the computer for the astrogation files as well as other intelligence on the pirates.

## CHARTING THE PASSAGE

Space Fleet has captured the astrogation data for the Scree Fron to Zebulon jump route but someone must test the information by actually travelling the route. A vessel from the Scree Fron station is sent to test the route. The Space Fleet captain arrives in the vicinity of the Oort cloud for the Zebulon system and detects some stray radio traffic and decides to investigate knowing that this is a pirate charted jump route.

The pirates have an automated outpost on a large chunk of ice and rock in this area that acts as a meeting point and clearing house for exchanging goods between pirate bands. The outpost has a deluxe White Noise Broadcaster which activates when the UPF frigate appears preventing it from communicating with other UPF forces in the system. The UPF player must knock out the automated base and attempt to stop any pirate vessels present.

### SETUP

The pirate player places an asteroid counter in the center of the map and a random pirate vessel(s) within 5 hexes of the asteroid. The pirate player dices for ships rolling 1d6 (Results: 1= 1 Moonbright Stinger Class, 2= 1 Imp class & 1 Light Speed Lady class, 3= 1 Imp Class & 1 Astro-Blaster III class, 4= 1 Nova Class & 1 Lightspeed Lady class, 5= 2 Nova Class, 6= 3 Imp Class). All pirate vessels are speed 0. The automated base is HP 30, Seeker Missile Rack (x2), Reflective Hull, Deluxe WNB.

The UPF player sets up a frigate anywhere on any long side of the map with a speed of 10.

### VICTORY CONDITIONS

The UPF player wins a partial victory if he only destroys the automated base and all pirate vessels escape. He wins a major victory if he destroys the base and stops at least one pirate vessel. He wins a total victory if he destroys the base and stops all pirate vessels.

The Pirate player wins a minor victory if one vessel escape and one is stopped. He wins a major victory if all of his vessels escape. He wins a total victory if he destroys the Space Fleet ship and the automated base is not destroyed.

## MECHANON DIPLOMACY BY OTHER MEANS

The friendly mechanons are sending an ambassador to the Council of Worlds on Gran Quivera to petition for their acceptance into the UPF. This ambassador is arriving in Scree Fron by shuttle with mechanon heavy fighter escort. A space fleet patrol group is detailed to meet and escort them to Histran base before they continue on to Athor and Prengular. A hostile mechanon force will attempt to

intercept the ambassador before he can accomplish his diplomatic mission.

The UPF player has received a subspace alert that a mechanon force of unknown intentions was spotted in the Zebulon system accelerating to jump speed with no chance of an intercept by UPF or Rim forces stationed there. This is the hostile force.

### RULES

The friendly mechanon shuttle is exactly like a heavy mechanon fighter but without the weapons. It may be stacked within the same hex as other mechanon fighters and the opposing player will not be able to distinguish it from other fighters that do not fire. Thus any attacks on a stack of fighters including the shuttle will apply damage to a random ship that has not revealed itself to be a fighter by firing weapons.

### SETUP

The UPF (and friendly mechanon player) sets up his mechanon and UPF forces on opposite short sides of the map with a speed of 15. Their original intention was to meet in the center of the map and proceed to the UPF side. The friendly mechanon force is one shuttle and four heavy fighters. The Space Fleet patrol group is one frigate and two assault scouts. The ambassador's shuttle must escape off the UPF short side of the map with no hostile mechanon ships within 20 hexes.

The Hostile mechanon force is one base ship and 8 heavy fighters which set up on the center of one of the long sides of the map with a speed of 20.

### VICTORY CONDITIONS

It's a major UPF victory if the mechanon ambassador escapes but a major hostile mechanon victory if the ambassador's ship is destroyed. There can be no other result.

**FE**



Spaceships

# FREEDOM CLASS SHIPS

Chance Folmar

**SOURCE: HIVE MOTHER'S (CHANCE FOLMAR)  
QUANTUM WEBSITE**

## HISTORY

Freedom class ships were designed right after the Great Sathar Conflict had ended. Although by no means an efficient design, Freedom Ships were mass produced in such numbers that many are still capable of flying today.

The Great Sathar Conflict left the Four Races fleets devastated. Most of the ships capable of transporting goods and passengers had been wiped out by Sathar forces. The systems of Dramune and Fromeltar lost half of the ships registered there. Cassidine, during the Rape of Triad, lost all but a handful of transports who were away on other business in the Vrusk and Yazirian sectors. Finally, almost all armed ships were lost during the Battle of Prenglar (aka Battle of Drolk Ata, now known as Morgaine's World)), leaving the Four Races vulnerable to a second Sathar attack.

In order to replenish the number of ships quickly, the Freedom ships were born. Freedom ships were capable of being built quickly using technology at even the lowest level of space construction yard. Furthermore, although not very space efficient, the ships could be outfitted in one of several different "versions" that permitted the transporting of a wide variety of goods, from raw ore to passengers. Even a specialized hospital ship was available. Freedom ships could even be specialized to carry weapons and a few were built with upgraded engines to provide escort duties of convoys.

All Freedom ships had a semi-reinforced hull that improved their Hull strength, but they are not on par with a full-fledged warship. In addition, the original engines were not particularly fuel efficient. Since the ships were designed for both ease-of-construction and versatility, space efficiency was relatively poor.

Despite this, the Freedom ships were an unqualified success. They were built in the thousands (more than any other design to date), with the Four Races achieving a peak production of six ships per day for two ten-day. The Timeon Shipyards managed the remarkable feat of 1 ship per day during this stretch, with the remainder of the quota being formed from the White Light (15), Araks (14), Theseus (18), Gruna Garu (15), Dramune (15) K'Aken-Kar (12) and Yast (11) shipyards. Despite this



mass production, or because of it, the quality of construction of these ships varied. A few ships even had small "leaks" that air escaped from and had to be replenished at regular intervals.

Over time, as the possibility of a second attack became remote and Triad became stabilized, the production of these ships decreased. Eventually the ships were sold, at bargain prices or with reduced loans, to their captains or corporations. A few, that had been upgraded to combat status, went on to form the backbone of the new UPF fleet (all of these have since been scrapped except for a museum piece ship around Drolk Ata).

For nearly two decades the Freedom Ships formed the bulk of the UPF merchant fleets. Over time, however, there were advances in designs. Competition from more specialized ships with better engines, more space, or higher speeds began to replace the Freedom ships. At first they were forced out of the lucrative "short" routes from around Dramune and Prenglar. Later, as engine design improved and the "luxury" liners appeared, the Freedom ships were relegated to longer routes. But now even that is threatened by further advances in technology.

Currently, except for a few "specialist" contracts, Freedom ships are only found patrolling the Yazirian sector, where their large fuel capacity (an early design specification) still permits them to operate where other ships cannot. The captains and crews of Freedom Ships are notoriously proud of their ship's history and valiantly defend them as being the "most important ship" in saving the lives of the people of Cassidine.

## MODELS AVAILABLE:

### TYPE [NICKNAME, IF ANY] (SPECIAL NOTES)

H+	Hospital Transport Ship
C	Bulk Emergency Passenger Transport Ship [Freezers] (Freeze field passengers only)
B	Foodstuff [Candy Carrier] (Refrigerated/Airtight hull)
O	Ore Carrier (Non-Airtight hull, normally with shuttle for asteroid mining)
P	Fuel Processor (only a few built, mostly to temporarily replace fuel processors at Prenglar and Cassidine and K'tsa-Kar)
F	Fuel Transport (with Hydrogen pumping and transfer equipment, capable of in-transit fueling)
H	Standard Passenger Transport ship [Live or Hot Ship]
Z1	Armed Rocket Escort ship [Aries] (RB x3) - Available at all stations. Most late model White Light versions had dual Launchers with independent magazines of 3 each (essentially, RBx6, fire twice per round), while those at Timeon Shipyards tended to have single launchers with 2 rounds, but they also had a universal Torpedo firing tube with 2 rounds (RB x2, Tx2). Vrusk ships tended to meet the basic requirements (RBx3), but had a more efficient drive system and a reduced fuel capacity (RBx3, cannot make jumps over 9 LY).
Z2	Beam Armed Transport [BAT] (LB, only available at Dramune, although many ships retrofitted later)
Z3	Combined Weapons Platform [War Wagon] (LB [FF only], RBx3) - All of these were originally Armed Rocket Escorts that underwent retrofit additions at White Light when Laser Batteries become available. The first of these retrofits occurred after production had peaked and the "crisis" period was past.
Q	Bulk Freighter [Goody Ship] - Many ships were converted from one type to another during their lifetime. During the year that the Triad Crisis existed many of the ships would haul goods to Triad, go through a quick conversion process, then haul refugees back to Prenglar or Dramune. Later, many of the ships were built with an extended crew quarters so that they could transport cargo in and refugees or soldiers out without having to go through a lengthy conversion process.

## GAME STATISTICS

(Note, only the basic model is represented.)

ADF:	1
MR:	1
DCR:	50
HP:	36 (most warships had 45 HP, with those from Timeon having roughly 20% more HP)
Fuel:	95 Ku
Range:	Max 16 LY without refuel and 4 day maneuvering.
HS:	9/8

Hull size is 9 externally, but only are equivalent to a HS 8 internally.

**Editor's Note** – I have no idea what exactly his fuel specification is. Using the standard Knight Hawks rules, I'd treat them as only having the range of a single jump, needing to be refueled after each one. If you're using a variation of the 1 ly/day idea from Alpha Dawn and not the void jumping idea from KH, treat this as is with 16 ly being the maximum distance that can be traveled before refueling.

FE



# TITAN RISING: 2299

## EPISODE # 2.0: "INTRUSION"

C.S.S. INTREPID: HIGH ORBIT SPACE DOCK...

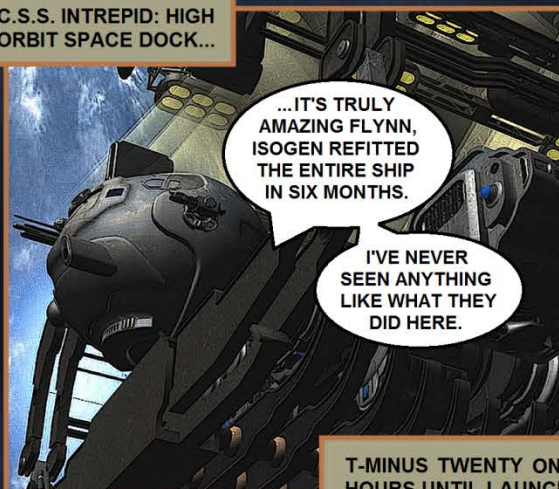

...IT'S TRULY AMAZING FLYNN, ISOGEN REFITTED THE ENTIRE SHIP IN SIX MONTHS.

I'VE NEVER SEEN ANYTHING LIKE WHAT THEY DID HERE.

T-MINUS TWENTY ONE HOURS UNTIL LAUNCH.

...AND HERE WE ARE FINALLY AT THE INTREPID'S MAIN BRIDGE.



WOW!

...COMPLETELY RE-DESIGNED WITH THE LATEST ISOGEN HOLO-VID DISPLAY TECHNOLOGY.

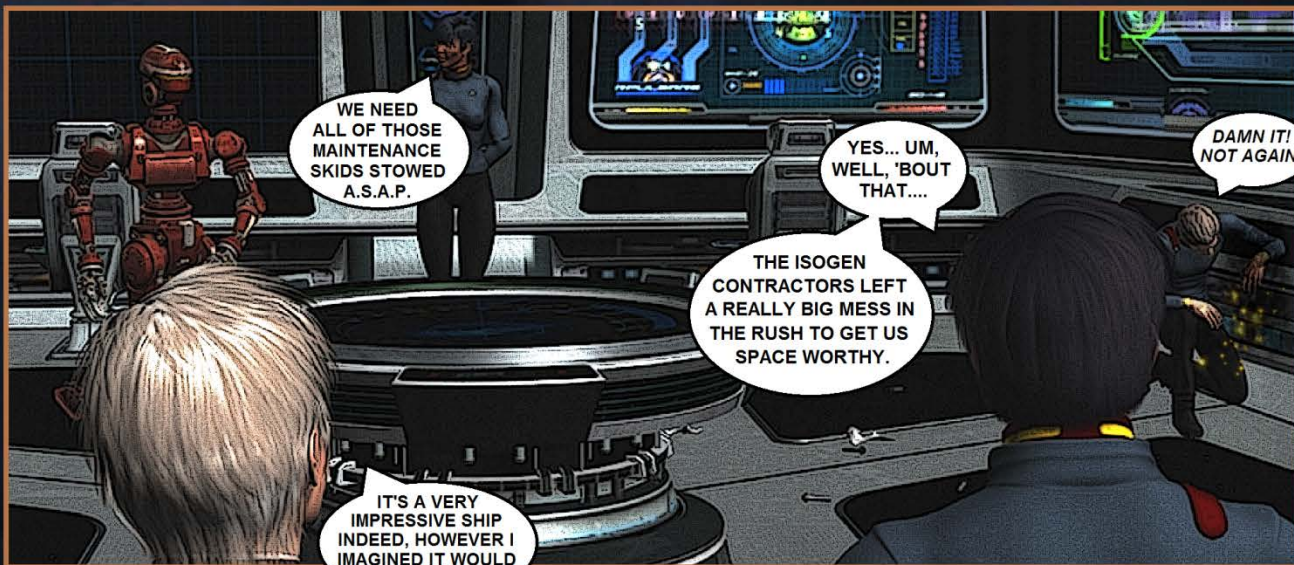

WE NEED ALL OF THOSE MAINTENANCE SKIDS STOWED A.S.A.P.

YES... UM, WELL, 'BOUT THAT....

DAMN IT! NOT AGAIN!

THE ISOGEN CONTRACTORS LEFT A REALLY BIG MESS IN THE RUSH TO GET US SPACE WORTHY.

IT'S A VERY IMPRESSIVE SHIP INDEED, HOWEVER I IMAGINED IT WOULD BE...CLEANER.



... AND REMEMBER 'IGGY' NO RE-CHARGE BREAKS ALONG THE WAY THIS TIME!

AFFIRMATIVE, CAPTAIN



HELLO, THERE...

HEY, CAPTAIN! LOOKS LIKE YOUR NEW ADVISOR HAS ARRIVED.

BY CHANCE, DOES SHE KNOW HOW TO FIX A FUSED RELAY?

.... OH YES,  
WELCOME ABOARD THE  
INTREPID LIEUTENANT  
FLYNN.

EXCUSE,  
COMMANDER  
GARRET'S BAD  
MANNERS...

HE'S BEEN  
TRYING TO FIX  
THAT DATA RELAY  
FOR THE BETTER  
PART OF THE  
WEEK.

LIEUTENANT  
GOLDMAN CAN  
TAKE YOU TO THE  
CREW MODULE TO  
GET SETTLED IN.

THERE'S A LARGE  
CLOUD OF SPACE JUNK  
DRIFTING OUR WAY AND I  
WOULD PREFER THAT ALL  
CREW WERE IN A SHIELDED  
AREA OF THE SHIP  
WHEN IT HITS.

A FEW MINUTES LATER...

THE DEBRIS CLOUD OF  
SPACE JUNK COLLIDES  
INTO THE DOCK FRAME.

AMONGST THE TRASH  
AND DEBRIS DRIFTS A  
LONE SURVIVAL POD...



CARRYING A SINGLE  
PASSENGER TO AN  
UNSECURED HATCH.

BYPASSING THE INTREPID'S  
SECURITY MEASURES WITH  
AMAZING SPEED AND EASE

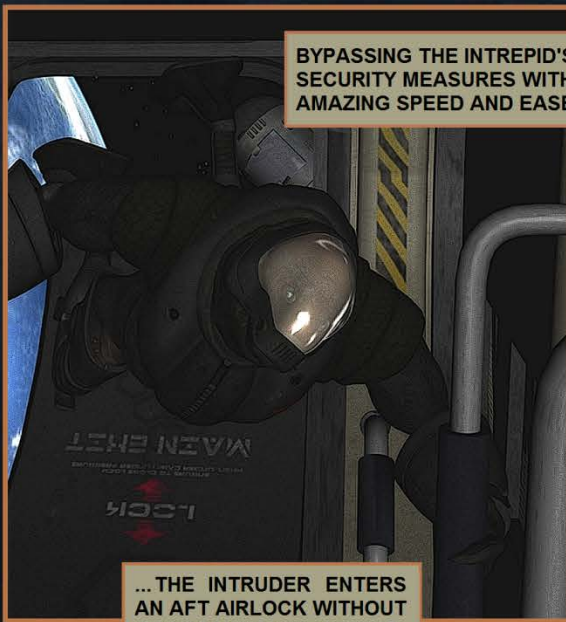

...THE INTRUDER ENTERS  
AN AFT AIRLOCK WITHOUT  
RESISTANCE OR NOTICE.

AIRLOCK NOW  
PRESSURIZING,  
STAND BY...

SSSHHHH



BING!

ATMOSPHERE  
AND ARTIFICIAL  
GRAVITY NOW  
RESTORED.



TO BE CONTINUED...



## Equipment

# IN THE MINZII MARKETPLACE

Tom Verreault

The Capellan Free Merchants of the planet Faire are renowned as the merchants of the Frontier that can find the truly unusual, rare, alien, or items impossible to find elsewhere. Strolling through the Minzii Marketplace is an adventure in itself as one never knows what one might discover for sale there.

Some things have a set cost or price while others have a value. Ifshnit traders will know the value of an item but are quite willing to haggle over the price. Note that in Zebulon's Guide, one of the racial abilities of the ifshnit is an innate skill chosen from the following: gemology, appraisal, or haggling. It should be a given that any ifshnit selling stuff in the market place will almost certainly have the haggling skill unless he's a jeweler or expert appraiser.

## THE EORNA SOLAR CRYSTAL LANTERN

This item is an artifact of the eorna civilization from before the Day of Doom. It is essentially a solar powered lantern of solid state design which may account for the longevity of their operational life (thus far 900+ years). The core of the lantern is a large crystal encased in elegant metal alloy housing. If exposed to sunlight for 6-12 hours it will radiate light 15m for up to 12 hours. Some lanterns come equipped with a shuttered mechanism and some do not which affects value.

**Weight:** 1 kg

**Value:** w/ shutter 5000 Cr, w/o shutter 3000.

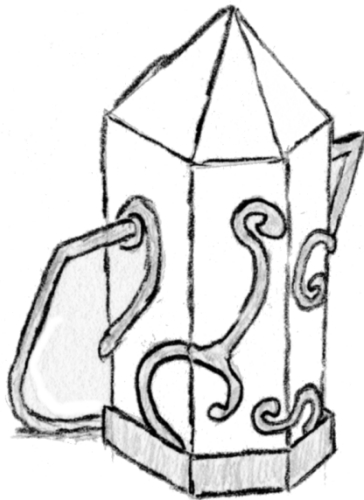

**Editor's Note:** The CFM is always a source of new, old, and rare items. Look for more items from the Minzii marketplaces in future issues.

## PALE EXPLORATION SERVICE UTILITY BELT

This utility belt was issued to the Pale Exploration Service prior to SW1 and is highly valued by explorers. The belt is a rugged design and doubles as a climber's harness (+20 to climbing maneuvers when using ropes or may automatically rappel safely). Originally, it came equipped with a multi-tool, flashlight, compass, 50m of rope and a folding mini grappling hook. The rope can support 500kg but due to age the mini grappling hooks have been known to break or fail (10% of the time). Most of these utility belts have many or all of the tools missing but replacement tools can be found.

**Value:** w/all original tools 150 Cr, w/replacement tools 50 Cr, w/o tools 25 Cr.

## KURABANDA BLOW GUN

Handcrafted by kurabanda hunters, the blow gun is an effective hunting weapon for small game in the bachanda forest. Any creature immune to needler weapon is immune to the blow gun as well. As a weapon it has limited range and does little damage. For this reason the kurabanda employ poison collected from the mordax insect (S5/T5). A kurabanda blow gun can have up to 5 needle darts (roll 1d5 to randomly determine) and a small stoppered pot of poison which is worn around the neck on a cord (2d10+5 doses of poison). Fakes and low grade knock offs are common but are -10% when used due to poor quality.



Tom Verreault

**Damage:** 1pt

**Ammo:** 1

**Rate:** 1

**Defense:** Inertia

**Range:** PB: 0-3/S: 3-10/M: 11-15/L: 16-20/ E: N/A

**Cost:** authentic 30 Cr, fake or knock off 10 Cr

**Cost of poison:** 2 Cr/dose

## Spaceships

# RED THUNDER

Joseph Meager

**Editor's Note:** Red Thunder was designed by Joseph Meager. The deck plans were recovered from an internet archive and are presented here with an eye to preserving an excellent set of deck plans. We have been unable to discover if a write up on the Red Thunder ever existed so the following write up is presented by the FE editors as background for a ship class with the Red Thunder being the most notorious to be built in the series.

The Red Thunder series is a HS4 privateer classed starship designed and built under contract for the Strel Corporation. In some way it has a lot in common with the corvette class ship, also designed and built under contract for Strel. The design philosophy for its offensive armament is for extended operation without need for resupply since the ship has no expendable munitions.

The Red Thunder class was originally designed during Laco's War. However, before any ship of this class could be commissioned the war ended which resulted in a redesign for a privateer that could be deployed on scouting missions. Five ships were delivered to the Strel Corporation with the Prodigal Sun being the most famous, having scouted the New Strel star system for the company. Subsequently, ships were built to order for other customers with the stipulation that Strel receive a royalty on their war fighting IP used in the original design. This resulted in few sales after the first five because customers disliked paying the royalty on items not included in the redesign. However, it is rumored that some obscure CFM merchants sell the original war fighting design along with guides detailing how to implement many of the original Strel design capabilities.

The ship boasts a lot of redundant computer capacity with a lander module like that of the Eleanor Moraes Class in place of a masking screen. The lander module increases the structural integrity of the ship (28 HP) but if the module is missing the ship cannot take as much punishment (22 HP).

Decks 1-4 and 7-8 all have sub decks that are the same size as the deck above them. A sub deck is little more than a crawl space interlaced with power runs, air ducts, plumbing connections and so on. A sub deck is accessed via an air tight floor hatch located near the elevator. Movement is slowed to ½ walking.

A somewhat unique feature of the ship is the fact that there are 3 separate mainframe computers. The original



computer was sufficient to run the ship as a corporate gunship but when Laco's War ended and the ships were repurposed for other missions, two more mainframes were added to support a med bay, laboratory, and probe control. These added computers are cross-linked with each other but standalone from the main computer. Some ships of this class *may* have had cross-links connecting the added computers to the main computer but this is not standard.

Another interesting feature to this class of ship is the holo theater which was originally intended to be used to brief company sized groups of corporate mercenaries for upcoming operations. During the redesign of the class, there were numerous plans to eliminate this feature but somehow it remained. It's been popular with deep space exploration crews and continues to be used for operational briefings. However, since it represents a significant amount of deck space, it also becomes a secondary storage hold with the walls lined with stacks of supplies and consumables.

The lander module is designed to be a base of operations while exploring a new planet. It has four different computers but none of these have the computational power of the ship's main computer. The landing module comes equipped with an explorer and a jet copter. The jet copter has a folding tail and rotor for ease of storage and requires 1 hour to deploy but the explorer can be deployed in 10 minutes.

## KNIGHT HAWKS STATISTICS

The ship itself is slightly larger than a standard HS 4 vessel. The lander, by itself is about the same size as a

HS 3 ship. It has the same volume as an Assault Scout. The KH statistics for the two parts of the ship along with their costs are given below.

**SHIP**

**HS:** 4 **HP:** 22 **DCR:** 32  
**ADF:** 4 **MR:** 4 (without Lander Module)  
**ADF:** 3 **MR:** 2 (with Lander Module)  
**Engines:** 2 Atomic, Class A  
**Weapons:** LC LB  
**Defenses:** RH  
**Life Support Capacity:** **Primary:** 20 **Backup:** 20  
**Accommodations:** 1 First Class (captain), 12 Journey (crew)  
**Computer:** **Level:** 4 **FP:** 146  
**Programs:** Drive 4 (32), Life Support 1 (2), Alarm 2 (2), Computer Lockout 4 (8), Damage Control 2 (4), Astrogation 4 (24), Camera 1 (1), Skin Sensors 1 (1), Laser Cannon 1 (3), Laser Battery 1 (4), Atmoprobe Guidance 3 (9), Robot Management 4 (16), Information Storage 4 (16), Analysis 4 (8), Computer Security 4 (16)  
**Other Equipment:** Standard Starship astrogation suite, videocom radio+ second viewing screen, subspace radio,

intercom w/3 master panels and 40 standard panels, Radar, Energy Sensors, Camera System, 7 Escape Pods, 2 atmoprobos, 4 Laboratories (2= medbay, 1 physics, 1 astro), 2 workpods

**Cost:** 1,949,650 cr.

**LANDER**

**HS:** 3 **HP:** 6 **DCR:** N/A  
**ADF:** 0 **MR:** 0  
**Engines:** Chemical- landing only  
**Life Support Capacity:** **Primary:** 6 **Backup:** 6  
**Accommodations:** 6 Journey class  
**Computer:** **Level:** 3 **FP:** 52  
**Programs:** Life Support 1 (2), Alarm 1 (1), Analysis 3 (9), Information Storage 4 (16), Computer Security 3 (8), Robot Management 4 (16)  
**Other Equipment:** Videocom radio, Intercom w/ 1 master and 15 regular panels, radar, Laboratory, Type 3 Generator/reactor, Jetcopter, Explorer  
**Cost:** 469,200 cr.

**FE**

**RED THUNDER**

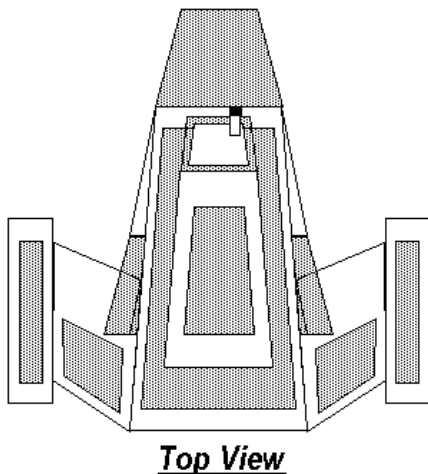

**Top View**

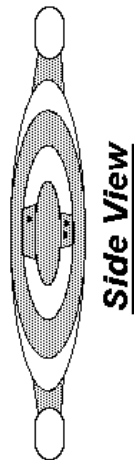

**Side View**

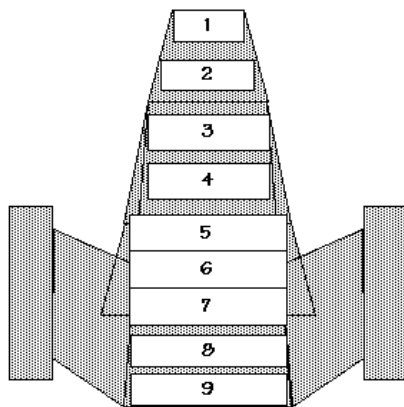

**Deck Cutaway**

- Deck 1: Sky Bridge
- Deck 2: Bridge
- Deck 3: Main Hatch
- Deck 4: Computer Deck
- Deck 5: Crew Quarters
- Deck 6: Mess Hall/ Rec. Area
- Deck 7: Lab/ Medical Decks
- Deck 8: Engineering Deck
- Deck 9: Storage/ Landing Deck

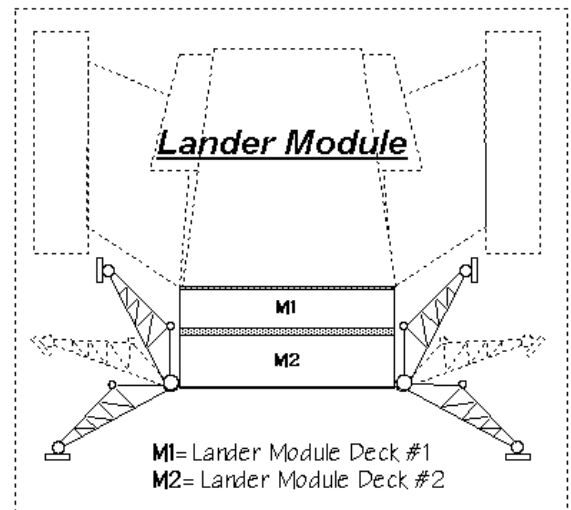

M1= Lander Module Deck #1  
M2= Lander Module Deck #2

**Note:** Landing Module can be landed with the Red Thunder, or by parachute. The lander can be used as temporary outpost. It has its own Life Support and Power. The legs of the lander are retracted for flight and extended for landing. When used with the ship the lander can be reused. Multiple landers can be attached together.

# Red Thunder

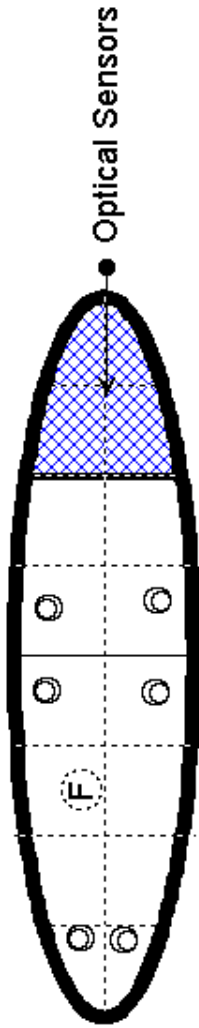



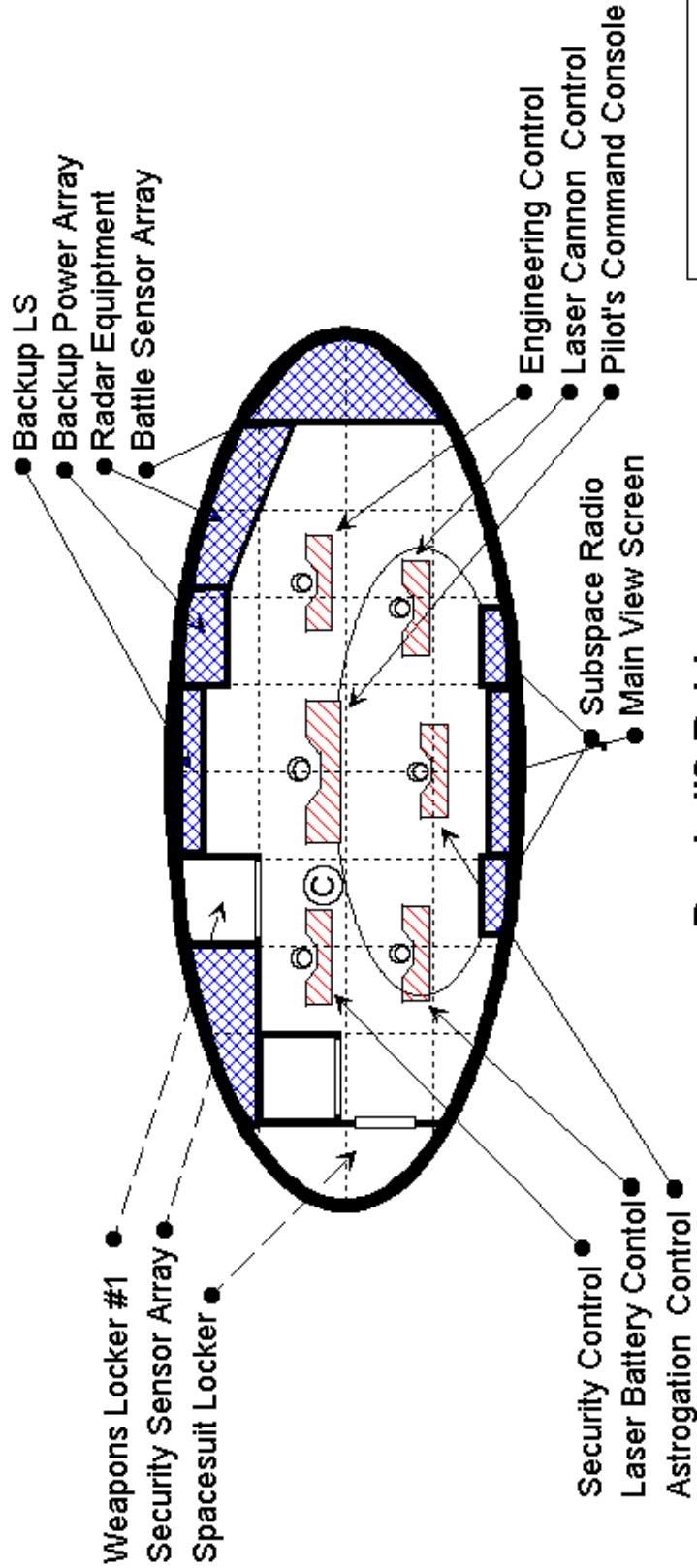

## Deck #1 Sky Deck



## Deck #2 Bridge

# RED THUNDER

**Key:**

	Computer Related
	Machinery Related
	Access Panel
<b>SL</b>	Spacesuit Locker
<b>RP</b>	Rocketpack
<b>M</b>	Machinegun Mount
	Security Door

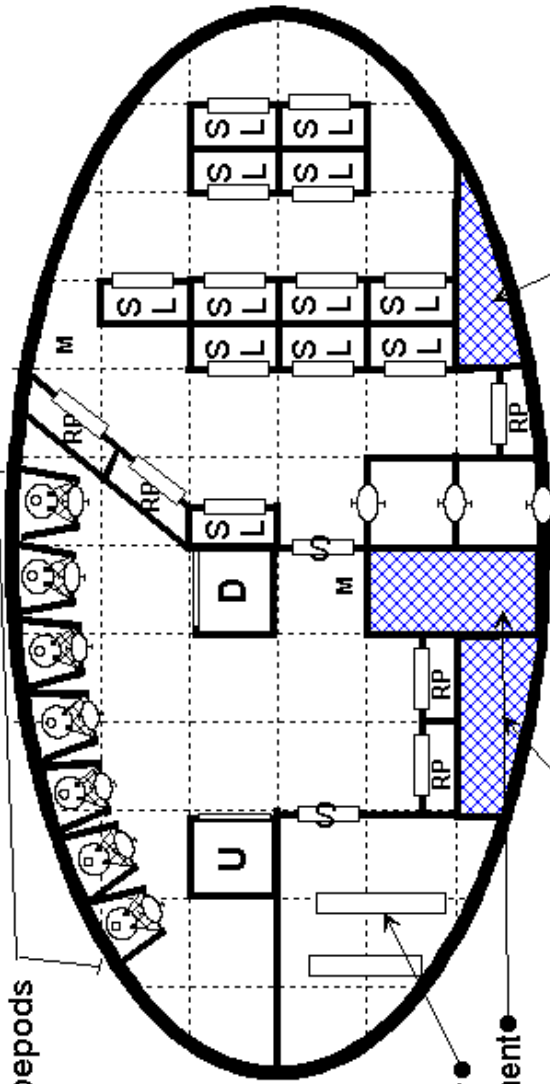

**Deck #3**  
**Main Hatch**  
**Deck**

Escapepods  
Main Weapons Locker  
Decompression Equipment  
Docking Clamp Motors  
Turrent Motors

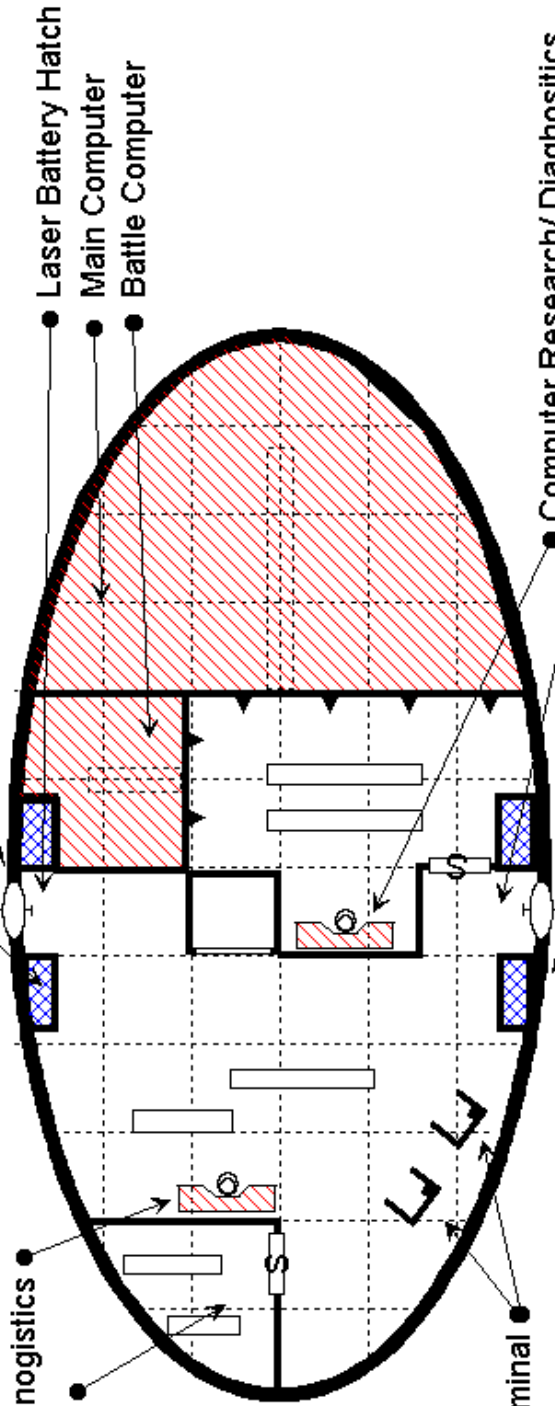



**Deck #4**  
**Computer**  
**Deck**

Robotic Research/Diagnostics  
Robotic Parts Storage  
Laser Battery Hatch  
Main Computer  
Battle Computer  
Computer Research/Diagnostics  
Laser Cannon Hatch  
Robotic Recharge Terminal  
Turrent Motors

# RED THUNDER

## Deck #5 Crew Quarters

<b>Key:</b>		Computer Related
		Machinery Related
	M	Gun Mount
	S	Security Door

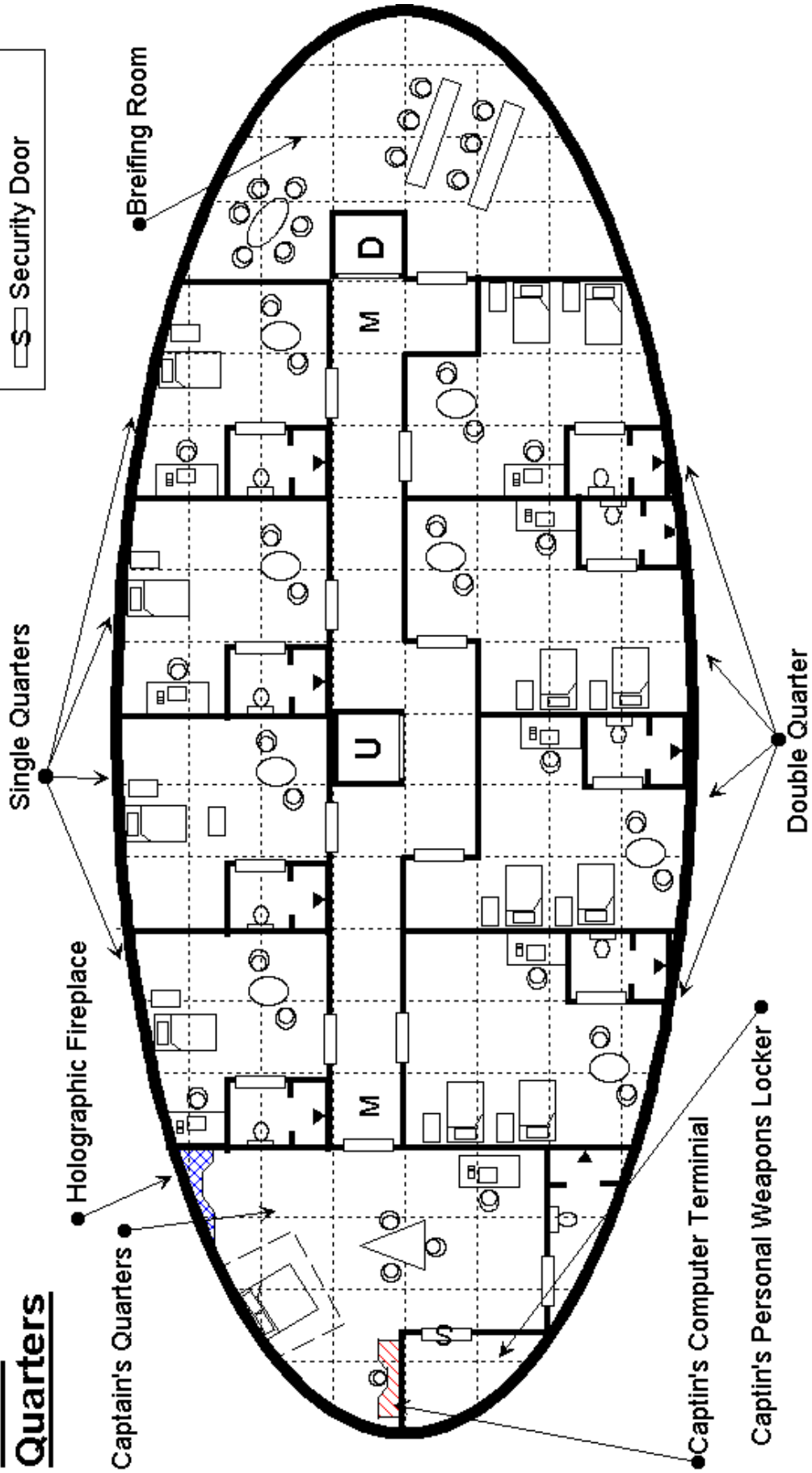



# RED THUNDER

Deck #6  
Mess Hall/  
Rec Deck

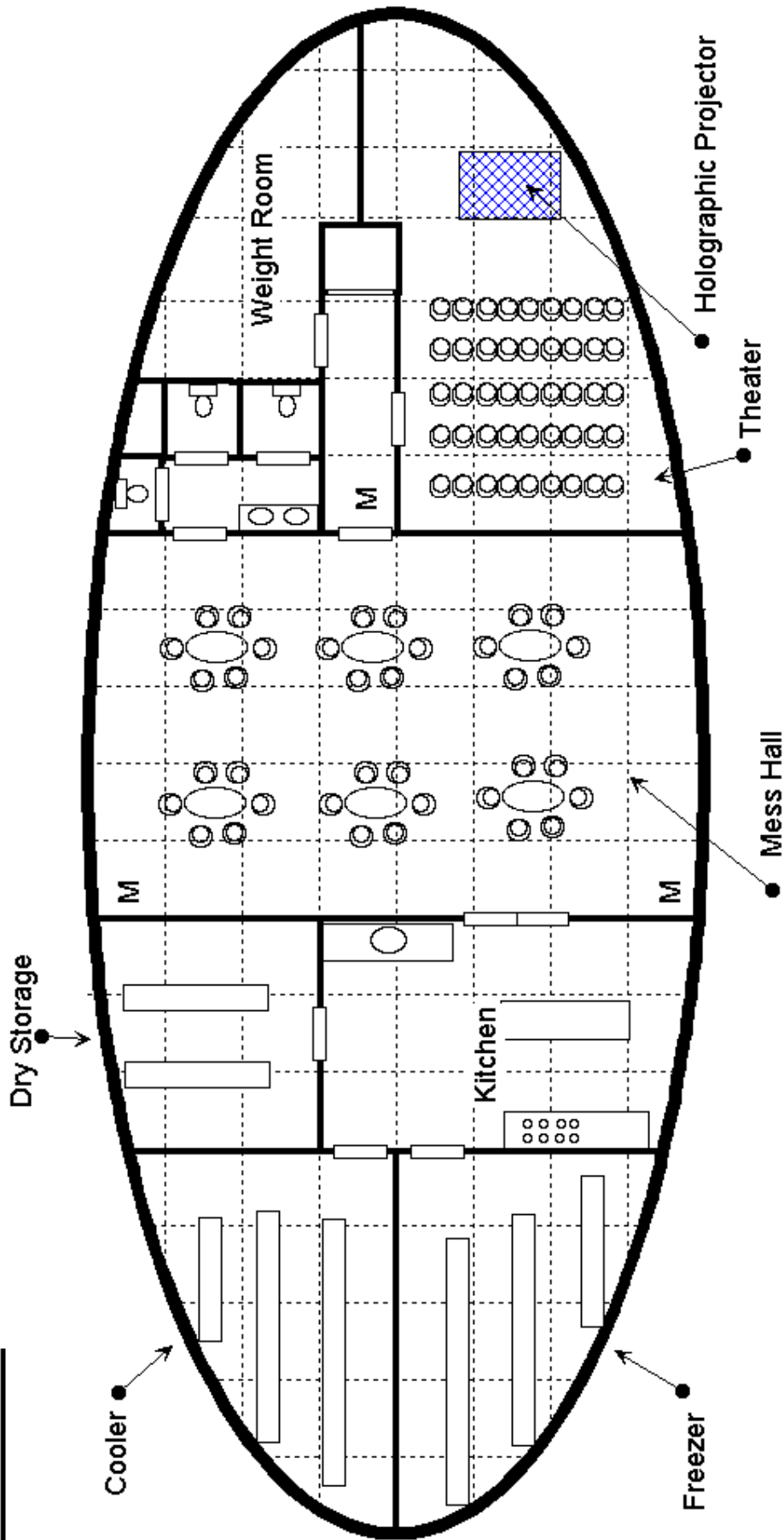

# RED THUNDER

## Deck #7 Lab/ Medical Deck

**Key:**

-  Computer Related
-  Machinery Related
- M Gun Mount
- S Security Door

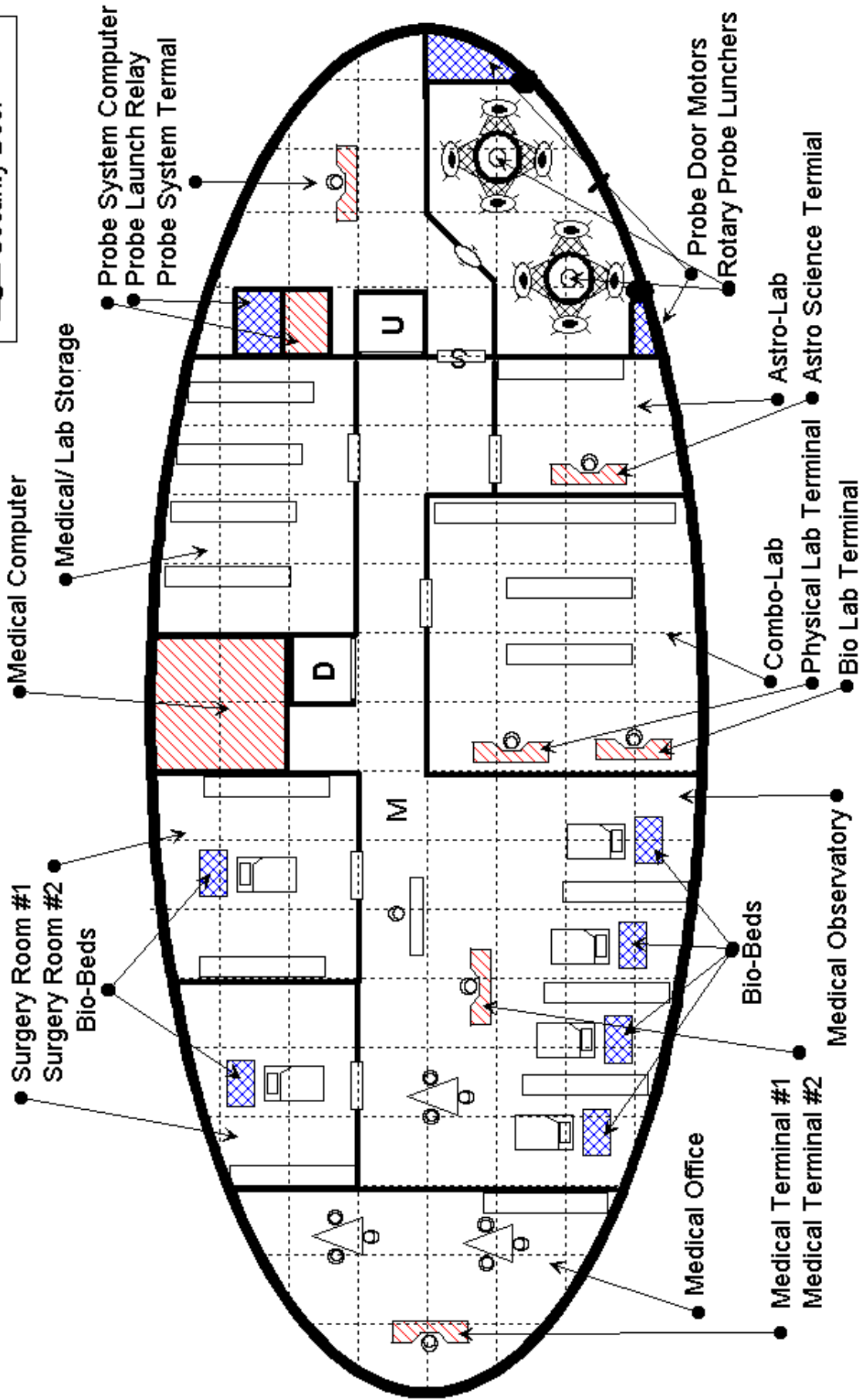



# RED THUNDER

## Deck #8 Engineering Deck

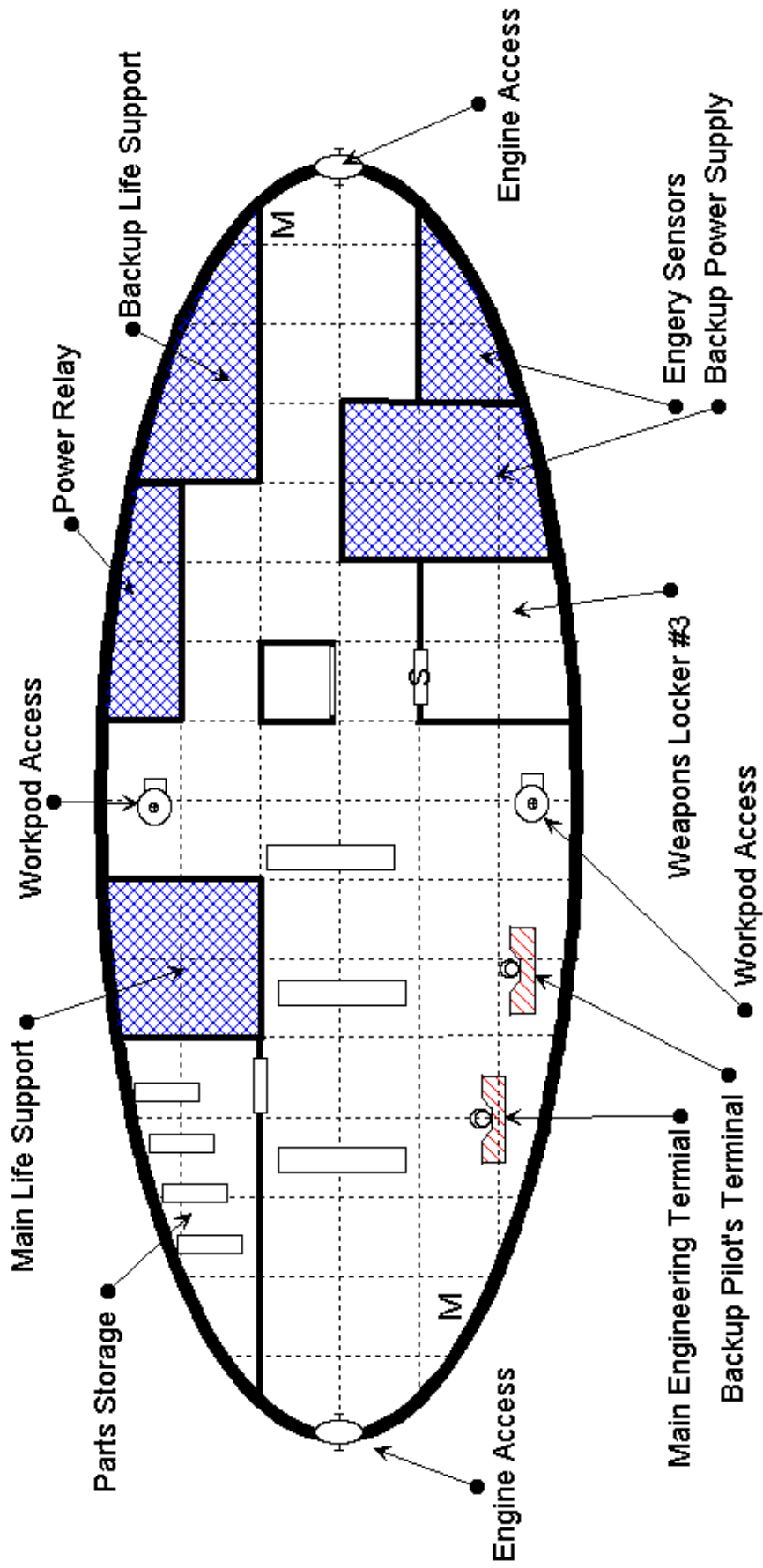

# RED THUNDER

## Deck #9 Storage Deck

<b>Key:</b>		Computer Related
		Machinery Related
	M	Gun Mount
		Security Door

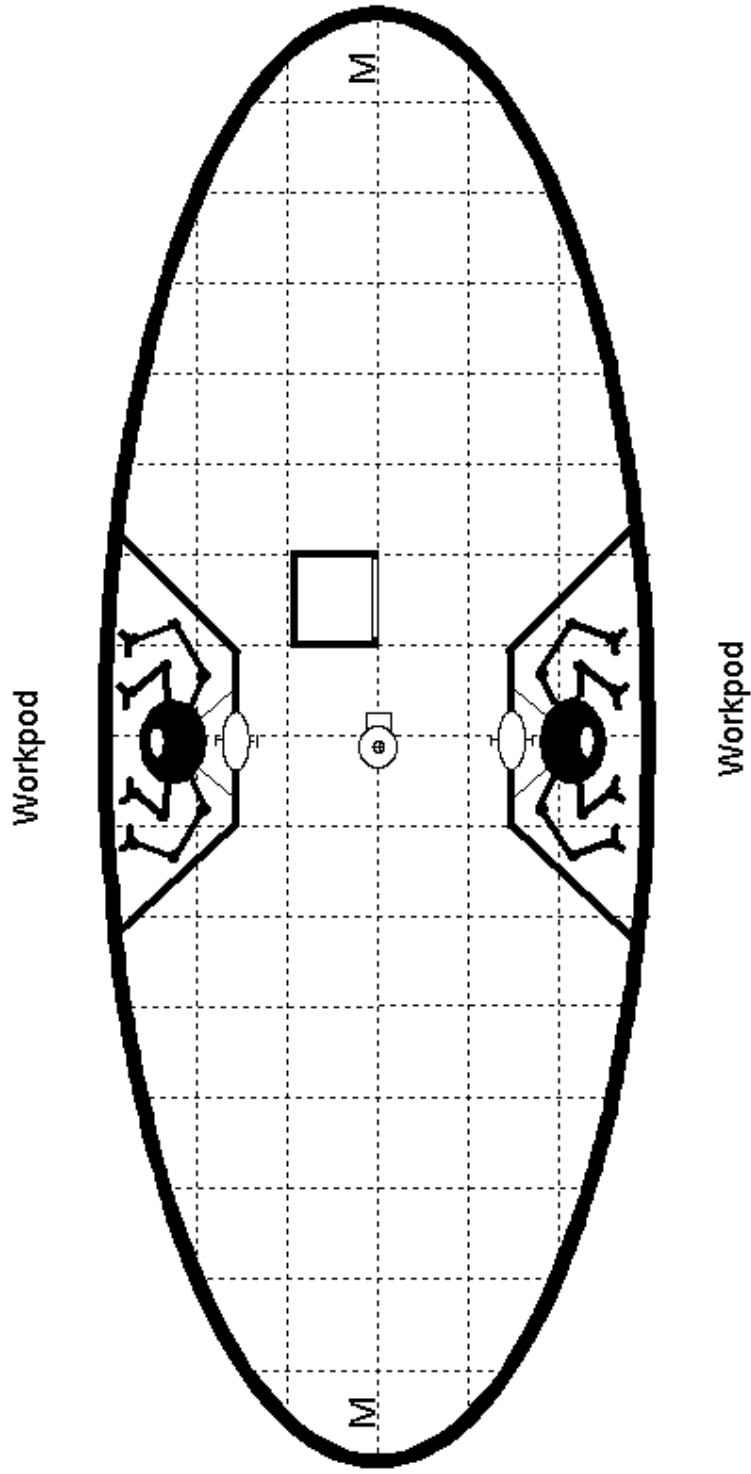

# RED THUNDER (LANDING MODULE)

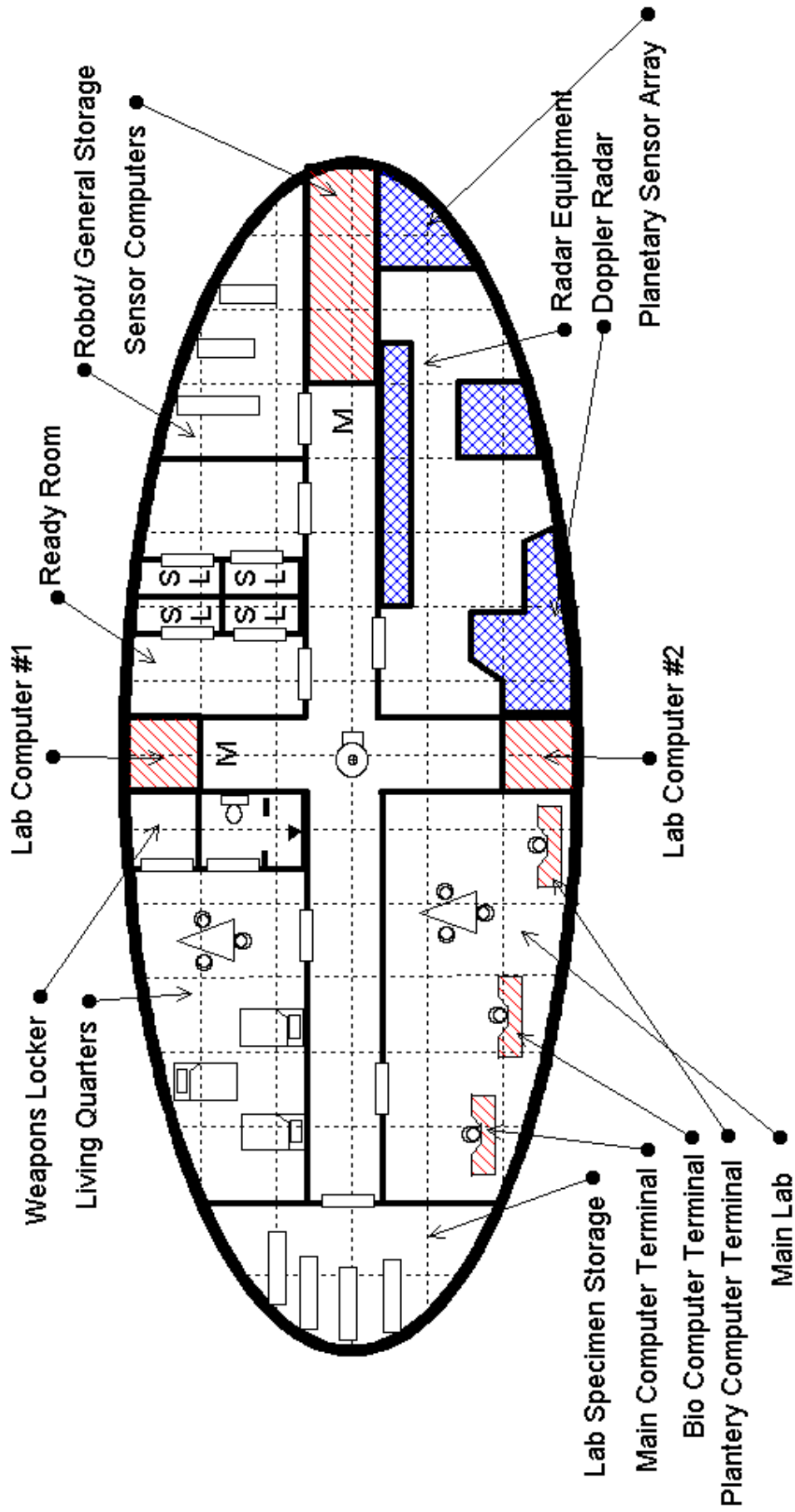

## Deck #1 Living Quarters/ Lab

Key:	
	Computer Related
	Machinery Related
M	Gun Mount
	Security Door



# RED THUNDER (LANDING MODULE)

## Deck #2 Maintenance/ Vehicle Deck

<b>Key:</b>		Computer Related
		Machinery Related
	M	Gun Mount
		Security Door

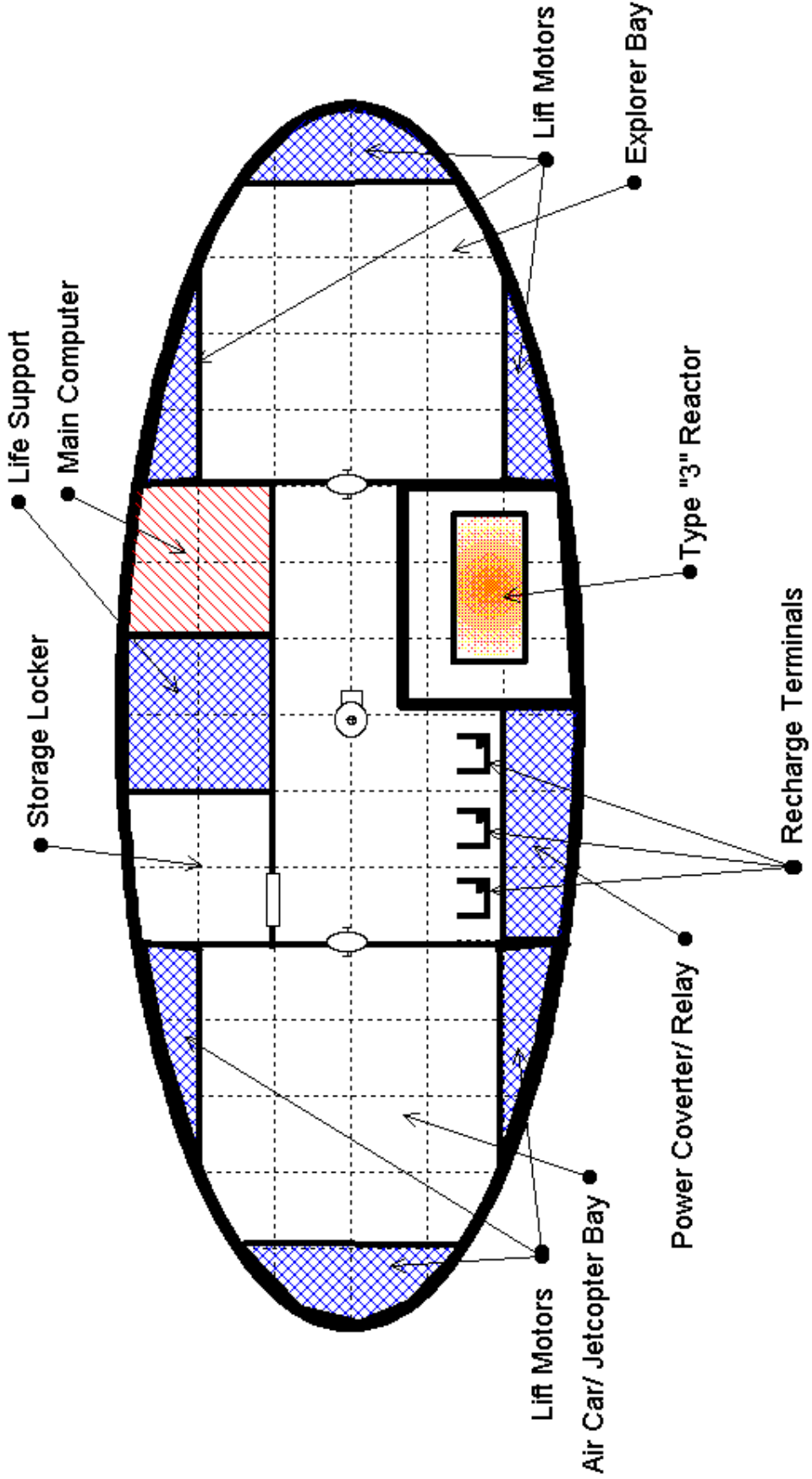

# RODWORTH GUIDE TO PRE-FRONTIER ATOMIC ROCKETS

Edwin Cintron

## A NOTE ON EARLY SCI-FI ROCKETS

The early Atomic rocket pulp fiction was filled with tales of the Torch Ship, a rocket that was powered either by fusion or fission power, that allow a constant one gee thrust. The Star Frontier universe atomic rockets are akin to the classic science fiction Torch Ship as they are able to maintain a 1 G acceleration for a long period of time.

The performance of real rockets is usually measured in units of ISP which is basically how long a rocket can burn on a unit of fuel. Large ISP generally allow high delta V or changes in velocities.

Another unit of performance is thrust, basically the force the rocket engines apply, and the acceleration rocket undergoes. Unfortunately for most real rocket engines, thrust and ISP are a trade-off. Drives such as the ion drive, have very high ISP but low thrust, meaning they take a very long period for them to reach high velocities, or rockets with high thrust will burn out quickly getting you to their maximum Delta V in a short time period.

This even applies to most nuclear rockets; the few exceptions are the types of nuclear engines that are labeled as nuclear impulse rockets. Instead of heating a

reaction mass like water, or liquid hydrogen, nuclear impulse rockets use a series of either fission or fusion explosions to propel the rocket at fairly high acceleration and in theory can achieve high ISP and delta V's between 2 to 5 percent of the speed of light (PSL), perfect for the Star Frontier universe. The trade-off is the use of thousands of small nuclear bombs to obtain such results.

Another high delta V nuclear rocket would be Fission Fragment Rocket. This rocket actually uses the fragments of split atoms for thrust by directing them through a magnetic field to channel the fragments. This allows not only a way to propel the craft, but also a means to draw power. While the thrust is higher than Ion Drive it still does not give the kind of acceleration of the nuclear Pulse rocket, but it does have ISP of over a million seconds and delta v of between 2 to 5 PSL and uses only a fraction of nuclear fuel of a Nuclear Pulse rocket.

## A BRIEF HISTORY OF ROCKETS

I'm always asked by some flatlander how interstellar travel is even possible; many of them start by quoting how atomic drives violate either the conservation of energy or momentum. That it would take tons of Plutonium to accelerate a rocket up to 1 percent of c. While I am not the smartest of the Shimout clan, Xenon has that honor, I know a thing or two about atomic rockets.

One should not mistakenly associate current atomic drive units with the earlier nuclear thermo rockets that dominated early space travel. Those early atomic rockets were a vast improvement over chemical rockets, but they couldn't provide the sustained thrust or exhaust velocities needed to reach one PSL needed to enter the void.

Mankind used the old thermal nuclear rockets with their ISP of 700 seconds and delta v of 70 km/sec to spread us over the entire home system of Sol. We were luckily that there were thousands of comets and asteroids to provide us pit stops to leap frog from fueling point to fueling point (really filling up the

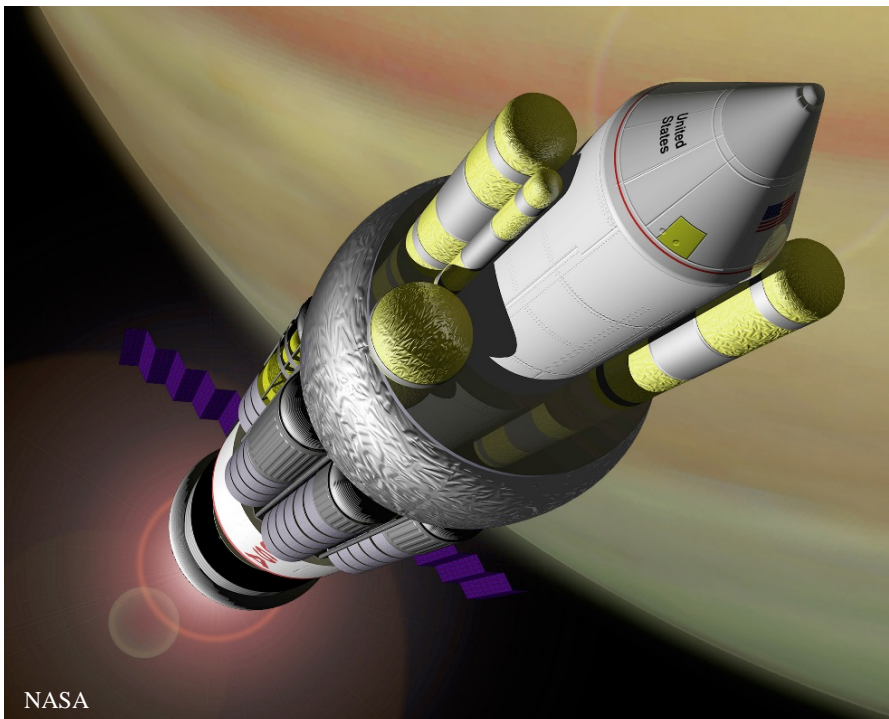

NASA

## Frontier Explorer

reaction mass like water) until we eventually reached the Oort Cloud and Kuiper Belts.

It was on the first of the Oort missions where the predecessor of today fission fragment rocket was used. It was a ten year trip according to the history books, where the *Far Traveler* covered a distant of over 500 AU with only burning 180 KG of Plutonium. *Far Traveler* also had the honor of reaching 0.9 PSL and almost became the first human vessel to reach the speed needed to rotate into the void.

The *Far Traveler's* mission was to set up the first of the gravitational lens point observatories that allowed man to detect the first earth-like worlds orbiting neighboring stars. Detections of these worlds prompted the cries for missions to visit and colonize these worlds and the governments of man began in-depth research into new technologies. The fission fragment engine used by the *Far Traveler* was not up to the task, so an old idea was revived, the nuclear pulse rocket.

Instead of throwing out reaction mass or ions, nuclear pulse rockets ride on the fire ball of nuclear explosives to push the craft. Not only would these rockets achieve delta V of over 2 to 5 PSL, they would allow the transport of massive cargo and the humans of Sol had thousands of unused nuclear weapons from an early warlike age.

The first colony fleet was composed of massive ships, each over eight megatons powered by thousands of one megaton charges and would carry tens of thousands of colonist in cyro sleep with all the equipment needed to start a new civilization. As it turned out, when the Fleet reach one percent the speed of light, the ships rotated into void space and scattered mankind across the Frontier.

It took almost a decade for these stranded colonists to unravel the principles of void travel, but when travel between White Light and Theseus became possible, it was the nuclear pulse rocket that made it so.

While nuclear pulse rockets opened interstellar travel to

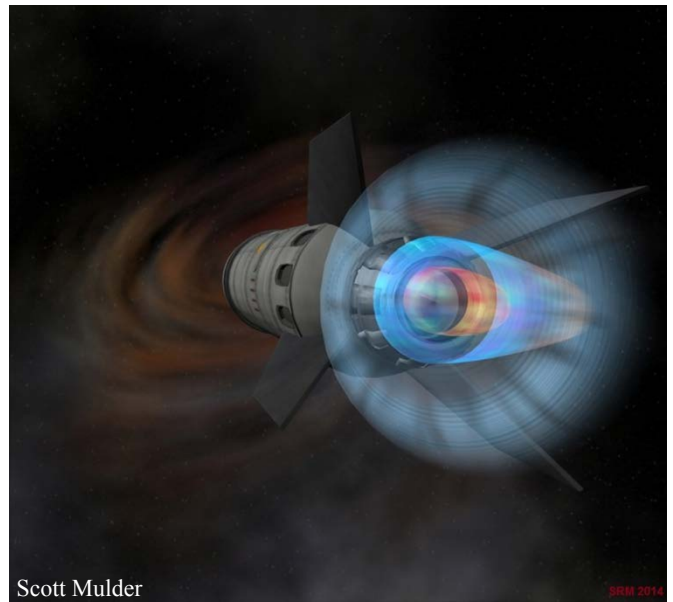

the races of the Frontier, they used massive amounts of fissionable material. The cost of uranium and plutonium rose to a level that limited the access of interstellar travel to mega corporations or governments of home worlds of the Frontier races.

It was dralaslite scientists that came upon the idea of revisiting the use of the fragments of split atoms from the atomic fission as a drive mechanism. These particles were hundreds of times heavier than the hydrogen atoms used in ion drives and were able to propel ships to velocities of five to ten PSL. These fission fragment rockets used kilograms instead of tons of fissionable fuels to obtain a delta-v of one to three PSL.

What made the dralaslite fission rocket different from early human fission rockets was the addition of the Thrust Amplifier which turned the few Newtons of thrust into thousands by the use of the same technology used to create the tachyon radio.

What we call tachyons or faster than light particles are actually a form of neutrino. Normal neutrinos travel a bit slower than the speed of light that have a tendency to change into different types of neutrinos as they travel which also involves changing mass. This changing of mass involves the neutrino actually rotating in and out of the void, gaining and losing energy.

What the dralaslite scientists manage to do was to have this same effect occur with the particle stream that the fission rocket produces, changing the mass of the neutrons and protons by a factor of thousands. These heavy nucleons would change back to normal mass particle but not until after transferring their momentum to the rocket.

With this invention, uranium and plutonium markets on Frontier home worlds crashed, as fission fragment rockets brought the means of interstellar travel within the reach of

small companies and private individuals. The Frontier was now truly open for exploration.

## PRE-FRONTIER NUCLEAR ROCKETS FOR STAR FRONTIERS

### THERMO ROCKET

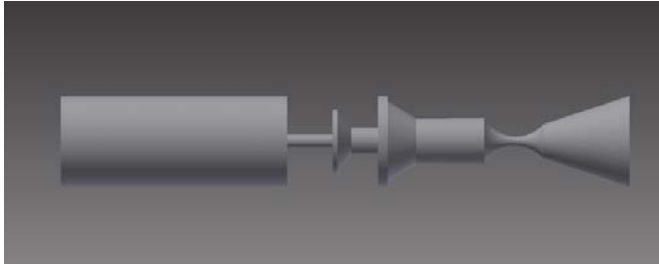

Basically a thermo nuclear rocket uses a small nuclear reactor to heat reaction mass. While the reactor itself only requires refueling once every 5 years, there is a constant need to replace reaction mass.

The class of thermo rockets are similar to modern atomic rockets with multiple engines being required depending on the ship size. You can use the chart from Knight Hawk to see the required number of engines needed per ship size.

A standard class A reactor requires 100 fuel pellets, class B requires 200, and class C requires 400. All three require a lengthy processes similar to atomic engine overhaul after five years.

The Thermal rocket behave very similar to chemical rockets as they expend a load of reaction per trip and are unable to reach the velocity need to enter the Void.

The rocket ADF is bases on the type of reaction mass



Scott Mulder

SRM 2014

used. Standard reaction mass is Liquid Hydrogen, but other elements can be used even water, cutting ADF fuel per load in half. Generally one load of reaction mass provides a max change of ADF of 8.

So a standard trip would require a max change of 4 ADF to accelerate and 4 to de-accelerate (cut all this by 1/2 if Hydrogen is not used)

Cost of reaction mass is equal to 10 cr. x hull size of the ship.

### NUCLEAR PULSE ROCKETS

As with atomic engines there are 3 classes of Charges (A, B, and C). Only a single engine and blast plate is required per ship. The size charge needed is as per the engine size requirements in the Knight Hawks rules. The cost of the blast plate is the same as a single atomic engine of the class appropriate to the size of the ship.

In order to accelerate or de-accelerate a pulse charge will be used. A single charge can deliver an ADF of 4 or less per round. To make a complete trip through the void will require 1000 charges.

#### COST PER CHARGE

A – 100 cr

B – 250 cr

C – 500 cr

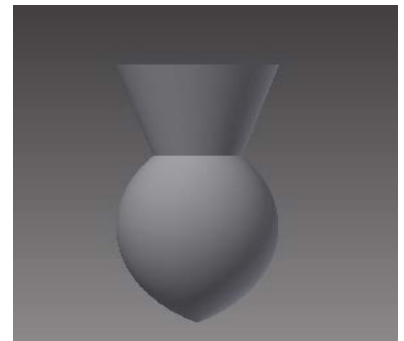

Pulse Charge

The kick or blast plate has the same effect on attacks from direction rear of the ship as a masking screen. A common tactic in pre Frontier days was to rotate the ship toward an attack. This rotation can only happen once per round.

The charge themselves can be fired at any spacecraft at the rear of nuclear pulse rocket and has the same range and damage as an assault rocket.

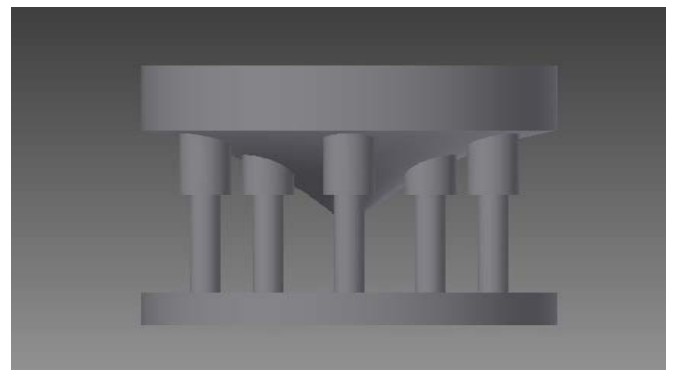

Standard Blast Plate

FE

# THE MINOTAUR SEALION

Eric Winsor

Dwain was pretty down after the skad ate so many of the specimens in his menagerie. But I have never seen Dwain down in the dumps for long. He always finds something that catches his attention and brings him right back up. Dwain popped into my office a few weeks back and dropped some pencil sketches on my desk. “Meet Merek!” he belted. “A full grown Minotaur Sealion! I’m off to the star port customs office to pick him up. I think I’ve found something that can hold its own against the Alzof in the ice habitat.” And he left the room headed for the garage. Tik took one glance at me and we bolted after him.

The Alzof provided Tik with a quite a medical challenge after they tore up Dwain pretty bad in his attempts to domesticate them. Tik published a paper in the Zebulon Journal of Reconstructive Surgery detailing the surgery. Dwain has a fascination with dangerous creatures and neither of us dared to let him work alone with something he thought could, “Hold its own against the Alzof”.

## AN UNEXPECTED CREATURE FROM AN UNEXPECTED WORLD

Minotaur is a very unlikely world that likes to make its presence known. The original explorers did not expect to find a habitable world orbiting the gas giant Ares. They did not expect the world to be divided by blistering heat and deathly cold. And when they began exploring the maze of equatorial canyons they did not expect the life forms there to have competitors in the frozen north or the baked south.

The Minotaur Sealion is the dominant predator along the northern coast of Minotaur. They range from the ice ocean in the north to the maze canyon rivers all along the northern coast. Maze Sea harbors many sealions. They are adept swimmers comfortable in both the ocean waters and fresh waters of Minotaur. They have been observed to dive 300 meters deep and hold their breath for as long



Minotaur Sealion – from [Sealion](#) by [silent-rage](#)



as 50 minutes while stalking prey. They are also perfectly at home on land or ice.

Adult sealions travel in pairs, mated for life. They stand 1.65 meters at the shoulder and 1.8 meters when their mane crest is flashed. The sealion is an unexpected mixture of fish and mammal appropriate to the unexpectedness of Minotaur. They have a strong internal skeleton like many mammal-like creatures in xenobiology. However, they augment this skeletal structure with fish-like spines around their forearms and calves as well as along their mane crests and tail. They have scales that are made up of tiny hairs that they can fluff apart when in the icy air to provide extra insulation. Their flipper paws are webbed and the digits support keratin claws. The mouth of the sealion is equipped with very stout sharp teeth that would make any carnivore proud. They have two sets of eyes, one set adapted to the equatorial day light of Minotaur, the other set adapted to the perpetual twilight on the fringes of Minotaur's icy black night near the north pole.

Mated sealions are very protective of each other. They always guard each other as they move about. When one is sleeping the other will be awake. If one is seen the other will be hidden nearby waiting to pounce. Underwater they always travel within sight of each other. If only one is swimming the other will either be secreted on the bottom or watching from the surface. When the hunter strikes, the mate quickly joins in to bring down the kill. The prey of Sealions range from bite size fish to land and sea beasts twice their size. Large prey will be protected fiercely. If large prey is caught underwater it will be pulled to the surface and dragged ashore if possible.

Sealions attack by grappling with their claws and biting to destroy vital organs. They slash and bite until they can grapple the prey. Often this involves wearing down the creature until most of its strength is spent. A successful grapple results in the sealion sinking its claws deeply into the victim and biting at the throat, head, lungs, etc. Target vital organs for fish are the gills and swim bladders with the goal to stop the prey from fleeing. Surface creatures diving are targeted for their lungs to cause them to drown. Surface creatures caught on land or ice are attacked at the throat, head, and lungs to disable breathing and cause suffocation. Piercing the lungs is common to allow the sealion to bring down the prey and hold it while it dies. Often the sealion will release large prey that are gasping for breath from ruptured lungs and flailing about. They will then follow the prey waiting for it to die. This tactic seems to be driven by self preservation to keep from being hurt by the beast or being trapped under it when it falls.

Sealion pairs will roam from Maze Sea down the rivers of the maze canyons to the northern ocean and out to the ice then return. These trips will be taken repeatedly throughout their lives. Most mating relationships are made along the shores of Maze Sea. The new pairs will

mate and raise a litter of four to eight kitten fish in the shallows of the sea. When the kittens are mature enough to travel on land, the parents will guide their pride out into the maze canyons following the rivers to the northern ocean. They teach their pride how to hunt as they cross the ocean to the ice pack. They will then teach their pride to hunt the creatures of the ice pack as they travel to the deathly cold darkness around the north pole. This frozen destination and the darkness serve as the dispersion place of the pride. The parents will abandon the offspring that have survived the journey in the icy darkness to make the return journey to Maze Sea alone. Young adult sealions that survive the journey back to Maze Sea seek mates and start the journey themselves with their own prides.

## MERЕК ARRIVES

Merek, Dwain's sealion was captured on the ice pack returning from his abandonment in the deathly darkness. Merek has never been mated and has not established the cycle of journeys native to his species. All sealions held in captivity are obtained this way because sealions who have established themselves in the journey always seek to maintain the journey and will do anything to escape from captivity. Sealions in captivity that have been allowed to mate also seek to escape but wander in their journeys if they have never established themselves in the journey. The current theory is that new mated pairs establish their journey path from the dominate mate's memory. The dominate mate can be either the male or the female.

When we reached the starport customs containment area for alien livestock, the staff informed us that they had one of the robotlifts park the sealion cage in an empty dock because no one wanted to go near it. A robot was currently dropping live fish into its cage to feed it. Dwain sat transfixed as the beast smashed each fish flat against the floor of the cage and then lifted it into its mouth stuck to its claws. Dwain would not let us load the sealion until it had finished its meal. We brought the sealion back to the xenological center in the shipping cage because the customs agents would not allow us to do the cage transfer in their facility.

The first night in the preserve Merek tore the insides of his cage apart trying to escape. Dwain then moved him to a habitat next to the ice habitat with the alzo. The habitat has three sections, ice, sea water, and canyon land with a river in the center of it. The water and air temperature are controlled between each section. Merek spent the next few weeks probing the boundaries of his habitat. Then he disappeared. No one could find Merek on the monitors or other sensors. A thorough examination of the habitat did not show any signs of escape. Dwain surmised that Merek was hiding somewhere in the habitat or dead somewhere in the habitat. Dwain announced that he was going into the habitat to find Merek.

## TOY HURTBOT GIVES ALL

Tik and I determined that Dwain needed support in the attempt. Tik had been privately preparing for such a contingency since the alzof incident. The fight with the skad had intensified his efforts. When Dwain appeared at the door to the habitat Tik and I meet him with Toy Hurtbot. Hurtbot is a humanoid robot that appears like a past Jack Hangna Foundation intern. Hurtbot's function is to be the target for all of Dwain's creatures. Hurtbot has a mimic mode where Dwain can act out the events in a holo chamber and Hurtbot will perform them precisely to the eye movements.

Dwain reluctantly relinquished his place searching the habitat to Hurtbot after Tik began reading the introduction to his reconstructive surgery paper. We left Hurtbot at the door and escorted Dwain down to the holo chamber. Dwain entered the chamber and Tik activated the true-vision display. The walls displayed everything that Hurtbot could see. Additional sensors gathered the views from behind Hurtbot's vision so that we could see the entire surroundings as well. Dwain began miming the actions and Hurtbot followed.

Hurtbot palmed the access lock and keyed in the code. It entered the isolation room and the door shut behind him, then the door into the habitat opened. Hurtbot ventured into the maze canyon replica enclosure. The temperature was moderate to warm and the sensors on Hurtbot provided readings that the holo chamber used to adjust the temperature and humidity in the chamber. Dwain lead Hurtbot to examine every corner and crevice of the canyon. He paused at the river and Tik anticipated that Dwain was wondering if Hurtbot was water tolerant. Tik buzzed over the intercom, "Jump in if you wish!" Immediately Hurtbot jumped into the river and began searching the bottom. Nothing came up so Dwain directed Hurtbot down river to the sea section. Hurtbot walked up and down the short beach checking for signs then strode directly into the mechanically induced waves.

Hurtbot does not float so he continued walking all the way down to the bottom of the habitat sea bed. It crisscrossed the sea bed searching the floor for the sealion. Dwain pressed Hurtbot on below the ice pack and Tik activated infrared and suppressed the holo chamber temperature following to be cool only. After searching the entire sea bed there were no signs of Merek so Dwain looked up toward our control booth to talk to us and the infra red caught a faint glow on the edge of the ice. Tik trained one of the habitat cameras on the location and there was Merek under the ice motionless. Only the infrared glow hinted that there might be life left in him.

Dwain turned Hurtbot around quickly and headed back toward the beach. "We've got to get a boat or something in here and get Merek to the infirmary!" declared Dwain. Tik jumped and started babbling and buzzing, gesturing at

a monitor. I went into alert mode and shouted, "Dwain! Behind you!" Dwain turned around causing Hurtbot to turn around just in time to see Merek diving directly into Hutbot. The attack and grapple was swift and violent. Hurtbot fought back and we all cringed. Dwain kept yelling, "Stop! Stop! Stop!" Tik and I feared the worst. Then it hit us both, the yelling was not coming from Hurtbot but Dwain. We had been so fixed to the monitor and Hurtbot's demise that we didn't notice that Dwain was in full frustration flailing about in the holo chamber trying to fight the phantom Merek that Hurtbot was broadcasting into the chamber as it was being dismembered by Merek.

The attack only lasted seconds before Hurtbot was laying in pieces on the habitat sea bed. Dwain stood in the holo chamber staring at the odd angle view as Merek swam back to the surface. Hurtbot's severed head was lying looking up. The displays were beginning to show odd colors as water seeped into Hurtbot's head and shorted circuit after circuit. Dwain, Tik, and I busted up laughing in relief.

Minotaur Sealion	
TYPE:	Carnivore
SIZE:	Medium 1.65m
NUMBER:	1-2, usually 2
MOVE:	Fast (30 - 35m/turn)
IM/RS:	+6/58
STAMINA:	125-175
ATTACK:	80
DAMAGE:	3d10
SPECIAL ATTACK:	None
SPECIAL DEFENSE:	None
NATIVE WORLD:	Minotaur, Theseus (Northern ice pack, coastal oceans, tide waters Maze Sea, and inland rivers)

## GM NOTES

Sealions are ambush hunters. They are very patient and will wait hours or days in a hidden location to ambush prey. They have a natural desire to hunt and will become very moody if they do not get the satisfaction of an ambush attack every week or two.

Beings raised on Minotaur those living in the wild are conditioned to watch for sealion ambushes. Off-worlders and urbanites are often caught off guard by ambushes. Minotaur officials recommend that anyone going into the wild should have a native guide. This is not properly publicized, however. Players with the environmental skill may learn to detect sealion ambushes from a native guide by successfully applying the analyze ecosystems subskill.

Spaceships

# SKYLAB SERIES STATIONS

Jason Combs

The Skylab series of research space stations are cheap, easily deployed and have seen frequent use in the Frontier since before the founding of the UPF. They come in three stages: Type 1, Type 2 and Type 3.

## SKYLAB 1



This model includes:

- 1) Multiple Docking Adapter (with one docking port)
- 2) Airlock Module with EVA hatch
- 3) Main habitable volume.
- 4) Electrical power came from solar arrays
- 5) The rear of the station included a waste tank, propellant tanks for maneuvering jets, and a heat radiator.

**Size:** 20 meters

**Crew:** 1-2

**HS:** 1

**HP:** 5

**ADF/MR:** 0

**Power Source:** 1 solar collector (partitioned)

**Cost:** 75,000 cr.

## SKYLAB 2

This model includes:

- 1) A Telescope Mount, which was a multispectral solar observatory
- 2) Multiple Docking Adapter (with two docking ports)
- 3) Airlock Module with EVA hatches
- 4) Orbital Workshop

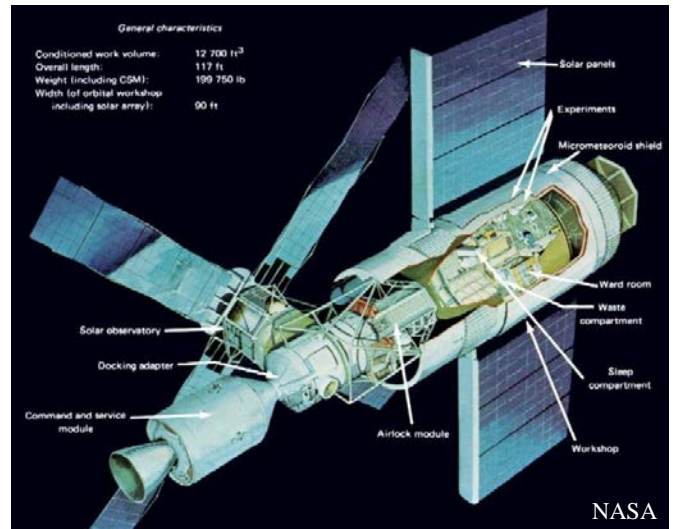

- 5) Main habitable volume.
- 6) Electrical power came from solar arrays, as well as fuel cells in the docked Apollo CSM.
- 7) The rear of the station included a large waste tank, propellant tanks for maneuvering jets, and a heat radiator.

**Size:** 40 meters

**Crew:** 3

**HS:** 2

**HP:** 10

**ADF/MR:** 0

**Power Source:** 3 solar collectors

**Cost:** 235,000 cr.

## SKY LAB; TYPE 3

Skylab 3 includes:

- 1) A Telescope Mount, which was a multi-spectral solar observatory
- 2) Multiple Docking Adapter (with two docking ports)
- 3) Airlock Module with EVA hatches
- 4) Orbital Workshop
- 5) Main habitable volume.
- 6) Electrical power came from solar arrays, as well as fuel cells in the docked Apollo CSM.
- 7) The rear of the station included a large waste tank, propellant tanks for maneuvering jets, and a heat radiator.

## Frontier Explorer



**Size:** 80 meters  
**Crew:** 3-6  
**HS:** 4  
**HP:** 20  
**ADF/MR:** 0  
**Power Source:** 4 solar collectors  
**Cost:** 345,000 cr.

## HISTORY

TriGen launched a SkyLab Type 1 station in the Ora system. It was damaged during launch when the micrometeoroid shield separated from the workshop and tore away, taking one of two main solar panel arrays with it and jamming the other one so that it could not deploy. This deprived Skylab of most of its electrical power, and also removed protection from intense solar heating, threatening to make it unusable. The first crew was able to save it with major repairs, by deploying a replacement heat shade and freeing the jammed solar panels.

Interplanetary Industries maintains a SkyLab Type 2 station orbiting Canberra (Cassadine VI). Numerous scientific experiments were conducted aboard this station. Its crews were able to confirm the existence of

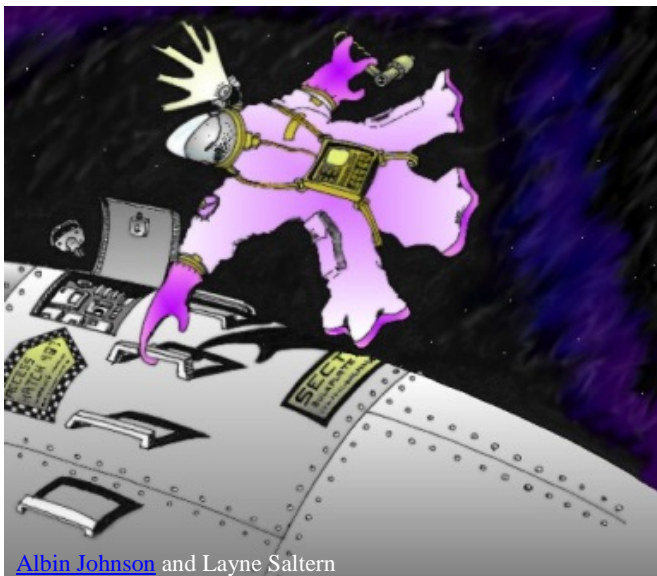

Albin Johnson and Layne Saltern

atmospheric holes similar to coronal holes of a star.

PGC has also used a SkyLab space station. PGC uses the PGCS Opportunity to make observations within the Prenglar system. It is in orbit of Prenglar 1. It was equipped with the Planetary Resources Experiment Package (PREP) that was used to view Prenglar 1 with sensors that recorded data in the visible, infrared, and microwave spectral regions. This information is used to improve their mining operations on that planet.

**FE**

## CALL FOR SUBMISSIONS

Our next issue will be out in October and we're going for a horror/mystery/espionage theme this time around. If you have any material, whether it be stories, rules, art, adventures, or anything else related to those topics, we'd love to have you submit them through the Frontier Explorer website (<http://frontierexplorer.org>) for inclusion in the Fall issue. Just hit the big, gold "Submit New Content" button to send it in.

And if you have material that you'd like to submit that doesn't relate to those themes specifically, that's okay too, you don't have to wait. Submit them now and they may still end up in the next issue or the one after that. We prioritize all user submissions over anything we create so we can get your material published as soon as possible.

And don't worry if you don't think it is good enough yet. We'll work with you to get it ready if you want. And if you need an idea to help get your creative juices flowing, we're considering doing a Yazirian themed issue. So think up anything related to Yazirian creatures, clans, equipment, attitudes, etc and send it in. We can't wait to see what you come up with.

Submissions for the next issue need to be in by September 1<sup>st</sup> at the absolute latest so we have time to review, edit, and work with you to prepare the articles for publication. Submission early is even better as that gives us more time to prepare. So don't be shy, send in your articles and share your work with the community.

## IN THE NEXT ISSUE

We've already got some great material for our up-coming issue. Look for the following articles among others:

### ***THE FRONTIERS OF HORROR***

Tips and tricks for running a horror themed adventure in a science fiction setting.

### ***SHADES OF THE BLADE***

A short story piece about yazirian clan spirits haunting the defilers of a yazirian warrior gravesite.

### ***SHADOW OF THE PRODIGAL SUN***

A mystery/horror adventure set on a Red Thunder class ship. Can the players solve the mystery before it kills them?



# GRYMZ



GUIDE TO INTERGALACTIC CONQUEST

## LESSON #9: ASSUMPTION

EIGHT HOURS LATER...

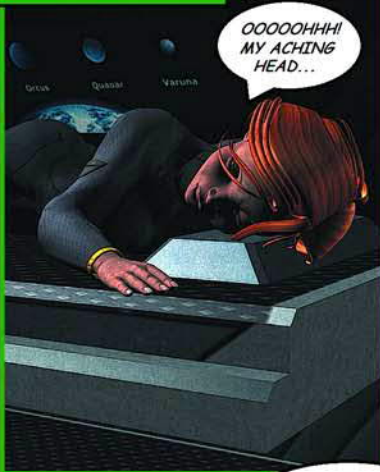

OOOOHHH!  
MY ACHING  
HEAD...

WHAT THE HELL  
HAPPENED...

WHERE IS  
GRYMZ?



MAYBE IT  
WAS ALL JUST  
A BAD CRYO  
DREAM.

OH, HELLO, I  
SEE THAT YOU ARE  
FINALLY AWAKE.

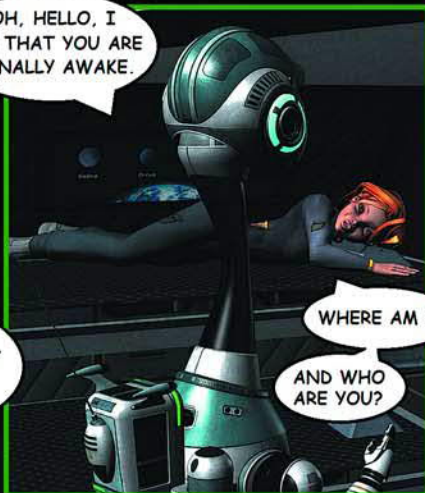

WHERE AM I?  
AND WHO  
ARE YOU?



CADET SAWYER,  
I AM THE SHIP'S  
A.I. ANDROID...

AND YOU ARE  
ON BOARD THE  
TANHAUSER'S  
EXPEDITION  
SCOUT.



CAPTAIN GRYMZ  
HAS ORDERED OUR  
EVACUATION OF THE  
SHIP DUE TO A SEVERE  
DRIVE PLASMA LEAK.



**CAPTAIN  
GRYMZ?!?**

OH GAWD NO!  
LESSON NUMBER  
NINE: NEVER MAKE  
ASSUMPTIONS.

HOLY CRAP!  
NOW HE'S GOT  
ME DOING IT  
TOO!

