

# Frontier Explorer

Issue 5  
Summer 2013



**... From star to star the  
mental optics rove ...**



## FEATURES

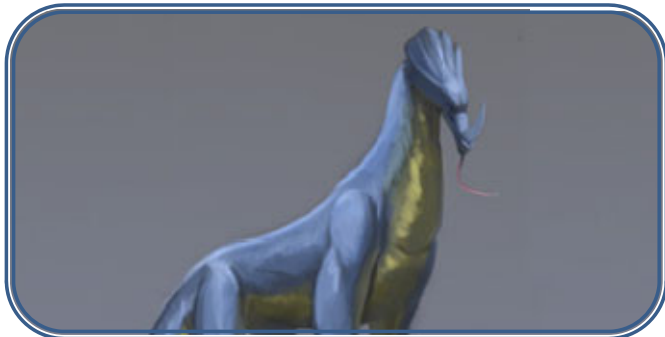

**ICE CAVE WOLVES OF ALCAZZAR**.....4

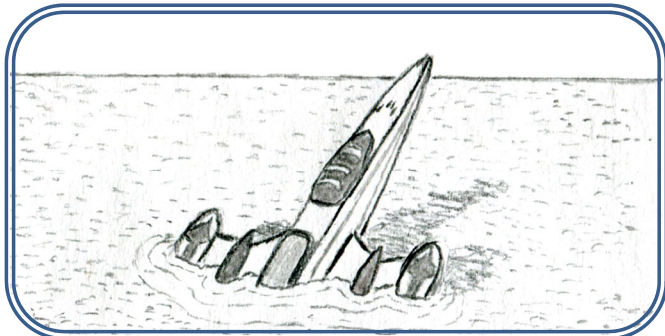

**THE ALBATROSS**.....23

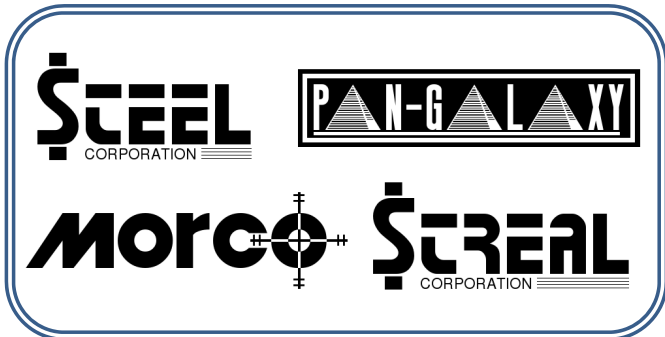

**ONI-SENADA CORPORATION**.....31

## CONTENTS

<b>A Vrusk Life in Song</b> .....	1
<i>A look at one aspect of the Vrusk's love of art and beauty.</i>	
<b>Ice Cave Wolves of Alcazzar</b> .....	4
<i>A replacement for man's best friend? Maybe not.</i>	
<b>Creating Plot Hook Laden Backgrounds</b> .....	7
<i>Ideas to help players flesh out character backgrounds that provide adventure seeds for the referee.</i>	
<b>Backgrounds - Rooting Player Characters in the Setting</b> .....	9
<i>Some optional backgrounds for Star Frontiers characters.</i>	
<b>Crafting Personal RPG Quests</b> .....	12
<i>Make the game more engaging by developing personal quests for each character.</i>	
<b>Financing a Frontier Freighter</b> .....	15
<i>It's all the little expenses that add up to bite you.</i>	
<b>The Yazirian Warrior Bard</b> .....	17
<i>Song and music can be a powerful force</i>	
<b>The Assault Scout</b> .....	20
<i>A look at the iconic Star Frontiers starship with remastered deck plans</i>	
<b>The Albatross</b> .....	23
<i>Play the part of a Star Law Ranger trying to capture a band of pirates in this solo adventure</i>	
<b>Going For the Head</b> .....	29
<i>A big fleet battle Knight Hawks Encounter from the Second Sathar War campaign</i>	
<b>Oni-Senada Corporation</b> .....	31
<i>Is that an authentic WarTech blaster or a cheap Oni-Senada knockoff?</i>	
<b>A Blast From The Past</b> .....	33
<i>Various new (old?) equipment collected from now defunct Star Frontiers websites</i>	
<b>Riddle Me This, Puzzle Me That</b> .....	36
<i>Add puzzles and riddles to your game with these tips on how to craft them</i>	
<b>Dealing with Power Creep</b> .....	39
<i>How do you keep characters from getting too rich and powerful too fast?</i>	
<b>To Live and Die in Starlight</b> .....	41
<i>A battle for freedom from Earth's oppression</i>	
<b>Grymz Guide Comic</b> .....	back cover
<i>Things are sometimes lost in translation</i>	

## FROM THE EDITORS

Welcome back explorers!

Wow! It's been a year since we started this adventure and it is still going strong. I can honestly say I'm pretty amazed at the reception the Frontier Explorer has received. As we hit our one year anniversary, I want to take a moment and look back over the last year.

Issue 5 is coming out just 11 months after the release of issue 1. We compressed our release schedule slightly in the first year to get onto the schedule we wanted, namely an issue every January, April, July, and October. Continue to look for new issues around the middle of those months in the future.

Interest in the magazine seems to be growing. Each issue sees an increase in the number of people downloading the magazine, a strong testament to the growing size of our readership. I just want to say thank you for reading and thank you for spreading the word. We had a big surge on issue 1 due to a shout out from our friends over at the Star Frontiersman Magazine that we haven't quite recreated yet but we are close, and getting closer with each issue. This issue may well be the tipping point.

If I had to guess, looking at the numbers, I'd say we now have about 600 "regular" readers that have downloaded every issue and several hundred more that have downloaded more than one and may come back for more in the future. That may not seem like a lot but I'll be the first to admit that it is many more than I honestly expected to have at this point when we started this project a year ago. The total downloads to date for issue 4 is sitting at about 850 copies as of the end of June. The totals for the earlier issues are even larger (over 2500 for issue 1!) but they've been out longer.

Over the past year we've had great contributions from several of the community members: art, stories, creature write-ups, optional rules, and locations that have helped to expand and fill the pages of the magazine. The submissions we've received have been great and we'd love to see more. These community submissions are truly the core of the magazine. If you've got something you'd like to share, feel free to submit it on the magazine's website and we'll get it published.

This issue is a smorgasbord of random articles we had laying around in the submission queue, including a short fiction piece that is completely outside the Star Frontiers setting. Many of the other articles, which pertain to gaming tips and tricks, are also applicable to any game setting or system you use. This trend away from Star

## PRODUCTION CREDITS

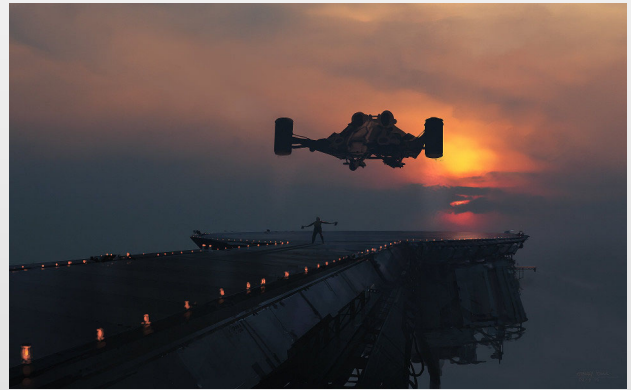

**Cover Art:** [Landing Field](#) by [Sergey Lesiuk](#), a digital artist from Kiev, Ukraine.

**Back cover comic:** AZ\_Gamer

**Banner Logo Image:** NASA

**Editors:** Tom Stephens, Tom Verreault, Eric Winsor

**Layout:** Tom Stephens

**Full Cover Quote:**

*Imagination! who can sing thy force?  
Or who describe the swiftness of thy course?  
Soaring though air to find the bright abode,  
Th'empyrean palace of the thund'ring God,  
We on thy pinions can surpass the wind,  
And leave the rolling universe behind;  
From star to star the mental optics rove,  
Measure the skies, and range the realms above.  
There in one view we grasp the mighty whole,  
Or with new worlds amaze th' unbounded soul.*

- Philis Wheatly, *On Imagination*

Frontiers focused material is something that I hope to see continue as we get more community submissions.

So sit back, get comfortable, and explore another article packed issue. And when you're done, come over to the Frontier Explorer website and tell us what you think in the forums and rate us and write a review on DriveThruRPG. But as always,

Keep exploring!

- Tom Stephens  
Senior Editor

**Legal** – The Frontier Explorer is not affiliated with, endorsed, sponsored, or specifically approved by Wizards of the Coast LLC. The Frontier Explorer may use the trademarks and other intellectual property of Wizards of the Coast LLC, which is permitted under Wizards' Fan Site Policy.

# A VRUSK LIFE IN SONG

Tom Verreault and Bradley McMillian

Back in 2011 I tracked down archived images of a Star Frontiers website that was no longer on the web. Material posted there by Bradley McMillian on vrusk singing was quite good and so I reposted it in the “Core Four” project at the starfrontiers.us site. This in turn led to a series of discussions that produced new ideas about this alien race: flicking emotions with their antennae, group sodality or solidarity songs, vrusk Tai-Chi, and my short fiction “A Vrusk In Two Worlds”. Special thanks is due to the community of fans at starfrontiers.us for input of ideas on the vrusk species and their emotional life.

## FLICKING EMOTIONS

The vrusk antenna is a sensory organ with the ability to both sense vibrations and to smell. It is quite mobile and is used by the vrusk in an analog to what humans do with facial expressions. With the flick of an antenna a vrusk can convey a wealth of emotional feeling. Flicking an emotion begins with the base emotional feeling then tones of modification are added to the antenna flick. These tones of modification can be other emotional states or degrees of strength of the base emotion.

For example, an emotion flick of “mild angry annoyance” begins with the base emotion of annoyance with a hint of anger mixed in and the overall strength of feeling is mild. The combinations are hundreds and only a vrusk can truly read them all. It would take a non-vrusk years of study in vrusk communication to read these emotion flicks in all their nuances and even then they would not be able to reproduce them without a holographic projection of antenna on their head that was tied to a computer based translation program.

## SONG AND DANCE

The mechanics of vrusk singing were described by Bradley McMillian. The ideas that came from that description involved a corporate experience by groups of vrusk performing a sort of line dance with singing. The singing is of musical notes or words. It’s a group practice that is at the heart of vrusk emotional experience and conveys feelings of sodality and solidarity. Most vrusk trade houses have scheduled times for corporate song and dance, but informal groups will also come together to share this experience.

The alliteration, in Pan-Gal, of the vrusk name for the practice is pronounced Ti'Yagong-Tu, which means “group gathering song”. The song called “Chai'Ti”, which

means corporate familial morning song, gave rise to calling these practices “Vrusk Tai-Chi” by humans. Vrusk find this human name for their practice somewhat annoying though most never comment on it.

## SONG OF THE VRUSK: AN ARTIST'S REFLECTIONS

by Bradley McMillian

**Editor's note:** This material was originally published approximately a decade ago on the internet and the site is no longer available. It was located while delving into an internet archive. We're publishing it again because it was the inspiration for the fiction piece “A Vrusk in Two Worlds”

## THE VRUSK RESPIRATORY SYSTEM

The Vrusk respiratory system is an outgrowth of the Vrusk nervous system (both run the length of the 'bug'). The vrusk's spiracles are lengthy, hollow tubes which run from the underbelly up into the vrusk's body to a that



serves as the vrusk's diaphragm. All along these hollow tubes are smaller tubes (capillaries) that carry oxygen to all the other areas of the vrusk's body where oxygen is diffused into the blood stream. The spiracles are capped externally by a flap-like membrane and internally by a piston-like muscle. The piston-like muscles pull air into the lungs and expel carbon dioxide, while the flap-like membranes serve a similar function to the human epiglottis (i.e., it prevents foreign objects from entering the vrusk's lungs and prevents the vrusk from suffocating in dust storms, drowning, etc.).

## VRUSK SONG

Vrusk have control over each individual spiracle in much the same way that humans have control over their breathing if they actively try to do so. This level of control allows the Vrusk to make a variety of whistling noises. These whistling noises in combination with mandible clicks comprise Vrusk speech. Vrusk singing is accomplished by relaxing or tensing the external spiracle membrane and building up levels of pressure by speeding up or slowing down the internal piston-like movements. This level of control takes a great deal of practice (much like human singers have to practice breath control and the like), but essentially makes Vrusk into living instruments

(the noise that is produced sounds similar to the noise one makes when blowing across the top of a bottle). A fair range of tone and pitch can be produced with appropriate practice. In addition, Vrusk musicians occasionally work in mandible sounds for percussive effects.

As the Vrusk became more technologically sophisticated, various harnesses and other devices were constructed to make use of the vrusk's natural talents (e.g., a harness with tubes that cover half of the vrusk's spiracles and acts similar to an accordion with the vrusk's natural breathing process acting as the bladder motion. This harness can also be hooked into a synthesizer, which allows for additional accompaniment and/or alters the vrusk's natural body sounds).

## A VRUSK IN TWO WORLDS

by Tom Verreault

Vi-k'tr flowed through the movements of the Ti'Yagong-Tu, the Group Gathering Song. He felt energized and invigorated to be with other members of his species, the vrusk, doing this quintessentially vrusk activity. To be a vrusk was to participate in a public show of social solidarity through song and dance; beauty in motion and sound.

Humans liked to call this social solidarity gathering *Vrusk Tai Chi*, because the Corporate Familial Morning-Song, as properly pronounce by a vrusk sounded like "Chai'Ti Qind'Yagong. In typically human fashion "Chai'Ti" became "Vrusk Tai Chi." To a certain degree he understood humans better than most and recognized the similarities between Thai Chi and social solidarity songs. They both involved structured graceful movement by groups of beings but the similarities were superficial. For a vrusk a solidarity song was an emotional experience that conferred a feeling of belonging and bonding to his social circle or company. Even as the participants focused on the dance moves and the song notes created by expelling air from their spiracles under their abdomen, there was a wealth of communication going on amongst the participants. This communication was lost on non-vrusk as it was carried by minute flourishes of movement in body or antennae or by the slightest stress of a song note.

Vi-k'tr had not been able to participate in this activity while growing up because he had not been raised by his own kind. Born on a pirate vessel crewed by vrusk he had become a ward of the Crown of Clarion when the Royal Marines had captured the pirate vessel. None of the

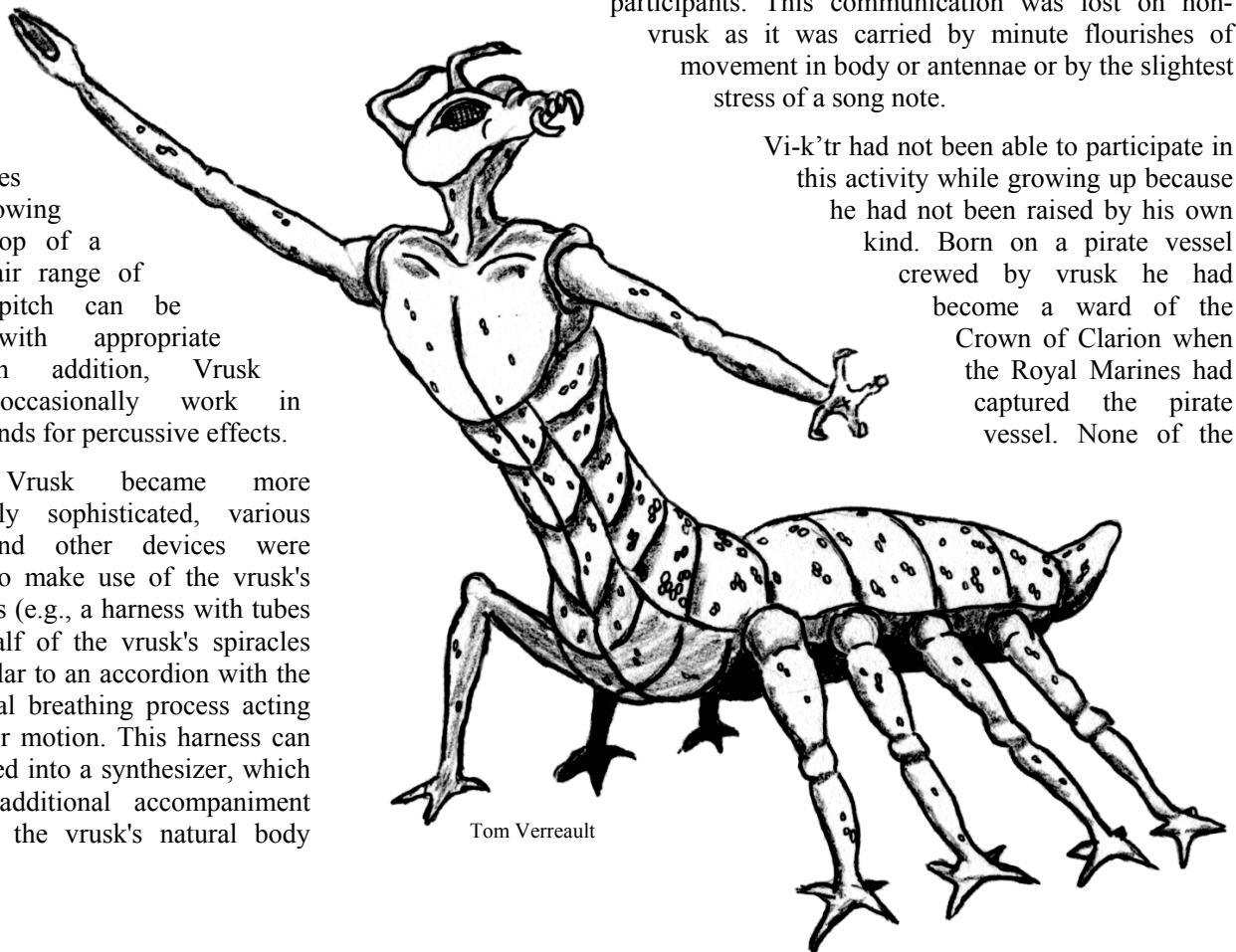

Tom Verreault

vrusk crew had surrendered nor survived. With no living relative to take him in, and no vrusk trade house willing to accept the orphan of criminals into their crèche programs, Vi-k'tr entered the foster care system on Clarion, a human world.

His foster parents had been working class Commoners. His foster father had served with the Royal Guard during the famed Mercy Mission to Madderly's Star when the human colonist of Kdikit had risen in rebellion and evicted the vrusk running that colony. Atrocities had occurred and the Crown of Clarion had sent in troops to stop the killing. It seemed to Vi-k'tr that his father had perhaps taken him in as some form of penance for guilt associated with that long ago police action. He had never been able to discover the truth behind it, and his mother vigorously professed their love for him. She had been prone to doting.

He loved and appreciated his human parents but he had always felt cut off and a misfit in Clarion's human society. After his mother had called him Victor in front of class mates he had garnered the nick name, Victor the Vrusk. There had been bullies too but his natural speed had allowed him to avoid most harassment. It was the sense of not belonging that had led him to attend college on Triad with its evenly mixed human, dralosite and vrusk population. His mother was hurt at his refusal to attend school on Clarion but something drove him to seek out other vrusk.

The first time he had joined a solidarity song as a freshman had been like an epiphany. Many of the other vrusk students had showed amused surprise at his awkwardness, not suspecting it was his first time. The moment had

changed his life. From then on he had become a student of vrusk culture, history, and society. Later that passion matured to focus in depth on the Hive Period of Vrusk History but the passion of his heart was the social solidarity dance.

After graduating, and about the time he had taken the job at the institute, he had made peace with his human culture. He had embraced the name Victor for use with his non-vrusk colleagues and begun to send Christmas presents and birthday cards to his parents every year. He still felt somewhat out of place because his youth had given him a deep insight into humanity and his adulthood was honing his insight into vrusk society. He would probably forever have a bond to both that neither would understand, But, if he was honest with himself, he enjoyed both the solidarity song and decorating the Christmas tree with his foster mother. Perhaps next Christmas he would develop a modified "Vrusk Tai Chi" to share with his human family.

The Group Gathering Song ended and the twenty or so vrusk present began to twitch their antennae in the customary "warm embrace" gesture to one another. Vi-k'tr enjoyed this moment of afterglow most but it was suddenly disturbed by a passing trio of humans.

The group had the appearance of parents bringing their son to attend the institute.

"Look, Honey! They're doing Vrusk Tai Chi," exclaimed the mother a little too loudly.

Some of the vrusk clicked their mandibles in mild angry annoyance while others gestured mild perturbed annoyance with their antennae. Vi-k'tr just flicked his antennae in laughter.

Sharp looks from his fellow vrusk brought forth his first true spoken communication since the song had begun, "Humans, to know them is to love them."

Many of the vrusk flicked "warm love mild annoyance" back at Vi-k'tr.

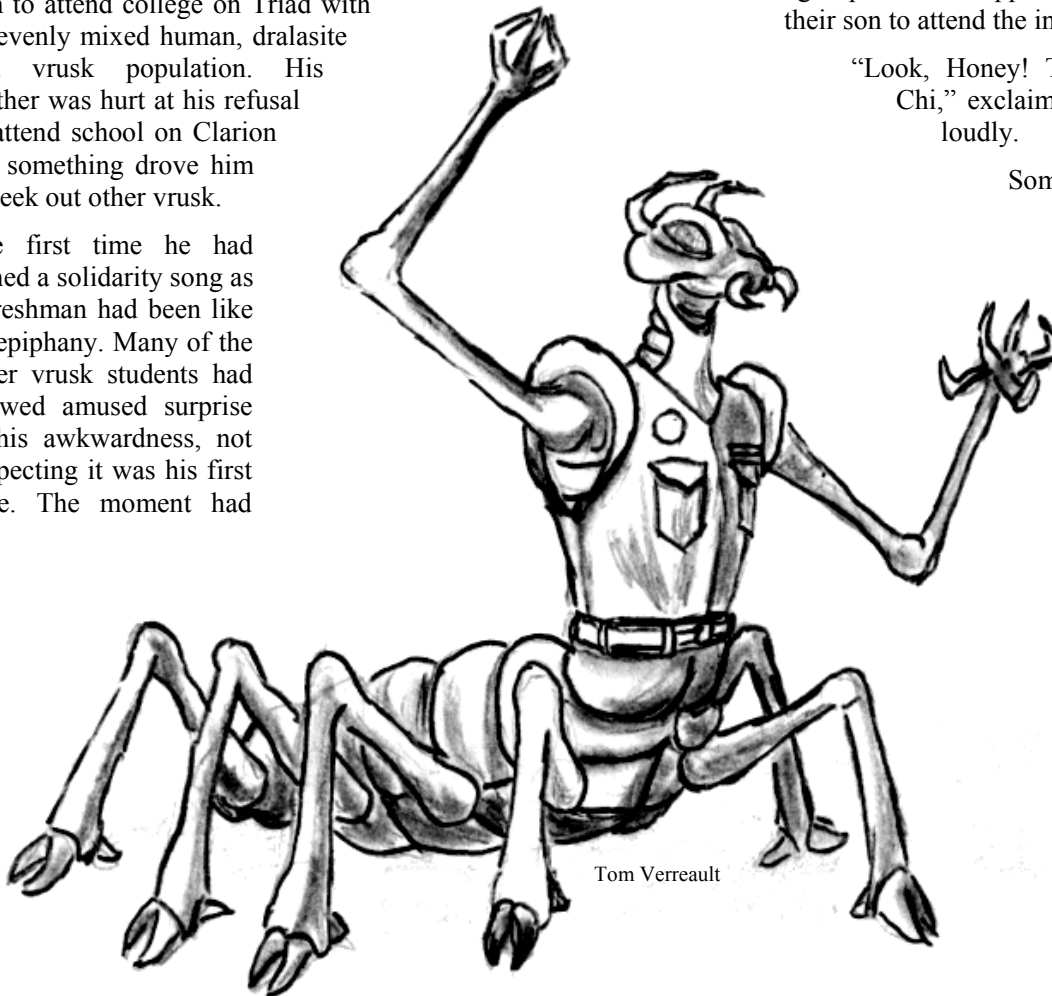

Tom Verreault

Cultural Perspectives

# ICE CAVE WOLVES OF ALCAZZAR

Eric "Iggy" Winsor

Recently the ever faithful guard dog brought to the Frontier by the humans has seen new competition. In this issue Dwain, Tik, and I of the Jurak Hangna Foundation wish to introduce our readers to a creature supplanting the guard dog that we want to caution you about.

Along the arctic coasts of Alcazzar, the climate causes tunnels to form in the melting ice pack as the seasons change. This cycle of change drives an ecosystem which a specialized population of animals thrive upon. The dominate predator in this environment is the Alzof (Alcazzar wolf), a blue skinned canine-like mammal that stands a meter high at the shoulder when full grown.



Ice Cave Wolves – from [Random Creatures](#) by [Tysho](#)

## IN THE WILD

Alzof follow the constantly receding ice of Alcazzar. They shelter in the caves that form as the ice melts. Packs of 4 to 20 Alzof hunt any available animal found among the ice melt. A primary food source is the Albbit (Alcazzar Rabbit) which has the unique ability to survive in all the seasonal habitats of Alcazzar and freezes in the ice during the Alcazzar winter. Alzof search out the frozen Albbit and dig them out of the ice.

The Alzof range from the edge of the solid winter ice sheet to the ice peninsulas that bridge with the re-exposed land. They avoid the ice along the re-opening oceans. They attack prey by ambush, surrounding, and driving the prey into crevasses, cracks, and caves in the ice. They claw their prey down then crush them under their forelegs and upper body weight. A bite is then inflicted to cause severe bleeding and cause the prey to bleed out. This blood is licked up by the pack with their long tongues.

Breeding packs are dominated by one mating male and several females. When the females become pregnant the alpha female will lead the pack to the edge of the solid winter ice sheets to birth the pups where they can get the longest time in their dens while they mature. Litters of pups average six with a nearly even split between males and females.

Females that have not reached breeding age and males that have not dominated a pack of females form packs of four to eight. Typically the stronger males will begin driving off the other males as they approach adulthood so as to form their own breeding packs. Elderly alzof that become ejected from breeding packs will often join these packs of adolescent alzof.

## A CAPTIVE DANGER

Recently, several different corporations have begun selling trained Alzof's across the Frontier. The JHF tracked the source of these animals to Alcazzar through the UPF Alien Creature File. UPF xeno-biologists were taken to Alcazzar shortly after WarTech received their planetary charter. These biologists discovered the Alzof and sent a breeding pair to the Federation Zoo on Gran Quivera. The JHF received a pair of pups a year and a half ago and have been raising them. During this time Dwain has been put in hospital no less than three times with injuries that caused even Tik concern. In the wild, alzof are a dominant predator of the Alcazzar ice. Domesticated alzof retain their predator heritage and must be handled with extreme caution.

## A ROCKY START

When Dwain first received the two alzof pups he took to them instantly. They exhibited all the traits of a creature with the potential to be tamed. Too boot, they are intelligent enough to learn verbal, visual, auditory, olfactory, and sequenced commands. Dwain was soon

able to train the two pups to sit, wait, and eat on command only. He beamed like a father each and every day he demonstrated new abilities to Tik and I. After a few months Dwain had the pair trained to carry out a sequence of commands moving items around the compound. Different commands caused different routes or items to be collected.

One day Dwain was running a routine for Tik and I and changed up the items. The male alzof froze and could not complete the commands. The female turned violent and attacked the male. Dwain grabbed the female to restrain her and the male turned on him and put a clawed paw five centimeters into his abdomen. Tik stayed the lot of them to pull Dwain out. Dwain recovered nicely and, as is his nature, dismissed the incident as youthful actions of pups and forgave the animals. They were three months old. Tik, however, was no longer trusting of the alzof and kept strict tabs of Dwain's activities with them.

In a later drill where Dwain had the two selecting illegal drugs out of cargo containers as a demonstration to the local constabulary only Tik's quick actions prevented what may have been a severe bite. Dwain led the female through the collection of crates and she correctly identified each crate the constables had hidden dream stims in. Dwain rewarded her with a food treat and put her on guard with two of the officers.

The male was then brought in and totally failed the exam, identifying vrusk sugar sticks in three of the containers. Dwain then put the male at guard beside the female without providing a reward treat. The female then began dancing her head about and poking her prehensile tongue at the male. When Dwain instructed the constables to open the crates and remove the dream stims one of the officers began removing the vrusk sugar sticks whereupon the male clawed the female across the face and lunged at the officer. Tik jumped forward and slapped the sugar sticks out of the officers hand just as the male's jaws snapped into the package of sugar stick right where his hand would have been.

Two days later Dwain experimented with the sugar sticks to determine what was the motivating cause of the incident. Dwain had never exposed the two alzof to sugar sticks. The male took to the sugar sticks and enjoyed them. The female took no interest. When put through paces to retrieve hidden sugar sticks the male was very interested and the female began to act agitated by the change from the regular reward treats.

Later that afternoon Dwain was working with the two identifying images on a screen when the male bit Dwain in the buttocks. Somehow, a sugar stick had found its way into Dwain's back pocket and the male had bitten him to get the sugar stick. Tik examined the security holos and discovered that the female had taken one sugar stick from the earlier search exercise and later pushed it into

Dwain's back pocket with her tongue while he was leading them into the image test station. Then she kept calling attention to the sugar stick whenever Dwain's back was turned until the male could no longer resist the allure of the treat.

## FROM BAD TO WORSE

The second incident to put Dwain in the hospital occurred shortly after being bitten in the buttocks. Dwain and Tik began suspecting higher intelligence in the alzof and devised an experiment to test for communication between the two. The experiment was going well until Dwain and Tik reversed the sequence of events with the female and then left her with the male to see if she would communicate the change to him before he was brought in. When Dwain brought the male to the reversed test he started through the tasks in reverse then suddenly tore into Dwain's right leg shredding his calf. Tik stayed the lot of them both again and rushed Dwain to the hospital.

After this, Dwain started wearing skeinsuit coveralls over his regular khaki shorts and bush shirt. Dwain eventually considered the male too unstable to work with after it had shredded two skeinsuits he was wearing and he stopped working with the male. The female seemed to enjoy working without the male and was a star subject for the next few months. Tik even let his guard down and stopped monitoring Dwain's work with the female.

One afternoon Dwain came to the female's cage to take her out for exercise. He was sucking on a sugar stick when he opened the cage and she leaped at him and bit him across the face, knocking him to the ground. Dwain wrestled with her and broke free. As he maneuvered to exit the room she dashed to the door and blocked his exit. Dwain summoned Tik on his chronocom and had to use a tangler on her as she charged him when he entered the hallway to the kennel. Dwain is still in the hospital as I write this for reconstructive surgery.

## A WORD OF WARNING

Tik informs me that they have determined that the alzof are a higher intelligence creature than initially determined by the UPF xeno-biologists. Tik had begun corresponding with the zoologists the Federation Zoo on Gran Quivera about their wild caught alzofs. They share Dwain and Tik's belief that the alzof are more intelligent than initially determined.

However, they are concerned that alzof raised in captivity like ours and those currently being marketed as security animals lack the social and communications skills that they believe are taught in the wild packs. Wild and captive breed alzof have been documented to lack communication ability between the groups. The Federation Zoo's theory is that alzof communication and social norms are taught and learned from generation to generation.



Dwain, Tik, and I at the JHF agree with the assessments and theories of the Federation Zoo and feel that alzo are not currently suitable for use as security animals and replacements for dogs. The Humans have inadvertently brought centuries of domestication with them as they brought dogs to the frontier. The alzo lack this benefit of centuries of breeding and domestication. We feel the corporations are premature in believing they can skip this and domesticate the alzo in a few generations.

Additionally the alzo are of superior intelligence to the dog and other species being domesticated throughout the Frontier. Alzo are intelligent enough to learn and recognize that their behavior is being controlled and react against it. The JHF and the Federation Zoo have both obtained reports from within the companies domesticating and marketing the alzo that similar violent incidents are continuing to occur in successive generations of captive bred alzo. Alzo as a species are independent minded creatures. Domestication attempts are akin to forced servitude for the alzo.

## FEDERATION ZOO ASSESSMENT OF ALZO DOMESTICATION

The Federation Zoo alzo handlers have provided the JHF the following assessment of their domestication attempts.

Alzo raised in captivity are much more erratic in their violent actions than the alzo they have captured in the wild. This is true of all wild alzo captured as adolescents or older. The few pups captured in the wild have each exhibited the erratic violent actions similar to their captive breed alzo.

A telling experiment conducted by the Federation Zoo Alzo Team Lead was to introduce captive breed weaned pups to a small pack of wild captured alzo. Initially the pups were pushy and fought with the other alzo. They did not follow the dominant male in the pack. Then after several conflicts, the dominant alzo and one other adult alzo separated the pups from each other and spent several days with each pup individually. After each pup completed their individual time with the two wild alzo, they each began to measure their actions by the guidance and example of the two wild alzo. The pups then watched for a response from the dominant alzo before taking food, wandering further from the pack, or other actions which had previously been contrary to the actions of the wild pack.

The zoo team then tested the hunting capability of the pups introduced to the wild pack and a captive bread pack. The zoo released alzo into the habitat enclosures and observed the hunting styles. The captive bread alzo exhibit many various hunting methods and seldom worked together beyond two or three alzo. The wild alzo used

hunting patterns observed in packs studied on Alcazzar. They also restrained themselves from killing all of the alzo and the dominant alzo pressed the captive bread pups into partnerships with wild alzo who guided the captive pups until they learned to hunt as the wild alzo.

Clearly the alzo are intelligent beyond the human canine and have a need for social and societal structure. The opinion of the Federation Zoo is that the potential for domestication of Alzo cannot be determined until the social structure of the alzo is understood. All alzo studied by the Federation Zoo who have lacked alzo social training have acted in erratic and anti-social ways with other alzo which they have not been raised with.

## GM NOTES

Wild alzo will always be deferent to the dominant alzo of the pack, this is typically a male. Captive bread alzo will constantly rotate dominance between the alzo in the pack. The desire of each alzo is to take advantage of the others for selfish reasons.

All alzo bred in the wild are instantly able to integrate with each other and communicate through animal touch, smell, and sound. Alzo bred in captivity have trouble communicating with other packs and will fail to integrate if introduced to a pack after adolescence. This is because they have not learned the alzo animal language. Captive bread alzo end up creating their own animal language if not taught by another alzo. This animal language learning happens from birth up through adolescence.

Alzo intelligence is not capable of creating tools but they are capable of understanding and remembering simple tool use similar to human primate species.

**FE**

Alzo (Alcazzar Ice Wolf)	
<b>TYPE:</b>	Carnivore
<b>SIZE:</b>	Medium : 1m
<b>NUMBER:</b>	4 to 20
<b>MOVE:</b>	Medium : 65 m/t
<b>IM/RS:</b>	+6/60
<b>STAMINA:</b>	60-100
<b>ATTACK:</b>	75
<b>DAMAGE:</b>	2d10
<b>SPECIAL ATTACK:</b>	None
<b>SPECIAL DEFENSE:</b>	None
<b>NATIVE WORLD:</b>	Alcazzar, Rhianna

# CREATING PLOT HOOK LADEN BACKGROUNDS

Tom Verreault

Game mastering is like relationships. After you've been through a few you have your, "been there, done that and got the T-shirt to prove it" stories. Relationships that worked out and others that didn't, some that were horrible and others that leave you with a warm fuzzy glow when you ponder them; they come in all shapes and sizes. Campaigns and gaming groups are very much like this: some shined, others died with a whimper, and some just blew the doors off.

I've game mastered table top and online RPGs from a variety of games and rule systems. When I was a teenager I never stopped to consider my GMing technique or why a game was fun, or why a particular adventure was exciting. I suppose it's symptomatic of aging, but I've become introspective. Time is short and demands on it are high, so if a group falls apart or a campaign dries up I want to know why. Consequently, I also quiz myself to understand why something was successful. Ultimately, I hope I can learn from my mistakes and duplicate my successes before I hang up my dice.

I've been pondering some developments in one campaign that stood out over nearly every other campaign I've run. In one online campaign nearly every player had written a character background that had elements that begged me as the GM to use them as plot hooks. At the same time I had a table top game that lacked this depth of character in the character backgrounds and one player played in both games! The comparison and contrast between the two is so sharp that it cannot be by chance. So what happened, or rather what went right in the online game? In analyzing what was done in each campaign I've come up with some strategies that could help a game master encourage his gaming group to write great plot hooks into their character's backgrounds.

## CHARACTER BACKGROUNDS

In the online game I offered 1 experience point each for writing a background, a character description, and coming up with a character portrait. Initially, I thought this exercise made the characters more grounded or more real to the players and to me. It doesn't really hold that offering a carrot to get someone to write a background will guarantee that they will write in plot hooks for the GM. Then I realized that for the online game, I wrote up some setting background documents to familiarize the

players with the setting I was planning to use. It was patently obvious that some of the players had read these and incorporated information from them in their character background.

For the table top game the player characters were rolled up and thrown into the campaign with no background information on the setting. Thus the character backgrounds were general and adequate but they contained no glaring plot hooks. Those players simply never had the opportunity to write a plot hook laden background. They were experienced role players that I've observed using changes in tone, style, vocabulary, and speed of speaking to nail a character during role play. One of them is so good at this that you always know it's his character speaking when he talks to you in character, he never has to tell you he's in character. Would they not have pulled setting details together for their character background if they had had a document titled, "*What the PCs Ought to Know About the Setting*"? I believe so.

I have come to the conclusion that most players want to have a character well-grounded in the setting. If a game master puts in the work of writing a one to two page background on the setting for the players, the effort will pay dividends in the player character backgrounds. It will not only give them a feeling for the tone of the campaign but provide them with meat for their backgrounds. Most players realize that the game master presents the adventure and the setting so they won't try to create the setting details; instead they get to explore the setting through the course of the game.

However, if they have a couple of pages of outline of PC knowledge they will include some of that in the character they develop. The details they include can then be worked into the course of an adventure. For example, a character who worked his uncle's asteroid mining ship before joining the military will always be the go to guy when the military unit deals with miners and prospectors and all things asteroid, all that is required is for the adventure to have asteroids figure largely in it and he's gained story share. Another example would be the player who writes that his character's brother is a member of the terrorist group that is to be a major foil in the setting.

To create a setting background document, don't bog the players down with tons of information. Make it more like a bullet list: about the monarchy, about the Cult of the Red Death, about the last war, and so on. Endless

paragraphs are tough to read so break up the document with short paragraphs and double spacing between them. Include some information on the groups that will be the antagonist in the campaign. Don't tell them everything though. What you don't tell them becomes content for the campaign.

## I'VE GOT A SECRET

The next strategy for encouraging plot hooks in the player character background is to require all players to write a secret about their character that only they and the game master know. This is a new idea that I'm using but not really that new an idea to me. I had previously read a suggestion to give each major non-player character a secret and had been using that with some success. However, a player in the online game suggested a secret about his character during character creation. It's a fabulous plot hook.

I now believe every player character should have a secret. As a game master, you don't have to use these secrets at all but they are there as potential energy, waiting to be used. Naturally, you'll only get to use them once or twice and this is good lest the device becomes stale.

The weaving of a character secret into the adventure can make the campaign more memorable for the player. So what that the PC defeated the pirate fleet through stunning

tactics and iron nerve, he also managed to rescue his brother's remains from the pirate base and return them to their home planet so that his brother's spirit may rest in peace. Which will be of more importance to the player; killing yet another big bad pirate or resolving the mystery of his brother's fate?

## I'VE GOT THIS FRIEND

Finally, the last strategy was discovered by chance as much as the "secret" strategy was. Require each player to write an NPC contact. The NPC contact is just someone they know in the setting that may or may not help them in an adventure with advice, clues or material. The NPC may also function as a plot hook. If, after several campaigns, the PC gets a message from the NPC to meet with him over an urgent matter and they discover his house or office ransacked and the NPC missing, how could the player not desire to help their "friend?"

This has become a favorite strategy of mine after using it in a Voltarnus campaign. I gave each player a little something extra and one of the players got an NPC contact that I wrote. The contact was of another race than the PC but had always been like an uncle to him. The player used the contact to weasel a free gun from him which I allowed. However, the pirates recognized the gun and PC was to learn that it originally belonged to a traitorous member of the pirate band and the leader wanted him found and killed. Is the PC's uncle the traitor or did he obtain the gun another way? Is he in danger? Suddenly this contact has blossomed into all sorts of possibilities and is fodder for plot hooks and twists.

## SUMMARY

In the Alpha Dawn Remastered rules, an optional rule on edges and flaws was included (ADR page 142). I have not used this but I think it would duplicate some of what I proposed above wrapped up in a game mechanic. In particular, the flaws read like plot hooks. This could be another way of encouraging creativity on the part of the players.

To sum up: provide players with a background brief on the setting and or a document on PC baseline knowledge. Require them to create a secret about their character and to write an NPC. Be open to their questions and desires and use them as an opportunity to create depth and plot hooks in your campaign. Then let the fun begin.



Tom Verreault

FE

# BACKGROUNDS - ROOTING PLAYER CHARACTERS IN THE SETTING

Tom Verreault

I developed these backgrounds for an entry level adventure I wrote for the Star Frontiers game. I've always been a fan of the Yazirian Clans article of Star Frontiersman #8, because that article tied a player's character to a specific planet and rooted him to a specific location in the setting. I felt that it would be good to expand this to have backgrounds for all the player character species across the map of the Frontier.

What follows is general player character backgrounds developed for the early portion of the Star Frontiers timeline. Some of the backgrounds are tied to specific historical events like the First Sathar War or the Free World Rebellion. If an adventure is set later in the timeline, these backgrounds may need to be modified. For example if the time frame is post Second Sathar War, the "Legacy of the Sathar War" background will be about that war and not necessarily tied to the planets mentioned.

One of the neat features of the Yazirian Clans article is that it gave a small benefit to the player character and I've incorporated that feature into these backgrounds. A player may use the yazirian backgrounds below and roll on the clan tables of the Yazirian Clans article but he does not gain any material benefit of the clan's article. The purpose for rolling on the clan table is purely for generating a clan name and symbol. At the referee's discretion the benefit from the yazirian clan tables may be allowed.

*Example: Yazirians from the Kuegla clan of Hentz begin play with a musical instrument; this is not a significant item of starting equipment and thus could be allowed. However, yazirians from the Gorlia clan of Hentz gain a bonus to their battle rage and it would not be appropriate to allow this benefit in conjunction with the yazirian background benefits listed below.*

Some backgrounds confer a skill that does not match with any Alpha Dawn skill or PSA. These skills can be advanced by paying two times the skill level desired in experience points and are treated as in PSA. Finally the backgrounds below only reflect the Alpha Dawn Frontier map due to the time frame in history that it was developed for.

## BACKGROUNDS

### MIXED RACE COLONIES

Mixed race colonies (Triad, Outer Reach, Gran Quivera, and Pale) cause exposure to other languages and cultures.

Choose one: (A) character can fluently speak or understand the language of one of the other races or (B) character has a deep understanding of one other race's culture and gains +15% bonus when dealing with that race as well as a +10% bonus to their wage when being hired by that race. *Note: the vrusk vocal apparatus cannot form words in any language but their own and the other races cannot pronounce the vrusk language so if this situation applies the character only gains understanding of the language not the ability to speak it.*

### LEGACY OF THE SATHAR WAR

Due to how the populations of Truane's Star and Dixon's Star suffered from the depredations of the sathar they have an intense hatred for the worms: +5% to melee attacks against the sathar and their creatures.

### YAZIRIAN HERITAGE

A yazirian character may come from a very traditional family and is steeped in his or her heritage. Choose one: (A) a level of skill with the honor weapons (the zamra and the kha'dan), or (B) roll on the Yazirian Clans tables from Star Frontiersman #8. Note any yazirian can roll on the clan tables regardless of the colony they're from and thus may represent a yazirian who has immigrated to another colony.

### RELIGIOUS YAZIRIAN

Yazirian society is dominated by the Family of One religion which is headquartered on Hentz in the Araks system. There is some resentment by yazirians from other colonies over the heavy handedness of this organization. Choose one: (A) two levels of theology and a +10 bonus when dealing with Family of One clergy, or (B) keeps a miniature domesticated wyvole pet (see below) as a statement of defiance against the Family of One.

### CLANLESS/OUTCAST YAZIRIAN

The clanless and outcast exist in yazirian society and occupy the lowest social strata. The yazirian word for outcast is 'gak' and it is also synonymous with feces, as in a piece of feces that one might accidentally step on. There is a pronounced tendency for these yazirians to live in mixed race colonies away from yazirian dominated society. Choose one: (A) -5% reaction from other yazirians but +10% bonus to reactions from the other core four races, (B) -20% from the clan that cast him out and -10% from all other yazirians but begins play with double the starting money. Note: with option B the clan that the character is cast out of must be determined.

**YAZIRIAN ORPHANED AT BIRTH**

Orphaned at birth and raised by another race, this yazirian does not know his clan or heritage and culturally is more like his adoptive parents. This character begins play with a side quest to discover his clan. The referee must determine which clan or create one as well as create opportunities for the character to discover his heritage over the course of play. The player may suggest a starting background benefit for the referee to approve and/or the referee will provide a starting benefit linked to the secrets he's created concerning this character. *Note that this background is possible for other player character races with some adjustments.*

**DRALASITE CULTURE, INNER REACH**

Dralasites from Inner Reach paint their bodies in washable dyes to show their mood for the day. The rival planet in this system is a mecca for pirates and crime. All dralasites from this colony begin with a collection of dyes and a brush or two. Choose one: (A) two levels of artist skill with paints and dyes (may attempt to create works of art for extra money in between adventures as per the rules in the article, "Artisan Skill PSA" in SFman #9), (B) +5% melee bonus when fighting pirates or organized crime figures and -5% to reactions from pirates.

**DRALASITE CULTURE, FROMELTAR SYSTEM**

Fromeltar system is the location of some of the most prestigious dralasite academies. It's also a system they share with the vrusk. Choose one: (A) fluently understand vrusk speech, (B) two levels of philosophy and +10 bonus when dealing with scholars, or (C) a deep understanding of vrusk culture +15% when dealing with vrusk and +10% to wages when being hired by a vrusk.

**LEGACY OF THE FREE WORLD REBELLION**

The Free World Rebellion on Kdi-kit in Madderly's Star involved the human population evicting the vrusk population. Some atrocities occurred. Some vrusk distrust humanity because of this event; they have a -5% penalty to reactions involving humans but gain +15% to comprehension rolls when observing humans. A vrusk with this background is one of the refugees evicted from Madderly's Star and now hails from some other colony.

Humans from this colony are prone to prejudicial attitudes against non-humans. The colony has a strong agricultural economy as well as exporting mercenaries. A human from this system can choose one of the following: (A) two levels of Horticultural, Botanical, or Animal Handling skill (see Frontier Explorer #4), or (B) starts with a free skein suit from previous paramilitary training but must have at least 1 military skill (no restrictions on PSA).

**VRUSK BUSINESS EXPERIENCE; RESOURCE DEVELOPMENT**

Vrusk from planets that have a resource development economy like Zik-Kit have an intimate understanding of the mining and the resource exploitation business. Choose

one: (A) a level of geology skill, or (B) able to operate mining equipment and machinery as a level 1 technician would. In addition to the prior they also have the ability to make a LOG check while reviewing mining business records and spot problems or inconsistencies.

**VRUSK BUSINESS EXPERIENCE; AGRICULTURE**

Vrusk from planets that have an agriculture based economy like Ken'Zah-Kit have an intimate understanding of the agriculture business. Choose one: (A) 2 levels of Horticulture, Botanical, or Animal Handling skill or (B) able to operate farming equipment and machinery as a level 1 technician would. In addition to the prior they also have the ability to make a LOG check while reviewing farming business records and spot problems or inconsistencies.

**VRUSK BUSINESS EXPERIENCE; INDUSTRY**

Vrusk from planets that have an industrial based economy like Terledrom or Zik-Kit have an intimate understanding of industry. Choose one: (A) 2 levels of engineering (usually industrial but not starship engineering) or (B) able to operate factory equipment and machinery as a level 1 technician would. In addition to the prior they also have the ability to make a LOG check while reviewing industry records and spot problems or inconsistencies.

**VRUSK BUSINESS EXPERIENCE; R&D**

Vrusk from planets with major R&D centers like Kwadl-Kit have an intimate understanding of the research and development business. Choose one: (A) 1 level of a scientific skill (physics, chemistry, etc), or (B) owns a referee approved prototype piece of equipment with a small bonus over standard equipment (has degree of miniaturization that either reduces weight, or increases range, or reduces energy consumption). In addition to the prior they also have the ability to make a LOG check while reviewing R&D business records and spot problems or inconsistencies.

**VRUSK CRIMINAL EXPERIENCE; Z'NK**

The vrusk word translated mafia is z'nk and it was famously (or infamously) used as the basis for the name for the most famous vrusk criminal organization; the Zenk (see Dragon magazine #109). Vrusk criminal trade houses spring up from time to time. They don't see themselves as criminal just businesses with a more ruthless set of practices. They raise their own young "in house". When law enforcement dismantles the criminal organization the young are not prosecuted. Their fate is uncertain and some fall through the cracks in society while others end up wards of the state. These experiences can provide an edge for such a vrusk. Choose one: (A) +5% bonus to comprehension ability, (B) 2 levels of knowledge skill tied to the vrusk criminal underground, (C) +5% to PER checks when dealing with bureaucrats and government "systems".

## Frontier Explorer

*Note: defecting from a still functioning z'nk organization is very difficult as the organization is likely to eliminate defecting vrusk as a security risk. Its more usual that vrusk with this background were young vrusk at the time of the dismantling of the trade house by law enforcement.*

### **HUMAN AG COLONY BACKGROUND**

Ag colonies like Rupert's Hole, Kdi-Kit, Lossend and New Pale have a tradition of hard work. Any human character from these colonies gains either +5% to STR or STA.

### **MILITARY BOARDING SCHOOL**

This background is usually for a human but could apply to other races. Some families send their young children away to boarding school (not college). Character gains +5 to LDR score.

### **GYMNASTIC OR DANCE BACKGROUND**

This background is typically for humans but could apply to the other races. Parents enrolled the character in dance school or they took dance or gymnastics as an extracurricular activity while growing up and may have performed in major entertainment venues. Choose one: (A) 2 levels of dance skill, or (B) +5% to DEX.

### **SPORTS BACKGROUND**

This background is typically for humans but could apply to the other races. Character has spent his life participating in sports and may have played semi pro or possibly even professionally. Choose one: (A) Double starting money, or (B) +5% to RS.

### **SPACER BACKGROUND**

Some characters spent their lives on ships and stations. Choose one: (A) able to operate small craft like launches and work pods without the requisite skill as a 0 level pilot and gain +10% bonus when they acquire the skill, (B) gains one level of astronomy (not astrogation), or (C) +10% to RS checks in 0g combat to retain control.

### **STREETWISE BACKGROUND**

For human characters in particular, a person that has grown up on the rough side of town in a major city like Port Loren, Prenglar or Port Royal, Clarion has an edge from these experiences. Choose one: (A) +5% to INT or (B) +5% to RS or (C) 2 levels of knowledge skill tied to the criminal underground of a specific planet.

### **COMPUTER GEEK BACKGROUND**

For human characters in particular, when a person grows up plugged into computers or robots they have an edge from those experiences. Choose one: (A) able to perform one sub-skill from the Computers or Robotics skills at one level higher than actual level (must have either Computer or Robotics skills), (B) gain the ability to write an extra computer program (example: can write 2 programs at level 1), or (C) +5% LOG. This background does not make much sense if the character has no technical skills or interest in learning computers or robotics skills. **FE**

## WYVOLES

### **WYVOLES**

**Type:** Small Arboreal Carnivore

**Number:** 2-20

**Move:** Walking-Slow 20m/turn; Climbing- Slow 30m/turn; Gliding- Medium 50m/turn

**IM/RS:** 6/60

**Stamina:** 20

**Attack:** 45% (Bite)

**Damage:** 1d10

**Special Attack:** Flying Grapple 60% for 2d10 & grapple & knocked prone, RS check for half damage, no grapple and not prone; grappled prey must make a STR check against a STR 35 to break free; every turn grappled the prey is automatically bit for 1d10 but gets a RS check for half damage.



The wyvole was a native of the lost yazirian home world and were brought to the Frontier during the Yazirian Star Exodus. It has short powerful legs with a patagium (skin flap for flying) stretched between the fore and hind legs. The body is longish for the legs and the head is wolfish in shape with a mouth full of sharp teeth. Its ears are large and mobile giving it extremely good hearing.

A tree dwelling pack animal, it specializes in attacking from the air. Grounded wyvoles will circle their prey and wait for a pack member to perform the flying grapple before dashing in to overwhelm the prey. A successful flying grapple will slam the target to the ground while the wyvole wraps its limbs around the victim and bites. Other wyvoles will rush in and quickly overwhelm the prey.

Wyvoles are considered vicious, cunning and extremely dangerous.

### **DOMESTICATED MINIATURE WYVOLES**

**Type:** Tiny Carnivore

**Number:** 1-2

**Move:** Walking-Slow 20m/turn; Climbing- Slow 30m/turn; Gliding- Medium 50m/turn

**IM/RS:** 5/50

**Stamina:** 10

**Attack:** 45% (Bite)

**Damage:** 1d10

Only yazirians consider this animal a suitable pet. They are a miniaturized version of the wild animal but lack the special attack ability. They maintain their pack mentality but it is ascribed to their owners and they are usually vicious towards outsiders.

# CRAFTING PERSONAL RPG QUESTS

Tom Verreault

The quest is not only a staple of role playing games but also of fantasy literature, folk and fairy tales as well other forms of story-telling like television and movies. Modern storytelling has morphed the quest to suit its needs. Traditionally, the quest has been a hero's journey that is only accomplished after great difficulty and exertion but in some online role playing games a quest is little more than killing 10 rats and returning for a paltry reward.

In one sense a RPG campaign or a module adventure can be viewed as a quest. It is a hero's journey that takes time, exertion and may involve travel. It is, however, shared by the group and it is not the individual hero's journey. There exist multitudes of advice and guides on writing adventures, modules, and campaigns so this article will focus on the individual quest for RPG characters. In particular for science fiction RPG characters but the principles here are valid for fantasy and other genres as well.

The elements of a quest are the hero, his desire/goal, the journey, and the reward. The hero is crafted by the player and is the player character. I suppose that a non-player character companion of the player characters could have an individual quest but it would be largely for plot hooks as the focus of the game is the player characters.

## THE HERO AND HIS DESIRE

Since these characters are the creation of the players, a good referee will ask the players at the time of PC creation what their goals and desires are for their characters. For the quest to be more than a simple business contract of do X and get paid Y, the player has to want or desire the quest for his character. Player input is crucial to this.

For example a player in a table top Star Frontiers game I ran expressed a desire for his character to have mentalism powers (psionics) at character creation. I took note and made provision for that in the first adventure and explained that it would happen in the course of the adventure. The character encountered telepathic land octopi that invited him to participate in a mystical ceremony. This was the catalyst for emergent mentalism powers but the quest would be the full player control of these powers as they were to be emerging during the course of the campaign. I knew the player would enjoy pursuing this quest simply because I had asked.

The best time to find out what a player's desires are for his character is during character creation but the question can be posed at any time. To preserve an element of mystery I would recommend presenting players with a brief questionnaire at character creation:

1. Write a secret about your character that no one else knows.
2. Name an NPC from the characters past and write a paragraph about his or her relationship to your character.
3. Name your character's biggest fear, if any.
4. Write 2-3 earnest desires of you character for his life.

The above questions are great material for a referee to guide the direction of a campaign but also provide a basis for crafting a quest. The NPC can be used at some point to provide a clue. The PC's fear or secret can be worked into part of the challenge to resolve the quest – forcing the PC into a situation where he must face his fear or own his secret. Remember, nothing will work so well for a quest than the one the player tells you he wants.

Finally, if you're stumped by the answers from your players, you can suggest some personal quests: restoring the honor of one's clan, discovering the real identity of one's mother, becoming an ace fighter pilot, and etc. If a game is established, a quest can be introduced through role play between an NPC and a PC. If the NPC is asking for help, it's up to the player to say yes or no. In this case the player is given a choice to accept the quest. If a group is into role play the referee can role play with the player at character creation playing the above player created NPC and talking to the character about their desires. Take careful notes of the conversation.

The goal of the quest can be anything. Common goals in RPG quests are money, power, a title, an item, rescuing a person, and sometimes personal fulfillment. The motivation should be personal to the character involved. Lots of people desire money but why does this character desire money? Lots of people desire to own their own space ship (or some other McGuffin) but why does this character have that desire or is it a desire for a specific ship? These are questions the player must give input on but the referee will be plotting the journey the PC will travel to fulfill their quest. The personal fulfillment goal

## Frontier Explorer

has the greatest scope for story telling but is probably under used.

*Example: A PC's brother who disappeared and was branded a criminal by the government. The PC desires to clear his brother's name and find him. After many adventures he pieces together the clues that his brother had joined a pirate band to rescue the love of his life. When the PC storms the pirate stronghold he discovers the grave of his brother. It is bittersweet, he's learned the truth, brought his brother's body home, but has failed to prove his innocence. He's left like a tragic Sir Lancelot who failed in his quest. Yet after the funeral service the undertaker or coroner gives the PC the personal effects taken from the body and among them is a picture of a woman with a child that looks exactly like his brother. The PC has just learned that he is an uncle and the quest is on again.*

There is so much storytelling potential there and the quest leads to actual adventure sessions to handle storming the pirate strong hold.

Television series now use the personal quest in their storytelling. Each week there is a primary story that unfolds but somewhere toward the end of the episode a little detail about a main character's personal quest is revealed. Sometimes you are more interested in what is going to be revealed about the main character or their personal quest than the challenge of the week that they are resolving. It's not uncommon for the personal quest to become the problem of the week particularly for the season closer or opener.

It's actually possible for multiple characters to have the same goal with individually different motivations. In *The Wizard of Oz*, Dorothy adds party members to her quest by suggesting that the wizard that she is questing for may be able to help them with their individual goals. I like to refer to that as the Oz quest. It might be very satisfying to allow for multiple quests by the player characters and as things reach a culmination only then do the players realize that their individual quests are intertwined. Such a quest should end with a big satisfying bang and not the "ignore that man behind the curtain" ending of *The Wizard of Oz*. An Oz quest will be a lot of work but, done right, it will end a campaign or series of campaigns in a very memorable way.

The Romanticism of the Middle Ages focused on the travel aspect in a quest because the purpose of the storyteller was to showcase exotic locales. This plays well with a star hopping RPG like *Star Frontiers* where the scope of the game is often to visit many planets in a sector of space. This type of individual quest is also not just a journey in space, but in time as it is primarily intended to be a backdrop over the course of one or more campaigns. It is, of course, possible for the journey to take place all in one city or location if the goal of the quest so dictates.

More importantly it can also be a chance for the referee to paint with a broad brush and introduce exotic locales in his game.

## THE MCGUFFIN

The McGuffin is a word coined by film makers about the object of a hero's quest. In the King Arthur legends it's the Holy Grail. Alfred Hitchcock said in a crime story it's the necklace and in a spy story it's the papers but that the audience didn't really care what it was exactly. George Lucas turned that on its head making the audience care about the McGuffin in *Star Wars* because it was R2D2 that had the Death Star plans locked away inside.

In an RPG quest there will be objects that are the focus of the quest. To a certain extent it doesn't matter what they are but they need to matter to the characters in the story. This is another reason that you might give the player the questionnaire described above; the NPC they created can always become a McGuffin. It can be property or something intangible like honor. If the player created it they may have an emotional investment in it and thus it makes the quest more memorable to them.

## THE JOURNEY

The journey is the challenges the hero or PC faces before the resolution of the quest. MMORPGs (massively multiplayer on-line role playing games) have introduced simple kill lists to the hero's journey: kill 10 rats and 5 snakes. These are almost too simple for a table top, a play by post, or play by email RPG. However, the PC in the above example may decide that killing or bringing to justice the leaders of the pirate band that killed his brother is something he needs to do. At this point the PC's journey becomes a kill list. As a side note, the MMORPG convention of a kill list quest could be suitable material for an adventure hook: a new zoo is being set up and it's paying good money for live specimens or a Capellan Free Merchant was just at a planet where the latest fad is krik hide holsters for your laser gun so he's offering money for fresh hides.

Other lists are to-do lists, visit locations lists, deliver lists, and collect lists. They are all simply variations on the theme. Each thing must be accomplished to advance the story one more step. Eventually the quest will necessitate becoming the focus of the game session. Especially if a quest is moving toward a resolution or even a mini resolution like the hero in our above example who recovers his brother's remains and has a resolution only to discover that he has a nephew out there somewhere. The pirate stronghold may have taken 2-3 game sessions to resolve but now the PC has a new mystery to unravel and not much for clues. A puzzle of some sort may also be ideal for the hero's journey. It could be as simple as map torn in pieces or something more elaborate.



The essential thing is that a personal quest should only be accomplished after much exertion and this is best simulated by allowing for small pieces or clues to the resolution of the quest to be discovered a little at a time each adventure. The best mechanic I would suggest is to allow for a few minutes time at the end of a game session for the clue discovery. If the clue discovery was at the beginning of a game session it would distract from the adventure at hand and perhaps confuse the players. Relegating quest clues to the final minutes of a game session gives a player something to think about after the game and perhaps makes them anticipate the next game session more.

## STRUCTURING THE JOURNEY

There are two basic structures: the laundry list and the linear flowchart. A laundry list is simply a list of things and can be done or collected in any order that once the whole list is complete the hero enters the Emerald City. The linear flowchart is a list of challenges or clues and each must be tackled in order before the hero moves on. Often the whole linear flowchart is only known to the referee and the PC is only aware of the challenge in front of him or perhaps only the next few challenges.

The laundry list structure is most suitable to kill list, collection list, or to-do and delivery list challenges. The linear flowchart is most suitable for self-realization and mystery type quests.

## THE DARK LORD

A dark lord or nemesis is a common troupe in quests. Sauron in *Lord of the Rings* is famous in the annals of fantasy literature but Darth Vader and Emperor Palpatine from the *Star Wars* franchise are equally famous dark lords in the science fiction genre. In the *Firefly/Serenity* stories it's the Blue Sun Corporation.

A dark lord provides a nemesis for the hero to oppose and defeat. He or she should be powerful and not easily defeated. A dark lord may remain secret for most of the quest yet he provides some form and structure to the challenges facing the hero.

In the Star Frontiers setting there are already a few dark lords suggested in the setting material: the "Jabba the Hut" like Malthar and his criminal organization, CEO's of misbehaving mega-corps, the Star Devil pirate leader, the leadership of the Family of One church and the ever inscrutable sathar or their agents. Other dark lords are implied with the cults and cadres material in the Zebulon's Guide rules. A sathar dark lord will of necessity remain hidden and inscrutable to the PC but the referee should write up motivations and personality for him.

A dark lord is not absolutely necessary but since it is a frequent troupe in quest stories it is a tool that the referee should consider using.

## REACHING THE EMERALD CITY

At some point the quest may conclude. As a resolution comes to a head, the referee will need to transition the game session from just another mission to a game session focused on the quest of one or more of the player characters. This should happen fairly naturally as the player will have solved a major clue and be chomping at the bit to finish the quest. In the case of an Oz quest where all the PCs have separate motivations that become entwined in the same resolution, it may be that this will be the climax of the campaign(s).

Not all quest end successfully. Some heroes fail like Lancelot. Some heroes succeed but die like Beowulf. Some heroes fail at the quest they desired but find some deeper personal understanding like Gilgamesh. Some heroes are on an endless quest like Bruce Banner (the Hulk) and never find a resolution. Be prepared for the player characters to not attain the golden success in their quests. We are talking about a role playing game with dice where many results can happen and often as not it is the unexpected result that occurs. Think about possible resolutions to a quest and prepare for them. In my running example, the player never did find his brother alive which was certainly a possible expectation but the mini resolution of recovering the body led to an unexpected quest of finding the nephew. The character has gone from a somber moment of burying his brother to discovering he has family.

Don't be afraid to throw twists at the players. There is a deep truth to the famous Grecian urn that depicts a youth in pursuit of a maiden. For millennia she has remained just a little out of reach and he has remained just short of grasping the object of his desire. To me this urn epitomizes desire and knowing that the young man will never get the girl leaves me feeling bittersweet about it every time I see a picture of that artifact. A TV/Hollywood ending is fine, but crafting a bittersweet ending might have more impact for the players.

One word of caution though: if you have crafted a big ending for the quest and the dice and game mechanics show a mind to kill the character then don't allow for the quest to fail. A tragic hero is powerful; let the player character go out with a bang and the quest fulfilled.

**FE**

Optional Rules

# FINANCING A FRONTIER FREIGHTER

Albin Johnson

**Editor's note:** The following material comes from a PBEM game run by Albin Johnson circa 2001-2002. *Life in the Space Lanes* was an adventure involving the crew of a freighter travelling the Frontier. Albin created some great background material for that game and in particular this material on the expenses involved in running a freighter. The Knight Hawks rules covered financing a ship but overlooked a lot. In light of the recent serial adventure, "Mooks Without Number", we thought this material would be handy for anyone running a freight hauler campaign or continuing where "Mooks" left off.

You've managed to get your hands on a shiny, new (or maybe not so shiny and not so new) freighter and have dreams of plying the space lanes and gathering untold wealth as an independent merchant. That's all well and good, but have you considered all the expenses involved. Here are just a few that you will have to deal with.

## STARSHIP REGISTRATION (REQUIRED ANNUALLY)

This document registers the starship as a space-worthy vessel that can travel the space lanes safely. It also labels the ship with a public name, number, and transponder signature that can be identified by any starship, space station, or space port in the Frontier. The name and number are stenciled onto the side of the ship. The transponder is programmed by station or port personnel. It is illegal to tamper with a transponder or change its signature, but this is a common ploy of pirates and smugglers. Some illegal ships run with more than one transponder, switching out the signals as necessary.

Registration must be done for a specific planet in the Frontier. From that point on, the ship is registered under that planet's authority and is recognized as representing that planet and star system. Registration can be changed as often as is preferred, but the fee is the same and must be paid each time. Registration can be done at any space station or space port at the planet's Commerce Department Office and requires an inspection by the station or port's head starship engineer. The entire process takes 1d5 days. Criteria for passing inspection will be an operational engine, life support system, and bridge controls. Serious defects or damaged systems will be called into question and will require repair before being passed. This is at the GM's discretion.

Before registering one's ship at a specific planet, consider the government's tax laws, import-export laws, the state of their economy, and whether or not they are at war.

**Cost:** Hull Size of ship x 1000 credits

## INSURANCE (REQUIRED ANNUALLY)

Insurance covers the value of cargo as assessed from the source, not the destination. This is because of the highly speculative nature of selling goods at their destination - there is no guarantee the haulers will actually realize selling value if the cargo is lost before it reaches its destination. For this reason, many suppliers will ask to see proof and extent of insurance before letting freight be loaded onto a ship. This is to ensure that the freighter will have the money to cover losses if any occur (like under-insured insurance in an automotive policy). Claims filed for losses will be investigated by a representative of the insurance company, to verify the validity of the claim.

**Cost:** *Annual Premium:* 5% of maximum freight value covered if paid in a single lump sum. Or it can be paid in 10 monthly installments at 6%/10 cr per month.

## FREIGHTER LICENSE (REQUIRED ANNUALLY)

This license entitles a starship to carry freight from one star system to another. This license is issued by the UPF, not a single planet or system, so is therefore unbound by any single planetary government. Licensure is for any cargo listed on the Knight Hawks cargo tables, but

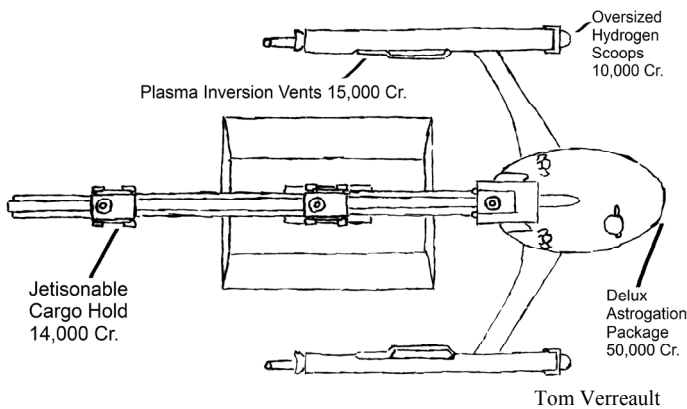

assumes proper facilities and preparation for risky cargo such as radioactive or flammable products.

**Cost:** Hull Size of ship x 1000 credits

## GUILD MEMBERSHIP (FREIGHTER'S GUILD)

The Freighter's Guild is a registered union representing all independent interstellar freight-haulers operating in the Frontier. It lobbies for the rights of freighters by appealing to the UPF and local planetary governments. Its sole mission is to preserve a competitive market in the Frontier economy that will allow independent haulers to operate in spite of heavy pressure from megacorporations to consolidate and monopolize shipping. It is also constantly pressuring the UPF to lower tariffs and soften transport inspections to make shipping easier and more profitable. The Guild often finds itself at odds with Star Law, which opposes relaxing the security of the Frontier in any way. Sometimes the work of the Guild lies outside of the law, using funds to buy special consideration from port authorities, establishing connections with the underworld for exclusive shipping rights, and occasionally offering muscle when members need protection from the megacorps.

The Guild has offices on every commercial space station and at every civilian starport throughout the Frontier. Limited lodging is available near these offices at a reduced rate for Guild members. The Guild also provides special rates for leasing or buying weapons and equipment and for loans. Items can be leased at a cost of 10% of the item value compounded every 40 days. Items can be purchased at a 10% discount. Loans are made at 3% monthly interest rate instead of the 4% listed in the Knight Hawks rules. Collateral must still be provided or a tracer implant will be required. On the other hand, it is not uncommon for the Guild to ask its members to perform duties for the Guild that may skirt the law to varying degrees. This is another price for Guild membership, but it normally works to help the cause of the Guild and its members.

The Guild is divided into factions. These factions came from various shipping markets that already existed in the Frontier, such as major Vrusk trade houses and even the smuggling network around Dramune. They banded together to reinforce their strength in the Frontier economy, but they tend to have drastically different opinions about how the Guild should operate. Characters joining the Guild will be strongly influenced to join a faction. The GM can decide later how faction loyalty will play into the gaming campaigns, including positive reactions from fellow faction members and even violent reactions from rival factions.

**Membership Cost:** 100 credits annually per member

## ADVERTISING

Advertising goods and services in the Frontier involves plugging into the large infrastructure already put in place by the megacorps. The biggest venues would be the Galactic Task Force (GTF) boards, used for employment and contractual work, and Star Play's Classifieds, used to advertise goods for sale or trade. Both outlets enjoy a heavy presence in highly developed areas, especially over electronic media. One can easily find animated holographic panels pushing products from GTF and Star Play in every city, star port, and space station. Placing ads requires specifying how far the ad will be distributed and for how long. Ads can be text-only or thirty-second media pieces with audio/video. A GTF or Star Play office will film a media clip for 100 credits. Distribution of the ad can range from local to across the entire Frontier. Local ads appear on a single station, port, or city. The next levels of distribution include planetary-wide, system-wide, and ultimately across the entire Frontier.

### STANDARD CLASSIFIED/POSTING RATES

Service	Cost per day
Text-only, thirty words	1 cr (local)
Text-only, unlimited words and still images	10 cr (local)
Visual/audio ad - 30 seconds	100 cr (local)
Planetary-wide distribution	10x standard rate
System-wide distribution	100x standard rate
Frontier-wide distribution	1000x standard rate

## SHIP REPAIRS

Fixing a starship subsystem such as lighting on a given deck or any isolated system can be done by a starship engineer using the standard repair rule. Replacing these systems costs 200 cr x the hull size of the ship. Divide the ship's hull size by 2 and round up. This is the number of days it will take to replace the system.

*Example: Quaroek decides the plumbing on deck 2 is old and will never work properly again. He decides to replace it. His ship is a hull size 6 vessel, so the cost of replacing it will be  $6 \times 200 = 1200$  credits. It will take three days to replace it.*

For more information, check out the Ship Maintenance Rule. [Ed. Note: I assume he was referring to the *Spaceship Maintenance and Repairs* section of the *Knight Hawks Campaign Book* (p10)]

# THE YAZIRIAN WARRIOR BARD

Tom Verreault

## ORIGINS OF THE WARRIOR BARD & MERCENARY MINSTREL

It is believed that the bard/minstrel of yazirian society dates back to Stone Hunter Age. The first bards may have been clan outcasts who made their way in yazirian society by musical talent. During this age, trespassing in a clan's territory could have dire consequences. However, a yazirian who announced his presence in a clan's territory by music and song would, often as not, be invited to entertain and receive a share in the meat at a clan gathering. Yazirians with skill in song, poetry and music became an important institution performing important functions.

While each clan had keepers of the clan wisdom, it was the traveling bards that kept alive racial wisdom. As they traveled they gathered poetry, stories, and songs from the width and breadth of their society. Passing it on orally, they preserved a vast anthology of material that would have been lost long before the development of writing and printing. They also served as emissaries, diplomats, and mail carriers as they were able to pass the boundaries of clan territories almost at will.

As yazirian society matured and evolved into its Metal Hunting Age and beyond, these bards and minstrels became so valued that a clan would adopt one, giving him a permanent home and treating him like a beloved clan elder. Usually this was an older, well-traveled bard with great status. It may also have been that the older bards needed to settle down feeling the effects of old age. A clan could gain great status by landing a famous bard in this way. During this period, bards became the councilors, advisers, and sages of yazirian society.

During the Stone and Metal Hunting Ages, clan wars would be more properly described as clan feuds. The ancient mythic ballads suggest that it was a bard that brought about the first clan war. With rising populations and improvements in science, clan war may have been inevitable but the female bard Callistra is universally credited with igniting the first true clan war.

Callistra, an unjustly disinherited yazirian, became a highly sought after bard even in her youth. Using both her feminine wiles and a prodigious talent to sing, she discovered she could move and influence warriors and

hunters with ease. She even discovered methods and techniques to bring out the battle rage that lay dormant in even the most placid of yazirian. For some reason, be it revenge, jealousy, or spite, she stirred animosity for the clan of her youth amongst several neighboring clans. Eventually, at a clan gathering she whipped the hunters and warriors into a raging fury and ignited the first clan war. Other bards became involved and clans began to formally form alliances as distrust and suspicion spread. During this time, several clans ceased to exist, including Callistra's. She became an outcast of outcasts. She was reviled universally but still possessed the ability to beguile and influence. She spent the rest of her life traveling and stirring up strife. After her death she was viewed as a demi-goddess of war, spite, and revenge. Today she is a metaphor for viciousness, spite, envy, and revenge.

During the centuries of clan war, the yazirian bard evolved into the warrior bard or mercenary minstrel. Bards, being travelers, often had to rely on their own skill to eat and typically they were well skilled with a zamira or other weapons. Sometimes, in order to ingratiate themselves to a clan, they had to demonstrate their hunting skill. These bards came under pressure from clan leaders to stir the battle fury in the clan's hunters and warriors. What emerged from the clan wars was a bard that led in battle and could draw forth the battle fury of a clan's warriors. Eventually, there evolved a class of mercenary minstrels known as "sell song", who would be hired for specific campaigns and battles but with little connection or loyalty to the hiring clan.

In some regions warrior bards morphed into priests and shamans with several religious sects emerging as well. Unsurprisingly, in these religious sects Callistra was portrayed as a semi-demonic temptress.

## THE YAZIRIAN MINSTREL TRADITION

Any Yazirian can take Minstrel Tradition Skill. It is treated as being part of the Biosocial PSA for purposes of determining EXP cost. A yazirian always pays the "in PSA" rate regardless of his actual PSA.

### MINSTREL TRADITION SKILL

This skill encompasses an encyclopedic knowledge of yazirian poetry, literature, and song, the ability to play

musical instruments and sing, skill with the zamira, and comprehension of social dynamics.

### **SUBSKILLS**

#### **KNOWLEDGE OF YAZIRIAN HISTORY**

(1/2 LOG + 10% per level)

Since yazirian history is encapsulated in song, poetry, and in latter times, literature, a yazirian bard has a chance to remember significant details and important pieces from any age up to and including the history of yazirians in the Frontier.

#### **MUSICAL INSTRUMENTS AND SINGING**

(+5% per level)

Yazirian minstrels are adept at playing musical instruments and singing and can use this subskill to enhance racial reaction or other skills. This skill can be used to prep other yazirians to enter battle rage by consciously singing songs of valor, honor, and battle prior to combat and throughout the day and at the moment of combat giving a stirring shout echoing a line from a song previously sung. Other yazirians gain a +5% per level of the bard as a bonus to their battle rage roll.

A bard with psycho-social skill can use music and song as part of his attempt to hypnotize gaining +5% per level of skill. Other social interactions that involve a skill or ability check can receive this bonus as long as it's appropriate to include music and song.

A yazirian bard knows how to sing automatically as well as play a number of instruments determined by his level; level 1-2 is 1 instrument, level 3-4 is 2 instruments, and levels 5-6 is 3 instruments. After 6th level a bard may learn more instruments for 4 EXP each.

#### **RACIAL WEAPON SKILL**

(1/2 DEX + 10% per level)

Yazirian minstrels all carry the traditional weapon, the zamira (note a referee may allow the other fan created racial weapon, the kha'dan). The use of racial weapons is rooted in tradition and expected of them.

#### **COMPREHENSION**

(1/2 LOG + 10% per level)

Same as the vrusk racial ability but only works with yazirians. A yazirian bard observing a social interaction between two or more yazirians has a chance to understand what is going on between them.

#### **CRAFT TRADITIONAL YAZIRIAN EQUIPMENT**

Much like the ability to craft tools of the AD Environmentalist Skill, the yazirian minstrel can craft traditional yazirian equipment and musical instruments depending on availability of materials.

## **TRADITIONAL YAZIRIAN EQUIPMENT**

### **BOWER TENT**

The bower tent is a temporary tent-like shelter that can be mounted on the side of a giant tree. Traditionally, it's made from wood poles, vine ropes, and hides but modern versions are light-weight and water-proof. The tent can be mounted above or beneath a large branch for extra stability. A yazirian with skills that allow him to craft items in survival situation can make one automatically depending on the availability of materials. Any yazirian without such a skill can make a LOG check to see if he remembers enough to attempt to make one and then must make a LOG check to succeed at doing it. The primitive version can be water-proofed with animal fat or plant oils but it's not permanent nor 100% successful in a torrential downpour.

**Primitive Bower Tent:** 5kg, Approx. 10 Cr.

**Modern Bower Tent:** 1kg, 45 Cr.

### **KESHECK OL-TOR**

The ancient name is kesheck o-tor which is literally "kesheck tooth" since this war club is made from the teeth of that giant carnivore. The modern usage is o-tor. Modern versions of this weapon usually have a metal head since the kesheck is an endangered species. It is effectively a primitive mace.

Originally the weapon was made from a hardwood handle with kesheck teeth set into the club by drilling holes with a stone drill tip and a bow drill. The teeth were secured with a tough animal blood glue and thin leather wrap. The pattern for setting the teeth varied by region and clan but a common pattern was four set at 90 degrees from each other at the end of the club. Sometimes one was mounted on the end of the club if the owner desired to be able to throw it. The handle had a leather wrap and a loop for gripping or hanging it from an equipment harness. This facilitated climbing or secured the club during combat with a loop over the wrist.

This weapon was a status symbol for only the greatest hunters and warriors since tradition held that a warrior must kill the dangerous kesheck by himself. Once a warrior died who owned a kesheck the weapon became a ceremonial item for his clan. In ancient times it was believed that the spirit of both the kesheck and the warrior that made the weapon were imbued in the weapon.

A yazirian able to craft items can make similar weapons with claws or teeth from a suitable animal. This weapon conforms to the statistics for a club except the damage is 2d10 instead.

**Kesheck Ol-Tor:** 1kg, Considered priceless by the clan it belongs to but valued at 40,000 Cr by the CFM.  
**Modern Ol-Tor:** 1kg, 30 Cr.

### BRAK'DAN

The brak'dan is an ancient weapon made using similar construction techniques as the kesheck ol-tor. A straight or curved length of wood has a lengthwise groove carved into it and micro blades of obsidian or flint were glued in place with strong blood glue. Prone to dulling, the weapon was abandoned, once metal working was developed. A traditional brak'dan will dull on any attack roll of 95-00 or doubles and will lose 1d10 of damage. Modern names for the weapon are bakdan or kha'dan depending on dialect, region, or clan. The ancient form, brak-dan, derived from the root word dan, meaning blade. Modern bakdan are often simply referred to by their Pan Gal name: sword. Some very rare and ancient examples of this weapon used flat sharp aquatic carnivore teeth and were less prone to the dulling problem.

**Traditional Brak'dan:** 1kg, 75 Cr.  
**Modern Sword:** 2kg, 30 Cr.

### OLT'DAN

The olt'dan derived from the root words for tooth and blade. In antiquity, when suitable teeth were available, ceremonial knives were carved from these teeth with micro blades of obsidian or flint glued into a carved groove. Many were made from kesheck teeth if the beast was killed by group effort. Ceremonial knives are still made in this fashion in modern times but kesheck teeth only become available as these animals die from natural causes. The Family of One tightly controls the availability of these teeth, favoring clans according to its own agenda.

**Traditional Kesheck Olt'dan ceremonial blade:**  
 Considered priceless by its clan but valued by the CFM at 15,000 Cr.

**Traditional Olt'dan (non-kesheck tooth):** Considered priceless by its clan but valued by the CFM at 1,000 Cr.

### OTHER TRADITIONAL EQUIPMENT

Ropes, waterskins, spears, fire starting bows, clay pots, inks, dyes, and paints from plant and mineral sources as well as hand crafted paint brushes.

## YAZIRIAN MUSICAL INSTRUMENTS

### THE DUMRA (DRUM)

Dumra vary in size from small to huge two meter cylinders. The Great Dumra (2m diameter by 1m) is a staple for clan celebrations and saw military use toward the end of the Clan Wars. Traveling bards favored a bongo like dumra of 4 drums of decreasing size mounted

in a curved shape that matched the contour of the waist called the singer's dumra. A singer's dumra usually comes with an attached bandolier to allow the bard to climb and glide with it securely attached to his back.

Another type of drum was the **Ranga**. It was 60 to 90 cm long and 20 cm wide and carried on a bandolier. It was played by beating the ends and the cylinder with the hands.

**Great Druma:** 30 kg, 500 Cr.  
**Ranga Druma:** 1 kg, 30 Cr.  
**Other Druma:** 1 kg, 20-40 Cr.

### THE BOLLU (FLUTES)

A popular minstrel bollu is the sek bollu, literally 3 flute. The sek bollu is 3 flutes of decreasing size bound together with an ingenious mouth piece that allows the musician to redirect the air flow between the 3 flutes or into any combination of the 3 at the same time. This instrument is near impossible for any other race to master as it takes the long fingers of a yazirian with its extra knuckles to wrap around the instrument and properly play it. In the hands of a skilled yazirian, the sek bollu produces beautiful and even haunting melodies evoking battle and hunting.

**Sek Bollu:** n/a kg, 45 Cr.  
**Other Bollu:** n/a kg, 25-35 Cr.

### THE SHEM DURA (UKULELE)

Literally, a stringed dumra, the shem dura is a small stringed instrument that has been compared to the human ukulele. It was developed by yazirian bards to be carried strapped across the back. After contact with humanity some musicians began using the bow from violins to play the shem dura.

**Shem Dura:** n/a kg, 75 Cr.

### HORNS

A wide variety of animal horns were used as horns, largely for martial accompaniment.

**Traditional Yazirian Horns:** n/a to 1 kg, 25-35 Cr.

FE

Weapon	Damage	Mod	Defense	Mass	Cost
Traditional Kesheck Ol-Tor	2d10	+5	Inertia	1 kg	20,000
Modern Ol-Tor	2d10	+5	Inertia	1 kg	30
Traditional Brak-dan	3d10	+10	Inertia	1 kg	75 (new)
Modern Bak'dan	3d10	+10	Inertia	2 kg	30
Olt'dan	1d10	+5	Inertia	n/a	20 (new)

Starships

# THE ASSAULT SCOUT

Tom Stephens

The Assault Scout is probably the iconic Star Frontiers starship. It graces the cover of the Knight Hawks rules and several of the modules. I even used it when creating the [30<sup>th</sup> Anniversary logo](#) and patch last year. And while there has been some debate in the various Star Frontiers forums about its true practicality as warship, there is no doubt that it is a great ship for a small adventuring group. Moderately armed and armored, fast and maneuverable, and capable of interstellar travel, the Assault Scout provides an excellent ship for a band of adventurers.

## THE STILETTO CLASS ASSAULT SCOUT

We commonly refer to the standard, iconic Assault Scout model as the “Stiletto” Class. I’m sure it got this name since UPFS Stiletto is name of the Assault Scout in very first Basic Rules scenario in the UPF Tactical Operations Manual (board game rules). Here we present the detailed Knight Hawks ship statistics for an “average” ship of this class.

### STILETTO CLASS KNIGHT HAWKS STATISTICS

**Name:** UPFS Stiletto

**HS:** 3

**HP:** 15

**Engines:** 2 Class A Atomics

**Max ADF/MR:** 5/4

**DCR:** 50

**Life Support:** up to 12 beings (primary and backup)

**Crew Accommodations:** 4 double bunk rooms

**Passenger Accommodations:** none

**Cargo Capacity:** none

**Computer Level/Function points:** Level 4 / 179 FP

**Computer Programs:** Drives 4, Life Support 1, Alarm 2, Computer Lockout 4, Damage Control 2, Astrogation 4, Laser Battery 1, Assault Rockets 1, Communication 1, Computer Security 5, Information Storage 4, Installation Security 4, Robot Management 4, Skin Sensors 1

**Astrogation Equipment:** Standard Starship

**Communications Equipment:** Videocom Radio, Subspace Radio, Intercom with 12 speaker/mikes

**Sensor Systems:** Radar, 10 portholes, Energy Sensors, Skin Sensors

**Weapons:** ARx4, LB

**Defenses:** RH

**Ship's Vehicles:** small launch

**Other Equipment:** Engineer's Toolkit x2, Laser Power Torch, 2 refills for life support system

**Total Cost(unfueled):** 1,088,470 cr.

### REMASTERED DECK PLANS

The back of the battle map provided with the Knight Hawks rules had two sets of deck plans for the Assault Scout. Those deck plans were drawn at a two meter per square scale. I have reproduced them, as identically to the original as possible, but at a one meter per square scale. This makes the decks a little larger and easier to work with. Each square is ½ inch in size and the plans can be directly used with the counters from the original games. We’ve printed the “green” deck plans here. You can get the “blue” ones as well on the magazine’s website.

In working on these deck plans, I’ve come to realize that there are few things missing from and/or different than what I would expect a hull size 3 vessel to have.

- 1. Only 4 crew rooms** – The description in the Campaign book says it has a crew of 4-6 but I believe this is a little small for a full interstellar warship. The four rooms are sufficient assuming a crew of 4-6 but for a larger crew (>8) you need more rooms. This can be accomplished by simply adding in a second crew’s quarters deck (deck 4) into the ship.
- 2. These deck plans are for a smaller than average ship** – The total volume of these decks, as laid out and give the profile presented with them, only amounts to about 800 cubic meters of space (assuming each deck is 3m (10ft) high. The typical volume of a HS 3 ship is 2500 cubic meters. Or more than 3 times larger. There is some of that space taken up by the unoccupied nose of the ship (filled with equipment) but that is less than the occupied volume and so can’t account for all of available volume. Clearly the Assault Scout could be much bigger than it is. And so adding in another deck for more crew rooms is completely reasonable. It

## Frontier Explorer

would just stretch out the lines a little on the ship as drawn.

3. **No ship's launch** – By the time you have a HS 3 ship, there is no reason not to have a small launch associated with it. The detailed stats above include such a launch but the deck plans don't allow for it. Again, the space is there, simply adding in another deck to hold the launch would completely fit within the HS 3 volume budget.

Look for a future article here in the Frontier Explorer with a set of redesigned Assault Scout deck plans that take these features into account.

## OTHER ASSAULT SCOUT CLASSES

Of course, if we have a Stiletto class Assault Scout, that begs the question, are there other types of Assault Scouts? And if so, what are their characteristics and roles. Here are a few other types of Assault Scouts that might exist. The complete details of the ship design are left as an exercise for the reader (or possibly for a future article).

### OSPREY CLASS

If the Stiletto class is the one favored by the UPF, this is the one typically used by the planetary militias. It is slightly longer than the Stiletto Class and sports a second crew deck and a life support capacity of 16 beings. It has a command crew of 4 and can hold up to a 12 being boarding party. This class is used for cargo inspections and boarding of other (non-military) vessels.

While capable of interstellar travel, it would be a little cramped if fully crewed as the crew quarters are designed around short stints in space of only a few days on patrol and then off time on station or planetside.

The Osprey Class Assault Scout has the same armament and performance as the Stiletto Class.

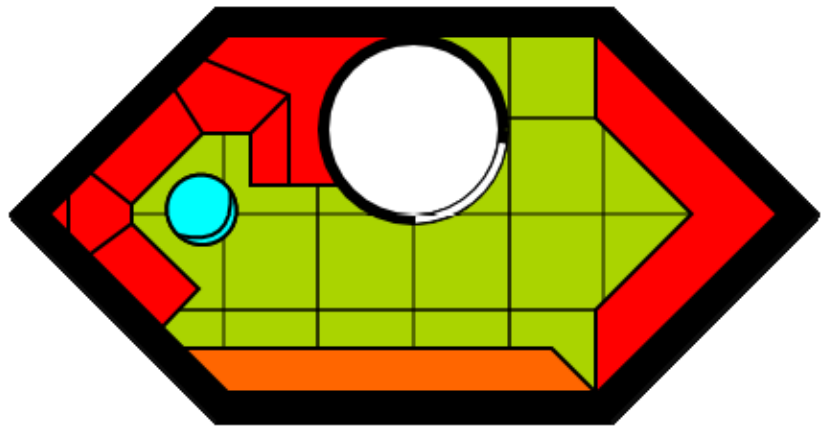

**DECK 1 – SKY BRIDGE**

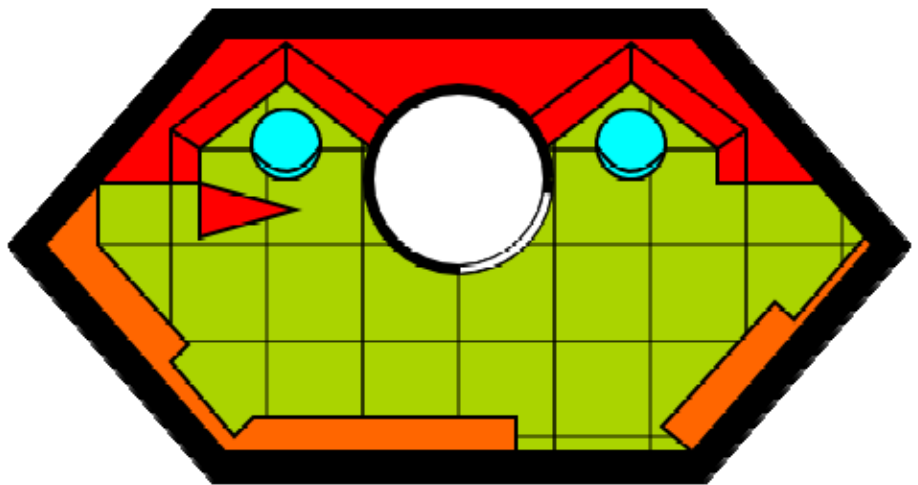

**DECK 2 – LOWER BRIDGE**

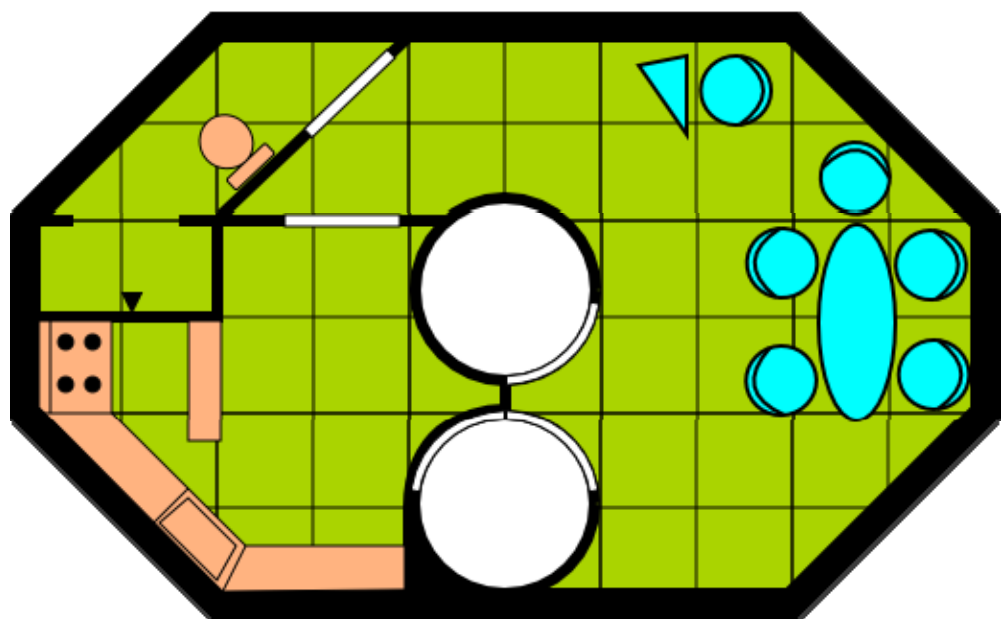

**DECK 3 – CREW DECK**



## LANCET CLASS

This class trades the heavy hitting power of the Assault Rockets for the longer range and more rapid firing rate of the Laser Battery. This variation on the Assault Scout is relatively new and is seeing a lot of use in the smaller, mobile operations groups used by the UPF as well as in the order of battle for Strike Force Nova. Armed only with a pair of laser batteries, there is no worry about resupply when on assignment away from the core worlds where armament supplies could be scarce or non-existent.

This class has a typical crew compliment of 8 beings and sports a pair of laser batteries instead of the usual laser battery and four assault rockets.

## ENDEAVOR CLASS

The Endeavor Class is geared more toward Scout rather than Assault. It is more of a survey ship than a warship. This class, like the Lancet Class, trades in its assault rockets for a second laser battery. This class is larger than the other Assault Scout classes as it also sports two atmoprobes and a laboratory deck plus a second and third crew's quarters deck for a total crew capacity of 16 beings. It also carries the deluxe astrogation package instead of the standard one. This extra size comes with a slight performance hit and the Endeavor Class only has an ADF of 4 instead of the ADF of 5 typical of the Assault Scout ship design.

This class is primarily designed to scout out new star routes and open up new systems for further investigation. The ship will jump into a system, perform preliminary surveys and then return home, paving the way for follow on mission and identifying high priority systems for more detailed study by dedicated research ships.

**FE**

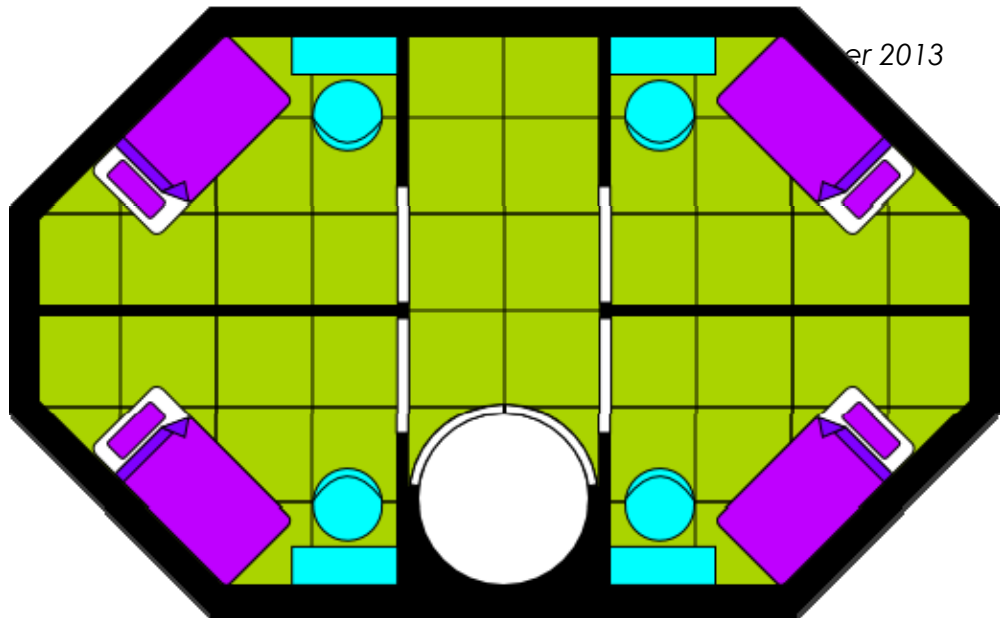

**DECK 4 – CREW'S QUARTERS**

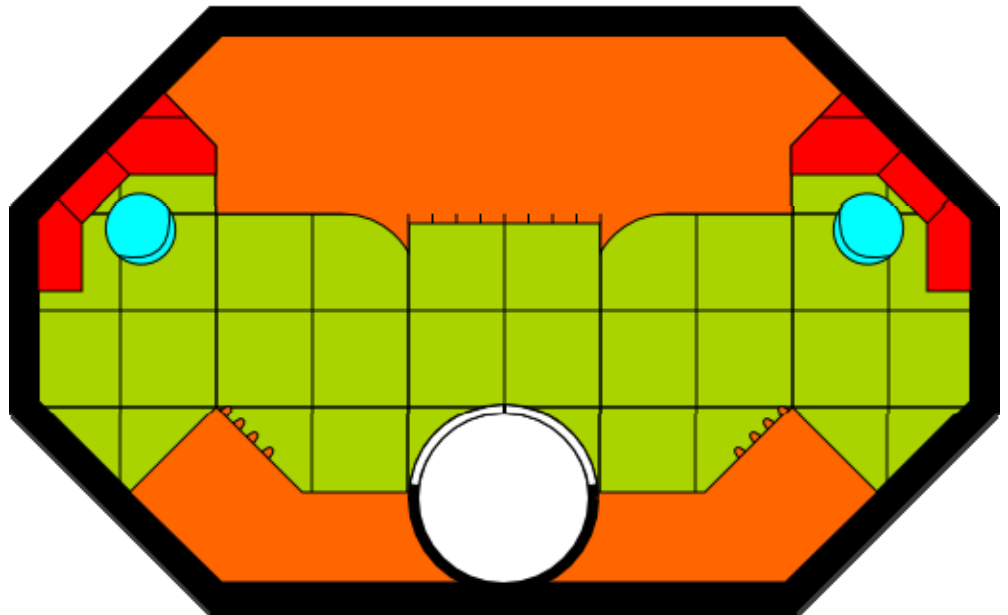

**DECK 5 – ENGINEERING**

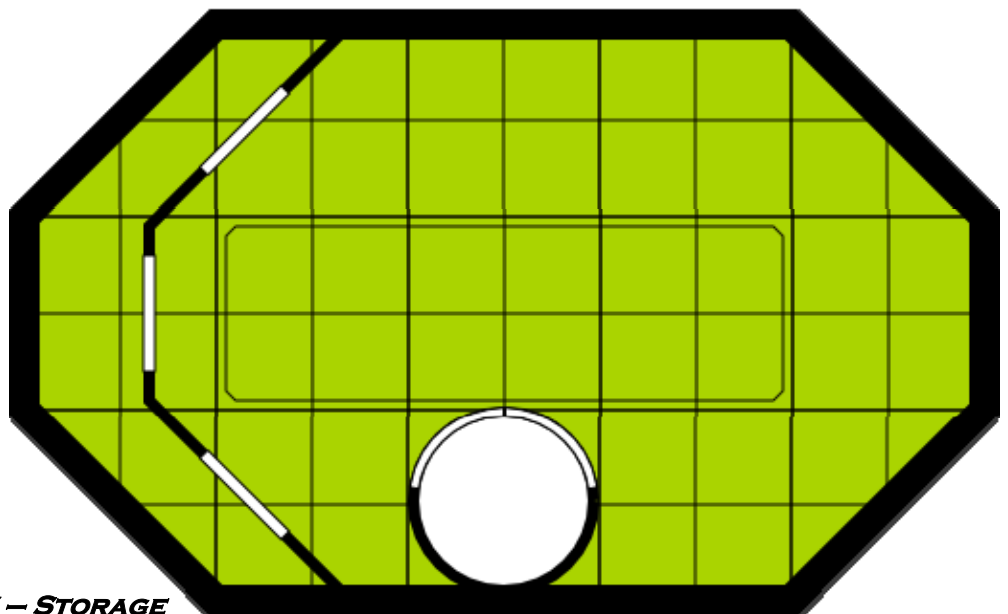

**DECK 6 – STORAGE**

# THE ALBATROSS

Tom Verreault

## INTRODUCTION

The Albatross encounter is a solo mini adventure. You, the player character, are an undercover Star Law Deputy. Your assignment was to infiltrate the pirate crew of the Albatross, recover stolen vault schematics on hundreds of *Dralasite Savings and Loan* vaults and apprehend the Albatross's captain. You were successful in infiltrating the crew but your cover was blown and you were shot with a stunner from behind. You woke up stripped to your skein suit and locked in a cargo container just big enough to hold your body.

It was impossible to tell the passage of time while in the cargo container and the only events to relieve the monotony of imprisonment and the isolation of sensory deprivation were the periodic banging on the side of the container with a tool by the ship's engineer to taunt you. One such taunting incident was interrupted with an alarm klaxon and then followed with several shudders that rocked the ship. Shortly after that the ship was buffeted from a rough descent through an atmosphere which ended with a hard impact that threw the cargo container across the compartment and cracked its casing. The violence of this was enough to cause a black out for a few seconds.

You hear water entering the compartment but you are not free from the cargo container. The crack in the container is substantial. Perhaps you can break it open or fatigue the material enough to squeeze out.

## ENCOUNTER REQUIREMENTS

To play this encounter you will need access to the Alpha Dawn rule book, possibly the Knight Hawks rule book for equipment descriptions, an Alpha Dawn character sheet, and the assault scout deck plans from the Knight Hawks box set or this issue of the Frontier Explorer (p20).

## CREATING YOUR CHARACTER

Character creation follows guideline from the "Careers in Star Law" by Alex Curylo from Dragon Magazine #91. You may wish to review that article and print an Alpha Dawn character sheet prior to doing this adventure. The following is the character creation check list.

1. Choose a name and species
2. Roll and arrange ability scores as per the Alpha Dawn rules transferring up to 10 points between an ability pair and apply racial modifier. To have entered Star Law, 5 of your ability scores must have been 5 points higher than the racial averages (given in the table below) and two of which must be INT & LOG.

Species	STR/STA	DEX/RS	INT/LOG	PER/LDR
Human	45/45	45/45	45/45	45/45
Dralasite	50/50	40/40	45/45	45/45
Vrusk	40/40	50/50	45/45	45/45
Yazirian	35/35	50/50	50/50	45/45

If your ability scores do not meet this requirement then redo the process or simply use the racial average and add 5 points to five individual scores of which INT & LOG must be part of the five.

After all that add 5 points to one ability score in the STR/STA pair and 5 points to one ability score in the DEX/RS pair as per the rigorous academy training you have received.

3. Choose a PSA
4. If your PSA is Technological or Biosocial choose one 5<sup>th</sup> level skill and one 3<sup>rd</sup> level skill from that PSA and a 2<sup>nd</sup> level ranged weapon skill (usually beam) and a 1<sup>st</sup> level non ranged weapon skill (usually melee). If your PSA is Military choose two 5<sup>th</sup> level weapons skills plus 2<sup>nd</sup> level Martial Arts and 1<sup>st</sup> level Demolitions.
5. Choose one more bonus 1<sup>st</sup> level skill from any PSA.

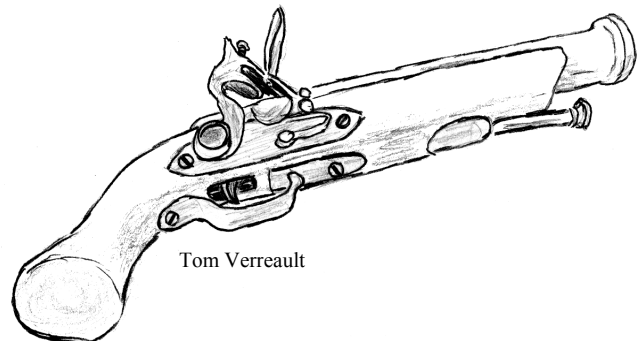

Tom Verreault

6. Compute your punching score, initiative modifier, and length of time your character can hold his breathe (STA/5)
7. Add a skein suite to the character sheet as your only item of equipment

## MISSION BRIEFING

A security breach at the Dralasite Savings & Loan corporate office was tracked to the crew of the pirate ship *Albatross*. The stolen data is the vault security schematics to hundreds of bank vaults across the Frontier. Your primary mission is to recover the data and apprehend the thief, Lady Cassen Mcgee. She is also the ship's captain and Star Law wants her alive, but the other members of the crew can be brought in dead or alive as the situation warrants.

## SUSPECT BIOS

### LADY CASSEN MCGEE

Captain of the Albatross & pilot  
Human female

RS 45, STA 45  
RW 53, M43, PS 3, IM 5

Beam 3, Tech 6, Comp 3, Starship  
Piloting 2, Martial arts 2

Skein suit, laser pistol, 4 SEU clips, power belt, albedo screen, Robcom tool kit, chronocom

Notes: Lady Cassen is an independent pirate not affiliated with any pirate band which makes it a mystery as to how she came into possession of an assault scout. She maintains good relations with the powers that be on Outer Reach but the reality is that she is more of a thief and a smuggler than a pirate.



### SVIDGE

#### AKA SAVAGE MONKEY

Ship's engineer  
Yazirian male (Gliding, Battle  
Rage 20%)

RS 50, STA 35  
RW 45, M38, PS 2, IM 5

Technician 6, Robotics 2, Melee 2, Thrown Weapons 2

Skein suit, Kah'dan honor sword (treat as sword), Zamra throwing blade, Technician's tool kit, chronocom

Notes: Savage Monkey is a sociopath and sadist. He enjoys torturing people that cannot fight back. He's competent as an engineer but he is considered crazy.



### XXX, AKA TRIPLE X, AKA TRIP

Ship's astrogator  
Vrusk male (ambidextrous,  
comprehension 15%)

RS 45, STA 45  
RW 53, M43, PS 3, IM 5

Beam 1, Comp 6, Astrogation 2, Melee 1

Skein suit, sonic stunner, power belt, inertia screen, vibro knife 1 SEU clip, Robcom tool kit, polyvox, chronocom

Notes: XXX is inscrutable and not very talkative. He's hiding from his past and his secret could be anything as he's not talking about it.

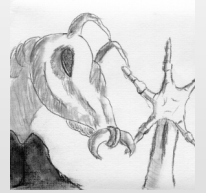

### OLD BILL YEAGER

Ship's energy weapon gunner  
Human male

RS 45, STA 45  
RW 83, M33, PS 3, IM 5

Beam 6, Energy Weapons 2, Melee 1

Skein suit, sonic stunner, power belt, inertia screen, vibro knife 1 SEU clip, chronocom

Notes: Bill's been with the Albatross a long time. He is a petty thief and Lady Cassen has been forced to replace dead crew that objected to his stealing from them.



### MARLO MUSKET MOUTH

Ship's rocket gunner  
Dralasite male (4 limbs total, lie  
detection 5%)

RS 40, STA 50  
RW 40, M35, PS 3, IM 4

Gyro Weapons 2, Projectile 4, Starship  
Rocket Weapons 1, Melee 1

Skein suit, Needler pistol, 2 clips, cutlass (sword), flint lock pistol, 20 shot and powder., chronocom

Notes: Marlo plays the part of pirate to the hilt. He wears an eye patch, says, "Arrhh" every other sentence, and carries a flint lock pistol with shot and powder. He always shoots first with the flint lock before switching to more modern weaponry. His flint lock pistol has shorter range than a musket but the other stats are the same and in the close quarters of the ship the range is immaterial.



## ENCOUNTER RULES

### **DOORS**

Standard room doors may be opened and moved through at half movement. Elevator doors are unpowered and act as a pressure door. To open an elevator door a character must stop in front of one, spend one turn opening it, and then can move through at half movement. All doors that are opened will remain open unless closed.

### **SPACE SUITS**

Space suits are fitted to the owner and normally take about 40 minutes to don. The player character will not be able to don his suit (if found) in time nor the suit of one of the NPCs. Even if he was able to do so he would have to be weighed down with at least 35 kg of equipment to have neutral buoyancy otherwise he would float on top of the water and become trapped against the ceiling in a flooded deck.

### **ELEVATORS**

The elevators are unpowered and at the bottom of their shafts. If the player character enters an elevator he must come to a stop and spend one complete turn opening the roof hatch before moving through at half speed. The elevator shaft has a recessed ladder that allows for climbing the shaft and the rate of climb for all characters is one deck per turn. If a character is in a shaft when the next deck begins flooding he simply floats to the elevator door for that deck and may spend the next turn opening it or may climb to the next deck up.

### **THE SHIP'S ANGLE**

The ship is canted over at a 45 degree in the water. This affects all characters by halving movement and reducing IM by -1. The halving of movement compounds with the half movement for passing through doors. Once deck 3 begins to flood the ship will have enough of a vertical orientation that these effects are nullified.

### **POWER**

The ship's engines are off line and the ship is on emergency back-up power. Each deck has a parabattery hidden behind a bulkhead wall that powers the lights and equipment on that deck. This power source will short out 8 turns after the deck begins flooding. If this happens and the player character is still on the deck, he will be plunged into darkness. If a character is forced to move in darkness he must make a INT check to move or the darkness confuses him and he does not reach the point he was making for and will have to make a INT check next turn to move.

### **FLOODING**

The ship sustained damage in space and upon crash landing in the water. It is flooding at a rate of 1 deck per minute starting with deck 6. If certain doors and hatches are closed as the player character moves up the ship, bonus time can be gained. This is covered in the deck description. If the player character is on a deck after the

10 turns of flooding for that deck he must begin to hold his breath. When the player character reaches his breath limit he begins to take damage (2d10 per turn). If the player character reaches 0 STA he drowns and the encounter is over. This STA loss is temporary and will be recovered at the rate of 1 STA per 10 minutes of rest once out of the water

### **TIME**

The encounter is played in Alpha Dawn game turns of (6 seconds per turn) and 10 turns to the minute. An extra sheet of paper will be required to track turns. Label six decks and mark hash marks for each turn of flooding for a deck until 10 then begin marking hash marks for the next deck unless bonus time is awarded by the deck descriptions.

### **LOOTING & SEARCHING PIRATES**

Looting a pirate takes one turn and means the player character has collected all of the gear listed in their stat block except their defensive suit. A pirate may be searched once and it takes one turn. A search will turn up a random item plus their ID card; consult the "Search a Pirate Table". It takes 3 turns to strip a pirate of a defensive suit and 1 turn each for the PC to undress or dress himself. In other words it's possible to use the defensive suits from the pirates but they must be the same species as the player character and it takes time to undress and dress.

## TO PLAY THE GAME

Read each deck description and resolve any combat as it occurs. There are specific actions that may be taken on each deck. These actions have a cost in time and they are keyed to an Action Result Index below. Consult the number listed to find out what happens when your character takes that action. You must escape the ship and accomplish your mission before it fully floods. The Decks are keyed to the deck plans from the Assault Scout article on page 20.

### **DECK 6**

The player character begins play locked in a damaged cargo container. He may either make a STR check to

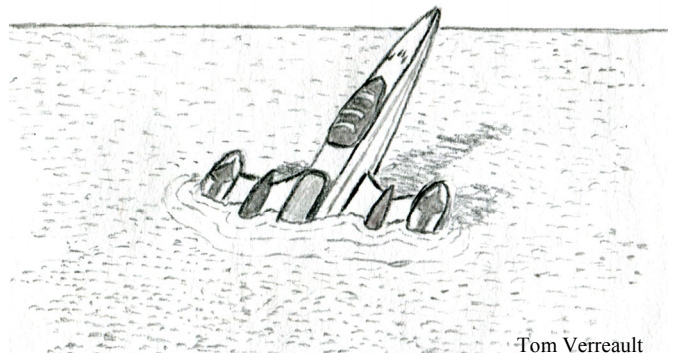

Tom Verreault

break the container open in one turn or may attempt to fatigue the material of the container over a few turns to break it in time. The fatigue method simply records the PC's STR score each turn till he reaches a total of 150 and may stand up on that turn. This is an either or choice break the container open in 1 turn or work to fatigue it. Failure to break it open does not apply the STR score to the fatigue method.

Savage Monkey is on this deck and he was stunned by the crash. The stun wears off in the first turn but he does nothing that turn. Baring the appearance of the Star Law deputy he will move to the elevator and begin opening it to climb up ship. If the cargo container is opened in the first turn combat will commence on the second turn. If he has moved to the elevator and has his back to the cargo container then the PC gets a turn of surprise to attack from behind. Unless stopped Savage Monkey will be in the elevator on turn 4, opening the roof hatch on turn 5, on the roof of the elevator on turn 6, climbing to deck 5 on turn 7, opening the door to deck 5 on turn 8 and entering deck 5 on turn 9.

On this deck the player character may:

- A. Search the closet for 2 turns (see Action Result Index #2 )
- B. Search the open deck for 1 turn (see #7 )
- C. Attempt to open the cargo hatch in the floor (see #11)

Note: If the elevator door is closed and the roof hatch is closed then there is a 3 turn bonus before deck 5 begins flooding.

## DECK 5

The vrusk astrogator, Trip, is sitting at the right hand control station arguing with the captain by intercom about whether they should send a mayday. The Captain simply orders Trip to get to the sky bridge and help her cut a hole in the hull and cuts the connection on the turn that the PC enters the deck. Trip will turn and engage the PC when he enters the deck.

Savage Monkey may be encountered here if he escaped deck 6. Place him at the left hand control station. Note it may be a very close combat for both Trip and Savage Monkey to fight the player character but this is the consequence of allowing Savage Monkey to escape deck 6.

On this deck the player character may:

- A. Open the arms locker either with a successful technician skill roll vs a level 3 lock in 1 turn or smash the lock with a blunt object for 1d10 damage per turn till 30 points are reached. (see # 9)

- B. Operate communications gear to issue a mayday; 1 turn with a crew member's ID card to unlock system or technician's skill check vs level 2 lock for 2 turns (see #3 )
- C. Search Deck for 1 turn (see #13 )
- D. Access the computer; requires an ID card to unlock or technician skill check vs a level 2 lock then a successful Display information roll (see #14 )

## DECK 4

This deck appears deserted but then the player character will notice that the lock to the captain's cabin has been smashed and kicked in and the door is slightly ajar. See #21 immediately.

On this deck the player character may:

- A. Search the Captain's quarters for 1 turn (see #10)
- B. Search Savage Monkey's quarters; 1 turn if in possession of his ID card, or 2 turns with a successful technician skill check vs a level 2 lock, or by doing 25 points of damage to the lock (see #16 )
- C. Search Trip's quarters; 1 turn if in possession of his ID card, or 2 turns with a successful technician skill check vs a level 2 lock, or by doing 25 points of damage to the lock (see #19)
- D. Search Old Bill Yeager and Musket Mouth's quarters; 1 turn if in possession of his ID card, or 2 turns with a successful technician skill check vs a level 2 lock, or by doing 25 points of damage to the lock (see #5 )

## DECK 3

This deck appears deserted.

On this deck the player character may:

- A. Search the dining area for 1 turn (see #1 )
- B. Search the galley for 1 turn (see #6 )

*Note: if the elevator door is closed here there is a 3 turn bonus before deck 3 begins to flood.*

## DECK 2

Marlo Musket Mouth, the ship's rocket gunner, is here and he's just begun calling the other crew members down ship via chronocom. He will engage the player character with his flintlock pistol then switch to his modern weapon.

On this Deck the player character may:

- A. Operate communications gear to issue a mayday; 1 turn with a crew member's ID card to unlock system or technician's skill check vs level 2 lock for 2 turns (see #3 )

## Frontier Explorer

- B. Search deck 2 (see #17)
- C. Access the computer for 1 turn; requires an ID card to unlock or technician skill check vs a level 2 lock then a successful Display information roll (see #14)

### DECK 1

Lady Cassen is here. She will fight but not to the death. Once she is wounded below half she will offer 100,000 Cr for her freedom. If the player character accepts this offer (see #15). If he does not accept that offer but negotiates for the vault schematics (see #20).

Once Lady Cassen is subdued, captured or killed the player character may:

- A. Operate communications gear to issue a mayday; 1 turn with a crew member's ID card to unlock system or technician's skill check vs level 2 lock for 2 turns (see #3)
- B. Search deck 1 for 1 turn (see #8)
- C. Access the computer for 1 turn; requires an ID card to unlock or technician skill check vs a level 2 lock then a successful Display information roll (see #14)
- D. Cut a hole in the hull with hand weapons (see #4)
- E. Improvise a power source for a laser weapon to cut a hole in the hull (see #12)

### SEARCH PIRATE TABLE

Die Roll	Result
1	Compass
2	Survival Rations
3	Flashlight
4	Everflame
5	100 Cr voucher chit
6	Nothing
7	Flashlight
8	a SEU clip
9	Sungoggles
10	Computer Storage disk (blank)

### ACTION RESULT INDEX

1. Nothing found
2. Savage Monkey's and the player character's space suits found. Strapped on the leg of Savage Monkey's space suit is a knife and sheath.
3. You send out a mayday call but there is no answer. Note how many turns you spend sending a mayday.
4. Cutting a hole in the hull with hand weapons requires doing 200+2d100 structural points of damage.

Weapons used to cut a hole must be consulted for rate of fire and ammo available to determine the turns involved. The player will have to track the number of turns to accomplish this action. See the Structural Damage Table for the damage caused by each weapon.

5. You find a trashy novel, a 50 Cr voucher chit, and 1 power clip with 20 SEUs.
6. You find 100 ration pack and 6 kitchen knives. The kitchen knives are not that useful for fighting: melee modifier is +0.
7. You find a star ship engineer's tool kit (see the Knight Hawks rule book).
8. You find a file computer with notes on defeating the security at Dralosite Saving & Loan's central headquarters as well as a contact name, "Fresno", to deliver the vault schematics to on Minotaur.
9. You open the arms locker to discover 2 sonic stunners, 2 stun sticks, 2 needler pistols, 2 dose grenades, 4 gas masks, 4 smoke grenades, 5 power clips, 4 needler pistol ammo clips, and 1 power backpack.
10. You locate a wall safe behind a picture by cutting away the picture (the frame is tightly mounted to the wall for 0 g. Open the safe for a technician's skill check vs a level 5 lock or do 100+d100 structural points worth of damage. See the Structural Damage Table for the damage caused by each weapon.
11. If before the 8<sup>th</sup> turn of flooding on this deck there is still power to open the door. It retracts in one turn and water rushes in. The compartment is flooded in one turn, the lights short out but you are pinned against the ceiling or wall. You try to hold your breath but it doesn't matter as the whole ship floods in seconds instead of minutes and the ship goes down with all aboard. Congratulations you've prevented the sale of the sensitive data and Star Law extends its condolences to your family.
12. You locate the wall panel that covers the back-up battery. It may be cut away in 1 turn with tools from a tech kit, robocom kit, or starship engineer's tool kit. Otherwise, shoot the four bolts with a non needler or stun weapon. The number of turns to do that depends

### STRUCTURAL DAMAGE TABLE

Weapon	Structural Damage
Rifle or Pistol shot	5 points per shot
Gyrojet ammo	10 points per shot
Laser	5 points per shot (SEU)
Needler ammo	No damage

on the rate of fire of the weapon at 1 shot per bolt. 1 turn to jack a laser into the parabattery. The battery has 5d100-20 SEU.

13. You search the engineering deck. In a closet near his station you find Trip’s space suit, a flashlight and a computer storage disk. To read the disk, unlock a computer station (map items D on deck 5, C on deck 2, or C on Deck 1) then see #18.
14. Roll on the Computer Data Search Table. Extra rolls can be made at the rate of 1 per turn.
15. Lady Cassen tells you that you need to cut a hole in the hull and when you both get a credit terminal she’d withdraw a credit voucher for 100,000 Cr. When your weapon is drained from cutting the hull she jumps you and initiates hand to hand combat.
16. You find a bottle of yazirian brandy, incense, pry bar (treat as a night stick at 2 kg wt.), and two blank computer storage disks.
17. You find plasti-paper map of the capitol city of Minotaur with coded notations that you cannot make out at this time.
18. You discover that the astrogator, Trip, has been making notes on this disk for plotting a course to Theseus system.
19. You find a collection of 25 rare and beautiful art statues that you believe might be stolen. Each weighs 1 kg.
20. The Lady Cassen offers to give you the stolen data if you do not kill her. You disarm her and she carefully pulls out her ID card and inserts it into a slot then enters a code with her left hand. Make an INT check to realize that she’s hiding what she’s doing with her right hand. The code she entered releases a secret compartment under the computer consol. If you fail the INT check you are surprised and she spins with an auto pistol on burst fire (Note: she lacks skill with this weapon thus -20 but +20 for burst fire) otherwise combat continues as normal. The secret compartment held not only the auto pistol but a disk with data.
21. Because of your police training you are not surprised by Old Bill Yeager who is waiting to shoot you from inside the captain’s quarters. Roll for initiative.
22. You may search for the secret compartment on deck 1 in 1 turn if you have Lady Cassen’s ID, shoot it open by doing 25 structural points of damage with non-stun or needler weapons, or spend 5 turns prying it open.

## EPILOGUE

Cutting a hole in the ship’s hull causes it to sink twice as fast. This is the reason that the captain didn’t cut a hole in the hull herself as she was waiting for crew members to

## COMPUTER DATA SEARCH TABLE

Roll 2d10	Data File Discovered
2	Engineering schematic for a secret compartment on Deck 1 (see #22)
3	Bank records showing transfer of 250,000 Cr to Lady Cassen
4	Security plans for Dralasite S&L’s corporate headquarters
5	Bank records of a transfer of 25,000 Cr to a Star Law secretary
6	Evidence that the stolen data was transferred to a disk and deleted from the ships computer
7-15	Nothing of interest found
16	Name of contact on Minotaur: "Fresno"
17	Passwords for Dralasite S&L computers
18	Log of Lady Cassen talking about a 500,000 Cr job
19	Coded map of Minotaur’s capitol
20	Star Law Personnel file on the player character

come forward. When deck 1 fills completely with water the ship will sink beneath the surface.

If the player character makes it out of the ship before it sinks and swims away from it for two turns he will not be affected by the under tow of the sinking ship. If he is on the ship’s hull or has not swum away from it they he must make a STR check to resist being sucked under.

Unbeknownst to the player character, he is on Lossend, a light population world. The Lossend Rangers noted the crash of the ship in a remote area of the planet and dispatched search teams. Unfortunately, it will take time for them to reach the vicinity of the crash and to locate any survivors. This impacts the player character if he is not a dralasite that can inflate his body with air and float almost indefinitely. A character can swim for 1 hour but then loses 5 STA per 30 minutes of swimming past that.

The time till the arrival of the search teams is 1d10 hours. If the player character has issued maydays this will help the Lossend Rangers locate him. Multiply the number of turns the player character spent issuing maydays over the radio by 1 hour and subtract this from the total time till the Rangers arrive.

If he manages to recover the stolen data and survive he will receive a commendation. There many other clues that will lead to the leak that got him shot and stuffed into a cargo container as well as the buyer on Minotaur. Discovering this data is bonus to completing the mission.

# GOING FOR THE HEAD

Tom Stephens

Welcome to another installment of the Knight Hawks encounter series. We'd love to hear your experiences playing these scenarios on the forums at the [Frontier Explorer website](#) or at [editors@frontierexplorer.org](mailto:editors@frontierexplorer.org). In this issue we return to more encounters from the start of a possible Second Sathar War campaign game. In issue 1, the militia was seriously out numbered. In issue 3, the militia and Sathar forces were more evenly matched. This time the Sathar bring out the big guns against some of the more heavily populated systems. But this time they are up against the highly trained and armed UPF Spacefleet.

## GOING FOR THE HEAD

The Second Sathar War gets serious as a major sathar fleet drops into the Prenglar System

### BACKGROUND

Just before the battles chronicled in the Hopelessly Outgunned (issue 1 – p38) and Stand Your Ground (issue 3 – p30) encounters, two massive Sathar fleets entered the Frontier. One entered the K'tsa-Kar system, which was undefended. The other burst into the heart of the Frontier, entering the Prenglar system, decelerating toward Morgaine's World. With Task Force Cassidine pulled out of position to Dramune and unable to jump to Prenglar to assist, Task Force Prenglar must face the Sathar onslaught alone. Will they be able to repel the invasion?

### ORDER OF BATTLE

#### TASK FORCE PRENGLAR

- 5 Assault Scouts
- 3 Frigates
- 2 Destroyers
- 3 Light Cruisers
- 1 Battleship
- 2 Minelayers
- UPF Fortress Gollwin

#### SATHAR SHIPS

- 12 Fighters
- 2 Frigates
- 3 Destroyers
- 1 Light Cruiser
- 2 Heavy Cruisers
- 2 Assault Carriers

### UPF & SATHAR SHIP STATISTICS

Here are the statistics for all the UPF and Sathar ships used in this scenario.

#### FIGHTER

HP: 8 ADF: 5 MR: 5 DCR: 30  
Weapons: AR(x3)  
Defenses: RH

#### ASSAULT SCOUT

HP: 15 ADF: 5 MR: 4 DCR: 50  
Weapons: LB, AR(x4)  
Defenses: RH

#### FRIGATE

HP: 40 ADF: 4 MR: 3 DCR: 70  
Weapons: LC, LB, RB(x4), T(x2)  
Defenses: RH, MS(x2), ICM(x4)

#### DESTROYER

HP: 50 ADF: 3 MR: 3 DCR: 75  
Weapons: LC, LB, EB, RB(x4), T(x2)  
Defenses: RH, MS(x2), ICM(x5)

#### LIGHT CRUISER

HP: 70 ADF: 3 MR: 2 DCR: 100  
Weapons: DC, LB, EB, PB, RB(x8), T(x4)  
Defenses: RH, ES, SS, ICM(x8)

#### HEAVY CRUISER

HP: 80 ADF: 2 MR: 1 DCR: 120  
Weapons: DC, LB(x2), PB, EB, RB(x8), T(x4), S(x2)  
Defenses: RH, ES, PS, SS, ICM(x8)

#### ASSAULT CARRIER

HP: 75 ADF: 2 MR: 1 DCR: 150  
Weapons: LB, PB, RB(x8)  
Defenses: RH, MS(x4), ICM(x10)

#### BATTLESHIP

HP: 120 ADF: 2 MR: 2 DCR: 200  
Weapons: DC, LB(x3), EB(x2), PB, RB(x10), T(x8), SM(x2)  
Defenses: RH, ES, PS, SS, ICM(x12)

#### MINELAYER

HP: 50 ADF: 1 MR: 2 DCR: 75  
Weapons: M(x20), SM(x4), LB(x2)  
Defenses: RH, ICM(x4)

#### UPF FORTRESS

HP: 300 ADF: 0 MR: 0 DCR: 200  
Weapons: LB(x3), EB, PB, RB(x12)  
Defenses: RH, MS(x3), ES, PS, ICM(x20)



## SETUP

The Sathar player declares which side of the map the Sathar ships will be entering from.

The UPF player then places a planet marker in the center of the map, places the Fortress in orbit around it, and declares its orbital direction (clockwise or counterclockwise). They then place the UPF ships anywhere on the map and declare their initial speeds up to a maximum of 10 hexes per turn.

If desired, the UPF can deploy any of the Minelayer's mines or the Battleship's and Minelayer's seeker missiles. Simply note the hex each of the mines or seeker missiles are deployed into.

Once the UPF ships are placed, and any mines or seeker missiles are deployed, the Sathar player places their ships within five hexes of the side of the map they declared to be entering from. The ships can be moving at any speed up to 15 hexes per turn, but all ships must be moving at the same speed.

## SPECIAL RULES

### REARM AND REPAIR

The UPF assault scouts can take advantage of the Fortress to rearm and repair. If they dock with the station and spend 1 full turn docked, consider them to have replenished all their expended assault rockets. They also get a +10 DCR bonus per turn they spend at the station on the next repair turn. To dock with the station, an assault scout must end its turn in the same hex as the station and have a speed less than its current ADF. They are considered to have docked this turn. On the next turn they

may rearm. They may then leave on any following turn with an initial speed of 0.

The sathar fighters can rearm and repair by docking with either of the assault carriers. The rules for docking and repair are the same as for the assault scouts and the Fortress except that to dock the fighters must end their turn in the same hex as the carrier and have a speed difference no greater than their ADF. When they undock they have the same speed as the carrier.

### STRIKE FORCE NOVA

In the Second Sathar War game, there is a 30% chance that Strike Force Nova will appear in the Prenglar system when it is placed on the board. As an alternates setup to this game, the UPF player may have Strike Force Nova in addition to Task Force Prenglar. The order of battle for Strike Force Nova is

- 6 Fighters
- 3 Assault Scouts
- 2 Frigates
- 1 Destroyer
- 2 Light Cruisers
- 1 Battleship
- 1 Assault Carrier

Including Strike Force Nova heavily weights the encounter in favor of the UPF. But if the Sathar player is up to the challenge, it could be a grand melee on the largest scale.

### LANCET CLASS ASSAULT SCOUTS

As an optional variation, the UPF player can substitute the Lancet Class Assault Scout (described in the Assault Scout article on page 20) for the standard Assault Scout. This Assault Scout has the same characteristics as a regular Assault Scout except that it has two laser batteries instead of a single laser battery and four assault rockets.

## VICTORY CONDITIONS

Note it is possible for both sides to claim victory in this scenario.

### SATHAR VICTORY

The Sathar score a minor victory if they manage to destroy the station, the UPF battleship and at least 5 other ships. They claim a major victory if they destroy all of the UPF ships and the station.

### UPF VICTORY

The UPF can claim a minor victory if they manage to at least destroy the sathar Light Cruiser, Heavy Cruisers, and Assault Carriers. They can claim a major victory if the Sathar ships are destroyed and the station and at least half of the UPF ships survive. If all the Sathar ships are eliminated but the fortress and battleship are destroyed, it is only a minor victory.

**FE**

## GET PUBLISHED!

Do you like what you see in the Frontier Explorer? Do you have ideas of your own that you'd like to share with the community? We'd love to help you.

The Frontier Explorer is always looking for submissions and ideas from new authors. We're open to submissions of art and articles on any topic from adventures to character sketches to locations to background information to new rules to whatever else you can think of. The only requirement is that it should be sci-fi related. A lot of our content to date has been focused on Star Frontiers but it doesn't have to be that way.

If you've got material you'd like to publish we'd love to help you get it ready and into a future issue of the Frontier Explorer. To submit material all you have to do is jump on over to the [Frontier Explorer website](#) and hit the big, gold "Submit New Content" button. Or if you'd like to talk to the editors about your ideas first, feel free to drop us a line at [editors@frontierexplorer.org](mailto:editors@frontierexplorer.org) and we'd be happy to talk to you about it.

Corporate Connections

# ONI-SENADA CORPORATION

Roy Crisman and "Indy"

In this first installment of Corporate Connections we have recovered material from lost web sites but have expanded upon it. Roy Crisman developed the Oni-Senada Corporation as a manufacturer of low quality knock-offs to plague the player characters with. Indy of the "Raiders of the Lost Dungeon" developed a low quality weapons failure table which was simple and easy to use.

The editorial staff of the Frontier Explorer has expanded on this material by developing fresh graphics for the logos of the knock off brands that the Oni-Senada creates to cash in on quality brand names with cheaper products. Taken all together this installment of Corporate Connection equips a referee with the material to slip dud items past the players in much the same way a fantasy genre game slips cursed items into treasure hordes.

The cheap and low quality items can be slipped into play as items carried by opponents that end up looted by the player characters, issued by a credit pinching employer or out-right sold to the PCs through a front business. To soften the blow of being sold bad items the players might earn a modest reward from the mega corp whose name was being infringed on by providing the tip that closes down the front business.

## THE ONI-SENADA CORPORATION

by Roy Crisman

When I was in high-school, I often borrowed a friend's calculator. It was a nice looking Sharp that could do everything we needed way back then. I started looking at its design one day and realized that the company name wasn't SHARP at all, it was SHRAP. The font, the color, and everything else were taken directly from the Sharp logo but this was a cheap imitation, and my friend paid for a Sharp. This became the inspiration for a Star Frontiers mega-corporation.

### ONI-SENADA (O-S)

Oni-Senada formed from the merger of two smaller corporations: *Onidata* which designed less expensive ways to produce products by simplifying designs of existing products and *Senada Manufacturing* which was a producer of medium to lower quality merchandise. The new company, while profitable, isn't necessarily the first name in quality.

Oni-Senada is the supplier of choice for those who can get by on less fancy products, have little money, or need equipment where having it is more important than quality. The company specializes in look-a-likes, generic versions, quality look with cheap construction, and buttons which do nothing. Low-tech and mass produced items, as well as less complicated lower yield high-tech items, are their specialty. One of the major benefits of the corporation is that they rarely put their logo where it is immediately visible or use front companies with similar yet legal look-a-like logos. Not all products made by Oni-Senada are low quality, they are just best known for the low quality ones: "No wonder...Oni-Senada!" being a clichéd punch-line and "Oni-Senada?!? Oh Crap!!!" being famous last words.

Many mega-corps do not appreciate Oni-Senada. This corporation floods the market with cheaper merchandise lowering prices and often lower public opinion of the other mega-corps products with their look-a-likes. But Oni-Senada is like a hydra, as soon as one area becomes non-profitable or risky they move on to the next area just as quickly. Since their production methods are cheap, there is little damage that can be done. Despite these annoyances to the other mega-corps, Oni-Senada does also benefit mega-corps as the public learns to distrust no-names and buys directly from chain stores.

### CORPORATE DATA

**Headquarters:** Lake Geneva, Rupert's Hole (Cassidine)

**Chief Executive:** Ernie G. Xagy

**Subsidiaries:** Look-a-likes of virtually every mega-corp or manufacturer of quality.

**Allies:** None

**Enemies:** Makers of quality merchandise and name-brands

**Occasional Opposition:** Anyone with taste

This happy Dralasite agrees that Oni-Senada shavers give the best shave on this side of the White Light Nebulae that credits can buy! Oni-Senada. A name you can always count on.

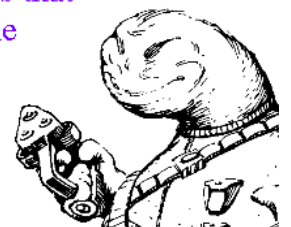

## SATURDAY NIGHT SPECIAL FAILURE TABLE

Poor quality weapons sometimes screw-up; in either minor or major ways. This is why there's a market for higher-cost, quality items. Sadly, some people insist on using cheap imitations (in some campaigns, the Oni-Senada corporation is infamous for making these cheap knock-offs). Here's what can happen:

On a to-hit roll of 98-00, check on the following table. Weapons of slightly better quality check this table at -10, really bad or damaged weapons check it at +10.

Roll	Result
40 or less	nothing
41-75	misfire
76-95	jam
96+	explosion

### PROJECTILE OR GYROJET WEAPONS

**MISFIRE** -- weapon doesn't shoot. Cycle action to remove round, then weapon may fire normally after this one turn delay.

**JAM** -- round lodged in action. On following turn, make DEX check; if successful, weapon may fire normally the next turn. If not, character may attempt DEX check in subsequent turns.

**EXPLOSION** -- round explodes in barrel. Weapon is ruined. Character takes 1d10 points inertia damage.

### BEAM WEAPONS

**MISFIRE** -- gun doesn't shoot, circuit not completed. No SEU used, gun may fire normally next opportunity (may be next turn, or same turn if ROF > 1)

**JAM** -- one of the weapon's components was fried (Blown Circuit). SEU lost, gun not useable until repaired (standard repair rules).

**EXPLOSION** -- catastrophic failure, weapon destroyed (and SEU lost). Character takes 1d10 electrical damage.

## CORPORATE LOGOS

By Tom Stephens and Tom Verreault

Here we present some of the corporate logos of both the real corporations and the Oni-Senada front corporations. Just like the products they sell, the corporate logos are knockoffs of the real thing.



Merco is allied with Streel and specializing in mercenaries. It aggressively goes after the Oni-Senada front corporation Morco. Emphasis should be placed on "aggressive".



Morco is a front corporation for Oni-Senada that dabbles in cut rate mercenaries and cheap arms. The corporation is not above maintaining contacts with pirates and smugglers.



The PanGalaxy corporate front has been used to sell cheap knockoffs of PGC goods. Fake PGC showrooms spring up and close rapidly before PGC can take action. PanGalaxy knockoff items make their way into the hulls of independent traders and shippers as well, though the Capellan Free Merchants avoid trading in PanGalaxy goods altogether.



The PanGal Corporation is famous throughout the Frontier for their show rooms. PGC lawyers constantly pursue infringements of the PGC name.



The Steel & Streal corporations are front businesses for Oni-Senada and are currently under investigation by Star Law for illegal banking practices.



Streeel Corporation is cooperating with Star Law in pursuing the perpetrators of several savings and loan scandals that tarnished the Streeel name by association.

Equipment

# A BLAST FROM THE PAST

This article contains a smorgasbord of equipment collected from various Star Frontiers sites around the web. Most of these items were lost on various sites that are no longer available and were found by digging through the Internet Archive.

## SOLVAWAY GRENADE

(Source: Roy Romero's Hole in the Wall website)

This grenade releases a foam that dissolves tangle thread within a 3 m blast radius. Otherwise acts as a regular Solvaway vial.

**Cost:** 200 Cr.

## ASBESTOS SUIT

(source: Roy Romero Hole in the Wall Website)

This protective suit is a fire proof garment that covers the entire body including head and extremities. A character wearing an Asbestos Suit takes no damage from Incendiary Grenades or other weapons that cause damage by fire. However, if the character takes damage from any other weapon, the Asbestos suit has been punctured/penetrated and only reduces damage from fire weapons by half instead of completely.

The Asbestos Suit also negates damage from exposure to fire that would cause up to 4d10 points of damage. However, if the suit is exposed to such an intense flame for more than 10 rounds it begins to fail losing 1d10 worth of protection each turn for the next 4 turns until it is useless.

**Cost:** 500 Cr, 3 kg

## SLING PACK

(source: Tim Carrier's Ephemeris website)

A sling pack looks like a normal bandolier sling for a rifle. However it can hold up to four standard powerclips and has an adapter like a power backpack. The sling draws from each clip in sequence and can be reloaded at any time (1 clip per turn). It can only power one weapon. The sling can be modified to be worn as a belt and used to power a pistol if necessary.

**Cost:** 40 Cr.

## LASER DESIGNATOR

(source: Indy's Raiders of the Lost Dungeon website)

Attached to a direct fire weapon, it projects a laser beam to the spot where the weapon will hit when it is fired (assuming it is correctly sighted in). It can be used in place of a scope or under the barrel in place of a grenade launcher / knife / flashlight mount. It could also be built into a specially designed scope. It gives a +10% to hit, +15% if careful aim is taken (in addition to the normal +15% modifier for a total of +30%). A light shift screen (Zeb's Guide p69) negates the effects of a laser designator (unless IR optics are used with a special IR laser designator), as does a nightfall grenade (ZG, p69), while a dusk grenade (ZG, p 68) limits it to a +5% unless starlight optics are used. It is powered for 400 hours of use on two SEU microdiscs (ZG p63).

**Cost:** 200 Cr.

## PSIONIC SCRAMBLER

(source: Tim Carrier's Ephemeris website)

This device broadcasts random patterns of brainwave frequencies. It is powered by an SEU microdisc for 10 days (but see below). It prevents the use of Telepathy, Empathy, or Illusion disciplines on creatures within 5m of the device, and further gives a -10% on the use of other disciplines targeted on a creature within that area.

The device can also be used at high power, and uses 1 SEU/hour. The area of effect is increased to 50m, and additionally causes a -25% penalty within 20m.

When on high power, a mentalist takes -5% on ALL disciplines as long as he's within 20m, and for as long afterwards as he was in the field (i.e. if the mentalist is within the field for 10 turns, he continues to suffer the negative modifier until 10 turns after he left the field.). A mentalist takes a -10 on ALL disciplines while he's within 5m, and for afterwards for the same amount of time, then a -5 for as long as he was within 20m (counting time within 5m, of course). Note that the -5 or -10 penalties are not cumulative with each other.

Any mentalist will notice such a field upon entering it (or when close to it) and the approximate direction of the center. Telepathy or Empathy use will detect such a field

if a normal check for the discipline succeeds with no negative modifiers.

Each minute of high power use there is a non-cumulative 1% chance for burnout or overheating.

Weight: 45 kg

*Note: This item was not described with a cost or wt. For that reason I don't think it was intended to be a regular equipment list item. Thus I will not present it here with cost but instead label it a prototype item and assigned a heavy weight to it.*

## MICRO LASER

AD: Micro Laser/ Dam: 1d10/ Ammo:10 SEU clip/ SEU: 1-5/ Rof:1/ Defences: Albedo/ PB:0-5 Short:6-10 Med:11-15 Long:16-25 Ext:26-50/ Mass: 0.4 kg Cost: 850 Cr. (due to rarity)

Zeb's: Ke-600 (Micro Laser)/ Range: A/ MaxDam: 7ps/ Ammo: 10 SEU clip/ SEU Use: 1-5/ Rof:1/ Effective Def: Albedo, Grid/ Mass (kg) 0.4/ Cost: 850 Cr

## YAZIN'S ARMORY: MICRO LASER

by M. Crymble

Slim: "Hi all! I'm Slim the Dralasite. I am a member of a group you may have heard about, known as Force Five Inc. My simian friend Yazin asked me to share a few of the items the force has collected or made in our travels. Weapons are always a hot item, and today, that will be our focus."

[Slim walks over to a table filled with wicked looking stuff and picks something up]

Slim: "This is the 'Eversafe Arms' Micro Laser. Many of you may not have known that Eversafe Corp dealt in the arms market. This is one of their rare efforts and is a departure from other companies' products. As you can see, the weapon is simple in design and very small. Sentients with smaller hands should be able to work this weapon with ease. It is made diminutive to be easily concealable and is smaller than even the Ke-1000 laser pistol.

The Micro Laser is Eversafe's bid to fill the gap between the Rafflur M-1 and the Ke-1000. The Micro Laser is exactly that. It is favored by people who wish to appear unarmed and it is a good backup weapon. It is carried by undercover Star Lawmen and Intelligence agents quite frequently. Some uniformed Star Law, as well as special operations personnel, carry the Micro Laser as a backup weapon. Although it is not issued by any institution as far as I know, it fulfills the backup role well.

The Micro Laser is designed to have a smooth exterior so to be easily drawn. The sights are simple iron type sights, but are adequate for the weapon's range. The small weapon only accepts mini powerclips and cannot use

standard powerclips. The weapon can be attached to a power belt or backpack however, though this is rare. The non-slip finger grooved grips provide a comfortable firing hold, and the weapon is accurate at closer ranges.

Although the Micro Laser does have a power setting like most lasers, the weapon is so small that it can only be set from 1 to 5. The weapon, when used, is often set to the maximum setting and can be devastating at close range. This will of course give the user only 2 shots in most situations."

[Slim holds the weapon and fires it against the target 5 meters away]

***FWWWWZAP!***

"As you can see, the weapon has almost no flare baffles and very little in the way of heat exchange other than the cooling shroud. The firer will often feel a hot flash in his hands as the weapon is fired, and it is not recommended to be held close to the body when discharged. This poor cooling system results in the micro laser having a lower rate of fire than most weapons.

The lack of flare baffles makes the weapon a dazzling experience to fire at night. This unfortunately has a tendency to give the firer away, though this is not often a problem. When fired, the micro laser is usually used at close range, and this often precludes the firer's concealment."

[Slim walks to target, a burned hole is apparent in the metal.]

"You can see here that the laser has good power for such a small weapon. This burn is from the highest setting, lower setting's results will not be quite as respectable.

Concealment of the weapon is achieved differently by each of the major races. Many bipeds conceal at the ankle or small of the back. Vrusks might consider the base of their torsos. Humma can conceal this weapon strapped to their belly. Some Dralasites might be able to absorb this weapon into their bodies and conceal it, though I would not recommend this due to the danger of accidental discharge.

In conclusion, the Micro Laser is an excellent choice for a backup or a small easily concealed weapon. It is not the most comfortable weapon to hold while firing, but delivers respectable damage to the target. Its power reservoir is small, but is adequate for a few shots. Care should be taken in the discharge of this and all deadly weapons. Range is limited, so a target must be close for the laser blast to be effective."

Slim: "Well, that's about it for now. Tune in soon when we will cover other nifty items for adventurers everywhere."

[Signal Ends]

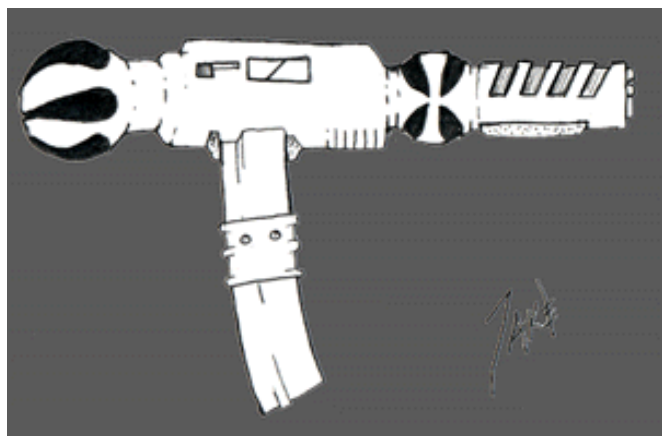

## RAZOR GUN CARBINE

(source: M. Jason Parent's Star Base Hellhound)

The RazorGun Carbine was introduced to the public eye during a daring anti-terrorist action by Star Law operatives. Soon it became synonymous with anti-terrorism and with the Star Law Anti-Terrorist Operations Division. The brutal black lines of the RazorGun Carbine are very reminiscent of old fourth-generation sub-machine guns or assault rifles, with the magazine in front of the main grip instead of inside it or behind it.

What makes the RazorGun Carbine so useful is the multi-role versatility it has demonstrated. The basic design is that of a needle gun, loading standard needle ammo, but capable of full auto-fire. Since needle ammo is more effective against soft targets than conventional munitions, the advantage is immediately obvious.

But the main advantage it has in anti-terrorist ops, is that it can also load sleep-dart ammo, dealing less damage when fired into potentially friendly environments, and also delivering significantly more dosage due to its multiple-hit probability (during burst fire, treat sleep loaded guns as standard autopistols for burst rules, but for each point of damage done above 10 points, reduce the target's STA by one for purposes of the stun save).

## WHOOMP NEEDLER

(source: Roy Crisman's Hole In the Wall web site)

These needler guns are capable of firing needles which can pierce skienisuits. The needles must be specially produced by Whoomp and are only capable of being fired by Whoomp needler weapons. Skienisuits provide no protection from these weapons and take no significant damage as the needles pass between the fibers. There are 4 different types of Whoomp Needler weapons

- **Whoomp Needler L1:** This pistol (type I) version can only fire Whoomp needles. Mass: 1kg
- **Whoomp Needler L2:** This rifle (type III) version can only fire Whoomp needles. Mass: 3kg
- **Whoomp Needler L3c:** This pistol version fires Whoomp magazines or ordinary needler magazines. Mass: 1.25kg
- **Whoomp Needler L4c:** This rifle version fires Whoomp magazines or ordinary needler magazines. Mass: 3.5kg

**FE**

Weapon	Rate	AD Range	ZG Range	Cost	
Razor Gun Carbine	3 or burst	0-5/6-10/11-20/21-40/41-100	B	950	
Whoomp Needler L1	3	0-5/6-10/11-20/21-40/41-100	B	400	
Whoomp Needler L2	3	0-10/11-20/21-40/41-75/76-150	C	700	
Whoomp Needler L3c	3	0-5/6-10/11-20/21-40/41-100	B	500	
Whoomp Needler L4c	3	0-10/11-30/31-75/76-120/121-250	D	900	
Ammo	Damage (normal)	Damage (burst)	Defense	Rounds	Cost
Barbed (standard)	2d10	10d10	Inertia	10	10
Barbed (extended)	2d10	10d10	Inertia	20	20
Sleep (standard)	1d10 + sleep	5d10 + sleep	Inertia	10	10
Sleep (extended)	1d10 + sleep	5d10 + sleep	Inertia	20	20
Whoomp Pistol clip (normal)	2d10	n/a	None	12	15
Whoomp Pistol clip (sleep)	1d10 + sleep	n/a	None	12	15
Whoomp Rifle clip (normal)	3d10	n/a	None	12	25
Whoomp Rifle clip (sleep)	2d10 + sleep	n/a	None	12	25

# RIDDLE ME THIS, PUZZLE ME THAT

Tom Verreault

Riddles are an uncommon staple in role playing games. The idea of including a riddle in a RPG adventure is popular, though the actual implementation probably uncommon. I remember thinking once that I should include some riddles in a fantasy game but I could only think of the riddles famously used in “The Hobbit”. Unfortunately, all of the players in my game had read that book as well so I abandoned the idea for that adventure. Puzzles, like riddles, show up as challenges in a RPG adventure and can be boring or challenging depending on if they’ve been previously seen or not. Again the implementation is probably less common than the desire to use them.

Martin Ralya in his gaming blog, [Treasure Tables](#), defined what a puzzle is in the RPG arena as well as giving four guidelines for what makes a good puzzle. His definition of a puzzle (and this can apply to riddles too) is any game/world activity that is played out and solved primarily (or entirely) by your players in the real world. It is not a puzzle if the solution is handed out by a series of die rolls.

## GUIDELINES FOR A GOOD PUZZLE

***“It can be solved in 15 minutes or less. A puzzle shouldn’t take your players more than 15 minutes to solve. If it does there is the risk of the average group getting frustrated — and of that puzzle derailing the evening’s session.”***

On one occasion a referee sprung a series of logic puzzles on myself and the other players and smirked over the course of two sessions, thinking it funny that we could not solve them. This experience was more frustrating than fun and constituted a huge delay of game.

***“It includes a mechanism for providing hints.”***

If the players are stumped allow for character skills to generate a hint. In the above example I felt the referee was laughing in his sleeve and I had to suppress the urge to throw a hard cover rule book at him.

***“It involves the whole group. Not every player enjoys puzzles, and chances are your group includes at least one person who isn’t overly fond of them. Any puzzle you include needs to take that player into account. If you know why that player doesn’t usually enjoy puzzles***

***(perhaps because you asked them about it before the session), try to design or choose your puzzles accordingly.***

***You can also employ the time-honored GMing technique of simply asking them what their character is doing while the party tries to solve the puzzle. Sometimes it’s easier to engage players who don’t like puzzles on an in-game level than a real-world level — they’d like to contribute, but they’d rather base their contributions on their character.”***

This is good advice and to it I would add that great props draw people in. If you’re going to hand out a puzzle on a photocopied sheet, make enough for all the players and not just one. With only one copy of the puzzle, it limits the number of players who can actively work on it leaving some to tap their toes and wonder when the game will get going again.

Actually making the puzzle prop for the real world can heighten interest as it provides a focus for the players in the middle of the gaming table. When I was starting a new campaign I concocted a situation where the players found a dead body with a map and a letter. The letter was written by the dead man and detailed 3 locations where he had hidden treasure. The map was a board with nine circular 1 inch depressions set close together in a 3X3 pattern. There were matching 1 inch circular tiles that went into these depressions and on the tiles were bits of the map. It was a literal puzzle in that they had to figure out the puzzle map but the challenge came in to play as the puzzle pieces, being circles, gave no clue as to how they might go together. I made the board from clay and the tiles from 1 inch wood disks.





For several sessions in a row the players agonized over whether they had deciphered the clues on the disk to get the map right, until they found a cartographer selling maps and were able to buy a local map and proof their tile map. The fact that I set out a real prop engaged everyone and became the focus of 15 minutes of time while they discussed options for where to travel to look for treasure. I also put into the dice pouch that the tiles came in one extra blank tile as a curve ball but also put X's on the backs of the tiles where the three treasure locations were. The beauty of it was that the puzzle was used for several sessions and is completely recyclable in the future with new map tiles. The only downside to doing this is that you have to be a little bit creative and take the time to build such a prop.

***“It doesn’t have to be solved. There has to be a way for the PCs to progress even if they can’t solve the puzzle. There are lots of options when it comes to building this element into your puzzles — here are two suggestions.***

***The first is to make the puzzle part of a side quest or subplot — a section of the adventure that, by definition, can be skipped without negatively impacting the main event. The second is to include an escape hatch: an ambush that occurs at the 15-minute mark, a hint that will automatically be revealed after a certain amount of time or a change in circumstances that allows the party to bypass the puzzle entirely.”***

This is very important. A puzzle should never derail the adventure or halt the game. As the referee, you should also be watching for signs of frustration in the players and provide hints to move the game past the puzzle.

## USING RIDDLES

The guidelines for puzzles are equally important for riddles. A good riddle should not delay the game, have a mechanism for hints, and the adventure should be able to progress with or without solving the riddle.

*Example: An eccentric yazirian built a vault with an unusual key. He left clues concerning the key in the form of a series of riddles. The key hole is equally mystifying as it is an unusual pattern of five holes.*

The first riddle in the eccentric yazirian example is, “A city with no people,” and the answer is “electricity” but if the players don’t solve it then the referee can call for a LOG check and tell the player that his character doesn’t think it’s a real city but perhaps a word with city in it.

The second riddle is, “As I walked along the path I saw something with four fingers and one thumb, but it was not flesh, fish, bone, or fowl” and the answer is “glove.” The two riddles give you electricity and glove which should spur the average Star Frontiers player to think of shock gloves from the equipment list (though the referee could have primed the players to think of shock gloves by having them encounter a character using them before they discover the riddles).

The players will be able to enter the vault by wearing a shock glove and poking the fingers and thumb into the series of five holes or if they’re totally stumped they can blow the vault with explosive as well. However, using explosive should have consequences like damaging some of the vault’s contents or drawing unwanted attention.

## RIDDLES CAN FUNCTION AS LOCATION OR TIME CLUES.

Many riddles have answers like water, mountain, shore, library, and etc. Use these riddles to direct the players to the location they need to travel to. Researching the internet will turn up a variety of riddles that can be used in this way and I’ve included a sampling below.

*The building with the most stories.* - “the library” (Used in a city the players may first go looking for the tallest building)

*When does a boat show affection?* - “When it hugs the shore.” (Could be used to describe a location where a ship is beached on a shore or where several boats are anchored close to shore)

*What can run but never walks, has a mouth but never talks, has a head but never weeps, has a bed but never sleeps?* - “River” (This is a straight forward location and easily used as a clue.)

*How far can a dralasite walk into the woods?* - “Halfway then he’s walking out.” (Could be used to describe a general location in the woods or within a similar terrain feature.)

*What crosses the river but doesn’t move?* - “Bridge” (A very specific location clue.)

*What runs smoother than any rhyme, and loves to fall but cannot climb!* - “Water” (Could be used to describe a local water feature, perhaps a water fall.)



*What is made of wood but has never been cut?* - “A tree” (A very general feature but if there is a unique tree in the local environment this is a good clue.)

*What is so bright in the day and very far away?* - “the Sun” (Included since Star Frontiers involves adventure in space.)

*They come at night without being called. They're lost during the day without being stolen.* - “stars” (This clue is less about place than it is about time and could be telling the players when an action must occur.)

## BUILDING AND USING A PUZZLE FOR STAR FRONTIERS

The tile puzzle map that I described above will, with a little reworking, work as a great puzzle for a Star Frontiers campaign. The following is a puzzle map designed specifically for the Star Frontiers RPG that will be the significant focus of a campaign. It could represent an archaeological artifact found on Laco and connected to the Tetrarch ruins or be a space pirate's map showing locations of cached treasure and hideouts. In either case the campaign would involve obtaining all the map pieces, figuring them out, and traveling to various star systems to complete the campaign.

Obtain two pieces of wood or hard board 10.5 inches wide by 8.5 inches long and about ¼ inch thick. On one, lightly draw out a ¼ inch grid horizontally and vertically like graph paper. This will give you a grid that conforms to the size and dimensions of the Frontier map from the Alpha Dawn rules. Now choose about 8 of the inhabited stars and four of the unexplored stars from that map and mark them on the grid. After they are marked drill them with a 5/32 drill bit (basically 1/32 bigger than a ¼ inch to accommodate the puzzle pieces) and sand smooth all edges. Next glue the two pieces of wood together with wood glue and pressure (clamps or heavy weights on top) being sure to wipe away excess glue from inside the holes. Once dry, spray paint black and you now have a map board showing star systems in space that were significant, for some reason, to the map maker.

Next obtain ¼ inch wooden disk from an arts and crafts store or cut some from ¼ inch dowel. These coins should fit into the holes of the map board without getting stuck. Paint each disk a different color with an eye to making each look like a different kind of stone and on a handful paint cryptic symbols. Decide which disks go into which holes and document this.

Now you're ready to introduce the map to the players. Describe the board as black obsidian and the disks as stone coins. The coins seem to be no two alike. In the archaeological campaign, the player characters will first

observe the coins being sold by a scruffy looking artifact smuggler to another buyer as “tetrarch money.” Later when they discover the board and a few coins they realize they might just need the rest of the coins. This leads to a varied quest for the artifact smuggler and his buyers. In addition one “coin” has found its way into a museum and could be very difficult to obtain or gain access to.

Once they have the map, the clue to where each coin goes lies in the fact that each is made of stone. Analyzing the stones or even just close examination of them should reveal that they are all different and from different sources. Any environmentalist, geologist, or competent scientist should be able to tell which is sandstone, marble, granite, or crystal. Further investigation will reveal that each comes from a specific planet; the crystal “coin” is Volturian Quartz, while the sandstone “coin” is from Clarion, one of the granite “coins” matches granite from Minotaur and etc. Some of the stones will not turn up in any database as they are from unexplored worlds. Even if the players fail to realize the nature of the stone “coins” they can still progress with the puzzle if they simply realize that it matches the map of the Frontier.

The campaign then transitions to visiting locations shown by coins with cryptic symbols on them and should take on an “Indiana Jones” flavor of adventure. Ultimately, the full map used with other tetrarch artifacts could be a navigational device. If the board is placed into the helm of a derelict tetrarch ship and one stone is placed into its proper place, the ship calculates the void jump to that star system and transports the whole ship there within minutes saving the players the time and effort to calculate a void jump and accelerate to 1% of light speed.

If the map is a pirate's map then the campaign will be a fairly straight forward treasure hunt but with competing pirates, Star Law marshals, treasure hunters and insurance agents for complications.

Just running down and obtaining all the pieces can take several sessions while the players are still figuring out details of the map. At some point a “Rosetta Stone” could be found that will let the player's decipher the cryptic symbols on the coins as well.

Note, a rectangular map should be readily recognizable as the Frontier map but a circular or even triangular design may be more mysterious and could include star systems not on the Alpha Dawn map. A large circular map could represent the Tetrarch's view of the local galactic sector. The basic idea for this map can also work as just a system map showing the star and planets with the catch that the planets must be in relative locations shown on the map because something important will happen or be revealed when the planets are in this exact alignment.

# DEALING WITH POWER CREEP

Tom Verreault

Power Creep is a common problem in most role playing games. The term “power creep” describes a situation where the player characters become so powerful that a referee is forced to trot out progressively more powerful enemies and common street thugs need not apply. In Star Frontiers power creep can occur on two fronts: equipment and skills. Power creep with skills can happen when a player has pushed a skill to level 6<sup>th</sup> and in most circumstances becomes a one hit wonder with that skill. In the area of equipment, it naturally happens through the accumulation of wages, captured equipment, and issued equipment.

## POWER CREEP IN SKILLS

Power creep in the skills area is really the natural progression of the game. Game play results in experience points that are spent on skills and abilities which make the player characters naturally capable irrespective of their equipment. There are no game mechanics for taking away skills and abilities other than combat modifiers for the effects of wounds and etc. It may be possible to introduce story elements that strip player characters of skills or abilities. I strongly recommend against that as it is a recipe for player resentment. It may be possible to do it carefully but it is counter to the point of the game.

If the player characters have become too powerful due to skills and abilities there are two strategies that can deal with that.

## ARMAGEDDON

Armageddon is the climatic battle of good and evil in the Bible; sort of a battle of all battles. Craft a climatic campaign that embraces the worst of power creep in the adversaries and allow the player characters to go out with a bang. If you have time to plan ahead and see power creep coming down the road, ask the players what they envision for the character and file their answers away. If power creep is already upon you then you can even discuss the situation with the players suggesting an Armageddon campaign to them before starting new with new characters. Their feedback will guide you in campaign creation and help you deliver a satisfying climatic game. They may wish to simply retire the characters quietly and move on to a new gaming experience.



## CHANGE THE ENVIRONMENT

Another strategy for dealing with skills power creep would be to change the environment. Carefully write adventures to feature more role-play and problem solving elements. Some players may not like the shift in game focus away from combat so a referee should watch for signs of apathy and restlessness in the players. Hostile weather, disasters and environments can provide threats to player characters despite their skill levels. It won't really matter what their skills are if they're freezing to death or facing an advancing wall of lava.

Another way to change the environment is to move the characters into dealing with alien environments and technology. This automatically carries a -20% modifier to all skills, effectively stripping them of two skill levels and making challenges more difficult.

## EQUIPMENT POWER CREEP

Advanced and high level Star Frontiers gaming has long been characterized by greater amounts of or more expensive equipment. Through the natural process of earning wages, stripping the enemy dead, and hanging onto issued equipment, player characters can amass a large stockpile. I once heard the “levels” of Star Frontiers described as; low levels involving player characters walking around doing stuff, mid levels involving PC's riding around in vehicles doing stuff, and high levels involving PC's riding around in spaceships doing stuff. This dovetails with the progression of “Alpha Dawn” action to “Knight Hawks” action caused by the original

skill rules that characterized starship skills as advanced skills.

Over the past decade the trend in fan re-writes of the skills rules has been away from starship skills being advance skills. This consequently leads to a trend to introduce starship ownership to the player characters earlier in the game. Naturally that exacerbated the power creep trend.

Cost is the natural game limitation on powerful equipment. The rules state that half a player character's paycheck should go to cover simple cost of living expenses. It's a rough rule of thumb but probably one that most referees ignore especially if the player characters live on a starship. I recommend that the rule be enforced from the beginning with the percentage being reduced to a quarter of the pay check if they have access to free or cheap accommodations. Also nothing lasts forever. From the beginning have equipment break and malfunction so that just keeping a vehicle or starship running becomes a significant cost. Damage control during and after a battle can set battle damage to rights but this should only be considered a temporary or jury rigged fix and require an expenditure of money and time after the fact to make the repairs permanent.

## BE CAREFUL

Never arbitrarily take things away from the player characters; this breeds resentment. If the strategies for limiting power creep are consistently used from the beginning of the campaign, players will automatically accept them. If the campaign is in progress and power creep has set in, it can be difficult to institute these measures. In this case introduce them slowly. If all else fails let the player characters go out with a big bang.

FE



Tom Verreault

# STAR FRONTIERS NETCON 2013

September 27-28, 2013

Are you interested in refereeing or playing in one or more on-line Star Frontiers games? Do you want to connect with other members of the Star Frontiers community directly instead of just via the forums? Or maybe you just want to listen in and see how others play. Here's your chance. Register to participate in the [Star Frontiers NetCon 2013](http://starfrontiers.info/NetCon/2013).

A follow-on event to the successful Virtual Con held in March 2012, SF NetCon 2013 is a day and a half focused on getting together as a community and playing Star Frontiers, in whatever flavor you like. You can play on-line or organize a local in-person group for one or more sessions. The exact date hasn't been finalized yet. Check the website for more details.

There will be nine potential game sessions starting Friday afternoon/evening and running all day Saturday designed to accommodate almost any schedule. Sign up for as many or as few as you'd like.

Want to referee a game? Great! Once you've registered, you can set up a game in any of the sessions that work for you. You pick the technology you want to use to run the game as well as the rule set you want to run.

Looking to just play? Every game needs players. Browse the schedule and game descriptions and sign up for the ones you like.

The Con is completely free (although you might spend a buck or two on munchies). We are also looking to produce a Con patch again for this con like we did for the Virtual Con 2012. The patch will be available to all participants. The cost of the patch will be \$5-\$10 depending on the interest (more interest = lower price).

We look forward to seeing everyone on-line and playing Star Frontiers in September.

To find out more about the Con and to register, visit the Con website site at:

<http://starfrontiers.info/NetCon/2013>

# TO LIVE AND DIE IN STARLIGHT

William J. Wilson

**Location:** Near The Moon's L-4 point

“Lieutenant Armel, what do we have left?”

On a normal day, Lieutenant Commander Larssen, Captain of the *HCS* (High Colonial Ship) *Korona*, would have not been so urgent in her question. This day was far from normal; it was day three of a battle between Earth's forces and the High Colonial Rebel fleet. The largest battle to date in the civil war would now be added to their ship's record – if they survived.

It had been almost six years since the war started. That was when the colonies on Earth's Moon revolted against the Air Tax. The Governing body of Earth, ruled by their NOPL (New Order of the Promised Land) doctrine, felt that living off of Earth was a transgression against God. It didn't matter that Earth's hungry billions relied upon colonial support for resources. The government kept that information hid from the populace, maintaining the image of being the “All-Providing Prophets.”

NOPL, in its divine wisdom, sent marines to the Moon's largest city, New Kiev, and depopulated it. 740,000 exposed to space the hard way. The shock of this action sent all of the other worlds in the Sol System – the High Colonies – into revolt.

The revolt didn't go well. NOPL forces recaptured the inner planets and were moving into the Jovian and Saturnian moons. The rebellion might have been crushed if it weren't for the wisdom of a former Martian businesswoman-turned-admiral, Katrina Mendoza. She, along with help from Heinrick's Claim – an extra-solar colony world orbiting the star Sirius – helped to turn the tide of the war in the Rebel's favor. Her actions led the massive multi-colony fleet to this confrontation: the bulk of their fleet against what NOPL could muster. They were outnumbered three to one, but they had Admiral Mendoza.

The first two days of the battle, being fought near Trotsky Shipyards – the largest array of shipyards at The Moon's L-4 point – were a grueling display of absolute brutality. The Earth forces, governed by their NOPL doctrine, would neither give nor accept quarter. These shipyards were the only yards available to Earth, as no such facilities existed on the planet anymore. If Earth lost these yards, the planet would no longer be able to continue their aggression against the rebelling High Colonies. Their fury and tenacity would be unrelenting.



Larssen's ship, the *Korona*, was a 2000 cubic meter missile destroyer. Her main weaponry were the munitions she could deploy: from small-class anti-frigate missiles to heavy anti-battlecruiser torpedoes. The only “guns” she had were short-ranged anti-fighter/missile lasers. Her mission profile was to be in the rear-guard, striking with the long-range missiles. In battle, however, things never go to plan. Admiral Mendoza's tactics, however, were superior. The way she maneuvered the fleet around NOPL forces was like a dancer around a stage. After three days of near-continuous fighting, pausing only for a few hours to regroup and rearm however the ships could, everyone was bleeding.

The *Korona* herself was bleeding badly. During the latest engagement with the enemy, she suffered wave after wave of fighter squadrons which her wing fought off desperately. The *Korona* was fortuitous in one way by being the only ship in her wing still active in the fight. How active she was, Captain Larssen was trying to ascertain.

“Lieutenant Armel, respond!” Larssen repeated.

“Damage reports coming in,” Armel finally responded. “Missile batteries one through five are out of commission without dry-dock. Six through eight are being repaired now. Nine and ten are online.”

“What about propulsion?”

“Plasma thrusters are online, but we lost much of our propellant fuel. I estimate we have only about 17 thrust-

hours left. Reactor is back online. Battery cells are still okay. I do not have the data for Life Support yet.”

“Very well,” Larssen said, resigned, “keep me posted.”

“Aye, Ma'am.”

“Mr. Fry,” Larssen turned her attention to her Weapons Officer, “what do we have in the remaining tubes?”

“We have Mark-2's in Battery Nine, Mark-5's in Battery Ten, Ma'am,” Fry responded.

Larssen visibly showed a glimmer of hope at this news. Even though they were badly crippled, they were far from spent.

“We also have six remaining Mark-6 missiles and two Mark-10 torpedo loads in the magazine left,” Fry continued.

“Even better!” Larssen exclaimed. “Fry, prepare the Mark-10's for loading! Helmsman MacAuley, Plot me a course that will get us in range of the cruisers!”

“Aye aye, Ma'am,” MacAuley replied. “plotting an intercept course to --”

A white flash appeared at the Two-O'-Clock position on the view screen relative to the ship's bow – towards the region of the flagships.

“Sensor Ops!” Larssen yelled, “What was that?!”

Sensor Operator Sashti looked back at the Skipper with a pale look on her face.

“Skipper, I believe it was the *Gate*.”

The Lieutenant Commander balked at the reply. The *Tannhäuser Gate* was THE flagship of the Rebel fleet, Admiral Mendoza's personal ship. If that explosion was her battleship...

“Sensors,” Larssen was visibly shaken. “FULL SCAN! GIVE ME CONFIRMATION NOW!!”

“Confirmed, Ma'am. It was the *Gate*.”

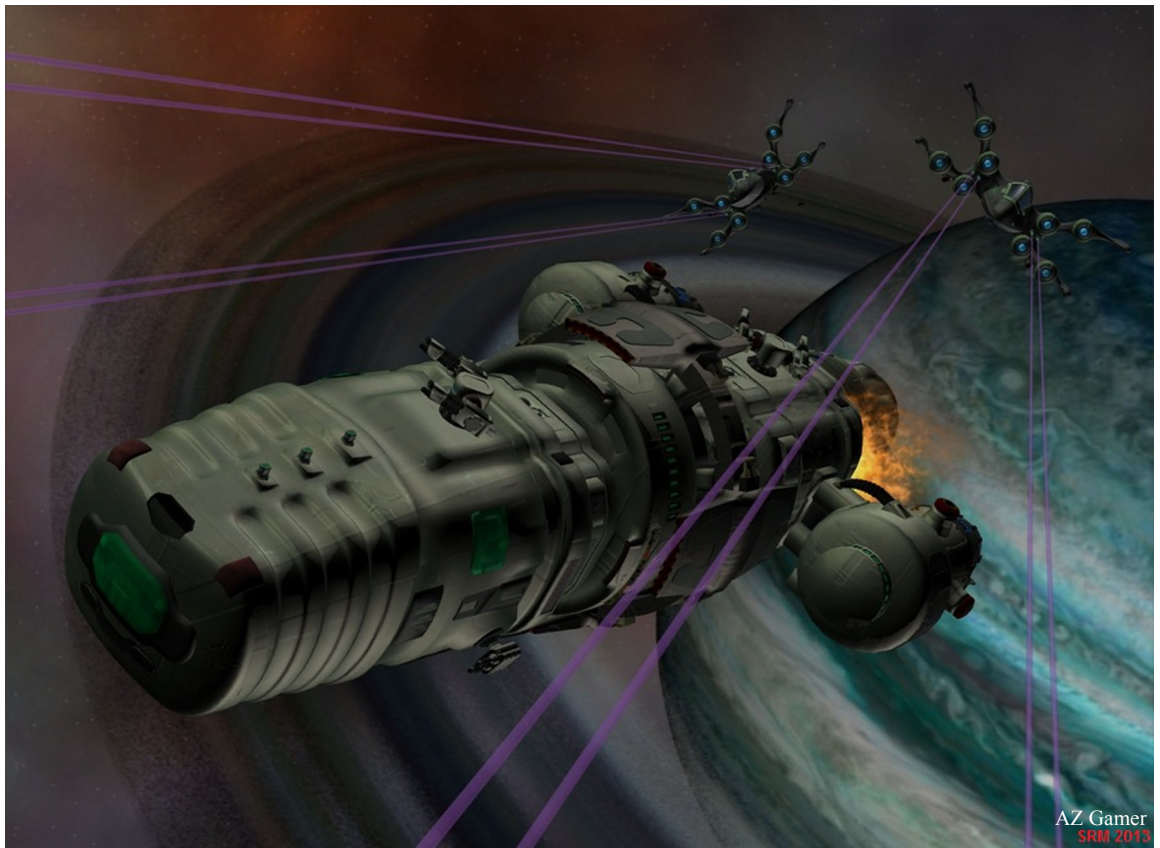

The last attack on her must have hit a munitions magazine. The ship became a star – for a few moments – then only black.

Larssen stopped straining against her seat straps. She was not even thinking about the fact that, if the restraints were suddenly released, her legs would've slammed her into the bulkhead in the weightless environment. She quickly recovered her composure – and her resolve.

“MacAuley,” She ordered, “continue my last order. Give me a vector!”

“Aye, Ma'am,” MacAuley replied. “Applying full acceleration!”

The admiral may be dead, but the battle was far from over.

The *Korona* thrust forward toward the NOPL core fleet. Her thrusters were capable of 4-G acceleration and she was using it. Her remaining missile ports were opened and ready to launch.

“Skipper,” Ensign Fry reported, “Damage Control reports Missile Tubes Six through Eight are online!”

“Excellent!” Larssen exclaimed, “Load Six and Seven with Mark-6's. Load Eight with remaining Mark-10's!”

“Aye, Ma'am. Weapons report it will take ten minutes for reload.”

## Frontier Explorer

“Good. In the meantime, Ensign, give me a firing solution. Give me something to shoot!”

“Aye, Ma'am. I think I have successfully targeted one of their carriers. Looks like a 20,000-tonner. Plotting firing solution now.”

“Helm,” Larssen ordered, “Cut acceleration! Orient ship for a missile run!”

The *Korona* cut her thrusters, putting the crew back to micro-gravity.

Ensign Fry worked feverishly at his console. The readout indicated that he had a strong fix on the carrier's position. His console reported the Mark-5's ready to fire.

“Skipper,” Fry reported, “I have a firing solution on the carrier. Mark-5's ready to go.”

“What about the heavies?” Larssen asked.

“Still have about four minutes before load completion.”

“Damn! This firing solution will not last. FIRE!”

An array of missiles spit out of the *Korona*. They blazed across space in a streak of fire at maximum velocity. The NOPL carrier – the 20,000 cubic meter *Apostle* – started to fire its anti-missile batteries. Half of the missiles were blasted by the laser fire; the other half made it to firing range. The warheads exploded, the energy from the explosions pumped the generators and fired their coherently-focused X-ray beams at the target

microseconds before the explosions consumed them. The hull of the *Apostle* ruptured, subsystems being vaporized by the beams.

“Considerable damage to the carrier,” Fry reported to the Skipper, “Her engines are cooling down, but power is still registering.”

“Do we still have a firing solution?”

“Yes, Ma'am.”

“We have anything left?”

“Not yet, Skipper. The tubes will take another 10 minutes to reload and we only have the Mark-2's and they might not be able to cause much damage to.... wait... Ma'am, Weapons reports the 6's and 10's are loaded now!”

“FIRE THE 6's!!!!”

The Mark-6 missiles were not X-beam pumpers; their warheads contained high-yield fusion warheads, as did all of the High Colony's missiles above Mark-5. This time, however, the *Apostle's* lasers did not fire. The missiles detonated without interference.

The *Apostle* flashed in an astounding series of white star-like blazes that almost matched the *Gate's* magnitude. Almost.

“Ma'am!” Fry exclaimed. “The *1<sup>st</sup> Commandment* is in range!”

The *1<sup>st</sup> Commandment* was NOPL's flagship. Her 35,000 cubic meter hull could not be mistaken. She showed signs of extreme battle damage, like every other ship in the battle, but she was far from out of the fight – just like the *Korona*.

“Fry, tell me you have the 10's prepared.”

“Yes, Ma'am. Firing solution being plotted now.”

“Very well, you may fire when ready.”

“Aye, Ma'am. Solution imminent... correcting... There! Firing!”

The Mark-10's flew out and traveled to their destination. Anti-laser fire started to work, then stopped. NOPL fighters, which



AZ Gamer  
SRM 2012

originally seemed to be on intercept vectors toward the Rebel fleet, suddenly changed course....

“Sensor Ops, plot the fighters' vector!”

SO Sashti acknowledged the order and started computing.

“Ma'am,” she replied, “they look like they're going for the missiles!”

And after them they went. If the fighters couldn't shoot them down, they rammed them with their craft. None of the missiles managed to reach their target.

“Weapons, RELOAD NOW!!”

The *Korona* frantically reloaded her Mark-10's, her last load of the heavies. The Captain of the *Korona* decided to make a fateful decision.

“Helm,” Larssen ordered, “set a course toward the *Commandment*, maximum thrust.”

“Ma'am?” the Helmsman asked.

“You heard me, FULL THRUST! Get us right up the *Commandment's* nose!”

“Aye, Ma'am,” MacAuley replied.

The *Korona* thrust forward. During the eternity between missile loadings, the ship sped toward her destination. Remaining fighters vectored in. *Korona's* defense lasers came to life. A NOPL missile frigate launched her ordinance at her, and was pulverized in return by the remaining Mark-2 load. The *Korona* made her way toward the *Commandment* and was right inside the anti-missile laser range when her thrusters were vaporized.

“Captain, this is Engineering, Armel here,” The Engineer's face was on the vidscreen. “We lost power to thrusters. That last blast lost us our fuel so, even if I can get the thrusters online, the point is moot.”

“Do we have any power at all?” Larssen asked.

“I have re-routed power to weapons. You have enough for one shot.”

“That's enough. Weapons, THE KITCHEN SINK! EVERYTHING WE'VE GOT!!”

The *Korona* launched whatever missiles she had. Her lasers fired as well. The *Commandment* started to rupture. Her reactor, however didn't flash, as it wasn't fission-based; the hull just went dark.

*That was for the Admiral,* Larssen thought to herself, *Katrina, that one was for you...*

Lieutenant MacAuley looked at her Skipper. “Ma'am, we have no power other than the emergency batteries. What can we do?”

All the eyes of the bridge were on the Captain. Lieutenant Commander Larssen was about to speak when the Communications Officer, Petty Officer Sweeny, spoke up.

“Skipper,” Sweeny said, “we have an incoming transmission from the *Mjöltnir*.”

The *HSS* (Heinrick Space Ship) *Mjöltnir* was a 25,000 cubic meter battlecruiser from Heinrick's Claim. Her Captain, Commodore Agnetha Trygstad, was one of the first officers of Heinrick's Claim's Navy that spoke in favor of war with Earth to the government.

“Put them on,” Larssen said.

The speaker in Larssen's helmet relayed the transmission:

“To *HCS Korona*, this is the *HSS Mjöltnir*. Repeat: this is the *HSS Mjöltnir*. We are aware of your status. We are matching vectors and will deploy grappling protocols when in range. How is your life support?”

“Roger, *Mjöltnir*,” Larssen replied, “Life support holding on battery power. We have about three and one-half hours left before batteries give out.”

“Understood, *Korona*, we should be in a rendezvous point within two hours. Prepare crew for evacuation.”

“Roger, *Mjöltnir*. Standing by.”

“I do not know what you or your crew are aware of, Captain, but, for the record, the remaining NOPL forces are out of commission. It looks like the remaining ships shut off their life support systems and killed their crews before they could be boarded and captured. It's incredible. We are trying to ascertain the reason for this.

“Anyways, the battle is over; we have taken the shipyards. NOPL will have quite a problem now engaging our fleets. You and your crew served with honor. When you come on-board, and your crew are taken care of, you will be officially debriefed. *Mjöltnir* out.”

“Understood. Thank you. *Korona* out.”

Lieutenant Larssen relaxed in her command chair. The *Korona* was in no shape to re-pump the atmosphere into the compartments; the crew would have to stay in their spacesuits for the time being until the rescue. She hoped the *Korona* could be saved. If not, she would always remember the ship, and her crew, with pride.

She didn't know what would lie ahead in the war, as it still seemed to be far from over, but she hoped that nothing else would compare to what they went through over the past three days. No matter what, she thought to herself, we will meet whatever comes next for us.

**FE**



# GRYMZ

GUIDE TO INTERGALACTIC CONQUEST



## LESSON #5: COMMUNICATION



GREETINGS  
PLANET  
DWELLERS!

GRYMZ HERE,  
TODAY'S LESSON  
IS ABOUT ESTABLISHING  
COMMUNICATION WITH  
THE PRIMITIVE ALIEN  
CULTURES YOU ENCOUNTER  
DURING YOUR CAREER  
OF INTERGALACTIC  
CONQUEST.



UGGGHH!

AGAIN?  
SERIOUSLY?

TAKE FOR  
EXAMPLE THIS  
UNCOOPERATIVE AND  
STRANGE ALIEN NAMED  
AN-NA WHO CHOOSES  
TO COMMUNICATE BY  
PRIMITIVE VOCAL  
LEXICAL ....



HOLD ON!  
JUST A SECOND  
POTATO HEAD...

WHO ARE YOU  
MAKING THIS VID FOR  
AND HOW IS IT THAT  
YOU CAN SPEAK PERFECT  
AMERICAN ENGLISH?

...AS I WAS  
ABOUT TO SAY,  
THE TRANSLATION  
PROCESSOR FOUND ON  
THE HOVER PACK OF  
ALL GREAT TEMPARZ  
IS AN INVALUABLE  
COMMUNICATION  
TOOL.



REALLY? WHERE  
DID YOU SAY THAT  
WAS LOCATED?

FOR THE LOVE OF...  
IT'S THE PANEL WITH  
THE GLOWING LIGHTS  
JUST ABOVE THE ANTI-  
GRAVITY INDUCERS.



YOU MEAN  
THIS ONE  
HERE?

YES, THAT'S  
RIGHT, THE ONE  
WITH ALL THE..



DOOPS!

!!!!

YOU'RE  
RIGHT, I CAN  
UNDERSTAND YOU  
SO MUCH BETTER  
NOW!

OH CLUMSY  
ME, I THINK I  
TURNED IT  
OFF!

SRM 2013