

FIGURE PAINTER magazine



REVIEWS FROM

Figone, LeBeN Studio

Guild of Harmony

& Terragnosis

INSIGHT
interview with **Jessica Rich**



Model Display Products ProPigments



Our pigments are finely ground Natural Earth Pigments and of the highest quality. Over recent years, earth pigments have become extremely popular with model makers who wish to achieve realistic and authentic looking finishes, especially with military and railway enthusiasts where a weathered look is far more desirable. The pigments are commonly mixed with thinners to create a paste or mixed with acrylic resins or varnish and glues to replicate urban, rural, industrial or warfare surface conditions like: dust, dirt, mud, rust or surfaces that are in state of damage or disrepair.

www.modeldisplayproducts.com

Available in ProPigment sets or individual pots.

Our pigments are not sold for cosmetic, pharmaceutical or food use.
Use care when handling any dry pigment.
Avoid inhaling pigment dust.

Model Display Products
ProPigments

Figure Painter Magazine is published by Robot Pigeon Publishing. South Cheshire. UK



Contact Figure Painter Magazine

Web www.figurepaintermagazine.co.uk

Email info@figurepaintermagazine.co.uk

Editor Shane Rozzell editor@figurepaintermagazine.co.uk

News Editor Robert Monnar news@figurepaintermagazine.co.uk

Content Editor Marko Paunovic content@figurepaintermagazine.co.uk

Sales Sarah Evans sales@figurepaintermagazine.co.uk

Proof Readers Martyn Dorey

Sean Fulton

Reviewers Marta Slusarska

Jake Cannon (Gamespace)

Shane Rozzell

Mario B Delgado (mbd)

Davide Rainone

Cover Artist Jessica Rich

Other Contributors Martyn Dorey, Marko Paunovic, Ana Polanscak, Andrija Jurisic, Tim Fitch, Sean Fulton, Barry Ford



The views and opinions relating to all material herein does not necessarily reflect the opinions of Figure Painter Magazine staff, editors or publishers who are not liable of said opinions. Figure Painter Magazine cannot be held responsible for inaccuracies in any of its publications. Furthermore, responsibility for any losses, damages or distress resulting from adherence to any information made available through this magazine or its website is not the responsibility of Figure Painter Magazine or its publisher, Robot Pigeon Publishing. Adverts and advertisers appearing in Figure Painter Magazine carry no implied recommendation from the magazine or the publishers. Artwork has also been either taken from company websites pertaining to the image and may not be reproduced (except for personal use) without prior written permission from the said author / artist. Most product names are trademarks owned by the companies that publish those products. Photos sent to Figure Painter Magazine will be treated as offered unconditionally for publication and copyright purposes and are subject to editing and comments by the editors. Please ensure that all photos have credits attached if necessary. All rights reserved. No part of this publication may be reproduced without prior consent from Figure Painter Magazine.



Welcome to Figure Painter Magazine issue 10 and our second of 2014; we're in double figures now and I'm still amazed by the reception our little magazine gets, so thank you all. This year's local shows have already started and everyone is starting to gear up for the first big show of the year, Salute 2014 so we wish everyone who is attending shows all the best ☺

Before I get into this issue, I do have some news to share. FPM has recently commissioned its first miniature – I can't tell you much, but I can tell you it is large scale and fantasy themed. I can also share that we'll be detailing its creation in the near future and having received the first concept drawing last week and I'm ever so excited.

Anyway, onto issue 10 and we have a cracker for you with some fantastic miniature reviews from Figone, LeBeN Studio, Terragnosis and Guild of Harmony; we also have a brilliant Gamespace article and many more of our usual articles including (now that he's over his New Year hangover) Martyn Dorey's regular tools round-up. We also have brilliant tutorials from Marko who continues his gaming table build and Barry Ford who tackles the monster from the 1951 movie "The Thing from Another World". We also have two great interviews starting with our cover artist Jessica Rich and finishing up with none other than Rick Priestley.

Web www.figurepaintermagazine.co.uk

Email info@figurepaintermagazine.co.uk



HIGHLIGHTS



Questions?
Page 84

Airbrushing
Page 64



CONTENTS

6	Headlines	The latest news from the hobby
8	Review	LeBeN Studio's Nightmare
11	Gamespace	Regular game review
16	Insight	Insider interviews
24	Airbrushing	Encounter with a H&S Evolution
28	Market Place	Modelling Tools & Accessories
31	Review	Three from Terragnosis
36	Putty&Paint	Putty & Paint Collaboration
40	Show Report	January Round-up
44	Tutorial	Malifaux gaming table Part 9
54	Exposé	What's hot this month
61	Review	Aykroyd, Paranormal Investigator
64	Airbrushing	De-mystifying the airbrush part II
69	Review	Gladiataure from Figone
72	Tutorial	The Thing!
84	Questions?	With Rick Priestley
93	Exhibition	Reader image submissions

69



Review

24



Airbrushing



Scale75 have another paint release under their Scalecolor banner. The new set, as always, consists of eight colours and is called Metal n' Alchemy Steel. Inside the box is an instruction sheet, which shows you how to use the paints to obtain various finishes.

This set retails for 24.8€ and is available from the Scale75 [website](#).

Staying with Scale75, on Jan 24th they launched their second crowd funding campaign on Indiegogo. This project will fund the production of a new steampunk miniature called Sarah Kilmister.



If you want to check out this campaign, follow this [link](#).



Resintopia III Plastic Model Kit and Statue Expo will be held September 12-14, 2014 at the Crowne Plaza Hotel, Fairfield, New Jersey. Guests include the talented and revered Mike Hill, the legendary Shifletts brothers, Tim Gore, Joe (The Godfather) Laudati and Mick Wood. Be prepared to see art and exhibits which have not been previously shown by these titans of the industry. More info [here](#).



ARES Mythologic have two new 35mm miniatures for their Darkstorm project coming this month. More details can be found on their website by clicking [here](#).



Pulp Sci-Fi fans rejoice! Airlock games has launched their new pulp sci-fi based skirmish game on Kickstarter.

Counterblast is an adventure battle game set in an alternate Earth future where humans join forces with several alien species to protect freedom throughout the Milky Way galaxy, particularly a region of space known as the Outer Reaches. Be they Alanti, Illyrian, Human, or Shrinaar serving in the Galactic Defense Force or as a member of the mercenary freighter crews for hire known as Lancers, they all strive to protect the galaxy and themselves from various threats, such as the expansion of the mighty and brutal Neiran Empire, extermination by the mechanical and merciless Mekkus, or invasion by the feared and alien Edofleini.

The miniatures for this game are by Patrick Keith, award winning sculptor and painter who has provided work since 2006 for companies such as Reaper, Dark Sword, Privateer Press and many, many others. More information can be found on the [Airlock Games website](#) or by checking out the new kickstarter campaign [here](#).



Mongoose Publishing announces Noble Armada End of Line Sale. After discussions with Holistic Design (the ultimate owners of Noble Armada and Fading Suns), the decision has been made to end the current A Call to Arms: Noble Armada game and miniatures line. Mongoose are currently having an end of line sale for Noble Armada, 50% off everything while they remain in stock.

You can get the full listing of bargains [here](#).

Saturday 8th March 2014
Learn the Miniature painting fundamentals that underpin all quality paintjobs. No matter what skill level

SKILL FOUNDATION MASTERCLASS

£60
Ticket price includes:
Full day of expert tuition in Golem's professional studio in Manchester
An assembled undercoated miniature so you can get to work right away!
Hot lunch, tea, coffee and soft drinks served during the day
Skills cheat sheet to help you grasp the principles

For information and booking:
events@golempaintingstudio.co.uk

GOLEM
PAINTING STUDIO

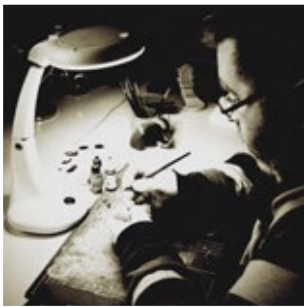
By **Shane Rozzell**

Unboxing LeBeN Studios' Knightmare

Following on from last issue where I unboxed LeBeN Studios' Gurka Le Rouge and Morko, I had the good luck to get hold of LeBeN's Knightmare.

Material: **Resin**

Scale: **32mm (44mm tall)**

Price: **25 € & 8 € P&P**

Available from:

LeBeN Studio

lebenstudio.blogspot.co.uk

▶ The miniature is a re-imagining of a Nurgle Chaos Lord and it is basically a wish list of everything a fan of the plague lord could want; sickly, bloated flesh, open sores, rusty, pitted armour and a face only a mother could love.

I have seen lots of fantastic paint jobs on this style of miniature. They have riotous colour schemes and special painting effects as well as giving the painter the opportunity to make a really over the top base; this appealed to me, but I have never painted one myself so I started to look around for a suitable miniature. I am not really a fan of the Games Workshop miniature because I think it's a bit soft and sanitised; not what I was looking for and, in my opinion, not really what a Lord of Nurgle is about. This left few options until Benoit Menard released his Knightmare miniature.

When I finally got my hands on the slightly soggy cardboard box (thank you Royal Mail :) I was immediately thankful of the extra effort LeBeN Studios put into packaging their products. Wading through the styrene chips, I come across the tightly wrapped layers of plastic bubble wrap containing



the now recognisable grey and black box with the LeBeN logo emblazoned upon the lid.

Like Gurka and Morko from last month, this miniature comes with a full colour printed card for reference and also a personal thank you from Benoit and the whole package exudes high production values and quality.

The miniature, this time sculpted by Benoit himself, comes in five pieces and includes three head options. I really like the sculpt; as I have come to expect from LeBeN, everything is engineered well and all the parts



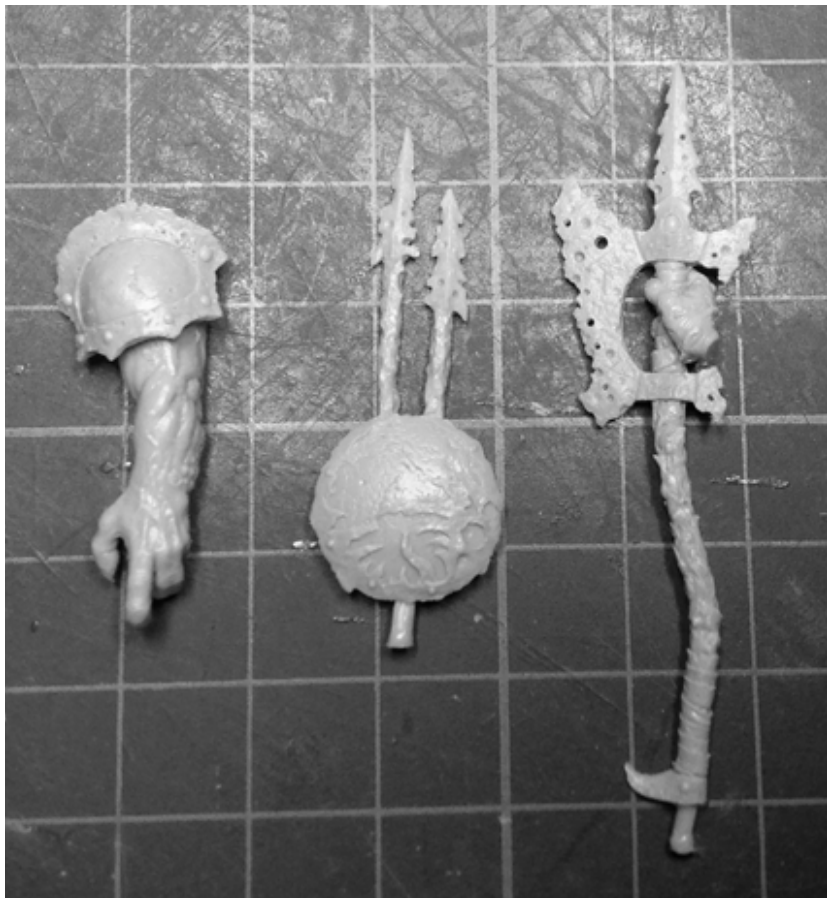

fit together perfectly. The warrior has a huge rusty cleaver type weapon and on his back is a shield and two long spikes both of which will give the painter plenty of opportunity to get some good effects on the miniature. It also has a mutated, oversized right arm and hand that has plenty of surface texture which again, will give the painter plenty to work with.

The cast is, as expected, very well done. On my first inspection it was hard to find any but the most obvious of mould lines. They are there, so you have to give the miniature a thorough going over before applying paint, but thankfully when you have spotted them they are so small it's almost a pleasure to remove them with one light scrape of the scalpel blade. Once you figure out where the mould joins have been made, you'll easily spot them. All in all the miniature only took me an hour or so to clean up and I have already planned a few subtle alterations to personalise this miniature.

Pro's

- » This is a good "painters" miniature.
- » Superbly engineered and cast with very little preparation time.
 - » Three head options and nice open pose give the opportunity to convert and personalise your copy of the miniature.
 - » €25 is a good value for this miniature.
 - » Nice size, this guy being over 40mm tall will stand out on any gaming table.

Con's

- » Limited to a run of 300 copies, so get yours quickly; you won't be disappointed.
- » €8 postage is a bit steep, but it does guarantee your package arrives safely.

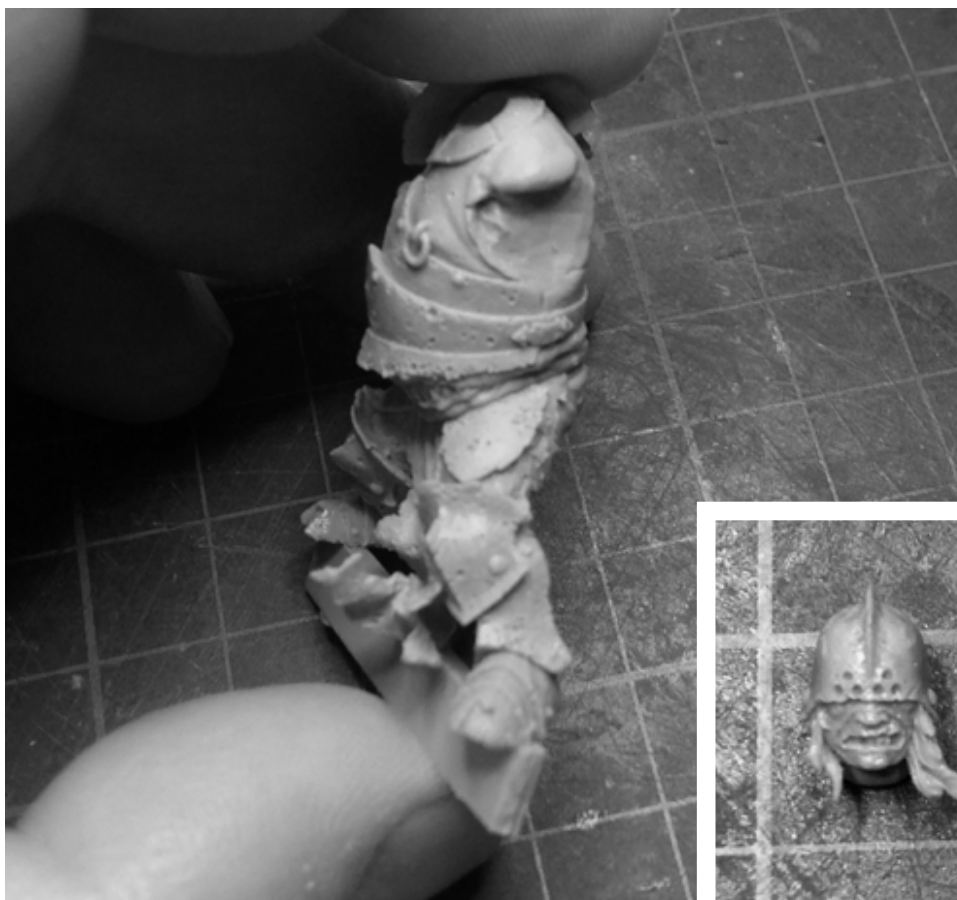



By **Jake Cannon**

Review – Short Version – It's Firefly, the game; go buy it. Now! Before it goes out of print... You require more? Very Well. Read on.



Introduction

This is a review of the Firefly board game produced and distributed by Gale Force Nine; if you don't recognise the name, immediately go check out the board game Spartacus, which they also produced—it's well worth a go. For those of you in the wargaming hobby, you may also recognise GF9 from their range of tools their parent company - Battlefront Miniatures, who amongst other games made the excellent Flames of War. I say excellent (and it is), but with the ongoing issues with stock supply, it might soon become described as "mythological."

Enough about the company that somehow beat Fantasy Flight to the licence and on the game. Firefly was a TV show that if you have not seen yet, you really do need to go and acquire quickly and enrich your life with. This is a game set in the Whedon-verse before the movie "Serenity". No Miranda, no brutal removal of loved characters; everyone is here from the show, but no Mr. Universe or the operative, etc.

So what kind of game is it? Let's look –



Overview

This game is, at its very core, a pick up and delivery game. Everyone gets a firefly class ship (yes one person gets serenity and no she doesn't have any special rules). You will spend the game getting jobs from the five employers and trying to complete them as efficiently as possible. Along the way you will gain extra crew members, ship upgrades and general improvements; the mechanic for adding items to the market is really quite superb, but more on that later.

The game will play up to 4 players and a fifth can be added if you are lucky enough to get the European special edition with an extra ship and custom rules. At the beginning of each game, you select one of the scenarios and they each have printed on them an expected game length, generally ranging from an hour up to three hours. This gives a good level of control to game length as you can select a scenario based on your available time.

Components

PLASTIC FIREFLY SHIPS. There are other components but let's look at these first. They are so cool! Ok, gush over. The ships are small, but detailed enough that you could bring them to life with a nice paint jobs. You also get a very nice Reaver ship, which is based on the design of the Reaver ship in the pilot episode. Finally you get an Alliance cruiser which



is a little disappointing compared to the other ships as the detail is just not quite as good. Still, it is instantly recognisable so it is fit for purpose.

The board is thick and durable and the design studio that created it has done a fantastic job of creating a colourful and functional board out of what is essentially the big black emptiness of space. Each system is named and the sectors within are split into areas that can also contain planets or space stations. The colour of the sectors denote if that area of space is Alliance patrolled or if it's border space where the Reavers prowl.

The cards are heavy card stock and put up with use very well. I can see why you would want to sleeve this game, but due to the interesting artwork on the backs of the cards, you really will want them visible. The job cards have the most information on them, but it has been laid out in an intelligent way so that you can swiftly find the information you need at any time. For example, if you are required to go to a planet, it gives you the name of the planet and the system it resides in. This might sound like a small thing, but try playing [Ticket to Tide: Netherlands](#) and you will appreciate help finding places.

Finally, you get paper money. This brings on such a nostalgic feeling to the game and it really fits with the theme; you work for money, not credit transfers – cold hard cash! If you haven't got it then the job ain't getting done; after all you might be looking for passengers, but you want to find ones that can pay.

Gameplay

The game plays at a gradually increasing pace. You start out with very little and scramble early to get ahead of the competition. I was afraid when I read through the rulebook that this game would suffer from one person getting a powerful early upgrade and being so far ahead that no-one could catch up. In fact, what happened was that everybody went off in different directions. Two of us grabbed early ship upgrades to make flying around fast cheaper and the other two grabbed crew straight away and ran off to do quick cheeky missions. Everybody was able to play the game in slightly different ways and still have a good shot at victory.

The variety in improving your ship and crew is mirrored by the variety of missions and people to work for. You have legal and illegal missions as well as moral and immoral missions. Moral crew don't like immoral jobs. The Alliance doesn't like catching you doing illegal things and then certain employers don't like you doing certain things as well. Niska is very funny about you getting warrants from the alliance whilst working for him and is prone to killing off your crew whenever

FIRST TIME IN THE CAPTAIN'S CHAIR

So you finally took the plunge and borrowed enough credits for a ship to call your own. You're the master of your destiny and right now that destiny looks mighty uncertain! You're in debt up to your eyeballs with a creditor that's not the sort of man to be trifled with.

SET-UP

When taking Starting Jobs, only take a Job from Harken and Amnon Duul. These Jobs may be discarded, as normal.

GOAL 1: Makin' Friends

To Complete Goal, be Solid with two different Contacts. After completing this Goal, take a Goal Token.

You ain't gonna get far in the 'Verse without makin' a few friends. It's just good business.

GOAL 2: Seein' Daylight

To Complete Goal, have \$6000 in hand and your first Goal Token. After completing this Goal, take a second Goal Token.

Carrying a heap a' debt on your back is no way to live. Scrape together enough cash to get back in the black.

GOAL 3: Feeding the Shark

Ezra Georgia

The first player who travels to Ezra with two Goal Tokens and then pays the bank \$6000 wins the game. You own your Ship free and clear!

Head over to pay off your loan shark. Adelai Niska is not a patient man...

🕒 1-2 Hours

Recommended for New Players

this happens. His missions are hard but offer massive payouts. The opposite end of the extreme is the Alliance officer Harken, who will dump you like a sack of bobble headed dolls if you get a warrant whilst working for him. The plus side is his missions are legal, so this will only happen if you start doing other missions on the side.

As you can start to see, there is a plethora of options and at every turn the creators have stuffed flavour and fluff into this game. Plots from episodes are available as missions and even small cameo parts get crew cards or missions.

Mechanics – The core mechanic to this game is based off a D6 system with a couple of very welcome additions. First 6's roll up, so no matter how bad a check looks, you could make it with a lucky roll. Second, all of your crew and some of your attachments have bonus icons. For example, you need to complete a 9 strength diplomacy check. It is not looking good on a single D6. Lucky for you your crew includes Inara and Mal. Now in-between giving each other knowing looks, they have a total of 4 diplomacy icons. This gives you +4 to your dice roll. This is still not great, but you now have a one in three of succeeding.

ZIR COM FRANCHISING:
LEGAL

TANIS DOCKS

DESTINATION	TASK
Osiris White Sun	Travel to Osiris. Get Paid \$400 + \$400 per 話 on Job.

Amnon Duul wants to open a new branch office on Osiris. Secure permits from the local magistrate's office and set up shipping contracts with local fabricators.

NEEDS

話

話

話

Companion Bonus: +\$500
\$400 + 話



The buying mechanic is very cool in my opinion. Any time you have the option to take jobs or upgrade cards, the rule is simple – you may look at up to three and may keep/buy up to two. What’s so cool about that you ask? Well, its where you can take the cards from. When you evaluate cards, any number of them can come from the associated discard pile and the rest come from the top of deck. As you try to buy more you leave more behind for others. Stay with me here because this is something I loved; what this means is that someone who runs off to Osiris to tool up their ship straight away might take the two best cards out of six and fly away at the speed of light, but they leave behind items for the other players that weren’t good enough for them, or they couldn’t afford. Those players who tooled up crew can then know it’s worth flying to Osiris to buy upgrades. This also means that if you get smashed by Reavers or something else out there and need to get back in the game quick you have numerous options sitting in the discard pile waiting for you. Any time items are destroyed or crew members quit your ship, they go to their discard pile and can be rebought or re-hired. Note that when a crew member is killed they are gone forever.

Flying around the ‘Verse – There are two options here, you can mosey one sector at a time and not spend any resources or draw any event cards or you can go full burn and try to go as far as your engine will take you. If you do this, you spend a fuel and move a number of spaces up to your engine value. Each space you move into draws you an event card, which can range from simple opportunities to Reaver attacks and Alliance inspections. Every card you draw has a chance of ending your burn, so it is a risk, but space travel is never going to be safe when a bunch of cowboys are in charge.

Conclusions

I have to say that I was very cynical about this game when it was announced. I wanted a co-operative game that was a mixture of Battlestar Galactica and Space Alert, not a space trading game. To me, the core of Firefly is the crew, so the idea of playing a game where you are all against each other and you have very little player interaction didn’t feel like it was ever going to do the franchise proud. What I didn’t count on was the depth of flavour added to this game. This is a game all about the experience. You aren’t playing this game to win and crush your friends; you are playing it to have fun and maybe try to get your friends eaten by Reavers or arrested by the Alliance.

So what’s the deal? Is it worth owning? If you are a hard core gamer who is looking for a tight game that will hit the table repeatedly and always be a close game with lots of well-planned moves then no-go get Dominant Species. If you are a Firefly fan and want to spend a bit of time flashing your arse at the Goram law over a few drinks and some good banter, then go grab this game now! The “Breakin’ Atmo” expansion has already shown how easy it will be for the manufacturer to release small add-ons to breathe new life into this game. Personally I think this game probably has ten good plays in it straight out of the box; between the different game end scenarios and different approaches to upgrade your ship. After that, it’s going on the shelf to come out every so often, when a new expansion hits or when we have a gamer/non-gamer mix to our group.

Final thoughts – If any of this has made you consider getting this game do it quick. It’s going to be on Tabletop before too long and once it is every pretend gamer is going to want a copy!



THE DRAGON LORD



Also available
The Old Gnome &
The Gem Smith
plus many more

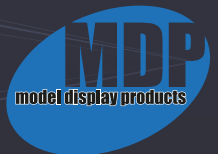

INSIGHT

interview with Jessica Rich

Questions by Sean Fulton



Place of Origin? I was born in Newport News, Virginia, but was raised in a military household, so we travelled up and down the East coast for much of my childhood. Moving around so much imbued a sense of wanderlust in me as an adult, so I continue to travel in the US and out as much as possible.

Years painting? I've been painting miniatures for 12 years, though for the first 7 it was strictly a hobby. I made a leap of faith that I could live off of the hobby I loved and began full time painting 5 years ago. It was rough at first – despite having awards to my name, it was difficult industry to break into professionally. The first time I was approached

by a company for studio work was an amazing feeling.

Major awards? I've won 7 Golden Demons (3 Bronze, 3 Silver and 1 Gold), Forge World Best in Show, ReaperCon Best in Show and GenCon Best in Show. I have several other awards from online competitions and placing's from various conventions. I don't enter competitions as frequently as I should – I honestly find them stressful. I've always had a hard time leaving my models to be judged and divorcing myself from the process. I'll loom by a display case for hours critiquing my own work and finding things that I wished I'd done differently. I also rarely allot an appropriate amount of time to entries – all of my Demon Statues were pieces that I painted 1 to 3 days prior to the convention, which just adds to my stress. I was much better about time management this year.

Future goals? I'd love to get my hands on a Slayer Sword, but I think that's a goal of many miniature painters! I'm just thrilled to be where I'm at right now. I certainly want to continue improving my art, and maybe work in a little more travel to conventions.

Last year, Jessica Rich was one of the dominate forces on the competitive American painting scene, winning back to back Best of Show titles at Reaper Con and Gen Con. Known for her exquisitely detailed freehand work, she has been highly sought after, working as a studio painter for both Dark Sword Miniatures and Wyrd Miniatures.

Q1: *The freehand work on your miniatures has become one of the hallmarks of your style. Do you have a formal background in art or have you been self-taught since you started painting?*

I've never had formal training in art. I consider "formal" a term used for those that have gone to college and studied art as a form of higher education. I did take every art class I could when in high school; outside of school I have continued to pursue my passion for art via reading and studying books on art and artists. In short – self-taught, but with a strong foundation from my teenage years.

Q2: *What prompted you to take the leap from hobbyist to professional painter? Do you have any suggestions for aspiring painters that have an interest in taking this on as a full time job?*

I had pondered the notion of being a professional painter from the moment I discovered I had a knack for painting miniatures and saw that there were a handful of painters out there that were making a living doing it. One morning, I found myself no longer employed in the job I had worked for 10 years. I was both devastated and thrilled. I realized there was no better time to take the chance and start getting my name out there as an artist.

Painting full time is not an easy way to make a living. There's no 9 to 5 schedule when you're your own boss. You've got to dig in and paint on days when you don't want to, while maintaining a balance of projects that are money makers and things you enjoy working on.

The greatest piece of advice I could give would be to have a decent base of clients before you make the jump, preferably steady work from companies. You'll have a hard time making it work as a job if you're only painting for friends and eBay. Entering online contests is a great way to get your name out there. My tenures at both Wyrd and Dark Sword sprung from wins in their respective online competitions.



Q3: *Last year you filmed a DVD in conjunction with Dark Sword Miniatures. Did you enjoy the process? Was it difficult to paint with the camera over your shoulder?*

The DVD filming process was grueling! Jim Ludwig of Dark Sword warned me that the hours would be long, the lights would be hot and that I'd want to throttle someone routinely. He was right on all accounts. That being said, the filming went by in a blur and the process wasn't difficult so much as awkward. You don't really start getting into a groove until the

fourth day of things, but by that time you're all done.

The camera was the worst part of filming. I had to lean my head to the side while filming, and despite my best efforts, my glasses still creep into frame every now and again on the footage. I also had a hard time keeping my hands in one place--I apparently wander all over the table when I paint, so part way through the first day we put down a "mark", so I knew where my hand should be. That was only partially successful, as you can't keep me still when I'm in the painting zone. You've also got to be cognizant of what the camera



can see as opposed to what you can see. It makes for holding your brush at strange angles sometimes.

Q4: *As a child in a military family, did you spend much time overseas? Do you have any desire to enter the world stage and attend any of the large European contests like Salute or Monte San Savino?*

We never left the country while my dad was in the military. He got to, but not us. That hasn't curtailed my desire to see more of the world though. I would very much like to enter European contests, though the biggest joy of those venues is soaking up all of the other amazing entries. Photography can only capture so much of a miniature's spirit and detail.

Q5: *Where do you draw your inspiration for your free-hand work?*

The inspiration depends on the subject matter. I am sometimes called upon to reproduce a preexisting work of art, so in those instances I have photos of the artwork in







question. Many of my freehand designs or patterns come straight from my head to the miniature. I've painted fleur-de-lis so many times I think I could do it blindfolded. I do have books on knot work and Nordic design, but the biggest fountain of knowledge is the internet. Not just miniature sites, but Wikipedia for traditional artists and DeviantArt for modern/contemporary ones.

Q6: *Do you work in other mediums as well (digital art, traditional canvas painting, etc.)?*

Yes. I started drawing as soon as I could hold a pencil. My Christmases were always dominated by art supplies. I don't get to paint on canvas as much as I used to--I'm lucky if I can finish one painting every three years. I work primarily in acrylic, though I've dabbled in oils and watercolor. I also very much enjoy digital art, which is something I'm exploring in depth at this time. I've also done graphic design work for both miniature companies and corporate America.

Q7: *You have painted miniatures for George R.R. Martin. What were the circumstances that brought that about and what was it like to meet him?*

I received an email from George on December 1st, 2011. I know the day because it changed who I was as a painter. Prior to his email, I was considering stopping painting full time--I was unhappy with my client base at the time and I didn't think I could continue painting figures I had no interest in just to make money.









Jim Ludwig had mentioned my name to George as a prospective freelancer and I'm so grateful. George wrote to express that he liked the work I was doing and wanted to know if I'd paint for him. There was no way I was going to say no! He's helped push me further in my painting than I thought I could go--the Ares Knight that won "Best in Show" at ReaperCon was a commission from him.

I met George prior to ReaperCon; Jim, Aaron Lovejoy and I were invited to fly out and just "hang out" for a few days with him. It was an amazing experience. I remember feeling very awkward and fangirly at first, but that passed as soon as I realized that he's just a regular man who happens to be famous. He also has an unparalleled miniatures collection – that gave us all lots of talking points to break the ice.

Q8: *Have you found it challenging to be a female painter in a predominantly male dominated hobby?*

Not at all; I've always had an alpha personality and tom-boy tendencies. I'm most comfortable when I'm treated as "one of the boys".

I was also fortunate enough to be able to come into the scene when other female painters were making a splash in North America. Anne Foerster and Jen Haley were already

paving the way for female painters when I got started in the miniatures hobby. I've never felt ostracized or unwelcome in the gaming community – an oddity perhaps, but not an outsider.

Q9: *What are you working on at the moment?*

I'm currently hard at work with Dark Sword Miniatures preparing for a new miniatures Kickstarter that will be launching next week.





My first encounter with

By **Marta Ślusarska**

H&S Evolution



First of all I need to make a disclaimer: I'm pretty much a noob when it comes to airbrushes. I really hope you won't mind that this article won't be a tutorial per-se (as there are way more qualified people to do that, than me), but more a subjective description of my very private, first experience with the new tool.



I have owned a cheap airbrush for quite a while now (2 or 3 years) but I used it very rarely and learned basically nothing except for base coating. But recently (after seeing a few tutorials) I got the idea to learn how to use an airbrush properly, to use it's whole potential, which combined with a little bit too much money at the time, led me to purchase a Harder & Steenbeck airbrush, Evolution Silverline fPc. I decided for that bold move mostly because I managed not to damage the old one so far, and guessed that this sole fact made me ready for the next step and a serious gun.

I'm not going to deny that the main reason behind me using the airbrush so rarely in the past was the cleaning time, and the fact that my pseudo(fake?)-Iwata was pretty hard to put together after taking it to pieces. Especially the needle was giving me lots of grief. For some reason, after cleaning, it was always slightly different 'length', if you know what I mean. I was always moving it slightly in the rear 'holding thing' so it was either a bit too short or too long to work nicely with the nozzle. So basically it was way more maintenance than painting... Keeping that in mind, I was looking for something easier to clean and use. True Iwata was out of the question, as I was already disappointed in the cheap fake one. Some friends suggested that the H&S airbrushes are the easiest to maintain, and the Ger-

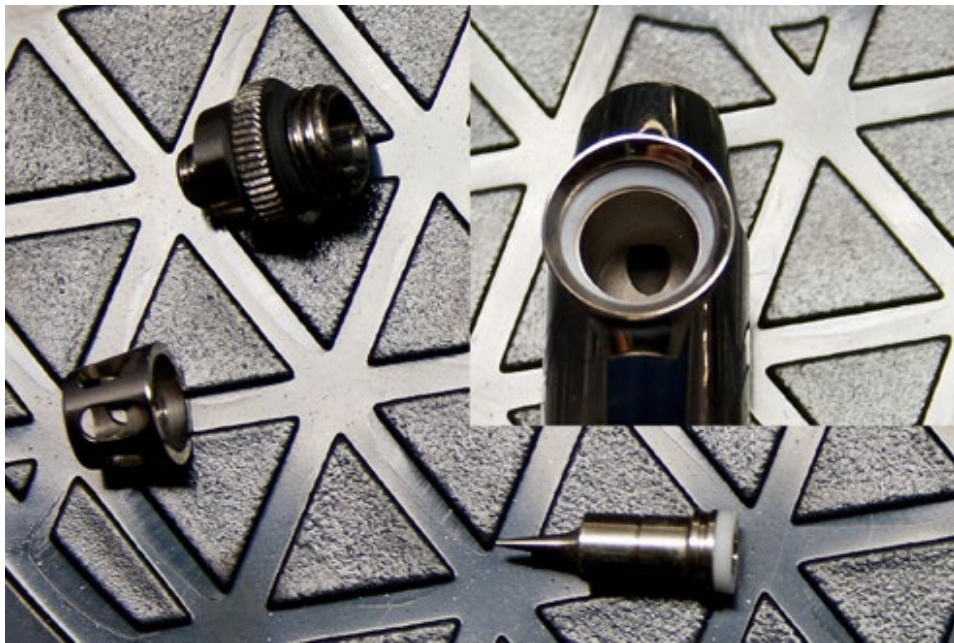

man 'Technical Thought' and quality of production wasn't something to ignore. That's why I decided to go for their gun. Maybe the particular model I choose (Evolution Silverline fPc) is not a top end product, but still way better than the one I had already, not so easy to break, and still within my budget.

OK, so basically below you can find all that I managed to do during the first few hours with my H&S Evo:

First some photos of the gun itself. If any of you can compare that to the cheap 'Iwata like' airbrushes, you can see that it kind of looks simpler; at least for me it does and to be honest, while cleaning, you don't even have to take the rear part of the airbrush apart altogether. You can just unscrew the whole thing and clean the needle. And the lever being one piece (opposite to my cheap gun where there is two separate parts, one of them tiny) is much easier to assemble. On the second photo you can see a close up of the very front parts of the airbrush. The nozzle itself is much bigger than in my previous one, which makes it much easier to find, even if slightly harder to clean. On the same photo you can see white O-rings, on the nozzle and on the main body, where the flow cup is attached. They're made out of viton, not regular rubber,





like the black O-ring at the air head. I'm not sure what the viton is, but apparently it's way more durable than rubber and can be cleaned with the rest of the airbrush using various solvents that could damage the rubber.

Next some test lines to get a feel for the gun. And even though I still have some issues with feeling the consistency of paint and air pressure ratio, and still struggle with nice, even coverage of large surfaces, I'm convinced that the fault is with me, not with the airbrush. But on the other hand check out how thin and almost even lines I was able to achieve. I'm pretty impressed, and full of hope that, when I master the tool, I'll be able to take full advantage of this fact.

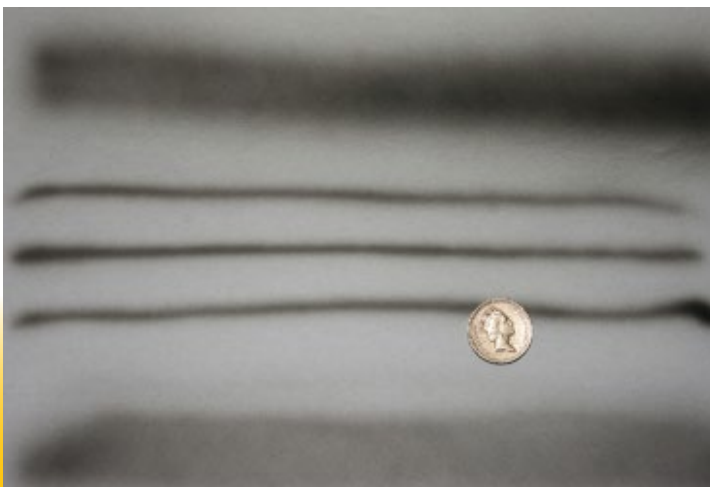

When I was feeling more or less familiar with the work of this particular gun, I decided to use it on some prepared miniatures to do some real work. First I used it to apply white and black paint to make painting with zenithal lighting much easier. Normally you would use just white paint/primer from the top, but because I use light gray primer, the white only wouldn't be too visible. That's why first I'm using the black paint from the bottom (more or less 45 degree) and then white from the top. This way I have a nice range of gray all over my miniature and first feel for the volumes.



Then I just picked up a few flesh tones and tried to do a bit more than I normally did with an airbrush. First I applied a really light skin tone (first light from Andrea flesh set I believe) to the miniatures/bust that will have normal, human skin. I was aiming my gun more from the top, to cover only those parts that will receive more light. Then with a darker shade of skin colour (first base from the same set, mixed a bit in some occasions with first shadow) I applied a layer of paint from the bottom to cover the places that will become mid-tones and shadows. I even tried to use some thin lines I knew that the gun is able to produce to shadow the sides of the nose or under the eyebrows, but, due to the lack of practice, I wasn't too successful. Well... I didn't fail either, which is half success for me.



Looking at the photos I can clearly see that the effect I managed to achieve is rather subtle, but I hope you can see, especially on the bust's face that there is some difference in colours and that the volumes are starting to show. There is even more done with Roberto Chaudon's Little Devil. I added some discolourations around his elbows. I guess I could go a bit further and try to achieve even more contrast, but I was afraid I'll spoil everything I did, so I decided to take a small step at the time.



What's on the Market?

a regular look at some of the hobby tools available



By **Martyn Dorey**

Does presentation really matter when all you are interested in is finishing the model? The simple answer is "Hell yes"; especially so if you are looking at entering your work in a competition, be it club contest or one of the major competitions.

Presentation

Did you know that up to ten marks of a judge's sheet can be awarded for how a model is presented?

A friend showed me his entry for the Salute Figure last year after the event. I can't remember what position he got for it but when I told him how it may have done better if it had a name plate on the plinth and how it was possible that he may have lost marks because of this, he looked very shocked, but it is also very true.

You don't have to be a judge to appreciate this; next time you are at a show and wandering around the competition room or browsing the entries in the cabinets, look at a model that has been mounted on a plinth or a disc and has a name plate on it and try and find one similar without and ask yourself which one you would prefer?

There are several choices for plinths. You can go for the exotic or normal turned and polished wood with prices starting at around the £6.00 mark and rising the larger you go for the plain





unpolished/stained wood whereby you will need to do the work yourself. Alternatively, you can pick up a resin plinth or disc, all these have their place in the hobby and it is nice to see a variety/mix when walking around the shows. For me, if I want a wooden plinth to mount a figure on, then I will use the ones that come ready polished and I have found [Oakwood Studios](#) to be one of the best for quality and variety when it comes to this type of base. [Miniature Heroes](#) also produce unpolished wooden plinths.

However, if I am going to carve a base up and use it as part of the story that the figure is telling, I would use a resin base/plinth. Using one in resin can also have the added challenge of making it look like wood; after all it doesn't have to be painted a plain colour and then forgotten about. Try putting a bit of gold paint on a piece of sponge wipe off the excess and dab it around the painted resin base — this can look very effect, especially when done around the dove tailing or fancy bottom of the plinth.

That extra little bit of thought and effort doesn't have to stop at the plinth, though. A name plate/plaque can also help immensely. It doesn't have to be very expensive, but it could make a big difference. Sometimes the simplest of plates can be very effective and if they are over emphasised, they can look out of place. A piece of paper torn, cut and rolled at the ends then coated in PVA glue to become a scroll that can be attached to the plinth can be very effective for some pieces. Likewise some putty flattened out can also do the job.

What, your freehand isn't up to the job of doing the lettering? Not a problem with a quick visit to a craft shop, which can result in a sheet of dry transfer letters that can be rubbed onto the plaque/plate that you have made and painted, you could even weather it before or after applying the letters. Alternatively, you can do all sorts of fancy script on the computer





These engraved plates are usually done on a very wide choice of plastic or brass and double sided tape is then used to attach the plate to the plinth of your model; all manner of different scripts can be used as well as a very wide choice of finishes and borders.

Here in the UK you will often see Paul and Julie Newman from Name It at www.nameitplates.co.uk at the shows with a table full of examples of their work and what they can do to help present your model to look its best. They are a very friendly couple and Paul has won awards for his modelling as well, so he has a lot of experience in the hobby and can help advise on what might be the best for you. They can even do the trophies/medals for your club event.

This was to be the last in the planned "What's on the Market" articles, but it seems I have underestimated the popularity of this, so future articles will cover a more in-depth look at some of the items that have been touched on; a little like a "how to use" plus as they appear or I come across them I will also be giving new items a try and reporting on them.

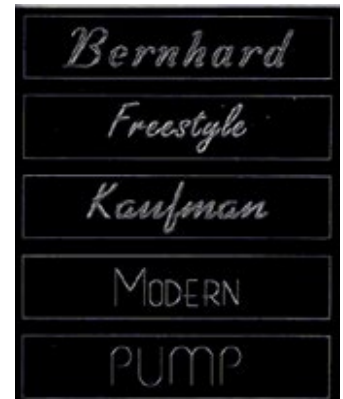

using a text program such as Word or if you are felling clever then try your hand with Photoshop and some of the extra fonts you can download to use with it.

I have even seen people use items from their bits box such as parts from a vehicle or cogs to make name plate, in a way it is a little like painting Sci-fi or Fantasy figures whereby your limit is your imagination.

When it comes to historical figures, I have even seen medals used as part of the name plate. At the end of the day, it is all about presenting the model to the best of your ability. Engraved plates are very common amongst historical figure modellers and you see a lot of this now in all aspects of the hobby and not just the figure side of it.



by Mario B Delgado (mbd)



Unboxing Terragnosis'

The Traveller, Erica & Tarquin

Terragnosis is one of the new independent miniature companies that has surfaced here in the UK in the last few years.

Material: **Resin**

Scale: **54mm**

Price: **£19.50 each**

Available from:

Terragnosis

www.terragnosis.co.uk

What makes them special is they're one of a few companies that have produced a larger scale range of miniatures fully sculpted in 3D. Not only that, but they complement their miniature production with a new game system called "Ruination" and they also make a few terrain objects that can also be used with the game.

I'm not a gamer, so I have little I can really say about their game system but regarding the miniatures, let me tell you – I'm delighted! This is because they produce 54mm resin models and this is a blessing to my tired eyes and it's always nice to work with a bigger figure.



For this review, I'll be looking at 3 miniatures from their range. All are produced in white resin and each has nice crisp details with a little excess resin to clean up along some of the mouldlines. The single 54mm miniatures are well priced at £19.50 + P&P, but as part of the game system there are some "Battlepack" deals you can enjoy that come with two different models plus the accessories necessary to play the game, as well as a nice concept art card.

The first figure to review is known only as 'The Traveller'; this wandering mercenary never stays long in one place. Her name might not be known, but her reputation as a fighter and the devastating skill with which she wields her great warhammer is common knowledge. This is a nice, original model with a relaxed pose and plenty to play with if you like to paint your models. Her face is well cast and has nice feminine features and the two parts of the model fit well with very little filler needed. The clothing is that of a medieval character very much similar to a Landsknecht, which allows some variety for painting.



The second one is another female character; Erica is a female fighter with a straight pose and some nice details. The face has nice casting details and the moulding of the shield is quite attractive. The proportions are good, but the hair is a bit simple for a 54mm model. The separated arm and sword fit well and need very little filling.





Figure number three is that of a dwarf male called Tarquin. Tarquin is a clever innovator and developer of new weapons. Unlike the majority of his kin, he is not satisfied with the crafting of fine jewels or other precious items. Tarquin's interest lies elsewhere — in warfare and destruction and new ways of harming those that get in his way. This again comes in two pieces; the head, main body and legs make up one piece and the other part is the main weapon (a sort of crossbow) and hands. The fit is very nicely engineered and smooth with no filling needed (as seen in the picture of the dry fit). The little details of the model are a delight for both modelers and painters.

Overall, these are interesting models on a very pleasant (for me) scale. The resin is good and the casting is well done with little flash and great fitting pieces. The prices aren't bad either, but I must say that for this review, the models were kindly sent to me by the guys at Terragnosis.



Exhibition of

Miniatures & Tabletop Scenery



27th Feb 2014 - 9th Mar 2014

Vladimir Horvat Gallery, Trg zrtava fasizma 14, Zagreb, Croatia



Free Malifaux demo
Wednesday March 5th
17:00-22:00. For more
information email us at,
ums.agram@gmail.com

& PUTTY & PAINT

Tzeentch Standard Bearer

by Mirko Cavalloni



PRO

Website

facebook

CONVERSION: Scale 28mm, Non-Metal
Metallic, Acrylic colour.





& PUTTY & PAINT

The Four Musketeere
by Matthias Schwaneberg



Thorunn Frozenfang

by sergiocalvo



A Brief Look Around the UK Shows January 2014

By **Martyn Dorey**, Pictures by **Ian McIntosh**



Well after the December break from the shows here in the UK, the new season kicked off with the IPMS Bolton Show in the middle of the month, thankfully this year without all the snow to slide around the car park in.

The show is held in a school each year; parking is plentiful, but the traders and clubs are spread throughout the lower halls of the school with the majority of traders in the main hall and on the stage and the clubs in some of the classrooms, main hall and corridor. This isn't necessarily a bad layout for this venue, though, as visitors have to pass all the rooms on the way to the main hall and then the remaining traders and some displays are set up in the corridor to the refreshments area so everything is seen at least once.

The Bolton Show is a friendly club show that has a lot of visitors from around the North West side of the UK and is very easy to find as it is located about a five minute drive from the motorway. Don't let the IPMS title of the club put you off; if your thing is figures, there is a lot more to be seen than just tanks/armour and aircraft. The club has a wide range of modellers who specialise in everything the hobby



has to offer so besides, the usual wings and armour on display, there was also a lot of figures with a good display from some of the Figureworld organisers such as Adrian Hopwood and Demon winner Mario Delgado amongst others seen wandering the halls throughout the day.

There is also a competition for those that chase the glory and reward for their modelling skills, although I didn't get a chance to see the competition room as I was kept fairly busy throughout the day. Traders attending this year besides the usual plastic kit sellers included MDP, Little Cars, Squires Tools, Avid Reader and MDC.

The end of January sees the annual wargames show for the Penarth Wargames club. This is about the only show here in the UK whereby my travelling time to the event is actually less than an hour's drive (literally a 20 minute trip for me) as it is held at the Cogan Leisure Centre just on the edge of Penarth. Not just for the wargamer, this year (as last year) several modellers had display space amongst the traders and display/participation games. This is something that is happening more and more at the wargames shows here in the UK now and seems to work very well. This year's display included some of the work from Stuart Little, a member of the UK Garage Kit scene, with some of his life size busts as well as smaller figures.



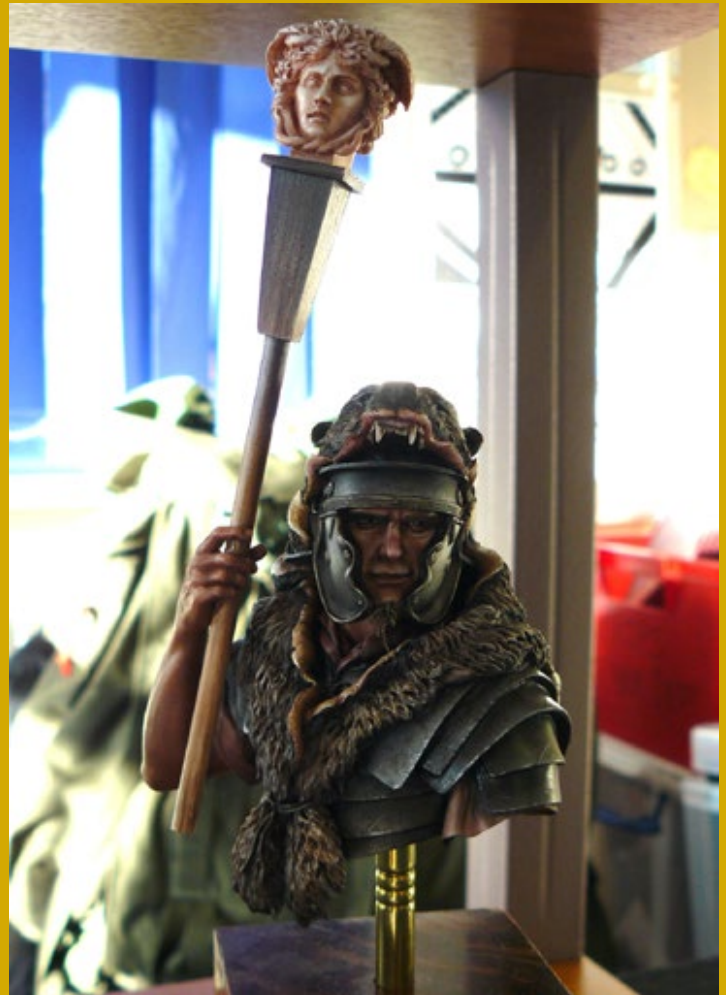



Centred around a wargames tournament, the Penarth Show also has a very active Bring & Buy, which was situated just off the main hall and from the comments I was hearing it proved popular as always. Demonstration and participation games were put on by various individuals as well as traders and included games of Firefly, Bushido, X-Wing and Dead Man's Hand .

A lot of the usual traders made it along to the show again this year such as Ainsty, Great Escape Games, Colonel Bill's, Magister Militum, Warlord and many others. It was a strange show, though, mainly due to the fact that all of the traders that usually sell GW were noted for their absence this year; could this be a trend that will be seen at a lot of the war-games shows here in the UK this year?

Well, that is about it for January. A lot of people are gearing up for Salute 2014 in April, which has already published its list of over 150 traders; no Bring & Buy this year, though, as it was apparently decided to scrap it in favour of more traders/participation games.



I think for me the biggest surprise so far for this year has been the decision by the committee that run Colours to cancel their show this year. I have heard that the decision was based on the committee deciding it wasn't worth it! To me this is a big shame, as I have been attending this event since the 80's when it was held at the Hexagon in Reading before it moved to the larger and better venue of Newbury Race Course. Such a shame for what has always been a popular show on the events calendar.

MALIFAUX

By Marko Paunovic



Even the best plans get spoiled. This indeed is just what's happened this month with me and the Malifaux table build. I'm getting married in March

and the responsibilities regarding the organizing of the event interfered greatly with my glitch free plans. Guess they weren't without a glitch after all.

Basically, what I'm trying to say is that I didn't manage to do even half of what I intended to for this month's issue. That said, Ana and Andrija did a whole lot of work so you will still be able to read quite a bit about the build. In my limited capacity I did manage to test out a couple of techniques that I'll be using while painting a bit later on in this series of articles.

At the beginning of 2014, my LGS finally got it's shipment of the new Citadel range of Technical Colours and I bought some and managed to test them out and even compare some with other similar products out there. In the electronic part of the article I'll describe another cool chip (and the appropriate circuit) that enables the LEDs to blink. This will come in handy in later issues where I'll describe how to build the effect of running lights. So let's begin.

Some time ago, Wyrd Miniatures organized one of their fun on-line painting competitions, the Rotten Harvest, so I decided I'd take part with a couple of minis I had lying around. I wanted to make a small diorama and I thought that the idea Ana and I were toying around of making some statues for the Malifaux board could work well

A story of a gaming board



with this too. Therefore I decided to make four statues with the Malifaux deck suit signs. Easiest way was Ana's advice: to convert some Warhammer statues (from the Warhammer Chapel set), to look like they might be a part of Malifaux. Conveniently, there were four of them – which is also the number of Suits in a Fate Deck, so each of them was to be transformed to represent either Rams, Crows, Masks or Tomes.

For starters I assembled the statues before me to decide which would be which. The easiest was the one holding a book – perfect for Tomes. It also has a spiked halo around its head, which I decided to trim so that it slightly resembles a cog. Another one was holding a skull in one hand and a twin – tailed comet in the other – that one would be Crows. The comet would be replaced by a feather, and its human head by a stylized crow head.





Electronics Top Tips

IC 555 Timer

555 timer is one of the chips most frequently used either as an oscillator or as a timer. For the purposes of this build, I'll describe the astable mode when the 555 timer is working as an oscillator. When it is connected to a voltage

source, its output voltage "jumps" from low level to high level (like on the graph). The frequency of low and high output voltages is determined by a RC circuit (combination of a resistor and a capacitor).

The length of time t_{low} and t_{high} are adjustable through resistors R_1 , R_2 and capacitor C and can be calculated thus:

$$t_{high} = 0,693 \cdot R_1 \cdot C, \quad t_{low} = 0,693 \cdot R_2 \cdot C,$$

$$f = \frac{1}{t_{high} + t_{low}},$$

$$cicle = \frac{t_{high}}{t_{high} + t_{low}} = [\%]$$

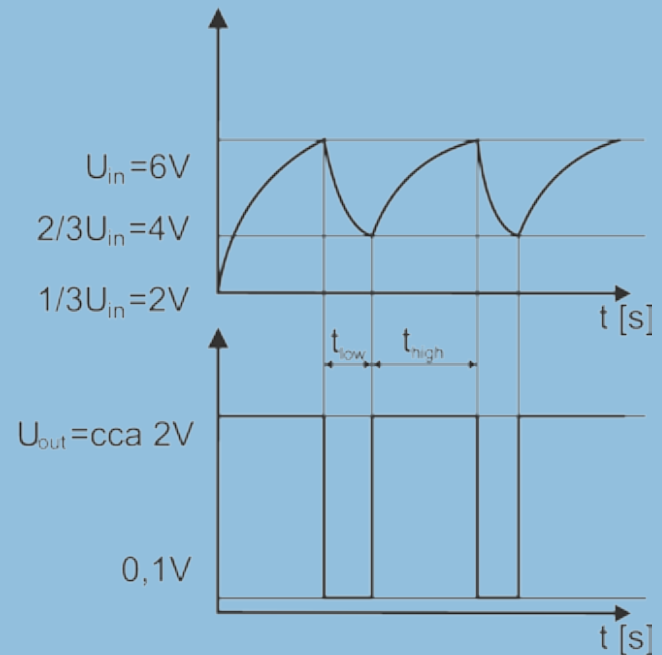
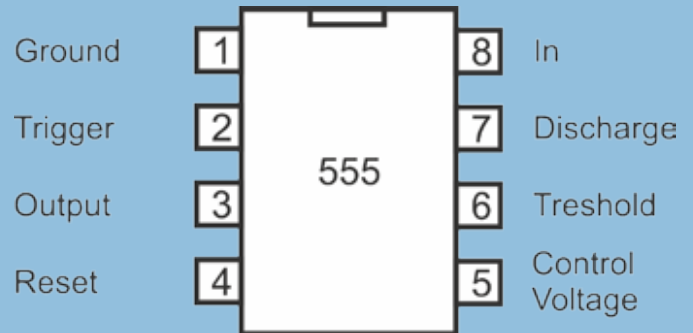
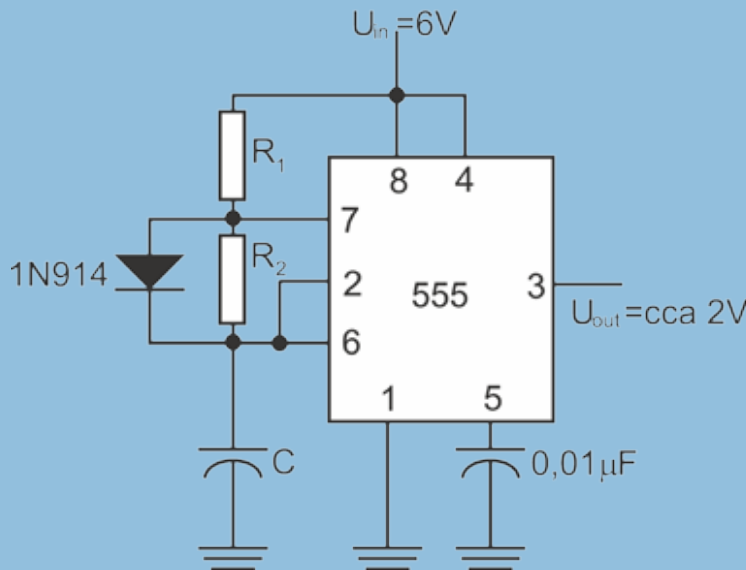

Planning Top Tip

Advice: depending on the way you wish your LEDs to blink (or in other words depending on the time you wish your LEDs to be turned on [t_{high}] or off [t_{low}]) you can choose your resistors

in relation to the capacitor (the most common choice of the capacitor is $1\mu F$ – beware when converting units!). For an example: $t_{high} = 0,5s$; $t_{low} = 5s$

$$R_1 = \frac{t_{high}}{0,693 \cdot C} = \frac{0,5}{0,693 \cdot 0,000001} = 722k\Omega,$$

$$R_2 = \frac{t_{low}}{0,693 \cdot C} = \frac{5}{0,693 \cdot 0,000001} = 7,22M\Omega$$

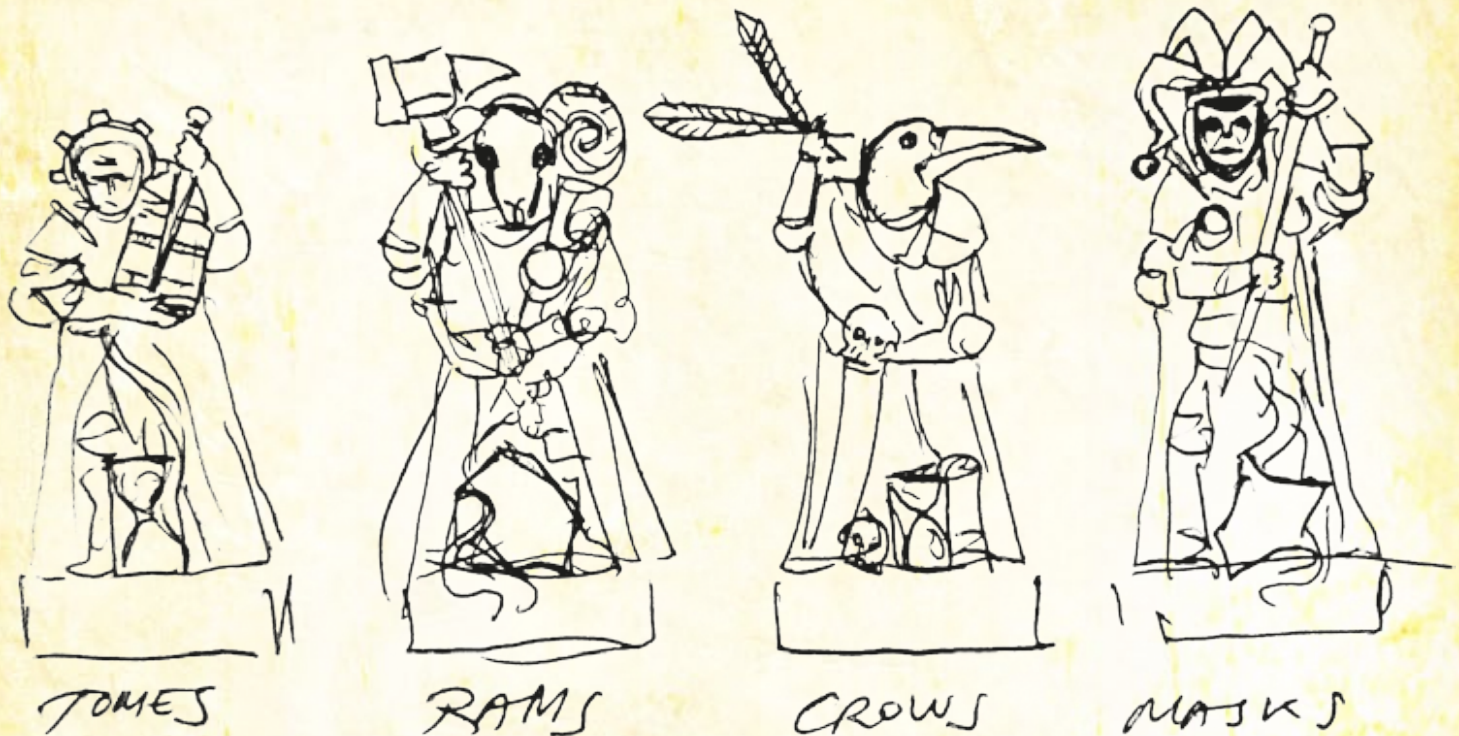

The remaining two would then have to be Masks and Rams. These didn't have such straightforward details that would help me make up my mind. In the end I went with the one holding a sword for Masks and the one with a hammer for Rams. Sword is a more elegant weapon and it suits the Never-born better. A hammer is a blunt and powerful thing, so it works better with Guild. Also, it may evoke the picture of a judge's gavel. The Ram one would get a ram's head, and the Mask one, not surprisingly, a mask.



At this point I made a quick sketch, just to serve me as notes about what I wanted to change. You will notice I didn't closely follow the design from the sketch, since I got a few better ideas later along the way.

Before I began sculpting I needed to remove the mould lines and all warhammer insignia littering the statues. All the parts I messed up this way I fixed later with green stuff. Next I sculpted the ram and crow heads, and the mask. As Tomes' head was fine as it was, it skipped this step. I went through my bits and found a feather to put in Crow's hand where the comet used to be.



When the green stuff cured, it was time to detail the statues' new mugs. At first I intended to sculpt the details myself, but rummaging through my bits box looking for the aforementioned feather I found a very useful demonic banner which provided me with two pairs of stylized horns and a pair of oval "eyes". The horns were pinned to Ram's and Mask's heads (the mask has horns just like the Nephilim do!). I glued the oval eyes to the sides of Crow's head.



In the end I washed the statues several times with diluted Liquid Green Stuff. This helps fix some of the tiny imperfections and blend the sculpted parts with the original plastic as it gives them a unified texture. You can also

stipple liquid GS on a smooth plastic surface to achieve different kinds of textures. I do this all the time with the new Wyrd plastics.

And finally, I was not happy with the glass hour clocks on two of the statues, so I decided to remove them and add two shields (to resemble the other two statues). On the flat surfaces of the shields I once again glued the suit signs

– this time cut out of a piece of paper. It should provide enough of a relief to look cool once painted.

Then I finished the miniatures and the rest of the scenery for the diorama, took photos of it and removed the statues for safe keeping until I'd need them for the board.





Marko's Lamentations

New Citadel Technical Paints

As soon as I heard GW was releasing the new Technical paint set, I was psyched as I realised that they would fit in perfectly with this board.

In the set there are several paints I was not interested in: first the bubonic/bile colour (Nurgle rot) and second the crackle effect brownish paint (Agrellan Earth).

However, I was really interested in Nihilakh Oxide, Blood for the Blood God (whoever thought of the name should be shot) and the pair of Typhus Corrosion and Ryza Rust. So at the beginning of January my LGS finally managed to stock these and I took the plunge and got them.

As I wanted to play it safe, I didn't want to leave it until it's painting the board time, so I did a trial run for these paints. Here are the scores ☺

First off, Nihilakh oxide – basically a bit thicker turquoise wash, that gives good coverage and can be moved around with a brush to leave that cool bronze patina effect. I first painted the plastic bit with Tin Bitz and then washed it all with Badab Black. After it was done, I dry brushed the Tin Bitz, Sycorax Bronze and a mix of Sycorax Bronze with some Burnished Gold. Then I applied the Nihilakh oxide. I did not particularly take care where I put it, apart from the corners. In the end, after leaving to dry, I dry brushed the whole thing with Dwarf Bronze and some Mithril Silver. The whole thing took no more than 5 minutes (excluding the drying time) and I was really pleased with the result.

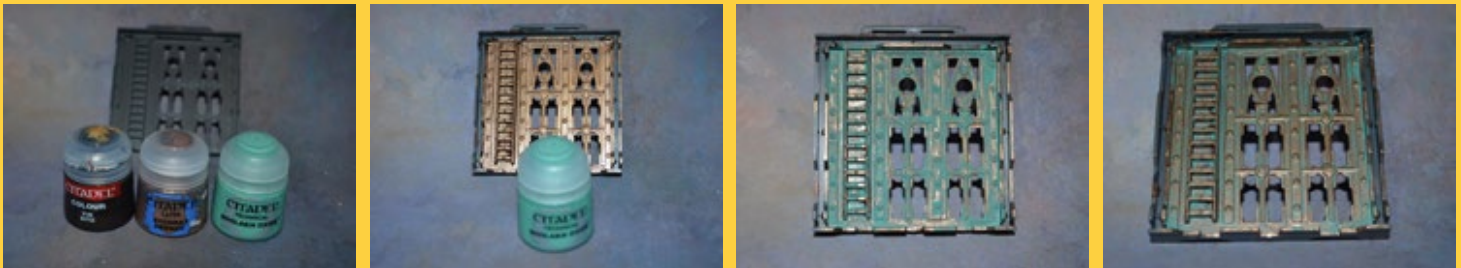

Next it was time to try the Typhus Corrosion (a brownish wash with some particles inside for roughness) and the Ryza Rust (basically an orange paint from their Dry range). As I wanted to try out the sea salt method, I first painted the plastic bit with Chainmail which I washed with Badab Black. Then I applied the Typhus Corrosion randomly and without any special care taken with regards to the placement. When dry, I dry brushed it all with Ryza Rust. Next up, I covered it with hair-spray and sprinkled some sea salt and left it all to dry. Then I painted it all with some greens (starting with Dark Angels Green and ending with Scorpion Green). When dry, I put the bit under a stream of cold water and let the salt dilute. It left generous rust patches under the green paint. In the end, I added even more weather damage by applying some Chainmail on the edges that protruded the most.

With both Oxide and Corrosion I was well pleased however; I must admit that for the entire table I'll need a LOT

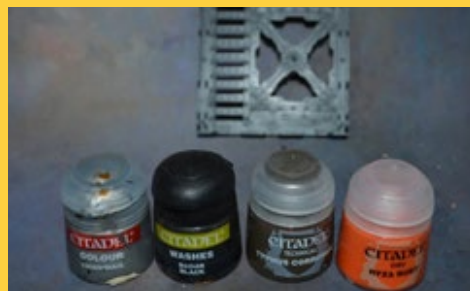

of these. However, after playing around with the sea salt method, Ana cleverly pointed out that I wouldn't be able to use it on this board as most of it is made from balsa wood and card while the frames are MDF so it would all get soaked. More glitches in my fool proof plans...



Finally, I tested the red technical paint to see if it's at least a bit better than its name...and it is quite a bit better, though I still do not think its good colour for blood on its own. For better results I suggest adding some black or brown wash (or even both). The paint itself is really thick, but not a lot of pigment inside. This makes it transparent where it is thinly applied but allows for the blobs of paint to be easily made. In the end, I decided to test out the Blood for the Blood God paint against its most famous rival, Tamiya X-27 Clear Red. To set the bar, I checked my notes on Tamiya. A while back I was doing a diorama of London alleyways for some of my Infamy minis and I needed to some blood pooling. In order to do so, I conducted several experiments (from left to right on the picture):



- | | |
|---------------------------------------|--|
| 1. PVA + Tamiya clear red | 5. TCR + Still Water + superglue |
| 2. PVA + superglue + Tamiya clear red | 6. Still Water + TCR + Devlan mud |
| 3. TCR + superglue | 7. TCR + Devlan Mud mixed and then added Still Water |
| 4. TCR + Still Water (Vallejo) | |



In the end, the best results showed the option #7 so that would be the one the Citadel What's-its-name had to beat. As I said, the BFTBG paint is quite thick so I didn't use the PVA methods I used on Tamiya, but went straight for the other ones:

1. Pure BFTBG
2. BFTBG + Badab Black wash
3. BFTBG + Devlan Mud wash
4. BFTBG + Ogryn Flesh wash
5. BFTBG + Badab Black + Devlan Mud + Still Water

Overall I was pleased with the BFTBG + Badab Black result the most. Now to check out against the Tamiya Clear Red option #7:

So, after comparing the best results, I'd have to say Tamiya is hands on winner. It remains glossy and is more translucent than the Citadel one. Plus I like the smell of Tamiya Clear Red more (am I the only one?).





Ana's Research

Steampunk Arachnids are Ramos' little minions which come in swarms to do his bidding. I painted three of those tin spiders to serve as decorations for that one module themed as an Arcanist workshop. There are three different versions of this unit around: the original and the alternate, which are both metal and the plastic, 2nd Edition versions.

I used the original ones as they were kindly provided to us by Wyrd miniatures. The clamshell pack contains three metal Arachnids, one 40mm and three 30mm round lipped bases, and four first edition stat-cards. The thing with Steampunk Arachnids is that they can start as individual spiders on 30mm bases, and through the course of the game they can team up into a Steampunk Arachnid Swarm, which is on a 40mm base.

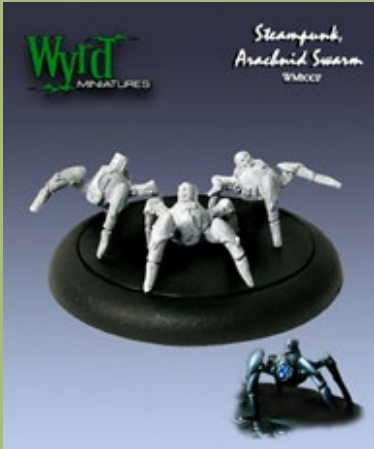

All three miniatures are copies of the same sculpt, but I don't see that at all as a problem in this instance. Each of them comes in three pieces: body with hind legs and two separate front legs. There is some flash and mould-lines, but nothing I would call exceptional. They are tiny, but I managed to assemble them without much trouble. One was put together in a normal way, another on its back, like a dead spider, and the last one was left in pieces - on to the painting part!





This was simple enough. I undercoated all three in black, followed by a basecoat of Citadel Leadbelcher. This was followed by a wash of brown Citadel Agrax Earthshade and black Nuln Oil. At this point I introduced some brassy-goldy details – painted with a mixture of Coat d'arms Bright Gold and Citadel Tin Bitz. These were also given a wash of Agrax Earthshade.

I highlighted the steel parts up to Citadel Mithril Silver, and brass parts up to Bright Gold. When choosing which parts to highlight I had to take into account what will go up and what down one day when these are glued to the board.



To finish them off I painted the eyes. The walking ones are glowing blue, and the other two have black eyes, since they are both shut down.



Andrija's Bitz and Bobs

Doors for Hungering Darkness' module

For the Honeypot casino we used the two basic techniques we described in [FPM #6](#). On one side we have shabby wooden doors to look uninteresting to the passer-by. The

doors are made out of purposely uneven cut balsa planks. The other side of the doors are made out of heavy metal to protect the casino patron's secrets "What happens in Honey-pot, stays in Honeypot!"

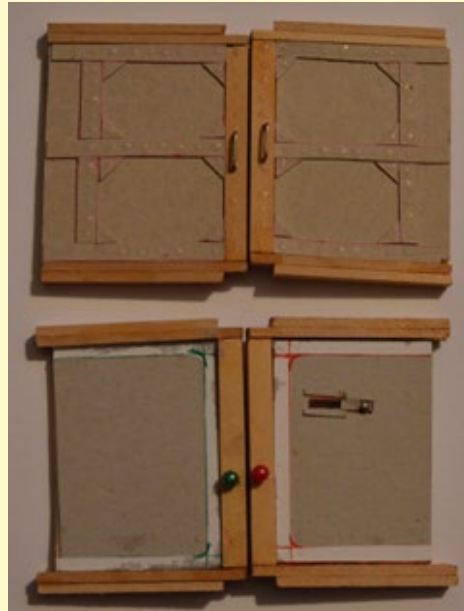

The door wings were in the end detailed with paper and PVA glue to imitate metal fittings and rivets. Cardboard and pin heads were used for door handles and the little spy window.

Doors for Nicodem's module

For Nicodem's module I wanted to have something like those ornamental metal doors you can find on old crypts. I covered the generic wooden sliding door with thin card to get smooth surfaces, since it will later be painted as metal. I used thin card for some detailing, also.

And I used pin heads to simulate rivets. To finish the doors off I added some detail in green stuff, such as floral decorations and Resurrectionist symbols. Before undercoating I stippled some parts of the doors with liquid green stuff, just to get a little bit of texture.

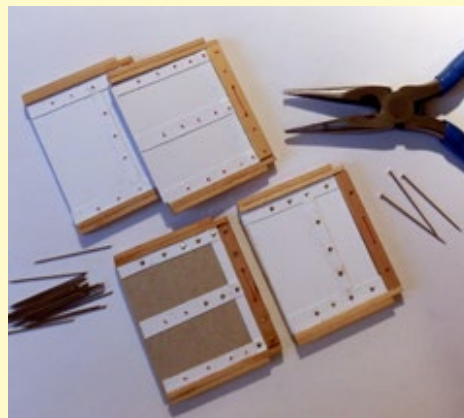
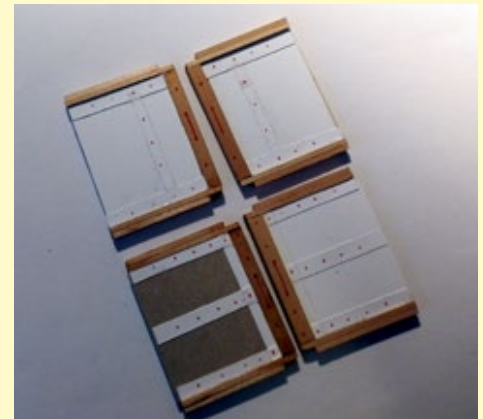

Doors for Ramos' module

For Ramos' module the whole idea was to have the doors whose sliding mechanism could be seen. A lot of cogs, wheels and pistons all over the place. That meant lots of tooth-gearing and some solenoids and magnets. I found those in some cheap plastic clocks from a one dollar shop.

Also, I used some copper tubing and wires you can easily buy in any DIY store. To accommodate all these bits I didn't put the balsa plank in the middle of the frame but almost completely to one side. On one side the doors were detailed with some paper and "PVA rivets", similar to what was described before to make them look like just some metal doors.

In the deep side of the doors I went crazy and glued all the parts I mentioned before to try to make it feel like the doors were functioning like with some elaborate clockwork or hydraulics.

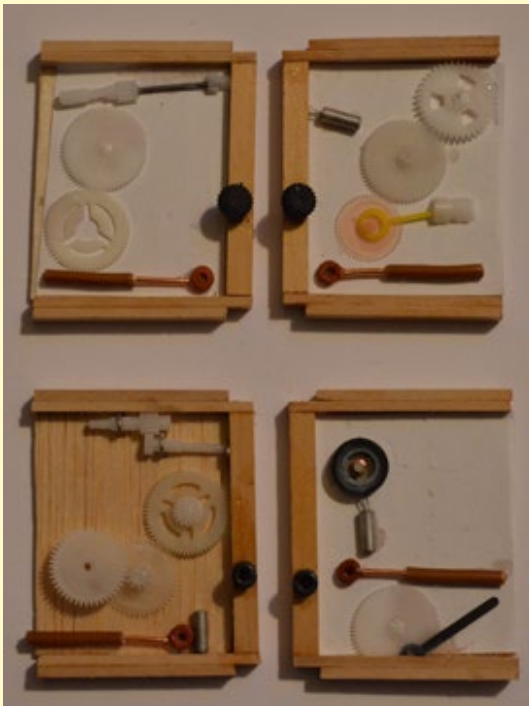
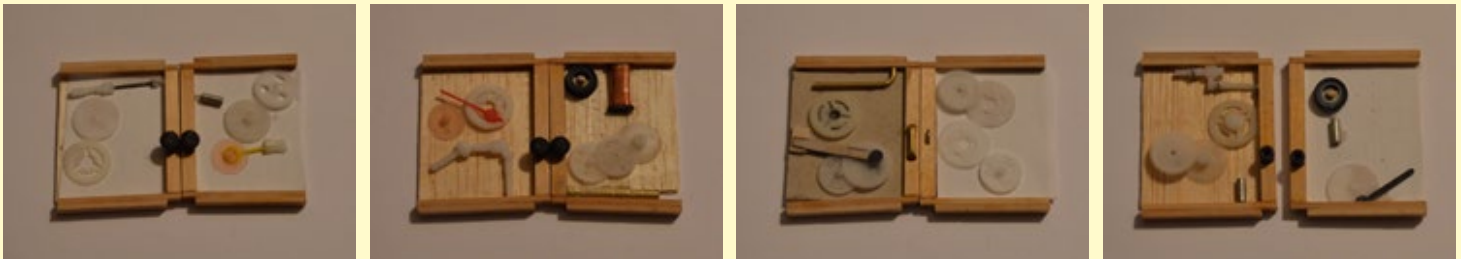

In the end I put in the pistons that move the doors open and shut. I made them from a piece of thicker insulated wire. On one part of the would-be piston I removed the insulation, and on the other that would act as a body of the piston I left it on. Then I added a wooden bead at the head of the piston clip and made the bolt to hold it in place. I used the method Marko described earlier to paint the inside of the door. Once the painting was done, I glued the plastic foil so the inside of the door could be seen but would be protected as well. The edges were camouflaged with metal sheeting and rivets (out of card and PVA).

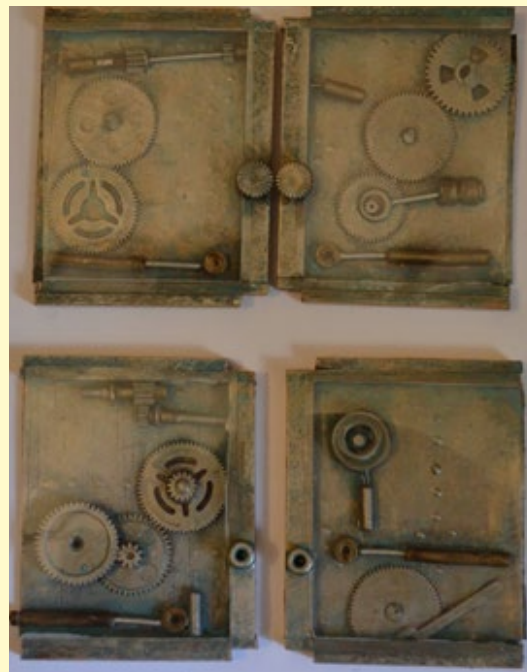

So, not a lot of progress done with the modules themselves, but still a lot of cool details were done that will make the final assembly of the modules run more smoothly and quickly. As always, if you have any questions about this build, feel free to contact us at Figure Painter Magazine (terrain@figurepaintermagazine.co.uk) and we'll try to answer your questions

The very best
EXPOSÉ
new releases



Prince Hector of Troy
Company: Nuts Planet
Scale: 250mm
Contact: www.nutsplanet.com

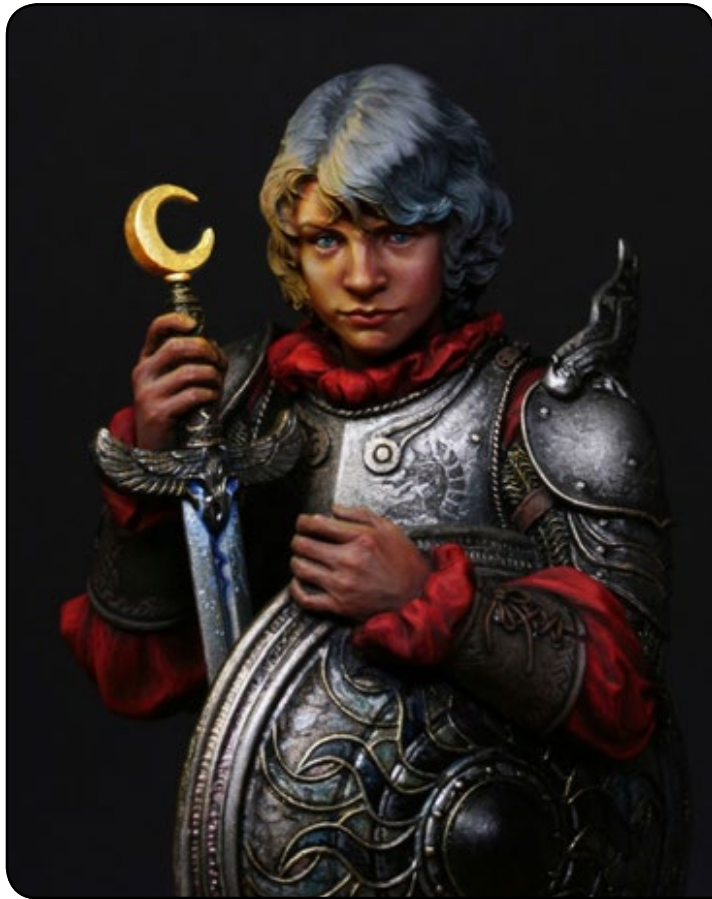

'KYLE' Heir to The Blue Sun
Company: Galapagos Miniatures
Scale: 1/10th scale
Contact: galapagos-miniatures.com

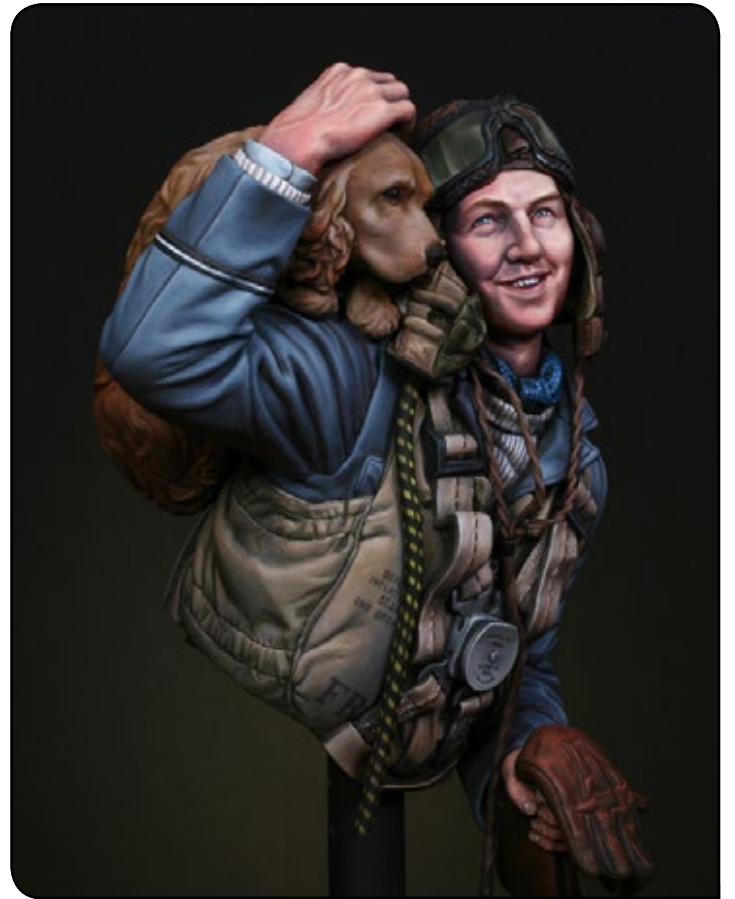

'The Few' RAF Fighter Pilot, 1940 Battle of Britain
Company: Life Miniatures
Scale: 1/10th scale
Contact: lifefigures.kr



Templar Knight

Company: Young Miniatures

Scale: 1/10th

Contact: www.young-miniatures.com



French Cuirassier

Company: CGS Military Figures

Scale: 200mm

Contact: www.cgs军事figures.co.uk



Vintage Pilot 1920
Company: Heroes & Villains Miniatures
Scale: 54mm
Contact: www.hvminiatures.com



U.S. Cavalry Flag Bearer, 1876
Company: Andrea Miniatures
Scale: 54mm
Contact: www.andreaeurope.com



Celtic Warrior
Company: Pegaso Models
Scale: 75mm
Contact: www.pegasomodels.com



The Lord of Lion

Company: Nuts Planet
Scale: 1/10th
Contact: www.nutsplanet.com



Night's Watch

Company: Nuts Planet
Scale: 1/10th
Contact: www.nutsplanet.com



Elven Fairy Magic

Company: Morland Studios
Scale: 12 inches tall
Contact: morlandstudios.com

Khalgrim Gunnarson

Company: Scale75

Scale: 75mm

Contact: www.scale75.com



The Phoenix

Company: Skulls Mini

Scale: 150mm high

Contact: www.skullsmi.com





SibilaVamp
 Company: Draconia
 Scale: 35mm
 Contact: www.aresmythologic.com



Berserker
 Company: Icon Figures
 Scale: 60mm
 Contact: iconfigures.blogspot.co.uk

Borormites Overseer Team
 Company: Warlord Games: BtGoA
 Scale: 28mm
 Contact: www.warlordgames.com



The Dwarves of Fire Canyon with Great Weapons
 Company: The Russian Alternative
 Scale: 28mm
 Contact: russian-alternative.ru



New from Miniature Heroes



WOODEN PLINTHS

A range of solid hardwood display plinths and bases.
All are handmade from sustainable English timbers.

www.miniature-heroes.co.uk

AIRBRUSH TUTORIAL

BEGINNERS WAR GAME MODEL PAINTING WORKSHOP

TWO DAY March 8th & 9th 2014 10am - 4pm

www.barwellbodyworks-shop.com

Miniature

war gaming figure artists paints





By Davide Rainone



Unboxing

Guild of Harmony's Aykroyd, Paranormal Investigator

It was June 1984 when the film came out in the cinema. I wasn't even born, but I've had the chance to see it at least ten or fifteen times from the nineties on and in 2014 falls the film's 30th anniversary. What am I talking about!? Ghostbusters the movie, of course!

Material: **Resin**

Scale: **32mm**

Price: **AUD 14.95 + 3.50 P&P**

Resin limited 300 copies

Available from:

Guild of Harmony

www.guildofharmony.com

A cult movie with a great cast (Bill Murray, Dan Aykroyd, Harold Ramis, Ernie Hudson, Sigourney Weaver and Rick Moranis) which, I guess, inspired the sculptor and also the for which the miniature is titled, being named after the actor Dan Aykroyd. One big difference which you'll notice straight away is that this miniature has been given a very different style and concept, Victorian steampunk, rather than sticking with what the character is based on, set in 1980's New York.

Sebastian Archer's Guild of Harmony line seduced me with his very beautiful models and I like his idea to portray famous literary subjects in a new way very much, so I decided to buy one and check out the quality of this model. The resin version, which I'm looking at for this review, is limited to 300 copies, although there is a cheaper metal option which will remain in production. It arrived to me in a protected envelope containing a little plastic bag with the model inside and a reference card hand signed which explains the concept and tells us the number for the limited series.

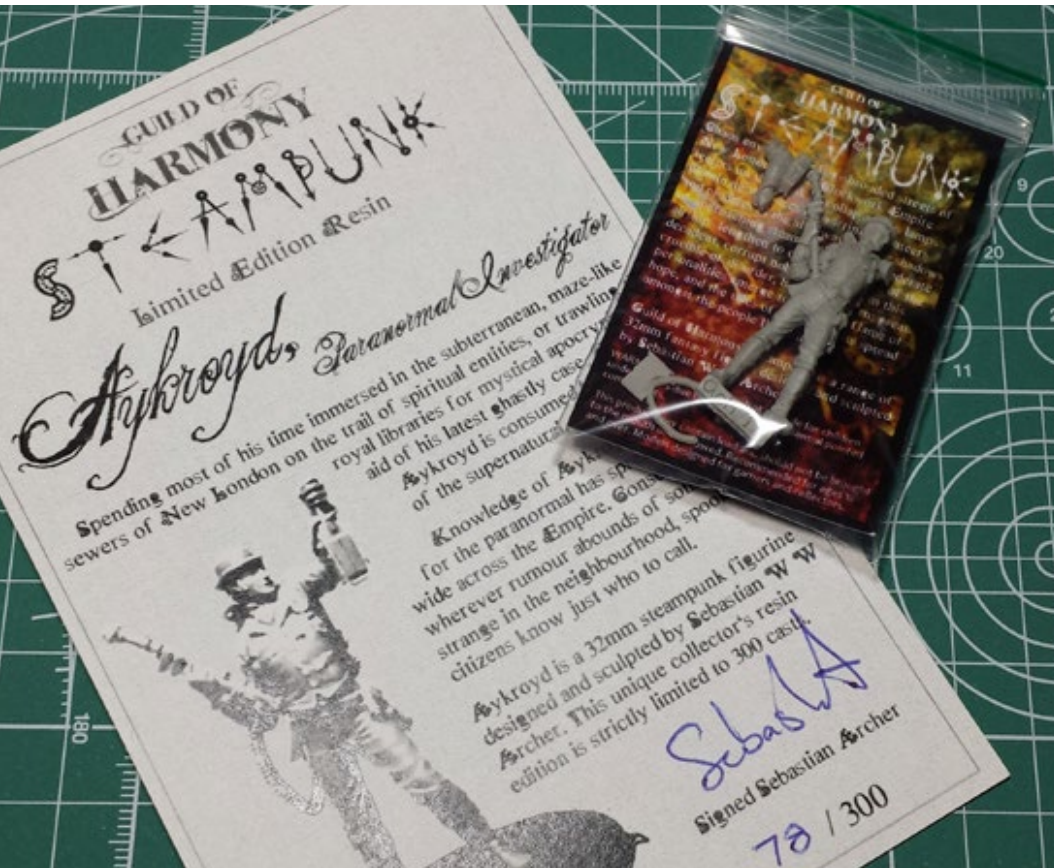

I must also mention that the envelope arrived at my home in Italy only nine days after it had been shipped from Australia! Maybe elsewhere this is normal, but I assure you here in Italy this is true science-fiction, so I'm very impressed!

The model is divided into three pieces with the addition of a round base. With the principal piece being the body there is also the left arm which carries the ghost trap and finally the little tube. Seb Archer has given to the model a certain style, characterisation and facial expression which I like very much. It's simple, but at the same time complex enough for a master painter to explore in a very significant way and in my opinion would be a good choice for both the beginner and the expert painter because it offers very fine detail, while still leaving space enough to bring it to life with colour.

My first inspection showed no apparent flaws but after a closer look I can see some very slight mouldlines; one over the right arm and weapon with some surplus resin underneath his chin and in the folds of his slacks; nothing that can't be removed in few seconds with a fine file or fine sand paper. The most important thing is the absolute lack of bubbles or holes! It's not quite perfect, but I think this a great result for a miniature of this scale.





In my opinion, the only one thing which lacks imagination is the backpack. The other steampunk models in the store are full of details; here we have a body, well done, but almost too simplistic for the steampunk genre. It's only my opinion, of course; I'm sure there are many happy people out there, but personally I'm a bit disappointed. I will try to modify it myself or characterise it more deeply during the painting process.

What more can I say? It's a beautiful concept; very good casting and has given me lots of ideas for when I paint it... I definitely approved!

I would like to congratulate Seb Archer for his work. I appreciate it a lot and not only for his Guild of Harmony range, but also for his sculpt for the Arena Rex game. I will be not surprised to see in even more beautiful work from him in the future, so good work and good luck Sebastian!

de-mystifying the Airbrush



By **Shane Rozzell**



In this second instalment of this series of articles where I'm attempting to de-mystify airbrushing, I'm going to explain the basic ways we can use our airbrush for painting miniatures.



Thinner, Mr. Surfacer & pre-mixed bottle

This first and most obvious way is to use it for priming a miniature. Several paint manufacturers make primers specifically for airbrushing and I have used a couple of types, but at the moment, my favourite is Mr. Surfacer. It's not as easy to use as other acrylic prim-

ers, because it needs its own specially formulated thinner which does give off a pretty bad smell, but nothing dangerous and I think the finish is far superior to anything else I have used before, so I'm willing to put up with that to get the best finish I can.

Keeping the airbrush at a good distance from the model not only helps with a nice flat, even coat, but also makes sure the paint particles are nearly dry as they hit the model.

One of the reasons why the airbrush is specifically suitable for the miniature artists is the fact that the way paint is fired from the airbrush mimics the miniature painter's best friend, light. If you think about it, miniature painting is all about how we mimic light acting on our models. The most common use



Shadows

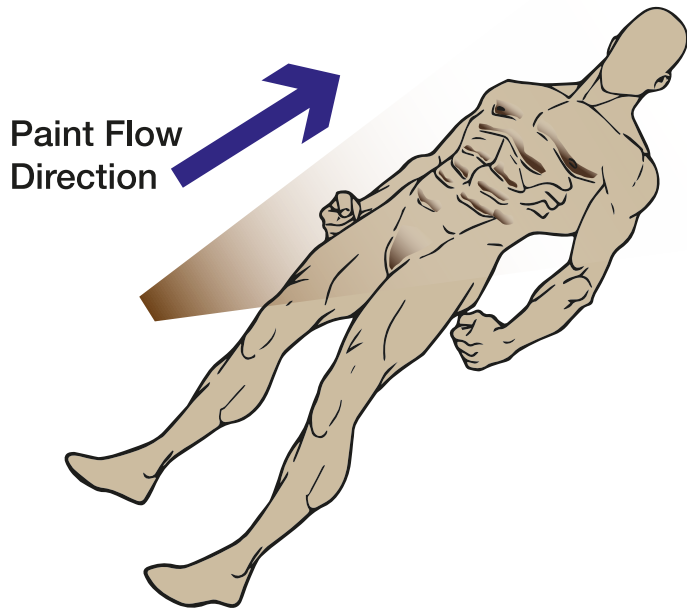

Highlights

Paint Flow
Direction

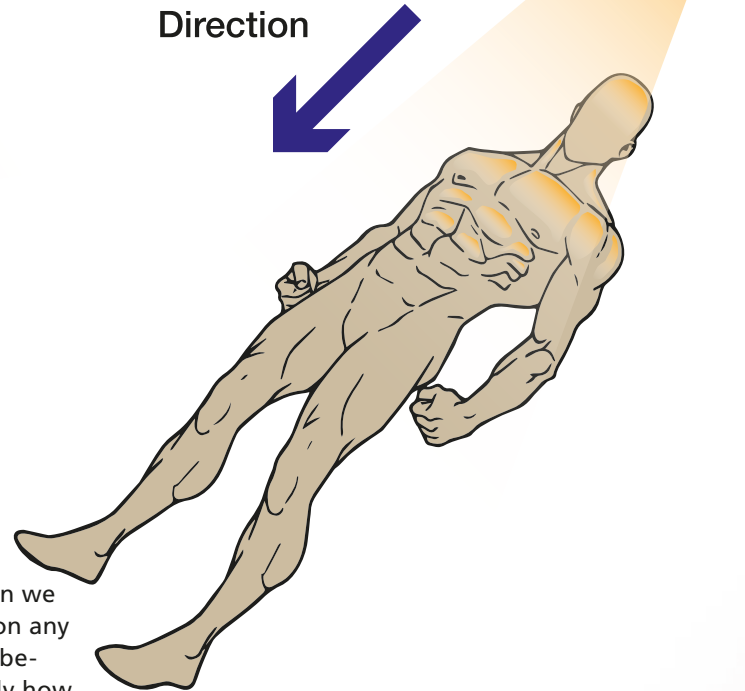

of this is zenithal or top down lighting; put simply, this is when we paint highlights on any upward facing surfaces and shadows on any downward facing surfaces and the airbrush is perfect for this because it fires paint in a straight line from a single point, exactly how light hits the surface of a model.

In the following SBS, I'll show this property while quickly painting the skin colours on a miniature. I'm not concentrating on colour mixes because we should all have our own, but rather on the technique used and it must be said that this isn't the only painting I'll be doing on the model's skin. Later, when this is dry, I'll go again with a traditional brush and add more shadows and highlights until I'm happy with the result. One other thing to note, I always prefer to airbrush with a black background because I feel I can see the airbrush's spray cone and better aim the tool. Lastly, between each colour change I run through some airbrush cleaner.

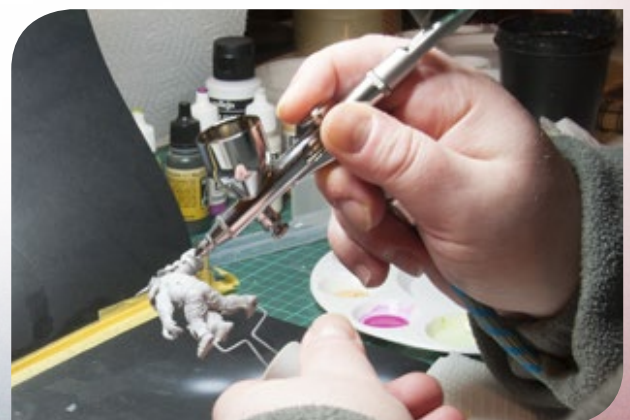



Step one: base colour

Since the miniature has a lot of armour which I can get some rusts in to I want to contrast that with some quite cold colours for the skin tones, however, I also want some contrasting on the skin to add interest, so I mix some colours onto my pallet that I want to use. These are a beige colour that will act as a base for the skin area. A pure magenta is for the areas where blood flows strongest and also those interesting contrasting areas. The last three colours will make up the bulk of the skin colour — a shadow, midtone and highlight. I turn up the compressor to around 40psi so I get a nice smooth coat and I start by giving the skin area a base coat of the beige colour.

Step two: under painting

Here I have turned down the pressure of my compressor to about 20psi, which will allow me to get a much finer spray and with the tip of the airbrush close up to the miniature I very carefully add magenta to where I want the skin colours to vary. This is sometimes called pre-shading. I have also painted the large hand and some of the forearm to add interest.



Step three: mid-tone

Here I'll be using the midtone colour to cover the entire skin area, but I'll also be relying on the transparent properties of the paint so the under painting shows through.



Step four: shadows

There is no particular reason for painting the shadows before the highlights; it's something that I always do because I think it helps define the shape of the miniature, so I can better see the details. Tilting the miniature and painting from below, the darker paint only hits the areas where shadows should appear.



Step five: highlights

Switching around and spraying from above I now add the highlights. I constantly turn the miniature around so I get a nice flat and even coverage. Once done, I'll add a quick spray of pure white as a final highlight. This can hardly be seen but adds a subtle desaturation of the colours.

That brings this instalment to an end and I hope I have given you enough basic understanding to get you started so you can have a go yourself. Next issue, I'll start to cover some more advanced techniques that can only be achieved when using your airbrush.



By **Marta Ślusarska**

Unboxing Figone's Gladiataure

Today I'd like to show you a beautiful miniature from Figone's stables, the Gladiataure. This massive beast is a second incarnation of their iconic figure Minotaure; but this time, as the name suggests, it's covered in some serious armour along with sword and shield and is ready for fight in the arena.

Material: **Resin**

Scale: **75mm**

Price: **45.00 €**

Available from:

Figone

www.figone.fr

In my personal opinion, it looks even cooler than the original sculpture and all the additional details add more character. Just check the website and compare these two guys — the 'naked' Minotaure, and upgraded version, Gladiataure.

The Box

Again, the miniature is packed in a plain plastic bag. I guess you all know by now how spoiled I am when it comes to packaging, so there is no point of complaining about the bag. The miniature arrived in perfect condition via Royal Mail, despite all the efforts of my mailman, who decided that the bubbly envelope would fit through the mail hole in my door (it didn't, it was just stuck in the middle; luckily for me it stuck so hard that no one could take it easily).

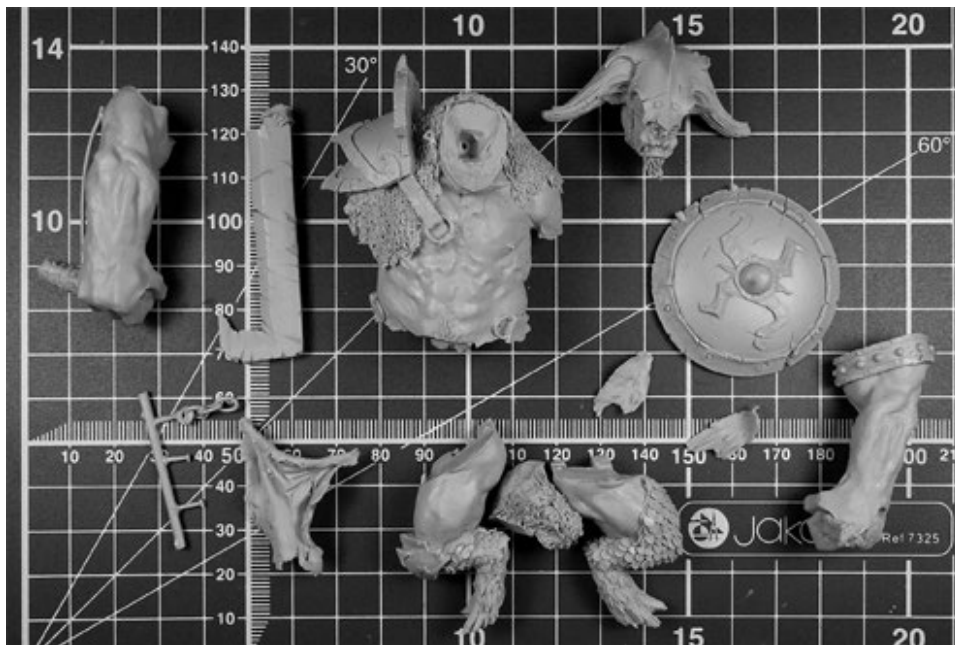

Quality of the Cast

To begin with, I must say that the mini is rather complicated and all the new elements are highly detailed (check out the close up of the hauberk on his shoulders, the scaly parts on his legs attached to the clearly visible leather). All those details are perfectly well cast, however; the miniature requires some cleaning and fixing anyway. Surprisingly these are mostly around simple elements like belts, straps and some just on the flesh. It's nothing major — just some small things easy to fix, but still it makes a rather strong contrast. I also found a few mouldlines along his arms, torso and at the back of the legs. Again nothing massive, just thin lines that are pretty easy to fix.

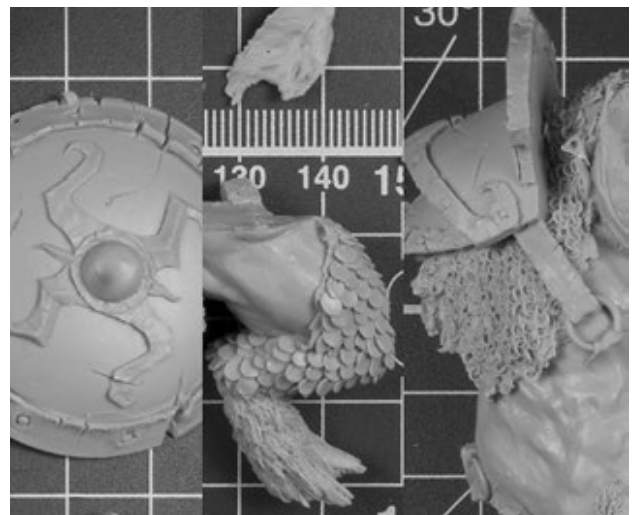

Assembly

I'd say that putting this mini-together should be fairly easy. The head, arms, sword and shield fit together really nicely. There might be some filling required to mask joining points, but that's normal I'd say; as there are no big holes to be covered, the whole procedure shouldn't take long. The only unpleasant moment for me may be fixing his legs. After an annoying misadventure with Pegaso's Templar, I'm not the biggest fan of '3 pieces' legs. It's much harder to assemble 3 pieces at the same time, while making sure all is in the right place. Masking joining lines in the fur under his bum will be fun.

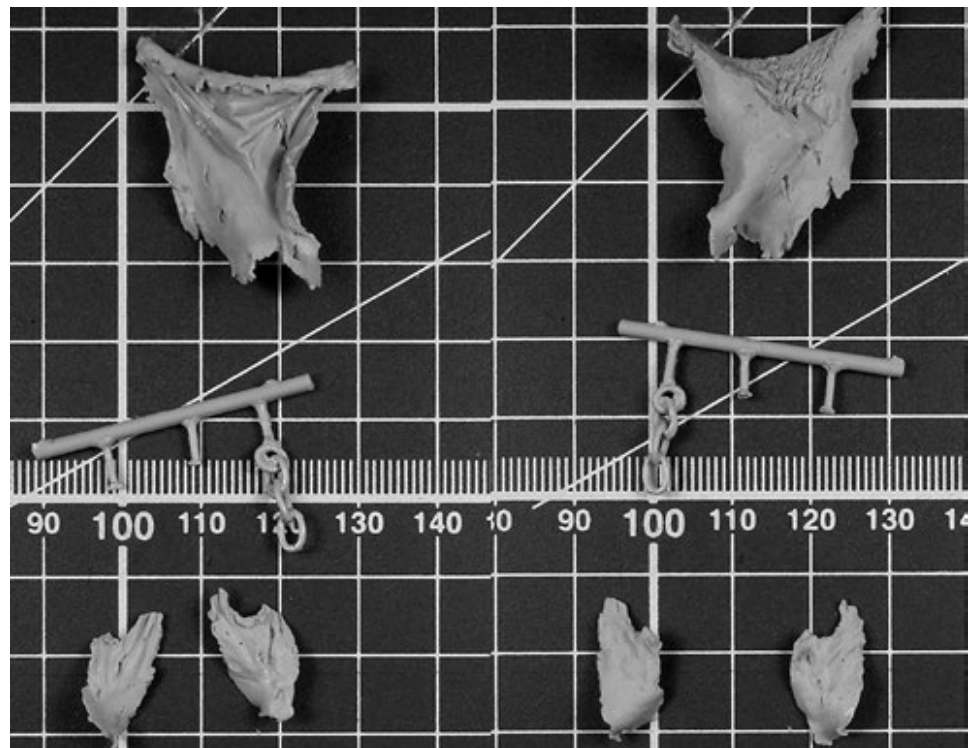
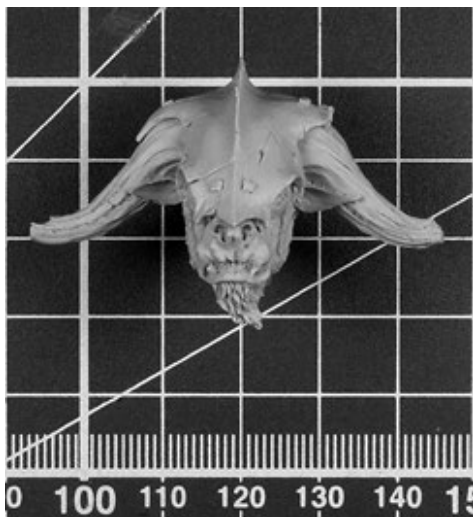
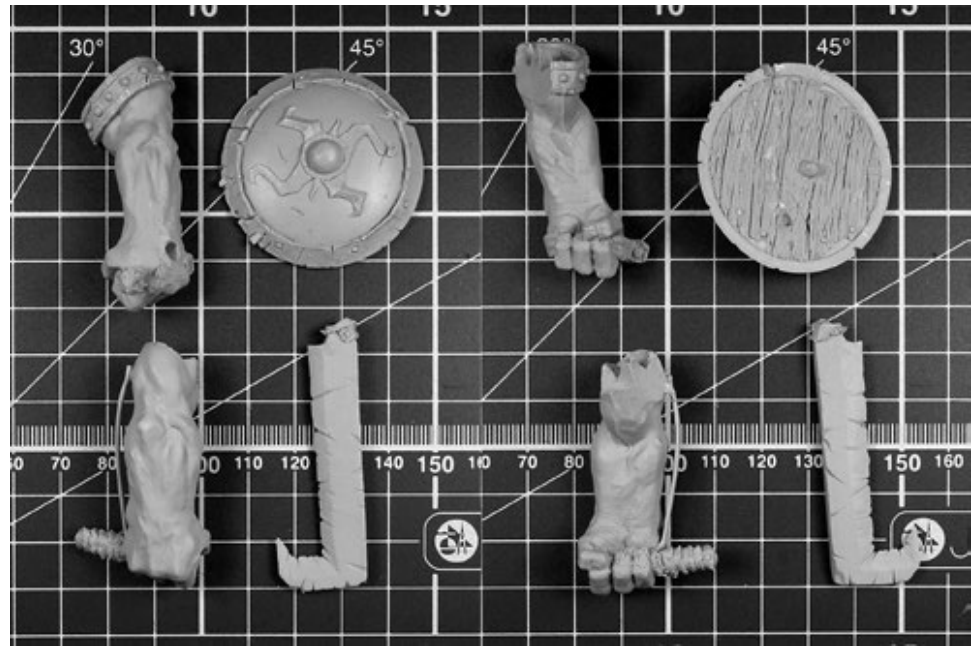

Overall Opinion

I'm not going to deny I love this miniature. I find all the alterations absolutely cool and I'm really happy I have him in my hands; of course it could be even better when it comes to the quality; but in my opinion, it's really good enough when we look at how complicated some of the parts are of this miniature. The combination of extreme details and smooth, nice surfaces give a great chance to show off your painting skills, so if you're looking for some massive beast (check out the scale on the photos to find out how massive indeed) with a fantasy twist, Gladiataure will be a great choice.

THE THING

from another world!



By **Barry Ford**

Thing's ain't what they used to be! I don't know about you, but I have a great love for old black and white horror and science fiction films. The lack of colour provides an atmosphere that can be lacking from modern films, and who could forget the creepy sound effects created using the Theremin? I'm obviously not alone in my love of these films, as they are obviously one of the factors in the creation of the Garage Kit hobby, and the number of kits inspired by the genre is extensive.



I am going to work on one of the kits produced by Solarwind Models and sculpted by Mike Cusanelli. Mr. Cusanelli has a very distinctive sculpting style and is perhaps best known for his rendition of the female form. However, this 1:8 scale kit is an accurate representation of one of those classic creatures, whilst being obviously sculpted by Mike. As well as the figure, the kit includes a small diorama base with snow covered packing crate, oil drum and section of fence. I decided to extend the base to include a section of one of the buildings and consider the use of modelling snow.

One of the advantages of working on a kit whose origin lies in a black and white film is that your imagination is given free reign when it comes to considering the colour palette. One option would be to build the kit purely in the grey tones you would see in one of these old films, and I did initially

consider this an option, using only Titanium White, Neutral Grey and Ivory Black paints and making intermediate tones by mixing white with grey and grey with black. However, as the base was going to be covered in snow I felt that it needed some colour to break it up. I understand that a coloured version of the film has been produced, but I have not seen it and so decided to come up with my own colour scheme, based on the fact that the monster is supposed to be a form of plant life.

I gave the resin parts the usual preparation process of a good clean in hot soapy water with a scrub using a stiff toothbrush and cream cleaner. There was a minor seam line to remove with some gentle sanding and a couple of air holes that needed filling. To fill small areas I use Squadron Putty, which is spread over the problem area and then, before it sets, is wiped off using a cotton bud soaked in acetone based

nail polish removed: a tissue can be used for larger areas, but try and keep skin contact with the acetone to a minimum. By using this process the holes are filled with minimum residue left on the surface and thus minimising sanding (which I'm all in favour of).

I glued the legs and torso together and after adding the hands to the upper body the figure was complete. The figure was that well sculpted that no further putty work was necessary. The figure and base were then primed and ready for painting. However, on further consideration I decided that the nicely sculpted film logo on the packing crate would look a little out of place in the diorama. To remove the logo I used an electric sanding tool from the Minitool range: shaped like an ordinary hobby drill the sanding tool's head has a rubbing motion and a series of different shaped heads to get into hard to reach corners. I used some course grade

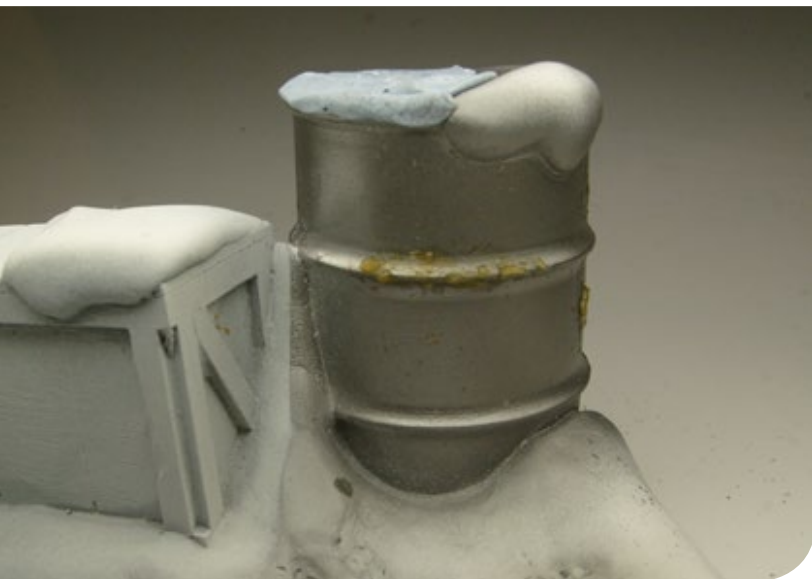

sanding paper as any scratches to the surface of the resin would appear to be texture in the timber. Once the logo was removed I re-scribed the board joints with an engraving bit in my regular hobby drill.

As I mentioned before I wanted to extend the base and so cut out a 260mm diameter circle from 6mm thick dense polystyrene. This was just big enough to add a section of building next to the resin section of base without having great blank expanses of snow.

For ease of painting I decided to paint the resin base, or rather the oil drum and crate on the base, before adding the resin part to the overall base. I started off by airbrushing the oil drum Games Workshop Boltgun Metal, which I think is one of the finest dark silver acrylic paints on the market today. I felt that the oil drum should be reasonably well worn and some of the paint would have peeled off it. The lid was masked with Blu-tac, which I find ideal for quickly masking irregular shapes, but for the areas of peeling paint I decided to use a masking fluid that is brush applied. I must admit I am not particularly fond of this method of masking as it is not always the easiest product to apply; it makes a mess of your brush; if it is not applied thick enough paint can get through it, and if it is left on the model too long it is very difficult to get off. However for areas of peeling paint I am not looking for exact masking of areas and because it is in liquid form I can dip a toothbrush in it and by running my thumb across the top of the toothbrush apply the liquid masking in small random patterns. I also found it easier to apply the masking fluid with a fine tipped rubber clay shaper, as any dried residue can easily be wiped off the tip rather than clogging up the bristles on a brush.

The masking fluid I used was made by Revell, and I have to admit once dried it looks like something you find in your hanky after you've blown your nose (now there's a thought for a bio-degradable modelling product: it's just a shame no one is going to get past the yuck-factor of the concept). I brush applied some Vallejo Medium Olive (a great shade of green for Thunderbird 2) in three thick coats. In normal circumstance one would aim to apply the paint as thin as possible over masking to try and minimise the opportunity for the paint to form a skin that can leave "flaps" as the masking is removed. However, in this instance, any flaps would only enhance the well worn appearance. With the paint dry I rubbed off the masking fluid with my finger to reveal the bare metal paint below. Unfortunately some of the masking fluid would not shift in a few areas (I can only put this down to the fluid being a bit old as there had only been a 36 hour period between applying the masking fluid and removing it), but that was not the end of the world as it just looked like the paint had bubbled in places.

I then started building up the weathering using Life-

color Tensocrom Active Surface Agents, in simple terms, thinned acrylic paint in appropriate colours. I applied Oil and Fuel around the top of the drum and where it might dribble down the face after being poured from. I also used Rust 1 and 2 on the bare metal areas. These colours are very thin and translucent, but used in layers they build up to a very satisfactory finish.

I decided I would make the drum rusty by using Deluxe's Scenic Rust product. Now, I must be honest here and say I do not know for certain if metal rusts in freezing temperatures: however, put a ferrous metal with water and rust will form – and there is a lot of water in snow. Even if rust is slow to develop in cold weather we can always make the assumption that the drum was rusty before it got there – so, on with the weathering. The rust powder and binder were mixed together in equal quantities and brushed onto the drum in appropriate areas: when dry, the developer was applied and left overnight for the rust to form. I then finished off weathering the drum by applying a little more Lifecolor Oil, as presumably the drum has been used since the rust developed.

The crate was given a base colour of Vallejo Tan Yellow and to create the effect of wood grain I applied some Liquitex Transparent Raw Umber with a tatty old brush: this leaves streaks and brush marks that are reminiscent of the grain you would see in real timber – just remember to keep all your brush strokes in one direction, which is usually along the length of the piece of timber. To tone down the Raw Umber and make it a little more worn looking I repeated the process using some Liquitex Driftwood Grey Woodstain, and applied a black wash to all the joints before finishing off with a dry brush of Tan Yellow to indicate where the crate may have got knocked revealing the raw timber below the surface.

Inevitably all the painting to the crate and drum had coloured the adjacent snow areas, so these were touched up with some Vallejo White paint airbrush applied to create a natural feathered edge to the snow. Before spraying the White paint I added a few drops of Payne's Grey to it. This does two things: firstly, the addition of the Payne's Grey improves the ability of the white paint to cover disparate colours below; secondly, the Payne's Grey has a hint of blue to it which makes the white look like it's come out of a washing powder commercial, rather than a beige white.

For the section of building I was going to include on the extended base I decided to use some 5mm thick foam board as the core structure, which I would clad on the inner and outer faces. Whilst this would not give me an accurate scale thickness of a timber-framed structure I decided to allow myself a little artistic license. After doing some test fits on the polystyrene base with the resin parts I decided upon a size for the corner of the building and





cut out a floor and two sections of wall. I wanted the near corner of the wall to be taller than the figure, but not too tall that it towered over it and distracted from the main focus of the diorama. I decided that the outer face of the building would be finished in ship-lap boarding, but as the building would naturally catch drifting snow it would not be necessary to clad the lower part of the wall with timber.

Sections of balsa were cut to length and glued to the foam board with superglue. Whilst this may seem an extravagant method of fixing I needed an instant “grab” as the next board would overlap the first, and so on: if the boards moved as the work progressed any hope of keeping them parallel would soon disappear. The other thing to bear in mind is that any glue that gets on the surface of the wood effectively seals the grain: this means that any stain or paint that is applied to the balsa will dry with a different finish depending on whether the grain is open or sealed. A careful hand is required to keep the glue off the wood in the best of circumstances, but if it starts moving about because the glue has not set you are on a hiding to nothing. This work was carried out to the two walls before they were stuck to the base to make life easier, and horizontal lines were drawn on the foam boards at regular intervals as a visual aid in setting out the balsa. The balsa to one sheet was cut the same length of the board, but was cut 5mm longer than the board for the other sheet to cover the butt joint of the two walls. With all the balsa strips in place the two walls and floor were glued together, and vertical cover strips were glued in place at the corner. I had decided not to create an interior for the corner of the building as the face of the black foam board provided an adequate finish, but added some doll’s house skirting boards for the sake of completeness and to tidy up the joints between boards.

The exterior of the building now needed weathering before gluing to the base. If you observe any timber in an external environment that has not been treated or painted you will see that it turns grey. To replicate this I brush applied Liquitex Driftwood Grey Woodstain to the balsa: all the time working along the grain and just applying enough so that it soaks into the grain and not sit on the surface. I created a secondary colour by adding English Oak Woodstain to the Driftwood and applied this at all the board junctions where a natural shadow would appear and muck collect. The skirting boards were given a coat of Charcoal Woodstain so that they did not stand out against the black walls. The completed section of building was glued down to the polystyrene base with some PVA glue. When the glue had dried I started a snow drift around the building using Woodland Scenics’ Foam Putty: as this was being laid on thick I left it a couple of days before gluing the resin base to the polystyrene so that the Foam Putty had chance to set before applying some more to consolidate the different parts of the base. The second coat of

putty was applied using an old butter knife and an artist's palette knife for the harder to reach areas. The putty was smoothed to some extent by wetting the knives on the final application. This was then set aside for a few more days to thoroughly dry.





Whilst the Foam Putty was drying I started work on the figure, beginning with the flesh areas. If you observe normal flesh you will realise that it is slightly translucent, which is not normally a factor when painting healthy skin, but for a creature like this I wanted to get an exaggerated effect by using transparent paints for the flesh tones. I started off by pre-shading the skin areas by applying Dark Olive pastel powders created by mixing together a Pale Olive pastel and a Raw Umber pastel. Pastels can be mixed together to create new colours, as you would paint, by rubbing the pastel on a sheet of sand paper to form a small pile of powder. Different coloured piles of powder can then be mixed together using an old brush to create a new colour: please use an old brush, as rubbing it against the sandpaper is probably the quickest way I can think of to ruin a brush. I like to apply the powder to the model with a chisel shaped brush, which I use in sizes of 1/8" to 1/2" depending on the size of the model. These brushes can be picked up for a reasonable price at craft and hobby shops, which is good, as with the best will in the world the tips of the brushes will wear with constant contact with the sandpaper, and need replacing on a regular basis (Games Workshop Drybrushes are also good for this technique, but are not so cheap to replace).

The Dark Olive pastel powder was applied to the naturally recesses areas of the face and hands, such as around the eyes; under the chin and other folds in the flesh. Once this process was complete the model was sprayed with matt varnish to fix the pastels in place, as I did not want further colours blending with what I had already laid down. Veins have been sculpted into the head and hands and I debated as to what colour they should be: green to carry on the plant motif, or blue as you see them under your own skin? I finally settled on Liquitex Burgundy Red, as I had been doing some gardening the day before (a chore, not a pleasure, let me assure you), and when I pulled up some weeds I noticed that the colour of the roots closest to the base of the plant were a deep red colour: besides, as this creature was designed in the 1950s, a little vivid red gore would not go amiss. I then blended in the painted veins using some Pale Olive pastel powder. As well as being clawed the hands had, what look like small horns projecting from the knuckles. I decided to treat these horns and claws as thorns on a rose and applied some burgundy pastel powder to their bases.

As I was using transparent colours for the flesh tones I would need to work from dark to light and not vice versa as I would do normally. I mixed a base flesh colour from Transparent White and Raw Sienna; used the Raw Sienna on its own for the first shade and added Transparent Raw Umber to the Raw Sienna for the deep shade colour. These colours were carefully applied using an airbrush, as using transparent paints means that you can't paint over a mistake and you have to start again from a new white base coat.

When the paint was dry I masked off the flesh areas using Blu-tack so that I could paint the uniform. The base colour for which I decided to be Liquitex Dark Victorian Rose: the Rose was darkened using Prism Violet and lightened with Titanium White. The paint for the uniform was applied in my usual dark to light method and when it was dry the Blu-Tack was removed so that I could assess any areas of making good of the paintwork. Fortunately this was minimal and I was able to complete the uniform with the application of darkened pin washes and drybrushing of the lightened base colour to the raised areas. The torn areas of uniform were given a little distress with a further drybrushing with Raw Sienna and Neutral Grey. Looking at the figure I decided that the uniform was a little too.... Uniform, and so decided to add an accent colour to the trim and boots using Vallejo Oxford Blue: this was also drybrushed and washed to create the shadows and highlights.

With the uniform complete I completed the work on the flesh areas by adding a pin wash of a mix of Transparent Raw Umber and Raw Sienna into the creases and wrinkles. The "whites" of the eyes were painted with a mixture of Titanium White and Raw Sienna, and the pupils were painted with Olive Green. The thorns comprising the knuckles and claws were drybrushed with Olive Green and Unbleached Titanium White before being given coats of Transparent Burnt Sienna and then Raw Umber to tone everything together. Sometimes transparent colours can dry with a slight sheen, but in this instance I had been fortunate that everything seemed to have a consistent finish: however, to be on the safe side, and protect the paintwork I gave the figure a coat of matt varnish.

It was only after I had completed the figure that I realised that the uniform's colour scheme matched that of the Fantastic Four in their origin story from the first issue of the comic: a case of one Thing influencing another.

Once I had completed the figure I returned to the now dry base. One of the advantages of Foam Putty is that it can be sanded: which is what I did, to remove any "snots" that had formed when the putty was being applied. I could now apply the "snow" using some model railway products. Firstly I applied a layer of Woodland Scenics' Snow Scatter by first brush applying a coat of PVA glue to all the "white" areas and scattering on the snow using a kitchen shaker, which I presume is intended for sprinkling flour or icing sugar: this gives a nice even coating and allows the snow to fall and settle in a natural manner. This was then fixed by a sprayed on coat of Woodland Scenics' Scenic Cement. A word of caution here: once you have laid the initial coat of snow do not touch it again with either your hand or a brush as it you will get yourself, and the model, in a heck of a mess. I normally spray on the Scenic Cement with a large spray or pump bottle, but I was concerned that this would get everywhere, and I did not want





the scenic items completely covered in snow. To give me a little more control of the sprayed area I used a small travel spray bottle from the chemists that had a smaller spray area and could be gotten into tight areas because of its size.

The Woodland Scenics product is relatively cheap, and I stress the word relatively cheap, and I was able to apply it generously so that I had a consistent covering that filled any remaining nooks and crannies. However, I have recently come across an alternative snow product manufactured by Deluxe, which I was a little concerned about applying liberally as it cost the same as the Woodland Scenics product but came in a container that appeared to be a quarter of the size. Having said that the Deluxe product is much finer and comes with "icy sparkles" that really catch the light and give that appearance of icy snow. I spray applied glue over the previously "snowed" areas and applied it to the face of the building with an almost drybrushing technique, so that the snow would only settle on the pronounced edges of the boarding: the Deluxe bottle of snow had a sprinkle option in the lid, so I used this for applying the snow which also allowed me to use it as a squeeze bottle to get some snow on vertical surfaces. When applying scatter to a relatively small base I have found it useful to sit the base in a roasting tin to collect the surplus scatter far easier than trying to roll up an old newspaper: you can then use a plastic funnel to return the scatter to the bottle in a fairly controlled manner. By the way, despite my concerns about the amount of snow I got for my money from Deluxe, by the time

I had returned the excess snow to the bottle there seemed to be very little gone from it. I would also note that the glue supplied by Deluxe with the snow remains tacky after drying and found that the only way to remove it from fingers etc was to use Isopropyl Alcohol.

When I was satisfied with the application of snow I scraped the snow out of the cast-in recesses for the creature's feet in the resin base so that the figure could be glued in place. I then added a little more snow to the figure's boots and pants, but refrained from going any further up the body for fear that he would end up looking like he had a bad case of dandruff. With that the diorama was complete, and it was only when I sat back to admire my handiwork that I realised that I had not created any footprints in the snow for the Thing to get where he is stood – bother. Knowing that any attempt to add





the footprints retrospectively would have made a mess of the work completed I decided to leave it be and console myself that the creature is very light on his feet, or perhaps he had just landed there after jumping out of the window, or he had just beamed in, or.... never mind, we all make mistakes: as the Dalek said climbing off a dustbin.



By Tim Fitch



Rick Priestley

Continuing with the Questions series of interviews I've been lucky enough to land one of the industry's real heavyweights. If you don't know who Rick Priestley is or what he's created, then a warm welcome to this dimension. Prepare to be enlightened.



Just in case anyone in the hobby has been living under a stone for the last 30 years, could you tell me a little about yourself please?

I was born 1959 and I'm from Lincoln in England – I've been wargaming, modelling and painting armies since I was 12 years old and writing my own games almost as long. I studied Archaeology at Lancaster – graduated 1981 – and joined Games Workshop's miniatures division Citadel in 1982. I went on to found the studio and create the Warhammer and Warhammer 40,000 games and backgrounds for Games Workshop. Aside from designing many, many games and writing countless books and articles, I also managed the GW studio throughout the 90's, was part of the management buy-out that purchased GW from the original owners, and was later involved in floating the company on the stock exchange. I live near Nottingham together with my wife, several cats, a dog, budgies and chickens.

Do you game, paint and /or collect?

Yes I game, paint and collect! I'm lucky in that most of my friends and work mates are gamers, so there's always a game of something going on somewhere. I enjoy painting and – once many years ago – was considered quite good! Sadly, standards have moved on, and I suspect my eyesight isn't



What was it like working for GW in the early days?

Well Citadel was a fairly small affair really – Alan and Michael Perry were still working from home in north London, so the Newark factory really was a factory and not much else – not a studio initially. Tony Ackland and me would type up the mail order sheets and organise the White Dwarf ads in a little back-office. Most of my time was spent on the factory floor – everybody did everything in the early days. When we had a metal delivery or a batch of cartons or something turn up, we'd all help unload the lorries – even the boss!

How did you manage to create a design studio for Citadel from scratch?

what it once was – but hey – it's still a good way of relaxing. Collect – well, I like to put armies together for gaming rather than accumulating metal and resin for the sake of it, but I do have lots of armies. Lots!

How did you start working for Games Workshop?

I actually joined Citadel Miniatures when it was based in Newark. Citadel was then run by Bryan Ansell – who was formerly founder of Asgard Miniatures based in Nottingham. I knew Bryan from of old when he helped Richard Halliwell and I publish our first wargames rules. Subsequently, I'd painted and then designed a few figures for Asgard. After I finished with college, I set-up as a figure designer working for various people including Tabletop Games (based in Nottingham) and Citadel (I didn't do much for Citadel – space-ships mostly as well as some straight-line work: treasure chests, weapons, machines, stuff like that). Every so often Bryan would ask me if I would come in and help pack mail orders – and I'd do a few day's work to help out – and in the end the days turned into a week at a time and in the end I quite enjoyed working at Citadel, and the design work wasn't really paying that well, so I just caved in and took the job!

You're renowned now as a wargames designer, but was that your primary role when you joined the fledgling GW?

I joined to sort out the mail order department – in fact I was the entire mail order department – before I turned up I think Bryan had been doing it himself. Which kinda shows how small the whole thing was. After a few months I built up the business and we took on a few other Mail Order Trolls to help out – so I was the primal Troll if you like. Mind you – I didn't join Citadel/GW until 1982 – GW had already been going for 5 years or so by then and there were about a half dozen shops, so I'm not sure it was entirely 'fledgling'.

It just happened organically – the Mail Order needed monthly release sheets, so part of the job was writing and producing those. Tony Ackland and I did that between us, Tony drawing the models, me writing the text, and both of us doing the production and layout. Then we did catalogues, boxes, and so on. Eventually, I recruited a new team to handle the actual Mail Order, and Tony and I moved to a new office down the road. Voila! The Citadel Studio was born. After that we recruited more people and eventually that became the Games Workshop Studio as we know it today. There was always a studio based in London that produced White Dwarf and the other games – Talisman being the most well known. When the companies merged the London studio closed and some of the staff joined us in Nottingham.

Is it right that initially Citadel cast and sold Ral Partha miniatures under licence to bolster their own miniature lines?

Yes – when I joined Citadel also manufactured and sold the Ral Partha range under license.

Back in the early days who did Citadel consider to be their main miniature based competitors?

I don't recall as we considered anyone to be a competitor really. Nick Lund's Chronicle Miniatures was about the closest to what we were doing, and Bryan Ansell obviously liked the range and Nick enough to buy him out – after which Nick joined us for a while as a designer.

In 1985 Citadel launched the 'slotta base' for their miniatures. Its now fairly common place but then it was quite a radical thing to do. What prompted its development and the expansion into plastic shields, arms and weapons later on?

As I remember it was the cost of metal – with the lighter slotta models being cheaper to cast. However, this seems a bit incidental to me, I think it was also a very neat and attractive way of presenting the models – and that had a lot to do with it. There was also the opportunity to use the base design as a gaming feature; we had hex bases originally as well as square and round. With larger models it also helps with mould making and posing, because the width of a large integral base can cause problems in some cases.

What was the thinking behind the creation of the first edition of Warhammer?

I'd already written a number of games in my teens with my friend Richard Halliwell, including Reaper – a fantasy wargame, and Combat 3000, an SF game. And Bryan had this ambition to publish a fantasy wargame to encourage customers to play battle games with their collections. Most of our customers were actually playing D&D – this was the age when role-playing games were all the rage – so loads of people had these collections of models for D&D but no real conception of what a wargame was. We figured that if people started playing proper battles we could sell them whole regiments of troops rather than just one or two models – and that was what started us off with what would become Warhammer.

How did the name Warhammer get chosen for the games' title?

Actually it started out as Rune Hammer – vaguely inspired by Michael Moorcocks's Runestaff series – but because there was an existing role-playing game called Rune Quest (which we sold) we had to come up with something different. So Rune Hammer just became Warhammer.

How well did the Warhammer rules sell in the early years?

I think we sold out the first run very quickly and maybe printed a second run before we did the second edition shortly afterwards. It sold very well for the time – it was certainly a success from the get-go. It was also a Citadel imprint – and I think the head office guys at GW in London did re-

present the fact that we'd produced this game that was outselling all their much slicker and professionally produced games©

Rogue trader was around from the early days of GW. What prompted its reboot into Warhammer 40K?

Actually RT wasn't produced until 1987 – so I don't think of it as the early days at all if you see what I mean – GW had been going over a decade by then! Rogue Trader was just the working title we'd been using for the game since I joined games workshop (I brought the first version of the game with me). When we actually came to publish Rogue Trader we'd taken out a license for games based on the 2000AD comic, and we already had a board game based on the Rogue Trooper character – so – once again we had to come

up with a different name. Hence, the first version was called Warhammer 40,000 – Rogue Trader. We had to use the RT strap line just so all the customers who were waiting for a game called RT would know that this was it!

Who came up with the concept of turning established fantasy races into futuristic versions?

Well I suppose that would be me – but it was a pragmatic decision forced upon us by the fact that no-one thought RT/40K would sell. When I started designing the game the prevalent view was that 'science fiction doesn't sell' (yes I know it sounds unlikely... but there you are!) Because no-

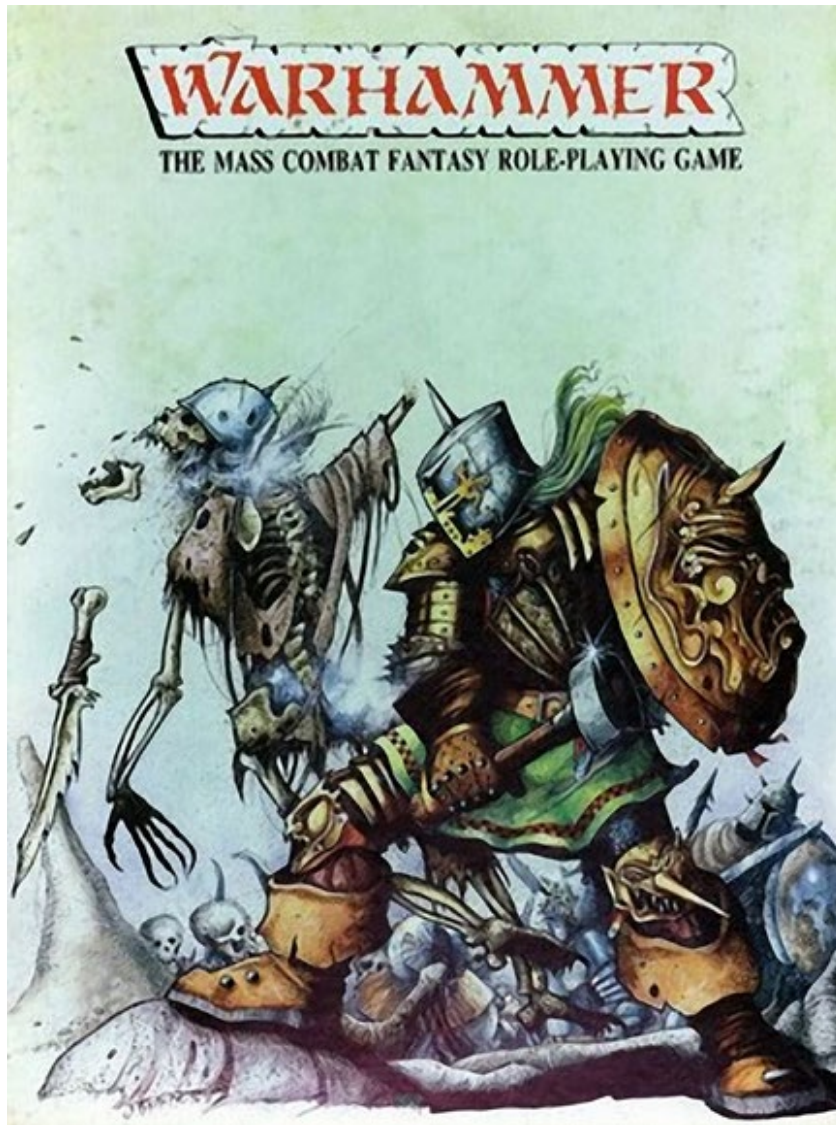



– in the end Andy Chambers did that – well you can't do everything can you! I also had a whole series planned that would explore the 40K universe by picking specific places and producing a super-detailed game. The first of these was Necromunda – the second Gorka Morka. I had planned a game based on an Eldar Craftworld as well – and we had all kinds of ideas for similar skirmish wargames based on specific Space Marine Chapters or worlds within the Imperium. If you considered some of the original backgrounds to the Imperial Guard (first IG book) you'll see a few of those ideas manifested themselves in the various IG homeworld – in particular Catachan. We were going to do a Catachan 'Deathworld' style game. To me – the games were there to explore the variety and depth of the universe – new frontiers – boldly going and all that☺

Are you happy with the way the Imperium of Man in the 40K universe has come to be realised?

I'm not really all that familiar with it to be honest! I'm very proud to have created and nurtured 40K. As the company grew 40K became an increasingly important part of it, other people began to contribute – people with fresh ideas and considerable enthusiasm and talent. I changed from a position of sole writer and creator to someone whose job was to encourage creativity in others and prepare them to accept responsibility for steering the company's games and models in the future. The needs of a business change hugely as it grows – it grows up and changes – and the later (and I imagine current) realisation of 40K reflects the needs of the business and player community of today. As it should☺

Do you think historical wargaming is seen as less appealing than fantasy of science-fiction ?

I suppose it's just down to what folks grow up with – and for years now SF has been such a huge thing in the movies and TV. That wasn't the case when I was growing up – well not so much! Westerns and WW2 movies were our versions



one thought the game would sell we didn't want to make many miniatures for it, so the plan was to make weapons packs so that people could convert Orcs, Elves and what-not into science-fiction versions. Hence, a lot of the creatures, races and monsters in the RT book are all based upon fantasy models that we sold at the time. Of course, before RT was actually printed it was obvious it would sell – so we started to make models for it – but by then I'd written the game!

Did you expect Warhammer 40K to be as successful as it has been?

Yes I did! It was the game I wanted to publish when I joined Citadel. In fact, when I joined it was on the understanding that Citadel would publish the game I'd already designed called Rogue Trader – which was really a SF ship combat game to go with the ships I'd made. Over time the concept just morphed into an SF version of Warhammer – but I could tell it would do well – it wasn't just me – it was all the people that helped play the game into existence, including the artists and figure designers – practically everyone started to get involved. That's always a good sign.

You've done rules for many different genres, what is your favourite?

I don't know if I have a favourite really – I always enjoyed SF but ironically WH40K became so big that I never got a chance to do more with the genre whilst I was at GW.

If things had been different, what would you have done with genre?

I'd have liked to have done an SF spaceship combat game

of fantasy – so I guess it depends.

How do you go about starting a new gaming system?

Can be any number of things. Sometimes it's the background that does it, sometimes it's the models, and often it's a mechanical idea – an idea for developing a turn sequence or player interaction. Often the development of the models or artwork will steer the design process – so it's as much about the team as it is about the games designer.

How long does it take to get the rules from initial concept through to working prototype?

That does vary too – but at GW in the 90's we usually had a big release in September (Necromunda, WH, 40K etc). I used to try and rough out the game concepts and mechanics over the Christmas holiday, then we'd start to develop the game and background in January when everyone got back. So, say two weeks to get the basics done. I'd put 10 weeks aside to get the first draught finished, then another 10 weeks to get everything ready for print, but by then you could pull the whole team to do bits if necessary.

Are gaming systems produced to suit the miniatures that have been designed, or the other way around?

You can do it either way but the best way is to design the two together – so the writer and sculptor can bounce ideas about. It's relatively easy to change text compared to models though, so often you end up working round the models. But you do need to set out the basics – like the models fitting certain base sizes, fitting in blisters, and so on. To be fair those things are as much to do with the economics of manufacture and practicalities of supply as anything else.

After being at GW for so long was it a shock to leave?

No it was quite a relief really – GW had long since ceased to be a creative environment – the company I joined was an exciting creative company led by design and a passion for games – that wasn't the case when I left, and quite frankly it was heart-breaking to see how the games and world's I'd created were being treated. At least now I don't have to look©

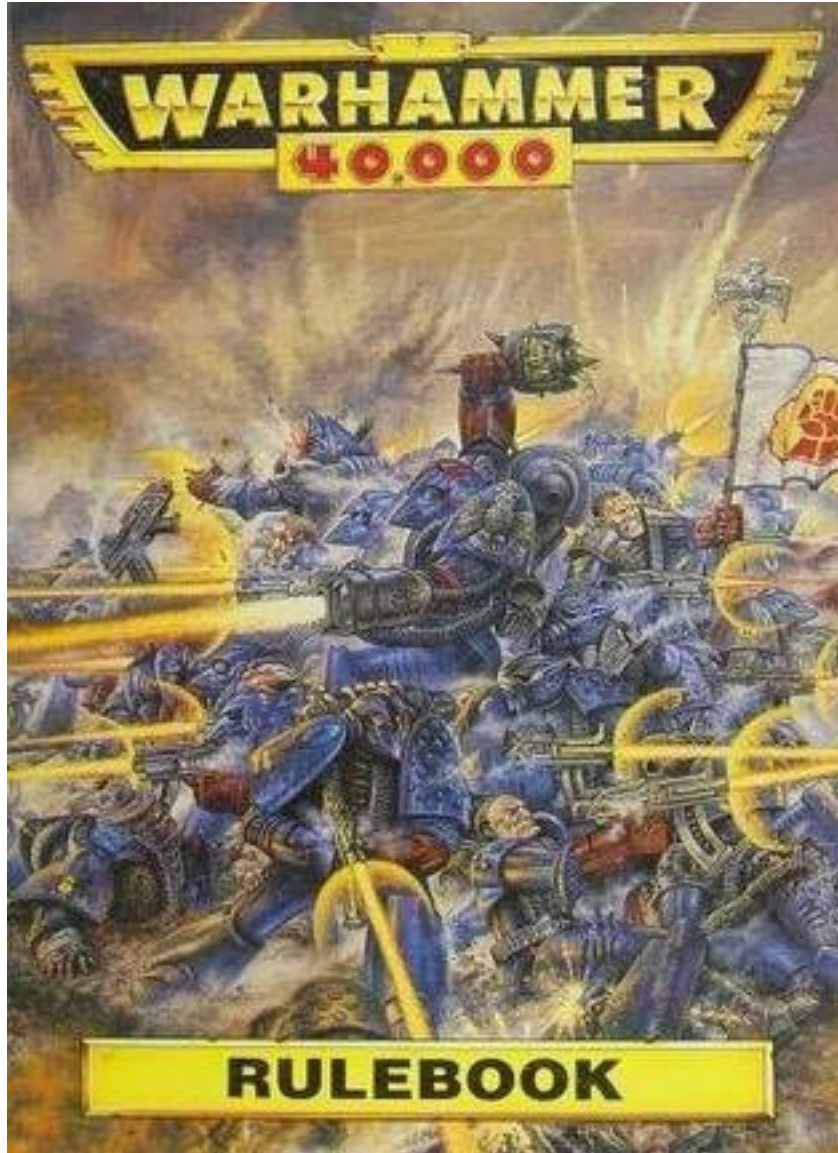

Having known GW from the early 80's myself I know just how creative they used to be. Almost every month White Dwarf would showcase a new range of miniatures or a new game. Do you think the business concerns of a listed company hurt the creative side?

Well that's just an inevitable factor in growing a small, entrepreneurial business into a larger established business. To begin with you can do almost anything – you can make decisions very quickly, change your tack quickly, and just keep trying out stuff until something 'sticks'. In the early day GW tried all sorts of ideas – Warhammer Records, T-shirts, LARP (never quite got off the ground that one), RPGs, Computer Games (before my time), Fiction, Comics, Jigsaw Puzzles – anything! Over time it

became apparent that the majority of the business – and all the profitable part of it – was Citadel models and Warhammer games. After that we worked out an effective business model based around Warhammer and spent our energies rolling that out. As time went on it became a question of establishing new processes, ensuring predictability of supply and cost, and striving for effectiveness within the supply chain. If you get that right – and because we were all amateurs and gamers we often got those things wrong first time round – then you have to start to manage efficiency to keep the profit coming as you grow. So, to start with it's all about



for more hard-core and experienced customers, as well as starter sets for those wanting to get into a game. So, in my experience – 28 years of it – no I wouldn't say that was a fair picture – but one can never address everyone's expectations no matter how hard you try!

The internet has changed the way we live, especially the advent of ecommerce. Did GW anticipate the change of has it always considered having a real world presence more important?

Our US business was actually well ahead of the curve – and to start with

ideas and product and energy – and as you grow it becomes increasingly about management of people and processes. That means you have to change the focus of the people at the top, instead of being driven by the creatives the company becomes driven by other factors – could be the manufacturing processes, the sales model, and so on – but change is inevitable.

Was there a big change when Bryan Ansell left the company?

Yes – that was when we organised the buy-out – that changed everything. Up to that point GW was substantially owned by Bryan who was happy to keep the company small and take the profit out of the business rather than invest in expansion. To buy GW Tom Kirby had to borrow money from venture capitalists (VCs), so he had a massive personal debt to pay off – about equivalent to the company's turnover I believe – as well as interest payments on that debt. So, to pay off that huge personal debt and generate enough spare money to invest as well, GW had to expand very fast – which we did! Part of that massive expansion was down to reorganising the product-line and getting the studio working effectively, so it was a time of great change and energy!

GW is often seen as the 'bad guy' with little regard for its customers long term. Is that a justified point of view in your opinion?

That's certainly not a picture I recognise from my time at GW – we were always very much focussed on customers and recognised that we had mature as well as novices amongst our customer base. We developed whole product lines

all the commercial engines were hand-built bespoke affairs by our US IT staff. The UK didn't really embrace the internet until a little later. The basic business model is predicated on running stores and I'm not sure to what extent you can replicate that on-line.

I interviewed Jean Bey of Rackham miniatures in issue 8. I asked him if he ever considered GW to be their main competitor back when Rackham were still running. He said no as the two companies were fairly different. However do you know what the GW view of Rackham was?

We didn't concern ourselves with what other wargames companies were doing – not as a business. We didn't think of Rackham or any similar company as a competitor. As Jean says – different companies.

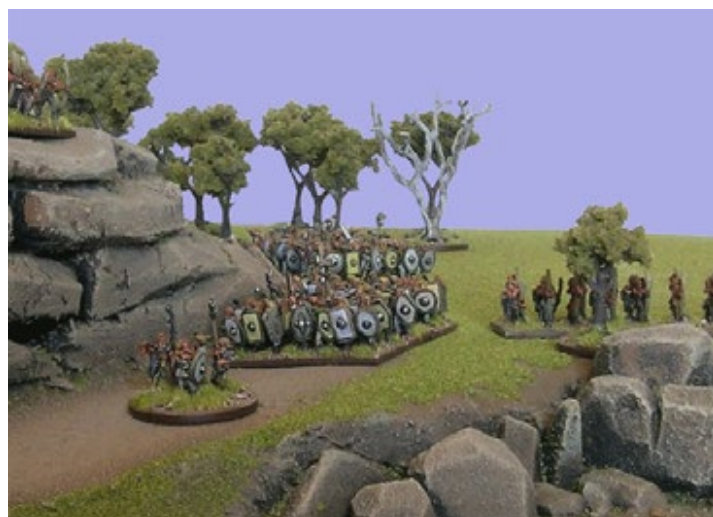

Just recently GW has announced a dip in profits and is currently contracting its operation. Do you think this is going to cause the management to focus more on the creative side once again?

No I don't – nor should it – it should and will cause the management to concentrate on their operational efficiencies. I'm sure they'll be very creative in addressing that – but in terms of generating new IP or suddenly starting making different kinds of products – that kind of thing wouldn't solve any of their problems and would just look like 'panic' to investors.

You've continued designing as a partner in Warlord Games. Do you find it less restrictive creatively designing as 'the boss' rather than as an employee?

Well it's certainly a lot more fun!

Beyond the Gates of Antares was a bold new take on science-fiction wargaming. Why do you think its kickstarter campaign fell short of its target?

Easy – because we didn't have anything lined up beyond my ambition to make a new SF game. Miniature kickstarters are not really good for start-ups – you need to have design ready to go and ideally most of your ranges worked out and finished. In contrast to that, I think you have to develop a game organically – bit at a time – you can't prep the whole thing and then spew it out. It needs to be played into existence!

Are there plans to bring the idea back, or has it been shelved for the time being?

Antares – yes we are developing the game and range at a more realistic pace and the first models will be available this year (2014). We won't be doing another kickstarter for it though I don't think. I've had to shelve the interactive elements because they would be just too expensive to realise – but maybe one day.

Are there any future projects you can tell us about?

I'm continuing to develop the Hail Caesar, Black Powder and Bolt Action lines for Warlord, and I'm plugging away with Antares – and that's plenty for now. I'm also writing a book about writing wargames rules for Pen and Sword – must get on with that!

Are there any projects you wished you'd had a chance to work on, and who do you admire in the industry?

I can't think of any projects I'd like to have worked on – assuming you mean non-GW games – I pretty much did everything I wanted to at GW over the years! Who do I most admire – tricky one as there are so many – by I've always



been a big fan of the Perry's work – it's just so naturalistic and well observed – they have inspired many other figure designers but no-one can touch them in terms of sheer volume and quality of work.

Are you still in touch with anyone from the early citadel days?

Yes – I'm actually going to Brunel Uni to give a talk to some of Steve Jackson's students later this year. I also keep in touch with Tony Ackland – who is retired now and lives in Cornwall. Many others are still friends who I see regularly – or work with – so yes – quite a few of 'em. Can't get rid of me quite that easily!

Apart from war gaming, and the industry in general, what else do you like to do?

Just the usual sort of stuff – I read a lot of history – especially ancient history – walk the dog, potter in the garden, go to the pub, shout at clouds... usual everyday crap really.

How do you see the industry changing in the next 10 to 20 years?

I think I'm the wrong person to ask really – when I look at the new 3D CAD design tools and 3D printers it's all beyond science-fiction to me. That sort of thing can only become more important as part of the design process – and potentially as a manufacturing process too, though from what I've seen that might take a good few years yet. The future of print is something you read about all the time – and again you do have to wonder whether traditional wargames rules are going to have much of a role amongst a population that is increasingly blind to reading books. Meantime, I await the arrival of our Martian overlords with great interest.

I'd just like to thank Rick for taking the time and trouble to provide such an interesting interview.

advertise in this space

Click [here](#) for more information

GROUNDWORKS

Whatever the project, whatever the need.

We have the tools for you.



Stockists of

- MiniNatur
- Vallejo Stone & Water Effects
- Modelmates
- GF9



www.modeldisplayproducts.co.uk

WIN A Free Plinth Every Month

With **FIGURE PAINTER** magazine

Simply upload an image of your painted miniature to our facebook page and the miniature with the most likes in one month wins a free display plinth from Model Display Products.



courtesy of

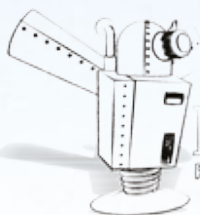

Robot Pigeon
PUBLISHING

www.modeldisplayproducts.com



**FIGURE
PAINTER** magazine
GOLD AWARD



Chaos Lord by Sergey Chasnyk



120mm WW1 British Tommy in-progress by Last Cavalry Historical Toys & Hobbies



By Łukasz Ziółkowski



Airtis, Battle Gnome by Matt Gwb



Winter Knight by Łukasz Ziółkowski

VAKO (The Dragon King)
by Luis Ariel Bernachea

VAKO
El Rey Dragón
por
Luis Ariel Bernachea
2014



FW Preyton by
Adam Mckenna



Angron, Lord of the Red Sands
by Lil Legend Studio





Eldar Harlequins by Adam Mckenna

FW Eldar Warp Hunter by Adam Mckenna





Chaos Chosen Trinity by Sergey Chasnyk

By Sid Freeman



Wall-E by Vincent Zhang





Firestorm Games



Firestorm Games is an Independent Wargames Retailer in Cardiff, South Wales. As well as the webstore, we have our own bricks and mortar store, a short walk from Cardiff City Centre.

Attached to the store is our gaming area known as 'the Battlefields' which consists of over 35 6"x4" gaming tables, full of scenery for your pleasure! We are open late nights on Tuesday and Thursday and attract a large mix of people ready to play whatever takes your fancy! The Battlefields now also has a fully licensed 'Khador themed' bar, great when playing a casual game against your mates or in one of our regular tournaments or events.

Firestorm Games Ltd

8A Trade Street, Penarth Road
Cardiff, United Kingdom
CF10 5DT.

Tel: 02920 227117

www.firestormgames.co.uk

Firestorm Games
www.firestormgames.co.uk
Tel 02920 227117

Up to 15% off RRP
With Free Worldwide shipping on orders
over £30!

