

Dungeon[®]

ADVENTURES FOR TSR ROLE-PLAYING GAMES

MARCH/APRIL 1995 ISSUE #52
VOL IX, NO. 4 \$3.95 USA



DUNGEON[®]

ADVENTURES FOR TSR ROLE-PLAYING GAMES

MARCH/APRIL 1995
ISSUE #52

COVER: Prospero and Miranda watch Caliban struggle against his chains in this month's cover painting by Scott Burdick for "Spirits of the Tempest."



New Blood

I thought I was totally ready, but, like any adventurer, I should have expected the unexpected. Midwinter brought more than just Christmas presents, it also brought a few pleasant surprises. The first was that Renée Ciske joined the staff as our new cartographer; her finely-rendered maps carry on DUNGEON's high standards. I'm especially pleased with the ship on page 10.

About the time the first maps were completed, *another* new person joined the staff. Michelle Vuckovich arrived just after the New Year and has been doing a terrific job as the new editorial assistant. Welcome aboard, Michelle!

Sure, you're saying, new staff, big deal. What has this new staff done for you lately? Well, in this issue you'll find our first adventure based on a play, Michael Selinker's "Spirits of the Tempests," inspired by Shakespeare's *The Tempest*. Like most Shakespeare, it's full of feuding family members, betrayals, and great characters, plus "Spirits" is much easier to read. Write to us and tell us what you think. Do you want to see more adventures adapted from classic stories or plays? There's this amazing adaptation of the movie *Casablanca* (with orcs) that's been floating around the office for the longest time.

This issue also contains our first sequel in a long time. Long-time readers might remember that "Out of the Ashes" (issue # 17) continued the tale of the dragon Flame, first described in "Into the Fire" (issue #1). Well, in this issue Christopher Perkins continues the tale of the potion of immortality first related in Peter Åberg's "The Lady of the Mists" (issue #42). This stand-alone sequel is called "My Lady's Mirror," and it opens a new chapter in the family history of the immortals. Are there any other adventures that seem to be crying out for sequels? Of course, if enough people propose it, someone may actually write it.

To let us know what you think of this issue's sequels, adapted plays, the new maps, or anything else, reach us on the net at tsr.mags@genie.geis.com or write to our new address: DUNGEON Magazine, 201 Sheridan Springs Road, Lake Geneva WI 53147, USA.

This issue's quote was suggested by Barbara Young. Thanks, Barbara.

Vol. IX, No. 4

PUBLISHER: TSR, Inc.
ASSOCIATE PUBLISHER:
Brian Thomsen
EDITOR-IN-CHIEF:
Kim Mohan
EDITOR: Wolfgang H. Baur
EDITORIAL ASSISTANTS:
Dale A. Donovan
Michelle Vuckovich

ART DIRECTOR:
Larry W. Smith
CARTOGRAPHER:
Renée Ciske
TYPESETTING: Tracey Isler
SUBSCRIPTIONS:
Janet L. Winters
ADVERTISING: Cindy Rick

Printed in U.S.A.

The Readers LETTERS 6

Michael Selinker SPIRITS OF THE TEMPEST
(AD&D[®] adventure, character levels
9-10; 65 total levels) Spirits bound and
unbound conspire against you. 8

Willie Walsh PAKKILILIR
(AD&D adventure, levels 1-3; 7
total levels) Cut off, marooned,
alone, a renegade struggles to
survive 24

Samuel Heath WELCOME TO
THE KRYPTHOME
(FORGOTTEN REALMS[®] adventure,
levels 1-3; 8 total levels) Wild magic:
need we say more? 26

Kevin Wilson THE HURLY-BURLY BROTHERS
(AD&D adventure, levels 3-5; 20 total
levels) Click, click, click, click 40

Christopher Perkins MY LADY'S MIRROR
(AD&D adventure, levels 6-8; 40
total levels) Seven years bad luck is
just the beginning. 46

Paul Culotta LAUGHING MAN
(RAVENLOFT[®] adventure, levels 5-9;
40 total levels) Laughing all the way
to the grave ... and beyond 71

O brave new world,
that has such people in't!

William Shakespeare, *The Tempest*

LETTERS

Please let us know what you think about this issue of *DUNGEON*® Adventures. Although we can't print every letter we receive, we read them all and seriously consider your comments and suggestions. Write to Letters, *DUNGEON* Adventures, 201 Sheridan Springs Road, Lake Geneva WI 53147, U.S.A. You can also contact us by sending electronic mail to tsr.mags@genie.geis.com. We will not publish your address (regular or email) unless you specifically ask us to do so.

Hitchhiking

I'd like to say that I really liked "The Vaka's Curse" in issue #50 because it's so useful for passing game time "on the road." Having on hand a well-written adventure involving a few days of intrigue set on the deck of a ship makes me feel a lot better than being ready with a sea monster attack and that always useful phrase, "The rest of the journey passes without event." I, for one, would like to see more adventures that help turn necessary travels into destinations in themselves, without leading PCs astray from their goals. Thumbs up to hitchhiking adventures.

I'd also like to suggest that *DUNGEON* Magazine contain a page or so of, say, paragraph-long ideas for full-fledged adventures. Such undeveloped "seeds" would allow the magazine to give GMs a larger selection of original ideas that would occupy very little space in each issue. The seeds are more adaptable to each DM's own twisted purposes, and it allows DMs to use *DUNGEON* Magazine's great idea material without worrying about a player reading that material beforehand. I also think that this distilled format would inspire DMs to get some

creative plots to back up creative details. That's my two bits! Keep up the good work. . . er, play.

McRey B. Moyer
459 SW I Street
Grants Pass, OR 97526

Smokin'

I think issue #48 is cool. I haven't figured out the instructions yet. I need a rule book for some stuff. It's really neat. Ogres, giants, dwarves, halflings . . . it's all very good. I'm a beginner at TSR hobbies and I think it's just "smokin'"! I hope issue #49 comes out good. I think with the *DUNGEONS & DRAGONS*® game, reality is boring! In issue #48 I think the best game might be "Them Apples," because it comes with a full color map. I'm 11 years old and it might be hard, but TSR is probably the best thing in most of life.

Jimmy Duncan
Boise, Idaho

Electronic Wizardry

First congratulations to Mr. Baur on being appointed the new editor of *DUNGEON* Magazine. I am sure you will do well in that position.

Now, a question: Does your fine periodical accept electronic submissions, that is, submissions on computer disk? If so, what format and what word processor? Would you accept something uploaded to GENIE?

J. Walton via email

More Electronic Wizardry

I would like to submit several ideas

for *DUNGEON* Adventures, but I need a copy of the submission guidelines and disclosure form. Can you send them as email? If not, I can send a SASE. Also, do you take submissions of adventure outlines over email?

Mike McIntyre via email

We've been getting a number of requests for information through email lately, so I'll take this opportunity to clarify how electronic proposals work.

There are two ways to get guidelines and a disclosure form (required reading for any proposal): you can either email tsr.mags@genie.geis.com and ask for them, or you can send a self-addressed, stamped envelope and a note asking for the writer's guidelines to *DUNGEON* Adventures, Writer's Guidelines, 201 Sheridan Springs Road, Lake Geneva, WI 53147, USA. Proposals are fully explained in the guidelines.

However, we cannot accept electronic submissions of complete adventures on disk or as email.

Great Guides

I am a 14-year-old gamer from San Antonio, Texas. I have been role-playing since I was 8 and I still love it.

Thanks for making such a great magazine to help me in my games. I DM mostly FORGOTTEN REALMS® setting games, and the adventures in your magazine are great guides for my DMing. I must thank you again for helping me keep my games running smoothly. I must thank most of all Mr. Willie Walsh for his wonderful adventures! My thanks!

Trey S.
No address given

DUNGEON® (ISSN 0890-7102) is published bimonthly by TSR, Inc., 201 Sheridan Springs Road, Lake Geneva WI 53147 U.S.A. The mailing address for all material except subscription orders is *DUNGEON*®, 201 Sheridan Springs Road, Lake Geneva WI 53147 U.S.A.; telephone (414) 248-3625; fax (414) 248-0389.

Distribution: *DUNGEON* is available from game and hobby shops throughout the United States, Canada, and the United Kingdom, and through a limited number of other overseas outlets. Distribution to the book trade in the United States is by Random House, Inc., and in Canada by Random House of Canada, Ltd. Distributed to the book trade in the United Kingdom by TSR Ltd. Send orders to: Random House, Inc., Order Entry Department, Westminster MD 21157, U.S.A.; telephone: (800) 733-3000.

Subscriptions: Subscription rates via second-class mail are as follows: \$18 in U.S. funds for six issues sent to an address in the U.S., \$23 in U.S. funds for delivery to Canada, \$35 in U.S. funds for surface mail delivery to any other address, and \$52 in U.S. funds for air mail delivery to any other address. Prices are subject to change without notice. Payment in full must accompany all subscription orders. Payment should be by check or money order, made payable to TSR, Inc., or by charges to valid MasterCard or VISA credit cards. Send subscription orders with payments to: TSR, Inc., P.O. Box 5695, Boston MA 02206. The issue of expiration of each subscription is printed on the mailing label for each subscriber's copy of the magazine. Changes of address for the delivery of subscription copies must be received at least six weeks prior to the effective date of the change, in order to assure uninterrupted delivery.

Back issues: Limited back issues of this magazine are available from the TSR Mail Order Hobby Shop, 201 Sheridan Springs Road, Lake Geneva WI 53147, U.S.A. For a copy of the current mail-order catalog, write to the above address.

Submissions: All material published in *DUNGEON* becomes the exclusive property of the publisher, unless special arrangements to the contrary are made prior to publication. *DUNGEON* welcomes unsolicited submissions of written material and artwork; however, no responsibility for such submissions can be assumed by the publisher in any event. Any submission accompanied by a self-addressed, stamped envelope of sufficient size will be returned if it cannot be published. Please write for our writers' guidelines before sending a module to us; send a self-addressed, stamped envelope (9½" long preferred) to: Module Guidelines, *DUNGEON*, TSR, Inc., 201 Sheridan Springs Road, Lake Geneva WI 53147, U.S.A.

Advertising: For information on placing advertisements in *DUNGEON*, ask for our rate card. Contact: Advertising Coordinator, TSR, Inc. 201 Sheridan Springs Road, Lake Geneva WI 53147, U.S.A.

DUNGEON is a registered trademark for the TSR role-playing adventure periodical published by TSR, Inc. All rights to the contents of this publication are reserved, and nothing may be reproduced from it in whole or in part, without first obtaining written permission from the publisher.

® designates registered trademarks owned by TSR, Inc.™ designates trademarks owned by TSR, Inc. Most other product names are trademarks owned by the companies publishing those products. Use of the name of any product without mention of trademark status should not be construed as a challenge to such status.

©1995 TSR, Inc. All Rights Reserved. Printed in the U.S.A. All TSR characters, character names, and the distinctive likenesses thereof are trademarks owned by TSR, Inc.

Second-class postage paid at Lake Geneva, Wis., U.S.A. and additional mailing offices. Postmaster: Send address changes to *DUNGEON*, c/o TSR, Inc., 201 Sheridan Springs Road, Lake Geneva WI 53147, U.S.A.

ZAP!

I wanted to write you a letter and thank you for a great magazine. I have always enjoyed reading DUNGEON Magazine and look forward to a long future of reading enjoyment. I have followed the AD&D® game for over 15 years now and have always found it interesting and ever changing. However, I do not get a chance to play that often. It is amazing how life's responsibilities can build up year after year! I would like to make the following suggestions, comments, and questions:

1. Publish DUNGEON Adventures monthly! I am sure there are enough good manuscripts submitted each month to justify this. After the first few weeks, I have read the current issue cover to cover (sometimes twice, depending on the modules), and want more. I have sent off for guidelines for writers and am working on a submission myself.

2. I would love to see more RAVENLOFT® campaign world adventures. RAVENLOFT has to be the best expansion for AD&D to come along in years. It allows for a tremendous amount of DM and PC creativity. I am also quite fond of Forgotten Realms. I know you get a lot of correspondence concerning the issue of world specific campaigns. The only comment I have is that if a DM does not have enough creativity to adapt a world specific adventure to his own campaign world, he should probably just be a PC. DMing is about creativity and inspiration, not just what is published in a magazine. If you don't have it, don't do it.

3. I loved "The Mud Sorcerer's Tomb" in issue #37. Please print more modules in this spirit. I love adventures that contain traps and puzzles. I have to agree with Mike Shel on some of the classic AD&D first edition modules. I would like to know if the following modules are still in print and if they can be ordered: *S2 White Plume Mountain*, *C1 Hidden Shrine of Tamoachan*, *WG4 The Forgotten Temple of Tharizdun*, and *S1 Tomb of Horrors*. I had these modules at one time, but in my ignorance, sold them during my college years.

4. I would love to see a Side Treks adventure each issue. These modules are great to throw in a campaign that needs a little twist and break from the central theme (if the central adventure is too long and involved). Sometimes my players and I use these for short gaming sessions, or when we don't have several

hours to play in an existing campaign. We just take a few characters, and ZAP! have a nice break from reality.

Please print my address; I would love to hear from other gamers.

James Davis
P.O. Box 952
Lincoln, AZ 72744

Tackling your points one at a time:

1. *We have discussed going monthly in the past, but at the moment it seems unlikely. With Barbara Young's departure, it will be a while before we consider the idea again.*

2. *Done! "The Laughing Man" is a RAVENLOFT adventure in this issue; we receive many RAVENLOFT proposals, but we can't print more than one specialized setting adventure each month, largely because adventures for the PLANESCAPE, DARK SUN, AL-QADIM, and RAVENLOFT settings require additional materials for DMs and players to get the most out of them.*

3. *We are as eager to print the next classic adventure as you are to play it. The classics are all underground adventures, and we need more of them—designers take note!*

These old modules are hard to come by, but convention auctions and a few game stores offer these and other collectible games. Good luck!

4. *We've printed five Side Treks in the last four issues, one in this issue, and we've got more on the way.*

Atashian Adventures

Your adventures are really great. I make my own adventures but they take months. Between my big adventures, I use adventures from your magazine. But the problem is that I am a DM for the DARK SUN campaign setting, and you haven't published a DARK SUN adventure since I've had a subscription (issue #45). I hope you or other DMs can help me out.

Justyn Stahl
1703 Seminole Lane
Godfrey, IL 62035

Worrying Trend

From a note found inside a DUNGEON Magazine Christmas present:

I bet you don't get many packages this size! The thingums in the packet are

"peppernoben" (which translates as "pepper nuts", but no pepper is involved). They are a traditional pre-Christmas sweet in the Netherlands, distributed by Santa Claus. But in this instance they're my thanks to the staff of DUNGEON Magazine, for producing such a consistently fine magazine over the years. (Thanks!) I've spent many pleasant hours with it.

Adventures I particularly enjoyed were "The Ghost of Mistmoor" (issue #35), "The White Boar of Kilfay" (issue #37), and "Quelkin's Quandary" (issue #47). Hats off to Leonard Wilson, Willie Walsh, and Christopher Perkins for producing such great modules. We want more!

But lately I've noticed a somewhat worrying trend: there seem to be more small adventures than before. In Dutch we have a saying, "small but fine" (it rhymes in Dutch; much is lost in translation). But I am not convinced it also applies to modules, so could we please go back to the old adventure size?

Continuing on this track, how about one somewhat larger module every couple of issues? It would be much appreciated by a least one adventuring Dutchman.

Jeroen Grasdyk
Hoensbroek, The Netherlands

It's true that we've been printing lots of short adventures (see the letter from James Davis), but the great advantage of short adventures are, well, short. They don't take up lots of space in the magazine, and still present some fun ideas and characters. In all the space we have left over, we can still print plenty of long, involved adventures. For proof, just look at "My Lady's Mirror" in this issue, a whopping 25 pages long.

I don't believe that an adventure has to be an epic to be fun. The adventures you mention are all medium-length: "Ghost" at 17 pages, "White Boar" at 15 pages, and "Quelkin's Quandary" at 10 pages. Actually, most of the classics that James mentioned are also quite short, in terms of pages. But lots of ideas are packed into that little space.

As a rule, we're always more interested in the quality of an adventure than in its word-count. We'll keep accepting the best of the best—if we've got too much to cram into the space available, we'll just save one for next issue.

Ω



SPIRITS OF THE TEMPEST

ADAPTED BY MICHAEL SELINKER

Let lightning strike and
thunder roar!

Artwork by Scott Burdick

Mike, in addition to being an award-winning investigative reporter and nationally recognized puzzle maker, has been a contributor to TSR magazines for more than a decade, starting with his first fantasy crossword puzzle in 1983's DRAGON® Magazine #89. In his first module for DUNGEON® Adventures, Mike turned to a play which he believes is "one of the all-time greatest influences on the AD&D® game. Prospero ranks alongside Merlin and Morgan Le Fay as one of the greatest sorcerers in English literature. Writing a module around this 400-year-old NPC was as obvious as designing a dungeon around a dragon."

"Spirits of the Tempest" is a game adaptation of Shakespeare's romance *The Tempest*, one of his last and most enigmatic tales. Unlike most of his plays, *The Tempest* has no obvious historical or mythological source, so it seems Shakespeare's most fanciful work, abounding with magic and spirits. Prospero, the Duke of Milan, is unseated by his scheming brother Antonio and exiled to a remote island. There he and his daughter Miranda have only the spirit Ariel and the monstrous Caliban for company. A decade after his banishment, Prospero and his spirits engineer the apparent wreck of Antonio's sea convoy. Five acts later, Prospero is restored to his rightful throne, Miranda is betrothed to the prince of Naples, and Ariel is given the true desire of any bound spirit—his freedom.

This story provides an ideal base for an AD&D® scenario. The scenario can be used in any campaign or as a stand-alone adventure for 4-7 player characters with an average level of 9th-10th (up to 65 total levels). The adventure makes use of spells and items from the *Tome of Magic*; these are indicated with an asterisk (*). Certain Dungeon Masters may be attracted to the module's conclusion, which may destroy several magical items belonging to the PCs. If you have accidentally allowed too much magic in your campaign, this adventure may help solve the problem.

Certain liberties had to be taken to adapt *The Tempest* for game use. Throughout Shakespeare's play, the wizard Prospero is in control of the situation, and the other characters have little chance of affecting its outcome. On balance, his magic overwhelms everyone, including his own daughter. But

AD&D game players are rarely as patient as theater-goers, so some passive characters in *The Tempest* have been abandoned. But Prospero, Miranda, Ariel and Caliban are here, providing ample opportunities for role-playing, combat and even the occasional moment of wonderment.

"Spirits of the Tempest" does not try to disguise its source. Players who read the play prior to playing the module will find their knowledge does not help them as much as they might like. Knowing Prospero is a mage and has magical servants does not make that magic any less dangerous. And one other aspect of the play has been altered for this module: Prospero is nowhere near as benevolent as in the play. His servants may try to kill the PCs, especially if they threaten to derail Prospero's careful scheme of revenge.

Prologue

Twelve years ago, the Duchy of Milano was ruled by a noble and just duke and duchess, Prospero and Bellisima. Prospero, a sorcerer beyond compare, used his powers to keep the duchy safe from rampaging monsters and evil necromancers alike. The royal couple doted on their young daughter Miranda, whose precociousness allowed her to use a cantrip at age seven. All was well until tragedy struck the duchy, darkening the lights of every house in Milano.

Milano went into mourning because the fair Bellisima died from mysterious causes, but Milano recovered from its grief. Prospero retreated into his wondrous library and stayed there. For a year, Prospero could not be bothered with matters of state, and the duchy's affairs declined. During his year of mourning, Prospero cared only for his daughter Miranda, in whom he saw the face of his beloved wife. No one else could move him from his books.

During that year, Prospero's evil brother Antonio struck a deal with some powerful sorcerers who resented Prospero's rule of Milano. The sorcerers found an idyllic island with a dark history. The island once belonged to the giant sea hag Sycorax, who destroyed many ships that crossed her path. A year before, a mighty band of adventurers was engaged to slay the hag, but her restless spirit had to be imprisoned in the island itself. The area of sea, now known as Sycorax's Reach, has been calm since. However, the power-

ful magic binding the hag's spirit also binds all other magic—and all other spellcasters—to the isle, making it the perfect wizard trap.

Antonio's sorcerous allies magically transported Miranda away from her father's side and to the island. Antonio's offer to his distraught brother was simple: In return for his daughter's life, Prospero would banish himself to the island prison. Acceding to his brother's demands, Prospero turned over all functions of state to Antonio and then teleported himself and his library to the island, where his daughter awaited. Antonio had won.

Once on the island, Prospero found that no magical or physical force could transport him or Miranda from its shores. Eventually, Prospero accepted his exile. He took in the sea hag's son Caliban, a coarse reef giant who claimed the island as his own; though the mage tried to civilize Caliban, the giant's nature would not allow it. A much happier alliance ensued when Prospero freed the air elemental Ariel, who had been bound in the heart of an ancient tree for decades by Sycorax's sorcery. With these and a legion of summoned magical servants, Prospero and Miranda passed more than ten happy years in the island's sun.

But the past is not forgotten. With his *mirror of mental prowess*, Prospero has tracked Antonio's movements for the past 12 years, waiting for revenge. At last, Dame Fortune has given him an opportunity: Antonio has taken a trip to the kingdom of Tusnia to see a friend's sister married, and the currents take the ship past Prospero's isle. As Antonio sails within Prospero's wizardly grasp, Prospero plans to imprison his brother as his brother imprisoned him. He has prepared a magical gem with a *trap the soul* spell, and he plans to confine Antonio within it. The PCs will be on the boat with Antonio, so they may bring about a happy ending to an otherwise tragic story.

This adventure begins as a sea voyage, so you must arrange for your PCs to travel by boat. The easiest way to this is to introduce two nobles: Antonio, the Duke of Milano, and Ferdinand, son of King Alonzo and heir to the realm that includes Milano. Antonio and Ferdinand are returning from the wedding of Ferdinand's sister Claribella to the king of savage Tusnia. The PCs may be offered passage on Antonio's sailing

ship, the *Donna Milano*. Antonio will accept no payment for passage, but the PCs must swear to protect him and the complement of the *Donna Milano*. Read the introduction, and the journey will be underway.

Act I, Scene I: Calm Before the Storm

"Boatswain!" The shout comes from the men above decks, a world away from your comfortable cabins below. You are oceanbound on the *Donna Milano*, as you have been for three days. The *Donna Milano* is a fine sailing ship, with three masts and a crew of forty. You still have far to go in your journey, but if the rest of the trip is as calm as it has been so far, you will not complain about the distance.

Your host for this voyage is the owner of the ship, Duke Antonio of Milano. The Duke is a high noble, having held his position for more than a decade. Among the crew of the *Donna Milano*, Antonio is also rumored to be a wizard of considerable skill. An otherwise impeccable host, Antonio carries himself with an insufferable superiority, a trait not uncommon among nobles of his stature. He would not accept payment for your passage on his ship, asking only that you swear to help protect him and the ship's crew should anything untoward occur in the crossing. To this you gladly agreed.

Also aboard is a more pleasant noble, Prince Ferdinand Napoli, heir to the throne of King Alonzo. Ferdinand is a robust swordsman at the tender age of 19; his courteousness is matched by an unhealthy fearlessness. He is proud of his noble birth, and though he has not labored a day in his life, he has shown a surprising facility for sea travel.

Ferdinand and Antonio are returning from a long trip to the Savage Continent, where Ferdinand's sister Claribella was married to King Z'Bræ of Tusnia. From the descriptions of the nobles, it sounds like it was an amazing sight, with wild dancing in the warmth of the Tusnian sun. You have seen the generosity of the Tusnians first hand, as the *Donna Milano*'s hold is filled with gifts from the Tusnians for King Alonzo. You have been granted one

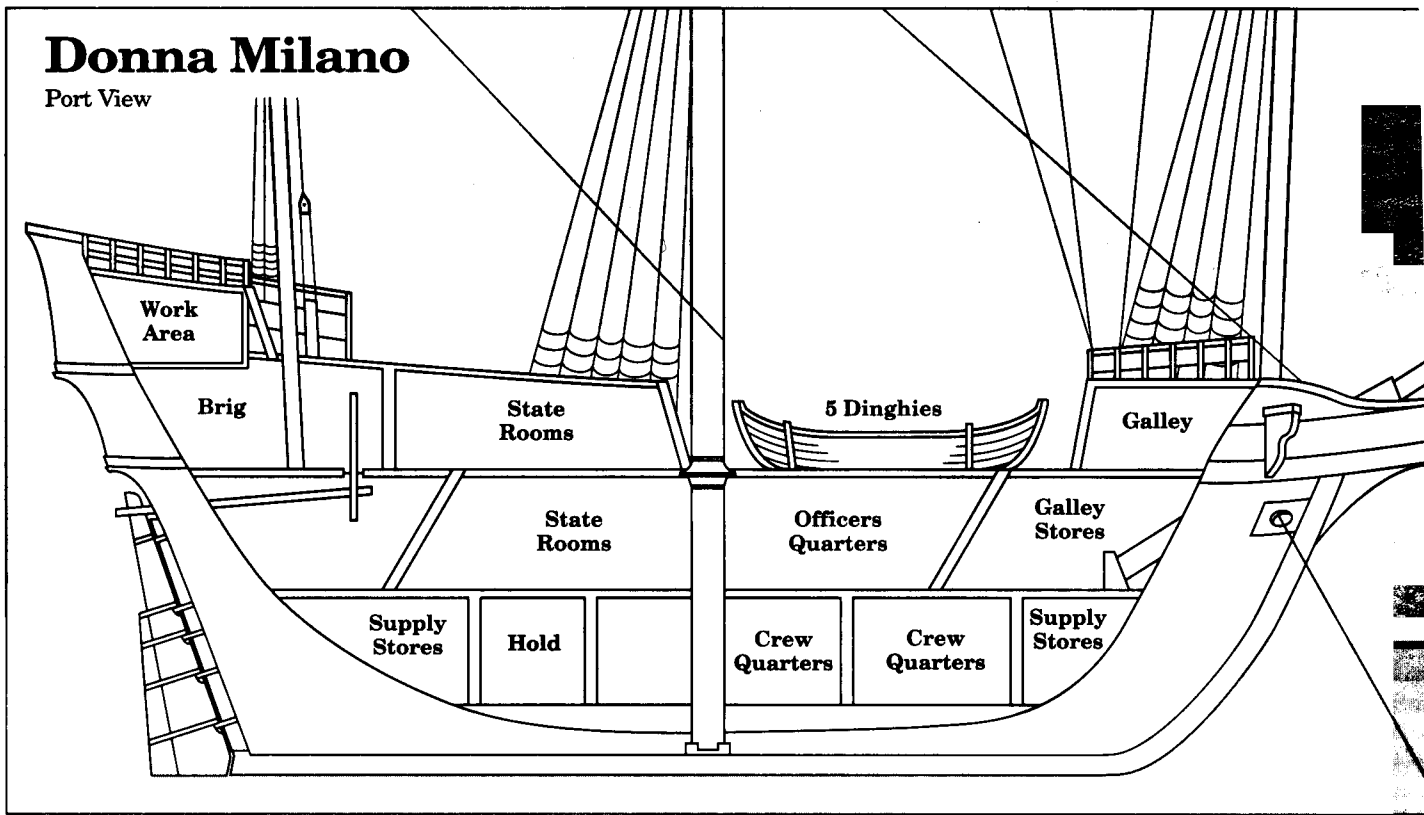

touch of the wedding: Ferdinand has shared with you some flavorful Tusnian dishes.

So with spicy cubeb berry and wart-hog flank fresh on your tongues, you have relaxed into your journey. Duke Antonio has been kind enough to allow you the three starboard staterooms, as the port staterooms are occupied by Antonio and the prince. The early morning equatorial sun is now streaming through your cabin curtains, and its call is difficult to ignore. The soft bells off the bow ring six.

What happens next is the stuff of drama. Storms will force the ship into Scyorax's Reach. The ship will be caught in the blasts of living tempests, and the PCs will have to confront the storms head-on. In the storms, the ship will appear to be lost, along with its crew and possibly Ferdinand and Antonio. If they beat the tempests, they will make it to the shores of a peaceful island. This is Prospero's island, where all bets are off.

The PCs will soon discover that the island spirits have it in for them. They

may also learn that Antonio is nowhere near as powerful as he boasts, and it will be up to them to save him from Prospero's forces. They may also meet the giant Caliban, whose loyalties will be with anyone who takes arms against Prospero. Eventually the PCs may reach Prospero's "cell," an extradimensional pocket universe where he, Miranda, and perhaps Ferdinand watch the PCs' progress against Ariel. Prospero cannot leave the cell unless Antonio gives him the secret, which he will be loath to do. The resolution of this situation is far from obvious, and should provide the most suspenseful part of the drama.

Act I, Scene II: Wrack and Ruin

It is 6 A.M., and the ship is heading north from Tusnia. The PCs begin in three adjoining underdeck staterooms on the starboard (right) side of the *Donna Milano*. Curtains separate each sleeper from his or her cabinmate, and unlocked doors separate the starboard staterooms from each other. The doors to the central corridor are also unlocked, but that will change in five minutes. The PCs begin unarmed,

unarmed, and unencumbered, their gear spread throughout their quarters. (Some may protest that they would never sleep without their armor. Remind them that they would never be able to sleep in armor aboard a ship.)

If the PCs part their window curtains, they will see a bright sunny morning, though storm clouds hover several miles off the port side. Let the PCs settle into the shipboard atmosphere during the first few minutes, though PCs in different rooms cannot talk to each other. If the PCs don armor, pray, or undertake other time-consuming activities, they will be interrupted.

Ferdinand and Antonio are still asleep, because their port cabins do not have the direct sun in early morning. The crewmen are all on deck. If the PCs go on deck, the agitated crew will be working for storm preparations. If Shipmaster Adrian or Boatswain Francisco is asked, either one will explain that the ship is cutting through something called "Scyorax's Reach" to avoid storms off to port. They should be safe, but the sailors are concerned about the legend of the Reach, which claims that the giant sea witch Scyorax destroyed ships for many years.



The sailors know the story that Sycorax was killed more than a decade ago, but they don't trust it.

This minor uneasiness turns to major fear when three storm clouds are spotted cutting *against* the wind toward the ship. If the PCs are below decks when this happens, the first they hear about the problem is the noise of increased foot traffic above their heads and shouts like "Yare, yare! Take in the topsail! Tend to the master's whistle!" Moments after this ruckus begins, the boatswain locks the corridor doors to the PCs' quarters, then those of Antonio and

Ferdinand; this is a precaution to protect the important passengers. If the PCs move above decks or protest, the boatswain speaks:

"Good travelers, keep below! Stay below lest you mar our labor and assist the storm. If you can command the elements to silence, my men will not hand a rope more; otherwise, ready yourselves for the mischance of the hour!"

Despite his assurances, the boatswain and men could not be more outmatched.

The storm clouds are two living tempests under the command of Ariel, who appears as a storm cloud of smaller size.

Descending upon the *Donna Milano* are three fearsome storm clouds, in whose billowing black folds you can almost see malevolent faces. The clouds' silver linings hardly seem like luckbringers; indeed, they crackle with lightning and roil with rain.

The tempests have been directed to capture Ferdinand and Antonio and leave everyone else alive. Barring PC interference, their strategy is to pour lashing rain down on the ship, keeping the crew occupied. Meanwhile, Ariel will kidnap Antonio and Ferdinand, using a *hallucinatory terrain* spell to make it seem as if the waves have consumed the *Donna Milano* and all hands. Ariel then casts *mass suggestion* to lull the ship's complement to sleep, and keeps his *sleep* spells for those who make their saving throws. Ariel assumes he needs only a few *sleep* spells to handle a normal ship's crew, since the *mass suggestion* will lull most of them. But Ariel's plan does not take into account an armed, capable group of escorts.

If the PCs stay below decks, they must make saving throws against the *mass suggestion*, assuming they are not affected by *sleep* spells. Those who fail find a corner and go to sleep; those who succeed hear a voice on the breeze say the word "sleep" in a hypnotic drone but are unaffected. If Ariel is unchallenged but several PCs remain awake, they may lie low long enough for Ariel and the tempests to leave. Under those circumstances, seafarer PCs may pilot the ship slowly to an island on the horizon if they raise the topsail.

If the PCs take a more active approach, Ariel and the tempests will be much more aggressive. They allow the PCs to make the first move, but respond with great force against those who attack them. Once the crew has succumbed to sleep, the tempests and Ariel use *lightning bolts*, whirlwinds and battering to attack PCs who fly or are in the water attacking them. (Flying PCs who are not wearing metal will take no damage from lightning.)

However, the attackers do not risk destroying the *Donna Milano* or its

crew, since Prospero needs it to escape the island. PCs on deck suffer only the tempests' wind attacks and Ariel's mind-affecting spells and physical attack. If the PCs physically damage the tempests, they respond by knocking the PCs into the water and hurling their lightning attacks (which resemble *fireballs* in water). If a tempest uses a whirlwind effect on waterbound PCs, any PC who survives may physically attack that tempest that round. Ariel will be very careful to avoid taking much damage.

Antonio and Ferdinand will fight in their own defense until captured by Ariel. Ferdinand's sword can harm the tempests and Ariel, but Ariel will use a *charm monster* to stay his hand. Antonio may annoy the attackers by casting *Melf's acid arrow* and (unsuccessfully) *ray of enfeeblement*, but he will soon run out of spells and use the party as his personal shield; note his *rod of beguiling* here.

Water-breathing PCs who dive deep can get out of the 80' range of the tempests' lightning. If the heroes take Antonio or Ferdinand with them, Ariel will follow them using either *water breathing* or *airy water* (if he has prisoners), but he will give up if his spells cannot defeat the PCs without harming Antonio. He will not risk being slain himself, nor will he risk the safety of his prisoners.

Ariel wants both prisoners, but if he cannot get one or both, he will retreat using *invisibility 10' radius*. He is loath to leave without kidnapping at least one prince. He would much rather not kill any PCs, but he may not have a choice. If Ariel and the tempests can defeat all of the PCs without slaying them, they will leave them to the perils of the ocean. If Ariel believes he has defeated all opposition, he will abandon the ship, commanding the tempests to blow it a mile offshore, dropping the anchor and leaving it parked in the sea.

Living tempests (2): INT average; AL CN; AC 2; MV fly 24 (D); HD 11; hp 78 each; THAC0 9; #AT 2; Dmg 2d8 (wind) and 11d6 (lightning); SA wind attacks (*wind wall*, *gust of wind*, buffet for 2-16, small whirlwind kills all under HD 2 or does 2-12, chilling wind for 1-4 damage plus saving throw vs. spells or lose 1 Strength point, batter down flying creatures who fail saves vs. paralyzation), *lightning bolt* 80' long, rain; SD +2 weapon to hit, AC -4 against missiles,

immune to air and water attacks, half damage from electricity and cold; SZ G (50' diameter); ML 16; XP 9,000; MM/105 (Elemental, Composite).

The tempests will not dehydrate dead victims. If the PCs slay a tempest, silver will rain over the water. At best there will be 180 pieces of silver per dead tempest, mostly unrecoverable.

Shipmaster Adrian, Boatswain Francisco and crew (40): AL N; AC 10; MV 12; 0-level humans; hp 4 each; THAC0 20; #AT 1; Dmg by weapon type; ML 9; XP 15; daggers.

Act I, Scene iii: Aftermath of the Storm

If Ariel gets Antonio and Ferdinand, he will leave the ship anchored and covered with a *hallucinatory terrain* of a shipwreck amid stormy seas. If the PCs are present, they will see this illusion from the inside, and will not be convinced by it.

Though you are still above the waterline, it appears that the ship has been destroyed by the storms. The waves are still crashing around you, and all hands appear to have been lost.

Of course, this might be a little more troubling could you actually hear the waves, or not hear the snoring of the crew.

PCs who are affected by the *suggestion* can be roused with a bit of battering and insistence that they rise. Affected PCs resist leaving their slumber, but they gain new saving throws to awaken. If they are present and asleep, Ferdinand and Antonio also can be woken in this way. 0-level crew members always fail their saving throws for waking. Both the *mass suggestion* and the *hallucinatory terrain* can be dispelled as against a 20th-level caster.

If Ferdinand is still with the PCs, he will want to rescue Antonio; if Antonio is here, he will insist on rescuing the king's son. If both are still with the PCs, getting to the far-off isle will seem like a good idea with the crew unconscious. Antonio is extremely agitated by the sleeping crew, suggesting they should be hanged for treason. He will be enraged by any suggestion that he could have done more to fight the tempests; in fact, he takes credit if the tempests were slain. If both Antonio and Ferdinand are gone, the PCs must make their own decisions.

The PCs cannot sail the ship by themselves, and the crew will be affected by Ariel's *mass suggestion* for 84 turns (14 hours). If the PCs wait, the events of the adventure proceed without them, and Prospero takes over the ship half a day later. If the PCs leave, certain spells—*conjure elemental*, *control weather*, *gust of wind*, *wind wall*, and others—could propel the ship to the isle. They may row in the dinghy, which holds up to 10 people. They might also decide to swim or use spells like *water walk* or *tree steed** to reach the island.

In the shipmaster's quarters, two items interest the PCs. A map shows the course of the *Donna Milano*, with the last charting showing the ship going out of its way to avoid an area called "Sycorax's Reach." Nearby, a book of sea landmarks describes "Sycorax's Reach" as an area that can be sailed through safely since the defeat of the giant sea hag Sycorax 13 years ago; it lists Milano as a duchy ruled by Antonio, who assumed his brother Prospero's throne after the latter abdicated 12 years ago.

Valuables on the ship include 3,000 gp worth of jewelry and fine clothes in Ferdinand's quarters, and 2,000 gp worth in Antonio's room. Other than 5,000 gp worth of Tusnian gifts in the ship's hold, little else of plot interest may be found on the ship.

Act II, Scene i: Approaching Paradise

The island paradise has steep hills rising toward the center, where there is an abrupt dropoff to a freshwater lagoon. But Prospero calls this island his "prison" because its lush beauty does little to alleviate the fear that he and his daughter will never leave.

The sorcerers who helped Antonio harnessed the power of the spell that binds the spirit of the hag Sycorax to the island, and then they expanded it: Now the island binds the spirits of *all* magic-using creatures to itself. No creature with any spellcasting ability can venture more than a mile from shore without being gripped by wracking pain. This pain requires a Constitution check every hour; if one is failed, the pain kills the victim within six hours unless he returns to the island. Of course, this binds Prospero, Miranda and Ariel to the island, and will bind Antonio and likely some of the PCs as well.

Magical items brought to the island also bring down the wracking, deadly pain on their owners, but clever PCs may be able to get around this limitation. If the items are left on the island, the owners can leave if they have no other spellcasting ability (powerful paladins would still be trapped even if they left their armor behind). Clever PCs may find ways to escape with magic intact by using *succor* or [Drawmij's *instant summons*] spells or by simply towing their items to take them with; the items must not be within 40' of the PCs when they leave or the binding takes hold, wracking the PCs with swollen joints, cramps, and fevers.

The island is also permanently linked to a finite pocket universe, a portion of the Prime Material plane that Prospero has "pinched off" and set adrift in the Ethereal plane using his *rod of security*. He has bound the *rod* itself to the island so that it maintains the extradimensional pocket indefinitely. This pocket universe, actually three successive spheres, is where Prospero and Miranda live, and is the site of Prospero's impressive magical library and laboratory.

No monsters live on the isle except as noted in the "Dramatis Personae." However, if it helps to have something dangerous in the ocean to keep the PCs focused on the island, a school of sharks may perform the task handily. Sharks can scent blood up to a mile away, and up to ten can attack any one creature in a given round. The number appearing is up to the DM, but the real danger should be back on the island.

Sharks (5-8): INT non; AL N; AC 6; MV swim 24; HD 6; hp 30 each; THAC0 15; #AT 1; Dmg 2-8; SZ L (10'); ML 10; XP 270; MM/117 (Fish).

Act II, Scene ii: Welcome of the Spirits

Ahead is an isle of unparalleled loveliness. The air is softly perfumed, and the beaches have a light golden hue. On the fringes of the sand are rings of radiant greenery, with lush grasses green and tawny. The fruit trees are rich with bounty: apple, banana, pomegranate and a few you have never seen. Birds flit from tree to tree, while crabs scuttle across the beach. A tree-lined ridge reaches 100' above the waterline. In all, the island seems an idyllic place.

The Island

0 100'
Feet

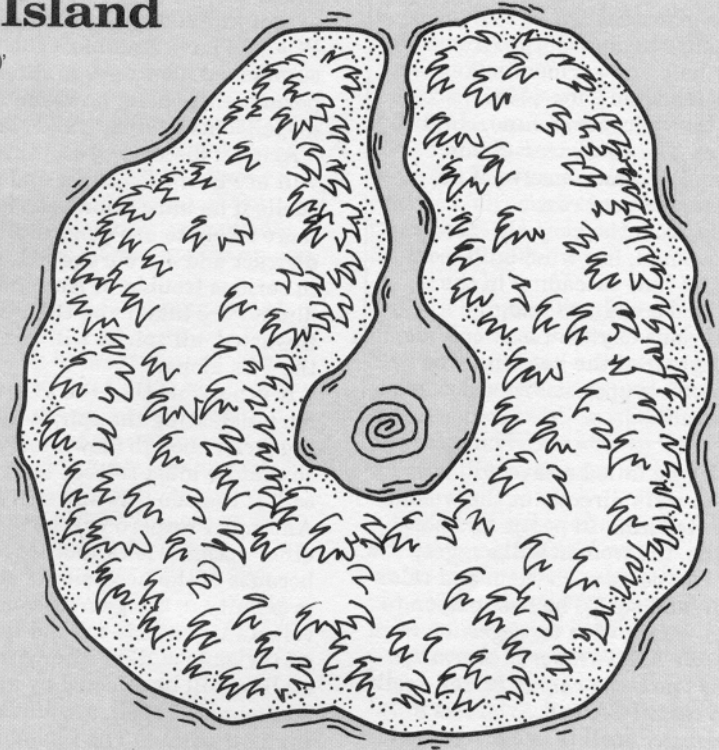

What happens when the PCs land will depend on three things: how they get there, who they're with, and who knows they're there. If they have come alone by swimming or under cover of darkness in the dinghy, they may not be spotted by Ariel, assuming he is not expecting them to come. If he does expect them or if they come with Antonio or Ferdinand, there is little the PCs can do to stop Ariel (or at least Prospero via his *mirror of mental prowess*) from spotting them. Regardless, three bound female spirits—a hamadryad named Ceres in the greenery, a sylph named Iris in the air, and a nymph named Juno in the sea—are on lookout. Iris periodically takes *invisible* flight to survey the island. One of the three will see the PCs and alert Ariel, who quickly joins her; the other two women arrive as fast as they can.

Ariel allows the PCs to land on the island, watching from an invisible position as long as he does not believe he is spotted by the PCs. (If they go straight for the lagoon, they will meet the spirits at the lagoon's mouth.) The PCs can talk among themselves, question Ferdinand or Antonio (if they are present),

and make any plans they like. As it becomes clear that the PCs plan to explore the isle, Ariel and the women will make their move. A lilting melody will waft on the air, and those who listen closely will hear a song (courtesy of Ariel's *whispering wind* spell):

*Come unto these yellow sands
And then take hands
Curtisied when you have and kissed
The wild waves whist*

At this point the women cast *charm person* at males in the group. Ceres aims her powerful *charm* (-3 on saving throws) at Ferdinand or Antonio if either is with the group (assume that the NPC will fail his save); otherwise, she targets a male spellcaster. The women introduce themselves to the men they have bound with their magic.

"Come forward, lovely ones," says a toga-clad goddess as she appears against the treeline. She has dark green hair ringed with leaves, and a leaf-covered toga to match. "I am Ceres, daughter of the lands and forests. I bid you to indulge in the

bounties of our home.”

A second woman emerges from the sea, her hair and garment silken wet and aquamarine. “Yes, please, accept as well the welcome of Juno, child of the water. The surf caresses our beach, and we can conceive of no finer place for your rest.”

Finally, from the very air emerges a third woman, her wind-buffed blue-white hair cascading in the wind. “And could you imagine a more glorious day! You may call me Iris, daughter of the heavens. The sun is smiling upon us! So welcome, welcome all!”

Any PC who failed a save will be tempted to walk directly at the woman who *charmed* him. In poetic and honeyed words, the women will suggest that the PCs come with them and relax in the sun and surf. The first person to object will be hit with a *suggestion* from the invisible Ariel’s *harp of charming*. Ceres has two more *charm person* spells to use on male PCs, and Ariel has a *charm monster* spell to use on a female PC. *Charmed* PCs may need to be reminded that they should do what the spirits tell them. The spirits will converse with the PCs, bemoaning the shipwreck that they know did not occur.

The spirits seek to separate Antonio and/or Ferdinand from the PCs, and to slow the PCs down. If the PCs attack the women, the spirits will order any *charmed* PCs to defend them as they fade into their respective elements. However, Ariel will make another grab for Antonio or Ferdinand here if the opportunity presents itself. To slow the PCs down, Ariel will use *solid fog*, *fog cloud*, and *glitterdust* spells; the women have good defensive spells as well. If worse comes to worst, Juno can doff the ribbon that mutes her natural nymph powers, so that all who see her must make a saving throw vs. spells to avoid permanent blindness (or death if she disrobes, an absolute last resort).

The three female spirits have been summoned by Prospero and placed under Ariel’s command; none have free will here, and will do whatever Ariel says. Each woman has a considerable natural seductive ability toward males, and each can spout flowery poetry. None will start a melee, preferring to use spells and natural abilities to confuse and divert opponents. The spirits do not

use deadly force to defend themselves, except in Ariel’s case and only if the PCs still have Antonio. (The women are summoned monsters, so cannot be killed permanently here; however, they can be dispelled as against a 17th-level caster.)

Ariel, if discovered and threatened, will use *chain lightning* and similar spells if he must. However, he is much more likely to use nonlethal spells to distract and discourage PCs unless he is in serious trouble. If Antonio and Ferdinand are taken and the PCs are thwarted, all spirits will vanish, leaving the PCs alone.

It is possible that the PCs will prevail here, defeating the spirits and wounding Ariel enough (down to 40 hp or less) so that he must retreat to Prospero’s cell. If they do this and still hold onto Antonio, Prospero will have to use another option. He cannot leave the cell because of the necessity of staying in proximity to the gem prison. He will reluctantly decide to send the summoned invisible stalker after Antonio. (The stalker will be affected by an *intensify summoning** spell, accounting for its high hit points.) The invisible stalker will be instructed to use stealth and not confront the PCs, spiting Antonio away at an opportune moment. However, the invisible stalker will defend himself if attacked, giving the PCs another chance to thwart Prospero. By this point, at least one of the two nobles should be kidnapped, forcing the PCs to continue searching for Prospero.

Juno (nymph): INT exceptional; AL N(G); AC 9; MV 12, swim 12; HD 3; hp 22; THAC0 17; #AT none; Dmg none; SD *dimension door* once per day, inflict blindness or death, *ribbon of disguise* (mutes blinding effect); MR 50%; SZ M (5’); ML 7; XP 2,000; MM/270.

Spells: *create water*, *entangle*, *faerie fire*, *pass without trace*; *charm person or mammal*, *messenger*, *straighten wood*; *air breathing*, *water walk*; *raise water*.

Iris (sylph): INT exceptional; AL N(G); AC 9; MV 12, fly 36 (A); HD 3; hp 21; THAC0 17; #AT none; Dmg none; SD *invisibility*, *levitate*; MR 50%; SZ M (5’); ML 14; XP 3,000; MM/101 (Elemental).

Spells: *charm person*, *lasting breath**, *sleep*, *wall of fog*; *stinking cloud*, *whispering wind*, *web*; *gust of wind*, *wind wall*; *confusion*; *conjure air elemental*.

Ceres (hamadryad): INT high; AL N; AC 7; MV 12; HD 4; hp 27; THAC0 19; #AT 1; Dmg by weapon type; SA spells; SD spells, immune to *entangle*; MR

75%; SZ M (5’); ML 12; XP 975; MC4.

Spells: *charm person* 3/day (-3 on saving throws), *speak with plants*, *animal friendship*, *detect snares and pits*, *entangle*, *pass without trace*, *quench fire and dimension door through trees* (660 yard range) at will, *hold plant* once a day.

These three spirits can be dispelled by releasing the conjuration of a 17th-level caster.

Invisible stalker: INT high; AL N; AC 3; MV 12, fly 12 (A); HD 8; hp 65; THAC0 13; #AT 1; Dmg 4-16; *invisibility* (-6 to surprise, -2 against *detect invisibility*); MR 30%; SZ L (8’); ML 14; XP 4,000; MM/208.

Act III, Scene i: Caliban in Chains

As the PCs approach the lagoon, they may meet Ariel and his three female servants; see above for details. Assuming the PCs can make it to the lagoon unmolested, read the following.

Ahead is a shimmering blue lagoon with the tips of coral formations forming a natural ring reaching up to the sandy shore. All is not well with the water, however. It swirls and spins in a violent eddy, as if the water itself were angry. The whirlpool makes details uncertain, but you can almost make out the form of a large statue far under the surface.

Caliban has been chained to the bottom of the 30’-deep lagoon with powerful magical bonds. Caliban’s chains allow him to stand upright on the lagoon bed so that his head is 15’ below sea level. His rage conjures a whirlpool in the lagoon. Any boat that comes into the lagoon will be drawn in; the bigger the boat, the harder it will be to turn it away from the whirlpool. Any person swimming within 10’ of the 50’-wide whirlpool must make a Strength check or be sucked in, each round suffering 2-16 hp battering damage plus 2-20 hp drowning damage if the victim can’t breathe water.

The depth of the water creates its own problems for those diving to the bottom. Without *water breathing* magic, it requires at least 17 Strength and at least 30 lbs. of encumbrance or armor to descend. Capable PCs can pull their friends down, and if Caliban is freed, he can carry two persons per trip to the bottom. If the PCs somehow get

close enough to see Caliban, read the following:

Chained to the seabed is a most impressive and furious creature. It is at least 15' tall and powerfully built. Its skin is scaly and copper-tinged, and its hair is scraggly white. It seems to be wearing the remnants of a once-stately robe, but its most prominent garment is the oversize set of thick chains and bonds against which it struggles mightily.

Caliban's chains are formed of a giant-sized set of *iron bands of Bilarro*, which cannot constrict anyone smaller than 10' tall but reduces the chance of a successful bend bars roll by a factor of ten (e.g., a frost giant would have a 7% chance of success, rather than the customary 70%). If anyone tries to free the giant, they may add to Caliban's 8% by tenths of points for each point of Strength. Any exceptional Strength score adds a flat 2%.

Allow one of the players to make the roll, but do not tell him the percentage. Various magical aids can boost this score, and magical weapons used as levers add 1% per plus. Spells may weaken or destroy the bonds; *knock*, *telekinesis*, *dispel magic*, *disintegrate* and *conjure elemental* may help. Magical weapons may also be used to hack at the bonds by someone with *free action*. If 20 hp damage are inflicted against the bonds in a single round, the metal must make a saving throw against crushing blow (7 or better) or break, allowing Caliban to escape.

Regardless, Caliban is in a fit of wracking pain from the *eyebite* spell on Prospero's punishing bracers, and must be calmed down before any discussion can occur. If he is released, he lashes out at anyone nearby, all the while shouting, "Spirits, do not torment me!" His painful rage adds +2 to his attack rolls, but worsens his armor class by 2 and cuts his damage in half; the bracers also penalize him -5 on his saves vs. all magical attacks. The *eyebite* can be negated by *dispel magic* as against a 17th-level caster; otherwise the bracers must be destroyed or removed with a *remove curse* spell. If none of this is done, Caliban will attack until incapacitated. But if his pain is calmed, Caliban becomes a wholly different creature.

"Hast thou not dropped from heaven?" pleads the 18'-tall creature who now prostrates himself before you. "I'll show you every fertile inch o' the island, and I will kiss your foot. I prith-ee be my god. I'll show you the best springs; I'll pluck berries for you; I'll fish for you and get thee wood enough. A plague upon the tyrant that I serve! 'Ban, 'Ban, Caliban, has a new master, get a new man!"

Caliban sees anyone who frees him as divine, and he is obsessed with fawning and flattery. Caliban especially favors anyone who gives him wine or beer; since he has never been allowed these spirits, he becomes intoxicated far more quickly than the PCs might expect of a giant.

Caliban desires aid in his fight against the cruel wizard Prospero, who punishes him at every pass. He tells tales of how the mage, who most assuredly caused their wreck, took over the isle given to Caliban by his mother Sycorax, and how Prospero has inflicted a decade of magical torment on him. He seeks to redress this grievous wrong by killing his master, but he needs help against the sorcerer's might. Caliban is hardly brilliant, and he may be tricked into believing PCs are his allies even if they are not.

If Ariel is around, he will change this conversation slightly. Any time Caliban speaks of his master as evil or threatens to harm Prospero, the *invisible* Ariel will use a *message* spell from a distance to whisper in Caliban's ear, "Thou liest." Caliban immediately shouts to the heavens, "You lie, you jesting monkey! You scurvy patch! I would my valiant new master would destroy thee!" Caliban continues railing at thin air for several minutes; Ariel remains *invisible*. If Caliban is asked about this unseen adversary, he tells the PCs about Ariel, the powerful wind spirit that Prospero has bound. Caliban has nothing but angry words for Ariel, who really does torment him at every turn.

This could be the first time the PCs hear the name Prospero, and if Antonio is with them, he will quickly show signs of panic. Antonio does not succumb to bullying easily; he is confident in the power of his *rod of beguiling*. Antonio may agree with Caliban's tale of abuse at Prospero's hands, inventing stories of an evil Duke Prospero. Once he knows he is on Prospero's island, he will no

longer desire to rescue Ferdinand; rather, he will insist on leaving immediately, though he believes he is trapped here forever by the power of the island.

Act III, Scene ii: A Portal Inward

On the lagoon bed, directly under where Caliban is chained, is a fixed portal to the pocket dimension that Prospero calls his "cell." (This can be revealed by an *extradimensional detection** spell.) The bed is of strong reefs, but a 10'-diameter cylinder has been carved out of the reef and capped with a stone hatch. The hatch is covered by an *illusionary wall* to look like a normal patch of reef; demihumans can detect it with normal chances.

The hatch turns easily and sinks into the reef, exposing the 10'-deep and 10'-diameter cylinder. Prospero, Miranda and Ariel don't bother with the hatch, instead using their *clasps of transference* to pop into the tube. (See the "Dramatis Personae" sidebar for details of the *clasp*.) The tube contains an *airy water* effect (at 17th level) and a glowing silver penny whistle suspended in the center of the cylinder. The whistle cannot be moved unless its *levitation* is dispelled, but *dispel magic* may remove the *airy water* as well. It can be played normally. Playing or singing the note of high C activates the penny whistle's magic, which transports anyone in the tube and anyone they touch into the pocket. (PCs playing notes at random on the penny whistle have a 15% cumulative chance per round of triggering the spell.) If Prospero already has Antonio and Ferdinand, he may send an invisible stalker to harass PCs in the tube (see page 14 for details of the stalker).

Of course, Caliban knows about the portal, but he cannot use it; he can neither fit inside nor make music. He knows nothing of notes, but he thinks Prospero may have said something about "playing on the high seas." He would be happy to tell any potential savior about the magic, but once he starts talking, he is suddenly overcome by a second *eyebite* spell of wracking pain, and again must be calmed to prevent him from attacking everyone within reach. More spells (such as *irritation*) will follow if necessary. Prospero will take the opportunity to send Ariel or a stalker to get Antonio or Ferdinand.

Maze Detail

- A = Ruby (Initially)
- B = Fire Opal
- C = Topaz
- D = Emerald
- E = Turquoise
- F = Sapphire
- G = Amethyst

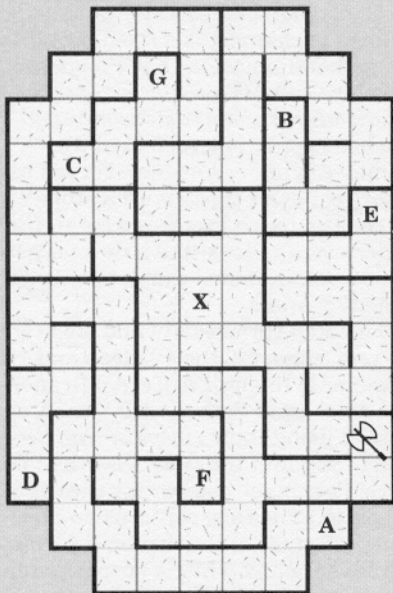

Act IV, scene i: Prospero's Cell

The inner sanctum is like nothing the PCs have ever seen. It has three "rooms," each a low-gravity sphere. The outer sphere is an entrance foyer, whose direct center acts as a portal to the second sphere. That sphere contains private quarters; its center is a portal to the inner sphere. The inner sphere is a library and laboratory, and also the repository of Prospero's special *rod of security*, the device that controls the cell.

Each sphere has the same diameter, about 100'. Each is well lit, though the source is not apparent; in fact, one can see everywhere in the room at once. PCs who look straight up see a small globe hanging in the exact center of the "ceiling." The spheres' gravity replicates the buoyancy of water, so PCs may walk on the floor or "swim" through the air as desired. The furniture is magically affixed to the surface of each sphere; these effects cannot be dispelled. For purposes of magic, the spheres are part of the Prime Material plane; because of the proximity to the Prime, magical items work normally here.

Each sphere has a central, 6"-

diameter globe enchanted like the whistle in the reef tube, but without a command note. (Prospero installed the whistle at the portal to reduce unwanted visitors and to act as an alarm. A PC in any sphere when other PCs activate the penny whistle will hear the high C note.) When anyone touches the globe in the center, he and everyone he touches is pulled into the next sphere. The second sphere's connection to the inner sphere has a telepathic "lock" on it: Unless the person attempting the transfer is visualizing a library, a book, or something related to learning, he will be transferred back to the outer sphere.

Act IV, Scene i: The Outer Sphere

When the PCs trigger the portal, read the following:

As the crystal tone resounds in your head, you feel yourselves being pulled inside an inconceivably small space. You emerge on the other side, but what an other side it is. You float in a well-lit spherical space, perhaps 100' across. Furniture from several rooms and a small garden decorate the surface of the sphere. At the center of the sphere floats a 6" globe, and just beyond that is a shimmering door, intricate and gem-inlaid. You cannot see beyond the portal, but you can hear faint music coming from inside.

The outer sphere is vaguely divided into several rooms, with well-appointed furniture for a kitchen, dining room, sitting room, musical conservatory and small garden. Because he knows that the PCs are coming at this point, Prospero has added a new feature: a door which is an entrance to a *maze* spell, masked by a *veil* spell.

If the PCs ignore the illusory door and are quick about it, they can touch the globe and *teleport* into the central sphere. They may also look around the outer sphere, examining the fine furniture and accoutrements; very little of it is helpful to the PCs. Though no one is visible, ten spirits lurk here and function as *unseen servants* in response to requests anyone makes. Some magical items are here: a *Zwann's watering can** in the garden, a *tapestry of disease warding** and *alchemy jug* in the dining room, an *everbountiful soup kettle** and *Murlynd's spoon* in the kitchen, a *rug of welcome* and *decanter of endless water*

in the sitting room, and *pipes of sounding* in the conservatory, as well as Prospero and Ariel's brilliant otherworldly compositions.

However, if the PCs take the bait and walk into the glowing portal, the first person through will be hit with Prospero's *maze* spell. That person instantly shrinks to 1/4" tall and appears on the door's intricate inlay. Remove the player from the group and read this description to the others:

As your friend touches the door, he vanishes! You cannot see him anywhere in the sphere, until one of you looks closely at the door. A small spot on the door, no bigger than an insect, is moving. Straining to see details that small, you realize that your friend is trapped in the intricate pattern of the door, and is as small as a fly!

Read this privately to the player who touched the door:

As you touch the door, the sphere and all your compatriots vanish. You find yourself in a brightly lit room with exit passages in four directions. The walls shimmer like a rainbow, and are translucent. You can see other corridors winding in an intricate pattern out from your location. At various points you can see the gems inlaid into the door, now huge as boulders: a sapphire here, a ruby there. Above there is no ceiling, only blackness. And troublingly, on the outside border of this maze, something big has started to move.

Put down a copy of the maze handout on the opposite page and place a miniature of the PC at the central "X." Place seven colored dice on the lettered areas: A = ruby (red), B = fire opal (orange), C = topaz (yellow), D = emerald (green), E = turquoise (light blue), F = sapphire (indigo), G = amethyst (violet). Place a minotaur or other figure on the axe symbol.

The maze works like this: The gems must be touched consecutively, in the order of the colors of the rainbow (ROYGBIV). The trapped person must first touch the ruby (which then disappears), then the fire opal (it vanishes), then the topaz, emerald, turquoise, sapphire, and lastly the amethyst, releasing the PC from the maze. Any gem touched out of order vanishes and reappears elsewhere, as do all the other gems. To illustrate this using the

Prospero's Maze

1 Square = 10'

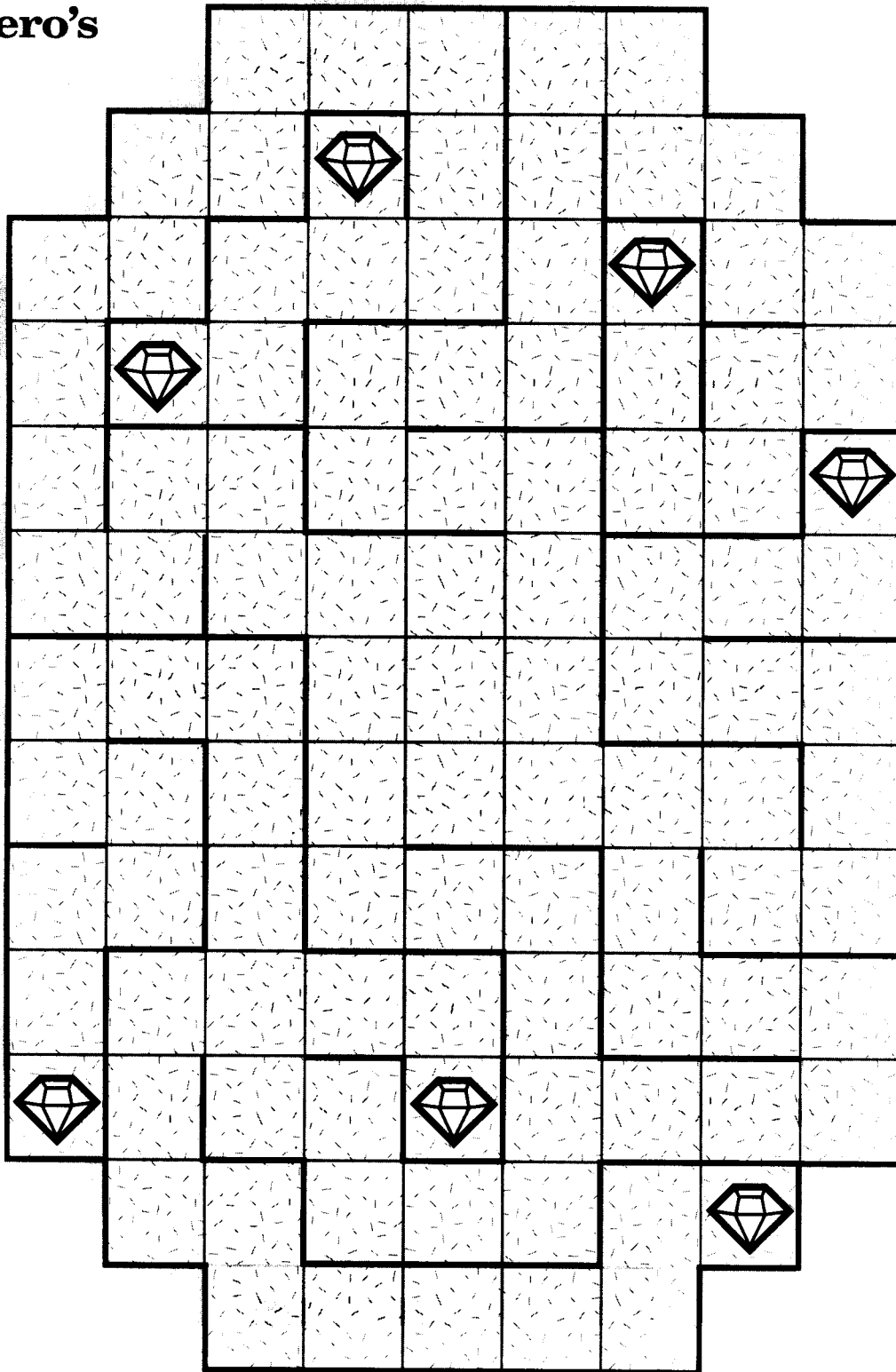

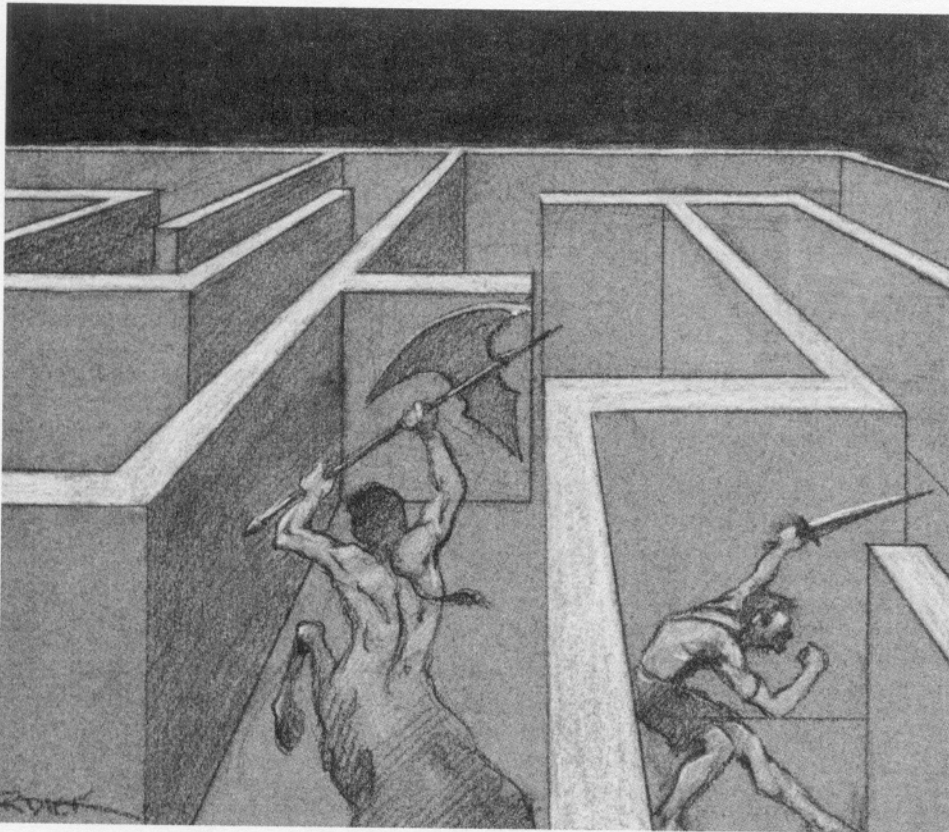

maze map, simply pick up all the gem markers and replace them on the gem sites at random.

The player whose character is trapped must trace his path on the map with a pencil, or move the miniature appropriately. Climbing and even flying over the walls is possible, but the trapped PC cannot leave the confines of the maze without a *wish*. The PC may wrap his arms around a gem and move with it as it shifts to another place, if it is touched out of order. If it is touched in sequence, the PC stays behind when the gem vanishes.

The other PCs can also affect the maze by prying out the gems with daggers or their fingernails (the wood is very soft); these gems can then be replaced in the maze in a position that helps the PCs' trapped comrade. However, prying out gems must be a cooperative effort, because of the way the gems shift when touched. The gems in the maze are difficult to pry out, because touching just one induces all of them to trade places as described above. A simple trick will allow a PC to pry them out: the gems must all be touched at once. Each PC can touch, pry out,

and replace up to two gems at a time.

The *maze* and *veil* allow no saving throws or disbelief chances. The *veil* can be dispelled (versus a 17th-level caster), but eliminating the illusion of the door reveals the trapped PC, still in the room, staring vacantly while his mind runs the maze. Unfortunately, removing the illusory door also prevents the PCs outside the maze from helping their trapped comrade (the spell lasts as long as the trapped PC requires to solve the puzzle). As a rough guideline, this puzzle should take as long as a *maze* spell's duration; i.e., up to 16 minutes of real time. If it takes longer, allow Intelligence checks for players to pick up on the theme.

A complication is the minotaur golem that moves to intercept the PC. As part of the spell that keeps the PC in the maze, the minotaur golem moves faster as the PC gets closer to leaving. Its Movement Rate is $9 + 1/\text{gem}$ that the PC has removed from the maze (to a maximum of 15 when only one gem remains).

If the golem reaches the PC, it attacks with a mighty axe for an automatic 2-12 illusory damage every round, though it automatically loses initiative. As it is part of the *veil* spell, it cannot be

harmed, except by a *dispel magic* spell. The minotaur can be seen by PCs outside the maze, but cannot be picked up. The statistics of the illusion are provided from the trapped victim's perspective; the minotaur cannot affect anything outside the maze.

Illusory Minotaur Golem: INT average; AL N; AC 0; MV 9 (+1/gem removed); HD 17; hp 130; THACO 3; #AT 1; Dmg 2-12; SD immune to mind-affecting magic; SZ L (10'); ML 20; XP 11,000; MM/164, 171 (Golem, variant). Even if slain, the minotaur golem simply reforms in a single round as long as the *maze* spell is active.

The PC inside the magic maze can be affected by spells from the PCs outside the maze, but cannot be physically removed or touched. This is because the PC is affected by a *maze* spell, and is only part of a powerful illusion that makes him tiny. The other PCs' spells affect and are incorporated into the illusion. For example, if an *enlarge* spell is cast on the PC, he doubles his size to 1/2" tall in the maze. But since the other PCs would be casting the spell at the illusion, the real PC's size does not actually change.

As a DM, try to avoid having the minotaur "kill" the trapped PC. However, if the players just don't catch on to the secret of the maze and the minotaur reduces the PC to zero hp, the victim appears at the other PCs' feet, unconscious for the next 16 rounds. All of his damage is psychological; his previous hp return when he regains consciousness.

If the PC solves the maze's puzzle, he reappears full-size and unharmed. The illusory door opens, presenting a view of a banquet hall. The PCs may think they have broken through a barrier. In fact, Prospero's trap simply unfolds further:

Your ally materializes before you, appearing none the worse for the experience. The door slowly swings open, allowing you to hear the wondrous music from within. On a vast banquet table are arrayed dishes of all types: meats and vegetables from all corners of the globe. Amorphous and translucent servants tour the table, decanting wines and peeling grapes.

At this point, the music becomes Ariel's *music of the spheres** (a wizard version of the priest spell), and all PCs must make saving throws vs. spells or be entranced for 30 rounds. Ariel can

Prospero's Spheres

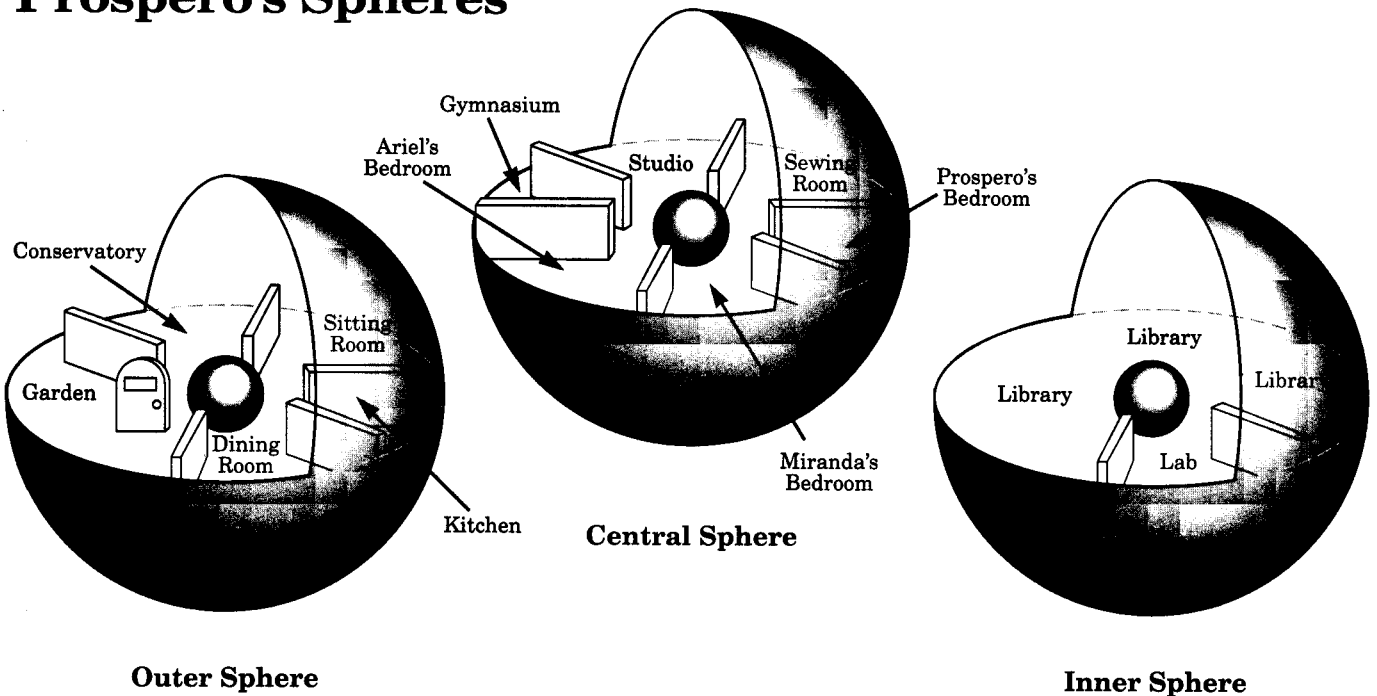

entrance up to six PCs at once; if more than six fail their saving throws, Ariel chooses which PCs to affect. The PCs may listen to the unearthly music as long as they like, but if they eat or drink from the banquet (perhaps after Prospero casts an *insatiable thirst** spell through his magical mirror), they must make saving throws vs. spells or fall asleep. If the adventurers all fall asleep, they wake back on the ship. If PCs refuse to eat or some remain awake, Ariel appears in the form of a giant bird-man.

The music and banquet vanish as a 20' bird-man appears before you. As he advances, he intones, "You fools! You among men are most unfit to live! I and my fellows are ministers of Fate. You may as well wound the loud winds, or with foolish stabs kill the still-closing waters, as diminish one feather of my plumage! Your swords are now too massy for your strengths and will not be uplifted!"

At this point, Prospero's *reverse gravity* affects the mansion, causing the gravity to become excessively strong. (In this

gravity-neutral environment, the spell increases each object's personal gravity to make them heavier.) Bend bars rolls must be made to move or swing a weapon, though minor motions might be possible without these rolls. As the PCs suffer (for up to 18 rounds, but no longer than one successful attack on Ariel), Ariel raises his wings quickly, creating a blast of air to blow the PCs back. Prospero's masterful timing allows him to cast a *banishment* at the same moment, blasting the PCs back to the reef entrance and the lagoon.

Act IV, Scene ii: The Central Sphere

When, after one or more attempts, the PCs get beyond the outer sphere, read the following:

As you are pulled again through the mysterious globe portal, you appear in a sphere similar to the one you were in before, minus the glowing door. The furniture again appears on all parts of the sphere's surface, but these furnishings are suited more to personal use. Some bedrooms and

studios, a gymnasium, and what can only be described as a huge perch are arranged around the walls. From the ruffles in the air, you assume that more invisible servants staff this area.

The sphere includes Prospero's master bedroom, Miranda's smaller bedroom, gymnasium, sewing room, painting room and Ariel's 20' perch. Ten unseen servants attend to anyone's needs. Many items here may interest the PCs, including the wardrobe and jewelry (total value 50,000 gp) of a gentleman of court, as well as a *Bell's palette of identity** and *Nolzur's marvelous pigments*.

Perhaps most interesting for those expecting a mean and terrible wizard is Miranda's chamber, which contains dozens of dolls and stuffed animals that look somewhat neglected. PCs looking closely notice that Miranda's garments have been carefully sewn together from smaller garments. Also of interest may be Miranda's diary, which contains almost no references of day-to-day events, nor does it mention anyone

Dramatis Personae

Prospero was Duke of Milano until the sudden death of his wife Bellissima made him retreat from affairs of state into his library of magical books. Emotionally, he has never left that library. For the last 12 years, he has done his best to raise Miranda. He has mastered the books in his library, and has summoned an army of servants. He will not rest until he has imprisoned his brother in the manner in which he was treated. When not acting on his consuming desire for revenge, he is a regal and likable nobleman.

Prospero Milano: AL N; AC -3; MV 12, fly 12; W17 (conjurer); hp 57; THAC0 15; #AT 1; Dmg by spell or weapon type; S 11, D 11, C 16, I 19, W 15, Ch 18; ML 19; SD immune to 1st-level illusions, -2 on saves vs. fire (ring); XP 18,000; *bracers of defense AC 2, cloak of protection +5, robe of eyes, ring of air elemental command, censer of controlling air elementals, staff of the magi* (25 charges), *rod of security, pearl of power* (8th level), *talisman of memorization**, *clasp of transference* (allows dimension door at will). Prospero is a courtly graybeard of 55, bedecked in the tasteful silver-red robes of a gentleman wizard.

Spells: *cantrip, detect magic, protection from evil, read magic, sleep, unseen servant, glitterdust, insatiable thirst**, *irritation, summon swarm, shatter, wizard lock, dispel magic, monster summoning I, nondetection, phantom steed, protection from evil 10' radius, protection from normal missiles; Evard's black tentacles, locate creature**, *monster summoning II, stoneskin, thunderstaff**, *wizard eye; avoidance, conjure elemental, dismissal, Mordenkainen's faithful hound, summon shadow, veil; control weather, eyebite, globe of invulnerability, invisible stalker; banishment, intensify summoning**, *Mordenkainen's magnificent mansion, reverse gravity; antipathy-sympathy, mass charm, maze, monster summoning VI; power word blind, trap the soul.*

Miranda was five when her mother died, and but seven when she last saw any man other than her father. She has no more than hazy recollections of others, and is thus quite impressionable for a 19-year-old. She takes after her father and is an accomplished mage as teen-agers go, which bars her from leaving the magical island. Miranda loves her father, but does not share his hate for her Uncle Antonio. She defers to her father on every issue, although Ferdinand makes her heart fluctuate for the first time. She likes Ariel, but has nothing but contempt for Caliban.

Miranda Milano: AL NG; AC 2; MV 12; W4 (conjurer); hp 20; THAC0 20; #AT 1;

Dmg by spell or weapon type; S 9, D 16, C 16, I 17, W 13, Ch 17; ML 12; *ring of protection +6 AC/+1 saving throws, ring of chameleon power, amulet of life protection, clasp of transference, dust of illusion* (8 pinches).

Miranda is a pretty teen, wearing a bright green and yellow patchwork dress and jewelry worth 1,500 gp.

Spells: *cantrip, read magic, message, mount; glitterdust, ride the wind**, *whispering wind.*

Ariel is a powerful spirit of elemental Air, controlled by Prospero's censer. He ranks among the noblest of elementals, with powers that set him apart from lesser elementals. He can control other elementals and can shapechange into any human form. He has mastered both music and magic, the latter a teaching of Prospero. He protects Prospero from harm, and may use lethal force to save his master. Despite this devotion, he wishes nothing more than freedom, which he cannot have until the magic of the isle is sundered. He treats Miranda as if she were his own daughter, and plays sport at Caliban's expense.

Ariel (greater air elemental): INT exceptional; AL N; AC -2; MV 12, fly 48 (A); HD 20/B20; hp 140; THAC0 5; #AT 1; Dmg 3-30; SA +2 to attack and +6 damage in the air, 100' whirlwind (kills all under 4 HD, 2-20 damage to others); SD assume humanoid or elemental form, +2 weapon to hit, *charm* air elementals and spirits; SZ any; ML 19; XP 23,000; MM/99 (Elemental, modified); *harp of charming, clasp of transference.* He often appears as a blond boy dressed in a blue toga, but in his natural form he is a breeze.

Spells: *charm person, message, sleep* (×2); *fog cloud, glitterdust, music of the spheres** (as priest spell), *whispering wind; invisibility 10' radius, lightning bolt, spectral force, water breathing; charm monster, hallucinatory terrain, ice storm, solid fog; airy water, cloudkill, conjure elemental, sending; chain lightning, control weather, mass suggestion.*

Caliban is the son of Sycorax, a giant sea hag, and Setebos, a reef giant. He favors his father, though the two have never met. Though Prospero taught Caliban language and culture, the giant has always hated the mage for taking over his island. He will ally himself with anyone who opposes Prospero, inventing many tales of hardship at the mage's hands. (Enough of them are true for him to be credible.) Caliban has spent the last month trapped in the lagoon as punishment for attacking Miranda, a foolish act meant to intimidate Prospero. As part of his punishment, Caliban has been sickened by

Prospero's *eyebite* spells, which cause wracking cramps.

Caliban (reef giant): INT average; AL NE; AC 0; MV 15, swim 12; HD 18; hp 130; THAC0 5; #AT 1; Dmg by weapon type or 1-10; SA hurl rocks 350 yards for 3d10, whirlpool; SD immune to water and ice attacks, no penalty in water; SZ H (16' tall), ML 17; XP 14,000; MM/144 (Giant); *spiked gauntlets +3* (2d8 +3 damage), *cursed bracers of vulnerability* (-5 on saving throws vs. magical effects).

Caliban's coppery skin is plated with scales. He wears a torn but well-appointed robe and coral-pearl jewelry worth 100 gp.

Antonio, Prospero's younger brother, has always lusted after his brother's achievements. As a minor noble, he could not achieve his ambitions, but he seized on his brother's weakness and wrested away the dukedom. Since Prospero's last act in court was a vocal endorsement of Antonio, he has enjoyed unparalleled prosperity. However, he has been controlled and blackmailed by the sorcerers who helped him control and blackmail Prospero. He views the Tusnian journey as a welcome departure from life at court. He is crafty and intelligent, and his charisma cannot be dismissed.

Antonio Milano: AL NE; AC 10; MV 12; W3 (enchanter); hp 12; THAC0 20; #AT 1; Dmg by spell or weapon type; S 13, D 9, C 15, I 16, W 13, Ch 16; ML 9; XP 420; *scroll of protection from magic, dagger of venom +1* (onset 2-5 minutes, 25/2-8 hp damage), *ring of mind shielding, brooch of shielding* (21 charges), *rod of beguiling* (8 charges). Antonio looks regal in his purple robes of court and his mountains of jewelry (worth 4,500 gp).

Spells: *charm person, hypnotism, protection from evil; Melf's acid arrow, ray of enfeeblement.*

Prince Ferdinand Napoli is an accomplished warrior at the age of 19. Though his father has tried to marry him off several times, Ferdinand has found ways to avoid marriage until he finds a woman to love. (Miranda will be that woman.) He is a polite young man, though he has the prejudices of nobility. He is not a great leader, but shows signs of developing with time.

Prince Ferdinand Napoli: AL NG; AC 7; MV 12; F3; hp 34; THAC0 18; #AT 1; Dmg by weapon type; S 16, D 17, C 17, I 12, W 13, Ch 14; ML 18; *long sword +2 giant slayer, ring of warmth.*

Ferdinand is a handsome lad, dressed in gray cloaks of state and an assortment of jewelry worth 1,000 gp.

other than her beloved father, Ariel, and the feared Caliban. Rather, Miranda focuses on astonishing theories about what the world outside is like, describing it in terms others might use to describe the Outer Planes. Importantly, the diary is the only book in the room, suggesting a library should be somewhere else.

Unless they still have not captured Antonio and/or Ferdinand, Prospero and Ariel will not mount any defenses here, fearing that to do so might entice the PCs further in. Instead, they intend to allow the PCs to come to the incorrect conclusion that there is nowhere else to go. Remember that the PCs cannot enter the inner sphere unless the person touching the globe is visualizing a library or some other type of learning. Otherwise, the PC and those he touches are transported to the outer sphere. (Prospero uses his *mirror of mental prowess* to scan the thoughts of anyone using the globe, so he will know instantly if a PC breaches the inner sanctum.)

If Prospero still does not have both Antonio and Ferdinand, he will try a kidnapping from a distance. If he has a *banishment* spell, he will cast it when Antonio or Ferdinand is more than 20' from the PCs; *unseen servants* may push the nobles away from the PCs. He has other means at his disposal: *Evard's black tentacles*, *summon shadow*, or *monster summoning VI*, which brings three ogre magi to keep the party busy.

In this case, one ogre mage attacks the fighters with spells while *polymorphed* to resemble Prospero. The others wait invisibly until they can spirit away Antonio or Ferdinand, then they use their *polymorph* ability to appear as Antonio and Ferdinand. The "Prospero" ogre mage then "destroys" the other two, who use their *invisibility* to simulate being *disintegrated*. This done, "Prospero" lets himself be defeated, and the PCs can leave. If necessary, Prospero will even let the PCs leave with the *Donna Milano*, figuring he can conjure an *airboat** if it comes to that.

Ogre Magi (3): INT very; AL LE; AC 4; MV 9, fly 15 (B); HD 5 + 2; hp 39 each; THAC0 15; #AT 1; Dmg 1-12; SD *regenerate 1 hp/round, invisibility, fly, darkness 10' radius, polymorph to bipedal form*; SZ L (10'); ML 14; XP 975; MM/272-3 (Ogre). Spells: *charm person, gaseous form, sleep, cone of cold* (8d8, 60' long and 20' diameter).



Act IV, Scene iii: The Inner Sphere

This sphere, though similar in size to the others, is packed with stacks of books at varying angles. Across from you is an impressive magical laboratory, and small tables and chairs are everywhere. A cart of books being pushed by an invisible force whisks by you; as it passes you catch a few titles: *The Tome of Clear Thought* and *The Libram of Gainful Conjunction* certainly pique your interest. From somewhere near you, you hear an unexpectedly girlish giggle.

If the PCs make it here, Prospero will have to concede that the PCs could interfere with his plans; he may also realize that some or all of them cannot leave the island. Thus, he views them as a serious threat. However, he is quite concerned about looking good in front of his innocent daughter (and perhaps her newfound love, Ferdinand—see "Dramatis Personae" sidebar), so he will be very circumspect.

This sphere is unlike the others in two important details: the central globe leads only one way (back to the second

sphere), and the inside is far more cluttered. Though the sphere is 100' across, it is crowded with bookshelves, half a dozen tables with corresponding chairs, a full alchemical lab and mage's workshop, and a permanent thaumaturgical sphere (a circle would be insufficient in this low-gravity environment). Twenty invisible servants scurry about, moving books and beakers back and forth across the sphere. Any PC making a request will immediately have it fulfilled to the best of the servants' abilities, including showing where NPCs might be.

As duke, Prospero assembled one of the greatest magical libraries and laboratories in history, and Antonio allowed him to bring it to the isle. The PCs may be astonished at the titles of the books. The magical items here include: *beaker of plentiful potions*, *Boccob's blessed book*, *book of infinite spells*, *crucible of melting**, *deck of illusions*, *glass of preserved words**, *jar of preserving**, *lens of detection*, *lens of speed reading**, *libram of gainful conjunction*, *libram of silver magic*, *manual of bodily health*, *manual of gainful exercise*, *manuals of golems* (caryatid column, flesh, iron, necrophidius, stone), *Nefradina's identifier**,

*philosopher's egg**, *prism of light splitting**, *quill of law**, *Tenser's portmantau of frugality**, *tome of clear thought*, *tome of leadership and influence*, *Trimia's catalogue of outer plane artifacts**, *vacuous grimoire*, *wand of element transmogrification**. In addition, hundreds of spellbooks, potions and scrolls abound.

The feminine laugh belongs to Miranda. If the PCs have Ferdinand, she will be hiding behind one of the stacks, giggling at the appearance of other humans, especially the handsome young Ferdinand. If she is sought out or asked to come forward, she greets the PCs courteously and runs to hug Ferdinand, falling in love at first sight. Ferdinand will quickly follow.

A beautiful young woman in a carefully but obviously patched-together dress rushes forward to hug Ferdinand. "You are a thing divine, for nothing natural I ever saw so noble!" Ferdinand turns to you and gushes, "O most majestic vision! Let me live here ever!"

Miranda explains that she has seen only two men since she can remember, and she cannot remember any women other than the vague image of her mother, Lady Bellissima. Ferdinand will not be swayed from pursuing his newfound love. In the unlikely event that Caliban is with the PCs, he and Miranda are visibly uncomfortable around each other.

More likely, Ferdinand will have been separated from the PCs, and thus Miranda's laugh will be coming from a chess table, where she and Ferdinand play the game of kings.

Sitting at a chess table are Prince Ferdinand and a lovely young woman in a regal but patchwork dress. The two are obviously lovestruck, a clear indication being that though all the chess pieces have moved far from their original positions, none have been captured. Ferdinand hails you. "This most majestic vision is the fair Miranda, daughter of noble Prospero. O let me live here ever! So rare a wond'ered father makes this place Paradise!"

Miranda will move toward female PCs, attempting to touch their hair. If the PCs tell of their trials, Ferdinand

will politely nod and listen, though he will clearly be distracted by his new ardor. He will not detect as magically charmed, as he is not.

Act V, Scene i: Facing Prospero

If Miranda or a servant is asked to find Prospero or Antonio, they will lead PCs to a thaumaturgical sphere in a far "corner."

In the center of an opaque sphere covered with barely visible magical sigils, a gray-bearded man in opulent robes stands in the air. His demeanor is regal and proud, though his expression is hardly benevolent. The man clutches a huge purple gem in his hand, and he concentrates upon it intently. In his other hand is a knotted staff with a gem at the head. Also in the opaque sphere is an upright mirror and a burning incense bowl. The air seems to shift around the man.

Prospero holds the gem vessel for his *trap the soul* spell. If Prospero has captured Antonio, he will be inside the vessel. The prison holds Antonio until it is broken, whereupon Antonio will reappear. Since he is on a different plane than his home origin, he owes Prospero a service when freed.

The sphere also contains a *mirror of mental prowess* and a *censer of controlling air elementals* attuned to Ariel. If Ariel is present, he will invisibly position himself between the PCs and the sphere. If Caliban is here, he will immediately urge the PCs to do the murder quickly, lest Prospero turn them to apes or barnacles.

If he is attacked, Prospero will defend himself with something terrifying but nonlethal, such as *Evard's black tentacles* or *power word blind*. If necessary, he will up the ante, but he should not have to. Before he is approached by the PCs, he will have already cast his protective magics: *stoneskin* (10 attacks), *globe of invulnerability*, *protection from evil 10'* radius, *protection from normal missiles*, *nondetection* and *avoidance*, the last on his *robe of eyes*. The *avoidance* spell repulses anyone who comes within 1', though if the person is much larger than Prospero, this will knock the conjurer out of his thaumaturgical sphere. The sphere is enchanted with a *mass charm* effect, so anyone touching it must make a saving throw or be

charmed. Finally, Ariel may interpose himself between the PCs and Prospero, making a formidable barrier.

If the PCs do not attack but still have Antonio, he will step forward and command the PCs, "Draw together!" (He means the PCs' swords, though they may misinterpret his meaning.) Prospero will laugh at his brother and toss the purple gem at his feet. Antonio flinches at first, but then dives for the gem because it is loaded with a *sympathy* spell keyed to him. If not stopped, Antonio will touch the gem and disappear instantly as the gem quivers a bit. The *trap the soul* effect draws him inside the gem, and he cannot be freed unless the gem is shattered. An *unseen servant* will draw the gem toward Prospero unless intercepted. Neither the *sympathy* nor the *trap the soul* can affect anyone but Antonio.

Once Prospero has trapped Antonio (either as above or before the PCs arrive), he will be in a more talkative mood.

"Behold, good fellows, the wronged Prospero! To you and your company I bid a hearty welcome! And welcome highest of all to my brother Antonio!" He brandishes the gem triumphantly, and you see it glows with a frantic light.

This scene horrifies Miranda, perplexes Ferdinand, and prompts Caliban to point out the mage's evil. Though Prospero does not appear mad, his words suggest that he might imprison Antonio forever. His staff, thaumaturgical sphere, robe, rod, and accoutrements suggest he might not be stoppable.

What happens next depends primarily on the PCs. Prospero will have his vengeance and will tell his story to the PCs. But he also wants his duchy and a way off this island for him and his daughter. This is the only tack on which to appeal to Prospero, though if the PCs do not, Miranda surely will. The PCs will either have to fight Prospero, agree to stay, or they must suggest one of two things: the correct way off the island, or that Antonio knows the correct way off the island. Prospero will not believe there is a way to leave, noting that he has tried every form of magic—teleportation, planar travel, you name it.

However, Prospero has made a crucial error for more than a decade. He

believes that no one can leave the island, but only *spellcasters* cannot leave. A partial solution (which does not help Prospero or Miranda) would be for the PCs to use one of Prospero's books to *teleport* any nonspellcasters off the island without their magical items, or for them to leave under natural means; either way, spellcasters likely would never leave. The complete solution may be far more difficult for the PCs to swallow: All magic—from items to memorized spells to the spheres themselves—on the isle must be eliminated, and then everyone can leave.

If the PCs suggest this solution or suggest questioning Antonio, Prospero casts a *shatter* spell on the gem. Antonio reforms before Prospero, shaken and befuddled. Before Antonio regains his wits, Prospero clutches his brother by the lapels and demands to know about the island's enchantment. Regardless of his wishes, Antonio must snivel the answer truthfully, as the *trap the soul* spell exacts a service from the freed being if it is not on its home plane.

Act V, Scene ii: Release

When Antonio confirms this pyrrhic solution, Prospero will release his hold on all the magic at his command.

Prospero breathes a palpable sigh of relief. "Come hither, spirit," he calls to Ariel, "Set Caliban and his companions free. Untie the spell." Ariel waves a gossamer hand as servants shimmer and wink out. The objects they carried drop, including a multi-colored tome at Prospero's feet. Prospero reaches toward a smoking censer and douses it with a wave. "And my Ariel, your service bravely done, thou shalt be free." Ariel smiles and becomes the wind itself, and for a moment you think you see the air shed a tear.

And then Prospero turns to you. "Pray you, draw near! There must be a catharsis of magic. These are but possessions, and to be free of them is the sweetest of liberations. So quickly, remove your scrolls, your potions, your enchanted blades, and I will bring it all to its needful end!" And before you, the powerful sorcerer removes his magical robe.

Prospero draws everyone together in a circle around him. He wants all PCs

and NPCs to remove all of their magic, and heap it on the pile; remember the *mass charm* from the thaumaturgical circle, though peer pressure should be even more powerful. Prospero removes all of his magic as well, the supreme conjurer being reduced to simple robes.

If you don't want to use the magic-draining ending, you may rule that the PCs' magical items are immune because they have not been on the isle long enough for the binding to catch them. Or you may make exceptions for items that have not been used. The decision is yours.

When the preparations are done, Prospero hands the colorful tome to a wizard (preferably a PC, otherwise Antonio) and bids him to read. The book's title is *Gunther's Kaleidoscopic Prism*, and a powerful *Gunther's kaleidoscopic strike** will be triggered by reading the first page aloud. The prismatic spell fires bursts of kaleidoscopic light at every spellcaster in the sphere (spell-using PCs, Prospero, Miranda, Antonio, and Ariel), blasting all of the spells out of their minds. Spellcasters must make a system shock roll to avoid being stunned for 1d3 rounds.

When all have recovered, Prospero bids everyone to hold hands and asks Miranda to clutch him around the chest.

The mage seems somber and reflective, as if he is about to make the most eventful decision of his life. He begins to chant, "This rough magic I here abjure. I'll break my staff, bury it certain fathoms in the earth, and deeper than did ever plummet sound, I'll drown my books."

Then he does the unthinkable: He raises his staff to the heavens and strikes it against a rod at the top of the pile. In a flash of electric blindness and roaring sound, the world goes white. The power of the explosion shatters the extradimensional spheres, catapulting you out through the lagoon and into the air. As you prepare to plummet back to the surface of the water, a wind catches you.

Prospero releases a *retributive strike* by hammering his *staff of the magi* against his *rod of security*. The staff's 25 charges pump into the rod, destroying the pocket dimensions. The world collapses in on the PCs as the reef tube explodes, destroying the silver penny whistle and the *iron bands*. The entire

gathering (including Caliban if he was still chained) is blown up through the surface of the lagoon, until the joyous, breeze-form Ariel catches everyone and settles them to earth. When the *strike* has done its work, the island is cleansed of all magic, including all that the PCs owned and held dear.

Epilogue

From this point, everyone can leave the island, which Prospero cedes to an elated but confused Caliban. Ariel fetches the ship and its crewmen, who will leave their slumber. All will be as it should: Prospero has his voyage home, Miranda and Ferdinand have each other, Antonio is exposed as a pretender, Caliban has his isle, Ariel has his freedom, and the PCs have the benevolent gratitude of the rightful duke, Prospero.

As you board the ship, Prospero invokes his last charge from his servant. "I'll deliver all, and promise you calm seas, auspicious gales and expeditious sailing. My Ariel, that is your charge, then to the elements be free and fare you well. Let your indulgence set me free."

The PCs receive full experience points for defeating Ariel, Prospero, and Antonio if they sail home with Prospero. Otherwise, the DM can decide a partial reward. However, if their greed for magic imprisons them on the isle, they should receive no experience points. If Prospero is escorted back to a hero's welcome, he will reward the PCs with an approximation of their magical losses. The DM should give the PCs items that are similar, but not identical, to what they lost. For example, if a fighter lost a *long sword +1, flame tongue*, he could receive a *long sword +1, luck blade* instead. Vary this in any way you like, including not restoring any magic at all. At the end of "Spirits of the Tempest," your campaign should contain exactly as much magic as you want it to have. Ω

EXERCISE

Does Your Heart Good.

 American Heart Association

Side Treks

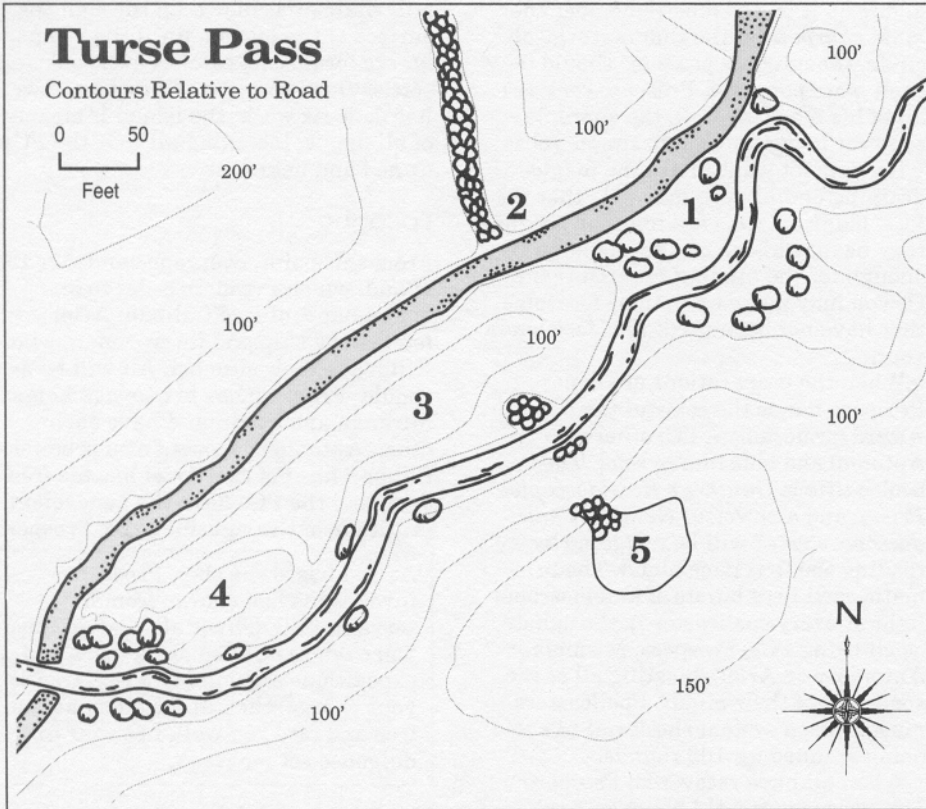

A good grell gone bad

By Willie Walsh

“Pakkililirr” is an AD&D® Side Trek adventure for four or more good-aligned PCs of levels 1-3 (about 7 total levels). Though intended as a wilderness encounter, it can be adapted to the sewers of a large town.

Adventure Background

Five grell workers were dropped from their ship in the region of the Turse Pass. Their secret mission was to find and examine a mine, abandoned centuries before. Information suggested it could be useful for making *lightning lances* (see the *MM*, page 173), and that a human settlement nearby could be enslaved as miners. But first it had to be located.

None of their generation had ever visited the mine, but their philosopher gave the workers a telepathic “map” of landmarks to follow. Stealth was essential, and they had orders not to allow their presence become known. So they found themselves levitating along the Turse Pass road, looking for a certain fork that would carry them nearer to their goal. But as soon as they came to the Pass, they ran into problems.

Pakkililirr, the youngest and most aggressive of the explorers, was bringing up the rear in the foggy night when his telepathic signal suddenly ceased. When the others backtracked, they found him by a stream bed, his tentacles clutching the

lifeless body of a man. It seemed he had missed their turning in the fog and encountered the human netting fish in the water. Pakkililirr had quickly killed him. Why his telepathic signal had temporarily failed, no one could say, but the whole incident was unsettling. Perhaps Pakkililirr was sick. If so, the grell couldn't care for an invalid. Also, though he'd stuck to the letter of their orders concerning discovery, his blunder might mean other humans would come looking for their comrade. After some consideration, the leader decided Pakkililirr was compromised. He told him to return to the rendezvous point and await their return. He couldn't be trusted on the mission any longer.

For the Dungeon Master

Pakkililirr waited until the others had passed out of range then furiously tore the body of the human to pieces. It made him feel a bit better, but he was alone, without his hive-brothers, in a hostile country. He didn't feel inclined to return to the rendezvous point; it was too far away to reach before sunrise. So he cast about in the Pass until he found a cave high up on the cliff face, and he retreated into the welcome dark, avoiding the dreaded sunlight and considering his fate.

It would be days before the explorers would return. He could rejoin them then and they could return to the hive together.

But as he sat there with just his own thoughts for company it occurred to him that if he went back he'd be punished for endangering the mission. And he was now disobeying orders by not going immediately to the rendezvous. So the punishment would be a harsh one. They would make an example of him in front of the whole hive. He would be killed for his failure.

Understandably, Pakkililirr decided not to return to the hive. He would live in this cave and hunt the creatures in the valley.

Cut off from his fellow grell, Pakkililirr has become a rogue—a grell that abandons its hive-brothers and fends for itself.

PAKKILILIRR

Players' Introduction

The party becomes involved after Pakkililirr hunts local people and their livestock as he strives to make a life for himself in the Turse Pass.

The DM may introduce the PCs to the region by reading the following boxed description.

The Pass above Turse Valley has long been a main route for travelers. Now you hear that some monster has moved into the area and travelers are unwilling to go through the pass without an armed escort. Details are sketchy, but if a monster exists it must have a lair somewhere, which probably contains treasure stolen from its victims. The village below the Pass seems like a good place to ask about the monster and its habits.

Turse is home to farmers whose goats and cows graze the hillsides. The local inn, the "Weary Waggoner," adds to the economy by giving travelers a place to pause and purchase supplies. They usually stay the night, setting out the next day bright and early for the pass.

At the moment the inn is full with a backlog of travelers who are impatiently waiting for someone to remove the threat of the monster that has already slain four people on the road. The farmers who visit the inn's common room are unhappy because a young farmer, out fishing late at night using torches, was torn to tiny pieces, and they are exchanging stories about the five goats and one cow that have also been slain. Rumor has it a troll has moved into the area; others say it is some kind of monstrous bird because no footprints were found after the attacks.

The cash bonanza of long-term visitors will not last, and the village will be abandoned if another path is found across the mountains. The villagers know this, so they are offering a reward of 200 gp to adventurers for destroying whatever menaces Turse Pass.

Details of specific attacks and victims may be enlarged by the DM. In all cases but that of the farmer (the human Pakkililirr first encountered) only blood and a severed limb or body part re-

mained, and no clues to the identity of the monster itself.

The Pass

The climb from either side of the Pass ends on a relatively flat area, the crest being the roadway over the hills. The gravel road runs through a deep gully. It's a good place for an ambush, as the PCs realize as soon as they see it.

Pakkililirr lairs in the cave in the southern hillside, overlooking the Pass. At night, the grell uses the cover of darkness to hunt livestock unhindered. By day, it must be overcast or very foggy for him to attack travelers; like most grell, he hates sunlight. In dense fog, he gains +2 modifier to surprise. Days in the pass have a 45% chance to begin foggy, though the fog burns off near noon. Whether fog reappears at dusk is up to the DM.

1. Gravel Road. The gravel road was once the bed of the stream that now flows in the southern gully into Turse Valley. Large boulders lie here and there, the product of water action, as are the gullies that the stream and road pass through.

2. Side Spur. A rubble-strewn side spur, an extended crack between the hills, runs off north here. Footing is decidedly dangerous. Anyone walking here needs to roll a Dexterity check to avoid falling for 1d4 hp damage. A horse, mule, or donkey cannot traverse this path; a goat can. The grell took this route when they parted from Pakkililirr.

3. Central Rock Core. An "island" of stone divides the road from the stream. It is rich in lead ore and telepathic effects cannot penetrate it. The island is also impervious to most magical radiations, and the dense ore caused the grells' communication problems (Pakkililirr isn't sick).

4. Monstrous Rubbish Repository. A hollow in the rock, open to the sky, has been partially closed off by rocks rolled across the entrance. PCs climbing or flying over it find bloodstained gear

of undiscovered victims. Pakkililirr isn't bothered about leaving animal bones but has finally realized that human remains might alert passers-by. He doesn't fear humans, but he doesn't want to alert his victims before an ambush.

The dumping ground is littered with torn clothes, a tangle of ropes, a ripped backpack, a boot (with a foot still inside), a potion of *healing*, and three purses containing 20 cp, 15 sp, and 35 gp; 11 cp, 30 sp, and 10 gp; 10 cp, 10 sp, and 50 gp. Other mundane salvageable gear may be available at the DM's option.

5. Pakkililirr's Lair. The grell's cave is about 100' above the level of the road. Sounds from below alert anyone waiting inside. Pakkililirr has filled the entrance with rocks and stones as a first line of defense against intruders who arrive while he's "at home." With a good shove, the stones can start a rockfall onto anyone climbing toward the cave. If Pakkililirr sets off the fall, damage to adventurers in its path depends on where they are.

Party members on the slope caught in it are attacked by 0-3 (1d4-1) missiles each round for 1-2 rounds. Each rock has a THAC0 of 13, does 1d4 hp damage, or half (minimum of one point) if the victim rolls a successful Dexterity check.

On any damage roll of 3 or more, the victim must make a Climbing check (a Dexterity check, if nonweapon proficiencies are not used) or be swept down the hillside. Unattached PCs suffer 10d6 damage falling to the pass below.

When striking PCs at the foot of the slope, the rocks have a THAC0 of 11 and hit for 1d6 hp damage (a successful Dexterity check halves damage, round up).

A moment after the rockfall is released, Pakkililirr levitates to the ceiling to ambush anyone who enters (+3 on surprise). He can direct tentacles against several opponents within reach. Any hit on a tentacle puts it out of action, regardless of damage.

Continued on page 39



WELCOME TO THE KRYPTHOME

by Samuel Heath

Honk if you like wild magic

Artwork by Paul Jaquays

Sam is a computer science student at the University of British Columbia. He has been using Elistar as an NPC for the last nine years, and wrote the Krypthome to share his elf with the masses. He dedicates this one to Natasha.

“Welcome to the Krypthome” is an AD&D® game adventure for 3-5 player characters of levels 1-3 (about 8 total levels). A party of any composition should be able to complete the adventure.

This adventure is intended to provide a little comic relief for bored players. There is no shortage of fighting, but noncombative encounters are far more common. To run the adventure effectively, an aura of magic gone slightly awry and the threat of undead should permeate the entire adventure.

The adventure takes place in the Kryptgarden forest, in the FORGOTTEN REALMS® campaign setting. It can be easily changed to fit in any cold temperate or subarctic forest on any world. The Kryptgarden forest is located to the west of the Long Road, halfway between Waterdeep in the south and Triboar in the north. There is a small village due east from the Krypthome named Westbridge, where the PCs should be heading when the adventure begins.

It is very important that the DM read the entire adventure before running it, in order to understand when and where important events take place.

Adventure Background

In late Uktar (October), in the Kryptgarden forest, four dwarves awoke to begin work in their mine, as they had every day for two years. There was snow on the ground, piled up as high as their waists in some places, but the pathway they took from their cabins to the mine entrance was clear. Tjegg left for the mine half an hour before the others, in order to work in solitude with the stone. The other three dwarves respected his peace, and would begin work later.

When the other dwarves neared the entrance to the mine, however, they heard Tjegg shout for help. The foreman, Hather, went in alone, ordering Bithendil and Jaemor to remain outside. After the initial shout, Tjegg's voice could no longer be heard. Hather found that an entire mine shaft—not just the ceiling—quite deep in the mine

had collapsed, leaving a gaping pit at least 50' deep and 100' across where the shaft had been. There was no sign of Tjegg.

Hather summoned the other two dwarves, and they searched the passages for signs of their lost friend. Finally, a little ways down the steeply sloping side of the pit, they found a single torn and bloody boot. More than a little worried, they looked around for other signs of their friend, but found nothing. When they heard a weirdly distorted snarl—a lynx, but they didn't know that—coming from somewhere deeper in the mountain, they decided to leave.

Tjegg was the only one of the four who had any real combat experience, and they decided that whatever had taken Tjegg would be too powerful for them to defeat, so they sealed the mine and set off to get help. They hiked out of the forest and headed directly west to the Long Road, intending to find adventurers for hire in Triboar, a town of about 3,000 that lay two days' walk to the north.

For the Dungeon Master

Elistar Els'edranor is a moon elven mage of considerable power (12th level). He left the city of his birth, Evereska, at the young age of 85 to pursue an unorthodox field of study: wild magic. The elven High Council did not approve of such an unpredictable and uncontrollable offshoot of the Art, preferring the more familiar eight schools of magic. The events transpiring during the Time of Troubles, when the gods were cast down on the earth, and all magic went wild, had given the elven council an unfairly biased (or so thought Elistar) view of what wild magic could accomplish.

Elistar found a tutor, a kindly but slightly eccentric old human gentleman. He learned what he could from the old man, studying under him for a half dozen years, before the old man was sucked into a magical vortex created by a wild surge from one of his spells, never to return again. Unperturbed, Elistar left his mentor's house to seek his fortune as an adventurer.

After traveling for a score of years fighting dragons, pillaging witch-kings' tombs, and saving towns both small and large, Elistar decided to settle down (somewhat in the manner that Elminster has settled down). He constructed

the Krypthome: a large manor house built into the side of a hill deep in the Kryptgarden forest.

The Kryptgarden got its name from the Southkrypt dungeon that lies deep within it. The undead within Southkrypt tend to keep to themselves for the most part, however, and the forest's reputation keeps out unwanted visitors—such as nosy youngsters that want to be apprentices to elven mages.

The initial construction took three years, with Elistar, four dwarves, and two dozen human laborers working six to eight months of the year. Once the complex was finished, Elistar returned to his research, the humans fled to civilization, and the dwarves, having discovered a few rich deposits of sapphires and a vein of gold ore, took up residence.

Elistar's studies and experiments with wild magic led to some unusual runoff from his laboratory. The small underground stream that he uses to provide water circulates back into the earth and the mountain. It retains some of the unusual energy present in Elistar's lab, and over time, some unusual magical effects have manifested in the lower levels of the natural caves in the hillside. Hather, the dwarven foreman, is not aware of the natural caves beneath the mine, or the magical residue seeping into the hill.

Hather professes little love for magic, but states, "For what we're mining here, I'd live in a mages' guild." Hather and the other three dwarves have become used to the occasional wild surge from Elistar's spells and research. The dwarves have even learned to live with a few random magical effects that have become permanent: the antigravity waterfall, blue rocks, and honkmoss, for example. When Elistar vanishes (whether literally, or simply leaving during the night), the dwarves don't bat an eye. "The crazy old mage'll turn up sooner or later," they say.

This time, during one of Elistar's prolonged absences, the dwarves have gotten themselves into a bit of a fix.

Let's meet the monsters

Gim and Rumble are goblins. They are smart goblins. They know that because they tell each other they are smart all the time. Gim and Rumble are brothers. They were born 15 winters ago. All their other brothers are dead, because

Gim and Rumble killed them.

Gim and Rumble lived in a cave with 17 . . . no, 70 . . . no, 6,000 . . . well, a lot of other goblins. One day, Gim and Rumble went out of the cave to find food. When Gim and Rumble came back, the cave was gone. All that was left was a pile of big, dirty rocks. Gim and Rumble couldn't find the rest of their tribe anywhere.

Gim and Rumble were alone. Rumble wanted to find a cave to live in, but Gim didn't think that was a good idea. Rumble hit Gim on the head with his bone club, and when Gim woke up, he decided that finding a cave would be a good idea. So Rumble and Gim found another cave that was about a mile . . . no, 40 miles . . . no, 300 yards . . . well, it was quite a long way from their old cave. (This was the entrance to the dwarves' mine, but the goblins didn't know that.) Rumble and Gim went inside (while the dwarves were asleep).

After eating a rat and sleeping for a while, Rumble and Gim explored their new home. It was bigger than their old one. There was more than one room. They explored most of the mine shafts, and then discovered the pit (area 21). Climbing up onto a ledge (area 12), they found two really flat walls. Rumble and Gim had never seen or felt such flat walls, so they decided to feel all over the walls. That's how Rumble found a secret compartment in the wall that held a bag (*bag of tricks, type A*), some bottles (2 potions of *speed*), a shiny ring (a *ring of invisibility*), and a GREAT BIG SWORD (*short sword +1*)! Rumble tried to keep everything for himself, but his brother stole the sword and the bottles from him.

Goblins and dwarves don't mix

When Tjegg got to the mine on the morning of Uktar (October) the 23rd, he noticed that something was awry. There was a thick layer of dust on everything, and a small trickle of mud ran out of the mine shaft down the mountain. Tjegg went further into the mine to investigate.

Rumble and Gim were inspecting their new finds, and arguing over who should keep what, when Rumble put on the *ring of invisibility* and vanished. Gim, very alarmed at his brother's disappearance, yelped and ran to where his brother had been. Rumble was still there, of course, and was more than a

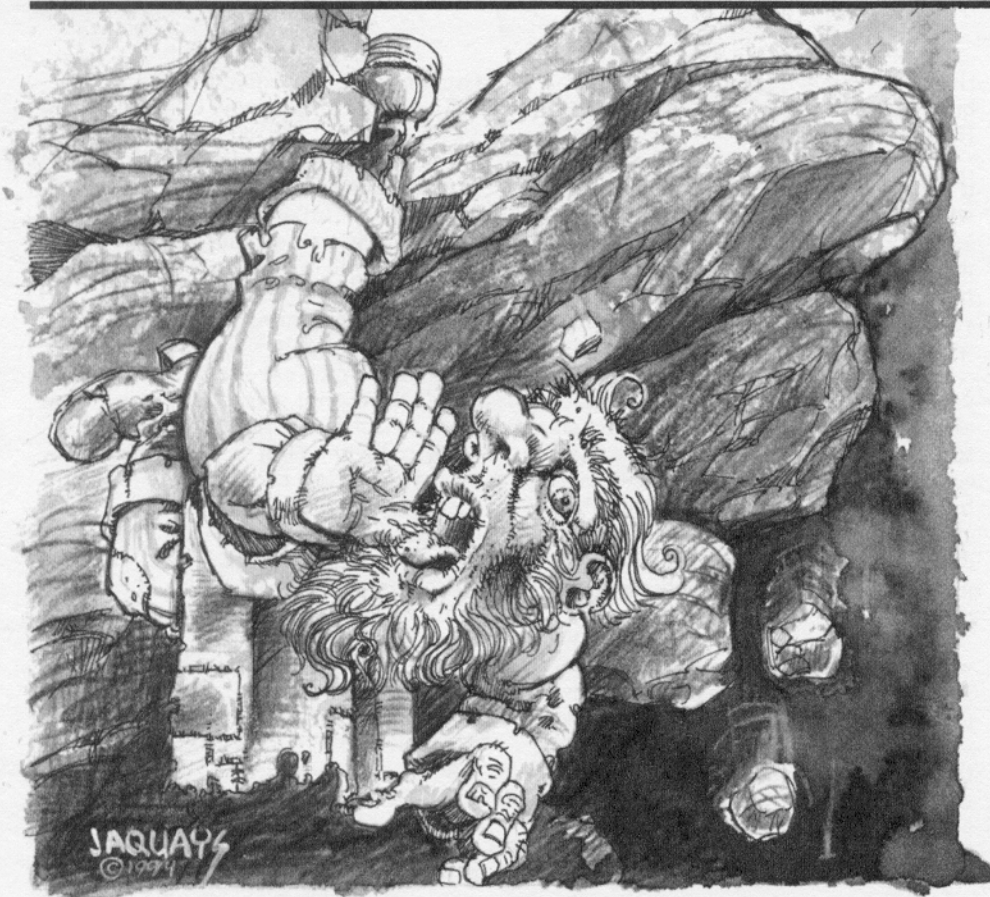

little surprised to see Gim charging toward him. When Gim ran into him, he lost his balance, and they both tumbled down the side of the pit that they had been standing at the edge of (in area 12). Gim could now see Rumpel, of course (he had just knocked his brother over the side of a small cliff, and the *invisibility* was canceled). They arrived at the bottom, quite unhurt, and started yelling at each other.

While this was taking place, Tjegg was slowly making his way toward the site of the cave-in. He arrived at the point where the mine shaft dropped off into an inky black hole (area 19), and heard goblin voices down below. Tjegg's face went bright red, and his temper flared. He assumed that the goblins were responsible for the cave-in of the tunnel (the whole area had actually fallen into a huge sinkhole in the natural caverns below). Tjegg shouted for help, then remembered that the goblins would probably hear him before the other dwarves would, and shut up (fortunately, Rumpel and Gim were making so much noise yelling at each other that they didn't hear him). Tjegg tried to stand up, intending to run back to the

supply room and get a weapon to deal with the goblins, but lost his balance because he was so agitated. He stumbled, and fell over the edge of the pit, preventing a long and painful tumble only by jamming his foot between two rocks, one of which painfully pierced his shin.

Tjegg now found himself hanging by one foot on the edge of a large black hole, and whatever was keeping him up was slowly cutting into his leg, through his boot. He yelled for help, but realized that the goblins would hear him, so he shut up. After pondering his situation for a bit, the dwarf prudently decided to cut himself free to avoid bleeding to death upside-down in a mine shaft. He freed his foot and fell, headfirst.

Tjegg rolled to a painful stop at the bottom of the hole at about the same time that the goblins stopped arguing and looked in the bag to see if there was anything to eat. Rumpel pulled a small furry thing out of his bag. Disgusted, he threw it away (in Tjegg's direction). When the furry thing hit the ground, it turned into a giant lynx. Gim stopped yelling at Rumpel for getting such a stupid bag long enough to notice the

lynx (and the dwarf, 10' past the lynx). Gim squealed in terror and tried to hide behind Rumpel. Rumpel, almost as scared as Gim, pointed at the lynx (and the dwarf, who was right behind the lynx) and yelled "Get it!" Rumpel was talking to Gim, but the lynx decided that Rumpel was talking to her, and decided to "get" Tjegg.

Tjegg stayed as still as a statue as the lynx walked toward him, and when the great cat picked him up gently, rather than tearing him from limb to limb, the dwarf was quite pleasantly surprised. So surprised, in fact, that he fainted. The two goblins cowered in fear as the lynx padded over to them, and dropped the unconscious dwarf at their feet. After a while (when the lynx didn't eat them), they decided that the lynx was their friend. They are smart goblins, after all.

With the help of the lynx, they dragged the dwarf off into a side passage, and relieved him of all his wealth (a ball of twine, a small rock hammer, three copper pieces, and a used handkerchief) and the food he was carrying in his backpack. They tied Tjegg up with the twine and sat down to eat lunch. The lynx disappeared, but the goblins weren't concerned. They figured they could get another one from the bag.

When Tjegg awoke, he strained at his bonds, trying to attack his jailers. He was unsuccessful, however, and mellowed considerably when Rumpel pulled a wolf out of the bag he was holding and ordered it to watch him. Eyeing the wolf warily, Tjegg yelled, "You little putrid sons of carrion crawlers can't keep me here forever! My friends will come looking for me, and then you'll be in trouble!" At that point, the wolf snarled, and Tjegg decided to be quiet. Rumpel (ever the smart one) had devised a plan: ransom Tjegg to his friends!

Rumpel ordered Tjegg to write a ransom note on a scrap of leather. The note, since Tjegg is only moderately more literate than his goblin captors, came out, "*We capture your friend dwarf. You want him back, you give us ~~XO~~ 2,000 gold pieces. Don't try to fight us. We strong.*" The goblins left the note (accompanied by another giant lynx) near the entrance to the mine where the dwarves would find it. (The dwarves did not find it.)

In the ten days since kidnapping Tjegg, they have been feeding him a little water and tiny portions of food

(rats and fish from the small stream), keeping him tied up at all times. They haven't let him move, except to relieve himself. The threat of "da big cat in da bag" has kept Tjegg from attempting to escape. Rumble and Gim have had plenty of time to explore the mines as well as the natural caves they now live in.

Beginning the Adventure

The tale begins when the PCs come across the band of three dwarves trudging through the snow on the Long Road, heading south into Westbridge. The adventurers and dwarves are at area A on the Kryptgarden Forest map. Read the following to the players:

As you slip and slide along the Long Road, you hope fervently that you'll be able to make it to the next village by nightfall and not have to spend another night in a tent in this accursed cold. It is just after highsun, and the air is barely above freezing. The wind begins to blow a little harder, and the deep, biting cold chills you to the bone.

Ahead on the road, you see three other travelers. They have stopped, and have a small fire going. As you approach, one of them stands; it is a dwarf.

"Well met!" he cries in a gruff voice. "Me name's Hather, 'n' this is Bithendil 'n' Jaemor." The other two dwarves grunt at the mention of their names, and rise to their feet. "Yer adventurers, right?" He doesn't wait for an answer before continuing. "Can ye give a hand to a few dwarves who might be needin' ye?"

If the PCs protest that they're not actually adventurers, but just travelers looking for a place to stay, or tell the dwarves that they can't spare any time to help, Hather is incredulous. "A mighty group such as yerselves can surely give us a hand! If ye're worried about a reward, rest assured that we can pay." He won't promise any specific rewards, other than a warm bed and hot food for as long as the party needs it, but alludes to monetary compensation. "And ye don't even know what I'm askin' of ye!" is his final attempt to coerce the party into hearing him out.

Once the group has been persuaded to listen, Hather relates his tale:

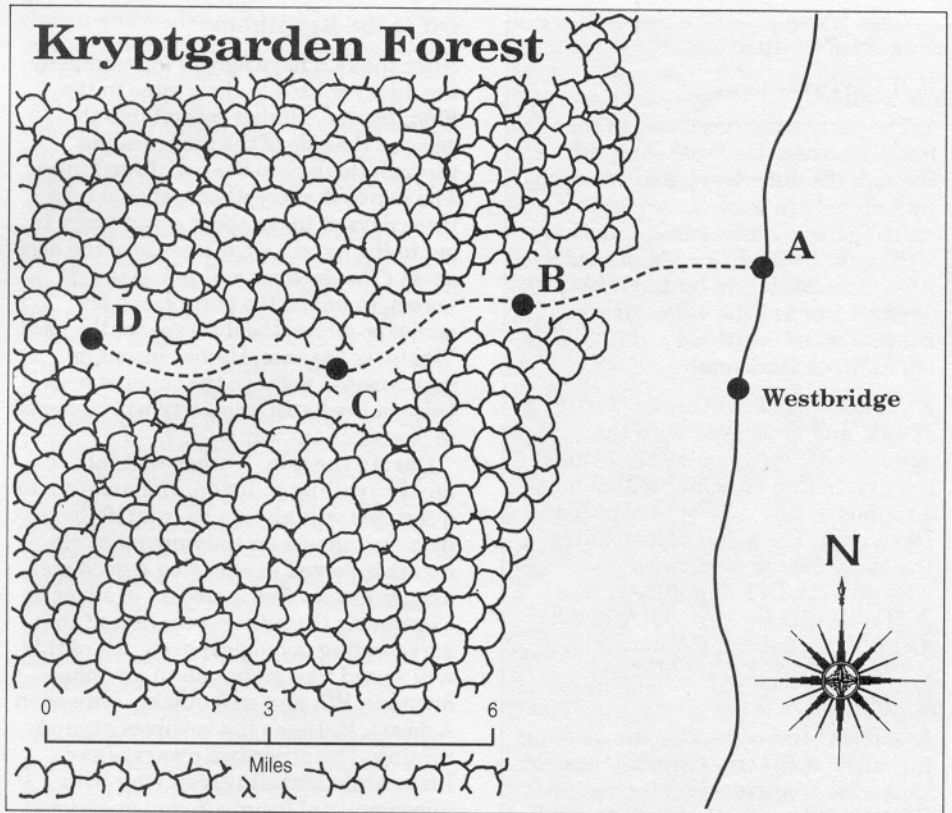

"Ye're as kind as ye look," the dwarf pronounces grandly. "Now listen to my tale . . .

"We three are miners. Our mine is off in the Kryptgarden forest, near our cabins and a larger house. The mansion belongs to a mage—an elf, mind you—but he's as good as their type come. He's gone away for a while, or we'd get him to help.

"About a tenday ago, we had trouble. Tjegg—poor Tjegg—disappeared. We looked around for 'im, but all we found was this boot." Hather shows you a torn, bloodstained boot that clearly illustrates what fate must have befallen Tjegg. "Ye must understand, the mine's safe—free o' monsters, that is—but there was a great collapse, and something wicked must have gotten into the mine from one of the lower caverns that the cave-in opened up.

"Tjegg was the best fighter we had. Whatever took him . . . Well, ye get the idea. We sealed the mine off and left to look for help. We were headin' into Westbridge when we saw ye, and well . . .

"What do ye say?"

If the PCs ask about a reward, Hather initially offers 75 gp to each party member, in addition to a warm bed and hot meals for as long as they need it. If the party tries to haggle, he will offer 100 gp per person, and can be bargained up to 150 gp, but will consult with Bithendil and Jaemor before offering any more than 100 gp to each member of the party. If the group demands no reward, Hather promises, "Suren I'll make it worth ye're while, ye can count on that."

If any members of the party are curious about the name of the forest or the name of the Krypthome itself, Hather shrugs it off as superstition, and explains that the reputation keeps out riffraff.

If the PCs attack the dwarves, they defend themselves as best they can.

Hather: AL NG; AC 5; MV 12; F2; hp 12; THAC0 19; #AT 1; Dmg by weapon type; S 17 (+1, +1), D 12, C 15, I 12, W 13, Ch 14; ML 13; chain mail, warhammer.

Bithendil & Jaemor: AL NG; AC 8; MV 12; F1; hp 8, 6; THAC0 20; #AT 1; Dmg by weapon type; statistics unremarkable; ML 12; leather armor, pickaxe.

Forest Encounters

Roll 1d8 twice a day.

1. The party surprises a stag in the forest. The massive beast charges through the underbrush and across the trail directly in front of the party, sporting huge, multibranch antlers.

Stag, wild (1): INT animal; AL N; AC 7; MV 24; HD 3; hp 19; THAC0 17; #AT 1 or 2; Dmg 1-3/1-3 (two hooves) or 2-8 (butt); SZ L; ML 5; XP 65; MM/241 (Mammal).

2. A random party member startles a skunk, and is sprayed with the skunk's odor (anyone within 5' must save vs. poison or be nauseated for 1-4 rounds, losing 50% of Strength and Dexterity). The smell accompanies the party for the next two days.

Skunk (1): INT animal; AL N; AC 8; MV 12; HD 1/2; hp 3; THAC0 20; #AT 1; Dmg 1 (bite); SA musk; SZ T (1' long); ML 6; XP 35; MM/241 (Mammal).

3. A flock of woodpeckers are pecking furiously at the trees around here. The noise is at times deafening, and it sounds like a herd of buffalo charging. The brightly colored birds can be seen everywhere in the trees.

Woodpeckers (21): INT animal; AL N; AC 7; MV 1, fly 36 (B); HD 1-2 hp; THAC0 20; #AT 1; Dmg 1 (peck); SZ T (6" long); ML 6; XP 15; MM/241 (Mammal, Raven).

4. On one of the trees at the side of the trail, long claw marks can be seen where the bark has been ripped off. They are the marks of a black bear, who was sharpening his claws on the tree trunk. The bear is long gone, and the dwarves do not want to go hunting.

5. The party passes a forest stream, frozen solid and glistening in the daylight.

6. Thick, heavy snowflakes begin to fall, obscuring vision, and continuing for 2d4 hours.

7. A fog bank rolls in and reduces vision to 10'. The mist remains in the forest for 1d6 hours.

8. A branch on a tree, frozen solid and laden with snow, snaps with a deafening crack and thunders to the ground.

Off to the Krypthome

After the PCs have agreed to accompany the dwarves back to their mine in the Kryptgarden, Hather sets off into the snow at the side of the road, wading through thigh-deep (for a 4' dwarf) snow. The trip to the Krypthome should take three days; it takes about seven hours to get to the forest's edge because of the deep snow. (The dwarves will refuse to ride horses, so unless the party has a few ponies or mules, the dwarves set the pace. Whatever the case, Hather insists on spending the night in the cabin at area B. Once in the forest, the party will be forced to dismount anyway.)

During the trip, Hather will talk to any PC willing to listen. His answers to questions will always be brief, followed by a monologue on the important elements involved in choosing a good pickaxe, or how to find a stream of silver by examining the mineral content of the surrounding geological area. All of this will sound like gibberish to any non-dwarven PC, and will quickly bore even a dwarf. Hather's life revolves around mining. The other two dwarves say little while traveling, replying with noncommittal grunts to any questions asked of them.

Each day spent traveling to the Krypthome, the DM should make one or two rolls on the Forest Encounters table, to add a little flavor.

The first cabin

Once the party reaches area B at the edge of the forest, read the following aloud:

It seems as if Hather hasn't stopped nattering since you left the Long Road. You've hiked for hours and hours through the snow listening to his incessant chatter. You're tired of listening, your feet are numb, your hands are frozen, and you've only now come to the edge of the forest. The sun is beginning to sink below the horizon. You enter the forest, hoping that it isn't much farther to the "Krypthome." At least the trees have prevented most of the snow from reaching the forest floor, and the going is much easier because of it.

Hather suddenly stops midstream in his diatribe on the glories of dwarven metallurgy and makes an unusually comprehensible remark.

"We're almost there," he announces.

"Just around the next bend . . . Ah! There it is! We'll be stoppin' there for the night!" Hather indicates a small cabin a hundred paces up a gently rising slope. It doesn't look much like the mansion Hather described earlier.

As you get closer, you can see that it is a small, rustic log cabin, with a large stone chimney on the south wall. A large silver holy symbol is mounted in the door, and when you enter, you notice garlic hanging above the door.

"Just two more days and we'll be at the Krypthome," Hather says cheerily as he stomps the snow off his boots and walks inside.

If asked about the holy symbol and garlic, Hather mumbles something about rumors that the forest is haunted, but that they've never had any trouble. If prodded further, he will explain that there is an ancient dungeon somewhere in the forest, and that's what gave rise to the rumors. He knows nothing else, and is speaking the truth.

If the party is upset about not reaching the Krypthome sooner, Hather laughs at them and assures them that they'll get there soon enough.

The log cabin (no map provided) is roughly 20' x 30' and has a huge fireplace at one end. Ample firewood is stacked between the bunkbeds that line the walls. There are 18 places to sleep in all, but no bedding for any of them. With a roaring fire going, the place quickly warms up, and Jaemor sets about making dinner. The dwarves insist on taking equal watches with the PCs.

Later that night, an hour or two after midnight, a scratching sound is heard at the door. If one of the dwarves was supposed to be on watch at the time, he has fallen asleep at the fire, and the sound wakes up the PCs—but not the dwarves. If an adventurer was on watch at the time, it's up to him whether or not to wake the others (the dwarves are heavy sleepers and require a full round of shaking to rouse). When it has been determined who is awake, read or paraphrase the following to the players:

The fire has burned low, casting long shadows throughout the room. The snores of the three dwarves drown out any sounds of the forest—except the wind, and an unnatural scratching

at the door. It sounds like someone—or something—is trying to claw its way inside the cabin . . .

The atmosphere of the situation should be played up as much as possible—try to really scare the players. When (or if) the party opens the door, they see two small wolflike figures with glowing eyes and bandit's masks staring at them—raccoons. At any sign of violence, the racoons run. No experience points should be awarded for killing the racoons, although the DM should consider a small award for role-playing this encounter.

Raccoons (2): INT animal; AL N; AC 9; MV 5; HD 1-6 hp; hp 3, 2; THAC0 20; #AT 1; Dmg 1 (bite); SZ T; ML 2; XP 7; MM/244 (Mammal, Small).

Pink Trees

Read or paraphrase the following to the players as the PCs approach the first wild magic zone (area C):

Hiking up through the forest has proven to be as hard as hiking through the snow, and you're exhausted by the time Hather announces that you're almost there. "Ye can tell because of the pink trees," he babbles. You suspect that Hather may be losing his mind.

Then you notice a scattered group of hot pink alders next to the trail 100' ahead. Not all of them are pink, and not all are the same shade, but about a dozen of the usually brown and green trees are unmistakably rose-colored. They look horribly out of place in this otherwise idyllic sylvan setting.

If the PCs ask why the trees are pink, all three dwarves reply in unison, "Magic." Hather will elaborate a little, if prodded, admitting that, "Uh, Elistar's spells don't always work exactly the way he wants 'em to," and an explanation that "the color's fading, and it'll be gone in a few winters, besides, it adds color to the forest, don't ye think?" Although Hather doesn't mention it at the time, the trees glow softly pink during the night (not enough light to read by, but enough so that PCs won't trip over roots if they walk around outside when it's dark).

The trees' unusual coloration is in fact a result of one of Elistar's misfired

spells. At first, an area over 100 yards across was brightly painted (and provided a glowing light as bright as the moon), but the coloring of most of the trees faded quickly. Hather is correct in predicting that the color (and glow) will be gone in a few years. Any wood cut from the trees will retain its pinkish hue for 4d6 months, slowly fading to brown over that time, but cut wood will not glow.

A second cabin (identical to the first one) is located about 200 yards farther down the trail than the pink trees. The night passes without incident; the natural wildlife is afraid of the unearthly glow of the flora.

Arriving at the Krypthome

As the PCs approach the Krypthome (area D), read or paraphrase the following to the players:

The third long day of hiking with the three dwarves is now drawing to an end. The sun is sinking low near the horizon, and the sky is lit up spectacularly with shades of red, orange and blues. You round a bend in the trail, and follow it a short ways up a hill, where it opens onto a clearing, covered in 2' of snow.

There are three huge mounds of snow in the middle of the clearing, and the top of a roof can be seen jutting out of one of them.

"Those are the cabins. Ye'll be staying in the great hall itself," says Hather as he makes a sweeping gesture at a small hill that is thickly blanketed with snow. As you watch, the snow begins to move, melted by the sun, and avalanches down the side of the hill, revealing a wooden roof underneath. The peak of the roof is about 50' high, and as you walk around to the front of the building, you can see a pair of massive double doors in the front wall, protected from the snow by the roof's generous overhang. The doors are nearly four times the height of a human, but as you get closer, you can see that there is a smaller set of doors within each of the giant ones. So this is the Krypthome . . .

Hather provides the party with blankets and furs, and informs them that they will have to spend the night on the floor of the great hall because their cabins are built and furnished for

dwarves, and quite full of mining stuff. The only free bed in their cabins belongs to Tjegg, and they are reluctant to let someone take his bed. Bithendil and Jaemor set about preparing a meal for the party. The next morning, the party is expected to head out to the mine and start searching for whatever got Tjegg. Hather will repeat the story of what happened on the day Tjegg disappeared if the party wishes, and tell them how to open the gate to the mine. The dwarves will not accompany the party to the mine, explaining that they prefer to leave the dangerous work to professionals.

If the party insists, they may explore the Krypthome, although they must be careful not to touch anything that might be of value, and Hather will accompany them at all times. If the party splits up to look around, Bithendil and Jaemor keep a discreet eye on all of them. Under no circumstances will the dwarves allow the party access to Elistar's private quarters, or his laboratory and inner chambers (and even if they did, the party would have no way of getting in the rooms; all the doors are *wizard locked* and also protected by very good locks).

The Krypthome Complex

The main building of the Krypthome is built right into the side of the hill. The only three rooms that are exposed to the outside are the great hall, the library, and Elistar's quarters.

All of the doors in the main building are solid cedar, and the walls are carved from the solid rock of the hillside. Ceilings are 12' high, unless otherwise noted.

1. Wooden Cabins. There are three identical cabins, each of which contains two beds, a desk, two chairs, an oil lamp, and a few other amenities. In the eastern cabin, in a secret compartment under the desk, is a locked strongbox containing 140 gp and 74 uncut gemstones worth 5 gp each as they are. Note that unless a PC makes a successful Appraising proficiency check he will be unable to tell the uncut gems from common rocks.

2. Great Hall. This hall, measuring 60' × 80', is the centerpiece of the Krypthome. The walls are solid stone, and very little mortar has been used in

their construction. The walls rise 25' above the ground. The wooden roof, supported by massive beams, rises to a peak in the center of the hall, 60' above the floor. A huge fireplace is set in the north wall, and three large tables surrounded by a half-dozen chairs furnish the room. On the walls hang six tapestries depicting elven deities, as well as Mystra, the goddess of magic (worth 100 gp each). Numerous large windows have been set in the walls at varying heights, letting sunshine stream in at all times of the day. At night, the fireplace provides ample heat and lighting.

The PCs will eat their meals in this room at a table near the fireplace.

3. Hallway. The hallway, as with all other rooms set entirely underground, is carved from solid rock. Glowing globes (*continual light* spells) are set in the walls and ceiling at regular intervals, bathing the hallway in light.

4. Kitchen. The meals are prepared here, on tables in the center of the room, and on counters carved from the stone around the walls. On the west end of the north wall, a natural spring (a small branch of the same one that provides water to Elistar's laboratory) pours from the wall, runs in a small depression in the counter for about 4', and disappears into the floor. Pots, pans, cauldrons, spoons, knives, and other cooking utensils clutter the walls on racks and hang from hooks in the ceiling. Two *continual light* spells in the ceiling illuminate the place, and a wood-fired stove and oven in the west wall provide heat, as well as a place to cook meals. A metal pipe vents smoke from the stove into the ceiling, where it flows through a crack in the rock to the outside.

5. Pantry. Dry goods are stored here in barrels, crates, and cartons. Cheese from the Dales, flour, rice, barley, fish, and meat are all present in abundance. There are even spices from Calimshan, Maztica, and the fabled Orient (Shou Lung) such as curry, chili, cinnamon, and cayenne.

6. Wine Cellar. Casks and barrels of Elturian and Silverywine (from Silverymoon), Evereskan elven wine (not the Fae wine detailed in *The Complete Book of Elves*), dwarven ale from the north, ciders from the Dales, and all types of ales are present here. The wines and

ales are quite valuable; 10 gp per keg of ale, and 1-10 gp per bottle of wine. The dwarves will let the party drink as much as they want and fill their wineskins as well. If the party rescues Tjegg, Elistar may reward them with a few bottles of wine. The DM should modify the sources of the drinks to fit his campaign.

7. Miscellaneous Perishables.

Small quantities of trail mix (nuts, berries, and bits of tasty elven and dwarven pastries all combined together in a loose mix), dried meat (jerky), wineskins already filled with good wine and purified water are stored here, along with a rack of unlabeled opaque glass vials. The vials are various colors and sizes, but all six of them hold the same contents: a *potion of healing*. Later on, if the party needs healing, the dwarves will provide them freely with these potions.

8. Junk Storage. Crates, sacks, bags, pots, chests, urns, and other containers fill this room. All are overflowing with random bits of odd items: a small square of iridescent blue silk with a circular hole in the middle, 14 brown scimitar hilts, a half-dozen stoppers for potion vials, a bottle of cheap Waterdhavian ale, etc. A layer of dust covers everything but a few items near the door; they were placed there more recently.

9. Library. This is Elistar's non-magical research library, so it contains no magical tomes. The room is filled with bookcases at odd angles, strategically placed to allow the most sunlight from the windows into the room. Six desks are located at various locations around the wall, and all are well stocked with parchment, quills and ink.

Many of the books pertain to elven and dwarven architecture (a hobby of his), elven wine, elven dances, elven religion, the history of the North, and other general topics. Sample books include the diary of a dwarven merchant from Luskan who died two centuries before, the notebook of an aspiring bard from Silverymoon (the last entry was made in Kythorn (June), 1312 DR), and a discourse on the influence that elven wine has on the taste of Silverymoon sparkling water.

10. Elistar's Private Quarters. The door to this room has been *wizard*

locked at the 14th level of ability, and under no circumstances should the PCs find a way into the room. If they peek in through the outside windows, they see a lavishly furnished suite, with tapestries, the skin of a winter wolf, a suit of armor hanging from the walls, and various small statues and paintings around the room.

11. Elistar's Laboratory and Treasure Rooms. The PCs should have no way of entering these rooms, as the doors are *wizard locked* at the 14th level. The rooms contain Elistar's beakers, alembics, sand baths, potion racks, spell components, and amassed wealth. All valuables in these areas are heavily trapped.

The only exception to this rule is the northern room (area 12) that was opened up by the collapse. Most of the magical traps in that room were set off by the collapse. Of course, the secret door that opens into the adjacent room was jammed quite solidly shut.

12. Treasure Room. This is one of Elistar's treasure rooms, and is almost completely hidden from view. Only PCs with a strong light source who are looking in the right direction will be able to find this room. Torches and lanterns are not bright enough to illuminate the entrance from the pit floor below.

When the nearby section of mines collapsed into a sinkhole, the northern wall fell away as well, opening it up to the caverns. Rumble and Gim climbed up here and discovered a small secret compartment in the east wall, where they found their magical items. PCs climbing up or down from here must make a successful Dexterity check or take 1d3 hp damage.

The sliding door to the secret compartment in the east wall is slightly open, so it will be visible to the party upon the most cursory of searches. This is where Rumble and Gim found their magical items. The secret door in the southern wall is made of solid stone, and was jarred shut by the tremors caused by the collapse. It will not open, even if found.

The secret compartment opened by the goblins has a false bottom. Beneath a small slab of stone that slides down and out of the way, a small velvet sack can be found. In the sack are 20 gp, a small aquamarine (50 gp), and a *potion of delusion*. Elistar believes the *potion* is a *potion of extra-healing*.

Outside the Mines

The trail to the mines is only a few hundred yards long, winding out of the clearing and into the forest. There is only one area of note along the path.

13. Upside-down Waterfall. When the party reaches this area on the map, read the following to the players:

The trail through the forest brings you closer to the steep base of the hill, so you're walking alongside what is essentially a small cliff face. You can hear cascading water up ahead. As you get closer, you see a small stream that runs down the steep, rocky slope—until it reaches a point about three arm-lengths up the hill.

At that point, the stream suddenly leaps out into the air, away from the hill, and arcs to a point almost 30' above your heads, before the water begins to fall earthward once again. The strange waterfall lands a few paces to the left of the trail and continues on though the trees. You'll have to pass under the strange archway of running water if you want to continue along the path.

The unusual waterfall is the result of a seemingly permanent wild surge from one of Elistar's spells. The surge created a localized antigravity area that the stream passes through. The antigravity effect is limited to a 10' cube suspended in midair with its bottom edge at the point on the hill where the stream lifts off. At that point, the water jumps away from the hill and begins arcing up. The inertia of the water carries it forward—horizontally—through the cube, and the stream falls to earth again shortly after it leaves the antigravity effect, forming a natural archway. The water itself has no special properties.

Any PC who enters the antigravity area (by climbing 10' up the slope, a slightly slippery, inward sloping wall with some handholds, climb walls adjustment +20%), will find himself floating up to the top of the cube (just under another 10' high). Once there, a strong wind, rope, or long pole is the only thing that will get him down.

14. Entrance to the Mines. Read the following to the players:

Krypthome and Mines

1 Square = 5'

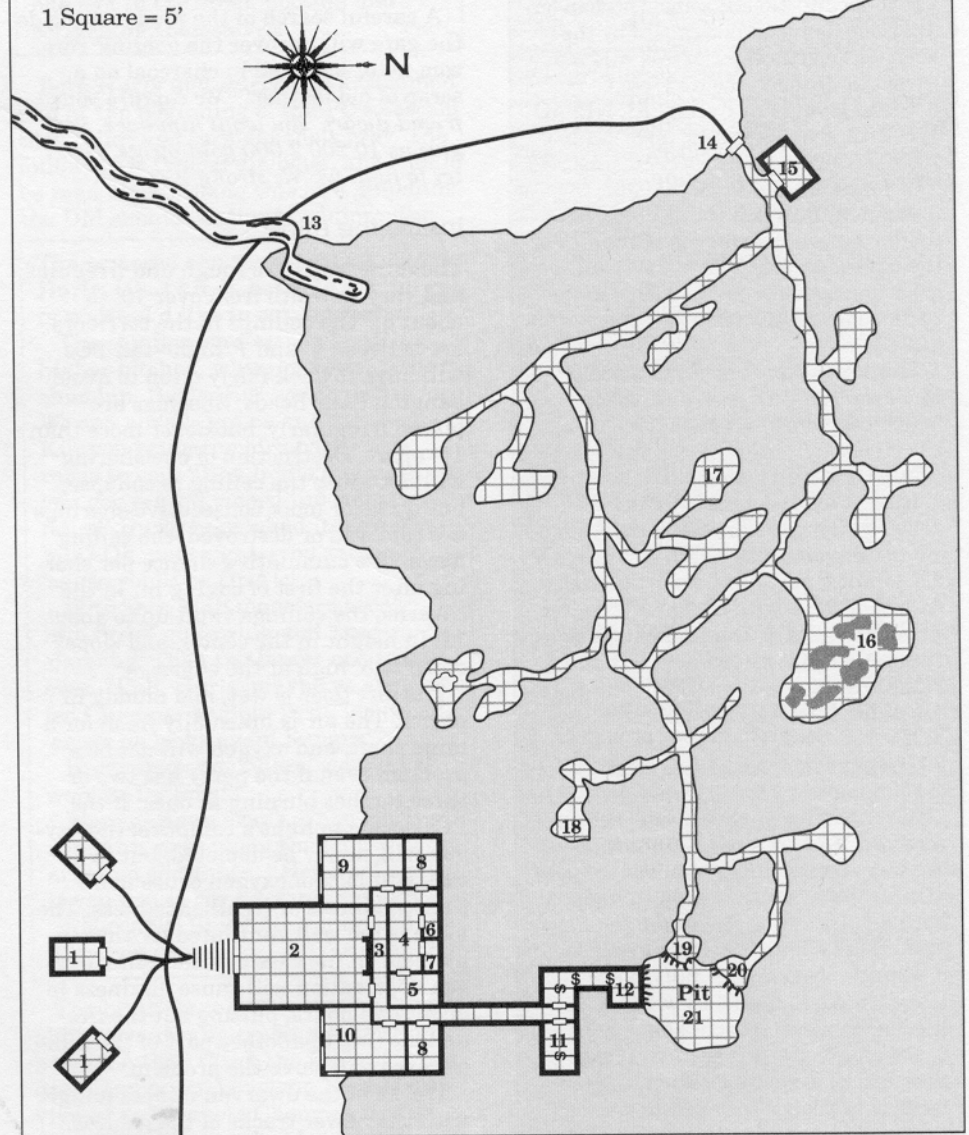

You now stand at the entrance to the mines. The door is made of solid stone and is barred with three massive wooden beams. A system of pulleys is attached to a hand crank mounted in the side of the hill. The pulleys appear to be the only possible way for the door to be opened by anyone weaker than a giant. Following Hather's instructions, you set about opening the forbidding portal.

The beams are removed with a minimum of difficulty, considering their

size, and [insert party strongman's name here] slowly begins to turn the crank. The door swings outward on huge iron hinges, creaking loudly.

Inside a dark passage leads into the depths of the mountain.

If the heroes thoughtfully close the door behind them, a successful bend bars/lift gates roll must be made (at half the normal chance of success) to open it from the inside—the dwarves designed this temporary gate to seal the mines off, and use a smaller, more functional door (that was

Mine Encounters

1. **Moaning.** A low moan is echoes from a random direction. It sounds human (or dwarven), but is in fact caused by the wind (or honk-moss, or excess wild magic venting through the rock, etc.).
2. **Giant Rat** (1): INT semi-; AL NE; AC 7; MV 12, swim 6; HD 1/2; hp 3; THACO 20; #AT 1; Dmg 1-3 (bite); SA disease; SZ T (2' long); ML 6; XP 15; MM/327.
3. **Magical flowers.** Half a dozen colorful flowers are growing out of the side of the mine shaft here. They derive all their sustenance from the magic in the rocks, and wither within an hour if picked.
4. **Honkmoss** (see area 17). One member of the party steps on a patch of honkmoss, which lets out a loud honk.

Cavern Encounters

1. **Blue Rocks** (see area 19). 1d4 of the glowing blue rocks are set in the wall, emitting a faint blue light.
- 2-3. **Giant Rat** (1): INT semi-; AL NE; AC 7; MV 12, Sw 6; HD 1/2; hp 3; THACO 20; #AT 1; Dmg 1-3 (bite); SA disease; SZ T (2' long); ML 6; XP 15; MM/327.
4. **Spider, hairy:** INT low; AL NE; AC 8; MV 12, web 9; HD 1-1; hp 4; THACO 20; #AT 1; Dmg 1 (bite); SA: poison; SZ T (4-5" diameter); ML 10; XP 65; MM/327 (Spider). Victims of the spiders' venom receive a +2 bonus to saving throws vs. the weak poison. Failure means the victim's AC and attack rolls are reduced by 1, and Dexterity checks are penalized by 3. These effects last 1d4 + 1 rounds.
5. **Honkmoss** (see area 17). One member of the party steps on a patch of honkmoss, which lets out a loud honk.
6. **Tracks.** In the dirt or mud on the floor, tracks made by a pair of booted feet can be seen. Next to them are the tracks of a boar. They lead on for 10-40' before becoming obscured.
7. **Shrieker:** INT non-; AL N; AC 7; MV 1; HD 3; hp 13; THACO 17; #AT 0; Dmg 0; SA noise; SZ M (5'); ML 12; XP 120; MM/121 (Fungus). If the goblins don't know of the party's presence yet, they do now (100% chance to alert the goblins).
8. **Rumple** (see "Goblin Tactics" sidebar). Rumple spots the party while wandering around *invisibly* (with the help of his ring). Thereafter, he will try to alert Gim, as well as keep the party in sight. The strain of doing both may make the goblin start talking to himself, thus revealing his presence.

removed when the dwarves built the current massive portal) when they are working the mines regularly.

A careful search of the mud just inside the gate will uncover the goblins' ransom note, scrawled in charcoal on a scrap of old leather: "We capture your friend dwarf. You want him back, you give us 10,000 gold pieces. Don't try to fight us. We strong."

Inside the mine

The mine walls are rough and irregular, and vary in width from over 10' to about 5'. The ceilings in the corridors are between 6' and 7' high—tall PCs will have to duck fairly often to avoid banging their heads. Shorings are placed irregularly, but never more than 15' apart. Destruction of one shoring will not cause the ceiling to collapse, but if two or more consecutive shorings are removed or destroyed, the ceiling has a 25% cumulative chance per shoring after the first of caving in. In the caverns, the ceilings vault up to about 12' in height in the center, and slope down to 5' high at the edges.

The dirt floor is wet, and muddy in places. The air is unusually fresh for a mine shaft, and oxygen will not be a problem even if the party has two or three torches burning at once. If the PCs decide to light a campfire, the oxygen will slowly be depleted, but in no case will lack of oxygen cause more than giddiness or lightheadedness. The mine is too well ventilated for that to happen. In the case of a campfire, oxygen deprivation will cause dizziness in about two hours; putting out the fire and moving to another part of the mine or caves will solve the problem.

Tracks of the dwarven miners mingle with the newer tracks of the goblins. Anyone tracking the goblins (-4 penalty to tracking proficiency check because of all the mixed trails) will find that the trail leads, after a twist and turn or two, to the ledge (area 19). The goblins are moving around the lower level caves, the natural caverns, while the party is exploring the mine. They are in areas 28 and 32 most of the time, and it is most likely that the party will encounter them there.

On the upper level, the dwarven mine, the DM should roll 1d8 every turn. A result of a one indicates a random encounter on the mine table. On the lower level of natural caves, roll 1d6 every

turn. A result of 1 indicates a random encounter on the cavern table.

The caves on the second level are difficult to navigate in places. In spots, the goblins' tracks will be clearly visible to all in the mud; in others, the rocky floor makes tracking all but impossible. The tunnels vary between 4' and 10' wide, averaging about 6'. The ceiling of the caves varies wildly from 5' to 30' in height, but in most places is about 10'.

15. Storeroom. Read the following to the players:

A massive iron door is set into the side of the passageway here, barred with an equally large iron bar fastened in place with a padlock. There are scratch marks around the edges of the door and around the lock, as though something has tried to claw its way inside but apparently failed.

The goblins have been unable to open this door, even with the help of their animals from the *bag of tricks*. If the party gains access (the lock is of average quality, and a successful bend bars roll will break the padlock), they will find that this is the most regular room in the complex, with almost vertical walls and a flat floor. Hanging on hooks and spikes all around the room are tools of the mining trade: six pickaxes, seven rock hammers, 15 chisels of various sizes, four mallets for banging chisels, two sledgehammers, six belts with a few leather pouches hanging from each (all empty), four backpacks (also empty), two broad swords, three battle axes, a shield, and a helmet. The last few items are for protection, not mining. The dwarves have little use for them.

16. Attack of the Honkmoss. When the PCs get within 40' of this cavern (as they pass close to the side passage that leads to the cavern), read or paraphrase the following to the players:

At first you thought you were imagining something, but now the sound becomes more distinct: little honking noises. Every dozen heartbeats or so, you can hear a little noise that sounds like a horn. The sound appears to be coming from down a side passage up ahead.

While honkmoss is scattered through-

out the mine and caves below, this cavern contains it in abundance.

Honkmoss has developed in the years that Elistar has pursued magical research in his underground laboratory.

The frequent wild surges created by his spells have required him to keep a ready supply of fresh water nearby to clean up the messy effects. The water he uses in his laboratory comes from an underground spring that flows into the lab and drains back into the floor. Every time he washes out the laboratory, some of the magic is drained away in the water. Most of the water flows along with the stream, and the magical energies slowly dissipate. Some of the water, however, seeps into the rocks in the hill, and is in turn absorbed by the plants—and moss.

When normal moss absorbs too much magical energy, the extra energy is usually dissipated in some fashion: light (glow-in-the-dark moss), heat (moss warm to the touch), or unusually fast growth. The honkmoss is simply moss that dissipates its magical energy through sound. The honkmoss in this area is abundant enough that little noises—honks that sound like a bicycle horn—can be heard several times a minute (2-3 times per round) by anyone within 60' or so. The honkmoss isn't very loud.

Honkmoss that isn't quite saturated with enough energy to honk on its own will most definitely make noise when poked, prodded, or stepped on. For game purposes, the floor in this particular area is about 40% covered with the moss. In any round that a PC is not actively watching where he steps, he will automatically step on some of the moss, creating a honking sound. If a PC wishes to avoid stepping on the moss, he must move at ¼ normal movement, and make a successful Dexterity check on 1d20.

The first round that the party enters the room, there should be a cacophony of honking before they realize what is making all the racket. Have fun emphasizing the noise, and make an additional random encounter check.

17. Look at all the Pretty . . . This is one of the areas that the dwarves were currently mining at the time of Tjegg's disappearance. Most of the other areas the were currently mining went down into The Pit (area 21). Any dwarf, or PC with mining proficiency has a 1 in 6

Goblin Tactics

Rumple and Gim are wandering around the caves of the lower level almost constantly. Sometimes they are together, and sometimes they are apart. When it comes time for their attack on the party, however, they will act in concert.

There is a 50% chance that by the time the PCs have wandered over 100' into the tunnels to the east of the large pit (area 21), the goblins will be aware of their presence. Also, any time the party makes a lot of noise, there is a 20% chance that the goblins hear them. Finally, Rumple may discover the PCs while walking around *invisible* (through a random encounter). After the goblins discover the party, they will follow the PCs (from a very safe distance) to observe, and get some measure of the party's strength. They are smart goblins, remember.

If the party runs into trouble with the rats or spiders, the goblins will attack them after they finish the battle. The goblins will never enter the spider cave (area 31), because they are terrified of an attack by the spiders. If the goblins are following the party when Tjegg is discovered, they will attack immediately. If the goblins do not discover and follow the party, there is an equal chance that they will be encountered in their bedroom or the hunting grounds (area 28 or area 32). Even there, they will still be ready for the party (having heard or smelled them) and will follow the same plan of attack.

The goblins' attack always follows the same course. If the party seems powerful (they dispatch the rats or spiders with ease), then Rumple summons 1-2 animals from the *bag of tricks* (one at a time, of course), and sends them to attack the party. Once the first animals are killed, he will pull another

from the bag, and order it to attack. Then he turns *invisible* and moves closer to watch the fight, as Gim drinks his potion of *speed* and charges into the fray with his *short sword +1* flashing blue sparks. Gim usually wants to play the hero, however, and may attack sooner than he should. Rumple will join the fight (and lose the cover of *invisibility*) when he deems it necessary.

If the party is weakened from a fight with rats or spiders, or if the goblins are attacking in the bed cave or hunting cave (area 28 or 32), then the goblins will attack simultaneously with a summoned animal (although Rumple may wait a round before becoming visible).

Rumple (goblin): INT average; AL LE; AC 6; MV 6; HD 1-1; hp 6; THACO 20; #AT 1; Dmg by weapon type; SZ S (4' tall); ML 10; XP 65; MM/163; dagger, *bag of tricks*, *ring of invisibility*.

Gim (goblin): INT average; AL LE; AC 6; MV 6; HD 1-1; hp 7; THACO 20; #AT 1; Dmg by weapon type; SZ S (4' tall); ML 11; XP 35; MM/163; *short sword +1*, *potion of speed*.

It shouldn't be difficult to make the combat a little more interesting than the standard manic fight-to-the-death struggle. The combination of random woodland animals, a hyperactive goblin with a sparking orange sword, and another goblin who appears out of nowhere in the second or third round can produce some funny events. Play up the antics of Gim, who wants to play the hero, and Rumple, who wants to stay alive.

Finally, if either goblin is wounded below half his hit points, he will either run for his life or fall to his knees, begging for mercy. If the goblins are winning the fight (the PCs are badly wounded or dying), the dwarves can be used as a *deus ex machina* to rush in, axes waving, to rescue the party.

chance of noticing one of the uncut gemstones in the walls. If there are no dwarves or miners in the party, they will notice nothing unusual about this area of the mine unless they search the walls carefully.

If the party does find any uncut gemstones (to anyone but a dwarf or miner, they look like common rocks) and wishes to continue searching, they will find one additional uncut, semiprecious stone for every miner or dwarf in the

party for every turn spent searching. Value of the uncut stones is 1 gp each.

18. Blue Rocks. Read or paraphrase the following to the players as the party nears the cavern:

Just around the next bend in the tunnel, a faint blue light shines. Cautiously rounding the corner, you see that the cave up ahead is

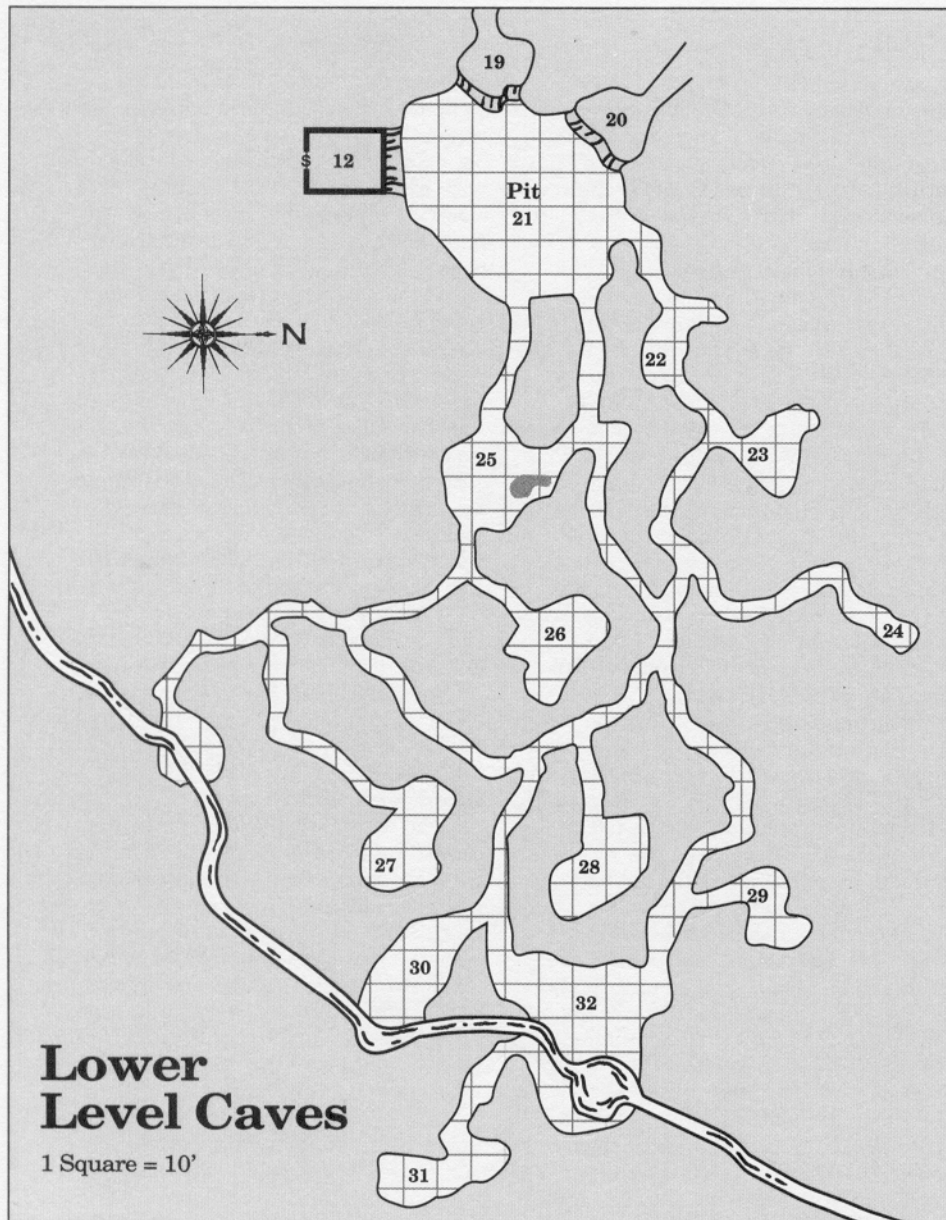

bathed in a soft blue glow, which seems to be emanating from the stones scattered in the cavern walls. What is more disconcerting, however, are the shadows that flit from the walls to the ceiling to the floor and back again. There appears to be no source for the shadows, which move of their own accord.

There are no undead in the room; the shadows and the blue light are both cast by the blue stones embedded at random intervals into the sides of the cavern.

This is yet another effect of Elistar's wild magic. The dwarves dislike this area, and quit mining it when the blue stones appeared (about three months ago). When the blue stones are removed from the walls, they fade to a pale, dusty gray in less than ten minutes, after which time they have no special properties. They do not regain their properties if jammed into the wall again, although the stones seem to grow on their own, regenerating about 10 per day. There will never be more than 100 stones in the room, however, as the magical energy in the walls cannot

support more than that number.

19. The Ledge. When the party is nearing this area, read or paraphrase the following:

You enter what seems at first to be simply another widened-out passage that the dwarves were mining, but a few steps farther in, you can see that the floor falls away into a very deep pit. As you slowly near the edge of the ledge you're standing on, you see that the side of the pit is climbable—with some difficulty.

Remember when giving information about the pit and the exits from the pit on the lower level, that torches (15'), light spells (20'), and hooded lanterns (30') do not have sufficient range to even let PCs see the bottom of the pit, let alone the exits from it on the far side. Only PCs with infravision will see any detail in (or exits from) the pit.

This is the pit that Tjegg fell into, and where he met with the goblins and lynx. Standing on the ledge here, the PCs have the same view of the pit as Tjegg did when he saw the goblins. Looking out from the ledge (eastward), the ceiling vaults up another 10', while the sides of the pit slope down steeply (although they are not so steep as to prevent the party from climbing down), descending about 50' below where the party currently stands. Each PC must make a successful Dexterity check to scale the steep walls to the bottom (area 21). Failure means that the PC has slipped and fallen a few feet, incurring 1d3 hp damage.

Due to a protruding chunk of rock on the south end of the ledge, it is nearly impossible to see the treasure room (area 12) from this vantage point, although the bat cave (area 20) may be visible if the party uses a bright light.

20. A Room With a View. This cave has also lost a wall in the cave-in, and affords another angle from which to observe the pit below. Climbing down is not any easier here than from the ledge (area 19), however. If the party looks out into the darkness beyond the ledge while using a strong light source, the ledge or the treasure room (areas 19 or 12) may be visible as a small alcove in the side of the pit, near the top. Any torch or lantern light, however, will wake the bats sleeping on the ceiling.

They will swarm around the party, squeaking, flapping their wings furiously, and attacking until they fail a morale check. The bats then disperse into the large cavern of the pit, returning three turns later to sleep again.

Bats, common (12): INT animal; AL N; AC 8 (4 in large cavern); MV 1, fly 24; HD 1-2 hp; hp 2 (×4), 1 (×8); THACO 20; #AT 1; Dmg 1 (bite); SA swarm can put out torches, Wisdom roll required to cast spells, -2 to opponent's THACO; SZ T (1'); ML 3; XP 15; MM/15.

21. The Pit. When the PCs have climbed down the walls, read the following to the players:

The floor of the large cavern is strewn with fresh rubble—rocks, boulders, and pebbles of all sizes are scattered everywhere. This must be the result of the cave-in that Hather spoke of.

Movement around the floor of the pit is very slow going (1/3 normal movement). When moving around the pit, each PC must make a Dexterity check (with a +4 bonus) every round to avoid stumbling and falling. If any PC falls, it simply means that movement for that round is zero, no damage is incurred. Also, the DM should keep in mind the very limited range of illumination provided by torches and lanterns; not all four—and possibly none—of the exits will be visible at any given time. To find them, the party will have to stumble around in the dark.

Rumple and Gim will probably know of the party's presence soon after they climb down the pit: Rumple is constantly walking around the lower level, *invisible* with the help of his ring, and may bump into them (as per the random encounter table), or the party will make too much noise in one of the caves. See the "Goblin Tactics" sidebar for details of the goblins' actions.

22. Lynx Tracks. As the party enters this area, read or paraphrase the following to the players—the tracks can be seen easily by everyone, not just rangers:

In the slightly muddy floor of this cave, the imprints of booted feet run every which way. One set of tracks stand out from all the rest, however: the tracks of a mountain lion or some other great cat.

These are the tracks of the lynx that Rumple summoned from the *bag of tricks*. The tracks lead directly to the alcove in the northwest of the cave, and vanish about 3' from the wall. This is where the summoned lynx was when it returned to the Astral plane. It should present a bit of a puzzle for the PCs.

23. A Skeleton. Read the following to the party:

As you enter yet another of the small areas hollowed out by the dwarves' digging, you see something on the floor: a skeleton. Its ivory-white bones are clearly visible on the floor, even in the flickering light. As you watch, however, a hand suddenly twitches and reaches for you!

If the party does not immediately flee, they will see the beady eyes of a rat staring up at them through the bones of the skeleton's hand. The skeleton is that of a hobgoblin who was buried here many hundreds of years ago. It is not animated; there is a rat underneath the bones. If the PCs investigate more closely, the rat will attack.

Rat (1): INT animal; AL N; AC 7; MV 15; HD 1/4; hp 2; THACO 20; #AT 1; Dmg 1 (bite); special attacks: disease; SZ T (1' long); ML 3; XP 7; MM/327.

The rat has no treasure, and neither does the hobgoblin skeleton.

24. Dead End. The passage here simply stops at a wall of solid rock. If the PCs search carefully, they will find a crudely made dagger (formerly belonging to Gim) in the dirt. From the lack of rust on the blade, it is obvious that the dagger is not very old.

25. Wind Tunnel. The ceiling of this cavern vaults up some 30' before closing overhead. One small shaft reaches all the way to the surface, however, and allows air to circulate somewhat. The shape of the air vent turns it into a large whistle, and as wind gusts past the opening far above, a long, keening wail can be heard. The adventurers need not know this, however. As they enter the room, read or paraphrase the following to the players:

As you enter this large cavern, filled with beautiful stalactites and stalagmites, you hear a sad, moaning wail. It lasts for a dozen heartbeats, keening loudly enough to be heard clearly

and distinctly. The wail sounds strikingly like the scream of a tormented undead soul.

There are a few circling goblin tracks, mainly around the entrance to this cavern, and a large patch of honkmoss in the north end of the cave. Other than that, the cavern is empty.

26. Giant Rat Nest. A pack of giant rats call this cave home. The two goblins know of the rats, and avoid them (except when they are desperate for food).

The floor of the cave is covered in debris: twigs, bits of bone, hairballs, and small skeletons of various animals litter the place. In the walls, numerous holes allow the rats easy entrances and exits. As the party looks around, a rustling noise can be heard, followed shortly by a vicious, snarling charge by four giant rats.

Giant Rats (4): INT semi-; AL NE; AC 7; MV 12, Sw 6; HD 1/2; hp 4, 3, 2, 2; THACO 20; #AT 1; Dmg 1-3 (bite); special attacks: disease; SZ T (2' long); ML 6; XP 15; MM/327.

Combat with the rats has a 75% chance of alerting the goblins to the party's presence. If the PCs return to this room later, after vanquishing the rats, there will be another three **giant rats** (hp 3, 3, 2) waiting to attack. There is no treasure in the rats' nest.

27. Tjegg's Prison. Read the following to the players:

Slowly entering the cave before you, you hear the sound of snoring: Rounding the corner cautiously, you see a small bearded body, bound hand and foot, sleeping against the wall and snoring loudly. A crude bowl and a few bones are scattered around him.

Then you notice he only wears one boot!

Sure enough, this is Tjegg, the missing dwarven miner. If awakened, he grunts and snorts a few times, glares at the PCs for a moment, and then, realizing that they're not goblins, asks them to cut him free and then begins to speak. If the party does not free him, he does not talk, remaining stubbornly mute in reply to all questions.

When he does begin to talk, read the

following boxed text to the party, in a low, ragged but gruff voice:

“Ye’re not the stinkin’ goblins, I see. What, me friends hired ye to come to me rescue? Mighty kind of ’em, the cowards. I been kidnapped by a couple o’ stinkin’ goblins. Sandstone! Only thing that puzzles me is the cat. Still don’t know . . .”

As the dwarf tries to rise to his feet, his voice trails off, and he collapses in a heap, exhausted.

If the party has the means to heal Tjegg, he will awaken and provide them with a little more information: that the goblins had a large cat at their command when they captured him, and that one of them has a magical sword (he knows because it glows orange when wielded). Tjegg wishes to return to the surface, and if the party lets him, will do just that. If the PCs force him to stay, he will do so grudgingly, but in any case, he is in no condition to fight. No matter how much healing magic is worked on him, he has barely slept in nearly ten days and won’t be able to exert himself.

If the party cannot heal Tjegg, he will sleep for at least another four hours, whether carried away or left here. If the goblins find Tjegg after he’s been untied, or in the company of the party, they will do their best to kill him.

Tjegg: AL CG; AC 10; MV 12; F3; hp 4 (max 19); THAC0 18; #AT 1; Dmg by weapon type; S 18/30 (+1, +3), D 11, C 16, I 9, W 10, Ch 15; ML 16; ragged clothing.

28. Home Sweet Home. This is where Rumble and Gim spend their nights. As such, it contains the lavish bedding and furnishings kept up to the pristine standards associated with goblins. In other words, it looks like another rat’s nest. It smells putrid, too.

All of Rumble and Gim’s possessions are strewn about on the floor. There are (in no particular order) a dirty spoon, a bent, dull knife, a broken dagger, three silver pieces in a rotten leather pouch, four copper pieces, another dirty spoon, a smooth round stone, and a tattered silk tunic scattered in the garbage on the floor. While they’re awake, the goblins spend little time here: it stinks too much, even for them.

29. The cave of rhythmic moss. As

the party approaches this cave, read the following boxed text aloud:

A flickering blue glow can be seen in the passageway ahead, and you can hear a rhythmic honking sound. Once every couple of heartbeats, a brief “honk” can be heard, like a bugle. It is occurring at an unnaturally regular interval.

Once the party reaches the room, they will see that the walls of this room are studded with the same glowing blue rocks that are present in the mines above. Small rivulets of water flow over almost every one of the stones, making their light flicker like that of a poorly trimmed lantern. And overhead, a trickle is causing a slow accumulation of water that drips down onto the bed of moss below every few seconds. Whenever the water drops onto the bed of moss, the moss lets off a “honk.”

The entire effect is not unlike a honkmoss band playing at a pleasure house in one of the seedier districts of Waterdeep. Because of the constant racket, PCs stomping around on the honkmoss here will not alert the goblins. Other than the moss and water, the cave is empty.

30. The Mushroom Chamber. In the east end of this cave, the small underground stream has formed a pool against the wall, where an occasional fish can be seen. The pool is no more than 3’ deep, and the water flows in and out through openings no more than 18” wide. The ground around the rest of the area is carpeted with mushrooms and mold of various sizes and shapes. The mushrooms range in size from 2” to 4’ in height, and the same in diameter. Honkmoss is scattered everywhere, and every round the PCs spend in the room, there is a 10% (noncumulative) chance of stepping on some and alerting the goblins to the party’s presence.

31. The Spider Cave. Spiderwebs run from wall to wall, floor to ceiling in this area, and PCs will have to clear the webs away in order to proceed (fire works wonders—but eats up oxygen fast). Every round the PCs spend in here, each PC has a 25% chance of being attacked by 1-3 hairy spiders. The spiders drop from the ceiling (surprising the PCs on a roll of 1-6 on 1d10), and cling to the PCs, biting away. The spi-

der attacks are cumulative, so if a PC is fighting off two spiders that have dropped from the ceiling the previous round, there is still a 25% chance that another 1-3 will attack him that round. There are a total of eight spiders.

Spiders, hairy (8): INT low; AL NE; AC 8; MV 12, web 9; HD 1-1; hp 6, 5, 4, 4, 3, 3, 2, 1; THAC0 20; #AT 1; Dmg 1 (bite); SA poison; SZ T (4-5” diameter); ML 10; XP 65; MM/327 (Spider). Victims of the spiders’ venom receive a +2 bonus to saving throws vs. the weak poison. Failure means the victim’s AC and attack rolls are penalized by -1, and Dexterity checks are penalized by 3. These effects last 1d4 + 1 rounds.

If the goblins have been following the party (see “Goblin Tactics”), they will attack the party as they leave this area, hoping the party is affected by spider venom.

32. Hunting Grounds. Read the following to the players:

This is the largest cave you’ve seen, other than the one caused by the cave-in from the mines above. The ceiling vaults high above your heads, and the walls open up in both directions, revealing a huge interior space. The sparkling sound of running water fills the room. In one end of the room is a large pool, fed by a spring that bursts out of the wall.

This is where Rumble and Gim do most of their hunting. There are fish to be had in the pool (6’ deep in the center), and rats frequent the south end of the cave. If the PCs explore the southern end of this area, there is a 1 in 6 chance that 2-3 rats (hp 3, 2) will attack, scurrying out of holes in the wall.

There are half a dozen rat skeletons lying on the ground near the pool (they were devoured on the spot by the two goblins).

This is where Rumble and Gim fight the party, unless the PCs visit the spiders in the spider cave (area 31) first (see “Goblin Tactics”).

Once the battle is over and the goblins are dealt with, the party can return to the Krypthome to meet the dwarves (and Elistar, eventually) and collect their reward.

Further Adventures

Back at the Krypthome, the party is welcomed joyously by the three dwarves

if they bring back Tjegg alive, and somberly if all they return with is Tjegg's body or news of his death. Elistar has not yet returned, however, and the dwarves have only 60 gp between them with which to reward the party. They will hand this small sum over most willingly.

If the PCs ask when Elistar is expected back, Hather says the following:

"Well, ye never can tell exactly when the elf'll be back. Comes and goes as he pleases, pretty much. He may be back tomorrow, and then he may be back in a month, ye can't say. Of course, ye're welcome to stay here for as long as ye want, but we're pretty far from the comforts o' civilization . . ."

If the party does elect to stay, Elistar returns in 1d10 days. When told of the events that transpired in his absence (and his magical stuff is returned), he is most generous, rewarding each PC with at least 100 gp (the DM should adjust this to suit his campaign). If the PCs decide not to return his magical toys, there is only a 25% chance that he will notice their absence and ask for them (there are no identifying marks on them) but he will provide the party with an additional 50 gp per person if the items are returned.

Elistar is a little scatterbrained, but obviously brilliant. Any conversation with him always seems to end up being a discussion of magic, which he loves. If one of the party's mages talks to him about matters magical and arcane, he may reward the party with one or more of the magical items that the goblins used, "because if it had not been for the fortunate intervention of you and your companions, I would have none of these items at all."

Elistar will gladly train wizards for level advancement, but he may not stay around to complete it. Just because he has a pupil doesn't mean he won't leave to pursue some adventure of his own: he is a wild mage, after all. To reflect this, there is a noncumulative 10% chance per week that Elistar simply vanishes, leaving the PC's training incomplete. If the party has returned his magical toys, however, he will charge minimal fees for training: just enough to cover materials (100 gp/level), and he won't collect his fees until the wizard's training is completed. Ω

Continued from page 25

Pakkililirr has picked up a *ring of warmth* which he wears on one tentacle. He doesn't bother with weapons other than his own natural attacks. The only weapon he has taken from his prey that the PCs may find is useful is a *battleaxe +1* lying in the back of the cave.

Pakkililirr the Grell: INT average; AL NE; AC 5; MV fly 12 (D); HD 5; hp 36; #AT 11 (10 tentacles, 1 bite); SA paralyzing touch (saving throw vs. paralysis at +4), magical ring; SZ M (4' diameter); ML 14; XP 3,000; MM/173 (Grell, Worker).

Staging the Encounter

Pakkililirr will not just wait in his cave for the adventurers to attack. When night falls the monster ventures out of the pass to hunt in the valley and on the road—hunting the heroes.

Grells fly, so the DM should consider how Pakkililirr may move about. He can go above and behind a party. He can also escape into the sky or can bombard the party with rocks. In other words, the grell won't remain a passive victim—he is a highly dangerous creature, skilled in combat, with a high morale.

Pakkililirr is arrogant and disdainful of all nongrell. His recent successes have made him confident that he can defeat any threat humans may throw at him. He is angry at being left behind by his hive-brothers, so he takes out his frustrations on his victims. A grell turned rogue without the backing of his hive-mates doesn't last long. Pakkililirr knows this but will do everything he can to survive.

If Pakkililirr escapes, or if the PCs find him too much to handle, the villagers will be reluctant to raise a militia to help the adventurers, until someone points out the toll that a rogue grell takes on people and livestock. When they know it is a flesh-and-blood creature, they'll be less afraid of going to the pass to help kill it (under the PCs' expert guidance, of course!).

Pakkililirr will be missed by the other grell, who may decide locals killed him before he could reach the rendezvous point. It will not occur to them he would disobey orders, so they won't linger in the pass. Indirectly, the defection or death of the grell will postpone the plans of the hive for a few years as they ponder whether the local population is now alert to the possibility of invasion.

Further Adventures

If the party does particularly well and slays Pakkililirr easily, the DM might re-introduce the grell exploration party returning from the mine. They are likely to try to slay all witnesses, or capture them as slaves and question them about Pakkililirr's whereabouts.

The mine itself has been occupied by monsters since grell last visited it. The grell may have driven them out while exploring, or their search may have been unsuccessful. Even if they find the mine, it may be worthless, mined out, or flooded. If the mine is worthwhile, though, the grell may return to mine ore by stealth. Such an operation would take animals from the nearby herds for food, and the PCs might be called upon by the local farmers to intervene.

This is Willie's 19th appearance in DUNGEON® Adventures, and his first Side Treks feature. He has other modules in the works which will see print in future issues. Ω

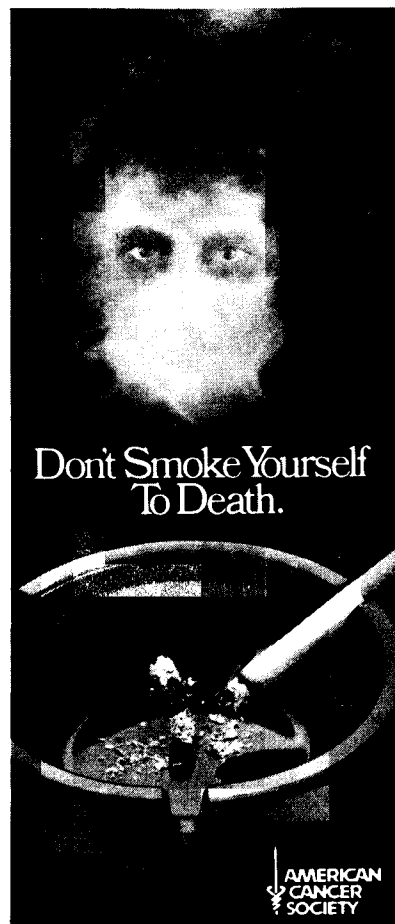



THE HURLY-BURLY BROTHERS

BY KEVIN WILSON

A snatch-and-grab . . .
with a sting

Artwork by David Kooharian

Kevin Wilson, a mechanical engineer, is a lifelong resident of Muscatine, Iowa. Having played AD&D® games for 15 years, he has long wanted to write for DUNGEON® Adventures or DRAGON® Magazine. Unfortunately, time was never available, and he only began submitting proposals last year. Aside from writing, Kevin's hobbies include model rocketry, which he enjoys because his rockets always undergo such stupendous explosions and crashes.

“The Hurlly-Burly Brothers” is a short AD&D adventure for a party of 4-6 PCs of levels 3-5 (about 20 total levels). The PCs may be of any class or alignment, but the adventure is less challenging if they have flying magic at their disposal. The adventure may be set in any forested region, and the adventurers should be traveling on a forest road or stopped in a clearing when the first encounter occurs. Accurate timekeeping is crucial during the adventure, so, as an aid to the Dungeon Master, the time various actions require is summarized on page 44.

Adventure Background

Hurly and Burly are a pair of particularly cruel ogre brothers. Their favorite pastimes are torture and mayhem. Of course, torture and mayhem are high on the agenda of most ogres, but Hurly and Burly have turned it into a fine art. They will go to extreme lengths for a little “entertainment.”

So it was that when the pair came into possession of a *Quaal's feather token* (see the *DUNGEON MASTER® Guide*, page 177) after sending its previous owner to an early end, Burly was inspired to try out a “fun idea.” The brothers searched the countryside until they found a particularly nasty monster, a giant scorpion. Capturing the beast, they imprisoned it in the bottom chamber of the tower that they have inhabited for the last year. The ancient tower is in sad shape, with holes in the roof and every floor. The ogres don't see this as a problem; indeed, the holes give them a clear view down to the scorpion from their quarters high up on the third floor.

To set up the rest of their hideous trap, Hurly and Burly drew on knowledge they gained years ago, when they were mechanics constructing tribal war machines. With the scorpion safely secured, they spread a net across the opening on the top floor and

tied the corners to short ropes. They tied the other ends of the short ropes together into a single strand and ran it over a pulley over the top of the net. The rope ran from the pulley to the wall and entered a ratchet mechanism taken from a massive old pendulum clock left behind by one of the tower's previous owners.

With all this done, Burly set the *Quaal's feather token* down in the clearing outside the ogres' tower and spoke its command word. (The previous owner told the ogres the command word while they were bludgeoning him in a futile attempt to make them stop.) When the token became a gigantic roc, Burly mounted it and flew off in search of scorpion food.

Enter the Player Characters

The roc first spots the PCs from 300' up as they are trudging along the road. The adventurers won't see it unless they have their eyes on the skies, and, in any event, the roc's rider is hidden by the distance and the beast's wings. Once the roc glides out of sight, it circles around and comes in low, just over the treetops. The instant it clears the trees, it dives at a random PC, seeking to scoop him up and carry him off. The roc flies silently, so the PCs suffer a -5 penalty to their surprise roll unless they saw the roc earlier and sent someone up a tree to see where it went. Let the players roll a die to determine which PC the roc selects as its target.

Since the roc is magically bound to Burly's will, it obeys his every command without question. It behaves more like a broken, submissive pet than a wild beast. Burly does not want his catch harmed (yet), so he has instructed the roc to be gentle. Its massive talons inflict only 1d4 + 1 hp damage when they strike. Furthermore, Burly has told the roc to carry off its prey even if only one claw hits, something rocs do not normally do. Burly knows that the party may hide among the trees before he can wheel around for a second pass, and his massive roc cannot penetrate the tree cover. If the entire party escapes into the forest, Burly will try again a few hours later, when he hopes they have let down their guard.

The PCs have no time to react if they are surprised, and only one round even if they are not surprised. If all goes as planned, read the following to the players:

Suddenly the peaceful wood is shattered by a blast of mighty wind as a gigantic bird clears the treetops near

the path and swoops down straight at you. Resembling a great eagle, it must be as long as a dragon, with a wingspan close to 150'. A humanoid figure, at least 10' tall and armored head to toe, sits astride the enormous bird, yet even this giant of a man is dwarfed by his steed.

The armored figure is twirling a two-handed sword high above his head and screaming in a deep, guttural voice, "YEEAAA! Hoo-hoo-hoo-hee. Everybody DIIIEEEE! AAAR!" The great eagle snatches [PC name] up in its claws and carries him away over the trees, flattening you all with powerful winds in the instant it passes overhead. It is all over in an eyeblink, and everything is now calm and normal again—but [PC name] is gone.

Roc: INT animal; AL N; AC 4; MV 3, fly 30; HD 18; hp 144; THAC0 5; #AT 2 or 1; Dmg 2-5/2-5 (normally 3-18/3-18) or 4-24; SA surprise; SZ G (60' long, 120' wingspan); ML 11; XP 10,000; MM/303.

If one of the PCs climbs a tree to see where the roc is headed, he will see it fly a few hundred yards away, circle in the distance, and settle down among the trees. The tower is in a shallow, wide clearing, and tall trees obscure it from the PCs' vantage point. If the PCs watch the entire flight before pursuing, they waste three rounds and hear their companion's cries for help (if any) grow ever fainter.

Ideally, the player whose PC has been captured should be taken into the next room, and the DM should shuttle back and forth between that room and the one with the rest of the players, running both groups at the same time. This will heighten the tension, because neither group will know how the other is faring. Once the group is split, read the following to the isolated player:

Securely held in the steely grip of mighty talons, you are rapidly carried into the sky. In just a few seconds, the ground has fallen away hundreds of feet, and the roar of wind drowns out everything else. Tears streak across your cheeks as you race ahead at breathtaking speed. The air chills you since your captor's great size completely blocks the sun, leaving you in total shadow.

You can no longer see the armored rider, because the eagle-thing's hulking body is interposed between you

and him. All your blurry eyes can make out is the green landscape flying past far below and two great wings pumping with majestic slowness to either side of a ceiling of 4'-long feathers.

If one claw caught the PC, the roc will try to secure him with its second claw as well, attacking once per round while in flight. The first claw has only a 30% chance to pin both arms (10% to pin one arm). Once both claws hold the PC, there is a 65% chance that PC's arms will be pinned to his sides (35% for one arm), eliminating weapon attacks or somatic spellcasting.

The PC captured by the roc should have enough sense not to struggle during the three-minute flight back to the tower unless he has some way to survive a 200'-fall. If the PC does fight, Burly will not allow the roc to respond unless it is in mortal danger. In this unlikely event, Burly orders the roc to drop its prey, since the ogre knows he will plunge to his doom if his steed is killed.

Once back at the tower, the roc drops the PC through the hole in the roof and down onto the net stretched across the third-floor hole. The net constricts tightly around the PC, and he dangles midway between the second and third floors, held by the long rope strung over the pulley.

After Burly makes the drop, he lands on the edge of the roof, dismounts, and proceeds to the tower hatch. Suddenly, there is a loud creaking sound and the roof of the tower begins to slowly sink. Burly realizes that the roc's tremendous weight is too much for the old roof to bear. Fearing that the thrust of the roc's wings will bring down the roof if he orders his steed to fly off, he quickly issues the command word and the roc vanishes forever. This does not bother Burly much, since he knew the beast was going to disappear at the end of the day anyway, and he didn't really have any more use for it. If the PCs explore the roof later, they will find one section sagging badly. At the bottom of the sagging area are the remains of the *Quaal's feather token*—a fist-sized, smoldering cinder roughly in the shape of a bird with outstretched wings. However, unless the PCs can get to the tower with a Movement Rate of 15 or better, they won't see the roc disappear when the token is used up.

When he joins his brother, Burly gives

Ogre Tower

1 Square = 5'

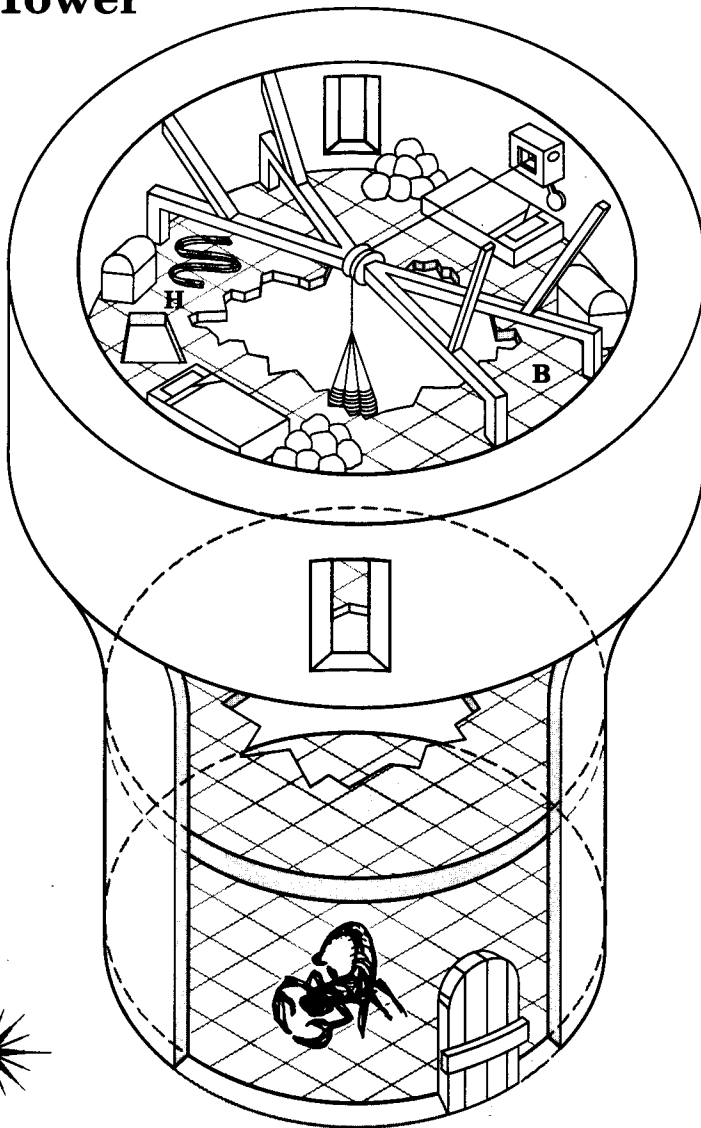

on a suitable landing place. Eventually it hovers for a moment just 20' above the tower's flat roof, right over the gaping hole. Just as the enormous bird seems about to land, the steely talons release their hold and you plummet through the hole into the blackness below. Suddenly you see a small, shadowy object racing toward you, directly in your path.

This object is the pulley that holds the net. Pause here for a brief moment to give the PC a chance to react. If he tries to avoid the object by contorting there is a 1-in-4 chance (let the player roll this) that the PC strikes the pulley on the way down anyway. Striking it inflicts 1-3 hp damage, but it also jams the pulley, requiring the ogres to spend two rounds to free it. The ogres do not realize the pulley is jammed until they try to start their winch. If the PC does not react fast enough, he strikes the pulley glancingly before continuing down toward the net, but not hard enough to jam it. Grabbing the pulley requires both a Dexterity check at -4 (to grab it properly) and a Strength check at -6 (to hold on). Failing the Dexterity check inflicts 1d4 + 1 hp damage from striking the pulley dead-on, but failing the Strength check inflicts no damage. Read the following to the player:

Your descent is broken by what feels like a web of cords. Your body is instantly compressed into an impossibly tight ball as the force of your fall draws the cords up tight around you, yanking you painfully to a halt. Although you are no longer falling, the sudden stop has set you spinning and wobbling about in your corded cocoon. As your eyes slowly adjust to the dim light inside the tower, you see shapes and colors blurring all around you. Your twisting and spinning gradually slow.

You have heard tales of nightmarish spiders that are so huge they weave webs with the strength of iron to support themselves and to hold their large prey. Is one of these horrors even now clambering across its wall-to-wall web in this hollow tower, anxious to see what has dropped in for dinner? You shudder at the thought.

The PC wobbles and spins for 1d3 rounds after he is engulfed by the net,

the pendulum a push. This starts the ratchet device and slowly lowers the tightly netted PC down to the hungry scorpion. The simple device moves at a constant speed; it cannot be sped up or slowed down, only stopped or started. Once the PC is within the scorpion's reach, its pincers rapidly cut away the net to get at the tasty morsel within. The scorpion does not use its stinger unless its prey injures it. For more information, consult "The Ecology of the Giant Scorpion" on page 10 of DRAGON Magazine #197.

Giant scorpion: INT non; AL N; AC

3; MV 15; HD 5 + 5; hp 25; THACO 15; #AT 3 or 1; Dmg 1-10/1-10/1-4; SA poison sting; SZ M (5'-6' long); ML 11; XP 650; MM/309.

Read the following to the player of the caught PC as soon as the roc arrives at the tower:

You see an ancient, stone tower zoom into view below you. It is obviously in sad shape—the entire center section of the roof has fallen through. The great bird slowly circles the tower a couple of times, flying lower with each pass, as if trying to decide

totally disoriented and dizzy. The PC cannot take any actions during this time. It takes Burly one round to climb down into the tower, but he does not start the contraption until the net has stabilized. He wants to get a good look at his prize before dropping the PC to his doom.

As your cocoon finally slows to a stop, a strange sight greets your eyes. You are not encased in a web at all, but in a strong rope net. With great effort, you twist your neck around, taking in your surroundings. You can see that the tower is about 50' wide and has three levels. On each level of the tower, the central floor has collapsed with age, leaving a 20'-25'-wide irregular hole all the way down through the tower. From your vantage point, you can see that the second floor is completely empty and windowless, illuminated only by light streaming down from above.

You are currently suspended midway between the second and third floors, held aloft by a single rope, which rises through the hole in the third floor. The rope passes over a pulley, suspended directly over the center of the hole by means of two support beams. From the pulley, the rope runs horizontally to a wall on the third floor, where it is attached to a peculiar apparatus. It looks as though someone has ripped the innards from a huge clock, attached some extra gears and gizmos, and then bolted the entire affair high up on the wall. The only clue that it was once a clock is that it still has a 5'-long pendulum dangling beneath it.

Standing next to the device and leering down at you is the armored humanoid who brought you here, now sans his helmet. He's rather large, maybe 10' tall, with warty skin, beady little purple eyes, and jutting orange teeth. Staring down from the other side of the pit is a similar beast, though this one smaller and dressed only in old, mangy pelts. He has a mighty club swung over his shoulder and seems to be wearing a beat-up, black iron kettle as a helmet.

The larger creature reaches behind him and starts the pendulum swinging, which sets the peculiar device into motion. With each swing, it feeds out a little more rope, slowly lowering you to the bottom of the

tower. For some reason, this seems to delight the creatures—they hop from one foot to the other, hooting and scratching themselves.

Both Hurly and Burly speak Common and at the beginning of the PC's descent they taunt and torment their prey. The following is typical dialogue, and should be read aloud. Using this as a guideline, the DM should continue to improvise:

The armored one speaks, "Duh, hey Hurly. Uh, I kinda hates to see 'im go ta waste. I'd like to eat 'im meself."

The smaller ogre responds with a higher-pitched, whining voice. "Ah shuddup, Burly. Jus' watch da fun. We can always get us annuder wun. Kin you bring the bird back?" He turns to you. "Hey liddle guy, after you get yousef ripped lim from lim, tell ol' Hurly here what it feels like, huh? Oh, dats right—you can't, 'cause you'll be DEAD!"

With this, both monsters break into fits of guffawing and knee-slapping. Then the larger one takes over. "Ooh, Hurly, maybe ya shoudda fed Chomper sumpin in da las' week, 'cause he looks awful hungry."

Hurly responds, "Don' worry; he won' be fer long!"

More guffaws ensue. Then Burly wipes his nose along the length of his arm and continues. "Hey liddle guy, is you gonna cry fer yer mommy?"

"He can't, Burly. He's gonna be too busy beggin' you an' me fer mercy!"

The brothers continue this low-grade abuse, eventually trading wagers on how soon they think the PC will break down and weep, how long he will survive after he meets Chomper, and so forth. The PC may decide to carry on a conversation with the ogres, but he will get no useful information and will only waste time. When the PC looks down, read the following:

You now see why the ogres are so gleeful. Earlier you thought you might meet your end in the clutches of a huge spider. Well, apparently you were almost right after all. Waiting for you at the very bottom of the tower is the largest scorpion you have ever seen. Its smooth, segmented body is bone-white, and at least as long as a full-grown man. The thing somehow seems to sense

your approach, and it is scuttling about in circles directly below you, periodically rearing up on its back legs and snapping its huge pincers in your direction. Its evil tail curls and uncurls in anticipation.

There are several ways the PC can try to save himself before he becomes scorpion food. All of these take time and dexterity, since the net fits very tightly. As a rule of thumb, assume that any action takes twice as long in the net as it normally would. Times required for specific actions are summarized on the Action Table (see page 44). The PC can muscle his way out by rolling his bend-bars percentage. Alternately, if he has a dagger or knife in a belt sheath, sleeve, or boot (but not in a backpack, for instance), he can reach it by making a successful Dexterity check at a -4 penalty. Other weapons are too big to be useful. The PC cannot muscle his way out and worm his dagger free at the same time.

If the PC is a spellcaster, he may have a useful spell that requires only verbal components. Casting spells with somatic components requires a successful Dexterity check with a -4 penalty, or the spell is ruined because of the caster's restricted motion. Digging out material components, magic wands, or other small items requires the same check.

Finally, even though the pincers cut through the net in a single round, the PC can hang onto the tatters of the net and climb up the rope to the second floor. The scorpion gets one free attack with each pincer before the PC can climb out of range and, if either pincer hits, the PC is held. If the PC is snared, see the **MONSTROUS MANUAL**® book for details.

If the PC takes refuge on the second floor, the ogres will be furious. Hurly tries to squash the "no-good coward" with thrown boulders. To further complicate the poor PC's life, each boulder that misses smashes away a 5'-wide section of the rotten floor, showering dust and debris everywhere; the PC must make a Dexterity check with a +6 bonus or fall through. Fortunately, 20% of the time the falling debris strikes the scorpion for 1-6 hp damage. The player should be allowed the pleasure of making these damage rolls.

After throwing a few boulders directly at the PC, a giggling Hurly may decide to smash away the floor all around the

PC to send him plunging down into the scorpion's embrace. Draw the area out in scale and use a miniature for the PC while keeping track of floor damage. If the PC just hangs on the rope or climbs up to the ogres' floor, Burly grabs the rope, snaps it, and drops the PC into the scorpion's clutches—his enormous strength allows him to shake off even the strongest PC.

As mentioned earlier, the DM must keep careful track of time. The roc's flight to the tower takes three minutes, and Burly must wait 1-3 minutes for the PC's net to stabilize before Burly can start the ratchet device. If the PC deliberately rocks or swings the net, Hurly throws a boulder at him and tells him to "settle down some, or else." Once the ratchet starts, it takes exactly five minutes for the PC to reach the second floor, and another five minutes for him to come within reach of the pincers. If the PC spends two rounds spinning and wobbling in the net, he will not be attacked by the scorpion until the six-

teenth round after he is snatched away from his friends, or the eighteenth round if the pulley broke his fall.

To the Tower

While all this is going on, the other PCs are probably hurrying to help their companion. The forest is too dense for horses, so the PCs must fly or run. To determine how many rounds it takes the PCs to reach the tower, divide 60 by their Movement Rate. For instance, a PC with a MV of 6 needs 10 rounds to reach the tower ($60/6 = 10$). A PC with a MV of 9 reaches the tower in seven rounds ($60/9 = 6.67$, rounded to 7).

For quick reference, the time it takes PCs to reach the tower is summarized on the Action Table. If the party sets out as soon as the roc takes their companion, anyone with a MV of 9 arrives at the tower nine rounds before the victim is in pincer range ($16-7 = 9$), assuming the trapped PC does not jam the pulley and spend two rounds spinning in the net. Once the PCs reach the tower, read the following:

Peering through the last few trees, you see a clearing ahead. The clearing is perfectly circular, with not so much as a tiny sapling within its bounds, so it is obviously not a natural feature. In the exact center of this clearing is a cylindrical tower made of weathered gray stone. It is about 50' high; the bottom half is 50' in diameter, fanning out to 60' in the top half.

The tower is very old; its walls are heavily weathered and bits of masonry have fallen to the ground. Just to your right is a barred door at ground level, and to your left is an open window 35' off the ground. From the open window, you hear loud guttural voices laughing and shouting.

If the PCs ask what the ogres are saying, read them some of the conversation from above, but omit any references to a scorpion, Chomper, etc. It would be a shame to spoil the surprise for any would-be rescuer who runs right up and unbars the door. The adventurers should hear just enough to realize that their companion is in big trouble.

The clearing is well maintained by the ogres, since they don't like the idea of someone sneaking up on them. A trip wire connected to a bell runs all around the edge of the clearing. Each person who enters the clearing without first

successfully checking for traps has a 75% chance of tripping the wire and ringing the bell. The ogres are far too engrossed in their fun to notice the PCs unless they set off the alarm or make a lot of noise. (For instance, by throwing a grapnel into the window.)

Hurly and Burly are not expecting pursuit. They don't understand loyalty very well, and they don't think anyone would be foolish enough to take on a mighty roc just to rescue a companion. If they notice the PCs, Hurly will assault them with a barrage of boulders while Burly keeps lookout from the opposite window. The PCs' attack diverts the ogres' attention from their victim, but the ratchet device will keep lowering him all the while the battle rages.

The Tower and the Ogres

The first two floors of the tower are empty and in total disrepair. The main door is located on the southwest side of the first floor. It is made of iron-bound wood, but is somewhat rotten. The door is barred from the outside and can be opened simply by lifting the bar. It can also be smashed open from the inside by someone making triple his bend bars roll; that is, if the PC has a bend-bars score of 10%, he has a 30% chance of success.

The tower roof and each floor has a 5' x 5' square hole that allows access to all floors below. At one time a ladder ran all the way up through the tower, so these openings are all directly above each other. The ladder and the wooden floor hatches have long since crumbled away. The brothers did, however, reconstruct a portion of the ladder from the third floor to the roof. They left the rest in ruins to prevent easy access to their quarters.

The third floor of the tower contains the ogres' stinking living quarters. This whole area reeks of something terrible, something dead and rotting, but the source isn't obvious.

Each of the windows has a pile of 10 boulders under it. Keep track of how many are used, since Hurly could run out. Piled on the floor is a strong rope ladder with hooks at one end. The ogres dangle this out a window when they need to climb into and out of their tower.

The only things of value here are the trunks. Hurly's contains five sable pelts worth 200 gp each, 15 pieces of silver dinnerware worth 50 gp each, a coffer containing a long roll of fine vellum worth 250 gp, and three beholder eye

Action Table

The Ogres

Rounds Action

- 3 Fly to tower
- 1 Burly climbs into tower
- 2 Free jammed pulley, if necessary
- 5 Lower PC to second floor
- 5 Lower PC from second floor to within scorpion's reach

The Trapped Hero

- 1-3 Disoriented due to spinning net
- 2 Struggle to freedom
- 2 Get small, accessible object
- 2 Use dagger to cut free of net
- 2 Aim wand or other device and fire it

The Rescue Party

- 20 Get to tower at MV 3
- 10 Get to tower at MV 6
- 7 Get to tower at MV 9
- 5 Get to tower at MV 12
- 4 Get to tower at MV 15
- 2 Get to tower at MV 30
- 1 Check for traps
- 2 Circle clearing perimeter to scout tower (50% chance to find the alarm)

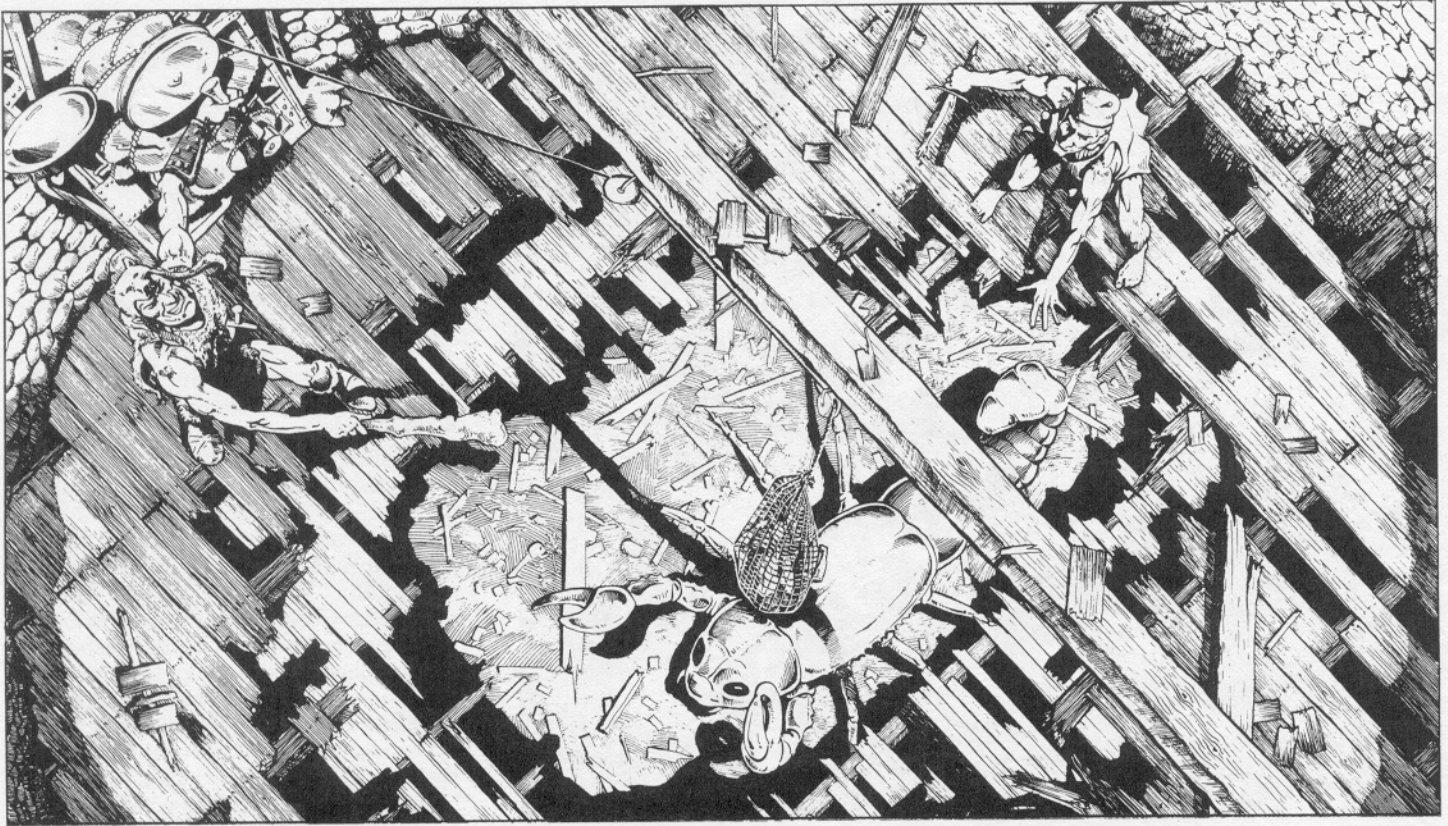

stalks. Burly's trunk is much larger, and has a big padlock on it. The source of the room's stench can be found crammed within. It is a beholder (missing three eye stalks, naturally) that has been dead at least a month. Burly didn't kill it, but he found its body and knew that it might be of value to some mage somewhere. The beast is actually too decayed to be of any use to anyone, but the PCs shouldn't be told this.

The beholder is bloated and tightly wedged inside the trunk, so great effort must be taken to pry or cut it out. If the PCs do so, they will find that it was resting on a beautiful silver flute. The flute is filigreed and jeweled, easily worth 2,500 gp. It is also enchanted and functions exactly as a *ring of animal friendship*, affecting all animals within 30' if played. The ogres do not know the flute is magical, or they would have used its power to *charm* the giant scorpion into following them to their tower. Still, if the scorpion survives, the PCs may yet use the flute on it. A PC who doesn't know how to play the flute may still use the item's magic, but its music will not be nearly as sweet, giving animals a +5 bonus to their saving throws. The flute has 15 charges remaining. Once the charges

are gone, it still functions as a flute of exceptional workmanship. Thanks to the beholder, of course, the flute should be thoroughly washed before anyone can stand to set lips to it. Otherwise, a successful Constitution ability check is required to avoid retching and nausea from the flute's foul taste and smell.

Some years ago Hurly and Burly spent some time in the company of a fire giant. The giant was rather small and was looked down upon by the others of his race, so he searched out some intelligent creatures who shared his evil outlook and who would look up to him. When he met the ogres and found that they accorded him the respect he was due, he took them under his wing for a while, treating them as favored pets. Since Burly was already a large, powerful ogre, the giant made him even more formidable by forging a great sword and armor for him. Hurly was more normal-sized, so he was taught the giantish art of hurling rocks. If one or both ogres escape, they will search for their giant friend, who will assist in hunting down the PCs if they remain in this general area.

Hurly: INT low; AL CE; AC 5; MV 9; HD 4+1; hp 18; THAC0 15; #AT 1; Dmg 1d8+6 (club); SA hurl rocks; SD catch

rocks; SZ L (9'); ML 12; XP 350; MM/272.

Hurly is clothed in stinking pelts and carries a big branch for a club. A heavy, dented iron kettle serves as his helmet. He walks with a stooped, hopping gait that, combined with his choice in clothing and weaponry, makes him look like a giant cave man. Hurly can hurl rocks accurately up to 200 yards for 2-12 hp damage, and he can catch large missiles thrown at him 30% of the time. He keeps 18 pp in his boot as an emergency reserve fund.

Burly: INT low; AL CE; AC 2; MV 6; HD 4+1; hp 26; THAC0 15; #AT 1; Dmg 2d6+7 (sword); SZ L (10'); ML 12; XP 350; MM/272.

Burly is much bulkier and stronger than his brother, so he gains increased damage when using weapons. He wears splint armor of fire giant design and wields a huge sword. The 6'-long, blue steel blade is a long sword to him but would be a two-handed sword in human hands. With his size, strength, and armor, Burly is clearly the boss of the family, and he likes to give his brother a good thrashing every now and then to make sure that fact is not forgotten. Burly wears a pouch containing 25 gp and three green spinels worth 300 gp each. Ω



MY LADY'S MIRROR

BY CHRIS PERKINS

Shattered beyond repair

Artwork by David Kooharian

Chris Perkins writes: "I designed the maps for Lady Avacia's castle in 1986, taking full advantage of its 'Dracula Meets Walt Disney' appearance. The adventure, a 'castle crawl,' went through many transformations until, in 1993, "The Lady of the Mists" was published. I had the good fortune of playtesting that adventure, and what follows is my humble continuation of Peter Åberg's inspiring tale. Thanks, Peter."

"My Lady's Mirror" is an AD&D® adventure for 4-8 player characters of levels 6-8 (about 40 total levels). The party should have several magical weapons, and a broad variety of character classes is recommended. This adventure was written as a companion to Peter Åberg's "The Lady of the Mists" (issue #42). "My Lady's Mirror" can take place weeks or even years before or after the events with Lucilla Germanicus are played out. Designed as a stand-alone adventure, this module can also be used as part of an ongoing campaign.

The DM should read through each section of the module carefully, particularly the gallery of NPCs provided on pages 58-59. As with "The Lady of the Mists," familiarity with the personalities and motivations of the major NPCs is crucial to running this adventure. Magical items from the *Tome of Magic* are indicated with an asterisk.

Adventure Background

The heroes have spent the last several days in the quiet, secluded town of Relvaunt, located in the heart of Jaernef, a neighboring kingdom to Archstedt (the realm where "The Lady of the Mists" takes place). Relvaunt's vineyards, wines, and scenic beauty are the subject of bards' songs, and many travelers journey long miles to visit them. Another site receives far fewer visitors—several miles east of town, partially obscured by woods and hills, stands the wondrous Castle Freitstein.

The castle has long been home to the mysterious Lady Avacia and her dedicated staff of servitors. Lady Avacia is something of an enigma to the people of Relvaunt, for few have actually met this seemingly ageless woman. Her castle is more familiar to the locals: a majestic, towering structure of unparalleled architecture, certainly one of the finest in all of Jaernef. Soaring above the landscape and reaching up to the heavens, the castle

remains untouched by the passage of time. So, too, does its occupant.

Lady Avacia's Secret

Three days ago, the beautiful mistress of Freitstein Castle told her servants that she was leaving "to visit friends in the capital." Nothing much was happening around Relvaunt, so Avacia decided that a week-long sojourn to distant Novolon—Jaernef's capital—was needed. Using magic known only to the eldest wizards, the youthful Avacia *teleported* away, entrusting the careful maintenance of her magnificent castle to her servants. (The true purpose of Avacia's visit to Novolon is detailed in "The Tryst," below.)

Avacia married only once. Her husband, Gareg Freitstein, died years ago, and many of Gareg's closest acquaintances were convinced his death was part of Avacia's plan to inherit the Freitstein estate. They believed she enjoyed watching her husband age while she remained young, when in fact Avacia had offered him potions of *longevity* and he declined. (Gareg wished to live a full life, not an endless one.)

Avacia rarely entertains guests and has gone to great lengths to ensure her privacy, using disguises and magic to travel unnoticed. Her servants, hired from the nearby towns, are the first to confess that Lady Avacia is not an overly sociable woman.

Despite the passing decades, Avacia has been miraculously preserved; her features seem ageless. The townspeople secretly believe that Avacia takes potions of *longevity* to preserve her striking good looks. In fact, she has invested large sums over the years to acquire such rare concoctions, but these are simply red herrings. Avacia doesn't need such potions, but she seeks them out to keep the true source of her longevity a secret. Lady Avacia has many secrets, some of which she's kept for hundreds of years.

The Dark Rose

Avacia is the sister of Lucilla Germanicus, the extraordinary heroine who figured prominently in "The Lady of the Mists." During their adolescence, the sisters had a parting of the ways. Lucilla's closely knit group of friends referred to Avacia as "the dark rose," for though she was as beautiful and elegant as her older sister, she lacked Lucilla's

charm and social graces. She was selfish and somewhat cruel. Lucilla's popularity blossomed like a rose, and so too did Avacia's jealousy (a rose laced with thorns). Envious of Lucilla and intolerant of her socialite friends, Avacia withdrew from her sister's castle and struck out on her own.

Avacia attached herself to many young nobles in an effort to make her life more prosperous and pleasant than her sister's. Many young suitors were drawn to Avacia by her beauty and charisma, only to turn away at the last moment when they saw Avacia's deeper selfishness, desperation, and jealousy. Ultimately, she always said or did the wrong thing and spoiled relationships that she'd spent months cultivating. One man who was not deterred by her flaws was Lord Freitstein. He had been married once before to a capricious woman who made Avacia seem saintly by comparison. The lonely and aging Gareg treated Avacia like a goddess, which is exactly what Avacia needed.

After finding success and stability, Avacia decided it was time to reconcile with her sister, if only to quell the ill feelings that lingered in her heart. Using a *crystal ball* to peer into her sister's life, Avacia learned that Lucilla had stumbled on the secret of immortality and was preparing to share it with her closest friends. Avacia was convinced that her sister was deliberately shutting her out, and jealousy boiled within her. Actually, Lucilla intended to offer the elixir to Avacia once she could arrange a reunion, but she was aware of how difficult a reconciliation might be, considering how the sisters had grown apart over the years.

Avacia wasn't interested in reconciliation. Ever impulsive, she used her magic to sneak into her sister's laboratory and drink a double dose of the immortality potion while Lucilla was entertaining guests. To Avacia's knowledge, Lucilla never uncovered the deception. A series of tragic events that occurred after Avacia's departure convinced Lucilla to revoke her own immortality, as well as the immortality she had bestowed on her former friends (see "The Lady of the Mists" for details). Through it all, Avacia remained untouched and eternal.

In fact, Lucilla knew about her sister's theft but chose to do nothing: she could never harm her own sister. Later, when the immortality potion wore out, Lucilla

knew that Avacia's time would come soon enough, for the double-dose's effect would dissipate just as the others had. The same fate that befell Lucilla would, in time, ensnare her sister.

Although decades have passed since Avacia took the potion, she still resents her sister. If this adventure takes place prior to Lucilla's "fall," Avacia is simply watching Lucilla's once-glorious castle fall into disrepair and ruin. Lucilla's transformation from "popular host" to "brooding recluse" does much to satisfy Avacia's cruel sense of irony.

If this adventure takes place after the tragic events of "The Lady of the Mists," Avacia will have convinced herself that Lucilla took her own life, as well as those of her friends, in a moment of weakness and self-pity. She blames her sister's death on a ruined love affair with the mage Dexter Swartz (who met a terrible end in Lucilla's castle), but in fact Lucilla died a noble death. On the surface, Avacia feels vindicated for all the years she stood in Lucilla's shadow, but she cannot forgive herself for deceiving Lucilla or hating her sister the way she did.

Avacia still believes she is immortal. Although she "maintains appearances" by investing huge sums of money in potions of *longevity*, she's never had to drink them. Lucilla's potion has served her well, although its effect may last only a few more years (DM's determination). When the time finally comes and her immortality begins to slip away, this investment will no doubt prove to be her last recourse . . . and her sole salvation.

The Tryst

Lady Avacia rarely leaves her castle, although she has been seen in Novolon on occasion, usually by aristocrats with an eye for beauty. When she does leave the confines of her castle, her reasons for doing so are usually obscure: a search for spell components, investigating some mystery, or searching for novelty to slake her jaded tastes.

For the last several months, Avacia has been a willing participant in an illicit affair with a young nobleman from the capital city. The gentleman's name is Lucien D'Mir, and he is betrothed to a young lady from a rival family. In fact, his marriage is supposed to end years of feuding between the two noble houses. But the affair has given

Avacia a new lust for life and romance, and Lucien is unable to resist her natural charms. Since discretion is her prime concern, Avacia has never mentioned her reason for visiting the capital, not even to her reliable staff. However, her secret tryst was nearly exposed when Nora, the head maid, found one of Lucien's letters stuffed under the mattress of Avacia's bed. Luckily, Avacia was nearby and cast a *forget* spell on the elderly maid!

Despite Avacia's best efforts to keep the affair a secret, her trusted manservant Kreswick observed some very peculiar behavior in his mistress. Her demeanor was unusually pleasant, her moods much more free-spirited. A worldly man, Kreswick realized that his mistress was behaving like a lonely woman in love. Fortunately for Avacia, Kreswick is as discreet as he is loyal.

The Shattered Mirror

Three days ago, Avacia decided on a whim to visit Lucien in the capital. As usual, Kreswick was entrusted with overseeing the castle in her absence. Ever attentive to detail, he assigned two maids the task of cleaning Avacia's bedchamber—and then tragedy struck. By accident, a young maid named Crystal knocked over Avacia's full-length bedroom mirror, shattering into a thousand glassy shards. Unknown to Crystal or the other staff, the 300 year-old antique was a *mirror of life trapping*, and its destruction released 16 prisoners trapped within.

The *mirror of life trapping* was just one of Avacia's dark secrets. Although a few of the mirror's occupants were confined before it fell into Avacia's hands, most of the prisoners were trapped inside the mirror by Avacia herself. The captives include several of Avacia's former lovers and ancient adversaries. All of them have been subjected to the slow passage of time, languishing for years or decades in their dimensional prisons.

The sudden release of all 16 prisoners resulted in a brief but bloody skirmish that left several dead or wounded. Only the charismatic survivors kept the others from annihilating each another. Several of these NPCs harbor a strong resentment toward Avacia, and most are angrily awaiting her return.

Only two members of Avacia's household escaped the chaos: Nora, the head maid, and Kreswick. Minutes after the

mirror's prisoners were unleashed, the clear-thinking Kreswick ushered Nora out of the castle, and together they fled to nearby Relvaunt. The castle garrison and the remaining staff held the vengeful NPCs at bay long enough for the elderly pair to make good their escape. Those who survived either sought refuge in the castle or surrendered as prisoners.

For the Players

As the PCs leave Relvaunt in search of adventure, they are approached by Kreswick and Nora:

An elderly couple dressed in plain black servants' attire staggers toward you. The woman, her face ghostly pale, is clinging awkwardly to the elderly gentleman beside her. One hand is clutched tightly to her chest, and she is gasping for breath. The old man calls out to you for help, but before you can reach them, the frail old woman collapses to the ground.

The strain of recent events has been especially cruel to Nora's weak heart. Although her collapse is mostly due to exhaustion and panic, the hasty trek from Castle Freitstein has aggravated her condition. She must rest, and Kreswick insists that she be taken directly to the temple in Relvaunt.

Kreswick and Nora (0-level humans): AL LG; AC 10; 0-level; hp 6,2; THAC0 20; #AT 1; Dmg by weapon type; ML 9; unarmed.

Only a *heal* spell will permanently cure Nora, but the clerics at the temple in Relvaunt will ensure that she gets the proper rest. In the temple, Kreswick explains why he and Nora came to Relvaunt in the first place:

"Both Nora and I serve the noble Lady Avacia, mistress of Freitstein Castle. We came to Relvaunt on her behalf in the hope of finding someone to help with an urgent matter.

"Three days ago, my mistress left to visit some friends in the capital city. As usual, I was placed in charge of things until her return. Earlier this morning, I asked Nora if she would help the maid Crystal tidy up my lady's bedchamber, and I went about my business. Less than an hour later, though, I heard a loud crash.

"At first, I thought Crystal had broken another of my lady's antique decanters. She was such a clumsy girl. But I knew the noise was much too loud for a mere decanter. Then Nora came stammering down the hallway, shouting that Crystal had knocked over my lady's antique mirror and shattered it in a thousand pieces.

"Nora said she saw strange creatures emerging from the shards of broken glass, one of whom seized poor Crystal just as Nora turned and fled the chamber. I dare say, I doubted poor Nora at first. But then, my lady owns many unusual treasures. That mirror was particularly valuable, though obviously my lady saw fit to keep its true nature a secret.

"The castle guards responded quickly to the intruders. During the ensuing battle, Nora and I fled the castle and hurried to Relvaunt. If only I had eased my pace, Nora would not have suffered so! But now I fear for the safety of my mistress, Lady Avacia, and the rest of my staff. The denizens of my lady's mirror are no doubt awaiting her return, and I fear her life is threatened as long as the invaders remain within the castle. I implore you—venture to Castle Freitstein and undo the damage that has been done. Rid the castle of its evil before my lady returns. Before it is too late."

Kreswick does not like to talk about his mistress' private life or his long-standing relationship with the Lady of Freitstein Castle. He suspects Avacia is having an affair with an unnamed gentleman from Novolon, he believes her longevity comes from very expensive magical potions (too expensive to share with her household), and he knows she's a mage with powers beyond her apparent years.

Kreswick and Nora are the oldest members of Avacia's staff, but even they were not hired until several years after Lord Freitstein's death, so serving Avacia has always been their first and only charge. The years spent living in Castle Freitstein have taught Kreswick many things. For one, he knows that Lady Avacia, despite her tolerance for other people's mistakes, can be quite cruel and spiteful. Kreswick wants to rescue the remaining household, preserve his

lady's possessions, and clean up the "mess" before Lady Avacia returns. She did, after all, leave him in charge of things, and Kreswick has no wish to displease her.

Kreswick can give a fairly detailed description of the castle interior, although he's not much of an artist. (Prepare a rough sketch if the players ask.) Before the PCs set out for Castle Freitstein, Kreswick tells them the command word to get past the outer gates (area B).

For the Dungeon Master

As far as the players are concerned, their PCs are being hired to rid Lady Avacia's castle of several evil monsters and NPCs accidentally released from the *mirror of life trapping*. In all likelihood, the details of Avacia's past, not to mention her link to Lucilla Germanicus, will not be revealed until the PCs explore her castle. Even then the PCs may remain oblivious to the origins of Avacia's apparent immortality, especially if they haven't met the mysterious Lucilla ("The Lady of the Mists").

Kreswick cannot pay the adventurers for their help. Lady Avacia, on the other hand, is quite wealthy (although Kreswick cannot vouch for her generosity). Good-aligned PCs may want to ensure that the captured members of Avacia's household are spared. The Lady's servants are, after all, innocent pawns in this whole affair.

Avacia's Antagonists

Most of the NPCs unleashed in Castle Freitstein share a common objective: to strike back at their old adversary, Avacia Freitstein. Years of imprisonment have left these NPCs outraged or insane. A tenuous truce exists between the individuals who now occupy Castle Freitstein. Some have banded together, while others have remained solitary. The castle is large enough to provide each NPC a space in which to plot revenge.

Not all of the NPCs are aware of Avacia's immortality, but only one individual, Kharl von Zaard (the "Immortal Hunter"), knows the secret to killing an Immortal. The shrewd Avacia stayed one step ahead of the zealous Von Zaard during their brief encounter, drawing him into the mirror before he could execute her.

The only way to slay an Immortal is by decapitation, and even then the head must remain detached from the body for

one full round to ensure death. Virtually everything else, from the mightiest of weapons to the strongest of poisons, is useless against Avacia. (One exception is the immortality potion antidote created by Lucilla, but this concoction almost impossible to obtain, and only Lucilla knew how to make more.)

Although Avacia is impervious to most of her enemies' attacks, the PCs are not. Most of the NPCs will regard the PCs as Avacia's allies. (They certainly know what Avacia does with her enemies.) NPCs who do not regard the party with abject hatred may try to sway the PCs to their side and conspire to eliminate Avacia once and for all.

The "Mirror Mortals" section describes six of the NPCs released from Avacia's magic mirror. The notes give the DM enough information (and freedom) to role-play these complex NPCs effectively. The castle's other occupants are lesser antagonists who are not given a full background. The DM may "flesh out" their backgrounds as required.

The PCs have roughly four days to rid Castle Freitstein of its new tenants before Lady Avacia returns. The timeframe, however, is flexible; the DM can extend Avacia's absence by several days, giving the PCs ample time to complete the necessary "house cleaning."

The Castle Grounds

The journey to Avacia's castle should be uneventful. Once the PCs are within sight of the castle grounds, read or paraphrase the following to the players:

Castle Freitstein is a commanding residence, monstrous yet elegant. Enclosed by a series of crenellated, ivy-covered walls, the great edifice towers above the landscape, casting its long shadow across the hillside. The castle walls consist of mortared bricks of silvery-gray, each speckled in a way that deftly captures the sunlight (or moonlight). Capping the tallest tower is a crystalline spire of gleaming glass.

The PCs may enter the castle grounds via the unguarded entrance (area A) or by scaling or flying over the surrounding walls. Neither route is especially hazardous. However, the closer the PCs get to the castle, the greater the peril. Vrinides—an evil barbazu freed from Avacia's magic mirror—has taken up residence in the castle and has sta-

tioned three gated abishai to guard the castle's innermost grounds. (They are usually positioned on the castle battlements, area 39, though their statistics are given in area F). The abishai have orders to attack anyone who dares approach within 100' of the castle.

From the castle battlements, the abishai have a clear view of the countryside, reducing the chance of a surprise attack. Unless the PCs approach using *invisibility* or camouflage, they will be seen. The abishai either swoop down on unsuspecting PCs (+2 to both claw attack rolls for double damage) or *teleport* and materialize behind their potential victims (-2 to surprise rolls).

The abishai can also create *advanced illusions*. They prefer to create the illusion of three armed guards rushing out of the castle to defend it from intruders. Each abishai can create only one guard, but the illusion is flawless, with all the visual, auditory, thermal, and olfactory attributes of an actual human fighter. (The DM may impose a -4 penalty to all disbelief rolls; see pages 82-84 of the *Player's Handbook* for details.) During battle, the fighters shout disparaging remarks such as "Foul knave! I shall have your head to lay upon milady's silver platter!" Once the PCs have been distracted, weakened, or rendered unconscious by the illusions, the abishai attack with surprise, using their spells and envenomed tails to dispose of enemies quickly. The illusions require only one (initial) round of concentration, after which they persist as programmed for nine rounds.

Illusory human fighters (3): INT average (same as abishai); AL LE (as abishai); AC 2; MV 12; F4; hp 30 each; THAC0 16; #AT 3/2; Dmg by weapon type +2; SD immune to mind-influencing attacks; ML 20; XP 120; plate mail, shield, broadsword (specialized). The illusory guards appear to die when reduced to 0 hp, but their bodies vanish only when the spell duration expires.

A. Archway Entrance.

A rough carriageway leads uphill to the emerald-green lawn of the castle courtyard. The only apparent entrance to the castle grounds is an open archway joined to a pair of unguarded turrets. Both the archway and the turrets show signs of age and neglect, but the masonry is nonetheless impressive.

Adventurers who inspect the moss-encrusted stonework of the archway will see a stylized "F" chiselled into its keystone. The turrets that flank the entrance can be entered via small, open doorways inside the grounds. PCs inspecting the turret interiors find nothing of value.

B. Enchanted Gates.

A heavy, wrought-iron gate bars your approach to Castle Freitstein. Flanking the gate are two ordinary stone gatehouses built into the adjoining walls.

Two gates bar the carriageway that leads to and from Castle Freitstein. Both iron gates have been *wizard locked* at 14th level. Lady Avacia enspelled them to deter unwanted visitors from coming any closer. The gates are programmed to open by themselves whenever the command word "Pharzael" is spoken within 30'. Only Avacia and her servants know this command word.

The four gatehouses are all empty and unoccupied.

C. Carriage House.

This stone, flat-roofed structure is detached from the main castle. Housed within its hollow interior is an exquisitely adorned four-passenger carriage of polished cedarwood. The sides of the coach are emblazoned with a stylized "F": the symbol of the Freitstein family.

Avacia rarely uses her carriage since she prefers to travel via *teleport* spells. She does take the carriage when she wants to hide her magical prowess, and once each spring Avacia takes the carriage to tour the countryside. Occasionally she lets her senior staff use the coach for family visits.

In addition to housing the coach, this building also contains barding for the horses (kept in area D) and apparel for the carriage driver. PCs who inspect the interior of Avacia's coach have a 1 in 6 chance of finding a secret compartment under the rear seat. This compartment holds two potions (*gaseous form* and *philter of glibness*) that Avacia keeps for emergencies, such as an ambush by marauders on a desolate stretch of road when she has no *teleport* spell handy.

D. Stables and Smithy.

These detached outbuildings actually consist of two buildings: a stone smithy and a wooden stable. Three blackened chimneys poke through the smithy roof. Just outside the stable is a 5' wide, stone-rimmed well.

The doors to the smithy are locked, and the padlock is of especially good quality (-15% to open locks roll). The smithy is orderly and clean, and the walls are lined with tool cabinets and crates filled with nails, horseshoes and pieces of unworked metal. PCs searching the cabinets for armor and weapons will find five spears, ten broadswords, and four disassembled suits of human banded mail.

The stable doors are locked (as above). Inside the stables are 10 horses: two draft horses (used for pulling the carriage in area C), six light warhorses, and two riding horses. The riding horses, named Phantom and Windwalker, are Avacia's pets. On occasion, Lady Avacia takes these prized steeds on long rides through her orchard (area E) or the nearby woods, usually in the company of an able horseman or bodyguard.

Also stored here are 10 saddles and several sacks of feed. Chain mail barding (AC 4) for the light warhorses is kept in a locked storage room at the back.

Draft horses (2): INT animal; AL N; AC 7; MV 12; HD 3; hp 15 each; THACO 17; #AT 1; Dmg 1-3; SZ L; ML 7; XP 65; MM/194.

Light warhorses (6): MV 24; HD 2+2; hp 12 each; THACO 19; #AT 2; Dmg 1-4/1-4; XP 35; other statistics as draft horses above.

Phantom and Windwalker, riding horses (2): MV 24; HD 2; hp 10 each; THACO 19; #AT 2; Dmg 1-2/1-2; XP 35; other statistics as draft horses above.

E. Apple Orchard.

A dirt trail weaves through this enclosed section of the castle grounds, enabling travellers to meander through a well-tended apple orchard.

In the summer, this orchard provides an abundance of sweet apples, though many rot and fall to the ground uneaten. (Avacia takes what she wants and leaves the rest.) As winter approaches, the trees take on a gnarled, lifeless appearance. When the cold finally sets

in, the barren orchard looks like a grove of giant petrified spiders.

F. Freitstein Castle.

The castle has two entrances. The ground floor entrance is preceded by a ramp and barred by a portcullis. The second entrance, no doubt the main entrance, can be reached by climbing a staircase to a balcony.

If the abishai have not yet created their illusions (see start of section), they do so as the party approaches the entrances to the castle. (The illusory guards emerge from the main entrance on the second floor). Given the chance, the abishai dive toward the PCs from the third floor battlements or *teleport* within striking distance of the adventurers. PCs have -2 to their surprise rolls in either event.

Green abishai (3): INT average; AL LE; AC 3; MV 9, fly 12 (C); HD 5+2; hp 36, 30, 26; THACO 15; #AT 3; Dmg 1-4/1-4/2-5; SA poison, dive (+2 to attack, double damage with claw attacks), spells; SD +1 weapons to hit, regenerate 1 hp/round, immune to fire and poison, half damage from cold and gas; MR 30%; SZ L (7' tall); ML 9; XP 8,000; PLANESCAPE™ MC/18.

Abishai can use the following abilities at will: *advanced illusion*, *animate dead*, *change self*, *charm person*, *command*, *infravision*, *know alignment* (always active), *produce flame*, *pyrotechnics*, *scare*, *suggestion*, *teleport without error*. They do not use their *gate* ability, but they use all other spells to fullest effect.

Any abishai that fails its morale check immediately *teleports* to safety (either to the battlements or Baator, more commonly known as the Nine Hells). Roll a morale check whenever an abishai loses half its total hit points. A group morale roll should be made whenever an abishai is slain. Abishai are worth lots of experience points and should not be overcome easily; generous DMs may award the PCs partial experience points for driving away the brutal baatezu.

Castle Freitstein

Surprising the inhabitants of Castle Freitstein should be difficult, and how the NPCs react to the party's incursion will determine the ebb and flow of the adventure. Most of the NPCs will

retreat to their strongpoints, labs, or other chambers and await the party's arrival, like spiders waiting patiently in the center of their webs. However, none of the NPCs are limited to a particular part of the keep, so the DM may exercise tremendous latitude when staging encounters inside the castle.

Whether the PCs enter the castle undetected or not, use the "Castle Encounters" table once they are inside.

Level One

1. Lower Entrance. The portcullis barring this entrance can be forcibly raised or lowered with a successful lift gates roll at -20%. If several PCs attempt to lift the gate at once (up to three maximum), their chances of success are combined into one roll at -20%. The winch is mounted on the wall beside the portcullis, out of reach of individuals outside the gate. Whenever the portcullis is raised or lowered by any means it rattles and grinds loudly, although no one will respond to the noise.

2. Storage Room.

This poorly lit chamber is replete with crates and pieces of furniture, many of them half-assembled or covered with faded dustcloths.

The many dark hiding places in this chamber are all currently unoccupied. Most of the crates contain old furnishings (candle holders, tapestries, dusty carpets, faded portraits, chairs, carved bedposts, and dishes). Some of these items are centuries-old antiques that would fetch a handsome price at an auction. Avacia considers most of these items junk, because they were purchased by Lord Gareg's first wife, Lady Sylvia. In fact, one neglected portrait depicts this unpleasant, cadaver-faced woman. Avacia found the portrait unsettling and had it removed from her sight.

3. Wood Storage.

Stacked along the walls of this unlit room are several cords of chopped wood used for fires. The piles are draped with cloth to protect them from dampness. Also stored here are several planks of timber and three spare carriage wheels.

4. Unlit Hall. This dark and dreary area is unguarded. The only adornments are two unlit torches placed in

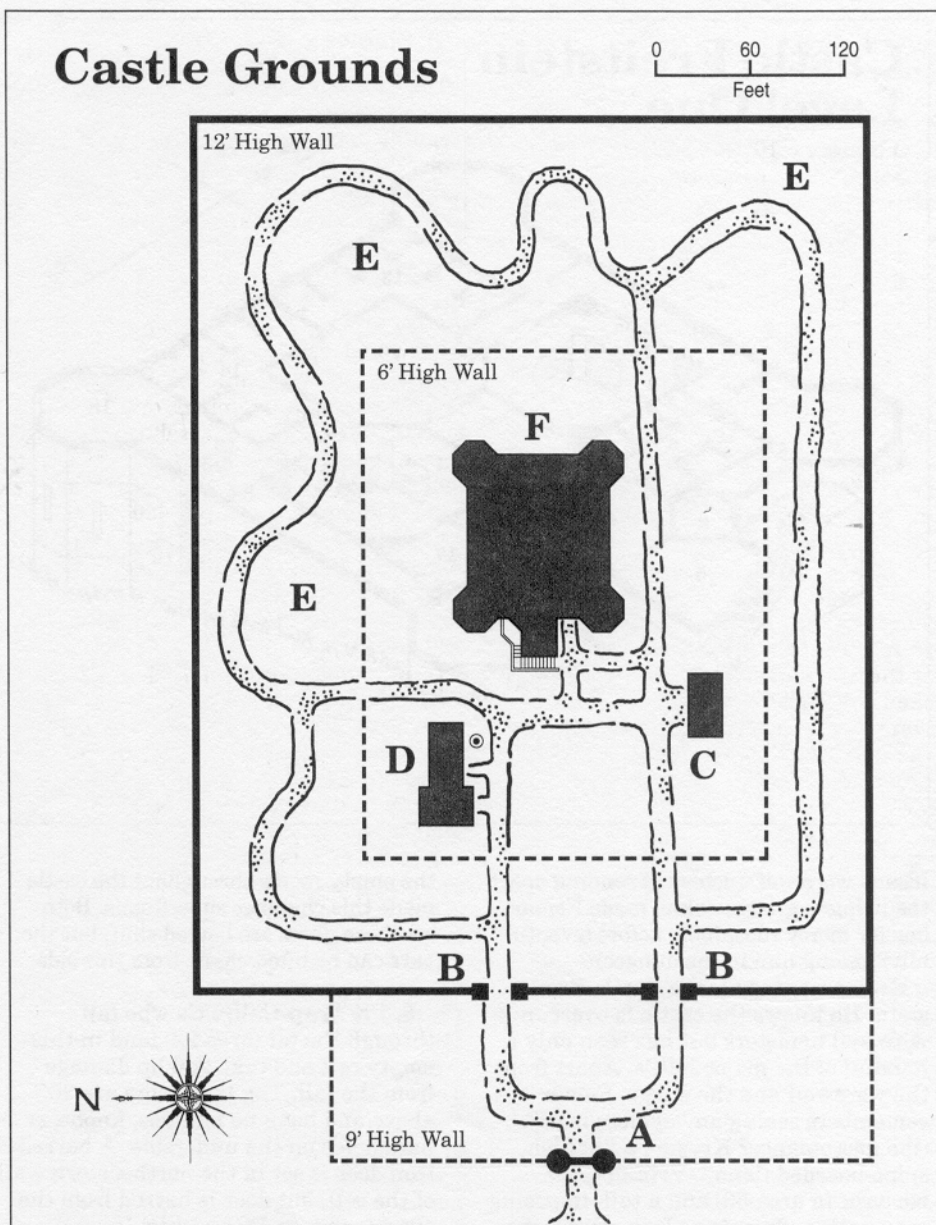

brackets on the walls.

5. Guardroom. This empty chamber is unlit and unoccupied. Four sets of bunks have been pushed against the walls, but the bunks are currently not in use.

6. Castle Dungeon.

Six iron doors line the walls of this dark corridor. Built into each door is a narrow window slit.

Two of the eastern cells (marked "T" on the map) are receptacles for the pit traps in area 37. All six cell doors are

bolted shut, although the bolts may be slid back by anyone standing in the hallway. The northern door leading to the empty barracks (area 7) is barred from the other side.

A faint moan echoes from one of the cells. In the northernmost cell on the west side of the cellblock is Eemar Fildrin, Avacia's faithful groom.

Eemar was among those left behind when Kreswick and Nora fled. Forced to fend for himself, Eemar tried to escape but was wounded by a stirge (one of the minor monsters released from Avacia's mirror). He freed himself of the stirge just in time to run head-long into Zekiel, the

Castle Freitstein Level One

1 Square = 10'

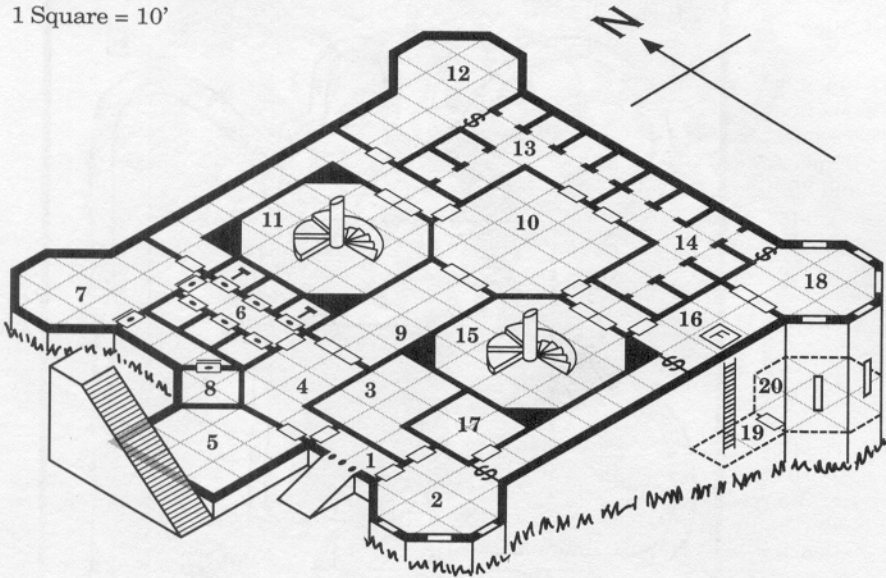

insane werewolf. Instead of rending apart the helpless groom, Zekiel made Eemar beg for mercy repeatedly before (eventually) tossing him in the dungeon.

Eemar wants to leave Castle Freitstein. He knows the castle is overrun with evil monsters but has seen only a handful of the major NPCs. Apart from the werewolf and the stirge, Eemar remembers seeing an "eyeless man" (the necromancer Krysm), a "hellish, spine-bearded fiend" (Vrinides, the barbazu in area 63) and a tall, imposing man with a gleaming black sword (the ex-paladin Kharl von Zaard). Given the chance, Eemar will run to the stables (area D) and leave on horseback. If the abishai survived their meeting with the PCs in the courtyard, they cut down poor Eemar before he reaches the courtyard wall.

Eemar: AL LG; AC 9; MV 12; 0-level; hp 1 (5); THAC0 20; #AT 1; Dmg by weapon type; D 15; ML 5; XP 150 (for rescue); keys to stables.

7. Empty Barracks. No furnishings indicate what this chamber was once used for. In fact, the room was originally set aside for additional barracks. However,

the empty rooms throughout the castle made this chamber superfluous. Both southern doors are barred shut, but the bars can be lifted easily from this side.

8. Pit Trap Cell. PCs who fall through the pit (area 22) land in this empty cell and take 2d6 hp damage from the fall. The trap doors are 20' above and have no handles, knobs, or handholds on the underside. A barred iron door is set in the northeastern wall of the cell, but door is barred from the outside to trap PCs within.

9. Hall of Tapestries.

Eight large tapestries hang from the walls of this dark, 20' wide corridor. The tapestries along the north wall depict a sylvan glade, a trickling brook, a white stag, and a satyr playing wooden pipes. The southern tapestries depict scenes of battle, some too bloody to describe in detail.

All eight tapestries are finely crafted (400 gp each) but are neither magical nor easily transportable.

10. Meeting Hall.

The floor of this chamber is tiled in black marble. Lit torches are placed in sconces along each wall, while part of the ceiling has been cut away to reveal another chamber directly overhead.

The overhanging room (area 27) and balcony (area 31) are 20' above the floor of this room. The hall is usually vacant, but it is a good place to stage a "random" encounter.

11. North Tower, First Floor. A spiral staircase with no bannister curls up to area 35 and down to areas 66-68. Unlit torches rest in brackets up and down the stairway's central pillar.

12. Laboratory.

Four tables stand side by side in the middle of this room. Draped over each table is a red sheet, its edges touching the cold stone floor. Resting on the first table are some peculiar metal instruments. The three remaining tables have cadavers on them. The corpses are dressed in simple attire.

The necromancer Krysm Darksight has just converted this chamber into a mortuary. The three corpses are the remains of Hengal, Skerrin and Vangar: Avacia's carriage driver, gardener and blacksmith. All three were killed by the blind necromancer and his *invisible* quasit familiar. Krysm is storing the corpses until he re-memorizes his *animate dead* spell.

This chamber serves as one of Avacia's labs. She experiments with magical items here and, every 10 years or so, develops magical items of her own. The metal instruments on the first table include primitive lenses and other intricate devices used for studying and adjusting small objects. The equipment is worth 2,500 gp.

Enias, the thief from area 33, was the first to explore this room. In fact, the *eyes of minute seeing* that he carries were pilfered from this chamber.

13. Ladies' Privies. Thick curtains are drawn over the alcoves in this unlit corridor. At the back of one privy is a secret door leading to the lab (area 12).

14. Gentlemen's Privies. This room is similar in all respects to area 13. A secret door at the back of one privy leads to the alchemical lab (area 18).

15. South Tower, First Floor. A spiral staircase ascends to area 29 and descends to area 69. Hanging on the walls are four ordinary soapstone masks (50 lbs. each) depicting a ram, a wolf, a tiger and a bull.

16. Guardroom.

A musky odor fills this unlit chamber, almost like the scent of blood. Four sinister shapes clutching long swords stand about the room, and their faces, sallow and white, stand out in the darkness.

Four of Avacia's slain guards stand watch here. Krysm transformed their lifeless bodies into zombies using an *animate dead* spell, then turned the ordinary zombies into juju zombies by making them drink a black, viscid liquid called *juju wine* (see POLYHEDRON® newzine #91). They attack the instant anyone enters the room, including other escapees from Avacia's mirror.

Juju zombies (☞): INT low; AL NE; AC 6; MV 9; HD 3 + 12; hp 30, 26, 25; THAC0 15; #AT 1; Dmg 3-12 or 1-8 (long sword); SD +1 or better weapons to hit (blunt and piercing weapons inflict half damage), climb walls 92%, immune to *sleep*, *charm*, *hold*, death magic, psionics, electricity, *magic missiles*, poison, and cold-based spells; SZ M; ML Special; XP 975; MM/373 (zombie). Juju zombies are turned as spectres.

The necromancer and his quasit lurk in the alchemical lab (area 18) and will hear any noises from this chamber. If they are alerted, Krysm casts his *wizard lock* on the doors leading into the lab (area 18). Krysm has modified this spell to invoke an additional effect: the locks and handles of both doors radiate an eerie green light as long as the *wizard lock* remains in place. Using his *ESP* spell, Krysm tries to assess the party's abilities before readying his offensive spells. (See area 18 for details.)

A red carpet covers the floor, adorned with various nonmagical designs. Hidden beneath the rug is a trap door with a recessed iron pull-ring. The trap door leads to the lower level (area 19).

17. Secret Armory.

A pair of wooden weapon racks stand against the far wall of this unlit chamber. Beneath the racks is a chest filled with crossbow quarrels.

Five fauchards, six broadswords, 12 spears, six heavy crossbows, and three light crossbows are mounted on the wall racks. Beneath the crossbows are 36 heavy and 25 light quarrels. Eight of the heavy quarrels are silver-tipped. Silver-tipped quarrels inflict the same damage as normal bolts.

18. Alchemical Laboratory.

Two unlit lanterns hang from the ceiling of this dark chamber, and red curtains are drawn over the windows. The floor is covered with triangular shards of broken glass. In the center of the room are two large tables, one badly scarred by fire and littered with broken beakers and other shattered apparatus. The other table and its contents appear jostled but intact. Standing behind the tables is a man in dark robes who seems at home in the darkness. He points at you accusingly.

The robed figure is Krysm Darksight (see "Mirror Mortals" section). His quasit familiar, Femur, is *invisible* and hidden among the alchemical apparatus in giant centipede form.

Krysm Darksight (human necromancer): AL CE; AC 9; MV 12; W10; hp 39; THAC0 17; #AT 1; Dmg by spell or weapon type; S 10, D 15, C 17, I 17, W 11, Ch 7; SD regenerates 1 hp/round (from quasit); MR 25% (from quasit); ML 12; XP 5,000; *vampire rod* (19 charges, see below), poisoned dagger (Dmg 1-3, save vs. poison or succumb to *feign death* for 3d4 turns, enough poison for three successful attacks), empty flask of *juju wine* (see area 16), spell book (contains spells given below).

Spells: *chill touch*, *magic missile*, *spider climb*, *unseen servant*; *choket*, *ESP*, *ghoul touch*†, *spectral hand*, *wizard lock*; *delay death*†, *hovering skull*†, *lightning bolt*, *vampiric touch*; *dimension door*, *eneration*, *Evard's black tentacles*; *animate dead*, *mummy rott*, *summon shadow*: (Spells marked with daggers (†) are described in *The Complete Wizard's Handbook*.)

Krysm's *vampire rod* is a unique +2 weapon; anyone struck by the rod is drained for 2d4 + 2 hp, which the rod's wielder gains. (The user's hit points cannot rise above his normal, uninjured amount.) Krysm has cast a *stoneskin* spell on himself (from a scroll), making him impervious to the first six attacks.

Femur (quasit): INT low; AL CE; AC 2; MV 15; HD 3; hp 17; THAC0 17; #AT 3; Dmg 1-2/1-2/1-4; SA poisonous claws (save vs. poison or lose 1 point of Dexterity for 2-12 rounds), *fear blast* (30' range); SD cold iron or magical weapons to hit, immune to cold, fire and lightning, regenerates 1 hp/round, *invisibility*, *detect good*, and *detect magic* at will, saves as 7-HD monster; MR 25%; SZ T; ML 9; XP 2,000; MM/201 (imp).

Despite his blindness, Krysm has no trouble "seeing" the PCs through the eyes of his quasit. (Femur's infravision allows the necromancer to see in the dark.) If his quasit is slain, Krysm casts a *hovering skull*† so he can see through the sockets of the magical skull.

To the first PC entering the room, he says "Allies of Avacia, you cannot stop me! I will have the secrets of immortality!" He then directs either his *lightning bolt* or *eneration* spell at the most dangerous PC. Talk and negotiations are not his style, and he quickly follows up with *magic missile*, *choket*, or *Evard's black tentacles* spells. In the meantime, Femur unleashes his *fear blast* to frighten away any PC spellcasters he sees.

If forced into melee, Krysm uses his poisoned dagger. His *stoneskin* spell absorbs six attacks; if he is wounded, Krysm uses his *vampire rod* to quickly recover lost hit points. If he is overwhelmed, Krysm uses a *dimension door* to flee to the summoning chamber (area 20). His quasit becomes *invisible* but keeps the party in sight. With the PCs still in view, the necromancer casts his *spectral hand* spell and attacks the PCs from a distance using his array of deadly touch spells.

Avacia's alchemical lab contains unusual concoctions, most of them failed experiments. Although she prepared many minor potions for her personal use, Avacia had to steal Lucilla's immortality potion. (Her attempts to uncover the formula by herself were all dismal failures.)

After his release from the *mirror of life trapping*, Krysm searched until he

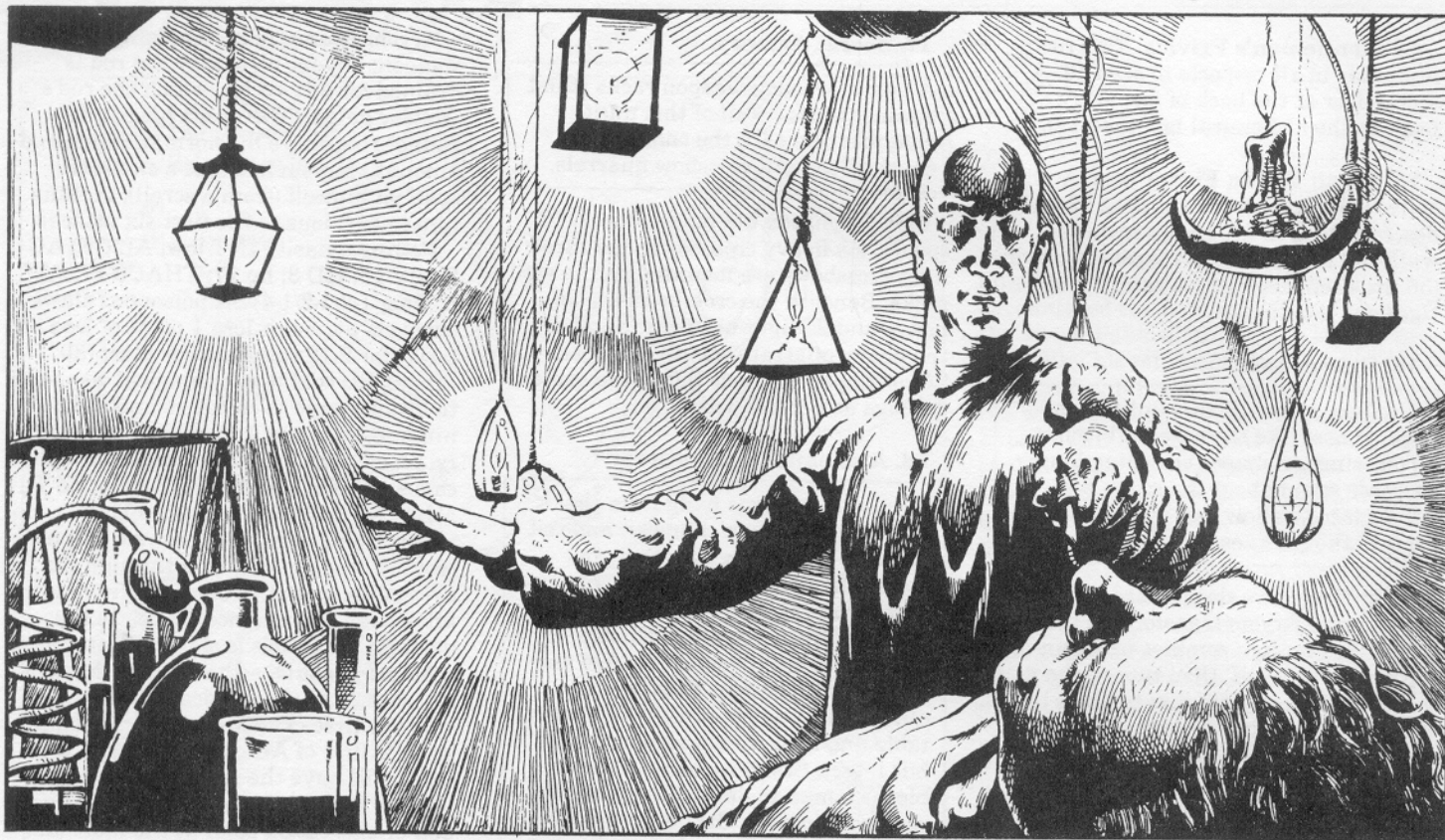

found Avacia's lab. He has spent the last several hours ransacking the chamber for Avacia's immortality potion. His reckless search led to the accidental explosion of several compounds atop one table. Fortunately for Krysm, his *stoneskin* spell absorbed the blast and his quasit is impervious to fire.

Not all the room's contents were destroyed in the blast. Several magical items on the second table survived: a *crucible of melting** and three unlabeled potions (*elixir of madness*, *fire resistance*, and a *philtre of stammering and stuttering*). Other items include an hourglass, a mortar and pestle, a retort, and many glass containers, most of them cracked or broken.

19. The Lower Level. If the PCs open the trap door in the guardroom (area 16), they will see an iron ladder descending into a dark, 20' long corridor. If the PCs prepare to descend the ladder, Krysm's *invisible* quasit assumes bat form and tries to follow them down (so that Krysm doesn't lose sight of them). Otherwise, Femur must leave the keep via a window and enter the tower's dark room (area 20) from the outside.

Krysm uses his *spectral hand* in conjunction with his touch spells for as long as possible. (The *spectral hand* lasts 20 rounds.) Before the PCs enter the summoning chamber itself (area 20), Krysm casts a *delay death*[†] on himself and a *summon shadow* spell to create reinforcements.

20. Summoning Chamber.

Uncovered windows allow only thin rays of light to enter this dark, octagonal chamber, just enough light to see magical symbols traced in gold on the floor. In the middle of the floor is a magical circle nearly 9' in diameter, its circumference inscribed with runes. Other ornate symbols are etched into the surrounding stone.

If he survived the fight in the lab (area 18), Krysm is standing on the far side of the room with a *delay death* spell cast on himself. Also in the room, virtually undetectable in the dimness, are three malevolent shadows.

Shadows (3): INT low; AL CE; AC 7; MV 12; HD 3 + 3; hp 24, 20, 19; THAC0 17; #AT 1; Dmg 2-5; SA drain Strength; SD +1 or better weapons to hit, im-

mune to *sleep*, *charm*, *hold*, poison, death magic, and cold-based attacks; SZ M; ML Special; XP 420; MM/312.

Krysm orders the shadows to attack fighters before he casts his remaining offensive spells. If he was wounded in the earlier confrontation, Krysm will have regained some of his lost points through regeneration (courtesy of his quasit). Femur stays out of sight until Krysm falls, at which point the quasit attacks, struggling to get close enough to capture his master's soul at his dying breath. That done, he returns to the Abyss that spawned him, a thin chuckle on his lips.

This room was set aside as Avacia's summoning chamber, although she seldom used it. Although she did summon one extraplanar creature, she found herself ill-prepared to deal with its savage temperament or vile manners. Since then, she has abandoned her research into conjuration.

The runes etched into the floor are ornamental and have no intrinsic magical properties. However, PCs who have dabbled in planar magic (or who have visited the planar city of Sigil) will recognize the runes as symbols representing the various outer planes.

Level Two

21. Castle Entrance.

Entry to the castle is barred by a pair of 10' tall, iron-bound oak doors. Mounted on each door is a bronze mask resembling a human face, one male and one female. A brass knocker is attached to the chin of each scowling visage.

If either knocker is lifted, the face it is affixed to speaks one of the following verses (courtesy of a permanent *magic mouth* cast at 14th level):

Left: Begone! You are not welcome here! I'll have no guests this time of year!

Right: I'll warn you once, now go away! I will not speak with you today!

Avacia cast the *magic mouths* to deter unwanted solicitors. The doors are not locked and can be opened easily.

22. Trapped Foyer.

Hanging on the walls of this entrance foyer are four wooden masks. Each mask depicts the same face but with a different expression: sorrow, glee, puzzlement and rage. A decorative mosaic adorns the tiled floor.

Set into the floor of this 14' × 14' foyer is a 12' square pit. The pit opens under 150 lbs. or more unless the lever in the guardroom (area 24) is raised. Unsuspecting PCs are dropped 20' into the cell below (area 8). PCs who make a successful Dexterity check at -8 can grab the pit's lip and avoid the fall. The pit doors stay open for one round before springing back to their original position. Once the pit doors close, they cannot be opened from the underside except by magic. The pit trap may be detected normally, although careful inspection of the mosaic floor is required.

The four wooden masks were carved by Avacia in her own likeness. A collector of masks, Avacia adorns many of her castle chambers with them. If the PCs have already met Avacia's sister, Lucilla (see issue #42), the masks will seem familiar to them. (Avacia bears a striking resemblance to her older sister.) The DM need not draw too much attention to this curious fact.

23. Great Hall.

A red carpet stretches from one end of this hall to the other. Ten suits of armor stand silently against the walls of this dark corridor.

Any loud noises in this hall are 90% likely to attract the guards (from area 24) and the half-orc in the captain's quarters (area 25). The guards arrive one round after being alerted and attack the PCs on sight.

The PCs may mistake the suits of armor for animated automatons, but these sinister sentinels are not enchanted.

24. Guardroom.

Four bunk beds line the walls of this lamp-lit chamber. The floor is partially concealed beneath a large round carpet emblazoned with a shield, while a round wooden table surrounded by eight chairs dominates the middle of the floor.

The contents of this chamber are ordinary. The guardroom is currently occupied by six human fighters, all of them *charmed* by Vrinides, the barbazu in the tower (area 63). The guards have orders to attack unwanted visitors on sight. When not actively defending the keep, the guards sit around the table playing cards with their swords nearby.

Set into the northeastern wall is a 10' iron lever that activates the pit trap in area 22. When the lever is moved into the "up" position, the pit is locked shut, and only *knock* spells can open it.

Human fighters (6): AL NG (*charmed*); AC 4; MV 9; F2; hp 10 each; THAC0 19; #AT 1; Dmg by weapon type; ML 12 (18 while *charmed*); XP 100 (for rescue); banded mail, long sword, 3d8 sp each.

25. Captain's Quarters.

Against the eastern wall of this room, underneath a banner depicting massed army of horsemen bearing flags, is a large, comfortable-looking bed draped in furs. At the foot of the bed sits a chest. Next to the door stands a two-door wardrobe. A sinister, snarling figure is picking through the wardrobe's contents.

This loathsome character is Ludwig, a treacherous half-orc renegade who

escaped from Avacia's mirror. Ludwig was one of three half-orcs trapped inside the mirror; his cohorts, Olec and Jalke, were killed in a skirmish with several other escapees. (The dead half-orcs can be found in area 49.) Wiser than his half-orc colleagues, Ludwig turned against his companions in the heat of battle. He has since sworn an oath of loyalty to Nekrul (see area 38 and the "Mirror Mortals" sidebar). Ludwig is supposedly helping the evil knight find his missing armor. In fact, Ludwig is looting the castle for himself.

If Ludwig is reduced to half hit points, he will flee if he can or surrender if he must. If captured, Ludwig will lead the PCs straight to Nekrul in exchange for his freedom.

Ludwig (half-orc fighter): AL CE; AC 6; MV 12; F4; hp 32; THAC0 16; #AT 1; Dmg by weapon type (2d4 + 1 with war spear); S 17 (+1/+1), D 12, C 13, I 9, W 11, Ch 6; ML 10; XP 120; studded leather, small shield, barbed war spear, *dagger* +1, jermlaine skull necklace, four chunks of amber (100 gp each) in pouch.

The pouch containing the amber and magical dagger are among the loot recently added to his trove. Other items Ludwig has acquired are hidden in the unlocked chest at the foot of the bed: nine gold dishes (1d10 × 10 gp each), a thin, platinum-studded leather belt (150 gp), and a solid silver mask (from Lady Avacia's bedchamber). The last item is a *mask of transformation* that instantly changes the wearer's gender (no saving throw). Wearing the mask a second time does not return the wearer's original gender; only a *remove curse* or *limited wish* can reverse the effect. The mask is worth 1,200 gp for the pure silver alone. Ludwig is unaware of its enchantments.

26. Barracks.

A dozen beds occupy this corner chamber. Most of the beds are unmade, as if the occupants were suddenly aroused from their slumber. Hanging from hooks along the walls are several articles of clothing.

The guards who once lived here were either *charmed* by the evil barbazu (see area 63) or killed during the initial confrontation with Avacia's antagonists. The room is currently unoccupied. Its contents are ordinary: cloaks, boots, bed linens, and worthless personal effects.

Castle Encounters

Check for random encounters every turn the PCs are inside. A roll of 1 on 1d6 indicates that a random encounter occurs; roll d% to determine what they meet. If the character encountered has already met the PCs and been defeated, no encounter occurs.

01-13 Nekrul (see area 38 and "Mirror Mortals") is searching for his magical plate armor. He attacks on sight unless heavily outnumbered, in which case he withdraws to his private suite (area 38).

14-36 **Zombies** (4): hp 16, 11, 9, 6; other statistics in area 42. These former guards are wandering the corridors looking for intruders. They wear bloodied banded mail and attack with their claws.

37-42 Ettel the doppelganger (see area 38) is wandering the halls, helping Nekrul search for his missing armor or making contact with other escapees from Avacia's mirror. Ettel is disguised as Crystal the maid or some other "harmless" servant.

43-52 Ludwig the half-orc (see area 25) and 1d4 + 1 castle guards from area 24 are searching for intruders. The guards have been *charmed* to follow the half-orc's orders and attack intruders on sight. Ludwig himself retreats if reduced to half hit points.

53-59 Lady Melora DeVay and the werewolf Zekiel (see area 44 and the "Mirror Mortals" sidebar) can be heard bickering in the distance. Zekiel is trying to persuade Melora to "give in to passion." Melora, fed up with Zekiel's pestering, tells him in no uncertain terms to begone. Zekiel's lupine senses alert him to the party's presence, and they withdraw to a safe distance, or back to the private dining room (area 43). If the PCs dare follow, Zekiel turns on them.

60-67 Femur the quasit (see area 18) is scouring the castle for intruders. The

quasit remains *invisible* to avoid detection but may attack lone PCs who seem vulnerable. If wounded, the quasit assumes bat form and flutters out the nearest window.

68-75 Kharl von Zaard (see area 30 and "Mirror Mortals") is stalking the halls, using his rogue abilities to move around unnoticed. When he sees the PCs, he withdraws to a safe hiding place and uses his *ring of x-ray vision* to watch them through a wall. If he's seen, Kharl either retires to the library (area 30) or steps forward, announcing himself as Lady Avacia's "knight protector" and demanding that the PCs leave Castle Freitstein immediately. He does not fight the PCs unless he knows he can win.

76-81 Kazang, the red abishai (see area 63), uses *change self* to appear as a wounded guard. The guard staggers to the party and collapses on the floor. If the foolish PCs offer assistance, Kazang grabs the nearest (requiring an attack roll against AC 10 plus Dexterity bonuses) and *teleports* back to the tower (area 63). Once it has a single PC in its clutches (and the help of the barbazu), it either *charms* the PC or kills him and animates the corpse. If its initial attack fails, Kazang uses its poisoned tail and spells to overcome as many PCs as possible before retreating to the tower.

82-93 Enias the thief (see area 33) is moving around in his servant disguise, guided by his *wand of metal and mineral detection*. He is pilfering items, storing them in his *bag of holding*. If asked why the castle's occupants let him wander around, Enias says he's pretending to be *charmed* when really he is not. He can lead the PCs to other NPCs but won't place himself in unnecessary danger.

94-00 Needle the stirge (see area 50) feasts upon the blood of any intruder it finds. (This low-risk encounter works best against a single PC.)

27. Avacia's Gallery.

This vaulted chamber is radiantly lit. Light spills forth from the eyes and mouths of four masks mounted on the angular walls that flank the western doors. Several other masks, each unique, adorn the plastered wall. Six marble pedestals crowd the floor, each of them supporting a carefully sculpted bust of the same subject.

Through a 30'x20' opening in the floor, you can see part of the room below. A chiselled stone wall encloses the perimeter.

The glowing masks are the result of four *continual light* spells cast by Avacia. The room contains eight wooden masks and four ceramic masks (many of them created by Avacia herself). Each mask has its own unique expression, its own peculiar countenance. For Lady Avacia, every mask represents an individual, and each mask adds a unique image to her collection.

The clay busts are the work of a timid sculptor who became infatuated with Avacia shortly after her husband's death. All of the busts depict Avacia, capturing her beauty in clay. When Avacia rejected the gentle sculptor's advances, the distraught artist killed himself. Out of remorse and guilt, Avacia bought the busts from the sculptor's family and placed them in her gallery. PCs who know Lucilla will see something familiar in the sculptures. A successful Intelligence check at -10 is necessary to place the resemblance.

28. Alcoves.

Two exquisite statues of white marble stand in these alcoves. The statues depict twin nymphs, beautiful and scantily clad. Leafy wreaths adorn their brows and tilted goblets are held in their delicate, outstretched hands.

These attractive statues were purchased by the lusty Lord Gareg. Each statue is 5' tall and stands atop a 2' high cylinder of black marble. The goblets are part of the stonework and cannot be removed.

29. South Tower, Second Floor. This chamber is illuminated by four torches placed in sconces along the angled

walls. Three tapestries depicting mountainous winter landscapes (worth 800 gp each) hang from iron rods along the north, west, and south walls.

30. Library.

This chamber is illuminated by a single, shimmering globe of light that hovers above a round, barren table in the middle of the floor. Hundreds of books are packed into 3' high bookcases along the walls. Hanging between the elaborate stained-glass windows are four black banners embroidered with gold thread and tracery. Several comfortably padded chairs are placed about the room in orderly fashion.

Sitting in one of the padded armchairs is the brooding ex-paladin, Kharl von Zard (see "Mirror Mortals"). The PCs may not notice him immediately, despite his imposing stature. He wears the tunic of a paladin's order (emerald green with a gold dragonne emblem), over which he has draped his magical *cloak of protection* +2. His shield leans against the chair, while strapped to his side is his sheathed, sentient *vorpal sword*.

Kharl's *ring of x-ray vision* makes him very difficult to surprise. He's been watching the PCs through the nearest wall or door while telepathically conversing with his sword.

Kharl is patiently awaiting the return of Lady Avacia. He harbors no animosity against the PCs unless they provoke him. Nevertheless, he is curious why the PCs have come. If the PCs question him, Kharl claims to be a Knight of the Emerald Order on a mission to kill the "evil sorceress" Avacia, whose malevolent escapades have caused much anger in the city of Novolon. Kharl dissociates himself from the other "mirror mortals," claiming they are either Avacia's allies or her unleashed enemies. Rather than waste his time "fighting these monstrous minions," Kharl says he is waiting for Avacia's return, at which point he will complete his task. If the PCs attack him, he retaliates with a savage swing of his sword.

Kharl is saving his *protection from magic* scroll for Avacia's return but will not hesitate to use it if attacked by PC spellcasters. His *vorpal sword*, when drawn, enables Kharl to *detect invisible* PCs within 10'. If combat erupts, the sword casts its *strength* spell on Kharl,

Castle Freitstein Level Two

1 Square = 10'

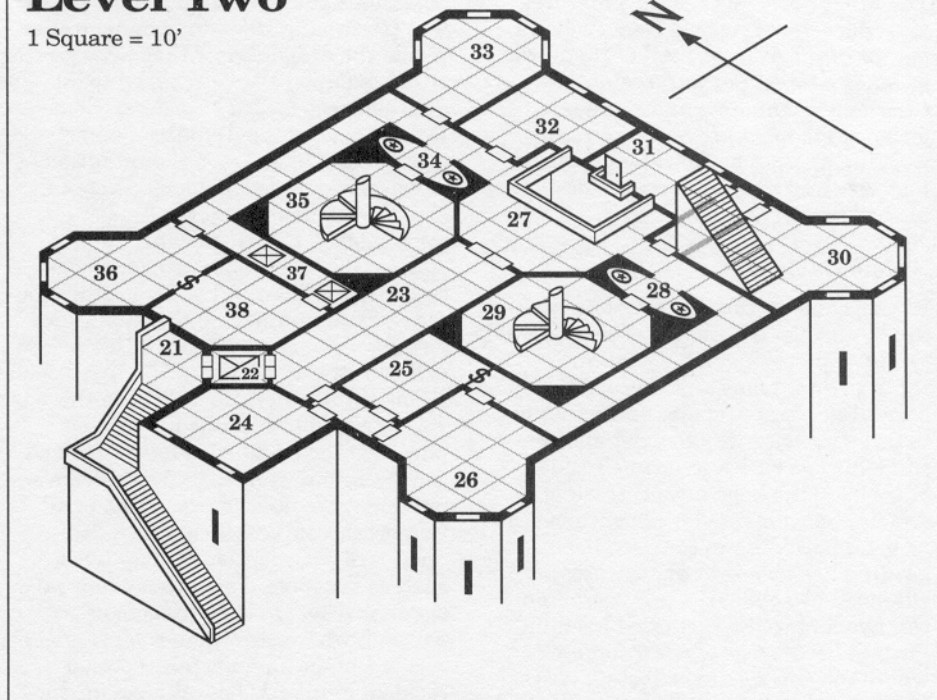

giving him +2 to attack and +3 on damage. If Kharl is reduced to 20 hp or less, he drinks his potion of *gaseous form* to escape. Once he regains his solid form, he relies on his rogue skills to skulk around the castle unseen until Avacia returns.

Kharl von Zard (human dual-classed fighter/thief): AL LE; AC-3 (5 without shield); MV 12; F6/T5; hp 63; THAC0 17 (14 with *vorpal sword*); #AT 1; Dmg by weapon type (×3 backstab); S 16, D 17, C 15, I 12, W 15, Ch 17; ML 12; XP 3,000; thief skills: PP 25%, OL 45%, F/RT 15%, MS 75%, HS 75%, DN 35%, CW 70%, RL 15%; *cloak of protection* +2, *shield* +1, *vorpal long sword* +3 (INT 15, Ego 15, *know alignment*, *detect magic* and *detect invisibility* in 10' radius, cast *strength* on wielder once/day, *telepathy*), *potion of gaseous form*, *scroll of protection from magic*, *ring of x-ray vision*.

The luminescent globe hovering above the table is made of ordinary glass, but Avacia has cast *continual light* and *levitate* spells on it. The globe can be moved easily, or even wrapped up and carried elsewhere.

One volume among the hundred or so in the bookcases is titled *The Codex of*

Conjuration and is trapped with a *sepia snake sigil*. Contained within its pages are the spells *find familiar*, *unseen servant*, *monster summoning I/II/III*, *phantom steed*, *Evard's black tentacles*, and *Mordenkainen's faithful hound*.

Most of the books in the library pertain to art and music. Like her sister Lucilla, Avacia is a creative person, as well versed in painting and sculpture as her sister was in music and alchemy. None of these volumes are magical.

31. Sitting Room.

This chamber contains all the amenities of comfortable living: large padded sofas, a well-stocked wine cabinet and a silver-filigree serving trolley loaded with fine crystal goblets and half-filled decanters. The walls are oak-pannelled, and the windows are obscured by red satin drapes. A pair of polished marble panthers stand between the windows. Above the panthers hangs the portrait of an elderly but distinguished man with a gleam of mischief in his dark eyes.

Mirror Mortals

The Mirror Mortals are the creatures and characters released from Avacia's *mirror of life trapping*. All of them bear grudges against her as a result, but their evil alignments and various forms of madness prevent them from working against her as a team. Their histories and personalities are described below.

Krysm Darksight

Krysm came to Castle Freitstein seeking to unravel the secrets of immortality. Having prolonged his own life through dangerous and excruciatingly painful necromantic means, he sought to find an easier way to exist and continue his "work." A longtime resident of Novolon, he kept careful track of Avacia's movements for nearly a century before deciding to confront her regarding her apparent agelessness. Offended by the loathsome necromancer, Avacia lured Krysm and his familiar into her *mirror of life trapping* where they've spent the last 62 years.

Born without eyes, Krysm is a chilling individual to behold. Thin membranes of skin cover his otherwise empty eye sockets. It was only through the necromantic assistance of another wizard, Grychil, that he was able to see at all. Grychil gave Krysm the means and knowledge to summon a quasit familiar, which Krysm did. So long as Krysm and his quasit remain within one mile of each other, Krysm can see through the quasit's eyes. (Krysm has a constant telepathic link with the quasit and receives all of its sensory impressions and abilities, including its infravision). The quasit remains *invisible* so that the secret of Krysm's "sight" remains a mystery. In addition to granting Krysm sensory benefits, the quasit also imparts 25% magic resistance, the ability to *regenerate* 1 hp/round, and one additional level of experience. If the quasit is slain, Krysm immediately loses 4 levels of experience (dropping him to 6th level).

Kharl von Zaard

Kharl von Zaard began his adventuring career as a paladin, protecting defenseless villages from evil humanoids and marauding brigands. Von

Zaard achieved recognition when he and his stalwart band of followers defeated a young black dragon that was terrorizing the countryside. It was inside the dragon's lair that Kharl stumbled upon Darkstrike, a lawful evil, sentient *vorpal sword* +3. Sensing the weapon's evil nature, Kharl grabbed the blade with the intention of dousing it in a pool of black dragon acid. Overwhelmed by the blade's formidable ego, Kharl suddenly turned against his loyal followers and decapitated them. Thankfully, his brutal deed did not go unpunished; the savage act forever stripped von Zaard of his paladin's abilities.

One thing Kharl never lost in the years that followed was his sense of purpose. The ex-paladin has continued the "mission" started by Darkstrike's previous owners: the extinction of all immortal creatures. (This includes creatures with especially long lives, such as dragons.) This quest eventually brought Kharl to the kingdom of Jaernef, where several of the beneficiaries of Lucilla's immortality potion resided. Realizing how elusive immortal beings were, Kharl decided to learn the thieving skills necessary to surprise his victims and strike them down quickly. He trained for many years under the finest assassins in the realm. Kharl's search for an immortal being ended at Castle Freitstein 76 years ago, when an attempt to decapitate Avacia Freitstein led to his imprisonment instead. (Kharl chased Avacia into her bedchamber, was tricked into looking at his reflection in the *mirror of life trapping*, and was immediately drawn inside.)

Darkstrike's evil influence has made Kharl a devious and deadly foe. While waiting for Avacia's return, von Zaard relies on his thieving skills to move around undetected. He will avoid combat until the moment of her arrival, then strike hard. He is a physically imposing man with long blonde hair swept back from the forehead. He wears the religious tunic of a paladin and sometimes plays the part of one to gain trust.

Nekrul (The Spectre Knight)

Contrary to his title, Nekrul is not some ancient, undead warrior. The

"spectre knight" earned his name from the magical armor he wears in battle: a malevolently gleaming suit of black field plate that renders its wearer incorporeal on command. Not only does the knight resemble a spectre in appearance; he can be hit only by +2 or better magic weapons in this state (much like a spectre). Only evil beings can wear the armor; others who don the suit must save vs. death magic or die. Even a successful saving throw drains one energy level. Simply touching the suit does not trigger this negative effect.

Nekrul is a fearsome, physically perfect specimen of manhood. A thick mane of black hair flows over his broad shoulders, and his skin is the shade of dark mocha. A single scar marks the left side of his face, adding to his already indomitable appearance. The scar is a constant reminder of the cruel and sadistic Baroness Ilse von Ulrichsten, a woman renowned for seducing and later mutilating her henchmen. After impaling Ilse with her own dagger and blaming the murder on another lover, Nekrul fought in the wars against Archstedt. His crusades made him popular among the ruling nobles and the target of many a lady's advances, including the lovely Lady Avacia.

Nekrul wanted Avacia to bear his "perfect" children, and when she explained to him that she could not (because of the immortality potion's side effect of infertility), Nekrul was outraged and tried to kill her. The attempt failed, and Nekrul was cast into the magic mirror. Avacia took all that was left of him—his magical armor, which he had removed—and placed it in a *Leomund's secret chest* for "safe keeping" (and to hide the evidence from the authorities). Since his recent release from the mirror, Nekrul has searched relentlessly for his lost armor.

Lady Melora DeVay

"Lady" Melora DeVay is a ruthless and conniving woman of extraordinary beauty and unparalleled vanity. Born into the wealthiest noble family in Novolon, Melora enjoyed being the center of attention at social gatherings. She was often placed on a pedestal by would-be suitors, many of whom were

as enticed by her wealth as by her beauty. The lovely but selfish Melora, spoiled and spiteful, launched many crusades against poverty, but her methods were harsh and insensitive. (Many of the city's vagrants and "poor folk" were imprisoned on false charges concocted by senators loyal to "Lady" DeVay.)

Melora's tight grip on the family fortune began to loosen shortly after her mother died and her father remarried. For undisclosed reasons, Melora fostered a particularly strong hatred for her father's second wife. The two women had many arguments, and after one especially heated confrontation, Melora threw a vial of acid in her stepmother's face. Some speculate that Melora's father signed over his entire fortune (out of sheer malice) to his new wife, dashing Melora's hopes for a substantial inheritance upon her father's demise.

Melora was cast out of the family for her increasingly temperamental behavior. She soon found herself blacklisted by virtually every noble house in Novolon. On the brink of poverty, Melora sold all of her jewelry and used the money to purchase several *charm-inducing* potions, among them a *philtre of love*. Melora intended to trick a rich nobleman into drinking it. When she heard that Lord Gareg Freitstein's wife had died (his first wife, not Lady Avacia), Melora immediately set out for Lord Gareg's castle with her potions in hand.

Melora soon found she had a rival for Lord Gareg's affections: Lady Avacia Germanicus. The shrewd Avacia caught Melora pouring her magical philtre into Gareg's wine glass. Using a carefully worded *suggestion* spell, Avacia lured poor Melora away from Lord Gareg and into the *mirror of life trapping* before returning just in time to watch Gareg drink the tampered wine. The unsuspecting Gareg was instantly enamored with the first person he set eyes on: the fair Lady Avacia. Melora, freed of her enemy's *suggestion* but trapped inside the mirror, screamed in anguish.

Zekiel of Novolon

Many years ago, Zekiel rose to prominence as one of the finest young stage

actors in all of Jaernef. His performances were attended by the most influential nobles, among them Lady Avacia Freitstein. Although Avacia remained sworn to her husband, Zekiel was nonetheless enamored by her beauty. He lavished her with romantic love letters and flowers until, at last, he realized she was out of his reach. In the weeks of self-pity that followed, Zekiel wrote a sorrowful play. Not only was the story of a tragic affair too dark and mournful for Novolon audiences, but halfway through the third act the theater caught fire and burned to the ground!

No longer cherished by the citizens of Novolon, Zekiel and his fellow actors took to traveling around the countryside. They introduced drama to many small towns and villages before tragedy struck once again. En route to a distant hamlet, their caravan was attacked by a pack of hungry werewolves. Only Zekiel escaped the carnage, but even he was bloodied in the melee. He spent three nights recovering in an abandoned chapel before his lycanthropy took hold, transforming him into a raging beast. Over time, Zekiel gained control over his affliction—at least to the point where he could rejoin civilization.

Zekiel's unannounced return to Novolon was heralded as a miracle, and the city's noble patrons once again embraced him. Several days later, after delivering a brilliant performance, Zekiel was named guest of honor at a feast sponsored by the wealthiest noblemen in Novolon. Swept away by the ecstasy of the moment, Zekiel completely forgot that a full moon would rise that very night; halfway through the evening's festivities, he lost control of his lycanthropy and involuntarily assumed vulpine shape. After a brief but savage altercation, Zekiel fled Novolon and sought sanctuary in the wilderness.

Bounty hunters were hired to track down and slay the feral beast. Temporarily restored to human form, Zekiel journeyed to Castle Freitstein, seeking shelter with Lady Avacia until a cure for his affliction could be found. Realizing that Zekiel was a serious threat to her household, Avacia trapped him in the magic mirror. To Zekiel, it seemed the safest place to hide. Little did he

suspect that Avacia never intended to release him. Decades of imprisonment have gradually eroded Zekiel's sanity. Nevertheless, he fully intends to repay Avacia for her treachery.

Throughout this adventure, Zekiel wears a *mask of true seeing* that grants him the same abilities as the 6th-level wizard's spell *true seeing*. (See area 43 for details.)

Rictavio the Minstrel

Rictavio was Avacia's first true love, long before she married Lord Gareg. Rictavio and Avacia met at a party hosted by Avacia's sister, Lucilla Germanicus, over 200 years ago. Avacia was impressed with the half-elf's egalitarian manner, but what captured Avacia's heart were his alluring compositions and serenades. However, in the midst of their whirlwind romance, Rictavio mysteriously disappeared.

Through her *crystal ball*, Avacia learned that Rictavio was meeting with several beautiful women, singing his brilliant serenades to each of them before setting out to woo another. Avacia was devastated, and the months that followed were marred by a number of dismal relationships (including one with the mage who gave Avacia her enchanted mirror). Three months later, Rictavio suddenly "reappeared" at one of Lucilla's parties. He professed his love to Avacia once more, claiming that a rival sorceress had enspelled him and led him astray. Avacia, seeing through Rictavio's transparent lies, reacted angrily and trapped the minstrel in her *mirror of life trapping*.

Although Rictavio harbors no hatred for Avacia, his long imprisonment has driven him slightly mad. Rarely is he seen playing the same instrument twice (thanks to his *alter instrument* spell), and he often perplexes people by speaking to them in ancient tongues. He is patiently awaiting Avacia's return so that he may once again profess his undying love to her.

Rictavio can cast spells only when playing a musical instrument. His spells are triggered by specific notes and melodies.



A cedar door leads to a balcony overlooking the meeting hall and gallery (areas 10 and 27). The wine cabinet is filled with vintages taken from Avacia's cellar (area 66), while the crystal on the trolley is worth 10,000 gp for the set. The trolley itself is valued at 2,500 gp. The panther statues are not magical, and are worth 300 gp as a set (but weigh 40 lbs. each).

The portrait depicts Lord Gareg Freitstein. His name is etched on a small plaque on the picture frame.

32. Servants' Quarters.

Five cozy beds and two cedar dressers are arranged along the walls of this unlit chamber. The room appears unoccupied.

This room once belonged to Avacia's five female servants: three maids (Nora, Crystal and Tamara) and two cooks (Elke and Rhianna). Enias the thief (see area 33) thoroughly searched this chamber for treasure but found nothing of value. The servant's dressers have been left in disarray.

33. Guest Room. If the PCs enter quietly, they may surprise the occupant of this room (normal chances). Enias, a thief who has disguised himself as a servant, is robbing the chamber of its valuables. If he notices the PCs, Enias quickly pulls out a dust cloth and pretends to clean whatever he has in his hand (a silver candlestick or platinum-framed hand mirror).

The room is handsomely appointed with a canopied bed against one wall and a tall wardrobe against another. Rugs cover the tiled floor, and ceramic masks hang from the otherwise barren walls. Several other pieces of furniture, including two leather armchairs and a dresser, occupy this regal chamber.

If the PCs accept Enias as one of Avacia's servants, the thief will provide valuable information on the whereabouts of several NPC villains, most notably Nekrul (area 38), the ex-paladin Kharl von Zaard (area 30), and Krysm the necromancer (area 18).

Enias knows Avacia's staff by name, having used a potion of *invisibility* to move around the castle prior to his

capture five years ago. He was trapped inside Avacia's *mirror of life trapping* only after the sorceress started noticing items missing from her bedchamber and performed a cursory search with *detect invisible* spells. PCs hoping to expose Enias as a fraud will have a difficult time because of the thief's intimate familiarity with the castle and its former occupants. (One person Enias doesn't know is Crystal the maid, because she was hired after Enias was trapped inside the mirror.)

Enias is moving from room to room stealing choice items. Since his *bag of holding* has limited space, he is fairly choosy about what he takes. In addition to a hoard of ornate and decorative trinkets (worth 6,653 gp total), Enias has acquired a jade coffer (1,000 gp) filled with 15 pieces of jewelry worth 100-1,000 gp each as well as Avacia's *crystal ball*.

His bag also contains a 5,000-gp replica of a *Leomund's secret chest*. (The replica does not contain extradimensional space and has no adverse effect on the bag.) Enias knows the chest is magical but is unaware of its powers. The PCs can use the replica to summon the real chest back from the Ethereal plane if they have found the command words written in Avacia's diary (see area 50). Several items of interest are stored in the *Leomund's chest*: a locked wooden coffer containing eight potions of *longevity* and three *elixirs of youth* (purchased by Avacia), a spell book containing 19 randomly selected spells of 1st-7th level, and Nekrul's disassembled *phantom plate armor +4* (see "Mirror Mortals" for details). A carefully worded *limited wish* allows Avacia to extend the duration of her *secret chest* spell beyond the normal 60-day timeframe. (The chest can drift through the Ethereal plane for months.)

Enias will retaliate if attacked but will not provoke a confrontation with the PCs. If necessary, he will trade his wands or the *everful purse* for safe passage from the castle. Neither the wands nor the purse belong to him; he stole them from Avacia's chambers.

Enias Sakellaros (human thief): AL N; AC 6; MV 12; T6; hp 23; THAC0 18; #AT 1; Dmg by weapon type (×3 backstab); S 11, D 18, C 9, I 13, W 9, Ch 14; ML 8; thieving skills: PP 95%, OL 85%, F/RT 45%, MS 70%, HS 50%, DN 25%, CW 80%, RL 5%; *bag of holding*, *wand of metal and mineral detection* (17

charges), *wand of magic detection* (6 charges), *Bucknard's everful purse*, *eyes of minute seeing*, short sword.

34. Alcoves.

Two dragon statues chiselled from black stone guard these shadowy alcoves. The necks of these reptilian rock-sculptures extend well out into the corridor, and their heads are tilted toward the western door.

The 6' tall statues are perched atop 2' cylinders of black marble. The dragons are finely crafted but otherwise ordinary. They are too heavy to move safely without tools (800 lbs. each).

35. North Tower, Second Floor. A spiral staircase climbs to the third floor (area 46) and descends to the first (area 11). Colorful tapestries depicting summer landscapes (worth 600 gp each) decorate the walls.

36. Guest Room.

A large canopied bed stands at the far end of this room, enclosed on all sides by panes of frosted glass. Lush green carpets cover the floor and lanterns hang from the ceiling by steel chains. A large trunk and cedar dresser stand against the south wall. Mounted on the wall next to the dresser is a full-length, oak-framed mirror.

The large trunk contains linens, pillow cases and an empty iron strongbox with a key still in the lock. The dresser drawers are empty. However, the wall behind the mirror is actually a secret door leading to a private suite (area 38).

37. Trapped Corridor. This corridor contains two pit traps, which can both be detected with normal chances of success. The pits open when more than 150 lbs. are placed on them. Any person triggering a pit trap is allowed a Dexterity check at -5 to avoid plunging down the shaft. Otherwise, damage from the fall is 2d6 hp. Falling PCs land in the castle dungeon (area 6). The pit doors close automatically after one round unless magically or physically held.

The pit doors can be locked in place by pulling up a lever in the private suite beyond (area 38). At the moment, the

lever is in the "down" position, meaning the traps are engaged.

38. Private Suite. The occupants of this chamber will be alerted by the voices in the guest room (area 36) or triggered pit traps in the hall (area 37).

Lanterns suspended from the ceiling illuminate this windowless chamber. A hexagonal wooden table stands in one corner, surrounded by six tall chairs, three of them knocked over. A pair of padded sofas and a 10' tall stuffed bear (with a sword sticking out of it) stand in the northeast corner. The walls are decorated with trophies of the hunt, including antlers, mounted boars' heads and hunting spears.

This room is normally occupied by Nekrul, the "Spectre Knight" (see "Mirror Mortals"). Nekrul is pacing in the middle of the room. Although he has searched most of this level and the levels above for his magical plate armor, he has been denied his prize. So far, Nekrul isn't discouraged—he intends to find his armor one way or another, even if that means tearing the castle apart. (For details on Nekrul's armor, see area 33.)

When the PCs enter, Nekrul orders them to identify themselves. If he suspects they are in league with Avacia, he commands them to divulge the location of his armor. Unless they oblige, he yanks his sword from the stuffed bear's gut and threatens to draw blood unless the PCs find and return his prized possession.

Also present is a young woman dressed in a maid's uniform. The girl claims to be Crystal, the one responsible for shattering Avacia's mirror. However, the "maid" is actually a doppelganger named Ettel. He has assumed Crystal's appearance to fool the PCs into helping Nekrul find his armor. Ettel is another escapee from Avacia's magic mirror and pretends to be Nekrul's prisoner, even creating welts and bruises on his "face" to simulate recent abuse. If the PCs refuse to help find the armor, Nekrul puts the edge of his sword to the maid's throat (an empty threat, since he will not kill the doppelganger). "Crystal" sobs "Please don't let him kill me! It's not my fault. I didn't mean to do it! I didn't mean to break the mirror!" Unless the PCs penetrate Ettel's disguise

(using *true seeing* spells or the *mask of true seeing* from area 44, for instance), they will be hard-pressed to leave the poor maid at the cruel knight's mercy.

If the PCs attack Nekrul, Ettel cowers in a corner until the fight is over. If the PCs emerge victorious, "Crystal" embraces them as her saviors and agrees to help rid the castle of its other evil occupants. Ettel then waits for an opportunity to dispatch or escape the party.

Nekrul (human myrmidon): AL LE; AC 7 (-3 with magical armor); MV 12; F9; hp 80; THAC0 12; #AT 2; Dmg by weapon type; S 18/77 (+2/+4), D 15, C 17, I 11, W 9, Ch 15; ML 14; XP 2,000; *bastard sword* +2. Nekrul possesses the single weapon style (double specialization, +2 to AC when not carrying a shield), weapon & shield style (double specialization, no penalty with weapon and +2 penalty to attack with shield) and punching specializations from the *Complete Fighter's Handbook*.

Ettel (doppelganger): INT very; AL N; AC 5; MV 9; HD 4; hp 25; THAC0 17; #AT 1; Dmg 1-12; SA surprise; SD mimicry, limited *ESP*, saves as F10; MR immune to *sleep* and *charm* spells; SZ M; ML 13; XP 420; MM/60.

Embedded in the eastern wall is a 10" metal lever currently in the "down" position. Raising the lever to the "up" position locks the trap doors in area 37 and keeps them from opening.

Level Three

39. Castle Overlook. The view from any of these areas is spectacular. PCs looking out to the horizon can even see the town of Relvaunt and its sprawling vineyards. However, these battlements are also watch towers for the three abishai. (See area F for statistics.)

The abishai use their *change self* ability to appear as human guards, since they are more likely to be approached in this form; they keep the form, even during combat, to avoid giving away their true strength. They can use their *charm person* and *suggestion* spells to lure PCs into melee range, if necessary. When the unwary PCs come within striking distance, the abishai lash out with their venomous tails. Party members slain by the baatezu are then animated and ordered to attack their former comrades.

The abishai have another option. If an

Castle Freitstein Level Three

1 Square = 10'

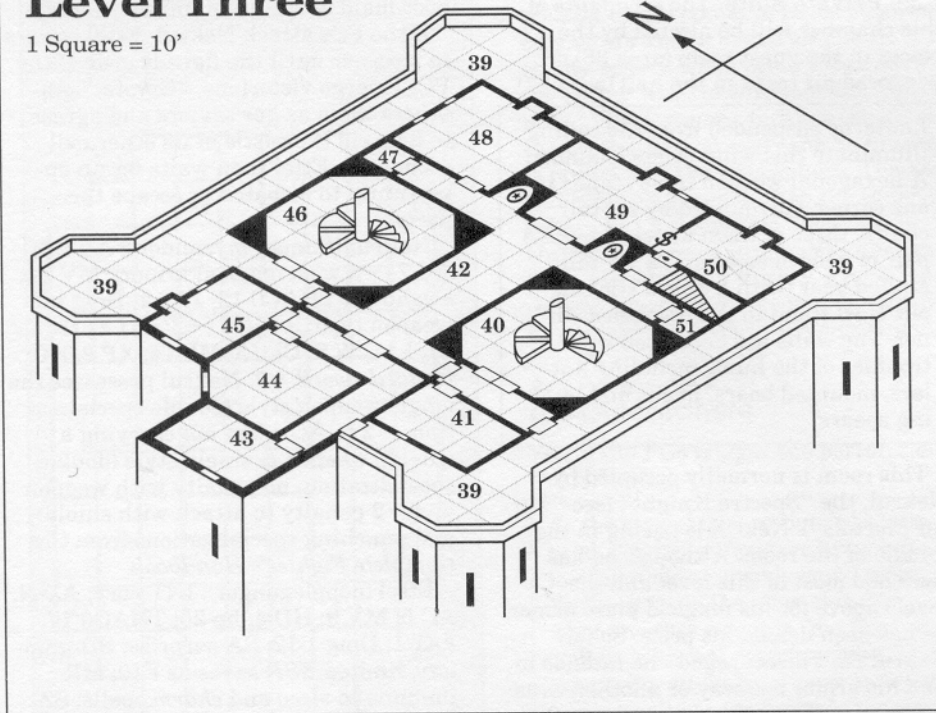

abishai hits a single opponent with both claws, it can forego damage in favor of hurling its prey off the wall. The thrown PC suffers 5d6 hp falling damage unless he has some way to negate damage (a *feather fall* spell, for instance); fragile items might be broken by the fall. The DM must declare before the abishai strikes whether it intends to throw a PC rather than rake him; if the abishai tries to throw its prey and fails to hit with both claws, the PC suffers no damage that round. Abishai thrown over the walls by a PC simply fly back into combat, but using their wings breaks the *change self* illusion.

If a single abishai is overwhelmed by antagonists, it will use its *scare* spell to frighten away its most powerful foe or its *gate* ability to summon 1-3 additional abishai (30% chance of success). If that fails, it flies or *teleport* up to the tower roof (area 62) and remains hidden until it regenerates.

40. South Tower, Third Floor. This torchlit area is unfurnished and bare. Lying in a heap on the staircase landing are the bloody remains of Loren, one of Avacia's young manservants. Loren was

torn to pieces by the werewolf Zekiel as he tried to flee the castle. PCs who search his remains find nothing of value. The stairs descend to area 29 and rise to area 52.

41. Kreswick's Quarters. The door to this room is locked.

Beyond the locked door is a bedchamber with a large four-poster bed, a tall wardrobe and a writing desk. Standing next to the wardrobe are two white-faced women in servants' uniforms. They shamble to one corner as you enter, as if fearing to attack.

This bedchamber belongs to Kreswick, Avacia's butler and manservant. The two women are Rhianna, a cook, and Tamara, a maid. They are not zombies but have powdered their hands and faces with baking flour to pass themselves off as undead minions of Krysm Darksight (area 18) or Vrinides the barbazu (area 63). They ran into castle guards who had been reanimated as zombies and, when they fled to the kitchen, concocted this clever means of staying alive.

The women need to know whether the

PCs are monsters from the mirror or people who have come to help. If the PCs mistake the servants for zombies and move to attack, the women scream in fear. The adventurers should know that real zombies do not scream in fear.

Tamara has keys to all locked doors in the castle, including this room. Both she and Rhianna are eager to flee the castle, but they have not yet mustered the courage to leave the kitchen. They have seen several of Avacia's new "house guests," most notably Vrinides the barbazu (area 63), the blind necromancer Krysm (area 18) and the dark warrior Nekrul (area 38). However, they do not know the current whereabouts of these evil beings, and they don't plan to start looking for them.

The contents of Kreswick's bedroom show signs of disturbance. Both Enias (area 33) and Ettel the doppelganger (area 38) searched this room thoroughly for treasure (while Rhianna and Tamara were whitening their faces in the kitchen). The room contains nothing of exceptional value.

Rhianna and Tamara (human servants): AL LG; AC 10; MV 12; 0-level; hp 3, 2; THAC0 20; #AT 1; Dmg by weapon type; ML 6; XP 150 (for rescue); unarmed.

42. Great Hall.

The bodies of two dozen castle guards are slumped against the walls of this vaulted, torchlit hall. A terrible stench pervades the corridor, nearly overwhelming you with nausea.

The guards were killed in the battle with Avacia's antagonists. However, Vrinides (area 63) has animated the corpses and commanded them to attack anyone who tries to cross the hall. The other "mirror mortals" are aware of the trap and avoid this hall.

Zombies (24): INT non; AL N; AC 4 (banded mail); MV 6; HD 2; hp 15 (x3), 14, 13 (x3), 11 (x3), 10 (x6), 9 (x2), 8, 7 (x3), 6 (x2); THAC0 19; #AT 1; Dmg 1-8; SD immune to *sleep*, *charm*, poison and cold-based attacks; SZ M; ML Special; XP 65; MM/373. They are sluggish and always attack last in melee.

Flanking the doors to area 49 are two extraordinarily lifelike statues of middle-aged women dressed in fancy garb. The two women, Elesa and Erika Dorescu, were turned to stone by Avacia (using

flesh to stone spells) after storming her castle and demanding the secret of eternal youth. If released from their stony prisons using *stone to flesh* spells, the two women scream out Avacia's name in outrage before disintegrating—their centuries-old, rapidly aging bodies collapsing into heaps of powdered bone and dust.

43. Private Dining Room. With a successful detect noise roll, thief PCs can hear two voices in this room: a female voice, harsh and unkind, and a male voice, deep and alluring. The man sounds as if he's reciting a passage from a book or play, while the woman's voice conveys irritation.

The main feature of this room is a massive dining table of varnished oak surrounded by eight tall chairs of equally impressive craftsmanship. The chamber is illuminated by a dazzling array of colors: the result of light entering through two exquisite stained-glass windows. A crystal chandelier, unlit but magnificent, dangles majestically above the table.

Seated at the far end of the table is Lady Melora DeVay, looking rather bored and annoyed. She has spent the last hour watching a lengthy performance delivered with sweeping zest by the actor-turned-werewolf Zekiel, whom she seduced with a *philtre of love*. (See "Mirror Mortals" for details on these two demented individuals.) Melora's original intent was to keep the werewolf from attacking her; now, it seems, he is utterly infatuated with her. In fact, Zekiel refuses to let his beautiful quarry leave the room until he has won her affections. Only a *dispel magic* or death can purge Zekiel of his adoration.

Zekiel is wearing a flashy, full-length red cape and golden mask taken from Avacia's bedchamber. The latter item is actually a *mask of true seeing* that lets its wearer see through illusions and falsehoods as the 6th-level wizard's spell. The magical mask is worth 7,500 gp.

Zekiel will be irked if the PCs interrupt his performance. In a grim baritone voice, he demands that they leave at once or face death. Even under the mask, his lupine features are clearly visible. Lady Melora entreats the party to stay, forcing Zekiel to retract his harsh remarks. Her goal is to let the PCs and the werewolf destroy each other so she can go on about her business.

If the PCs attack Melora or gawk at Zekiel's performance, the werewolf attacks them, chasing his quarry through the castle corridors if necessary. If Zekiel is defeated, Melora uses her potion of *human control* to charm one or more of the PCs. (The potion can charm up to 32 hit dice or levels.) Affected PCs become Melora's disposable henchmen. If the potion fails her, Melora surrenders and relies on her natural feminine charm and guile to survive.

Melora DeVay (0-level human): AL LE; AC 9; MV 12; 0-level; hp 6; THAC0 20; #AT 1; Dmg by weapon type; S 9, D 15, C 10, I 16, W 11, Ch 18; ML 9; XP 65; potion of *human control* (affects elves, half-elves, and humans, but elvish resistance to charm spells applies), *philtre of persuasiveness*, dagger.

Zekiel (werewolf): INT average; AL CE; AC 5; MV 15; HD 4 + 3; hp 27; THAC0 15; #AT 1; Dmg 2-8; SA surprise, inflict lycanthropy; SD silver or magical weapons to hit; SZ M; ML 12; XP 420; MM/240; *mask of true seeing*.

44. Dining Hall.

Two large dining tables and a slew of wooden chairs clutter this chamber. Lanterns dangle from the ceiling by iron chains, but they are unlit. Against the south wall stand two glass-door cabinets full of tableware.

This is where Avacia's garrison and servants ate. The tableware and utensils in the cabinets are finely crafted, as are the ceiling lanterns.

Slumped in the corner behind the door is the corpse of Elke, one of Avacia's cooks. She was strangled to death by Ettel the doppelganger (see area 38). PCs who search Elke's remains find nothing of value, although casting a *speak with dead* on the corpse reveals that Elke was attacked by a creature that "looked like Crystal the maid, but had a malevolent gleam in its eyes."

45. Kitchen.

This kitchen is equipped with all the standard items. The walls are lined with cupboards and shelves, a preparation table stands in the middle of the room, and a soup kettle hangs in the fireplace.

Amid the common jars on the kitchen shelves are three *jars of preserving**,

two empty, one containing a freshly diced apple. The kettle in the fireplace is an *everbountiful soup kettle**.

46. North Tower, Third Floor. A spiral staircase rises to the fourth floor (area 55) and descends to the second (area 35). The room is empty and unguarded, although the DM may stage an encounter here. (See "Castle Encounters" table.)

47. Privy and Storage. This privy is neatly kept and currently unoccupied. Shelves built into one wall are loaded with wool blankets, folded towels, linens, candles, candlesticks, oil lamps, torches, and boxes of soap. Leaning in a corner are two brooms and a dustpan.

48. Guest's Bedchamber. Adventurers listening at the door will hear music, as if someone on the other side is playing a stringed instrument. (A bard PC who makes an Intelligence check can identify the instrument as a balalaika.) A round of applause follows each refrain, as though the room were full of clapping people.

This chamber is elegantly furnished. A canopied bed stands between the two windows along the north wall, while a large writing desk rests against the south wall. On each side of the fireplace stands a tall bookshelf, while opposite the fireplace (near the door) is a mahogany wardrobe.

Sitting at the foot of the bed is a straw-haired musician wearing a ruffled tunic and tight leather pants. A broad smile is carved into his face as he plays his balalaika. Meanwhile, a captivated audience is seated in a semicircle around him, crouched comfortably on rugs about the floor. There are at least a dozen people in the crowd!

The attentive crowd is actually an *instant audience* summoned by the minstrel. (See the *Complete Bard's Handbook*, page 77, for a full spell description.) The summoned crowd of 20 persists for another hour before dissipating. Although they seem real enough, these people are actually phantasms without substance. They are AC 10 with 1 hp for attack purposes and cannot harm the party.

The half-elven minstrel is none other than Rictavio (see "Mirror Mortals" for

background). Moments after the PCs enter, he tries to quell the most threatening PC with his *friends* spell. With the help of his *tongues* spell, he then beckons the PC (in several languages) to come sit with the audience. If the PC declines, the *instant audience* harasses that person until he or she leaves the room.

If the party includes an attractive female PC, Rictavio has a 50% chance of mistaking that PC for Avacia. Unless the PC flatly denies being Avacia, the mad minstrel begins courting her as he courted Avacia more than 200 years ago.

Rictavio is not a threat to the party; however, a half-elf rogue named Mirizel is "hidden" among Rictavio's phantasmal audience. (If the *illusory audience* dissipates, she hides in the shadows of the room or inside the wardrobe.) A former prisoner of Avacia's magic mirror, Mirizel also succumbed to Rictavio's *friends* spell and now regards him as someone to be protected and defended at all costs. (Although the spell wore off days ago, Mirizel still maintains a strong liking for her fellow half-elf.)

Mirizel backstabs anyone who approaches the bard in a threatening manner. (What she perceives as "threatening" may not seem that way to the PCs.) She also keeps her hand crossbow loaded and ready. Rictavio, in turn, does not take kindly to attacks directed at Mirizel (or any members of his audience, for that matter). Rictavio casts a *mirror image* on himself, hurls his dancing shortsword at the party, and uses his *dancing lights* spell to confound the PCs and give Mirizel a chance to escape. Both NPCs have access to *invisibility* (Mirizel has a potion) if they need to retreat.

The dresser contains bathing towels, folded night gowns and linens. The wardrobe is empty. Inside the desk drawer are a ream of blank paper, a jar of ink, and a quill. The bookshelves are lined with volumes pertaining to art, music, and various other lore, none of them particularly valuable.

Rictavio (half-elf minstrel): AL CN; AC 4; MV 12; B9; hp 40; THAC0 16 (14 with shortsword of dancing); #AT 1; Dmg by weapon type; S 8, D 18, C 15, I 13, W 12, Ch 16; CW 70%, DN 60%, PP 75%, RL 40%; ML 11; XP 1,400; balalaika (a long neck, three-string guitar), *short sword of dancing*, *ring of protection +2*, *ring of feather falling*.

Mirizel (half-elf thief): AL NE; AC 4; MV 12; T4; hp 15; THAC0 19; #AT 1; Dmg by weapon type (× 2 backstab); S

10, D 18, C 12, I 11, W 9, Ch 14; PP 30%, OL 45%, F/RT 25%, MS 45%, HS 65%, DN 25%, CW 75%; ML 12; XP 420; leather armor, hand crossbow (12 bolts that may be coated with Type C poison), dagger, shortsword, potion of *invisibility*, vial of Type C poison (5 applications, Dmg 25/2-8).

49. Avacia's Bedchamber.

This once-lavish bedchamber has been reduced to utter disarray. A canopied bed, its veils torn and tattered, rests against the north wall. Tapestries have been ripped free of their hanging rods and thrown to the floor. Two padded chairs lie overturned in the middle of the room near the carcasses of two half-orcs and an owlbear. A wardrobe stands against the south wall, its doors agape. Between the wardrobe and the fireplace are the remains of a free-standing, full-length mirror. The ebony frame is intact, but the mirror itself has been reduced to thousands of glassy fragments scattered on the floor.

An iron chandelier hangs like a spider from the room's vaulted ceiling. Mounted above the fireplace is a giant framed portrait of a woman. The portrait has been shredded. As a result, the woman's face is concealed behind a flap of torn canvas.

Avacia's bedchamber has been thoroughly plundered by her adversaries. Her priceless collection of crystal decanters was destroyed when the table beneath it was thrown aside. The dead half-orcs are all that remains of Olec and Jalke, two renegades who were lured into the *mirror of life trapping*. They and the owlbear (another mirror escapee) were killed by the other "mirror mortals" in the frenzied fight following their release.

Casting a *detect magic* on the shattered mirror yields but a faint dweomer. Nothing short of a *wish* will restore the mirror. The wardrobe contains Avacia's clothing (all finely crafted but non-magical), and two pairs of slippers and an empty jewelry coffer are tucked away at the bottom of the wardrobe. Above the headboard of Avacia's bed is a small hook where her *mask of true seeing* once hung. The werewolf Zekiel took the mask for himself.

The framed portrait above the mantle is the most significant furnishing in this chamber and gives the PCs their

first glance at the mysterious mistress of Castle Freitstein. Those who have met Lucilla Germanicus ("The Lady of the Mists") will recognize the face immediately, though it is a portrait of Avacia Freitstein. PCs who make a successful Intelligence check at -2 can tell that the portrait is not of Lucilla but of someone with an uncanny and haunting resemblance to her. Avacia's grim countenance, perhaps even subtle contempt, is the only thing that truly distinguishes her from her sister.

50. Private Study.

Tall bookcases stand against the eastern and western walls, and a hulking desk has been shoved under a stained-glass window to the south. Resting atop the desk is a lit oil lamp which is partially obscured behind a tall, gaunt-looking chair that has been turned away from the desk to face the only door.

Fluttering about this room is a stirge named Needle. Eager to feast on the party's blood, it attacks the first PC it sees. This minor miscreant (once a familiar) was trapped in the magic mirror by the item's previous owner.

Needle (stirge): INT animal; AL N; AC 8; MV 3, fly 18 (C); HD 1 + 1; hp 7; THAC0 19; #AT 1; Dmg 1-3; SA drain blood for 1d4 hp/round; SZ S; ML 8; XP 175; MM/332.

Inside the desk is a secret compartment containing Avacia's four-volume diary. The first entry in Avacia's diary is dated nearly three centuries ago, although the subsequent entries are often months or years apart. Avacia has used *secret page* spells to conceal her most private entries. These hidden passages tell of her unrewarding childhood, her jealous hatred of Lucilla, and her feelings about the hundreds of men in her life, including her most recent consort (Lucien D'Mir). The third volume is entirely devoted to her years with Lord Gareg Freitstein, a period that she still considers among the happiest times of her life.

Scribbled on the last page of the fourth volume are the command words for summoning the *Leomund's secret chest* containing Avacia's potions of *longevity* and Nekrul's magic armor (see area 33). The command words are "Toreth firilas ishtok."

The books filling the shelves all per-

tain to magic and spellcraft. Several spell books are stashed among the more mundane tomes, but some of them are disguised and difficult to find. The DM should determine the number of spells per volume and the level. Books packed with high-powered spells are protected by wards including *sepia snake sigils*, programmed *disintegrate* spells, *explosive runes*, or bound guardian yugoloths. Wizards of limited experience would be well advised to steer clear of these ancient codices!

Guardian yugoloth (least): INT average; AL N; AC 3; MV 9; HD 6; hp 48; THAC0 15; #AT 3; Dmg 1-4/1-10/1-10; SA breathe cone of fire thrice/day (3d6 or half if save vs. breath weapon is successful); SD +1 or better weapons to hit, immune to *charm*, *hold*, *sleep*, *polymorph*, *fear* and fire-based spells; SZ M (7' tall); ML 14; XP 2,000; MM/371 (yugoloth, guardian).

This creature resembles a horned, froglike biped with glowing green eyes.

51. Private Bath. An iron bathtub with clawed feet occupies this room. Lying in the tub is Crystal, the maid who shattered Avacia's mirror. She was strangled to death (and later replaced) by Ettl the doppleganger (see area 38). PCs searching Crystal's corpse will find a silver-handled feather duster (30 gp) tied to her belt.

If the PCs cast a *speak with dead* spell on the body, they will hear the sad lament of a young maid consumed with remorse. Crystal can offer little information about her attackers, though she knows that her killer was clearly alien (the doppleganger in its true form).

Level Four

52. South Tower, Fourth Floor.

A pair of arched, stained-glass windows flood this chamber with dazzling light. Unlit torches wait in sconces along the walls, and a tapestry depicting an autumn vale hangs on the eastern wall.

Standing on the staircase leading up to the tapestry room (area 59) is a pale-faced young man in tattered servant's attire. This is Navarr, one of Avacia's manservants. Navarr was wounded by Zekiel and then *charmed* by Vrinides the barbazu. Navarr's instructions are to lure the unsuspecting adventurers into the barbazu's clutches by coaxing

the party toward the tower's upper floors (area 63).

Navarr has no combat skills. He is in a perpetual daze, leading the PCs here and there and rarely uttering a word. If asked why he was spared, Navarr answers with a feeble "I don't know." Although he admits he was bitten by a werewolf, Navarr has not contracted lycanthropy. He will not leave the castle willingly until his *charm* is broken.

Navarr: AL NG (*charmed*); AC 10; MV 12; 0-level; hp 2 (6); THAC0 20; #AT 1; Dmg by weapon type; ML 8 (12 while *charmed*); XP 150 (for rescue); unarmed.

53. Overlook. A 4' high stone wall encloses this 30' x 30' overlook. PCs who stay here too long may be attacked by the abishai on the battlements and rooftop (areas 39 and 62).

54. Rooftop Causeway. PCs who linger here for more than three rounds may be attacked by abishai perched atop the northern tower (area 62).

55. North Tower, Fourth Floor.

Perched on ledges in the corners of this tower chamber are four leering gargoyles with folded wings. However, the grim decor cannot compete with the ghastly sight before you. A host of lifeless zombies, the remnants of slain castle guards, stand idly about the room.

Six ordinary zombies and one juju zombie guard this area. The zombies were animated by Vrinides the barbazu, and one of them (Wilhelm, the captain of the guard) was later transformed into a juju zombie by Krysm Darksight using a vile concoction known as *juju wine* (see area 16). The zombies wear blood-stained uniforms and attack any living individual who enters this room.

Wilhelm (juju zombie): INT low; AL NE; AC 6; MV 9; HD 3+12; hp 35; THAC0 15; #AT 1; Dmg 3-12 or by weapon type; SD +1 or better weapons to hit (blunt and piercing weapons inflict half damage), climb walls as thief (92% chance), immune to *sleep*, *charm*, *hold*, death magic, psionics, electricity, *magic missiles*, poison, and cold-based spells; SZ M; ML Special; XP 1,400; MM/373 (zombie). Wilhelm attacks with his claws or the *broadsword* +2 strapped to his side. He is turned as a spectre.

Zombie guards (6): INT non; AL N;

AC 4 (banded mail); MV 6; HD 2; hp 15, 13, 11 (x2), 9, 8; THAC0 19; #AT 1; Dmg 1-8; SD immune to *sleep*, *charm*, poison and cold-based attacks; SZ M; ML Special; XP 65; MM/373. They are sluggish and their claws always attack last in melee.

56. Servants' Wing.

This spacious area contains four padded chairs and a cracked leather sofa. In one corner sits an iron bathtub and a wooden washtub with a scrub-board. Lanterns hang from the chamber's rafters, while two windows provide a view of the land to the east.

57. Servants' Quarters.

Three beds stand along the west wall of this plainly furnished room. At the foot of each bed is an opened trunk. Worn bearskins cover the cold stone floor.

The trunks contain clothing belonging to three of Avacia's servants: her two young manservants (Loren and Navarr) and her carriage driver (Hengel). The trunks were thoroughly searched by several of the invading NPCs, and the chests hold little of value.

58. Servants' Quarters. This room is similar to area 57. The three beds in this area belonged to Avacia's blacksmith (Vangar), her stablehand (Eemar, currently a prisoner in area 6) and her gardener (Skerrin). The trunks contain articles of clothing and little else.

Towers

59. Tapestry Chamber.

One of the windows of this chamber has been shattered inward, and shards of glass lie strewn on the floor. A large tapestry depicting Castle Freitstein spans the north wall.

The tapestry is exquisite (worth 2,000 gp). The shattered window is the result of a forced entry by one of the black abishai from the tower stairs (area 61). Three black scales can be found among the shards of broken glass.

60. Barracks.

Six wood-framed beds rest against the walls of this chamber. A wooden ladder leads up to a trap door in the ceiling.

Castle Freitstein Level Four

1 Square = 10'

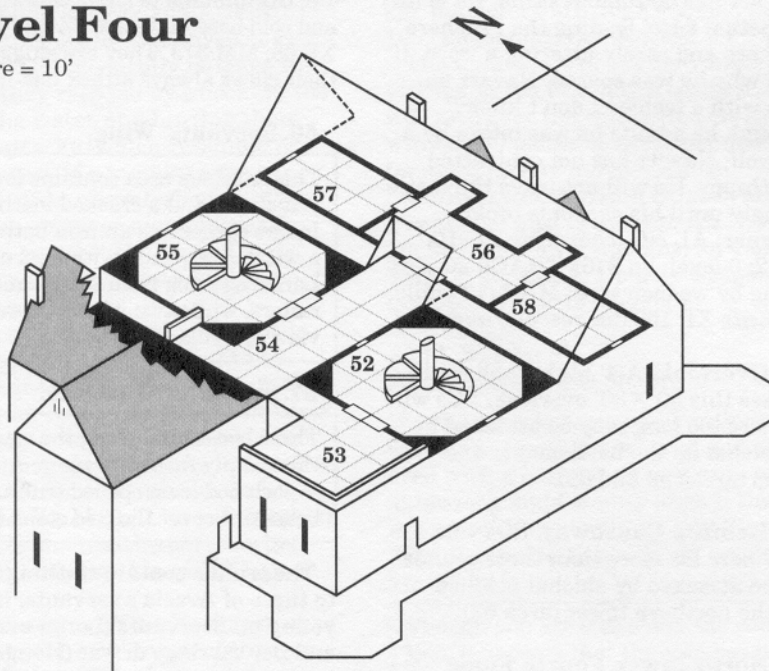

Guards assigned to patrol the castle battlements (areas 39 and 62) were typically quartered here. At the foot of each bed is a chest filled with common clothing and worthless personal effects.

61. Tower Vanguard.

Lurid, multi-colored light enters this room through seven stained-glass windows. Seated on the floor beneath the southernmost window are two young boys playing a game of cards. The spiral staircase takes up most of the room.

The two seven-year-old boys are actually a pair of black abishai using *change self* spells to conceal their true forms.

The "boys" claim to be Lady Avacia's young nephews, Darcy and Bryn. If the *charmed* Navarr is with the party (see area 52), he will corroborate the youths' story. In fact, Avacia couldn't be an aunt even if she wanted to; her only sibling, Lucilla, sacrificed her ability to procreate when she became immortal.

Darcy and Bryn know about the shattered mirror. If the PCs insist on taking them to a safer location, the youths will not protest. However, when their *change*

self spells expire after 22 rounds, the abishai will revert to their true forms and attack!

Darcy and Bryn will offer to take the PCs up to area 63 where "Uncle Gareg" can't wait to meet them. If the PCs learn that Gareg was Avacia's husband—for example, by reading Avacia's diaries in her private study (area 50)—the boys will claim that Lord Gareg was among those confined to the *mirror of life* trapping by "Aunt Avacia" (contrary to the fact that he died of old age).

If the PCs attack the "boys," the abishai lash out with their poisoned tails. If they are overwhelmed, the abishai *teleport* themselves to area 63 or back to Baator (the Nine Hells).

Black abishai (2): INT average; AL LE; AC 5; MV 9, fly 12 (C); HD 4 + 1; hp 25, 20; THAC0 17; #AT 3; Dmg 1-4/1-4/2-5; SA poison, dive; SD same as green abishai in area F; MR 30%; SZ L (8' tall); ML 9; XP 7,000; PLANESCAPE MC/18.

62. North Tower, Roof.

The view from the top of this tower is spectacular. From this godlike vantage point, you behold mile after mile of

distant, rolling countryside. Even the tallest trees are reduced to mere shrubs, and the clouds overhead seem near enough to climb upon.

Any green abishai that survived previous encounters with the PCs (see areas F and 39) will be resting here, regenerating lost hit points. The green abishai remain outside the castle and do not associate with the black abishai in area 61. They have orders to attack anyone on the rooftop or flying overhead. The abishai *teleport* back to Baator if reduced to one-third their total hit points or fewer.

A stone causeway joins this tower to the southern spire of Freitstein Castle. An unlocked trap door leads down to the barracks (area 60).

63. Barbazu's Lair.

The ceiling of this tower chamber is at least 40' high. The walls slant inward, becoming narrower as they near the roof. The spiral staircase continues up as well as down, and several lit candelabra placed around the perimeter of the staircase brighten the room. Natural light streams through four slender windows set into the walls 6' off the floor.

A deep, resonant voice greets you. Standing about 10' from the staircase landing is an aging man with a bristly gray beard and piercing blue eyes. Wrapped around his left arm is a sultry woman with long dark hair wearing a wizard's robe.

The bearded man is actually an *advanced illusion* meant to represent Lord Gareg Freitstein, although PCs who have seen Lord Gareg's portrait in the sitting room (area 31) will see little resemblance. The illusion is being created and sustained by a barbazu named Vrinides. (Vrinides has never seen Lord Gareg, so the illusion is not accurate.) The barbazu hiding near the top of the staircase leading to area 64 and uses the illusion to keep the PCs distracted. "Gareg" tries to turn the PCs against Avacia by claiming she trapped him in her magic mirror to secure his estate (which is, of course, a lie). When the party is most vulnerable, the barbazu attacks from behind with savage fury, using his *teleport* ability to appear suddenly (-4 to surprise rolls). Armed with

his wicked glaive, he cuts down anyone who stands in his way.

If the PCs withstand the barbazu's assault, it will use its *teleport* ability in a series of hit-and-run attacks on single PCs, seldom staying in a fight for more than three rounds.

The sultry female is not an illusion but rather a red abishai named Kazang (the barbazu's lieutenant). Kazang has used its *change self* spell to appear human but will lash out with its poisoned stinger if the PCs get too close. While assuming the guise of a female wizard, Kazang uses its *produce flame* ability to hurl goutts of fire at the PCs. If the battle goes poorly, Kazang will attempt to *gate* 1-3 additional abishai of the black variety (30% chance of success).

If the black abishai from area 61 are with the PCs, they assume their true forms the instant Vrinides attacks, fighting with their claws and poisoned tails. If Navarr (the *charmed* manservant) is present, the barbazu uses him as a hostage the moment the battle turns against him. If the barbazu is forced to *teleport* away, Kazang and any other abishai present must make a successful morale check or return to Baator.

Vrinides (barbazu): INT low; AL LE; AC 3; MV 15; HD 6 +6; hp 45; THAC0 13; #AT 3 or 1 (weapon); Dmg 1-2/1-2/1-8 or 2-12 (weapon); SA glaive (bleeding causes 2 hp/round damage until wound is tended), disease, battle frenzy (double the number of attacks, +2 on attack and damage rolls), spells; SD +1 or better weapons to hit, immune to fire, poison and iron weapons, half damage from cold and gas; MR 30%; SZ M (6' tall); ML 11; XP 6,000; PLANESCAPE MC/20.

The barbazu can cast the following spells once/round at will: *advanced illusion*, *affect normal fires*, *animate dead*, *charm person*, *command*, *infravision*, *fear by touch*, *know alignment* (always active), *produce flame*, *suggestion*, *teleport without error*. He can *gate* 2-12 abishai (50% chance) or 1-6 barbazu (35% chance) once/day; however, the barbazu has already used this ability to summon Kazang and the other abishai to the castle.

Kazang (red abishai): INT average; AL LE; AC 1; MV 9, fly 12 (C); HD 6 +3; hp 33; THAC0 13; #AT 3; Dmg 1-4/1-4/2-5; SA poison, spells; SD as green abishai (see area F); MR 30%; SZ M (6' tall); ML 12; XP 9,000; PLANESCAPE MC/18 (corrected from MM).

Castle Freitstein Towers

1 Square = 10'

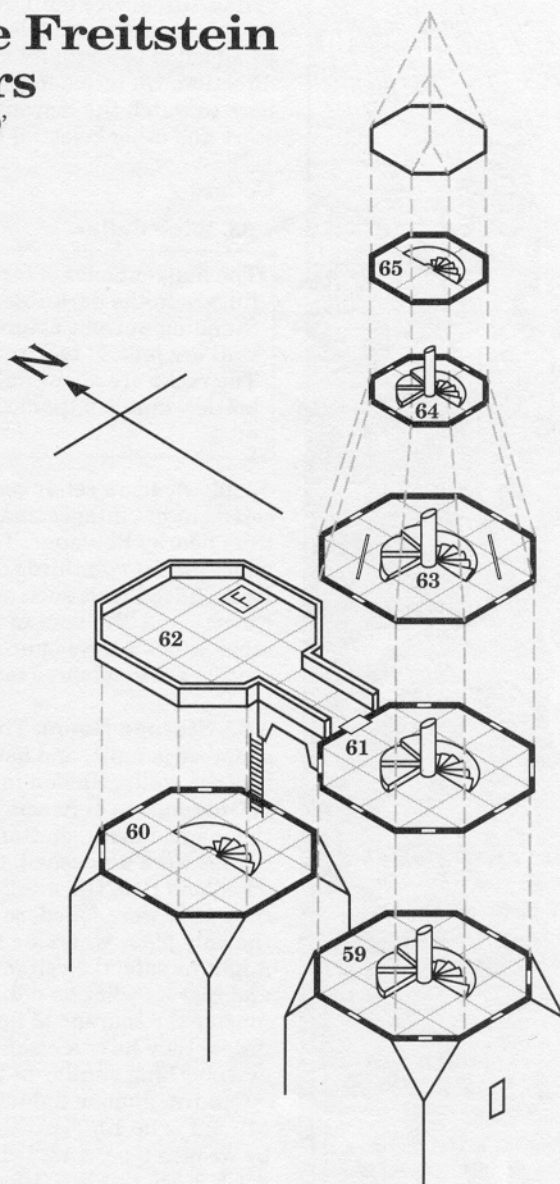

64. Tower Tier. Four narrow windows set into the walls allow light to enter this confined area.

65. Observatory.

The staircase finally winds its way up to the tower's peak. The cone of the tower is made of smooth transparent crystal, and beyond its surface you see the vast, unending sky. An elaborate platform has been erected in this self-contained observatory, and atop the platform you see

a cylindrical scrying device which, one might guess, allows one to view the very heavens themselves!

The crystal cone is protected by *glassteel* spells and has remained undamaged with the passing of years. A permanent *control temperature* spell keeps the observatory comfortable even in midsummer when the crystal cone acts like a giant heat intensifier.

Party members can climb onto the wooden observation platform via a ladder attached to the southwest wall. The

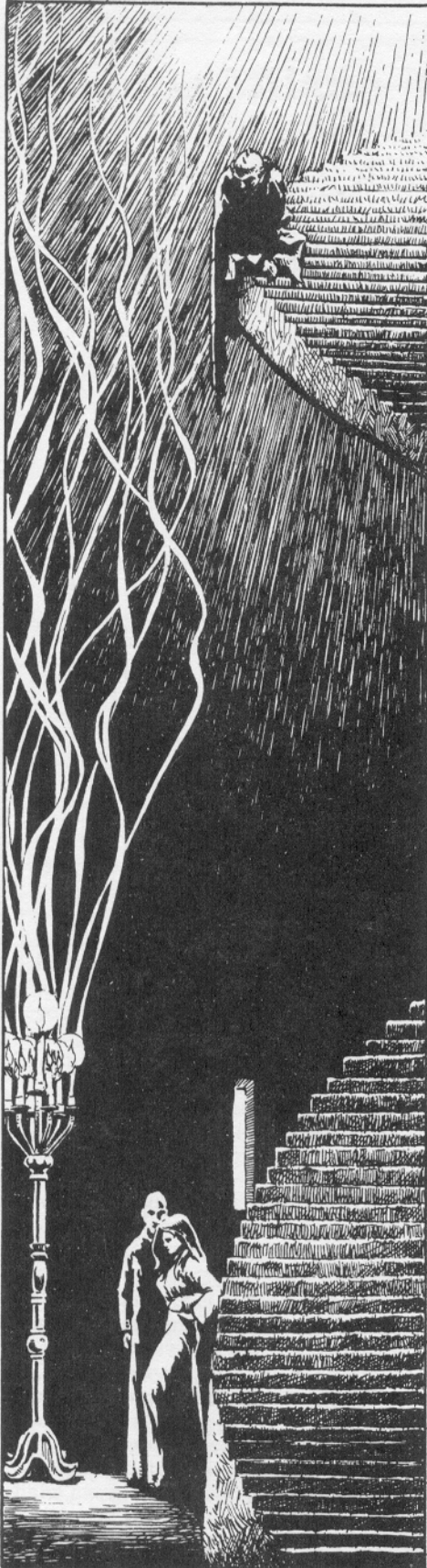

cylindrical device built atop the platform is an elaborate telescope that can be adjusted to virtually any angle and direction. On occasion, Avacia comes here to watch the movements of the stars and other celestial bodies.

Cellars

66. Wine Cellar.

The pungent odor of fermented wine lingers in the darkness of this room. Standing upright against the far wall are four, 7' tall iron wine racks. The racks are about half-filled with bottles, many of them shrouded with dust.

Lady Avacia's cellar contains an assortment of vintages, many of them from nearby Relvaunt. These local wines (about two-thirds of Avacia's stock) have labels such as "Froldick's Finest" and "Relvanian Dark." Her other wines were acquired from select vintners throughout Jaernef.

67. Storage Room. This 10' x 10' chamber is unlit, and barren shelves line the walls. Hidden inside the cubicle is Gharon, one of Avacia's guards. When the magic mirror shattered and the evil hordes were unleashed, Gharon panicked and fled. His attempts to escape the castle were foiled, so he retreated to the only place where he thought he might be safe: the cellar. He is a coward and regrets what he did, but he cannot muster the courage to help the PCs unless they have a *cloak of bravery* spell or something similar at their disposal.

Gharon (human fighter): AL NG; AC 4; MV 9; F2; hp 10; THAC0 19; #AT 1; Dmg by weapon type; S 13, D 11, C 10, I 9, W 8, Ch 9; ML 6; XP 100 (for rescue); banded mail, broadsword, 14 gp in pouch.

68. Storage Room. Avacia stores old furnishings here: chairs, tables, faded carpets, free-standing suits of armor, gaudy cloak racks, iron candelabra and other such items. Nothing in the room is particularly valuable, and the room's chittering rats are harmless.

69. Laboratory Storage.

The walls of this unlit room are lined with shelves, and stacked neatly upon the shelves are hundreds of

glass containers: vials, jars, and beakers of all shapes and sizes. The chamber is otherwise empty.

Avacia likes to store her alchemical equipment close to her laboratory (area 18). No hazardous or magical fluids are stored here.

Concluding the Adventure

Much of this adventure is a cat-and-mouse game between the PCs and the NPC villains, with the roles of cat and mouse switching back and forth as the PCs fight for control of the castle and, indeed, their very lives. The sudden return of Lady Avacia could incite a bloody climax or herald the story's denouement, which is why the exact moment of her return is left to the DM. She could appear hours or days after the PCs clear out the castle, or she could return in the midst of chaos to help set things right.

The Lady Returns

Avacia *teleports* from Novolon to her bedchamber (area 49) where she immediately notices the shattered mirror of life trapping. Not expecting to find her castle overrun by villains, Avacia has only a fraction of her full spell repertoire. (She was up all night with Lucien.) Unless the PCs defeated some or all of the mirror's escapees beforehand, Avacia will be hard-pressed to defend her castle and its remaining servants.

However, Avacia's greatest fear is not for herself or her staff. She has returned from Novolon with her secret lover, Lucien, hoping to impress him with the grandeur of her castle. As one of the kingdom's most gifted architects, Lucien wanted desperately to see the fabled Castle Freitstein for himself.

Unlike Avacia, Lucien is not immortal. He is vulnerable to the wrath of Avacia's enemies. Without a full spell complement, Avacia may find herself ill-equipped to defend Lucien against the onslaught of attackers awaiting them.

The DM must determine how the surviving "mirror mortals" react to Avacia's arrival. Some react as specified in the NPC descriptions (Khari von Zard attempts to behead Avacia, plain and simple). Some NPC reactions are more ambiguous (like Rictavio the bard, who still cares deeply for Avacia). The DM is encouraged to role-play each

villain individually. One suggestion: it is not essential that the DM kill off every NPC antagonist encountered in this module, as several will make excellent recurring villains in future adventures!

Avacia's first impulse after seeing the shattered mirror is to cast a *stoneskin* upon Lucien. In doing so, she has left herself vulnerable to Kharl von Zaard's sentient *vorpal sword*, which would otherwise be deflected by the *stoneskin* spell. Ironically, by protecting Lucien, she has left herself vulnerable to the one attack that can kill her. (Avacia would never waste such a potent defensive spell on someone unless that person was especially important to her.)

If the PCs have already rid the castle of villains, Avacia will show her thanks by allowing them to keep any items taken from the slain NPCs (with the exception of the crystal ball and Leomund's secret chest in area 33). She will even permit the PCs to remain at Castle Freitstein until Kreswick and Nora are summoned from Relvaunt and new defenders can be found to replace Avacia's conquered garrison.

Avacia is not prepared to discuss her past, her sister, her apparent immortality, or her love affair with Lucien. If the PCs become too nosy, she coldly orders them to leave. It should be obvious to the PCs that Avacia has detached herself from Lucilla forever, but that the pain of her past has swollen over the years.

Avacia despises thieves and will not tolerate PCs who loot her castle. If necessary, she will use her *suggestion* spells to force PC thieves into relinquishing all stolen items. She can also send invisible stalkers to plague the party until all stolen items are safely returned.

Avacia Freitstein: AL CN; AC 7; MV 12; W14; hp 32; THAC0 16; #AT 1; Dmg by spell or weapon type; S 11, D 14, C 14, I 18, W 13, Ch 17; ML 15; *ring of protection* +3 (identical to Lucilla's), *ring of wizardry* (doubles number of 2nd-level spells), *wand of lightning* (31 charges remaining), travelling spell book with an *item* spell cast upon it (spells determined by DM).

Spells memorized: *charm person*, *feather fall*, *magic missile*, *unseen servant*, *ESP*, *misdirection*, *web*; *dispel magic*, *suggestion*; *stoneskin*, *wizard eye*; *feblemind*, *teleport*, *mass suggestion*, *flesh to stone*.

Lucien D'Mir: AL CG; AC 8; MV 12;

Castle Freitstein Cellars

1 Square = 10'

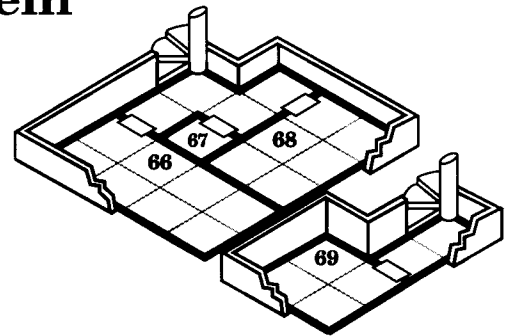
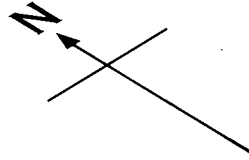

F2; hp 16; THAC0 19; #AT 1; Dmg by weapon type (unarmed); S 14, D 16, C 14, I 12, W 11, Ch 18; ML 14. Lucien served the requisite two years in the Jaernef militia before studying architecture in the capital's university.

Upon Reflection

Avacia has an ulterior motive for bringing Lucien to her castle. Under normal circumstances, displaying him openly to her household staff would be so unlike her. However, Lucien is betrothed to another woman from Novolon's aristocracy: a certain Antonina Morganstal. The marriage is destined to reunite two feuding merchant empires and cannot be circumvented without rocking the pillars of Novolon. Lucien could never be asked to betray his family in a way that would inflict so much damage.

Avacia has told Lucien about her potions of *longevity*, which she keeps in a Leomund's secret chest (see area 33). She claims the elixirs have kept her young for centuries and will enable Lucien to live out his life with Antonina, maintain a youthful vitality, and return to Avacia's side after Antonina's sad passing. (Avacia is actually counting on several illicit "visits" before then, but why mention the obvious.)

However, Lucien is having second thoughts about deceiving Antonina in this manner and using Avacia's potions to "live forever." Although he has never spoken of his feelings, judicious use of *ESP* spells has helped Avacia glean Lucien's true thoughts. She has used his love of architecture to lure him to her castle, hoping that a night of passion will finally convince Lucien to embrace her forever.

The terrible events surrounding Avacia's magic mirror only heighten Lu-

cien's concern. Initially he regarded Avacia with awe, but now he fears her. What kind of person keeps a mirror of trapped souls in her bedchamber? As doubt begins to overwhelm him, Avacia will sense Lucien slipping away and work harder to earn his confidence, perhaps resorting to magic in the end.

What happens to Avacia and Lucien is for the DM to decide. Even if they survive the NPCs' attack, their future with each other is uncertain. In time, Lucilla's immortality potion will wear off, compelling Avacia to drink potions of *longevity* to preserve her agelessness. If Lucien finally chooses to join her, these potions may be all they have left in common.

Picking up the Pieces

If Lucien is killed, Avacia will *teleport* his body to Novolon and *geas* a powerful priest into raising him (if possible). She can be persuaded to do the same for one slain PC, if the slain PC died defending either Lucien or herself. Otherwise, she does not intervene with Death.

If Avacia is decapitated and dies, only a *resurrection* or *wish* will restore her to life. (A *raise dead* cannot revive a headless corpse.) The chance of finding a priest able to resurrecting Avacia (not to mention willing) is slim. Weeks after her death, a mysterious deed turns up in Novolon. The deed names Lucien D'Mir as the sole inheritor of Avacia's estate. If Lucien dies, the castle and all its contents become the property of his children or, if he has none, the king.

If the PCs save Avacia, Lucien, and the surviving members of Avacia's staff, they gain a 25,000 XP story award. If they leave Castle Freitstein in the hands of the "mirror mortals," no story award should be given. Ω



LAUGHING MAN

BY PAUL CULOTTA

A deadly sense of humor

Artwork by P.L. Wolf

Paul thanks the TSR designers of the Realm of Terror for putting out lots of good accessories that inspire adventures such as this one.

“Laughing Man” is an AD&D® RAVENLOFT® short adventure for 4-8 PCs, levels 5-9 (about 40 levels total). It can be used easily as a random encounter in “The Price of Revenge” (issue #42) or “Felkovic’s Cat” (issue #50) since those adventures are also set in Valachan, the core land of this scenario. With some changes in the background, a DM could also run it elsewhere in the Domain of Dread, such as near Castle Forlorn, an area replete with ghosts.

For the Dungeon Master

The ghost Hugo was a trapper who was murdered one night at his campfire. He was slain by a crossbow bolt in the back of the head as he was laughing heartily at a joke told by one of his companions. Death was instantaneous, as was the creation of his ghost. At first his spirit was perplexed; it could not help his companions as they were butchered by outlaws. Later he realized what had happened, and since then his haunting laughter has terrified many a Valachan inhabitant. He is known as the Laughing Man of Valachan and is mentioned in *Van Richten’s Guide to Ghosts* (pages 17-18).

The most terrified victim of the Laughing Man was Mordal, the assassin who led the bandits who killed Hugo and his fellow trappers. Once he realized his powers, Laughing Man hunted down each of Mordal’s followers and killed them with his aging ability or his keening. Mordal fled to his liege, Baron Erik von Kharkov, the darklord of Valachan, but the powerful nosferatu vampire felt betrayed by the senseless murder of his subjects (his precious “cattle”). As punishment, he imprisoned Mordal in the dark dungeons of Castle Pantara.

This incarceration was long and cruel because von Kharkov tortured Mordal in a slow, painful way. The darklord had previously given the assassin a magical dagger, the *fang of the nosferatu*. (See sidebar for details.) The blade makes demands on its owner; he must let it “drink” blood each day, for if the blade starves it slowly kills its owner (-1 hp per day). Instead of using the blade on Mordal, von Kharkov kept it just out-

side his cell so that the assassin would die a little bit each day. Whenever Mordal got close to death (1 hp left), von Kharkov would kill animals with the dagger, restoring all but one of Mordal's hit points and starting the process all over again. It took three years for Mordal to die.

Laughing Man found Mordal languishing in the baron's dungeons, and the ghost laughed and laughed. Mordal could do nothing to shut it up. When he died, it was with three years worth of Hugo's giggling, howling, and guffawing ringing in his ears.

A few days later, Mordal's ghost arose and found that it was still cursed with ownership of the *fang*, but in a different way. As long as he owned the evil blade, his soul would not be released and he was doomed to an undead state. He tried everything to get rid of it (throwing it down a well, tossing it in a fire, and so on), but it always came back. So he left Castle Pantara and tried to give the blade away. Mordal's ghost is one of very few spirits that can take corporeal form, and this should have given him the edge he needed to get rid of the *fang*.

But it was not to be, because Hugo the Laughing Man immediately realized what Mordal was up to. Each time Mordal tried to give the cursed blade away, Hugo would laugh, softly at first, then louder the closer the recipient came to taking the *fang*. Hugo's innate *invisibility* made the situation all the more unnerving to whoever was offered the dagger. Each time Mordal tried to give it away, the person would run away in fear or Mordal would kill him in frustrated rage.

Now Mordal has found a group of sturdy adventurers (the PCs) who might take the *fang* and rid him of Hugo's eternally pestering laughter so he can rest in peace.

The Ghosts

The PCs are in the wilderness and have stopped to make camp on a damp, misty night. A dirty, bleeding, emaciated man staggers into their camp. It does not matter how closely the PCs have been keeping guard because the man is really Mordal, who quickly assumed corporeal form when the PCs were not looking (although they have reason to be suspicious if he slipped past several of their traps, guards, or magical wards).

The man identifies himself as Timo-

thy Cheever, a resident of Habelnik, and begs the PCs for sanctuary. He appears and claims to be terribly hungry, thirsty, and faint from loss of blood. All he is wearing are some tattered clothes, old boots, and a sheathed dagger. His fresh wounds seem quite real but are the result of Mordal's ability to create illusions. (See *VRGG*, pages 37-38.) His haggard appearance, on the other hand, is legitimate (what he looked like when he died; see *VRGG*, page 15). Clerics appear to bind his wounds successfully, cast healing spells, and so on, as Mordal subtly manipulates the illusory wounds to conform to the PCs' ministrations. Because he is solid, Mordal also can eat and drink, and he will devour anything offered to him as though he has not eaten for days. Indeed, he is so thin that his cheekbones are pronounced and the outline of his rib cage shows clearly through holes in his dirty shirt.

"Timothy" then spins an incredible tale to the PCs. He says he is an apprentice to a wizard named Felkovic, who sent him to this part of the woods to find the "Dagger of Valachan," a prized magical item that was in a hidden crypt. Unfortunately, it was guarded by a "big, evil, furry beast with long, sharp claws and teeth" that wounded him horribly, but he escaped with his life and the dagger. He has been running for nearly a day and believes he has lost the monster. He remarks how grateful he is to the PCs for giving him refuge and promises that if they escort him back to the town of Habelnik, his master will give them a large reward.

The PCs should be quite suspicious by now, as there are plenty of holes in Timothy's story. How could Timothy look so emaciated after only one day of running? He might have lost a few pounds, certainly, but not enough to look quite so gaunt. And then there is the fresh blood from the wounds. Surely some of it would have clotted after a full day, but Mordal has overlooked this detail. The story about his mission doesn't hold up either: Why would a wizard send an apprentice to secure an important magical item rather than a team of adventurers (or just go himself)? And how did an apprentice escape from an apparently ruthless and powerful guardian? And what is he doing out here with no equipment at all?

If the PCs start asking these hard questions, Timothy gets defensive, pulls

the dagger out, and offers it (hilt first) to the sturdiest fighter, saying, "As a gesture of my good will and innocence, here, keep the dagger until we get to town. It's my only weapon. I lost my others at the crypt." As soon as this happens, the *invisible* Hugo, who has been listening quietly to Mordal's latest ploy, starts a slow, eerie, hideous chuckle from the edge of the PCs' camp.

If the PCs don't act suspicious, a curious PC may ask to see the dagger. If no one does, Timothy will mention it to a wizard PC. ("Listen, I have the dagger here. Could you work some magic and tell me what it does?") Again, Hugo starts his hideous chuckling.

Whenever Laughing Man starts, Mordal exclaims furiously: "Oh, no, it's the guardian of the crypt! It's back! It tracked me!" Then he drops to his knees, pulls out the dagger, and begs a warrior PC: "Please, I recognize its laughter! It always laughs. Take this magical dagger and use it to defeat the monster! I have no chance! Please, I beg you!"

This makes Laughing Man laugh even harder. The closer the dagger gets to the PC (or the PC to the dagger), the louder the laughing grows. Conversely, the farther one gets from the dagger, the softer the laughing becomes, but it never stops while the dagger is unsheathed.

If a PC is about to touch the dagger, Hugo yells out, between booming cackles, "Don't do that, or I'll have to kill you, ha ha!" And Timothy, who by now has a feral gleam in his eye, cries desperately, "Come on, take it! What are you waiting for? It won't hurt you!"

If a PC takes the dagger, the laughter immediately stops, and a bright evil grin lights up Timothy's face. He laughs heartily and booms out, "Well, Hugo, it looks like the last laugh is on you! Free at last!" And then he fades away, laughing as his spirit is now free.

Hugo emerges from the woods in semi-corporeal form, enraged with the crossbow bolt in the back of his head showing clearly. He chuckles, "Didn't believe me, huh? Well, now you must pay the price, fool!" And with that he lets out with the most awful, fiendish, howling cackle imaginable. This is Hugo's form of keening. If the keening does not kill whoever took the dagger, Hugo will attack with his natural aging ability.

Hugo, the Laughing Man (2nd magnitude Ravenloft ghost): INT very; AL

The Fang of the Nosferatu

The following is an abbreviated description of the material on pages 133-134 of "Realm of Terror" in the RAVENLOFT campaign set (pages 29-30 of "Oaths of Evil" in the *Forbidden Lore* boxed set). Enough is presented here to run the adventure, but the DM is encouraged to review this cursed dagger in detail.

The *fang of the nosferatu* is an extraordinary dagger +3 that has strange symbols etched into its hardened steel blade. The symbols are filled with ruby dust, making them look like writing in blood. The handle is wrapped in a strange black hide, and the pommel has a fine ruby mounted in its end. The guard is oval, with the surface facing the blade carved to look like a vampire about to feed.

When the *fang* hits and is left in the body, it drains an additional 3 hp per round. For each round that the owner scores a hit with the dagger, he regains 1 hp. With the *fang*, the owner (but not his equipment) can shapechange into a wolf or bat with maximum hit points.

There are drawbacks to owning the *fang of the nosferatu*. Because the blade lusts for blood, it must inflict a wound and draw blood from a living creature each day, or the owner loses 1 hp, which can be recovered only by a *heal* or *wish* spell, or by using the dagger. Killing animals will satisfy the *fang*, but once a month it requires blood from an intelligent creature. The bond between the dagger and owner is permanent, broken only by the owner's death. Even then, the bond to the owner's ghost will remain if another living creature does not take possession of the *fang* within 24 hours.

This happened with Mordal, an assassin in the service of Baron von Kharkov, who was seen after his death in transparent, wraithlike form offering the dagger. After no one took the *fang*, Mordal's ghost discovered it could take a solid form and has used this ability to try to rid itself of this cursed item ever since.

LE; AC -1/6; MV 9; HD 6; hp 48; THAC0 15; #AT 1; Dmg age 10-40 years; SA causes fear at first sight with aging of 10 years (save vs. paralyzation to avoid), keens once per day (all within 20' save vs death magic with +1 bonus or die); SD struck only by silver or magical weapons when ethereal; immune to biologically based spells; SZ M; ML N/A; XP 7,000; MM/130 (Modified per *VRGG*, page 44).

If the PC who got the dagger is killed, the Laughing Man will immediately turn *invisible* and leave. But if another PC picks up the *fang of the nosferatu*, he will be cursed. Worse yet, if he tries to give it away, Laughing Man will show up and haunt the PC just like he did Mordal.

If Laughing Man is defeated, its spirit will also be released. But the PC who took the dagger will be stuck with the curse until someone figures out a way to get rid of it. This could be the beginning of a separate adventure.

If Mordal's ploy doesn't work, and no PC will take the dagger, Mordal exclaims, "Fine. Then if you won't take it freely, let me show you the point I'm trying to make!" And he attacks mercilessly with the *fang of the nosferatu*, focusing on whichever PC came closest to taking it (or the nearest if no one expressed an interest).

Mordal (3rd magnitude Ravenloft ghost): INT very; AL LE; AC -2/4, MV 9; HD 9; hp 63; THAC0 11; #AT 1; Dmg 1-4 +3; SA causes fear at first sight with aging of 10 years (save vs. paralyzation to avoid) at will, uses illusions (with up to three senses active); SD struck only by +2 or better weapons when ethereal, +1 when solid, immune to biologically based spells; SZ M; ML N/A; XP 7,000; MM/130 (Modified per *VRGG* as noted in the text).

During the battle with Mordal, Laughing Man will howl with amusement, and shout encouragement to the PCs. ("All right! Someone finally has the guts to fight him! Hey, good shot! Look out, don't let him cut you with that dagger!")

If the PCs flee, Mordal will pursue them relentlessly until each one is dead from the *fang*. If the PCs defeat him, he will disappear with a "Whump!" of yellowish-green smoke leaving the *fang of the nosferatu* on the ground. Hugo will then emerge from the woods, barely

visible and chuckling. He says, "Too bad. Too bad. I was having a good time with Mordal, but enough was enough. Now I can rest. But before I depart, I must advise you—leave this dagger alone." And with that he fades into nonexistence.

A PC who ignores Hugo's advice and takes the dagger will fall under its curse. Leaving it alone is a good course of action. But a cleric may devise a ritual to get rid of it in another way, and the DM should allow some latitude in player ingenuity and reasoning to make this happen (a *dispel evil* or *exorcise* spell with at least three flasks of holy water being poured on the blade during the spell's casting).

PCs who survive the adventure should be awarded a 3,000-XP story award plus the experience points for defeating Mordal. If a cleric PC thinks of a reasonable way to get rid of the *fang*, award him 1,500 XP. Anyone who voluntarily takes the *fang of the nosferatu* into his possession gets no experience points, but with the curse of this item hanging on the PC's soul, failure to gain experience will be the least of his worries. Even if the PCs manage to get rid of the knife, they may encounter it again in the RAVENLOFT adventure *Hour of the Knife*. Ω

Free Catalog!
Write for your free catalog of games and gaming supplies! In the United States and Canada, write to: TSR Mail Order Hobby Shop, c/o TSR, Inc., P.O. Box 756, Lake Geneva WI 53147, U.S.A. In Europe, write to: TSR Mail Order Catalogue, TSR Ltd, 120 Church End, Cherry Hinton, Cambridge CB1 3LB, United Kingdom. Send for it today!