

# ADVENTURES

## UNLIMITED



Issue #1

\$4.95 U.S. / \$6.50 Cdn

 **SHADOWRUN**

**VAMPIRE**  
The Masquerade™

**MAGIC**  
The Gathering™

**CALL OF**  
**ETHULHU**

**Mrs. Magica**

**CYBERPUNK**®

**OVER THE**  
**EDGE**

**GURPS**®

# WE WANT TO PUT YOU

# ON THE EDGE

## On the Edge



*On the Edge* is the trading card game of surreal conspiracies. You play an arch-conspirator on the Mediterranean island of Al Amarja, seeking to achieve sufficient influence to dominate your opponents. A game for two or more players.

Cepheus

**ATLAS GAMES**

On the Edge is a trademark of Trident, Inc. Copyright © 1994 Trident, Inc.

ADVENTURES UNLIMITED 25

# RIDE THE DIVINE WIND

BY LISA SMEDMAN

ART BY TRISCH LOHNER

**T**his adventure is designed for the *Cyberpunk 2020* game and is based on material found in R. Talsorian Games' upcoming *Pac Rim* sourcebook. While this supplement can provide detailed background material on Japan (the country in which this adventure is set) in the year 2020, it is not necessary to have the book to play *Ride the Divine Wind*.

*Ride the Divine Wind* sees the player characters used as unwitting pawns in a get-rich-quick scheme. It all starts innocently enough, with a search for a runaway teenager who has joined a gang of *boso-zoku* ("reckless-driving tribes"). But there's more at stake here than just a missing kid. Millions of yen and a radical new technology that could change the face of the transportation industry may also hang in the balance.

This adventure can accommodate a number of character types. As written, the characters

are a team of detectives (solos and freelancing cops) who are hired by a wealthy Japanese executive who wants to find his runaway daughter. This team could also include techies and netrunners.

Alternatively, the characters might be friends of the runaway, young rockers or school chums who want to find their friend before the father's "hired goons" do. Street types that the daughter has dealt with in the past (fixers, techies, rockers, and netrunners) might also be motivated to help out an old friend. The gamemaster should set this friendship up in advance by briefly introducing the daughter to the characters before this adventure begins. Since

she's from a wealthy family, maybe she helps one of the characters out with a "pay me back when you can" credit loan.

Finally, a media team might want to find the girl so that they can get an exclusive scoop. Since the daughter ran from the lap of luxury to the uncertain existence of a bike gang, it's the perfect "riches to rags" story.

The alternative set-ups listed above require the gamemaster to create the team of non-player characters that is hired by the father, and to work the actions of this team into the events described below.

## STORY BACKGROUND

Kinuko Sekiguchi was always too individualistic for her own good. First, it was the brightly-colored pockets and extra buttons on her school uniform.

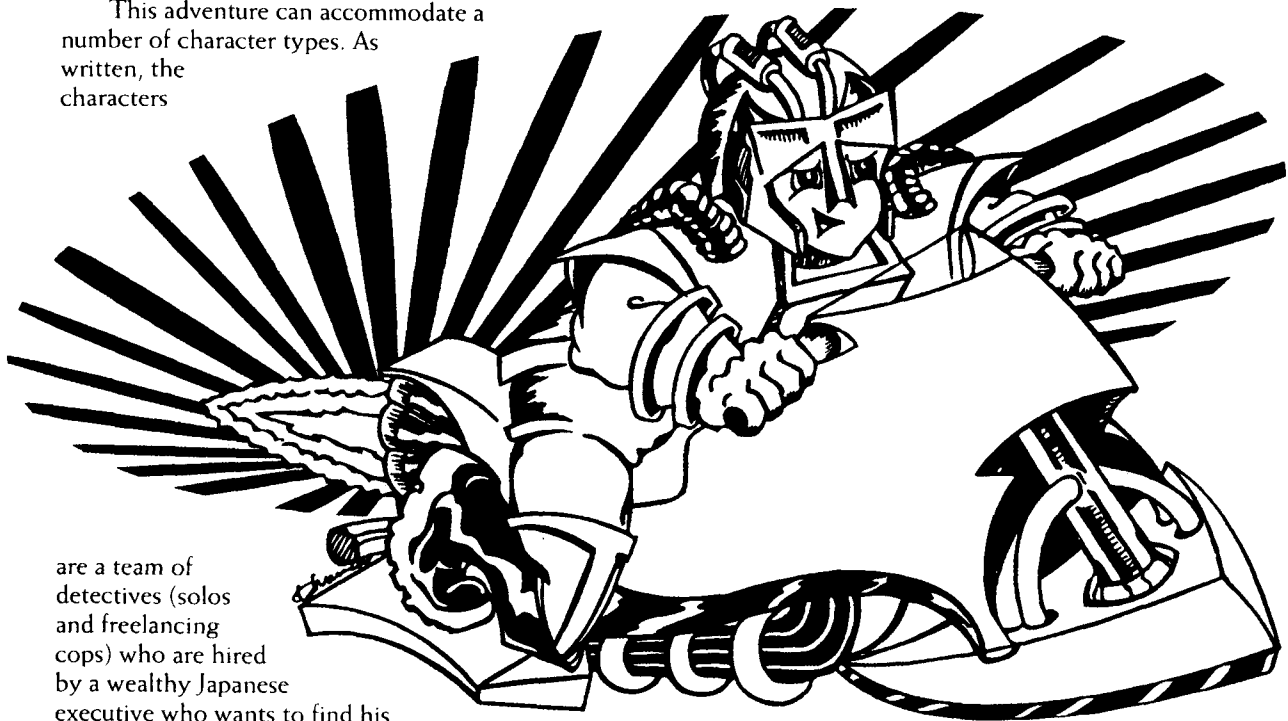

Then came the light tattoos and spiked hair. In no time she was neglecting her studies and hanging out at the *ge-sen* (game center) with the bad youths.

Her father, a middle-management executive with Yamaha International Cybercycle Systems (YICS), tried to talk sense into her. "If you continue on this course," said Naotomo Sekiguchi, "you will surely fail the university entrance exams and shame this family. We have enough of a burden to bear already."

This was a veiled reference to his wife's suicide,

which took place three years ago. The cause was Naotomo's infidelity—a fact Kinuko only recently learned. Her father throwing her mother's death in her face was too much for Kinuko. She lashed out at him, calling him an adulterer. The result was a stony silence, as Naotomo buried himself in his work. Unable to cope with her father's sudden indifference toward her, Kinuko ran away from home.

She found the love she was looking for in the arms of Shiro Toyomura, a member of the *Musha Bashiri* ("Running Soldiers" motorcycle gang. Shiro at first saw Kinuko only as a pretty plaything. But when he learned that Kinuko's father oversaw a research lab at YICS where cybernetic motorcycles were designed and built, he decided to use her to impress the gang's president. He pressured Kinuko into stealing her father's mag-key and entering the lab. The plan was for her to steal high-tech motorcycle accessories.

Security was tight, but Kinuko had made infrequent visits to the lab before and was recognized by the workers. She was able to sweet-talk her way past the guards. Inside the lab, she found a completed "concept bike"—a secret motorcycle prototype that would be the basis for next year's models.

Kinuko had been fitted with a vehicle link two years ago, when her father gave her a Yamaha Cute-Scoot to ride to school. She now used this interface to access the concept bike's control systems. As she revved the nearly-silent engine, the thrill of being one with such a powerful street bike overwhelmed her. Kinuko decided then and there that she would keep the bike, rather than give it to her boyfriend. Stealing it would allow her to enter the gang on her own terms.

When Kinuko wheeled the sleek-looking concept bike into a parking stall outside the *ge-sen* where *Musha Bashiri* hung out, the gang members were suitably impressed. Shiro tried to claim credit for the theft, but Kinuko refused to let him. Speaking her mind led to their first fight. Shiro broke up with her then and there, but Kinuko was allowed to join the gang.

Eventually, Shiro realized that he really did love Kinuko. But it was too late; she had already become the girlfriend of his chief rival, fellow gang member Hitoshi Yamada. Yet Kinuko still has a soft spot for Shiro. Her indecision as to which of the two young men she likes best is sure to cause some friction in the gang.

### THE YAMAHA KAMIKAZE

The motorcycle Kinuko stole is known as the Yamaha Kamikaze. Although it is a concept bike, the only significant technological improvement it offers is an improved muffler design that allows it to run almost silently. Otherwise it is a normal motorcycle albeit one with a sleek look, designed for speed.

A "dual engine" design provides the Yamaha Kamikaze with the power of the typhoon or "divine wind" for which it is named. Operated primarily on

- electrical power (8 hours of travel per one-hour fastcharge), it also features a secondary CHOOH2 engine that can accelerate it to a top speed of 250 kmh at a mere thought from its rider (an acceleration of 50 kmh/phase). The bike's small CHOOH2 tank is good only for about two hours' travel at moderate speeds.

- The name Kamikaze was chosen because of its association with the suicide pilots of World War II. This is a marketing ploy designed to attract Japan's rebellious youth; glamorizing the tragic deaths of these 20th century airmen has become a popular fad.

- The motorcycle is highly maneuverable (maximum maneuver speed of 150 kmh). It is only lightly armored (SP10) and relatively delicate (SDP 20). It's not a bike you'd want to dump too many times.

### NAOTOMO'S PLAN

- Naotomo Sekiguchi was understandably furious to learn that his own daughter was behind the theft of the Yamaha Kamikaze concept bike. Anger and shame were quickly followed by a well-founded fear that he would lose his job. Such is his standing at Yamaha International Cybercycle Systems, however, that he has convinced his superiors to let him personally handle the recovery of the bike. He hires a team (the player characters) at his own expense to track it down and to bring his daughter home.

- Although he pretends to be concerned for his daughter's welfare, Naotomo is so outraged by his daughter's actions that he no longer cares what happens to her. Ultimately, it becomes clear that his instructions to "go softly and use caution" come more out of a concern for recovering the bike intact than out of any fear of what might happen to his daughter.

- Naotomo knows that, even if he recovers the bike, his corporation will be forced to fire him as a result of his daughter's transgression. He will be blacklisted, unable to get a decent job anywhere else. Out of desperation, he has hatched a scheme. The first step involved planting information in the YICS lab's computer files that suggests that the Yamaha Kamikaze contained a unique design feature that would revolutionize the automotive industry: a micro-battery that never needs replacing and is capable of holding enormous power in a lightweight package. (Conventional automotive batteries are bulky and must be replaced every three to five years.) The next step was to call an impromptu press conference that hinted at radical new developments in the YICS lab without mentioning any specifics. Naotomo knew that his competitors would try to hack their way into the lab's computer files, where they would find the false information he had planted. The final step was hiring the characters then telling others in the industry "in strict confidence" about the bike's theft and YICS' hush-hush efforts to recover it. He knows this will confirm the micro-battery's value in the minds of his competitors.

- As soon as word "leaks out" about the amazing

new micro-battery, Yamaha International Cybercycle Systems stock will go through the roof. (It's already doing this when Naotomo hires the characters.) Naotomo, like all loyal managers who believe in the company they work for, owns large amounts of this stock. He plans to dump it and realize a healthy profit long before the motorcycle is recovered and his ruse is revealed. The rival corporations (and stock purchasers) will realize that they have been had but not by whom. Playing the role of the innocent, aggrieved father, Naotomo can pocket the rewards and will never need to seek employment again.

## MUSHA BASHIRI

*Musha Bashiri* are a gang of approximately fifty high-school and university drop-outs from middle- and upper-class homes. They roam the city of Tokyo and its suburbs on motorcycles that were originally gifts from their indulgent parents (although many of the parts are hot). Some of the gang's members have broken off all ties with their families, and a handful were tossed out on their ear for causing shame to their families by preferring to hang out with their friends, rather than cramming for university entrance exams. Others are on better terms and make regular visits home to beg for money or a home-cooked meal.

The *Musha Bashiri* are a typical example of a *bosozoku* gang. They ride an assortment of different motorcycles, but all are painted in brilliant colors and are decorated with the gang's slogans, painted in *kanji* characters. The gangers themselves are a mixture of Japanese tradition and rebellion. They wear baggy, Western-style pants and T-shirts, but when riding strap on thick plastic masks

- that cover their nose, cheeks and jaw. These colorful, grimacing masks are replicas of the lacquered iron masks worn by *samurai* warriors in battle.
- Those few gangers who do wear helmets burn incense in them before wearing them, just as ancient soldiers burned incense in their helmets so that their heads, if decapitated, would smell sweet.
- The average *Musha Bashiri* gang member is lightly armored, at best (leather pants and jacket; SP 4). A few carry knives, and the leader and his two lieutenants are armed with somewhat unreliable, home-made zip guns. Their Handgun skill is +2. (Zip Guns: Type P; WA -1; Con P; Avail P; Dmg 1d6+1; #Shots 6; ROF 1; Rel UR; Range 50 m.)

Among the other members, the weapon of choice is a seemingly innocent *sensu* (fan) whose ribs end in razor-sharp points. To use this specialized melee weapon properly, extensive training is required. (Warrior's Fan: WA +1; Con P; Avail R; Damage 2d3; Rel VR; Range 1m.)

Toshizo Koyanagi, a university drop-out, is the *socho* (president) of the gang. Competing for the spot of second in command, or *fukucho*, are Shiro Toyomura and Hitoshi Yamada. Each is constantly trying to outdo the other in daredevil riding feats on his motorcycle, either to impress the club president or to impress Kinuko, whose affections they are both vying for. These stunts usually include striking a *mei* (a dramatic *Kabuki*-style pose) while the motorcycle zooms over rough, dangerous terrain.

As yet, no females have made it into the upper echelons of the gang. But a number are included in the ranks of the gang's

### Typical Musha Bashiri Gang Member

Int 6	Ref 6	Cool 8	Tech 6
Luck 4	Attr 5	MA 6	Emp 4
Body 5	Save 5	BTM -2	

SKILLS: Special Ability: Gang Rank +2 to +6 (*beitai*); +7 (*fukucho*); +8 (*socho*).

Athletics +4; Awareness/Notice +3; Basic Tech +2; Brawling or Martial Art +3; Dodge & Escape +3; Education & General Knowledge +2; Expert: Battle Fan +4; Expert: Motorcycle Repair +4; Hide/Evade +3; Intimidation +5; Leadership +1 to +2 (*beitai*) +5 to +6 (*fukucho* and *socho*); Melee +4; Motorcycle +4; Personal Grooming +3; Streetwise +4; Wardrobe & Style +4.

CYBER: Basic processor; interface plugs; vehicle link; various fashionwear (e.g. skinwatch, light tattoo, shift-tacts, techhair); nasal filters (versus smog).

EQUIPMENT: Motorcycle (Kundalini Shiva Cyberbike, Yamaha Scorpion, Honda Microjet) with customized paint job and accessories; knife or battle fan; motorcycle repair kit; video/audio tape player; sleeping bag. Some gang members have stolen cell phones, while others (those still on speaking terms with their families) have Trauma Team International cards.

- *beitai* or "soldiers."
- At night, Toshizo and his vice-presidents lead the *Musha Bashiri* on their noisy excursions.
- Sometimes the gang roars through a quiet suburban

neighborhood in pairs, one member concentrating on driving the bike while another, sitting behind, waves a red flag that bears the gang's colors: a white fan with *Musha Bashiri* written in *kanji* across its opened face. At other times the gang becomes more violent, riding their motorcycles into shops to commit armed robbery. The gang also likes to crash house parties in suburban Tokyo, especially if the partiers have access to Smash or other soft drugs.

By day, the gang hangs out at Otaka Ge-sen, one of Tokyo's many gaming arcades. Doffing their masks, they blend in with the other teens who frequent the place; only the bikes parked outside reveal that the *Musha Bashiri* are within. Often members will sleep in these relatively safe environments, rolling out their sleeping bags in an empty virtual booth.

Suitable first names for male gang members: Jun, Keishi, Issei, Takaki, Taro, Tomoyuki. Suitable first names for female gang members: Miyuki, Mika, Ayako, Reiko, Shinobu, Kyoko, Marina, Ikuko. (Names graciously provided by playtester Ted Snell of Vancouver.)

### STARTING THE ADVENTURE

Unless the game master is running a campaign that is already set in Japan, the first challenge will be to get the players to that country. One of the easiest ways to transplant the characters is with the lure of easy money. Japan has a thriving film industry that is always on the lookout for non-Asian actors particularly beefy characters who can play the "tough guys" or perform stunts in action films. The industry is also looking for netrunners and techies for its computer graphics and special effects departments.

The players are lured to Japan by a lucrative employment offer from the Three Lions Film Company. Their flight to Japan is paid up-front, but once they arrive in the country the film offer falls through. Three Lions has gone into receivership and the picture has been canceled. Embarrassed that the deal has gone sour, the characters' contact offers alternative employment. A personal friend (Naotomo Sekiguchi) is looking for skilled operatives to perform a job that must be handled discreetly. The money is just as good as the film deal, and the client is willing to pick up the tab for the expensive Tokyo hotel that the characters are booked into. He is also willing to pay for Japanese-language chips for characters who have neural processors. Since the characters have three weeks to kill before their return flight, they might as well make a little pocket money.

Naotomo Sekiguchi meets the characters in a noodle bar in downtown Tokyo. He introduces himself as an executive with Yamaha International Cybercycle Systems, but does not tell the characters that he is the manager of YICS' research and development lab. He offers them 3,000 Eurodollars each, plus expenses, if they can bring his daughter back home and recover a motorcycle that she stole.

Naotomo gives the characters a school picture of

- his daughter that is two years out of date. It shows a rather plain-looking girl in a school uniform. He tells the characters that his daughter ran away from home three months ago, and that she has been hanging out with a *bosozoku* gang. He doesn't know the gang name, but can describe its "colors" its members wear red jackets that have a white fan painted across the back. A few weeks ago, Naotomo saw his daughter climbing onto one of these gang members' motorcycles outside a *ge-sen*. The motorcycle sped away before Naotomo could cross the street to talk to Kinuko. He doesn't remember the name of the arcade, but knows it was located near the Harajuku train station. He explains that the Harajuku is an area of fast-food outlets, fashion stores catering to teens, and arcades. Nearby Yoyogi Park is a popular hangout for "anti-establishment" kids.

- Naotomo adds that, four days ago, Kinuko broke into a Yamaha showroom and stole a motorcycle. He explains that it was a very expensive machine, and that he will lose his job unless it is recovered in one piece and returned to YICS. He describes it as white with a World War II era rising sun painted on the fuel tank.

- Naotomo pays the characters one-third of their fee up front (in yen, exchanged at 150 to the Eurodollar), explaining that another third will be paid when his daughter is brought home, and the final third when the stolen motorcycle is recovered.

### WEAPONS RESTRICTIONS

- Firearms and knives with blades longer than 30 cm are illegal in Japan. If the characters are foreigners who have entered Japan legally, any illegal weapons carried by the characters will have been seized by customs. To acquire a handgun through the black market, a character must make a Streetwise skill check at a difficulty level of 25. To acquire a knife, the difficulty level is 15. The purchase takes place in Tokyo's Shinjuku (Kabukiza) district, a stronghold of the Yakuza, or Japanese mob. Prices are two to three times those in America. Electronics equipment may be purchased in Akihabara, Tokyo's "electric circus."

- If the characters are instead Japanese citizens, only legitimate police officers who are actively working on cases under the jurisdiction of the National Police Agency will be allowed to carry firearms. These weapons will be issued by the Japanese police force. Non-standard weapons are not permitted.

### LANGUAGE AND SOCIAL PROBLEMS

- Unless the characters speak fluent Japanese (Know Language skill level 6+), they're going to have problems communicating with those around them. They may also face problems if they are obvious foreigners.

- A poor command of Japanese affects the following skills: Interrogation, Intimidate (if only verbal threats are involved), Oratory, Streetwise, Human Perception (if relying upon tone of voice and

word choice), Interview, Seduction, Social, Persuasion & Fast Talk, Perform (acting or singing), and Library Search (the character must also read Japanese). The penalties are as follows:

Know Language Skill:	Penalty:
+1 (can't read Japanese) .....	-5
+2 (can't read Japanese) .....	-4
+3 .....	-3
+4 .....	-2
+5 .....	-1

The alternative is to speak with the Japanese in English. To determine how well a Japanese non-player character speaks English, roll 1d10-2. This is the characters' Know Language (English) skill. A negative result means that the character does not speak English.

If a conversation is carried out in English, the above penalties apply, unless the non-player character is fluent in English (Know Language skill level 6+). At a skill level of 8, the character speaks English like a native, with one of the following accents: American, Australian, British, Canadian, Irish, New Zealander, Scottish, South African.

A player character's degree of success in a social situation also depends upon whether that character is a native-born Japanese, a *nikkei-jin* (an ethnic Japanese born and raised outside of the country), or a *keto* (foreigner). Native-born Japanese get a +3 bonus to all Empathy and Cool/Will skill checks (except Resist Torture/Drugs). *Nikkei-jin* get a -1 penalty, while *keto* get a -3 penalty. These bonuses and penalties are cumulative with the penalties for language listed above.

### TRACKING DOWN MUSHA BASHIRI

Downtown Tokyo has hundreds of gaming arcades fifteen of them within a five-block radius of the Harajuku train station alone. Its streets are filled with motorcycles and scooters of every description many of them ridden by young people wearing colorful clothes, including red jackets.

If the characters talk to the kids who hang out at any of the *ge-sen*, a successful Streetwise skill check will provide the necessary information to track down the *bosozoku* gang. Information is cumulative (e.g. on a result of 30 read the character everything listed below).

Result 10 (Police 10-15): A *bosozoku* gang frequents this part of town. It has a couple of dozen members who ride fancy *tanshas* (motorcycles) and wear weird looking masks.

Result 15 (Police 20-25): The *bosozoku* gang whose emblem is the white fan is called *Musha Bashiri*. Its leader is a *ronin* (university drop-out) named Toshizo. The gang hangs out at a *ge-sen* on Maiji-dori Avenue.

Result 20 (Police 30+): After Toshizo, two of the more important gang members are Shiro and Hitoshi. The two have been arguing a lot lately over

some girl. The name of the arcade they hang out at is Otaka Ge-Sen.

Result 25: *Musha Bashiri* gang members fight with warriors' battle fans. A few of their members also carry zip guns.

Result 30+: One of the new gang members, a girl named Kinuko, stole an experimental motorcycle worth a lot of money four days ago. The bike is parked outside the Otaka Ge-Sen gaming arcade right now.

### CHECKING WITH THE POLICE

The characters can also gain the above information from the two National Police Agency officers who staff a "police box" two blocks away from the Harajuku train station, on Omotesanda Avenue. These officers can provide the information listed above, but do not know about the stolen bike (the theft was not reported to police) and do not recognize Kinuko's name. She is not listed on the police database as a runaway, since she was never reported missing.

If the characters think to ask about the theft of a motorcycle from a Yamaha showroom four days ago, they can learn that no such crime was reported.

Hacking into the NPA database (there's a dataterm in the police box) requires an Interface skill check of 20+ to get around the passwords. Getting inside the police box itself requires a Pick Lock skill check of 15+.

### National Police Agency Officers

Int 8	Ref 7	Cool 6	Tech 6
Luck 5	Attr 4	MA 7	Emp 7
Body 6	Save 6	BTM -2	

SKILLS: Special Ability: Authority +6.

Athletics +5; Awareness/Notice +6; Basic Tech +2; Brawling +5; Education +7; Electronic Security +2; Expert: Law +5; Handgun +6; Human Perception +5; Interrogation +6; Intimidate +4; Melee +5; Shadow/Track +4; Streetwise +5.

CYBER: Skinwatch; neural processor with police dataterm link; smartgun link; nasal filters (versus smog). Some have grafted muscle (Body 8; BTM -3) or Sandevistan Speedware.

EQUIPMENT: Light armor jacket (SP 12); nylon helmet (SP 20) with built-in police radio; Towa Type 13 handgun with one extra clip; nightstick; flashlight; 10 sets plastic handcuffs.

(Towa Type 13 Police Pistol: Type P; WA +2; Con J; Avail P; Dmg 2d6+3 (10mm); #Shots 12; ROF 2; Rel VR; Range 50 m.)

### AT THE OTAKA GE-SEN

Otaka Ge-Sen is one of three arcades on Meiji-dori Avenue. When the characters arrive, a total of 21-30 (20+1d10) *Musha Bashiri* are present. Most are inside playing arcade games (or sleeping in virtual

booths), but four will be lounging outside the *ge-sen*, smoking cigarettes and eating junk food. They keep a close eye on the gang's motorcycles and immediately confront anyone who shows too keen an interest in them.

On an Awareness/Notice skill check of 15+, the characters notice a motorcycle parked outside the *ge-sen* that matches the description of the stolen bike.

The *Musba Bashiri* gang members can be spotted by the colorful plastic *samurai* masks that either hang from their belts or are stuffed in their pockets. Only Hitoshi Yamada (Kinuko's current boyfriend and one of the gang's two *fukuchos*) wears the gang colors a red satin jacket embroidered with a white fan. The other gang members wear normal (albeit unconservative) clothes.

Kinuko is inside the *ge-sen*, playing a game. She doesn't look a bit like her school picture. Since it was taken, she's dyed her hair a bright orange and implanted light tattoos in her cheeks that resemble neon blue "freckles." To spot her in the crowd (there's close to 200 kids in the *ge-sen*), the characters must make an Awareness/Notice skill check of 20+. Otherwise, they'll have to ask questions.

A non-gang member has only a 20% chance (1-2 on a 1d10) of knowing who Kinuko is. The kid will be suspicious of adults asking questions, however, and will only point her out if the character makes an

- Interrogation, Intimidate, Oratory, Interview, or Persuasion & Fast Talk skill check of 15+. All *Musba Bashiri* members know who Kinuko is, but characters must make the above skill checks at 20+ before a gang member will talk.

- If the characters are young enough, they might pose as university drop-outs looking to get into the gang. They can use this ploy to get background information on *Musba Bashiri*, either from the gang members themselves or the kids who know Kinuko but had better know enough about motorcycles to carry on an intelligent conversation. If the characters are accepted at face value by the gang, they are invited to come to an abandoned pier in the Harumi district that night and perform a few motorcycle stunts there. If the gang likes what they see, the character might be invited to become a member.

- To bring Kinuko home again, the characters are going to have to use a combination of guile (to lure her away from fellow gang members) and brute force. If the characters tell Kinuko that they have come to the arcade to take her home, she absolutely refuses to go with them. If any force is used in an effort to remove her from the *ge-sen*, she immediately screams for help. A total of 1d10+10 gang members come to Kinuko's aid, attacking the characters using Martial Arts skills and (if need be) battle fans and knives.

For Kinuko's statistics, use the Typical *Musba*

## Otaka Ge-Sen

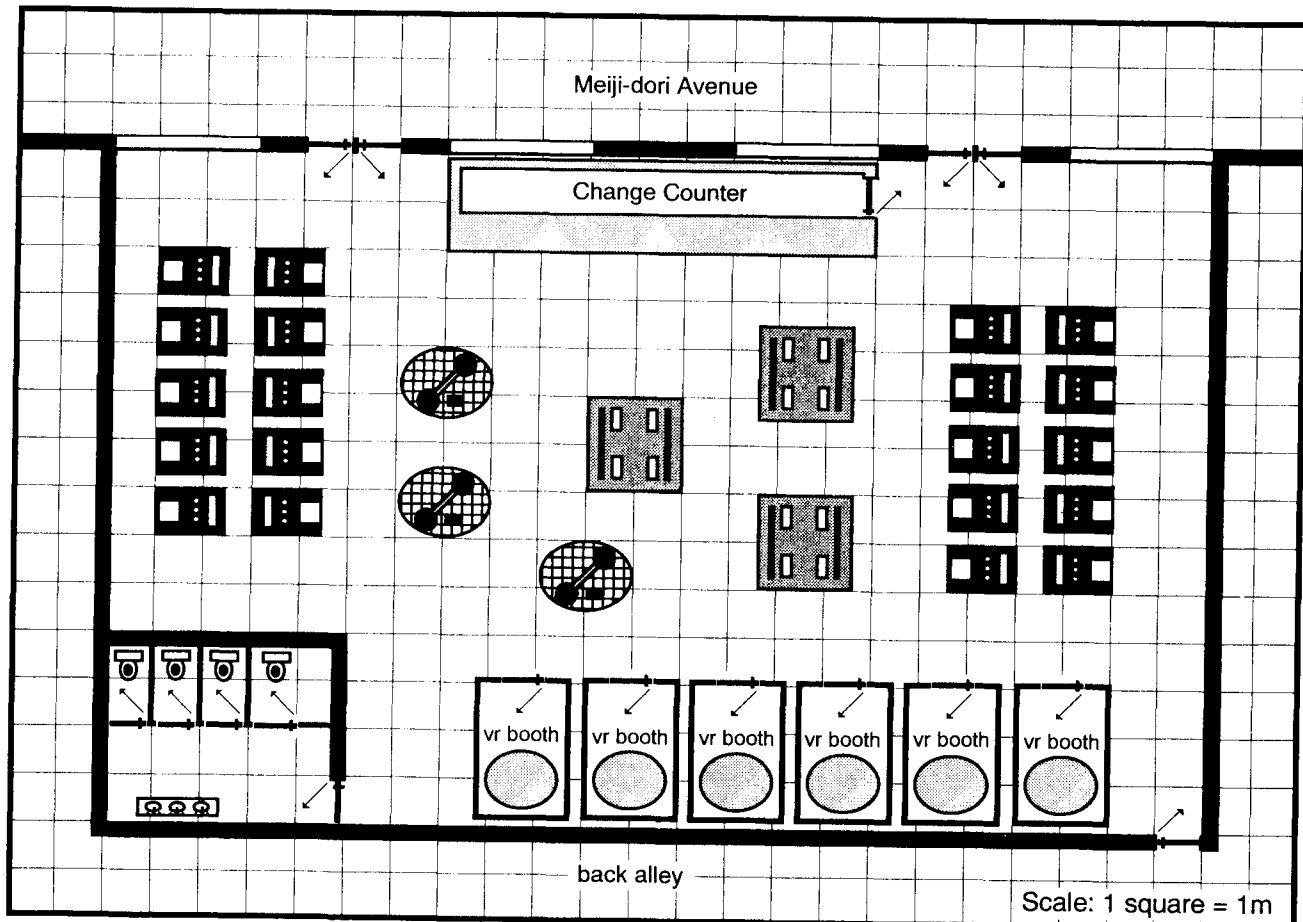



*Bashiri* Gang Member. She is a *beitai* (Gang Rank +2; Leadership +2). She carries a knife rather than a battle fan (she doesn't know how to use the fan yet), and her Martial Art skill is Judo.

If a fight breaks out at the *ge-sen*, the two officers from the neighborhood police box arrive within a few minutes to try and break things up. They also respond if they see Kinuko being dragged away by the characters. If a fight escalates to the point where weapons are being used, the officers call in reinforcements. If the police arrive, the gang members scramble for their motorcycles and roar away.

The gang's two lieutenants (Shiro Toyomura and Hitoshi Yamada) are also at the arcade. Both are carrying their zip guns. If the characters quietly observe the kids at the arcade, eventually Shiro and Hitoshi get into an argument.

"Kinuko must decide once and for all which of us she wants as her boyfriend," one yells.

"No!" the other shouts back angrily. "Kinuko can't make up her mind. Let her motorcycle decide it."

"*Hait* Tonight at Harumi Kurabashi. We decide it there."

A short time after this argument, all of the *Musha Bashiri* gang members leave the arcade. They get on their motorcycles and drive away. If Kinuko has disappeared (been captured by the player characters, for example) another gang member hot-wires her bike and drives it away.

### STEALING THE YAMAHA KAMIKAZE

The Yamaha Kamikaze can be started up by inserting a magnetic key (shaped like a triangular spike) into its ignition. From there, the bike is controlled cybernetically; a character must have interface plugs or a vehicle link to ride it. Any character with a Motorcycle skill of 1+ can drive the bike, but maneuver rolls (skill checks) are required to perform the following actions:

- Swerve: 10+
- Wheelie: 10+
- Tight turn: 15+
- Hard Brake: 15+
- Short Jump (up to 3 meters): 15+
- Hard Acceleration (using CHOOH2 engine): 15+
- Rotate/Bootleg Turn: 20+
- Long Jump (up to 6 meters): 20+
- Extreme Jump (more than 6 meters): 25+

For each 50 kmh the bike is traveling over its maximum maneuver speed of 150 kmh, add +2 to the difficulty number listed above. Some of the modifiers listed in the *Solo of Fortune* sourcebook may also apply (+5 for an oil slick, +3 for heavy rain or insufficient light, +2 for gravel, +1 for a downhill grade, and +2 to +6 for a wounded or injured driver).

Hot wiring the bike requires an Electronic Security skill check of 15+; fortunately there's no

- vehicle alarm since it's just a concept bike. It can be wheeled away without starting the engine, but a single character pushing the bike moves at half the normal movement allowance (two characters pushing it together move normally).

- Stealing the motorcycle from in front of the Otaka Ge-Sen is going to be tough. The four gang members out front immediately attack anyone who tries this, and at the same time yell for help. A total of 1d10+10 gang members come running from inside the arcade, arriving on the third round of the fight.

### AT THE PIER

- At night, the *Musha Bashiri* gang rides out to Harumi, an industrial area in the Port of Tokyo. Here, at the abandoned Kurabashi Pier, gang members try to outdo each other with motorcycle stunts. The rough pavement and large obstacles make for a dangerous course, while sloping ramps provide a raised platform from which the other gang members can watch, cans of Smash in their hands.

- The characters can locate this hangout either by overhearing the argument at the *ge-sen*, or by asking non-gang kids in and around Otaka Ge-Sen where the *Musha Bashiri* have gone. There is a 10% chance (a 1 on a 1d10) that any kid will be able to name the Kurabashi Pier. As before, the kids are suspicious of adults asking questions, however, and will answer only if the character makes an Interrogation, Intimidate, Oratory, Interview, or Persuasion & Fast Talk skill check of 15+.

- The gang gathers at the Kurabashi Pier at 10 p.m. If the characters can get there first, they can conceal themselves. Each character's Hide/Evade skill check should be compared to a single Awareness/Notice skill check on the part of the gang as a whole to see if that character is spotted.

- If the players are really having trouble deciding what to do next, one of the characters spots a gang member on a motorcycle. The kid tries to lose them but crashes his bike, seriously injuring one leg. The characters can use either their Interrogation or Intimidate skills to bully the whereabouts of the gang out of the kid, or can try Persuasion & Fast Talk, perhaps using the promise of medical aid as an incentive. In either case the difficulty number is 10.

- Tonight, Shiro and Hitoshi are going to try to outdo each other in a contest to see who will "win" Kinuko as his girlfriend. The stunts are to be performed on the Yamaha Kamikaze. In honor of the bike's name, each rider ties a white cloth around his forehead before setting out to do his stunts, and burns incense in his helmet. They take turns until one loses the contest.

- Kinuko doesn't approve of the contest, but if she protests, the gang's *socho*, Toshizo, may toss her out of *Musha Bashiri*. She watches from the sidelines, furious at being treated like a contest prize. After stealing the bike, she expected to be treated as an equal of the boys in the gang. Now she is somewhat disillusioned but is still fiercely loyal to her new "family."

Before the adventure begins, the gamemaster should decide in advance what stunts Shiro and Hitoshi will perform, then roll each gangers' Motorcycle skill checks to see if he succeed. The results should be noted, then described at a realistic pace when the story reaches this point.

The stunts are carried out at anywhere from 100 to 150 kmh (within maximum maneuvering speed). A skill check missed by 1-6 is a skid, from which the ganger is automatically deemed to recover. A skill check missed by 7+ is a crash. Both bike and rider take 1d10 points of damage per 30 kmh increment of speed (rounded up). As soon as either the bike is destroyed (loses 20 SDP) or one of the contestants is critically wounded the contest ends.

The contest will be especially dramatic if the loser is mortally injured and dies as the result of a crash. If this happens, Kinuko rushes down to embrace the fallen rider, only to be yanked back by the angry winner. A fist fight breaks out between Kinuko and the victor, while the gang members cheer. The boys urge him to "show your girlfriend who's boss," while a handful of the bolder girls (those with their own bikes) cheer Kinuko on.

If any of the characters has won the trust of the gang and been invited to perform motorcycle stunts, these take place before the contest between Shiro and Hitoshi. The gamemaster should use the rules for Maneuver Rolls, and for Losing and Regaining Control of a Vehicle from *Solo of Fortune*. The character can either use his or her own bike, or borrow one from a gang member on a Persuasion & Fast Talk skill check of 15+.

### PARTY CRASHERS

The characters are likely going to have to wait until the contest is over before trying to grab either Kinuko or the Yamaha Kamikaze. The full gang is in attendance this evening (all 50 of them), and any obvert attempt to interfere with the evening's proceedings is cause for the characters to be attacked.

At some point in the evening, the "party" at the Kurabashi Pier is crashed. Ideally this should occur just after the contest between Shiro and Hitoshi, when Kinuko and the victor are fighting, but the gamemaster may need to adjust the timing depending upon the player characters' actions. An armored AV-4 (SP 40) swoops low over the harbor, angling toward the pier. As soon as it touches down, six men leap out of the assault vehicle. Four of them threaten the gangers with assault weapons to keep them back, while the other two drag the Kamikaze inside the AV-4. All six then leap back inside the AV-4, which jets away. Unless there is serious opposition, the whole operation takes less than two minutes.

The men in the AV-4 are hired guns in the employ of a Japanese automotive firm. Their objective is to capture the Yamaha Kamikaze no matter how damaged it might be. They don't care who they kill in the process. Fortunately, the gangers

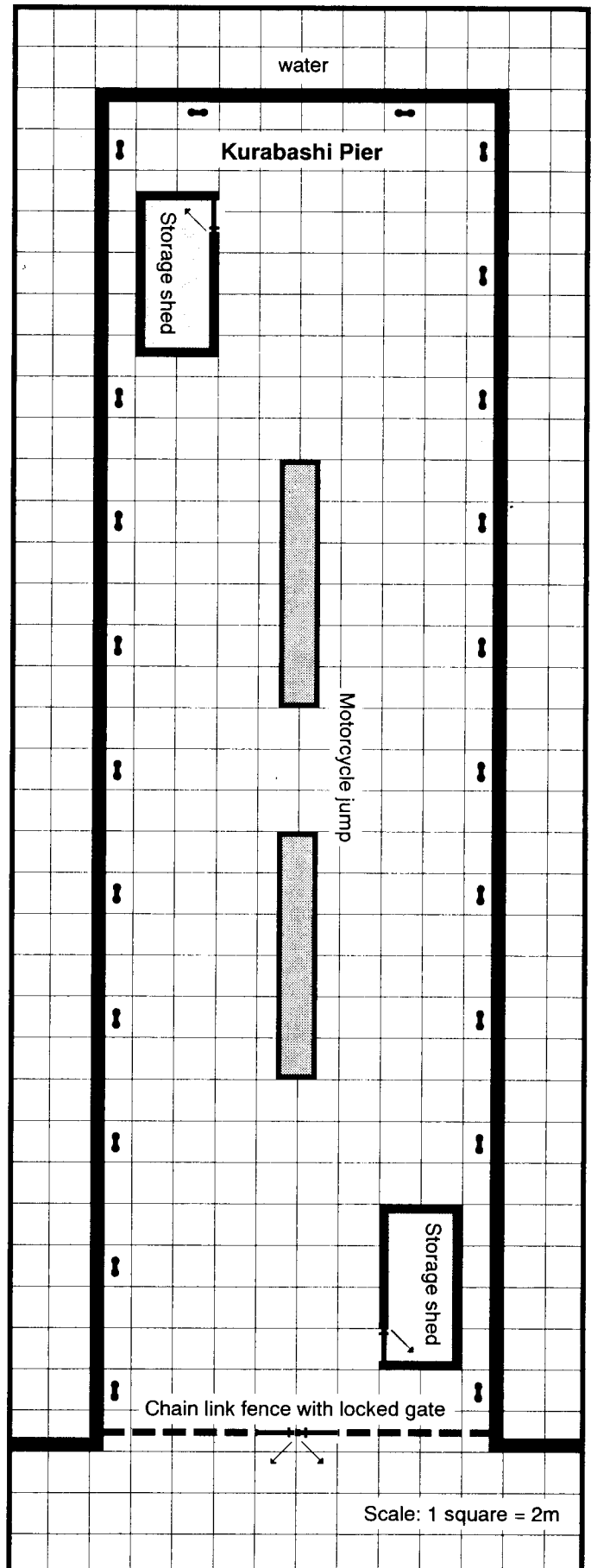

know when they're outgunned, and don't try to fight back. They have no idea who these goons are, but they respect a show of force. The player characters, however, may want to start something...

**Hired Thugs**

Int 6	Ref 7	Cool 7	Tech 6
Luck 5	Attr 4	MA 7	Emp 7
Body 8	Save 8	BTM -3	

**SKILLS:** Special Ability: Combat Sense +6. Athletics +6; Awareness/Notice +5; Basic Tech +2; Brawling +6; Education +3; Handgun +6; Intimidate +6; Melee +5; Rifle +6; Strength Feat +4.

**CYBER:** Neural processor with smartgun link; cyberoptic with targeting scope, image enhancement, low lite, and anti-dazzle; skin weave.

**EQUIPMENT:** Kevlar T-shirt (SP 10); Towa Type 99 assault rifle. (Towa Type 99 Assault Rifle: Type RIF; WA +1; Con N; Avail P; Dmg 5d6 (5.56mm); #Shots 35; ROF 30; Rel ST; Range 400 m.)

**TALKING TO THE SEKIGUCHIS**

If the characters succeed in subduing Kinuko and dragging her away from her gang, she swears at them. "Father hired you to do this, didn't he? He didn't care about me, until I stole the bike from his lab. That's what he really wants, isn't it? The Kamikaze. He's afraid I'll sell it to another motorcycle company."

If Kinuko's capture comes after the stunt riding contest between Shiro and Hitoshi and the attack of the hired thugs in the AV-4, Kinuko is badly shaken and ready to talk. She tells the characters all about how she stole the bike from the lab that it is a secret "concept bike" that was due to be unveiled soon. All she knows about the bike's design is that it's very quiet and very fast.

If the characters display any sympathy whatsoever, Kinuko confides in them the reason why she ran away, telling them all about her mother's suicide and her father's extreme disapproval of what was (prior to her joining *Musha Bashiri*) a relatively harmless teenage rebellion.

Should the characters return Kinuko to her home, her father is visibly disappointed. "And the motorcycle?" he asks. "Where is it?" He orders the characters to immediately resume their search for the bike, virtually ignoring his daughter. Within a few hours, Kinuko will have run away again and rejoined her gang.

As soon as the characters tell him about the AV-4 attack, Naotomo correctly concluding that the Kamikaze has fallen into a riva! corporations' hands. He immediately calls the characters off the search, telling them, "all is hopeless now." He pays them their fees and sends them on their way. If the characters have yet to bring Kinuko home, Naotomo

tells them to end that search as well. "It is getting too dangerous," he says. "I fear for her safety. Hiring people to search for her was a mistake. I will do it myself."

If the characters ask what was so special about the bike, or inquire as to why an armed team in an AV-4 would want to grab it, Naotomo admits that it's a concept motorcycle. He says he is sworn to secrecy on the details of its design.

Basically, Naotomo says whatever he must to brush the characters off. His next action is to immediately sell all of his shares in YICS.

**RETURN OF THE GOONS**

The day after the characters have been dismissed by Naotomo, the AV-4 makes a second surprise landing. Its objective this time is the capture of one or more of the characters. The game master should time the attack so that it occurs when the characters are in a thinly-populated part of the city, preferably under cover of darkness.

The same set of six hired thugs performs this raid. They shoot only if the characters resist the objective is to capture one or more of them alive. The victims are forced into the AV-4, blindfolded, and tied up. A few minutes after the AV-4 takes off, the characters are injected with a drug (truth serum). Each must make a Resist Torture/Drugs skill check of 25+ to avoid it taking effect. Otherwise, they must answer every question put to them truthfully.

The thugs question the characters, beginning by asking what corporation they are working for. "Are you with Ford-Mazda? Mitsubishi? Kawasaki? No? Then what corporation are you working for?"

They next ask about the characters' connections with *Musha Bashiri* and Kinuko Sekiguchi. "We know she stole the motorcycle," they say. "Did you help her do it?"

They also keep asking the characters the same two questions over and over: "Where is the battery? What have you done with it?"

Unless they have hacked into the YICS files, the characters will have no idea what the thugs are talking about and will probably say so. The game master should remind characters that they cannot lie.

A few hours later, the AV-4 lands and the characters are tossed out. Their bonds have been untied but their blindfolds are still in place. As they tear them off, they see the AV-4 rising into the sky. After a moment or two it disappears behind the Tokyo skyline.

**PUTTING THE PIECES TOGETHER**

The characters may want to try hacking their way into Yamaha International Cybercycle Systems' computer files to learn more about the Kamikaze. A netrunner can hack into the YICS system with an ease that should be suspicious (on an Interface roll of 10+) and find "secret" files on the bike that describe a revolutionary design feature: an enormously powerful, lightweight micro-battery with an

operational lifetime of a century. This information is false; the file was planted here by Naotomo for rival automotive corporations to find in a (highly successful) effort to drive YICS shares up. He will erase it a short time later.

If the Interface skill check was 20+, the netrunner notices an interesting anomaly. The file, which purports to be an ongoing record of work on the bike, was last updated and saved one day after the Kamikaze was stolen. Tests were supposedly performed on the micro-battery that day. (If the character specifically asks for the date of the file, the game master should reveal it.)

Another source of information is the Tokyo scream sheets. A story in the automotive section notes that YICS is working on a project that will "revolutionize the transportation industry." The top-secret design feature, expected to be a gold mine for the company, will be incorporated into a motorcycle that YICS has recently developed. The article coyly notes that details of the project have not yet been released, but that the motorcycle is to be called the Kamikaze "a name that only hints at the storm this product will cause upon its release."

The latter quote is attributed to YICS research and development manager Naotomo Sekiguchi, who made the comment at an impromptu press conference. The article notes the date of the press conference it was held two days after the bike was stolen.

A quick look at the business section of the scream sheet shows that YICS shares took off like a rocket one day after this press conference. They were heavily traded on the Tokyo stock exchange.

Naotomo Sekiguchi has accounts at the Bank of Tokyo (the characters will learn this when he pays them; the transaction on their credit sticks records the funds as coming from this bank). A netrunner can hack into the read-balance-only portion of the bank's accounts files on an Interface skill check of 15+. Once Naotomo dumps the shares, his account jumps by several million yen (hundreds of thousands of Eurodollars). The money was transferred from Shimoda Stock Brokers Inc.

Whether the characters follow up on Sekiguchi's scam and how they decide to go about it is up to the players. Perhaps they'll decide to make him pay for the way he treated his daughter... or maybe they'll try to blackmail him into sharing his windfall.

### ROLE-PLAYING A GANGER

Each time the characters interact with one of the *Musba Bashiri* gang members, the game master should strive to make the ganger an individual. The following three tables can be used to provide a ganger with a quick history.

The tables can also be used by players who choose a gang member character (in Japan or elsewhere). They augment the Lifepath provided in the *Cyberpunk 2020* game.

### Reactions of your family (roll 1d10):

- 1) They think joining a gang was a stupid mistake. But they still love you. They keep nagging at you to leave the gang and think you should see the family psychiatrist.
- 2) They think the gang corrupted you. They'll do everything in their power to get those bastards.
- 3) They couldn't care less about the gang, and about you.
- 4) You're the black sheep of the family. Your name isn't even spoken at family gatherings.
- 5) Your gang connections are a valuable asset that keeps them in money, weapons and drugs.
- 6) They don't know what's become of you, but have hired a private investigator to find out.
- 7) What reaction? Your whole family is involved in the gang.
- 8) You're the biggest disappointment of their lives. They mourn you as if you were dead.
- 9) They're terrified of you. If you show your face around home, they'll probably call the cops.
- 10) Family? What family? You haven't heard from them or made any effort to contact them in years.

### How you view your gang (roll 1d10):

- 1) They're the coolest people around and you're proud to be part of the gang.
- 2) You regret ever having joined. Being part of a gang is a good way to get killed. But backing out now would be more dangerous than staying in.
- 3) Being in a gang is just as boring as everything else. You stick with it because you can't think of anything better to do.
- 4) The gang members are the only people who ever cared for you. You love them like a family.
- 5) The gang is your lifeline. It provides everything you need: drugs, money, sex.
- 6) These people are crazy, but they're a lot of fun. Besides, you like hanging out with people who have the guts to take a few risks.
- 7) You're terrified of your fellow gang members. You know that if you quit, you're dead meat.
- 8) The gang is the fast track to the big time and you're glad you joined.
- 9) You're somewhat disillusioned by the gang, but you're in this relationship for better or for worse.
- 10) Wow! Do these guys ever know how to party!

Why you joined the gang (roll 1d10):

- 1) You were bored and gangs seemed exciting. They also wear great clothes.
- 2) Your best friend was in a gang and talked you into it. But now s/he's dead.
- 3) You dropped out of school and had nothing better to do.
- 4) Your parents ignored you and you sought attention elsewhere.
- 5) You needed to support your drug habit and the gang provided easy access to the pharmaceuticals you crave.
- 6) Someone dared you to and now it's too late to turn back.
- 7) You were forced to join the gang or else they would kill someone you loved (or would kill you).
- 8) You thought it was a quick road to easy money.
- 9) You were in love with a gang member.
- 10) You like to party and the gang listens to great music.



#### Lisa Smedman

Lisa Smedman has designed a number of adventures for TSR's *Dungeons and Dragons* Ravenloft and Dark Sun product lines. Her work has also appeared in *Dragon Magazine* and *Dungeon Magazine*.

Lisa also writes science fiction and fantasy. Her short story *Los Muertos* was a runner-up in the 1992 Writers of the Future contest. Other short stories have appeared in *Dragon Magazine*, in Dark Sun boxed sets, and in various SF and fantasy publications.

She is has also written for both Chameleon Eclectic Entertainment and West End Games.

Lisa lives in Burnaby, B.C. with her "spousal unit" and four (sometimes five) felines. She was introduced to wargaming at an early age, and began playing *Dungeons and Dragons* around 1980. She has been an active member of the B.C. Science Fiction Association for several years, and has helped to organize SFconventions in the Vancouver area.



#### Trisch Lohner

Artist, designer producer – those are the titles Trisch would like to have, and in that order. Originally from Victoria, B.C., Trisch moved to Vancouver in 1986 and one year later entered Emily Carr College with design in mind. The wild years had begun. Graduation, thankfully, came in 1991 and Trisch was ready for the real world. A few months later she took a job with U-TV (the voice of a new generation) and in three years has found herself in a senior position with three international awards to her credit. Always willing to try something new, Trisch has only recently begun exploring the fantasy and science fiction genre.

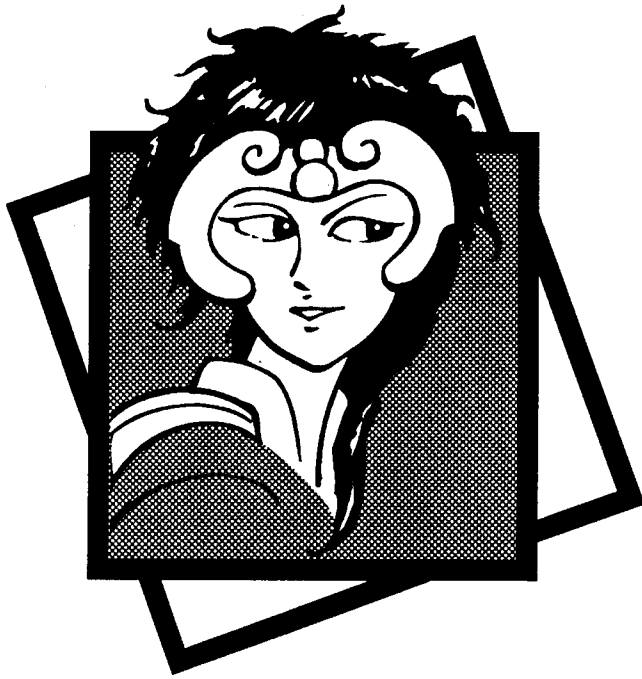

#### CONVERSION NOTES

*Ride the Divine Wind* can be converted into a Shadowrun adventure with very few changes. Here are the statistics for the characters and vehicles it contains:

##### Characters

For the major characters, use the following Archetypes; page numbers refer to the *Shadowrun II* rulebook, unless otherwise specified. (Note: Many of these characters require Vehicle Control Rigs. Add Vehicle Control Rig 1, and decrease the Essence listed in the Archetype by 1.0.)

Kinuko Sekiguchi: Corporate Secretary (p.205).

Naotomo Sekiguchi: Mr. Johnson (p.210).

Toshizo Koyanagi / Shiro Toyomura / Hitoshi Yamada: Gang Boss (p.207).

Other Musha Bashiri: Gang Member (p.57).

Hired Thugs: Bodyguard (p.49) x5; Combat Mage (Combat orientation) (p.50) x1.

Note that, in Shadowrun, the Japanese culture is highly xenophobic when it comes to *kawarubito* ("changed people") – that is, metahumans. Members of "respectable society" – the Sekiguchis, for example – will all be humans. There may be some metahumans among the gangers, but not many.

##### The Yamaha Kamikaze

This resembles a Yamaha Rapier, but with even more extreme lines, and a flashy custom paint-job. It has no hardpoints or firmpoints installed. Unlike the Rapier, it can only be controlled via a Vehicle Control Rig.

Handling: 3	Speed: 70/210	Body: 1
Aarmor: 0	Sig: 2	Pilot: 2
Cost: n/a		

# ADVENTURES UNLIMITED

**EVERWAY**  
cards inside

**Issue #4**  
\$4.95 U.S. / \$6.50 Cdn

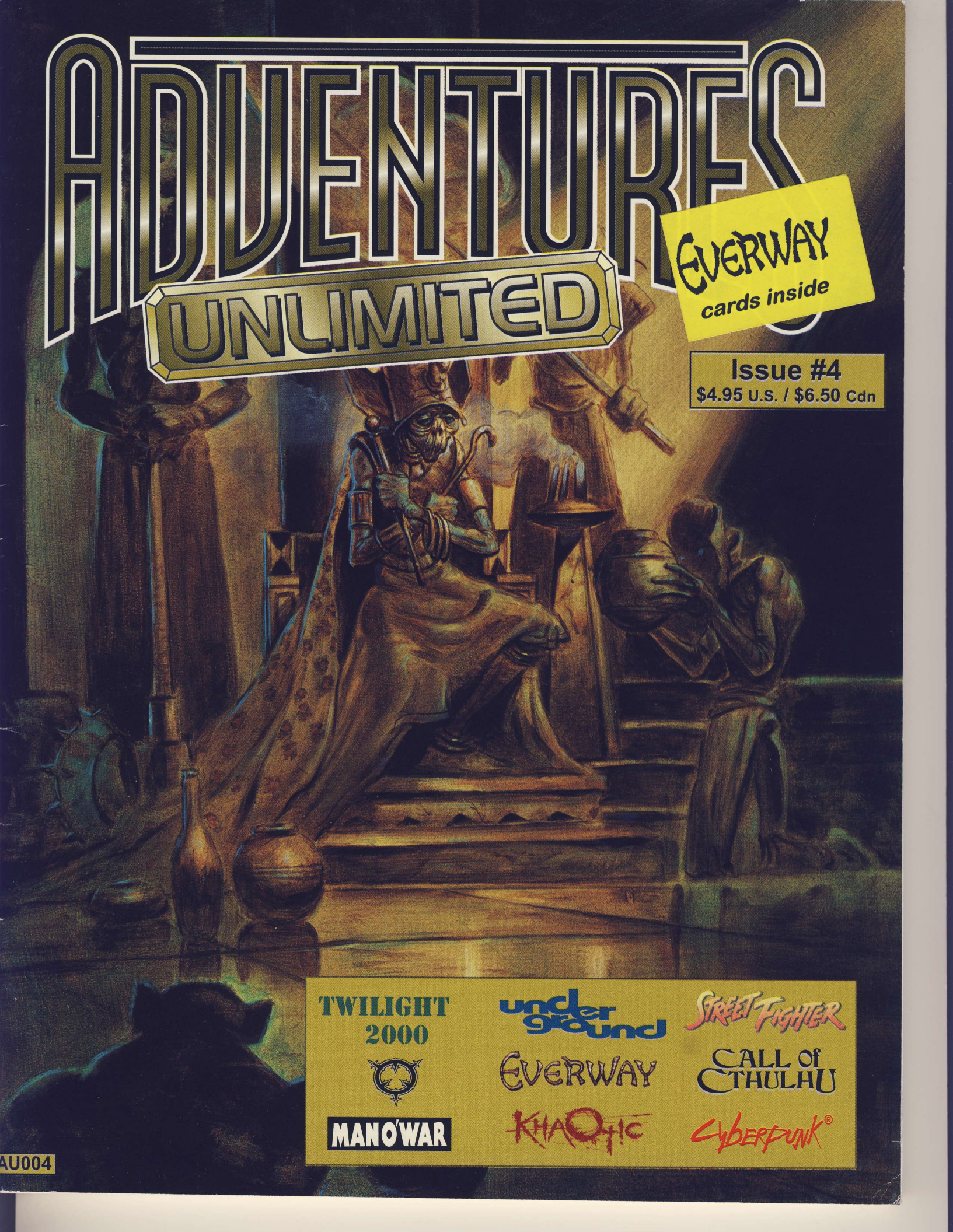

**TWILIGHT  
2000**



**MANO'WAR**

**under  
ground**

**EVERWAY**

**KHAOTIC**

**STREET FIGHTER**

**CALL OF  
CTHULHU**

**CYBERPUNK®**



# ROAD WARRIORS

BY LISA SMEDMAN



One of the best features of the Cyberpunk® game is that it can accommodate so many different types of characters – everything from cybered-up soldiers to suave corporate “suits.”

*Road Warriors* focuses on nomads and augments the recently released *Neo Tribes* sourcebook, which takes a look at nomad culture, equipment, and history. It also provides a use for all of the nifty vehicle combat rules found in the *Solo of Fortune* sourcebook. It is not necessary, however, to have either of these books to play this adventure. It's not even necessary to play a nomad – suggestions for running characters who have other roles are included.

This adventure makes use of the vehicles illustrated in the centerfold of our magazine. These can be photocopied, cut out, and placed on a tabletop to show the relative positions of vehicles in the convoy – and the vehicles that later attack them.

## ADVENTURE SUMMARY

*Road Warriors* revolves around the overland shipment of a cargo of hazardous waste sent from a United Environmental Services (UES) storage facility to a UES incinerator in another city. This nation-wide corporation has put together a convoy of six owner-operated trucks (two tankers, two tractor-trailers, and two smaller trucks) to carry a variety of contaminated and banned substances, including pesticides, chemical defoliants, and spent cleaning solutions.

The starting point for this journey is up to the Referee, as is destination, but the two cities should be at least 1,000 kilometers (620 miles) apart, to allow for a journey of at least two days with an overnight stop at an isolated roadside motel and CHOOH2 station. The trucks travel at an average highway speed of 80 km/h (50 mph) for 10 hours at a stretch. With rest breaks and meals, the convoy averages about 650 km (400 miles) per day. Unless there are delays, of course...

Accompanying the convoy are ten members of a nomad family known as Athena's Shield. These female mercenaries specialize in riding shotgun for those who travel the nation's lonely highways, through areas where lawlessness and anarchy prevail.

In the past Athena's Shield has escorted a variety of individuals who might have cause to fear for their safety: truckers hauling valuable cargoes; construction crews travelling to work on unpopular projects; and union members trying to organize migrant agricultural workers.

This time, Athena's Shield has been hired by UES to watch over its hazardous-waste convoy. The trucks will be travelling through areas where the Raffens Shiv are known to be active. This band of violent, lawless gangers – made up of outcasts from

other nomad families – will no doubt see the trucks as a tempting target with potential valuables aboard, and will think that the hazardous-materials warning placards are only a bluff. UES wants to avoid the cleanup bill that would result from any attack.

Also accompanying the convoy is a single police car. The two officers inside it will either be RCMP freeway patrol members (if the adventure is set in Canada) or members of the highway patrol (if in the U.S.).

Normally, highway patrol officers do not perform escort duties for commercial convoys – at least, not when the cargo is “garbage” with no commercial value. If the players don’t figure this out for themselves, the Athena’s Shield members point it out. They think the highway patrol is trying to muscle in on their business, and give the two officers a very cold reception.

In fact, the highway patrol has a good reason for coming along. United Environmental Services is a corporation on the verge of bankruptcy. It is highly likely that, in an effort to save money, the company will soon resort to “alternative” (and illegal) disposal methods. The patrol officers intend to ensure that the waste is not dumped along some lonely stretch of highway.

During the course of this scenario, the convoy is re-routed at least once, adding another day (and night) to the total journey. The reason for the re-routing is the closure of the incinerator to which the waste was originally to be delivered. It was shut down due to non-payment of municipal taxes. The hazardous materials now must be trucked to a UES incinerator in another city.

On the surface, Road Warriors is a straightforward tactical scenario in which the climax is an on-the-road attack by the Raffin Shiv. The players are in charge of the convoy, deciding the order of the trucks and escort vehicles, and running the players associated with them. The Referee runs the Raffin Shiv and their vehicles.

The Raffin Shiv know exactly what is on board the trucks. (One of them has a “static” (non-nomad) girlfriend who works in the UES storage facility.) They are after the sacks of Rodent Roundup carried in Truck J, and plan to use this rat poison to contaminate the drinking water of a small town whose police force had the audacity to stand up to them. If allowed to carry out their revenge, approximately 15,000 people will die a sudden and painful death.



## HITTING THE ROAD

*“I never could sit still. Never did like staying in one place for too long. Unless water flows, it gets stagnant. To me, the road is a river, fresh and clean. Too bad there’s so much human flotsam coming along for the ride.”*

Jeanette Huberman, Outrider, Athena’s Shield

Road Warriors can be run as a one-shot adventure, with each player taking on the role of an Athena’s Shield member. It can also be inserted into an ongoing campaign, using the suggestions that follow.

If the players are already running nomad characters, the Referee may choose to have UES hire the characters (rather than Athena’s Shield) to escort the convoy. The company offers a fee equivalent to the average nomad’s monthly income to each character on convoy duty (\$1,500 Euros for a warrior with combat skills; \$3,000 for a scout/pathfinder) for the equivalent of two days’ work. Ten percent is paid up front to cover CHOOH2 and other expenses; the balance can be collected once the hazardous materials have been safely delivered to the incinerator (assuming the company has not gone bankrupt by that time). It’s up to the characters to provide their own vehicles, weapons, ammunition and

other supplies – and to do their own checking into this prospective employer.

Alternatively, if the players are running solos, these mercenary soldiers might be hired to accompany the convoy. If the characters don’t have their own vehicles, they can literally ride shotgun, sitting in the passenger seats of the trucks.

Techie characters might be also be hired by UES for the duration of the journey, either as drivers, swamper, or mechanics.

A fixer character can get involved in the adventure by being asked by UES to locate a protective escort for the convoy (Athena’s Shield is the only group willing to take the job). The fixer might also be responsible for lining up motel accommodations, fuel, and other supplies along the route. He or she might even try to cut a few side deals along the way, perhaps selling the barium (which does not appear on any of the shipping

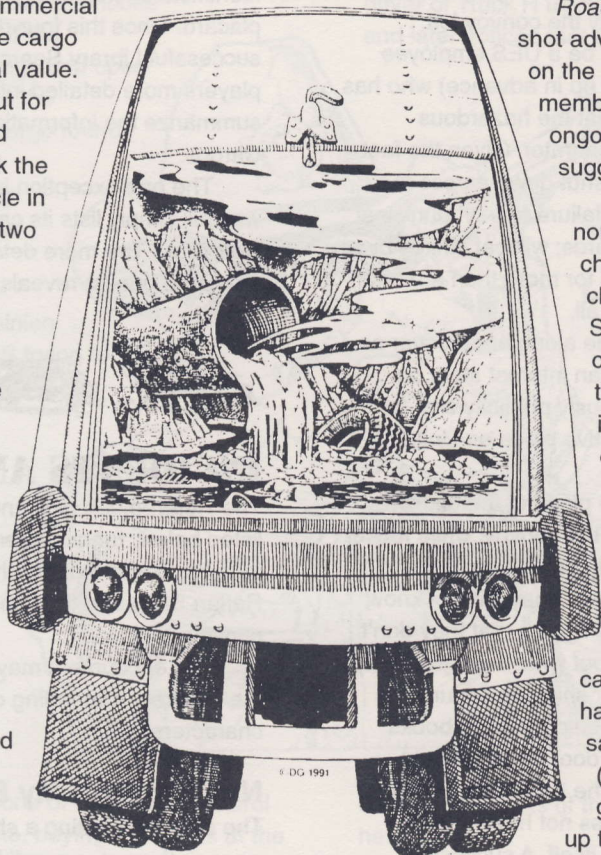

CYBERPUNK



documents and thus won't be missed).

A netranner character can be useful in investigating the history of UES and uncovering its shaky financial situation. The company is plagued by unpaid bills, shady operating practices, labor unrest, and equipment failures and pollution control violations due to a lack of maintenance. The runner could also be useful in figuring out what is in the mysterious, sealed box on Truck J. Hacking into the computers at the UES storage facility where the convoy originated can uncover the fact that a box of barium arrived at the storage facility by mistake – and then went missing on the day the convoy left.

A corporate character might be a UES employee (the Referee will need to set this up in advance) who has been given the job of ensuring that the hazardous materials get to an operating incinerator. Given the fact that UES incinerators are being shut down across the country for a variety of reasons (failure to pay municipal taxes; violating emissions standards; wildcat strikes by workers who have not been paid for more than a month) this might be the toughest job of all.

Media characters might come along undercover as “swampers” – either to do a human interest story on Athena's Shield (who are notoriously publicity shy, for security reasons) or an investigative piece on United Environmental Services itself.

Cop characters can take the place of the highway patrol officers who are escorting the convoy, while rocker characters might simply be hitching a ride on a big rig.

Unless the characters are cops, they will not know what the trucks are hauling; UES figures that they don't need to know. But they can find out what the cargo is by accessing the way bills and other shipping documents that are recorded on the drivers' electronic log books (found in a pocket in the driver's door of each truck). These documents will list either the trade name of the material being hauled, or (if it does not have a trade name) the name of the chemical itself. A successful Library Search (Difficulty 15) can unearth some of the health hazards associated with this material and its general properties (whether it's flammable, for example), and can tell the players what the chemical is commonly used for (cleaning solvent, as a pesticide, etc.). The Referee should summarize the information found in the section The Cargos.

Alternatively, the characters can note the dangerous goods placards (diamond-shaped metal signs) that are placed on the front, back, and both sides of each truck. These warning signs use symbols and numbers to indicate whether a cargo is: explosive (stylized explosion on orange placard with the number 1 beneath); flammable (flames on red placard with the number 2 to designate a gas, 3 to designate a liquid, and 4 to designate a solid); poisonous (skull and crossbones on white placard with the number 6 beneath); corrosive (liquid dissolving metal bar and hand on white-and-black

placard with the number 8 beneath); infectious (biohazard symbol on white placard with the number 6 beneath); radioactive (radioactive symbol on white-and-yellow placard with the number 7 beneath); or simply miscellaneous dangerous waste (red exclamation mark on white placard with the number 9 beneath). A successful Library Search (Difficulty 10) – or simply asking the drivers what the symbols mean – will give the players this basic information.

In the case of bulk shipments, a product identification number (PIN) may also appear on the placard. Once this four-digit number has been noted, a successful Library Search (Difficulty 15) will give the players more detailed information; the referee may summarize the information found in the section The Cargos.

The one exception is the Agent Orange. Truck D's way bill simply lists its cargo as: “Surplus Military Defoliant.” The more detailed Library Search (or an educated guess) reveals that the barrels contain Agent Orange.



## INCIDENTS AND ACCIDENTS

The Referee can pick and choose from the encounters listed below, running them in any order. Remember that they are a warm-up for the main event (the attack by the Raffin Shiv) and thus shouldn't entirely incapacitate the convoy.

The encounters may need to be adjusted slightly by the Referee, depending on the roles of the players' characters.

### Not Through My Backyard!

The convoy is taking a short cut – a side road that passes through a small Native Indian reservation. A few kilometers before reaching the reservation, the lead vehicle (and possibly others, if they don't stop in time) runs into an unexpected obstacle: a strip of board with several nails driven into it that has been placed across the road. One or more tires are punctured, and the driver must make a control roll to avoid crashing.

The tire-shredder has been placed here by local residents who are opposed to large trucks using their reserve as a short-cut. (And rightfully so; a small girl was run down by a truck and killed three weeks ago.) The locals do not interfere further with the convoy, but they do glare at the rigs as they go by. They certainly aren't going to help with any repairs – and that includes refusing to provide any parts for convoy vehicles that were damaged in a crash.

Note: If the players have put Truck J in the lead, either skip this encounter or use it as a prelude to the main attack; the Raffin Shiv immediately take advantage

of the disabled truck and try to heist its cargo. (It would be an ironic twist if the Indians who set up this seeming ambush were the very people whom the Raffin Shiv hoped to poison!)

### The Mysterious Box

One of the characters notices something spilling from the back of Truck J. It's a granular, gritty material. If the truck is stopped and inspected (perhaps by the highway patrol), several of the sacks inside are found to have broken open. There's also one box that looks out of place (the pure barium). If the characters disregard the warnings and open it, the results are explosive; see the description of this box and its cargo found under the entry for Truck J.

Media characters travelling incognito with the convoy should be especially intrigued by the mysterious box. Everyone who sees the box has a different opinion on what it might contain. Is UES trying to smuggle illegal drugs or technology by hiding it inside a shipment of "waste"? Does the box contain nuclear material destined for a third-world armaments program? The characters probably won't believe the truth (a simple mixup in shipments) when they hear it and will probably be tempted to open this Pandora's box.

### Police Problems

During the first overnight stop, one of the highway patrol officers starts hitting on Adrienne, buying her drinks at the roadside diner and none-too-subtly inviting her to share a room with him. Adrienne has no interest in the cop, and rudely brushes him off.

The next morning, Adrienne's dog Maxi is very sick. It is staggering about and its skin smells strongly of garlic. It was poisoned by being rubbed down with Phoskil (parathion). One of the containers of this insecticide is missing from Truck H; it has been opened and left, partially full, in the motel's parking lot, not too far from the police cruiser.

The furious Adrienne, believing this to be the handiwork of the cop, confronts him. Her intention is to shoot him dead. If his partner makes a move to defend him, she'll shoot him too. If she does kill a cop, the convoy will be halted while a full police investigation takes place – adding several days to the journey. There may be a bloody confrontation between Athena's Shield and the cops, if Adrienne is busted when the other nomads are around. The characters have better things to

do than submit to a police grilling, or get involved in a violent confrontation. And perhaps they have their own reasons for avoiding the cops...

Needless to say, the other Athena's Shield members won't interfere with Adrienne's vendetta. It's up to the characters to talk Adrienne down. (If they try more violent means of stopping her, they will have to deal with an immediate reprisal by the other Athena's Shield members.)

Fortunately, one of the characters witnessed the driver of Truck H trying to kick the dog the day before, and later noticed that the fellow's hand was bandaged.

(The Referee should set this up in advance.) Bite marks on the trucker's hand confirm that this fellow, and not the cop, was the one with a motive for trying to kill the dog.

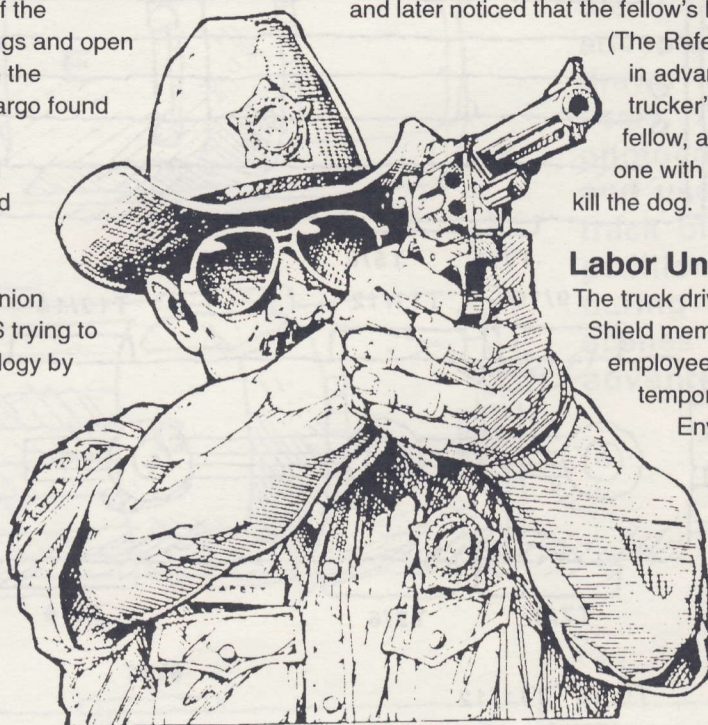

### Labor Unrest

The truck drivers, like the Athena's Shield members, are contracted employees who were hired on a temporary basis by United Environmental Systems.

Unlike Athena's Shield, they didn't receive up-front expenses for this haul, and it's questionable whether they'll be paid at the end of it. Should the corporation fold, they'll be stuck with

the disposal costs of the hazardous materials they are hauling.

At some point during the trip the truckers learn that the company may soon declare bankruptcy. The driver of Truck F decides to bail out. When the others stop for the night, he waits until they are sleeping, then slips away. His plan is to ditch his cargo in a nearby ravine.

The characters are alerted either by the truck's engine noise, or by the swamper from Truck F, who disagrees with what her boss (who is also her brother) is doing. Unfortunately, the rig will probably be gone before they can stop it – unless they act very quickly, and shoot out its tires before it can leave.

By the time they catch up to the vehicle, the driver has hooked up a hose to a manifold (port) on the underside of the tank and is pumping Methyl Ethyl Ketone into the ravine. There's a lot of minty-smelling MEK vapor in the air. Not only do these fumes pose a health hazard; they're also highly flammable. Fortunately, any character with the Chemistry skill (or who ever worked in a trade in which MEK was used) can easily

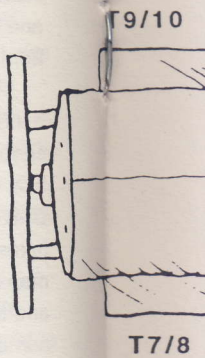
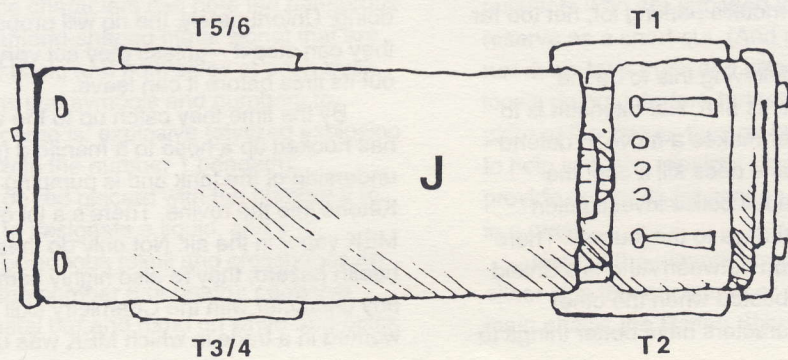
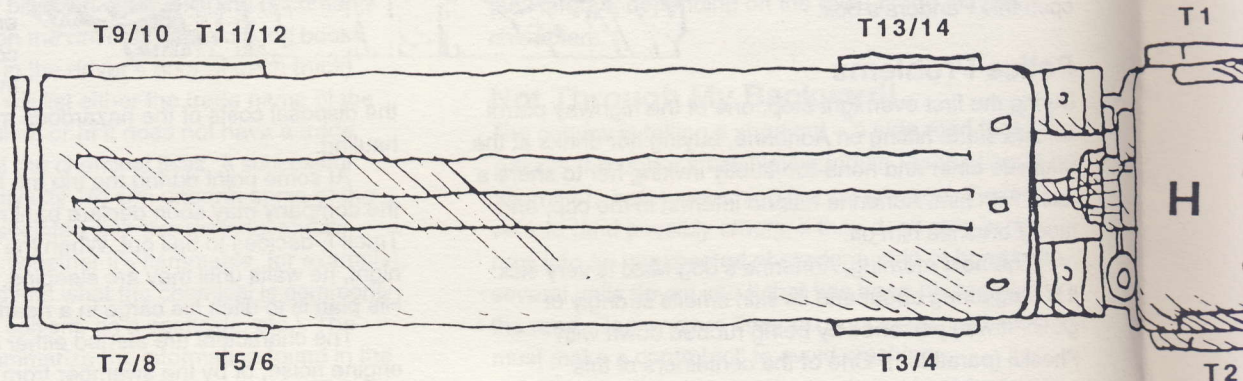
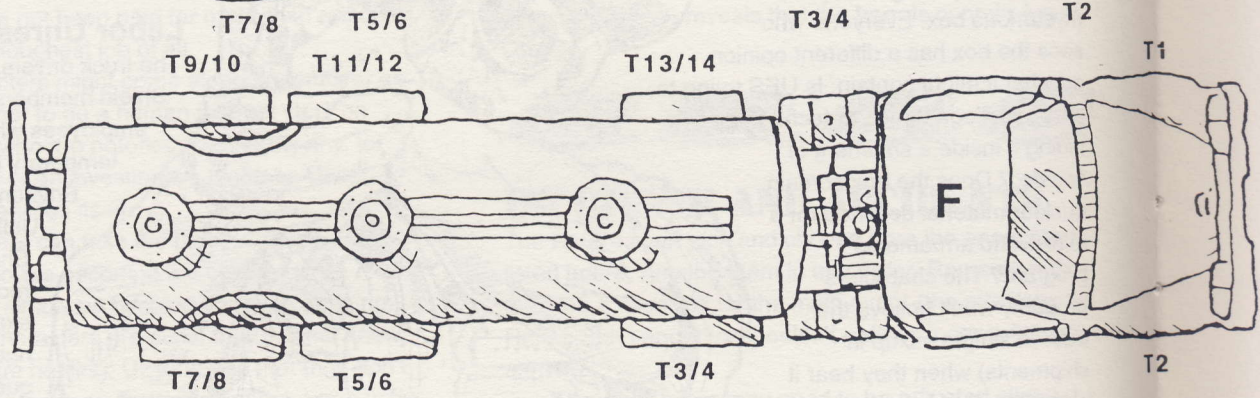
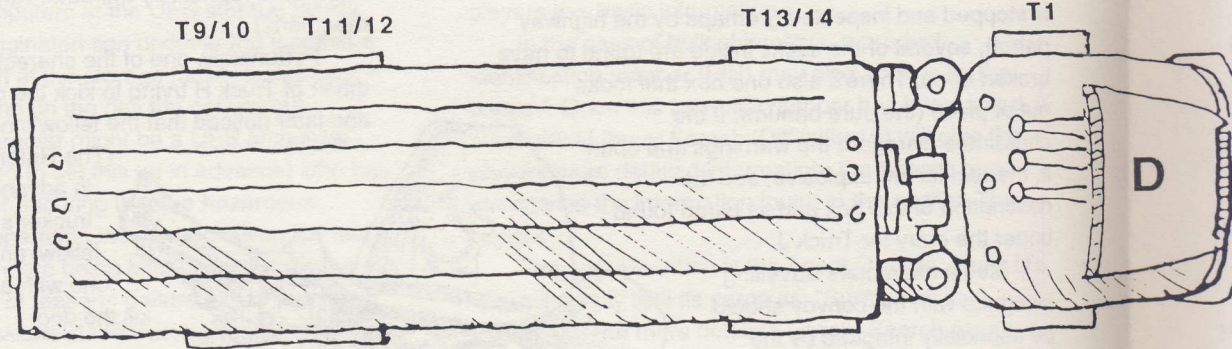
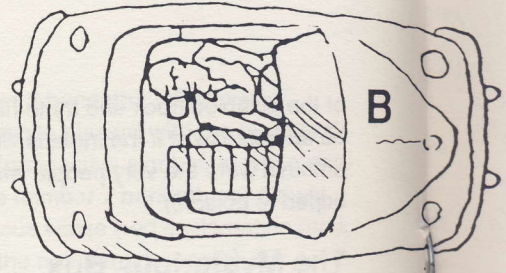
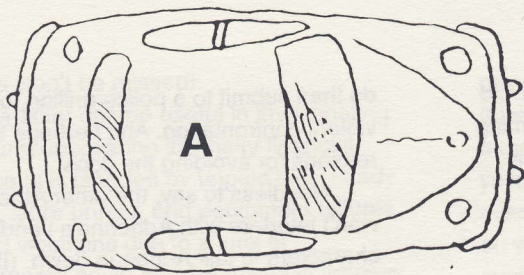

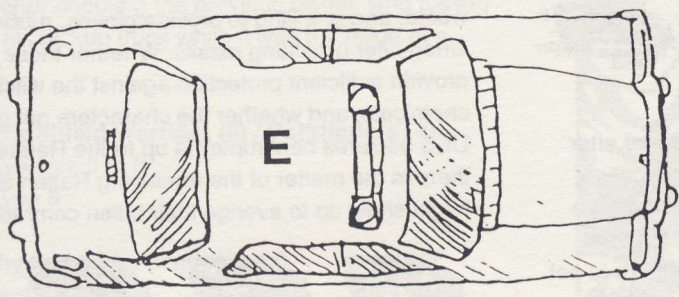
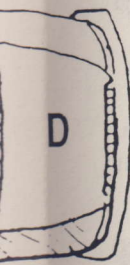
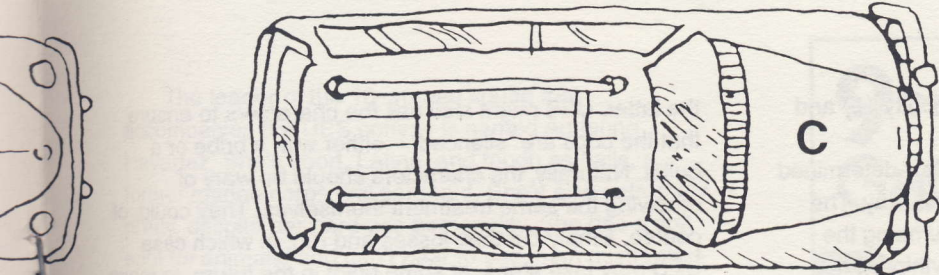

T2

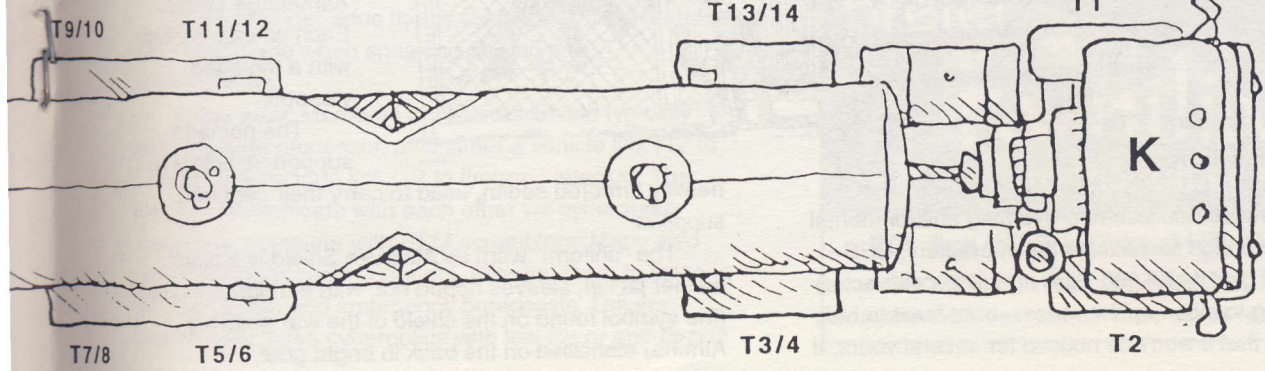
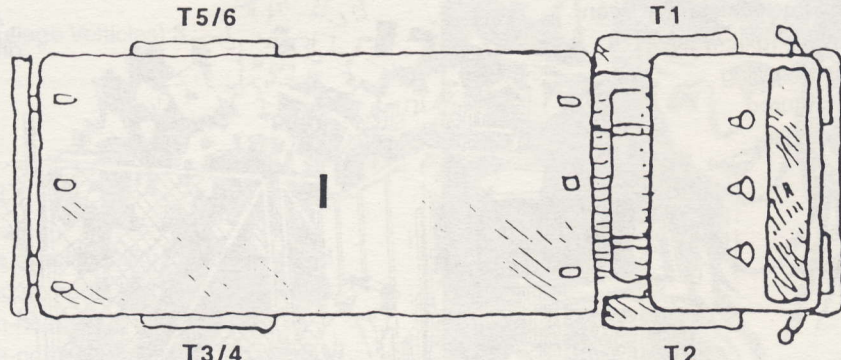

The vehicles illustrated here are intended for use with the *Road Warriors* adventure, and are drawn to a 25mm scale. They can be photocopied, cut out, and used to keep track of the relative positions of vehicles during the chase scenes in that adventure.

recognize the distinctive odor of MEK (Difficulty 10) and warn the others of its dangers.

The driver isn't about to back down. He's determined to drain the MEK from his tank and be on his way. The characters will have to prevent him from dumping the MEK by force. Unfortunately, if they do anything to produce an open flame or spark (shoot a gun or taser, for example) a fatal explosion could result.



## THE ATTACK

Ideally, the attack by the Raffen Shiv should come after the convoy has been turned back from the shut-down incinerator that was its original destination. By now, the players should be used to setting up the vehicles that make up the convoy. The Referee should ask them to set up the centerfold vehicle cutouts for the trucks, Athena's Shield vehicles, and patrol car, then should use the Raffen Shiv pickup trucks to indicate the direction of attack.

The Referee shouldn't worry too much about accurately depicting speed and distance. The cutouts are primarily designed to keep track of which vehicles are still functional – and which have crashed. Any vehicle following another that crashes or explodes must swerve around it. A control roll is required to complete this maneuver. Failure of this roll means that the following vehicle crashes.

Once the Raffen Shiv have been driven off or killed, the characters face the problem of what to do with any trucks that have been disabled or destroyed. Toxic waste is likely to be leaking or spilling from a number of ruptured containers. Some of this can be loaded onto the surviving trucks, but any characters handling a hazardous material face the health hazards associated with it. (Some of these problems may only surface years later, when the character bears or sires children or at last succumbs to cancer.)

If the moral compulsion of preventing environmental disaster isn't enough to motivate the characters, UES offers "hazard pay" (a \$2,000 Euro bonus per character) to those willing to clean up the mess – or at least to hide it somewhere that it won't be noticed for several years. If

the latter, UES might also ask the characters to ensure that the cops are "silenced" – either with a bribe or a bullet. Naturally, the characters should be wary of receiving the same treatment themselves. They could, of course, simply cut their losses and run, in which case UES may take steps, at some point in the future, to make sure its dirty little environmental secret stays buried...

The company assures the characters that only minimal protective gear is required to handle the toxic waste, and is willing to provide gloves, rubber boots, and smog-filter breathing masks. Whether these really do provide sufficient protection against the witches' brew of chemicals, and whether the characters get paid before UES declares bankruptcy is up to the Referee. And then there is the matter of the remaining Raffen Shiv, who just might show up to avenge their fallen comrades...



## THE CHARACTERS

### Athena's Shield

This nomad family has about fifty members, scattered in small groups across the face of North America. All are female, and many are ex-military or ex-police. They have heavy weapons and firearms training, and a handful are also skilled in martial arts – typically aikido, which uses the momentum of an opponent's attack against him, rather than relying upon brute strength.

Athena's Shield warriors drive Volkswagen Beetles – lightweight, souped-up machines with protective armor and high ground clearance that continued to be built in Brazil through the 2020s. The pathfinders (scouts) drive convertible "bugs" painted in camouflage colors. Each vehicle is fitted with a mounted weapon.

The nomad's support vehicle is a heavily armored sedan, used to carry their gear and supplies.

The "uniform" worn by Athena's Shield is a black leather jacket, sleeves ripped out, with a medusa's head (the symbol found on the shield of the war goddess Athena) stencilled on the back in bright green.

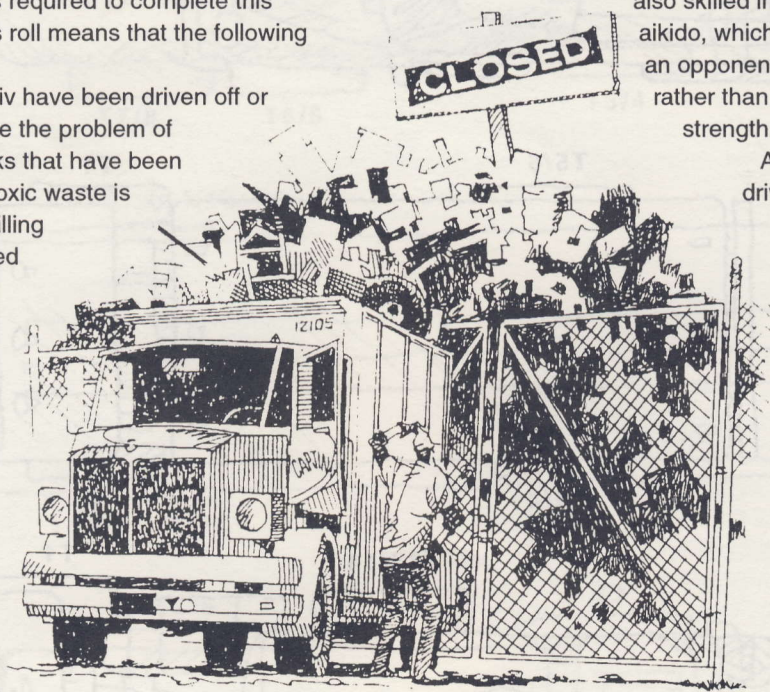

The leader of the 10-woman squad that accompanies the UES convoy is named Adrienne Havartez. She's short, Latina, and tough as nails, a former marine corps drill sergeant. She's also extremely pretty, despite her hard-ass personality. She has a soft spot for animals, and can't bear to see them mistreated. Her scruffy terrier Maxi accompanies her everywhere she goes, hanging out the window of her vehicle. She nursed the dog back to health after finding him at the side of the road – and after shooting the previous owner, who tossed Maxi out of his pickup truck while it was travelling at a high speed.

**Athena's Shield Warriors (6) / Pathfinders (4)**

Attractiveness 3 to 8  
 Body Type 8  
 Cool 4  
 Empathy (before humanity loss) 6  
 Intelligence 5  
 Luck 5  
 Movement Allowance 5  
 Reflexes 7  
 Technical Ability 8

Warpath 4 \* / Reconnaissance 4 \*\*  
 Awareness 5  
 Basic Tech 4  
 Brawling or Martial Art (Aikido) 4  
 Dodge & Escape 3  
 Driving 7  
 First Aid 3  
 Handgun 3  
 Heavy Weapons 5  
 Hide/Evade (Camouflage Vehicles) 3  
 Intimidate 3  
 Melee 3  
 Rifle 5  
 Weaponsmith 4  
 Wilderness Survival 4

\* A warrior adds this special ability to Initiative and Awareness when fighting nomads; half is added (round down) when fighting non-nomads. It is also added to Melee when fighting non-nomads; half is added when fighting nomads.

\*\* A pathfinder adds this special ability to Awareness and Hide/Evade when sneaking around and reconnoitering.

*Cyberwear:* Members of Athena's Shield typically have a neural processor, plus either a vehicle link (+2 to Driving) or smartgun link (+2 to firearms attacks). The drivers communicate with each other via cyberaudio radio links, complete with ECM scramblers. Many also have wide band radio scanners, allowing them to listen in on other police and emergency broadcasts. Drivers typically also have cyberoptics with low-lite or anti-dazzle

**9 out of 10 Gamers**



prefer  
**The Familiar**  
 to that other magazine

P.O. Box 2752 • Chapel Hill, NC 27515  
 subscriptions: \$15 for 6 issues, \$27 for 12  
 Contains 60% less angst than other leading brands.

options, while gunners have cyberoptics with targeting scopes (+1 to smartgun attacks) or infrared detectors. A handful of Athena's Shield members have cyberlimbs, sometimes with a built-in popup gun, micromissile launcher, or two-shot capacitor laser. Those who do not practice a martial art have body plating, typically a cowl or torso plate. The martial artists tend to go for Sandevistan speedware.

*Armor:* Drivers typically wear a light armor jacket (SP 14) and nylon helmet (SP 20), while gunners wear a heavy armor jacket (SP 20, EV 2), flack pants (SP 20, EV 1), and helmet (SP 20).

*Personal Weapons:* Athena's Shield members typically carry a heavy autopistol such as the Sternmeyer Type 35 (Type P; WA 0; Con J; #Shots 8; ROF 2; Rel VR; Range 50m; Damage: 3d6).

## The Truck Drivers

The truck drivers and their swamper assistants are all independent contractors who own their own rigs. They dress in jeans and T-shirts.

### Truck Drivers (6) / Swampers (3)

Attractiveness 2 to 7

Body Type 7

Cool 3

Empathy (before humanity loss) 6

Intelligence 4

Luck 3

Movement Allowance 5

Reflexes 8

Technical Ability 7

Jury Rig 6 / Jury Rig 4

Awareness/Notice 5

Basic Tech 6

Brawling 4

Driving 6

Education & General Knowledge 3

First Aid 2

Handgun 3 or Rifle 3

Truck Driving 6 / Truck Driving 2

*Cyberware:* Truck drivers typically have a neural processor, plus a vehicle link (+2 to Driving) and cyberoptic with either anti-dazzle or low-lite options. Swampers sometimes have linear frames – even though most of the loading and offloading is done by machine, these days.

*Personal Weapons:* For personal protection, truckers carry either a shotgun such as the Sternmeyer Stakeout 10 (Type SHT; WA -2; Con N; #Shots 10; ROF 2; Rel ST; Range 50m; Damage: 4d6) or a taser (Type P; WA -1; Con N; #Shots 10; ROF 1; Rel VR; Range 10m; Damage: stun).

## New Skill: Truck Driving

This reflex skill allows you to drive tractor-trailer trucks (semis) with air brakes and multiple gears. A skill of +3 is equal to that of a relative novice who has handled only smaller rigs. A skill of +6 represents a driver with several years of experience who is able to handle just about any size of truck. A skill of +8 or greater represents a driver with who has experienced every type of grade, road condition, and emergency situation there is. Note: This skill is not required for pickup trucks, vans, or small panel trucks; use the regular Driving skill for these vehicles.

## The Police

The highway patrol officers wear police uniforms. The Referee should tailor their description according to the setting of the adventure.

### Highway Patrol Police Officers (2)

Attractiveness 5

Body Type 7

Cool 5

Empathy (before humanity loss) 6

Intelligence 8

Luck 4

Movement Allowance 6

Reflexes 7

Technical Ability 5

Authority 4

Athletics 3

Awareness/Notice 7

Brawling 2

Drive 4

Education & General Knowledge 5

Handgun 6

Human Perception 6

Interrogation 5

Melee 4

Rifle 5

Shadow/Track 4

Streetwise 4

*Cyberwear:* Useful cybernetic enhancements for highway patrol officers include a neural processor with vehicle link (+2 to Driving), dataterm link (allowing them to access computerized police records), and smartgun link (+2 to firearms skills). Also useful would be cyberoptics with image enhancement (+2 to Awareness) and microvideo optics (used for filming evidence or suspects). Because the federally-funded highway patrol has little in the way of money or resources, only about half of its officers have enhancements – typically 1d3+1 pieces of the cyberwear described above.

*Armor:* Standard highway patrol gear includes a medium armor jacket (SP 18 EV 1), flack pants (SP 20 EV

1) and nylon helmet (SP 20) with built-in police band radio.

*Personal Weapons:* Each officer is armed with an Armalite 44 heavy pistol (Type P; WA 0; Con J; #Shots 8; ROF 1; Rel ST; Range 50m; Damage 4d6+1). Each patrol car contains a powerful, rapid-fire Arasaka Rapid Assault Shot 12 shotgun (Type SHT; WA -1; Con J; #Shots 20; ROF 10; Rel ST; Range 400m; Damage 4d6). Each of these weapons can only be used by someone with a highway patrol issue smartgun link. (The link has a unique port shape and requires a specialized software code, and thus can only be used by another smartgun user if it is first jury rigged; Difficulty is 20.)

## Raffen Shiv

This gang of cutthroats and thieves are parasites who prey on the unwary and innocent. They're scruffy, abusive, and cruel. Their leader is B.J. "Beej" Garrett, a psychotic but mesmerizing individual who was tossed out of the Hell's Angels for murdering one of his girlfriends in a fit of jealousy, then dragging her mutilated corpse behind his bike to a club meeting. He's a big, beefy guy with a beer belly, long red hair, and beard. He wears a black T-shirt, jeans, and Dayton boots. He recently switched to a pickup truck; it's not as "sexy" as a Harley – but you can mount weapons on it.

Beej's followers are those who believe that "honor" and brutal revenge go hand in hand. They're as dangerous and twisted as they come.

### Raffen Shiv Warriors (12)

Attractiveness 2 to 5  
Body Type 8  
Cool 6  
Empathy (before humanity loss) 4  
Intelligence 4  
Luck 5  
Movement Allowance 6  
Reflexes 8  
Technical Ability 7

Family 3 to 6  
Awareness 5  
Basic Tech 3  
Brawling 4  
Dodge & Escape 3  
Driving 6  
Endurance 5  
Gamble 3  
Heavy Weapons 5  
Hide/Evade 5  
Intimidate 7  
Melee 3  
Resist Torture/Drugs 5  
Shadow/Track 3  
Submachinegun 3  
Wilderness Survival 4

*Cyberwear:* Raffen Shiv members have cyberwear that ranges from the decorative (light tattoos and chemskin warpaint) to the brutally functional (a variety of implanted cyberweapons). Many have augmented their bodies with grafted muscle or skin weave. Those who have cyberlimbs make no effort to disguise them,



but instead flaunt their metal, painting it a matte black and peppering it with chrome studs.

*Armor:* The Raffen Shiv are careless of their personal safety and like to show off their muscles, and thus rarely wear more than a kevlar vest (SP 10). A handful wear flack pants (SP 20) but the majority prefer black riding leathers (SP 4).

*Personal Weapons:* Raffen Shiv like nothing better than a close-in melee, preferably with monokatanas (Type melee; WA +1; Con N; Rel VR; Range 1m; Damage 4d6). They also carry light submachineguns, such as the Uzi Miniauto 9 (Type SMG; WA +1; Con J; #Shots 30; ROF 35; Rel VR; Range 150 m; Damage 2d6+1).





## THE VEHICLES

The convoy is made up of a collection of vehicles; their statistics and cargoes are as follows:

### A Athena's Shield Volkswagen Beetles (2)

SDP: 60

Body SP: 30

Tires SP: 10

Maximum Speed: 160 km/h (100 mph)

Acceleration/Deceleration: 8 km/h (5 mph) per phase

Maneuver Speed: 60 km/h (40 mph)

Tight Turn: 10

Swerve: 10

Hard Brake: 10

Reverse: 10

Bootleg Turn: 20

Crew: 1 driver, 1 gunner

Mounted Weapons: Barret-Arasaka Light 20 mm (Type HVY; WA 0; #Shots 10; ROF 1; Rel VR; Range 450m; Damage: 4d10). Note: This weapon fires depleted-uranium armor-piercing rounds. It can only be fired to the front and sides of the vehicle it is mounted on.

Cargo Capacity: 200 kg (440 pounds)

Cargo: first aid kit, survival gear, ammunition



### B Athena's Shield Volkswagen Beetle Convertibles (2)

SDP: 60

Body SP: 30

Tires SP: 10

Maximum Speed: 160 km/h (100 mph)

Acceleration/Deceleration: 16 km/h (10 mph) per phase

Maneuver Speed: 80 km/h (50 mph)

Tight Turn: 10

Swerve: 10

Hard Brake: 10

Reverse: 10

Bootleg Turn: 20

Crew: 1 driver, 1 gunner

Mounted Weapons: M-60 Squad Light Machinegun (Type RIF; WA 1; #Shots 100; ROF 10; Rel ST; Range 450m; Damage: 6d6). Note: This weapon is belt-fed, and can fire to the front or sides of the vehicle it is mounted on. The gunner stands where the back seat would be, and is strapped in. The bullets on the belt alternate between normal and armor-piercing rounds.

Other Weapons: One of these vehicles also carries a Scorpion 16 Missile Launcher (Type HVY; WA -1; #Shots 1; ROF 1; Rel VR; Range 1 km; Damage: 7d10). Note: This long-range weapon is typically fired when the vehicle is at a standstill, or travelling

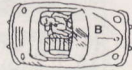

very slowly over level ground. It is not mounted to the vehicle but is fired from a shoulder position. Both the gunner and driver are trained to fire it.

Cargo Capacity: 100 kg (220 pounds)

Cargo: first aid kit, survival gear, ammunition

### C Athena's Shield Armored Sedan

SDP: 80

Body SP: 40

Tires SP: 10

Maximum Speed: 150 km/h (95 mph)

Acceleration/Deceleration: 8 km/h (5 mph) per phase

Maneuver Speed: 50 km/h (30 mph)

Tight Turn: 15

Swerve: 15

Hard Brake: 15

Reverse: 12

Bootleg Turn: 28

Crew: 1 driver, 1 gunner

Cargo Capacity: 500 kg (1,100 pounds)

Cargo: foodstuffs, camping gear, tools, small generator, extra fuel, spare tires for VWs and sedans, personal weapons, ammunition (or 6 passengers)



### D Tractor Trailer

SDP: 200

Cab SP: 15

Tires/Fuel Tanks SP: 10

Trailer SP: 15

Maximum Speed: 115 km/h (70 mph)

Acceleration/Deceleration: 3 km/h (2 mph) per phase

Maneuver Speed: 25 km/h (20 mph)

Tight Turn: 25

Swerve: 20

Hard Brake: 20

Reverse: 15

Crew: 1 driver, 1 swamper

Cargo Capacity: 24,000 kg (52,800 pounds)

Cargo: 45 metal barrels of dioxin-laden Agent Orange, marked only with the words: "US Army." All are painted orange. Each barrel contains 455 liters (100 gallons) of the herbicide, and weighs 375 kg (830 pounds). Characters crouching behind a full barrel can make use of it as a shield (SP 5), but will likely get sprayed with herbicide as the bullet exits. The height of any bullet holes determines how much of a barrel's contents leak out.

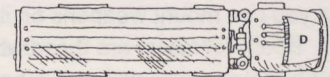

### E Police Cruiser

SDP: 80

Body SP: 40

Tires SP: 10

Maximum Speed: 195 km/h (120 mph)

Acceleration/Deceleration: 8 km/h (5 mph) per phase

Maneuver Speed: 60 km/h (40 mph)

Tight Turn: 15



Swerve: 15  
 Hard Brake: 15  
 Reverse: 12  
 Bootleg Turn: 28  
 Crew: 2 police officers  
 Cargo Capacity: 300 kg (660 pounds) or 200 kg (440 pounds) in trunk plus 3 passengers  
 Cargo: first aid kit, spare tire

**F Tractor with Tanker**

SDP: 200  
 Cab SP: 15  
 Tires/Fuel Tanks SP: 10  
 Tanker SP: 20  
 Maximum Speed: 175 km/h (110 mph)  
 Acceleration/Deceleration: 3 km/h (2 mph) per phase  
 Maneuver Speed: 25 km/h (20 mph)  
 Tight Turn: 25  
 Swerve: 20  
 Hard Brake: 20  
 Reverse: 15  
 Crew: 1 driver, 1 swamper  
 Cargo Capacity: 19,000 kg (41,800 pounds)  
 Cargo: Methyl Ethyl Ketone  
 Notes: The three hatches on top of this truck can only be opened with a wrench (or by someone with a powerful cyberhand). The tank is nearly full, but

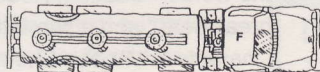

there is enough of an air pocket for some of the MEK to have evaporated; if this flammable gas is ignited the entire tanker explodes, killing all truck occupants and creating a large fireball.

**G Raffen Shiv Pickup Trucks (4)**

SDP: 80  
 Body SP: 15  
 Tires SP: 10  
 Maximum Speed: 160 km/h (100 mph)  
 Acceleration/Deceleration: 8 km/h (5 mph) per phase  
 Maneuver Speed: 50 km/h (30 mph)  
 Tight Turn: 15  
 Swerve: 15  
 Hard Brake: 15  
 Reverse: 12  
 Bootleg Turn: 28  
 Crew: 1 driver, 2 gunners  
 Mounted Weapons: Barrett-Arasaka Light 20mm (Type HVY; WA 0; #Shots 10; ROF 1; Rel VR; Range 450m; Damage: 4d10 armor piercing depleted uranium shell). Note: One gunner operates the "cannon," which is mounted in the box of the pickup truck. The second gunner fires an uzi when the truck closes to an appropriate range.  
 Cargo Capacity: 200 kg (440 pounds)  
 Cargo: survival gear, ammunition



op Circles. Alternative-3. Cattle Mutilations. Alien Abdu  
 ret Government Institutions. Foreign Rel  
 ack Helicopters. The Illuminoids. The JFK Assassination. E  
 ring Saupers. Adam Weishaupt. Electronic Brainwashing. I  
 rth. Roswell Crash Site. Anti-Gravity Experiments. Blac  
 erations. <sup>H</sup> <sup>I</sup> <sup>D</sup> <sup>E</sup> <sup>N</sup>  
**INVASION**<sup>TM</sup>  
 gineering. Star  
 ssile De  
 apons. Nazi  
 amski. Code T  
 ited Nation  
 IEGA. Tem  
 ngley, Va. Foo Fighters. Secret Service. The Philac  
 periment. J. Edgar Hoover. The Face on Mars. Under  
 ses. The Freemasons. Ranger 18. Pyramid Power. Tri  
 mmission. Easter Island. Alternative-3. Stealth. Technolog  
 ea-51. Men In Black. New World Order. The Flek

**This is Just The Beginning.**

**The Truth Is In Here!**

Nightshift Games \* 889 Mowry Ave. #105 \* Fremont, CA 94536

### H Tractor Trailer

SDP: 250

Cab SP: 15

Tires/Fuel Tanks SP: 10

Trailer SP: 15

Maximum Speed: 170 km/h (105 mph)

Acceleration/Deceleration: 3 km/h (2 mph) per phase

Maneuver Speed: 25 km/h (20 mph)

Tight Turn: 25

Swerve: 20

Hard Brake: 20

Reverse: 15

Crew: 1 driver, 1 swamper

Cargo Capacity: 28,000 kg (61,600 pounds)

Cargo: 2,031 plastic cannisters of parathion insecticide.

Each weighs 14.5 kg (32 pounds) and is labeled with a partially legible trade name: Phoskil. The cannisters are shaped like jerry cans, with a handle on top, and each hold 18 liters (4 gallons). Some are leaking slightly. They are made from thin plastic (SP 1) and will leak their contents if shot or stabbed.

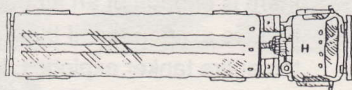

Crew: 1 driver

Cargo Capacity: 5,000 kg (11,000 pounds)

Cargo: 166 heavy paper sacks, each filled with 22.5 kg (50 pounds) of Rodent Roundup rat poison.

Notes: Many of the sacks are broken open, and the floor of the truck is covered in granular barium chloride.

Each is marked with the name of the pesticide, plus a logo showing a cat in a cowboy hat lassoing a rat.

Amid the sacks is a sealed cannister marked with the words: "Caution! Reactive substance. Do not break seal," and a two-letter designation: "Ba."

Characters with the Chemistry skill can easily recognize this as the symbol for barium; this box of pure barium was placed on the truck by mistake.

Characters who make an average skill check (Difficulty 15) can be given the information on this element that is summarized in The Cargo section, below.

### I Flatbed "Chinatop" Truck

SDP: 150

Cab Body SP: 15

Rear Body (canvas over metal framework) SP: 0

Tires/Fuel Tanks SP: 10

Maximum Speed: 170 km/h (105 mph)

Acceleration/Deceleration: 3 km/h (2 mph) per phase

Maneuver Speed: 25 km/h (20 mph)

Tight Turn: 20

Swerve: 15

Hard Brake: 15

Reverse: 12

Crew: 1 driver

Cargo Capacity: 6,000 kg (13,200 pounds)

Cargo: 20 plastic barrels filled with oxalic acid, each weighing 250 kg (550 pounds).

Notes: The waist-high blue barrels are marked with a corrosive symbol (a partially dissolved hand) and are lashed to the deck of the truck with wide straps.

Characters crouching behind a full barrel can make use of it as a shield (SP 5).

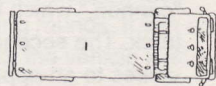

### K Tractor with Tanker

SDP: 250

Cab SP: 15

Tires/Fuel Tanks SP: 10

Tanker SP: 20

Maximum Speed: 160 km/h (100 mph)

Acceleration/Deceleration: 3 km/h (2 mph) per phase

Maneuver Speed: 25 km/h (20 mph)

Tight Turn: 25

Swerve: 20

Hard Brake: 20

Reverse: 15

Crew: 1 driver

Cargo Capacity: 22,000 kg (48,400 pounds)

Cargo: Tetrachloroethylene.

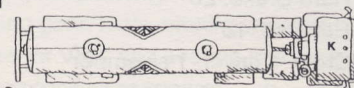

Notes: To make any of the maneuvers listed for each vehicle (tight turn, swerve, hard brake, reverse) the driver must make a control roll using his/her Reflexes + Driving or Truck Driving (as appropriate to vehicle). Target number is the number given for the maneuver +2 for each 15 km/h (10 mph) over the vehicle's listed maneuver speed. A roll that fails by 7 or more results in a crash. A roll that fails by less than this modifies the next control roll; the amount by which it failed is added to the target number needed.

A vehicle that crashes takes damage based upon its speed. For each 30 km/h (20 mph) of speed, it suffers 1d10 damage (ignore the vehicle's SP and subtract damage directly from the SPS). All occupants of the vehicle take half damage.

When a vehicle is reduced to half of its SPS, the driver must make a control roll. Target number is as per a critical hit (see Damage Location Table notes). When a vehicle reaches 0 SPS, it crashes.

### J Truck

SDP: 120

Cab SP: 15

Tires/Fuel Tanks SP: 10

Tank SP: 20

Maximum Speed: 160 km/h (100 mph)

Acceleration/Deceleration: 3 km/h (2 mph) per phase

Maneuver Speed: 25 km/h (20 mph)

Tight Turn: 20

Swerve: 15

Hard Brake: 15

Reverse: 12

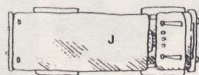

### Crash Notes

An exploding fuel tank automatically crashes a vehicle, resulting in the loss of 6d6 SDPs, plus crash damage based on vehicle speed. The driver and/or passengers suffer half damage.

Tires are indicated on the vehicle templates with the letter T and a number designation. Dual (paired) tires are indicated by two numbers separated by a slash. A car, sedan, or pickup truck that has suffered damage to any tire – or a multi-axle truck that has suffered damage to a steering (front) tire cannot be driven. The control roll determines whether the driver can bring it to a safe stop (rather than crashing it). This rule also applies to semi trucks that have lost all of the tires in a given area. For example, if Truck K lost only Tire 3, it could keep going, but if it lost both Tires 3 and 4, it would be forced to stop. If it lost Tires 5, 6 and 7 it could keep going on the last tire in that set of in-tandem duals, but if it lost Tires 5, 6, 7 and 8, it would be forced to stop.



## THE CARGO

The convoy is carrying some truly hazardous material. Descriptions and game mechanics follow:

### Hazard Codes

C = corrosive (extremely acidic or basic)

H = acute (fatal to humans in low doses)

I = ignitable (liquid with a flash point of less than 60°C (140°F); or non-liquid that can ignite through friction or moisture absorption; or an ignitable compressed gas)

R = reactive (explosive; or reacts violently with water; or generates harmful fumes when mixed with water; or an unstable substance that can undergo violent physical or chemical change)

T = toxic; may be carcinogenic (cancer-causing), mutagenic (causing mutations in future generations of offspring), or teratogenic (causing abnormalities in unborn children).

### Barium

Hazard Code: R

Other Names: n/a

Description: This silvery-white, shiny metal is used in the manufacture of fireworks, paints, and plastics. It is packed in airtight boxes. If exposed to air, it self-ignites, burning with a red flame (4d6 damage to those whom it touches). It also reacts violently when exposed to water. If water is used in an effort to quench the flames, the resulting explosion hurls flaming debris (5d6 damage to those within 5 feet).

Health Effects: as above.

### Barium Chloride

Hazard Code: H

Trade Name: Rodent Roundup

Description: This brownish, granular compound is a potent rat poison, better known by its commercial name: Rodent Roundup.

Health Effects: A fatal dose, for humans, of barium chloride is a mere one gram (about one-thirtieth of an

### Damage Location Table for Cars & Pickups

1	Driver **
2	Steering (Front) Tire *
3	Back Tire *
4	Fuel Tank * (25% chance explosion) or Engine *
5	Body (and Passenger if applicable)
6	Body (and Passenger if applicable)
7	Body (and Passenger if applicable)
8	Body
9	Body
10	Body

### Damage Location Table for Multi-Axle Trucks

1	Driver **
2	Cab (50% chance engine hit *)
3	Steering (Front of Cab) Tire *
4	Fuel Tank * (25% chance explosion)
5	Rear Tire (possible critical if last tire in area; see notes below)
6	Rear Tire (possible critical if last tire in area; see notes below)
7	Trailer/Tanker
8	Trailer/Tanker
9	Trailer/Tanker
10	Trailer/Tanker

\* = Critical hit if damage exceeds vehicle's SP for that area. Triple any damage that penetrates. Driver automatically loses control and must make a control roll to recover. Target number is  $15 + (1d10+3) + 2$  per each 15 km/h or 10 mph over maneuver speed. A roll that fails by 7 or more results in a crash.

\*\* = Apply damage that penetrated (that exceeded vehicle's SP) to driver. Roll for location and subtract SP of any armor plus driver's BTM. If driver takes a wound, s/he must make a control roll. Target number is 10, unless the damage is to the arm (Difficulty 15), or is a head shot or other critical hit (in which case the Difficulty may be increased to 20 or more).

ounce); half a gram is sufficient to cause health problems. These include violent vomiting, abdominal pain, excessive saliva production, jerky muscles, and a fluctuating heartbeat (Ref -5, Body -5 for 2d3 hours) – and possibly also paralysis and death. Any character who ingests it must make a shock save to avoid dying.

### **Dioxin**

Hazard Code: T

Other Names: TCDD

Trade Name: Agent Orange

Description: Dioxin is found in Agent Orange, a defoliant that was used extensively during the Vietnam War. The ingredient that contains the dioxin is known as 2,4,5-trichlorophenoxyacetic acid (usually abbreviated to 2,4,5-T). The defoliant itself is a clear liquid.

Health Effects: Exposure to dioxin (usually by getting some of the liquid defoliant on the skin) results in chloracne, a skin condition resembling acne (Attr -3 for 2d3 days). It also produces headaches, dizziness, digestive upsets, and generalized aches and pains (Int -1, Bod -1 for 2d3 hours). Dioxin is also a known carcinogen, and is believed to be a mutagen.

### **Methyl Ethyl Ketone**

Hazard Code: I, T

Other Names: MEK; 2-butanone; methyl acetone; ethyl methyl ketone; butanone.

Description: This colorless liquid has a sharp, minty smell. It rapidly evaporates into a gas. It is used in the manufacture of varnishes, plastics, oils, and cosmetics, and as a solvent. It mixes with water, and explodes if heated or exposed to flame.

Health Effects: MEK is absorbed into the body by inhaling vapors, or contact of the liquid with the skin. It causes eye and throat irritation and headaches at low doses (Cool -1, Int -1 for several minutes after exposure) as well as numbness in the fingers and legs and slowed reaction time at higher doses (Ref -1 for 1d3 hours). It is also suspected to be carcinogenic and teratogenic.

### **Oxalic Acid**

Hazard Code: C

Other Names: oxalic acid dihydrate; ethane dioic acid.

Description: This white, colorless powder is used as an industrial metal cleaner, and as a bleaching agent.

Health Effects: This caustic powder, when touched, causes the skin to tingle, turn blue, crack open, and form slow-healing ulcers (Cool -1, Attr -2 for 2d3 days). Swallowing oxalic acid causes vomiting, abdominal pain, and collapse (Ref -4 for 2d6 hours) – and possibly also convulsions and death. Any character who ingests a good mouthful of this powder must make a shock save to avoid dying. Gloves are sufficient protection to avoid contact.

### **Parathion**

Hazard Code: H

Trade Name: Phoskil

Description: This dark brown agricultural insecticide has a garlic-like odor. It does not dissolve in water.

Health Effects: When absorbed through contact with

the skin, this liquid interferes with the transmission of nerve signals, causing a delayed paralysis that sets in a day or two after exposure (Ref -3; sets in 1d3 days after exposure). Medical treatment with an injection of atropine can reduce this somewhat (Ref -2). Recovery is gradual (over 3d3 days) and is only complete if a shock save is made. If not, there is a permanent diminishing of motor function (Ref -1). Parathion is also believed to be a carcinogen.

### **Tetrachloroethylene**

Hazard Code: T

Other Names: PCE; carbon dichloride; perchloroethylene; PERC; 1,1,2,2-tetrachloroethylene.

Description: This colorless, heavy liquid has a sweet, chloroform-like odor. It evaporates quickly, but is not flammable. It is used extensively in the dry cleaning industry, and to remove grease and dirt from machinery.

Health Effects: Tetrachloroethylene, or “perc” as it is more commonly known, is absorbed into the body by inhalation (especially during times of exertion), and through the skin if direct contact is made with the liquid. It causes short-term eye irritation, dizziness, and confusion (Cool -1, Ref -1 for several minutes after exposure). It is suspected to be a carcinogen, and possibly also a teratogen.

*We would like to thank the following playtesters for their input and comments: Chuck Thibert, Tim McCloskey, Kim Ingalls, James Barron, Joelle Perreault, James Duncan, Dan Berger, and P. Ward.*



## **CONVERSION NOTES**

by “Gurth”

Cyberpunk adventures are generally easily converted to the Shadowrun system. Often, all that is required is the addition of magic and a few alterations to the background and setting. This adventure is no exception.

Due to the situation in North America, the convoy should pass through at least one national border. Suggested is to start out in Sheridan, Sioux Nation, and travel to Seattle from there.

Athena’s Shield is an all-women, all-Native American go-gang with mercenary ideals. You might want to rename them Dog Soldiers, after the Cheyenne warrior society whose members staked a sash into the ground, vowing to fight in that spot until killed or until a fellow warrior unstaked the sash, releasing them from their vows. (The women could have sashes tied to their vehicles.) The ten women who accompany the convoy drive four ancient Americans, two of which are little-seen convertible models, and one Honda-GM 3220ZX Turbo

(pages 11 & 12, RBB). All of these are modified like the VW Beetles, and have Body 4, and Armor 6; adjust their speeds accordingly. Change the weapons to an Assault Cannon for the Barret-Arasaka, Ingram Valiants for the M60s, and a Missile Launcher for the Scorpion-16.

One of the gangers is a Wolf shaman with a handful of spells like Mana Bolt, Detect Enemies, and Ram. The others have some cyberware, such as smartlinks, cybereyes, radios, etc., and are of varying races. Stats can be converted easily by halving the CP2020 stat (Cool for Willpower, Body Type for Body, etc.) or by using the Gang Member Archetype. Skills should *not* be halved, but kept at their current level; it's usually easy enough to determine an equivalent Shadowrun skill. (If you can't, make it a Special Skill.) For personal weapons, the gangers carry various pistols and SMGs.

The truck drivers have no cyberware save for datajacks and/or vehicle control rigs (level 1, usually). They carry civilian shotguns, pistols, or tasers, plus the required licenses. For the trucks, use stats for typical trucks from the RBB.

Raffen Shiv consists of various metatypes. They rarely wear armor over Ballistic 2, and carry SMGs and melee weapons. They have lots of cyberware, and they drive four pick-up trucks. (Pages 25 to 31 of the RBB should provide enough inspiration.) Replace the M134 with a Vindicator.

The police car will change at every border, since every nation the convoy passes through will provide its own escort. Police will typically drive a Honda-GM 3220ZX Turbo (page 132, *Lone Star*). For the cops, use the Auto Patrol Officer (page 126, *Lone Star*).

Each player could run a member of Athena's Shield during a one-off adventure, or the players' regular characters could be hired by UES to work together with the gangers. UES pays 3,000 nuyen per person, 10% up front. The PCs might have some trouble passing borders with the gear shadowrunners typically carry, but they can be from virtually anywhere, hauled over by UES to wherever the convoy leaves from.

Finding out what the trucks are carrying requires a Physical Sciences (Chemistry) test: target number 3 to identify the trade name of the chemicals; target number 5 to determine the stuff's health hazards.

When it comes time for the attack, Shadowrun's vehicle combat rules (pages 104-109, SR11) can be used to handle this situation, and will likely be made much easier by the vehicle templates provided. A vehicle that suffers Serious damage or higher is leaking chemicals.

Base game effects of the toxic waste on the description given of each cargo – and your imagination.

Subscribe to  
Adventures Unlimited  
and get \$1 off  
each issue!

For a one-year subscription to  
Adventures Unlimited, send  
cheque or money order (payable  
to Bootstrap Press) to:

3893 Norfolk St.  
Burnaby, B.C.  
Canada, V5G 1E6

Cost is \$15.80 US  
or \$21 Cdn (price includes GST)  
Overseas subscriptions: \$18 US

Single copies: \$6.50 Cdn or \$4.95 US

### Issue #2

- Star Wars
- Skyrealms of Jorune
- Nephilim
- Toon
- Earthdawn
- Whispering Vault
- Castle Falkenstein

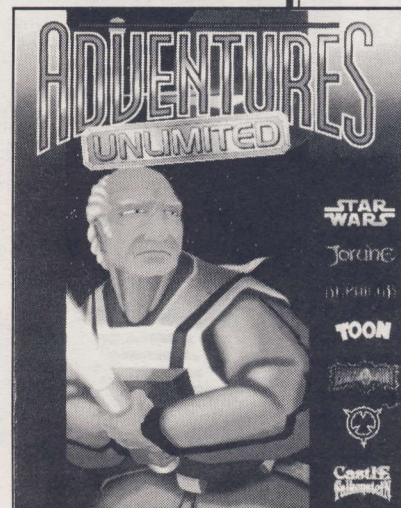

### Issue #3

- Shadowrun
- Kult
- Warhammer Fantasy Roleplay
- Indiana Jones
- MERP
- Street Fighter
- ST:NG Customizable Card Game

