

Airtech Windrider

When it absolutely *has* to be there on time . . .

Windrider — Small cargo hover, 6 std. skirts, 700 ci engine, blueprinted w/tubular headers, 25 gallon duelling tank, VP turbo, driver, BC front, SWC, streamlining, vertical stabilizer, cargo: 11 spaces, 4,050 lbs. Sloped FP Armor: 6 10-pt. skirt guards, 4 10-pt fan guards, 30 pts on each facing. Acceleration 10, MPG 11, top speed 190 (215 unloaded), HC 2; 16,500 lbs (loaded), \$98,025.

Windrider Deluxe — Upgrade skirts to extra-heavy, move BC to universal turret, add two BC magazines, upgrade BC ammo to HESH rounds, add HRSWC, Radar. Cargo capacity drops to 2,460 lbs. Unloaded top speed drops to 205 mph. \$117,285.

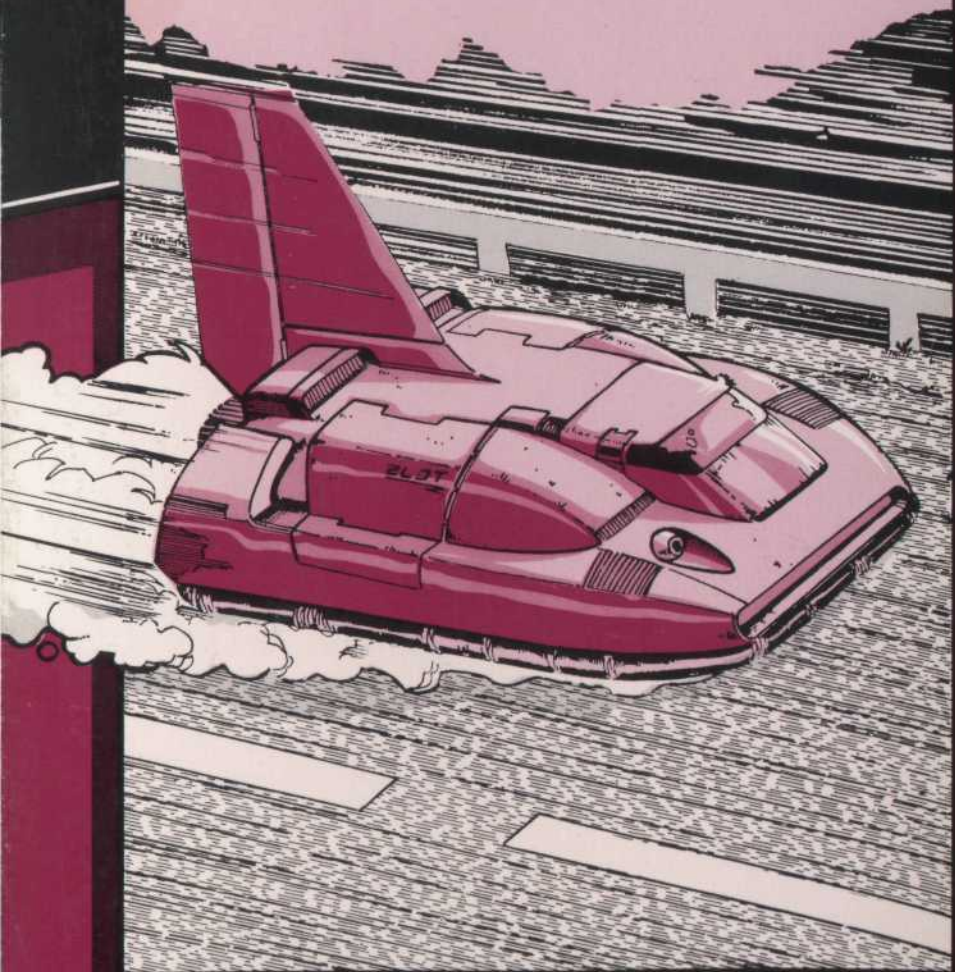

Autoduel Quarterly

THE JOURNAL OF THE AMERICAN AUTO DUEL ASSOCIATION

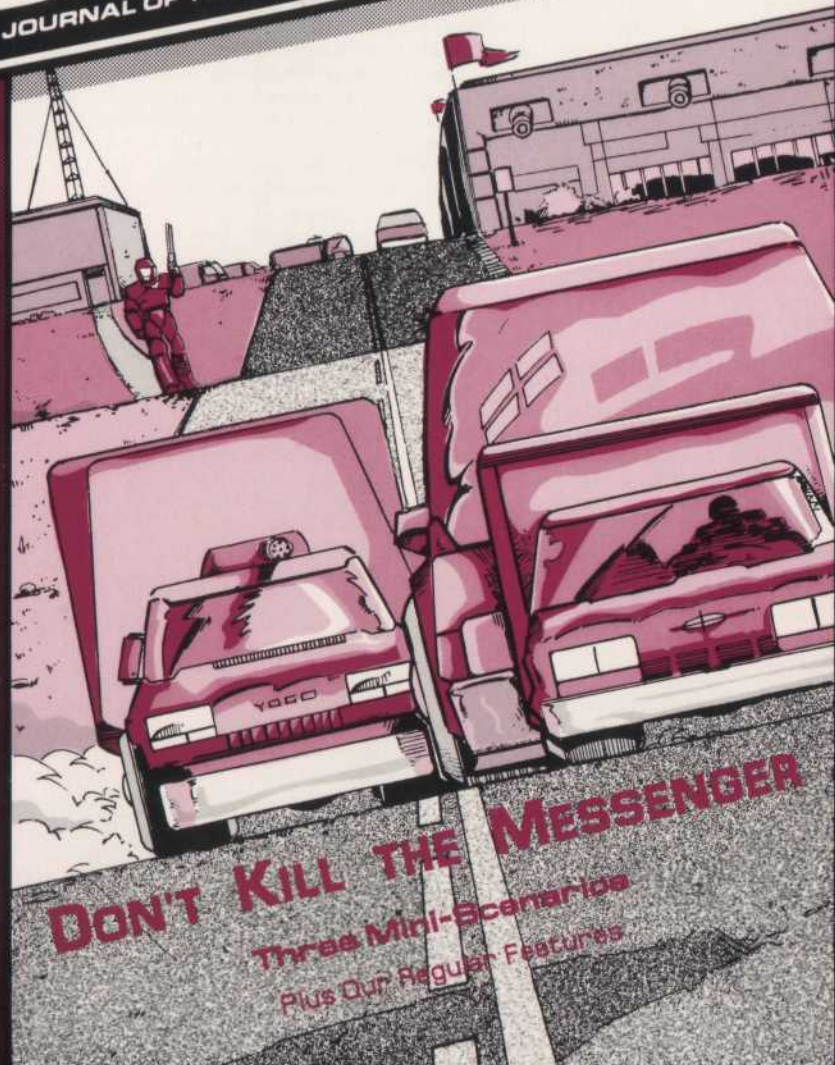

DON'T KILL THE MESSENGER

Three Mini-Scenarios
Plus Our Regular Features

SJ GAMES ORDER FORM

Please circle desired rate: 4 issues 8 issues 12 issues Lifetime
Autoduel Quarterly \$12 \$24 \$36 \$100

O Check here if this is a subscription renewal. Please add 50c per issue for Canadian addresses, and \$1.00 per issue for addresses outside the U.S. and Canada.

- CAR WARS® DELUXE EDITION — 64-page rulebook, 300 counters, three maps, and Deluxe Road Sections in a 9" x 11 1/2" box. \$20.50
 DUELTRACK® — gas engines, metal armor, racing! in a 9" x 12" box. \$16.50
 CAR WARS — Cycles and autos battle on the highways! (Pocket Box). \$7.50
 MINI CAR WARS — easy-to-learn introduction to the *Car Wars* world. \$1.00
 CRASH CITY⁹ — (New title) Midville MONDO motorcycle mayhem. (Pocket Box). \$7.50
 TRUCK STOP* — 18 wheelers and other large vehicles for *Car Wars*. (Pocket Box). \$7.50
 THE AADA® ROAD ATLAS AND SURVIVAL GUIDE _____
 VOLUME ONE: THE EAST COAST. \$9.50
 VOLUME TWO: THE WEST COAST. \$9.50
 VOLUME THREE: THE SOUTH. \$9.50
 VOLUME FOUR: AUSTRALIA. \$9.50
 VOLUME FIVE: THE MIDWEST. \$9.50
 VOLUME SIX: THE FREE OIL STATES. \$9.50
 THE BEST OF AUTODUEL QUARTERLY VOLUME 1 — The best from ADQ's first year. \$6.50
 UNCLE ALBERT'S • 2035 CATALOG — Gadgets & weapons from the autoduel dealer. \$6.50
 UNCLE ALBERT'S® 2036 CATALOG UPDATE - More gadgets and accessories! \$6.50
 UNCLE ALBERT'S® 2038 CATALOG UPDATE - Still *more* gadgets and accessories! \$6.50
 UNCLE AL'S GRAB BAG —one-of-a-kind packages of Al's "best stuff". \$4.50
 COMBAT SHOWCASE — Over 100 vehicles in a ready-to-play schematic display. \$7.50
 CAR WARRIORS® KILL STICKERS — vinyl stickers display your kills with pride. \$5.50
 CAR WARS EXPANSION SETS _____
 CWX-1 - More and different road counters. \$4.50
 CWX-2 - Duplicate Counters plus turning key. \$4.50
 CWX-3- East Midville. \$4.50
 CWX-4- Armadillo Autoduel Arena. \$4.50
 CWX-6- *The AADA Vehicle Guide* Counters — with wrecks on the back! \$4.50
 CWX-9- Four 21" x 32" maps to make the biggest *Car Wars* arena ever! \$4.50
 DELUXE ROAD SECTIONS - Durable high-quality highways _____
 Set 1: Starter Set — Complete track layout plus 116 counters. \$4.50
 Set 2: Intersections — Turnouts, crossroads, straights, 46 counters. \$4.50
 Set 3: Straights —Nine straight sections plus 27 counters. \$4.50
 CAR WARS MAP SHEETS-21" x 32" sheets marked in 1/4" grid. Five to a pack. \$4.50
 CAR WARS CITY BLOCKS — 32 separate city blocks to rearrange as you please. \$6.50
 CAR WARS CITY BLOCKS 2 — a city damaged by battle to challenge duellists. \$6.50
 THE AADA VEHICLE GUIDE-Over 100 vehicles, completely described. \$6.50
 THE AADA VEHICLE GUIDE VOLUME 2 — Over 130 never-before-published vehicles, completely described. \$6.50
 THE AADA VEHICLE GUIDE VOLUME 2 COUNTERS — with wrecks on the back. \$5.50
 CAR WARS DELUXE REFERENCE SCREEN - Charts, index, etc. for the Deluxe Edition. \$5.50
 CAR WARS ARENA BOOK— 14 arenas, plus 109 counters. \$6.50
 BOAT WARS — a Pocket Box supplement for *Car Wars*. \$7.50
 AUTODUEL® — Origin Systems' computer game, Circle computer type. \$52.00
 IBM Apple II Commodore 64 Amiga Atari XL/XE Atari ST Macintosh
 AUTODUEL POSTER-17" X 22" poster from the game cover. \$1.50
 CAR WARS T-SHIRT — The *Car Wars* cover art, six colors, on a white T-shirt. \$7.50

Circle Size: S M L XL
 Payment is by: Texas residents add 8% sales tax (on all items except subscriptions)
 O check O money order O MasterCard O Visa Total enclosed _____

Name _____ Address _____

City _____ State/Prov. _____ Zip _____

(Credit orders): Acct. no. _____

Signature _____ Exp. date _____

Prices include postage and handling. Payment must be in U.S. dollars on a U.S. bank. All subscriptions start with the next issue published. Make checks payable to Steve Jackson Games. Send to:

STEVE JACKSON GAMES
 BOX 18957-T AUSTIN, TX 78760

Winter 2038
 Vol. 6, No. 4

Autoduel Quarterly



STAFF

Editor
 Charles A. Oines

Art Director
 Guy Burchak

Production Staff
 Melinda Spray
 Charles Oines
 M.E. Roome

Publisher
 Steve Jackson

Managing Editor
 Ken Trobaugh

Circulation Manager
 Creede Lombard

Art in this issue:
 Guy Burchak: 6, 7;
 Bill Casserly: 14;
 Dan Carrol: 14, 38, 46;
 C. B. Gorby: 4;
 Mike Surbrook: 15;
 J. Waltrip: 13; Gary
 Washington: front and
 back cover, 5, 12, 28,
 29, 30, 31, 32, 36, 39;
 George "Speed"
 Weber: 11, 16.
 Photograph on p. 43
 courtesy of LEADA

Trademark Notice
Car Wars, *Dueltrack*,
Car Warriors, *Crash*
City, *Truck Stop*, *Con-*
voys, *AADA*, *Uncle*
Albert's and *Autoduel* are
 registered trademarks and
 the AADA logo is a
 trademark of Steve Jack-
 son Games Incorporated
 or are used under license.

CONTENTS

Mini-Scenarios/Davirf N. Searle
Gasman's Revenge. 12
The Agony of Defeat. 13
Route 'Em!. 15
 Duelling on a Budget/Don Jacques. 20
 Hovercraft Designer's Notes/Ken Scott. 21
Autogyros/Gareth Lowe and Charles Oines. 27
 Don't Kill the Messenger/Cristopher- Burke. 28
 Convoy Tactics/Rodney Orpheus. 34
 Advanced Cyclist Tactics/David N. Searle. 38

DEPARTMENTS

Driver's Seat/Charles Oines. 2
 Newswatch/Tim Jacques. 4
 Excerpts from *The AADA Road Atlas and Survival Guide*:
 SCHAUMBURG, IL/Barton H. Stano and M.K. Stoeklin. 8
 AADA Arenawatch/Dennis Lauhala & Tim Jacques. 17
 ADQ Classifieds. 37
 AADA News/Charles Oines. 40
 Backfire. 45
 ADQ&A. 47

ADVERTISERS

AADA. inside front mailer
 Airtech. back cover
 Origin Systems. inside back cover
 Crane Industries. 5
 Steve Jackson Games. inside front cover, 26, 32
 Indra Motors. 31
 Uncle Albert's Auto Stop and Gunnery Shop. 6, 7
 California Creations. 36

Designs in this issue:

Charles Oines: back cover, 5, 6, 36. Tom Jacobson: 31. H. John Romero, Jr. (ERIS): 7. Pete Hallenberg (ISC): 7.

Autoduel Quarterly (ISSN 0740-3356) is published quarterly by Steve Jackson Games Incorporated, 2700-A Metcalfe, Austin, TX 78741. Please address all correspondence to Steve Jackson Games, P.O. Box 18957, Austin, TX 78760-8957. "Winter 2038" issue published December, 1988. First-class postage paid at Austin, TX. POSTMASTER: Send address changes to *Autoduel Quarterly*, P.O. Box 18957, Austin, TX 78760-8957. All material is copyright © 1988 by Steve Jackson Games Incorporated. All rights reserved. Subscription rates as of December 1, 1988 — In the United States: 4 issues, \$12. Outside the US: please add 50c per issue for Canada, \$1 per issue for foreign surface mail. International rates are subject to change as postal rates change. NOTE: All payments must be in U. S. dollars, made by International Money Order or check drawn on a U. S. or Canadian bank. Printed in the U.S.A.

It's mine now.

Stephen Beeman is off at college, and I've taken over the *Driver's Seat* for the time being. And I intend to be here for a *long* time.

For those of you who wonder (or even fear) just what I intend to do with the magazine, just read on. This issue's cover story is *Don't Kill the Messenger*, a piece of *autoduel fiction* by Christopher Burke. There are three mini-scenarios by David Searle, two new arenas, and in the center spread we've printed hover and boat record sheets since we didn't have enough room in *Boat Wars* for them. In other news, AADA management (after charges of corruption) is undergoing complete reorganization — see p. 40.

Some of you may be worried about this magazine getting excessively silly now that I'm running it. Don't worry — I promise not to run *too* many pieces like "Dodges and Dragons" unless I'm really hard up for filler. But that means *you* have to submit some high-quality articles. *ADQ* depends on reader submissions; if you don't send it in, it'll probably never see print, and I'll be forced to resort to my own warped imagination. So submit now! And when you do . . .

Be Nice To Me

While shuffling through the submission files, I came across a few common irritations, and I want to correct that now. In no particular order:

1. Put your Name, Address, Social Security number (if this is an article submission) and Date on *every* page. If you aren't willing to do that, you run the risk of part of the manuscript being lost.

2. For those of you using dot-matrix printers, I have several requests. Don't get overly cute with GEOS or other low-resolution typesetting programs. I prefer NLQ or, failing that, straight draft. If you must use a graphics-based typesetter, make sure the font

is easily readable — don't use the tiniest print available. And please, *please* use a fresh ribbon. Your submission is no good at all if I can't read it.

3. I won't reply to anything that doesn't have a self-addressed, stamped envelope unless the letter, article or whatever is truly stunning. If you don't need a reply (and a lot of things don't — gadget and vehicle submissions, fr'instance. We get so many of these that responding to each one would take up all our time), don't put in an SASE.

4. *Do* submit often. I can't print it if I don't have it. And I'm going to need a *lot* of new articles soon . . . As to subject matter, we're running low on short filler articles and our regular features (Road Atlas and Survival Guide entries in particular, mini and full-size scenarios are also in desperately short supply), so these would be preferred. And remember, our rates have doubled — we now pay 2 to 6C per word and 3 complimentary copies.

Speaking of submissions, I haven't yet paid one person for his, because I couldn't find his address. Joe Mauloni — drop me a line, pronto.

5. Be nice to the mail room, too. When you have to change your mailing address for whatever reason, send us your old mailing label, or, failing that, your old address *along* with your new address. Be sure to label them so we can tell them apart, too.

Never Say Oops Again

This is probably the last time I'll be able to say "It's not my fault," and I hope it's the last time I'll have to come up with an Oops title. Here are the latest booboos for those of you keeping score:

In *ADQ 6/3*, Uncle Albert's ad displayed the Derringer, with a small omission. It carries two shots. Uncle Albert apologizes for any difficulties this may have caused, and regrets the error.

This next one was so obvious it got completely overlooked. When you combine streamlining (*Uncle Albert's 2038 Catalog Update*) with sloped armor (same), the combination reduces interior space by 15% (round up) not 20% or 10%. With the smaller vehicles, this probably won't make much of a difference, but it's nice to be certain.

Former editor Stephen Beeman cryptically mentioned the AADA Newsletter, saying "don't despair; there are other ways to get it," without bothering to tell anybody *how*. It's not that hard, actually. AADA chapters get a copy automatically. Any AADA at-large member may request a copy of the latest AADA Newsletter (sorry, no back issues) by sending us a letter about it and an SASE. Include your subscription number with your request. We only run off a limited number of extra copies, so it's first come, first serve.

There's a mention of the benefits of waterproofing underbody weapons in *Boat Wars* (p. 7), but nothing at all about the hazards of *not* waterproofing weapons. To set the record straight, non-waterproof weapons are ruined by immersion. Got it? If you still wonder about the benefits, consider that a boat with hydrofoils can raise its underside out of the water, and can mount as many turrets underneath as it can on top. So your hydrofoiled yacht can carry *four* turreted blast cannons.

Also, for some reason, we have the Northeast Regional Championship award sitting in our office. According to what records I have, it belongs to Christian J. Alipounarian. Christian, get in touch with me about this.

And this last one isn't really an Oops, but I have no idea where else to put it. **Subcom-pacts have a +1 HC, up to 4 without driver bonuses. This is official.** The feedback on this idea was overwhelmingly positive.

ADQ Gets Bigger!

Bigger?

Yep. *ADQ* is always growing, but next issue it's going to grow *dramatically!* All the way up to full size (8 1/2 X 11"), with a new look and more room for everything you want — fiction, scenarios, vehicles, articles, variants, *GURPS Autoduel*, and everything else you've come to expect from *ADQ*.

Down the Road

Boat Wars is out, complete with a 48-page rulebook, 2 big, wide, rolling blue maps and 2 beautiful counter sheets, all in one tiny Pocket Box. All you people clamoring for hovercraft rules, and all you who wanted **official** boat rules, rush out and buy it now. Go on — put down the magazine for a moment, and buy one. I'll wait. . .

City Blocks will have been out for a month or so by the time you read this. The fully geomorphic 8" X 8" map sections can be set up in nearly infinite combinations, thus allowing your duels to go careening illegally through the heart of the city, endangering passersby and all that sort of fun.

City Blocks 2 should be on the shelves a few weeks after you read this. The second collection features the ruins, burned-out buildings and abandoned areas so prevalent in the 2030s, with a fantastic cover by Guy Burchak.

In the works even as I write this is the *The L'Outrance Duel Circuit*, a *Car Wars* campaign book with details and schedules for the midwestern duel circuit, plus other campaigning goodies. Look for this one soon after this *ADQ* hits the stands.

If there's anything *you'd* like to see, let us know. We are planning a lot of new *Car Wars* products soon, and are open to new ideas.

Where It's At

If you need a quick answer from me on just about any subject, or you want to submit something and don't trust the Post Office (one can hardly blame you), and you have a computer & modem, call the Illuminati **BBS** (512-447-4449, 8-none-1, 24 hours, at 3/12/2400 baud) and post it on the *Car Wars* discussion board. A lot of bizarre things go on on the BBS, and there's no charge (besides long distance). Also, it's the quickest way to get my attention that won't bother me while I'm working. I usually log on every other morning.

The evolution of *Car Wars* (and our other games) can be heavily influenced by the roving discussions on the board. Whenever I need input on gadgets, scenarios and other topics, I usually go to the BBS first. And the other users often post good ideas on the board. Two-time World Champion Mike Montgomery, for instance, suggested that vehicles' maximum ram damage be equal to the amount of damage it takes to make confetti out of them (which, if you'll get out your older Reference Screens and read along, is cumulative damage equal to 1/50 of its weight (1 pt. per 50 lbs), which reduced the vehicle to a huge pile of debris counters), modified normally by ramplates and CA frames. Sounds good to me, and if I get more positive feedback on this, it may become official.

Don't worry — be trigger-happy. — CAO



NEWSWATCH

The Japanese Protectorate

1907: After centuries of the Samurai code, Japan creates a new war machine. Japan wages a successful war against Russia in a brief and bloody conflict. National pride soars.

1931: As the military rises in political power, Japan extends its influence in the Far East. Troops move into Manchuria and China for oil, coal, iron ore and other natural resources.

1941: Seeing that conflict is inevitable, Japan conducts a surprise attack on the American Pacific fleet at Pearl Harbor. Four years later, Japan is forced into submission when American forces drop atomic bombs on Hiroshima and Nagasaki.

1946: Japan's government and financial structure is reconstructed under American supervision. Japan eventually recovers.

1988: Japan is one of the top three economic superpowers of the world. Electronics, manufacturing and computers are their top three items.

1999: The Oil Crisis hits Japan particularly hard — their industry is crippled overnight. Major investment starts on alternative forms of power (more than any other country).

2012: The Grain Blight. While many countries fall into chaos, Japan holds firm due to strong internal discipline and cooperation. Though the Blight breaks out in some areas, strict quarantine controls keep it from devastating the rice crops. The Japanese Coast Guard is ordered to deal harshly with any boat people who try to enter the country.

2016: North Korean terrorists release the Blight into the Japanese rice crop. Starvation reaches epic proportions as millions die. Rioting breaks out in urban centers and is eventually put down by deadly force. There are several coup attempts during the year, but all of them fail. Algae production starts just in the nick of time, and reconstruction begins. Various Japanese corporations begin buying land in Montana at extremely low prices.

2020: After years of rebuilding, Japan has stabilized to a point where it can flex its muscle. The new corporate government begins its military and economic expansion.

2022: Over half of Montana, including 78% of the blighted eastern farmland is owned by four major Japanese corporations — Mitsui, Tanaka, American Nippon, and Aso-Shima. Several minor companies also acquire land in Montana.

2031: *Car Wars* released to the general public.

2036: Japan grows into an economic empire which spans the Pacific. Competing *zaibatus* effectively run the country — profit motives heavily influence national policy.

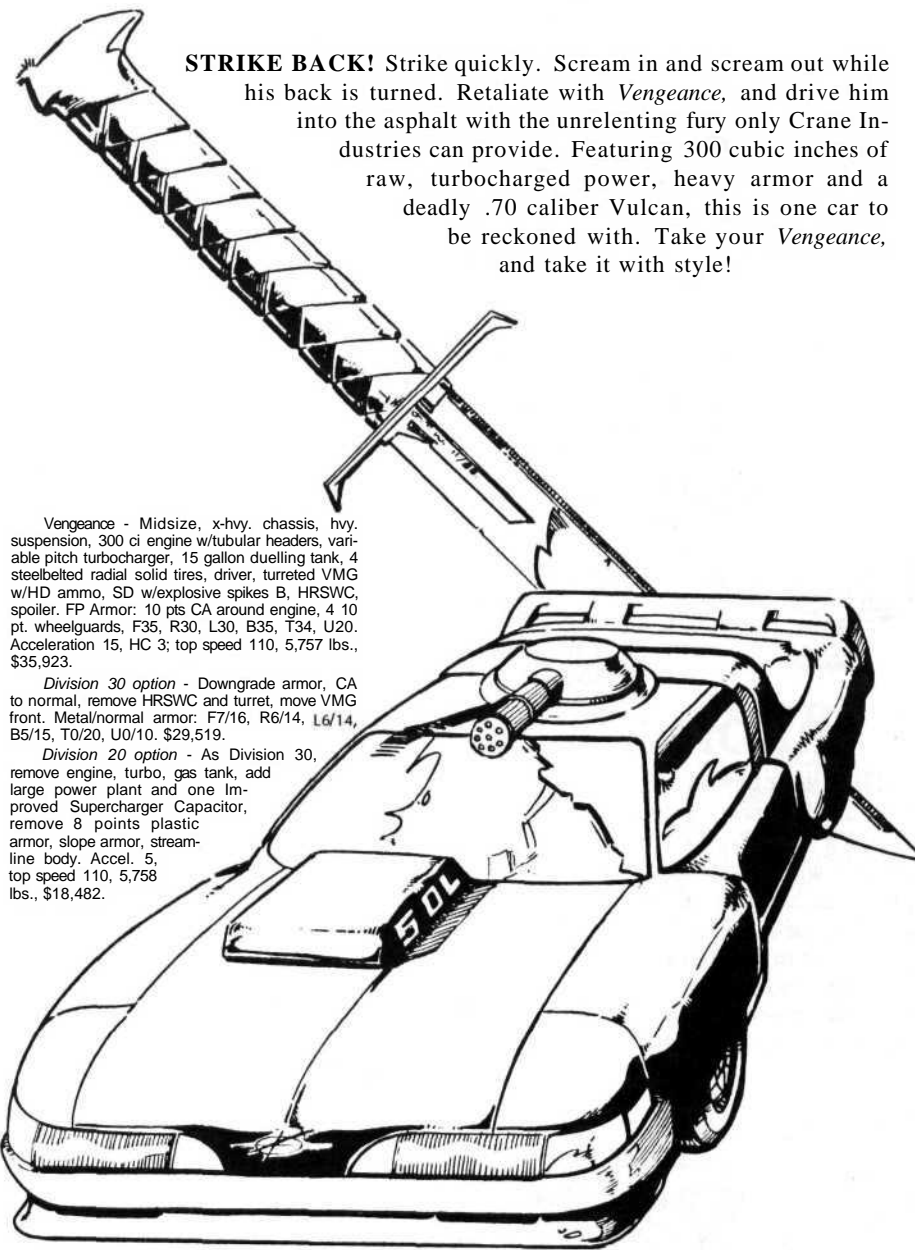

STRIKE BACK! Strike quickly. Scream in and scream out while his back is turned. Retaliate with *Vengeance*, and drive him into the asphalt with the unrelenting fury only Crane Industries can provide. Featuring 300 cubic inches of raw, turbocharged power, heavy armor and a deadly .70 caliber Vulcan, this is one car to be reckoned with. Take your *Vengeance*, and take it with style!

Vengeance - Midsize, x-hvy. chassis, hvy. suspension, 300 ci engine w/tubular headers, variable pitch turbocharger, 15 gallon duelling tank, 4 steelbelted radial solid tires, driver, turreted VMG w/HD ammo, SD w/explosive spikes B, HRSWC, spoiler, FP Armor: 10 pts CA around engine, 4 10 pt. wheelguards, F35, R30, L30, B35, T34, U20. Acceleration 15, HC 3; top speed 110, 5,757 lbs., \$35,923.

Division 30 option - Downgrade armor, CA to normal, remove HRSWC and turret, move VMG front. Metal/normal armor: F7/16, R6/14, L6/14, B5/15, T0/20, U0/10. \$29,519.

Division 20 option - As Division 30, remove engine, turbo, gas tank, add large power plant and one Improved Supercharger Capacitor, remove 8 points plastic armor, slope armor, streamline body. Accel. 5, top speed 110, 5,758 lbs., \$18,482.

VENGEANCE!

Crane Industries

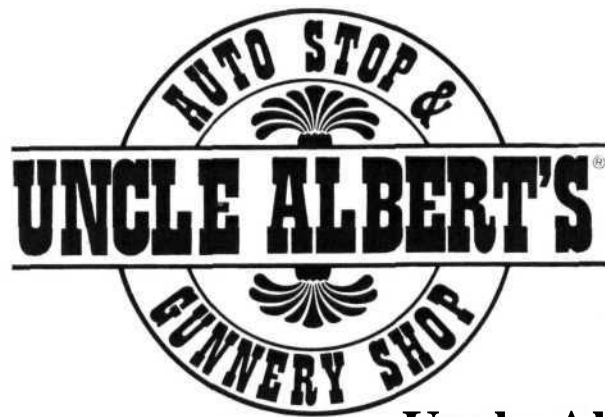

Uncle Albert Knows How To Perform!

For the duellist who wants to stay ahead of the pack, Uncle Al offers a wide line of high-performance equipment — fully guaranteed — to keep you in the lead!

RADIAL TIRES

Sure, your new car handles well. But you want it to handle *great* — nothing less will do. Uncle Albert's new *Fleetfoot* Wide Radial tires hug the asphalt with herculean grip. Take that winding mountain highway or duelttrack with confidence, and a set of Uncle Al's Radial tires! *Special: Say you saw it in ADQ and delivery is free!*

Radial Tires — Any car, cycle or trike with Radial Tires on all its wheels has its HC raised by 1. This may *not* raise it's HC above 3. Racing slicks, metal tires and oversized tires may not be made radial. Adds 150% to cost, 20% to weight, -1 DP.

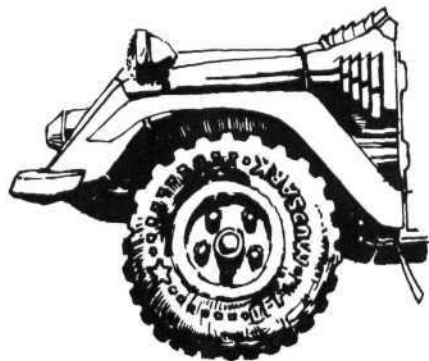

OFF-ROAD TIRES

Not all the action is on the highways. When you need to get off the road, do it in style with Uncle Al's *Mudshark* line of off-road tires.

Off-Road (OR) Tires — Any car, cycle or trike with Off-Road Tires on all its wheels has its HC raised by 1 when off-road. OR tires confer no benefits on the highway. Again, slicks, metal tires and oversized tires may not be made OR. Adds 20% to cost and 5 lbs. to weight. No tire may be both Off-Road *and* radial.

ENCODED REMOTE IGNITION SYSTEM

AADA statistics show that it takes the average driver three seconds to get his car started. Sometimes, three seconds isn't nearly enough — the duel could end before your car starts! Electrofabrique Suisse has the answer in their new Encoded Remote Ignition System. Start your car before you get to it — the time you save could mean your life! *Ask about our Corporate Fleet specials!*

Encoded Remote Ignition System (ERIS) — \$500, transmitter is 1/2 grenade equivalent, receiver is \$100, no space, no weight. Destroyed when the power plant is destroyed. Starts or stops a vehicle, unlocks its doors, or flashes its lights at the user's behest. Transmitter range is 15". Sending a command is a firing action. Each ERIS has a special "password" encoded into the transmission so others can't activate your vehicle by accident (or on purpose) while activating their own.



IMPROVED SUPERCHARGER CAPACITORS

Thanks to recent developments in fuel-cell technology, Uncle Albert can now deliver blistering gasburner performance to electric power plants! Blast past those guzzlers with the new, improved *Zippy* Supercharger Capacitors. Don't be a pinhead — order them today! *Note: Some powerplant damage will result from using this item.*

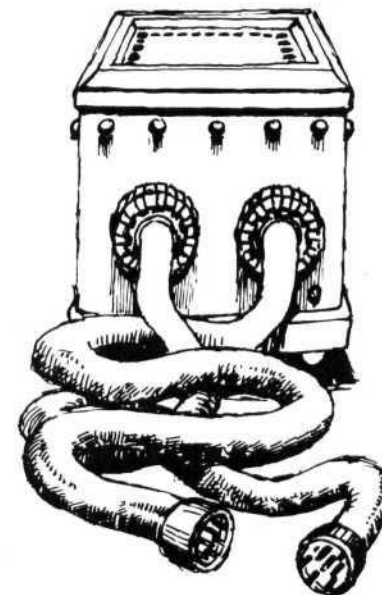

Improved Supercharger Capacitors (ISC) — \$500, 1 space, 75 lbs., adds 1 DP to power plant. Each ISC will raise an electric vehicle's acceleration by 5 mph and add 20 mph to its top speed for 3 turns. Triggering the ISC is a firing action taken during the Acceleration phase. It cannot be used again until recharged (which takes two minutes, and costs \$10). Triggering an ISC causes considerable damage to the power plant — divide the number of DP the plant originally had by 3, rounding down, and give the plant that much damage at the end of the third turn of use. This damage will not cause a fire or hazard, and component armor does not protect against it. However, damage caused by ISCs costs half as much to repair as normal damage. Up to three ISCs may be linked together for cumulative results. A vehicle that is above its maximum speed when the ISC's charge is used up will decelerate by 10 mph/turn until at or below its maximum speed. Gasoline engines may not use this item.

Excerpts from the AADA ROAD ATLAS AND SURVIVAL GUIDE

by Barton H. Stano
and M.K. Stoecklin

Schaumburg (nicknamed "Shoppingburg") is a northwest suburb of Chicago. It's comprised of a large mall and a small section of the old suburb that, before the Food Riots, was a thriving medium-sized city. Now, there are only 65,000 people within its city limits. Schaumburg today is a major financial and retail trading center for northern Illinois. However rich the city is, the edge of town is marked by burned-out ruins.

History

Founded over one hundred years ago, Schaumburg began as a rural farming village. With the advent of superhighways and an aggressive government, the community grew in an astounding manner. By the late 1980s, Schaumburg had the beginnings of a skyline. Although this rapid, unplanned growth brought traffic congestion and other problems, Schaumburg was still a more attractive business location than Chicago, and its economy soared.

However, the Grain Blight of 2016 ended this growth and shattered the illusion of security. Although the economy almost collapsed; the people here still had money. The Food Riots touched Schaumburg, but the wealthier citizens illegally bought vast quantities of relief food, (most of which was destined for Chicago) which allowed a significant portion of the populace to survive. The riots

laid waste to vast residential districts; those who escaped the worst fled to the protection of the malls. Police and mercenaries, funded by the corporations, maintained a fair degree of order. Fortifications were constructed, and Schaumburg survived the chaos while neighboring suburbs were destroyed.

One of the largest shopping centers, Woodmeadow Mall, became the new power center of the city. The corporations funded the city's protection and took over governmental processes, managing the city with an efficiency the old city government could never achieve. As the area recovered, the "corporate state" eventually held all city power, and only upper executives could vote or hold city office. Most of the Schaumburg populace prefers this system, as it has performed well.

Schaumburg is home to many financial and insurance companies, and the largest retail center in the Midwest: Woodmeadow Mall. The Mall is the largest shopping complex (over 500 stores) in the Midwest.

Points of Interest

The first map shows the Schaumburg area and its major highways. On the opposite page is a map of Woodmeadow Mall and area.

Schaumburg

1. *Woodmeadow Mall*: The seat of government and source of most of its income. The AADA has an office here, serving greater Chicagoland.

2. *Kendall Hospital*: The largest hospital in suburbia, Kendall has an excellent trauma center and ambulance service, in addition to complete Gold Cross facilities.

3. *Shellie's Full Service and Towing*: Full service garage and recharge station, very pricey. Shellie is known for her commitment

pricey. Shellie is known for her commitment to quality, and her mechanics are the best. Shellie's also has a large towing and salvage service; this garage owns the city towing contract.

4. *Lake Michigan Pipeline*: This water pipeline was built in the late 90s to bring lake water to Schaumburg, whose ground water supplies were drying up rapidly.

5. *The Dead Zone*: The surrounding suburbs, destroyed in the Food Riots, have been cleared in a three mile radius around the city limits to provide a clear fire zone. Near the city are the ruins of the old Schaumburg skyscrapers. The Dead Zone is ankle-deep in broken glass and debris, and is avoided by all but the most desperate.

6. *Tent City*: In the summer months, a cluster of prefabricated buildings spring up here. Tents are no longer used (too flimsy), but the prefab shelters are just as colorful. Outside of city limits, Tent City is a no-holds-barred red-light district. Locals patrol the district in expensive duelling cars — there's only trouble here if you want to make it.

7. *Police Headquarters*: Also contains the city jail.

8. *Clothing Factories*: Over 50 small, prefabricated sweatshops are located here. Labor is brought in from the poorer areas of Chicago under heavy guard to work in these plants.

The various managements are violently intolerant of Unionizing, and it hasn't succeeded yet.

9. *Silver & Gold Country Club*: 18-hole golf course and extraordinary dining for Schaumburg's elite. Silver & Gold is well protected by its own security staff, who patrol the course in armed golf carts. Non-members are evicted with extreme prejudice.

Woodmeadow Mall

The Mall proper has four stories (three of which are underground) and from the outside looks to be a large but nondescript gray building. Inside, however, are over 2,000 acres of beautifully landscaped and climate-controlled shopping area.

Not included are listings for most of the 500+ shops; stores and restaurants come and go so quickly that a complete listing would be out-of-date as soon as it hit the presses.

All visitors to the mall must post a \$100 "good behavior" bond. This is a reaction against the unescorted teenagers of the past.

1. *The Wall*: This 30' wall, a mixture of earth and ferrocete, rings the mall area. The wall is heavily patrolled, and twenty HL bunkers are evenly spaced along it to ensure that the mall is protected from undesirable activity. The only entrances are six double-

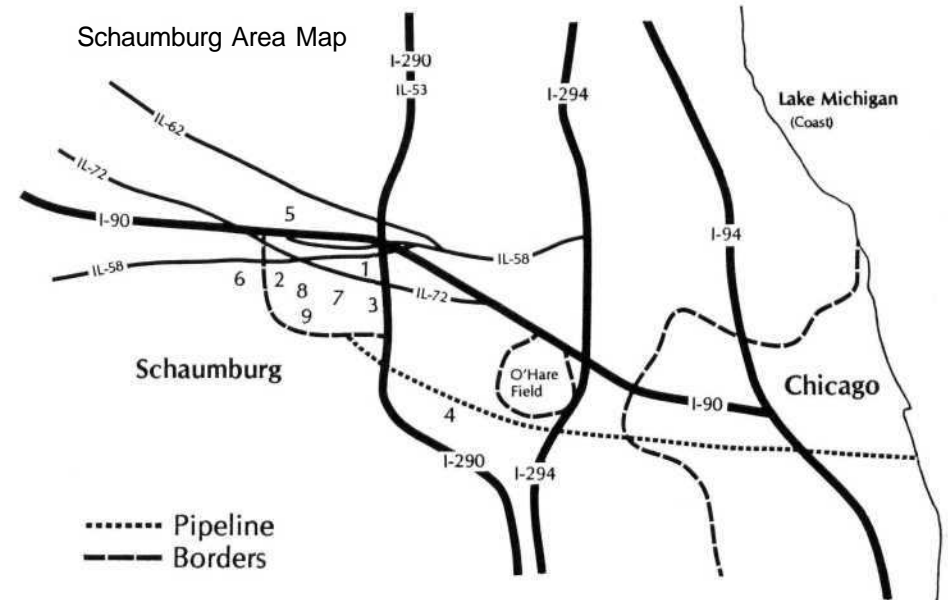

walled gates. All traffic in or out is carefully checked and vehicle weaponry disarmed.

2. *Cook County Autoduel Arena*: The most modern and up-to-date arena in northern Illinois. Events are run on weekends; most are AADA sponsored. The arena hosts gas-powered duelling four times a year; and once every five years hosts the Land of Lincoln Autoduel Championships. This event pays up to \$750,000 in cash prizes and is one of the major AADA events on the L'Outrance circuit.

3. *Helipad*: Standard helicopter facilities, with several HL and SAM emplacements for air defense.

4. *AADA Offices*: This is the Chicagoland office, serving the northern suburbs.

5. *Uncle Albert's Auto Shop & Gunnery Stop*: The famous distributor has a large, well-stocked store located near the Mall.

6. *Mall Management/City Hall*: The Schaumburg government offices are located here, along with Mall Security.

7. *Mall Condominiums*: These 75-story luxury condos house most of the Schaumburg population, and are connected by tunnels.

8. *Corporate Park*: This collection of high-rise buildings is home to many financial and insurance companies around the world.

Events

Woodmeadow Mall is always having special events, from video premieres to live concerts; there are too many to list. Some, however, are worth special attention.

In October, the Mall's fashion houses hold their fall previews. The latest in clothing and body-armor fashion is displayed. The Christmas season begins immediately after the fall pre-views, bringing in hundreds of buses filled with aging holiday shoppers. In January, all stores hold "white sales" that must be seen to be believed; last years' white sale turned into a riot over \$1 holocubes.

Facilities

The most up-to-date duelling and truck stop facilities in northern Illinois are located in and around Schaumburg. There are nine power stations and three fully-equipped garages located in the city. Almost every automobile manufacturer, both foreign and domestic, has a show-room and dealership in the Mall. A truck stop is located just north of the city on I-90.

There are two TV stations, Super Station 99 and WSCH. SS99 telecasts local duelling and more frothy entertainment; it is known best for the mindless but popular game show,



"Shop 'Til You Drop!" with live tapings from the Mall. WSCH operates several well-armed TV choppers, covering most of Cook County, reporting traffic snarls and road duels.

Duelling

Duelling within the city confines is strictly limited to the Cook County Arena, and is illegal elsewhere. Duelling on the interstates is tolerated, but a no-dropped-weapons ordinance is in effect; violate this, and you face a \$1,000 fine. Duelling in the Dead Zone is perfectly legal, and often encouraged; there's nothing out there worth protecting from stray gunfire.

The Cook County Autoduel Arena runs weekend events, with AADA events on Friday and Saturday, and practice and cleanups through the weekdays. The arena is famous for its spectator comforts; white wine, double safety walls, and door prizes.

Highways

Since 2030, Schaumburg, Chicago and the State Police operate in strictly defined territories. The three groups have agreed to stay within set boundaries, except during hot pursuit. Schaumburg police stay within five miles of city limits, Chicago police patrol all areas east to the lake, and the State Police fills in everywhere else. Usually, the three defenders ignore each other, and will not cooperate.

Interstate 290 is the major thoroughfare, heavily patrolled and kept in good repair between Schaumburg and Chicago. Tolls are relatively light: \$30 for cycles, \$50 for cars and \$75 for big rigs. Interstate 294 is in good repair, but tolls are collected to maintain police patrols at twice the above costs. 294 is fairly safe up to the Wisconsin State Line and south to I-65. Interstate 90 is in poor shape

and generally unpatrolled outside of the Schaumburg area.

State routes 72, 62, 58, and 53 are in good shape in the Schaumburg area, but be warned — outside of this area, the roads pass through the dreg and gang-infested ruins.

Organizations

Schaumburg Police: The Schaumburg police force has the responsibility of maintaining order outside the Mall complex. They support a fleet of 25 cars and cycles, and 2 helicopters, all painted white. Most of the Schaumburg police are mercenaries.

Mall Security: These are independent of the Police and are mostly retired duellists. They patrol the Mall and its walled confines, but are reluctant to cooperate with Schaumburg's finest, since they (on their home turf) are the police.

Schaumburg Autoduel Club (SAC): Schaumburg has only one duelling club, which is basically a collection of rich kids with imported cars and little to do. Only a few of their members compete; most don't like damaging their high-priced autos, and will try their best to avoid a fight without losing face.

Condor Salvage: Often seen around the area, this family-owned company has no real home, but wanders the Midwest in their fleet of Scarab buses, buying and selling highway salvage. They charge reasonable rates and can easily be reached by radio.

The Retros: This vicious street gang that operates in the northern Dead Zone is known for ambushing vehicles with a maze of road-blocks; they are well-armed and organized. State authorities believe the gang is connected with the various Chicago criminal families, as they are a persistent problem, and seem to survive every attempt to disperse them.

The Badgers: A Wisconsin cycle gang that often visits the area. They number 60 strong, and practice the usual smash-and-grab looting techniques.

The Dropouts: This is potentially the most dangerous, and definitely the most colorful cycle gang in the northern suburbs. The Dropouts are teenagers from wealthy families who randomly attack vehicles for fun. They often play "chicken" and other fatalistic games. They aren't looking for a fight as such, but their expensive bikes and invulnerable attitudes make encounters with them hazardous.

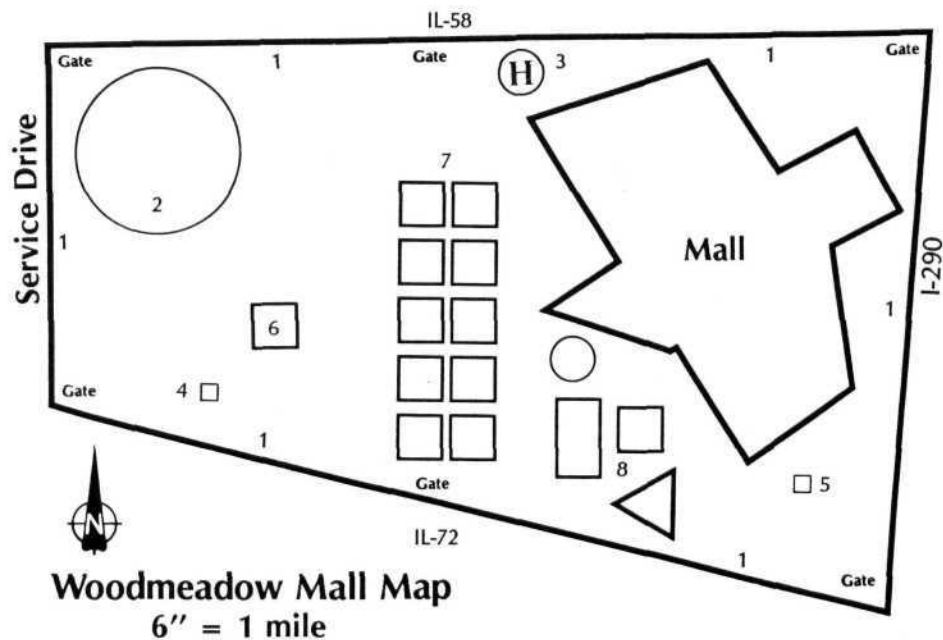

Woodmeadow Mall Map
6" = 1 mile

Three Mini-Scenarios

by David N. Searle

Gasman's Revenge

"Henderson's gone too far this time!" Ed Vargas filmed, angrily pacing the worn path on his living-room carpet. "That man is dead meat!"

He stopped suddenly and faced his colleagues with a steely gaze, and said in a low, quiet voice, "Any ideas?"

"Umm..."

"Speak up, Scarlotti."

Scarlotti swallowed, and continued in a shaky voice.

"We know Henderson has, um, Mob connections."

"Big deal. So do we."

"Just my point, sir. In two hours, he has an appointment with his godfather. And I know what route he's taking!"

Vargas stared at him for a moment, then laughed and slapped him on the shoulder.

"Lead the way, Scarlotti. Lead the way!"

Gasman's Revenge is a sequel to the mini-scenario The Gasman Cometh, from ADQ 4/3. Aggravated by the theft of 55 gallons of gasoline, Vargas works to make sure Henderson will never meet his mob contact to sell the gas. It's a two-player scenario, but a referee

might be desirable (especially in a couple of the variants below).

Setup

Henderson is riding in his stretched Luxury, the Enforcer (stats given below), and is escorted by \$75,000 worth of escort vehicles and equipment; no vehicle can be cheaper than \$15,000. The Henderson player also has a pool of 300 skill points to be divided among his crew, with no crewman getting more than 50, and no skill getting more than 30 points. The Henderson convoy is traveling at 60 mph.

The Enforcer (unofficial) — Stretched luxury, x-hvy chassis, hvy suspension, 6 solid tires, driver, gunner, 1 passenger (with 4 spaces worth of elbow room), turreted RR, AT gun F, 2 HRs linked B, HR R, HR L, fire extinguisher, 2 targeting computers, LD radio, Velvet Glove trimmings. Armor: F24, R20, L20, B33, T20, U10. Acc. 5, HC 3; 7,197 lbs., \$32,794.

The Vargas player has \$100,000 to spend on three elite gasburning duelling cars and personal equipment for three to six henchmen. He has 240 points to hand out, with the restric-

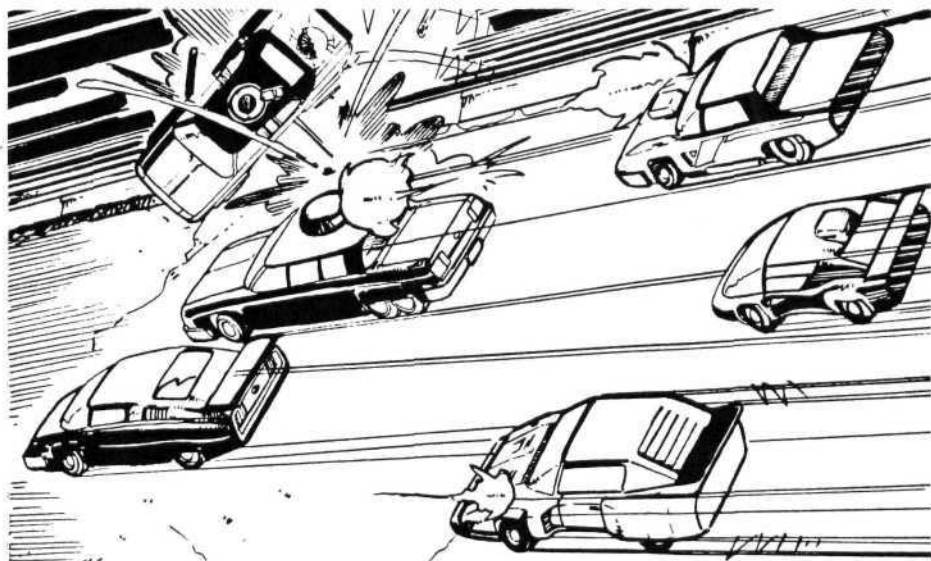

tions above. Due to the short notice, he didn't have time to set up an elaborate ambush.

Something both players know is that there is a "No Dropped Weapons, Ordinance" enforced in this area, so neither player may use dropped weapons.

Start with Henderson's cars on a single road section in any order the player wishes, traveling at 60 mph. Vargas' lackeys merge onto the section behind them, going 45 mph.

Victory Conditions

The Henderson player wins if Henderson escapes with his hide intact. The Vargas player simply wants to blow up Henderson and split.

Options

They're late! Vargas's forces had to stop for gas, wasting valuable minutes, and cut Henderson's convoy off much later than they expected. Use *Car Wars City Blocks* instead of road sections. Optionally, Henderson's group might have to get to a building on the opposite side of town. Set up the *City Blocks* in any arrangement you like, and pick a meeting sight on one edge of town. Henderson's forces enter from the far side, going between 20 and 50 mph. Two seconds later, Vargas's interceptors scream into town from any direction at any speed.

They're late in Venice! Still using the *City Blocks*, consider all street areas to be canals, and use boats! Since this variant takes place in Venice, Italy, you'll have to translate the opening paragraphs into Italian.

Counterstrike. Henderson's limo is a Q-car worth \$45,000, and Henderson is riding in one of the escort vehicles. Furthermore, after five turns, the Henderson player rolls one die and adds one for every turn past the fifth. Once he rolls 8+, 3 Div. 15 cars under Henderson's control merge onto the road 2d" behind the combat, going 20 mph faster. To partially compensate, Vargas's vehicles may violate the dropped weapons law . . .

Double Counterstrike. Vargas expected the counterstrike and prepared for it. 11d seconds after Henderson's reinforcements arrive, a \$50,000 vehicle (any kind), controlled by Vargas, approaches the group from any appropriate direction and at any speed.

Innocent Bystanders. The whole scenario happens during Rush Hour (see ADQ 2/3). The presence of a referee is recommended.

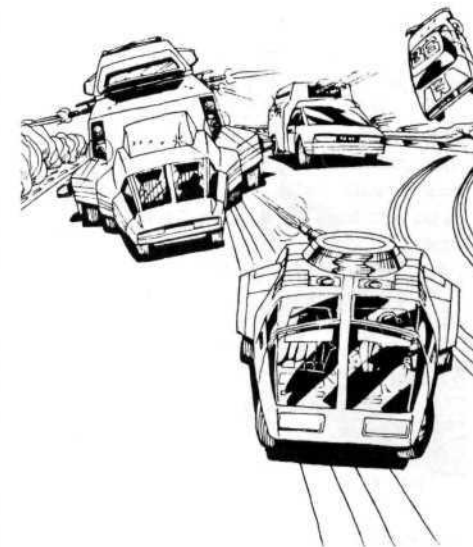

The Agony of Defeat

Let's hear it for USC! State Combat Football champions for the fifth time running! Poor UCLA is slightly upset about that. . .

In this two-player scenario, the USC Trojans are heading back to campus for at least a week of victory celebrations after viciously trouncing the UCLA Bruins in the California State Combat Football championships. A few of the Bruins' team members aren't willing to let them get away with that, and are intercepting the Trojan convoy with intent to destroy.

USC Setup

The Trojans are being hauled back in a Camel bus (see p. 14). The passenger compartment is full of wounded and unconscious football players; out of 14, 7 are at 2 DP, and 3 are at 1 DP (the rest are fine, at 3 DP). The Camel driver is Trucker+2, Gunner+2, and the gunner is Driver, Gunner+3.

A Bingo ten-wheel bus with five perfectly healthy USC cheerleaders and the team equipment is following the Camel. The driver is Trucker+2, Gunner+1, and the gunner is Trucker, Gunner+2. The crew of both vehicles wear standard body armor. The team equipment in the cargo bay can take up to 23 DP before being scattered to the four winds.

The USC player has \$7,500 to spend on personal equipment for his crew and passengers.

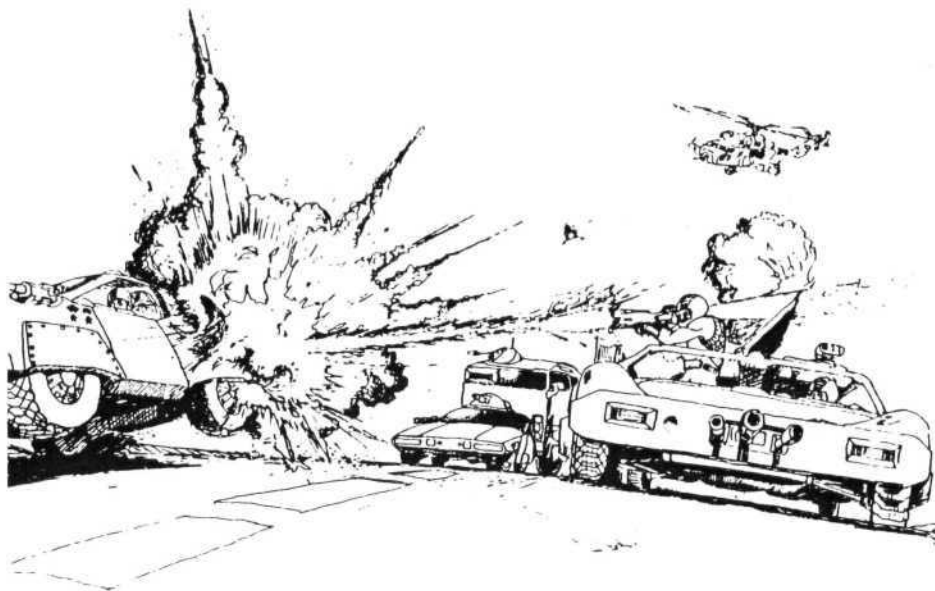

UCLA Setup

The Bruins are out for revenge, and the five Combat Football survivors have grabbed five Division 25 cars from the UCLA Autoduel Team and given chase. Each driver is wounded (2 DP), has body armor and is Driver+1, Gunner+2. The USC player should choose his cars from a published source, or local stock vehicle list — the Bruins didn't have time to run to their local Excalibur dealer and order up some custom bus-killers.

Following the convoy is an Excalibur Deluxe (see p. 15) carrying 6 perfectly healthy cheerleaders. The van driver is Driver+2, Gunner+2.

The UCLA player also has \$7,500 worth of personal equipment for his crew and passengers.

Starting the Fight

Set up two straight road sections and put the USC vehicles in the front one, and the UCLA attackers in the second one. USC starts

at 60 mph, and the UCLA cars are at 75 mph. For each road section coming up, roll one die.

1. Curve Right
2. Curve Left
- 3-4. Straight
5. Exit Ramp
6. Entrance Ramp.

On a six, roll again. On a 1-3, nothing happens. On 4, a USC fan merges onto the road between 55 and 80 mph (roll 1 die X 5 mph and add 50 mph), and falls under the control of the USC player. On a 5, a UCLA fan merges on as above, and on a 6, a commuter merges onto the road and rolls 1 die again. If the commuter rolls 1-4, he stays cool and doesn't enter the fight unless fired upon, and leaves the road at the next exit. On a 5, he goes berserk and attacks the nearest vehicle, always firing on the closest target. On a 6, he panics; his HC drops to 0, and he attempts to speed past the battle to safety. All highway entrants



wear body armor, carry an SMG and 4 explosive grenades, and have base skills.

The UCLA team will not fire on the Bingo (killing cheerleaders isn't cool), and the USC team will not fire on the Deluxe for the same reason. The cheerleaders are free to shoot at each other and the other teams. The random entrants won't really care either way, and will fire on the most convenient target if hostile.

The Winners

Easy enough — whichever team has the most survivors is the winner. All of this action is being broadcast *live* by BGN TV copters, so any prestige gained during this scenario is doubled. The winner may not salvage the loser's vehicles (these are football players, after all — no one has the proper equipment), but gets the adoration of both combat football and autodueling fans nationwide.

The Vehicles

Camel— 40' bus, x-hvy chassis, 2 regular truck plants, 10 solid tires, driver, gunner, 14 passengers, 2 linked RRs in back turret, 4

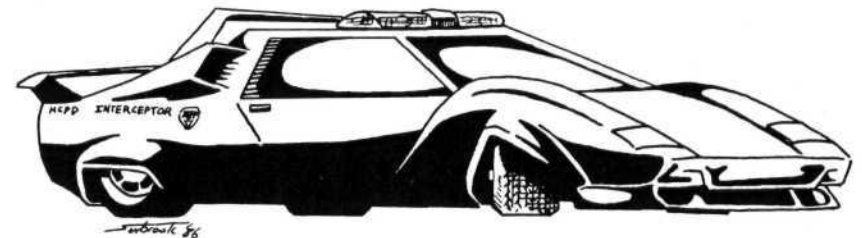

Route 'Em!

Nobody knew where the cops came from. One moment, the Mad Dogs were raising merry hell in San Marcos, and then the blue lights were everywhere! The Dogs holed up in the only refuge they could find — the abandoned ruins. The bikers scattered; most were on foot, only a few were armed.

In the old police bunker, a single Texas Ranger waited by a portable radio, following the fight's progress, waiting. He didn't have to wait long.

"Code Red. T.J., flush 'em out."

Route 'Em is a solo scenario for **Car Wars** involving the final destruction of the Mad Dogs cycle gang by a single Texas Ranger. Everything you need to play can be found in **DCW**. You play the Ranger and start in the

MGs (RF, RB, LF, LB), SD back, fire extinguisher. Armor: F40, RF40, RB30, LF40, LB30, B50, TF30, TB50, UF30, UB30, 6 10-pt. wheelguards. 25,125 lbs., \$88,250.

Bingo — Minibus, x-hvy chassis, small truck power plant, 10 PR tires, driver, gunner, 5 passengers, 4 RLs (w/incendiary ammo F, R, L, B), 3 HRs on rocket platform, large DSP under, 2 targeting computers, 5 spaces cargo (1,150 lbs). Armor: F45, R45, L45, B50, T20, U35. 12,400 lbs., \$39,430.

Deluxe — Van, x-hvy chassis, super power plant, hvy suspension, 6 PR radial tires, driver, 6 passengers, 2 linked MGs in turret, SG and SS back, fire extinguisher. Cargo: 1 space, 189 lbs. Armor: F15, R15, L15, B15, T18, U11, 10-point CA around each of driver, power plant and SS. Acceleration 5, HC 3; 7,011 lbs., \$19,070.

To find random vehicles for commuters and fans, roll 5 dice and turn to that page in one of the two Vehicle Guides or the **Combat Showcase**, and roll among vehicles on that page, discarding anything obviously silly.

police station on the Midville map. Your car, a Linden Motors Manslaughter (stats below), is parked behind the station. You have \$5,000 to spend on personal equipment and 60 points to spend on skills, with no more than 30 points maximum in any one skill.

Manslaughter — Midsize, x-hvy. chassis, hvy. suspension, large power plant, 4 PR tires, driver, GL in turret w/3 magazines (1 concussion, 1 explosive, 1 teargas) and magazine switch, FG right, FG left, spoiler, airdam, brushcutter, car blades. FP Armor: F50, R40, L40, B42, T35, U35. Acceleration 5, HC 3; 5,760 lbs., \$19,960.

There are 10 Mad Dogs somewhere in town. Their nerves are shattered, and one of them starts sprinting for the wilds off the nearest map edge. As soon as you know where he is, you run to your vehicle, start it, and go after the biker. To locate the first biker, roll two different colored dice. If the first die

comes up even, add six to the other die, and place a pedestrian counter in a randomly chosen doorway on that block. All the bikers are runner+2, and have any other appropriate skills at +1.

Roll 1 die — if it's even, he's wearing body armor (1-4 regular, 5-6 improved). Roll again. On a 1 or 2, the biker has one of the following (roll 3 dice and consult the following table):

Roll	Possession
3	Laser LAW
4	Laser VLAW
5	1-6 explosive grenades
6	Personal flamethrower
7	Machine pistol w/AV ammo
8	SMG
9	SMG w/AV ammo
10	AV Rifle
11	Rifle
12	Heavy pistol
13	Light pistol
14	Tripod MG
15	Laser rifle w/pack
16	GL w/explosive grenades
17	Roll twice
18	Shogun 150 cycle

Now that you know where the biker is, *go after him!* The biker will head directly for the nearest map edge. Keep track of how many seconds it takes to kill the biker or for the biker to make it off the map edge.

Once you kill the biker, go through the process above to find out where the next biker is, and go dust him. Continue until all 10 Mad Dogs are taken care of. Then tally up the total number of seconds, and add 5 seconds for each one that made it off the map edge. This is your score. Just like in golf, the lower the score, the better you did. If you are killed,

there are two ways to play it: A) Take the penalty for all remaining bikers escaping; or B) Take the 5 second penalty and add a 15 second penalty for dying, then start over at the station with a new car. You must decide which way you'll cover your death *before* you start.

Options

1. *Time Limit.* You have 30 seconds (or whatever) to wipe out as many bikers as you can. Remember that each biker that escapes adds five seconds to your elapsed time. The game ends when your time is up.

2. *Gentleman's Bet.* For two or more players, playing the police. Each starts with a Manslaughter, and there's an extra biker on the map for each player. Whoever dusts the most bikers in 30 seconds, wins.

3. *Innocent Bystanders.* This takes place in a populated area. Place 6 to 36 (6 dice) pedestrians on the map, wandering around the roads, who will scatter whenever the police car approaches. And park 3 to 18 (3 dice) cars on the streets. Add a 10-second penalty for killing a bystander. The biker will use as much cover as possible in getting to the edge.

4. *Come and get me.* For two players. The biker still wants to get off the map, but will behave intelligently (i.e., player controlled), and use cover to his best advantage. For those who think the cop should be in some danger, you could start out all ten bikers at once, with around \$20,000 or so in personal equipment.

5. *Dreg hunt.* It's time to cleanse the gene pool again . . . None of the pedestrians are armed. To make this one somewhat dangerous, either spread a lot of debris, craters and other garbage on the Midville map or *City Blocks*, and determine some other way to place the unfortunate victims.

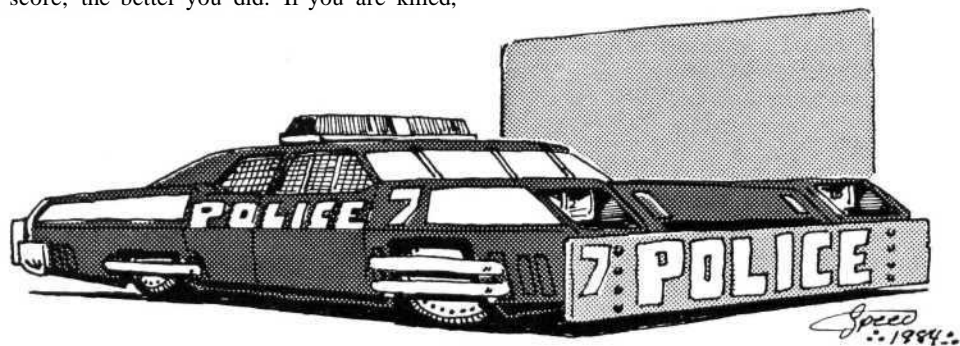

AADA Arenawatch

Tri-City Off-Road Arena

Richland, Washington.

The Tri-City Off-Road Arena opened in May of 2038, and so far has been very successful, filling a long-open niche in central Washington. The stands along the western edge seat 20,000 and are regularly filled to capacity. The Tri-City arena is unique in that the arena floor is sculptured, with steep hills and gullies for three-dimensional action.

Arena Notes

Each shaded band represents a gradual change in elevation, getting darker as the arena floor gets lower. The darkest is ground level, and the lightest level is 45' high. Moving from the ground level onto one of the slopes or vice versa is a D2 hazard, but there is no additional hazard to continue climbing. Vehicles will automatically decelerate 5 mph while climbing slopes and accelerate by 5 while descending. All slopes are roughly 30 degrees. In addition, the slopes subtract -D1 from all maneuvers made downward and add +D1 to all maneuvers made upward.

Line of fire is blocked by ground higher than your target. If LOS crosses a contour line higher than both the target's and the firer's height, it is blocked, and neither can shoot at the other.

The four pylons are TV bunkers, and each is 60 DP. The outside walls are 75 DP.

Arena Events

The Tri-City runs standard AADA Division-als through the week, and Amateur Nights on Mondays. The Tri-City also runs three special duels:

Mountain Climb. Competitors are required to circle each TV bunker twice, but not consecutively. The first one to do so wins.

Private Skirmish. A scaled-down Private War for 2 teams. Each side gets 30 men with \$40,000 in equipment, which may include one unarmed vehicle costing no more than \$10,000. The teams may enter from any or all of the three gates on their side. A flag is set in gates 1 and 4. The objective is to capture the opposition's flag and escape through any of the three gates on the other side. The flag is 1 GE and it takes a firing action to pick it up.

South Lexington "Rat Race" Arena

Lexington, Kentucky

The Rat Race is one of three arenas in the Lexington area, and the only one to concentrate on racing events, providing an alternative to the traditional racing oval. Its construction was plagued by cost overruns, and some things were skimmed on, but the arena pulls in a steady profit, and repairs are planned for the future . . .

Arena Notes

The outside walls are 30' high and 60 DP. The inner walls are 15' high and only 20 DP. The pylons (squares) at either end of each inner wall can take 50 DP before collapsing, which produces a pile of debris. If *both* pylons are taken out, the whole wall collapses — and the area 1 1/2" to each side of the wall will be showered liberally with debris and obstacles. Anyone caught within 1" of the wall will take 2 dice to their top armor and an appropriate hazard. Duellists deliberately trashing a wall

will be fined to pay for its repair; this runs about \$5,000, and is usually deducted from the offender's winnings.

Handling is at a premium in this arena. Spoilers and airdams are a must. HD Shocks, antilock brakes and heavy-duty brakes should also be considered. Metal armor and/or a ramplate can be useful when that corner turn would be a little *too* tight.

Arena Events

Racing. This is the most common event, usually run with electrics and always within standard AADA Divisional. Most feature two, three or five laps, allowing no weapons fire before at least one player completes a lap. Short races will just follow the outer wall, but most follow the arrows. Solid and liquid dropped weapons are forbidden in racing events.

The Hard Way. This event is much like above, but the racers must slalom through the small gateways opposite the arrows.

Duelling on a Budget

By Don Jacques

ADQ field reporters have plenty of opportunities to see divisional events. This is how we are able to write detailed duelling interviews. However, it has come to the attention of this reporter that relatively few stories have been written about Division 5 duellists. Recently I had the pleasure to correct that through an interview with Fred "The Undead" Acheson, a Division 5 duellist currently living in New Omaha. This interview took place just after Fred won the Nebraska Div. 5 state championship.

ADQ: How did you get your start in autoduellings?

Fred: Two years ago I graduated from UNNO with a degree in architectural engineering and no money in my pockets. The student loans people were expecting repayment soon, and I was unable to find a job in any of the big architect firms in town. I decided to enter amateur night to raise a quick thousand to pay off my first loan installment (there were 20 in all). Not only did I survive, but I made a few thousand more by salvaging my kills. After that I started as a "nickel" duellist and my loans were paid off in less than a year. I enjoyed my duelling so much that when I did find a job I took it part-time only. The rest is history.

ADQ: How many kills have you made? Which one do you remember the most?

Fred: As of now I have collected 18 license plates and only had to abandon my vehicle three times. The one kill I considered to be the most memorable happened two months ago. I fought against a Shrimp that was carrying a passenger shooting grenades. My tires bought it, but not before I rammed him, sending him into the wall. I got out and ran over to the Shrimp, trying to convince the crew to surrender. When they shot back, I lobbed a flechette grenade through their breached armor into the crew compartment. I was still able to salvage the engine intact.

ADQ: Sounds ghoulish. Do all nickel duellists salvage their kills?

Fred: Yes. The prize money is not so hot, and any extra money will help. You get into the habit of it when you lose a car every time you fight.

ADQ: What are some misconceptions of Division 5 duelling?

Fred: First of all, the majority of duelling spectators think the only difference between amateur night and Division 5 is the names. Well, you certainly don't see pro-Division 5 duellists fighting in Killer Karts! Division 5 cars are carefully constructed and tested, just like any other car. Second, duellist casualties are virtually the same, if not lower, than in other divisions. This is because a fleeing duellist can easily re-enter the division, while those in higher divisions tend to tough it out to the bitter end. Third, nickel duellist form tight circles of friends and are less likely to kill each other. Often they pay for hospital costs and even cloning if one dies. You don't see that in megamedia arenas. Finally, those duellists who survive become just as competent and skilled as those in higher divisions. Division 5 is not the "graveyard of punks and wimps."

ADQ: On the basis of what you said, how are tactics handled?

Fred: Two things dictate that: armor and tires. Armor is relatively thin, about one-half or two-thirds at most when compared to an equivalent large car. Three solid shots can punch right through. Mines are deadly because little armor is placed on the bottom. Tires tend to cluster to the heavy-duty and puncture-resistant variety. Three grenades will destroy one, on the average. Wheelguards are uncommon for Division 5 cars but will definitely extend your life. Anti-vehicular ammo and VLAW's are good weapons at point-blank range and for delivering the finishing blow. Keep your distance, wait for your opponent to waste his grenades, and then circle in. Fire pistols with A/V ammo and folding stocks. His armor should be weak enough on all sides so one good shot can go inside.

ADQ: What do you consider to be the best cars in Division 5?

Fred: To be honest, a car with sloped armor and component armor for the driver. My new car is a custom made compact built right here in New Omaha by a college friend of mine. An agent from Linden Motors saw my car in action and stated that his company would like to buy the rights to it. If my friend and I agree, I can quit my architect job for good. Oh, I've gotten off the subject of the best cars. Here are the best ones as I see them: The Hokie Special (nasty ramplate); the Gladiator, Needle and Firecracker (tire killers, the three of them); and the Shrimp, by virtue of its passenger who can be armed with grenade launchers.

ADQ: I see the officials are about to award the trophies. Correct me if I'm wrong, Fred, but is that a tin can with

wheels on top of the first place trophy?

Fred: Sure is. That's a friendly joke among nickel duellists.

ADQ: Congratulations, Fred, and thanks for taking time out for this interview.

Fred: My pleasure.

Fred's car is a custom built compact called the "Penny Pincher" and its stats are listed below.

Penny Pincher — compact, light chassis, imp. suspension, medium powerplant, 4 HD tires, driver, MML front, junk dropper rear, 10 points of component armor for driver. Single weapon computer, 2 point defense grenades (one left, one right), Armor (sloped): F9, R7, L7, B7, T1, U2. Accel. 10, HC 2; 2,798 lbs., \$4,312.

Hovercraft Designer's Notes

by Kenneth W. Scott

For the last several years one of the most requested new vehicle types has been hovercraft. It has not been an unreasonable request. Given the world in which *Car Wars* is set, where vast stretches of highway have gone unserved for decades, hovercraft are a very practical and viable form of transportation. Hovercraft travel above the surface, and are therefore little affected by its condition. No matter that the road is cracked, buckled and holed from years of disuse, that the bridge is out, that the road ahead of you is littered with left over mines, a hovercraft traverses all these surfaces with equal ease and safety. If I were living in 2038, and had to make treks between cities where a man is left to the resources of himself and his machine, I would want a hovercraft.

On the other hand, hovercraft are not nearly so maneuverable as cars, and unless the arena is wide-open and spacious like Armadillo or Buffalo, I would reconsider taking a hovercraft into an arena, and I would *never* take a hovercraft into the New Boston Autoduel Arena! Anyway, enough of the generalities and on to the specifics.

When I was asked to write the rules for hovercraft in *Car Wars* it was requested that I keep the rules for hovers as close to the rules

for other *Car Wars* vehicles as possible. Because of this, many of the hovercraft rules are variations of rules used for cars, trucks, boats and helicopters. Construction of hovercraft should be familiar to all *Car Wars* players, as it parallels the method used for all other *Car Wars* vehicles. There are a couple of differences that are unique to hovercraft.

The largest difference is the fact that hovers do not use tires. They use skirts. These skirts help keep the hover off the ground, and add to the craft's maneuverability and stability. They operate in game effect in almost all ways like tires on cars, and if disputes arise, unless *Boat Wars* says differently, treat a skirt as a tire.

Fans are also unique to hovercraft. The fans are used to keep the plenum chamber inflated (and thus keep the hover off the ground), and for thrust and steering. The lift fan is an internal vehicular component, and is protected by the armor. However, since its job is to force air beneath the vehicle, it is susceptible to flame cloud and cloud bomb damage. The thrust fans are used to propel and steer the hovercraft; the loss of these will further reduce the hover's already poor handling. All the fans take damage as helicopter rotors. The other major difference between hovercraft (and boat) construction is that both may use

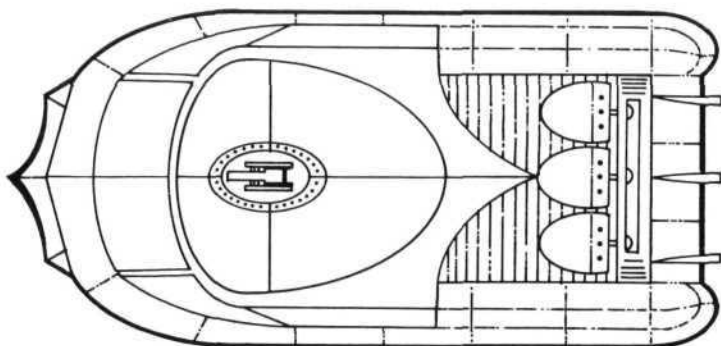

gasoline engines which had, until now, been restricted to cars. With a gas engine, and the modified top speed formula given for use with hovers (another formula is given for boats), a hovercraft may achieve top speeds in excess of 300 miles per hour. But any hazard at this speed is more than likely going to be fatal for the hover and its driver.

Except for a very few small differences that no *Car Wars* player should have difficulty grasping, the construction of hovercraft is very much like building any other vehicle. Which brings me to the real difference with the hovercraft: movement and acceleration.

Movement and acceleration for hovercraft is radically different from the movement for other *Car Wars* vehicles. The rules for this take 14 pages of the *Boat Wars* rulebook, so I can't give a concise synopsis of them here. I believe the rules given in the book are understandable and that a careful reading of them, with references to the abundant diagrams given, should make the process clear. These rules were the subject of extensive playtest and once the playtesters gained a little experience with them, they found them to be fairly easy, and a good simulation of the way that hovers move. The first draft of the rules had a much simpler version of the maneuver rules that closely resembled the standard movement system. This version, while simple, was found to be unacceptable. After much work and discussion trying to visualize what was happening and how to best express the concepts involved on paper, the present rules emerged.

One thing that is not explicitly stated in the rules, but which should be obvious is that the Vector marker (the arrow which shows which way the hover is moving) is not *really* there. It has no effect of play, cannot collide with anything, will pass with equal ease through walls,

lampposts, and other vehicles.

One piece of advice that I can give about actually flying hovers in a game — *think about where you are*. There is a tendency to think that the hover is where the vector marker is and forget about the actual hovercraft. This can be a deadly mistake. Think about where you *are*, where you *want* to be, and what it is going to take to *get* there. The generally poor handling characteristics of the hovercraft make this kind of thought necessary, and the difference between a successful hovercraft pilot and a dead one will be the amount of thought that the pilot gives to his position and maneuvers.

Hovercraft are fun to play, and I enjoyed being able to write the rules for them. The construction rules are very familiar to all *Car Wars* players and any player should be able to build effective hovers as soon as he opens the rules. I also tried (I think I was successful) to make hovers competitive with cars of the same division, if the arena is not too close to allow for the hover's poorer maneuverability. I believe the hovercraft to be a superior vehicle for cross country travel because it is not, except in extreme cases, concerned with the terrain over which it travels. The hovercraft can also be a successful duelling machine if thought is given to its limitations. So go buy the supplement, and have as much fun flying hovercraft as I and my playtesters have. Keep the shiny side up, the windy side down, and leave all those poor suckers with wheels eating your dust.

Editor's Note: *On the following pages are the Boat and Hovercraft record sheets — we didn't have room in the Boat Wars box for them. To use them, simply photocopy the diagram over the speed and handling tracks of a Car or Trailer Record Sheet as appropriate.*

Hover Record Sheet

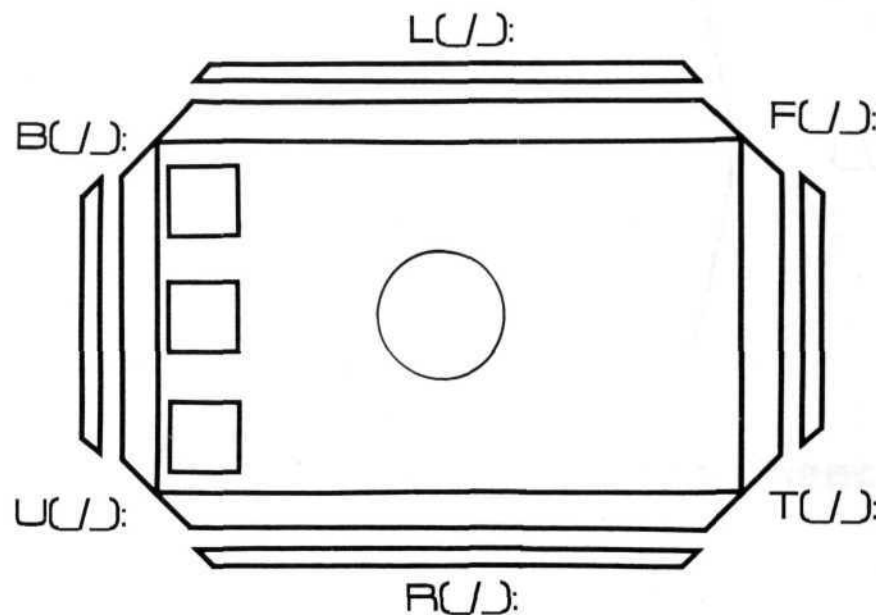

Boat Record Sheet

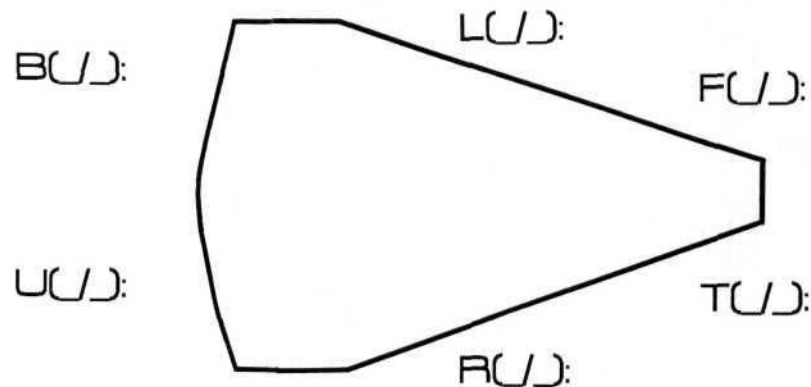

Yacht Record Sheet

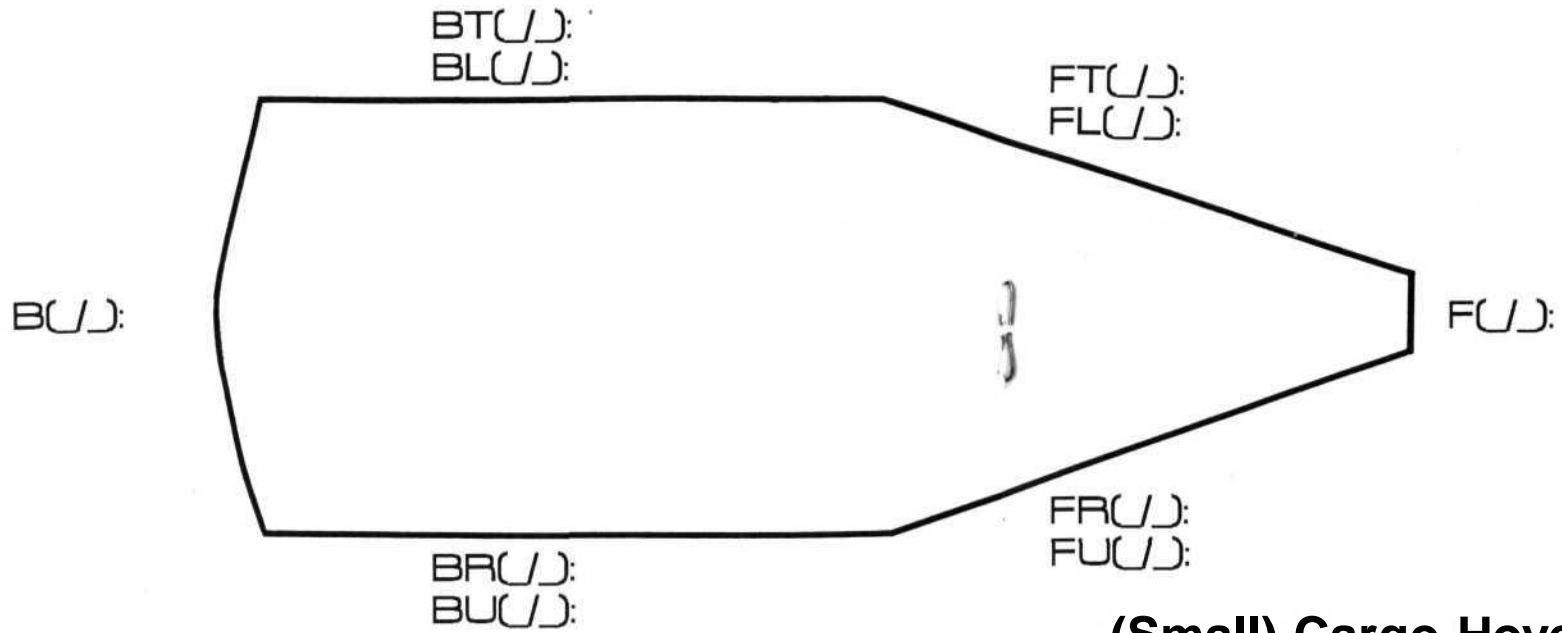

(Small) Cargo Hover Record Sheet

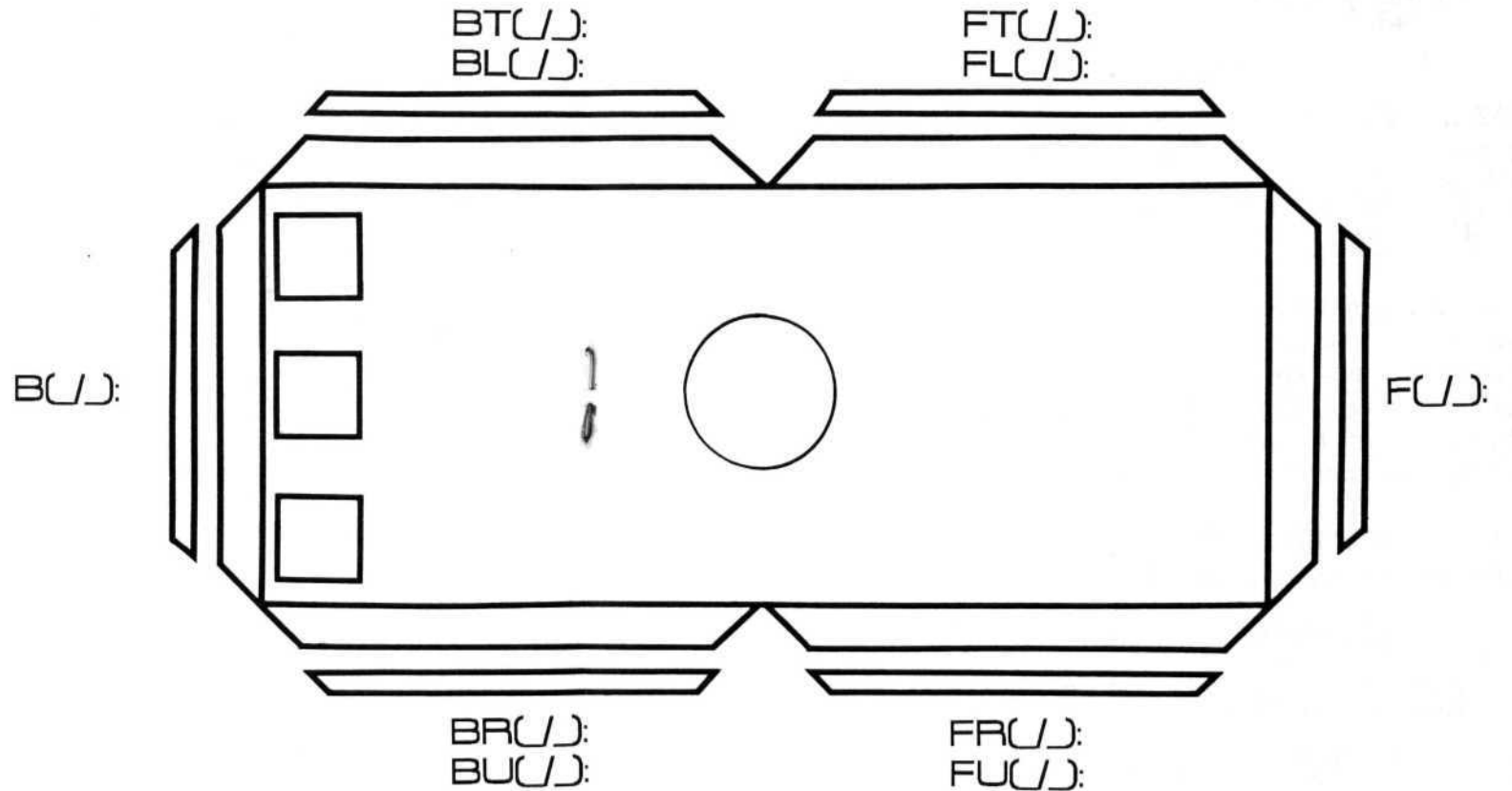

Just when you thought
it was safe to go in the water . . .



Boat Wars



If you thought the roads were tough in 2038, you ain't seen nothin' yet! *Boat Wars* takes the action and excitement of *Car Wars* off the land and onto the water. This new Pocket Box *Car Wars* supplement has complete official rules for movement, combat and construction of boats — plus hovercraft! In addition, there are beautiful full-color counters for boats and hovercraft and two large, blue-water maps.

Look for *Boat Wars* in fine stores everywhere. Or order by mail — send \$7.50 (Texas residents please add 56C sales tax) to:

STEVE JACKSON GAMES
BOX 18957-T AUSTIN, TX 78760

Boat Wars is a trademark and *Car Wars* is a registered trademark of Steve Jackson Games Incorporated. All rights reserved.

Autogyros

By Gareth Lowe and Charles Oines

Editor's Note: These rules are a variant only, and, although they are amusing, they are not official. So don't even ask.

Autogyros are very simple predecessors of helicopters. The main rotor is unpowered and free-moving, and is made to rotate by forward movement. Due to this rotation, the rotor acts as a wing surface. Forward movement is achieved by a pusher propeller behind the pilot.

The basic gyro body does not include landing wheels, and requires three cycle tires. These tires may use wheelguards just like a trike. All autogyros have HC 2 in the air, and HC 1 on land.

Gyros may use any cycle power plant or gas engine. Acceleration for gyros is computed like helicopter acceleration: If the gyro's power factors are less than its weight, it is underpowered and won't move; if the factors are at least equal to its weight but less than 1 1/2 times its weight, it has acceleration 5; if the factors are 1 1/2 times its weight, it accelerates at 10 mph. For all engines, though, maximum speed is reduced by 20 mph.

Gyros are treated like trikes for purposes of weapon and armor placement. They can use improved tail assemblies, one pair of

maneuver foils, and extra rotor blades. They may not use CACR, since there is no real stabilizing rotor.

Autogyros use 1"X 1/2" counters. They are -2 to hit from the front or back, and -1 from the sides. They may not mount turrets except the zero-space turret underneath. The propeller may be targeted from the rear only, and is at -8 to hit, and the main rotor is at -6.

Flight

Autogyros take off differently than helicopters; they must be moving at 25 mph or better to lift off the ground. In the air, gyros must move forward at at least 15 mph; any less, and the main rotor loses its ability to lift the vehicle. Once in the air, though, an autogyro maneuvers just like a helicopter.

Autogyros are strongly affected by high winds; each turn, they take a D2 hazard while in strong wind.

If the propeller is destroyed or the engine fails, the main rotor will continue to spin (it's unpowered already), but the pilot must roll on the Helicopter Crash Table at -2, in addition to speed penalties. The autogyro will slow by 5 mph and lose 1/2" of altitude every turn. If it falls below 15 mph, the main rotor will not be able to support the gyro, and it will crash.

Construction

Autogyro Body	Cost	Weight	Spaces	Armor	Rotor/Propeller DP
Light	\$1,000	150 lbs.	6	\$10/4lbs.	2/2
Standard	\$1,500	200 lbs.	8	\$12/5lbs.	3/2
Heavy	\$2,000	300 lbs.	10	\$16/8lbs.	4/3

Sample Autogyros

Scout — Light gyro, large cycle plant w/platcats and supercons, 3 PR tires, pilot, MML front, SWC. Sloped Armor: F16, R13, L13, B14, T1, U8. Acceleration 5, HC 2; top speed 80, 918 lbs., \$8,748.

Scout II — upgrade to HRSWC, add AP ammo to MML. \$10,848.

Miscreant — Standard gyro w/CA frame, super trike plant with PCs & SCs, 3 PR tires,

pilot, 2 SAMs (1 R, 1 L). Armor: F19, R15, L15, B18, T5, U15. Acceleraton 5, HC 2; top speed 80,1,316 lbs, \$16,040.

Fang — Heavy gyro, 250 ci engine, 5 gallon racing tank, 3 HD tires, pilot, RL front, SAM R, HRSWC. Armor: F20, R15, L15, B15, T6, U15. Acceleration 10, HC 2; top speed 122.5, 2,128 lbs., \$12,448.

Heavy armor option — add 134 points armor. Accel 5; top speed 100, 3,200 lbs., \$14,860.

Don't Kill the Messenger



By Christopher Burke

Life as a messenger can really get a guy down sometimes. Don't get me wrong — I live for danger. Usually, I love a long distance haul on the open highways. But this was one of *those* times. The highways have become increasingly more perilous over the past few years. A driver would have to be nuts to get on the interstate unarmed. Anyone who even thinks of trying it should be put in a wooden box or a rubber room.

I was speeding down the interstate in an unarmed compact.

The messenger business takes unusual twists every now and then. You never know what might happen when you're making a delivery. A courier has to protect himself and his cargo at all costs. When an unmarked car approaches, there's a standard procedure. First, try to establish contact — it could be an escort. Second, if he's not an escort, warn the vehicle away. Third, if the driver refuses or does not answer, trash him.

However, if you trash an escort, you could cause an incident, even if the other guy has a broken radio. The boss was not amused and

did not care whose fault it was. He gave me the choice between "offensive probation" or a quiet lifetime of interoffice memos. If it can be said that driving unarmed is like spitting in Death's face, then it is my belief that interoffice memos are in the deepest circles of Hell.

I decided to take my chances with ambushes. They have better dispositions than most of the firm's partners anyway.

It was shortly after 11 a.m. when I left Wall Street in a company car, complete with ramplate and a mini-van trailer. No guns. The theory was that I could outrun any potentially dangerous situation because of the nice, big engine under the hood. In any case, there is nothing more satisfying than the kick of a Thundercat power plant when you step on the pedal.

The boss' standing order is No Stops on a Run, "unless you're dead." Death, by the way, requires a note from your doctor. I ignored his standing order about lunchtime and pulled into an anonymous little truck stop on the way.

I picked the wrong place.

Inside the diner was a wildcat trucker with whom I'd gone to high school. Joe Carletti was by no means one of my better friends, and

I wouldn't give him the satisfaction of being my worst enemy. He was, in fact, a liar, braggart, prankster, self-centered cretin and all around pain in the neck. I was not surprised when he didn't let me eat my lunch in peace. I had hoped he would ignore me if I ignored him. Sometimes I'm dumb like that.

"Hey, guys!" he yelled. "That's my old pal, Sean O'Hara! How are you doing? I haven't seen you since that night we were racing and you drove into the lake!"

"With a little help from my friends," I muttered. Keeping my head down, I concentrated on my hero sandwich. Carletti walked past me and looked out the diner's inch-thick safety window.

"Where's your car, O'Hara? I don't see any rusty barrels."

I made another mistake. I decided to humor him to keep him off my back. "Right outside. The one with the mini-van attached."

After studying it for a moment, Carletti became hysterical. "You mean that tin can? For heaven's sake, O'Hara, that thing's unarmed! I remember you being crazy, but never suicidal. I like the itty-bitty ramplate."

He turned to face me, a grin twisting his face. "Say, d'ya want to go head-to-head?"

Actually, I wanted to go fist-to-skull with him. One thing I could not understand about truckers was why they put ramplates on their rigs. Talk about overkill. Carletti was laughing his way across the diner back to his friends. After joking around, they apparently wised up and left him. He came back to my table. Lucky me.

"O'Hara, let me buy you a drink." He leaned over my table. "For old time's sake."

I was becoming nauseous rather rapidly. "You mean like the time your pals tossed me onto the rifle range and you shot out all of the targets around me? Or the time I found your pistol in my locker and you suddenly popped up spraying an Uzi at me, screaming 'Self defense!' at the top of your lungs?"

Missing the chair he was about to sit in, Carletti fell to the floor, still laughing. You might have thought he had just spent six hours watching *Three Stooges* reruns or something. To him, a chuckle at my expense was a wondrous thing.

"What's the big deal?" He said, pausing for breath. "I missed you, didn't I? You didn't think I was actually going to hit you, did you?"

"The thought had crossed my mind."





All laughter stopped. The room could not have become quieter if a librarian in powered armor had walked in. Tension built up in Carletti's face. He exploded.

"Who do you think I am? I do not slip up. I never slip up! You, on the other hand, are a different story." He paused, and smiled nastily-

"I remember your performance on the rifle range. The coach finally asked you to quit the team as a public service. He knew you might kill somebody."

Leaving the last bite of my hero, I quickly headed for the door. I knew that Carletti was up to something and thought it best that I leave before he could try anything. When I walked outside, I saw that the trailer had disappeared and the chain was lying on the asphalt.

"Where is it, Carletti?"

"Where's what? What are you talking about?" His friends backed him up with a few muddled responses, all mocking.

"There's a state trooper behind the Burma Shave billboard," I said as I got into my car, "about a mile up the road. The two of us will be back soon." I could see him as I drove off, telling his buddies how I was running like a scared rabbit with my chain dangling between my rear wheels.

Shortly afterwards, the gang was boozing it up, awaiting my inevitable return with the police. Their victory bash was interrupted by a small explosion. Piling out of the diner, they saw me jumping my accelerator. The chain behind me was wrapped tightly about the front of Carletti's rig.

"Hey, Joe! He's trying to steal your truck!"

Everyone cheered me on in my attempt at the absurd. Carletti was laughing too, although he was also pulling out his machine pistol and walking my way. When I started moving, their jolly time ended. The tractor was following me, slowly but surely. Its back was still smoking from where I'd blown the kingpin. I told you Thundercats were great!

"Blast him!" Carletti yelled frantically. The jerk suddenly realized he was standing between me and his buddies and kissed asphalt before he could be shot in the back. Too bad.

The worst damage done was scratching the paint on Carletti's cab. I wanted to fire back, having a great excuse for picking off Joeboy, but pity stayed my hand. Pity I had no weapons . . . On top of that, my concentration was mainly planted on trying not to kill myself while pulling off the most insane stunt of my life. Impulsive. Sometimes I'm just too damn impulsive.

Their only option left was to pursue me. Someone had started their truck. Six of them, including Carletti, piled into the ten-wheeler and gave chase.

"You're not leaving, O'Hara!" my radio spat.

I wondered for a moment if he knew what I was up to. I swung the car around, executing a very wide turn, and managed to survive without bringing the tractor down on top of me. They did not stop to ask why I had turned around; they just fired heavy artillery at me. I could almost see Carletti yelling, "Be careful of my truck!"

Carletti was on the radio again. "Stop it right now, O'Hara!"



This time, he was a little off, but he was close. I hit the brake lightly and the tractor rear-ended me, shattering my hitch with its ram plate and sheer momentum. The impact had me wondering if I could sue myself for whiplash. With a very loud prayer, I swerved out of the tractor's path.

The tractor made a beeline for Carletti's trailer.

The explosion was spectacular. It was a shame that his rig wasn't a gasburner — what a fireball that would have been — but one must make do.

Without missing a beat — unlike my heart, which missed quite a few — I swung around and was leaving for real. Acceleration was no problem with the extra baggage gone. Over the radio, for the first time in my life, I heard Joseph Antonio Carletti cry.

"L-look what you d-did to my r-r-rig!" Alas, the tears were short-lived. He composed himself quickly and buzzed me again. "Kiss your van goodbye, O'Hara. We'll settle this next time. Tell your boss you lost your cargo in a parking lot."

Trying to follow me would have been impossible. Besides, Carletti seemed bent on revenge. The truck stopped and the motley crew unloaded themselves. They gathered together and opened the cargo bay, revealing my mini-van. Pre-sumably, Carletti was about to destroy it and its contents. I could not allow them to do that.

I did it myself.

With a touch of the radio remote, I set off the charges packed inside the mini-van. It blew up from the inside out. Shards of metal and plastic flew out of the rear of the truck, and Carletti and his pals jumped for cover.

My main regret over the whole incident was that I couldn't use napalm — I have this thing about fire. Unfortunately, prices being what they are, the boss nixed the idea. There is a very strict spending limit for decoys, since the firm doesn't make any money on them.

I pulled a large brown envelope out of the glove compartment, folded it, and stuck it into my jacket.

"I'd better get you delivered before we have more problems."

Indra Motors Protector XS

"Out on the roads, the only thing between you and Highway One is your car. The Indra Protector XS is probably the safest bet for the road traveler today. I'd bet my life on it!"

— Gene Pontello,
Texas Ranger

Safety First

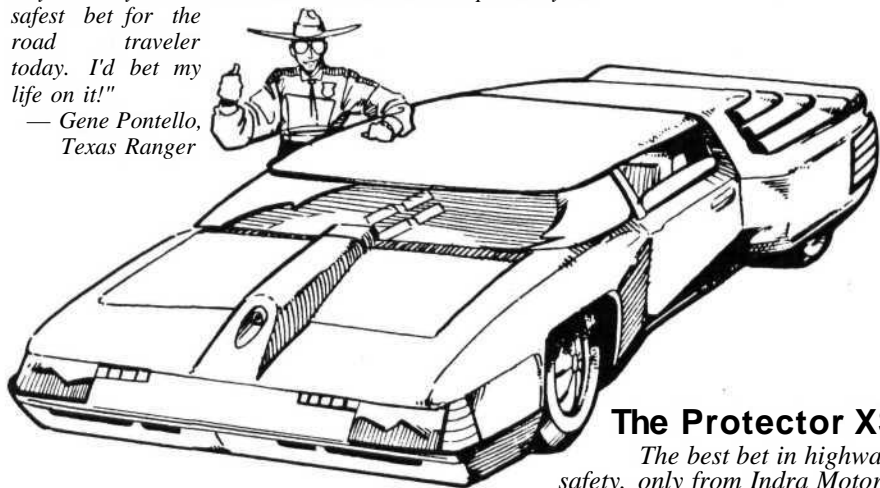

The Protector XS

The best bet in highway safety, only from Indra Motors.

Protector XS — Midsize w/CA frame, x-hvy. chassis, hvy. suspension, large power plant, 4 solid tires, driver, RR w/AP ammo and extra magazine F, HRSWC, safety seat, 10 pts FPCA around driver, RR and powerplant. LR Metal armor: F17, R16, L16, B16. FP Armor: T10, U13, 2 5-pt. wheelguards back, 2 5-pt. hubs front. Accel. 5, HC 3; 5,699 lbs., \$23,461.

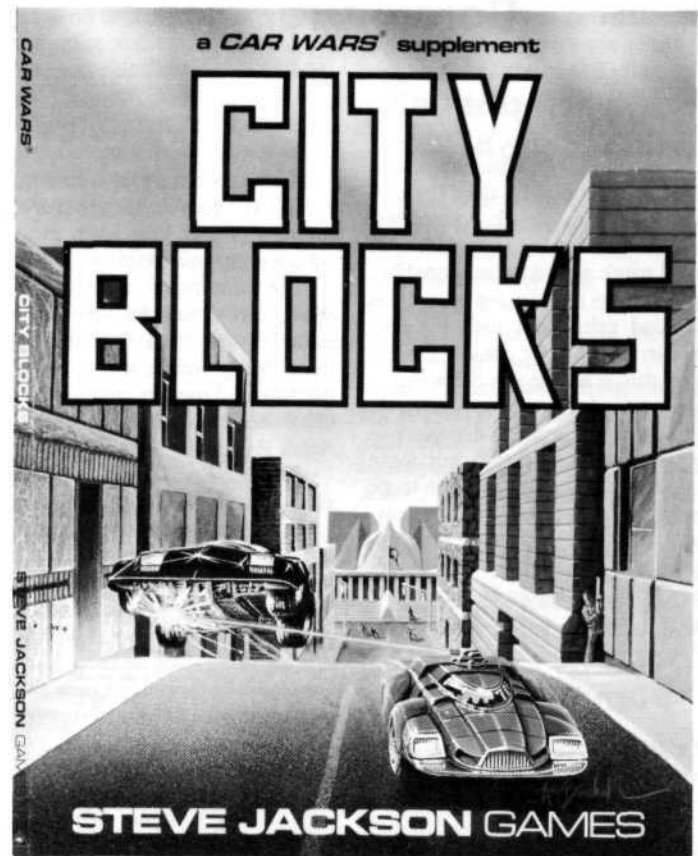

Car Wars City Blocks

Tired of using the same old maps for your *Car Wars* battles? Here's a map you'll never get tired of! *Car Wars City Blocks* has 32 separate city blocks. These sturdy map sections geomorph and can be rearranged time after time. Also included are additional obstacles and accessories.

Car Wars City Blocks 2 adds a city damaged by battle. Burned-out buildings, craters and debris provide many challenges for the duellist of 2038. Best of all, this set is fully compatible with the first set.

Look for *Car Wars City Blocks* and *Car Wars City Blocks 2* in fine stores everywhere. Or order by mail — send \$6.50 each (Texas residents please add 56C sales tax) to:

STEVE JACKSON GAMES
BOX 18957-T AUSTIN, TX 78760

Convoy Tactics

by Rodney Orpheus

The roads of modern America are a dangerous place, but people still need to drive on them. Bus companies, truck companies, and private travelers are all at risk. Although a heavily-armed truck or bus is an incredibly dangerous opponent on its own, the recent rise in organized road crime has meant a corresponding rise in the need for convoy drivers to protect them; this is where you come in.

So you wanna work a convoy. Where do you start? Check out the local bus company — they usually use their own staff, but there might be a vacancy. Try the nearest truck stop, ask around and advertise your services. The local AADA office might know if an important personage needs escorting to an appointment in a nearby city, or if a group of citizens are leaving town and need bodyguards.

Planning

"90% of successful convoy driving takes place before you hit the road."

—Ed Deever,
Convoy foreman

The success or failure of a convoy rests on the pre-mission planning. A convoy foreman must have the right personnel, the right vehicles and weapons, and the right supplies.

Personnel

Go for a good mixture of talents. Good driving skill and gunnery skill is important of course, but remember that having at least one good mechanic is vital. Your vehicles will almost certainly take damage, and even though most truck stops have their own mechanics, that doesn't help a lot when the next stop is 50 miles off and all your weapons have been shot up. Since your fellow drivers may be hit too, keep someone along with paramedic skills. A crewman who can ride bikes or drive trucks can be handy, even if your convoy is all cars — many convoys have only made it to their destination by abandoning their own wrecked vehicles in favor of others that they have been able to salvage or steal.

Vehicles

If your convoy is small (two or three vehicles), go for all around armored and armed cars. If you have more than three vehicles, try to specialize.

The most important car is the leader of the convoy. It should be very heavily armored, especially at the front, and have powerful front-firing weaponry — linked VMGs or laser-guided rockets are nice. A ram plate is a good idea too, since many bandits will barricade the road when they set up an ambush.

A "Tail-End Charlie" car at the rear can save a lot of problems. Rearguards usually have a huge amount of back armor and carry only defensive dropped weapons like smokescreens, flame clouds and mines. The driver of a tail-ender like this doesn't need any gunnery skill at all; but make sure he has high driving skill, since he should weave from side to side while dropping mines and oil, to create a wider spread of hazards for enemies coming up the back door.

An essential part of any convoy is a cargo vehicle. Convoys must carry a great deal of spares (see *Supplies*, below), and so *must* have at least one vehicle with cargo space available, preferably two.

When choosing vehicles, remember that armor does not miraculously grow back after it has been shot away, and that you will often have to drive for many miles before damaged armor can be replaced. In other words, get a heavily armored car. Midsize cars are good and pickups are excellent. Compacts can carry a fair amount of armor, but not much else. Luxuries and sedans are better for firepower than armor. Station wagons are excellent convoy vehicles — they have a huge cargo area, and can carry a pretty good weapons mix. Vans can carry more cargo and passengers, but their light armor is a major weakness. A van or camper with an autocannon or heavy laser in a turret makes a good helicopter buster, so long as it travels in the center of the convoy, where it can be shielded by the more heavily armored vehicles. Trailers are becoming increasingly common, due to their low cost and high cargo capacity.

Bikes are not good choices unless the rider is an excellent cyclist and can't afford anything else. If you must ride a cycle, fit OR tires and ride alongside the road, and use a fully-armored windshell and improved body armor.

Driving a subcompact in a convoy is a good way to lose any prestige you ever accumulated, along with your life.

Weapons

"The .50 caliber machine gun may not be the most sophisticated weapon around, but you sure as heck don't run out of ammo."

—Ed Deever,
Convoy Foreman

Good convoy weapons must be cheap, reliable, and have a plentiful supply of ammunition. The most common weapon on today's road is still the humble MG, and many old hands swear by it. MG ammunition may be bought anywhere, and is easily salvaged from destroyed bandit vehicles. The twenty-round magazine is a definite plus.

But the weapon of choice for today's convoy driver is the Vulcan MG. A 20-shot magazine, coupled with a low cost/damage ratio and high accuracy, makes the VMG ideal. VMG ammo is readily available — naturally, it's also the most popular among long-distance travelers. Other good offensive choices are the autocannon and recoilless rifle.

Lasers are a controversial choice for convoy duty. Some are very much in favor of these hi-tech heavies — you never have to buy ammo, after all — but the drain on the power plant can mean the difference between life and death on the long haul. Convoy drivers who mount lasers invariably carry laser batteries if they have any sense. The recent upsurge of interest in laser guidance has not been mirrored by convoy escorts; convoy drivers are conservative as a rule and tend to stick to the simpler and more easily repaired hardware. Rockets without laser guidance are too inaccurate to be a serious choice. Rockets with laser guidance are good, but very expensive, with an extra \$200 per round every time you reload.

All convoys should carry a good range of defensive and dropped weaponry. Smokescreens are an old favorite, and paint sprays are even better (25-shot magazines!). Spikes are cheap, and explosive spikes are popular, but mines, flaming oil, and flame

clouds are much more effective at deterring pursuit. Junk droppers are good for those on a budget: light, cheap and you certainly won't have any trouble finding ammo for them!

Accessories

Vehicle accessories are often overlooked by the novice courier, but pro convoy escorts often drive cars with so many additions and alterations that they look vastly different than the original model.

Fire extinguishers are the first addition, followed by anti-personnel grenades. For those vehicles with turrets, universal mounting is a very good idea — many terrorist organizations and some outlaws use stolen helicopters and grasshoppers to deadly effect. A spoiler and/or airdam can make all the difference between life or death in a high-speed chase — many drivers won't travel without them. If you need extra cargo space (and what convoy driver doesn't), think seriously about a car-top carrier. As for tires, there is no excuse not to get steel-belted, or at least solids. LD radios and targeting computers are essential to highway travel.

Supplies

Convoys usually have limited space and weight capacity, so the choosing of correct supplies is an art in itself. The most important items are *tires!* This cannot be emphasized too much. Even the best highways today are not in good repair, and the worst ones can really hack up your tires. Add to this the dangers of enemy fire, mines and spikes, it's not surprising that most convoys will carry two spares for every vehicle, and will always salvage any usable tires that they come across. Some desperate drivers have even been known to start firefights to get at their opponent's tires.

A good toolkit or portable shop should always be carried; on-the-road repairs and salvage are facts of life for the convoy guard. Don't forget to carry lots of spare ammunition for all your weaponry. Make sure to strip any wrecks you come across (or are responsible for) for usable tires and unused ammo. If you can strip armor and weapons from them, so much the better. All personnel should wear body armor at the very least. Hand weapons, grenades and mini-mechanics or medikits are easy to carry, and can be real lifesavers.

The Route

Most convoys are a race against time. Being late for a schedule is a sure-fire way to get your wages cut, so plan your travel route carefully. Get a map and conditions update from your local AADA office and study it carefully. Remember that you will have (usually) to stop every 200 miles or so to recharge your power plant, and if you go faster than 55, you'll cut that distance still further. The importance of food and water is often overlooked, but remember that drivers are people, and if they don't eat, drink, exercise and take care of other personal matters, their efficiency will be impaired. Repairs invariably take too long to complete, even if you have excellent mechanics; many convoys are forced to take to the road in damaged vehicles because waiting for repairs would mean too long a delay.

Many convoys are forced by time to break the speed limit. In most areas, this isn't a problem — enforcing the speed limit means police cruisers getting needlessly shot at — but in the areas that still enforce them, it's a good idea not to break the speed limit. At the

lightest, the cops will skim some money or ammunition off of you. At the other extreme, driving too fast can bring a swift death at a well-concealed speedtrap.

Make sure your convoy has a regular formation, and *stick to it*. A common mistake among rookies is to stay in a tight formation to concentrate firepower, and end up crashing into each other when they run into trouble. Don't let it happen to you (nothing is more embarrassing). Keep a good distance between cars, around 30' is good breathing room, and make sure that cars with good forward weaponry have a clear arc of fire. Ditto for rear weapons. Cars with turrets should hold the middle ground where they can best make use of their 360 degree firing arc. Try to work out specific "game plans" for common occurrences — what each driver should do if a cycle gang attacks from the rear, for example.

Well, that's about it. Stick to these handy hints, and you should be able to take whatever the road throws at you. Driving convoy may not be as glamorous as arena combat, but if you're a driver with brains as well as guts, it provides a good steady job with lots of travel, and all the excitement one could ever need.

CALIFORNIA CREATIONS

CONVERTIBLE HARDTOPS

Feel the wind in your hair and travel in style with our new, fully automatic Convertible Hardtop! *California Creations accepts no responsibility for damage suffered while using this product.*

Convertible Hardtop - \$1,500 (\$2,500 to retrofit), 50 lbs., takes up 1/6 (round up) of the vehicle's spaces. Not available for vans, station wagons, campers, buses, helicopters, hovercraft or cycles. Only takes up 2 spaces on pickups. Raising or lowering the top is a firing action, taken in the acceleration phase. It takes 1 full turn to raise or lower the top. When the top is down, the vehicle still has top armor, but the driver and any crew are not protected by it. Passengers and gunners may fire into any arc, and the driver may fire into any arc but forward. People in the car are targeted at -5 (in addition to other penalties). Top armor is bought normally, but is limited to 20 points (plastic) for structural reasons. No top-mounted weapons or accessories may be mounted with a convertible hardtop.

ADQ Classified

Editor's Note: As of this issue, I'm loosening the restrictions placed on ADQ Classifieds earlier. Specifically; the 25 word limit for a free ad is no longer in effect, and you only have to pay us the \$2.50 if you're selling something. Only one to a customer, though; and don't tread on our copyrights.

—CAO

FOR SALE: **DELUXE CW, DUELTRACK, ADQ 4/4-6/4, 2038 Uncle Alberts, Expansion #8, Armadillo Arena, Reference Screen**, more. Best offer over \$40. Andrew Swan, 2631 Irving Ave. S., Minneapolis, MN 55408.

WANTED: DUELLISTS IN BALTIMORE Area. Preferably in the Roland Park/Wyman Park area. Write — Philip Meyer, 3308 Beach Avenue, Baltimore, MD 21211.

LONE DUELLIST SEEKS PEN PAL to trade designs. Also I seek ADQ 4/3 and 4/4. Write Rick Mika, 5820 Carpenter, Downers Grove, IL 60516.

LOOKING FOR DUELLISTS in Montana. Also pen pals who are out of state or the country. Write to: Gordon Wright III, 6942 Frey Rd., Shepherd MT, 59079.

BETA SECTOR: NOTHING TO REPORT. Repeat, *nothing* to report. A.A.

DUELLIST ON THE RUN JUST relocated in McHenry County, IL needs help in combatting some old enemies. Please contact David Klein at 3511 Fairview Ave., McHenry, IL 60050.

UNOFFICIAL RULES FOR ANYTHING in *Car Wars* — nothing's ridiculous! Send

SASE and request for subject area to Brian Julin, 6 Philip Dr. Holyoke, MA 01040.

LOOKING FOR TROOPERS in the Philadelphia area and those abroad with C-64s. Contact: Jeff Gilbert (a.k.a. M.C. Psyche), 2076 E. Lippincott St., Philadelphia, PA 19134.

I'M HOPING TO START AN AADA chapter in San Diego, especially in the La Jolla/Pacific Beach/University City area. All ages accepted! Contact Robert Eikel, 1405 La Jolla Knoll, La Jolla, CA 92037.

HEY, COLORADO! I'M STARTING AN AADA club in Veil. Interested? Contact Charlie Bolton, 1851C Arboretum Circle, Birmingham, AL 35216. I'm moving to Colorado.

DESI - FROM THE MOMENT YOUR bullets raked my side, I knew we were meant for each other. You'll always be Unlimited Champion of my heart. XXX/OOO, Teresa.

ATTENTION ALL YOUNG Enterprising Autoduellists in the Lansing area! I want to duel! Contact Kyle Mox, 4541 Shance Hwy., Charlotte, MI 48813. Y.E.A.!!

TUCSON AREA AUTODUELLISTS! Those of you willing to start an AADA Chapter for fun and mayhem, contact Billy Bishop, SUPO #10561, Tucson, AZ 85720.

ALL SAN DIEGO AUTODUELLISTS who want to join SCRAM (Southern CA. Racing and Autoduelling Membership) contact Robert "Alpha Complex" Eikel, 1405 La Jolla Knoll, La Jolla, CA 92037

WE NEED DUELLISTS in the Mid-Missouri area to form an AADA chapter. Please contact Kirk Utterback, 7906 Rollingwood Blvd., Columbia, MO 65202.

ATTENTION ALL NEW JERSEY Duellists! If you live in or near Bergen County, NJ, join JADE East. AADA Sanction preferred. Contact: Chris Alipounarian, 727 Chestnut Street, New Milford, NJ 07646 for more information.

FNORD! (512) 442-6461. 3/1200, 24 hours/day and never on Sundays.

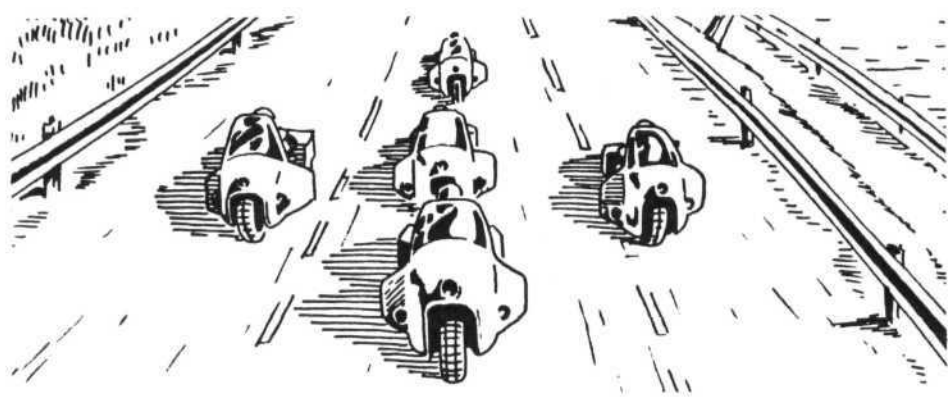

Advanced Cyclist Tactics

By David N. Searle

It's been over two years since Larry Sewel illuminated the biking world to the art of intelligent cycle tactics (see *ADQ* 3/2, "Bikers Are People Too." —*Ed.*). Since then, both the men and the machines they ride have changed drastically. The following is not meant to be a replacement for the original article, but a supplement to it. Using the tactics described in Larry Sewel's article and the techniques outlined below, anything on wheels can be yours to plunder.

Numbers

A lone biker is no threat to anyone but himself. On the other hand, a group of 20 or more will put fear in any man, and attract unwanted attention from local authorities and rival bike gangs.

Try not to let more than eight (but no fewer than five) bikers ride in a group. Any more than eight, and they will only get in each other's way. Run with less than five, and your gang will be road cookies in no time. While most gangs are much larger than eight members, you will usually only see eight of them at a time. This not only helps to keep the attrition rate down (the most you can lose is 8 bikes), but it also keeps everyone in the dark about your gang's *true* size.

Range

With the advanced technology now on the market, attack range has become your most trusted ally and your worst enemy. You have

two choices: Close fast with your target (within 8") and destroy him quickly, or hang back about 18" and hope you hit more than he does. Get caught in the middle and Splat-o.

When fighting within the 8" range, make sure the battle doesn't last long. Most drivers won't miss at that range, so use high-output weaponry like HRs, lasers and the like.

If fighting from long range is your preferred method, use weapons you are certain to hit with (MGs, lasers again, guided rockets, etc.) and be sure you have a targeting computer and a lot of ammo. Don't be overly concerned with getting hit; trying to hit a cycle front at 18+ " range is a tough job for even the best electronically aided gunners. Just make sure *you* don't miss.

Fighting from a distance has an added benefit: Your prey's dropped weapons are rendered practically useless. With an 18" lead, you have plenty of time to react and adjust. Provided, of course, you are in a good formation.

Tactics

Simply PLAN, PLAN, PLAN! Plan your attacks well in advance. Don't jump all over the first vehicle you see whenever you're on the road. Not attacking every vehicle will create an air of doubt (and some paranoia) in the locals. They will wonder if you are attacking or just passing by every time they see you. Most will wait for you to take the first shot; this will let you get within 8" easily . . .

Know the area, and *use* it. Place several gang members under cover on the roadside.

When you route your victim past them, they open fire with hand weapons, aiming for tires or weak armor positions. Footwarriors can spell the difference between failure and success, especially with the new, more powerful hand weapons available.

Even after Larry's warning on traveling in tight formations, many *still* practice this suicidal technique and wonder why they lose so many men. Dropped weapons are much more deadly now, with exploding spikes, proximity mines and the dreaded Flame Clouds. A pack must be able to flow smoothly around hazards like this, so travel in parallel lines of two or three.

"Never give a sucker an even break." This classic quote still applies today. Too many gangs are just pulling up from behind and opening fire. Some of the brighter ones have a bike or two in front. This is called by some a Fair Fight. Wrongo, bucky! Never, *never* fight fair unless you have to, and even then try to find some way to weasel out of it. Can you spell a-m-b-u-s-h? Be subtle, and always be creative. Use that Trenchfoot Opener against them. Don't drop that tree until it's *far* too late for them to stop. Don't be afraid to use an old classic; the Fake Toll Boodi. Just remember not to do this more than two or three times in one location, or the local authorities will shut you down permanently. Of course, if all they do is demand a cut, then you have their unofficial approval.

Use "cycle fodder" whenever possible. If Johnny really wants to join the Mad Dogs, he and three other bright-eyed "initiates" on Shogun 200s will "prove their worth" by attacking that courier you've had your eye on. It's an effective way to find out what a potential victim's defenses are, and, if nothing else, it's a good way to get rid of Johnny. If they die, you've lost some bikes (unless they provided their own) and learned something

about your target. If they manage to pull it off, let them join!

Reminders

Keep your gang balanced. Have about 25% of the bikes built for defense, with dropped and rear weaponry. Another 25% should be made up of heavy weapons and light armor for close combat, or light weapons and heavy armor for longer engagements. The rest of the bikes should be more general in design, able to fill out any needed position. When building, purchasing or stealing your bikes, do your best to have at least some side protection; either component armor around the biker, or an armored windshell.

Always accept surrender; never kill someone unless you have to. Excellent arguments for this have already been printed in *ADQ* in the recent past.

And when you are successful, keep in mind that you need to sell your salvage *somewhere*. A recent poll in *Car & Duellist* magazine showed that 43% of all small towns have good connections with at least one cycle gang. Keep a town safe from crazies, other cycle gangs and anything else that threatens it, and the people will more than return the favor. Getting information on who is gunning for you, a safe place to hide out, and a good place to sell your salvage is a big plus for any gang.

As a gang leader, play it smart and keep at least three hideouts; one for the whole gang, one for your elite, and one for yourself and, at most, three friends. There is always a chance of a gang being infiltrated by rival gangs, police and other do-gooders. Having a place to vanish to can save yourself and the core of your gang.

By keeping your wits about you, and following the suggestions in *ADQ* 3/2 and this article, your gang can quickly become rich and powerful. And hey, that's what it's all about, right?

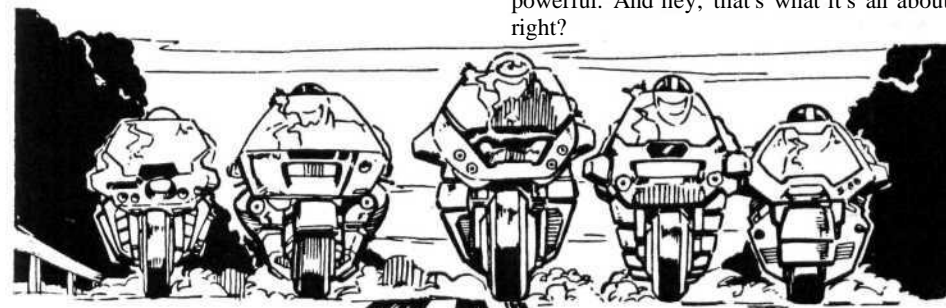

Here is a complete list of AADA Chapters (both active and recently expired) as of this time. If your club is not included, drop us a line immediately.

These clubs are in good standing and their charters all expire in November of 1989:

Riverside Organized Autoduelling Society (ROADS)
 President: Eric Gregory
 1255 Nicola Dr.
 Riverside, CA 92506

Royal Autoduel Association of Great Britain
 President: Mike Wyvill
 3/B Richmond St.
 Hull
 N. Humberside
 HU5 3JY
 ENGLAND

Flaming Lakers
 President: Paul Schwartzberg
 2728 Upton Avenue South
 Minneapolis, MN 55416

River City Autoduel Association
 President: Tim Ray
 8910 Research, #C-2
 Austin, TX 78758
 Sponsored by: Republic Motors Corporation
 One Republic Square
 Austin, TX 78748

Warmongers From Hell
 President: Craig Kember
 3717 Middlefield Road
 Palo Alto, CA 94303

London, England Autoduel Association (LEADA)
 President: Phil Radley
 12 Wordsworth Close
 Romford
 Essex
 RM3 7PD
 ENGLAND

LEADA Turbo Wicked Scary
 Nutter Bastard
 President: John Davies
 17 Garry Way
 Rise Park
 Romford
 Essex
 RM14YU
 ENGLAND
 Sponsored by LEADA

Woodinville Auto Rangers (WAR)
 President: Gavin Shearer
 16220 197th Avenue NE
 Woodinville, WA 98072

N.O.V.A.
 President: Norman McMullen
 2201 Joyce Circle
 Bellevue, NE 68005

Southern Pacific Autoduel Elites (SPADE)
 President: Mike Smith
 9620 Graceland Way
 San Diego, CA 92129

Tennessee River Autoduel Society in Huntsville (TRASH)
 President: Jesse Hamner
 2916 Barcody Road
 Huntsville, AL 35801

Coalition of Oregon Duelling Establishment (CODE)
 President: Dmitri Ashling
 4065 N. Mississippi
 Portland, OR 97227

Missouri Autoduel Division (MADD)
 President: Craig Sheeley
 1619 South Broadway
 Springfield, MO 65807

These groups' charters have expired, or are about to. If your group is on this list, and you have paid up on your dues, please send us a copy of your cancelled check.

Aussie Impact
 President: Tim Wodetzki
 6 Woodside Crescent
 Toorak 3142
 Victoria, AUSTRALIA

Baltimore League of the Autoduelling Elite (BLADE)
 President: Joseph Lightman
 6131 Cardiff
 Baltimore, MD 21224

California Racing and Autoduelling Society of Hell-Raisers (CRASH)
 President: David Crowe
 6221 Balderstone Dr.
 San Jose, CA 95120

Canadian Autoduel Association
 President: Mad Al Loud
 501 Kingston Road #105
 Toronto, Ontario
 CANADA M4L 1V7

Carmel Autoduel Association
 President: Curt Graham
 Rt. 1, Box 231
 Carmel, CA 93923

Central Arizona Road Duellists (CARDS)
 President: Bill Webb
 3612 E. Mariposa St.
 Phoenix, AZ 85018

Central Ohio Duellist Association (CODA)
 President: Leo E. Seaman, Jr.
 263 Cliffview Dr.
 Gahanna, OH 43230

Cleveland League of Duellists (CLOD)
 President: Dan Duvall
 29629 Schwartz Rd.
 Westlake, OH 44145

Commercial Intelligence Bureau (C.I.B.)
 President: Brian Kelly
 31 Aliso Way
 Menlo Park, CA 94025

Community Leaders of Duelling Sanelly (CLODS)
 President: Matt Larsen
 425 Ahwahnee Rd.
 Lake Forest, IL 60045
 Sponsored by: Pinnacle Games & Comics, Inc.
 1081 Conway Rd.
 Lake Forest, IL 60045

Corporate League of Autoduellists in Washington (CLAW)
 President: Patrick Burt
 7665 NE 14th
 Bellevue, WA 98004

Driving Tigers/Road Wolves
 President: Christopher Burke
 156 11th St.
 Brooklyn, NY 11215

Duellists, Exterminators and Terminators for Hire (DEATH)
 President: David Wilson
 37 Yorkshire
 Bedford, TX 76021

G.U.T.S.
 President: Steve Mriowec
 32 McRae Rd. NE
 Arlington, WA 98223
 Sponsored by: Gary's Books and Collectibles
 1904-1/2 Hewitt Avenue
 Everett, WA 98201

Houston Free Oilers
 President: Jeff Ferris
 9582 Windswept
 Houston, TX 77063

Indiana Brickyard Autoduellists (IBAD)
 President: Richard B. Wilson
 6119 Shawnee Trail N. Dr.
 Indianapolis, IN 46220

Iron Rangers
 President: Chris Yue
 521 12th Ave. SE
 Minneapolis, MN 55414

Jersey Autoduelling Establishment
(JADE)
President: Mitchell Goldman
17 Walnut Terrace
East Hanover, NJ 07936

Land of Lincoln Autoduel Association
President: Russel McKinney
1407 Scottswood Rd.
Rockford, IL 61107

Lex Talionis
President: Pete "Havoc" Hallenberg
9647 Wenzel St.
Fairfax, VA 22032

Lincoln Avengers
President: Tim Jacques
7222 Selleck
600 N. 15th
Lincoln, NE 68508

Madison Autoduel Association
President: Andy Egan
2244 Rugby Row
Madison, WI 53703
Sponsored by: Pegasus Games
444 State Street
Madison, WI 53703

Marin Marauders
President: Steven Huntsberry
27 River Oaks Rd.
San Rafael, CA 94901

Motorcity Warriors
President: Tim Basham
6040 Janet
Taylor, MI 48180

New England Autoduellists —
Connecticut Chapter (NACC)
President: Todd Browne
#3 Seventy Acre Rd.
West Redding, CT 06896
Sponsored by: War and Pieces
7 South Main St.
West Hartford, CT 06107

NOMADS After Six
President: Amn. MacDonald, Sean
c/o A1C McCoy, Craig
PSC Box 1407,
Hill AFB, UT 84056
Sponsored by: NOMADS

NOMADS, North Division
President: Tom Stuckel
4160 N. Buhach
Merced, CA 95340
Sponsored by: NOMADS

North American MONDO and Duellist
Society (NOMADS)
President: Joe Rudynski
2013 W. 245th St.
Lomita, CA 90717
Sponsored by: S-4 Hobbies
24419 Narbonne Ave.
Lomita, CA 90717

Northwest Autoduellists
President: Mark Miller
2239 Woburn #21
Bellingham, WA 98225
Sponsored by: American Eagles,
Bellingham
1213 1/2 Cornwall
Bellingham, WA 98225

Order of the Black Rose
President: Gary Lee Green, Jr.
7740 Asterella Ct.
Springfield, VA 22152

Outlaws
President: Michael DeVanney
20522 13th Dr. S.E.
Bothell, WA 98012

Ridgewood Organization of
Autoduelling (ROAD)
President: Matt Patterson
207 McKinley Place
Ridgewood, NJ 07450

Slaughter Autoduelling Incorporated
Saskatoon Troop (SADIST)
President: Bruce Brodie
302-720 8th St. E
Saskatoon, Saskatchewan
Canada S7N 1B5
Sponsored by: Wizard's Corner
810C Broadway Ave.
Saskatoon, Saskatchewan
CANADA S7N 1B5

Suffern Autoduel Division (SADD)
President: Val J. Cassotta, Jr.
4 Beechwood Rd.
Suffern, NY 10901

Sydney's Highly Intelligent Elite
Legionaires of Death (SHIELD)
President: Simon Beissel
12 Calvert Ave.
Croydon, 2132
Sydney, NSW, AUSTRALIA

The Syndicate
President: John Wendt
c/o Robert Kiel
225 Clifton Ave. #123
Oakland, CA 94618

Washington Recreational Extracurricular
Kamikaze Strike Force
(WRECKS)
President: Dan Ladd
11813 Trailridge Drive
Potomac, MD 20854

West Coast Autoduelling Vigilante
Enforcement (WAVE)
President: Moe Gemoya
33735 14th St.
Union City, CA 94587

There's been another passing of the AADA torch. Our last president, Bill Wendland, has been sacked with extreme prejudice for excessive laziness and occasional graft. We hope his clone will learn from Bill Prime's mistakes. But until Bill II can leave the Gold Cross vats, it's in my hands. I want to take this opportunity to apologize for the present state of the AADA. It's a terrible mess, and I'm doing what I can to clean up. (Mostly, this involves creative application of the torch . . .)

As of this writing, all active Chapters are active until November of 1989, both as partial recompense for the present situation, and to make our file-keeping a little easier. I'm also aiming to get the AADA newsletter onto a fairly regular schedule.

Chapters should start thinking about the Regionals sometime real soon, so we can print the Regional locations in issue 7/1. I'm also quite open to feedback on how to make the Regionals, At-large and World Championship events better, so if you have any suggestions, by all means send them in soon. And speaking of the Championships . . .



LEADA's Illustrious President demonstrates the pointlessness of fitting fireproof tires to your car.

2039 Schedule

This year's championship season will be pretty much like last year's season. There will be four rounds: Club, Regional, Semi-Final and World. All AADA members will be eligible to compete, one way or another.

Eligible chapters may hold Club Championships any time before Regionals. Club presidents are responsible for providing us with the name and address of the winner and a copy of the winning vehicle design; they are encouraged to provide as much additional description of the event as they wish. Steve Jackson Games will mail a \$15 gift certificate to each reported club champion. Club champions qualify for the final round of their Regional Championship; they will receive a bye into the second round of the World Championships if they are unable to attend Regionals.

Regional Championships will take place between March and July at major gaming conventions. There should be ten Regional locations: California North, California South, Northwest, North, Northeast, Southeast, Texas, Midwest, Mountain West and Central. Each tournament should be hosted by an AADA chapter at a convention; interested clubs should contact us as soon as possible. SJ Games will provide the arena rules and setup. The host chapters are responsible for the same information required from the club presidents, i.e., winner's name and address and a copy of the winning vehicle. We will give an official list of the Regional locations in issue 7/1.

All AADA members are eligible to play in any Regional, regardless of whether they compete in other Regionals; however, no person may win more than one Regional. The event will consist of two rounds, six winners from the first round advancing to the second. Club champions are automatically eligible for the second round. The division classifications and arena will be the same for all regions and will be published in *ADQ 7/1* to give everyone equal information before the event. Regional champions are automatically eligible to play in the Semi-Final round of the World Championships and will receive a prize to be announced. To help defray travel costs, Steve Jackson Games will give a \$50 reimbursement upon arrival to all regional champions attending the World Championships. Club champions of overseas chapters are considered to be

regional champions and will receive the prize and travel reimbursement as well.

World Championships

This year's World Championships will be held by SJ Games at Origins '89 in Los Angeles, California on June 29th through July 2nd, 1989. The event will consist of four rounds. The qualifying round is open to all AADA members regardless of participation in previous events. To enter, you will need to show proof of membership, preferably the mailer cover from *ADQ 7/1* or *7/2*. The number of duellists who advance will depend on how many participants show up for the eliminations, but will probably be around 18. All club champions are eligible for the eliminations, as are all participants in last year's World Championship Final. About eight winners will advance into the Semi-Finals.

All Regional champions, previous World Champions, overseas club champions and the eight eliminations winners, will be eligible for the Semi-Finals. Seven Semi-Finalists will move on to the World Championships. The defending World Champion, Jeff Boe, will also be eligible to compete in the World Championship Final round. Further details will be published in *ADQ 7/1*.

Official Rules

All official rules from the second editions of *Deluxe Car Wars* and *Dueltrack* will be used. The Variant Fire Rules and Variant Movement Rules (from *ADQ 6/2*) will be in effect, though all other optional rules and variants will not. In addition, all rules will be subject to clarifications made in *Autoduel Quarterly* and other *Car Wars* supplements, provided such supplements were released one month prior to the event. Can-am, Indy, Sprint and Dragster bodies will not be available, nor will mini-safes, pending a decision from the AADA Safety and Fairness Committee.

Get those tournament proposals in soon. If no club volunteers to hold a Regional for their region, there won't be one, and you'll have to try your luck in the Qualifiers at Origins '89. More details, including the locations, divisions and arena for the Regional Championships, will appear in issue 7/1.



I am 13 years old, and I love your game — *Deluxe Car Wars*. I play it all the time. What I wrote this letter about is kind of dumb to be sending all the way to Texas for, but I have a problem. The game has something not printed in the rulebook about Ds.

Example: A hazard for hitting a curb or pedestrian is a D3. That D is bothering me a lot, because I have no idea what it stands for.

Another Example: A road conditions hazard for running into heavy snow is another D3. That big D is what this whole letter is about. I would appreciate it a lot if you could send me a letter telling me what it means. Thanks.

Sincerely,

—Jesse Daniels
Mountain View, CA

Oh, that's easy. D stands for Difficulty (p. 9 in DCW), or how hard it is for the driver to maintain control of his vehicle after a maneuver or hazard. The higher the D value, the more difficult it is to keep control. It's kind of refreshing to get a simple question once in a while. . .

—CAO

Page 43 of *ADQ 5/3* in backfire lists a formula for determining maximum weight of a vehicle for a desired top speed. That formula is no longer valid with the advent of the new gas rules in issue 6/2. By using simple algebraic theory, I have rearranged the new gas rule formula as follows:

$$\text{Max. wgt.} = (240 \times \text{PF}) - \text{TS} (\text{PF})$$

where TS = Desired top speed, and PF = Power Factors of desired engine.

Example: John has come into possession of

a 300 ci engine, and would like a top speed of 120 mph. Unfortunately, he doesn't know what kind of vehicle he should choose to put this new engine in. PF=4,000, TS = 120, so Max. wt. = $(240 \times 4,000) - (120 \times 4,000)$

$$\begin{aligned} &= 960,000 - 480,000 = 480,000 \\ &= 480,000 \div 120 = 4,000 \end{aligned}$$

Therefore, John has 4,000 lbs to work with, and his best choice would be a compact.

—Micheal Heacock
Calgary, Alberta, CANADA

Dear Sirs,

First off, thanks for publishing my arena designs in *ADQ 6/3*. I take it that the last sentence in the Editor's note was a hint that you guys need my Social Security number before you can pay me . . .

With regards to the AADA championships, if you guys are going to do the same format next year, your Division 20 duel in the Double Drum needs to be changed a bit. I was in the Southern California regional, and when the combat began, only about half of the cars went forward — the rest stayed still, or moved in reverse, and then picked off those cars that went forward. While this is a perfectly legal tactic (my only sorrow was that I was one of those that moved forward), I have the feeling that you intended this to be more of a race. I suggest that next time, a vehicle cannot fire until after it has first passed the 'center line' of the arena.

Once again, thanks for publishing me, and I will continue to drive offensively!

—Douglas Kelley,
Chatsworth, CA

Just a few suggestions:

1. Why can't a vehicle within a trike's front arc of fire target the trike's side? A car's side can be targeted from the front — and its sides are at a steeper angle. Surely the ruling should be reversed — it should not be possible to hit a trike's side from behind because you can't get line of sight on its sloped sides; the reverse being applicable for reversed trikes.

2. Dragsters should not be +1 to hit from the side, seeing as they are much lower than other cars. The narrow frame presents a smaller target (in height) than a normal car's body. With dragsters being longer and lower they should be no penalty to hit from the side.

3. The weapons location restriction should apply to cycles because at present a heavy cycle can mount four spaces of weaponry on one side, while a light trike can mount only 2 2/3 spaces of weaponry at most on a side.

A couple of questions:

1. Do weapons mounted in EWPs count toward the weapons location restriction?

2. If two linked weapons of different types in a turret are fired together, how does the non-aimed one fire? In the same direction it last fired, or in some other direction?

—J. McEvoy
West Yorkshire, ENGLAND

1. *Oooh, the contradictions do pile up over the years, don't they? Personally, I don't know why trike targeting is so quirky, either. I suppose I'd better get in the practice of doing this, so I'll wave my magic wand, and presto! A new, official ruling: A trike's sides can be targeted from the front arc at the usual -2 penalty. They cannot be targeted from behind (switch for reversed trikes, of course). In addition, you cannot target a trike's top armor unless you could normally target anyone's top armor.*

2. *Sounds good to me. If you want to play it that way, fine.*

3. *Cycles are exempt from this because (everybody say this with me) cyclists need all the help they can get. As to your questions:*

1. *No.*

2. *That's what referees are for. What happens depends strongly on what the two weapons are. Usually, the other weapon would use the automatic fire rules along the direction the turret is facing.*

-CAO

I am sending for your purview the design specifications and script for Autoduel II, the sequel to Lord British and Chuckles' computer adaptation of *Car Wars*, which we are



developing for Origin Systems, Inc. We are very pleased to have the opportunity to design this game, and we have strong ideas of what enhancements are possible and necessary to add more *Car Wars* flavor to the game. We are very interested in your impression of the script and any changes you can suggest which would enhance the appeal of the finished game. We would also like to know how you feel about inviting AADA West Coast and World Champions to join the game as NPCs.

At our script review we banded about the idea of expanding the car construction system and marketing it as a computerized car-design play aid for *Car Wars* and *GURPS Autoduel*. Please let us know what you think of this idea.

Yours Truly,

—Kiri Naiman,
MicroMagic

Me, I think it's a fantastic idea . . .

I had a chance to look over the script and suggested changes, and it looks good! The vehicle construction and combat systems look like they will mirror Everybody's Favorite Game, with nearly every gadget up to and including the most recent Uncle Albert's catalog available. Among other interesting options are an online newspaper called Autoduel Weekly, featuring local arena schedules and news of famous duellists (including PCs once they become famous), printouts of completed designs, and saving designs to disk (which allows swapping designs between friends). Stay tuned — more news as it comes in.

—CAO

I have come up with a way to solve the encumbrance problems in *Car Wars* without radical change. The 6-GE limit still applies, but only to the torso. The head can carry one GE (within reason), and the arms 5. This makes it possible for a man to wear body armor, a flak vest, a battle vest, a backpack full of goodies and still carry a weapon. However, if a person carries the maximum limit of grenade equivalents on both body and hands, he loses 1/4" move per second.

—Douglas W. Glover
Huntsville, AL

He's probably going to be rather clumsy, as well, but your suggestion has interesting possibilities. Anyone else have any ideas on this?

—CAO

ADQ&A

1. What penalties does a vehicle suffer for losing 1 EWP of a pair?

2. Does Stealth Mode add any bonuses to a CACR equipped copter?

3. Can a driver or passenger lean out of the window to fire a hand weapon in the front or rear arc?

4. What about a Safety Ejection Seat?

—Dave Searle
Antioch, IL

1. *-3 to HC until the EWP is replaced, or the other one is shot off.*

2. *No.*

3. *I guess some suicidal fool could do that. Targeting said fool would be at -4, and if the driver is leaning out, all maneuvers and hazards during that turn are at +D2.*

4. *Sure, why not? \$1,000, no space, 125 lbs.*

-CAO

1. Can helicopters target the ground when dropping bombs (and cluster bombs)? This happened once and two CBs destroyed every tire on each of seven different cars! Four-hundred-and-some-odd dollars for over \$150,000 worth of vehicles — and this is regardless of wheelguards and hubs! There's got to be at least *one* penalty — please?

2. This one is complicated (at least to me). Now, when 10+ damage is done to a vehicle with *one* weapon, this is a D3. What happens when *two* or more weapons that are linked hit, and *each* does 10+ damage? Is the hazard D3 or D6? The rules state that the maximum hazard that can be incurred on a vehicle is D3; is this per weapon fired, per linked salvo, or per segment?

3. Can a bus have four tires in the front?

—Jason "The Red" Baron
Irvine, CA

1. *Yes, targeting the ground is perfectly legal (where else will the bombs go?).*

2. *A single salvo in a single phase inflicts a single D hazard.*

3. *No.*

-CAO

1. Does a CACR-equipped helicopter still retain its stabilizing rotor? If one of the main rotors gets shot off, can it still use the original stabilizing rotor?

2. Can a vehicle have an ejectable EWP on top, and then, after the weapon in it was out of ammo, eject the EWP and raise a pop-up turret? Could these actions be linked?

3. Does streamlined *and* sloped armor reduce internal space by 20% or just 10%?

—Gavin Shearer
Woodinville, WA

1. *No. A CACR replaces the stabilizing rotor.*

2. *Yes.*

3. *The sloped/streamlined combo reduces interior space by 15%.*

-CAO

1. Can the E-Z ejection seat be put on a cycle? How about a Safety Seat?

2. Can a zero-space turret be universal?

3. (This is dumb, but) can a junk-dropper be loaded with toxic waste?

4. What damage (if any) do metal tires take from a DSP?

—Noel Hendrickson
San Jose, CA

1. *Yes, and yes.*

2. *Yes.*

3. *Not if it's liquid.*

4. *I die, just like a solid tire.*

-BDE

1. If you sloped the armor of a pickup taking away 1.3 spaces in the cab, would it be possible to put a PFE in the remaining .7 spaces since a PFE only takes up a half space?

2. In the Uncle Albert's description of a foam grenade, it said it acted like paint for three turns. If this is true, does the same go for the two vehicular fire extinguishers as well as the PFE?

3. What happens when a paint, smoke or tear gas grenade goes off in a vehicle?

4. With the advent of the Under-Barrel GL on the assault rifle, shouldn't there be an im-

pact modification for grenades so when they hit they go off? An M-16's UBGL's grenades usually go off on contact, so it would only make sense that there would be other grenades than the minimum of 1-second-delay type.

—John Siminoff
Chester, NY

1. *No. The rules specifically state that you round up when subtracting interior space, so when you slope the armor on the pickup, you take away 2 spaces. Of course, if your referee says you can, feel free.*

2. *No.*

3. *The occupants suffer the effects of the grenade. If it was a paint or teargas grenade, they're probably in a lot of trouble . . .*

4. *In reality (arrgh), yes; in game terms, no.*

-CAO

1. Can the FOJ use HT Ammo? In *ADQ 6/2*, the Sceptre had a FOJ with HT ammo.

2. In *ADQ 6/2*, the laser guidance rules state that the laser must hit, and then the rockets hit only on a 4 or better, and miss on a 2 or 3. What happens if you roll a 1?

—Bart Larrenaga

1. *Yes, and the flaming oil slick does 1d damage to underbody and each tire, and lasts for two seconds.*

2. *Beats me. I've never rolled a 1 on 2 dice before.*

-CAO

1. Exactly how do RGMs and WGMs move? I've been playing them so that they have unlimited HC and follow the target until they hit it. Are they like this, or more like a homing torpedo?

2. Can a computer gunner switch magazines, program a weapon timer, or conceal/unconceal a weapon it is linked to?

3. Can gasoline be used as an explosive?

4. Can you hold a riot shield and fire a tripod weapon at the same time?

—Anonymous Duellist

1. *You're doing it right.*

2. *Yes, yes and yes/yes.*

3. *Sure.*

4. *No.*

—BDE

1. Why wasn't the change in IR lasers mentioned in the *2038 Uncle Albert's Catalog Update*?

2. Are shots from the deadman switch and the damage sensor aimed at the vehicle that fired the damaging shot? When are deadman switches and damage sensors destroyed?

3. Can a motorcycle with a windshell use Stealthkote?

4. Will chaff trip an AT AD?

5. If the underbody armor is breached, can retractable landing gear be damaged?

—Peter Eng
Seattle, WA

1. *We forgot.*

2. *No. When the items they are attached to are destroyed.*

3. *Sure.*

4. *Yes, on a 1-3 on 1 die.*

5. *Certainly.*

-CAO

1. Can two heavy pistols be fired at the same time, if one is held in each hand?

2. Why is it that the hand-held grenade launcher can hold five grenades, but the vehicular model can only hold ten, and takes up 2 spaces? If the vehicular model was one space and held 15 grenades, things would compare a little better.

3. How big are different hand-weapon magazines?

4. Can mines be shot out of the road to avoid running into them? How much DP?

—Another Anonymous Duellist

1. *Yes. The one in the good hand is -1 to hit, the other is -4 to hit.*

2. *Compare in what way? Personally, I'm happy with the numbers as they are.*

3. *1/2 grenade equivalent for the most part, but SMG magazines are 1 GE.*

4. *Convoy has an unofficial rule for shooting mines: Make a regular to-hit roll (no +4 for targeting the ground!). It takes 2 hits to disperse one mine counter.*

—CAO

1. *Having a nice day?*

—Doug Ingebretsen
Jackson, MS

1. *It's okay.*

—BDE

AUTODUEL[®]

Now For Your Computer

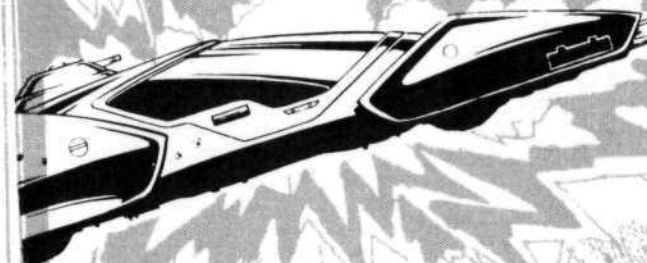

Drive the freeways of the future where the right of way goes to the biggest gun. Somewhere within the 16 cities and outlaw-infested highways are the clues you will need to complete the ultimate mission.

Step into the arena on *Amateur Night* and earn the right to custom-build your combat vehicles.

The AADA will offer you courier missions. The FBI and the underworld will vie for favors. But watch out! To survive you'll need road experience, the ability to decipher clues, gambling skills, money, a super car — even a clone.

The final gauntlet will test your tactical skills and hair trigger reactions to the limit. But with triumph comes honor, and entry into the elite circle of Autoduellists. The challenge of Autoduel[®] awaits you. Are you ready?



340 HARVEY ROAD
MANCHESTER, NH 03103

Available now for the Appel II series, Commodore 64, Atari XI/XE and ST, Amiga, IBM and Macintosh. Please specify when ordering.
To order by mail, send \$52.00 (includes postage and handling) to: Steve Jackson Games, Box 18957-T, Austin, TX 78760. Texas residents please add \$3.77 sales tax.