

AURORA

THE SILHOUETTE MAGAZINE

INSIDE THIS ISSUE:
JOTUNHEIM ARMY
BLITZ! PROBABILITIES
MASSIVE WEAPON GLOSSARY



AURORA: THE SILHOUETTE MAGAZINE
TABLE OF CONTENTS
VOLUME 6, ISSUE 1

Shades in the Night... <i>Editor's Message</i>	2
About the Authors <i>The Whos and Copyright Information</i>	3
Axe of Independence <i>Campaign Info and House Rules for Heavy Gear Blitz! by Marcus Lindner</i>	5
Alfie's Tenners <i>Graphic Novel set in Gear Krieg by John Bell</i>	34
Probabilities in Heavy Gear Blitz! <i>Rules Exploration for Heavy Gear Blitz! by Gerrit Kitts & Marc-Antoine Rondeau</i>	37
Jovian Koma <i>Gallery Image set in Jovian Chronicles by John Bell</i>	51
Weapons of War <i>House Rules for Heavy Gear Blitz! by Alexander Stockert</i>	52
Messages from the Pod <i>Official DP9 Material by Jason Dickerson</i>	61
Submission Guidelines <i>How to Submit Material to Aurora</i>	62
Article Suggestions <i>What Aurora is Looking For</i>	63

AURORA: THE SILHOUETTE MAGAZINE SHADES IN THE NIGHT

From the Editor...

*"Fly free and happy beyond birthdays and across forever,
and we'll meet now and then when we wish,
in the midst of the one celebration that never can end."*

– Richard Bach

Anniversaries or birthdays are moments of festivity, a time to celebrate all that has come before and party forward into the future. So too is the new year, a time of reflection. That we at Aurora get to partake in both at the same time is fortuitous and a doubly joyous time for us.

Here we sit on the cusp of the sixth year of operation of Aurora, and what a celebration it is: of all the articles, of all the authors, of all the art, and all the creative exploration of our favourite games. Our artists and authors of course are the real ones to be celebrated, for they are the ones who have put their time, joys and efforts into creating the material we publish every issue, and to them I give a big bow and salute of thanks for sharing their passion with us, and being a contribution to feed our own passions. You guys amaze me, and I know and see that there is no slowing down in our older age.

And to show our vitality, this month we have some massive articles for you, bulging our page count to the highest ever in our history, along with our equally long-lived and beloved Gear Krieg graphic novel and the humorous Jovian Koma. Get yourself cozy and grab your favourite beverage – you may be here a while digging into all this goodness.

We here at Aurora Magazine wish everyone a wonderful 2012 filled with fun, warmth and love. May the only combat that sees the light of day occur on the gaming table and not in the world proper.

Welcome to issue 6.1 of your Silhouette Magazine.

Game on,

Oliver Bollmann
Aurora Magazine Editor

PS - Remember to drop by the forums to voice your appreciation, comments, support and feedback to the fine authors of our magazine!

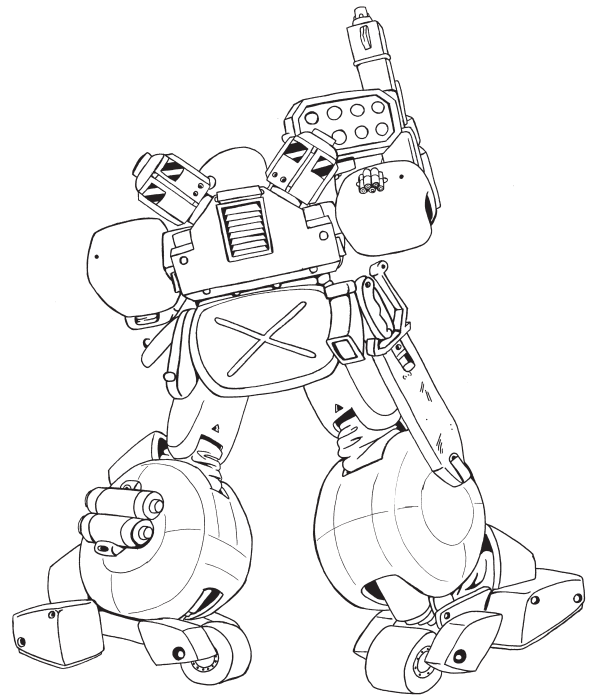

OFFICIAL-DP9

"Official" Dream Pod 9 rules, updates and materials can be found in the Gear Up magazine, available at DP9's store on RPGnow.com.

HOME BREW RULES

All material inside Aurora is fan submitted and are not regarded as official and do not change the games or the DP9 game-universes as written in the books. Aurora material may not be used in tournament or other official play and may differ from current or future books. Any Aurora rules or material should only be used if all players agree upon their inclusion before play.

AURORA: THE SILHOUETTE MAGAZINE

ABOUT THE AUTHORS

Alexander Stockert (Smilodon UP on the forums) -- *Weapons of War*

Is amazed at how many words in the English language end in -ly, and how difficult it is to not abuse adjectives that end in -ly. Likewise, but, as a word, is far too common and keeping tense can cause one nightmares. And don't get him started on 'by', 'and', and 'the' ...

Gerrit "IceRaptor" Kitts (gkitts@gmail.com) -- *Probabilities in Heavy Gear Blitz!*

A Pod Squad representative for Columbus, OH and a regular fixture at the Origins and Gencon game fairs, he might enjoy the math behind the game a little too much.

Jason Dickerson (JDDWolf@yahoo.com) -- *From the Pod*

Jason is the Line Editor for Heavy Gear and has been an advocate of all things Heavy Gear since the first edition came out. He is also the founder and President of the Save the Asp Society (S.A.S) on the DP9 Forums.

John Bell (jakarnilson@magma.ca) -- *Alfie's Tanners & Jovian Koma*

He gets labeled a "walking-talking encyclopedia." He draws what goes through his mind. He builds what he can't afford. He walks what others would take a lift for. He'd probably trade in his bike for a real, working Ferret; but then again, who wouldn't?

Marc-Antoine Rondeau (marc-antoine.rondeau@gmail.com) -- *Probabilities in Heavy Gear Blitz!*

An humble engineering graduate student and a strong advocate of the use of maths in life in general and Heavy Gear in particular.

Marus Lindner (Goldritter on the forums) -- *Axe of Independence*

This article was edited by Brandon Fero -- many thanks!

Oliver Bollmann (auroramag@gmail.com) -- *Editor*

It all started in a hobby store one day twenty odd years ago with an odd box containing something called Top Secret. Since then games have just become a big part of his life. He's been in love with the DP9 universes since the first HG release and began his direct involvement with the Pod crew a couple of years ago. He also runs a gaming imprint *Kannik Studios at rpgnow:*

http://rpg.drivethrustuff.com/index.php?manufacturers_id=291

FYI from the Editor: Yon Koma manga, a comic-strip format, generally consists of gag comic strips within four panels of equal size ordered from top to bottom, read right to left.
(an FYI because I looked it up too... :)

AURORA: THE SILHOUETTE MAGAZINE ABOUT THE AUTHORS

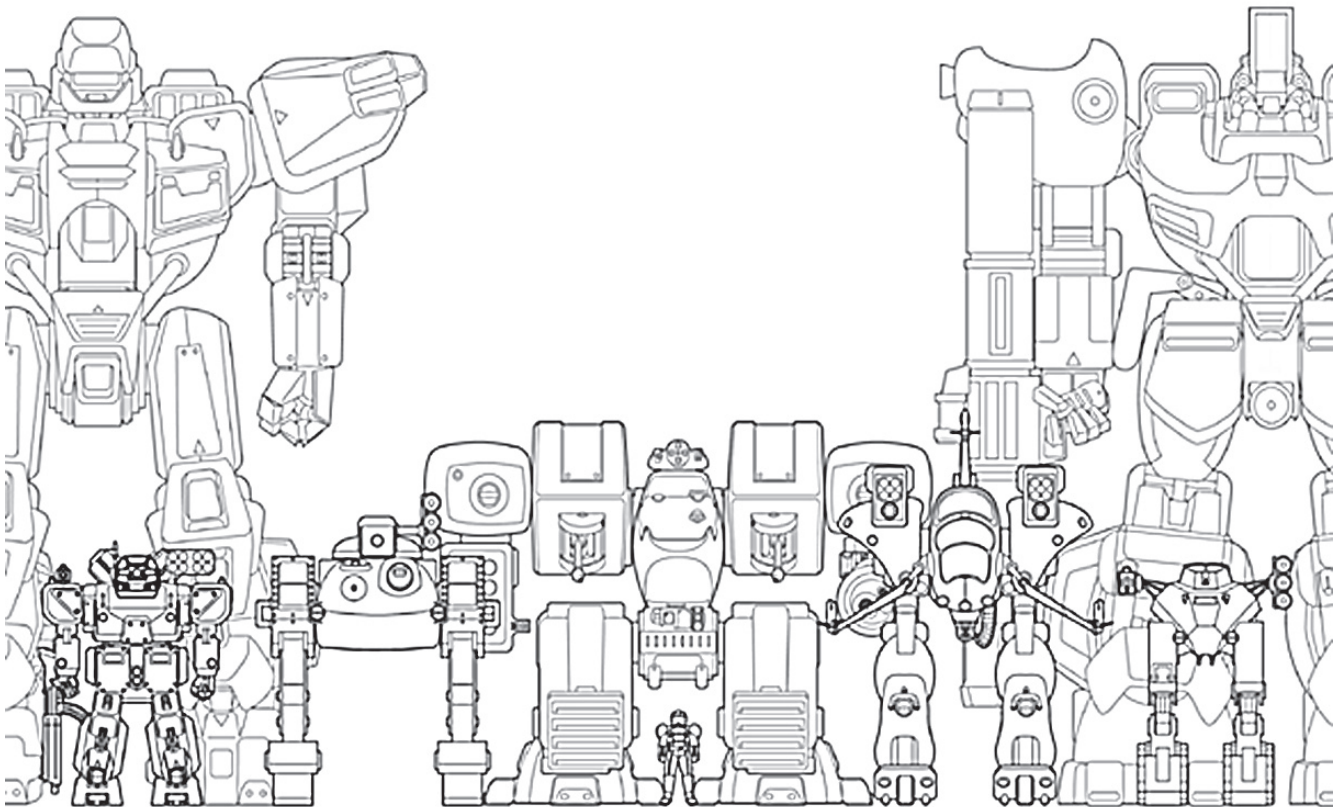

COPYRIGHT INFORMATION

Silhouette™, Silhouette Core™, Core Command™, Heavy Gear™, Heavy Gear Blitz!™, Jovian Chronicles™, Tribe 8™ and Gear Krieg™ are Trademarks of Dream Pod 9, Inc. Silhouette™ Core Rules are © Dream Pod 9, Inc.

All articles written within are © their respective authors, as indicated on the list above. Permission has been granted for the sole purpose of their publication in Aurora. No reproduction is allowed without their express consent.

All images not specifically listed above, as well as all game logos are © DP9 and their original artists. No reproduction is allowed without their express consent.

Permission granted to reproduce this document in full for private use.

Please visit www.dp9.com and aurora.dp9forum.com for more information.

Aurora Magazine, Volume 6, Issue 1, Published January 1st, 2012

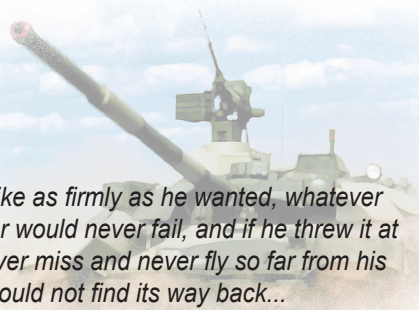

... would be able to strike as firmly as he wanted, whatever his aim, and the hammer would never fail, and if he threw it at something, it would never miss and never fly so far from his hand that it would not find its way back...

This is a fan-made article about how to field a possible Jotunheim Army. Little is known about this enigmatic planet, the only collectively owned colony where no corporations held sway. Over time the tribes and cantons have worked collectively in waxing and waning alliances, creating an army in case Earth ever decided to come knocking, or if they chose to go out and do some knocking of their own. What devices or involvement Jotunheim has in your campaign is left to the devices of the GM in an RPG game, or they can simply be used in an (unofficial) tactical game for additional interest and fun, using their unique equipment.

After seeing the film Thor, I decided that Norse terminology might be good names for units from a planet named Jotunheim. In addition to the movie Thor, I was inspired by the game Renegade Legion Centurion, which includes main battle tanks which use anti-gravity technology. The largest problem was to find a way to add such tanks into Heavy Gear without having to add real anti-gravity to the storyline. My thanks go to Brad Bellows who helped me on this problem and to develop the basics for the Magnetic-Drive Tanks (Mag-Tanks) and the basic principles for their usage and roles.

I also want to thank Brandon Fero for editing my text and removing the more gruesome grammatical and orthography errors, and my gratitude goes out to Mark Perre and his friends Dan Liswood, Paul Goodrich, and Barry, that they could take a look over these lists and assist me in play-testing them. From the beginning there was much more than the military units, their weapons and the army lists. There was more fluff about Jotunheim and its populace, its families and familial structure, political structure. I also had descriptions for the military vehicle variants, and even some ideas for Regiments of Note, but for the moment I have removed all these from this first article, and they may re-appear in a future issue of Aurora. Until then, I hope you enjoy this unofficial colony army list.

AURORA: THE SILHOUETTE MAGAZINE

AXE OF INDEPENDENCE

MARCUS LINDNER

**HOME
BREW
RULES**

JOTUNHEIM TECHNOLOGY

Master of Magnetics

One area in which the Johtumeimers excel is in their knowledge and manipulation of magnetic fields. This is expressed in their usage of warped magnetic fields, which allow heavy objects to float several meters off of the ground, and also by their intimate knowledge of railguns and a more unique design, the coilgun.

Udbruck Propulsion Engine

The Udbruck Propulsion Engine (UPE) is the engine which has allowed the Jotunheim armies to create their quintessential Mag-Tanks. The UPE is a technological marvel that almost magically allows even heavy weights to fly nearly weightless a few centimeters above the ground, thus allowing even heavy masses to be moved easily.

The underlying scientific principle of the UPE is based on the fact that objects can create a magnetic field if a huge external magnetic field is applied to said object. The created magnetic field is then placed in opposition of the applied magnetic field, thus creating a repulsive effect, termed Diamagnetism.

The UPE is named after Anadell Udbruck. Anadell discovered how to generate a magnetic field which creates the diamagnetism effect on a portable platform. The unique magnetic properties of the planet Jotunheim, which are similar to those of the planet Terra Nova, helped in the original design of the engine's calibrations; over the course of time, the engine was refined to an even greater degree than its earlier predecessors. Modern UPEs are so effective that it is theorized that they are even effective on planets which do not have the magnetic properties of Jotunheim, and lose only a few percentiles of their effectiveness on these lesser 'charged' planets.

Coilguns

Unlike railguns, which use a sled to accelerate the projectile, coilguns accelerate the projectile directly with magnetic streams. Projectiles that are fired by coilguns are significantly heavier and can be larger in diameter than those used by railguns; this results in a higher impact kinetic energy spread out over a greater area. In addition, ammunition shot by coilguns can carry ordnance such as high explosives, increasing the tactical flexibility of these weapons.

Rapid-Fire Coilguns

Rapid-fire coilguns exchange the high damage potential of a single heavy projectile for a higher rate of fire with smaller projectiles. These smaller projectiles allow a rapid-fire coilgun to carry more ammunition. They also have a higher rate-of-fire than their equivalent conventional automatic cannon.

**HOME
BREW
RULES**

Plasma-Cannons

The plasma cannon is a specialized type of coilgun. Plasma cannon use a magnetic-flux compression generator to induce a high amperage into the projectile, which is normally a small aluminum projectile), and then accelerate it to 100 kilometers per second, transforming it into a plasma-torus. Through the artificially-created magnetic fields, this plasma-torus remains stable for a relatively long period of time, until it hits something.

NEW RULES

New Combat Group Type Escorts (Model)

Escorts are a special Combat Group Type. Unlike normal combat group types, Escorts are not purchased separately; they are purchased in combination with a Model. This is defined in the Combat Group Type name. The entire Escort squad is attached to the Model, and count as members of the same combat group as the model they are attached to. Any model with an attached Escort Squad is always activated under the optional Sub-Squad rules (see page 7 in the Field Manual).

Escorts do not count for preconditions set by the Priority Level of the Army, and if the model they are attached to is a veteran, then the Escort Squad counts as a veteran squad.

Only one Escort Squad may be attached to any model. Escort Squads that may be purchased in multiples will be described in the Squad description of the model.

New Movement Mode

Hoverflight (HF)

In Hoverflight mode the unit treats Rough, Very Rough, Roads and any Water terrain as Open/Clear Terrain. They treat any Dense terrain as Difficult terrain, and Very Dense terrain as Dangerous terrain.

If the unit is stationary, it can turn freely in any direction, when moving at Combat speed the unit may turn every inch, while at Top Speed they may make a turn every 5 inches of forward movement.

A Hoverflight unit may change its movement heading every 5 inches moved in Combat Speed, and every 10 inches moved in Top Speed. The Heading may be in any direction (left, right, forward, backwards or even diagonal) and it can be combined with a turn.

Beside the normal movement directions, a unit in Hoverflight may also change increase its altitude for 1 MP per inch of altitude change.

New Traits

Cold Immunity (CI):

The unit is immune to any effects conferred by cold or extremely cold conditions. If there are table effects which reduce the effectiveness of a unit by low temperatures (like arctic storms or snow) this unit ignores the effects on dice rolls or modifiers, except concerning detection.

Grapple Launcher (GL):

A unit with a grapple launcher may always climb a cliff - even if it has no arms or climbing equipment - while using their lowest Combat Speed. If a Model cannot ascend or descend an entire cliff in a single movement, mark its place and treat it as if it were at Combat Speed, but it suffers an additional -1 Modifier to both Attack and Defense rolls. If combined with arms or climbing equipment, the unit may use its highest Top Speed for climbing, and if the unit has arms and climbing equipment it must spend only 1 MP per elevation level.

Stun immunity (SI):

A Unit with Stun Immunity is immune against the effects of Stun counters (e.g it does not get the -1 modifier if it gains a Stun-Counter), but it accumulates Stun counters normally.

JOTUNHEIM UNITS DESCRIPTIONS

Einherjer

Jotunheim units that use Artificial Intelligence refer to them as Einherjer, hearkening back to the mythical warriors who died and were brought to Valhalla to live and fight for eternity. Unlike the Artificial Intelligence used by the Utopians, Einherjer do not need any controlling unit, nor do they need to be put into a cluster. Any Einherjer is an autarkic AI, sophisticated enough to learn during its usage. One of the most significant advantages of Einherjer is their standard interface, which allows them to be built into existing units without too much effort.

Magnetic-Drive Tanks

Magnetic-Drive Tanks (colloquially named Mag-Tanks) are the common fighting vehicles of Jotunheim. The manipulation of the planet's peculiar magnetic field allows these units to be faster than ground vehicles of a similar size. Mag-Tanks can travel over nearly any surface, above water, and if enough power is available, they can even make small jumps. This can be a nasty surprise for opponents who may be lured into believing that such heavy vehicles could never be so nimble.

AURORA: THE SILHOUETTE MAGAZINE

AXE OF INDEPENDENCE

Thurse

A Thurse is a Strider-like combat robot. Jotunheim engineers have not had any experience in constructing small, rugged walkers such as Terra Nova's Heavy Gears or the Earth's new Frames. In order to carry the necessary armor and weapons, Jotunheim Thurses were developed to be large, and somewhat clumsy. This was the primary reason for their title of Thurse, the equivalent of Giant for the Jotunheimers. Despite their size and clumsiness, Thurses can bring weapons into terrain which is hard to reach, or even dangerous for the more conventional Mag-Tanks.

SPECIAL RULES

Magnetic-drive

Jotunheim units use a magnetic drive for their Hover-mode. This allows Jotunheim units to enter Dense and Very Dense Terrain and Jungle Terrain as if they were units with the Ground movement mode. They can move over any other terrain as with the normal Hover mode.

Coilgun Ammunition

Coilguns have the tactical advantage in that they can use a variety of ammunition that would not be possible with railguns. The Jotunheim militaries prefer to carry two different types of shells for their units' weapons. These two standards are a solid metal slug, intended to tear through the armor of any target it hits through pure kinetic power. The other is an explosive shell that creates a dense cloud of high-velocity shrapnel similar to the ancient idea of 'beehive' rounds.

Any Unit equipped with a coilgun chooses between the AC trait or the AE trait (indicated by ||) given by its ammunition type before every Attack.

Clan Army Jumble

Every Clan has its own army structure and army composition. To reflect this, Jotunheim squads have a different design rule. At first, squads can have different Squad Types, which can be chosen during the creation process. The chosen Squad Type unlocks the options available for the squad Type and all options for lower Squad Types. The order of the Squad Types is Core, Auxiliary, Specialist and last Elite. The Squad Type which is given in the Squad description is the minimal Squad Type of this Squad. So a Squad where the Squad Type is Specialist, cannot be used as Core or Auxiliary, a Squad where the initial Squad Type is Core can also be used as Auxiliary, Specialist and Elite. The maximal Squad Type the squad can have is specified by the possible options. So if a Squad has no Elite options, its Squad Type cannot be Elite.

**HOME
BREW
RULES**

Army Commander

Any Combat Group that contains the Army Commander may add an Odin Herföðr for +140 TV. The Odin Herföðr becomes the Combat Group Leader and Army Commander. The original CGL becomes the Second-in-Command of the combat group, with the basic Skill values given for the unit. The Second-in-Command may increase its Leadership Skill by one step for +10 TV.

The AC may take any option from the attached Combat group. Any AC in a Odin Herföðr may increase his Attack, Defense and EW Skill up to 4. Every Skill increase step cost 15 TV. The AC may also increase its Leadership Skill to a maximum of 5 for +10TV per Level step. The AC may take 2 different Escort Squads, instead of the normal one.

General Options

Option

- Any Unit which has multiples of the same weapon with the same firing arc may add a Weapon-Link to these weapons for +5 TV.
- Any CGL may increase EW by 1 for +5 TV per action of the unit (+5 for 1-Action Model, +10 for 2-Action Models, and so on).

Veteran Option

- Any CGL may increase its Leadership by 1 for +10 TV

Odin Herföðr Command Mag-Tank

HEAVY GEAR
BLITZ!

ATT	DEF	EW	LD	DETECT	SENSORS	COMM	AUTOCOMM	3	0	3	5
SPD	STOP	CBT	TOP								
H	5	/	10	-3	-1	0					
ATTACK	1	0	-1								
ARMOR	28	OVERKILL	140								
ACTIONS	3	SIZE	12								
DAMAGE	S	L	H	C							

PERKS	Reinforced Armor (Front, 2 / 150), Low-Profile, CI, Backup-Communication										
FLAWS	LSP(2)										
AUX	Sat.-Uplink										
NAME	ARC	ACC	RANGE	DAM	ROF	TRAITS	ROUNDS				
MCG	T	0	30/120/∞	x20		AC AE (2)					
HRFC	T	0	18/72/∞	x10	4*	AA					
Physical								x12	M		
Add +1 to any Leadership roll during the game.											

AURORA: THE SILHOUETTE MAGAZINE AXE OF INDEPENDENCE

JOTUNHEIM WEAPONS

Name	Code	Acc	DM	Optimal	Sub-Optimal	Extreme	RoF	Notes
Heavy Airburst Missile	HABM	1	x15	30	120	∞		G, Blast(3)
Very Light Coilgun	VLCG	0	x8	18	72	∞		AC AE(1)
Light Coilgun	LCG	0	x12	24	96	∞		AC AE(1)
Medium Coilgun	MCG	0	x20	30	120	∞		AC AE(2)
Heavy Coilgun	HCG	0	x28	48	192	∞		AC AE(2)
Very Heavy Coilgun	VHCG	0	x34	60	240	∞		AC AE(2)
Very Light Plasma-Cannon	VLPC	0	x6	18	72	∞		AP
Light Plasma-Cannon	LPC	0	x10	24	96	∞		AP
Medium Plasma-Cannon	MPC	0	x15	30	120	∞		AP
Heavy Plasma-Cannon	HPC	0	x20	48	192	∞		AP
Very Heavy Plasma-Cannon	VHPC	0	x25	60	240	∞		AP
Very Light Rapit-Fire Coilgun	VLRFC	0	x4	12	48	∞	8*	AA
Light Rapit-Fire Coilgun	LRFC	0	x6	12	48	∞	6*	AA
Medium Rapit-Fire Coilgun	MRFC	0	x8	18	72	∞	5*	AA
Heavy Rapit-Fire Coilgun	HRFC	0	x10	18	72	∞	4*	AA
Very Heavy Rapit-Fire Coilgun	VHRFC	0	x13	18	72	∞	3*	AA

* Subtract 2 from the RoF used when determining the RoF-Value to get the Out-of-Ammo Threshold for its Result x || y Every attack chooses between Trait x or Trait y

Note: This weapon table uses the optional Weapon Range rules from Gear Up issue #2

**HOME
BREW
RULES**

JOTUNHEIM UNITS

Name	Type	Role	Description
Berserkir	Battle-suit	Infantry like	Besides normal Infantry, Jotunheim uses specialized Battle-suits, the Berserkir Suits. These suits carry more armor and weaponry than a standard infantryman could, but they still allow the Unit to be carried by transport vehicles and are still small enough to enter buildings.
Byleist	Thurse	Force Recon Unit	The Byleist is a specialized Thurse. The Byleist performs reconnaissance in terrain that is not easily reached by Mag-Tanks. It also brings some firepower with it to attack units which might disrupt its mission goals and objectives.
Fenrir	Thurse-tank (AI)	Assault Unit	<p>The Fenrir is an AI-controlled version of the Loki, swapping electronic equipment and stealth capability for better weaponry, and increased front armor. The maneuverability and perks for the different movement modes remains. The Fenrir carries heavy weaponry which enables it to hunt down bigger targets as it self and be a Threat even for the heaviest Tank. The controlling AI is very aggressive and will not fall back, even if it is outnumbered or outgunned.</p> <p>The most notable variant of the Fenrir is the Alpha Fenrir, a rare Einherjar unit, which has excellent Leadership abilities.</p>
Geri / Freki	Thurse-Tank (AI)	Escorts	<p>The Geri and Freki are the newest types of Thurse-Tanks. They are direct descendants of the original Fenrir Thurse-Tank. They are the smallest walking units on Jotunheim, and can only be operated by an Einherjar, since a normal human would not be capable of using the complex controls needed to control the walking system.</p> <p>The Geri and the Freki are both escort Units of the Odin command Mag-Tank. The Geri takes the role of the hard-hitting unit, while the Freki takes the role of a mass murderer, capable of engaging multiple targets.</p>
Heimdall	Mag-Tank	Medium Tank	The Heimdall is the working horse of the Jotunheim Mag-Tank armies. It is fast, well-armed, and packs a heavy punch. If needed, it can also slip into a support role. The Heimdall is the most produced Mag-Tank on Jotunheim, with many variants in circulation.
Hugin	Flying Drone (AI)	Recon Unit	Munin is a flying recon drone which is normally paired with the Odin Command Strider. It is controlled by a cunning AI, adding to its Communication Rating.
Loki	Thurse-Tank	Support Unit	<p>The Loki is a unit used to support other units by confusing and deceiving enemy forces. It possesses one of the best ECM and ECCM suites ever built, in addition to a smoke launcher. In its walker mode, it towers over the battlefield, giving it a good overview of the battlefield and what transpires in front of it. In ground mode, it becomes so small that it can drive through tunnels that are off-limits even to other Thurses or Tanks. The Loki also possesses adequate sensor shielding and other components that helps it not be seen.</p> <p>It possesses only light weaponry and mediocre armor, but it has a good maneuverability for its size. From the designers' standpoint, this is enough.</p>
Munin	Flying Drone (AI)	Recon Unit	The Hugin is a flying recon drone which is mainly paired with the Odin Command Strider. It is controlled by a cunning AI which adds its bonus to the Autodetect Rating.
Odin	Command Mag-Tank	Command unit	The Odin Command Mag-Tank is the center of any larger military force. The Odin possesses high-end command and control equipment. If necessary, the Odin can carry heavy weaponry, allowing it to take on a more aggressive role. This is not unusual for Jotunheim commanders.

AURORA: THE SILHOUETTE MAGAZINE

AXE OF INDEPENDENCE

Name	Type	Role	Description
Skalli	Mag-Tank (AI)	Light Tank	The Skalli is a version of the Skirnir, and is controlled by an Einherjar. The AI of the Skalli is very aggressive, and enjoys any combat it can be brought into. This hampers the usage of this unit as a fast recon unit, but as both a skirmisher and harasser this attitude is a bonus.
Skirnir	Mag-Tank	Light Tank	The Skirnir was designed to be a fast, small Mag-Tank on the battlefield, taking the role of a skirmisher, harasser, and scout. It is one of the fastest Mag-Tanks on Jotunheim, and can normally outrun any enemy which it cannot defeat.
Sleipnir	Mag-Tank (AI)	Transport	The Sleipnir Mag-Tank is the transport of the Jotunheim armies. Because infantry transports tend to draw fire, it was designed to be piloted by an AI. It is moderately armed, possessing only the weapons needed to defend itself if needed. The vehicle's AI is generally very defensive, and always attempts to avoid anything which can harm its passengers.
Surtr	Thurse	Assault Thurse	The Surtr is a relatively old Thurse, designed for mountain operations. In a normal fight against Mag-Tanks, the Surtr have a low chance of success. However, in dense mountain terrain the odds are increased substantially.
Tanngnjostr / Tanngrisnir	Mag-Tank (AI)	Escort Unit	The Tanngnjostr and Tanngrisnir were designed specifically as escort units for the Thor heavy Mag-Tank. These two are the toughest AI units available, however they do not carry the same amount of weapons that other Einherjar tanks carry. Instead, they can ram even the heaviest armored unit and come away without a scratch.
Thiazi	Thurse	AAA	The Thiaz was developed to bring anti-aircraft weapons into terrain that is hard to reach for Mag-Tanks. It provides some defense for the cumbersome Thurses against airstrikes.
Thor	Mag-Tank	Heavy Tank	The Thor is the largest Mag-Tank built on Jotunheim. Its magnetic drive is so strong that the Thor can carry the best armor, and still has enough free weight to support the Very Heavy Plasma-Cannon, capable of tearing through any known armor.
Ulfhednar	Battle-suit (AI)	Infantry like	Ulfhednar are Berserkir-suits controlled by an Einherjar. It trades the sturdiness of the Berserkir for higher speed, allowing it to keep up with the Mag-Tanks while on the offensive.
Uller	Mag-Tank	IFV	The Uller was designed in parallel to the Sleipnir. It has the same transport capacity as the Sleipnir, but the mission profile is totally different. Where the Sleipnir was built to safely transport troops between mission objectives and leave the combat zone, the mission profile of the Uller is to transport troops and also provide support on the battlefield.

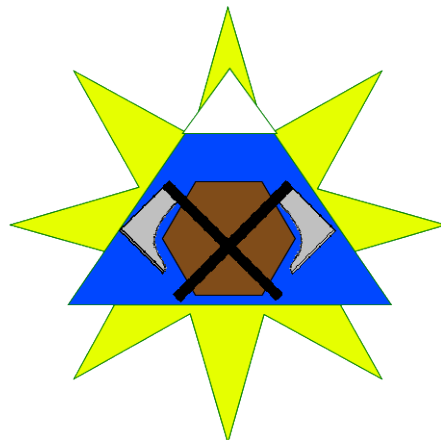

AURORA: THE SILHOUETTE MAGAZINE

AXE OF INDEPENDENCE

Command Squad

TV: 125

Type: Spec/Elite

*From the hall of Heaven he rode away
to Lidskialf, and sate upon his throne,
the mount, from whence his eye surveys the world.*

*And far from Heaven he turned his shining orbs
to look on Midgard, and earth, and men.
(Balder Dead (Matthew Arnold))*

The Command Group has only one purpose, which is to lead its force to victory. The chosen equipment and escorts decide which type of leader any Odin in the Squad may be. If the Odin is paired with a Raven Flock, it will be a conductor of the force. If paired with a Wolf Pack, then the Commander will lead from the front of the charge.

Options:

Specialist:

- Add up to two additional Odins for +115 TV each
- Any Odin may increase its EW-Skill by 1 for +15 TV each
- Any Odin may increase its Leadership Skill by 1 for +10 TV
- One Odin may add an ATM (F, limited ammo 6) for +70 TV

Elite:

- Add Stealth (2) to any unit which has no Stealth for +5 TV each
- One Odin may add the CBS and the EWH Trait for +25 TV
- One Odin may swap the HRFC for two LPCs (T, Sniper, No Reloads) for +35 TV or for one HLC (T, no reloads, AA) for +10 TV

Veteran Option:

Specialist:

- May use Elite options
- Any Odin may increase its Attack Skill by 1 for +15 TV
- Any Odin may increase its Defense Skill by 1 for +15 TV
- The Odin may increase its EW-Skill by 1 for +15 TV (this is in addition to the previous EW upgrade, for a total of 2 dice for +30 TV)
- Any Odin may add an ATM (F, limited ammo 6) for +70 TV

Elite:

- One Odin may increase its LD Skill from 3 to 4 for +10 TV
- Any Odin may add a Satellite Uplink for +10 TV each
- Any Odin may swap the HRFC for two LPCs (T, Sniper, No Reloads) for +35 TV or for one HLC (T,AA, No Reloads) for +10 TV



Combat Group Leader

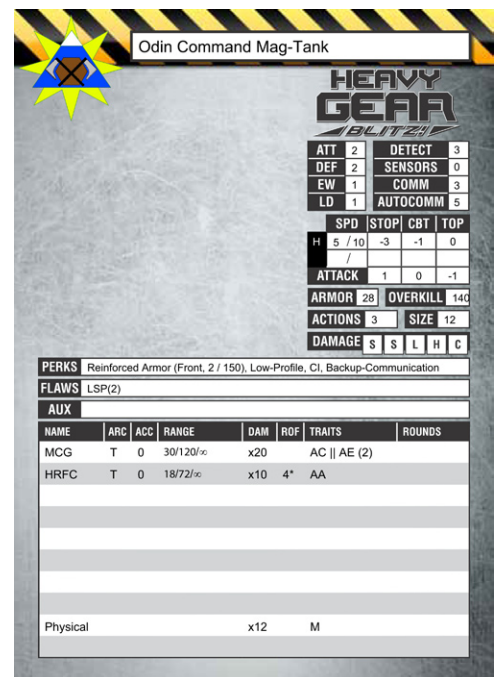

Additional Units (max 3)

AURORA: THE SILHOUETTE MAGAZINE

AXE OF INDEPENDENCE

Raven Flock

TV: 85

Type: Escort (Odin)

*O'er Mithgarth Hugin and Munin both
Each day set forth to fly;
For Hugin I fear lest he come not home,
But for Munin my care is more.*

(Bellows (1923:92))

The Raven Flock are the eyes and ears of any Odin. The Hugin and Munin Einherjer fly above the battlefield, and take notice of everything that transpires before them.

Options:

Auxiliary:

- The Munin may add an ECCM[3] for +5TV

Specialist:

- The Hugin may increase its Sensors to +3 for +5 TV

Elite:

- The Munin may add an AGM (FF, limited ammo 4) for +15 TV
- The Hugin may remove its TD and add 2 Very Light Rapid-Fire Cannon (FF, No Reloads) for +0 TV each

Veteran Option:

Auxiliary:

- May use Specialist options
- Any Hugin or Munin may increase their EW Skill by 1 for +5 TV each
- Any Hugin or Munin may increase their Defense Skill by 1 for +5 TV each

Specialist:

- May use Elite options
- The Hugin and Munin may increase Stealth[3] to Stealth[4] for +10 TV per Model

Elite:

- Any Hugin or Munin may increase their Attack and Defense Skill by 1 for +10 TV per Model

Hugin (AI) Escort Flying Drone							
HEAVY GEAR <i>BLITZ!</i>							
ATT 1	DEFECT 4						
DEF 2	SENSORS 1						
EW 2	COMM 3						
LD 0	AUTOCOMM 4						
SPD 9 / 18	STOP 0 CBT 2 TOP 3						
ATTACK 1	0 -1						
ARMOR 10	OVERKILL 40						
ACTIONS 1	SIZE 4						
DAMAGE	S L H C						
PERKS							
FLAWS Haywire Vulnerable							
AUX Stealth [3], TD [2]							
NAME	ARC	ACC	RANGE	DAM	RDF	TRAITS	ROUNDS
Physical				x4		M	
Physical				x4		M	

Munin (AI) Escort Flying Drone							
HEAVY GEAR <i>BLITZ!</i>							
ATT 1	DEFECT 7						
DEF 2	SENSORS 2						
EW 2	COMM 1						
LD 0	AUTOCOMM 2						
SPD 9 / 18	STOP 0 CBT 2 TOP 3						
ATTACK 1	0 -1						
ARMOR 10	OVERKILL 40						
ACTIONS 1	SIZE 4						
DAMAGE	S L H C						
PERKS Backup Sensors							
FLAWS Haywire Vulnerable							
AUX Stealth [3]							
NAME	ARC	ACC	RANGE	DAM	RDF	TRAITS	ROUNDS
Physical				x4		M	
Physical				x4		M	

Units

AURORA: THE SILHOUETTE MAGAZINE

AXE OF INDEPENDENCE

Wolf Pack

TV: 110

Type: Escort (Odin)

*Geri and Freki the war-wont sates,
the triumphant sire of hosts;
but on wine only the famed in arms,
Odin, ever lives.*

(Thorpe (1907:21))

The Geri and Freki Thurse-Tanks are the bodyguards of the Odin Command Mag-Tank. They are tasked with intercepting and destroying any enemy unit that attempts to destroy their charge.

Options:

Auxiliary:

- Any unit may add two VLCGs (F) for +10 TV each

Specialist:

- The Freki may swap both VLRFCs for two HRPDs (F, RoF 4, No Reloads) for +30 TV
- The Geri may swap both LCGs for two AGM (F, limited ammo 6) for +35 TV

Elite:

- Add Stealth (2) to any unit which has no Stealth for +5 TV each
- The Geri may swap both LGCs for one MPC (F, No Reloads) for +15 TV
- The Freki may swap both VLRFCs for one HRFC (F, Sniper, No Reloads) for -5 TV

Veteran Option:

Auxiliary:

- May use Specialist options
- Any Geri or Freki may increase their Attack and Defense Skill once by 1 for + 20 TV per Model

Specialist:

- May use Elite options

Elite:

- Add Stealth (4) to any unit which has no Stealth for +20 TV each

Freki (AI) Escort Thurse-Tank							
HEAVY GEAR BLITZ!							
ATT 2	DEFECT 2						
DEF 2	SENSORS 0						
EW 1	COMM 0						
LD 0	AUTOCOMM 2						
SPD 8 / 14	STOP -1 CBT 1 TOP 2						
W 4 / 8	0 1 2						
ATTACK 1	0 -1						
ARMOR 18	OVERKILL 72						
ACTIONS 2	SIZE B						
DAMAGE	<input type="checkbox"/> S <input type="checkbox"/> L <input type="checkbox"/> H <input type="checkbox"/> C						
PERKS RF (2 / 80), Low-Profile (Hovermode only), CI, Stun Immunity,							
FLAWS							
AUX							
NAME	ARC	ACC	RANGE	DAM	ROF	TRAITS	ROUNDS
VLRFC	F	0	12/48/∞	x4	8*	AA	
VLRFC	F	0	12/48/∞	x4	8*	AA	
HMG	F	0	6/24/∞	x4	3	AI	
HMG	F	0	6/14/∞	x4	3	AI	
Physical x8 M							

Geri (AI) Escort Thurse-Tank							
HEAVY GEAR BLITZ!							
ATT 2	DEFECT 2						
DEF 2	SENSORS 0						
EW 1	COMM 0						
LD 0	AUTOCOMM 2						
SPD 8 / 14	STOP -1 CBT 1 TOP 2						
W 4 / 8	0 1 2						
ATTACK 1	0 -1						
ARMOR 18	OVERKILL 72						
ACTIONS 2	SIZE B						
DAMAGE	<input type="checkbox"/> S <input type="checkbox"/> L <input type="checkbox"/> H <input type="checkbox"/> C						
PERKS RF (2 / 80), Low-Profile (Hovermode only), CI, Stun Immunity,							
FLAWS							
AUX							
NAME	ARC	ACC	RANGE	DAM	ROF	TRAITS	ROUNDS
LCG	F	0	24/96/∞	x12	0	AC AE(1)	
LCG	F	0	24/96/∞	x12	0	AC AE(1)	
Physical x8 M							

Units

AURORA: THE SILHOUETTE MAGAZINE

AXE OF INDEPENDENCE

Buck Squad

TV: 170

Type: Escort (Thor)

*Straightway were the goats homeward driven,
hurried to the traces; they had fast to run.
The rocks were shivered, the earth was in a blaze;
Odin's son drove to Jötunheim.*

(Thorpe (1866:64-65).)

Like the Thor that they escort, the Buck Squad is hard to kill. Their purpose is not only to defend the Thor they are attached to, but also to disturb the movement of an enemy so that their Thor can line up a killing shot.

Options:

Auxiliary:

- Any Tanngnisnir or Tanngnjostr may add the Rugged Movement Trait for +10 TV each

Specialist:

- Any Tanngnisnir or Tanngnjostr may increase the Reinforced Front trait to (5 / 150) for +5 TV each

Elite:

- The Tanngnisnir may swap the LCG for a LPC (F, No Reloads) for +10 TV
- The Tanngnjostr may swap the HGLC for a LLC (F, AA, No Reloads) for +10 TV

Veteran Option:

Auxiliary:

- Any Tanngnisnir or Tanngnjostr may increase the Defense Skill by 1 for +5 TV each
- May use Specialist options

Specialist:

- May use Elite options

Elite:

- Any Tanngnisnir or Tanngnjostr may increase the Attack Skill by 1 for +5 TV each

Tanngnjostr (AI) Escort Mag-Tank							
HEAVY GEAR <i>BLITZ!</i>							
ATT 3	DEFECT 2						
DEF 2	SENSORS 0						
EW 1	COMM 0						
LD 0	AUTOCOMM 2						
SPD 7 / 14	STOP -2						
CBT 0	TOP 1						
ATTACK 1	0 -1						
ARMOR 25	OVERKILL 120						
ACTIONS 1	SIZE 10						
DAMAGE S	S L H C						
PERKS	Reinforced Armor (Front, 2 / 135), Low-Profile, CI, Stun Immunity, Ram Plate						
FLAWS							
AUX	Jump Jets [6]						
NAME	ARC	ACC	RANGE	DAM	RDF	TRAITS	ROUNDS
HGLC	T	1	12/48/∞	x16	1	AA, MB3	
Physical x10 M							

Tanngnisnir (AI) Escort Mag-Tank							
HEAVY GEAR <i>BLITZ!</i>							
ATT 3	DEFECT 2						
DEF 2	SENSORS 0						
EW 1	COMM 0						
LD 0	AUTOCOMM 2						
SPD 7 / 14	STOP -2						
CBT 0	TOP 1						
ATTACK 1	0 -1						
ARMOR 25	OVERKILL 120						
ACTIONS 1	SIZE 10						
DAMAGE S	S L H C						
PERKS	Reinforced Armor (Front, 2 / 135), Low-Profile, CI, Stun Immunity, Ram Plate						
FLAWS							
AUX	Jump Jets [6]						
NAME	ARC	ACC	RANGE	DAM	RDF	TRAITS	ROUNDS
LCG	T	0	24/96/∞	x12	0	AC AE(1)	
Physical x10 M							

Units

AURORA: THE SILHOUETTE MAGAZINE

AXE OF INDEPENDENCE

Heavy Mag-Tank Squad

TV: 360

Type: Aux/Spec/Elite

*Then comes the mighty son of Hlôdyn:
Odin's son goes with the monster to fight;
Midgård's Veor in his rage will slay the worm.
(Thorpe (1907:7))*

The Heavy Mag-Tanks represent the spearhead of any Jotunheim force. They bring the most brutal firepower, combined with the best armor available. They are hard to dispatch of and can damage even the heaviest armored vehicle known.

Options:

Auxiliary:

- Add up to two Thors for +350 TV each
- Any Thor may increase the ammo for the ATM (F, limited ammo 2) to 12 for +15 TV each

Specialist:

- One Thor may swapped for a Vingthor for +60 TV
- One Thor may swap both LRFCs for two VHRFC (T, AA, No Reloads) for +35 TV

Elite:

- Up to two Thors may swap the ATM (F, limited ammo 2) for an HATM(F, limited ammo 2) for +60 TV each
- Up to two Thors may swap both LLCs for two HLCs (T, AA, No Reloads) for +20 TV per Model
- The CGL may increase its Autocomm to 4, Comms to +2 and add the Backup Communication Perk for +5 TV
- One additional Thor may swap both LRFCs for two VHRFC (T, AA, No Reloads) for +35 TV

Veteran Option:

Auxiliary:

- Any Thor may increase the Attack Skill by 1 for +10 TV each
- Any Thor may increase the Defense Skill by 1 for +10 TV each
- May use Specialist options

Specialist:

- May use Elite options
- Any Unit may add an AMS for +5 TV each
- Any Thor may swap both LRFCs for two VHRFC (T, AA, No Reloads) for +35 TV each

Elite:

- Any Thor may swapped for a Vingthor for +60 TV each
- Any Thor may increase the Attack and Defense skill from 3 to 4 for +20 TV each

Special Rule:

You must have 3 Thors in order to purchase sequential Heavy Mag-Tank Combat Groups.

See Following Page for Units

AURORA: THE SILHOUETTE MAGAZINE AXE OF INDEPENDENCE

Thor Heavy Mag-Tank

HEAVY GEAR
BLITZ!

ATT	2	DETECT	3
DEF	2	SENSORS	0
EW	1	COMM	0
LD	1	AUTOCOMM	2

SPD	STOP	CBT	TOP
H	6 / 12	-4	-2 -1
/	/	/	/

ATTACK	1	0	-1
--------	---	---	----

ARMOR	38	OVERKILL	190
-------	----	----------	-----

ACTIONS	3	SIZE	14
---------	---	------	----

DAMAGE	S	S	L	H	C
--------	---	---	---	---	---

PERKS Reinforced Armor (Front, 14 / 260), Low-Profile, Cold Immunity

FLAWS LSP(2), Sensor Dependent

AUX

NAME	ARC	ACC	RANGE	DAM	RDF	TRAITS	ROUNDS
VHCG	F	0	60/240/∞	x34		AC AE (2)	
LRFC	T	0	12/48/∞	x6	6*	AA	
LRFC	T	0	12/48/∞	x6	6*	AA	
LLC	T	1	30/120/∞	x16		AA, MB2	
LLC	T	1	30/120/∞	x16		AA, MB2	
ATM	F	1	18/72/∞	x25		IF,G	∞∞
AGM	F	1	18/72/∞	x15		IF,G	∞∞∞∞∞∞∞∞∞

Physical x14 M

Combat Group Leader

Thor Heavy Mag-Tank

HEAVY GEAR
BLITZ!

ATT	2	DETECT	3
DEF	2	SENSORS	0
EW	1	COMM	0
LD	0	AUTOCOMM	2

SPD	STOP	CBT	TOP
H	6 / 12	-4	-2 -1
/	/	/	/

ATTACK	1	0	-1
--------	---	---	----

ARMOR	38	OVERKILL	190
-------	----	----------	-----

ACTIONS	3	SIZE	14
---------	---	------	----

DAMAGE	S	S	L	H	C
--------	---	---	---	---	---

PERKS Reinforced Armor (Front, 14 / 260), Low-Profile, Cold Immunity

FLAWS LSP(2), Sensor Dependent

AUX

NAME	ARC	ACC	RANGE	DAM	RDF	TRAITS	ROUNDS
VHCG	F	0	60/240/∞	x34		AC AE (2)	
LRFC	T	0	12/48/∞	x6	6*	AA	
LRFC	T	0	12/48/∞	x6	6*	AA	
LLC	T	1	30/120/∞	x16		AA, MB2	
LLC	T	1	30/120/∞	x16		AA, MB2	
ATM	F	1	18/72/∞	x25		IF,G	∞∞
AGM	F	1	18/72/∞	x15		IF,G	∞∞∞∞∞∞∞∞∞

Physical x14 M

Vingthor Heavy Mag-Tank

HEAVY GEAR
BLITZ!

ATT	2	DETECT	3
DEF	2	SENSORS	0
EW	1	COMM	0
LD	0	AUTOCOMM	2

SPD	STOP	CBT	TOP
H	6 / 12	-4	-2 -1
/	/	/	/

ATTACK	1	0	-1
--------	---	---	----

ARMOR	38	OVERKILL	190
-------	----	----------	-----

ACTIONS	3	SIZE	14
---------	---	------	----

DAMAGE	S	S	L	H	C
--------	---	---	---	---	---

PERKS Reinforced Armor (Front, 14 / 260), Low-Profile, Cold Immunity, AP-Charge

FLAWS LSP(2), Sensor Dependent

AUX

NAME	ARC	ACC	RANGE	DAM	RDF	TRAITS	ROUNDS
VHPC	F	0	60/240/∞	x25		AP, Sniper	
LPC	T	0	24/96/∞	x10		AP, Sniper	
LPC	T	0	24/96/∞	x10		AP, Sniper	
LLC	T	1	30/120/∞	x16		AA, MB2	
LLC	T	1	30/120/∞	x16		AA, MB2	
ATM	F	1	18/72/∞	x25		IF,G	∞∞
AGM	F	1	18/72/∞	x15		IF,G	∞∞∞∞∞∞∞∞∞

Physical x14 M

Additional Units (max 3)

AURORA: THE SILHOUETTE MAGAZINE

AXE OF INDEPENDENCE

Medium Mag-Tank Squad

TV: 230

Type: Core/Aux/Spec

*Fast move the sons of Mim and fate
Is heard in the note of the Gjallarhorn;
Loud blows Heimdall, the horn is aloft,
In fear quake all who on Hel-roads are*
(Bellows (1923:20))

The medium Mag-Tanks form the backbone of the Jotunheim armies. They are considered the quintessential jack-of-all-trades, and are not masters of any one particular specialized field. Nevertheless, their balance of firepower, armor and speed means that the medium Mag-Tanks can be found on almost every battlefield.

Options:

Core:

- Add up to two Heimdalls for +220 TV each
- Any Heimdall may add an additional Sturdy box for +10 TV, increasing the Overkill value to 120, 150 in the Front arc

Auxiliary:

- Any Heimdall may increase Autodetection to 6 for +5 TV each

Specialist::

- One Heimdall may swap the LLC for a HLC (T, AA, No Reloads) for +10 TV
- One Heimdall may swap any AGM for an ATM (FF, limited ammo 2) for +20 TV
- Any Heimdall may add Jump Jets (6) for +10 TV each

Veteran Option:

Core:

- Any Heimdall may increase its Attack Skill by 1 for +10 TV each
- Any Heimdall may increase its Defense Skill by 1 for +10 TV each
- One Heimdall may swap the HCG for a HPC (T, No Reloads) for +10 TV
- May use Auxiliary options

Auxiliary:

- Any Heimdall may increase its EW Skill by 1 for +10 TV each
- The CGL may increase its LD Skill by 1 for +10 TV
- May use Specialist options

Specialist::

- An additional Heimdall may swap the LLC for a HLC (T, AA, No Reloads) for +10 TV
- One additional Heimdall may swap its HCG for a HPC (T, No Reloads) for +10 TV
- One additional Heimdall may swap any AGM for an ATM (FF, limited ammo 2) for +20 TV each

ATT	2	DEFECT	4
DEF	2	SENSORS	2
EW	1	COMM	0
LD	1	AUTOCOMM	2
SPD	7 / 14	STOP	-3
		CBT	-1
		TOP	0
ATTACK	1	0	-1
ARMOR	24	OVERKILL	96
ACTIONS	2	SIZE	12
DAMAGE		S	L H C

NAME	ARC	ACC	RANGE	DAM	RDF	TRAITS	ROUNDS
HCG	T	0	48/192/∞	x28		AC AE (2)	
LLC	T	1	30/120/∞	x16		AA, MB2	
MRFC	T	0	18/72/∞	x8	5*	AA	
AGM	FF	1	18/72/∞	x15		IF,G	0000
AGM	FF	1	18/72/∞	x15		IF,G	0000

Physical x12 M

Combat Group Leader

ATT	2	DEFECT	4
DEF	2	SENSORS	2
EW	1	COMM	0
LD	0	AUTOCOMM	2
SPD	7 / 14	STOP	-3
		CBT	-1
		TOP	0
ATTACK	1	0	-1
ARMOR	24	OVERKILL	96
ACTIONS	2	SIZE	12
DAMAGE		S	L H C

NAME	ARC	ACC	RANGE	DAM	RDF	TRAITS	ROUNDS
HCG	T	0	48/192/∞	x28		AC AE (2)	
LLC	T	1	30/120/∞	x16		AA, MB2	
MRFC	T	0	18/72/∞	x8	5*	AA	
AGM	FF	1	18/72/∞	x15		IF,G	0000
AGM	FF	1	18/72/∞	x15		IF,G	0000

Physical x12 M

Additional Units (max 3)

AURORA: THE SILHOUETTE MAGAZINE

AXE OF INDEPENDENCE

Light Mag-Tank Squad

TV: 190

Type: Core/Aux/Spec

*Nine feet will go Fiörgyn's son,
bowed by the serpent, who feared no foe.
All men will their homes forsake*

(Thorpe (1907:7))

The Light Mag-Tanks Squads are designed to gather information and harass the enemy. If their mission is too dangerous, the squad can increase its numbers with units which are controlled by Einherjars.

Options:

Core:

- Add an additional Skimir for +90 TV

Auxiliary:

- Any Skimir may increase the EW Skill by 1 for +10 TV each
- Any Skimir may swap the ECCM for an ECCM[3] and an ECM[3] for +5 TV each

Specialist::

- Up to two Skimirs may be swapped for Skallis for +15 TV each
- One unit may swap the LCG for a LPC (T, No Reloads) for +10 TV
- One Unit may swap the MRP for an AGM (T, limited ammo 4) for +20 TV

Veteran Option:

Core:

- Any Skimir may increase Attack and Defense by 1 for +20 TV each
- May use Auxilliary options

Auxiliary:

- May use Specialist options
- Any Skimir may increase the EW skill a second time by 1 for +10 TV each

Specialist::

- May use Specialist options
- Any Skimir may increase the EW skill a second time by 1 for +10 TV each

See Following Page for Units

AURORA: THE SILHOUETTE MAGAZINE

AXE OF INDEPENDENCE

Skirnir Light Mag-Tank

HEAVY GEAR
BLITZ!

ATT	2	DETECT	4
DEF	2	SENSORS	2
EW	1	COMM	1
LD	0	AUTOCOMM	4

SPD	STOP	CBT	TOP	
H	10/20	-3	-1	0
/	/	/	/	/

ATTACK	1	0	-1
--------	---	---	----

ARMOR	20	OVERKILL	80
-------	----	----------	----

ACTIONS	2	SIZE	9
---------	---	------	---

DAMAGE	<input type="checkbox"/>	S	L	H	C
--------	--------------------------	---	---	---	---

PERKS Reinforced Armor (Front, 4 / 96), Low-Profile, CI

FLAWS LSP(1), Sensor Dependent

AUX ECCM(2), Jump Jets (6)

NAME	ARC	ACC	RANGE	DAM	ROF	TRAITS	ROUNDS
LCG	T	0	24/96/∞	x12		AC AE (1)	
SLC	T	1	30/120/∞	x12		AA, MB1	
MRP/9	T	-1	12/48/∞	x18	1	IF	

Physical x9 M

Member

Skirnir Light Mag-Tank (CGL)

HEAVY GEAR
BLITZ!

ATT	2	DETECT	4
DEF	2	SENSORS	2
EW	1	COMM	1
LD	1	AUTOCOMM	4

SPD	STOP	CBT	TOP	
H	10/20	-3	-1	0
/	/	/	/	/

ATTACK	1	0	-1
--------	---	---	----

ARMOR	20	OVERKILL	80
-------	----	----------	----

ACTIONS	2	SIZE	9
---------	---	------	---

DAMAGE	<input type="checkbox"/>	S	L	H	C
--------	--------------------------	---	---	---	---

PERKS Reinforced Armor (Front, 4 / 96), Low-Profile, CI

FLAWS LSP(1), Sensor Dependent

AUX ECCM(2), Jump Jets (6)

NAME	ARC	ACC	RANGE	DAM	ROF	TRAITS	ROUNDS
LCG	T	0	24/96/∞	x12		AC AE (1)	
SLC	T	1	30/120/∞	x12		AA, MB1	
MRP/9	T	-1	12/48/∞	x18	1	IF	

Physical x9 M

Combat Group Leader

Skirnir Light Mag-Tank

HEAVY GEAR
BLITZ!

ATT	2	DETECT	4
DEF	2	SENSORS	2
EW	1	COMM	1
LD	0	AUTOCOMM	4

SPD	STOP	CBT	TOP	
H	10/20	-3	-1	0
/	/	/	/	/

ATTACK	1	0	-1
--------	---	---	----

ARMOR	20	OVERKILL	80
-------	----	----------	----

ACTIONS	2	SIZE	9
---------	---	------	---

DAMAGE	<input type="checkbox"/>	S	L	H	C
--------	--------------------------	---	---	---	---

PERKS Reinforced Armor (Front, 4 / 96), Low-Profile, CI

FLAWS LSP(1), Sensor Dependent

AUX ECCM(2), Jump Jets (6)

NAME	ARC	ACC	RANGE	DAM	ROF	TRAITS	ROUNDS
LCG	T	0	24/96/∞	x12		AC AE (1)	
SLC	T	1	30/120/∞	x12		AA, MB1	
MRP/9	T	-1	12/48/∞	x18	1	IF	

Physical x9 M

Additional Units (max 3)

Skalli Light (AI) Mag-Tank

HEAVY GEAR
BLITZ!

ATT	3	DETECT	3
DEF	2	SENSORS	0
EW	1	COMM	0
LD	0	AUTOCOMM	2

SPD	STOP	CBT	TOP	
H	10/20	-3	-1	0
/	/	/	/	/

ATTACK	1	0	-1
--------	---	---	----

ARMOR	20	OVERKILL	80
-------	----	----------	----

ACTIONS	2	SIZE	9
---------	---	------	---

DAMAGE	<input type="checkbox"/>	S	L	H	C
--------	--------------------------	---	---	---	---

PERKS Reinforced Armor (Front, 4 / 96), Low-Profile, CI, Stun Immunity

FLAWS LSP(1), Sensor Dependent

AUX Jump Jets (6)

NAME	ARC	ACC	RANGE	DAM	ROF	TRAITS	ROUNDS
LCG	T	0	24/96/∞	x12		AC AE (1)	
SLC	T	1	30/120/∞	x12		AA, MB1	
MRP/9	T	-1	12/48/∞	x18	1	IF	

Physical x9 M

AURORA: THE SILHOUETTE MAGAZINE

AXE OF INDEPENDENCE

Berserkir Squad

TV: 95

Type: Core/Aux/Spec/Elite

Berserkir groups are the substitute for normal Infantry in the Jotunheim armies. The Berserkir battle-suits increase the survivability of the common infantryman and increase the weapons that a soldier can bring into the field. Like normal infantry, Berserkir groups can also be used to conquer or hold terrain, and they can still be transported by specialized vehicles. If necessary, human Berserkir suits can be swapped by the Einherjar-controlled Ulfhednars.

Options:

Core:

- One unit may swap its VLCCG for a LAC (F, Reload) and LGL(F, Reload) for +10 TV
- One unit may swap its VLCCG for a VLAC (F, Reload) and AGM (F, limited ammo 4) for +25 TV
- Add one Sleipnir for +90 TV
- Add up to two additional Berserkir Suites for +20 TV each

Auxiliary:

- Any Berserkir, except the CGL, may be swapped for an Ulfhednar for +5 TV each
- One additional unit may swap its VLCCG for a LAC (F, Reloads) and LGL(F, Reload) for +10 TV
- One additional unit may swap its VLCCG for a VLAC (F, Reloads) and AGM (F, limited ammo 4) for +25 TV
- One Berserkir or Ulfhednar may add a TD(4) for +10 TV

Specialist:

- Add Airdroppable to any Unit for +5 TV each
- Any Sleipnir may add an AMS for +15 TV each
- One Berserkir or Ulfhednar may swap the VLCCG for a second VA (F) , MBZK(F, No Reloads) and Weapon-Link (VA) for + 15 TV

Elite:

- Add Jump Jets (3) to any Unit for +5 TV each
- Any unit without Stealth may add Stealth (2) for +5 TV each

Veteran Option:

Core:

- Any Berserkir or Ulfhednar may increase Attack and Defense by 1 for + 10 TV each
- May use Auxiliary options

Auxiliary:

- May use Specialist options
- One additional Berserkir or Ulfhednar may add a TD(4) for +10 TV

Specialist:

- May use Elite options
- One additional Berserkir or Ulfhednars may swap the VLCCG for a second VA (F) , MBZK(F, No Reloads) and Weapon-Link (VA) for + 15 TV

Elite:

- Any Berserkir or Ulfhednar may increase Attack and Defense from 3 to 4 for +10 TV each

See Following Page for Units

AURORA: THE SILHOUETTE MAGAZINE

AXE OF INDEPENDENCE

Sleipnir APC (AI) Mag-Tank

HEAVY GEAR
BLITZ!

ATT	2	DETECT	2
DEF	3	SENSORS	0
EW	1	COMM	0
LD	0	AUTOCOMM	2

SPD	STOP	CBT	TOP	
H	7 / 14	-3	-1	0
W	/			

ATTACK	1	0	-1
--------	---	---	----

ARMOR	24	OVERKILL	120
-------	----	----------	-----

ACTIONS	2	SIZE	11
---------	---	------	----

DAMAGE	S	S	L	H	C
--------	---	---	---	---	---

PERKS Low-Profile, CI, Transport[1 Infantry squad or 1 Berserker Squad], SI

FLAWS LSP(2)

AUX

NAME	ARC	ACC	RANGE	DAM	ROF	TRAITS	ROUNDS
LRFC	T	0	18/72/∞	x6	6*	AA	
LRFC	T	0	18/72/∞	x6	6*	AA	

Physical x11 M

Transport

Beserkir Battlesuite

HEAVY GEAR
BLITZ!

ATT	2	DETECT	2
DEF	2	SENSORS	0
EW	1	COMM	0
LD	0	AUTOCOMM	2

SPD	STOP	CBT	TOP	
H	3 / 6	0	1	2
W	/			

ATTACK	1	0	-1
--------	---	---	----

ARMOR	10	OVERKILL	50
-------	----	----------	----

ACTIONS	1	SIZE	4
---------	---	------	---

DAMAGE	S	S	L	H	C
--------	---	---	---	---	---

PERKS Arms, CI, Reinforced Front (2 /60)

FLAWS

AUX

NAME	ARC	ACC	RANGE	DAM	ROF	TRAITS	ROUNDS
VLCG	F	0	18/72/∞	x8		AC AE(1)	
VA	F	-1	0	x8		AC, M	

Physical x4 M

Can enter buildings and transports.

Member x3

Command Beserkir Battlesuite

HEAVY GEAR
BLITZ!

ATT	2	DETECT	2
DEF	2	SENSORS	0
EW	1	COMM	0
LD	1	AUTOCOMM	2

SPD	STOP	CBT	TOP	
H	3 / 6	0	1	2
W	/			

ATTACK	1	0	-1
--------	---	---	----

ARMOR	10	OVERKILL	50
-------	----	----------	----

ACTIONS	1	SIZE	4
---------	---	------	---

DAMAGE	S	S	L	H	C
--------	---	---	---	---	---

PERKS Arms, CI, Reinforced Front (2 /60)

FLAWS

AUX ECCM (2)

NAME	ARC	ACC	RANGE	DAM	ROF	TRAITS	ROUNDS
VLCG	F	0	18/72/∞	x8		AC AE(1)	
VA	F	-1	0	x8		AC, M	

Physical x4 M

Can enter buildings and transports.

Combat Group Leader

Beserkir Battlesuite

HEAVY GEAR
BLITZ!

ATT	2	DETECT	2
DEF	2	SENSORS	0
EW	1	COMM	0
LD	0	AUTOCOMM	2

SPD	STOP	CBT	TOP	
H	3 / 6	0	1	2
W	/			

ATTACK	1	0	-1
--------	---	---	----

ARMOR	10	OVERKILL	50
-------	----	----------	----

ACTIONS	1	SIZE	4
---------	---	------	---

DAMAGE	S	S	L	H	C
--------	---	---	---	---	---

PERKS Arms, CI, Reinforced Front (2 /60)

FLAWS

AUX

NAME	ARC	ACC	RANGE	DAM	ROF	TRAITS	ROUNDS
VLCG	F	0	18/72/∞	x8		AC AE(1)	
VA	F	-1	0	x8		AC, M	

Physical x4 M

Can enter buildings and transports.

Additional Units (max 6)

Ulfhednar (AI) Battlesuite

HEAVY GEAR
BLITZ!

ATT	2	DETECT	2
DEF	2	SENSORS	0
EW	1	COMM	0
LD	0	AUTOCOMM	2

SPD	STOP	CBT	TOP	
H	4 / 9	0	1	2
W	/			

ATTACK	1	0	-1
--------	---	---	----

ARMOR	10	OVERKILL	40
-------	----	----------	----

ACTIONS	1	SIZE	4
---------	---	------	---

DAMAGE	S	S	L	H	C
--------	---	---	---	---	---

PERKS Arms, CI, Reinforced Front (2 / 48), Stun Immunity

FLAWS

AUX

NAME	ARC	ACC	RANGE	DAM	ROF	TRAITS	ROUNDS
VLCG	F	0	18/72/∞	x8		AC AE(1)	
VA	F	-1	0	x8		AC, M	

Physical x4 M

Can enter buildings and transports.

AURORA: THE SILHOUETTE MAGAZINE

AXE OF INDEPENDENCE

Cavalry Squad

TV: 290

Type: Aux/Spec

The cavalry squad has only one purpose. To transport a unit safely from point A to point B and that as save as possible.

Options:

Auxiliary:

- Add an additional Sleipnir for +90 TV
- The CGL may increase the EW Skill by 1 for +10 TV

Specialist:

- Any Sleipnir except the CGL may be swapped to a Warhorse Sleipnir for +35 TV each
- One Warhorse Sleipnir may swap the AGM for HGM (T, No Reloads) for -10 TV

Veteran Option:

Auxiliary:

- Any Sleipnir may increase its Attack Skill by 1 for +10 TV each
- Any Sleipnir may increase its Defense Skill by 1 for +10 TV each
- The CGL may increase its LD Skill by 1 for +10 TV

Specialist:

- Add Airdroppable to any Unit for +5 TV each
- Any Sleipnir may add an AMS for +15 TV each
- One additional Warhorse Sleipnir may swap the AGM for HGM (T, No Reloads) for -10 TV

See Following Page for Units

AURORA: THE SILHOUETTE MAGAZINE

AXE OF INDEPENDENCE

Sleipnir APC (AI) Mag-Tank

HEAVY GEAR
BLITZ!

ATT	2	DETECT	2
DEF	3	SENSORS	0
EW	1	COMM	0
LD	0	AUTOCOMM	2

SPD	STOP	CBT	TOP
H 7 / 14	-3	-1	0
/			

ATTACK	1	0	-1
--------	---	---	----

ARMOR	24	OVERKILL	120
-------	----	----------	-----

ACTIONS	2	SIZE	11
---------	---	------	----

DAMAGE	S	S	L	H	C
--------	---	---	---	---	---

PERKS Low-Profile, CI, Transport[1 Infantry squad or 1 Berserker Squad], SI
 FLAWS LSP(2)

AUX

NAME	ARC	ACC	RANGE	DAM	ROF	TRAITS	ROUNDS
LRFC	T	0	18/72/∞	x6	6*	AA	
LRFC	T	0	18/72/∞	x6	6*	AA	
Physical				x11		M	

Member x2

Leadstallion Sleipnir APC (AI) Mag-Tank

HEAVY GEAR
BLITZ!

ATT	2	DETECT	2
DEF	2	SENSORS	0
EW	1	COMM	1
LD	2	AUTOCOMM	4

SPD	STOP	CBT	TOP
H 7 / 14	-3	-1	0
/			

ATTACK	1	0	-1
--------	---	---	----

ARMOR	24	OVERKILL	120
-------	----	----------	-----

ACTIONS	2	SIZE	11
---------	---	------	----

DAMAGE	S	S	L	H	C
--------	---	---	---	---	---

PERKS Low-Profile, CI, Transport[1 Infantry squad or 1 Berserker Squad], SI
 FLAWS LSP(2)

AUX

NAME	ARC	ACC	RANGE	DAM	ROF	TRAITS	ROUNDS
LCG	T	0	24/96/∞	x12	0	AC AE(1)	
LCG	T	0	24/96/∞	x12	0	AC AE(1)	
Physical				x11		M	

Combat Group Leader

Sleipnir APC (AI) Mag-Tank

HEAVY GEAR
BLITZ!

ATT	2	DETECT	2
DEF	3	SENSORS	0
EW	1	COMM	0
LD	0	AUTOCOMM	2

SPD	STOP	CBT	TOP
H 7 / 14	-3	-1	0
/			

ATTACK	1	0	-1
--------	---	---	----

ARMOR	24	OVERKILL	120
-------	----	----------	-----

ACTIONS	2	SIZE	11
---------	---	------	----

DAMAGE	S	S	L	H	C
--------	---	---	---	---	---

PERKS Low-Profile, CI, Transport[1 Infantry squad or 1 Berserker Squad], SI
 FLAWS LSP(2)

AUX

NAME	ARC	ACC	RANGE	DAM	ROF	TRAITS	ROUNDS
LRFC	T	0	18/72/∞	x6	6*	AA	
LRFC	T	0	18/72/∞	x6	6*	AA	
Physical				x11		M	

Additional Units (max 4)

Warhorse Sleipnir APC (AI) Mag-Tank

HEAVY GEAR
BLITZ!

ATT	2	DETECT	2
DEF	2	SENSORS	0
EW	1	COMM	0
LD	0	AUTOCOMM	2

SPD	STOP	CBT	TOP
H 7 / 14	-3	-1	0
/			

ATTACK	1	0	-1
--------	---	---	----

ARMOR	24	OVERKILL	120
-------	----	----------	-----

ACTIONS	2	SIZE	11
---------	---	------	----

DAMAGE	S	S	L	H	C
--------	---	---	---	---	---

PERKS Low-Profile, CI, Transport[1 Infantry squad or 1 Berserker Squad], SI
 FLAWS LSP(2)

AUX

NAME	ARC	ACC	RANGE	DAM	ROF	TRAITS	ROUNDS
AGM	T	+1	18/72/∞	x15	0	IF, G	
LCG	T	0	24/96/∞	x12	0	AC AE(1)	
Physical				x11		M	

AURORA: THE SILHOUETTE MAGAZINE

AXE OF INDEPENDENCE

Valkyrie Squad

TV: 490

Type: Aux/Spec

Unlike the Cavalry squad, the Valkyrie Squad is designed to actively support the troops it carries into the field.

Options:

Auxiliary:

- Add an additional Uller for +160 TV
- Any Uller may add an AMS for +10 TV each

Specialist:

- Add an additional Uller for +160 TV
- Any Uller may add an AMS for +10 TV each

Veteran Option:

Auxiliary:

- Any Uller may increase its Attack and Defense Skills by 1 for +20 TV each
- The CGL may increase its LD Skill by 1 for +10 TV
- May use Specialist options

Specialist:

- Any Uller may add Jump Jets (6) for +15 TV each
- One Uller may swap both LLCs for two HLCs (T, AA, No Reloads) for +20 TV

See Following Page for Units

AURORA: THE SILHOUETTE MAGAZINE

AXE OF INDEPENDENCE

Uller IFV Mag-Tank

HEAVY GEAR
BLITZ!

ATT	2	DETECT	2
DEF	2	SENSORS	0
EW	1	COMM	0
LD	0	AUTOCOMM	2

SPD	STOP	CBT	TOP	
H	7 / 14	-3	-1	0
/	/	/	/	/

ATTACK	+1	0	-1
--------	----	---	----

ARMOR	20	OVERKILL	100
-------	----	----------	-----

ACTIONS	2	SIZE	11
---------	---	------	----

DAMAGE	S	S	L	H	C
--------	---	---	---	---	---

PERKS Low-Profile, CI, Transport[1 Infantry squad or 1 Berserker Squad]

FLAWS LSP(2)

AUX

NAME	ARC	ACC	RANGE	DAM	RDF	TRAITS	ROUNDS
LLC	T	+1	30/120/∞	x16		AA, MB2	
LLC	T	+1	30/120/∞	x16		AA, MB2	
AGM	T	+1	18/72/∞	x15		IF, G	oooo
MRP/18	F	-1	12/48/∞	x18	3	IF	
MRP/18	F	-1	12/48/∞	x18	3	IF	

Physical x11 M

Member x2

Uller IFV Mag-Tank

HEAVY GEAR
BLITZ!

ATT	2	DETECT	2
DEF	2	SENSORS	0
EW	1	COMM	0
LD	0	AUTOCOMM	2

SPD	STOP	CBT	TOP	
H	7 / 14	-3	-1	0
/	/	/	/	/

ATTACK	+1	0	-1
--------	----	---	----

ARMOR	20	OVERKILL	100
-------	----	----------	-----

ACTIONS	2	SIZE	11
---------	---	------	----

DAMAGE	S	S	L	H	C
--------	---	---	---	---	---

PERKS Low-Profile, CI, Transport[1 Infantry squad or 1 Berserker Squad]

FLAWS LSP(2)

AUX

NAME	ARC	ACC	RANGE	DAM	RDF	TRAITS	ROUNDS
LLC	T	+1	30/120/∞	x16		AA, MB2	
LLC	T	+1	30/120/∞	x16		AA, MB2	
AGM	T	+1	18/72/∞	x15		IF, G	oooo
MRP/18	F	-1	12/48/∞	x18	3	IF	
MRP/18	F	-1	12/48/∞	x18	3	IF	

Physical x11 M

Combat Group Leader

Uller IFV Mag-Tank

HEAVY GEAR
BLITZ!

ATT	2	DETECT	2
DEF	2	SENSORS	0
EW	1	COMM	0
LD	0	AUTOCOMM	2

SPD	STOP	CBT	TOP	
H	7 / 14	-3	-1	0
/	/	/	/	/

ATTACK	+1	0	-1
--------	----	---	----

ARMOR	20	OVERKILL	100
-------	----	----------	-----

ACTIONS	2	SIZE	11
---------	---	------	----

DAMAGE	S	S	L	H	C
--------	---	---	---	---	---

PERKS Low-Profile, CI, Transport[1 Infantry squad or 1 Berserker Squad]

FLAWS LSP(2)

AUX

NAME	ARC	ACC	RANGE	DAM	RDF	TRAITS	ROUNDS
LLC	T	+1	30/120/∞	x16		AA, MB2	
LLC	T	+1	30/120/∞	x16		AA, MB2	
AGM	T	+1	18/72/∞	x15		IF, G	oooo
MRP/18	F	-1	12/48/∞	x18	3	IF	
MRP/18	F	-1	12/48/∞	x18	3	IF	

Physical x11 M

Additional Units (max 4)

AURORA: THE SILHOUETTE MAGAZINE

AXE OF INDEPENDENCE

Light Thurse-Tank Squad

TV: 130

Type: Aux/Spec/Elite

*Unfettered will fare the Fenris Wolf
and ravaged the realm of men,
ere that cometh a kingly prince
as good, to stand in his stead.*

Hollander (2007:127)

Light Thurse-Tank Squads combine the maneuverability of the Thurse with the speed and armor of a Mag-Tank. This squad also contains the best electronic-warfare equipment available to Jotunheim. This squad can also swap its high-end electronics for heavier firepower.

Options:

Auxiliary:

- Add up to two additional Lokis for +110 TV each
- One Loki may swap the ECM[4] and ECCM[4] for ECM[5] and ECCM[5] for +5 TV

Specialist:

- Any Loki except the CGL may be swapped for a Fenrir for +30 TV each
- One Loki may increase Autodetect to 8 and Sensor to +3 for +5 TV
- One Fenrir may swap both MCGs for two MPCs (F, No Reloads) for +15 TV
- The CGL may add an Satellite Uplink for +10 TV

Elite:

- Any unit without Stealth may add Stealth(2) for +5 TV each
- The CGL Loki may be swapped for an Alpha Fenrir for +50 TV
- One Loki may be swapped for a Trickster Loki for +25 TV
- One Trickster Loki may swap the LRFC for LPC (T, No Reloads) for +5 TV
- Any Trickster Loki may increase Attack and Defense once by 1 for +30 TV each
- One Trickster Loki may add a AGM (T, limited ammo 6) for +45 TV
- Add Airdroppable to any unit for +5 TV each

Veteran Option:

Auxiliary:

- May use Specialist options
- The CGL may increase its LD Skill by 1 for +10 TV
- Any Loki may increase the EW Skill once by 1 for +15 TV each
- One additional Loki may swap the ECM[4] and ECCM[4] for ECM[5] and ECCM[5] for +5 TV

Specialist:

- May use Elite options
- Any Loki may increase the EW Skill a second time by 1 for +15 TV each
- The CGL may increase its LD Skill a second time by 1 for +10 TV
- One additional Loki may increase Autodetect to 8 and Sensor to +3 for +5 TV

Elite:

- Any Loki may be swapped for a Trickster Loki for +25 TV each
- Any Fenrir may swap both MCGs for two MPCs (F, No Reloads) for +15 TV each
- Any Fenrir may increase its Defense Skill by 1 for +10 TV each
- The Alpha Fenrir may increase Attack and Defense by 1 for +20 TV

See Following Page for Units

AURORA: THE SILHOUETTE MAGAZINE

AXE OF INDEPENDENCE

Fenrir Light (AI) Thurse-Tank

HEAVY GEAR
BLITZ!

ATT	3	DETECT	3
DEF	2	SENSORS	1
EW	1	COMM	0
LD	0	AUTOCOMM	2

SPD	STOP	CBT	TOP	
H	6 / 12	-3	-1	0
W	4 / 8	-2	-1	0
ATTACK	1	0	-1	

ARMOR 22 OVERKILL 88
ACTIONS 3 SIZE 10
DAMAGE S L H C

PERKS RF(4 / 104), Low-Profile (Hovermode only), SI, CI

FLAWS

AUX

NAME	ARC	ACC	RANGE	DAM	ROF	TRAITS	ROUNDS
MCG	F	0	30/120/∞	x20		AC AE(2)	
MCG	F	0	30/120/∞	x20		AC AE(2)	
APGL	T	-1	6 / 24/--	x4		IF, AI, AE3, M	
MRFC	T	0	30/120/∞	x8	5*	AA	

Physical x10 M

Alpha Fenrir Light (AI) Thurse-Tank

HEAVY GEAR
BLITZ!

ATT	2	DETECT	3
DEF	2	SENSORS	1
EW	1	COMM	1
LD	2	AUTOCOMM	4

SPD	STOP	CBT	TOP	
H	6 / 12	-3	-1	0
W	4 / 8	-2	-1	0
ATTACK	1	0	-1	

ARMOR 22 OVERKILL 88
ACTIONS 3 SIZE 10
DAMAGE S L H C

PERKS RF(4 / 104), Low-Profile (Hovermode only), SI, CI

FLAWS

AUX Sat. Uplink

NAME	ARC	ACC	RANGE	DAM	ROF	TRAITS	ROUNDS
MCG	F	0	30/120/∞	x20		AC AE(2)	
MCG	F	0	30/120/∞	x20		AC AE(2)	
APGL	T	-1	6 / 24/--	x4		IF, AI, AE3, M	
MRFC	T	0	30/120/∞	x8	5*	AA	

Physical x10 M

Loki Light Thurse-Tank (CGL)

HEAVY GEAR
BLITZ!

ATT	2	DETECT	5
DEF	2	SENSORS	2
EW	2	COMM	0
LD	2	AUTOCOMM	2

SPD	STOP	CBT	TOP	
H	6 / 12	-3	-1	0
W	4 / 8	-2	-1	0
ATTACK	1	0	-1	

ARMOR 22 OVERKILL 88
ACTIONS 3 SIZE 10
DAMAGE S L H C

PERKS Low-Profile (Hovermode only), Backup Sensors, CI

FLAWS Haywire Vulnerable

AUX ECM[4], ECCM[4], Stealth[4], Smoke[15]

NAME	ARC	ACC	RANGE	DAM	ROF	TRAITS	ROUNDS
LCG	T	0	24/96/∞	x12		AC AE(1)	
LRFC	T	0	12/48/∞	x6	6*	AA	

Physical x11 M

Combat Group Leader

Loki Light Thurse-Tank

HEAVY GEAR
BLITZ!

ATT	2	DETECT	3
DEF	2	SENSORS	2
EW	2	COMM	0
LD	0	AUTOCOMM	2

SPD	STOP	CBT	TOP	
H	6 / 12	-3	-1	0
W	4 / 8	-2	-1	0
ATTACK	1	0	-1	

ARMOR 22 OVERKILL 88
ACTIONS 3 SIZE 10
DAMAGE S L H C

PERKS Low-Profile (Hovermode only), Backup Sensors, CI

FLAWS Haywire Vulnerable

AUX ECM[4], ECCM[4], Stealth[4], Smoke[15]

NAME	ARC	ACC	RANGE	DAM	ROF	TRAITS	ROUNDS
LCG	T	0	24/96/∞	x12		AC AE(1)	
LRFC	T	0	12/48/∞	x6	6*	AA	

Physical x11 M

Trickster Loki Light Thurse-Tank

HEAVY GEAR
BLITZ!

ATT	2	DETECT	4
DEF	2	SENSORS	1
EW	2	COMM	0
LD	0	AUTOCOMM	2

SPD	STOP	CBT	TOP	
H	6 / 12	-3	-1	0
W	4 / 8	-2	-1	0
ATTACK	1	0	-1	

ARMOR 22 OVERKILL 88
ACTIONS 3 SIZE 10
DAMAGE S L H C

PERKS Low-Profile (Hovermode only), CI

FLAWS

AUX Stealth[4], Smoke[15]

NAME	ARC	ACC	RANGE	DAM	ROF	TRAITS	ROUNDS
MGC	T	0	24/96/∞	x20		AC AE(2)	
LRFC	T	0	12/48/∞	x6	6*	AA	

Physical x11 M

Additional Units (max 3)

AURORA: THE SILHOUETTE MAGAZINE

AXE OF INDEPENDENCE

Thurse Squad

TV: 95

Type: Aux/Spec/Elite

Mag-Tanks have difficulty in operating in dense woodlands, jungles, or rough mountains. These are the terrains where the Thurses shine. The normal Thurse Squad helps to secure paths that would be difficult for Mag-Tanks to hold.

Options:

Auxiliary:

- Add an additional Byleist for +85 TV
- One Byleist may add ECM[3] and ECCM[3] for +10 TV

Specialist:

- One Byleist may be swapped for a Thiazi for +75 TV
- Any unit may add a Grapple Launcher and Climbing Equipment for +5 TV each

Elite:

- One Thiazi may swap both VHRFC for two LLCs (F, Sniper, AA, No Reloads) for +10 TV

Veteran Option:

Auxiliary:

- Add a third Byleist for +85 TV
- An additional Byleist may add ECM[3] and ECCM[3] for +10 TV
- Any Unit may increase its EW Skill by 1 for +10 TV each
- The CGL may increase its LD Skill by 1 for +10 TV
- May use Specialist options

Specialist:

- An additional Byleist may be swapped for a Thiazi for +75 TV
- Any Unit may increase its Attack Skill by 1 for +10 TV each
- Any Unit may increase its Defense Skill by 1 for +10 TV each
- May use Elite options

Elite:

- The CGL may increase its LD Skill a second time by 1 for +10 TV
- Any Unit may increase its Attack Skill from 3 to 4 for +10 TV each
- Any Unit may increase its Defense Skill from 3 to 4 for +10 TV each
- Any Unit may increase its EW Skill from 2 to 3 for +10 TV each

See Following Page for Units

AURORA: THE SILHOUETTE MAGAZINE

AXE OF INDEPENDENCE

Byleist Thurse (CGL)



ATT	2	DETECT	4
DEF	2	SENSORS	1
EW	2	COMM	0
LD	1	AUTOCOMM	2

SPD	STOP	CBT	TOP
W 4 / 8	-3	-2	-1
/			

ATTACK	1	0	-1
--------	---	---	----

ARMOR	22	OVERKILL	88
-------	----	----------	----

ACTIONS	2	SIZE	10
---------	---	------	----

DAMAGE		S	L	H	C
--------	--	---	---	---	---

PERKS Arms, CI, Improved Off-Road, Sensor-Boom

FLAWS LSP(2)

AUX

NAME	ARC	ACC	RANGE	DAM	ROF	TRAITS	ROUNDS
MCG	F	0	30/120/∞	x20		AC AE(2)	
LRFC	T	0	12/48/∞	x6	6*	AA	
HMG	T	0	6/24/∞	x4	3	AI,M	

Physical x10 M

Combat Group Leader

Thiazi Thurse



ATT	2	DETECT	4
DEF	2	SENSORS	1
EW	2	COMM	0
LD	0	AUTOCOMM	2

SPD	STOP	CBT	TOP
W 4 / 8	-3	-2	-1
/			

ATTACK	2	1	0
--------	---	---	---

ARMOR	22	OVERKILL	88
-------	----	----------	----

ACTIONS	2	SIZE	10
---------	---	------	----

DAMAGE		S	L	H	C
--------	--	---	---	---	---

PERKS Arms, CI, Improved Off-Road, Anti-Personal Charges

FLAWS LSP(2)

AUX

NAME	ARC	ACC	RANGE	DAM	ROF	TRAITS	ROUNDS
VHRFC	T	0	18/72/∞	x13	3*	AA	
VHRFC	T	0	18/72/∞	x13	3*	AA	

Physical x10 M

Byleist Thurse



ATT	2	DETECT	4
DEF	2	SENSORS	1
EW	2	COMM	0
LD	0	AUTOCOMM	2

SPD	STOP	CBT	TOP
W 4 / 8	-3	-2	-1
/			

ATTACK	1	0	-1
--------	---	---	----

ARMOR	22	OVERKILL	88
-------	----	----------	----

ACTIONS	2	SIZE	10
---------	---	------	----

DAMAGE		S	L	H	C
--------	--	---	---	---	---

PERKS Arms, CI, Improved Off-Road, Sensor-Boom

FLAWS LSP(2)

AUX

NAME	ARC	ACC	RANGE	DAM	ROF	TRAITS	ROUNDS
MCG	F	0	30/120/∞	x20		AC AE(2)	
LRFC	T	0	12/48/∞	x6	6*	AA	
HMG	T	0	6/24/∞	x4	3	AI,M	

Physical x10 M

Additional Units (max 3)

AURORA: THE SILHOUETTE MAGAZINE

AXE OF INDEPENDENCE

Heavy Thurse Squad

TV: 120

Type: Spec

The Heavy Thurse Squad brings even heavier weaponry than their lighter cousins. While they cannot compare to the armaments of a Mag-Tank, heavy Thurses cannot be underestimated, and help to control rough terrain.

Options:

Specialist:

- Add an additional Surtr for +115 TV
- One Surtr may be swapped for a Muspell for +0 TV
- One Surtr may swap both MCGs for one HFM (F, No Reloads) for +0 TV
- Any Surtr may add a Grapple Launcher and Climbing Equipment for +10 TV each

Veteran Option:

Specialist:

- Add a third Surtr for +115 TV
- The CGL may increase its LD Skill by 1 for +10 TV
- Any Unit may increase its Attack Skill by 1 for +10 TV
- Any Unit may increase its Defense Skill by 1 for +10 TV
- One Muspell may swap both HIRPs for two HABM (F, No Reloads) for +5 TV
- A Second Surtr may be swapped for a Muspell for +0 TV
- One Surtr may swap both MCGs for two MPC(F, No Reloads) for +20 TV
- Any Muspell may add a Grapple Launcher and Climbing Equipment for +15 TV each

See Following Page for Units

AURORA: THE SILHOUETTE MAGAZINE AXE OF INDEPENDENCE

Surtr Thurse (CGL)

HEAVY GEAR
BLITZ!

ATT	2	DETECT	2
DEF	2	SENSORS	0
EW	1	COMM	0
LD	1	AUTOCOMM	2

SPD	STOP	CBT	TOP
W 4 / 8	-3	-2	-1
/			

ATTACK	1	0	-1
--------	---	---	----

ARMOR	22	OVERKILL	110
-------	----	----------	-----

ACTIONS	2	SIZE	12
---------	---	------	----

DAMAGE	S	S	L	H	C
--------	---	---	---	---	---

PERKS Arms, CI, Improved Off-Road, Anti-Personal Charges, RF (8 / 150)

FLAWS LSP(2), Sensor-Dependant

AUX

NAME	ARC	ACC	RANGE	DAM	ROF	TRAITS	ROUNDS
MCG	F	0	30/120/∞	x20		AC AE(2)	
MCG	T	0	30/120/∞	x20		AC AE(2)	
MRFC	T	0	18/72/∞	x8	5*	AA	
HMG	F	0	6/24/∞	x4	3	AI,M	
HMG	F	0	6/24/∞	x4	3	AI,M	

Physical x12 M

Combat Group Leader

Muspell Thurse

HEAVY GEAR
BLITZ!

ATT	2	DETECT	2
DEF	2	SENSORS	0
EW	1	COMM	0
LD	0	AUTOCOMM	2

SPD	STOP	CBT	TOP
W 4 / 8	-3	-2	-1
/			

ATTACK	1	0	-1
--------	---	---	----

ARMOR	22	OVERKILL	110
-------	----	----------	-----

ACTIONS	2	SIZE	12
---------	---	------	----

DAMAGE	S	S	L	H	C
--------	---	---	---	---	---

PERKS Arms, CI, Improved Off-Road, AP Charges, RF (8 / 150), Fire Resistant

FLAWS LSP(2), Sensor Dependant

AUX

NAME	ARC	ACC	RANGE	DAM	ROF	TRAITS	ROUNDS
MRFC	F	0	18/72/∞	x8	5*	AA	
HIRP/48	F	-1	18/72/∞	x16	4	IF, SB	
HIRP/48	F	-1	18/72/∞	x16	4	IF, SB	
HFL	F	1	6/24/∞	x9	2	AE(2), IF, SB, M	

Physical x12 M

Surtr Thurse

HEAVY GEAR
BLITZ!

ATT	2	DETECT	2
DEF	2	SENSORS	0
EW	1	COMM	0
LD	0	AUTOCOMM	2

SPD	STOP	CBT	TOP
W 4 / 8	-3	-2	-1
/			

ATTACK	1	0	-1
--------	---	---	----

ARMOR	22	OVERKILL	110
-------	----	----------	-----

ACTIONS	2	SIZE	12
---------	---	------	----

DAMAGE	S	S	L	H	C
--------	---	---	---	---	---

PERKS Arms, CI, Improved Off-Road, Anti-Personal Charges, RF (8 / 150)

FLAWS LSP(2), Sensor-Dependant

AUX

NAME	ARC	ACC	RANGE	DAM	ROF	TRAITS	ROUNDS
MCG	F	0	30/120/∞	x20		AC AE(2)	
MCG	T	0	30/120/∞	x20		AC AE(2)	
MRFC	T	0	18/72/∞	x8	5*	AA	
HMG	F	0	6/24/∞	x4	3	AI,M	
HMG	F	0	6/24/∞	x4	3	AI,M	

Physical x12 M

Additional Units (max 3)

AURORA: THE SILHOUETTE MAGAZINE

AXE OF INDEPENDENCE

Fire Support Group

TV: 290

Type: Core/Aux/Spec

Even if nearly every Mag-Tank possesses some sort of indirect fire weapon, this is not always enough. For such cases, the Fire Support Group was designed, carrying the most indirect fire weapons available to any Squad.

Options:

Core:

- Add an additional Support Skimir for +90 TV

Auxiliary:

- Any Support Skimir may be swapped for a Support Heimdall for +40 TV each
- One unit may swap any HRP for a HGM (same arc as the HRP, Sniper, No Reloads) for +5 TV for each swapped HRP

Specialist:

- Any Support Heimdall may be swapped for an Rym Thor for +120 TV each
- One unit may swap any MFMs for a HFM (same arc as the MFM, Sniper, No Reloads) for +40 TV for each swapped MFM
- One unit may swap any LRFC for a VHRFC (same arc as the LRFC, Sniper, No Reloads) for +15 TV for each swapped LRFC

Veteran Option:

Core:

- May use Auxilliary options
- Any Support Skimir may increase its Attack and Defense Skill by 1 for +20 TV each

Auxiliary:

- May use Specialist options
- Any Support Heimdall may increase its Attack and Defense Skill by 1 for +20 TV each
- Any unit may swap any HRP for a HGM (same arc as the HRP, Sniper, No Reloads) for +5 TV each for each swapped HRP

Specialist:

- Any Rym Thor may increase its Attack and Defense Skill by 1 once for +30 TV each
- Any unit may swap any MFMs for a HFM (same arc as the MFM, Sniper, No Reloads) for +40 TV each for each swapped MFM
- Any unit may swap any LRFC for a VHRFC (same arc as the LRFC, Sniper, No Reloads) for +15 TV each for each swapped LRFC

See Following Page for Units

AURORA: THE SILHOUETTE MAGAZINE

AXE OF INDEPENDENCE

Support Skimir Light Support Mag-Tank



ATT	2	DETECT	4
DEF	2	SENSORS	2
EW	1	COMM	0
LD	0	AUTOCOMM	4

SPD	STOP	CBT	TOP	
H	10/20	-3	-1	0
/	/	/	/	/

ATTACK	1	0	-1
--------	---	---	----

ARMOR	20	OVERKILL	80
-------	----	----------	----

ACTIONS	2	SIZE	9
---------	---	------	---

DAMAGE	S	L	H	C
--------	---	---	---	---

PERKS Reinforced Armor (Front, 4 / 96), Low-Profile, CI

FLAWS LSP(1), Sensor Dependent

AUX Jump Jets [6]

NAME	ARC	ACC	RANGE	DAM	ROF	TRAITS	ROUNDS
HRP/48	T	-1	18/72/∞	x20	4	IF, SNPR	
SLC	T	1	30/120/∞	x12		AA, MB1	

Physical x9 M

Member x2

Support Skimir Light Support Mag-Tank (CGL)



ATT	2	DETECT	4
DEF	2	SENSORS	2
EW	1	COMM	0
LD	2	AUTOCOMM	4

SPD	STOP	CBT	TOP	
H	10/20	-3	-1	0
/	/	/	/	/

ATTACK	1	0	-1
--------	---	---	----

ARMOR	20	OVERKILL	80
-------	----	----------	----

ACTIONS	2	SIZE	9
---------	---	------	---

DAMAGE	S	L	H	C
--------	---	---	---	---

PERKS Reinforced Armor (Front, 4 / 96), Low-Profile, CI

FLAWS LSP(1), Sensor Dependent

AUX Jump Jets [6]

NAME	ARC	ACC	RANGE	DAM	ROF	TRAITS	ROUNDS
HRP/48	T	-1	18/72/∞	x20	4	IF, SNPR	
SLC	T	1	30/120/∞	x12		AA, MB1	

Physical x9 M

Combat Group Leader

Rym Thor Heavy Support Mag-Tank



ATT	2	DETECT	3
DEF	2	SENSORS	1
EW	1	COMM	0
LD	0	AUTOCOMM	2

SPD	STOP	CBT	TOP	
H	6 / 12	-4	-2	-1
/	/	/	/	/

ATTACK	1	0	-1
--------	---	---	----

ARMOR	38	OVERKILL	190
-------	----	----------	-----

ACTIONS	3	SIZE	14
---------	---	------	----

DAMAGE	S	L	H	C
--------	---	---	---	---

PERKS Reinforced Armor (Front, 14 / 260), Low-Profile, Cold Immunity

FLAWS LSP(2), Sensor Dependent

AUX

NAME	ARC	ACC	RANGE	DAM	ROF	TRAITS	ROUNDS
LRFC	T	0	12/48/∞	x6	6*	AA	
LRFC	T	0	12/48/∞	x6	6*	AA	
MFM	T	-1	30/120/∞	x20		IF, MR, AE3, SNPR	
MFM	T	-1	30/120/∞	x20		IF, MR, AE3, SNPR	
HRP/48	F	-1	18/72/∞	x20	4	IF, SNPR	
HRP/48	F	-1	18/72/∞	x20	4	IF, SNPR	

Physical x14 M

Support Skimir Light Support Mag-Tank



ATT	2	DETECT	4
DEF	2	SENSORS	2
EW	1	COMM	0
LD	0	AUTOCOMM	4

SPD	STOP	CBT	TOP	
H	10/20	-3	-1	0
/	/	/	/	/

ATTACK	1	0	-1
--------	---	---	----

ARMOR	20	OVERKILL	80
-------	----	----------	----

ACTIONS	2	SIZE	9
---------	---	------	---

DAMAGE	S	L	H	C
--------	---	---	---	---

PERKS Reinforced Armor (Front, 4 / 96), Low-Profile, CI

FLAWS LSP(1), Sensor Dependent

AUX Jump Jets [6]

NAME	ARC	ACC	RANGE	DAM	ROF	TRAITS	ROUNDS
HRP/48	T	-1	18/72/∞	x20	4	IF, SNPR	
SLC	T	1	30/120/∞	x12		AA, MB1	

Physical x9 M

Additional Units (max 4)

Support Heimdall Medium Support Mag-Tank



ATT	2	DETECT	4
DEF	2	SENSORS	1
EW	1	COMM	0
LD	0	AUTOCOMM	2

SPD	STOP	CBT	TOP	
H	7 / 14	-3	-1	0
/	/	/	/	/

ATTACK	1	0	-1
--------	---	---	----

ARMOR	24	OVERKILL	96
-------	----	----------	----

ACTIONS	2	SIZE	12
---------	---	------	----

DAMAGE	S	L	H	C
--------	---	---	---	---

PERKS Reinforced Armor (Front, 6 / 120), Low-Profile, CI

FLAWS LSP(2), Sensor Dependent

AUX

NAME	ARC	ACC	RANGE	DAM	ROF	TRAITS	ROUNDS
HRFC	T	0	18/72/∞	x10	4*	AA	
HRP/48	T	-1	18/72/∞	x20	4	IF, SNPR	
HRP/48	T	-1	18/72/∞	x20	4	IF, SNPR	

Physical x12 M

ALFIE'S TENNERS

ART & STORY: JACK BELL

BASED ON A SCENARIO
BY SCOTT LYNCH

SEP 1, 1940. ALL THROUGH OUT KENT, THE BELLS ARE RINGING, WHICH CAN MEAN ONLY ONE THING: THE INVASION OF BRITAIN HAS BEGUN! UNDER THE COVER OF DARKNESS, SCORES OF FALLSCHRIMJÄGERS HAVE DROPPED OVER THE ENGLISH COUNTRYSIDE, CAUSING MAYHEM AND MISCHIEF. IT'S UP TO MEN LIKE 2/LT ALPHONSE MARCH AND HIS WALKER TROOP TO STOP THEM BEFORE IT'S TOO LATE...

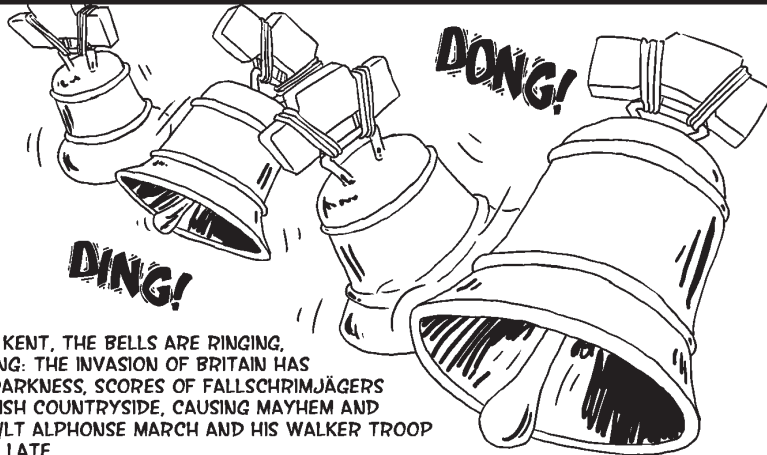

JAMESON, DO YOU HAVE ANY IDEA OF WHERE THE JERRIES MIGHT BE LOCATED?

NO, SIR. IF ANYONE KNOWS, THEY'RE BURIED UNDER ALL THE DEAFNING SQUAWKING ON THE WIRELESS.

SQUAWKING OR NOT, I WANT EVERYONE READY TO MOVE OUT!

THEY COULD BE ANYWHERE! DOVER! CANTERBURY! RAMSGATE!



THIS IS OBERST WASSERMANN. REMEMBER YOUR OBJECTIVES! DRIVE ONTO THEM!

KNACKER, DO YOU COPY? ARE THE MARINEKAMPFERS HANDLING WELL?

JAWHOL MEIN OBERST! THEY ARE!

IT IS NO WALKÜRE, MEIN OBERST, BUT I CAN MAKE THIS WALRUS ACT LIKE A SWAN.

AURORA: THE SILHOUETTE MAGAZINE

ALFIE'S TENNERS

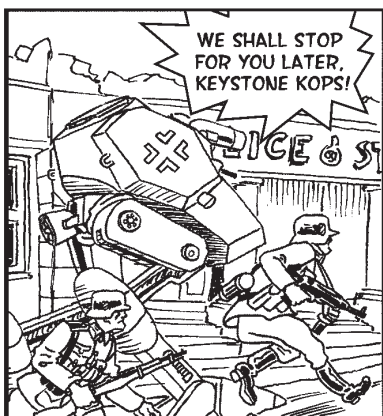
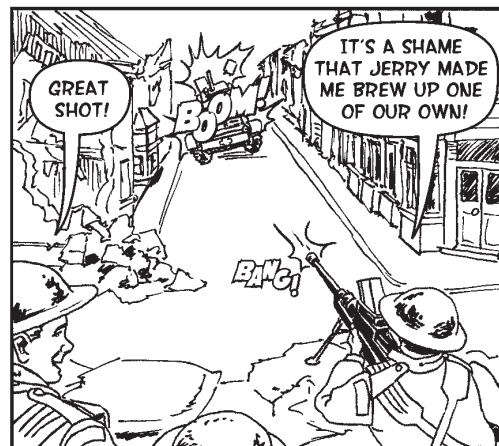
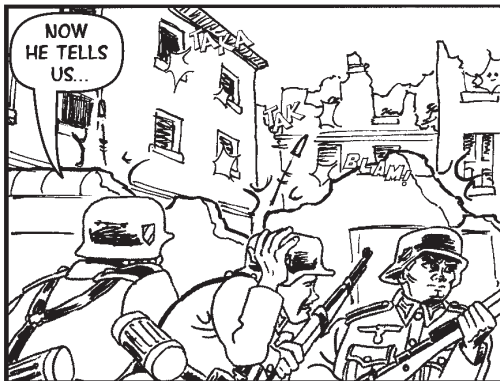
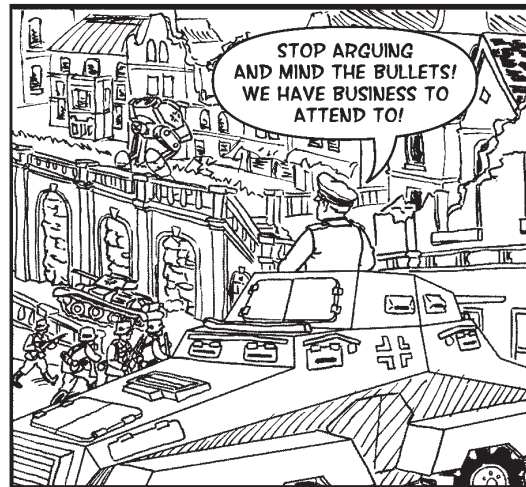
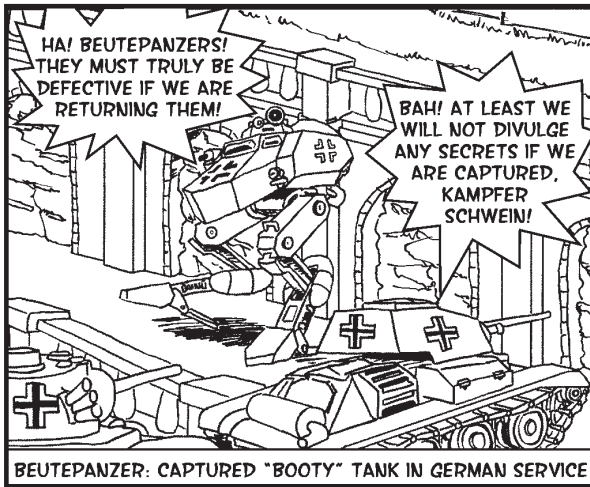

AURORA: THE SILHOUETTE MAGAZINE

ALFIE'S TENNERS

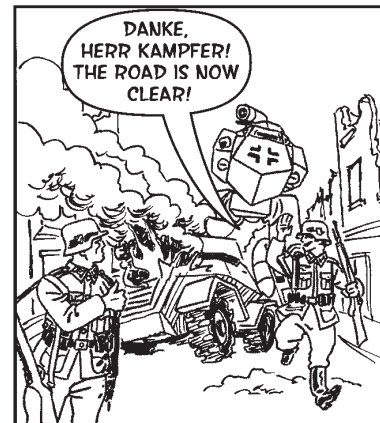
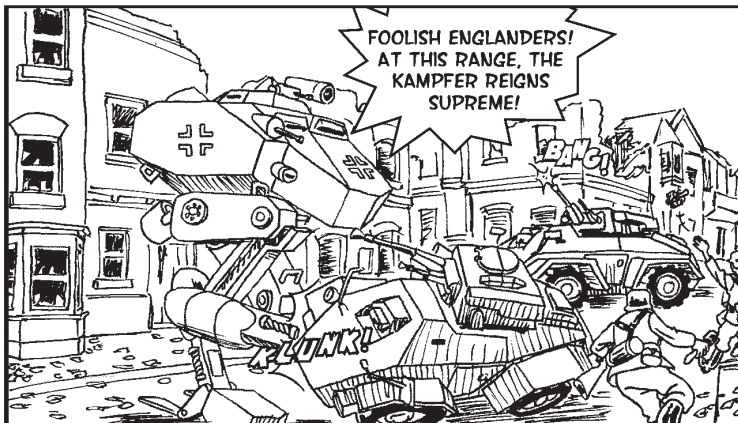
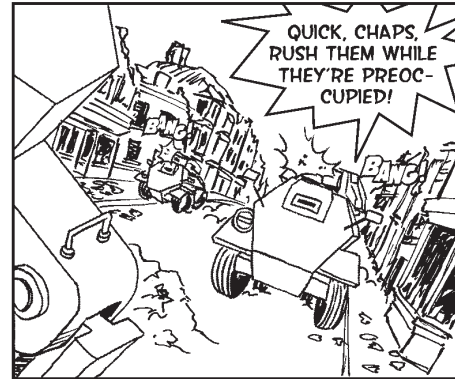
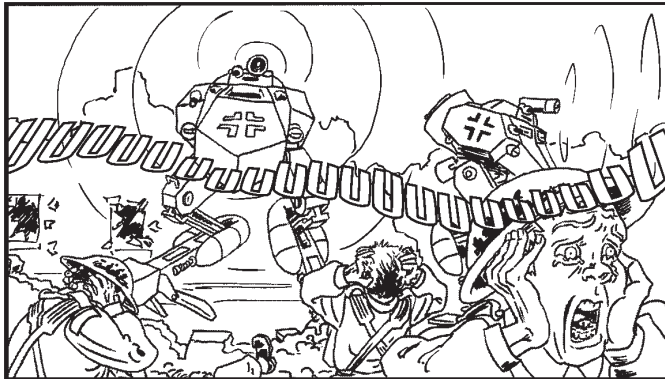
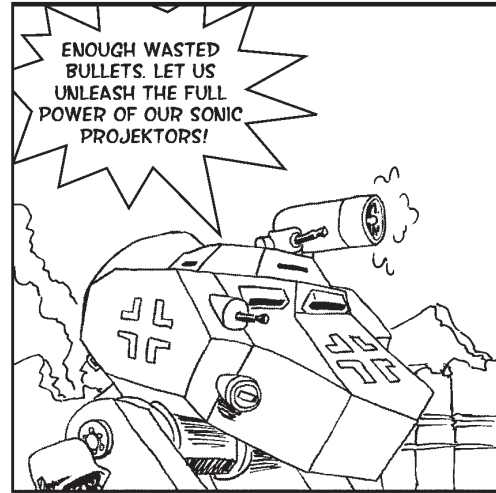
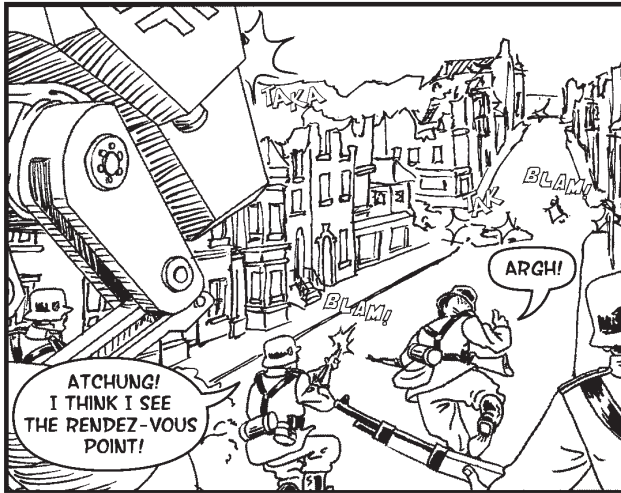

NEXT: THE TENNERS RETURN, SO THE GERMANS BETTER BE READY TO FALL BACK!

Heavy Gear Blitz is built upon the Silhouette dice mechanic, a very unique system that fans of the series come to either love - or hate - passionately. Unlike most dice systems, Silhouette (referred to in the remainder of the article as Sil) tends to promote consistent, predictable results and minimizes randomness.

ANATOMY OF THE DIRECT ATTACK

Now that we have most of the mechanics down, let's talk about application. The Direct Attack is perhaps most important action in the game; as such, we are going to carefully dissect it to better understand how it works. For most players, this will be the most common roll you make, so understanding how it works should make you a better Blitz! player in general. With that said, let's consider that there are three main components to a Direct Attack action:

- Attack Skill versus Defense Skill
- The Attacker/Defender bias
- The Ratio of DM (weapon damage) to the target's Armor

Skill differences are by far the least important component, while the *bias* is the most important, though in some situations the DM / ARMOR ratio (DAR) has a greater impact than the *bias*. We've already talked about skill levels and *bias*, so let's look at the DM to ARMOR ratio next. When we're done we'll look at how everything fits together.

DM versus Armour Ratio

You should be familiar with how we calculate boxes of damage in Blitz!; you take the MoS and multiply it by the DM of the weapon - this gives you the *total damage*. You then divide the *total damage* by the Defender's armor value; after rounding this value down you have the number of *boxes of damage* dealt to the Defender. For the newbies; if I have a MAC (DM x10) and achieve a MoS 3, then I inflict $10 \times 3 = 30$ *total damage*. If my target is a Ferret (Armor 12), then dividing $30 / 12$ gives me 2.5, which is rounded down to 2 - the Ferret takes *two boxes* of damage.

Yes, the term 'damage' is used too many times for too many different things, only one of which (boxes of damage) is the common usage of the term. Sadly that's out of our control, but in the rest of the article *DM* means the weapon attribute damage, *damage* means the total damage, and *boxes of damage* should be self-explanatory (though we may also call them damage boxes). Got it?

The ratio between DM and Armor then is a measure of how easily you can convert a MoS into boxes of damage. In the example just given, the ratio is $10 / 12 = 0.83$. This value quickly shows you just how much MoS you need to get a particular number of damage boxes. Multiply the ratio by the MoS to determine the boxes of damage; $\text{MoS } 1 \times 0.83$ is less than 1, so no boxes of damage. $\text{MoS } 2 \times 0.83 = 1.66$, or one box of damage. We can keep going on for whatever MoS we want to in this fashion. We will refer to this DM / Armor Ratio as **DAR** for the rest of the article.

The reason we like to use the DAR is because different scenarios can be discussed at the same time, without having to directly figure out how probable the scenario is. In practice, DM 10 vs Armour 15 (a ratio of 0.66) is equivalent to DM 20 vs Armour 30 (also a ratio of 0.66), and can be studied at the same time. In both cases, the same MoS will cause the same number of damage boxes to be generated.

Further, we use the ratio because small changes in either DM or Armour are generally not significant by themselves. DM 11 is mostly equivalent to DM 10, especially if you're talking about Armour 20; the respective ratios would be 0.5 (10 v. 20) and 0.55 (11 v 20). In specific situations those small differences may change the outcome in a significant way, however. Identifying those points where differences are important is the key to making the best use of your weapons against your opponents.

Before we continue, take a step back and remember what we pointed out very early in this article - the most probable MoS values for any attack are going to be 1, then 2, then 3. Depending on the circumstances, higher values may be likely; but for most situations you will see MoS 1 more than you will MoS 2, and MoS 2 more than you will MoS 3. With that in mind, let's go back to the ratios we were just talking about. If we limit our discussion to just MoS 1, 2 and 3 we can use the DAR to make some decisions about how useful a weapon.

Let's take the humble Hunter (or Jager or Warrior, as your preferences lie) and it's basic armor of 15, and see what all of the above gets us. Your basic LAC has a DM of x8, a HAC has x12, a LBZK x15 and a HBZK x25. That gives us ratios of 0.53 (LAC), 0.8 (HAC), 1.0 (LBZK) and 1.67 (HBZK) *against armor 15*, and immediately tells just hat the LBZK and HBZK are always going to be better weapons against a Hunter than the LAC and HAC **given the same circumstances**. Let's take those ratios, and look at the damage boxes we might get given the common MoS values we talked about:

AURORA: THE SILHOUETTE MAGAZINE

PROBABILITIES IN HEAVY GEAR BLITZ!

	MoS 1	MoS 2	MoS 3
LAC	0.53	1.06	1.59
HAC	0.8	1.6	2.4
LBZK	1.0	2.0	3.0
HBZK	1.67	3.34	5.01

Now, these results aren't surprising to anybody who's played the game. You've probably plinked something to death with your LAC, and left the same target it a smoking crater from your HBZK. But it was important to stress one critical idea - you want to tailor your weapon to your target based upon a 1.0 (or better!) ratio; anything else and you're not likely to do any boxes of damage. If you were to choose the LAC in the situation above, you're going to 'waste' those good MoS 3 rolls doing a box of damage, and end up with no effect most of the time. This shows why the LBZK 'feels' like such a great weapon; all other things equal, most of the time you roll 'well' you get some kind of result out of it. Not so with the LAC or even the HAC.

When to use RoF for DM

The above ideas play straight into a question that people often ask; when should I trade RoF for DM? Assuming that the scenario is the same (no difference in modifiers) and there is some inherent risk (going out of ammo), what you're really asking is how to maximize your RoF expenditure without putting yourself completely at risk. Basically you take the above, and figure out what happens at MoS 1, 2 and 3 - and make your decision based upon that.

If the DM increase will cause more damage at MoS 1, do it - this is a very likely scenario! If it would only cause more damage at MoS 2, think about it; how much danger does it put you in to go out of ammo? If the DM increase requires MoS 3 (or more), you may want to hesitate; you're not very likely to achieve the MoS necessary to make the tradeoff worthwhile.

Let's again turn to the humble LAC; it's base DM is 8, but RoF can be used to get a 9 or a 10. Suppose that all other things are equal, and that we have 3 potential targets: 1 with Armour 15, one with Armour 16 and one with Armour 25 - what should you do?

First, let's consider the target with Armor 15. If we calculate out all of our values, we get a table like the following.

	MoS 1	MoS 2	MoS 3
DM 8	8 / 15 = 0 box	16 / 15 = 1 box	24 / 15 = 1 box
DM 9	9 / 15 = 0 box	18 / 15 = 1 box	27 / 15 = 1 box
DM 10	10 / 15 = 0 box	20 / 15 = 1 box	30 / 15 = 2 box

The only point at which we see a difference is at DM 10, and even then only in the MoS 3 category. Clearly, increasing the DM to 10 would be marginally useful (if you feel like gambling, or the situation favors you), while increasing it to 9 will never be worth the risk. Save the ammo for another target.

Next, let's consider the target with Armor 16. Again, calculating out all of the values to make it easier for you, dear reader:

	MoS 1	MoS 2	MoS 3
DM 8	8 / 16 = 0 box	16 / 16 = 1 box	24 / 16 = 1 box
DM 9	9 / 16 = 0 box	18 / 16 = 1 box	27 / 16 = 1 box
DM 10	10 / 16 = 0 box	20 / 16 = 1 box	30 / 16 = 1 box

AURORA: THE SILHOUETTE MAGAZINE

PROBABILITIES IN HEAVY GEAR BLITZ!

There's not a single place where increasing the DM did us any good; obviously choosing to use RoF in this case is all risk and no rewards.

Finally, let's look at the target with Armor 25.

	MoS 1	MoS 2	MoS 3
DM 8	8 / 25 = 0 box	16 / 25 = 1 box	24 / 25 = 0 box
DM 9	9 / 25 = 0 box	18 / 25 = 1 box	27 / 25 = 1 box
DM 10	10 / 25 = 0 box	20 / 25 = 1 box	30 / 25 = 1 box

Again we only see a difference at MoS 3; In this case, increasing the DM to 9 is useful, but increasing it to 10 is not. A MoS of 5 would be required to make DM 10 more useful than DM 9 ($50 / 25 = 2$ boxes, as opposed to $48 / 25 = 1$ box). However unless the modifiers are very greatly weighted in favor of the attacker, MoS 5 is very unlikely - and thus DM x10 in this case is hardly worth the risk used to get it.

In all of these cases, notice that even the highest DM (10) never quite reaches a 1.0 ratio; this explains why sometimes you'd see some benefits at MoS 3 but rarely at MoS 2 and never at MoS 1. In any case where you go from a less than a 1.0 to a 1.0 (or better), you should always spend enough RoF to increase your ratio to that 1.0 position, but no further. For instance, consider the RFB; at DM x14 and RoF 2 it's a good way to illustrate what I mean. Let's look just at an armor 15 target this time:

	MoS 1	MoS 2	MoS 3
DM 14	14 / 15 = 0 box	28 / 15 = 1 box	42 / 15 = 2 box
DM 15	15 / 15 = 1 box	30 / 15 = 2 box	45 / 15 = 3 box
DM 16	16 / 15 = 1 box	32 / 15 = 2 box	48 / 15 = 3 box

You get absolutely no benefit from going just a little bit higher than a 1.0 ratio, so you should save it for spray or for a lower OOA check.

Finally, what about when our ratio is very large - say a MRP/36 (DM x18) versus a Golem (Armor 7)? In this case our base ratio is nearly 2.6, which means any damage should be slaughtering the little buggers. We'll turn to a table one more time to show you this situation as well:

	MoS 1	MoS 2	MoS 3
DM 18	18 / 7 = 2 box	36 / 7 = 5 box	54 / 7 = 7 box
DM 19	19 / 7 = 2 box	38 / 7 = 5 box	57 / 7 = 8 box
DM 20	20 / 7 = 2 box	40 / 7 = 5 box	60 / 7 = 8 box
DM 21	21 / 7 = 3 box	42 / 7 = 6 box	63 / 7 = 9 box
DM 22	22 / 7 = 3 box	44 / 7 = 6 box	66 / 7 = 9 box

There are two places where there is additional DM from RoF; at DM 21 and DM 19. Notice that the DM 19 difference is only for MoS 3 - again, a pretty unlikely scenario. But the DM 21 has consistently better results across the board. The reason? You go from a 2.6 ratio to a 3.0 ratio. Any time you can increase your ratio to a full number it's worth it - though in this case it's horribly excessive overkill. Some players (including one of the authors) don't believe there is such a thing as overkill - so feel free to turn those little grubs into smoking holes, then make those holes *bounce!*

AURORA: THE SILHOUETTE MAGAZINE

PROBABILITIES IN HEAVY GEAR BLITZ!

When is +1 DEF Better than +15 Armor

A **very** common mistake is to assume that armor determines survivability (how likely is a model *not* to explode.) While that would certainly be the common usage of armor, unfortunately this is not quite true. When all things are equal, armor does survivability - but differences in DEF are *incredibly* more important. After all, a MOS of 0 does no damage, no matter the DAR!

Let's look at four examples; a Warrior, a Crusader IV, a Warrior IV and a Warrior IV Elite, all of which are attacked by a MAC and a MBZK. We will suppose that the only modifier is the DEF rating of the model, and that everyone has Skill 2. Each column's color indicates the DEF modifier for that model: red is -1, green is +1 and white is +0.

MAC (x10 DM)	Warrior	Warrior IV	Crusader IV	Warrior IV Elite
Chance of Damage	23%	23%	40%	12%
Expected Damage	0.39	0.29	0.52	0.15

MBZK (X20 DM)	Warrior	Warrior IV	Crusader IV	Warrior IV Elite
Chance of Damage	40%	40%	60%	23%
Expected Damage	0.99	0.85	1.46	0.45

As you might expect, the Warrior IV fares better than the Warrior by virtue of its higher armor. It has the same *chance* to take damage, but ends taking *fewer boxes of damage* against some MoS values. In contrast the Warrior IV Elite fares significantly better in both categories; not only is it less likely to take damage in the first place, attacks do cause damage tend to only cause 1 or 2 boxes.

But the Crusader is one sad Gear: its armor is the highest, yet its survivability is the lowest, and by a **significant** margin! This is completely contrary to what most people will expect; more armor means it's tougher to kill, correct? The gains from the Warrior IV to the Warrior IV Elite further proves the point; they are much better than the gain from the Warrior to the Warrior IV.

Since these effects depend on the DM of the weapon, it's hard to establish a DEF to armor equivalency. But, as a rule of thumb :

+1 DEF is roughly worth 1.5-2x the same Armor value

Which we see proven above. Even with better armor than all of the other models, the Crusader is one of the most vulnerable to every category of weapons, thanks to its poor DEF modifier.

This analysis excluded Sturdy Boxes, which skews a bit how we think of 'tough' in the common sense. So let's take a minute to look at them. If we consider how many shots it takes to put our target into the 'Heavy Damage' category, we find that it takes:

- 7 shots from a MAC or 2 shots from a MBZK for a Warrior IV
- 8 shots from a MAC or 3 shots from a MBZK for a Warrior
- 10 shots from a MAC or 3 shots from a MBZK for a Crusader
- 13 shots from a MAC or 4 shots from a MBZK for a Warrior IV Elite

Most people will likely be marginally surprised by the Warrior IV results - again, because we associate 'armor' with 'toughness'. In the case of HGB! though, 'toughness' tends to follow the path of DEF modifiers, then sturdy boxes, then armor. This explains to a great extent why Crusaders are, relatively to Warriors, more vulnerable to heavy weapons.

If there's a MBZK ahead, send a Warrior. If there's a MAC, send a Crusader. Or just laugh and send a Warrior IV Elite no matter what's ahead!

AURORA: THE SILHOUETTE MAGAZINE

PROBABILITIES IN HEAVY GEAR BLITZ!

Takeaways

- +1 DEF is generally worth 1.5-2x Armor if everything else is equal
- Sturdy boxes are good, and you should get more
- 'Toughness' is generally decided by DEF modifiers, sturdy boxes, then Armor
- Warriors IV should always be swapped for Warriors IV Elite
- One of the authors is a PRDF player

When is +1 ATK Better than +15 DM?

Now obviously, anytime you can get a higher DM, the better - but often when selecting weapons for your troops, you have to pick between several weapon choices which vary in DM, ACC and range. Range is generally a straightforward comparison, and tends to be heavily influenced by what type of terrain you play with; lots of city terrain probably has you able to use shorter ranged weapons, while long flat spaces give you incentives to break out the snipers. Since that's a playstyle issue more than a mechanical one, we are going to ignore it for the moment and concentrate on the other two attributes a bit.

Beginning players incorrectly assume DM is more important than ACC; they quickly learn that high DM, -1 ACC weapons are hard to 'hit with' and thus don't put that DM to good use. However, many of the +1 ACC weapons have low DM which would seem to keep them from hitting really 'hard'. So how much DM should you trade for ACC, and vice versa? Answering that question is very complex and depends greatly on the total *bias* as well as the comparative armor and DM. As such, we can't present a complete picture for you in this document. However, we'll provide some hand-picked examples and hopefully provide you enough information to make educated decisions in the future.

First, let's look at the most simple case, where we have no bias and our skills are equal - and remember, we're assuming the range modifiers are equivalent (though in practice they will often vary). We'll take a Hunter as the first victim of the testing range, with a 'normal' armor of 15, and compare a LRP (DM x12, -1 ACC) versus a HAC (DM x12, +0 ACC) versus a SLC (DM x12, +1 ACC). With DM x12, we need MoS 2 to get one box of damage, MoS 3 for 2 boxes of damage, MoS 4 for 3 boxes of damage and MoS 5 for 4 boxes of damage. We'll show the percentage chance of getting a certain number of boxes of damage based upon ATK rolls of **2D6-1** (LRP), **2D6+0** (HAC) and **2D6+1** (SLC) respectively against a DEF roll of **2D6+0**:

	ATK Roll	0 boxes	1 box	2 boxes	3 boxes	4 boxes	5 boxes
LRP	2D6-1	88.12%	6.87%	3.24%	1.78%	0.85%	-
HAC	2D6+0	76.70%	11.42%	6.87%	5.02%	1.70%	0.08%
SLC	2D6+1	60.26%	16.44%	11.42%	6.87%	4.17%	0.85%

Remember that 5 boxes is our theoretical max, as we're overkilling anything in the game at this point. As you might expect, adding +1 ACC improves how many boxes of damage we do, with the difference between -1 ACC and +1 ACC being rather significant (nearly 30% between the pair).

Now, what happens if we compare the LBZK (DM x15, +0 ACC) and MBZK (DM x10, +1 ACC) against the SLC (we will drop the LRP as it's not competitive).

	ATK Roll	0 boxes	1 box	2 boxes	3 boxes	4 boxes	5 boxes
HAC	2D6+0	76.70%	11.42%	6.87%	5.02%	1.70%	0.08%
LBZK	2D6+0	60.26%	16.44%	11.42%	6.87%	3.24%	1.78%
MBZK	2D6+0	60.26%	16.44%	11.42%	-	6.87%	5.02%
SLC	2D6+1	60.26%	16.44%	11.42%	6.87%	4.17%	0.85%

AURORA: THE SILHOUETTE MAGAZINE

PROBABILITIES IN HEAVY GEAR BLITZ!

In this particular situation, getting that +3 DM from the LBZK boosted the boxes of damage we could expect - but only to be equivalent to our SLC! If you've read the last few sections, you could probably guess this is because we changed the **DAR** (DM / Armor Ratio) from 0.8 for the SCL to 1.0 for the LBZK and 1.33 for the MBZK. What's very important to note is the changes primarily occur in the 4 to 5 boxes range, and that the impact of a higher DM is to push the results towards the 5 boxes (i.e. guaranteed overkill) range.

Now, before we jump to any conclusions, what if we didn't happen to cross a DAR threshold? In this case, let's say we're using a Spitting Cobra for target practice, with armor 21; what happens?

	ATK Roll	0 boxes	1 box	2 boxes	3 boxes	4 boxes	5 boxes
HAC	2D6+0	76.70%	18.29%	4.17%	0.78%	0.08%	-
LBZK	2D6+0	76.70%	11.42%	10.11%	0.93%	0.78%	0.08%
MBZK	2D6+0	76.70%	11.42%	6.87%	3.24%	0.93%	0.85%
SLC	2D6+1	60.26%	27.86%	10.11%	0.93%	0.85%	-

In this case the extra damage didn't go across the DAR threshold; all of the weapons stay below 1.0. Even though we increase our DM by a spread of 8 points (from x12 to x20) with the LBZK and MBZK we have a lower chance to do *any boxes of damage* compared to the SLC. However, we do tend to have a small chance of inflicting a *higher number of damage boxes* than the SLC if we are successful

Before we try to make something of this, let's look at one more target - the LHT-67, with armor 25 (from the front arc). Most importantly this puts the x12 weapons (HAC and SLC) at a > 0.5 DAR, which is very unfavorable; they need MoS 2 to get a single box of damage. We'll also add the HBZK, which has a DM x25 and thus has a DAR of = 1.0.

	ATK Roll	0 boxes	1 box	2 boxes	3 boxes	4 boxes	5 boxes
HAC	2D6+0	88.12%	10.11%	1.70%	0.08%	-	-
LBZK	2D6+0	76.70%	18.29%	3.24%	1.70%	0.08%	-
MBZK	2D6+0	76.70%	11.42%	6.87%	3.24%	0.93%	0.85%
HBZK	2D6+0	60.26%	16.44%	11.42%	6.87%	3.24%	1.78%
SLC	2D6+1	76.70%	18.29%	10.11%	4.17%	0.08%	-

In this situation you can see how the HAC really falls behind; but the SLC keeps pace with the MBZK and LBZK *even though it crossed a DAR threshold* (it's less than 0.5, whereas the MBZK and LBZK are in the 1.0 - 0.5 range). Again though, higher DM weapons tend to give bigger explosions if they do hit.

What all of the above shows is that, all things being equal, +1 ACC will **always** deliver more *consistent* damage (not necessarily *greater* damage) when compared to increased DM, so long as you don't cross any DAR thresholds. The SLC is a 'better' weapon than the MBZK for anything armor 20-24; while it's equal to the LBZK in the 15-20 range. Beyond armor 25, it stays competitive with the others but is only holding it's own. This generally holds true across most weapons, so we can state with some confidence a general rule of thumb:

+1 ACC is roughly worth 2x the DM value

AURORA: THE SILHOUETTE MAGAZINE

PROBABILITIES IN HEAVY GEAR BLITZ!

This is not always true, of course - it varies from situation to situation, but in general you can put this to good use when army building. For instance, if you have access to an AGM (x15 DM, +1 ACC), you could make the general comparison that for the same price, you'd need to get an x30 DM weapon to have roughly the same level of 'lethality'. In practice you're going to cross many DAR thresholds for such a large value, however - so that +0 ACC Snub Cannon (using the Dedicated Tankhunter upgrade from RtCE) is still going to compare very favorably for certain models. For instance, compare a Hun (armor 27, green) versus a Klemm (armor 30, orange) for those two weapons:

	ATK Roll	0 boxes	1 box	2 boxes	3 boxes	4 boxes	5 boxes
AGM	2D6+1	60.26%	27.86%	10.11%	1.70%	0.08%	-
AGM	2D6+1	60.26%	27.86%	10.11%	1.70%	0.08%	-
SC+DHTI	2D6+0	60.26%	16.44%	11.42%	6.87%	3.24%	1.78%
SC+DTHI	2D6+0	76.70%	11.42%	6.87%	3.24%	0.93%	0.85%

Obviously the SC is doing quite well against the Hun; but drops sharply once it's DAR goes below 1.0 on the Klemm even though the SC's DM is nearly 2x the DM of the AGM. The comparison becomes even more unfavorable if the AGM has a TD available!

Takeaways

- Favor weapons that cross DAR boundaries
- +1 ACC is generally worth 2x DM if everything else is equal
- Range is worth less than ACC, but more than DM



REMEMBER RANGUARD!

AURORA: THE SILHOUETTE MAGAZINE

PROBABILITIES IN HEAVY GEAR BLITZ!

CONCLUSIONS

Now that we've walked through lots of different options, and you've seen how both skills and modifiers contribute to results, let's talk conclusions - in particular, how to approach army building while keeping the mathematics of the system at the edge of your mind.

Skills vs Modifiers

Many times, mostly during army construction, a player has to choose between a +1 modifier or +1 to skill (+1D6). Looking at all of the above, the conclusion is simple : generally, the modifier is better. When your skill is 2D6 or above, there is almost no variation in the expected MoS due to dice, but a +1 to the roll directly changes the expected MoS by 1. However if your (or your opponent's) skill is below 2D6 to begin with, then you get roughly +1 MoS simply by increasing your dice results, **and** your individual results - what you're likely to throw on any given toss - are vastly more consistent.

From this the authors propose a simple rule: when going from 0D6 or 1D6 to 2D6, always favor the skill increase over a +1 modifier to your result. You're going to be more consistent on any given roll, fumble less and generally going to have better results across the board. If choosing between increasing your skill from 2D6 to 3D6 or a flat +1, pick the modifier; it tends to give you better results than simply increasing your skill would. If choosing between increasing your skill from 2D6 to 4D6 or 5D6 versus a flat +1; you probably want to choose based upon the cost of the upgrade; that's a substantial difference not only in your expected outcome, but also your consistency of any individual roll.

However if the modifier is circumstantial - like range or the *Improved Rear Defense* perk - you may want to choose the skill increase instead. It's going to be 'always' on so while you'll be weaker in the specific case where the circumstantial modifier is applied, when the modifier isn't present you'll be stronger (which should be most of the time). However you must weigh how much the cost of the circumstantial modifier is versus the cost of a skill; while a MAC's range is generally better than a LAC, it costs +5 TV versus +10 to upgrade ATK (and DEF). That +5 TV may be a cheaper way to get a +1 circumstantial modifier depending on your terrain and play-style, but the +10 TV applies across the board to every weapon you carry. If they both cost the same, the skill upgrade is the obvious choice.

When choosing between modifiers and skills when you start at 3D6 or higher - always pick the modifier. Unless you're specifically trying to boost your IF potency (where the additional dice tend to increase the raw outcome that the defender has to use) the boost from skill increases is relatively minor. Modifiers will still determine your outcome in most cases, and the TV you spent likely could have been used better elsewhere.

Note that in the case of EW and LD, both of which use the raw numerical value of the skill, this advice is flipped, and you should choose the skill upgrade instead of the modifier in most cases. Since the EW skill rating directly influences the number of models that can make indirect attacks against a given Forward Observation (FO), if you really need to maximize your recon assets giving them boosted skills will help.

Further, as the number of Command Points (CP) that can be spent each turn are directly related to your LD skill, you want to maximize that burn rate as much as possible. For Army Commanders, LD upgrades should take precedence over other upgrades - you get to spend one additional CP for each point of LD you increase. Going from LD 2 to LD 3 means you can spend 3 CPs each turn instead of 2, which is a **major** benefit when you really need to make that parting shot. Combat Group Leaders (CGLs) should buy upgrades that take them to even numbers (i.e. LD 1 to LD 2, LD 3 to LD4) as their LD score is halved when determining CP expenditure; sadly going from LD 2 to LD 3 is only useful if you plan on the CGL being a backup Army Commander.

Takeaways

- **For ATK and DEF, always increase them from 0D6 or 1D6**
- **+1 ACC weapon upgrades are worth more than raising ATK/DEF from 2D6 to 3D6**
- **Increase ATK/DEF from 2D6 to 3D6 if you're going to rely on IF attacks**
- **EW increases are useful to a point; but you can have too many EW 3 models**
- **LD increases are always useful for Army Commanders**
- **LD increases are only useful for Combat Group Leaders if they are even**

AURORA: THE SILHOUETTE MAGAZINE

PROBABILITIES IN HEAVY GEAR BLITZ!

Weapons

Choosing between weapons is much more complicated, and involves many different variables - their DM, ACC and Range, along with the Skill and any applicable bonuses of the model that will mount the weapon, and the targets you expect to be hunting. We've already shown how ACC is generally worth twice DM, and how crossing a DAR (damage / armor ratio) breakpoint is important, so now let's take the other factors, mush them together and figure out if a weapon is going to be useful to us in a given role or not.

Range plays a critical role in selecting a weapon, due to it granting essentially negative ACC values the further you are from your target. Two weapons with equivalent DM and ACC values could be worth radically different amounts based upon their ranges; if the first is a **12 / 48 / inf.** weapon and the second is **24 / 96 / inf.** then the second generally is worth at least twice the first in terms of usefulness - so long as you play on a board larger than 12", that is. Short optimal ranges radically reduce the usefulness of high DM values, due to the need to get very close (within 6" + movement) to make that payoff worthwhile. If we assume +1 ACC is roughly worth a doubling of DM, then the following weapons would be basically equivalent:

ACC	DM	Optimal	Sub-Optimal
+0	x32	6	24
+0	x16	24	96
+0	x8	96	384

Wait, you cry - that doesn't make sense! A LAC with 96" optimal range isn't better than a LBZK with a 24" optimal range! And you would be correct - if you're attacking a target 24" away. In that case the x16 and x8 weapon are in the same 'effective ACC' modifier - both are +0. But what if we're attacking a target between 24" and 96" away; when the x32 is -2 to hit, the x16 is at -1 to hit, and the x8 is at +0? Well, look at the results against a Hunter (armor 15):

DM	0 Box	1 Box	2 Box	3 Box	4 Box
x32	88.12%	-	6.87%	-	5.02%
x16	76.70%	11.42%	6.87%	3.24%	1.78%
x8	76.70%	18.29%	4.17%	0.85%	-

The total chance of doing **some** damage is equivalent, but the damage outcomes swerve all over the place, as they cross DAR boundaries. The x16 weapon is terrific as it inflicts solid damage (the x8 is mostly stuck on 1 box) while the x32 is a 'wing and a prayer' kind of shot. But again - the **total** chance of doing some damage *generally doesn't change*. This implies that generally we're correct; range as a driver of the Attack roll is almost more important than the DM of the weapon in the first place.

Notice however there's an assumption being made - namely, that you can make use of the range difference. Before the Field Manual, it was much easier to find weapons that crossed multiple range boundaries during the normal course of play. The Snub Cannon for instance had ranges of **2 / 3 / 6 / 12 / 24** while the LGM had ranges of **8 / 15 / 30 / 60 / 120**; against a target 24" the SC had an effective **-2** over the LGM, which makes the above trend absolutely horrible (the LGM had a **60.26%** chance of no damage versus the SC's **88.11%**). With the FM changes you'd need to be more than 96" away to see the difference across three weapons - more than the length of most tables!

So while Range has an impact under the Field Manual rules, it's most concentrated on those weapons with really short optimal ranges; those that have optimal ranges of less than 12" feel the impact the most. The reason they suffer so much is because the rate of movement is roughly equal to their range, making it difficult get them into position with positive modifiers versus an opponent with a longer range. The RFB's range of 6" is roughly the combat speed of most Gears in ground mode; while the LBZK's range of 12" is two full turns of movement at combat speed. Both are capable of firing a x15 shot against a target; but the LBZK can do it nearly a full turn earlier, where the RFB has roughly the same performance as a x8 weapon.

AURORA: THE SILHOUETTE MAGAZINE

PROBABILITIES IN HEAVY GEAR BLITZ!

Now that's a lot to absorb, and we've not answered any questions yet. Let's try to take what we've learned, and create some axioms when trying to pick between weapons. First, we know that ACC - and by extension Range - is often more useful than a higher DM, by a large amount. Secondly, we know that a DM is only important if it crosses the DAR boundary of a target; otherwise we're not gaining any benefit (the probability of doing any damage won't change). Given that, if we're hunting Gears - whose armor is in the 12-24 range - we could say the following:

- A +1 ACC, DM x12 weapon is better than a +0 ACC, DM x20 weapon against Gears with armor < 20, *so long as ranges are equal*
- A +0 ACC, DM x14 weapon is better than a -1 ACC, DM x28 weapon against Gears with armor < 13, *so long as ranges are equal*

Notice how important armor is in the equation; you really need to take your intended target into account. If you're hunting Spitting Cobras (armor 21), the +1 ACC DM x15 AGM is vastly superior to the +0 ACC DM x20 MBZK and will deliver more kills, more often. But if you're facing Sidewinders (armor 16) there's no real need to take the more costly AGM; the MBZK is going to be in the same ballpark of inflicting damage and is generally cheaper. What's most important is how *reliably* you can deliver damage, and there's lots of way to do that; picking the one that best fits your army is close to an art. But armed with the above, you can at least make educated decisions.

Takeaways

- **Cheaper weapons that cross DAR boundaries are equal to more expensive ones that have ACC / Range bonuses**
- **Having a DAR of 1.0 or better is optimal for a given target**

When to Use Hull Down

The effect of the Hull Down special action is simple: the *Final Result* of the DEF roll is fixed at a specific number (i.e. it becomes a Threshold). This makes it easy to predict the end result of the attack by taking Expected Value of the Attacker's skill, add or subtract any modifier on the attacker's roll, then subtracting the Hull Down value. As such, Hull Down 3 or 4 (i.e. Heavy or Solid Cover) will cancel out most of the effect of the attacker's raw roll result - and even better, the defender will be in Cover, adding a penalty to the attack roll. This allows us to assume the expected MoS for an attack against a model that's Hull Down will be the attacker's modifiers plus between 0 and 2 (dependent on the attacker's skill and the defender's Hull Down value).

This property makes Indirect Fire (IF) much less effective against a target that is Hull Down, since the attacker's modifier for IF is... 0! The attacker's expected value is 4.5 (between 4 and 5), so if the Hull Down value is either 3 or 4, the MoS will be either 1 or 2 at best. Especially for heavily armored models, this is a huge advantage, since weapons designed to damage them will generally require MoS 2 or so (more on that in a bit). This makes it quite possible to park your Aller (armor 45 from the front) in a commanding position with Hull Down 4 and not have to worry too much about indirect fire; there's a very reasonable chance that you will take no damage, even from a direct hit by a HRP or HGM (for the curious it's about a 30% chance of a single box of damage).

Conversely however, Direct Fire (DF) is not impacted as much, since it's possible to pile up positive modifiers and do some damage. In fact, that's how to succeed against a Hull Down target - get a positive Attack modifier and keep making Direct Fire attacks to whittle them down. In the same situation above, an ATM fired at the Hull Down (3) Aller, using an ATK of 2D6 and assuming the Aller has +0 cover, yields the following chances of doing damage:

	ATK Roll	0 box	1 box	2 box	3 box
No modifier	2D6+1 vs. 3	25.0%	44.44%	30.56%	-
+TD	2D6+2 vs. 3	11.11%	33.33%	52.78%	2.78%
+TD, +Stop	2D6+3 vs. 3	2.78%	22.22%	44.44%	30.56%

AURORA: THE SILHOUETTE MAGAZINE

PROBABILITIES IN HEAVY GEAR BLITZ!

If the Aller is behind solid cover (most hills, for instance) the chance of doing damage drops significantly, due to the additional -1 penalty for being behind solid cover:

	ATK Roll	0 box	1 box	2 box	3 box
No modifier	2D6+0 vs. 4	69.44%	30.56%	-	-
+TD	2D6+1 vs. 4	44.44%	52.78%	2.78%	-
+TD, +Stop	2D6+2 vs. 4	25.00%	44.44%	30.56%	-

Of course, you can just maneuver behind the cover for even more hilarity.

Finally, note the expected value helps deciding when to consider going Hull Down. Whenever the expected value of the defender skill minus the DEF modifier is less than the Hull Down Value **OR** the defender is going to stay stationary for a while, you probably want to spend an action to go Hull Down. Remember that you forgo the ability to engage your opponent on your own terms, however. You should also keep the cost of the action in mind; trading a good chance at a kill for Hull Down 1 is not going to be worth it. Trading in a shot that will probably do nothing for Hull Down 4 is completely different.

Takeaways

- **Use direct fire attacks with positive ATK modifiers to whittle down Hull Down defenders**
- **Avoid IF against Hull Down defenders**

Static Defense, Modifiers and You - Hull Down and the HHT-90

Many CEF players salivate at the prospect of fielding their newest hammer, the HHT-90 as a mobile bunker with massive firepower. Bristling with guns and seemingly impenetrable armor, it would seem as if the Overlord is a force to be reckoned with. But the truth is sadly different from the marketing (as usual), and abysmal DEF modifiers coupled with an enormous cross-section makes hiding this beast nearly impossible. Fortunately it boasts a Static Defense value of 3 - which should make it tough enough to perform it's intended role. But is it to your benefit to use static defense? Judging from the previous section on hull down, you might be inclined to think so.

Again, let's set aside our preconceptions and look at the numbers. The Overlord's Hull (which controls it's DEF modifiers) starts at a DEF of -3 at Combat Speed with four actions, and a terrific armor of 60. Though it contains a plethora of IF weapons that are used for CBS fire, we'll temporarily ignore them and focus just on avoiding damage (instead of a more balanced view that includes the potential damage output of trading vulnerability for CBS fire).

Most opponents bring weapons more than capable of damaging the HHT-90; some of the most common will be the ATM, the SC (with Dedicated Tankhunter upgrade), the Demo Drone and the MBZK. Let's take these weapons and look at how much damage you can expect to do against a HHT-90 that uses the Static Defense option. Everything assumes the attacker is at combat speed, with a clear line of sight to the HHT-90 (i.e. there is no cover modifier), at Combat Optimal range.

Name	Roll	0 box	1 box	2 box	3 box
MBZK	2D6+1 vs. 3	44.44%	55.56%	0.0%	-
SC + DHTI	2D6+1 vs. 3	44.44%	52.78%	2.78%	-
ATM	2D6+2 vs. 3	25.00%	44.44%	30.56%	-
ATM + TD	2D6+3 vs. 3	11.11%	33.33%	55.56%	-
Demo Drone (AP)	2D6+0 vs. 3	11.11%	33.33%	52.78%	2.78%
ATM + TD + Stop	2D6+4 vs. 3	2.78%	22.22%	72.22%	2.78%

AURORA: THE SILHOUETTE MAGAZINE

PROBABILITIES IN HEAVY GEAR BLITZ!

Those are pretty depressing numbers! Just firing an ATM at the Overlord's hull should generally net you one or two boxes of damage - and the MBZK isn't a bad bet either. One or two demo drones will generally wreck your day as well, with a reasonable chance that 3 of them placed in your path would wipe out the hull in a single turn. Given that most forces will include more than a few of these weapons spread around, the chances of the HHT-90 surviving to bring it's powerful suite of weapons to bear seems slim - and predicated mostly on finding a big enough hill to hide behind.

Fortunately - at least for the HHT-90 - it doesn't necessarily have to be that bad. The hull has four actions by default - each of which can be spent to use the 'We're in Trouble' action, increasing your DEF modifier by +1 (until you're rolling DEF + 0). At Combat Speed, the Overlord has a -3 DEF modifier, which means we can spend three actions for 'We're In Trouble' (WIT), and have one left over for counter-battery fire. This puts us sitting nicely at +0 DEF, which is pretty good! But the downside is, we're now vulnerable to crossfire, coordinated attack, and attack from above / below penalties - all of which we didn't worry about when using Static Defense. And further, we can fumble our roll - which has the potential to really, really hurt.

Since we know we're going to be rolling more often, let's assume the HHT-90 upgrades it's hull's DEF skill to 3D6 (it didn't matter for Static Defense), and further we'll assume that every model benefits from the *Coordinated Attack* modifier before it takes it's shot. It could be *Crossfire* instead, or *Attacked from Below* in the case of the demo drone - we're just going to assume the HHT-90 has a -1 DEF in all cases. What does it look like then?

	Roll	0 box	1 box	2 box	3 box	4 box
MBZK	2D6+1 vs. 3D6-1	70.97%	27.55%	1.50%	-	-
SC + DHTI	2D6+1 vs. 3D6-1	70.97%	23.73%	5.08%	0.23%	-
ATM	2D6+2 vs. 3D6-1	49.24%	37.01%	13.52%	0.23%	-
ATM + TD	2D6+3 vs. 3D6-1	30.02%	40.95%	27.55%	1.48%	0.01%
Demo Drone (AP)	2D6+0 vs. 3D6-1	30.00%	40.96%	23.73%	5.08%	0.23%
ATM + TD + Stop	2D6+4 vs. 3D6-1	16.05%	33.19%	45.45%	5.08%	0.23%

Wow! That's a significant difference, especially for the weapons with lower DM. This happens because it's much, much easier to tie the attacker (i.e. narrow the MoS) on any given dice roll, rather than relying on that 3 to save you. Now sure - there's quite a larger percentage of 3 and 4 box results in the second table, which represent occurrences that you fumble your roll on 3D6. The dice gods are fickle and you might do badly on a particular roll. But generally you're going to do better by taking your chances and rolling the dice, rather than letting your opponent whittle you away more quickly. Let's put the chance of getting 0 box results (i.e. the HHT-90 taking no damage) side by side so they are easier to see:

Static Defense		Rolling 3D6
44.44%	MBZK	70.97%
44.44%	SC + DHTI	70.97%
25.00%	ATM	49.24%
11.11%	ATM + TD	30.02%
11.11%	Demo Drone (AP)	30.00%
2.78%	ATM + TD + Stop	16.05%

AURORA: THE SILHOUETTE MAGAZINE

PROBABILITIES IN HEAVY GEAR BLITZ!

Putting everything into context, it's generally better to roll your DEF rather than rely on Static Defense. But it's also expensive; you have to allocate 3 of your 4 actions on the hull each and every turn, which cuts down your firepower significantly. Going Top Speed can mitigate some of the cost (in actions), but also makes your own attacks suffer a -1 ATK penalty - so any way you slice it the HHT-90 loses some offensive capability. This tends to favor the strategy of relying on Static Defense only once you've eliminated the most dangerous threats and you can be reasonably safe when taking your shots. Getting a little bit of solid cover - like a hillside - also helps you reduce your damage profile and makes both options far more appealing. Static Defense while protected by enough terrain to offer a -1 ATK penalty is usually going to be more than sufficient to keep the Overlord dominating it's slice of the battlefield.

Takeaways

- Use Static Defense only if you have solid cover between you and your opponent
- Otherwise, rely on WIT and DEF rolls, but make sure to increase your DEF skill

Why Direct Fire is (Usually) Better than Indirect

One question that never seems to have an certain answer is whether or not it's better to use direct or indirect fire against a target. Each side has it's proponents who argue the benefits and the disadvantages of both, which leaves newbies and veterans alike a bit confused. Since we're all about dispelling math myths, let's take a look!

Before we get started however, let's make plain that we're going to take a bit of a shortcut, and assume an indirect shot lands close enough to count. We'll resolve IF shots as if they were from a +0 Attacker, which is close to their actual evaluation; normally you'd just drop the results that 'scattered away' - but this is highly dependent on both model (as sensors applies to reduce scatter), weapon (different weapons have different AE or Spray values) and individual scatter rolls (as you can deviate between 1-6" just on dice). So while we'll paint a reasonably accurate portrait of Indirect Fire, it won't be 100% complete, and you should keep that in mind. We're not trying to deceive you, but we're not being wholly *accurate* either. A more rigorous investigation would be less favorable to IF, since deviation would prevent some of the damage we are assuming will occur.

Beyond scatter, the biggest difference between IF and DF is that IF comes with a 'built-in' *bias* of +1 to the attacker, due to the *Attacked from Above* penalty. In any given situation then, IF would seem to be the better choice; after all, you're +1 *bias* ahead of the direct fire shot. Assuming you can hit on target, it seems like you'd be more likely to do real damage. However, because you drop all Attack modifiers this *bias* difference is only present when the ATK roll begins at +0 or worse. Think about this for a second; a Direct Fire attack at 2D6+1 versus 2D6+0 has the exact same *bias* as a IF attack that is resolved at 2D6+0 versus 2D6-1. However, as the ATK modifier goes higher the *Attacker Ceiling* effect starts to really kick in and penalize the IF shot more and more. A DF attack at 2D6+2 versus 2D6+0 has a +2 attacker *bias*, while the IF shot still only has a +1 Attacker *bias*. The following table shows this progression nicely, for a DM x15 weapon against an Armor 15 target:

Roll	0 box	1 box	2 box	3 box	4 box
2D6+2 vs. 2D6+0	23.38%	16.44%	20.45%	16.44%	23.30%
2D6+1 vs. 2D6+0	39.82%	20.45%	16.44%	11.42%	11.88%
2D6+0 vs. 2D6+0	60.26%	16.44%	11.42%	6.87%	5.02%
2D6+0 vs. 2D6-1	39.82%	20.45%	16.67%	11.57%	11.50%

Anytime your *bias* is the same, the Direct Fire shot is generally better both due to the slightly higher percentages at the highest end of the table, but also because you won't have to worry about scatter - you either hit and do damage, or you don't. You can see this clearly by comparing the second and fourth rows in the table (highlighted in orange for your convenience); the results are basically the same but the scatter we're not accounting for will reduce our chances of any damage at all by some amount on the fourth row.

AURORA: THE SILHOUETTE MAGAZINE

PROBABILITIES IN HEAVY GEAR BLITZ!

Once you start talking about negative ATK modifiers, the Indirect Fire attack has an additional benefit - shots that actually manage to land on target will tend to do more damage than a Direct Fire shot in the same situation. If you are rolling 2D6-2 versus 2D6+0 to begin with, as long as your AE or Spray is large enough to give you a decent chance to scatter onto your target the Indirect Shot ends up being significantly better damage wise:

Roll	0 box	1 box	2 box	3 box	4 box
2D6+0 vs. 2D6-1	39.82%	20.45%	16.67%	11.57%	11.50%
2D6-1 vs. 2D6+0	76.70%	11.42%	6.87%	3.24%	1.78%
2D6-2 vs. 2D6+0	88.12%	6.87%	3.24%	0.93%	0.85%
2D6-3 vs. 2D6+0	94.99%	3.24%	0.93%	0.73%	0.08%

A VLRP/128 shot that uses a Spray 6" in radius is likely going to hit unless you roll a 5 or 6 on your scatter roll, and generate the damage in the first column; while the equivalent DF shot in the second column becomes much less likely to do any damage at all.

The choice between Direct Fire and Indirect is complicated further by the rules that prevent a Direct Fire shot that misses from generating an AE, while a Indirect Fire shot always does so. If you simply are wanting to stun your target, IF wins most of the time, since the risk of scatter is better than the risk of a bum dice roll that causes you to get to MoF 0+. This is especially true against high DEF targets like Jaguars and Cheetahs. It's easier to hit the ground under a Cheetah via a IF attack (against a threshold of 4) rather than through an opposed roll where it's getting +2 or +3. Keep that in mind and choose the Indirect Fire attack unless you can get a +2 or better attacker *bias*, which should overwhelm the defender's dice solely through modifiers.

Takeaways

- **If Stun / AE is not an issue, choose DF if the ATK modifier is +0 or better, otherwise choose IF**
- **Choose IF for Stun / AE unless you have a +2 or better attacker bias**
- **Sprays should use DF if the ATK modifier is +0 or better, otherwise choose IF**

NEXT ISSUE!

The final chapter, speaking about the metagame, d6 vs d8, and the impressive and extensive Weapon Comparisons Appendix!

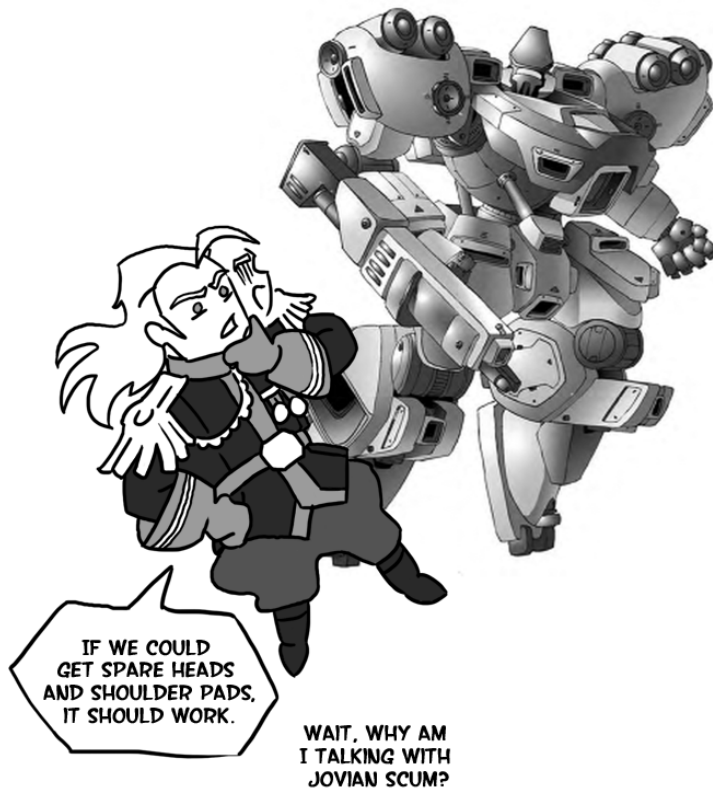
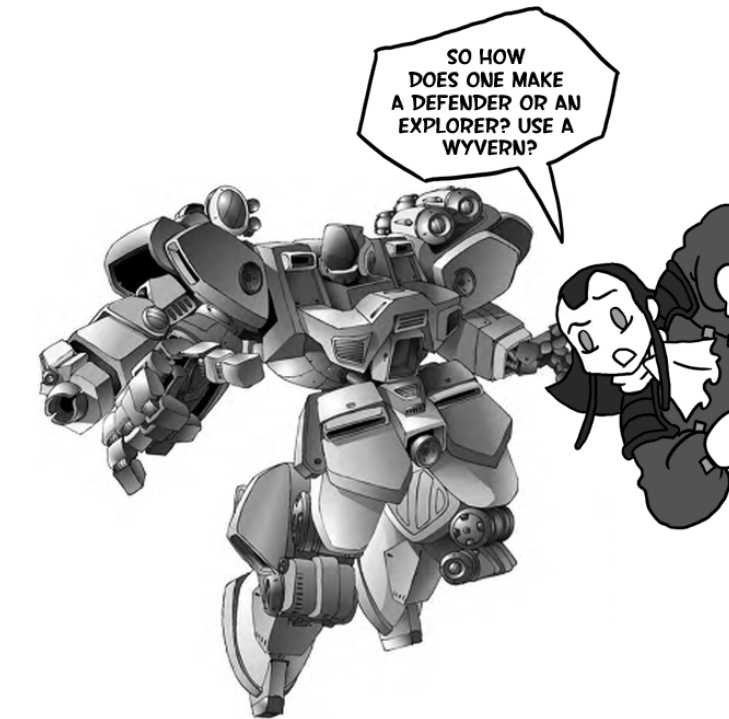

A FIGHTING MAN OF MARS...

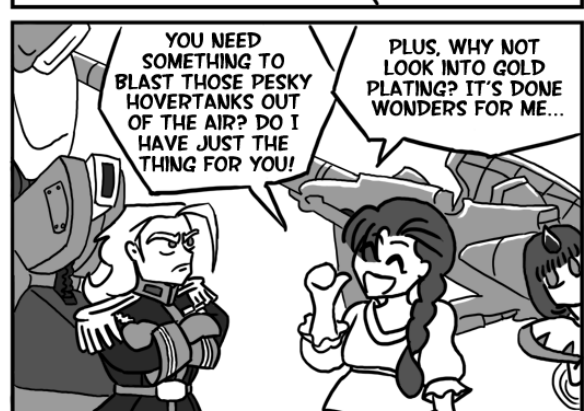
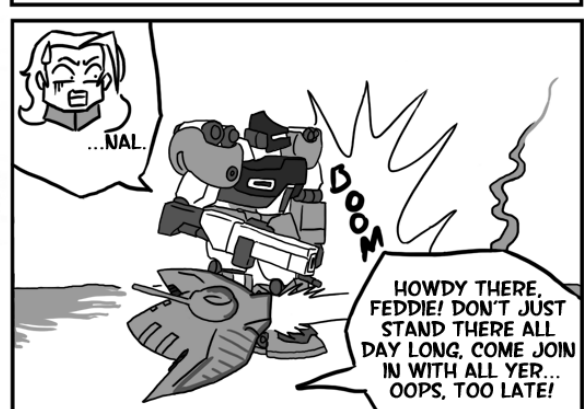
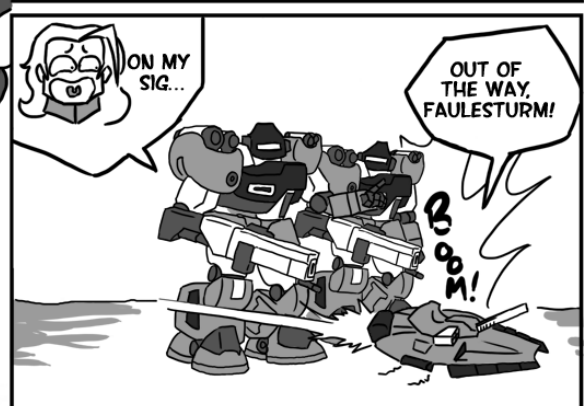
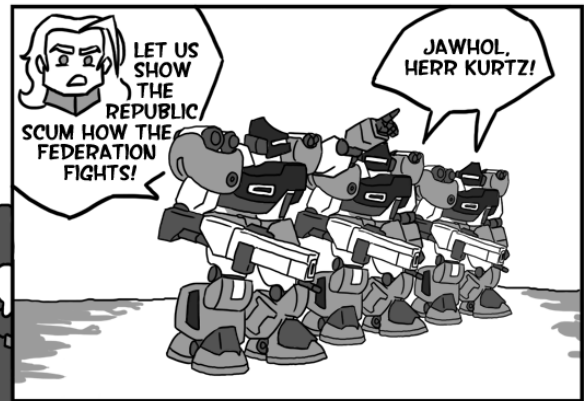

AURORA: THE SILHOUETTE MAGAZINE WEAPONS OF WAR

APFSDS: Armor-Piercing, Fin Stabilized, Discarding Sabot; A type of shell using a long rod penetrator of dense metal or super-hard alloy fired at extreme velocity, fitted with some form of polymer or cast light alloy fins and break away composite 'petals' to guide the joined projectile through a weapon's barrel. On impact the penetrator transfers considerable kinetic energy into thermal energy, boring through armor to damage vehicles via a spray of white-hot spall and high velocity armor fragments. In modern usage such projectiles tend to be longer and/or of a greater diameter than the more common cone stabilized versions.



APHE: Armor-Piercing, High Explosive; A shell type pre-dating mechanized warfare that comprises a tough, blunt nosed alloy body with less than 5% explosive filler mass, an unannealed metal cap to support the hardened point during penetration of thick armor surfaces, and a polymer or light alloy ballistic cap. Such rounds have good behind armor effects and their heavy mass can negate many defensive suites. They can also be used versus hard structures, burying themselves in thick materials before the base fuze detonates the desensitized filler. Often combined with GLRA to reduce the muzzle energy required for full effect or allow a lighter gun to utilize this projectile type.

Anti-Structure; Weapons or projectiles designed to have greater effect versus construction. Penetrators such as APDS variants or HEAP-based systems often do little more than create minor holes in earthen berms or thick ferrocrete as they are designed to concentrate their energy while most other battlefield weapons lack enough explosives to crater packed earth. Aside from artillery delivered concrete-piercing rounds, solid AP shot of blunt or near blunt profile and many types of training rounds tend to cause the greatest damage to unhardened structures.

Autoloading; A mechanical system replacing human loading of ordnance into crew-served weapons. Such aids can upload or download both shells and propellant charges into or from a weapon's chamber while closing and opening the breech. Depending on how an autoloader is integrated into an AFV's design the aided system may or may not have to return to a specific elevation and direction before a round is loaded. Although somewhat complex and often of considerable volume most systems that replace one or more live crew-members can reduce a vehicle's overall mass by lowering the protected size needing armor plating.

ATGW: Anti-Tank Guided Weapon; System designed for attacking heavy armored battle tanks, in either gun or tube launched variants. In larger designs range and loiter ability is considerable, with autonomous self-seeking processors replacing designated homing or external guidance.



Ballistic Cap: Rounded, near blunt full or sub-caliber projectiles possess the best profile for penetrating armor at the cost of sacrificing aerodynamics. A cap is simply an often hollow 'windscreen' structure of polymer or light alloy attached to the nose of a shell or penetrator for improving ballistic performance.

Barrel; The hollow tube integral with or connected by mechanical means to a weapon's chamber. Used to confine an expanding propellant or serve as a waveguide for the acceleration of a projectile.

BB: Base Bleed; A projectile fitted with a slow-burning chemical in the base, or heel, or a gas generation system otherwise attached by a shell extension. Intended to create a low pressure zone for reducing air resistance and increasing range. Incompatible with Electro-Thermal weapons.

Blowback; Automatic weapon operation type for self-loading designs where the breech block obtains energy from the motion of a cartridge case as it is pushed to the rear by expanding propellant gases after ignition of the charge. Dependent on inertia from component mass and the strength of mechanical springs to create a safe delay period. Given the common usage of caseless ammunition and combustible CTA this operational type has all but disappeared, replaced by systems using long recoil, gas, or chain-drive.

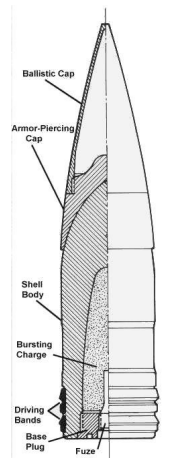

AURORA: THE SILHOUETTE MAGAZINE WEAPONS OF WAR

Bore: A weapon's inner barrel diameter measurement. Also called caliber, and can refer to a projectile size. **Breech;** The chamber end opposite the barrel, where cartridges are inserted and ejected. Closed by the breech-block, which uses either the base of a metallic cartridge or a fireproof pad to provide a gas check.

CAP: Combustion Augmented Plasma; Sometimes called ETC: Electro-Thermal Chemical. A designation for ET weapons that utilize an energetic fluid or gas of low molecular mass for plasma generation. **Capped;** A shell type having a mass of soft metal alloy attached to the main projectile's nose by low yield welds to support the point upon striking hardened surfaces. This layer may also stabilize a shell into a more optimum penetrating angle as the harder body continues forward. Often combined with ballistic caps, in such cases noted as [type] Capped, Ballistic Capped, or abbreviated as [x]CBC.

Caseless; A type of ammunition where the metallic or composite casing used to hold the primer, propellant, and projectile together as a unified cartridge is eliminated. Such ammunition is an attempt to reduce weight and cost while simplifying the operation of automatic weapons by removing both the extraction and ejection steps after firing. However, as little more than a projectile embedded in a block of propellant the rounds are vulnerable to damage by environment and simple impact. No matter how sealed, the potential of variable humidity and temperature conditions affecting the round makes it less attractive for large caliber weapons. Thus the bulk of such ammunition is used in assault rifles and lighter machine-guns where an ammunition load can be carried and protected as tough, sealed magazines.



Chain Drive; Automatic weapon operation type arming most AFVs, adapting well to multiple ammunition feeds and types. This simple, rugged system comprises a breech block attached to an endless chain via a sliding post. A power source drives the endless loop over several large gears to move the action back and forth, maintaining the chosen rate of fire. One of the advantages to this system is that stoppages or misfires do not disable the weapon, meaning an unfired round is ejected as if it had fired.



Chamber; The cylindrical space preceding a barrel, sized to support a unified cartridge or a separate shell and propellant combination. In rifled weapons the projectile will just touch or be started into the grooves.

CIWS: Close-In Weapon System; A short ranged defensive system, optimized for defense versus air or missile threats. Almost always features autonomous tracking, targeting, and firing.

Coax: Coaxial Mounting; A secondary weapon sharing the mounting frame of another system, in parallel alignment to utilize the same fire control equipment. On tanks, this tends to be some form of machine-gun.

CTA: Cased Telescoped Ammunition; A sealed unit where the projectile is contained within the cartridge case. Like caseless ammunition, where the projectile is also surrounded by propellant, telescoping rounds must deal with the issue of blocking the transition from chamber to bore, so a two-staged design is used to provide an initial burst of pressure to force a projectile out of the cartridge body and into the barrel before the remaining propellant ignites. The casing itself is often fully or partially combustible, leaving only the rear, or head, needing to be ejected or otherwise blown out of a chamber. On Terra Nova these cartridges taper at both the top and head, allowing their use in front-loading designs and more conventional weapons. This feature also ensures correct chamber seating which eliminates most of the problems inherent in using telescoped ammunition with long recoil operation types.

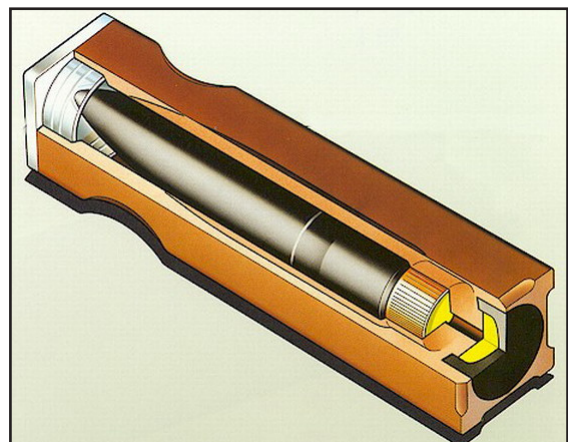

AURORA: THE SILHOUETTE MAGAZINE WEAPONS OF WAR

Composite Armor; Low mass protection involving the use of plastics, polymers, ceramics, silica glass, or other non-metallic materials. Unlike other armor schemes composite materials, ceramics in particular, tend to offer a greater amount of penetration resistance at vertical or near vertical angles.

CLGP: Cannon Launched Guided Projectile; Special purpose munitions fired from ballistic weapons to supplement conventional projectiles when other resources are required or otherwise unavailable from dedicated systems. May take the form of self-guiding missiles, homing rockets, or some other combination.

DEW: Directed Energy Weapon; A system that uses photon energy, most often in visible light bands, or accelerated atomic particles rather than kinetic or chemical means to damage a target.

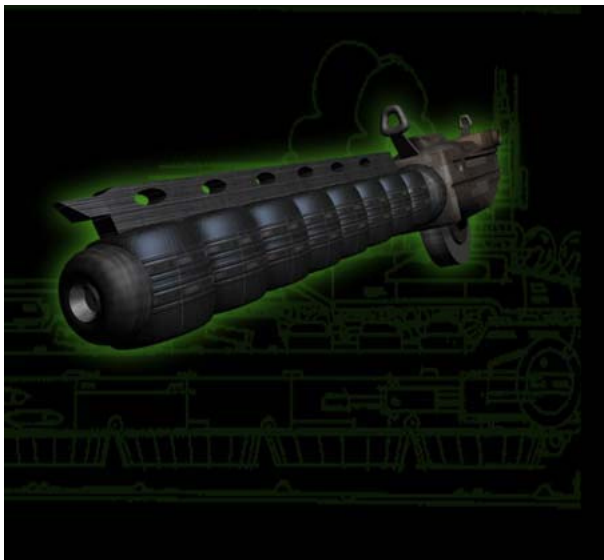

DSS: Discarding Sabot Shell; A sub-caliber projectile fired from a weapon for the purpose of increasing range. Unlike APDS this term applies to heavier rounds with an explosive filler, utilized by artillery systems.

E-Bomb: Electromagnetic Bomb; Sometimes called a Pinch, or NNEMP: Non-Nuclear Electromagnetic

Pulse. A system to generate a type of electrical overburden in local magnetic fields, damaging or resetting circuitry through current fluctuation and voltage surges. Can be effective in a small radius depending on the surrounding level of geomagnetism but often causes little widespread, long term damage.

EFP: Explosively Formed Penetrator; Sometimes also called **SEFOP:** Self-Forging Penetrator. A system using explosives to deform a shallow metal lining, or 'dish', into a variety of shapes capable of penetrating up to the charge diameter in most materials, dependent on the specific metal comprising the liner. In small calibers tantalum is common with larger weapons using copper, or most any dense yet ductile near pure metal can function with appropriate thickness and filler charge. Unlike **HEAP**-based weapons most armors tend not to degrade an **EFP**'s basic capability as the charge itself may be detonated at some distance from a target. Differing fuze or dish profiles may create alternative shapes for specific applications.

EPG: Explosive Power Generator; Sometimes also called **Explosive Pulsed Power Generators.** Devices that either convert the chemical potential energy of explosives into direct electrical energy or use explosive generated shock waves to release energy stored in ferroelectric and ferromagnetic materials. Somewhat similar in principle to how an **E-Bomb** generates a 'pinch' field, but directed into another system.

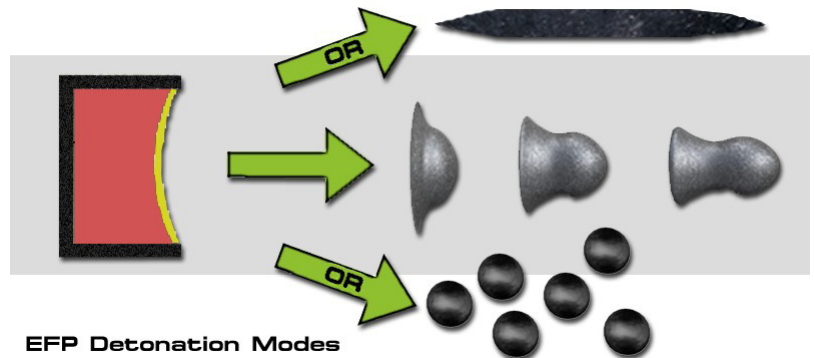

EFP Detonation Modes

ERFB: Extended Range, Full Bore; An oversized projectile with sighting enhancements or self-guidance fired from gun weapons. May also take the form of **EFSC:** Extended Range, Sub-Caliber.

ET: Electro-Thermal; A weapon system using a plasma generator for creating an expanding propellant from inert fluids or gases at a predictable rate of expansion instead of a primer igniting chemicals.

FS: Fin-Stabilized; A method of flight stabilization other than barrel rifling, using some form of attached fin assembly, angled vanes, slotted discs, high-temperature formed memory plastics, or mechanical spring-out mechanisms. Depending on velocity, shell mass, and desired level of maneuverability fin stabilization may require some method of extending into the slipstream beyond a shell's body.

AURORA: THE SILHOUETTE MAGAZINE WEAPONS OF WAR

Front-Loading: Automatic weapon operation type common for Paxton produced weapon designs, in particular for hand-held Gear cannons. The dropping breech block is a modification of long recoil operation using both recoil and mechanical force to raise and lower itself. For Gears this style allows utilization of low cost and low mass stacked magazine clips, much like an over-sized infantry assault rifle. Capacity is limited however by spring limitations so weapons of this system tend to be used more in unspecialized roles.

Full Bore/Full Caliber: A projectile the same diameter as a weapon's bore dimension, common for artillery and mortar shells plus APCR, APHE, or SAPHE types in other weapons. Used when a specific type of penetration or damage is required, most often in aerospace or rifled applications. Full caliber shells used in smooth bore guns require some form of fin stabilization.



Fuze: A device using either mechanical, electrical, or chemical means to ignite a small booster charge that will in turn detonate an explosive filler or split a cargo shell to deploy smaller projectiles. May take the form of point-detonating with quick or super-quick delays on impact, base detonating for delayed effect in thick materials, timed for a variable delay, or proximity to detonate a set distance from a target. Fuzes can be integral to a system or attached by threads machined into a shell body and activate when the round is fired.

Gas: Automatic weapon operation type used to provide energy in self-loading designs. A portion of high-pressure gas from burning propellant is tapped via a port in the barrel when the projectile passes. This gas impinges on a piston head to provide a linear kinetic motion for unlocking of the bolt assembly, extraction and ejection of an empty casing as necessary, cocking of the striker, chambering of a fresh cartridge, and locking of the action. This short-stroke piston operation has the advantage of minimal moving mass to disrupt aim in lightweight automatic weapons, while being cooler and cleaner in use than other gas types, reducing maintenance and replacement cycles.

Gas Check; An alloy or synthetic band pressed tight to a shell body or sabot assembly during passage through a barrel to contain expanding propellant gas for maximum efficiency. The provision of gas check for a weapon's breech is also called obturation.

Gelled Propellant; Cool burning semi-solid chemical ignited into a propulsive gas. Has a greater efficiency than double-base nitrocellulose types and in some weapons causes a reaction with non-metallic cartridge casings, allowing them to be combusted. Decays to a lubricating film that prevents dust adhering to barrel interiors or other moving parts where conventional weapon oils would attract earth to form a gritty sludge.

Guided; A weapon using some form of targeting or tracking system capable of repeated corrections.

GLRA: Gun Launched, Rocket Assisted; A shell using an integral or add-on rocket boost for increased velocity and to reduce firing recoil, most often in anti-armor or anti-structure applications. The rocket may ignite upon exiting the muzzle or after a short delay period and unlike RAP shells tend to be short ranged.

HC: High Capacity; A type of HE projectile with a larger than normal charge, or enhanced filler mixture.

HEAP: High Energy Armor Penetrating; A low mass hollow charge weapon using explosives to deform an inverted metal cone into a hot, high velocity liquid jet capable of penetrating upwards of six times the caliber in homogeneous alloys. May be point detonating or use a stand-off probe to ensure correct distance for maximum effect, while some designs use one or more charges to defeat Reactive Armor. In all versions however capability versus laminate and many composite armors is often limited.

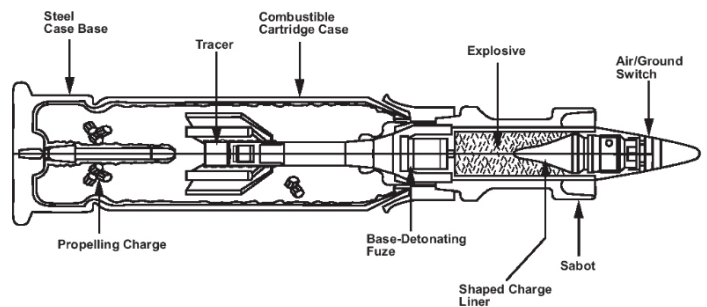

AURORA: THE SILHOUETTE MAGAZINE WEAPONS OF WAR

HE: High Explosive; Can refer to a variety of filler materials packed into a shell body as preformed blocks, molten liquid that cools to a solid mass, gelatinous slurry, or bagged particles. The proportion of explosive content is varied along with shell body thickness and alloy material to achieve a desired terminal effect – either a high volume of expanding gas or a considerable number of fragment splinters. If the material used for the body is forged to the wrong specification it is possible for the filler to pulverize a shell into harmless metallic particles, although for some applications such as training rounds this is intentional.

HEDP: High Explosive, Dual-Purpose; A general use HEAP projectile combined with a pre-fragmented shell casing or some other type of Anti-Personnel lining to create a moderate Area of Effect at detonation.

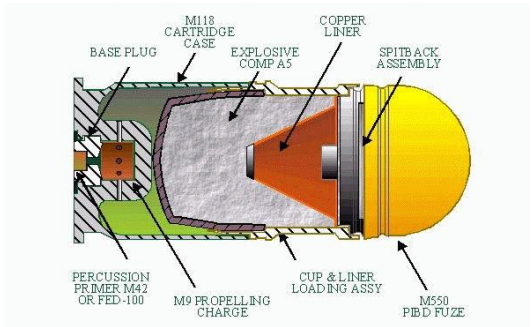

HE-FRAG: High Explosive Fragmentation; An explosive projectile containing a layer of metal alloy balls or other preformed fragments for enhanced Anti-Personnel effect. Common in low caliber general usage artillery and mortar shells. May be combined with a hollow charge warhead to produce HEDP shells.

HESH: High Explosive Squash Head; Sometimes also called HEP: High Explosive Plastic; A full caliber shell containing a heavy charge of insensitive explosive within a thin walled body. On impact with a surface the casing ruptures and the explosive forms into a thick pancake before detonating. Shock waves fracture high velocity scabs from homogeneous materials such as metal and ferrocete, making it ideal for demolition work. HESH is less effective versus spaced or laminate armors.

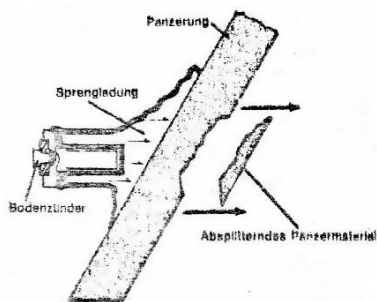

IF: Indirect Fire; The capability to fire a projectile over intervening obstacles or terrain. Increases Area of Effect for shells fuzed to air-burst and allows attacks versus targets behind cover which blocks direct fire.

LAHMP: Laser Homing Multi-Purpose; A type of CLGP capable of self-tracking the energy reflected off a target painted by a compatible designator. Has reasonable accuracy without using the homing ability when lasing a target would trigger some form of warning system. Retained in service due to the complexity and cost of more 'brilliant' autonomous self-seeking munitions. 'Lamp' rounds are common shell types for selfpropelled artillery weapons, mobile armored gun systems, and Gear snub or mobile cannons in both APHE and HE-FRAG projectile types.

Laminate Armor; Combines features of composite, homogeneous, and spaced armor schemes as well as components of the vehicle itself where possible as part of an integrated protection package. Outer facing layers are a tough material such as Flexite backing a hard metal alloy or low mass super-hard material surface which either breaks up kinetic penetrators or absorbs energy through compression. In vehicles this is followed by either layered ceramic blocks in a 3D ultra-hard wire mesh or cylindrical ceramic prisms in a light alloy framing, both oriented versus horizontal attacks. The ceramic layer(s) shatter or sublime under kinetic and thermal impact to dissipate energy by decompression. In some schemes enhanced RHA metals are used to sandwich composites into a toughened, super-plasticity state where volume is insufficient to include full ceramic layers. Additional metal plates, sandwiched materials, or ceramics can be added over the vehicle's skin or frame for enhanced protection of specific orientations as mass or surface area allows.

Long Recoil; Automatic weapon operation type allowing the barrel itself to function as the driving force, eliminating the need for additional buffering assemblies or a hard point mounting. Rate of fire tends to be somewhat lower than with pure blowback systems but accuracy is higher and functionality more compatible with the common auto-cannon caliber sizes. Ammunition feed for this style tends to be from the top or side using either pulley-tensioned columnar types or helical magazines, both capable of considerable capacity.

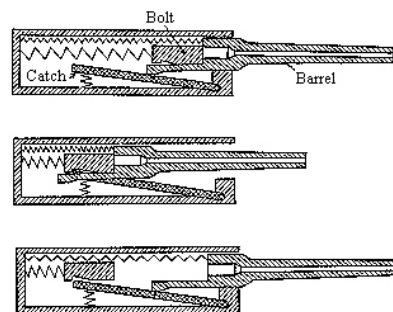

AURORA: THE SILHOUETTE MAGAZINE WEAPONS OF WAR

Long Rod Penetrator; Kinetic energy projectiles pierce a thickness of armor based on applying force over a circle equal to the penetrator's frontal area. For two shells of the same mass traveling at equal velocity whichever has less diameter will bore deeper when impacting a surface. Long rod projectiles combine a minimal body cross section to length ratio with an increased mass to maintain a high striking velocity over considerable distances, requiring the use of dense metal or super-hard alloy bodies that will not shatter on striking armor surfaces while traveling thousands of meters per second. Tungsten compressed into a carbide using a cobalt-nickel matrix is most common, followed by platinum alloyed with a titanium-copper-vanadium mix. Due to the costs of machining and heat treatment compared to other materials combined with associated handling and clean-up responsibilities depleted uranium has fallen into disuse.

Multiplex; A cartridge or shell loaded with multiple projectiles, able to be fired down a barrel all at once.

Polygonal Rifling; A type of gun barrel rifling using a regular convex polygonal pattern, either octagonal or decagonal in modern usage. Such rifling offers improved gas sealing compared with land and groove types while retaining more strength due to less cutting away of internal material. Projectiles are not as deformed during their passage, velocity loss to friction is reduced, and barrel wear minimal. A further advantage to this system is that a bored barrel blank may be profiled, chambered, and rifled in one step by hammer or press forging prior to heat treatments for removing the resultant induced metal stress. [pic]

Primer; A type of booster charge utilized to ignite a main propellant charge or another booster type in a chained sequence. In small arms cartridges primers tend to be filled with shock sensitive metallic salts. In larger calibers cases almost always use an electrical pulse to detonate nitrocellulose based compounds.

RAP: Rocket Assisted Projectile; A shell using either integral or add-on rockets, or some form of SCRAM (supersonic combustion ramjet) for a significant range boost. Incompatible with ET weapons and dispersion over long trajectories is common without guidance if boost or burnout occurs at a non-optimum angle.

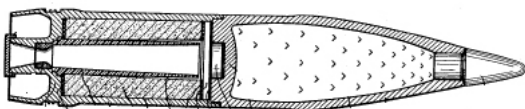

Reactive Armor; Most often an add-on protection utilizing shaped blocks of formed explosive sandwiched between alloy plates. When struck by penetrating attack the explosive deforms the facing plates to disrupt a HEAP jet and can deflect, damage, or break-up kinetic penetrators. Uncommon on Terra Nova due to the debris hazard for nearby troops, whilst the blocks themselves are expensive in quantity and less effective on the multi-faceted surfaces of Gears or similar walker vehicles compared to AFV usage.



RHA: Rolled Homogeneous Armor; A simple scheme of protection comprising a malleable thickness of hot rolled alloy such as nickel-molybdenum steel resistant to deformation by spreading force out across elongated lines of grain structure. Effective only versus low to moderate velocity kinetic penetrators, quite heavy for a given thickness unless using low mass alloys, and vulnerable to systems using HEAP plus all Directed Energy Weapons. Sometimes cheaper than other protective schemes, but often superseded by composite/ceramic armors on most worlds.

Rotary; Automatic weapon operation type of multi-barrel designs, using tapped gun gas or external power. Each barrel has a distinct chamber and bolt, firing a single shot when it reaches a certain point in the cycle, after which it ejects and/or loads a new round. The primary reason for using this design is countering barrel over-heating to reduce wear during repeated firing of sustained bursts, but a major drawback is the time it takes to get up to speed before discharge, and needing to compensate for the rounds having a right or left inertia from the weapon's rotation as they leave the muzzle. Due to reasons of complexity, maintenance, and cost however gas operated multi-barrel ballistic weapons have all but disappeared. Ground combat does not often require that high a rate of fire and single barrel weapons can achieve similar performance.

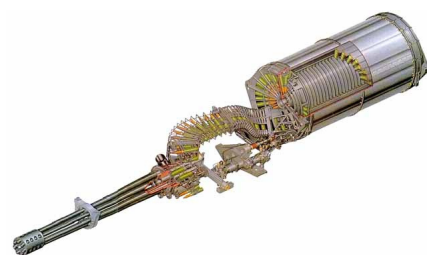

Rotating Band; In rounds for rifled barrels a pressed soft metal or synthetic band wrapped around a shell or sabot to impart spin as the peaks cut into the material rather than the hardened projectile surface.

RPM: Rounds per Minute; Also known as Rate of Fire. The rate a weapon can load and fire projectiles.

Sabot; A means of centering sub-caliber projectiles in a barrel, used to provide a gas seal for maximum efficiency of an expanding propellant. Any type of material may be used from alloy to composites, held together by pins or bands sheared under acceleration – leaving the sections to fall away as the projectile exits the muzzle. Widespread use requires care to be taken so nearby friendly troops and soft-skin vehicles are not hit by discarded sections that may take hundreds of meters to slow from supersonic velocities.

SAPHE: Semi-Armor-Piercing, High Explosive; A variation of APCR with explosive filler replacing much of the inert light structure. On impact the core crushes incendiary pellets mixed into the filler, detonating the explosive. Rare in most ground service applications, common for ballistic air to air and aerospace defense weapons in both rifled and smooth bore variations. Limited damage potential compared to APDS rounds.

Shell; In correct terminology refers to a projectile with an explosive filler, while solid rounds are referred to as 'shot'. By modern usage however shell is a generic term for any unpowered gun projectile.

SLAP: Saboted Light Armor Penetrator; A type of small HVAP projectile used in infantry weapons, often a dense metal post and base encased by low mass material. On impact the exterior shears away from the harder core. Depending on muzzle energy useful versus APCs, soft skin vehicles, and light armored Gears.

Sloping; Armor scheme modification enhancing protection by sacrificing volume. Angling a protective layer increases the horizontal thickness of a facing based on the degree of slope. A drawback to this gain is the amount of armor needed to cover a facing increases, constraining the thickness of a plate so mass may be kept within limits. Likewise, some types of composite materials such as ceramics offer more protection not sloped and must be formed in special shapes to maintain horizontal orientation. However very few modern vehicles or Gears of any kind lack sloped armor in critical facings.

Smooth Bore; A type of barrel that lacks rifling, requiring any projectiles to be stabilized by some form of vanes instead of through rotation. Optimized for shell types such as HEAP and long rod penetrators which lose effectiveness if spun. Smooth bored barrels also allow a greater muzzle velocity using a given amount of propellant, suffering less friction wear while offering a reduced internal surface area for thermal erosion. Often referred to as cannons, or tubes in artillery systems.

Soft Recoil; A modification in systems with high muzzle energy where propellant ignition occurs as the weapon is released from maximum rearwards position, with the effect of recoil forces having to overcome the inertia of a combined gun mass moving forwards before recoil travel can begin to bring the barrel back.

Soft Skin; A military or civilian vehicle lacking any significant form of armored protection. Common in many organizations for general duties, logistics, and low intensity warfare usage.

Spall-Catching Liner; An internal layer of protection consisting of dense-woven, layered fibers that catch fragments penetrating exterior surfaces. Common in all vehicle types, for all varieties of armored schemes.

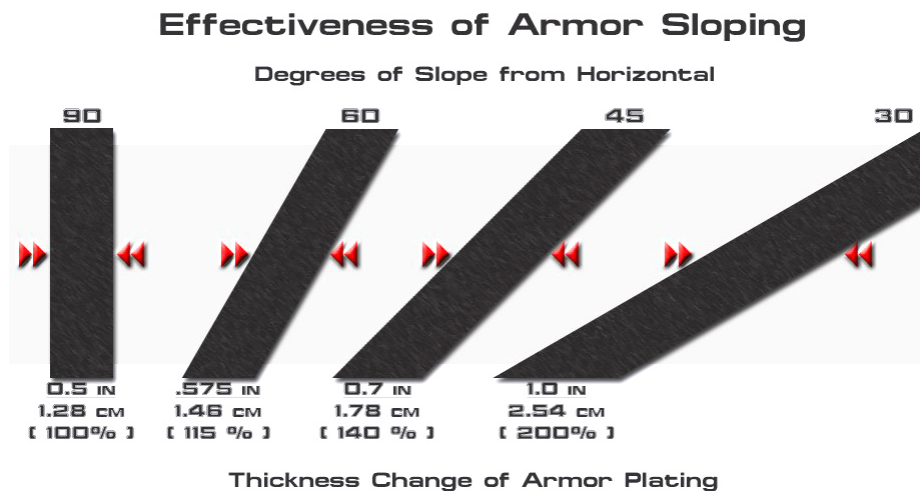

AURORA: THE SILHOUETTE MAGAZINE WEAPONS OF WAR

Spaced Armor; One of the oldest modifications to basic metal armor protection spacing most often refers to the use of multiple equal or varied thickness plates set millimeters or centimeters apart from one another faced towards a specific orientation yet still internal to an AFV's outer facing. At times this may also refer to intentional voids left in large armor castings or those created through welding, as well as any skirts or slats hung along a vehicle's sides to deflect, detonate, or deform impacting projectiles. Internal spaces and gaps between plates may be filled with low mass material such as resins, granular ceramic silicate slurry, types of closed- and open-cell foams, or just left empty. When such armor is hit by HEAP based and other similar non-kinetic attacks they expend energy into each gap or filler mass through decompression effect.

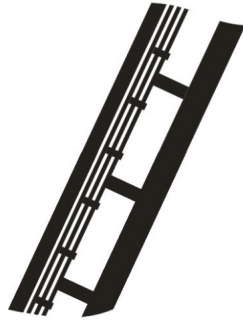

SS: Spin-Stabilized; Projectiles given a twisting rotation by peaks and flats in a rifled barrel, or some form of angled rocket nozzle, to maintain a controlled flight trajectory.

Sub-Caliber; A projectile where any portion is of lesser diameter than the bore measurement.

Super-Hard Penetrator; With a velocity limit of 2,000 mps for ballistic weapons using gelled or cellulosebase propellant dense metal projectiles can grow too massive in a particular caliber for effective use versus a desired level of armor penetration. As an alternative long rod penetrators may be formed at near diamond hardness either by using nano-structured low carbon silicate steel, molecular titanium alloy, or armor grade cubic-boron nitride. Such aligned alloy penetrators are also very resistant to 'mushrooming', a deformative action when metal strikes another object with force, and thus lose less energy boring a constant diameter hole where even a tungsten projectile would begin to expand. However, while quite tough and hard for their mass such materials are expensive to produce in quantity and are in common usage for very few systems. Weapons must also be modified with longer barrels to compensate for the lighter mass so range is not lost.

Tracer; A slow-burning chemical pellet or charge in a projectile base, creating a visible trail for tracking a shell to point of impact. Often has a smokeless delay to conceal a firing position if muzzle flash is hidden.



Tracers Light Up the Night

Find all the latest official Pod material in the latest issue of Gear Up!



ISSUE 4

GEAR UP

THE OFFICIAL DREAM POD 9 MAGAZINE

ARMY SPOTLIGHT
MILICIA

ENGINEERING SQUADS
SHAPING THE BATTLEFIELD

THE BEAST IN THE WILDERNESS
HHT-90 AFTER ACTION REPORT

NEW ARENA HIRED GUNS
TORVAS, CORNICE, & MUSASHI

FIELD TESTING
HEAVY HOVERTANK SQUADS

TERRA NOVA TERRAFORMER
BADLANDS OASIS TOWERS

Available for free download at RPGnow.com:
http://rpg.drivethrustuff.com/index.php?manufacturers_id=19

AURORA: THE SILHOUETTE MAGAZINE

SUBMISSION GUIDELINES

Article Guidelines

The Aurora Magazine focuses on the worlds created by Dream Pod 9. As such, we are primarily interested in, but not limited to, articles dealing with SilCore and Blitz rules (variants, additions, explorations of the rules) and on fiction, mechanized designs, equipment and the like that draw on established DP9 universes. This does not mean, however, that articles that are generic in nature or that do not deal with unique or original material, only that the focus is on exploring Silhouette and its attendant universes.

Any article that is a promotion piece for another product, be it an excerpt or a lead-in to another product, must be clearly defined as such within the article body.

No articles will be accepted that use another's Intellectual Property or Copyrighted material without an included signed permission to use said material.

Fiction may be a one-off or serial based, as desired. Please note that long works of fiction may be split into multiple pieces over multiple issues for length reasons; if you are writing a long story it is best to indicate breaks in the story (chapters, for example) that allow us to choose the best point to split the story, if necessary. In keeping with the nature of the magazine we ask that fiction be accompanied by Silhouette CORE or Blitz! rules detail of some kind, be it stats for characters or equipment in the story, game scenarios, mechanized designs, new rules or explanations of how to simulate aspects of the story using the Silhouette/Blitz rules. This is not a hard requirement, and you may request that another contributor be asked to create the rules support based on your story.

Aurora is also looking for original artwork. Art may be used to accompany the article and/or for the cover of the APA. Please see below for copyright information regarding images.

Submission Guidelines

All work for Aurora should be submitted in an .rtf (Rich Text Format) file. The text within should be in Arial 10pt font, and single-spaced. Hard returns should be used only to separate paragraphs (with a double hard return) or with bullet points and list items. Do not indent paragraphs. You may use italics, boldface or bullets where deemed necessary.

Tables may be included in the submission. Preferably, tables should be created with minimal lines between cells, instead using background colour and/or cell spacing for clarity. Tables may also be included in courier-font/fixed-formatting. Identify these kind of tables with the following: <<<Table>>>

The article's title should be clearly noted at the beginning of the file, followed by a short (less than 75 words) introductory text. This introductory text can either be a synopsis, a quote, story, etc. It will be used at the beginning of the article to 'set the stage'.

The file should end with the Author's name(s), contact information (if desired) and a short bio (optional). This information will be placed on a Contributing Author's page in the magazine.

Please spell check and proofread your article. English or American spellings may be used as desired.

Photos, drawings or images should be accompanied by photo credits as well as a brief description/caption for each photo (optional). Indicate within your article where the images are to be included like so: <<<Image_Filename.ext>>>. Images should be sent at a maximum of 150dpi for greyscale or colour images, 300dpi for black & white images (1-bit). Given the size of a page, images should be no larger than 7 by 7 inches (18 by 18 cm). If we need a higher resolution image, we will contact you. Images should be compressed with an appropriate method; please check the quality of your images before sending. If by including images the submission would grow over 2 megabytes in size, please place the images on an Internet-accessible server where we will download them (don't forget to tell us where they are located).

Copyright Guidelines

Quotes or information that are attributable to other sources are permissible in appropriate quantities, and should be identified/cited (including page numbers), preferably within the article. Be sure that each quote is written exactly as it appears in the original source.

If you wish to include photos/drawings/images with your article, please provide the photo credits (artist/photographer/illustrator and subject if applicable). You may only submit images for which you have obtained permission to include in your article.

All articles and images used by Aurora remain in the copyright of the original submitters. You, as the author, must consent to release the article for publication by Aurora, with the knowledge that Aurora will not provide any compensation other than what has been listed above, and that Aurora, as an online magazine, will be downloaded by third-parties in a PDF format. All work for Aurora is volunteer-based. Should DP9 decide at a later time to compile and sell articles within a contract will be negotiated with the author at that time.

The End Print

Please send all submissions to the following email address:

auroramag@gmail.com

Thank you everyone for your interest, and we look forward to seeing your submissions soon!

Deadline for Submissions for Issue #6.2: March 15th 2012

AURORA: THE SILHOUETTE MAGAZINE

ARTICLE SUGGESTIONS

Historical Articles

Under this broad category are pieces meant primarily for illuminating or detailing something within the game universe. This can be truly historical in nature (describing history), detailing a region, the language, customs, architecture, technical systems, corporations, social structure, music, and more, to name a few. Articles may either be written from a neutral point of view (impartial observer from above) or written 'in character', that is, in the manner such information may be presented if it were available in the game world. See the Historical Accuracy note, below (especially important for this category).

Fiction

Any story (narrative with characters) that takes place within the established DP9 game worlds falls under this category. See the Historical Accuracy note, below, and also see the submission guidelines for further requirements.

Modules

Also known as adventures, a written collection of plot, character, and location details used by the gamemaster to manage the plot or story in the DP9 RPGs. All manner of modules are open for submission, from espionage to social to military to a combination of all three. Module submissions must be detailed enough for the GM to run the entire adventure, including descriptions and dispositions (where applicable) of major NPCs, locations, accessories and story/plot. See the Historical Accuracy note, below.

Scenarios

These are the tactical equivalent of modules, an encounter between two (or more) factions set up for combat. A complete scenario will detail the background of the encounter (the why), the forces engaged (the who -- what physical units at a minimum, regiment and designations to go the full way), the map and terrain (the where) the victory conditions (the how) and any special rules or conditions (the what). Scenarios should be designed to be balanced for each side, either via the types/numbers of units or through special circumstances or conditions. If the scenario is not balanced this must be mentioned in the background. See the Historical Accuracy note, below.

Note: Historical Accuracy

Aurora is committed to accuracy within the established DP9 worlds. All articles that take place 'within' the game world should be checked for its accuracy within the established timeline, faction dispositions, available equipment, etc. Submitted articles will be run by the game world historians, so check your work! You may, however, submit your article clearly marked as "Alternate History" and if published the article too will bear this mark. Be sure, if you submit this way, to provide in the background all that is necessary to describe what has changed.

Designs

New mechanical designs/vehicles/ships for use in the DP9 worlds. Designs must be legal and use either the latest SilCore rules (including all errata and the FAQ) or Blitz rules. Please indicate which design rules were used. Mechanical designs should fill a void that is not already covered by another unit. Background and a description must be included with the design, while artwork is optional and preferred. See the Historical Accuracy note, above.

Artwork

Aurora accepts all artwork for consideration, no matter the media type (rendering, sketch, painting, etc) within the rules set herein. Miniature photographs will also be accepted (dioramas encouraged!). Artwork must relate to an established DP9 universe and be easily identified as such. Artwork with nudity, racial undertones, sexism or sex will not be considered. See the submission guidelines on how to submit images.

House Rules

Original rules for the Silhouette/Blitz! system and modifications to existing rules. All rules submittals must include an explanation of the rule's purpose, the rules themselves clearly written, and an example of the rule in play.

Note: Blitz! Rules

House Rules covering existing Blitz! Rules will be limited. New Rules covering areas of the game not explicitly contained in the existing rules (as found in the Blitz! line of books) may be submitted freely. House Rules that modify or replace the written Blitz! ruleset (as found in the Blitz! line of books) will be forwarded to the line developer for review and comment. They will then contact you if the idea may proceed forward. Note that this applies only to the Blitz! line -- rules may be freely submitted for any other SilCore game.

Tactics

Have you won countless battles? Have a strategy you would like to share? Write a tactics article. Usually this type of article will be in a step-by-step (or turn by turn) format to illustrate the tactic. An introduction and conclusion is required to create a complete package and to convey to the reader where the tactic is applicable and how it came about.

Miniatures/Modeling

Any article on preparing miniatures, painting, terrain making, sculpting, foliage techniques, etc will be accepted. Photographs and/or diagrams are strongly encouraged.