

AURORA

THE SILHOUETTE MAGAZINE

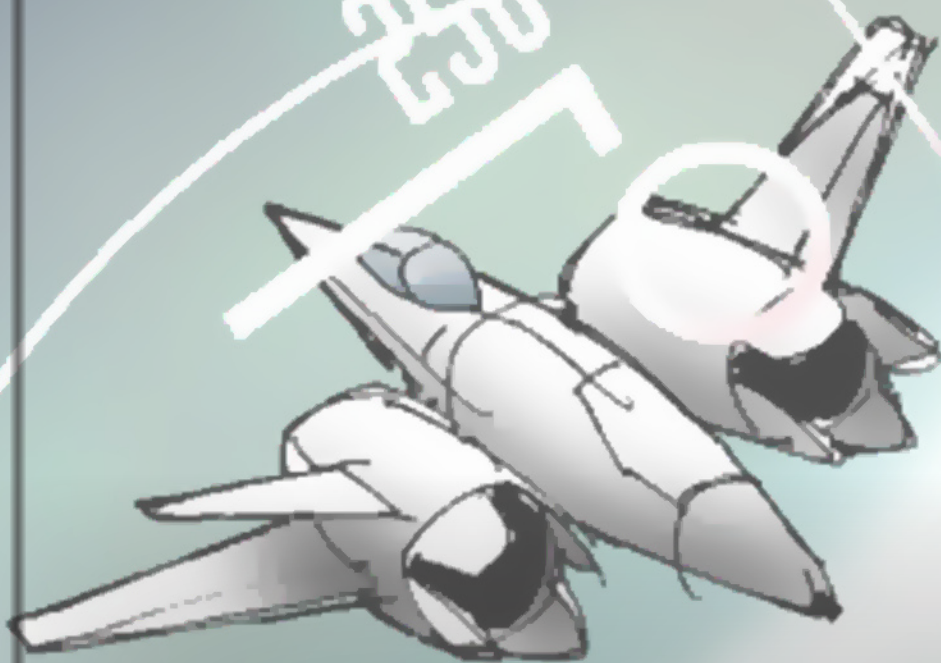

INSIDE THIS ISSUE:
VARIANT RULES FOR BLITZ!
GEAR KRIEG FICTION
PAPER MINIATURES
VARIANT DAMAGE RULES FOR SILCORE



AURORA: THE SILHOUETTE MAGAZINE
TABLE OF CONTENTS
VOLUME 3, ISSUE 6

Shades in the Night... <i>Editor's Message</i>	2
About the Authors <i>The Whos and Copyright Information</i>	3
Alfie's Tanners <i>Graphic Novel set in Gear Krieg by John Bell</i>	5
The HG-B:G House Rules <i>House Rules for Heavy Gear Blitz by Gareth Lazelle</i>	8
Gear Krieg Paper Craft <i>Paper Models for Gear Krieg by John Bell</i>	11
Piecemeal Operational Degradation <i>Variant Rules for SilCORE by Oliver Bollmann</i>	16
Messages from the Pod <i>Official DP9 Material by John Buckmaster</i>	24
Submission Guidelines <i>How to Submit Material to Aurora</i>	25
Article Suggestions <i>What Aurora is Looking For</i>	26

AURORA: THE SILHOUETTE MAGAZINE SHADES IN THE NIGHT

From the Editor...

Another year of publishing Aurora has come to a close with the issue you now hold in your, er, computer. Amazing to think that it's been three years, eighteen successive and successful issues. None of this could happen without the excellence of our contributors, and for that we thank you all.

This will be a short and sweet message this issue as we barrel headlong into the upcoming end of and beginning of year festivities. Here at Aurora HQ we're also gearing up for our fourth year, and we have no intention of slowing down. Where there's DP9 gaming to be done, we'll be there.

Best of wishes to everyone this holiday season. Be safe, be loving, be fair, be gracious and happy gaming.

Oliver Bollmann
Aurora Magazine Editor

PS – Got something burning in your mind for Aurora? Want to be in the first issue of Volume _4_? Fire it our way! The holidays are a great time for writing...

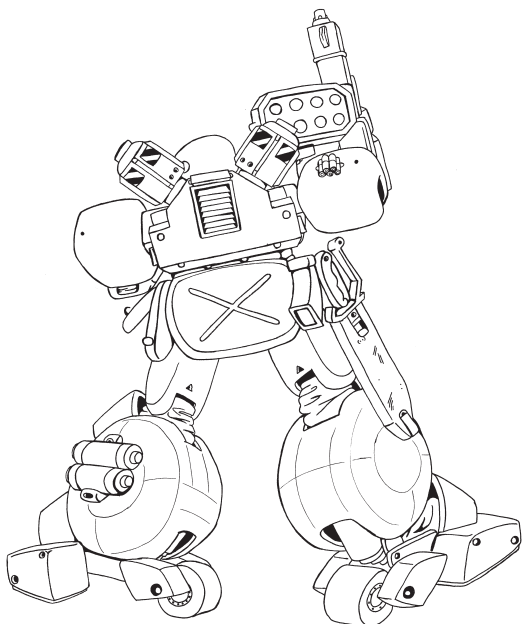

OFFICIAL-DP9

Only articles stamped "Official" are considered to be from Dream Pod 9 for Tournament or similar reasons. Some official material will be noted as optional, and are therefore treated as "Officially Optional". Said another way, consider the material in Official articles the same though published in a DP9 book.

TEST DRIVE

Articles stamped Test Drive indicates that the rules being presented are in testing. The rules are not official -- yet -- and being considered for later publication as Errata or are products in development. DP9 would appreciate feedback on their use, but they are not to be considered official. Note that they may change at any time or never be seen again.

HOME BREW RULES

Anything not so marked is a fan submitted rule not regarded as official and does not change the games or the DP9 game-universes as written in the books. Optional rules should only be used if all players agree upon their inclusion before play.

AURORA: THE SILHOUETTE MAGAZINE

ABOUT THE AUTHORS

Gareth Lazelle (gareth@cyanlion.com) -- *The HGLB-G House Rules*

Gareth is an obsessive role-player/war gamer who became fascinated by Heavy Gear around ten years ago. He spends his time on all sorts of geeky little projects when not otherwise distracted by work, life at home or cats.

John Bell (jakarnilson@magma.ca) -- *Alfie's Tanners and Paper Model: LC1/40*

He gets labeled a "walking-talking encyclopedia." He draws what goes through his mind. He builds what he can't afford. He walks what others would take a lift for. He'd probably trade in his bike for a real, working Ferret; but then again, who wouldn't?

John Buckmaster (dp9.rules.support@gmail.com) -- *Messages from the Pod*

John Buckmaster is DP9's head rules monkey and line developer. He's one of the masterminds behind the whole Blitz thing, and has been a Heavy Gear fan forever.

Oliver Bollmann (kannikcat@hotmail.com) -- *Piecemeal Operational Degradation*

It all started in a hobby store one day twenty odd years ago with an odd box containing something called Top Secret. Almost as soon as he began gaming he began writing, tinkering and adding for and to them, which led to self-publishing and e-publishing several supplements. In the times he's not playing games, practicing traditional Chinese martial arts, designing buildings, or being a stand for the world he continues to write and create for all manner of things. He's been in love with the DP9 universes since the first HG release and began his direct involvement with the Pod crew a couple of years ago.

AURORA: THE SILHOUETTE MAGAZINE ABOUT THE AUTHORS

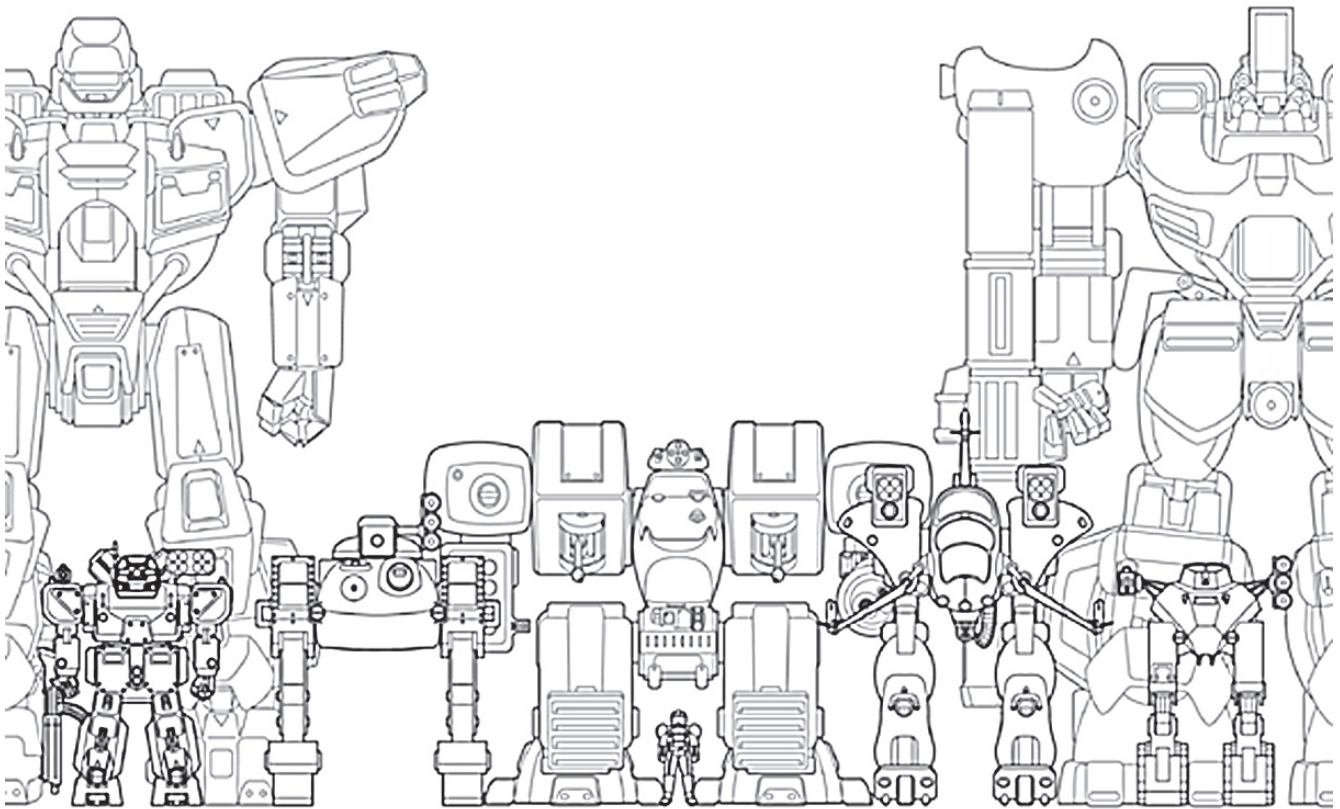

COPYRIGHT INFORMATION

Silhouette™, Silhouette Core™, Core Command™, Heavy Gear™, Heavy Gear Blitz!™, Jovian Chronicles™, Tribe 8™ and Gear Krieg™ are Trademarks of Dream Pod 9, Inc. Silhouette™ Core Rules are © Dream Pod 9, Inc.

All articles written within are © their respective authors, as indicated on the list above. Permission has been granted for the sole purpose of their publication in Aurora. No reproduction is allowed without their express consent.

All images not specifically listed above, as well as all game logos are © DP9 and their original artists. No reproduction is allowed without their express consent.

Permission granted to reproduce this document in full for private use.

Please visit www.dp9.com and aurora.dp9forum.com for more information.

Aurora Magazine, Volume 3, Issue 6, Published November 1st, 2009

JOHN BELL

ALFIE'S TENNERS

ART & STORY: JACK BELL

FRANCE, MAY 1940. HAVING REACHED THE CHANNEL, THE GERMAN DIVISIONS ARE NOW ADVANCING ON THE ENCIRCLED B.E.F. 2/LT. ALPHONSE MARCH AND HIS WALKER TROOP CAN ONLY GO ONE WAY: NORTH!

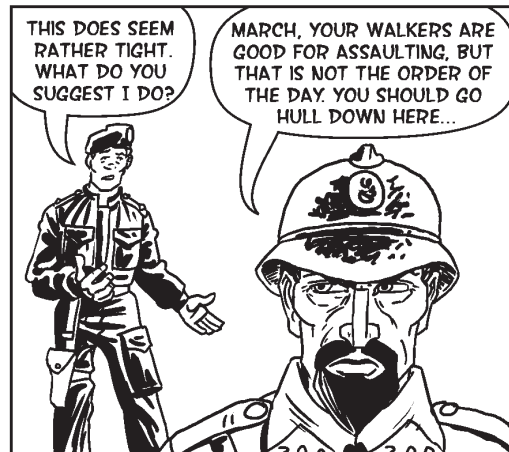
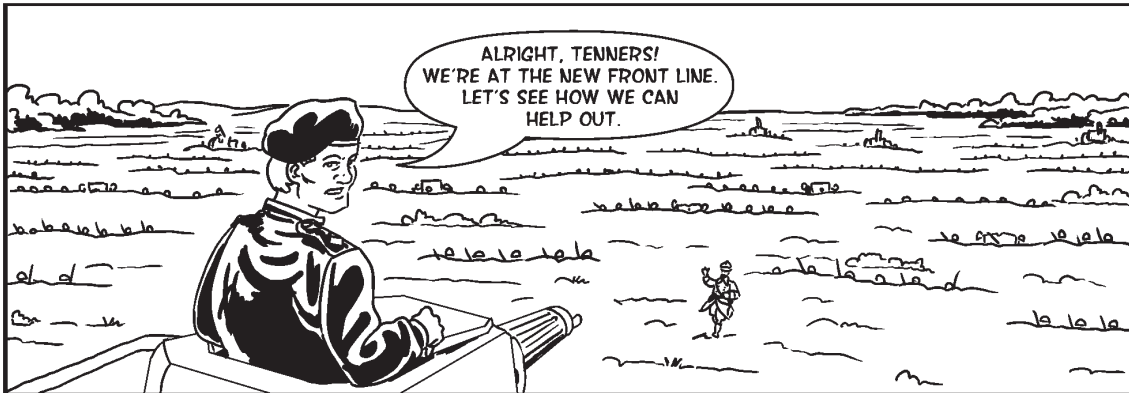
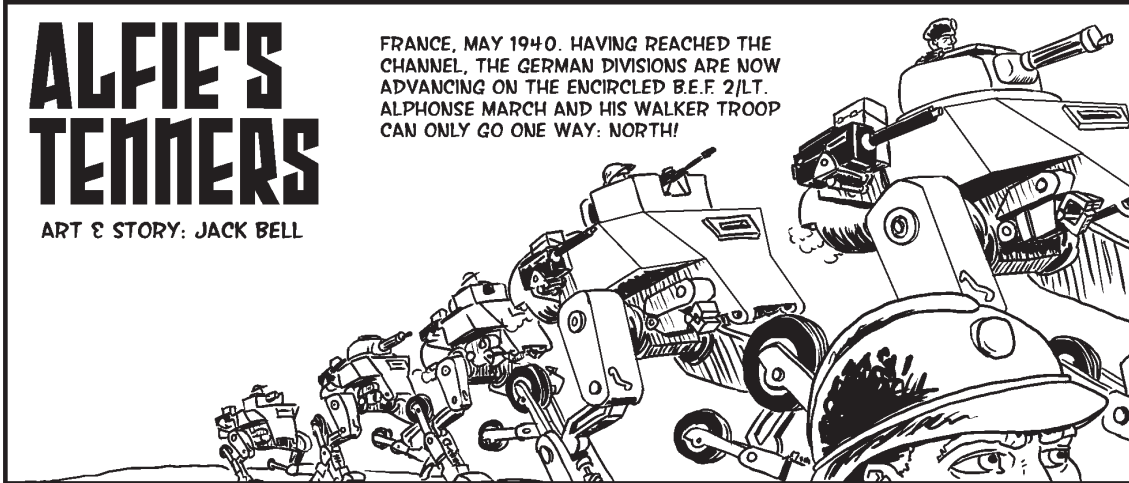

AURORA: THE SILHOUETTE MAGAZINE
ALFIE'S TENNERS

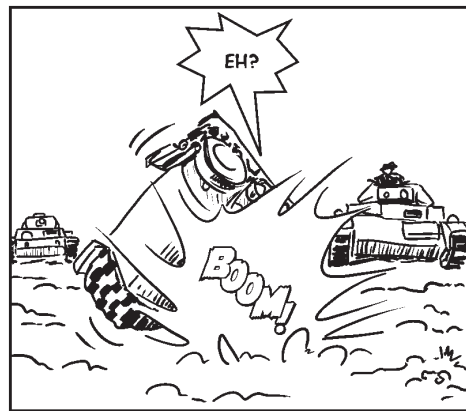
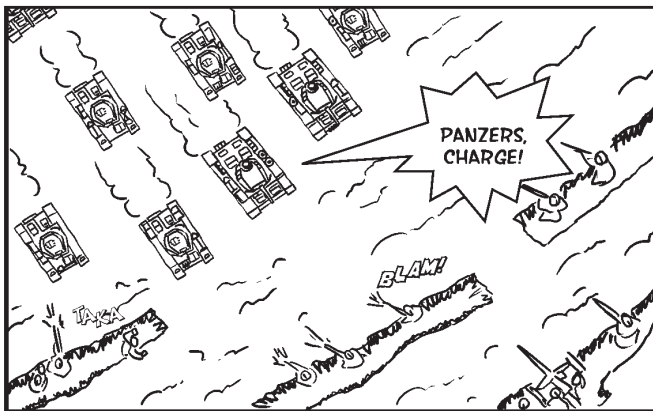
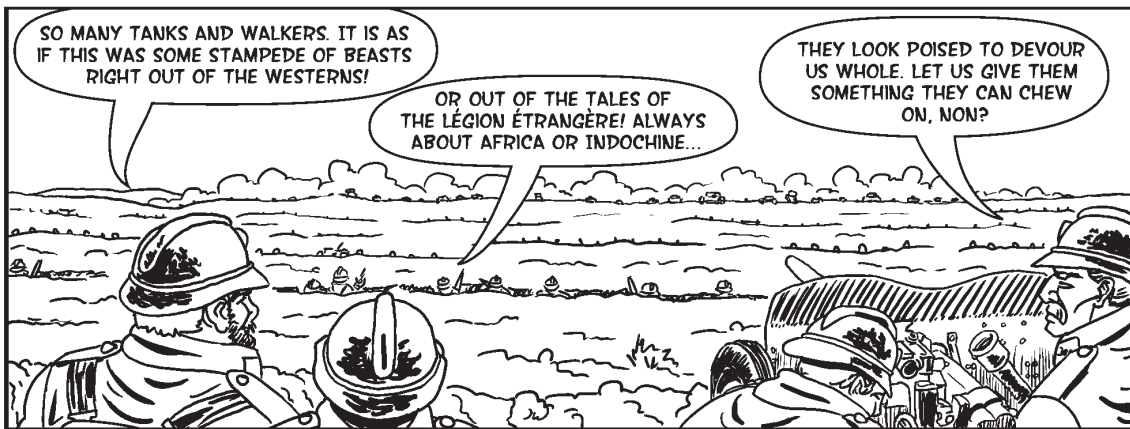

AURORA: THE SILHOUETTE MAGAZINE
ALFIE'S TENNERS

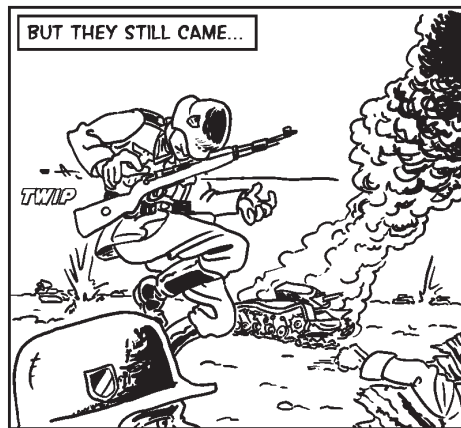
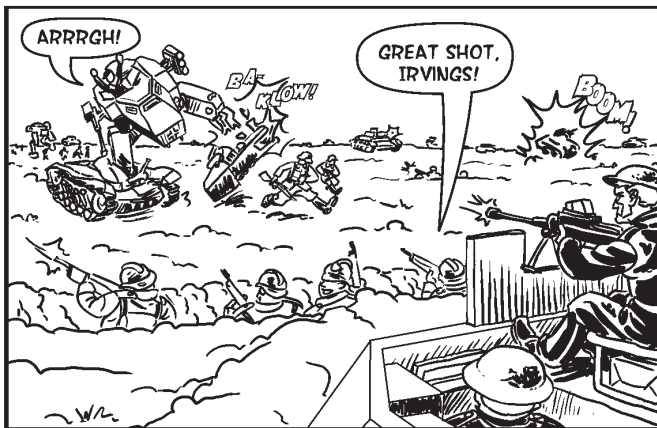
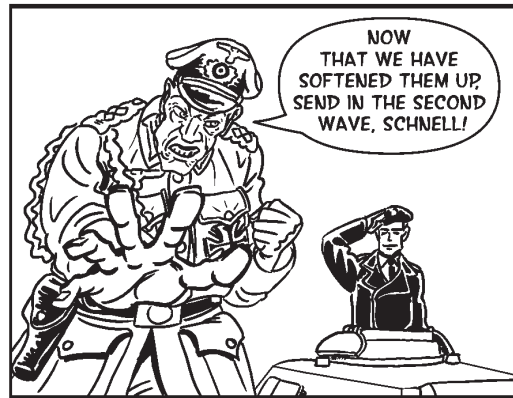

NEXT EPISODE: ENTER THE GREEN DEVILS...

A selection of House rules are presented below. They are mostly intended to work together, so additional work may be needed if you wish to use any of the discussed options in isolation (the EW-Mode and Second in Command sections being possible exceptions). As always, use at your own risk!

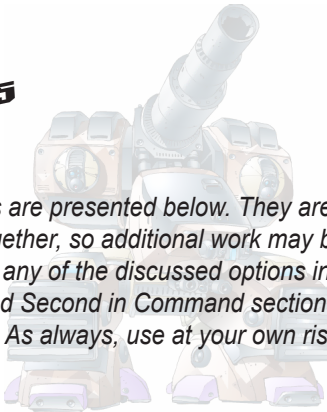

Area Effect (X) [AE X]

(Replaces the rules text on page 177 of Locked and Loaded)

[The written AE and IF rules seem backwards to me, this and the next few items are intended to rework the two traits into something slightly different. The presented AE gives you the option of employing high-explosive ammunition, with high odds of achieving hits if your shell is on target, all at the cost of lower damage. It also removes the “automatic stun” caused by AE weapons when fired directly.]

Rather than make a normal attack, the Model may elect to fire a fragmentation shell to attack all targets within a large area. When you do so, select a target-point on the table. This point can be a model or a point on the ground, but you must have a Lock onto the target-point, and if it is a point on the ground there may be no enemy models within the AE that you do not currently have a Lock onto. Additionally, if it is a point on the ground and it is not In the Open then it is automatically considered to be in Full Cover when you perform your attack roll (Cover for any targets should still be worked out as detailed below).

Make a normal attack roll against a threshold of 4 to hit the target point. If the attack misses (a MoF of zero or more) then make a skill roll using the MoF as the skill level, and adding the MoF onto the result. The total is the scatter distance (divide this distance by two if you are using a Thrown weapon, or if the attack is at Short range or closer, rounding any fractions up). To determine the direction of any scatter, roll 1d6 and, with 1 being directly behind the target in a straight line from the attacker, count in 60° increments clockwise around the target point. The target-point will then travel the rolled scatter distance in that direction.

Once the final target-point is determined, any models within the weapons AE in inches from this point must defend against the attack. The attack total is 8, but should be modified by the cover modifier of the defender as seen from the target point (if the target point falls onto the target this means that the cover modifier will always be “in the open”, or +1, as there will be no intervening cover – direct hits can be powerful). Each eligible model (friendly or enemy) must make a normal Defence test, modified as per a normal ranged attack, against their own attack total. If any MoF is rolled, the defender takes MoF x AE DM damage, where the AE DM is determined according to the following table:

AE Weapon Type	DM	AE DM
Low Damage	0-15	5
Medium Damage	16-20	6
High Damage	21-25	7
Very High Damage	26+	8

Weapons with the Area Effect Trait may cause concussion. If the Armour of a Model touched by the AE is no more than twice the basic DM of the weapon, the Model will gain a Stun Counter.

Example:

Blake fires his Black Mambas HGL at a Cheetah in the open at long range. Looking at the weapons DM he elects to spend one point of RoF on upping the damage (just enough to up his AE DM from 5 to 6), and also uses the weapons AE. Being at long range his final attack bonus is -1 (-2 for long range, -1 for weapon accuracy, +1 for fire control and +1 for the target point being in the open).

He proceeds to roll a $5 - 2 = 4$ – not quite enough to get the grenades on target, but the MoF of 0 means that the attack will only scatter according to a skill zero roll. Rolling two dice he gets a 1 and a 4 – a result of a one-inch. After determining the scatter direction the shell lands between the Cheetah and a hostile Hunter, but close enough that both are affected by the AE2 attack.

Looking from the target point quickly determines that the cheetah is in the open (+1), while the Hunter has partial cover (-1). The Cheetah will defend against a 9, while the Hunter defends against a 7.

Rolling their defence totals, the Hunter rolls a 4, -1 for its movement modifier for a total of 3. It takes $4 \times 6 = 24$ damage for one box of damage and a stun counter (lucky there was some cover, otherwise it would have been two boxes), the cheetah rolls a 5, +3 for its movement for a total of 8 – and takes 6 damage for no effect other than damaged paint and a stun counter!

Blast (X) [B X]

(Replaces the rules text on page 177 of Locked and Loaded)

[A minor rules tweak to account for the modified AE rules above.]

Some weapons are designed to have a devastating blast. These work like AE attacks above with the following minor alteration. All Models in blast which suffer one or more points of damage will always take a minimum of the blasts basic DM in damage, unless touching a terrain piece.

Infantry

(page 33 of Locked and Loaded)

[This rule is intended to expand the infantry trait to accommodate the revised AE trait above.]

Infantry in any cover are automatically considered to be in full cover when defending against any AE attack. Cover should be determined for each affected base individually (attack bases in the open last).

Example:

Mack's infantry squad has one base in the open and two in full cover. An AE attack with DM 5 hits two bases – one of those in cover and the base in the open. As Mack's Infantry have a skill level of 2, so he makes a 3D Defence check, the first against a target number of 6 (full cover) and the second against a target number of a 9 (as it is in the open) after dropping the highest dice in the usual way.

Since Mack rolls a 3, 5 and a 6, with a +1 bonus for the infantries Defence modifier, the base in cover is subject to a MoF of 0. The six is then dropped, and the base in the open suffers a MoF of 3, doing 15 damage and eliminating them.

Indirect Fire [IF]

(Replaces the rules text on page 25 & 177 of L&L)

[This text simplifies indirect fire a lot, and meshes with the AE rules above. Note that it can make highly accurate non-AE attacks a lot nastier than they currently are when fired indirectly]

When firing upon a model that has been previously forward-observed, and using a weapon with the IF trait, you may choose to use the cover modifier that would be applicable to the forward-observer had they made the attack. You may do this regardless of whether or not you have a Lock to the intended target.

Defence Rolls

(page 27 of Locked and Loaded)

[This clause reduces some of the nastiness of indirect fire.]

The IF clause should be removed from the defence penalties from "attacks from above" entry.

Active Detection

(page 22 of Locked and Loaded)

[Why do you need IF weapons when you use active sensors to Lock onto a stealthy unit at night in the open?]

The clause requiring a weapon to have the IF trait when used for the free attack after a successful active detection attempt should be removed.

**HOME
BREW
RULES**

Rate of Fire (X) [RoF X]

(Replaces the rules text on page 26 of Locked and Loaded)

[This text is not significantly different to that presented in the Locked and Loaded rulebook. However it does somewhat clarify the intent of the rules.]

When making an attack with a weapon with Rate of Fire (RoF), you may choose to use RoF on the Attack. RoF attacks generally eat up more ammunition than normal attacks (see Ammunition Tracking below), but in exchange; they can cover many enemies or deal considerable damage to a single enemy.

Before firing, you must choose how much RoF you wish to use. You may use any amount of the RoF from nothing (single shot), all the way to the maximum listed. If a RoF of 1 or more is used, the attack may target any point up to the end of Long Range. Before rolling any dice you should divide the used RoF points into Damage and Area.

Points added to Damage add directly to the weapons Damage Multiplier. Points added to Area add directly to the weapons normal Area Effect if it is using one, or otherwise generate a "Beaten Zone" with a rating equal to the number of assigned points (AE weapons electing not to use their AE generate a Beaten zone and not an AE).

If you do not create a Beaten Zone then you proceed with the attack in the usual way.

However, if you do generate a Beaten Zone, you then attack every model even partly within the Beaten Zone in inches from your target-point. The target point may be any point on the ground at up to the long range of your weapon. Roll only once for your attack, but assign modifiers to the attack roll on a case-by-case basis as if you were making a normal attack against each target in turn (so you will need to determine cover, range and all other modifiers individually as if you were performing a normal attack). This means that you may not attack any model that you could not have attacked normally (i.e.: a model you do not have a Lock onto).

EW-Mode

(Additional Rules for page 34 of Locked and Loaded)

[EW has been somewhat neutered in the Locked and Loaded rules-set, this option brings some of that ability back, hopefully without being overpowered.]

You may spend an action to go into EW-Mode. Place an EW-Mode token next to your model when you do so. This expenditure may be performed immediately in response to a event you could normally respond to with an ECM or ECCM action, during a models normal activation, or as a use of a Standby token.

Once in EW-Mode you may perform one free ECM or ECCM action per triggering event (Communications Event or Active-Lock) that you could legitimately respond to, without spending any further actions.

Once you fail an ECM or ECCM action (i.e.: fail to jam a Communications-Event or Active-Lock with ECM, or fail at a Communications-Event with ECCM), lose any damage box (sturdy boxes included) or are the target of any melee attack, you lose your EW-Mode token.

Second in Command

(Additional Army Generation Special Rule)

[Squad second in command characters can be extremely important if you play using morale, the following entry makes them a little easier to field as current deployments are "a little patchy"!]

The following army selections may nominate one non-CGL model as Second in Command for +10TV, the nominated model may take any Leadership upgrades allowed to the CGL.

- All Veteran Squads,
- All Elite Army Selections,
- The following other squad selections:
 - North
 - Strike Squads
 - Ranger Squads
 - Airborne Squads
 - South
 - Strike Cadres
 - Paratroop Cadres
 - Opsec Cadres
 - PRDF
 - Strike Squads
 - Special Forces Squads

LC1/40

Cut out WWII Walker
15mm / 1:100 Scale

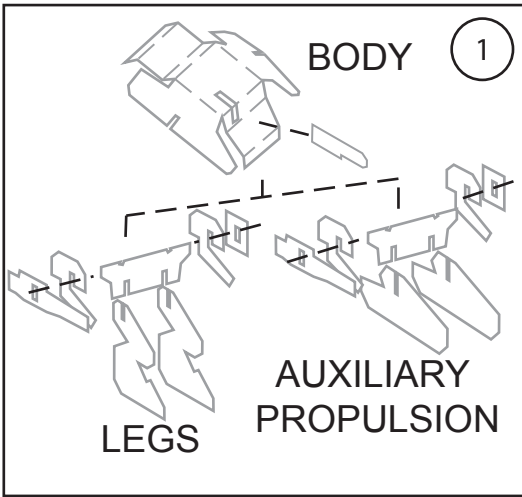
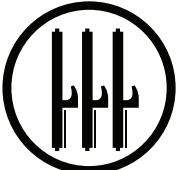

There are enough parts to convert 4 PzKpf V Valkurie Walkers into Italian LC1/40 Light Walkers. You will need the Valkurie card model to complete these.

Instructions: Print out paper and paste to a 1mm or .040 thick sheet of cardboard. Score all the dashed lines. Cut out all the pieces marked with an X. Fold and assemble the pieces according to the schematic. To assemble the hull machine gun, cut out the black rectangular box on the front side, then cut and peel the matching box beside it. Glue the back side piece to the back of the card, making sure that both sides line up, and leave to dry. Once dry, cut out the piece following the grey lines, starting with the slits.

Paint scheme:

Grigio Verde- Italian vehicles in Italy and in the Balkans were generally painted in grigio verde (grey-green). The similarity to Panzer Grey is deliberate here.

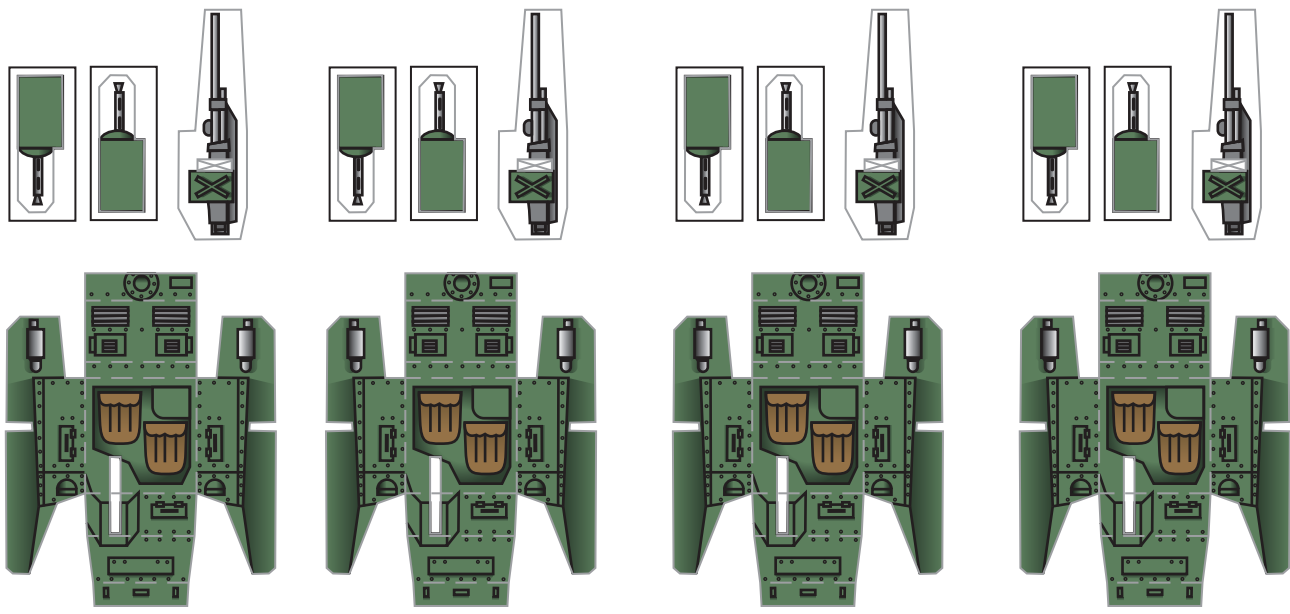

Weapons:

Variants:



Breda 20mm Cannon



Breda 8mm MG

LC1/40

Cut out WWII Walker
15mm / 1:100 Scale

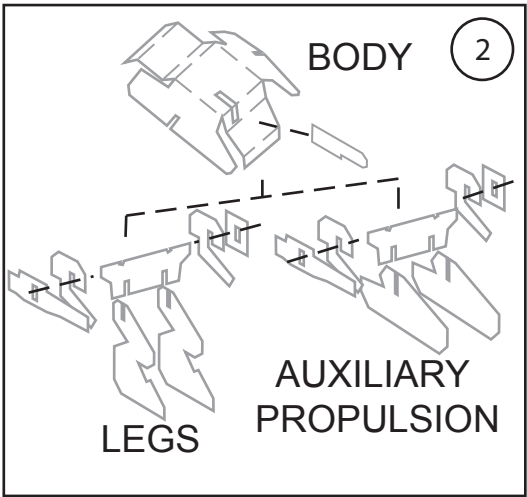
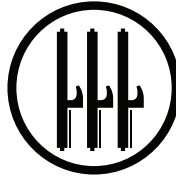

There are enough parts to convert 4 PzKpf V Valkurie Walkers into Italian LC1/40 Light Walkers. You will need the Valkurie card model to complete these.

Instructions: Print out paper and paste to a 1mm or .040 thick sheet of cardboard. Score all the dashed lines. Cut out all the pieces marked with an X. Fold and assemble the pieces according to the schematic. To assemble the hull machine gun, cut out the black rectangular box on the front side, then cut and peel the matching box beside it. Glue the back side piece to the back of the card, making sure that both sides line up, and leave to dry. Once dry, cut out the piece following the grey lines, starting with the slits.

Paint scheme:

Desert Yellow- Italian vehicles were painted in ocre yellow for the North African theatre. Dunkelgelb (German "Dark Yellow")

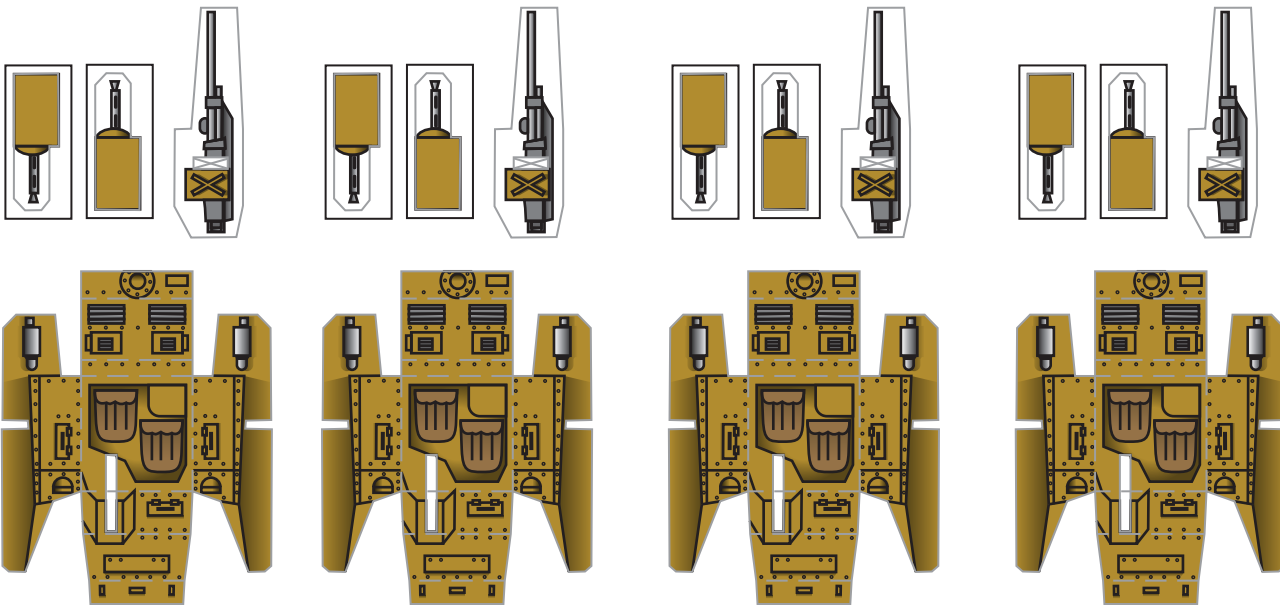

Weapons:



Breda 20mm Cannon



Breda 8mm MG

Variants:

LC1/40

Cut out WWII Walker
15mm / 1:100 Scale

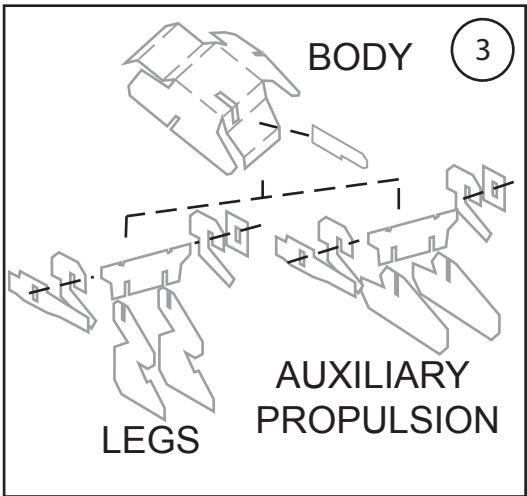
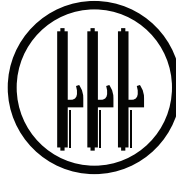

There are enough parts to convert 4 PzKpf V Valkurie Walkers into Italian LC1/40 Light Walkers. You will need the Valkurie card model to complete these.

Instructions: Print out paper and paste to a 1mm or .040 thick sheet of cardboard. Score all the dashed lines. Cut out all the pieces marked with an X. Fold and assemble the pieces according to the schematic. To assemble the hull machine gun, cut out the black rectangular box on the front side, then cut and peel the matching box beside it. Glue the back side piece to the back of the card, making sure that both sides line up, and leave to dry. Once dry, cut out the piece following the grey lines, starting with the slits.

Paint scheme:

Stripes- Italian vehicles in the North African theatre used olive green paint to paint disruptive patterns over a base of ocre yellow.

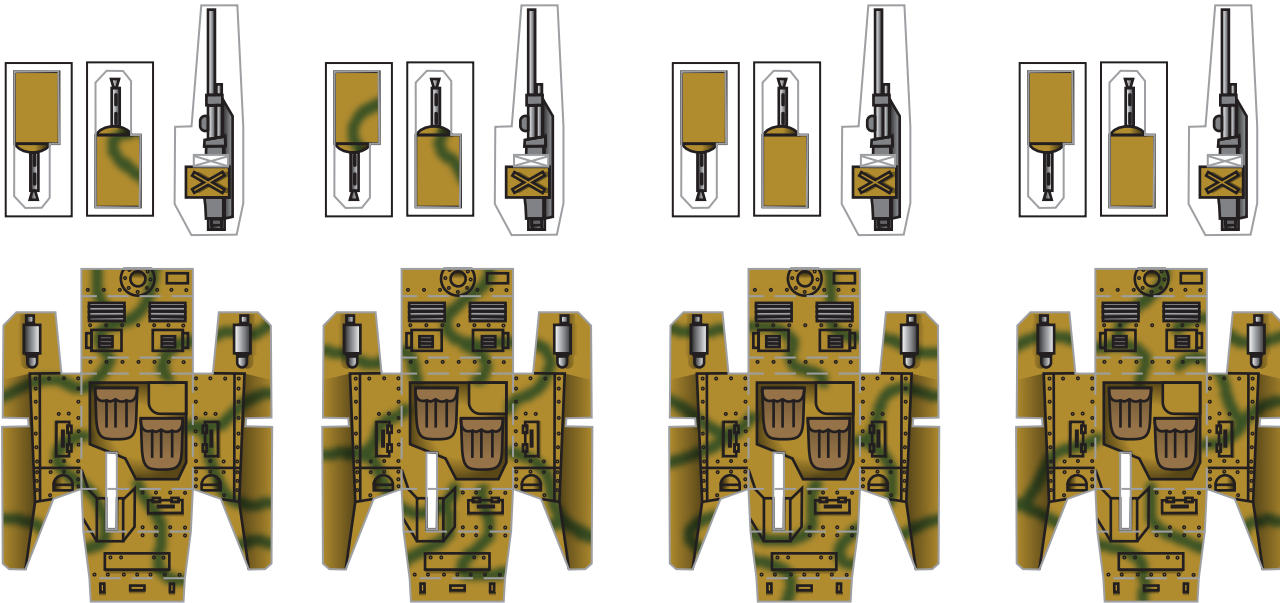

Weapons:



Breda 20mm Cannon



Breda 8mm MG

Variants:

LC1/40

Cut out WWII Walker
15mm / 1:100 Scale

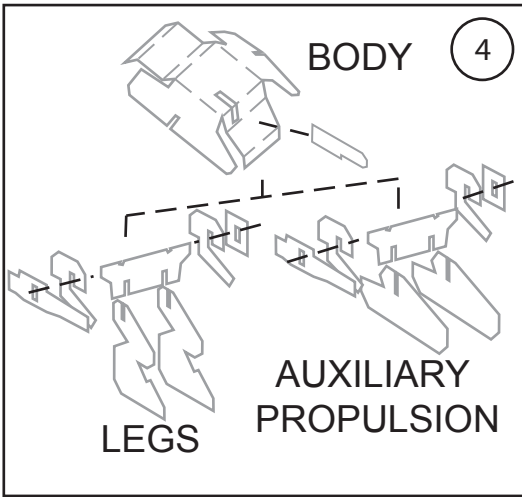

There are enough parts to convert 4 PzKpf V Valkurie Walkers into Italian LC1/40 Light Walkers. You will need the Valkurie card model to complete these.

Instructions: Print out paper and paste to a 1mm or .040 thick sheet of cardboard. Score all the dashed lines. Cut out all the pieces marked with an X. Fold and assemble the pieces according to the schematic. To assemble the hull machine gun, cut out the black rectangular box on the front side, then cut and peel the matching box beside it. Glue the back side piece to the back of the card, making sure that both sides line up, and leave to dry. Once dry, cut out the piece following the grey lines, starting with the slits.

Paint scheme:

Patches- Some Italian vehicles in Italy and the Balkans used patches of olive green and terracotta (red brown) over a base of ocre yellow paint.

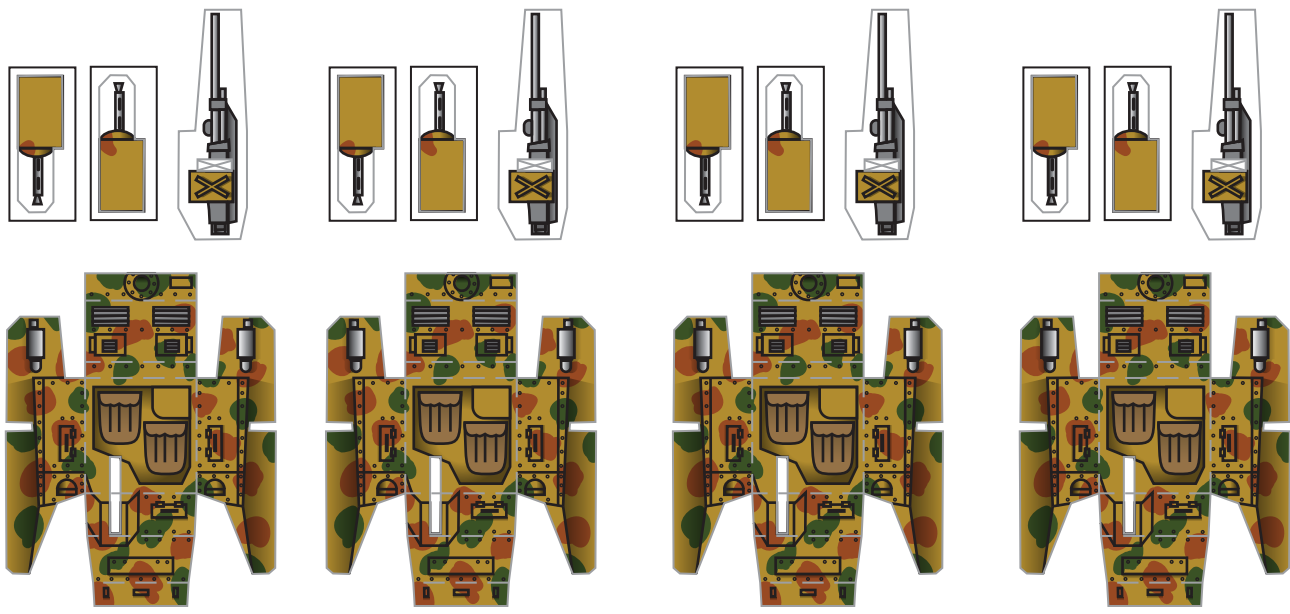

Weapons:



Breda 20mm Cannon



Breda 8mm MG

Variants:

LC1/40

Cut out WWII Walker
15mm / 1:100 Scale

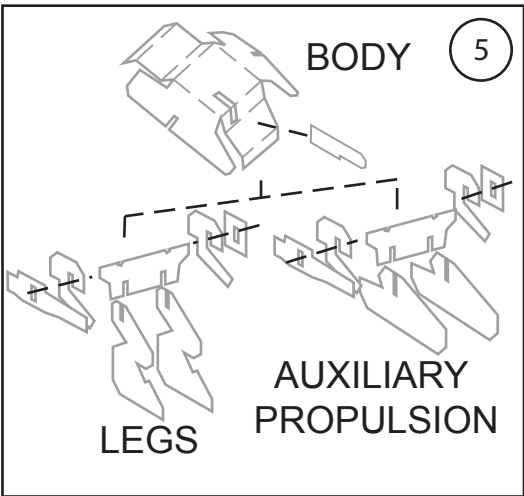
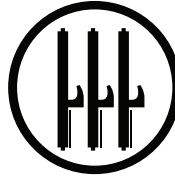

There are enough parts to convert 4 PzKpf V Valkurie Walkers into Italian LC1/40 Light Walkers. You will need the Valkurie card model to complete these.

Instructions: Print out paper and paste to a 1mm or .040 thick sheet of cardboard. Score all the dashed lines. Cut out all the pieces marked with an X. Fold and assemble the pieces according to the schematic. To assemble the hull machine gun, cut out the black rectangular box on the front side, then cut and peel the matching box beside it. Glue the back side piece to the back of the card, making sure that both sides line up, and leave to dry. Once dry, cut out the piece following the grey lines, starting with the slits.

Paint scheme:

Russian Camouflage- Italian vehicles on the Eastern Front arrived with tropical paint. As they were immediately put into combat, the crews had no choice but to improvise, splattering Russian soil over the vehicles.

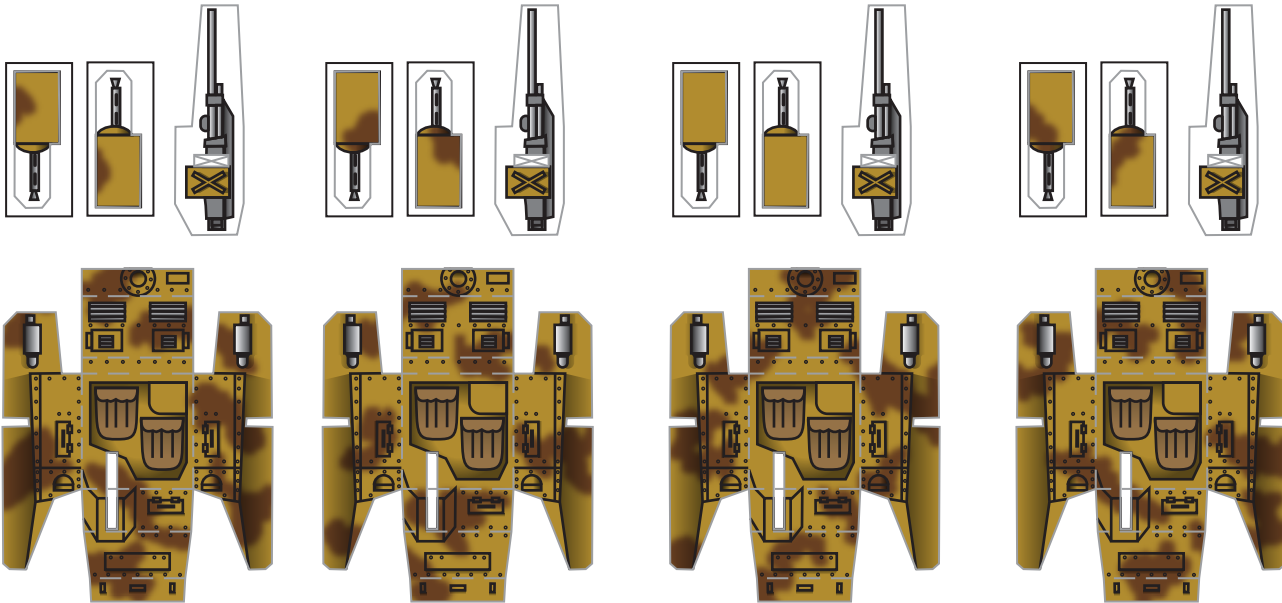

Weapons:

Variants:



Breda 20mm Cannon



Breda 8mm MG



PIECEMEAL OPERATIONAL DEGRADATION

OLIVER BOLLMANN

"C'mon, just hold together!"

Etienne shouted, if only to hear himself over the wail of the warning klaxons. He'd not gotten the better of the exchange.

Retreat would be the most prudent action. The scores of refugees he was protecting dictated actions other than prudence.

"Alright you little mother," he cursed at his opponent, watching several weapons systems sputter back online. "Let's see if you can take it as well as you can dish it out..."

Introduction

The Piecemeal Operational Degradation (POD) system for Silhouette CORE is an alternate damage system that can complement or replace the standard System Damage tables. The basic premise of the POD system is to convert all damage levels into component/systems damage, without an 'instant kill' level. As the vehicle takes damage, its systems are rendered out of commission and its capabilities and performance reduced, until the vehicle is no longer able to function.

No other rules are changed with the POD system. The default method of comparing final DM results to Armour remains the same: higher 'levels' of damage result in increased number of components damaged.

Implications And Use

Without an Overkill level of damage, vehicles under the POD system will tend to last longer than their CORE damage system counterparts, finding their capabilities continually degraded until they are rendered inoperative or something catastrophic occurs (such as an ammunition hit). Additionally, the POD system does increase the requirements for bookkeeping, resolution time and dice rolls. Thus, the POD system is best suited for RPG-type games rather than purely tactical ones, though it will of course work in both circumstances.

In an RPG setting, the POD system can help reduce the possible volatility of player deaths through vehicle destruction (and/or a lack of emergency dice), while increasing the tension and RP possibilities through system damage and limping home in a battered vehicle. Jurry-rigging temporary repairs also adds to the drama of the situation.

The POD system can find a home in just about every style of RPG play, and every level of reality distortion. In a game where mechanical action does not come into play often, but when it does it is a major event, the POD system will keep the action going and provide extra tension and descriptive potential. In a more 'traditional' adventurous or even anime-inspired game, the POD system can be used for only certain vehicles. PCs and major NPC vehicles could be tracked using the POD system, while generic soldiers/vehicles (aka goons) would be tracked with the standard SilCORE damage system. This simulates very well heroes blasting their way through scores of enemies, destroying them left, right and centre, only to enter into a protracted battle with the main enemy that rages on for hours while they whittle each other's vehicles down...

Pure tactical play can also make use of the POD system quite handily, especially for small, unit-on-unit encounters. The POD system is also appropriate when converting other game systems/universes into Silhouette rules, as it may preserve the 'feel' of the damage system in the original game system.

Use in Blitz!

By its very nature, the POD system is contrary to the intent of Blitz! – that is being a quick resolving system. That aside, as stated above for tactical play the POD system can fully be inserted into the Blitz! System replacing the standard damage model. This works especially well for small skirmishes, allowing the battle to go on longer (it is less easy to take out a vehicle quickly) all while ratcheting up the tension as the turns go by. This can also allow you to use the majority of the Blitz! System for RPG battles while keeping the extra detail that makes RPGs so juicy.

AURORA: THE SILHOUETTE MAGAZINE

PIECEMEAL OPERATIONAL DEGRADATION

Using The POD Damage System

Standard SilCORE combat is unaffected with the use of the POD system except in the area of vehicle damage, and the effects of this damage. The Damage itself is calculated normally (DM times MoS), but the outcome of the damage becomes an increasing number of rolls on a new Component Damage Table.

DAMAGE EFFECTS

DAMAGE	EFFECT	EFFECT (REDUCED)	EFFECT (ENHANCED)	ARMOUR REMOVED
Damage < 1	No Effect; Nothing	No Effect; Nothing	No Effect; Nothing	
1 < Damage < 2	1 Roll	1 Roll	2 Rolls	1 point
2 < Damage < 3	3 Rolls	2 Rolls	4 Rolls	2 points
3 < Damage < 4	6 Rolls	4 Rolls	8 Rolls	2 points
4 < Damage < 5	10 Rolls	6 Rolls	12 Rolls	3 points
5 < Damage	15 Rolls	8 Rolls	18 Rolls	3 points

For each Component Table roll indicated above, two dice are rolled on the Component Table (found below). The first indicates which of the major component system is affected, the second specifies the exact subsystem damaged. For ease of play, it is suggested to use dice of differing colours to better differentiate between which die indicates the system, and which indicates the subsystem.

PERK AND FLAW CHANGES

- **Armour Piercing** -- Armour Piercing weapons use the Reduced column of the Damage Effects table to determine the number of Component Damage table rolls.
- **Haywire/Cascade** -- Haywire weapons use the Enhanced column of the Damage Effects table to determine the number of Component Damage table rolls.
- **Reinforced Systems** -- There is fundamentally no changes to the way the various reinforced perks work. A hit to the appropriate subsystem is negated for each time the perk was added to the vehicle. The only difference deals with the Reinforced Ammo/Fuel perk: do not divide Deployment Range and Ammunition by one half.
- **Overheating** -- Vehicles that possess this flaw who take a Power Plant hit gain the Extreme Overheating flaw on the first hit, Random Shutdown (3) on the second hit, and the usual Plant Destroyed on the third.
- **Extreme Overheating** -- Vehicles that possess this flaw who take a Power Plant hit gain the Random Shutdown (2) flaw on the first hit, Random Shutdown (5) on the second hit, and the usual Plant Destroyed on the third.

- **Vulnerable to Haywire** -- In brutality, vehicles with this flaw hit by Haywire weapons suffer damage at one level higher on the Damage Effects table (ie, if hit with 2.5x their AR, they would take damage not at 4 rolls, the usual for a Haywire weapon, but instead take 8 rolls!).

- **Exposed Auxiliaries** -- 2d6 (normal Silhouette dice rolling applies) systems are hit per AUX hit.

- **Exposed Crew** -- Vehicles with this flaw begin the game as though they had already suffered a Crew result. Fill in one Crew Hit box on the Record Sheet. No crew has been killed, nor does the vehicle begin with a stunned crew, but hits against the crew are immediately handled at the worse threshold.

- **Exposed Systems** -- Add 1 to the die roll whenever rolling under the Weapon Systems subtable.

- **Exposed Movement** -- Add 1 to the die roll whenever rolling under the Movement Systems subtable.

- **Fragile Chassis** -- Add 1 to the die roll whenever rolling under the Structure subtable.

- **Hazardous Ammo** -- Vehicles with this flaw begin the game as though they had already suffered an Ammunition hit. Fill in one Ammunition Hit box on the Record Shot. The vehicle did not explode, but hits against the Ammunition are immediately handled at the worse threshold.

OPTIONAL GENRE POINTS USAGE

Even under the POD system, a lucky hit can result in a very tough break for the pilot, knocking the helm out of kilter, or touching off an ammunition explosion. At the GM's option, the following new Genre Effect can be included in the campaign:

It Only Hit the Door!

At the cost of 1 to 3 Genre Points, a character can annul the effects of a single roll on the Component System Table (and appropriate subtable), in effect converting the roll into a Bulkhead hit. The cost in GP is determined by the GM as appropriate for the situation and the severity of the hit.

AURORA: THE SILHOUETTE MAGAZINE

PIECEMEAL OPERATIONAL DEGRADATION

DAMAGE EFFECTS

DAMAGE	EFFECT	EFFECT (REDUCED)	EFFECT (ENHANCED)	ARMOUR REMOVED
Damage < 1	No Effect; Nothing	No Effect; Nothing	No Effect; Nothing	
1 < Damage < 2	1 Roll	1 Roll	2 Rolls	1 point
2 < Damage < 3	3 Rolls	2 Rolls	4 Rolls	2 points
3 < Damage < 4	6 Rolls	4 Rolls	8 Rolls	2 points
4 < Damage < 5	10 Rolls	6 Rolls	12 Rolls	3 points
5 < Damage	15 Rolls	8 Rolls	18 Rolls	3 points

COMPONENT SYSTEM TABLE

ROLL	COMPONENT
1	Structure
2	Engineering
3	Drive Systems
4	Weapon Systems
5	Cockpit
6	Auxiliary

SUBSYSTEMS: STRUCTURE

ROLL	EFFECT
1	Bulkheads: No effect
2	Bulkheads: No effect
3	Minor Systems
4	Structure
5	Structure
6	Structure: 1 - Struts Break 2 - Spine Cracks and Decompression 3 - Vehicle Destroyed

SUBSYSTEMS: ENGINEERING

ROLL	EFFECT
1	Power Grid Shorts: 1d6 Weapon Systems
2	Helm Controls: -5 to Piloting
3	Power Converter: -5 to Systems
4	Power Transfer: No Movement
5	Plant
6	Plant: 1 - Overheating 2 - Heavy Overheating 3 - Plant Destroyed (Test vs Explosion vs 4)

SUBSYSTEMS: DRIVE SYSTEMS

ROLL	EFFECT
1	Maneuver: -1
2	Direction: +1 MP (base) to change facing
3	Maneuver: -1
4	Movement: -1 MP
5	Drive
6	Drive: 1 - Base MP reduced by 1/3 2 - Base MP reduced by 2/3 3 - Movement System Destroyed

SUBSYSTEMS: WEAPON SYSTEMS

ROLL	EFFECT
1	Short: System Shorts for 1 turn
2	Damaged: -1 to a single weapon
3	Damaged: -1 to a single weapon
4	Destroyed: Single weapon destroyed
5	Ammunition
6	Ammunition: 1 - Explosion Threshold (2) 2 - Explosion Threshold (4) 3 - Explosion Threshold (6) 4 - Explosion Threshold (7)

SUBSYSTEMS: COCKPIT

ROLL	EFFECT
1	Information Warfare: -2 to 1d6 Systems
2	Targeting: -1 to Gunnery
3	Information Warfare: -2 to 1d6 Systems
4	Crew Compartment
5	Crew Compartment
6	Crew Compartment

SUBSYSTEMS: AUXILIARY

ROLL	EFFECT
1	AUX: -2 to 1d6 Systems
2	AUX: -2 to 1d6 Systems
3	Cascade: Roll Twice More
4	Cascade: Roll Twice More
5	AUX: -2 to 1d6 Systems
6	AUX: -2 to 1d6 Systems

Note that Information Warfare systems are not counted as AUX systems in POD.

AURORA: THE SILHOUETTE MAGAZINE

PIECEMEAL OPERATIONAL DEGRADATION

WEAPON SYSTEMS

(ANYTHING DESIGNED UNDER 4.2: SYSTEM DESIGN)

Short

Base Effect: A single weapon system shorts out and is unavailable for the remainder of this turn as well as being unavailable next turn. The weapon is not damaged, and automatically becomes available again after the short period

Multiple: For every Short result, the affected system is chosen randomly.

Same Turn: If a shorted system receives additional short results during the same hit, the short result is unaffected, but the system additionally receives a System Damaged result.

Other Turn: If a shorted system receives additional short results from a different hit (either in the same or subsequent turn), then the short result is extended by an additional turn.

System Damaged

Base Effect: A single system suffers a -1 penalty to any further actions that involve it.

Multiple: For every Damaged result, the affected system is chosen randomly.

Each additional System Damaged result against a system (regardless when it is received) applies an additional -1 penalty to the system. A system no longer functions when it reaches -3 worth of penalties (independent of the inherent ACC of the weapon). At -4 they cannot even be salvaged and are treated as System Destroyed, below. (Note that Fire Control Destroyed results are not counted as weapon damage)

If all Systems have been destroyed, this result is treated as an Ammunition hit, below.

System Destroyed

Base Effect: A single system is rendered inoperative by incoming fire. For the remainder of combat, the system cannot be used for any purpose.

Multiple: For every Destroyed result, the affected system is chosen randomly.

A system can only receive a System Destroyed once. Do not count the system as part of the eligible weapons pool on System Damaged or System Destroyed results.

If all Systems have been destroyed, this result is treated as an Ammunition hit, below.

Ammunition

Base Effect: Each hit to the volatile ammunition may cause an explosion. Make a single test at two dice and compare versus the threshold to avoid ammunition explosion. If the test is failed, the ammunition explodes, destroying the vehicle.

First Hit: Threshold = 3

Second Hit: Threshold = 5

Third Hit: Threshold = 6

Fourth Plus: Threshold = 7

Special: Ammunition, for the purposes of internal explosions and causing vehicle destruction, is not only limited to the conventional rockets and/or shells, but also high-energy capacitors for lasers and gauss weapons, cooling relays, internal plasma taps, etc. Unless a vehicle has no weapons that could possibly fit within the above parameters (a regular passenger car, a mecha with only non-powered melee weapons) it is still eligible for Ammunition hits.

At the end of any round, a pilot may elect to jettison the ammunition from his weapons. Whether this is possible is entirely up to the designers of the vehicle; in general, externally mounted or handheld weapons, as well as weapons mounted on hardpoints, can have their ammunition disposed of (in the case of hardpoints, it may be jettisoning the entire weapon). Internally mounted weapons may or may not have the ability depending on vehicle type (a tank likely would not, while a giant robot might very well).

It is also possible to 'power down' energy weapons to eliminate their volatility (be it capacitors, plasma bottles, etc).

Jettisoning ammo for a single weapon is a Free Action (costs no actions); jettisoning ammo for all eligible weapons takes 1 Action. Once ammunition has been ejected, the weapon can no longer fire, however, if no ammunition remains on board (all weapons ammunition depleted, jettisoned or deactivated) Ammunition results on the subsystem roll no longer has any effect.

AURORA: THE SILHOUETTE MAGAZINE

PIECEMEAL OPERATIONAL DEGRADATION

DRIVE SYSTEMS

Maneuver

Base Effect: The currently engaged movement system has its Maneuver value reduced by one.

Multiple: Each subsequent Maneuver result against a movement system further reduces its maneuver value by one.

After 3 Maneuver hits, each subsequent Maneuver hit result counts as a Direction Control hit, described below.

Direction Control

Base Effect: The base cost for changing the vehicle's facing with the currently engaged movement system is increased by 1 MP.

Multiple: A second Direction Control hit against a movement system increases the MP cost for a facing change by an additional 1 MP.

After two Direction Control results, each subsequent Direction Control result counts as a Drive Hit result, described below.

Movement

Base Effect: The currently engaged movement system's Combat Speed is reduced by 1 MP.

Multiple: Each subsequent Movement result against a movement system further reduces its Combat Speed by 1 MP. At 0 MPs, the movement system is no longer usable and is considered destroyed. The vehicle may switch to an alternate movement system if capable.

Special: If the unit does not (or is unable to) switch to a different movement system after a system is reduced to 0 MP, or is suffers this damage result again before being able to switch, apply the results to one of the remaining movement systems.

Drive Hit

Base Effect: The current movement system's Combat Speed MP is reduced by one-third (round up).

Special: The MP reduction is to the base MP of the drive system. Movement results, described above, subtract their penalty from this base number.

Multiple: A second Drive Hit against a movement system reduces the Combat Speed MP by another third.

The third hit reduces the MP to zero and is considered destroyed. The vehicle may switch to an alternate movement system if capable.

Special: If the unit does not (or is unable to) switch to a different movement system after a system is destroyed, or is suffers this damage result again before being able to switch, apply the results to one of the remaining movement systems.

AURORA: THE SILHOUETTE MAGAZINE

PIECEMEAL OPERATIONAL DEGRADATION

ENGINEERING SYSTEMS

Power Grid Short

Base Effect: 1d6 worth of (Weapon) Systems are affected by the (Weapon) Short effect, described under Weapon Systems

Multiple: Additional Power Grid Short results during the same damage result are handled as are multiple Short results, found under Weapon Systems, with the exception of 1d6 worth of Systems are affected.

Helm Controls

Base Effect: When this system is hit, all subsequent Piloting tests (including Defence) are performed at a -5 penalty.

Multiple: This effect can only occur once. Further hits to this subsystem are ignored.

Power Converters

Base Effect: When this system is hit, all subsequent Gunnery tests are performed at a -5 penalty.

Multiple: This effect can only occur once. Further hits to this subsystem are ignored.

Power Transfers

Base Effect: When this system is hit, the power couplings and/or fuel couplings between the power plant and the drive units are severed. No further MP or Thrust may be spent by the vehicle until repaired.

Multiple: This effect can only occur once. Further hits to this subsystem are treated as a Plant Hit, below.

Plant Hit

Base Effect: Damage to the Power Plant of the vehicle causes the vehicle to gain the following flaws:

First Hit: Vehicle gains the Overheating Flaw.

Second Hit: Vehicle gains the Heavy Overheating Flaw.

Third Hit: The Power Plant is destroyed. Roll 2d6 versus a threshold of 4.

If successful, Vehicle is rendered inoperative, but no further effect.

If the check fails, the Power Plant does something nasty, destroying the vehicle utterly.

STRUCTURE

Minor System

Base Effect: A vehicular system not readily important to its combat value is destroyed.

Examples: Lifepod, Navigation System, Navigation Lights, Docking Port, Laboratory, Sickbay, Satellite Uplink, Beer Fridge, Platoon Logo, Transponder, etc.

Special: In RPG campaigns, this may have some detrimental effects (especially life pods!) but it does not immediately impact the vehicle's combat worthiness.

Bulkheads

Base Effect: Something makes a very loud sickening sound deep within the hull of the vehicle.

Multiple: The crew gets very nervous from the strange groans emanating from their vehicle's structure.

Structure

Base Effect: The vehicle begins to take damage to the structure which holds it together.

First Hit: No game effect occurs at this stage.

Second Hit: The vehicle shows signs of structural duress, as it begins to come apart. The vehicle loses all HEP for its occupants.

Third Hit: The vehicle's internal structure suffers a catastrophic failure. The vehicle is destroyed.

AURORA: THE SILHOUETTE MAGAZINE

PIECEMEAL OPERATIONAL DEGRADATION

COCKPIT SYSTEMS

Targeting

Base Effect: All weapons fire tests from the vehicle suffer a -1 penalty to further actions.

Multiple: Additional Targeting hits add a further cumulative -1 penalty.

Special: The maximum penalty to Targeting is -4.

Information Warfare

Base Effect: Roll 1d6; this number of Information Warfare systems on the vehicle are damaged, suffering a -1 penalty to their rating.

Multiple: Each additional IW hit against an IW system increases the penalty by two. When IW systems reach -5, they are considered destroyed. Remove those systems from the pool of eligible IW affected by an IW hit.

If no IW systems remain, no damage is done.

Crew Compartment

Base Effect: The cockpit or bridge is hit, stunning and possibly injuring the crew. Roll a single test on 2 dice versus the threshold listed below. As further Crew hits are taken, the threshold increases.

If the test passes, the crew is stunned/injured. During the following turn, the vehicle has one less action than normal.

If the test is failed, 10% (rounded up) of the crew is considered a casualty.

If the crew is all killed, unless the vehicle possesses a sentient computer, it is considered destroyed.

First Hit: Threshold = 2

Second Hit: Threshold = 3

Third Hit: Threshold = 4

Fourth Hit: Threshold = 5

Fifth Plus: Threshold = 6

AUXILIARY

AUX Systems

Base Effect: Roll 1d6; this number of Auxiliary systems on the vehicle are damaged, suffering a -1 penalty to their rating. Auxiliary Systems without ratings degrade on the basis of Skill use (-1 to any Skill roll using that device) or efficiency (lose 33% efficiency).

Multiple: Each additional AUX hit against an Auxiliary system increases the penalty by two. When Auxiliary systems reach -5 they are considered destroyed. Remove those systems from the pool of eligible Auxiliary Systems affected by an AUX hit.

If no AUX systems remain, no damage is done.

Cascade

Base Effect: The shot penetrates deeply or ricochets within the hull. Roll twice more on the Component Damage Table



From the rules monkey...

You want your Southern Cadres? We got 'em right here for ya!



AURORA: THE SILHOUETTE MAGAZINE

SUBMISSION GUIDELINES

Article Guidelines

The Aurora Magazine focuses on the worlds created by Dream Pod 9. As such, we are primarily interested in, but not limited to, articles dealing with SilCore and Blitz rules (variants, additions, explorations of the rules) and on fiction, mechanized designs, equipment and the like that draw on established DP9 universes. This does not mean, however, that articles that are generic in nature or that do not deal with unique or original material, only that the focus is on exploring Silhouette and its attendant universes.

Any article that is a promotion piece for another product, be it an excerpt or a lead-in to another product, must be clearly defined as such within the article body.

No articles will be accepted that use another's Intellectual Property or Copyrighted material without an included signed permission to use said material.

Fiction may be a one-off or serial based, as desired. Please note that long works of fiction may be split into multiple pieces over multiple issues for length reasons; if you are writing a long story it is best to indicate breaks in the story (chapters, for example) that allow us to chose the best point to split the story, if necessary. In keeping with the nature of the magazine we ask that fiction be accompanied by Silhouette CORE or Blitz! rules detail of some kind, be it stats for characters or equipment in the story, game scenarios, mechanized designs, new rules or explanations of how to simulate aspects of the story using the Silhouette/Blitz rules. This is not a hard requirement, and you may request that another contributor be asked to create the rules support based on your story.

Aurora is also looking for original artwork. Art may be used to accompany the article and/or for the cover of the APA. Please see below for copyright information regarding images.

Submission Guidelines

All work for Aurora should be submitted in an .rtf (Rich Text Format) file. The text within should be in Arial 10pt font, and single-spaced. Hard returns should be used only to separate paragraphs (with a double hard return) or with bullet points and list items. Do not indent paragraphs. You may use italics, boldface or bullets where deemed necessary.

Tables may be included in the submission. Preferably, tables should be created with minimal lines between cells, instead using background colour and/or cell spacing for clarity. Tables may also be included in courier-font/fixed-formatting. Identify these kind of tables with the following: <<<Table>>>

The article's title should be clearly noted at the beginning of the file, followed by a short (less than 75 words) introductory text. This introductory text can either be a synopsis, a quote, story, etc. It will be used at the beginning of the article to 'set the stage'.

The file should end with the Author's name(s), contact information (if desired) and a short bio (optional). This information will be placed on a Contributing Author's page in the magazine.

Please spell check and proofread your article. English or American spellings may be used as desired.

Photos, drawings or images should be accompanied by photo credits as well as a brief description/caption for each photo (optional). Indicate within your article where the images are to be included like so: <<<Image_Filename.ext>>>. Images should be sent at a maximum of 150dpi for greyscale or colour images, 300dpi for black & white images (1-bit). Given the size of a page, images should be no larger than 7 by 7 inches (18 by 18 cm). If we need a higher resolution image, we will contact you. Images should be compressed with an appropriate method; please check the quality of your images before sending. If by including images the submission would grow over 2 megabytes in size, please place the images on an Internet-accessible server where we will download them (don't forget to tell us where they are located).

Copyright Guidelines

Quotes or information that are attributable to other sources are permissible in appropriate quantities, and should be identified/cited (including page numbers), preferably within the article. Be sure that each quote is written exactly as it appears in the original source.

If you wish to include photos/drawings/images with your article, please provide the photo credits (artist/photographer/illustrator and subject if applicable). You may only submit images for which you have obtained permission to include in your article.

All articles and images used by Aurora remain in the copyright of the original submitters. You, as the author, must consent to release the article for publication by Aurora, with the knowledge that Aurora will not provide any compensation other than what has been listed above, and that Aurora, as an online magazine, will be downloaded by third-parties in a PDF format. All work for Aurora is volunteer-based. Should DP9 decide at a later time to compile and sell articles within a contract will be negotiated with the author at that time.

The End Print

Please send all submissions to the following email address:

auroramag@gmail.com

Thank you everyone for your interest, and we look forward to seeing your submissions soon!

Deadline for Submissions for Issue #4.1: December 15th 2009

AURORA: THE SILHOUETTE MAGAZINE

ARTICLE SUGGESTIONS

Historical Articles

Under this broad category are pieces meant primarily for illuminating or detailing something within the game universe. This can be truly historical in nature (describing history), detailing a region, the language, customs, architecture, technical systems, corporations, social structure, music, and more, to name a few. Articles may either be written from a neutral point of view (impartial observer from above) or written 'in character', that is, in the manner such information may be presented if it were available in the game world. See the Historical Accuracy note, below (especially important for this category).

Fiction

Any story (narrative with characters) that takes place within the established DP9 game worlds falls under this category. See the Historical Accuracy note, below, and also see the submission guidelines for further requirements.

Modules

Also known as adventures, a written collection of plot, character, and location details used by the gamemaster to manage the plot or story in the DP9 RPGs. All manner of modules are open for submission, from espionage to social to military to a combination of all three. Module submissions must be detailed enough for the GM to run the entire adventure, including descriptions and dispositions (where applicable) of major NPCs, locations, accessories and story/plot. See the Historical Accuracy note, below.

Scenarios

These are the tactical equivalent of modules, an encounter between two (or more) factions set up for combat. A complete scenario will detail the background of the encounter (the why), the forces engaged (the who -- what physical units at a minimum, regiment and designations to go the full way), the map and terrain (the where) the victory conditions (the how) and any special rules or conditions (the what). Scenarios should be designed to be balanced for each side, either via the types/numbers of units or through special circumstances or conditions. If the scenario is not balanced this must be mentioned in the background. See the Historical Accuracy note, below.

Note: Historical Accuracy

Aurora is committed to accuracy within the established DP9 worlds. All articles that take place 'within' the game world should be checked for its accuracy within the established timeline, faction dispositions, available equipment, etc. Submitted articles will be run by the game world historians, so check your work! You may, however, submit your article clearly marked as "Alternate History" and if published the article too will bear this mark. Be sure, if you submit this way, to provide in the background all that is necessary to describe what has changed.

Designs

New mechanical designs/vehicles/ships for use in the DP9 worlds. Designs must be legal and use either the latest SilCore rules (including all errata and the FAQ) or Blitz rules. Please indicate which design rules were used. Mechanical designs should fill a void that is not already covered by another unit. Background and a description must be included with the design, while artwork is optional and preferred. See the Historical Accuracy note, above.

Artwork

Aurora accepts all artwork for consideration, no matter the media type (rendering, sketch, painting, etc) within the rules set herein. Miniature photographs will also be accepted (dioramas encouraged!). Artwork must relate to an established DP9 universe and be easily identified as such. Artwork with nudity, racial undertones, sexism or sex will not be considered. See the submission guidelines on how to submit images.

House Rules

Original rules for the Silhouette/Blitz! system and modifications to existing rules. All rules submittals must include an explanation of the rule's purpose, the rules themselves clearly written, and an example of the rule in play.

Note: Blitz! Rules

House Rules covering existing Blitz! Rules will be limited. New Rules covering areas of the game not explicitly contained in the existing rules (as found in the Blitz! line of books) may be submitted freely. House Rules that modify or replace the written Blitz! ruleset (as found in the Blitz! line of books) will be forwarded to the line developer for review and comment. They will then contact you if the idea may proceed forward. Note that this applies only to the Blitz! line -- rules may be freely submitted for any other SilCore game.

Tactics

Have you won countless battles? Have a strategy you would like to share? Write a tactics article. Usually this type of article will be in a step-by-step (or turn by turn) format to illustrate the tactic. An introduction and conclusion is required to create a complete package and to convey to the reader where the tactic is applicable and how it came about.

Miniatures/Modeling

Any article on preparing miniatures, painting, terrain making, sculpting, foliage techniques, etc will be accepted. Photographs and/or diagrams are strongly encouraged.