

# Ares™

Haunted Places: Fact  
and Fiction. Plus *Into  
the Void* Role Playing  
Game and Story.

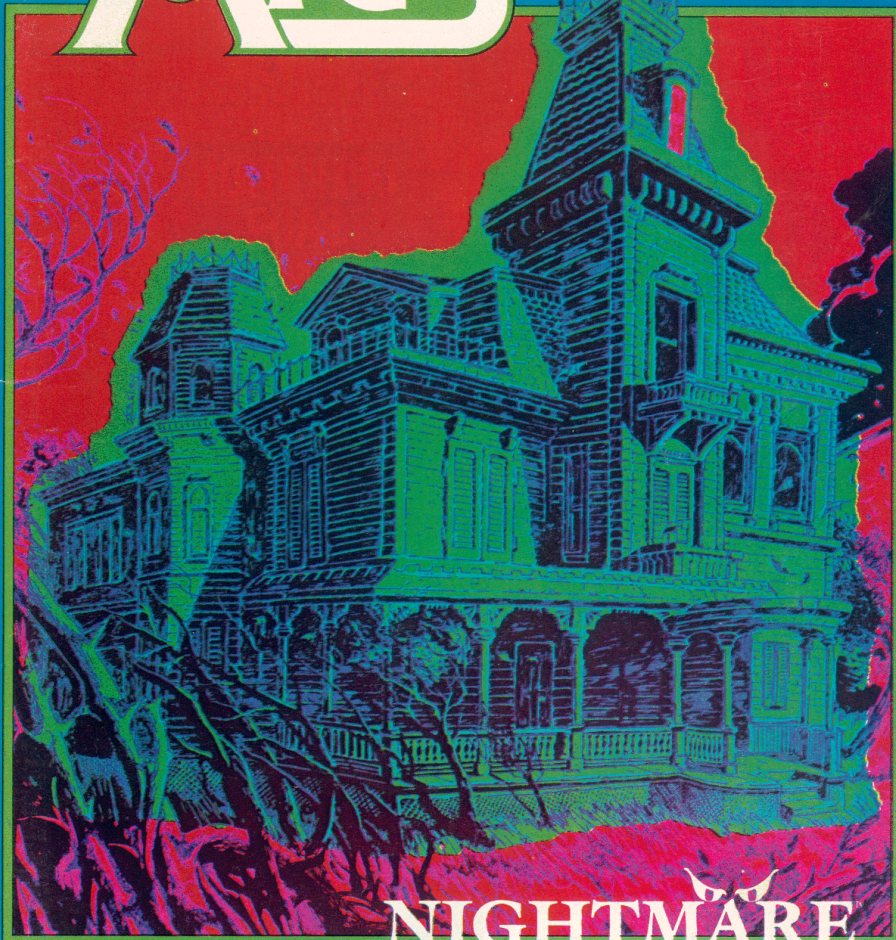

## NIGHTMARE HOUSE

A GOTHIC HORROR  
BOARDGAME

# WEST END'S LATEST RELEASES!

It was the darkest hour of the Union. The Army of Northern Virginia, unbeaten since Lee had taken command, was marching north to force Confederate independence on a badly weakened opponent. Only a depleted and much understrength Army of the Potomac stood between Robert E. Lee and final victory. Meade stopped Lee, and turned the tide of the war. Can you? **THE KILLER ANGELS™**, an operational/strategic Gettysburg campaign game. **Available at Origins.**

The Ost Front stood again on the brink of disaster. Only a tiny panzer force lay between the Red Spearheads and the heart of Central Europe. **THE LAST PANZER VICTORY™**, a tactical/operational armored free-for-all, pits the Red tank spearheads thrusting towards final victory against the valiant remnants of the Wehrmacht. **Available now!**

Yom Kippur 1973: In just 48 short hours, the Israelis' confidence in their country's military infallibility would be shattered and their country almost lost to one of the greatest armored assaults in the world. **OPERATION BADR™**, a game of the first modern "come-as-you-are war", combines centuries old hatreds with up-to-the-minute technology. An operational level game with all of the feel of modern mechanized war, **OPERATION BADR™** is a panzer blitz on the Golan! **Available now!**

send check or  
money order to:  
**WEST END  
GAMES, INC.**  
251 West 30th St.  
New York, N. Y.  
10001

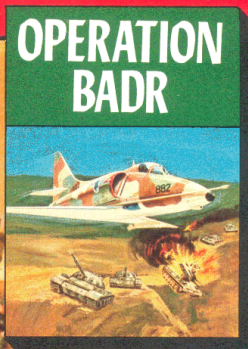

- |                                                        |         |                                                              |         |
|--------------------------------------------------------|---------|--------------------------------------------------------------|---------|
| <input type="checkbox"/> Killer Angels .....           | \$18.00 | <input type="checkbox"/> Campaigns of Napoleon .....         | \$15.00 |
| <input type="checkbox"/> Operation Badr .....          | \$12.00 | <input type="checkbox"/> Counter trays (3 per package) ..... | \$ 6.00 |
| <input type="checkbox"/> The Last Panzer Victory ..... | \$15.00 | <input type="checkbox"/> 4 Color blank counter sheets        |         |
| <input type="checkbox"/> Imperium Romanum .....        | \$25.00 | (4 per package) .....                                        | \$ 6.00 |
| <input type="checkbox"/> Kamakura .....                | \$12.00 | <input type="checkbox"/> Please send me your catalogue       |         |

ST-3G

Name \_\_\_\_\_  
Address \_\_\_\_\_  
City \_\_\_\_\_ State \_\_\_\_\_ Zip Code \_\_\_\_\_  
*New York State residents add applicable sales tax.*

Cover art for  
The Last Panzer Victory



## EDITORIAL

**ARES log** ..... 4

## SCIENCE

**MATTERS OF FACT**

*Frank Kendig* ..... 5

Our new science fact column debuts with a compendium of odd and interesting bits of news from the various scientific disciplines. In this issue, science writer Kendig reports on self-replication machines, other dimensions, tooth sleuths, and other subjects. The column is accompanied by "In Terms of Gaming," a suggestion by designer David Cook on how to use the science information in a game system.

## FICTION

**VISITATION**

*David J. Schow* ..... 18

A famed debunker of the paranormal meets his match in a thrilling horror tale that pits human will against monstrous evil. The story serves as a tempting prelude to the "Haunted House" game in this issue.

## FICTION

**HAUNTED PLACES**

*David J. Schow* ..... 44

Schow, writer-at-large, combs through the history of haunted houses, villages, and other locales as they have been represented in books, film, and television. Not surprisingly, Schow has discovered that trends and fads can even influence the spiritual world.

## FICTION

**INTO THE VOID**

*Carl Smith* ..... 47

Characters plucked from the Star Frontiers™ role-playing game tangle with deadly Sathar agents in this short story by designer/writer Smith. The story was written in conjunction with the mini-module in this issue's RPG section and together they constitute a unique role-playing package.

## OPINIONS

**ARES REVIEWS**

**Film:** Reviewer Christopher John shares his thoughts about *Return of the Jedi*, *The Hunger*, *Something Wicked This Way Comes*, *Psycho II*, and *War Games*. ..... 10

**Lexicon:** David Schow makes a third appearance in this issue as he tackles the idioms and idiosyncrasies of "mediaspeak." ..... 15

**Games:** Games review editor Steve List provides reviews of *Striker™*, *Star Fleet Battles™*, and *Moon Base Clavius™* games. ..... 16

**Books:** Reviewer Greg Costikyan reports on new novels from the likes of Jack Vance, John Varley, and L. Sprague de Camp. ..... 42

## COMIC

**RINGSHIPPER**

*Roger Raupp* ..... 61

The first installment of an out-of-this-galaxy comic strip introduces a space pirate who stumbles across secrets of the universe.

## READERS' COMMENTS

**FEEDBACK** ..... 62

## SIMULATION GAME

**NIGHTMARE HOUSE**

*David Marshall and David J. Ritchie* ..... 25

Something stalks you inside Darkholm Manor, something evil, something unspeakable. Do you dare enter this home of ultimate evil? Designers Marshall and Ritchie have created a game that takes you into the nether worlds of the supernatural and tests your cunning at escaping the clutches of menacing and horrific power.



p.7



p.18

## ROLE PLAYING GAMER

**INTO THE VOID**

*Carl Smith* ..... 52

A cast of six characters must guard an experimental spaceship from Sathar agents who want the ship for its advanced void drive.

**Cargo Bay** ..... 53

**Battle in the Corridor** ..... 53

**Sathar Statistics** ..... 53

**Battle in the Cargo Bay** .... 54

**Inside the XV-1** ..... 55

**Key to the XV-1** ..... 56

**Attack by Sathar Fighters** .. 58

**Into the Void** ..... 58

**Slard, the Traitor** ..... 58

**The Sathar Frigate** ..... 60

**Character Statistics** ..... 60

**NPC Statistics** ..... 60

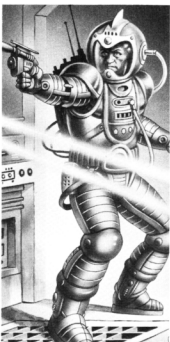

p.52

## ON THE COVER

Nightmare House line illustration by Jeff Easley. Color Posterization by K&S Photographic, Chicago, Ill.

**ARES™ Magazine Number 15**  
**Fall 1983**  
**THE SCIENCE FICTION**  
**GAMING MAGAZINE**

**Publisher:** Michael Cook  
**Editor-in-Chief:** Kim Mohan  
**Managing Editor:** Geoffrey Goltson  
**Design Director:** Kristine Bartyzel  
**Games Editor:** David J. Ritchie  
**Production Coordinator:** Eileen Lucas  
**Fiction Editor:** Patrick L. Price  
**Advertising Dept.:** Mary Parkinson, Bob Dewey  
**Subscriptions:** Mary Cossman  
**Office Manager:** Sharon Walton  
**Contributing Editors:** Charles Ramsay, Debra C. Ritchie, David Cook, Edward Sillers, David J. Schow, Ian Chadwick, Greg Costikyan, Christopher John, Steve List  
**Graphic:** Stephen D. Sullivan, Harry Quinn, David Deisel LaForce, Clyde Caldwell, Kitty Thompson, Ray Silbersdorf  
**Production Staff:** Kristin Pelisek

ARES Magazine is published six times a year. One year subscriptions, including 4 quarterly "game" issues (ISSN 0737-6537) and 2 special "non-game" editions (ISSN 0737-6545), are \$24 in US currency (checks or money orders only). Subscription orders should be sent to Dragon Publishing, a division of TSR Hobbies, Inc., P.O. Box 110, Lake Geneva, WI 53147.

ARES Magazine is available at hobby stores and bookstores throughout the United States and Canada, and through a limited number of overseas outlets. Subscription rates in US currency are as follows: \$24 for a one-year sub to US addresses; \$32.50 via surface mail to Canada and Mexico; \$36.60 via surface mail to other countries; \$36.60 via air mail to Canada only; \$74.40 via air mail to all other countries.

Payment in advance by check or money order must accompany all orders. Payments cannot be made through a credit card, and orders cannot be taken nor merchandise reserved by telephone. Neither an individual nor an institution can be billed for a subscription unless prior arrangements are made.

The number of issues remaining in each subscription is printed on the mailing label for each subscriber's copy of the magazine. Changes of address for the delivery of subscriptions must be received at least 45 days prior to the effective change to assure uninterrupted delivery.

All material published in ARES Magazine becomes the exclusive property of the publisher upon publication, unless special arrangements to the contrary are made prior to publication. Unsolicited manuscripts are welcome, but the publisher assumes no responsibility for them and they will not be returned unless accompanied by a stamped, self-addressed envelope of sufficient size and volume.

ARES™ is a trademark for Dragon Publishing's science fiction gaming magazine. All rights on the contents of these publications are reserved, and nothing may be reproduced from them in whole or in part without prior permission in writing from the publisher. ©1983 TSR, Inc.  
Third class postages paid at Lake Geneva, WI, and additional mailing offices.

Postmaster: Please send all address changes to Dragon Publishing, P.O. Box 110, Lake Geneva, WI 53147.

**Dragon Publishing**  
**Dragon Box 110**  
**Lake Geneva, WI 53147**  
**Telephone: (414)248-8044**



Before you read the rest of this editorial, take a moment and turn to page 43 to the Statement of Policy. *Ares*™ Magazine and DRAGON® Magazine are now fully complementary. *Ares* Magazine will cover the span of science-fiction gaming, from role-playing games to boardgames, while DRAGON Magazine will cover all fantasy games. Those of you who play the DRAGONQUEST™ fantasy role-playing game will be pleased to know that a large amount of DQ material will be appearing in DRAGON Magazine in the near future; UNIVERSE™ game players should stay tuned to these pages for more on that fine system. We believe that the division of science fiction and fantasy material in this manner will benefit everyone, and we welcome your ideas and support.

There are two major themes explored in this issue: the realm of horror, and the realm of interstellar war. By way of horror material we have "Nightmare House," a fascinating game in which you, the players, have the opportunity to explore and hopefully exorcise a quaint little haunted house; as a solitaire game or with a number of players, we hope you find it . . . interesting.

Filling out the horror arena we have "Visitation," a short peek into the life of a professional disbeliever in ghosts who looks at one case too many, and an examination of "Haunted Places" in literature, with some horror film reviews to round out the section.

The realm of interstellar war is explored within the framework of the STAR FRONTIERS™ role-playing game. Humanity and its allies are locked in battle with a xenophobic alien race called the Sathar — and only one side will win. "Into the Void" details an episode in this conflict as a short story and as a game module that STAR FRONTIERS game players may use in their campaigns.

*Ares* Magazine will be exploring other game universes in issues to come, such as the STAR FRONTIERS, Knight Hawks, GAMMA WORLD®, TRAVELLER®, STRIKER™, STAR TREK™, UNIVERSE, STAR FLEET BATTLES™, SPACE OPERA™, OGRE™, and SPACE MARINES™ game systems, as well as any others that you, the readers, suggest to us. We are very open to your suggestions and would welcome the chance to hear from you. On that note, we also strongly encourage everyone who reads *Ares* Magazine to fill out the Feedback card with each issue and mail it in to us. We do read our mail and we do value the feedback from you.

In future issues we will also offer you articles on game variants, mini-modules and short scenarios, in-depth looks at aliens, star empires, new worlds, campaign backgrounds, hints on playing and refereeing, solitaire gaming, and science-fact material that you can use in your own SF games. We plan to increase our coverage of role-playing material in particular, but SF boardgaming will still be a part of *Ares* Magazine.

We are also looking for articles from our readers (that means you) to fill our magazine. If you like to write and write well, and if you have an idea for an article on science-fiction gaming in any of its aspects, we would like to hear from you. We are building up our files and want to give you the best SF gaming magazine you can lay your hands on.

*Ares* Magazine is not just a gaming magazine. *Ares* Magazine is the magazine for science-fiction gaming, and we aim to keep it that way.

*The Editors*

™ and ® designate trademarks of TSR, Inc. TRAVELLER and STRIKER are trademarks of Game Designers' Workshop. OGRE is a trademark of Steve Jackson Games. SPACE MARINES and SPACE OPERA are trademarks of Fantasy Games Unlimited. STAR FLEET BATTLES is a trademark of Task Force Games. STAR TREK is a trademark of FASA Corporation. ©Copyright 1983 TSR, Inc. All Rights Reserved.

## Other Dimensions

Most of us move about comfortably in our three-dimensional space, and Dr. Einstein, of course, made the fourth dimension a household word. A few scientists (and all science-fiction fans) gambol about quite easily in six-, seven-, and even eight-dimensional spaces.

All well and good, but unfortunately it does not stop there. An IBM mathematician named Benoit B. Mandelbrot has recently complicated the picture by pointing out that there is a whole family of shapes that don't fit into any of the usual dimensions. Mandelbrot calls these curves "fractals" (from the Latin meaning broken or fragmented). Fractals, it seems, live in 1.26-dimensional, and 1.57-dimensional space, etc.

It's not as confusing as it seems. Draw an equilateral triangle. Then divide each side into three equal segments and let the middle segment serve as

the base for another equilateral triangle. The result is a large triangle with smaller triangles sprouting from each side, a 12-sided Star of David. The shape is also known as the Koch Snowflake, after the Swedish mathematician who introduced it in 1904. It is a fractal.

What is remarkable about this 12-sided shape is that while its enclosed area is about the same as the original triangle, its perimeter has increased dramatically (by four-thirds, in fact). If the process is repeated again and again, the perimeter quickly approaches infinity in length while the enclosed area remains about the same. The fractal becomes more than a one-dimensional line that can enclose no area, and yet something less than a two-dimensional space in which the curves that enclose areas are finite in length. Thus fractals open up worlds of 1.36-dimensional space, and 1.68-dimensional space, and so on.

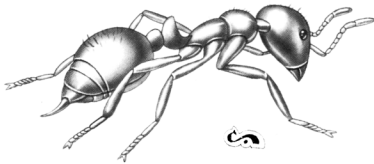

## Black Holes Revisited

Biologist/geneticist Bruce Wallace of Virginia Polytechnic is one of those scientists who seems to be interested in everything. Among his current interests is the fire ant, named for its painful, fiery sting.

Wallace notes that within the territory of a colony of fire ants usually lives a second species of ant. These other ants, for the most part, are of the small variety to which most of us are accustomed. About 10-20% of them, however, are large, sickle-jawed soldiers. They seem to have but one function — to kill fire ants — and they are incredibly good at it. No fire ant that confronts one of these tough soldier ants survives.

The fire ants forage their territory for food in a more-or-less random pattern, but when they encounter something edible they beat a straight path back to their nests, marking their trail chemically for other fire ants to follow. Wallace likes to speculate about what would happen if the fire ants made maps of their territory back in their nests. He goes so far as to imagine a symposium in which fire ant representatives from various colonies meet to discuss their universe.

"By superimposing their

individual charts, those attending the symposium would learn that their space contains holes from which no trails emanate. (The domain of the other species, although the fire ants would not know it since none returned to report). With no additional information, these would be shown on fire ant maps as Black Holes."

## Unsung Heroes

Among humans, scientists have shown a strong preference for twins and sophomores as research subjects. Among animals, mice, guinea pigs, and chimpanzees are the traditional favorites. But now two other animals are making more and more of a mark in the lab — the horseshoe crab and the armadillo.

The horseshoe crab is favored in the lab because of its blood, from which is produced a substance called *Limulus ameocyte lysate* (LAL). LAL is the most sensitive assay reagent known to detect certain disease-producing substances (bacterial endotoxins). The armadillo, that peculiar tank-like mammal now common in the southern U.S., is popular in the lab for another reason: the female armadillo always gives birth to identical quadruplets.

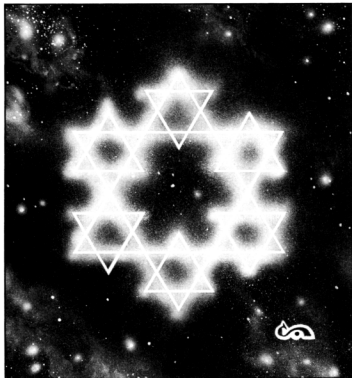



## Tooth Sleuths

While police-employed psychics, and other questionable characters get the bulk of the press coverage, more and more of the real work of crime detection is being done by dentists. According to Dr. Howard S. Glazer, a consultant in forensic odontology to New York City's Chief Medical Examiner, forensic dentistry is becoming more important as the FBI gradually destroys its files of non-criminal fingerprints. Moreover, today's tooth sleuths are adding some bite to the law. Says Glazer, "bite evidence is court admissible, so we're going to see more and more dentists testifying."

## Lawn Power

Scientists call them "anthropogenic grasslands," and they occupy somewhere between 25 and 30 million acres of the United States, enough to cover the state of Massachusetts. The rest of us call them lawns, and we care for them, fret over them, and occasionally decorate them with pink flamingos, concrete Mexicans, and hedges pruned to look like chickens.

John Falk has spent the last 13 years studying these little seas of what the poet Walt Whitman called "the journeywork of the stars." An ecologist at the Smithsonian's Chesapeake Bay Center for Environmental Studies in Edgewater, Maryland, Falk spent one of those years

examining his own 1,000 sq. ft. lawn. He collected and identified the insects on his lawn, counted and cataloged the birds, and weighed and analyzed all the grass clippings. He recorded everything that happened, even the time it took to move the water sprinkler. For the rest of his research, however, Falk ranged far afield, studying lawns around the world. Some of his findings:

- The average lawn contains 30-50 different kinds of grasses and weeds, as well as snails, spider mites, spiders, earthworms, and over 100 different species of insects. It supports some 20 to 40 times more birds than found in natural grasslands. The reason, says Falk: "Lawns are islands of food resources in a sea of concrete."

- The energy spent maintaining this average lawn is more than twice that required to grow a comparable crop of corn or tobacco, or to raise a vegetable garden.

- Many insects — leaf hoppers and frit flies ("frit" not "fruit" is correct) among them — prefer mowed to unmowed lawns.

- Our fondness for lawns may be deep-rooted in our distant past, particularly that time some three million years ago when our ancestors populated the grass savannas of East Africa. Falk tested this idea by showing photographs of different landscapes to people from various parts of the world. Asked their preference, the subjects overwhelmingly picked savannas, even though many had never seen such terrain before.

## 2010: One Mystery Solved

Stanley Kubrick's now classic film of Arthur C. Clarke's 2001: *A Space Odyssey*, released in 1968, left moviegoers with a host of questions: Who or what transformed astronaut Dave Bowman into a Star-Child? Was HAL, easily the best known computer in all of literature or film, really insane? And perhaps the most puzzling question of all: What purpose lay behind the black monolith on the moon and its much larger brother orbiting Jupiter? At the close of Clarke's original novel, Bowman takes a space pod out to investigate the Jupiter monolith and utters his final, enigmatic statement — "My God, it's full of stars!"

Before long moviegoers will have answers to several of these questions. Clarke's sequel to 2001, *2010: Odyssey Two*, was published last year, and the film version, although now snarled in Hollywood politics, is sure to be forthcoming.

Clarke's sequel clears up the matter of the monoliths, among other things. In 2010, the Jupiter monolith descends to the surface and, after reproducing itself millions of times, turns Jupiter into the solar system's second star. "I know what they are! They're von Neumann machines!" cries one of Clarke's characters as he watches this incredible spectacle. "Suppose you had a very big engineering job to do ... like strip-mining the face of the moon," he explains. "You could build millions of machines to do it, but that might take centuries. If you were clever enough, you'd make just one machine — but with the ability to reproduce itself from the raw materials around it."

The von Neumann machine is the brainchild of mathematician John von

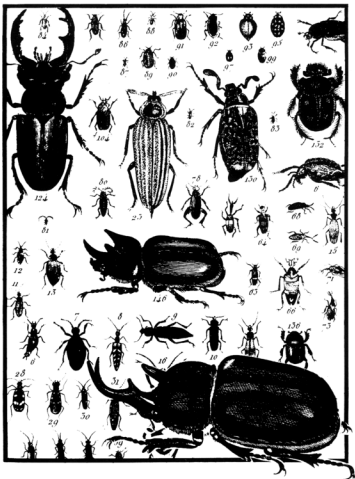



Neumann (1903-1957), generally regarded as the father of the computer. Von Neumann, in the 1930s, considered the then widely held notion that machines somehow follow a law of complexity — that the tasks performed by the machine must be less complex than the machine itself. In other words, any machine produced by another machine must be less complex than the original. Noticing that living systems — cells, cats, and humans among them — routinely produced new systems at least as complicated as themselves, von Neuman suspected that there was in fact no law of complexity. He then went on to demonstrate it mathematically, in his “General and Logical Theory of Automata”, published in 1950.

Von Neuman not only showed that it was theoretically possible to build a machine that could reproduce itself, but also showed that it was possible to build a

machine that will produce any other machine, no matter how complex. All it needs is raw materials and sufficiently detailed instructions. Moreover, such a machine need only have four parts — an assembler or “factory” that puts together raw materials according to instructions, a set of instructions, a duplicator to make copies of instructions, and a controller to feed instructions to the factory. Such a machine can not only reproduce itself, but can produce new machines of superior complexity. Decades after von Neumann’s original work on self-reproducing machines it was shown that DNA, the stuff of life, is made up of four parts and works exactly as von Neumann described.

Fans of the original film will be pleased to know the sequel does not clear up all the mysteries. There are enough questions left open to warrant a third, perhaps even a fourth installment of the tale that begins in 2001. **A**

## IN GAMING TERMS

By David Cook

The idea of a reproducing machine was a common one to science fiction even before von Neumann set out to study it. If a referee wishes to include these machines in a STAR FRONTIER™ game, the following information covers possible situations.

**History:** The first known use of a von Neumann-type of machine in the Frontier came shortly after the entry of Human colonies into the area. Once the first Human bases were established, the now-overthrown government of Theseus sent 10 Independent Material Processing Plants (IMPPs) into space. Each IMPP was sent in a fully automatic starship with the following tasks to complete:

1. Locate a Human-habitable world currently not recorded.
2. Construct copies of an IMPP unit to computed maximum efficiency number.
3. Process raw mineral resources of a planet into usable form.
4. Process all IMPP units (but one) into usable form.
5. Proceed with cycle again.

The idea was that the IMPPs would be forerunners of Human expansion into the Frontier. When a colony ship arrived at a new planet there would be a good chance that large quantities of mineral ore would have been mined and refined before the Humans even landed. Unfortunately, there were problems.

The worst of these was the fact that the machines were instructed to only avoid planets they had not previously recorded. Through an immense error, the machines were not instructed to check for life forms before beginning work. This oversight resulted in the environmental destruction of several Human-habitable planets, the destruction of at least one intelligent primitive race, and a full-scale war between the machines and a Vrusk colony. Given the events that occurred, the IMPP project was abandoned and all known IMPPs were destroyed. However, not all the machines were found.

The other major use for von Neumann machines has been recently devised by the Sathar. Fragmentary messages from the edges of the Frontier and beyond have reported raids and attacks by Sathar and machines working together. The few facts available seem to indicate the machines are of the von Neumann type.

**Referee’s Information:** The following gives the information the referee needs if he wants to have an encounter between the player characters and a von Neumann machine. The types of machines covered here are both the IMPP and the Sathar war machines.

### IMPP (Independent Materials Processing Plant)

There are 3 main units to an IMPP. They are:

#### Starship

This unit is an unmanned spaceship capable of interstellar travel. It is the heart of the IMPP, containing the



level 6 main computer (the controller/duplicator), the memory banks, an assembler unit, 50 hunter units, 8 orbital shuttles, sensors, full maintenance services, the starship controls, and the drives. Upon detecting a suitable planet, the computer places the ship in a geosynchronous orbit above the equator, locates an easily accessible deposit of raw material, and sends the assembler unit to the surface. This unit then begins to build the next major unit of the IMPP, the plant.

The starship unit is 500 meters long and 100 meters in diameter. Although unmanned, it does have access passageways and hatches for Human maintenance crews. The inside of the ship is not pressurized, however.

#### **The Plant**

This unit begins its work once it is assembled on the surface of a planet. The plant unit has three functions — to create a pre-determined number of copies of itself, to produce hunter units, and to then become a processing center. The plant is a semi-mobile operation controlled by its own level 6 computer. Composed of modules, each module has a set of tracks that allow it to move cross-country very slowly. Once the original plant has created a second, the second moves to a new location and begins to build another plant. The number of plants grows like a spreading wave from the original. After a set number of plants have been built in an area, hunters (the third unit) are produced. Each plant will produce 1000 hunters. These hunters will be under the control of that plant, which is in turn under the direction of the main controller. After the hunters are produced, the plant begins to process raw materials, generally in the form of bars or sheets. These are sealed in a urethane coating to prevent oxidation.

A plant looks like a collection of huge tank-like vehicles, interconnected by huge pipes, conveyers, wiring, etc. The area is almost always desolate-looking, with slag heaps, waste, soot, and smoke surrounding the plant.

#### **The Hunter**

**Top Speed/Cruise Speed:** 60 kph/30 kph

**Passengers:** None

**Cargo Limit:** 20,000 kg, 40 cubic meters

**Mission:** Variable

**IM:** -3

**To Hit:** 40%

The third major unit of the IMPP is the hunter. This is a small (6 meters by 4 meters), mobile unit that serves as the legs and hands of the entire operation. The hunter's task is to gather the raw materials, carry them to the plant, and move the processed materials to a storage location.

The hunter resembles a cross between a dump truck and a backhoe with three extra mechanical arms attached. One arm is fitted with a clamp hand and is capable of lifting 1000 kilograms. Any character clamped by this hand will suffer 5-50 points of damage each turn. The second arm is an articulated hard rock drill used for mining. This drill will do

10-100 points of damage to any character it hits. The third arm is a sample probe, used to take mineral samples and perform preliminary analysis on them. If a character is struck by the probe, he will only take 1-10 points of damage. However, the probe will inject several chemicals, doing S20/T3 unless neutralized by an injection of an antidote.

Each hunter is run by a built-in level 3 computer. The mission of the hunter is usually to gather raw materials (ore) and carry finished materials to the storage area. A hunter will almost never bother living creatures. However, a hunter will be attracted to large deposits of metal such as a spaceship or a vehicle. If these are in the area, the hunter will attempt to dismantle them and carry the parts to the plant.

#### **Sathar Ravagers**

Very little is known about these machines and there are still serious questions to be answered concerning their true purpose, construction and use. It is considered unlikely that the Sathar would create reproducing war machines without some type of control over their numbers and activities. So far, only one type of machine has been positively identified. However, reliable reports of automated factories have supplied enough information to positively identify these machines as being of the von Neumann type.

#### **Skimmer Ravager**

**Top Speed/Cruise Speed:** 200 kph/150 kph

**Passengers:** None

**Cargo Limit:** Not carried

**Mission:** Unknown

**Weapons:** Turret-mounted heavy laser

**To Hit:** 60%

**Damage:** 8-80 points

**Defenses:** Albedo covering

The Skimmer Ravager is a hovercraft vehicle approximately 2.5 meters long, 2 meters wide, and 1.5 meters high. The entire outside of the vehicle is covered with albedo armor, giving it protection from laser fire equal to an albedo suit. The turret located on the top center of the vehicle gives the laser a 360 degree field of fire. The laser always seems to fire at the same power setting (8). The machine has never shown any inclination to conserve ammunition.

The machine is equipped with full sonar/radar/infrared/visible light/radio scanning. Each machine is connected to a main battle computer located some distance away, but is also capable of independent action if this link is jammed. However, when on independent, the machines are handicapped as they cannot work together as a unit; each machine can only do what it is programmed to think best at the moment.

Although the exact nature of the programming is not known, experience has proven the machines are instantaneously hostile to most lifeforms, including all character races.



# WE WOULDN'T CALL THEM GAMING MAGAZINES IF THEY DIDN'T INCLUDE GAMES.

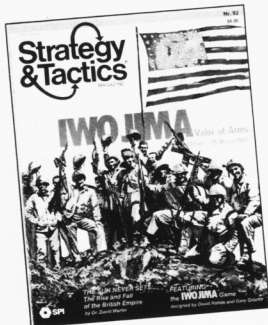

## STRATEGY & TACTICS® and ARES™ Gaming Magazines

Military history games in each quarterly issue of STRATEGY & TACTICS® Magazine let you relive the greatest battles!

You will receive biannual Special Editions featuring new gaming variants and special subscription information.

Journey through the annals of military history with STRATEGY & TACTICS® Magazine—the number one military adventure gaming magazine.

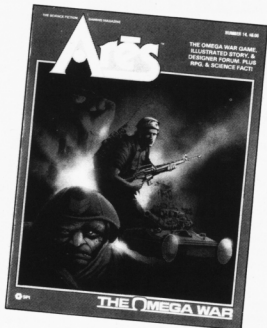

## Engage in futuristic galactic adventures with our science fiction ARES™ Magazine.

The science fiction games included in ARES™ Magazine's quarterly issues take you from future rebellions in a devastated America to spectacular alien worlds.

You'll also receive biannual Special Editions filled with gaming, fiction and factual science articles with ARES™ Magazine — the only game-playing science fiction magazine.

Subscribe to STRATEGY & TACTICS® and ARES™ Magazines today. We call them "gaming" magazines because we put games into them.

STRATEGY & TACTICS, S&T, and ARES are trademarks owned by TSR Hobbies, Inc.  
©1983, TSR Hobbies, Inc. All Rights Reserved.

## SUBSCRIPTION FORM

Name \_\_\_\_\_

Address \_\_\_\_\_

City & State \_\_\_\_\_

Zip \_\_\_\_\_

Send check or money order to:

**Dragon Publishing**  
P.O. Box 110 C200A2  
Lake Geneva, WI. 53147

**Note:** U.S. currency only. We cannot accept credit card orders.  
We cannot bill for subscriptions.

I wish to enter my subscription to:

- S&T™ Magazine: \$24** (Quarterly issues plus biannual Special Editions)
- ARES™ Magazines: \$24** (Quarterly issues plus biannual Special Editions)
- Both S&T™ and ARES™ Magazines: \$48** (Quarterly issues plus biannual Special Editions)

**Foreign Subscribers:** Please indicate by which method you would like your magazines sent to you. You must add the appropriate amount to your order for each magazine.

- 3rd Class Mail** to Canada and Mexico, add \$8.40 (for 6 issues)
- 3rd Class Mail** to all other countries, add \$9.60 (for 6 issues)
- 1st Class Mail** to Canada only, add \$12.60 (for 6 issues)
- 1st Class Mail** to all other countries, add \$50.40 (for 6 issues)

F I L M

By Christopher John

## THE RETURN OF THE JEDI

Producer ..... George Lucas  
 Director ..... Richard Marquand  
 Screenplay ..... Lawrence Kasdan/  
 George Lucas  
 Photography ..... Alan Hume, B.S.C.  
 Music ..... John Williams

Luke Skywalker .... Mark Hamill  
 Han Solo ..... Harrison Ford  
 Princess Leia ..... Carrie Fisher  
 Lando Calrissian ..... Billy Dee Williams  
 C-3PO ..... Anthony Daniels  
 Chewbacca ..... Peter Mayhew  
 Anakin Skywalker .. Sebastian Shaw  
 Emperor ..... Ian McDiarmid  
 Yoda ..... Frank Oz  
 Darth Vader ..... David Prowse  
 Obi-Wan Kenobi ..... Alec Guinness  
 R2-D2 ..... Kenny Baker

By now you have heard all of the arguments; you have heard from those who think the newest *Star Wars* film is the greatest thing since sliced bread, and you have heard from those who like their loaves whole.

So far, a lot of the noise made about *Return of the Jedi* has been more emotional than thought out. Many people, pro and con, have vented their anger at, or defenses of, *Jedi* without really reviewing the facts. The facts, oddly enough, tend to support both sides roughly along the following lines; *Return of the Jedi* is not really a bad picture. It is not, however, good enough to be the sequel to *The Empire Strikes Back*.

Since most everyone by now has heard everything they need of the plot, of who winds up with whom, and what happens to Luke and Vader, et cetera, it would seem best to look at the various points of contention which have brought so many people out against what should have been the biggest success of 1983.

**Fact #1: The direction is not up to that found in the other two films.** Richard Marquand is not the world's most famous or popular director. His major credits before *Jedi* were two fairly static and highly forgettable films, *The Legacy* and *Eye of the Needle*. Many feel he was not the man to pick for such a delicate project, and they may have been right. Examples: Jabba the Hut appears to the

audience as nothing more than a big plastic bag. The more of him that shows on the screen, the worse he looks. Marquand chose to shoot Jabba full-figure most of the time, usually in bright lighting. When Jabba captures Leia, he forces her into slave girl costuming, complete with a Gorian chain collar. The camera angles Marquand chose neither show Leia off provocatively, nor give us a feeling of her humiliation. She merely looks bored, sitting around in her scanties, waiting for the next scene.

The movie moves like this throughout, each scene woodenly blocked, all of the actors taking far more time to do their business than Kershner would have allowed in *Empire*.

**Fact #2: The plot is filled with useless, but cute, devices.** Far too much of *Jedi* is given over to excessive cuteness. One might want to level charges of "E.T.ing-up" the script, except for the fact that *Jedi* was written and in production at the same time as *E.T.* Regardless, though, *Jedi* wields a heavy hand with the sweetness, much of it seeming out of place when comparing the present storyline to the harsh war realities of *Empire*. The teddybear aliens, the cavalcade of muppets (they look too cheap to be called aliens), R2-D2's 101-gadgets-for-any-emergency, the

completely silly cast at Jabba's, Chewbacca's Tarzan imitation complete with bull ape call, and so forth are not the things audiences were expecting, or for the most part ready to put up with. Distracting more often than amusing, these cloying bits peppered throughout the story do not help it. It seems that every time the script reached a point where audience excitement levels were beginning to build, one of these annoying scenes were thrown in on purpose to keep them from getting too caught up in the picture. One way or the other, they do not help much.

**Fact #3: Much of what is new to *Jedi* seems business, rather than plot, inspired.** Sadly, it is true. Dozens of new space ships are seen, but no reason is given for their appearances. Dozens of new alien characters appear as well as a number of new Imperial uniforms. Since most of these characters serve no real function, one must wonder if the charges of planning for toys at the expense of the movie, and the audience, might not be viable ones.

The new solidly red, Imperial Guards or whatever they are — we see them all through the movie, but we never see one of them move, or use their unusual weapons. Perfect toy candidates, as are the new Imperial Cruiser, Jabba the



*Executive Producer* GEORGE LUCAS (far left), *director* RICHARD MARQUAND (far right), and the cast: Back row (l-r) HARRISON FORD, CARRIE FISHER, MARK HAMILL. Front row (l-r) ANTHONY DANIELS (C-3PO), KENNY BAKER (R2-D2) and PETER MAYHEW (Chewbacca).

Hut and all his cronies, the new rebel ships, and all the other unexplained paraphernalia that abound throughout the picture. It is not that other movies not signed toy deals before they were released as well, it is only that we expect toys to come from logical bits from a film, not from things stuck into a film merely so a toy might be manufactured.

**Fact #4:** *Much of the film's new flavor is phonily European.* Everything new in *Jedi* seems to have been set-up for the European market. Jabba the Hut's headquarters, and its inhabitants are all perfectly suited for a Fellini movie. The new spaceships are all from the pages of *Heavy Metal*. This would not be offensive if there was a reason for these variations, but none is given. The rebels all of a sudden just happen to have a new command ship structured to look like a sack of grapes; they also have a new leader, an appealing worm the audience has never met, and indeed, is never introduced to.

The look is European, and coupling this with the fact that the European market has supported many slapstick science fiction films, one wonders if the silly cuteness and new bits which seem so out of place to American audiences were in truth not crafted for the overseas arena. With their dollars assured in this country, the plan may have been to concentrate on tastes outside of the U.S., forgetting where the dollars came from to support the whole *Star Wars* craze in the first place.

**Fact #5:** *Much of Jedi does not jell with Star Wars or Empire.* Yoda was strong in *Empire*; why does he die weakly away in *Jedi*? The Force used to be something anyone could use; why now is it something only certain families seem to be able to manipulate? How knew Leia loved him before she did in *Empire*; why does he forget this in *Jedi*? And on and on and on. In their hurry to wrap things up, and to make the plot more Japanese (the last half of *Jedi* is nothing more than a rehash of any number of mystical, father/son samurai films), more than a few mistakes in logic have been made.

At one point, Han looks at his ship, soon to be taken by Lando into battle, and comments that he is afraid he will never see it again. This is a cruel red herring, since Han, Lando and the Falcon are all intact at the end.

*Jedi* does not mesh well with what we have been previously told about the *Star Wars* universe, nor does it mesh well as a



screenplay. Audiences expect certain things to happen when a film makes certain statements. *Return of the Jedi* does not seem concerned with either sequential integrity, or even internal integrity. Floundering as it can, the scripts seem to suffer from overwork, rather than a lack of attention. Unfortunately, to those seeing the finished product, one affliction is as bad as the other.

The facts against *Jedi*, to say the least, do not leave much with which to defend it. The last in the series (with this set of characters), it is arguable the creators had difficulty jamming in all the answers to all the questions the first two pictures left up in the air. Indeed, *Jedi* does it everything up — but the answers are so pat, so predictable, that most audiences have ended up laughing at the film's revelations.

On top of that, even if the trouble of tying all the loose ends together was much harder than it looked, it is still the filmmaker's responsibility to entertain, not the audience's responsibility to be entertained on their own.

Lastly, **Fact #6:** *The special effects are not up to par.* With all of the other complaints lodged, it seems petty to even bother with this last one, but it is valid, and needs to be said. Matt lines, blue lines, and wires show at every turn. The aliens look cheap, plastic, *Outer Limits*-ish. The entire rebel attack fleet looks to have no more than fifteen ships in it. We got more than that in *Star Wars*.

Maybe the Industrial Light & Magic special effects company took on more than they could handle this time, or

maybe their numerous outside contracts took too much of their time from *Jedi*. Whatever the reason, the effects, like the rest of the facets of the film, are sorely lacking.

And after all that, there is little more to say. My complaint is disappointment. I do not deny it. I am willing to admit I allowed myself to become smug, to "know" that *Return of the Jedi* was going to be great, long before I saw it. Going in to a theater with the notion a film is perfect before you see it is an easy way to set yourself up for a fall. In the case of *Jedi*, I, along with most of the country, climbed high up the ladder for the privilege of tumbling down on our collective heads. But that kind of pre-judging can not be held accountable for the level of disappointment encountered here. *Jedi* is not a very good film; there is no getting around it.

In many ways, this was a hard review to write. Like the monument cutter whose best friend passed away, the feeling was there that as long as the words were not cut into the stone, the friend would not be dead. Such is not the case. *Star Wars* may not be dead, but *Return of the Jedi* is a failure, and is a cheap and tarnished crown for the series which shook the world of film when it started out . . . a long time ago, in that galaxy far, far away.

## WAR GAMES

Director	John Badham
Producer	Harold Schneider
Music	Arthur B. Rubinstein
Screenplay	Lawrence Lasker/ Walter F. Parkes
Photography	William A. Fraker, A.S.C.
David	Matthew Broderick
McKittrick	Dabney Coleman
Falken	John Wood
Jennifer	Ally Sheedy

Apparently, John Badham decided to make this his summer. First, striking with *Blue Thunder*, he wowed audiences with a flashdance of technological images while slipping in his "keep watching the government" message neatly in the corners. Then, while *Thunder* was still playing to packed houses around the country, his latest feature, *War Games* was released, disturbingly similar in the way it wows audiences with a flashdance of technological images while slipping a

"keep watching the government" message in the corners.

The major flaw in *War Games* is that although the dazzling images are there to distract our attention, the story they are so lavishly painted on is not strong enough to hold them all in place.

*Games* concerns teenager David Lightman, an average guy who escapes the boredom of unchallenging, uninteresting schoolwork, his mundane parents, and the bland world around him through his home computer set-up. By dialing the telephone and inserting a program into his machine, he hitchhikes around the hidden electronic world which surrounds us all, traveling on the Earth's vast communications grid, talking with people like himself, and their computers. David plays with other computers without thinking of the consequences; he changes his school grades, impresses a girl by ordering up plane reservations for Paris, and finally decides to break into a video game manufacturer's computer to steal its newest game plans for his own amusement via the wireways.

David unwittingly, however, breaks into NORAD instead, and accidentally triggers a series of events which may (by the film's end) lead to World War III. The world's only hope, since the F.B.I. and the NORAD officials who catch up to David refuse to believe the truth, is for David to find the computer's original programmer. The government says the man is dead. The computer says he isn't. David has 27 hours and 59 minutes to escape NORAD security and the F.B.I., find a man there is no trace of, and avert a nuclear holocaust.

Exciting, fast-moving stuff, but clumsily constructed and badly thought-out. The movie expects us to believe a number of silly things. David breaks into the war computer which protects America, without even realizing it. Even if the audience doesn't stop to consider how implausible this is (i.e., if teenagers can break in without half trying, what's to stop the Russian computer experts who have been trying since the beginning of the computer age?) they still may get fouled up in some of the other crossing nets this film unfortunately trawls behind it; is the government actually stupid enough to suspect a teenage boy of international espionage, and if they really do, how then is it so easy for him to escape from one of the most (if not *the* most) tightly secure areas of the country, the NORAD command center? How does



The computer screens at NORAD show evidence of a surprise nuclear attack in *WAR GAMES*.

he find a top scientist hidden by the government in a matter of hours? Why does NORAD have busloads of tourists walking through the War Room? How does David out-think the war computer in a matter of seconds, when its own programmers can think of nothing? Why can't the F.B.I. find David after he escapes, especially since they know where he is heading?

*War Games* tries very hard to be entertaining, and it succeeds. Except for the music (which is flat, silly and unfitting throughout — one of the picture's major disappointments) there is little wrong with *War Games* as an amusement, a modern, dismissable fairy tale. The trouble the picture has started in is circles outside of the theaters. Far too many people have accepted the movie's premise as totally believable; wanting so strongly to preach their own message of global nuclear disarmament, they have ignored the film's flaws and inconsistencies in order to start up the doom-shouting-machines with this new bit of fodder. *War Games* is not *Blute Thunder*. It is far too simplistic a work to hold up as *proof* that no one can win a nuclear war. *Thunder* delivered a hostile message. It wanted to shake people up

and, while entertaining them, *Thunder* makes a statement about America, her image, and the men who manipulate both. For those who want to speak out against those things, the film is a wonderful backdrop for their ideas.

In *War Games*, though, almost the exact opposite is at work. *War Games* was not intended to shake people up. Its big message, that "no one wins a nuclear war," is no great revelation. The last fifteen years have seen the words echoed to us from television shows, science fiction novels, comic books, and other films to where we are coming dangerously close to thinking of it as a cliché, rather than the threat which hangs over the world's collective head every day.

The movie cloaked itself in a standard message, but then set out to take something we have heard many times before and retell it in a new, interesting fashion. *War Games* is highly entertaining, fast-moving, colorful, and mentally stimulating. Your brain has to be working as fast as the computer's, and the computer whizz's to keep up with the storytelling. As a big-budget comic book, it has everything one could want. As a prophecy, however, it has a long way to go.

## PSYCHO II

Director ..... Richard Franklin  
 Producer ..... Hilton A. Green  
 Music ..... Jerry Goldsmith  
 Photography ..... Dean Cundey  
 Screenplay ..... Tom Holland

Norman Bates ..... Anthony Perkins  
 Lila ..... Vera Miles  
 Mary ..... Meg Tilly  
 Dr. Raymond ..... Robert Loggia

Twenty-two years ago, Alfred Hitchcock, Anthony Perkins, and a number of other extremely creative people got together to make a mystery-thriller they called *Psycho*. Taking an excellent book by veteran horror-fantasy writer Robert Bloch, they made a picture that frightened the entire world. Since the film was first released, there have been stories of people too terrified to take showers in their own homes.

When word started to spread that, after two decades, someone was going to make a sequel to *Psycho*, most everyone scoffed. As anyone who has seen the original knew, *no one* could make a good enough film to follow it. Even though Bloch had finally written a sequel (something he refused to do for years until he felt he had something new to say), word had it the book would not be the basis for the movie. Indeed, those who read the book agreed, even though the way Bloch handled things made for excellent reading, his version was not good source material for a film. Whatever the producers of *Psycho II* came up with, it was going to have to be totally original.

Luckily for those of us who like to be scared out of our wits, it is more than original — it is *great*. There is no doubt *Psycho II* is just as good, if not better than the foundation on which it is built.

The film opens with the original shower sequence. After we are reminded of what Norman is capable of, we are taken to a courtroom where, after twenty-two years, Norman Bates is being released. Deemed sane by the courts, he is given his freedom to return to society.

Opposing this move is Lila, the sister of one of Norman's original victims. She is at the court, trying to keep Norman from being released. She fails, and Norman steps out into the light of day for the first time in two decades. From there, he goes back to his home, and the motel, to discover it has been turned into a sleazy operation by the state-appointed manager.

Norman fires the manager, holding his temper, but forcing him to get out. Next, we see that he also has a job as a chef's assistant, a position obtained for him by his doctor. Here he befriends a young waitress. After helping her a few times, she befriends him, and the movie begins to strain from tension as it holds back, teasing the audience with threats and hints of what will soon happen.

What soon happens is a string of murders, violent and unreasoning, all committed with the same type of kitchen knife Norman wielded in the first picture. The questions begin to mount, and from this point on, the audience is slammed back in its seats time and again as more and more questions are posed with few answers.

The problem most people have had with *Psycho II* is that they have forgotten what *Psycho* was all about. In *Psycho*, the movie started as a mystery. A woman steals a large sum of money on impulse, and then tries to escape with it. There is no hint of what is to come. Hitchcock masterfully mis-directed the audience from beginning to end, making them expect the obvious, and yet always delivering something no one was ready for. This is essentially what happens again. In *Psycho*,

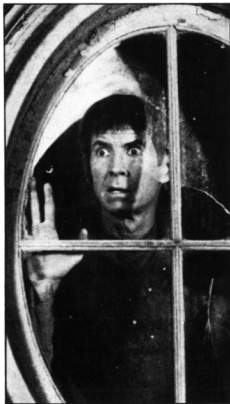

everyone thought Norman was sane, and later discovered he was crazy. Everyone was sure his mother was alive and was the killer. Of course, Norman was crazy, and the killer, and his mother was dead.

Playing on what they knew the audience would expect, the filmmakers started out with these assumptions, and completely changed them around; when the picture starts, Norman is sane, and his killer mother is alive. It is a simple juxtaposition of the facts, but no one catches on until it is too late. In *Psycho II*, Norman Bates is the victim, one preyed upon by a vicious society.

Taking every character in the film, one can identify everyone as a "type." It is fairly easy to see Norman as a symbol of a ruined, fearful society, and everyone around him as the groups we see at work in the news every day. Lila is the voice of vengeance, her daughter the voice of fearful liberalism. The manager comes to us as a representative of those who would fill our daily lives with crime and cheap thrills. And so it goes, with Norman having to face, in a few days, all the kinds of guilt and doubt and self-inflicted horror most people spend their entire lives enduring in bits and pieces.

Unlike the crop of slash-em-ups we get every year, *Psycho II* is a daring, well-thought-out work which is so perfect, it does not actually need the first film to stand. Richard Franklin has imitated Hitchcock so well, one would think the film had been planned out before Hitchcock's death, and that Franklin had worked from his notes.

Jerry Goldsmith has also done an excellent job, taking the late Bernard Herrmann's score in the original and creating a new soundtrack equally as effective.

Everything within the film, actually, is perfect. Although nothing of the motel existed, it was recreated exactly for the sequel. The nit-pickers in the audience will find little to point at as out of place.

Regardless of all the work that went into recreating the sets, music, and mood of *Psycho*, though, the real importance of *Psycho II* rests in its originality. Refusing to just be a blood-letting free-for-all, the picture goes to great lengths to create an entirely new story. The continued tale of Norman Bates and his motel is just as mysterious, misleading, and scarily enjoyable as the first. For those who have not seen it, go quickly. For those who have seen it, go again.

It's even better the second time.

## THE HUNGER

Director ..... Tony Scott  
 Producer ..... Richard A. Shepherd  
 Music ..... Howard Blake  
 Photography ..... Stephen Goldblatt  
 Screenplay ..... Ivan Davis/  
                                  Michael Thomas

Miriam ..... Catherine Deneuve  
 John ..... David Bowie  
 Sarah Roberts ..... Susan Sarandon

By now, you have either heard, or know from personal experience, that *The Hunger* was not one of the movies of the year. The reason is not that it was actually terrible in anyway but, that it was basically *too* well done for its own good.

The story is straight-forward "modern" horror; a woman who has been alive for centuries (Deneuve) is about to lose another of her lovers (Bowie). Somehow she drains these lovers of their life force, while keeping them alive forever with her. She loses them after

about two hundred years, as they suddenly age rapidly and fall into an enfeebled state; they live forever, but without the strength to move, speak, et cetera. Miriam keeps on living, forever young and vital, and all the old lovers are packed away in crates in the attic.

The story is neither exciting nor awful. It is an average story waiting for a strong production to make it an exciting film. Unfortunately, the showmen decided to make *The Hunger* artistic. Every shot in the film is carefully set up to be exquisite. Every bit of shadow, every arrangement of furniture — *everything* in the picture is purposely posed to convey meaning, mood, style, atmosphere, and a dozen other things no one had time to catch. Every shot is beautiful, every tiny bit of *The Hunger* is exotically crafted and, due to this maniacal attention to detail, almost the entire movie is devoid of feeling or story.

Beautifully filmed, but boringly void of substance, *The Hunger* is (was) a film to be avoided like the plague.



are skeptical, since carnivals do not come to small towns, especially in October. But come it does, mysterious in the middle of the night, appearing out of the fog and the steam of its black train.

Most of the town turns out for the carnival, and one by one, people are given a chance to have their deepest desires made true — for a price. An elderly spinster wishes for the beauty of her youth, only to discover the price is her power of sight. The town barber, a lonely man wishing for the "smell of women all around him," is changed into a woman.

Will and Jim discover the secret of Dark's Pandemonium Carnival, and manage to tell Will's father. Mr. Halloween fights Mr. Dark (the evil carnival leader) for the boys, standing up to Dark's magical powers, and the temptation of returned youth.

*Something Wicked* suffers for want of little. The story is one of Bradbury's best. Strongly moral, yet never preachy, the audience is reminded that there is always a terrible price to pay for trying to change the truth. Will Halloween knows there is a way to reach his son and be his friend, despite a weak heart that keeps him from sharing a youngster's life the way he feels a father should. His willingness to sacrifice the chance to gain his son's love and regain his own lost vigor show as much courage as any screen hero might need.

As Halloween, Jason Robards gives one of the strongest performances of his career. His agony comes across to the audience so vividly, it is hard to believe he is *really* enfeebled and dying as he collapses gasping after his defeat at Mr. Dark's hands. Indeed, Mr. Dark (Jonathan Price) and most everyone else are played in superb fashion, with not a bad performance in the bunch.

Both the photography and the



CATHERINE DENEUVE and DAVID BOWIE star as lovers who possess the bizarre secret of eternal life in *The Hunger*.

## SOMETHING WICKED THIS WAY COMES

Director ..... Jack Clayton  
 Producer ..... Peter Vincent Douglas  
 Music ..... James Horner  
 Photography ..... Stephen H. Burum,  
                                  A.S.C.  
 Screenplay ..... Ray Bradbury

Charles Halloway ..... Jason Robards  
 Mr. Dark ..... Jonathan Price  
 Dust Witch ..... Pam Grier

As surprisingly bad as *The Hunger* was, this year's fantasy release from the Disney studios was surprisingly good. Shunned by audiences who, after *The Black Hole*, and *The Watcher in the Wood*, were less than forgiving, the picture did terribly at the box

office, and may never make it to cable, the networks, or VHS. This would be a shame for it is one of the best fantasy films to have come along in many a year. True to the book, it is a finely wrought, careful adaptation of a sinister work by a master veteran in the field.

The movie opens in Green Town, Illinois, the setting of so many of Bradbury's stories. Two boys, Will Halloween and Jim Nightshade race home after being held late at school. The mood of a small town existing in some older time is set, and we are introduced to a number of the townspeople, and their hidden desires, including Will's father, who wants to be young again.

Will and his father both find handbills announcing the arrival of a carnival. Both



Carnival proprietor Mr. Dark offers free passes to two curious trespassers.

soundtrack are excellent. Green Town is shown as a pastoral memory of an America gone by with the same kind of photographic clarity which brought Smallville to life in *Superman: The Movie*. As to the music, up-and-coming James Horner (*Star Trek II, Wolfen, Battle Beyond the Stars*) has delivered once more. Unlike some of his other soundtracks, which have had a John Williamsesque tendency to sound somewhat alike, this latest score rings in quite differently than any of his others, setting the mood for the film as perfectly as one might hope.

The special effects as well are top-notch. Although many of them are of a more subtle variety than most science-fiction or fantasy films these days, they all work very well, helping to give Dark and his carnival just the right touches to make them as frightening on the screen as they were in the book (if not more so).

Again, as to why *Something Wicked This Way Comes* did so miserably, there seems to be no answer. More the time of its release, having to compete with *Jedi, War Games, Blue Thunder*, and the dozens of other summer movies which have poured across the country, killed it. With so many flashy, showy films around, it may have been lost in the shuffle. More than one good picture has died this way in recent years.

Whatever the reason, don't let a bad track record keep you away. If the chance ever comes your way to take this one in, grab it. Rarely does such a quiet, yet strong picture get made in this country. It would be a shame if lack of notice condemned us to a future of *Space Hunters* and *Friday the Thirteenth* merely because we continued to follow the dollar-chasers to the bank every summer.

## LEXICON

By David J. Schow

For a genre that espouses the imaginative, science fiction seems to have more exhausted superlatives and senile promotional doublespeak than any of its sister fields. Horror films, for example, have birthed the colorful new vocabulary of "stalk-and-slash cinema," "knifekill movies," "splatter films" (and their television equivalent, "veg-o-matic video"), while the only descriptives attendant to the release of a new sf film or novel are mired in antediluvian idioms that self-program failure (and dismal sales) thanks to the sheer ergasiophobia of editors and promoters capable of thinking only in terms of clichés and mind-deadening repetition.

How many times, for example, have you heard a forthcoming sf production — book, film, or otherwise — touted as anything but "mind boggling," "way out," or (especially in sf publishing) "out of this world?" How often have you been invited to "enter the space age," a trivium that's been hanging around since World War II, like a threadbare, desiccated wino? And how many of these mind-boggling, way-out-of-this-world, space-age epics are soon to be a major motion picture, which on release will garner rave reviews? Picture, if you will, the raving reviewer, trussed up in a strait jacket, foaming at the mouth, spoonfed mushy meals from sectioned plastic trays. He is probably the blurbist who authored the outmoded slugline Bantam Books has been using in their coupon/backstock ads (the lists-with-orderforms inserted into the tail end of a paperback) for over a

quarter of a century: "Welcome to Outer Space!" Books from *Something Wicked This Way Comes* to *Mockingbird* and *Valis* are dubbed "space-age thrillers" in these same ads, current for 1983 books, not reprints. When *Star Wars* first became available on videocassette last year, what buzzline did the highly-paid PR think-tank invoke to sell it in their ultra-slick, expensive two-page ad spreads? You got it — *OUT OF THIS WORLD!* — another one the Bantam ad is still using.

Or consider how sf consistently stumbles over its own tail attempting to euphemize itself, and failing so abysmally each time that it concretizes its own enduring ghetto status. In film, the heinously political Academy Awards are to blame for a lot of this title hacking, the rationale being forevermore that anything labeled as — gasp! — a science fiction movie could never move into Oscar's neighborhood without causing the property values to plummet. Thus, in competition for the "major" Oscars (the minor ones are never announced on the evening news), *Star Wars* became a "space fantasy," *Close Encounters* a "UFO docu-melodrama," *Alien* a "Gothic horror thriller in deep space," *E.T.* a sortie into "magic realism," and *The Empire Strikes Back* a "high-tech space allegory," which is like calling an explosion an "energetic multidirectional indiscrete disassembly."

Notice how the sf films that received the best review press of 1982, *Blade Runner* and *Road Warrior*, did so because they were the most vulnerable to the old wheeze of sf-as-prophecy, a justification from Jules Verne's day. It neatly ignores the dramatic and plot tenets by which mainstream work is judged, and

## HOVERTANK

HOVERTANK is a tactical simultaneous combat and movement simulation of warfare in the period 2054-2115. Sixteen scenarios depict four major conflicts: the Moon War (2054), the Mars Colony Revolt (2080), the Alpha Centauri I Revolt (2110) and the Second Alpha Centauri War (2115). Also included is a multi-player scenario: Recovery of the Alien Star Drive (2081). Scale is platoon level, each turn equals three minutes real time and each hex 100 meters. Physical components: Four 11"X17" back printed three color geomorphic maps (for a total of eight maps) • A 16 page Rule book • Two Combat Charts and Tables sheets • One die • One pad of plotting sheets • Two back printed counter sheets (392 counters) • Unit storage tray with snap lid • All this for only \$16.00 Send check or money order to



Close  
Simulations

P.O. Box 2247 Dept D  
Northbrook, IL 60062

Include \$1 for Postage. Illinois residents please add 6% sales tax.

automatically trivializes the whole sf field.

Another thing sf films do frequently, with particular regard to special optical effects, is "come of age" as "state of the art." Film hacks love hawking the availability of "state of the art" effects technology for their forthcoming bombs as though the phrase is a brand name or a self-explanatory noun. Who cares if it's good, we got us some *state of the art* — an old wheeze as meaningless today as two other cinema catchphrases you'll recognize as neutralized through attrition over the years: "BROUGHT TO YOU AT A COST OF 'X' MILLION DOLLARS" and "'X' YEARS IN THE MAKING." It would be wise for the discriminating sf fan to remember that the film *Damnation Alley* cost as many millions as did *Star Wars*, and was four years in the making . . . followed by a swift death at the box office.

Such lie-ridden grandstanding in the name of profits is nothing new, and overbudgeted turkeys often beg talking up in order to ease the angst of studio accountants — as was the case with both *Star Trek* and *Flash Gordon* at over \$40 million each. Or, to use the most hyperbolic example at over \$100 million (and still growing), please call to mind the speech you heard in the promotional trailers for *Superman*, a film . . . beyond the ability of any known medium to realize. But now, the greatest creative and technical minds in the motion picture industry have gathered to meet the challenge of *Superman!* All that, just so moviegoers could watch Chris Reeve float past the camera on wires that are plainly visible in the upper left of the frame in the very first scene where we are supposed to believe a man can fly.

Sf media magazines promote confusion even more with an unruly zoo of buzz-talk that makes even Valley Girl lingo sound like Oxford diction, and authors babble on for hours without ever really saying anything: *Sf honcho Joe Faust has been tapped to helm lensing chores on STAR FEESB, a kil-bashed low-tech uncloak galaxy paradigm* . . . Now, "tapped" implies poor Joe Faust is some kind of creative beer keg in need of periodic draining, and "helm" promotes the unwieldy image of films as tightly-run ships prone to sinking after mutiny. *Lens* has never been a verb, at least according to Webster's, but if it was it would undoubtedly denote something done by the cameraman (sorry — cinematographer) and not the director,

who, being a "honcho," is above such "chores," which Webster's defines as "disagreeable or difficult tasks." In Hollywood jargon, this is all "confusing," meaning "acceptably obtuse," but normal humans can also learn this bastard form of *Variety*-ese and play too. Appended below is an irreverent glossary of the sort of juvenile gobbledygook you'll find in *Starlog* or *Cinefantastique*, with definitions given in English to the right.

"tapped" *chosen and paid*  
 "lensed" *filmed*  
 "helmed" *directed*  
 "bankrolled" *produced*  
 "skedded" *slated*  
 "slated" *skedded*  
 "honcho" *director with baseball cap*  
 "key roll" *uncredited job*  
 "reworked" *trashed the writer*  
 "tightened up" *cut to less than 3 hours*  
 "trimmed" *censored unmercifully*  
 "wrapped" *finished*  
 "break wide" *unwrap*  
 "spokesman" *PR lackey*  
 "spokesperson" *female PR lackey*  
 "consultant" *one who threatens litigation*  
 "production source" *spy*  
 "insider" *blabbermouth*  
 "ink a pact" *to sell one's body and soul*  
 "sequel" *ripoff*  
 "followup" *ripoff*  
 "hommage" *ripoff*  
 "prequel" *ripoff*  
 "remake" *ripoff*  
 "inspired by" *ripped off from*  
 "based on" *ripped off from a book*  
 "true story" *fiction without pacing*  
 "press screening" *bribe*  
 "formulaic" *no press passes given*  
 "oeuvre" *hackwork from France*  
 "mise-en-scene" *compositional hackwork*  
 "cineaste" *teenaged filmgoer*  
 "one of the year's ten best" *released this week*  
 "classic" *fluke moneymaker*  
 "minor classic" *a cable sale will put it in the black*  
 "state of the art" *outmoded*  
 "slick" *in focus*  
 "smash hit" *lowest common denominator*  
 "pivotal vision" *stolen idea*  
 "between assignments" *unemployed*  
 "between contracts" *washed-up*  
 "bold new departure" *retreat to commercialism*

"unlike anything ever seen before"  
 "startling"  
 "altered the dramatic thrust"  
 "discussed new possibilities"  
 "rethought concept"  
 "fits no category"  
 "it promises to be"

*clicked dull*  
*rewrote*  
*rewrote derivative*  
*we're gambling on it being*

And, of course, THE END, which means, "the end unless we make money."

## G A M E S

Edited by Steve List

### STAR FLEET BATTLES

Expansion Module #2, Task Force Games, Designed by Steve Cole and multitudes of contributors; one 50-page booklet, 108 die-cut counters, numerous charts, \$6.95, ziplock.

*Star Fleet Battles* is a tactical spaceship game set in the universe of *STAR TREK*. Originally published as a mini-game, it proved so popular it was expanded in a boxed "Designer's Edition," followed by Expansion Module #1. Expansion Module #2 builds on both of these, which are in turn required to make use of this expansion kit. For those unfamiliar with SFB, it is a ship-to-ship combat game at warp speeds (i.e., faster than light). Scale is 10,000km per hex and 1/30 second per turn. Each player is the captain of one ship (or more if desired) represented by a counter on the map and a Ship System Display. The latter is a schematic view of the ship with weapons and operational systems shown as groups of hit boxes, which are checked off as hits are incurred. The key to the game is energy allocation. No ship produces enough energy each turn to power movement, offense, and defense completely, so the essence of tactics is to know when to shoot, when to scoot, and when to cover up. In this game system, "drones" are unmanned missiles guided by remote control or homing devices, while "shuttles," "shuttlecraft," and "fighters" are all forms of ships' boats, small manned vessels normally carried inside a larger ship.

A major element of this expansion kit is an attempt to correct faults in the previous works. Over 19 pages of the



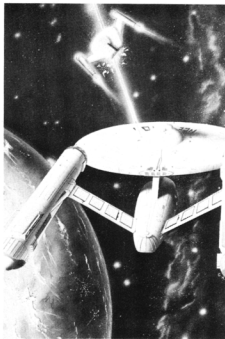

rulebook are devoted to "Additional Rules, Errata, and Clarifications," with a note that previously issued errata are invalid and superceded by the new ones. The amount of ground covered is hinted at by the 140 numbered rules.

The balance of the book is new material. A partial listing includes: New Weapons — Hydra Hellbores, Improved Drone Racks, Additional Combat Rules (Chaff, Emergency Repairs and Scouting); Additional Rules — Sideslips and Erratic Maneuvering, Ship Crew Quality, Special Individuals (e.g., the "Legendary Captain"); New Ships — Pseudo Fighters, Federation Carriers and Escort Vessels, plus vessel types for nonhuman races to round out their fleets.

Section XXV contains new scenarios to use the new rules. There is a Carrier Group Campaign game for two players. Each player selects a carrier group and then plays 3 scenarios and the "piracy mini-campaign" (itself composed of up to 6 scenarios). In each of these, one player pits forces defined by the scenario against the other's carrier group, until at the end comes the "carrier group mini-campaign" (which contains a variable number of rounds) in which the players pit their carrier groups against each other. Losses incurred during the preceding scenarios are only partially restored, so the combatants must attempt to conserve strength for the final showdown. Of

course, any of the scenarios or mini-campaigns can be played outside the context of the main campaign if desired, and in addition there are eight individual scenarios, with many variants, mostly intended to exercise the new weapons and combat rules. Particular attention is paid to a new vessel type, the pseudo-fighter. This cross between a starship and the one man fighter shuttlecraft is used to supplant mere fighters in all navies, except the Federation's, which sticks by its "superb F-14 Tomcat."

All in all, this is another tremendous load of grist for the mills of SFB fans. Players not already immersed in the nuances of the system are advised to steer clear until the contents of the previous publications have been mastered. In this respect at least, *Star Fleet Battles* is the *Squad Leader* of Space.

— Steve List

## STRIKER

Game Designers' Workshop, designed by Frank Chadwick, three rule books, three sets of tables, two six-sided dice.

Since the introduction of *Panzerblitz*, modern tactical level combat has been a consistently popular game subject. But even such traditionally favored subjects can hardly compete with the current explosion of interest in role-playing games. The introduction of *Striker* by Game Designers' Workshop is an obvious effort to fuse these two popular topics into one game.

*Striker* is a game of tactical level combat from the modern (post WWI) era into the far future. A single infantry unit represents a fire team and each vehicle unit represents a single vehicle. While the rules cover the period since WWI, the emphasis is clearly futuristic.

The universe of *Traveler* (GDW's science fiction role-playing game) provides the backdrop for the game. Neither knowledge of, or possession of *Traveler* is necessary to play *Striker*, however. The basic premises of the game are general enough to make it compatible with most science fiction role-playing games (including SPI's *Universe*).

*Striker* is something more than just a *Squad Leader* in the 25th century. It boasts several unique features that lend it a distinctive role-playing flavor.

First of all, it's a miniatures game. In miniatures games actual figures and

(continued on page 41)

# Games Plus Your SPI Specialists

Looking for that special historical boardgame or computer game? Give us a call, chances are we have in stock or can have it by the time you stop by.

We do mail order!

## GAMES PLUS

20 W. BUSSETT AVE.  
MT. PROSPECT, IL 60056  
(312) 577-9656

2 Blocks N.W. Mt. Prospect Train Station

## Feudal Lords

*The original medieval pbm game of economic development, military conquest, and political intrigue.*



Feudal Lords is a computer-moderated play-by-mail strategic game of power politics set in Arthurian England.

Each player is the lord of a medieval fiefdom seeking to become King against up to 14 other players and over 30 non-player lords controlled by the computer. To accomplish this task, a player may select from over 30 types of military, economic, and diplomatic orders each turn.

— The game is processed entirely by computer for fast, accurate, and impartial results.

— A two-page computer printout details each turn's economic results and reports all major battles fought.

— Armies may move by land or sea, limited only by the extent of their lord's political influence.

— Other features include random events, spies, vassals, trading, mercenaries, and more.

— Rated one of the four best pbm games as reviewed in issue #72 of *DRAGON* magazine!

**GRAAF SIMULATIONS**  
27530 Harper  
St. Clair Shores, MI 48081

ENTRY: \$10.00 for the rulebook, set-up, and first 3 turns.  
\$2.50 per turn.  
RULEBOOK only: \$2.50

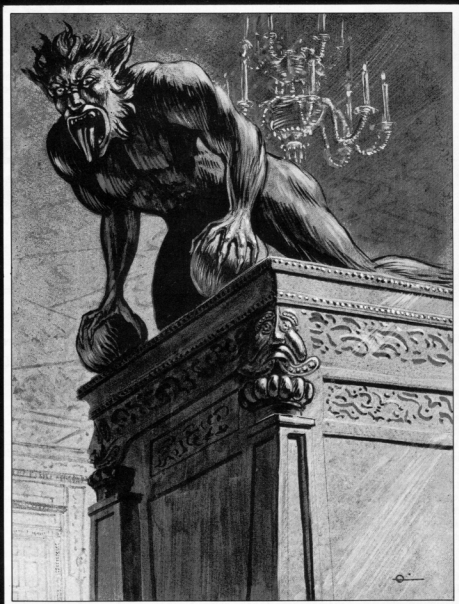

# VISITATION

by David J. Schow

Angus Bond checked into the Hermitage alone, under an assumed name. He had been recognized in consort with too many fanatics to risk a travelling companion, though having Nicholas along would have been comforting. Nicholas was dead.

"Room 724," said the deskman, handing over a bronze key "One of our suites, mister . . . ah, Orion, yes. Heh." The man's smile looked like a mortician's joke on a corpse, and Angus restrained himself from looking to see if the natty, three-piece clerk's suit was split up the back. The deskman was no zombie.

Close, thought Angus as he hefted his bags. *But no.*

The Hermitage was as Gothically overstated as Angus had expected it to be. Nothing he saw really surprised him — the ornamental iron gargoyles guarding the lobby doors, the unsettling, Bosch-like grotesques hanging in gilt frames beneath low-wattage display lamps, the Marie Antoinette chandeliers, their hexagonal prisms suggesting the imprisonment of lost souls like dragonflies stuck in amber. None of it moved Angus one way or the other. It was all rather standard haunted house crap; occult chintz to get a rise out of the *touristas*.

The wine-red carpeting absorbed his footfalls (greedily, he thought). The Hermitage seemed to be the place. At the door to 724, Angus held his key to the feeble light. He knew how to tilt it so the embossed metal threw down the shadow impression of a deathhead.

Satisfied, he unlocked the door and moved his baggage inside, in order that he might unpack and await the coming of the monsters.



The knock on the door jolted him to instant wakefulness. Angus took a bite out of a hard roll and left it behind on the leather-topped table with the sausage and cheese he had brought.

It was the zombie-like clerk, carrying a tarnished salver bearing a brilliantly white calling card, face-down. Angus noted that the clerk seemed to smell like the sachets tucked into wardrobes by grandmothers to fend off mildew. The

stark whiteness of the card cast deathly shadows on the man's pale features. It seemed to light up the hallway much more efficiently than the guttering yellow bulbs in the brass sconces.

"A gentleman to see you, sir," he said, with all the verve of a ventriloquist's dummy.

Angus picked up the card. It bore two words:

*Imperative.*

*Bray.*

The clerk stood fast. When Angus realized why, he decided to test the water a little.

"Just a minute." He hurried off to fumble briefly through the depths of his greatcoat. There was the telltale click of change, and he returned to the door with a silver dollar. Instead of placing it on the salver, he contrived to drop it, apparently accidentally, so that the clerk caught it, smoothly interrupting its fall with his free hand. He wore dusty butler's gloves that were going threadbare at the fingertips. He weighed the coin in the palm of his hand.

The air in the draftless hallway seemed to darken and roil thickly, like cream in hot coffee, for just a second. The clerk's features darkened, too, making his eyes appear to glow, the way a lightbulb flares just before it burns out. He sucked a quick gulp of air, as though dizzied by an abrupt stab of nausea. His features fought to remain whole, shifting like lard in a skillet, and Angus heard a distant, mad wail. It all took less than a second.

The clerk let the tip slide from the palm of his hand, to rattle in the bowl of the metal dish. The queasy, death-rictus smile split across his face again, and he said, "Thank you. Sir."

He left. Angus closed his door, and nodded to himself in affirmation.

The stranger was swaddled in fog-dampened tweeds and crowned with a road-weary homburg that had seen better days a few decades earlier. The initial impression left by the bearing of the man was that he was very old — not withered, or incapacitated in the way of those who wore years gracefully, but old in the sense of worldly experience. An *old* man. Angus felt a sting of kinship here, deep in the midst of hazardous and alien territory.

"You are Angus Bond?" said the old man, arching a snow-white eyebrow. "I am Turquine Bray."

"Nicholas Bray's father?" said Angus, ignoring that no one at the Hermitage knew his real name. The stranger had obviously just arrived.

"Grandfather. Paternal. His father

was a null spiritual quantity, neither evil, nor good, like most in the world. He lived out his merchant's life, and desired nothing but material things. Tawdriness. Despair. The sum of his presence on the planet was insignificance, and a more horrible fate than that I cannot think of."

The two men shook hands in the dank lobby of the Hermitage.

"I cannot say I am pleased to meet you at last, sir," Bray said. "But I am relieved. Shall we walk outside? The atmosphere in here could make a culture's eyes water . . . as it is no doubt intended to do."

The clerk's basilisk gaze tracked them until they passed through the cataracted glass of the lobby's imposing double doors. Outside, the slate-grey bulk of the Hermitage's castellated architecture monitored them dispassionately. It diminished behind them as they walked into the dense southern Kentucky woodland that made up the grounds.

"Gloomy," said Bray. "All this place needs is a tarn."

"Notice how the foliage grows together in tangles?" said Angus. "It meshes, with no nutritional support from the earth. The soil is nearly pure alkaline; I checked it. The stuff grows, and yet is dead. It laces together to keep out the sunlight — see? It's always overcast here."

"The appointments of that hotel are certainly Grand Guignol-ish. Like a Hollywood set for a horror film."

"Rather like the supposed 'ambiance' one gains by patronizing a more expensive restaurant," said Angus. "I suspect you hit it on the head when you mentioned 'atmosphere.' That seems to be the purpose of all this theatrical embroidery — supernatural furniture. Atmosphere."

"Hm." Bray stepped laboriously over a rotting tree trunk. "Sinister chic."

The iron-colored mud stole dark footsteps from them as they walked, their breath condensing wittily in the late January chill. Frost still rimmed the dead vegetation, even in late afternoon. Angus was glad he had trotted out his muffler. If Poe could have seen this place, he mused, he would have been scared into a writing diet of musical comedy.

"Have you a room?" said Angus, after both men had stood in contemplative silence for a moment.

"I wanted to assure myself of your presence here, first."

"You followed me, then?" said Angus. "For whatever purpose? You certainly know of Nicholas's death already."

"I need you, Mr. Bond, to tell me

the manner in which he died."

Angus sighed with resignation. "Mr. Bray," he said in a tone often rehearsed, "do you know just who I am?"

Bray's steely, chrome-colored eyes shot up to meet with Angus' water blue ones, and he smiled a cursory smile. "You are Angus Gwylm Orion Bond. Until roughly two years ago, your profession was that of occult debunker — exposé of supernatural hoaxes. Absolute bane of fraudulent mediums, scamming astrologers, warlocks who were more con-men than sorcerers, and all the pop salesmen of lizard's tooth and owl's wing. Until two years ago."

Bray's breath plumed out as he spoke. His speech was almost a recitation; Angus was impressed with the research.

"Two years ago, you vanished from the considerable media time and space you commanded. You evaporated from the airwaves; the talk shows. Rumor had you seeking the counsel of spiritualists and dabbling in magic yourself. Though you wound up debunking yourself, your books and other franchised items sold better than ever. I presume you've been supporting your now-private life with royalties?"

"Something like that."

"It was at precisely that time that you met up with my grandson. Nicholas was the antithesis of his father — a fantastic capacity for intellect and change. You know how he died."

"It ties together. The change in my life. Nick's death. I'm not sure you'd —"

"I am prepared for the outrageous, Mr. Bond. But I'm only interested in the truth. If the truth is merely outrageous, fire away."



"Nicholas came to my estate one night. He was frantic, pounding on the door, sweating, panicked. He couldn't tell me why. He had just moved into his new home at the time — do you recall it?"

"It was next to your estate. The Spilsbury mansion. Where all those actors were slaughtered by the religious cultists in the mid-1960s."

"Yes," said Angus. "Of course, by the time Nick moved in, that was ancient history. That place's allotted fifteen minutes of pop fame had been used up years before."

Bray smiled again.

"I went back with him. It was clear he was unnerved by the fact that the place felt wrong to him. The closest he could

speculate was that it still 'felt evil.' We sat, and drank by the fireplace, and reasoned. It happened about forty-five minutes later." Angus felt a tiny stab of embarrassment at the dramatic way he was relating things. But then . . .

"It was the first time I ever witnessed an interface," he said, simply. "Mr. Bray, are you aware how supernatural agencies function physically? What enables the paranormal to co-exist with the normal universe — yours and mine?"

"Assuming its reality," said Bray, "I'd speculate that it would be like an alternate dimension."

"Good. But not a physical dimension, not like a parallel world just staggered out of sync with our own. The supernatural is a matter of power potentials. It accumulates, in degrees, like a nuclear pile approaching critical mass. When there's too much, it blows off steam, venting into the real world, our world, becoming a temporary reality, sometimes only for a second or two."

"Accumulates? Like dust?" said Bray incredulously. "How?"

"It happens every time someone knocks on wood. Or crosses their fingers for luck, or says *gesundheit*. Every time one avoids walking under a ladder or lighting three on a match. Every time someone makes a joke about ghosts and doesn't disbelieve what he's saying one hundred percent; every time somebody uses a superstitious expression as a reflex cliché — *let the sandman come and take you away; don't let the boogie-man get you*. Every time some idiot in a church mentions the Devil. *Anytime* anyone seriously considers any of millions of minor-league bad luck totems. It compounds itself *exactly* like dust, Mr. Bray — each of those things is a conscious, willful act that requires a minute portion of physical energy in some way. The paranormal energy simultaneously prompted by such action remains unperceived, but it is there, and it stacks up, one imperceptible degree at a time. Just like dust. And when you get an extra infusion of high-potency metaphysical force —"

"Like that Jim Jones thing?" said Bray. "Or the Spilsbury murders?"

"Precisely. You boost the backlog of power that much more. Whenever it reaches its own critical mass, it discharges into our reality. The house that Nicholas had moved into was a metaphysical stress point; it was still weak, thanks to the Spilsbury thing. A break point that had not completely healed."

"And during this — this interface, all that accumulated power blew through into my grandson's living room?" Bray shook his head. "I find that difficult to believe."

"Too outrageous?" said Angus, stopping suddenly.

Bray's expression dissolved to

neutral. "Go on."

"That night, the 'weakness' was not only at the juncture point of that house, but elsewhere. Temporarily, it was a 'weak' time period. Nick was in an agitated fear state — a 'weak,' receptive mental condition. But this phenomenon has no regular characteristic save that of overload — you can't count on it venting itself at any regular time, or place, or under any regular conditions. It vented somewhere else that night, and because of the weakened conditions we caught a squirt of it — *bam!* Two or three seconds; a drop of water from a flood. The flood went somewhere else."

Now Bray was frankly interested. "What was it like?"

"I got an impression of tremendous motive force," said Angus. "Blinding black light; a contradictory thing, I know, but there. The air felt pushed out of my lungs by a giant hand. Everything loose in the living room was blown free like summer chaff in a hurricane. Overpowering nausea. Vertigo. Disorientation. I was afraid, but it was a vague, unfocused kind of terror. It was much worse for Nicholas."

"You see, he — like most people — held latent beliefs in supernatural things. I did not. Too many years debunking special effects led to an utter skepticism for things that go bump in the night — for me. I saw raw, 'evil energy.' Nicholas saw whatever he did not totally disbelieve. You might see demons, ghouls, vampire lycanthropes, the Old Ones all hungering for your flesh and soul, dragons gobbling you up and farting brimstone, Satan browsing through your body with a hot fondue fork . . ."

Bray was taken aback, obviously considering what such an experience would mean for him, given his life's collection of myth and superstition, of fairytale monsters and real-life guilts. All of it would manifest to his eyes. *All* of it, at once. He said, "You mean that every superstitious fear I've ever had is waiting to eat me, on the other side of a paranormal power overload?"

"Not as such," said Angus. "Your belief is what makes it real. True disbelief renders it unreal, back into energy — which is what I saw. But that energy, filtered through Nick's mind, made a monster. He said he was trying to hold the doorway to Hell shut, and something horrifying was pulling from the other side. It gave a good yank and the doorway cracked open for a split instant before the briefness of the 'squirt' closed it for good — but Nick, in that instant, saw what was trying to get him. It scared him white."

Bray was quiet for a long moment. Then: "He moved in with you shortly afterward?"

"Yes."

"You could not debunk the supernatural after that?"

"Not and do it with anything like conviction. Investigating the nature of the phenomenon became paramount."

"Nicholas helped you?"

"He was just the ally I needed. He had a propensity for pure research and a keen mind for deduction. We collected data and he indexed it. Using a computer, we were able to produce flow charts. One of the first things we discovered was the presence of 'pressure points' in the time flow — specific dates that were receptive to the power burst, as the Spilsbury house had been. Lammas, Beltane, Candlemas, Hallowe'en. Almost all holidays. There are short bursts, long bursts, multidirectional bursts, weak and strong ones. Sometimes the proximity of a weak date will magnetize the power, attracting it to a particular time. But most of it concentrates at one physical place. Of course, there might be a dozen such outbursts in a day. Consider Jack the Ripper's reign over Spitalfields, or World War Two — the phenomenon would damn near become cyclical, feeding on itself."

"I see," said Bray. "But what about —"

"Nicholas?" Angus interrupted his meandering walk, hands in pockets. "I think the road is just above us, there. Shall we climb up out of this muck and make our way back? I have a flask of arack in my room, to help cut the chill."

"Thank you," Bray said, as Angus helped him through a web of creepers.

"Nicholas was very good at charts," said Angus. "He cross-matched all the power bursts — he called them 'squirts,' by the way — to ebb and flow grids, and to longitudes and latitudes. He calculated in 'weak spots' and compensated for them. He synthesized a means whereby he could predict, with reasonable accuracy, the location and date of a future 'squirt.' Sometimes he was wrong."

"But he was right for at least one," said Bray.

"In Wisconsin," said Angus, "in a boarded-up mansion called Darkholm Manor, he and I faced a full-power blast, alone."

"Oh my god —"

"God is right. Nicholas was eaten alive by the demon on the other side of the door. He still believed."

The two old men scrambled up onto the road facing the Hermitage, in the distance. It loomed darkly against the overcast sky, in silhouette, like a dinosaur waiting for dinner.

"In that hotel, tonight, at precisely 1:30 am, there will be an interface such as I've described. On paper, at least, it's one of the biggest I've ever seen. There are a lot of superstitious people out there in the world. I can show you the graphs, in my room."

Together, Angus and Bray entered the maw of the Hermitage.



"Have you taken stock of the clientele here yet?" said Bray, as Angus shook his heavy coat. Neither of them had given up their sweaters, and Angus (since he had not been able to coax the antediluvian steam heater into more output) kept his sweater on in the room. The arack had been forestalled when Bray produced his private stock, a travel decanter of Laphroaig, from the depths of his own overcoat.

"There's a word for this power," said Angus. "Some call it *mana*. It's like electricity — not really good or evil in itself, but available to those who know how to harness it. I'm afraid I'm not the only one who can chart the interfaces. Others might; others who would embrace the power for evil ends. That desk clerk is a great representative example; I never saw anyone who wanted to be a vampire more. I slipped him a silver dollar earlier — one I had charged as a protective talisman." He dragged a ponderous Victorian chair over to the table where Bray was nursing his whiskey, staring abstractedly out the parted drapes to the courtyard below.

He saw three men in black, herding an enormous footlocker into the lobby. "You mean like a witchcraft amulet?" Bray said, sipping.

"Amulets are no good if they're not in your possession," said Angus. "This was a talisman, charged according to the original text of a grimoire called the *Liber Daemonorum*, published in Paris by Protassus in 1328. I have a copy."

"And the clerk?"

"I thought he was going to burst at the seams. If not for the gloves he had on, I think the talisman would've burned right through his open hand to the floor. Don't kid yourself about the intent some people have for this power. It's backed up like sewage on the other side of the veil, and a lot of evil could be done just by tapping into it." He killed his glass and motioned for Bray to refill it.

"Why expose yourself to something like that?" said Bray, now concerned. "Surely you've had a bellyful of baring your psyche to the tempest — or can you build some kind of tolerance?"

"To a degree, yes. It's still an ordeal, a mental and physical drain. But I can stand, where others would bend." Angus leaned closer; spoke confidentially:

"You've missed a more obvious reason for doing so."

"Nicholas?" said Bray finally.

"Vengeance?"

Angus swallowed another firebolt of liquor. "Not as an eye-for-an-eye thing. Nicholas' death convinced me that the phenomenon itself must be interrupted. Each outburst is more powerful. Each comes closer on the heels of the last. It is as though it is creating a bigger and bigger space in our reality, in which to exist. The 'valve' must be closed before the continuous escalation makes preventive action impossible."

"By god!" said Bray, his eyes lighting up. "The talisman!"

"I hope that wasn't too ostentatious — announcing my presence in the Hermitage with that stunt. As far as the rest of the congregation here is concerned, I'm just another acolyte."

"I haven't seen too many people since I arrived."

"Well, they'd shun the daylight by nature, anyway," said Angus. "Or what passes for daylight around here." He let his eyes drift into infinity focus, regarding the courtyard below. "You know, the Hermitage is quite an achievement, for what it is. The power I spoke of, the *mana*, and evil itself are two different things — but not mutually exclusive. It is evil that keeps the sunlight from this place; makes dead trees root in dead ground. Tonight's surge is a big one. Something evil couldn't hope for a more custom-made maw. Maybe that surge of power is to fuel a birth tonight. Or a special death . . ."

"I don't even want to think about that possibility," said Bray.

"I *must*." Angus dumped one of his satchels onto the bed. "During that 1:30 juncture tonight, I must try to put a bogey in the paranormal plumbing."

"How?" said Bray, now visibly unnerved and looking about fruitlessly for a clock. "How does one stop that much power, barreling right at you?"

"One doesn't. You turn it against itself, like holding a mirror up to a gorgon's face. It takes, in this special case, not only protective talismans against the sheer forces themselves, but also my anti-befit in the various physical manifestations — the monsters. The power will exhaust itself through an infinite echo effect, crashing back and forth like a violently bouncing ball inside a tiny box." He drained his glass again.

"Plausible," said Bray. "But then, you're the expert on this sort of thing. I suppose we'll see the truth early this morning . . ."

"No!" Angus' face flushed with sudden panic. "You must leave this place, before —"

"Leave you here alone, to fight such a fight alone? I admit that two old men may not present much of a threat to the powers you describe, but where in hell am I to go, knowing that such things transpire?" Bray's hand grew white-knuckled around his glass.

"Your own dormant fears might destroy you," said Angus, levelly.

"Another death on my conscience?"

"What am I to do, then?" Bray stiffened. "You may not believe in revenge, but I do. I insist! I side with you or I am less than a man . . . and that is my final word on the matter, sir." As punctuation, he finished his Laphroaig.

The expression on Angus' face was neutrally sober, but within, he was smiling.



In the funeral quiet of the lobby, an ebony clock boomed out twelve brass tones that resounded throughout the hotel like strikes on a huge dinner gong. A straggler, dressed in tatters, fell to the wine-red carpeting in convulsions, thrashing madly about. The stalwart desk clerk had watched the man inscribe three sixes on his forehead earlier, using hot ashes from the lobby fireplace. The ornamental andirons hissed their pleasure, hotly.

An almost subaural dirge, like a deep, constant synthesizer note, emanated from the ground floor and gradually possessed the entire structure. A chilling unrecurrent of voices seemed to seep upward through the building's pipework and the hidden, dead spaces between walls.

In the Grand Ballroom, the chandeliers began to move by themselves. Below their ghostly tinkling, a quartet of figures in hooded tabards raised their arms in supplication. Candles of sheep tallow were ignited. Mass was enjoined.

Somewhere near the top of the hotel, someone screamed for nearly a whole minute. Uneartily, lowering noises issued from the grounds, now heavily misted in nightfog. There were the sounds of strange beasts in pain, and vague echoes of something large and massy, moving sluggishly, as though trapped in a tar pit. It was starlessly dark outside.

"Are you positive you wish to stay?" said Angus, opening the flask of arrack. The Laphroaig was long gone.

"Yes. Just pour me another glass, please." Each new, alien sound made Bray wince a little, inside the folds of his coat, but he maintained bravely.

From within his shirt, Angus fished out a key on a thin chain of silver links. He twiddled it in each of his satchel's two locks. The first thing he produced from the case was a book lashed together with stained violet ribbons.

"Good god," choked Bray. "Is that the —"

"The *Liber Daemonorum*. Pity this must be destroyed tonight. By burning. Damn shame. This is a collector's item." He heaved the volume onto the bed and the rank smell of foxed and mildewed age-old paper washed toward Bray. Brittle pieces of the ragged hide binding flaked to the floor.

Nearly, probably in the hall outside 724, someone howled like a dog until his voice gave out with an adenooidal squeak.

Bray's attention was drawn from the ancient witchcraft tome to the disk of burnished gold Angus removed from the satchel. It was an unbroken ring, big as a salad plate, with freecast template characters clinging to its inner borders. It caught the feeble light in the room and threw it around in sharp flashes.

"Gold?" said Bray, awestruck.

"Solid, refined 24K, pure to the fifth decimal point," said Angus, tossing it to the bed. The heavy chain necklace attached to it jingled; the disk bounced a hard crescent of light off the ceiling directly above. "The purity of the metal used in the talisman has protective value. I won't put it on until a few seconds before deadline — keep it as potent as possible, you understand."

From the satchel came more protective fetishes, mojo bags of donkey teeth, copper thread and travertine, hex stones with glyptic symbols, inked spells on parchment bound with hide thongs, tiny corked vials of opaque liquids. Angus tucked these into his clothing.

Something thumped heavily and repeatedly on the floor above them. Drum chants could be faintly heard.

"Any doubts now about there not being a full house here tonight?" said Angus. Bray's hand quivered in betrayal as he drank. Angus regretted that the academic portion of his mind regarded Bray simply as a handicap; his sense of honor could not refuse the older man. He hoped he would survive what was to follow, but would allow no compromising of his own task. Silence hung between them awhile longer.

"Does it matter where we are when it hits?"

"No. This hotel is the place. The psychos surrounding us are like the creepy trappings — more supernatural furniture. Pay them no heed. What we're dealing with has no form. You can be tricked by illusions; if you even consider for a second that something monstrous before your eyes might possibly be real, you're lost — you *must* remember that. The demon Nicholas saw was not real, until he thought it might be, making him afraid. Then it ate him up."

"Angus!" Bray stood from his chair.

"I can — I can *feel* something strange . . . palpable, a swelling . . . like a balloon about to burst . . ."

Angus hauled out his railroad watch. "1:27 am. I set this by the time service in Willoughby late yesterday. Hmm — I suppose no time service is strictly accurate." He slipped into the talisman.

"It's really coming," said Bray in shaky disbelief.

"Exactly like the atmospheric buildup Nicholas sensed, before the squirt at his house," said Angus. "I have no extra white power objects, friend Bray. You'll have to stick close behind me. That's about the only aid I can offer you. And something else —" He hurriedly dug a dented tin of Ronson lighter fluid out of the satchel and doused the *Liber Daemonorum*. The pungent liquid soaked slowly into the comforter on the bed and saturated the book of sorcery. Angus then came up with several disposable plastic cigarette lighters, each gimmicked with electrical tape. "Take one of these, and listen to me: During the confrontation, I may become momentarily transfixed. If that happens, I want you to light the book. It must be burned during the interface if my other, lesser shielding spells are to function. The lighter is modified to produce a long jet of flame when you thumb the wheel. Understand that the book is rare, and dangerous, and the supplicants booked into this place would gladly murder us to get it. If I hesitate, destroy it!"

Bray clutched the lighter tightly, like a crucifix against a vampire.

As though in the grip of an earthquake tremor, the Hermitage shuddered. A chunk of the whorled plaster ceiling disengaged, and smashed into chalky crumbles at Angus' feet.

"Remember, Bray!" he shouted.

"It's not real —"

The rest of his words were obliterated by a thunderclap concussion of moving air as the oak door to 724 blew off its hinges and slapped the floor like a huge, wooden playing card. The French windows past Bray splintered outward in a shrieking hail of needlelike glass bits. The bottles and rickrack on the table scattered toward the window. The Laphroaig flask pegged Bray's temple and brought blood. The vacuum force of the moving air seemed to suck the breath from him. He screamed Angus' name, soundlessly.

Angus labored toward the door, walking ponderously, like a trapper in a snowbank, one hand holding the outrust talisman, the other readying the lighter for the *Liber Daemonorum* crooked against his chest. Outside, the corridor was awash in stunning yellow light. A high-frequency sound knifed into his ears and numbed his brain. He heard his name being called over and over, coupled with a maniacal laugh that kept shifting speeds, accelerating and slowing, a warped record in the hands of a lunatic disc jockey. Through the shimmer and glare Angus thought he could see stunted, writing

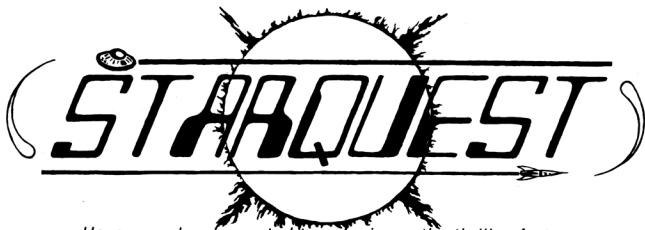

# STARQUEST

*Have you always wanted to experience the thrills of your favorite science fiction books and movies?? HERE'S HOW!!!*

You are a Special Agent of the Imperial Government. Using your well equipped one man ship, you've penetrated the group of asteroids you suspect to hide the secret Zershan base. For weeks you've been investigating the mysterious sabotage at nearby Imperial Spaceports, and you're sure that they originate here. Now ... how can you stop their operation without getting yourself blown into sub-atomic particles!?

You're the Captain of a small space freighter. On what should have been a routine landing at Cerinath, your ship is ordered to remain in orbit. In minutes an Imperial Cruiser matches orbits and sends across a boarding team. Shortly, they unearth some hidden contraband drugs. Worse, you had no idea they were on your ship! You've been set up! As you and your four man crew are shuttled over to the Cruiser, you're determined to return to your last port of call and find out what's behind this ... IF you can keep from being locked away in the lowest jail on Cerinath!!!

You and your partners go over what seems like the hundredth set of scanning reports. You're trying to locate the daughter of Bradon Harkman, a VERY wealthy industrialist. Her ship was lost in this area, and he hired YOU rather than turn to his own corporate resources because you specialize in this type of thing, and you're GOOD at it! This is the only habitable planet in the sector, tho it remains uncolonized due to the severely lethal life forms native to it. If Harkman's daughter DID get here in a lifepod, finding where it landed will be the EASY part!!

**STARQUEST** is ECI's new game of interstellar adventure. This is the first game which allows players to experience character level role-playing adventure in a Sci-Fi correspondence game. And just like our other games, you receive response to your moves in a narrative style ... no computer read-out sheets to have to decipher!

## What does STARQUEST have to offer?

**INDIVIDUALITY** — you select your own ship and crew of adventurers using a unique system of buying equipment and abilities with a pool of Resource Points. You can use these resources to buy a ship and a small crew of varied skills, or pile points into one character who's got it all!

**VARIETY** — Choose from MANY types of starships and options, skills, professions, alien races, and equipment!

**ADVENTURE** — Make your own choices of the types of adventure you'd like to pursue, or sit back and be delighted by one of the many surprises our gamemasters cook up for you! Whether you wish to be a mercenary, government agent, explorer, pirate, journalist, or one of the many other professions available, we have more than enough adventures to challenge you for years to come. And when you tire of one profession, your characters can move to another as easily as sending in your next move!

**MYSTERY** — We've created an entire galaxy of thousands of individual worlds. Quite a few are already populated with civilizations, human and otherwise. Many more than that are waiting for YOU to find and explore them!

**FLEXIBILITY** — **STARQUEST** allows you to obtain more characters and ships as the game progresses, and to improve the ones you already have ... all for the SAME low price of one move!

**COLOR GRAPHICS** — Several game elements come displayed to you in color graphics printouts, including ship's plans, star maps, damage reports, and more!!

**LOW COST** — **STARQUEST** costs only \$6.00 to enter. This covers rules, set-up sheets, and the first turn, which includes your set-up and first adventure narrative. Each move thereafter is only \$3.50, with no special action or combat charges to worry about! You can move whenever you wish, **STARQUEST** has no deadlines.

**EXTRAS** — Like our other games, **STARQUEST** will have its own monthly newsletter to inform you of interesting events happening in the game, and to give you the opportunity to win cash prizes in monthly contests!

If you love adventure, or if you love Science Fiction, then **STARQUEST** is the game for you!  
**Enter now and in only a few days you'll be living the life of your dreams among the STARS!!!**

Please send my **STARQUEST** Player's Kit RIGHT AWAY.

I would like \_\_\_\_\_ individual set-ups in **STARQUEST**.

Enclosed is \$6 for the first set-up and \$4 for each additional set-up.

Send to:

Name \_\_\_\_\_

Address \_\_\_\_\_

City \_\_\_\_\_

State \_\_\_\_\_

Zip \_\_\_\_\_

Mail orders to: Entertainment Concepts, Inc., P.O. Box 13190, Charlotte, NC 28211

shapes — various monsters struggling to be born of his mind. He stared them down and one by one they were absorbed back into the light that produced them, dissolving as though beaten progressively thinner with a mallet until the light shone through, and disintegrated them. The talisman began to radiate heat against his chest. The first echo had been achieved.

The maniac sounds were definitely caused by something in terrific pain, fighting him. In the hallway mirror, Angus saw himself vaporize — hair popping aflame, shearing away, skin peeling back as though sandblasted off, skull rushing backward in a cloud of sugary powder, blood and brains vanishing in a cloud of color and stink.

It was an illusion, and he ignored it. He tried to ignore the dim, background sound of Bray's screaming.

A grey lizard demon, scales caked in glistening slime, breached the outside window to 724 and pounced on Bray's back, ripping and tearing. More rushed in like a floodtide, their alligator snouts rending his clothing, their flying spittle frying through his skin like brown acid. Curved black talons laid open his chest and they began to devour him organ by organ. His lighter went spinning uselessly across the floor.

Angus caught a glimpse of the carnage taking place behind him. Bray was lost.

Angus stopped his advance. Bray was dead.

Bray was dead, and the typhoon of yellow force petered to nothingness in a second. Standing ridiculously alone in the quiet of the cathedral-like hallway, Angus realized, with a plummeting kind of bright, orange horror in his stomach, that he had lost.



He looked up and down the hallway. Nothing.

Then, distant, indecipherable sounds. Hungry sounds.

The book! *The book!* His mind screamed. His thumb automatically worked the lighter, and a jet of blue propane fire at least half a foot long sputtered up, caressing the *Liber Daemonorum*. It billowed into flame along with his soaked coat sleeve.

But the two iron gargoyles from the lobby were already winging toward Angus with metal-muscled strokes. He heard the grating of their black, iron flesh pumping, and looked up to see their diamond eyes

fixed on him. They peeled to either side of him as the book touched off, one swooped past in a blur, hooking the book away to smother it against its bellows chest, the other jacking up in midair to strafe Angus. He felt cold, sharp pain. His feet left the floor and he crashed onto his back, rolling clumsily, blood daubing into one eye from the gashes the gargoyle's iron, butcher-cleaver claws had carved in his forehead.

His name was still being called, fast and slow and fast and —

"Angus." The tone was first disapproving, then pitying. "Angus, you poor old sod."

Turquine Bray stood over him holding the still-smoking *Liber Daemonorum*. The violet ribbons were charred.

The iron gargoyles circled high in the corridor, lighting behind Bray. They cringed and fidgeted, like greyhounds, grinding their javelin teeth and snorting mist through their cast-iron nostrils with impatience.

"Since you've delivered this book to us," said Bray, "I think you're owed a few words." His hands slithered proudly around the tome and his chromium eyes glittered at Angus.

"The gargoyles —" Angus gasped from the floor.

"Oh, yes, they're real enough. They're a bit piquet because I haven't given you to them yet." Angus could see that Bray spoke a mouthful of needled fangs like the dental-work of a rattlesnake. "Your disbelief in monsters posed an intriguing problem. How to chink such metal armor? How to trick you, the expert on all the tricks? You wouldn't believe in the patently unreal, so we made you believe in something else you'd accept with less question. The gargoyles are now real, thanks to your mind. Turquine Bray, however, died in 1974. On Valentine's Day." The Bray-thing, its hair gone jet-black, eyes sunken to mad ball bearings in seductive, dark pits, grinned wolfishly.

"Impossible!" Breathing was becoming difficult for Angus, as though his lungs were filling with hot candle wax. "Impossible . . . the power burst . . . you existed before the interface took place . . ."

"My dear Angus," the creature rasped in a phlegmatic voice, "you're not paying attention. This power burst was the biggest of all so far. People are more superstitious than ever. They go right on stacking it up. This surge was preceded by what young Nicholas characterized as a 'squirt,' a considerable leakage that primed the paranormal pump, you might say." It pretended to inspect its elongated, spiked nails. "How do you think something as melodramatic as the Hermitage got here in the first place? It came out of your mind. It was what you

expected; know-nothing cultists and pop satanists and horror-movie props — supernatural furniture. It was *all* an illusion, as was I. But it's real now. The *Liber Daemonorum* will help to keep our family corporeal."

Two shuffling corpses battered down the stairway door leading into the hallway. Their sightless, maggoty eyesockets sought Angus' prone form. They made for him with inexorable slowness, rotting flesh dropping off their frames in clots. They hungered.

"Your H. P. Lovecraft might be pleased to know that his Old Ones are finally coming home," growled the monster. It stretched cavernously, bursting from its human clothes, revealing a wide body of insectile armor plating with double-jointed birdlike legs whose hooked toes gathered the carpet up in bunches. "It's all quite real now, friend Angus." The steely, silver eyes transfixed Angus from a nine-foot height. "As are my other friends. Here. Now."

The gargoyles jumped into the air and hovered like carrion birds. From 724 the reptilian scavengers continued to swarm, champing their oversized jaws, streamers of drool webbing the carpeting. Beyond the steaming, toothy thing that had been Bray, Angus saw a translucent horde of ghostly, humanoid leeches. The scuttling things advanced, worrying their bloodless, watchmaker's claws together in anticipation of a dark, gurgundy-hued snack.

He recognized them now, all of the monsters, all of his lifetime's research into the occult, echoing back upon him. If he could be made to believe Bray had been real, than anything could follow . . . Zaeobos, a demon with a human head and the body of a crocodile, entreated him from the end of the corridor. Near the ceiling floated the Keres, the Greek vampire entities who appear before death. Windigos — cannibalistic Indian ghosts — crowded past the living dead corpses to get to Angus' position. They licked their lips. Now Angus knew the name of the monster before him, the spirit who had assumed Bray's form to trick him. It was the Master of Ceremonies to the Infernal Court.

"Verdelet!" he croaked, holding the talisman forward. "Swallow this!"

"Now, now," the demon said. "Too late for that hocus-pocus, Angus. You believe now." It waded an ebony claw carelessly, and the talisman melted, sizzling through Angus' clothing, scalding and eating into his chest with a geyser of golden steam.

He managed a howling scream. "I have nought but gratitude for you, friend Angus," Verdelet said. "Thanks to you, as of this night, the Hermitage is open for business."

The last thing Angus heard was the wet sound of jaws, opening. ▲



# NIGHTMARE<sup>™</sup> HOUSE

A GOTHIC HORROR  
BOARDGAME

by David Marshall





# NIGHTMARE HOUSE™

A GOTHIC HORROR BOARDGAME

## CREDITS

Design: David Marshall  
 Development: David James Ritchie  
 Editing: Deborah Campbell Ritchie  
 Graphic Design: Kristine Bartyzel, Kitty Thompson  
 Art: Jeff Easley  
 Developmental Assistance: Jon Pickens  
 Production: Kristin Pelisek  
 Playtesting: John-Michael Spangler, Julie Spangler, Mark Acres,  
 David Cook, Jon Pickens, Tracy Hickman, and Gali Sanchez.

## TABLE OF CONTENTS

PART 1 INTRODUCTION .....	PAGE 3
PART 2 GAME PARTS .....	PAGE 4
PART 3 HOW TO SET UP .....	PAGE 6
PART 4 HOW TO PLAY .....	PAGE 7
PART 5 LOST ON THE ASTRAL .....	PAGE 11
PART 6 HAUNTING .....	PAGE 11
PART 7 EXORCISM .....	PAGE 12
PART 8 POSSESSION .....	PAGE 13
PART 9 HAUNT SUMMARY .....	PAGE 13
PART 10 DISCOVERY SUMMARY .....	PAGE 14
COUNTER FACES .....	PAGE 16

SPI is a trademark owned by TSR, Inc.  
 Copyright 1983 by TSR, Inc. All Rights Reserved.

Printed in the USA.

These rules are protected under the copyright laws of the United States of America. Any unauthorized reproduction of the material or artwork presented herein is prohibited without the express written consent of TSR, Inc.

The names of the characters used herein are fictitious and do not refer to any persons living or dead. Any descriptions including similarities to persons living or dead are merely coincidental.

## PART

## 1



## INTRODUCTION

Darkholm Manor — the name strikes fear in the hearts of those steeped in the occult. Something walks inside the house, something... evil... something... unspeakable. Located on a windy bluff overlooking Wisconsin's swank summer resort, Lake Bernie, the Manor stands in eerie isolation, strangely preserved, strangely beckoning. Few who have entered it have survived, and of those survivors, none has ever been quite the same.

Built in the mid-1800's as the retirement home of a Yankee sea captain, the house was the fruit of a fortune made in the mysterious East. According to Indian folktales, the site was "ha'nted," a place of evil. The locals are said to have warned the builder of this fact. The Yankee sea captain is said to have laughed. His name was Josiah Darkholm and that name is still a curse in some parts of rural Wisconsin. Legend says that Darkholm learned things in the East that were better left unknown, things that allowed him to bind the forces of that place to his will and to his house. Perhaps. Or perhaps such stories were just the envious talk of his commercial rivals who watched the Darkholm empire prosper while their own businesses fell into ruin through a series of bizarre calamities. Whatever the truth may be, to those who lived in the shadow of the house, Josiah Darkholm was a monster and a father of monsters, a man whose arrogance and coarseness of appetite made him both shunned and hated.

Some say his spirit haunts the house still, chained there by the very forces he sought to invoke and which one moonless night led him to hang himself in his study. Others say the evil is something unloosed by his son, Alistair Darkholm, who devoted his life to the black arts and who was found slashed to death one bright morning, the razor that had inflicted the death wound still clutched in his hand. Still others say that the evil is the legacy of Alistair's misbegotten daugh-

ter, the evil Lilith, a coldly beautiful woman, who married seven wealthy men — all of whom died mysteriously following bizarre, secret ceremonies in the Manor's deconsecrated chapel. Perhaps it was one of those ceremonies that killed her, the last of the Darkholms to live in the house. When they opened the chapel, Lilith's face was frozen in a mask of horror and her hand still clutched the ceremonial dagger she had driven into her fair breast. Upon her death, her seven children were taken from the Manor... six of them never to return for they all died mysteriously within a year. Only the youngest child, Kate, is believed to have escaped the family curse.

With the removal of the Darkholm children to a healthier environment, the house appeared to wither and moulder. But its evil remained potent... restive. Small children seemed drawn to it like moths to a flame. Those who entered, on a dare or a lark were likely to lose or alter their young lives in a variety of unpleasant ways. Attempts by the family solicitors to break the chain of evil events surrounding the Manor by selling it into other non-Darkholm hands, met with failure. Potential buyers always seemed to have fatal accidents shortly after visiting the house. Finally, by popular demand, the windows of the dangerous old ruin's lower stories were bricked up and it was more or less permanently sealed. By these steps, potential victims were kept out of the house. But the evil was not kept in. Its restless menace still broods over the town, threatening... promising... watching... waiting...

**NIGHTMARE HOUSE** is a two to five-player game of ghost hunting and exorcism. One player (the **House**) takes the role of the evil Entity that has spun its web of power over the Darkholm Manor. The other players (called the **Hunters**) each represent a ghost hunter who has entered the house one dark night to confront and banish its evil.

The battle against the House takes place on two planes. On the Astral Plane, the Hunters try to reach and exorcise the Entity hidden in the heart of darkness of the House. The Hunters must advance along the 12 Axes of Power, weakening the House and destroying its web of evil by exorcising the Entity's power from individual rooms in the Manor. The House tries to trap the Hunter's Psyches and cast their Astral Bodies adrift on this plane.

On the Material Plane, the physical manifestation of the House, the Hunters search for discoveries to help them on the Astral Plane, as the House materializes Physical and Psychic Haunts against them through its Foci of Evil. The House tries to take possession of the Hunter's physical bodies, destroy them and absorb their souls. The Hunters use various tools and strengths to defend themselves against Haunts.

## THE CHARACTERS

Twelve characters are included in the game. Each is tied to the house in some way and has certain strengths and weaknesses when used in play. It is strongly suggested that Kate, Potter or Lorenzo be used in two-player or solitary games.

**Kate Darkholm**, the last of the Darkholms, is a conscious medium. Raised by distant relatives far from Darkholm Manor from the age of 6, her mediumistic and psychic abilities became active on her 12th birthday. Since then, Kate has been obsessed with the Darkholm curse. She is determined to return to the Manor and rid it of its evil, banishing the lingering ghosts of her great-grandfather, grandfather and mother. The House has been waiting for her to rekindle its power.

**Ted Holt**, now a famous photojournalist with credits in scores of prestigious magazines, is a local boy who grew to manhood in the shadow of the Manor. Holt is haunted by the memory of one black night spent in the house when, on a childish dare, he entered the darkened tower to confront the spirit of Alistair Darkholm. The House can't wait for Teddy to come back and play again.

**Dr. Opal Devlin**, noted professor of psychology, spends her sabbaticals investigating reports of psychic phenomena. She is drawn to Darkholm Manor because of the evil she feels growing there. It is an evil she thinks she can destroy. The House thinks otherwise.

**Lorenzo Lane** is quite possibly the most famous stage magician and escape artist in history. Having started in show business as a mentalist, he has made a lucrative hobby of debunking mediums, psychics and haunted houses. Nonetheless, Lorenzo believes in the evil of Darkholm Manor... and the House is waiting to embrace him.

**Jim Chase**, private investigator. He believes only in what he can hold in his hand and see with his eyes. Business draws him to Darkholm Manor, an investigation into the mysterious disappearance of a writer who was researching the Darkholm curse. Chase looks forward to cracking the case. The House looks forward to cracking Chase.

**Father Eamonn Doran**, newly-arrived from Ireland, is the parish priest of Lake Bernie. Since coming to the village, he has felt a growing wrongness, almost a challenge, emanating from the house, reaching out to grip his parish in icy, twisted fingers of evil. The inexplicable suicide of a parishioner has prompted him to accept the challenge.

**Eliot Evans**, professor emeritus of anthropology at Old Salem University, has made a livelihood out of proving that ghosts and psychic phenomena are mundane realities. Of late, his nights have been filled with dreams of Lilith Darkholm, a woman he

has never met and knows only by reputation. Now he has come to meet her.

**Jason Rivers-Smythe**, Captain in the Howards, has come in search of his beloved twin sister missing 14 years since the night of Lilith Darkholm's death. Sweet Janet Rivers-Smythe had travelled to America to earn a modest dowry as personal secretary to a gentlewoman. She found instead a life of small horrors and black secrets behind a door called Darkholm. Jason thinks that he has come to learn the truth about his sister that will ease his dying mother's mind. The House knows that he has come instead to hear a ghost story.

**Hal Roarke**, the young, iconoclastic founder of the Functionalist School of Architecture, has made a study of old houses reputed to be haunted. Hal also dabbles in the occult and considers Darkholm Manor to be the ultimate challenge to those who study other planes of existence. He is sure that he will be the first person to master the

house and unravel its secrets. The House is eager to touch his soul.

**Lemuel Jakes**, a lonely aged widower, has been caretaker of the Manor since the family solicitors closed it up 14 years ago. He has never put much stock in the stories about the house but has steadfastly avoided staying on the property after sunset. The death of his only daughter by her own hand has kindled his suspicions and goaded him to action. If anyone can find the heart of its darkness, it will be Lemuel. The only requirement is that he enter the house when its power is strongest... at night.

**Dr. Ben Addams**, the village doctor, was always amused by the tales the locals told about Darkholm Manor. But Nora Jakes was his patient... and, perhaps, in the heart of the shy, middle-aged physician, much more than that. Addams can't forget that Nora died with the name of Darkholm on her lips. The house welcomes his hate.

**John Potter**, one of the most famous an-

tique dealers in the United States and Europe, has an uncanny ability to read the history of objects by touching them. This talent has led him to study the occult and he is an acknowledged expert on psychic phenomena. This night, he will try to uncover the secret of Darkholm Manor... if only he can open himself to the emanations of the house without becoming part of it.

## SOLITAIRE PLAY

Playing the game solitaire is a good way to become familiar with the rules. If you choose this option, you should only use one Character of your choice and seek to beat the House with that Character. Follow all rules with these changes: During set up, choose the Character you will play instead of drawing it randomly; place the Discovery Markers on the map without looking at their faces. Place the Entity in the Seventh Circle to start. Whenever the House plays a Power Marker, draw it randomly from the POWER WHEEL.

## PART 2



## GAME PARTS

### A. PARTS LIST: Each game contains...

- one 22" x 34" mapsheet
- one sheet of 200 cardboard playing pieces
- one 16-page rules booklet
- three 6-sided dice (*not included in magazine*)
- one game box (*not included in magazine*)
- one plastic tray (*not included in magazine*)

**B. THE RULES:** All information needed to play the game is explained in these rules. Read them carefully before beginning play. Don't try to memorize the entire booklet — just read everything! Then set up the game by following the steps in **PART 3** and play it through by following the Steps in **PART 4**. Refer to the other rule sections during play to clarify anything you don't understand. A number of special terms are used in the rules. These include:

**Astral Plane:** The plane of existence inhabited by the Soul. In the game, the portion of the Astral Plane in and around the House is represented by the ASTRAL MAP. A Character can affect the Astral Plane through his *Psyche* (the structure of his mind). He can also use his *Astral Body* (the manifestation of his Psyche as energy) to move around the Astral Plane. A Character can build a *Lifeline* of Power Markers between his Psyche and his Astral Body so as to ease the return of his Astral Body to his Psyche. In some cases, despite this precaution, a Character's Astral Body will become dissociated from his Psyche and he will become *Lost on the Astral Plane*.

**Entity:** The other-dimensional being whose evil is manifested in Darkholm Manor. The House is actually representing the Entity in the game. In order to dispel the evil that controls the House, the Characters must *exorcise* (drive out) the Entity. Before they can do this, however, they must first weaken the Entity by driving it from the various *Rooms* in the House and destroying the various *Power Axes* that the Entity uses to control the House. This process of weakening the Entity is also called *exorcism*.

**Focus of Evil:** A pool of other-dimensional energy that the House can gather into a sort of "portal" into its own dimension. The House can then cause *Haunts* to materialize in this pool of energy. The Hunters can keep the House from using a Focus of Evil for this purpose by *Warding* (creating a protective atmosphere in) the Space containing the Focus of Evil. A Focus of Evil is represented in the game by a Focus Marker which can be front face up (*Intact*) or back face up (*Dispersed* by a Ward). The *Graveyard*, *Cellar*, *Crypt* and *Tower* are also considered to be Foci of Evil, but they cannot be Warded.

**Haunt:** A manifestation on the Material Plane of the Entity's evil. Haunts can be *Physical* (having their primary effect on the bodies of their victims) or *Psychic* (having their primary effect on the minds of their victims). All Physical Haunts are *Mobile* (can move around the HOUSE MAP). Psychic Haunts can be *Mobile* or *Immobile* (existing only at a particular point in space). For a Haunt to have an effect on the Characters in the game, the House must *energize* it by placing 1 or 2 Power Markers under the Haunt. The Haunt then takes several Hours to *materialize* (enter the Material Plane). A *Haunting* occurs whenever a Haunt starts a **HAUNT PHASE** in the same Space with a Character or enters a Space with a Character during the Phase.

**Pentagram:** A five-pointed star inside a circle of protection which can be used as a place of shelter from evil (especially Haunts).

**Possession:** The means by which the House adds the energy of a Character to its own power. A Character's *Unconscious Body* may be Possessed and used by the House on a temporary basis. A Character's *Soul* can become permanently Possessed (absorbed) by the House once the Character's psychic defenses have been stripped away via Hauntings or attempted Possessions of the Character's Body while the Character is on the Astral Plane.

**Power:** A measure of one's ability to manipulate other-dimensional energies. Power Markers are used in the game to represent the power of both the House and the Hunters. They are tools the players use to perform many game functions. Each player has a number of Power Markers available for use in a given Hour. These markers are stored in his individual section of the

**POWER WHEEL.** As play progresses, the players spend or transfer Power Markers. When Power is transferred from a Character to the House, the Character's Soul is weakened. Used Power Markers are returned to the POWER CUP.

**Soul:** The spiritual essence of each Character is distinct from his Physical Body, Psyche or Astral Body. Possession of the Characters' Souls is the ultimate goal of the House.

**C. THE MAPSHEET:** The mapsheet includes two maps:

**THE HOUSE MAP,** showing the three floors of the Nightmare House. This map consists of a number of separate rooms and areas called *Spaces* through which the players move the pieces during play. The First Floor includes the attached **Verandas, Garden, Toolshed** and **Graveyard**. The Second Floor is reached by a pair of Stairways from the First Floor. The Third Floor is reached by a Stairway from the Second Floor. The **Attic** is reached by a Stairway from the Third Floor Storeroom. The **Tower** is reached by a Stairway from the Third Floor Main Hall. The **Cellar** is reached by a Stairway from the Main Storeroom. Most Spaces have matching *Room Markers* that are used on the ASTRAL MAP to show where each Space fits in the web of evil that surrounds the House.

**THE ASTRAL MAP,** showing the web of energy that the Entity has woven through the house. This web consists of a number of *Power Points* connected by *Power Lines*. Twelve *Axes of Power* formed by the Power Lines radiate from the center of the web to form 4 *Circles of Energy*. At the heart of the web are three *Circles of Darkness* (the *Fifth, Sixth, and Seventh*), the lair of the Entity. These 7 Circles connected by the 12 Axes form the ASTRAL MAP. The Circles are numbered from 7 (the innermost circle) to 1 (the outermost circle). The Axes are numbered from 1 to 12. There are 4 *Power Points* in each Axis. The Fourth Circle of 12 Power Points is the *Axis Control Circle* and each Power Point in that Circle is an *Axis Control Point*. The other 36 Power Points on the 3 outer Circles are *Room Control Points*. The status of each Power Point is indicated by which side of the marker occupying that Point is showing. *Room Markers* and *Control Markers* each have a *Controlled Side* indicating that the House controls the Room or Axis represented by the marker and a *Dispersed Side* indicating that the Room or Axis represented by the marker has been Exorcised and is no longer Controlled by the House.

Also printed on mapsheet are the...

**ABBREVIATED COURSE OF PLAY,** showing the Phases that must be performed each Hour.

**CLOCK,** showing what Hour it is. **NOTE:**

The numbered hours on the clock do not contain AM or PM designations. The Hours from 6 to 12 are always PM. The numbers from 1 to 5 are always AM.

**MAP KEY,** showing what the symbols and colors on the Maps mean.

**POWER WHEEL,** where the players keep the Power Markers they get each Hour.

**SOUL TRACK,** used to keep track of how close each Character's Soul is to Possession by the House.

**D. THE PLAYING PIECES:** The sheet of die-cut cardboard pieces contains a variety of different markers. Samples of each are shown below:

#### SAMPLE HAUNT

Front Face



Back Face

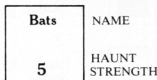

#### SAMPLE CHARACTER —

Front Face  
(Normal)

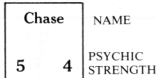

PHYSICAL  
STRENGTH

PSYCHIC  
STRENGTH

Back Face  
(Possessed)

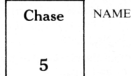

HAUNT  
STRENGTH

#### SAMPLE TOOL

Front Face



Back Face

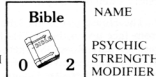

PHYSICAL  
STRENGTH  
MODIFIER

PSYCHIC  
STRENGTH  
MODIFIER

**NAME:** The name of the Character, Haunt or Tool. The named Character Markers represent the Hunters' Physical Bodies on the HOUSE MAP. The front of each Character Marker is the side that is normally showing. The back side is used when the Character's Physical Body is Possessed by the House.

**PHYSICAL STRENGTH:** The amount of physical energy the Character has at his disposal. This number is used to determine how far the Character can move on the HOUSE MAP, how effectively he can combat Physical Haunts and what the Character's own Haunt Strength is when his Physical Body is Possessed by the House.

**PSYCHIC STRENGTH:** The amount of psychic energy the Character has at his disposal. This number is used to determine how far the Character can safely move on the ASTRAL MAP, how effectively he can combat Psychic Haunts and perform Exorcisms, how easily he panics and how many Power Markers he gets each Hour.

**HAUNT STRENGTH:** The power of the Haunt when it engages in a Haunting of one or more Characters. If the Haunt Strength is surrounded by a *triangle*, the Haunt is a Mobile Physical Haunt. If the Haunt Strength is surrounded by a *square*, the Haunt is a Mobile Psychic Haunt. If the Haunt Strength is surrounded by a *circle*, the Haunt is an Immobile Psychic Haunt.

**PHYSICAL STRENGTH MODIFIER:** The number that modifies the die roll of the Character who possesses the Tool whenever that Character is haunted by a Physical Haunt.

**PSYCHIC STRENGTH MODIFIER:** The number that modifies the die roll of the Character who possesses the Tool whenever the Character is haunted by a Psychic Haunt.

## SAMPLE MARKERS

Front Face

Discovery  
MarkerThe  
EntityControl  
MarkerRoom  
MarkerPsyche  
MarkerSoul  
MarkerAstral  
Body  
MarkerPower  
MarkerFocus  
MarkerLights  
MarkerPentagram  
MarkerStatus  
MarkerHour  
Marker

Back Face

Blood-  
stains

Kitchen



4th Hunter



4th Hunter



4th Hunter



2



4th Hunter



The front faces of the Control, Room and Focus Markers are the *Intact Sides* (showing that the Entity's control of these elements is complete). The back faces of these markers are the *Dispersed Sides* (showing that the Entity's control of these elements has been dispersed by Warding or Exorcism). The front faces of the Psyche and Soul Markers are the *Intact Sides* (showing that the Character's psychic defenses are intact). The back faces of these markers are the *Vulnerable Sides* (showing that the Character's psychic defenses have been overcome). The front face of the Astral Body Marker is its *Normal Side* (showing that the Astral Body is under the Character's control). The back face is the *Lost Side* (showing that the Character is Lost on the Astral Plane). The front faces of the Status Markers are used to show that Characters are *Panicked*. The back faces are used to show that Characters are *Unconscious*. The front faces of the Lights Markers are *On*. The back faces are used to indicate that Floor Lights are *Off*.

## PART

## 3

## HOW TO SET UP

- Choose which player will be the House. By gaming convention, the game's owner plays the House and performs **Steps 2** through **12** below before the other players arrive to start play.
- Cut out the playing pieces and sort them by color and type.
- Unfold the mapsheet, bend it back against the creases to make it lie flat, and place it on a flat surface.
- The House places the Entity front face up in the *Fifth, Sixth or Seventh Circle* of the ASTRAL MAP (House's choice). Generally, the farther the Entity is from the center of the web, the more powerful it is on the Physical Plane.
- The House places one Control Marker front face up in each Axis Control Point on the ASTRAL MAP to indicate that all Axes are Controlled at the start of the game.
- The House places one Room Marker of his choice front face up in each Room Control Point on the ASTRAL MAP to indicate that the named Rooms are part of the Entity's web of evil at the start of the game.
- The House places his 2 Focus Markers front face up on the ASTRAL MAP, one each on any Room Marker. Each Focus Marker indicates a Focus of Evil where the House can materialize Haunts during play.

8. The House places all of the Power Markers in a tea cup or other opaque container from which they are drawn during play. This cup is called the POWER CUP.

9. The House places one Immobile Haunt Marker of his choice front face up in the **Crypt, Graveyard, Cellar, and Tower Spaces** on the HOUSE MAP. The House then blindly draws 4 Power Markers from the POWER CUP, looks at them, and places 1 Power Marker front face up under each Immobile Haunt.

10. The House places the remaining Haunt Markers in a tea cup or other container from which they are drawn during play. This cup is called the HAUNT CUP.

11. The House secretly looks at the Discovery Markers and places one marker front face up in each Space of his choice on the HOUSE MAP that has a Room Marker on the ASTRAL MAP. All Discovery Markers must be placed on the HOUSE MAP at the start of the game.

12. The House places one Lights Marker in the Main Hall of each of the 3 Floors (*First, Second and Third*) of the HOUSE MAP, with the On side showing.

13. The House places all of the Characters in a cup or other opaque container. Each Hunter blindly draws a Character from the cup. He plays this Character in the game. The remaining Characters are set aside and are not used in play.

14. The House places the Tool Markers in a tea cup or other opaque container. Beginning with the Hunter to the House's left and going around the table clockwise, each Hunter blindly draws 3 markers and looks at them. He can show them to the other Hunters, but not to the House.

He then places the markers he drew front face down in front of him for use in the game.

15. Each player selects a set of markers for his Character. **NIGHTMARE HOUSE** contains four sets of markers, one for each of the 4 possible players. Each set includes a Psyche Marker, Soul Marker, Astral Body Marker and Status Marker. The player to the left of the House is always the *First Hunter* and uses the markers labelled "First Hunter." The player to his left is the *Second Hunter* and uses the markers labelled "Second Hunter" and so on around the table. When the Hunters are instructed to perform a Step "in turn," the First Hunter (if eligible) always performs the Step first; the Second Hunter second, and so on.

16. Each Hunter's Soul Marker is placed with the Intact Side showing in the box containing his Character's name on the SOUL TRACK.

17. If **Ted Holt** is not in the game, skip this Step and go to **Step 18**. If Holt is in the game, the Hunter who controls him

picks 2 of the 4 Immobile Haunt Markers that were placed on the map in **Step 9** and flips them over to reveal their identity. These markers stay flipped over for the rest of the game (or until the Haunts they represent are Exorcised).

**18.** The Astral Body Markers, and the 2 Pentagrams are set aside until used in play.

**19.** Each Hunter places his Character front face up on the **Front Veranda**. He places his Psyche Marker with its Intact Side showing under his Character.

**20.** Set the Hour Marker at **6 PM** on the **CLOCK** and begin play.

## PART

# 4



## HOW TO PLAY

The game consists of **12 Hours**. Each Hour is divided into a number of **Phases**, that are further divided into **Steps**. Each Hour, the players must perform all game activities in the order given below, completing each Phase before going on to the next. When all the Phases have been performed, the Hour is over. Advance the Hour Marker one Hour on the **CLOCK** and go to the next Hour, repeating the sequence below each Hour until the game is over.

### A. POWER PHASE

**1.** The House blindly draws from the **POWER CUP** a number of Power Markers equal to the number of Axes he controls plus the number of Hunters in the game minus the number of Power Markers currently being used to energize Mobile Haunts. After looking at them, he places them front face up in the House section of the **POWER WHEEL** until they are used during play.

**2.** If it is **3 AM** or **4 AM**, the House blindly draws 2 additional Power Markers from the

**POWER CUP**, looks at them and places them front face up in the House section of the **POWER WHEEL** until they are used during play.

**3.** If it is **Midnight, 1 AM** or **2 AM**, the House blindly draws 1 additional Power Marker from the **POWER CUP**, looks at it and places it front face up in the House section of the **POWER WHEEL** until it is used during play.

**4.** Each Hunter who is not Lost, in turn, blindly draws from the **POWER CUP** a number of Power Markers equal to his Character's Psychic Strength, looks at them and places them front face up in his section of the **POWER WHEEL** until they are used during play. Add 1 to this number if the Hunter's Character occupies the **Crypt, Cellar, Graveyard**, or **Tower** Spaces on the **HOUSE MAP**. Hunters can't show each other which markers they draw. They can't "lend" Power Markers to each other or trade them among themselves.

**5.** If it is **6 PM** or if **Chase, Addams** or **Doran** are not in the game, skip this Step. Otherwise, the Hunter controlling each of these Characters states in turn whether his Character will try to heal one other Character of his choice who occupies the same Space and performs the following procedure. The Hunter rolls a die. If either **Addams** or **Doran** is doing the Healing, he subtracts 1 from the die roll. If the modified result is less than the Psychic Strength of the Character performing the Healing, the subject of the attempt is Healed (has his defenses partially restored) and his Soul Marker is moved 1 box further away from the "0" box of the **SOUL TRACK**. The Character who did the Healing replaces one of the Power Markers from his section of the **POWER WHEEL** in the **POWER CUP**. If the modified result is equal to or greater than the Psychic Strength of the Character performing the Healing, then no Healing takes place, but the Character who made the attempt still puts 1 Power Marker in the **POWER CUP**. A Character whose Soul Marker is on the "0" box of the **SOUL TRACK** can't be Healed. A Character's Soul Marker can never be moved above the box on the **SOUL TRACK** in which it started the game. A Character who is Possessed or Unconscious or whose Psyche is Vulnerable can't heal another Character. The same Character can be healed by different Characters during this Step.

### B. LIGHT PHASE

**1.** If all lights are **On** or if no Character occupies a Space with a Fuse Box, skip this Step and go to **Step 2**. Otherwise, each Hunter whose Character is Conscious, is not Possessed and occupies a Space with a Fuse Box on a Floor where the Lights are **Off** rolls two dice. If he rolls a number equal to or greater than the number of Controlled Axes on the **ASTRAL MAP**, then

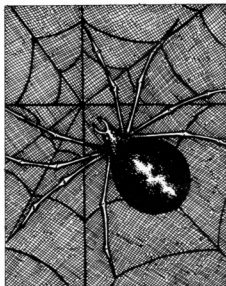

the Lights on that Floor are turned **On**. The House flips that Floor's Lights Marker over to the **On** side to show that the Lights are **On**. If he rolls less than the number of Controlled Axes on the **ASTRAL MAP**, the lights stay **Off**.

**2.** If all lights are **Off** or if it is earlier than **8 PM**, skip this Step and go to the next Phase. Otherwise, the House determines whether any Lights are turned **Off** by rolling two dice for each Floor on which the Lights are **On**. If he rolls a number less than the number of Controlled Axes on the **ASTRAL MAP**, then the Lights on that Floor are turned **Off**. The House flips that Floor's Lights Marker over to its **Off** Side to show that the Lights are **Off**. If he rolls a number greater than or equal to the number of Controlled Axes on the **ASTRAL MAP**, the Lights stay **On**.

### C. MOVEMENT PHASE

**1.** Each Hunter whose character is not Possessed or Unconscious in turn states which Tools (if any) he will drop in the Space he occupies on the **HOUSE MAP** and places the appropriate Tool Marker(s) in that Space. All Tool Markers in the possession of any Hunters who are Unconscious are then placed on the Space occupied by the Hunter's Physical Body. If there is a Pentagram on the map at this point, the Hunter whose character drew it states whether or not he will destroy the Pentagram. If he chooses to destroy it, both Pentagram Markers are immediately removed from the map and set aside. They can be reused to represent another Pentagram at some future time in the game.

**2.** Each Hunter whose Character is not Possessed or Unconscious in turn looks at and/or picks up any Tools of his choice in the Space he occupies. Characters can't have more than 3 Tools in their possession at any one time. Tools in a Hunter's possession are kept off-map unless that Hunter is Unconscious.

3. Each Hunter whose Character is not Possessed or Unconscious in turn moves his Character between connected Spaces on the HOUSE MAP, spending *Movement Points* (MP's) to enter each Space as described below. Each Character has a number of MP's equal to his Physical Strength to use each Hour. These MP's can't be saved from Hour to Hour or "loaned" to another Character. Any MP's not used are lost. It costs 1 MP to enter most Spaces. It costs 2 MP's to enter the **Crypt, Graveyard, Cellar, or Tower**. The entry cost for all Spaces is doubled for all Characters except **Lemuel and Roarke** if the Space is *Dark* and the Character does not have a Candle or Flashlight. **NOTE:** The **Garden, Graveyard, Attic, Cellar, Verandas, Crypt, and Tower** are always *Dark*; other Spaces are *Dark* if the Lights on the Floor are *Off*. Characters can only enter Spaces through *Doors* or (if moving between Floors) the *Stairways*. **Lemuel** and any Characters who begin the Phase in the same Space with him can use any *Secret Passage* to move directly from the Space in which they start the Phase to that Passage's destination Space. The windows of *Darkholm Manor* are, for the most part, bricked up and cannot be used as entrances or exits. Characters are considered trapped by the Entity in the house and can't leave the house or grounds until the game is over. Characters must stop moving upon entering a Space containing a Haunt. If a Character moves out of a Space containing a Pentagram he previously drew, the Pentagram is destroyed. Remove both Pentagram Markers from the map and set them aside. They can be reused to represent a new Pentagram at some future time.

4. If **Opal, Father Doran, Dr. Evans and Roarke** are not in the game or if all these Characters who are in the game moved during this Phase or if there is already a Pentagram on the map, skip this Step and go to **Step 1** of the **WARDING PHASE**. Otherwise, the Hunter controlling each of these Characters states in turn whether his Character will attempt to draw a Pentagram this Hour. As soon as one Hunter states his intention to draw a Pentagram, the rest of this Step is skipped and play goes to **Step 5**. Only Characters who occupy a *Lighted Space* (or who have a *Candle* or *Flashlight*) that has a *Room Marker* on the **ASTRAL MAP**, who are not *Unconscious* or *Possessed* and who did not move during **Step 3** can draw a Pentagram.

5. If no Character is drawing a Pentagram, skip this Step and go to **Step 1** of the **WARDING PHASE**. Otherwise, the Hunter who announced in **Step 4** that his Character was drawing a Pentagram, takes possession of the two Pentagram Markers. He places one in the Space he occupies on the **HOUSE MAP** and one on the *Room Marker* for that Space on the **ASTRAL MAP**.

## D. WARDING PHASE

1. Each Hunter whose Character is not Unconscious or Possessed and who occupies a Space whose matching *Room Marker* on the **ASTRAL MAP** is stacked with a *Focus Marker* states in turn whether his Character will try to disperse that *Focus of Evil* and create a *Ward*.

2. Each Hunter trying to create a *Ward* rolls two dice. If the modified result is less than the strength of the *Focus of Evil* within the Room, there is no effect. If the modified result is greater than or equal to the strength of the *Focus of Evil* within the Room, the *Ward* is created. The strength of the *Focus of Evil* is equal to the number of *Controlled Axes* plus the number of the *Circle* on which the *Focus Marker* is located. The dice roll is modified by adding 2 if the Character creating the *Ward* is **Kate, Potter or Addams** and by adding 3 if the Character creating the *Ward* is **Opal, Roarke or Dr. Evans**. If the *Warding* is successful, the Hunter flips the *Focus Marker* over to its *Dispersed Side*. No Haunt can materialize in the Room this Hour.

## E. HAUNT PHASE

1. The House removes from the **CLOCK** all Haunt Markers occupying the same box as the *Hour Marker*. These Haunts now materialize on the **HOUSE MAP**. Each Haunt is placed front face up on the **HOUSE MAP** in any Space that has an *Innact Focus Marker* on its matching *Room Marker* on the **ASTRAL MAP** or in the **Crypt, Cellar, Graveyard or Tower**. Haunts can't appear in the **Crypt, Graveyard, Cellar or Tower** if the *Immobile Haunts* in each of these Spaces have been destroyed (*Exorcised*). Only one *Mobile Haunt* can occupy a Space at any given time. Note that the House could place a *Mobile Haunt* in the **Crypt, Graveyard, Cellar or Tower** while it is occupied by an *Immobile Haunt*, attacking any Characters in that Space twice. If all Spaces in which a Haunt could materialize are *Warded* or (in the case of the **Crypt, Graveyard, Cellar and Tower**) no longer contain an *Immobile Haunt*, the Haunt does not materialize. Instead, the *Haunt Marker* is replaced in the **HAUNT CUP** and any *Power Markers* used to energize it are replaced in the **POWER CUP**.

2. The House moves any or all of its *Mobile Haunts* on the **HOUSE MAP** one at a time according to the procedure explained below. Haunts move on the **HOUSE MAP** by spending MP's to enter each Space on the Map. Each Haunt has 6 MP's per Hour. These MP's can't be saved from Hour to Hour or "loaned" between Haunts. *Psychic Haunts* can move through *Walls, Floors and Ceilings*; they don't require *Doors and Stairways*. For vertical movement purposes, the names of the Spaces above and below each Space are printed on

the **HOUSE MAP** to show which can be entered from that Space by Haunts. *Physical Haunts* must move through *Doors and Stairways* like Hunters. *Physical and Psychic Haunts* can also use any and all *Secret Passages*. Haunts pay 1 MP to enter all Spaces (including *Dark Spaces*). A Haunt can't move into a Space containing a *Pentagram, Rosary or Host Marker*. A Haunt can freely enter an *Exorcised Space*. When a Haunt enters a Space containing one or more Characters or occupies such a Space at the beginning of this Step, the *Haunt Marker* is flipped over and the Haunt's identity is revealed. The House then finds the name of the Haunt in the **HAUNT SUMMARY** and reads the description aloud to the Hunters. The *Haunting* is then resolved according to the procedure in **PART 6**. If two Haunts begin the Step in the same Space, the House chooses the order in which their *Hauntings* are resolved.

3. The House removes any Haunts of his choice from the **HOUSE MAP**, replacing the *Haunt Marker* in the **HAUNT CUP** and the *Power Marker* used to energize it in the **POWER CUP**.

4. If it is 5 AM, skip this Step and go to **Step 1** of the **SEARCH PHASE**. Otherwise, the House blindly draws from the **HAUNT CUP** 3 Haunt Markers if the Entity is in the *Seventh Circle*; 4 Markers if the Entity is in the *Sixth Circle*; and 5 Haunt Markers if the Entity is in the *Fifth Circle*. These are the Haunts that can be energized this Hour. If the House draws a Haunt Marker that can no longer be used due to the effect of some *Discovery*, this Haunt Marker is permanently removed from play and a replacement is drawn.

5. The House takes one *Power Marker* of his choice from his section of the **POWER WHEEL** for each of the Haunts he drew that he wants to energize. He places the *Haunt Marker* that he wants to energize front face up on top of this *Power Marker* (also front face up). This stack is then placed two boxes ahead on the **CLOCK** if it is a *Physical Haunt* and 1 Box ahead if it is a *Psychic Haunt*. The House can create as many Haunts as he has *Haunt Markers* and *Power Markers* available. Any Haunt markers drawn in **Step 4** that were not energized during **Step 5** are immediately replaced in the **HAUNT CUP**. *Physical Haunts* can't be energized after 3 AM.

6. The House states whether he will accelerate the appearance of any *Physical Haunts* that he just placed on the **CLOCK**. For each such Haunt, he takes one *Power Marker* of his choice from his section of the **POWER WHEEL** and places it front face up under the Haunt he wants to accelerate. The entire stack of one *Haunt Marker* and two *Power Markers* representing that Haunt is then moved one box closer to the box occupied by the *Hour Marker*.



7. Each Hunter whose Soul is Possessed by the House moves his Character as if it were a Physical Hunt, conducting Hauntings against other Hunters as described in **Step 2**, above, and in **PART 6**. Unlike regular Mobile Haunts, the Character is not removed after a Haunting, and does not have to be energized. His Hunt Strength is equal to his Physical Strength plus the Physical Strength of any Tools in his possession.

## F. SEARCH PHASE

1. Each Hunter whose Character is not Unconscious or Possessed and who occupies a Space with a Discovery Marker whose front face is showing states in turn whether his Character will search the Space he occupies. If the Room is Dark, no Character other than **Potter** can search unless the Character has a Candle or a Flashlight.

2. Each Hunter who is conducting a Search rolls one die in turn. If the resulting number is less than either his Character's Physical or Psychic Strength (whichever is higher), he flips over the Discovery Marker in the same Space. If the result is equal to or greater than the Character's highest strength, there is no effect. Subtract 2 from the die roll if the Character performing the Search is **Potter**, **Chase**, or **Kate**.

3. The House checks the DISCOVERY SUMMARY in these rules and reads aloud the description of each Discovery flipped over during **Step 2**. The instructions in the DISCOVERY SUMMARY are followed immediately. **NOTE:** In many cases, the Hunters will be instructed to permanently remove a Hunt from play as a result of a Discovery. In instances where such Haunts are in the HAUNT CUP, these instructions are ignored until the Hunt is actually drawn, at which time it is permanently removed from play.

4. If **Kate** and **Lorenzo** are not in the game, skip this Step and go to **Step 1** of the **FIRST PANIC PHASE**. Otherwise, the Hunters controlling **Kate** and **Lorenzo** state in turn whether their Characters will conduct a Psychic Search of the House. If neither Hunter is conducting a Psychic Search, skip the rest of this Phase and go to **Step 1** of the **FIRST PANIC PHASE**. If either **Kate** or **Lorenzo** are conducting a Psychic Search, go to **Step 5**. Characters who are Unconscious or Possessed can't conduct Psychic Searches.

5. Each Hunter whose Character is conducting a Psychic Search rolls one die in turn. If the result is greater than or equal to his Character's Psychic Strength, nothing happens. If the result is less than his Character's Psychic Strength, the House must reveal to the Hunter the identity of one Discovery of the Hunter's choice whose front face is showing. The Discovery is flipped over for the rest of the game (or un-

til it is removed from play). A Psychic Search reveals the identity of a Discovery, but the effects of the Discovery are not applied to the Characters or the House until a Physical Search of the Discovery's Space is successfully completed. Regardless of the outcome each Hunter whose Character conducted a Psychic Search must immediately remove 1 Power Marker from his section of the POWER WHEEL and replace it in the POWER CUP. If he has no Power Markers, his Character's Soul Marker is moved one box toward the "0" box of the SOUL TRACK.

## G. FIRST PANIC PHASE

1. Each Panicked Character with an Intact Psyche flips his Psyche Marker so that its Vulnerable Side is showing.

2. Each Hunter whose Character is Panicked rolls one die. If the modified result is less than the Character's Psychic Strength, he immediately removes the Panic Marker. If the modified result is equal to or greater than the Character's Psychic Strength, the House immediately moves the Panicked Character via Doors and/or Stairways to any Space of the House's choice up to 3 connected Spaces distant. The Character stays Panicked. He modifies the die roll by subtracting 1 from the die roll if the Character has a Bible and 2 if the Character is **Jason**. He adds 1 if the Space the Character occupies is Dark; 1 if his Soul is Vulnerable, and 1 if the Character being checked is **Holt**.



## H. ASTRAL PHASE

1. If a Hunter's Character is Panicked or if he does not occupy the **Cellar**, **Crypt**, **Tower**, **Graveyard** or a Space with a Room Marker, he skips this Phase and goes to

**Step 1** of the **POSSESSION PHASE**. If a Hunter's Character is Lost, he skips this Step and goes to **Step 15**. Otherwise, he places the Character's Psyche Marker on the ASTRAL MAP on the Room Marker matching the Space he occupies on the HOUSE MAP. If the Character occupies the **Cellar**, **Graveyard**, **Tower** or **Crypt**, he places his Psyche Marker on any Axis Control Point on the ASTRAL MAP.

2. Each Hunter, in turn, states whether his Character will move on the ASTRAL MAP this Phase. If the Hunter does not want to move on the ASTRAL MAP, he skips this Step and goes to **Step 8**. Otherwise, he goes to **Step 3**.

3. If a Hunter's Character is **Kate**, **Father Doran**, **Dr. Evans**, **Opal**, or **Roarke**, he skips this Step and goes to **Step 4**. The other Hunters, in turn, each roll one die. In each case, if the resulting number is less than his Character's Psychic Strength, the Hunter places his Astral Body Marker on top of his Psyche marker on the ASTRAL MAP and places a Status Marker with its Unconscious Side showing on that Character's Marker on the HOUSE MAP. If the number is equal to or greater than his Character's Psychic Strength, the Character immediately becomes Lost as described in **PART 5** and must give the House one Power Marker (and move his Soul Marker one box closer to the "0" box on the SOUL TRACK). Upon becoming Lost, his Psyche is flipped over to its Vulnerable side if it is not already there.

4. Hunters controlling Characters other than **Kate**, **Father Doran**, **Dr. Evans**, **Opal**, or **Roarke** skip this Step and go to **Step 5**. Each Hunter controlling one of these Characters places his Astral Body Marker on his Psyche Marker on the ASTRAL MAP and places a Status Marker with its Unconscious Side showing on that Character's Marker on the HOUSE MAP.

5. Each Hunter whose Astral Body occupies a Room Control Point on the ASTRAL MAP moves his Astral Body in turn into any number of connected Room Control Points. Power Points are connected when a Power Line exists between them. Whenever, during this Step, a Hunter's Astral Body is moved into a Power Point containing a Character who is Lost, that Character immediately stops being Lost. His Astral Body is removed from the map and he immediately regains full control of his Physical Body, even if it is Possessed by the House. Flip the Character Marker over to its Normal Side if the Character was Possessed and remove the Status Marker from the Character if he was Unconscious. His Psyche remains Vulnerable.

6. Each Hunter whose Astral Body occupies a Power Point on the ASTRAL MAP states in turn whether he will create a Lifeline for his Character.

7. Each Hunter who stated in **Step 6** that he was creating a Lifeline, now creates the Lifeline in turn by placing one Power Marker from his section of the POWER WHEEL in each Power Point through which he moved his Astral Body in **Step 5**. No Power markers are placed in the Power Points occupied by his Astral Body or his Psyche. Only one Power Marker can be placed (not one per Hunter) in each Power Point during this Step. Characters who are unable to place a Power Marker in a Power Point through which they moved because some other Character's Power Marker already occupies that Power Point or who don't have enough Power Markers to create an unbroken chain from their Astral Bodies to their Psyche can't create a Lifeline. They skip this Step.

8. If a Hunter does not want to perform an Exorcism, he skips this Step and goes to **Step 16**. Otherwise, each Hunter in turn announces which one Power Point occupied by or next to his Astral Body or Psyche he will Exorcise during **Steps 9** through **15**. The Entity is always considered to be in a single Power Point next to all Power Points in the *Fourth Circle* for this purpose. Exorcisms can't be directed at Circles of Darkness, only against the Entity. The Entity haunting the house can only be Exorcised after a number of Axes equal to the number of the Circle the Entity currently occupies have been Exorcised. More Axes than the required minimum can be Exorcised. Characters who occupy Power Points on the *Fourth Circle* during this Step can try to Exorcise the Entity, the Power Point they occupy, or any adjacent Power Point. Characters who occupy Room Control Points during this Step can only Exorcise their own or another Room Control Point.



9. Each Hunter in turn places any number of Power Markers from his section of the POWER WHEEL on the Power Point that he wants to exorcise. A Hunter can choose to use no Power Markers for this purpose only if the Hunter's Astral Body is next to the Power Point he is exorcising and is in a different Power Point than his Psyche. Otherwise, he must use at least one Power

Marker. If he has no Power Markers and can't perform an Exorcism within these restrictions, the Hunter skips this Step and goes to **Step 16**.

10. The House moves any number of his own Power Markers from his section of the POWER WHEEL to each Power Point being Exorcised up to the value of the circle on which the Power Point is found. Thus the closer the Power Point to the center of the ASTRAL MAP, the more power the House can focus upon it.

11. All Hunters and the House now flip over their Power Markers revealing the numbers on their backs.

12. Each Hunter in turn rolls one die and adds to the result the numbers on all of the Power Markers that he is moved during **Step 9**. The die roll is also modified by the addition of 2 if the Character performing the Exorcism is **Opal, Dr. Evans or Roarke** and by the addition of 3 if the Character performing the Exorcism is **Father Doran**. In addition, the Hunter can add the number on any Exorcism Discovery Marker in his possession to the dice roll. Once used, the Exorcism Discovery Marker is permanently removed from the game. If the Character's Psyche is Vulnerable, he subtracts 1 from the dice roll. If it is **5 AM**, he adds 1. If he possesses the "*Bell*," "*Bible*," and "*Candle*" Tools, he adds 3. Possession of any one or two of these three Tools confers no benefit when performing an Exorcism.

13. The House rolls one die for each Exorcism being performed and modifies the result in each case by adding the numbers on any Power Markers that he moved to the Power Point being Exorcised and the number of the Circle of Light in which the Power Point is located (if appropriate). He also adds 1 if it is **Midnight, 1 AM or 2 AM** and 2 if it is **3 AM or 4 AM**. Finally, if the Exorcism is directed against the Entity, the number of Controlled Axes is added to the die roll.

14. The results found in **Steps 12** and **13** are compared in each case and a winner is determined. If the House's total is equal to or greater than the Hunter's total for a particular Exorcism, the House wins. If the House's total is less than the Hunter's total, the Hunter wins. Exorcism results are described in **PART 7**. All results are applied immediately.

15. Each Hunter who is Lost rolls 3 dice. The result on the first die indicates which Circle the Hunter's Astral Body is moved into: **1, 2 = First Circle; 3, 4 = Second Circle; 5, 6 = Third Circle**. The result found on the other two dice is the number of the Axis to which the Hunter's Astral Body is moved. The Hunter's Astral Body is removed from the map and the Hunter stops being Lost when the sum of the 3 dice being rolled is less than his Character's Psyche or when the Character is moved to an Exorcised

Power Point or a Power Point with a Pentagram on it as a result of this 3-dice roll. His Psyche Marker remains on the ASTRAL MAP with its Vulnerable Side showing. If the Hunter's Physical Body was Possessed, his Character Marker is flipped over to its normal side and he is no longer Possessed. The Hunter ceases to be Unconscious and the Unconscious Marker is removed from the Hunter's Character.

16. Each Hunter whose Astral Body is on the ASTRAL MAP counts the number of Power Points he entered during **Step 5** (including the Power Point that his Astral Body currently occupies) and adds the number of the Circle in which his Astral Body is currently located.

17. Each Hunter who performed **Step 16** rolls two dice. He adds the number of Power Markers in his Lifeline (if any) and subtracts 1 if his Character's Psyche is Vulnerable. If the modified result is less than or equal to the number found in **Step 16**, the Hunter becomes Lost and his Astral Body Marker is flipped over to its Lost Side. If the modified result is greater than the number found in **Step 16**, there is no effect. The Hunter removes his Astral Body from the map and sets it aside for future use. He removes the Unconscious Marker from his Character Marker on the HOUSE MAP. Regardless of the outcome of the dice roll, the Hunter returns all Power Markers from his Lifeline to the POWER CUP.

## I. POSSESSION PHASE

1. If any Character with a Vulnerable Psyche is in a Space on the HOUSE MAP matching a Room Marker on the ASTRAL MAP that doesn't contain a Pentagram, the Hunter places his Psyche Marker on that matching Room Marker on the ASTRAL MAP if it is not already there. In addition, the Hunter controlling any Character in the **Crypt, Graveyard, Cellar, or Tower** places that Character's Psyche Marker in any Axis Control Point of his choice.

2. The House moves either or both of the Focus Markers that he wants along the Power Lines on the ASTRAL MAP. Each Focus Marker can be moved through a connected path of Room Control Points equal in length to the number of Hunters who started the game. A Focus Marker can move even if it is Dispersed. If it ends its movement in a Power Point containing an Exorcised Room Marker or occupied by another Focus Marker, the Focus Marker being moved is immediately and permanently removed from play.

3. The House states which Psyche Markers occupying the ASTRAL MAP he will attack. He can attack all, some or none of the Psyche Markers on the ASTRAL MAP during this Step. For each attack, the House selects a number of Power Markers of his choice from his section of the

**POWER WHEEL** equal to or less than the number of Hunters who started the game. He places these markers on the Power Point containing the Psyche Marker.

4. Each Hunter whose Psyche Marker was designated in **Step 3** states in turn how many Power Markers he is moving from his section of the **POWER WHEEL** to the Power Point occupied by his Psyche. There is no limit to the number of Power Markers each Hunter may commit to the defense of his Psyche.

5. Everyone who moved Power Markers to a Power Point during **Steps 3 and 4** flips the markers over to show the numbers on the back.

6. The House rolls a die for each Psyche he is attacking and adds to each result the numbers on the Power Markers he moved to the Power Point the Psyche occupies. He further modifies this result by adding the number of the Circle occupied by the Psyche in each case.

7. Each Hunter whose Psyche is being attacked rolls a die and adds to the result the numbers on the Power Markers that he moved onto his Psyche in **Step 4**. In addition, if the Hunter's Character is **Lemuel**, **Opal** or **Chase**, 3 is added to the result. If the Hunter's Character is **Evans**, **Lorenzo** or **Doran**, 2 is added to the result. If the Hunter's Character is **Kate**, **Roarke** or **Adams**, 1 is subtracted from the result.

8. In each case if the Hunter's total found in **Step 7** is greater than or equal to the House's total found in **Step 6**, the Hunter wins the contest and there is no further effect. In each case in which the House's total is greater than the Hunter's total, the House wins and the Hunter's Soul Marker is moved one box closer to the "0" Box on the **SOUL TRACK**. If the Hunter's Soul Marker is already in the "0" Box on the **SOUL TRACK**, the House immediately takes Possession of the Hunter's Soul. Move his Soul Marker into the Seventh Circle of the **ASTRAL MAP** to indicate this fact and flip the Character Marker over to its Possessed Side. For the rest of the game, the Possessed Hunter moves his Character during **Step 7** of the **HAUNT PHASE** only. His Psyche and Astral Body Markers and any Tools he possesses that have a Psychic Strength modifier greater than "0" are removed from play. For all purposes, the Hunter's Character is treated as a Haunt. If the House wins the game, all Hunters whose Souls are Possessed also win. All Power Markers on the **ASTRAL MAP** are replaced in the **POWER CUP** at the end of this Step. If the House wants, he can take Possession of the Hunter's Physical Body instead of moving his Soul Marker along the **SOUL TRACK**; flip the Hunter's Character Marker over to its Possessed Side to indicate this fact.

9. Each Hunter whose Character is not Lost

removes his Psyche Marker from the **ASTRAL MAP** and replaces it under his character's piece on the **HOUSE MAP**.

## J. SECOND PANIC PHASE

1. Each Hunter whose Character is Panicked rolls one die. If the modified result is less than the Character's Psychic Strength, he removes the Panic Marker. If the modified result is equal to or greater than the Character's Psychic Strength, he removes 1 Power Marker from his section of the **POWER WHEEL**, places it in the House section of the **POWER WHEEL** and moves his Character's Soul Marker one box closer to the "0" box of the **SOUL TRACK**. He then removes the Panic Marker. Subtract 1 from the die roll if the Character has a Bible, and 2 if the Character is **Jason**. Add 1 if the Space the Character occupies is Dark; 1 if his Soul is Vulnerable, and 1 if the Character being checked is **Holt**.

2. The Psyche Markers of all Characters whose Souls are Intact are flipped over to their Intact side.

## K. HOUR PHASE

1. If it is 5 AM the game is over and the House is the winner. Otherwise, go to **Step 2**.

2. If there are no Hunters left in the game who are not Dead or whose Souls are not Possessed by the House, the game is over and the House is the winner. Otherwise, go to **Step 3**.

3. Replace all unused Power Markers in the **POWER WHEEL** in the **POWER CUP**.

4. Flip any Dispersed Focus Markers over to their Intact side.

5. Advance the Hour Marker 1 Hour on the **CLOCK** and begin a new Hour.

## PART 5

## LOST ON THE ASTRAL

A Character can become Lost on the Astral due to a faulty entry of the Astral Plane, a failed Exorcism, or a failed Recovery of his Astral Body. When a Character becomes Lost, flip over his Astral Body Marker to its Lost side and his Psyche to its Vulnerable Side. Place a Status Marker on his Physical Body on the **HOUSE MAP** with the Unconscious Side Showing, if there is not already such a Marker present. Any Power Markers in his Lifeline are returned to the

**POWER CUP**. He then rolls 3 dice. The first die determines the Circle to which he moves: 1,2 = **First Circle**; 3,4 = **Second Circle**; 5,6 = **Third Circle**. The other two dice determine the number of the Axis to which he moves. When a Character is Lost, his body is Unconscious on the **HOUSE MAP**. Place a Status Marker on it with the Unconscious Side showing. He can't move on the **HOUSE MAP** until he returns to his Body. While he is Lost, the House can possess his Body. It then becomes a Physical Haunt that the House can move and use to attack other Characters on the **HOUSE MAP**. A Hunter's Character stops being Lost as described in **Steps 5 and 15** of the **ASTRAL PHASE**. When a Character returns to his Body, he immediately takes control of it, even if it is Possessed by the House. Remove the Unconscious Marker. The Character now functions normally.

## PART 6



## HAUNTING

Haunts are the manifestations of the Entity's evil. During the **HAUNT PHASE**, the House creates Haunts. During succeeding Hours, these Haunts materialize in the house where they try to attack and weaken the Characters, making them more susceptible to Possession. When a Haunt begins the **HAUNT PHASE** or enters a Space containing one or more Hunters, a Haunting takes place. The Haunt Marker and the Power Marker(s) energizing it are flipped over, showing the true nature of the Haunt. Two or more Haunts can't combine their Haunt Strengths. They must attack sequentially in whatever order the House determines. If the House possesses the Physical Body of a Character who is Lost, he moves and uses that body as if it were a Physical Haunt to attack other Characters. Its Haunt Strength is equal to its Physical Strength. The Possessed Character does not need to be Energized. If a Hunter's Soul is Possessed, the Hunter moves his Physical Body during the **HAUNT PHASE** only and

uses it as a Physical Haunt. It doesn't need to be Energized. Its Haunt Strength is equal to its Physical Strength plus the Physical Strength modifiers on any Tool the Hunter possesses. Whenever a Hunter whose Soul is possessed conducts a Haunting, the Hunter rolls the die and applies the same modifiers listed in **Step 1** below exactly as if he were the House. The players determine the outcome of a Haunting by performing the following Steps:

1. The House rolls one die and adds to it the numbers on the Power Marker(s) used to energize the Haunt and the Haunt Strength found on the Haunt Marker. If it is **Midnight, 1 AM, or 2 AM**, he adds 1 to this number. If it is **3 AM or 4 AM**, he adds 2. If the Haunt is a Psychic Haunt and the Haunting occurs in the **Crypt, Graveyard, Cellar, or Tower**, he adds 1 to the die roll.

2. Each Hunter occupying the same room with the Haunt rolls one die and modifies the result by adding the Physical Strength Modifier of any Tool in his possession if the Haunt is Physical and the Psychic Strength Modifier of any Tool in his possession if the Haunt is Psychic. He then adds his Character's Psychic Strength if the Haunt is Psychic and his Physical Strength if the Haunt is Physical. He adds 2 for each Character in the Space with his Character and 3 if it is **5 AM**. He subtracts 1 if his Psyche is Vulnerable.

3. Each Hunter compares the total found in **Step 1** with the total he found for his

Character in **Step 2**. If the House total is greater than the Hunter's total, that Hunter must immediately give the House 1 Power Marker from his section of the **POWER WHEEL** if the Haunt was Psychic and 2 Power Markers if the Haunt was Physical. The Hunter then moves his Soul Marker a number of boxes closer to the "0" box on the **SOUL TRACK** equal to the number of Power Markers he gave to the House. If a Hunter does not have enough Power Markers in his section of the **POWER WHEEL** to give the House all of the Power Markers due him, the Hunter's Soul Marker is moved 2 boxes closer to the "0" box on the **SOUL TRACK** for each Power Marker that is due the House and is not actually turned over to him. If the Hunter's total is equal to or greater than the House's total, the House immediately gives the Hunter 1 Power Marker from his section of the **POWER WHEEL**. There is no effect if the House does not have enough Power Markers to give the Hunters what they are due, but all available Power Markers must be used to pay the penalty. If some, but not all of the Hunters can be paid the Power Markers due them, the House gives Power Markers to the victorious Hunters in the order in which they move. If a Character's Soul is Vulnerable and he loses a Haunting and doesn't have enough Power Markers to pay the House, he dies, and the House automatically gains immediate permanent possession of the Character's Soul with the consequences described in **Step 8** of the **POSSESSION PHASE**.

4. Each Character who lost a Haunting undergoes a Panic Check. The Hunter controlling the Character rolls one die. He modifies the die roll by subtracting 1 if the Character has a Bible and 2 if the Character is **Jason**. He adds 1 if the Space the Character occupies is Dark; 1 if his Soul is Vulnerable; 1 if he occupies a Space with other Characters who lost a Haunting during **Step 3**, and 1 if the Character being checked is **Holt**. If the modified result is less than the Character's Psychic Strength, there is no effect. If the modified result is equal to or greater than the Character's Psychic Strength, the Character immediately panics. His Psyche Marker is flipped over to its Vulnerable side and the House immediately moves the Panicked Character via Doors and/or Stairways to any Space up to 3 connected Spaces distant. If the Space occupied by the Character at the end of this move has a Room Marker on the **ASTRAL MAP**, the House moves that Hunter's Psyche Marker to that Room Marker. Otherwise, the Psyche Marker remains under the Character.

5. The House replaces the Haunt Marker in the **HAUNT CUP** and replaces any Power Markers used to energize it in the **POWER CUP**. **EXCEPTION:** Immobile Haunts and their Power Markers stay on the **HOUSE MAP** until the Haunts are Exorcised. They can conduct any number of Hauntings during the game, but can conduct only one Haunting per **HAUNT PHASE**.

## PART

# 7

## EXORCISM

Exorcism is the way in which the Hunters defeat the House and win the game. Four things can be Exorcised: Rooms, Axes, Immobile Haunts and the Entity itself. The following results can occur during Exorcisms.

- If a Room Marker was being Exorcised and the Hunter wins, the Room is Exorcised. Flip the Room Marker over to its Exorcised side. The players replace in the **POWER CUP** any Power Markers used in the Exorcism. If a Focus Marker was on the Room Marker that was Exorcised, the House moves it to the nearest House-controlled Room Marker of his choice that doesn't have a Focus Marker. If there are no House-Controlled Room Markers without a Focus Marker left on the map, the Focus Marker is permanently removed from play. If the Exorcised Room contained a Mobile Haunt, the Haunt Marker is replaced in the **HAUNT CUP** and any

Power Markers used to energize it are replaced in the **POWER CUP**.

- If an Axis Control Marker was being Exorcised and the Hunter wins, the Axis is Exorcised. Flip the Axis Control Marker and all the Room Markers on that Axis over to their Exorcised Sides to indicate that the House no longer controls that Axis. The players replace in the **POWER CUP** any Power Markers used in the Exorcism. If a Focus Marker was on a Room Marker on the Axis, the House moves it to the nearest House-Controlled Room Marker of his choice that doesn't have a Focus Marker. If there are no House-controlled Room Markers without a Focus Marker left on the map, the Focus Marker is permanently removed from play. All Mobile Haunts whose Room Markers are flipped over as a result of the Exorcism of an Axis Control Marker are destroyed. Replace the Haunt in the **HAUNT CUP** and replace any Power Markers used to energize it in the **POWER CUP**. Whenever a Character successfully Exorcises an Axis Control Point which his Psyche occupies, the Space occupied by his Physical Body is also Exorcised. Any Immobile Haunts in that Space are Exorcised immediately and permanently removed from play. Any Power Markers used to

energize those Haunts are replaced in the **POWER CUP**. Thereafter, the Space from which the Immobile Haunt was removed (**Cellar, Crypt, Graveyard or Tower**) can't be used for Haunts to materialize. Otherwise, there is no change in the status of the Space.

- If the Entity was being Exorcised and the Hunter wins, the game is immediately over and the Hunter who exorcised the Entity wins. **EXCEPTION:** If the House loses an Exorcism directed against the Entity and the Entity occupies the Fifth or Sixth Circle, the Entity is not exorcised. Instead, the Entity is moved into the next highest numbered Circle of Darkness and one Controlled Axis of the House's choice is immediately exorcised instead. If all Axes have been exorcised, there is no further effect. The Entity can never be moved except as a result of an Exorcism directed against it and it can only be moved from the Fifth to the Sixth Circle or from the Sixth to the Seventh Circle.

- If a Hunter loses any Exorcism, his Psyche becomes Vulnerable (flip the Psyche marker over to the Vulnerable Side if it is not already there) and the Hunter's Soul is moved one box closer to the "0" box on the

**SOUL TRACK. EXCEPTION:** If the Entity was being Exorcised and the House wins, the Hunter's Soul is immediately Possessed. Remove his Soul from the SOUL TRACK and place it in the Seventh Circle of the ASTRAL MAP. See Step 8 of the POSSESSION PHASE for the other consequences of Possession.

he can declare that he is going to take over the Body of that Character instead of moving his Soul Marker. Flip the Body Marker over to its Possessed Side. The House stays in control of the Character's Body until he uses it in combat as a Physical Haunt against other Characters or until the Character is no longer Lost and his Astral Body returns to reclaim its Physical Body or until the Character's Soul is Possessed. A Character whose body is in a Room with a Pentagram can't be attacked or Possessed, even if he is Lost.

## PART 9

### HAUNT SUMMARY

**ANIMATED CORPSE:** The pallid, embalmed corpse of Marcus Fuller, Lilith's last husband, lurches at you from out of a dim corner. The dead man's lips are still tinged blue from the potent poison with which his scheming wife laced his sherry and his presence fills the room with the sweet smell of bitter almonds.

**ANIMATED SHADOW:** Your shadow leaps from the floor and takes on a life of its own under the control of the House. As you struggle to combat it, the shadow anticipates your every move, striking and choking you before you can block its attacks.

**ANIMATED SKELETON:** A mouldering skeleton approaches. It is the mortal remains of one of Lilith's many victims, animated by the House and thrown into battle. Though the dry, powdery bones are easily broken, the skeleton continues to pull itself toward you until it is pounded to dust.

**ARCANE FORCE:** You experience the presence of a powerful force that is not of this world. Shortly, you are seized by an unbearable choking sensation accompanied by an intense desire to abase yourself in the presence of one of "His" many faces.

**ALISTAIR'S DEATH:** Alistair Darkhold appears before you. He is a darkly handsome man with pale, aristocratic features. He wears clothing that was fashionable about 20 years ago. As you stand transfixed in horror, he smiles and raises a gleaming razor to his throat. With a single stroke, he traces a fine red wound from ear to ear.

**BATS:** Hundreds of large filthy bats suddenly materialize out of thin air and begin diving on you.

**BLOOD:** Gouts of bright red blood well up at your feet, filling the air with an awful coppery scent.

**COLD SPOT:** A mysterious spot of arctic cold appears in the air and begins to swell, causing the temperature in the vicinity to drop precipitously and coating everything with a pale, glittering rime.

**CREEPING HAND:** A bloody, severed hand appears at your feet and starts creeping toward you, using its fingers to pull itself along. Whenever the hand gets close enough, it flies at your throat and tries to throttle you.

**CREEPING MIST:** A cold, oily mist slips across the floor and rolls around your feet, becoming thicker with each passing second until, finally, it obscures everything more than a few feet away.

**DEADLY VISION:** You meet an aged, dying version of yourself. It beckons with a skeletal hand and speaks to you in a croaking voice of failure and mortality, promising eternal life as part of the House if you will but slay your mortal body.



## PART 8

### POSSESSION

The House can try to possess the Character's Physical Bodies and their Souls. Vulnerability is a state of being in which a Character is more susceptible to the influences and energies of the Entity Haunting the house. A Character's Psyche is normally Intact, as shown by his Psyche Marker being placed face up on the Map. Panic, certain Discoveries, and the failure of an Exorcism can render a Character temporarily Vulnerable, in which case his Psyche Marker is flipped over to show its Vulnerable side. If the Soul is Vulnerable, the Psyche is also Vulnerable. The Soul becomes Vulnerable when it is moved into the "0" box on the SOUL TRACK. It can then be possessed if the House successfully attacks the Character during the POSSESSION PHASE or kills the Character during the HAUNT PHASE.

The House can possess the Unconscious Body of a Hunter who is Lost. If the House successfully attacks a Character's Psyche,

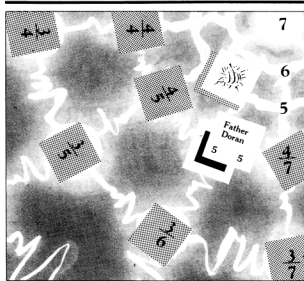

#### Exorcising the Entity EXAMPLE

*Father Doran occupies Axis Control Point 4/6 and is attempting to Exorcise the Entity in the Fifth Circle of Darkness. Doran's attempt is successful and the Entity should be Exorcised...but since the Entity is in the Fifth Circle, it is automatically moved into the Sixth Circle instead. The House chooses to lose control of Axis 4.*

**DUST GOLEM:** The dust in the air coalesces into a ravening monster, vaguely humanoid, and, therefore, all the more horrible. It fixes you with a baleful stare and advances on you with its dusty fingers grasping and snapping.

**EERIE LIGHTS:** Strange, multi-colored, pulsing lights keep appearing and disappearing, dazzling and disorienting you.

**ENERGY FIELD:** A pocket of malignant energy materializes around you, making your limbs heavy and causing you to experience shooting pains throughout your body.

**FAMILIAR:** Lilith's sleek, black cat, Dweomer, materializes in your presence and leaps at the face of whoever is nearest to it, clawing and scratching at their eyes.

**FLOATING WEAPON:** A bloodstained dagger appears in the air and begins slashing randomly at you. A woman's mad laughter punctuates each swooping attack.

**GHOSTLY VOICES:** Sinister voices inside your head promise a grim and painful death to all who oppose "Him".

**HAND OF GLORY:** The preserved, severed hand of a murderer appears before you. To your horror, the fingers begin to glow and melt, finally bursting into eerie green flames.

**HELL HOLE:** A vortex of other-dimensional energy opens up at your feet, threatening to suck you into its maw. A sound like all of the souls in Hell crying out at once emanates from the hole.

**INSECT SWARM:** Thousands of savage biting flies appear out of nowhere, swarming over you until you are covered with a biting, pulsing mass of insect life.

**JOSIAH'S WRAITH:** Josiah Darkholm approaches. His swollen tongue protrudes from a mouth frozen in a ghastly grin and his eyes pop from his mottled, purpled face. A dark bruise circles his broken neck. His twitching fingers clasp a crisp new hemp rope wound into a noose which he graciously offers to you.

**LILITH'S GHOST:** Lilith Darkholm approaches. Her pale skin and gleaming white gown pulse with an unearthly glow. Throwing back her long raven tresses, she reveals a bloody stain over her heaving bodice. With a wanton smile of pleasure, she plucks a dagger from the wound in the center of this stain and offers it to you.

**OCCULT VOICES:** Your head pounds with the whisperings of unworlly voices that softly call your name and beg you to join them.

**POLTERGEIST:** Small objects start flying through the air to the accompaniment of a rhythmic drumming produced by the slamming up and down of heavier objects.

Within a few seconds, gale-force winds begin sweeping through the area, carrying off whatever is not securely anchored.

**RATS:** First scores, then hundreds of ferocious black rats crawl and scurry over your feet, tearing loose chunks of flesh and carrying them away in their drooling mouths.

**SEALED ROOM:** All exits to the area you occupy are securely shut, trapping you inside. Mocking peals of hysterical laughter greet every attempt to leave the area.

**SECRET FEARS:** Your deepest and most hidden fear takes physical form before your eyes.

**SPECTRE:** A dim, shadowy form approaches. It seems to waft and waver at the edges as though insubstantial. The figure is the partially-material form of a Spectre, a being that exists simultaneously on two material planes. Doubly damned, it serves the House on whatever plane it occupies.

**SPIDER SWARM:** Scores of hairy black spiders drop on you from above, savagely tearing at you with venom-smearred jaws. The bloated belly of each spider is marked with a perfect likeness of Lilith Darkholm's twisted face.

**BOOK OF SHADOWS:** You find a dusty tome of spells and rituals written in blood and bound in what appears to be human skin. This is Lilith's Book of Shadows, the repository of all the learning of a ceremonial magician. Each Hunter who makes a successful Search of the Space is considered to have read a part of it and gained valuable knowledge of the House's evil. Those who have gained this knowledge each move 1 Power Marker from the House section of the POWER WHEEL to their own section of the POWER WHEEL. If the House does not have sufficient Power Markers in its section of the POWER WHEEL for each eligible Hunter to take a Power Marker, then the available markers are transferred to the Hunters in the order in which they moved and transfers above the number of Power Markers available are ignored. As soon as the Power Markers have been transferred, the Book of Shadows is destroyed (disintegrated by the wrath of the Entity) and is permanently removed from play.

**CHANDELIER:** You find a Chandelier that rattles and shakes as if animated. A noose hangs from it. It is pulled taut as if it still held a body. This is the Chandelier from which Josiah hung himself and is the focal point of his presence in the House. Anyone who discovers the Chandelier is assumed to smash it, thus freeing Josiah from the metaphysical chains that bind him to the House. Immediately and permanently remove this Discovery and the Haunt, Josiah's Wraith, from play.

**COLD WIND:** An icy wind sweeps through the room, blowing out all of the Candles and causing everyone present to make an immediate Panic Check. Each Hunter rolls one die and adds 1 if the Character's Soul is Vulnerable, 1 if the Space is Dark and 1 if the Character is **Holt**. For purposes of this Panic Check, the Space is Dark if the Lights on the Floor are Off and no Character in the Space has a Flashlight. All Candles are considered to be temporarily extinguished. Subtract 1 from the die roll if the Character has a Bible and 2 if the Character is **Jason**. If the modified result is less than the Character's Psychic Strength, nothing happens. If the modified result is equal to or greater than the Character's Psychic Strength, the Character panics, a Panic Marker is placed on him and his Psyche Marker is flipped over to its Vulnerable side. Regardless of the outcome of any Panic Check(s), this Discovery Marker is immediately and permanently removed from play as soon as anyone finds it during a Search.

**EMILY'S GHOST:** You contact the ghost of Emily Darkholm, Josiah's frail, gentle first wife. Murdered by Josiah during one of his legendary drunken rages, her spirit remains in the House but is not part of it. Though she has seen much of the House's evil, she can only speak of what she knew

## PART 10



## DISCOVERY SUMMARY

**BLOODSTAINS:** Blood begins to flow from a nearby wall, spelling out the nature and location of one other Discovery of the House's choice. This Discovery is immediately flipped over and the first Hunter to enter the same Space with that Discovery is immediately affected by it (stopping play to determine the effect). As soon as the Bloodstains are read, this Discovery marker is permanently removed from play.

before she died. Fortunately, this includes the location of all of the Secret Passages in the House. Once found, this Discovery is immediately and permanently removed from play. Thereafter, all Hunters in the game may freely use all Secret Passages to move from a Space in which they begin a **MOVEMENT PHASE** to any connected Space. It is no longer necessary for Lemuel to be present for this option to be used.

**EXORCISM:** You discover a clue to the nature of the Entity that makes it easier to Exorcise it from the house. The first Character to determine the nature of this Discovery flips over the Discovery Marker, removes it from the map and places it in front of him. He can play the piece later in the game as a means of affecting an Exorcism or he can hold it indefinitely. Anyone who successfully searches a Space after an Exorcism Discovery has been removed from it during a phase chooses any Haunt on the HOUSE MAP or the CLOCK for examination. The Hunter immediately looks at the Haunt Marker (but not any Power Markers that are energizing it) and replaces it on the map. He is assumed to have discovered some clue as to the kind of Haunts that are available to the House and can share this knowledge with the other Hunters or withhold it at his option.

**JANET'S GHOST:** You contact the ghost of Janet Rivers-Smythe. Sacrificed by her mistress during the final terrible rites in the family Chapel, Janet is now part of the House, but retains a weak identity of her own. If Jason is not in the game or is Possessed when this Discovery is found, the Discovery is immediately and permanently removed from play and there is no further effect. If Jason is in the game and isn't Possessed, Janet feels his presence and reclaims her identity for long enough to tell the Hunters all she knows of the House's power. All Power Markers in the House section of the POWER WHEEL are immediately flipped over so that the numbers on the back can be seen. They remain flipped over for the rest of this Hour. For this betrayal, the House absorbs Janet completely, erasing all vestiges of her ego. The Discovery is immediately and permanently removed from play.

**LILITH'S MIRROR:** You look in a gilded mirror and see the spectre of your own death. It is Lilith's Mirror and is the focus of her presence in the House. By smashing it the Hunters free her spirit from the metaphysical chains that bind it to the House. The Discovery is immediately and permanently removed from play and so is the Haunt, Lilith's Ghost.

**MARCUS FULLER'S GHOST:** You contact the vengeful spirit of Marcus Fuller, Lilith's last husband. Fuller manages to babble the location of one Immobile Haunt before the House destroys him. The Discovery is immediately and permanently

removed from play and the House flips over one Immobile Haunt of his choice to reveal its identity. The Haunt remains flipped over for the rest of the game (or until Exorcised). The Power Marker under the Haunt is not flipped over. In addition, the severe energy drain used to destroy Fuller causes the House to lose control of any one Controlled Axis of the House's choice. The Control Marker for that Axis and all Room Markers on that Axis are flipped over to show their Dispersed Sides if those sides are not already showing.

**NICK'S GHOST:** The ghost of Nicholas Bray materializes before you. He is a young man, dressed in fashionably rumpled clothing. As you approach him, he smiles sadly and tells you something of his experiences as a ghost hunter before he met his death in Darkholm Manor. He then reveals information about the Foci of the House's evil. With this, you feel, rather than hear, the House give a shriek of anguish as though wounded. One Focus of Evil Marker is permanently removed from the game to simulate the damage Nicholas has done. Nicholas is now at rest and is immediately and permanently removed from the game.

**NORA'S GHOST:** The ghost of Nora Jakes materializes before you. Her silvery-blue gown drips water and is festooned with tendrils of water lilies from the millpond in which she drowned herself. Her thin, white fingers clutch a bouquet of wild roses. If Lemuel and Doctor Addams are not in the game, there is no further effect. If either or both of those Characters is in the game, each of the two Characters' Soul Markers is immediately moved 1 box closer to the "0" Box on the SOUL TRACK. There is no further effect on either Character if his Soul Marker is in the "0" Box of the SOUL TRACK.

**PORTRAIT OF ALISTAIR:** You discover a portrait of Alistair Darkholm. There is a gaping tear in the painting about where Alistair's throat should be. What appears to be fresh blood seeps copiously from the canvas around this tear. The painting is the focus of Alistair's presence in the House and anyone who discovers it is assumed to have destroyed the painting, thus freeing Alistair's spirit from the metaphysical chains that bind it to the House. The Discovery is immediately and permanently removed from play and so is the Haunt, Alistair's Death.

**ROBES:** You find a tattered, bloody robe used by Lilith to clothe her victim during the last of the human sacrifices in which she delighted. The Robes are the focus of that victim's presence in the House. Anyone who discovers them is assumed to destroy them, freeing the victim from the metaphysical chains that bind it to the House. Immediately and permanently remove this Discovery and the Animated Skeleton Haunt from play.

**SARAH'S GHOST:** You contact the ghost of Sarah Darkholm, wife of Alistair Darkholm and one of the friendly spirits trapped in, but not dominated by, the House. Always a strong-willed woman, Sarah fought a lifelong battle to break the House's hold on her husband. She continues this fight even in death. This Discovery is immediately and permanently removed from play as soon as its back face is turned up. Thereafter, Sarah's Ghost is presumed to have attached itself to the Hunters and to be advising them for the rest of the game. As a means of representing this fact, as soon as the Sarah's Ghost Marker is removed from play, all other Discovery Markers on the HOUSE MAP and all Haunt Markers on the HOUSE MAP or the CLOCK are flipped over to reveal their identity. The numbers on the Power Markers that are energizing the Haunts are not revealed, however.

**SCRATCHES:** All exits from this Space are marred by minute Scratches, as if someone had been trying to escape. Whenever this Discovery is revealed, both it and the Sealed Room Haunt are immediately and permanently removed from play.

**SKULL:** You find a human skull weighted for use as a paperweight. It is the preserved skull of one of Lilith's deceased husbands, and it will immediately begin chatting with the Hunters, all the while bitterly denouncing Lilith and revealing the identity of all of the Discoveries on any one Floor (First, Second or Third) of the House's choice. All of the Discoveries on that Floor are immediately flipped over and remain that way for the rest of the game (or until removed from the map). Each Discovery must still be uncovered via a Search before a Hunter can claim or otherwise be affected by it. As soon as the other Discoveries revealed by the Skull are flipped over, the Skull is destroyed (by a blast of energy from the vengeful Entity) and is immediately and permanently removed from play. ▲



NIGHTMARE HOUSE™ Gothic Horror Boardgame Counter Section Nr. 1  
(200 pieces) Front

Quantity of sections of this identical type in game: 1. Total quantity of sections of all types in game: 1.

**Front**

**Hunt Markers**

**The Entry**

**Arch Control Markers**

**Room Markers**

**Characters**

Kate	Holt	Opal	Lorenza	Chae	Father Derran	1st Hunter	2nd Hunter	3rd Hunter	4th Hunter
5	6	6	4	3	5	6	6	5	4
5	5	5	3	4	4	4	4	4	6

**Room Markers**

**Characters**

4th Hunter	3rd Hunter	2nd Hunter	1st Hunter	3	3	4	4	4	4
4th Hunter	3rd Hunter	2nd Hunter	1st Hunter	4	4	4	4	4	4

**Characters**

Cold Wind	Bible	Candle	Candle	Flash	Flash	Patrol	Light	Light
0	0	2	0	0	0	0	3	0
Cold Wind	Talisman	Talisman	Rosary	Hair	Bell	Dagger	Light	Light
0	1	0	2	0	3	0	2	0

**Room Markers**

Blood-stains	Book of Shades	Chandelier	Emily's Ghost	Jane's Ghost	Libby's Mirror	Marcus Fuller's Ghost	Nick's Ghost	Nara's Ghost	Portrait of Alastair
4th Hunter	3rd Hunter	2nd Hunter	1st Hunter	4th Hunter	3rd Hunter	2nd Hunter	1st Hunter	4th Hunter	3rd Hunter
4th Hunter	3rd Hunter	2nd Hunter	1st Hunter	4	5	5	6	3	6
4th Hunter	3rd Hunter	2nd Hunter	1st Hunter	4	4	5	5	6	4

**Room Markers**

Rules	Sarah's Ghost	Scratches	Skull	EXOR-CISM +1	EXOR-CISM +1	EXOR-CISM +2	EXOR-CISM +2	EXOR-CISM +3	EXOR-CISM +4
-------	---------------	-----------	-------	--------------	--------------	--------------	--------------	--------------	--------------

**Front**

**Power Markers**

**Tail Markers**

**Light Markers**

**Pentagram**

**Status Markers**

**Hour Marker**

**Tool Markers**

**Discovery Markers**

**Back**

Crooping Head	Armed Shadow	Hand of Glory	Dust Golem	Bats	Rats	Armed Corpse	Sealed Room	Spine	Insert Vases
4	5	4	6	5	5	5	6	6	5
Flaming Weapon	Armed Skeleton	Crooping Mat	Pulver-gest	Spectre	Deadly Vision	Jane's Wealth	Libby's Ghost	Cold Spot	Blood
4	4	3	4	3	6	4	4	3	3

4th Hunter	3rd Hunter	2nd Hunter	1st Hunter	3	3	4	4	4	4
4th Hunter	3rd Hunter	2nd Hunter	1st Hunter	4	4	4	4	4	4

Cook's Room	Butler's Room	Suite Living Room	Suite Parlor	Main Staircase	Sewing Room	Reception Room	Parlor	House-keeper's Room	Attic
4th Hunter	3rd Hunter	2nd Hunter	1st Hunter	4th Hunter	3rd Hunter	2nd Hunter	1st Hunter	4th Hunter	3rd Hunter
4th Hunter	3rd Hunter	2nd Hunter	1st Hunter	4	5	5	6	3	6
4th Hunter	3rd Hunter	2nd Hunter	1st Hunter	4	4	5	5	6	4

© Copyright 1983 TSR, Inc. All Rights Reserved

NIGHTMARE HOUSE™ Gothic Horror Boardgame Counter Section Nr. 1  
(200 pieces) Back

**Back**

Crooping Head	Armed Shadow	Hand of Glory	Dust Golem	Bats	Rats	Armed Corpse	Sealed Room	Spine	Insert Vases
4	5	4	6	5	5	5	6	6	5
Flaming Weapon	Armed Skeleton	Crooping Mat	Pulver-gest	Spectre	Deadly Vision	Jane's Wealth	Libby's Ghost	Cold Spot	Blood
4	4	3	4	3	6	4	4	3	3

4th Hunter	3rd Hunter	2nd Hunter	1st Hunter	3	3	4	4	4	4
4th Hunter	3rd Hunter	2nd Hunter	1st Hunter	4	4	4	4	4	4

Cook's Room	Butler's Room	Suite Living Room	Suite Parlor	Main Staircase	Sewing Room	Reception Room	Parlor	House-keeper's Room	Attic
4th Hunter	3rd Hunter	2nd Hunter	1st Hunter	4th Hunter	3rd Hunter	2nd Hunter	1st Hunter	4th Hunter	3rd Hunter
4th Hunter	3rd Hunter	2nd Hunter	1st Hunter	4	5	5	6	3	6
4th Hunter	3rd Hunter	2nd Hunter	1st Hunter	4	4	5	5	6	4

Father Derran	Chae	Lorenza	Opal	Holt	Kate
5	5	6	3	6	5
5	5	6	3	6	5
5	5	6	3	6	5

4th Hunter	3rd Hunter	2nd Hunter	1st Hunter	4th Hunter	3rd Hunter	2nd Hunter	1st Hunter	4th Hunter	3rd Hunter
4th Hunter	3rd Hunter	2nd Hunter	1st Hunter	4	4	5	5	6	4

© Copyright 1983 TSR, Inc. All Rights Reserved



(continued from page 17)

models represent the troops and vehicles used in a battle. Hexagonal grids are not used. Instead real space is simply reduced (in *Striker*, 1 millimeter equals a meter) with ranges and movement translated into the new scale. *Striker* is designed for 15mm scale miniatures.

Traditionally, miniatures games have been long on spectacle and short on playability. This reputation stems from games like *Tactics* which had more pages of tables than most board games have rules. Miniature rules generally managed to be both incredibly complex and frustratingly ambiguous.

Mr. Chadwick's rules in *Striker* are very likely to change that reputation, forever. They are quite clear and concise. An outline format is used, which allows cross-reference between rules sections (an unheard of innovation in miniatures rules). One rule book is devoted entirely to the basics, which allows the initial rules to be quickly mastered. Two more rule books offer additional material on fortifications, air power, extraterrestrial environments, etc.

*Striker's* most innovative feature is a complete set of command and initiative rules. A player actually assumes the role of a small unit commander. The rules demonstrate the limits on both a commander's time and the varying abilities of troops to respond to changing situations. In order to get most troops to deviate from an initial battle plan, a commander must either directly lead them or communicate new orders. Few game systems so strikingly illustrate the command control restraints faced by a small unit commander.

While brilliant in concept, the command system does have some problems in execution. Orders must be written and some players may find this burdensome. The rules make a valiant effort to define exactly what types of orders can be given and to which types of units. Nevertheless, they often fall back on expressions like "all statements must be clear and unambiguous, as determined by the referee." Courts have wrestled for years trying to determine what actually constitutes "clear and unambiguous" language. Victories in *Striker* may go to the side with the best lawyers.

Nor is relying on referees a satisfying solution. Referees are wonderful fellows who have a thorough knowledge of the game, enjoy it greatly, and don't mind not actually playing. If you know of one, please send his address.

Traditional miniature rules have depended on referees to straighten out the ambiguities and generalities of the rules. An effective lobbying effort with the referee could often prevail over the cleverest tactical schemes. Fortunately, the rules of *Striker* generally avoid this problem. But for some reason Mr. Chadwick could not shake the old miniatures bias toward having a referee. Players are advised to work out their own order-writing conventions (say limiting them to ten words) and abolish referees.

Mr. Chadwick has made a considerable and generally successful effort to link present and speculative technology to the equipment presented in *Striker*. Instead of Zapatron rays, the weapons systems are based on intelligent projections of existing or proposed technologies.

One drawback of the "scientific approach," however, is the design rules. These rules envision the players individually designing each vehicle or aircraft. The rules provide an extensive design sequence that, while interesting, is incredibly time-consuming. A list of existing vehicles at various technology levels would have been much more useful, particularly to the beginning player. Self-design materials could have been left to a later supplement (one suspects we will soon see a supplement filled with pre-designed equipment).

As a tactical combat simulation, *Striker* effectively synthesizes the best of both current board games and miniatures games. The game features an integrated sequence of play with alternating fire within each fire phase after each movement phase (the non-moving player fires first). All fire (including infantry) is a two-step process with hits and damage being determined separately. The morale rules are quite solid and represent a considerable advance over the appalling generalities which pass for morale rules in most miniature games.

Purists may complain that the rules are not as comprehensive as miniatures rules have been in the past. The angle of attack has no effect on penetration, for instance. Nor are hit chances increased for consecutive attacks on the same target (this oversight should probably be corrected by the players). The increase in playability, however, more than offsets these minor flaws.

*Striker* represents a significant advance for miniatures games. It is particularly recommended for the beginning miniatures player. More

advanced players, however, should find its command and initiative rules an interesting attempt to cover an often neglected aspect of tactical combat. Though not without its flaws, *Striker*, nevertheless, is probably the most interesting and coherent modern miniatures game available.

— Thomas J. Thomas

## MOON BASE CLAVIUS

Task Force Games, designed by Kerry Anderson, 18-page rules booklet, 108 die-cut counters, 16x21 map, \$3.95.

*Moon Base Clavius* is a two-player game about a Soviet-American battle on the moon. The similarities to Metagaming's *Ice War* can be seen immediately: an isolated American outpost in an unlikely and faraway place, the Soviets on the attack, and play balanced in favor of the Americans.

I am not saying that *Moon Base Clavius* is an *Ice War* rip-off. Indeed, there is no comparison; the former is a mediocre and simplistic game whose cut-and-dried scenarios become dull after being played twice, while the latter is variable enough in strategy and forces to be interesting after dozens of games.

It is hard to pinpoint what makes *Moon Base Clavius* such an inferior game. Everything seems to be in order when you read the rules; but after a few minutes of playing, spectators and kibitzers begin wandering off. And after a few more minutes, I found myself more interested in getting something to eat than in plotting my next move. The problem is not with any particular rule that should be deleted or added, but rather with the entire game. I think that it just tries too hard. The description of the game in Task Force Games' catalog reads: "*Moon Base Clavius* uses a revolutionary new combat system to depict the effects of terrain and nuclear weapons on the moon." That sentence sums up the problem: the game tries to be revolutionary when it should be trying to be good. There are a lot of things in *Moon Base Clavius* that are different, but nothing is revolutionary.

The movement system certainly is one thing that is different. I was expecting a novel, perhaps even humorous, type of movement. I had envisioned crack U.S. Marines taking leaping bounds of fifty feet or more, only to land in crumpled heaps and bounce around on their heads

for awhile. Instead, all infantry units are equipped with rocket-powered backpacks, enabling them to ignore all terrain for purposes of movement, paying a uniform one movement point per hex. To make movement even duller, all infantry units have the same number of movement points, and most of the time it is all infantry on the battlefield. There are a few tanks that rumble around on the ground, but they only arrive as U.S. reinforcements in two of the scenarios.

The combat system is somewhat better. Rather than the usual attack/defense ratio, the game uses the number of attacking combat strength points cross-indexed with the terrain in the defender's hex. This yields the needed roll on two dice to destroy the defending unit. Although this system is new and interesting, it does have its flaws. First, all units, from U.S. Marines to Soviet mortar crews, defend the same; second, the defending unit is either destroyed utterly or it escapes unharmed. Both of these flaws contribute to the game's inaccurate simplicity. Also, the effects of nuclear weapons are shown with about as much detail as they are in *Ogre* or *G.E.V.*: nuclear weapons destroy units with a great deal of efficiency, and that is all. There is one token rule which makes a hex unenterable for one turn after it has been successfully attacked by only nuclear weapons. But there are no special rules for the radiation or heat that occur in a nuclear blast, even a tactical one. I expect this in a game like *Ogre* or *G.E.V.*, which makes no extravagant claims to its attention to detail. But I would expect a game with a "revolutionary new combat system" to take such things into account.

*Moon Base Clavius* also meddles with some well established premises of game designing. I had long wondered why these premises were so well established; after playing *Moon Base Clavius*, I can see why.

One of the most universally accepted rules in the gaming industry is the way in which a piece's Zone of Control is treated. In every game I have ever played which included Zones of Control, a marker's piece's Zone of Control is the six hexes surrounding the marker piece; enemy markers' pieces moving into one of these six hexes must stop all movement and must attack the marker piece. In *Moon Base Clavius*, markers' pieces can go through enemy Zones of Control by paying an extra movement point and need not attack the opposing marker piece. This sounds like another "revolutionary"

idea, but all it really does is make strategies almost impossible, as enemy units can run circles around your forces.

Another rule that is accepted without question, at least in the world of pocket-sized games, is the "move-and-shoot" turn sequence. The "shoot-and-move" turn sequence has been tried, with a great deal of success, in games such as *Squad Leader*. But in *Squad Leader*, the theory is that you lay down a withering cross-fire so that your troops can then run across an open field or street in relative safety. In a game like *Moon Base Clavius*, in which the average firing piece's range is only one hex, and there is no defensive fire phase, a "shoot-and-move" turn sequence is useless.

Besides these negative points, *Moon Base Clavius* has my favorite things about pocket-sized games: lots of typos and ill-made rules, many of them rather humorous. The first one I noticed was the name of the Soviet forces: Soviet Lunar Army, which has the unfortunate acronym of SLA (terrorists in space?). Another, and more subtle, ambiguity is the absurd redundancy of the rules.

I have read the line "Movement points may not be accumulated from turn

to turn nor may they be transferred from one unit to another" a hundred times, and there it is twice in *Moon Base Clavius*. But my favorite is their rendering of decided: deduced. (Deduce: to create a role-playing game character.)

All kidding aside, *Moon Base Clavius* is a pretty sorry game. I think a battle on the moon could have been done much better on a more tactical level: hexes representing fifty meters instead of 27.52 kilometers, turns representing minutes instead of hours, and units representing squads instead of platoons. This would have made troop maneuvering and combat more interesting, perhaps even adding hand-to-hand and street-to-street fighting inside the moon colonies.

Task Force has done many fine games in the past, particularly in the field of science fiction games. Their *Starfire* trilogy and their *Starfleet Battles* series are perhaps the best space combat games ever made. And *Intruder* is my favorite solitaire game, with every playing being really different. I hope *Moon Base Clavius* is not representative of their future releases.

—Kim Paffenroth

## BOOKS

By Greg Costikyan

### MILLENNIUM

John Varley, Berkley Books, \$6.95 (trade paperback)

John Varley has, in some circles, been heralded as the greatest new science fiction talent since Heinlein. That's overstated a bit. Despite his occasional use of experimental techniques, Varley is not a stylist, nor are his insights terribly deep. He does do something well, however; he writes seamless prose of the sort one expects from Laumer, Leiber, and de Camp, and he is never less than interesting. This alone merits him a place as a science fiction writer of some stature; it remains to be seen whether he is capable of the occasional brilliance which infuses, for example, Leiber's work.

*Millennium* illustrates the contention that Varley is something old rather than something new. It deals with admittedly large themes — time travel, the end of the world, and the future of humanity. But it deals with them in tested and true ways. The story is told by two protagonists —

Bill Smith a present-day FAA employee, and Louise Baltimore, a future-era time traveler. The themes are humanized and illuminated by their experiences, an advantage that makes the themes readily understandable, a disadvantage because it trivializes them; the characters necessarily deal with the themes in matter-of-fact, everyday ways.

Another tried-and-true technique: *Millennium*, like many another science fiction novel, is a puzzle for the reader to untangle. He begins with imperfect information, and must figure out what the characters do and why they do it as the story proceeds. Ideally, as in a mystery novel, the reader's understanding develops along with that of the main character. Because of the puzzle nature of the novel, it behooves this reviewer to reveal as little of the plot as practical.

Should Varley be condemned for using tested techniques? Certainly not, at least if they are used effectively, as they are. Should he be condemned for lack of experimentalism? Again no — or at least, only to the extent that his boosters claim he is highly innovative.

*Millennium* is old-fashioned, seamless science fiction. One gets the feeling that all is done well, but most of it has been

done before. Does this mean one shouldn't buy it? By no means. There is certainly little enough well-written, old-fashioned science fiction being published.

## LYONESSE

Jack Vance, Berkley Books, \$6.95 (trade paperback)

It is sometimes said that one of the distinctions between science fiction and mainstream literature is that the modern mainstream emphasizes technique and style, while science fiction eschews both for the seamless and style-neutral prose exemplified by Asimov's writing. This may have been true in the 1950's, but is utterly untrue today. Where in mainstream fiction can one find, as extreme a stylist as Gene Wolfe — or Jack Vance?

*Lyonesse* is not of this world at all, but of Poictesme, or of Dunsany's worlds. It is filled with the timeless beauty of the best of 19th century fantasy. Its greatest feature is an elegance of style, a beauty of language. In a way, the story itself is almost incidental. At the end, what will remain in the mind of the reader is not the story of King Casimir's ambitions, but the images of Suldrun's gold-lit garden, the terrifying Ska, the pretensions of the mad bird-king of Pomperol. But *Lyonesse* is not simply a series of gorgeous images tentatively held

together by a shaky plot; it is the first in a chronicle of the history and, presumably, ultimate destruction of the Elder Isles. The danger is that readers, familiarized with Vance's world in the first books of the series, will find little to hold their interest in the later books; but Vance is an inventive writer, and one can hope he will avoid this trap, the bane of the series writer's life.

*Lyonesse* will not appeal to all tastes; it is emphatically not written in the telegraphic, Hammet-style prose which many readers find appealing. Like a fine wine, it must be savored, and requires a patient reader. But for those with the patience, it is an eminently rewarding experience.

## THE PRISONER OF ZHAMANAK

L. Sprague de Camp, Ace Books, \$2.50

The most notable thing about L. Sprague de Camp's fiction, I think, is its likability. It's hard to imagine how or why anyone could dislike de Camp's stories.

*The Prisoner of Zhamanak* is the fifth book of de Camp's Krishna series, a series of "sword-and-spaceship" novels. The sword-and-spaceship genre consists of science fiction tales which take place on primitive planets where iron-age

technology is still in use; in this series' case, on the planet Krishna. The natives of Krishna are humanoid, although they have blue skin and feathery antennae, and are oviparous. Earth maintains a consulate there, but the planet is under interdict — which means that revealing technologies the natives have not developed for themselves is illegal. Such revelations occur, of course, but rarely. Each of the Krishna stories follows the adventure of one or several humans who have decided to travel to Krishna for one reason or another. In *Prisoner*, a cultural anthropologist, Alicia Dyckman, is held captive by the Heshvavu of Zhamanak, a conservative paranoid who believes Earth is trying to destroy Krishna and her culture. One of the Terran diplomats, Percy Mjija, is sent to spring her.

What follows is an adventure in the traditional de Camp style — intelligent and amusing. Mjija himself is one of de Camp's most attractive characters; an Oxford-educated Botswanan, he, despite his African heritage, has no doubts about the superiority of civilized men to the barbarous Krishnan natives.

Readers should not be put off by the pulpish names of the Krishna novels; *The Prisoner of Zhamanak* is not *Conan the Blood-Drenched*. Rather, it is de Camp at his best. Those who miss *Prisoner*, and the foregoing four books (which have all been recently reprinted) are missing something worthwhile. ▲

## A POLICY STATEMENT

In the beginning there was *Dragon*® magazine. Since its inception it has encompassed the rise of *Dungeons & Dragons*® and other role-playing games including those with science-fiction themes.

Now there's *Ares*™ magazine. A bi-monthly periodical resurrected from the demise of Simulations Publications, Inc. *Ares* used to be primarily a simulation map-and-counter gaming magazine, and indeed four of its issues contain complete boardgames. But now every issue contains an expansive "Role-Playing Gamer" section dedicated to science-fiction role-playing games.

Originally *Ares* balanced its content between fantasy and sf. And in the past, *Dragon* included sf in its pages.

No more. Both *Dragon* and *Ares* will now streamline their focal points. The fantasy that was in

*Ares* will now appear in *Dragon*. Conversely, the sf that appeared in *Dragon* will now be showcased in *Ares*.

This realignment means fans of both genres will receive substantially more material.

Fantasy-gaming enthusiasts should be reading *Dragon*, the premier magazine in the field — a menu of fantasy role-playing games, articles, stories, plus reviews of the entire media spectrum of fantasy.

The minimal attention that *Dragon* could afford to devote to games like *Star Frontiers*™, *Gamma World*®, *Traveller*™, etc., can now be fully addressed in *Ares* with modules, supplements, variants.

TSR, Inc. is determined to properly service the rapidly-expanding fields of fantasy and science-fiction games. *Dragon* has done so with fantasy. *Ares* can now do so with sf. ▲

# HAUNTED PLACES

By David J. Schow

The concept of the Haunted Place is a cornerstone archetype of horror fiction, one garnering renewed popularity in the face of such bestseller-into-movie efforts as *The Amityville Horror* and *The Shining*. The usually-malefic forces encountered on excursions into such places are occasionally paranormal gravy, an added fillip to an already-malevolent location that is sometimes the root cause of the evil. Then there are the intrepid haunted-house-hunters themselves — victimized by Places, or the Ghosts, or more corporeal haunts (loonies bearing meat cleavers and overdeveloped senses of duty), and sometimes carting the Evil in among their own numbers.

But it is the encounter with evil in the given Arena of the Haunted Place that is most relevant here. Boundary lines between the real and imaginary vacillate; what remains after cosmetic differences are boiled away (MacGuffins, misdirection, twist of plot and polarity reversals of loyalty among comrades, and between the supernatural and the "normal") is the conflict on the unreliably sinister grounds of the Haunted Place...who wins, survives or comes out ahead as a result of the encounter.

## The Evil Place

A blanket outline of the most typical Haunted Place situation can be drawn from gimmick-meister William Castle's 1958 film *House on Haunted Hill*: A pigsty-rich eccentric invites a selection of predictable character types to an Old Dark House, remote and isolated, where he wagers some drop-in-the-bucket wealth against the consent of each guest to endure the house's legendary terrors for one night. Everyone is locked in and the host pockets the key with an evil chuckle (isolation from outside intervention is always proportional to the degree of threat a Haunted Place can generate; it can run away from a ghost, it automatically becomes less imposing).

Around midnight the guests begin to drop like mosquitos, bumped off ten-little-Indians style by the Place's resident spooks, who are ultimately revealed to be illusions under the control of the host, who happens to have a convenient, gangster-like motive for group homicide. The supposedly unrelated guests all have something in common that earmarks them

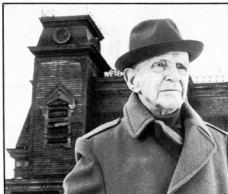

GHOST STORY

for the acid-tub in the cellar. The host gets consumed by his own plot, leaving the Young Couple as the nominal heroes and sole survivors of the night, and a parting shot reveals that despite the pragmatic goings-on, *real* spooks have been avidly watching over the entire proceeding, perhaps even fingering the host as the bastard we knew him to be all along.

Haunted Places may assume active or passive roles in the terrorization of their occupants. Passively, they merely provide walls, shuttered windows, and lockable doors for the benefit of a nemesis all too human, as Vincent Price was in the previously mentioned film, or around-the-bend maniacs of the stalk-and-slash school. *Black Christmas* (1974; the film that inspired *Halloween* and its endless imitators) featured an unseen wacko hove up in the attic of a sorority house. Every Place from the Bates Motel in *Psycho* to the bizarre farmhouse in *Texas Chainsaw Massacre* fits this subcategory.

Actively, houses may be infested with onerous ghosts, or may themselves be evil, either as a result of "attracting" evil like a magnet to a specific locale — like the apartment house in Jeffrey Konvitz's *The Sentinel*, whose top floor is the gateway to Hell — or by being what Stephen King calls "malign storage batteries" for the accreted evil of the past, as are the Marsten House and the Overlook Hotel in his novels *Salem's Lot* and *The Shining*, respectively.

The more familiar role of the Haunted Place as a protective shell for a simple ghost (good or evil) is best-represented in the genre; Eva Galli's home in Peter Straub's *Ghost Story*, the female spirit haunting her mansion in Dorothy Macardle's *Uneasy Freehold* (better known as the 1944 film *The Uninvited*), the seductive manifestations of Henry James' 1897 novelette "Turn of the Screw," or the hopped-up Freudian ghosts of the eventual film version, *The Innocents*. The standardized haunted-house tale of folklore belongs in this mold, providing the most common definition of the term *ghost story* along the lines of the Headless Horseman in the *Legend of Sleepy Hollow*. Benevolent

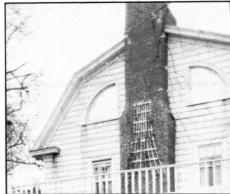

THE AMITYVILLE HORROR

spirits are rarer, but usually memorable, such as sea captain Daniel Gregg, the Ghost who woos Mrs. Muir in R.A. Dick's 1945 novel and in the 1947 film, or the lady wraith who does likewise to Joseph Cotton in *Portrait of Jennie*.

But what of those malign storage batteries? The evil that pervades them traditionally festers and spreads, extending beyond the property boundaries if given time and periodic abominations to feed it. King suggested the concept of a whole haunted *town* this way in *Salem's Lot*, not so much via the existence of the Marsten House as through an on-again, off-again chronology of fictional addenda regarding the Lot itself. His novelette "Jerusalem's Lot" predates the vampire invasion by almost a century with a burgeoning pocket of strictly Lovecraftian monstrosities that are clearly still kicking in 1971; *Salem's Lot* is set in 1975, and the vampires are still in control by 1977, in the short story "One for the Road." Since fire is a classical purgative and a spot-welder of monster movie loose-ends, it is no surprise that both the Overlook Hotel and the Marsten House get burned to ground level to exorcise them — and the Marsten House takes the entire Lot with it in replay of a 1951 conflagration; thus, exorcism according to "legend." Such curative steps against evil forces suggests that from time to time, clear-cut battle lines are drawn between our world and that of the paranormal.

## The Hunters

To the Van Helsings of ghostdom, the rationale for such a confrontation is to evict the spirits (real, imagined, corporeal or ethereal) squatting there. It automatically renews the Haunted Place's Arena aspect.

Haunted Places approached in this way appear deceptively mundane, while eventually proving to be better left alone in the aftermath of most conflicts with spook-busters. Shirley Jackson's classic *Haunting of Hill House* addresses this aspect among others — a manse with a record of supernatural incidents is the focal point of an investigation by an academic who (like his lampoon-counterpart in *House on Haunted Hill*)



POLTERGEIST

invites veterans of the supposed incidents to R.S.V.P. his conclave at the site. Purpose: To either verify or debunk the presence of supernatural forces. The weird things that come to pass are sometimes upfront and creepily obvious, sometimes just at the periphery of perception, but it is clear that the deck is stacked against those who enter the Place from the start. One of Jackson's supposed spook-busters is a ringer (though she doesn't know it), a woman whose considerable, latent mental motive force is focused by the "lens" of Hill House into a virtual laserbeam of mayhem. Rule: Check just who's on *your* side before entering the Haunted Place.

Richard Matheson goes a step further in his ode to Jackson's novel. The psychic/investigative team in the novel *Hell House* is assembled like the Impossible Missions Force for the purpose of venturing into "the Mount Everest of haunted houses" to discover just what the resident spook's beef against the world is — or was. This brings up the idea of anti-haunt artillery. *Hell House* brims with all ghost-busting approaches from seances to a huge machine, laden with blinking lights, which is trundled in to vacuum away the ghostly presence by neutralizing it electronically. Like the Overlook, *Hell House* is also a storage battery, the scene of murder, debauchery, and cannibalism years previously. Its attacks on the invading party of spook-busters are by turns horrifically violent, then disorientingly sensual — at one point a woman has sex with the presence dominating the place. It is the sugar and vinegar approach that leads to defeat from the left, while the spook-busters are guarding the right.

The "trap" of a Haunted Place is a restriction either physiological — the visitors are locked in, or boatless on an island, or somesuch — or psychological — they refuse to leave because of mental delusions, ethics, or the nature of their personal quest (as in *The Haunting*, the Robert Wise film of Jackson's book, *The Legend of Hell House*, and *The Uninvited*). The latter implies a discreet connection to the spiritual in terms of will to remain in the face of presumed hazard being a mental state (the spirit world being largely a matter of mental interpretation);

the former deals in the harsh reality of the locked door. This shutting away from the outside world may serve metaphorical purposes, as the welded castle gates in Poe's "Masque of the Red Death," or practical ones, as in the speeding *Terror Train* — in both, killers in masks mingle unsuspecting among their victims. The impediments serve the contrary or "evil" force either way.

Since Roderick Usher's house, such places have also operated as traps *without* locks, by virtue of being labyrinthine. Of course, a wide-open door is no good to any potential escapee if there's a werewolf bracing it, and this brings us to the nature of the supernatural antagonist, be it ghostly or all too real.

### The Hunted

*Ghost* is a generalization for the visible spirit of a former mortal, as opposed to apparitions and astral bodies. Since scientists have claimed that ghosts per se may be composed of electrical manifestations from the brain, and occultists counter with the concept of ghosts as a physically real, trans-mortal, luminous effluvium called *ectoplasm*, the nature of the ghost as antagonist is sometimes dependent on just what the spook-buster's idea of a ghost really is. Spiritualists say that ghosts may shed their ectoplasm and enter the bodies of people or animals, or cause inanimate objects to stir up trouble.

Ghosts have several motivations for the havoc they wreck, the most common of these being vengeance for their own murders, as in M.R. James' "The Ash Tree," which can be seen as a sort of long-distance forerunner of "witch's revenge" films like *Black Sunday*. As in the Steven Spielberg film of the same name, poltergeists (literally, "knocking spirits") just like to raise hell and sometimes kill people in the process. They are usually invisible, and for some inexplicable reason, they are either attracted toward or are activated by the presence of pubescent girls. The above mentioned scientists prefer to interpret poltergeist phenomena as the hostile telekinetic impulses foisted by such girls; that's as good an explanation as any for the "invisible" chaos caused by Carrie White in

*Carrier*, or Gillian in *The Fury*. It indicates a pure, yet unchanneled destructive force born of the mind...which brings us back to Eleanor and the mental granger of "ghost" manifestations caused by her interface with Hill House.

Some antagonists are still supernatural, but physically real. Vampires, werewolves, and zombies are all one form or another of reanimated corpse having little influence brought to bear on them by the animal or persona of the experson. Pick your own book and movie favorites in *this* category: there are millions of possibilities. Some are human beings despite actions so nefarious that they seem wraithlike in operation — Jack the Ripper, for example, who was never identified and never apprehended (other biggies in this particular annal of homicide include Bela Kiss — who at least had a name — the Hillside Strangler, and the Cleveland Torso Killer). Some supernatural antagonists are real and unreal simultaneously, such as Jack the Ripper in *The Century*, orchestrating bloodbaths from his own private afterlife, or Michael Myers in *Halloween*, getting a promotion from teenage mental case to palpable Boogeyman.

In rare cases, a Haunted Place uninhabited by any of these worthies may be hungrily evil all by itself, like Anne Rivers Siddons' *The House Next Door*, a kind of psychic Venus flytrap. More often, it is the box inside which neurosis ferments into psychosis, sending normal and likable folks over the precipice to madness, as in Polanski's *Repulsion* and *The Tenant*.

Many ghosts and Haunted Places suffer from the Sisyphus syndrome; that is, they play out one tune from life, repeatedly in a single location, some being locked into scare tactics not from necessity, but from habit. Captain Gregg ran through the basic spookshow repertoire but was benevolent; the ghosts in films like *Heaven Can Wait* and *The Return of Peter Grimm* demonstrate that even spirits can be taken advantage of.

Similarly, the "trap" of a Haunted Place lies not so much in the bonafide terrors trespassers may activate unwittingly or purposefully, but in the willful

act to enter the house in the first place. If conscious spook-busters haul in astrologers and apparatuses, "unaware" New Tenants usually count one among their number who turn out to be supernaturally sensitive, thus "making" ghosts when the mirrors stop reflecting and the doors start slamming by themselves. The authentic terrors are augmented by the mental anguish, and such characters invariably believe themselves insane when their minds explain phenomena in the form of ghosts — or invent the ghosts telekinetically. "Am I losing my mind?" is a litany in such cases (again, as in the Polanski films). They may be crazy, but in many cases this does not make the denizens of the Haunted Places less real.

### A Lingering Presence

Often, almost as a supernatural catalyst, Haunted Places have portraits of the former occupants hanging around. The one in Bram Stoker's "The Judge's House" favors necktie parties when it can get a tenant alone. Sometimes just the paintings are haunted, as with Poe's "The Oval Portrait." Most of the time these *objets d'art* possess Dorian Gray characteristics; that is, they alter their own composition somehow after doing their dirty work.

Admittedly such broad supernatural rules of order make the typical Haunted Place encounter seem overly formulaic, and thus cut-and-dried, further implying predictable corrective or offensive action can be easily dictated. It must be remembered that ghosts frequently tailor their appearances to resonate with the mental state of the observer, making for a false sense of security on the part of the spook-buster. Also, while ghosts are aware of time and space, they are in no way governed by either, and this extends to other supernatural antagonists as well. "So soon?" growls the repulsive demon Surtag, twelve years after it was first invoked (in the Harlan Ellison story, "Grail"). "You need me again so soon?" Ambrose Bierce's surprisingly apt description of *ghost* is "the outward and visible sign of an inward fear." They sometimes manage the feat of transcending the supernatural fictions detailing their worst deeds, as with the real ghost who haunted the production of *The Haunting* (Supposedly the daughter of the lord who owned the hotel in which we were shooting," said Robert Wise. "She was kept from marrying the young man of her choice and jumped out one of the upper windows, in 1790. Now she roams through the hotel looking for the spirit of the young man.") and the "real-life" basis for the Lutz house in *The Amityville Horror*.

Creators of ghost stories sometimes get absorbed into the mythologies as well; thus was Lovecraft taken away to join the Old Ones at the age of 47, and thus did

every bit and piece of Poe's life become pregnant with beyond-the-grave influence. In Robert Bloch's "The Man Who Collected Poe" the haunt is Edgar Allan himself; in other tales, a lock of his hair or one of his quill pens is enough to possess the hapless characters.

The fiction of Charles Grant specializes in deadly flowers administered by recently killed people. *Twilight Zone* segments featured haunted mirrors, automobiles, wax museum figures and TV sets; *Thriller* offered up haunted glass and paintings. A *Night Stalker* episode

featured a haunted motorcycle with a headless, sword-swinging rider ("Chopper"), a haunted suit of armor ("The Knightly Murders"), and a poltergeist/doppelganger/pyromaniac ("Firefall"). Spooks are diversified if nothing else; progressive in the sense that King's 1975 vampires can snap the arms off crucifixes while cackling, and such paranormal invention could easily outwit human interlopers set on busting spooks according to old-fashioned rules.

Those who are found inside Haunted Places rarely play games. **A**



## Ha! Ha! Choke! Gasp! Aarrgh! Humor in Horror

"Horror and comedy are opposite sides of the same coin," says Robert Bloch. "Both depend on the unexpected and the grotesque, on the dislocation of seemingly natural events, and both depend on timing and tempo that sucks an audience into a scene."

For every ghost depicted seriously in film, there seem to be five more strictly for laughs. *I Married a Witch*, *The Canterville Ghost*, *Blackbeard's Ghost*, *The Spirit is Willing...* and then there are the singing ghosts of *Bittersweet*, *Carousel*, and *Maytime*.

Spoofing the supernatural works out as more the province of films and TV than written fiction, and the main drawback of this juncture where humor and horror meet is that most of the time the humor is *about* horror rather than *in* it, contextually. The laugh is at the genre and its stereotypes instead of rising from the situation.

The defunct TV series *Night Gallery* can provide good and bad examples: Producer Jack Laird continually edged the show in the direction of incredibly hackneyed comic "black-out" — two or three-minute skits that managed to invalidate the show's other 40-odd minutes of material completely (Example: a vampire rips a soul of a victim who says, "Sorry, I gave at the office.").

But the show also (somehow) managed a good adaptation of Richard Matheson's "Funeral," wherein a venal mortician named Milton Silklines finds himself a buyer's market in burial services for vampires and aliens, one of whom chooses a memorial in a chamber Silklines calls the Eternal Rest Room. "We have pomps for all circumstances," he says.

Badly-written horror spoofs *itself*, becoming unintentionally funny. Many of the quickie scripts for ABC's recently cancelled *Darkroom* series are prime examples of how an attempt to resurrect *Twilight Zone's* format without updating it dissolves helplessly into self-parody.

The spoof has always been the last refuge of the film industry in the matter of the monster/horror genre as well. As most of Universal's topline monsters wound up meeting Abbot and Costello in the 1940s, so is today's glut of knife-kill films like *Death Dorm* and *The Boogeyman* satirized by *Thursday the 12th*, *Saturday the 14th*, and *Student Bodies*. 1981 saw Jack Arnold's *The Incredible Shrinking Man* undergo a gender change into the realm of expensive comedy flops.

Good humorous horror is still easily found, however, in the cartoons of Edward Gorey, Gahan Wilson, S. Gross and Rodriguez; in the lighter work of Matheson and Bloch, or in Ellison's short-darts like "Bleeding Stones," a blackly funny story in which living gargoyles, nurtured on pollution, decimate a million zombiotic Jesus Persons. Gallows-humor was practically reborn with John Landis' *American Werewolf in London*, wherein a chewed-up walking corpse convinces his best friend to commit suicide for the general good. "You ever talk to a corpse?" he says. "It's boring!"

# INTO THE VOID

By Carl Smith

Llewellyn sweated. Scanning the digital readouts on the console, he edged the XV-1 into raw space. For a moment the old panic of being in charge and the pressure of lives depending upon him returned. If he judged wrong, a torpedo or burst of fire from a laser battery would leave him and the survivors from the freighter dead and charred in space. What if the Sathar attack ships expected the freighter to jettison the prototype, or what if some of the Sathar mercenaries aboard the *Prachil Star* had communicated with the warships outside and were waiting like carrion crows?

Chewing his gum fiercely, Llewellyn squinted at the console lights, taking the escape vessel out the jagged hole. Not too close to the edges, or he'd open the prototype like a can of sardines. He had seen the effects of explosive decompression on humans and felt that it was one of the uglier ways to die. Gently his fingers touched the control panel, and the XV-1 slipped forward.

A drop of sweat slid down behind his head, and ran down his neck, making him think of the centipedes on Pavan. Swallowing to clear his throat, he announced, "We're just about to clear the freighter. Once we're free of it, I'm going to goose this and get us going."

A bright light flared to the port side of the XV-1 and he flinched. Dammit, he thought, this is no time to let the pressure get to you. You've been shot at before and you've been hit. Of course, that was small-arms fire and if a gun this big hits you, you'll never know it.

Eyes slitted against the glare of another close miss, he nudged the XV-1 free of the wounded *Prachil Star*. Those Wormies



Thinking about it, today had promised to be another in a long string of dull days.

A Sathar loomed close, firing. The screens of the XV-1 deflected the bursts from the Sathar's laser batteries. Checking the console, everything seemed in order, and he punched in the void drive. Today had sure gone to hell in a hurry.

Routine governed Dai Llewellyn's life, from roll-call to lights-out. Part of him detested the regimen while another, more secret, part loved the security of an ordered society. That was what the Pan Galactic Corporation was all about — order. But even order had its limits . . . and guard duty aboard a transport was one of them.

Dai scratched his chin with the back of one hand, and wished the PGC did not have the standing order making twenty-four hours a year of duty in exo-suits mandatory. Sure, they did deep space duty occasionally and wore the suits, but most of the time the PGC pulled duty on a planet with some sort of atmosphere. Outside the ship, the bulky space suits saved lives. Inside a

weren't good shots. Either that or they were missing on purpose — and that didn't make sense. He'd never heard of Sathar taking prisoners.

He wanted to slam the void drive on and put light years between himself and here, but he fought the impulse. Take it easy, make sure you have everything ready. . . .

Another close shot rippled the blistered hull of the freighter, registering on the XV-1's screens. Today had started out no worse than a hundred other days, he told himself, reaching for the protective cover of the void drive and flipping it open.

controlled atmosphere, the suits were as cumbersome as power-armor. The system of gaskets and self-sealing joints insured that the exo-suit was uncomfortable, but the training manual said twenty-four hours a year, and twenty-four it was.

Colonel Gaedynn, head of security aboard the freighter, briefed Llewellyn's watch. Ever a man for regulations, Gaedynn called roll, waiting patiently for the slow Dralaste to answer, nodding at the precision of the Vrusk's answer, and ignoring the measured insolence of Viyizzi the Yazirian's answer.

As Viyizzi's commanding officer, Captain Llewellyn started to reprimand her, but caught himself. The Yazirians were a proud race. They looked like so many tall, skinny monkeys to most humans, but they could glide between trees, were loyal to their friends, and carried a long grudge.

Earlier this year, Gaedynn had chewed Viyizzi out on the small-arms range. She had been showing off, firing both pistols from the hips and knocking down targets as soon as they popped up. Unquestionably, she was the best shot in the squad, but the small-arms range was not a place for showing-off.

"Here . . . sir," answered Viyizzi with measured disrespect. Yoe, the other Yazirian in the squad, flinched and elbowed her. Yoe was the pilot and ship's gunner. In contrast to Viyizzi's whiplike gauntness, Yoe was so heavy that he could glide on only the lightest-gravity planets.

Not to be outdone, Viyizzi jabbed back at him with a sharp elbow. Llewellyn liked her for all her brass — she didn't let anyone put anything over on her and she didn't take anything from anyone either. Yoe ignored her. Colonel Gaedynn continued with roll call, calling Sergeant Slard's name last.

"Here, sir," Slard was too crisp, too polished, almost too perfect. Dai could not nail down what it was, but there was something about Slard he did not like.

The Sergeant spent too much time with the XV-1 — it seemed almost an obsession with him. Why, Llewellyn couldn't figure out. Machines were tools, nothing more and nothing less. Some people personified and romanticized robots. Hota Lea, his squad robotics expert, was like that. Dai couldn't picture himself getting excited over a hammer, and couldn't fathom Slard's fascination with the experimental vessel.

Roll call finished, Colonel Gaedynn paused and flipped to a new page on his clipboard. "As you know, we are aboard the *Prachil Star* to escort our . . . cargo . . . to homework for evaluation. Possibly it will be adopted for use after testing. What happens after it arrives, we cannot control, but that is not why we are here. We are to guard the XV-1. As you know, the Sathar have intruded in this area before, but it has been quiet for the

last two weeks. From all appearances, this old freighter will get us to homework with no problems. We might be transporting history."

Abruptly, he changed the subject: "Anyway, you have your assignments. They have not changed in the last five days. This is a security area. No one is to enter this cargo hold without a pass. No unauthorized personnel are allowed in the same area as the XV-1. You are not to leave your posts unless officially relieved. Any questions?"

Llewellyn would have been surprised if there had been. For the last week in-transit they had heard the same speech twice a day, once on each four-hour shift. Gaedynn called them to attention and then turned them over to Llewellyn, who dismissed them.

Hota Lea stopped to pull out her compact mirror and check her make-up. Passing close by, Viyizzi joked, "Pretting yourself for Vi?" and took up her post by the XV-1. Hota blushed slightly, snapping the compact shut.

Dai caught up with Hota before she entered the XV-1 and whispered, "How about a date — dinner perhaps when we arrive homework?"

Hota Lea flushed. "Sir, officers do not date subalterns, not until they are lieutenant j.g., anyway." She spoke loud enough for others close by to hear, but then dropped her voice to a lower tone, "It is a nice thought . . ."

Llewellyn grinned. "The offer goes — as long as you don't bring Violet."

Immediately Hota became defensive. "What's wrong with Violet?" "Nothing, absolutely nothing. She's perfect. Never makes a mistake." He shrugged. "I prefer your company to that of our robot medic." His voice took on a more serious tone. "In the corporation on Pavan, we didn't have them. The sand screwed up their circuits."

Hota grew a little angry. "If more people took a lesson from robots . . ."

Llewellyn shook his head. It irritated him that she was so close to the robot. "Who wants to be a robot? It puts my teeth on edge when you treat it like it's human. People are people and . . ."

Hota's grin was sharp enough to cut. "I know . . . and robots are robots. We've had this discussion before, Da . . . Captain Llewellyn."

Llewellyn realized he had blown it again. "Let's get Violet aboard the XV-1 and check out the life support systems." If they had checked it once, they had checked that damned experimental escape vessel twenty times. For all he knew, the thing could punch its way through the hull of the freighter like it was paper, and jump the void to wherever they wanted to go.

They checked the sublight drive, the void drive to jump into the void, the laser cannons mounted in the bow, the sub-space and void-communication systems,

the three life support systems, both exo-suits in the weapon's locker, the grav-couches, and the reprocessing plant for food. To get at these systems, Dai had to remove a score of access panels, crawl through the engineering rear section, and plug Violet into the XV-1's main computer. As usual, all worked. Leaving Hota Lea working with Violet inside the craft, Dai popped a piece of gum in his mouth. He offered some to Dorf the Dralaste and Viyizzi who stood guard by the XV-1's port hatch.

Viyizzi grinned evilly. "How's the fairy princess?" She was clearly referring to Hota Lea. Dai tried to fight a smile and only partially succeeded.

"She's all incensed about a remark I made."

With her usual insight, the irrepressible Yazirian chuckled. "You knocking her tin head again?"

As usual, she was on target. Llewellyn shook his head, amazed at Viyizzi's perception. "How do you do it?"

She chewed her gum noisily, smacking her lips. "Do what? I just watch you humans and grin. You're easy to read — and amusing."

Dai nodded in agreement. "I'll try to pay more attention."

Viyizzi gave a little shrug. "Yazirians and humans aren't so different. You could have been just like me — if your ancestors hadn't been thrown out of the tribe for taking too many banana breaks." She grinned to show that no real disrespect was meant.

The ship rocked. Llewellyn was knocked to the floor. The sound was felt more than heard. Lumbering to his feet, Dai bellowed to Viyizzi, "Stay here. Tell Hota and Vi to stay put." Viyizzi had her weapon out. She hesitated and then nodded.

Pulling his 9mm pistol from his holster, Dai ran to the doorway. He pushed the button and stepped cautiously into the corridor. A beam of light flickered by him, drilling a neat little hole in the metal by his shoulder. Figures were moving down the corridor, firing. Someone knelt ahead of him.

"Slard?" "Starled, the kneeling figure turned, laser drawn. For a moment Dai thought the kneeling Slard was going to fire at him. Then Slard turned away, squeezing off a shot down the corridor. Llewellyn noticed the prone form of Colonel Gaedynn.

"How is the Colonel?"

"Dead." "Crouching, making his way to Slard, Dai checked the Colonel. His body was still warm, but he was dead. A neat little hole exited his forehead. There were no burns on his forehead, so it had to be the exit wound. Dark shapes filled the corridor, coming towards them, firing lasers. Slard returned their fire. Both he and Llewellyn saw his hasty shot splatter



harmlessly off an albedo suit.

"Damn," Slard muttered.

Llewellyn slapped him on the shoulder. "Let's get inside the cargo area. In there we can link up with the others and then we can hold them off. . . ." a bolt from a laser made him shift nervously. He snapped back a shot. The 9mm slug slapped the firer down. Albedo suits weren't worth a damn against projectile weapons.

"Cap'n," Slard said, "I've got an idea. How about you taking the others and heading up the corridor. I'll stay in the cargo area and hold off these pirates. . . ."

---

## *Orders were orders — and orders were that no one who was unauthorized would get their hands on the XV-1.*

---

This suggestion surprised Llewellyn. He was not sure why, but he had never thought of the Sergeant as the heroic type. Maybe he had underestimated the man. Still, the suggestion did not feel right coming from Slard.

Llewellyn pulled the trigger again. "Get in the cargo area. I'll cover you."

"Sir, I'll cover you."

"No, get moving, Sergeant!"

"Sir, why don't. . . ."

"That's an order — move out!"

Llewellyn heard the squeak of Slard's boots as the Sergeant obeyed.

An eternity later, Slard yelled, "I've got you covered. Come on."

Dai fired again, whirled, and dove at the door. Slard fired down the hall, one of his shots ricocheting where Llewellyn had stood an instant before.

Rolling through the cargo bay doors, there was a whine and a hiss. The triple-plated cargo doors slid shut as the floorplates quivered. A grenade launcher, most likely, Viyizzi was there and helped him up. He looked at Slard, wondering about the close shot, but dismissed it as an accident.

Viyizzi had her gun drawn, "Having trouble. . . sir?"

"Thanks," he answered, and then yelled to members of the squad standing around the XV-1. "Get inside the vessel."

"Why'd you do that?" asked Slard. "I thought you liked my plan to. . . ."

"We can't. I got a look at that metal mess that was our escape route. Nothing short of a Mark VII Hover Panzer could get through there." Llewellyn did not add that they were stuck here.

Llewellyn wondered who the intruders were, not that it made any real difference.

Orders were orders — and orders were that no one who was unauthorized would get their hands on the XV-1. If these were pirates, they'd leave once they'd lost a few men, but if they were Sathar or mercenaries, they'd fight until the last one was eliminated.

From outside there were dull whumps against the door. Whoever was out there wanted in badly enough to throw some pretty heavy firepower against the cargo door.

Viyizzi was beside Dai, her gun ready. She was making a low growling sound in her throat.

"Viyizzi," he said, "get me a helmet

for this exo-suit." An idea was forming. It might not be necessary to do what he had in mind, but it never hurt to be prepared.

"Just where do you think you're going. . . sir?"

"Nowhere right now, but I think I know how to make things rough for our visitors."

Gun in hand, he watched the door. While she was gone, he tried the communicator by the door, but could get only static on it. In a minute, she returned with his helmet. Dai snapped it in place with her help and then he cut on the intercom.

"Viyizzi, get everyone aboard the XV-1 and close its airlock. Have Yoe take the co-pilot's seat. Leave the pilot's seat empty. Have him monitor me — when I give the signal have him blast a hole through the hull."

"That's crazy," she shouted, "you'll be sucked into space with the sudden decompression," and then she added, "sir."

Dai grinned. "I'll be secured, but I don't think our friends outside will be. I think the intruders will be in for quite a nasty surprise." He pushed her toward the vehicle. "Now get ready."

Nodding, she ran off. Dai knew she was worried. When Viyizzi was too upset to make a slur at an officer, she really was upset.

Time oozed by while thumps and whumps came from outside the cargo door. It began to glow, turned a cherry red, then pink, and finally white.

"Ready, Yoe?" he asked into the helmet intercom.

"Ready when you are, boss."

The melting metal ran onto the floor. "Now!" yelled Dai, snapping his safety line onto a stanchion. He heard no sound, but felt a vibration; then he was jerked off his feet and dragged backward until the safety line was taut. Those at the cargo bay door were sucked right through the cargo bay and out through the plated-hole into space. Inside their suits, their mouths formed silent "O's" and then they disappeared. Whoever they were, they were gone.

"You OK, sir?" It was Yoe's voice.

Dai ached where he had jerked against the cable with the sudden decompression and no doubt he'd sport a bruise tomorrow. "I'm fine," he said, standing. "Coming aboard. . . sir?" It was Viyizzi.

"Soon, but first I want to find something to seal this hole. Meanwhile, make sure everyone stays inside. I'll keep you informed."

"Whatever you say. . . sir."

Checking the cargo bay was futile. No sealant kits were around, but he was certain some had been loose on the repair table. Most likely, they'd gone out the hole with the intruders. Maybe some were in the corridor emergency locker.

Approaching the melted cargo door, a figure suddenly appeared and Dai hesitated. The others had been mercenaries, but this was a Sathar, the first he'd seen in years. The Sathar fired through the cooling hole in the doorway, swinging his beam weapon in a broad arc. Llewellyn leapt, careening against the ceiling. His 9mm did not have its open-space adaptor on and was useless. Holstering it, he pulled his flechette pistol from his shoulder holster. The figure in the doorway shot again.

Using his feet against the ceiling, Dai avoided the beam weapon's blast which scorched the area where he had just been. Hitting the floor with teeth-jolting impact he rolled and came up firing. Of the three flechette rounds, two were on target. The Sathar exploded in a pinkish mist. The round which had missed exploded against the far bulkhead.

"Pavan's pink moons," growled Viyizzi in his earphone, "what's going on out there?"

"Nothing I can't handle. Is the airlock functioning?"

"I think so." There was a pause and a muddled conversation. In a few seconds Viyizzi's voice was back. "Old Yodler says 'Can do!'" She hesitated. "I thought you were going to seal the outer hull?"

"We've got bigger problems than that — Sathar. Tell Yoe to get everyone belted down and get the airlock open."

"Sir?" She sounded puzzled.

"I'm coming in. Then we're going to get out."

Exactly how do you plan to do that. . . sir?"

Dai lost any further conversation as he leapt toward the XV-1. His jump was a

little low, failing to carry him over the top. Rolling over the tear-drop shaped surface, he used a handhold near the airlock to pull himself down.

Pushing the entry button, there was a pause and a hiss he could hear over the suit's audio unit. The outer airlock opened. Inside was just enough room for a man in an exo-suit to stand. Pushing the button, the outer doors closed. Gravity returned, and the inner door opened.

Everyone was in their gravity-couches and they turned their faces toward him. The pilot seat was empty. Stuffing himself into it without removing his exo-suit took some doing, but Dai thought he accomplished it rather well.

"What's happening out there . . . sir?" demanded Viyizi.

"Intruders. They've blown the corridor up and they've burned through the cargo door. We're going to get this vehicle out of here." While speaking, Llewellyn slid his hands over the familiar controls. Although no flyboy by a long shot, he considered himself a fair hand at moving one of these when the occasion arose.

"Would leaving be wise, sir?" Slard's tone indicated that he thought it was unwise. "We don't even know what's out there . . . or even if this craft actually works."

Llewellyn laughed. "We're going to find out."

Small-arms fire pinged on the hull.

Powered, the console lit. With the flick of a switch, the ship moved slightly. Dai found the button he wanted. It was under a protective cover. Lifting it, he pressed the button. Bolts of energized light tore through the soft inside of the freighter's hull, widening the hole Yoe had made earlier and opening an escape route.

"This is insane," yelled Slard, "risking our lives on a vessel we don't even know works! We'd be better off chancing surrender."

With a curled lip and disgusted snarl, Viyizi delivered her answer. "When was the last time you met a Sathar captive? They don't take prisoners, fool!"

"At ease!" Llewellyn ordered. "This is an escape craft," he muttered as much to himself as to his companions, "and that's just exactly what we're going to use her for. We're supposed to keep this out of unauthorized hands, and that's what we'll do. I've been told this is a void-jumper — we may give that a try."

"You intend to jump from inside a freighter?" asked Slard.

"Not exactly. First we get outside, and then I'm going to jump her well away from here."

More shots pinged off the hull. "Pavan's pink moons," cursed Viyizi, "step on it and get us outta here. Going down fighting, or with my boots off in bed is one thing, but strapped down in a grav-couch is no way for this furry female to check out."

Slowly the teardrop-shaped vessel

approached the hole in the hull.

Cautiously it emerged, a featured ballerina in *Swan Lake*, with Sathar warships attending. Clearing the hull, Llewellyn saw three Sathar assault scouts turn toward him, anxious to catch him.

One of the Sathar scouts was faster than the others. It sped toward the slow XV-1. Evidently it was not aware that the XV-1 was armed. Cursing, Dai punched the firing button to the laser cannons. In a white ball of light, the Sathar blew up. Its companions hung back.

Dai pushed the button to lock in the void-computer and then hit the void-drive button as one of the assault scouts fired on the XV-1. The torpedo reached the XV-1 as she leapt into the void. The digital displays blinked as the ship streamlined between space as the crimson ball collided with the hull, shaking the inhabitants in their grav-couches.

Dai's head snapped back against the headrest of his grav-couch. Needles on the screen sensors jumped to the danger line and slowly receded. The ship popped out of being while faerie fire from the near-miss blistered her hull. Dai blacked out.

Ears ringing, the darkness in his mind was traded for the vast darkness of space before his console. Violet, the medic-robot, injected him with stim-dose. Its metallic voice asked, "Are you all right, Captain Llewellyn? Your vital signs read well, but that is never a certain indicator of your mental state, although your alpha waves scan well."

He rubbed the lump left by the auto-injector. "I'm fine, Vi. How're the others?"

"All personnel have been checked, and appear to be in excellent condition, except for Yoe. He is overweight. I have not injected any others yet. Since you are in the pilot's seat, I felt it was logical to revive you first, and then see to the needs of others."

"Good. Vi, can you tap into the ship's sensors and give me a damage report?"

"In a moment sir. I am a Mark V robot, but even I have my limitations. My primary function is to care for the sick and wounded. Once that is finished, I think I can access the data banks and vocalize the damage report." It whirred with a soft, competent tone, sliding over to the others, a metallic Florence Nightingale.

It spent time with each one, pausing over Dorf the longest.

"Is there anything wrong?"

"I do not believe anything is amiss," answered Vi.

"Are you sure?" asked Dai.

"No," said Vi slowly, as if contemplating the idea. "I seem to have sustained a bit of structural damage. I am having a little more difficulty in accessing information about Dralastes than anyone else. That should not be. I seem to have no trouble accessing humans, Vrusk or Yazirians — only Dralastes. That

is curious."

"Can you tap into the computers now?"

"Yes, Captain Llewellyn."

"Would you . . . please?" asked Llewellyn.

"Certainly, sir." Vi removed a service panel; its multi-fingered metallic appendages, remarkably delicate, manipulated several wires and finally attached a jack into its circuitry box. It sat quietly humming for two and a half minutes, and then unplugged itself.

"Well?" asked Llewellyn.

"I know of vessels surviving with much worse damage," was the robot's answer. "The XV-1 seems to have sustained damage to its shields, and is operating at 60% efficiency. The life support systems are functioning well. The subspace communication is in good condition, but the void-communication is gone. I think the torpedo blast did that. Sublight drive appears in excellent shape, but there is some fused circuitry in the void-jump panel and I cannot assess the severity of its damage. The astrogation received one of the secondary effects of the near miss."

Viyizi shook her head to clear away night and mental cobwebs. "And just what does that mean?"

Hota Lea answered: "Vi is saying that we cannot tell where we are and that we cannot call anyone to ask for help. Also, it seems to be advising us against using void drive."

"Pavan's pink moons," muttered Viyizi, "first Sathar agents out the kazoo, then warships fire on us and now we're stranded who knows how far from the nearest banana bush."

"Tree," corrected Violet. "Bananas grow on trees."

"Find me one and I'll tell you." The Yazirian lapsed into disgruntled mumbling, the general gist of which was heaven help any Sathar who came her way.

Dai sat quietly throughout the exchange. His eyes met Hota Lea's across the cabin and locked with hers. She returned his look without turning her eyes away.

"Well," Dai asked her, "you're the technician, do you think you can fix it?"

Hota gave a wistful half-smile.

"Anything can be fixed with the right tools and equipment. The biggest problem will be spare parts; I don't think we have any. If we don't have any spare parts, our dilemma is this: Do we suffer along crippled, or do we cannibalize what we've got? We can probably trade off shields for void communication by cannibalizing. But we don't know if anyone we would want to hear us would hear and respond. As far as the damaged void drive goes, trying to fix it blindly would be like trying to invent star drive using a screwdriver and lead pipes."

"We got problems," said Viyizi.

"Very astute observation and summary," commented Violet.

"Troubles ain't all we got," said Yoe. "I've been watching this screen, and I think we're going to have visitors."

Llewellyn returned his eyes to the dull white console. "Visitors?"

"Yup. Sathar, I'd say."

"How many would you guess, Yoe?"

"Looks like one, maybe two in a tight formation, sir." Yoe was silent a moment, then added, "I'd like to know how they found us."

"Just a guess, Yodler," answered Viyizzi, "but I'd say that torpedo must've done enough damage to us to leave a particle trail that even you could follow."

Dai carefully folded a piece of chewing gum and put it in his mouth. He chewed vigorously, but not nearly so fast as his mind raced. If Sathar were here, they wanted this vessel, or they wanted the crew, or both. Any way he looked at it, the crew of the XV-1 was in for a rough time. He reached for the void drive, intent on putting light years between himself and the Sathar and stopped. What had Vi said? There appeared to be a malfunction, something about the circuits. He hesitated, and then he made up his mind. His hand cut on the computer to coordinate the jump, and then reached for the switch to pop them into the void. A chance at escape, any chance, was better than blind acceptance of fate. No guts, no glory.

The computer hummed, cycled, and indicated readiness. He hit the button and the ship lurched. According to his astrogation gyro, they had moved. According to the stars he could see, they hadn't. Something wasn't quite right. The console digitals indicated some void movement, and he stared at them a few seconds, trying to make sense out of what he saw. If anything, he decided, he was farther away from his destination than he had been before the jump. His relative position to certain stars had increased — they had jumped back! The computer verified his suspicion. Damn, this was just great! Here they were, in a battered experimental escape craft, their shields functioning at about half power, and Sathar coming after them. No void-drive, and not enough sublight to outmaneuver the Sathar assault scout.

Yoe nudged him. "Whadda we do, boss?"

"Surrender the vessel," said Slard. What was Slard saying? Dai turned to face him, and stared straight at the laser aimed partway between Yoe and himself. Slard could move his wrist slightly and burn either one of them.

Suddenly it began to make sense. The exit wound had been in Colonel Gaedynn's forehead. That meant someone had shot him from behind. Most likely, Slard. Chances are, Slard's nearly hitting him in the cargo corridor had not been an accident.

"Why?" Dai asked.

"It pays well," Slard answered with a small shrug of his shoulders.

Slard's fascination with the XV-1 now made sense to Llewellyn.

"Clan-killer!" snarled Viyizzi, half-rising.

"At ease!" yelled Dai, as Slard turned his gun toward her.

Viyizzi gave Dai a murderous look. She was trembling, her hands clenched on the armrests of her grav-couch; but slowly she eased herself down into it. Slard kept his laser pointed in her direction.

"Don't throw your life away, Viyizzi," Dai said. With his hand hidden by the back of the grav-couch, he unbuckled his seat belt, and edged his fingers near his pistol.

"Good advice. Listen to him, Viyizzi," said Slard. "The Sathar might kill you, or reprogram you, but you don't know that for a fact. Who knows, they might even make you a very lucrative offer." Slard's tone took on a goading note. "Why die any sooner than you have to?"

"Because I don't want to live like you," she spat.

Whatever else he was, Slard was no fool. Out of the corner of his eye, he caught a movement as Dai jumped from his grav-couch, gun in hand.

Slard whipped a shot at Dai which missed, frying the naugahide on the back of the grav-couch. Llewellyn's 9mm was in his hand. It roared three times, the slugs catching Slard twice in the chest, and once in the forehead. Even as Llewellyn fired, Viyizzi's laser was in her hand. She put four holes in Slard before Dai finished firing. Slard half-sput, half-jerked and dropped like he'd been fileted.

Dai didn't need Vi to tell him Slard was dead.

"Not bad shooting . . . sir," said Viyizzi. "The way I see it is, one down, six to go."

"Six?" asked Hota Lea.

"The assault scout's crew," explained Violet. "We still have to deal with them."

"Buckle in," Dai ordered, sliding into his grav-couch and buckling his seat belt. The Sathar scout closed. He chewed his gum, thinking. It had to be this vessel they wanted. If the Sathar wanted the crew dead, they could easily have managed that without closing. He bet they wanted this vessel intact, if possible. If that was the case, they'd be a little hesitant to fire on it for fear of damaging it. Most likely, the Sathar would try to board and they would accomplish that by approaching from the rear. They wouldn't want to put themselves in front of his laser cannons. They had seen what the little tear-drop shaped ship could do. An idea grew slowly. The Sathar would cut speed and stop, and then attempt to board. If only he could get them in front of his guns . . .

A metallic hiss came over the intercom. He had heard tapes of Wormies' voices

before, and each time it had given him goosebumps. On the astrogation scanner, a blip appeared, closing with the center, his ship. A small trickle of sweat inches its way between shoulders that were hunched with anticipation. Closer, closer, he thought.

"Surrender," the voice said. "Surrender, and you will be well-treated."

In a pig's eye, he thought. Still, he cut the sublight drive off. At the same time, he switched the void-computer on, punching in a small jump forward. The red light on the console winked, blinking steadily. The coordinates were engaged, not that they mattered.

"Captain," Viyizzi asked, "what are you doing?" She was concerned, he knew — she had forgotten to be disrespectful. "I thought we were going to escape, not surrender — you've cut the sublight off."

"Yeah, but I put the void-drive on."

"Sir," interrupted Violet, "perhaps you have forgotten your last little experiment with the void drive. It is not functioning properly."

Llewellyn forced a grin. "I'm counting on the damaged circuits to do just what they did before . . ."

"Wait a minute," Viyizzi scowled, "they didn't jump the void; in fact, we lost distance. How can we escape by moving backwards?"

Dai ignored her. He swallowed, his finger shaking slightly as it hung above the blinking red button, ready to push it and engage the void drive. He watched the blip come closer on the screen. Just a little closer, he prayed. His throat was dry. He strained his ears for the slightest sound.

"Yoe," Dai said, his voice a dry whisper, "engage the target computers."

Yoe gave Dai a peculiar look, but then none of this made any sense to him. Stress did strange things to some men, but he had never known the Captain to panic. With forward-firing guns, and the enemy closing behind, what good would it do to fire at an enemy that couldn't be hit?

"Sir," Yoe began, "do you mean . . ."

There was a metallic scraping, as the Sathar extended a boarding tube. Llewellyn's whisper was urgent, "Gunnergy computer engaged?"

Yoe's head filled with questions, but finally his hand flipped the correct switch. "Engaged, sir."

Dai let out a slow breath and punched the void-drive. XV-1 bucked like a turpentine Stillar's Bovine and jumped back. The targeting computer whined, indicating a target and Dai depressed the laser cannons' button twice. The first shot took the Sathar scout in the rear; the second sent it into eternity with a burst of white light.

Viyizzi's mouth hung open. Finally she cleared her throat. "Good shooting, sir." Then she added, "But we're still lost."

Dai shrugged. "We're alive, and now we've got time. That's what counts." ▲



illustration by Clyde Caldwell

# INTO THE VOID

By Carl Smith

STAR FRONTIERS: ALPHA DAWN™ and STAR FRONTIERS: KNIGHTHAWKS™ are role-playing rules of conquest and combat in outer space. Men and allied extraterrestrials stand side by side to fight the menace of the dreaded Sathar.

The Sathar are an evil and warlike race. Resembling giant, multi-legged worms, they have infiltrated the United Planetary Federation (UPF). The Sathar's goal is to destroy the UPF and all non-Sathar life forms, and they use traitors and the technology of tomorrow to achieve it. Only a few adventurers and professionals stand between the Sathar and the fate of the universe.

To play this game, players need the original STAR FRONTIERS: ALPHA DAWN and the new STAR FRONTIERS: KNIGHTHAWKS. Also needed are three 10-sided dice and scratchpaper. Beyond that, add a little creativity and imaginative role-playing, and begin your adventure in the future.

This mini-module is meant for the referee. It is based on the short story, "Into the Void," in this issue. If you intend to play a character in this module, read no further. (Sections meant to be read aloud are in large type.)

The scenario begins aboard a freighter, the United Planetary Federation's *Prachil Star*. It is bound homeworld, carrying cargo from several galaxies. In one cargo hold, it carries a precious burden: an experimental escape vessel prototype. Because of the prototype's nature, several agents of the Pan-Galactic Corporation (PGC) have been assigned to guard it while it is in transit.

Pirates have attacked several ships in this area and the possibility exists that Sathar agents would like to steal the experimental ship for its compact void drive system.

Members of the PGC are to guard the vessel, see that it does not fall into unauthorized hands, keep unauthorized personnel out of the cargo bay where it is stored, and repulse anyone seeking to sabotage or steal the prototype.

Colonel Gaedynn is commander of the PGC force aboard the *Prachil Star*. Other members of the PGC are on board the freighter, but are not with the group at the cargo bay. The adventurers have just reported for a four-hour shift of duty.

## CARGO BAY WHERE THE XV-1 IS STORED

The cargo bay is bare metal. A few common tools lie on a work bench near the cargo doors. An emergency repair kit for the hull of the freighter lies under the work bench. The XV-1 is the only item in the cargo hold other than the tools and repair kit that is

not a molded part of the freighter's hull.

Above the door is a speaker and the emergency light. In case of attack, or depressurization of the outside corridor, the light and its accompanying alarm come on. Using the speaker and the on-off switch, a person inside can communicate with someone outside of the cargo bay without opening the cargo door.

A button on a panel to the left of the cargo door controls the two-way speaker. Just below that button are three other buttons which control the door. They read "Open," "Close," and "Lock." Once locked, only a security card and thumbprint can open the door from the outside. From inside, the door can be opened by simply depressing the "Lock" button a second time. When the door is locked, the "Lock" button light is red. When unlocked, the button is unlit.

The XV-1 faces the front of the *Prachil Star*. Its starboard airlock is next to the outside bulkhead of the freighter. Anyone on the starboard side of the XV-1 cannot see the cargo bay door.

The floor of the cargo bay has mini-stanchions every ten feet. A safety line can be secured to the stanchions for zero-gravity cargo. A player in a space suit can secure his safety line to one of the stanchions by snapping it on for zero-gravity repairs inside the cargo bay.

## BATTLE IN THE CORRIDOR

Everyone has a duty station. Listed below are where PCs can be stationed prior to the beginning of this encounter:

<b>Cpt. Llewellyn</b>	Inside cargo bay doors
<b>Hota Lea</b>	Inside XV-1
<b>Violet (robot NPC)</b>	Inside XV-1
<b>Dorf</b>	By starboard airlock of XV-1
<b>Gillimk</b>	By starboard airlock of XV-1
<b>Viyizzi</b>	By port airlock of XV-1
<b>Yoe</b>	By port airlock of XV-1
<b>Slard (NPC)</b>	In corridor outside cargo bay
<b>Col. Gaedynn (NPC)</b>	In corridor outside cargo bay

During this four-hour watch, the ship is attacked. To find out when it is attacked, roll 1d4 for the hour of the watch. If the attack occurs during the first hour, give the diagram of the XV-1 to the adventurers inside the vessel in the cargo area. Do not let others see it until they enter the XV-1.

If the attack occurs in the second, third, or fourth hour, let everyone look at the XV-1 plan. No NPCs are inside the cargo bay, and PCs are never stationed outside the cargo bay.

Every hour, one of the PCs go outside the cargo bay to check the NPC on guard duty. When the attack occurs, the PC opens the door and is fired upon by a mercenary NPC.

## SATHAR AND MERCENARY STATISTICS

All Sathar and mercenaries move at a standard human rate. Specific Sathar statistics are: Str/Sta 45/45, Dex/Rs 35/35, Int/Log 40/40, Per/Ldr 55/55, Im 4, Walk/Run/Hour 10m/30m/5km. All mercenaries have the following statistics: Str/Sta 40/40, Dex/Rs 40/40, Int/Log 45/45, Per/Ldr 40/40, Im 4, Walk/Run/Hour 10m/30m/5km.

Eight Sathar, each armed with a laser rifle, are aboard the *Prachil Star*. Each Sathar commands six mercenaries (total 48). Three (of the six) are armed with projectile rifles and pistols;

one has a grenade launcher and a pistol, and the other two have laser pistols and rifles. Each mercenary has three magazines for each weapon. The mercenary with the grenade launcher has four grenades. Two of the Sathar-led groups have a heavy laser each. When the PC goes into the hall, start the attack. Read the following to the PCs:

The *Prachil Star* shudders and throbbing floorplates shake the cargo bay. The red light over the door of the cargo bay goes on, and an alarm begins whining — it's the battle alarm. A figure in a PGC uniform kneels in the corridor. Beside him lies another figure, an officer who is not moving. The figures are under fire from someone at the end of the corridor. There is a buzz, the metal of the cargo bulkhead glows, and then blackens. Several figures at the end of the corridor fire laser and projectile weapons.

If the PC checks the two in PGC uniforms, he discovers that Col. Gaedynn lies dead at Sgt. Slard's feet. The Sathar down the hall are firing at Slard and the PC.

There are two Sathar and three mercenaries. The Sathar have lasers, and the mercenaries are armed with projectile weapons. At this range, they have a flat chance of hitting Slard or the PC on:

Laser 10% Gun 05%

Every turn equals six seconds. For each turn the PC and Slard remain in the hall, a mercenary joins the troops firing at them. The first five have projectile weapons, and the sixth has a laser, and this pattern is repeated as long as PCs stay in the corridor.

If Slard or any PC is hit, they take a standard 1d10 of damage, because all weapons are set on their lowest setting to minimize chances of damaging the XV-1.

Attackers keep coming until Slard and the PC retreat to the door of the cargo bay. If anyone stays in the corridor for more than two minutes, he comes under fire from the corridor behind him. Sathar agents have worked their way behind the PCs by way of the port cargo corridor. Any shots fired by the five Sathar attackers misses the first turn they sneak up behind the PCs. Thereafter, those Sathar behind the PCs stand the same chance of hitting as the Sathar in front of the PCs.

## THE BATTLE IN THE CARGO BAY

Treat the cargo bay door as having 50 + 2d10 worth of structural points. The first turn after the PCs go inside the bay, the Sathar fire a grenade rifle at the cargo door. The grenade hits the wall beside the door, causing half its normal 8d10 damage to the door.

There is a loud, muffled explosion in the corridor. It sounds as if someone threw an explosive charge against the cargo door.

- 1 Observation Dome
- 2 Upper Bridge
- 3 Lower Bridge
- 4 Crew Quarters
- 5 Crew Quarters/Galley
- 6 Recreation Rooms/Sickbay
- 7 Maintenance/Repair
- 8-11 Cargo Holds
- \*9 Cargo Bay Where XV-1 Is Kept

## PRACHIL STAR UPF FREIGHTER

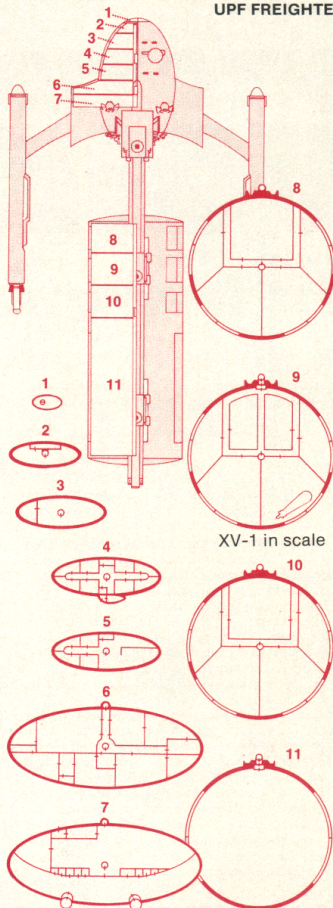

OVERALL LENGTH: 315m  
OVERALL WIDTH: 166m  
OVERALL HEIGHT: 75m

CARGO POD LENGTH: 166m  
CARGO POD WIDTH: 64m  
ENGINE LENGTH: 154m

On the third turn, the Sathar use a heavy laser on the door. It is set to use 20 Standard Energy Units (SEU) per shot/turn. A Sathar continues shooting the heavy laser at the door until the door is burned through. The first turn after the door is burned through, the hole is too hot to enter. It is cool enough not to burn through space suits on every turn thereafter.

The door then begins to get warm. The metal changes colors, glowing, sagging, and turning molten. A 24-inch hole appears.

On the first turn the door is burnt through, one Sathar mercenary may fire either a laser or a projectile weapon through it per turn. Through the hole in the cargo door, the mercenaries can see only the port side of the XV-1.

Sathar mercenaries fire at targets in the following order:

1. Anyone close to the door.
2. Anyone in the cargo bay not near the XV-1.
3. Anyone in the port airlock of the XV-1 or hiding behind the vessel and shooting at them.
4. The XV-1 itself.

Players may fire at the Sathar or attempt to board the XV-1. To board the vessel, they must go to an airlock and step inside. They may not fire during that turn, as they need both hands to get aboard the XV-1.

PCs firing at any Sathar coming through or firing through the door do so with the penalty for firing at a target behind cover. Sathar receive a penalty for firing at PCs on the starboard side of the XV-1 (treat as hard cover).

## INSIDE THE XV-1

PCs inside the XV-1 cannot see what is going on outside unless they are in either the pilot or co-pilot/gunner's seat. All PCs have some ship-handling skills, but Llewellyn is the best pilot, followed by Yoe.

It takes one turn to ready the XV-1's weapons, sublight, void, life support, and communication systems. Using the console microphone, those inside can communicate with Llewellyn (or any PC) who is wearing an exo-suit (a space suit) equipped with an intercom.

Once someone takes one of the two pilot's chairs, the others may choose any seat #3-7. Slard, an NPC, automatically takes seat #8.

Once aboard, Slard voices his uncertainty about the safety of the craft. He complains about the risk they are taking in using an untested experimental vessel, and how dangerous flying near the Sathar warships is once the XV-1 gets outside the *Prachil Star*.

Whoever is in the pilot or co-pilot's chair knows what is going on outside the XV-1. Tell that PC (and he can inform the others):

You see the PCs outside the ship moving away from the cargo door. The cargo door appears to be melting.

If the PCs switch on the vessel's power so its sensors can be used, they hear a PC say shots are being fired. Once the door has a hole melted through it, the sensors reveal life forms in the corridor outside the cargo bay.

The XV-1 is capable of sublight and void travel. Its console is no more complex than an orbital craft's.

Players inside the XV-1 should be made aware that they have very little chance of fighting their way through the corridor. If necessary, they may contact other areas of the

freighter. The advice they receive from other areas of the ship is to stay put and not attempt to enter the corridors.

Make the players aware of the capabilities of the FF laser cannon on the XV-1. The cannon has a possible 10,000 SEU at its disposal. It can be fired in increments as small as 10 SEU or as large as 100 SEU.

As soon as the players are aware that the FF laser cannon can destroy a portion of the wall, it is up to one of them to know that the XV-1 can blast a hole through it, and they can escape. If they do so, point out that one of their primary directives is to keep the XV-1 out of unauthorized hands.

The exterior wall of the ship has a value of 50 + 2d10. If the PCs attempt to blast through the wall, the cannon is set at 50 SEU. To create a hole large enough for the XV-1 to pass through, the PC must get three hits on the wall, or a total greater than the value of the wall.

When the PC makes his first hit on the wall, the cargo bay depressurizes. Anyone or anything in the cargo bay or just outside its door is sucked into space unless secured to something or safely inside the XV-1. A safety line from a spacesuit can withstand the strain of depressurization, although the sudden loss of pressure will knock a secured PC off his feet.

Any PC outside the XV-1 after the depressurization must fight in zero-gravity conditions, and make his way inside the escape craft. On the third turn after depressurization, more Sathar mercenaries come to the door and begin firing at anyone in the cargo bay. They all have laser rifles set at 20 SEU.

Should the players be reluctant to blast a hole through the outer hull of the *Prachil Star* and escape, the Sathar and their mercenaries enter the cargo bay. The Sathar and mercenaries take two turns to reach the XV-1. Once they have reached it, they can open the airlocks by pressing the button on the outside. There is no effective way of "locking" it, although the airlock between the cabin and the entry room can be locked from the console; so can the airlock going into the engineering and tail section of the craft. The Sathar can open the "locked" airlocks by firing at them as they did with the door to the cargo bay. Each airlock has a structural value of 50 + 2d10.

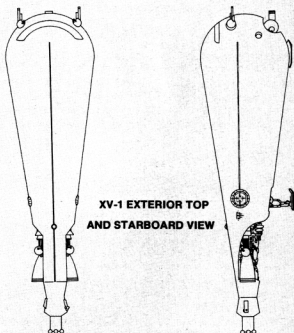

XV-1 EXTERIOR TOP AND STARBOARD VIEW

XV-1

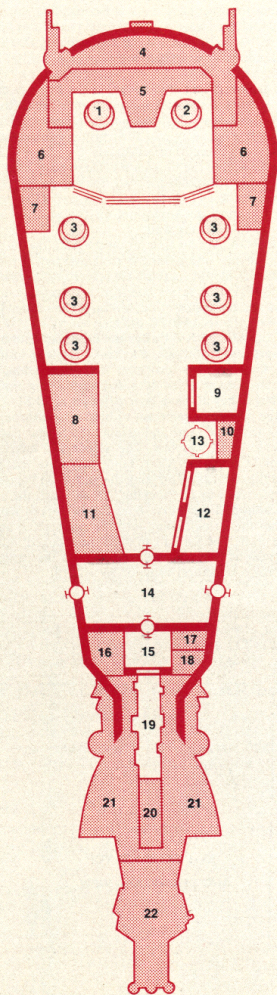

## KEY TO THE XV-1

Locations on the XV-1 are numbered for specific locations. General areas are simply referred to as forward, or the passenger compartment; the airlock entry; or the rear section. The key to the deck plan is:

- 1 Pilot's Grav-Couch
- 2 Co-pilot's/ Gunner's Grav-Couch
- 3 Passenger Grav-Couch
- 4 Gunnery Control
- 5 Flight Control Console
- 6 Life Support Console
- 7 Shield Unit
- 8 Food Processing/ Recycling
- 9 Chemical Toilet
- 10 Robotic Charging/ Service Center
- 11 Medical and Exo-Scanner Computers
- 12 Exo-Suit Storage
- 13 Robotic Mooring Station
- 14 Airlock/ Pressurization Area
- 15 Engineering Area
- 16 Astrostation Unit
- 17 Sublight Communication Comp.
- 18 Void Communication Comp.
- 19 Sublight Drive Access Way
- 20 Life Support System
- 21 Sublight Drive Unit
- 22 Void Drive Unit

Total Length 22m.

## DETAILED DESCRIPTION

Item #10, Captain's Control Console. On the console are tie-ins and screens for all computers. From this console all interior airlocks and hatches can be locked, as well as all fired weapons and powered defenses. Radio communication outside the hull, to anyone in a space suit on the same band, sublight communication, and void communication originate with the radio here.

Item #17, Robotic Charging and Tie-in Computer. This unit allows Violet to tie-in directly with the XV-1's computers and to inform the crew the extent of any damage. The computer can also fix any damage to Violet requiring fourth level skills or less. Violet has the equivalent of three power-packs, and they can be recharged from this unit.

Item #18, Medical and Exo-Scanner Computers. Using these computers, the crew can determine if any accessible asteroid can support human life. Also, the medical computers can identify damage to characters, and recommend treatment. The computer has the equivalent of 10 stimdose, a freezefield with a 2,000 SEU power pack, first aid, diagnosis, minor surgery, 10 anti-tox, communication interpretation, a built-in polyvox, 10 staydose, and 10 telol. It has a success rate of 20% in identifying/treating any life form which is not a PC.

Item #19, Exo-Suit and Weapons Storage Locker. Inside are five laser rifles each with three power packs; three laser pistols with a total of 30 power packs; a heavy laser with four power packs





# Introducing The Stars Of The STAR FRONTIERS™ Game



UNPAINTED  
ACTUAL SIZE

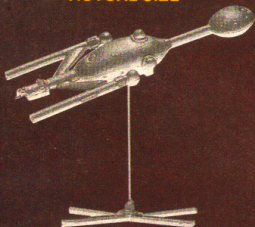

Expertly crafted and intricately detailed STAR FRONTIERS™ Metal Miniatures are the finest quality metal miniatures anywhere.

Whether you're engaging the deadly Sathar in ship-to-ship combat or exploring alien worlds, new STAR FRONTIERS™ Metal Miniatures let you see your interstellar characters and galactic encounters. In fact, superbly crafted white metal STAR FRONTIERS™ miniatures are great for any game.

STAR FRONTIERS™ are the only metal miniatures authorized for use with the STAR FRONTIERS™ game. The four boxed sets of metal miniatures include STAR FRONTIERS™ Player Characters and Monsters, as well as STAR FRONTIERS™ *Knight Hawks* Federation and Sathar spaceships.

Bring your galactic adventures to life with the only Official STAR FRONTIERS™ Miniatures — available in August at toy, hobby and gift stores everywhere.

Perfect for use with Official AD&D™ paints, brushes and adhesives. Some assembly required. Ages 14 and up.

TSR Hobbies, Inc.  
Producers of DUNGEONS & DRAGONS® games

For your free color poster/catalog write:

In the U.S.:

TSR Hobbies, Inc.  
P.O. Box 756, C213A1  
Lake Geneva, WI 53147

In the UK:

TSR Hobbies, (UK) Ltd.  
The Mill, Rathmore Rd.  
Cambridge, ENGLAND  
CB1 4AD



TSR Hobbies, Inc.  
Products Of Your Imagination.™

and tripod; four machetes; two vibroknives and power packs; three automatic rifles with three magazines each; three automatic pistols with three magazines each and 2,000 rounds of pistol ammunition in a box; six holoflars; eight all-weather coveralls with arctic inserts; and three exo-suits with helmets.

When the PCs use the XV-1 to exit the freighter, they must do so at sublight drive speed. If they attempt to use void drive, the void computer automatically cuts the void drive off. A second attempt results in a flashing message from the computer: *Void drive cannot be activated in a confined space. Move to open space and reactivate void drive unit.*

### ATTACK BY SATHAR FIGHTERS

Once outside the hull of the freighter, the PCs are attacked by Sathar Fighters and a Sathar Frigate. The Sathar ships fire bursts of increasing strength (10 SEU, 20 SEU, etc. . . ) until it is evident that the PCs do not intend to stop. The Sathar may increase their power to 100 SEU once the XV-1 fires on one of them and achieves a hit. After that happens, or when the PCs go into void drive, the Sathar Frigate fires its last torpedo.

The torpedo hits the XV-1, but does negligible damage. It damages three different areas of the XV-1 using the STAR FRONTIERS: KNIGHTHAWKS™ Advanced Damage/Location Table. None of the damage is multiple. If the d% indicates more than one hit in an area, roll again. If the void drive is hit, it is damaged. If no die roll results in damage to the void drive, assign damage there. The XV-1 goes into the void one time, and thereafter the void drive malfunctions as follows.

After the first void drive attempt any further trials will force the XV-1 to jump backward 10,000 km. The XV-1 may successfully jump into the void as it fights the Sathar Fighters and Frigate the first time, and then it takes void drive damage. Thereafter, any attempts to jump the void result in the XV-1 going backward as outlined.

The XV-1 may take damage to the ammunition supply of its cannon. Treat each 100 SEU as one shot. Under no circumstance is the XV-1 to have less than two shots at the final scenario. Other ammunition may be destroyed, as long as 200 SEU remain.

### INTO THE VOID

The XV-1 has jumped into the void successfully. It now lies far away from the ships attacking the *Prachil Star*. The portion of space it occupies is unknown to all aboard the vessel.

A vast expanse of space lies ahead. The astrogation computers show that the ship has jumped across space into the void.

If the PCs attempt to use the astrogation computers further, give them computer feedback that is gibberish. If the players think to have the command console run a check on the XV-1's systems, reveal that they cannot fully access void drive, void communication, or astrogation.

If a player thinks to link Violet to the void computer, tell him that the system has sustained minimal damage.

Any further attempts to jump into the void result in the XV-1 jumping backward 1d6 x 10,000 km in a straight line. If the players do not think to jump backward after a reasonable period of time, let Hota Lea attempt to fix the computer. After a brief interval, she announces:

With the equipment we have on board, attempting to fix the computer is like trying to fix void drive with a screwdriver.

Violet can diagnose what is wrong with the ship, if asked. She can also indicate what will happen if the PCs attempt to use void drive, i.e., the XV-1 will jump backward up to 60,000 km. If asked to attempt to repair it, Violet answers:

I am one of the finest diagnostic medical robots available. I am not a surgical robot. I am not a robotic repair unit. The damaged circuit is in such a place on the panel that we would have to chance leaving the XV-1 a floating hulk, totally without power. The chances of such an operation succeeding with our limited repair facilities are 11 in 3,736,941. The chances of compounding the damage with human error are prohibitive. It would be unwise to attempt repairs outside of a qualified and well-fitted repair facility.

Aboard the XV-1, all computers, drives, and numbered areas have an access panel from both the interior and exterior of the ship. To attempt repairs on any of these computers or drives requires a tech Level 5 repairing machinery, and a robotics skill Level 6 altering mission, as well as Level 6 repairing computers.

For sublight drive, a Level 3 repairing machinery is needed. Anyone with any operating machinery skill can fly this simple craft. In order to operate the FF cannon, a person must have a military skill with beam weapons, or the ability to operate machinery, as firing is integral to the operation of the XV-1.

### SLARD, THE TRAITOR

Once the vessel has been explored, and the damage assessed, the NPC Slard begins having what the PCs may interpret as "second thoughts" about escaping the battle. He talks to them about how badly damaged the ship is, and how it might be wiser to seek an inhabited planet or habitable asteroid and send out a distress signal on all operating bands. Slard says:

I don't know how much damage this vessel can take. How do we know Violet's right? After all, it is primarily a medical robot — it might have made a mistake.

If the PCs think Slard's assessment is correct, Slard plays along with them until a suitable asteroid is found. To find a habitable asteroid, roll 1d10 every turn. A result of 1 means an asteroid capable of supporting life has been located.

If the PCs do not find an asteroid within ten turns, or if they do not agree to Slard's plan, he acts as if nothing is the matter. As soon as he has a chance, he secretly pulls out his weapon, a laser pistol, and orders the XV-1 to go in the direction from which they came. Slard says:

All right, listen to me. I am taking over command of this ship. We're going to turn her right around and go back where we came from. Nobody do anything foolish, and we'll all live a lot longer.

If PCs accuse Slard of being a Sathar agent, he tells them the truth: The Sathar want the XV-1 because they heard rumors about how well it works. They want it to use its drive system and computers on kamikaze fighters for attacks on PGC ships, bases, and planets. Slard says:

What's a traitor? I see which way things are going, and I want to be on the winning side. A traitor becomes a hero when his side wins — he's only a



**Role play with the best.**

**Join the only official  
DUNGEONS & DRAGONS<sup>®</sup>  
game club.**

**T**housands of gamers the world over agree that our new fully illustrated, 32-page POLYHEDRON™ Newszine and the RPGA™ Network are the best way to stay in the arena with the most avid

role players. There are membership cards and pins, new product releases and a two-way communication with the experts. For membership applications write:  
RPGA HQ, C185A1, Box 509  
Lake Geneva, WI 53147



DUNGEONS & DRAGONS and POLYHEDRON are trademarks owned by TSR Hobbies, Inc. RPGA is a service mark owned by TSR Hobbies, Inc.  
©1983 TSR Hobbies, Inc. All Rights Reserved.

traitor if his side loses. The Sathar pay well, and they aren't going to lose.

Slard is alert. A player must have a reaction speed of better than 5 to catch Slard off-guard. If a PC with a reaction speed of 5 or less attempts to draw his weapon, Slard receives first shot at them.

Players in their grav-couches suffer a -20 to their dexterity. If they draw their weapon, they must also make their dexterity roll or Slard will fire first. A player attempting to draw his weapon, but failing his dexterity roll, still is able to fire. Failure means that he did not draw quickly enough to get first shot.

Players shooting at Slard may hit him. If so, consult the star frontiers chart for damage. If they miss Slard, check what is in their line of fire, and have them roll again to see if they hit anything. All interior items (with the exception of airlocks and separating walls, which have already been covered) have 25 + 1d10 of structural points. If the number of points is exceeded, the machinery or computer is damaged.

When fired upon, Slard returns fire at the nearest target firing at him, or moving toward him. If several targets are equidistant from Slard, he returns fire to the one most nearby in front of him.

Slard also has a doze grenade and a tangler grenade in his suit. On the second round of firing, he throws the doze grenade at those firing at him. On the following round, he throws the tangler grenade at the PCs in the pilot/co-pilot area.

Should Slard die or be incapacitated, the PCs become aware of a blip on the sensor screen. If they ask the computer, it reveals that the blip on the screen is most likely the Sathar Frigate which has followed them into the void.

## ENCOUNTER WITH THE SATHAR FRIGATE

When the Frigate appears, the PCs notice a blip on their sensor screen. The Sathar vessel does not attack them at once. It prefers to take the XV-1 undamaged. Over the sublight intercom comes the message:

Surrender! You will be well treated. It is futile to resist. Further attempts at evasion will result in your vessel being destroyed. We offer you your lives.

The offer, of course, is only a ploy to capture the XV-1. The PCs who surrender will be brainwashed and sent back to the UPF as saboteurs. Should any resist, they will be executed on the spot.

If the PCs attempt to escape, the Sathar fires on them with laser cannons. The first Sathar shots automatically miss. Thereafter, the Sathar has a 20% chance of hitting the XV-1. The XV-1 has 150 structural points. All damage from the Sathar is non-specific. If it is important that the players know, roll on the Weapons Table in the STAR FRONTIERS Expanded Game Rules to see where damage would occur, and tell the players that the XV-1 is partially damaged in that area.

The PCs may be able to bring the XV-1 about and face the Sathar. If they do so, allow them to fight normally, but the Sathar has the option of using all weaponry, save the torpedoes. The Sathar Frigate fired its last torpedo at the XV-1 in the previous encounter when it damaged the XV-1's void drive system.

If the PCs use the vessel to jump backward and put themselves behind the Sathar, allow them to do so. When they shoot from behind, give them two rolls on the Advanced Damage Chart from KNIGHTHAWKS™ to show the severe effect of this unexpected maneuver.

If the PCs have not destroyed the Sathar prior to their fourth hit on the Sathar, the fourth hit will blow up the Sathar Frigate.

Once the Sathar is destroyed, the players automatically find an asteroid which is habitable. They cannot repair void drive or void communication, although they have sublight capability in both areas. They may wait for help, or explore the asteroid while awaiting rescue.

## PLAYER CHARACTER STATISTICS

Capt. Dai Llewellyn: Str/Sta 50/50, Dex/Rs 55/55, Int/Log 50/50, Per/Ldr 65/70, Im 6. Left-handed human male. Armed with laser pistol, 9mm service automatic (projectile) pistol, gyrojet pistol and a vibroknife. His skills are: Level 3 beam, projectile and gyrojet weapons; Level 2 thrown weapons, and martial arts; Level 2 operating machinery, detecting alarms, and Level 1 tracking and first aid. He has an albedo suit under his exo-suit (spacesuit).

Viyizzi: Str/Sta 25/25, Dex/Rs 65/65, Int/Log 45/45, Per/Ldr 60/60, Im 7. She is an ambidextrous Yazirian female, armed with a laser pistol, automatic pistol, and vibroknife. She wears an albedo suit, and has the following ability levels: Level 4 beam and projectile weapons; Level 3 deactivating alarms; Level 2 tracking, survival, and stealth.

Yoe: Str/Sta 60/60, Dex/Rs 55/55, Int/Log 40/40, Per/Ldr 50/50, Im 6. He is an overweight Yazirian male able to "glide" only on the lightest gravity planets, and is right-handed. He carries a laser pistol and a vibroknife, and wears an albedo suit. His experience levels are: Level 1 beam and projectile weapons; Level 2 setting charges, following directions; Level 3 operating machinery and repairing machinery.

Hota Lea: Str/Sta 55/55, Dex/Rs 50/50, Int/Log 70/75, Per/Ldr 40/40, Im 4. She is a right-handed human female. She carries a laser pistol and vibroknife and wears an albedo suit. Her experience levels are: Level 1 beam and projectile weapons; Level 2 bypassing security, manipulating programs; Level 3 operating computers, interfacing, and repairing computers; Level 4 repairing robots, altering functions, and altering mission.

Dorf: Str/Sta 55/55, Dex/Rs 45/45, Int/Log 35/35, Per/Ldr 50/50, Im 5. Dorf is a Dralist who wears an albedo suit, carries a laser pistol and vibroknife, and has a permanent "arm/pseudopod" on his right side due to an accident in the Sathar Wars. His experience levels are: Level 1 beam and projectile weapons; Level 2 martial arts; Level 3 making tools/weapons, and empathy.

Gillmik: Str/Sta 45/45, Dex/Rs 45/45, Int/Log 40/40, Per/Ldr 45/45, Im 5. He is an ambidextrous Vruskan male who wears an albedo suit and carries a laser pistol and vibroknife. His experience levels are: Level 1 beam and projectile weapons; Level 2 operating machinery, repairing machinery; Level 3 first aid, controlling infection.

## NON-PLAYER CHARACTER STATISTICS

Slard: Str/Sta 50/50, Dex/Rs 40/40, Int/Log 45/45, Per/Ldr 50/50, Im 4. He is a right-handed human male who wears an albedo suit. He is armed with a laser pistol, a vibroknife, a doze grenade, and a tangler grenade. His experience levels are: Level 1 thrown weapons; Level 2 beam and projectile weapons; Level 3 making tools/weapons. **A**

**L**ONG, LONG AGO A RACE TRAVELED THE UNIVERSES. THEIR NAME, THEIR CULTURE AND THEIR CIVILIZATION HAVE ALL BEEN FORGOTTEN, BUT RELICS OF THEIR ADVANCED ACHIEVEMENTS LINGER ON... **RINGSHIPS!**

WE SHALL JUST HAVE TO SEE. BRING US ABOUT TO 21.3 AND UP ALONG HER STARBOARD SIDE!

VESSEL ENTERING DYNACO SPACE AT MARK 21.3; LOOKS LIKE A MERCHANTMAN. FAIR PLUNDER, AYE CAPTAIN?

WAVESENDER, OPEN UP A CHANNEL TO HER. TELL THEM TO PREPARE TO BE BOARDED!

SHE'S FIRING ON US! HAVE THE PORT SIDE GUNNERS GIVE HER A ROUND BROADSIDE!

THE BLOODY IDIOTS! MUST THEY FORCE THEIR DEATHS UPON ME!?

TO BE CONTINUED...

# RINGSHIPPER

# FEEDBACK QUESTIONS

## ARES™ MAGAZINE, FALL 1983

**How to Use the Feedback Response Card:** After you have finished reading this issue of Ares™ Magazine, please read the Feedback questions below, and give us your answers by writing the answer numbers on the card in the response boxes which correspond to each question number. In the first two shaded boxes (questions 1 and 2), put the issue number of this magazine; thus, for issue number 15, a "1" would go in the first question box and "5" would go in the second question box.

The Feedback section is an important means for us to learn your interests and opinions both on the contents of this issue and on future materials and games that may appear in the magazine or as boxed items.

**What the numbers mean:** When answering the questions, a "0" response always means NO OPINION or NOT APPLICABLE. When the question is a "yes" or "no" question, a response of "1" means YES and a "2" means NO. When the question is a rating question, a response of "1" is the WORST rating, a "2" is a POOR rating, a "3" is an AVERAGE rating, a "4" is a GOOD rating, and a "5" is the BEST rating. Please be sure to answer all questions (but do not write anything in the box for the question-numbers labelled "no question"). Incompletely filled-out cards can not be processed.

**Please Note:** TSR Hobbies uses a 1 to 5 scale for its surveys. Readers should not use the former 1 to 9 rating scale or the response card will be invalid.

1-3. No question.

The following questions ask you to rate the articles in this issue on a scale of 1 (poor) through 5 (excellent) 0 = No opinion.

1. NIGHTMARE HOUSE™ Game
2. Haunted Places article
3. Matters of Fact science column
4. Into the Void mini-module
5. Games (reviews)
6. Books (reviews)
7. Film (reviews)
8. This issue overall
9. Is this issue better than the last one?  
1 = Yes; 2 = No.
10. Assume you don't subscribe to Ares Magazine. Would the quality of this issue alone motivate you to subscribe? 1 = Yes; 2 = No.
11. Do you subscribe to Ares Magazine?  
1 = Yes; 2 = No.
12. Your age: 0 = 15 years old or younger; 1 = 16-19; 2 = 20-24; 3 = 25-29; 4 = 30-34; 5 = 35 years or older
13. Education: 0 = 8 years or less; 1 = 9-11 years; 2 = 12 years; 3 = 13-15 years; 4 = 16 years; 5 = 17 years or more.
14. What is the average number of times each month you spend playing simulation games? 0 = none; 1 = once or twice; 2 = 3-6 times; 3 = 7-9 times; 4 = 10-15 times; 5 = 16 or more times.
15. How long have you been playing simulation games? 0 = less than a year; 1 = 1 year; 2 = 2-3 years; 3 = 4-6 years; 4 = 7-9 years; 5 = 10 years or more.
16. How many simulation games (of all publishers) do you possess? 0 = 1-30; 2 = 31-60; 3 = 61-90; 4 = 91-120; 5 = 121 or more.
17. How many science fiction/science fantasy boardgames (of all publishers) do you possess? 0 = none; 1 = 1-15; 2 = 16-30; 3 = 31-45; 4 = 46-60; 5 = 61 or more.
18. How many fantasy boardgames (of all publishers) do you possess? 0 = none; 1 = 1-15; 2 = 16-30; 3 = 31-45; 4 = 46-60; 5 = 61 or more.
19. How many science fiction and fantasy role-playing games (complete game

systems, not adventures or modules) do you possess? 0 = none; 1 = 2; 2 = 3-6; 3 = 6-9; 4 = 10-15; 5 = 16 or more.

20. What level of complexity do you prefer in your simulation games? Rate your preference on a 1 to 5 scale, using the following games as guides; 1 = THE CREATURE THAT ATE SHEBOYGANTM game; 2 = RAGNAROK™ game; 3 = STAR FORCE™ game; 4 = ALBION: LAND OF FAERIE™ game; 5 = BATTLEFLEET: MARSTM game.

*Questions 24 through 73 concern games. Pick the one statement that is most true about each game: 0 = I have never seen or played the game; 1 = I have seen others play this game but have never played it myself; 2 = I do not own a copy but I occasionally play the game; 3 = I do not own a copy but I frequently play the game; 4 = I own the game and play it occasionally; 5 = I own the game and play it frequently. Games by other publishers are indicated by initials or names in parentheses.*

24. Imperium™ Game (GDW)
25. CREATURE . . . SHEBOYGANTM Game (SPI)
26. GEVTM Game (SjG)
27. Freedom in the Galaxy™ Game (AH)
28. Starfleet Battles™ Game (TFG)
29. SWORD & THE STARSTM Game (SPI)
30. Ogre™ Game (TSG)
31. VOYAGE OF THE PANDORATM Game (SPI)
32. Dark Nebula™ Game (GDW)
33. BATTLEFLEET MARSTM Game (SPI)
34. Traveller™ Game (GDW)
35. Starfire II™ Game (TFG)
36. JOHN CARTER OF MARSTM Game (SPI)
37. Stellar Conquest™ Game (MGC)
38. Asteroid™ Game (GDW)
39. Cosmic Encounters™ Game (EP)
40. TIMETRIPPERTM Game (SPI)
41. OBJECTIVE MOSCOW™ Game (SPI)
42. TRIPLANETARY™ Game (SPI)
43. Space Opera™ Game (FGUI)
44. AFTER THE HOLOCAUST™ Game (SPI)
45. Mayday™ Game (GDW)

46. Starship Troopers™ Game (AH)
  47. STAR TRADER™ Game (SPI)
  48. DAMOCLES MISSION™ Game (SPI)
  49. OMEGA WARTM Game (SPI)
  50. STAINLESS STEEL RAT™ Game (SPI)
  51. INVASION AMERICATM Game (SPI)
  52. Bloodrebellion™ Game (GDW)
  53. Doctor Who™ Game (GW)
  54. Belter™ Game (GDW)
  55. STARFORCETM Game (SPI)
  56. Starfire™ Game (TFG)
  57. Olympica™ Game (MGC)
  58. Ice War™ Game (MGC)
  59. WORLDKILLERTM Game (SPI)
  60. Double Star™ Game (GDW)
  61. Cerebrus™ Game (TFG)
  62. Artifact™ Game (MGC)
  63. Starfall™ Game (YP)
  64. RESCUE FROM THE HIVETM Game (SPI)
  65. Kung Fu 2100™ Game (SjG)
  66. Car Wars™ Game (SjG)
  67. Illuminati™ Game (SjG)
  68. Gamma World® Game, 2nd Edition (TSR)
  69. Hot Spot™ Game (MGC)
  70. Striker™ Game (GDW)
  71. Nuclear War Card Game™ (FBI)
  72. Dune™ Game (AH)
  73. REVOLT ON ANTARESTM Game (TSR)
- Questions 74 through 92 concern magazines. Pick the one statement that is most true about each magazine: 0 = I have never seen or bought this magazine; 1 = I have never had a subscription to this magazine, but I have bought one or more copies at a newsstand or hobby outlet; 2 = I used to subscribe to this magazine, but I no longer buy any issues; 3 = I used to subscribe to this magazine, but I only buy issues now at a newsstand or hobby outlet; 4 = I now have subscribed to this magazine for a year or less; 5 = I now have subscribed for a year or more.*
74. STRATEGY & TACTICS® Magazine
  75. ARES™ Magazine
  76. DRAGON™ Magazine
  77. Fire & Movement
  78. The Space Gamer
  79. The Wargamer
  80. Sorcerer's Apprentice
  81. Different Worlds
  82. Journal of 20th Century Wargaming
  83. Nexus
  84. Journal of the Traveller's Aid Society
  85. The General
  86. Analog
  87. AMAZING™ Magazine
  88. Omni
  89. Scientific American
  90. Newsweek
  91. Games
  92. Byte
- 93-96. No question.

# Hardcover Editions of a Dark-Ages Drama

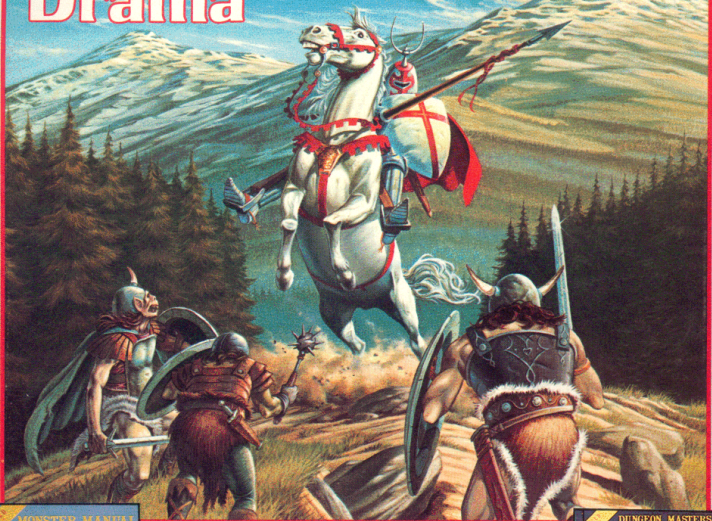

MONSTER MANUAL

PLAYERS HANDBOOK

Field Folio



DUNGEON MASTERS  
GUIDE

TRIP PRESENTS  
DEITIES  
& DEMIGODS



## ADVANCED DUNGEONS & DRAGONS® Game System

Our world-famous AD&D™ game system converts the novice enthusiast into a paragon of chivalry. Within the hardbound pages of our books lurks an immeasurable wealth of information. And now that AD&D™ books are hot enough to be added to any "best sellers" list, more and more players have graduated to the highest ranks.

Become part of our prominent class of AD&D™ game players by starting your set today!



In the U.S.  
TSR, Inc.  
P.O. Box 756, C213A1  
Lake Geneva, WI 53147

In the UK:  
TSR Hobbies, (UK) Ltd.  
The Mill, Rathmore Rd.  
Cambridge, England  
CB14AD

# STAR TREK™

THE ROLE PLAYING GAME



A FLEET OF KLINGON D-7 BATTLECRUISERS HAVE SURROUNDED THE USS ENTERPRISE AND ARE READY TO ATTACK!!!! YOU ARE CAPTAIN KIRK! WHAT WILL YOU DO TO SAVE THE LIVES OF YOUR CREW AND YOUR SHIP?

STAR TREK™: The Role Playing Game — \$25.00



STAR TREK™: The Role Playing Game is manufactured by FASA Corporation under exclusive license from Paramount Pictures.



NIGHTMARE HOUSE™ Gothic Horror Boardgame Counter Section Nr. 1  
 (200 pieces) Front.

Quantity of sections of this identical type in game: 1. Total quantity of sections (all types) in game: 1

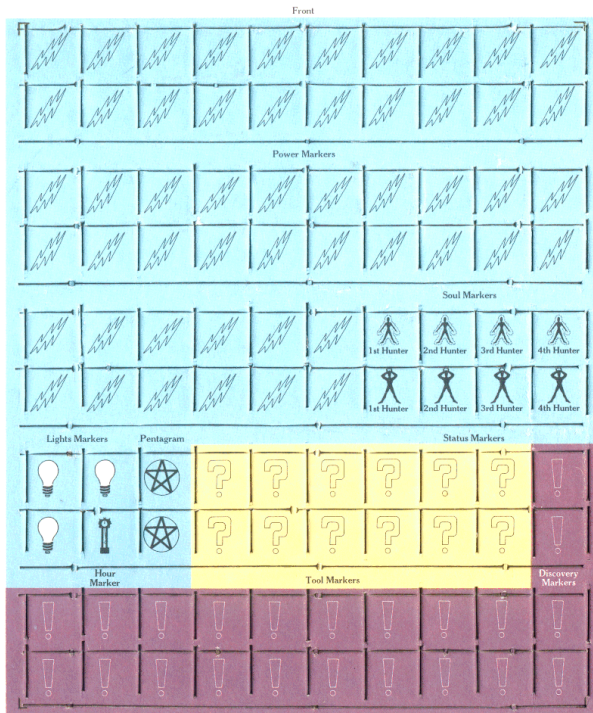
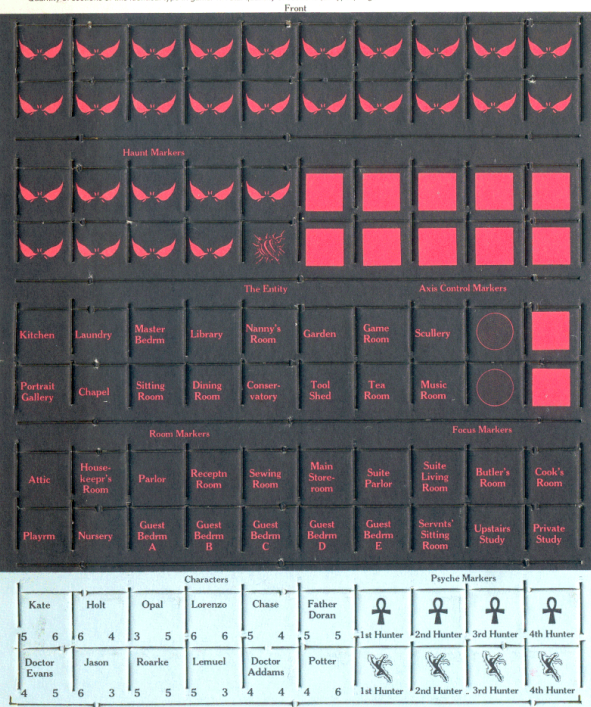

Back



©Copyright 1983, TSR, Inc. All Rights Reserved.

NIGHTMARE HOUSE™ Gothic Horror Boardgame Counter Section Nr. 1  
(200 pieces) Back.

Back



# NIGHTMARE HOUSE™

A GOTHIC HORROR BOARDGAME

A GOTHIC HORROR BOARDGAME

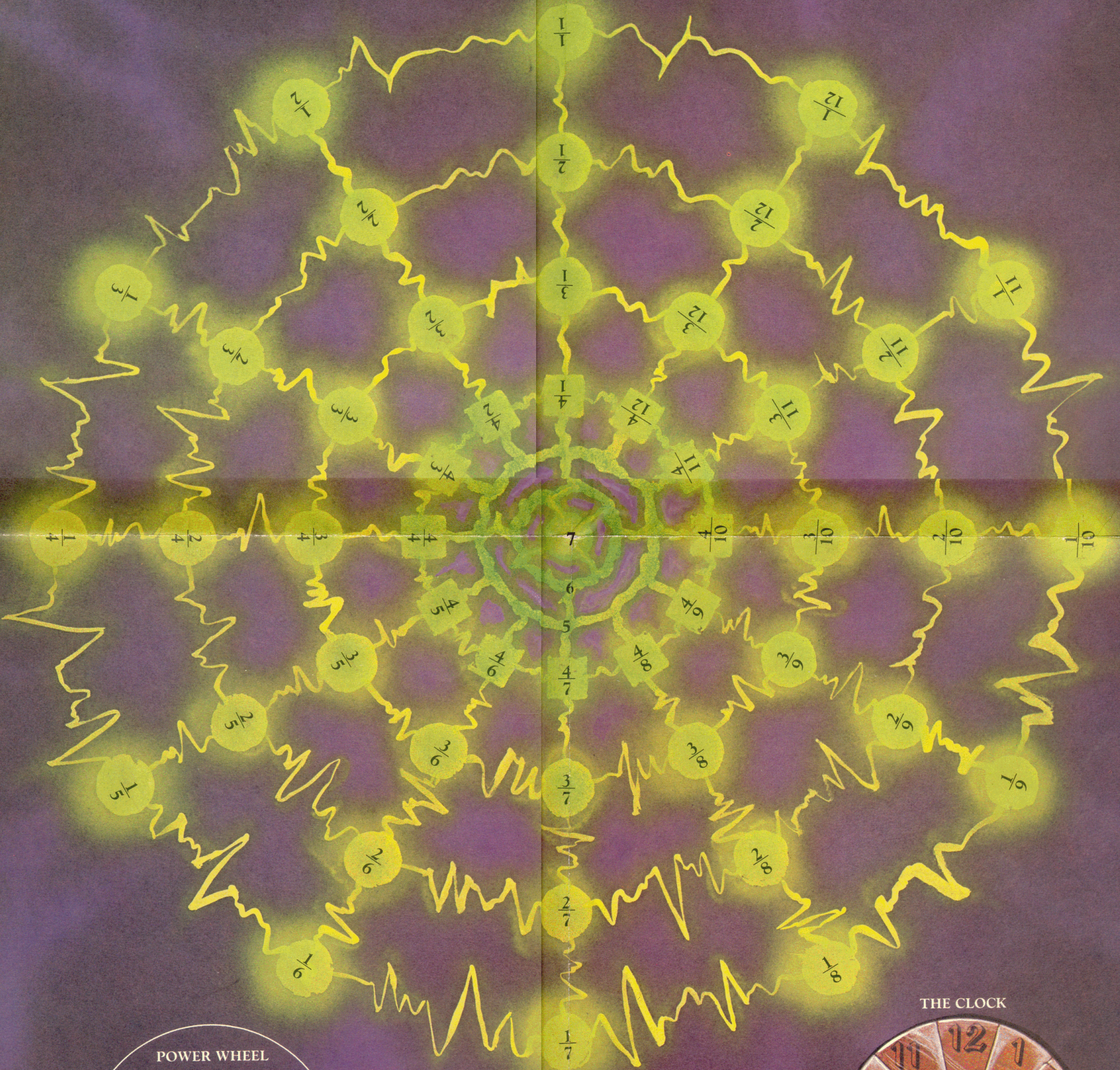

THE ASTRAL MAP

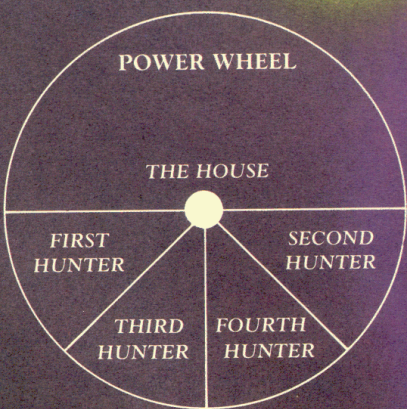

THE CLOCK

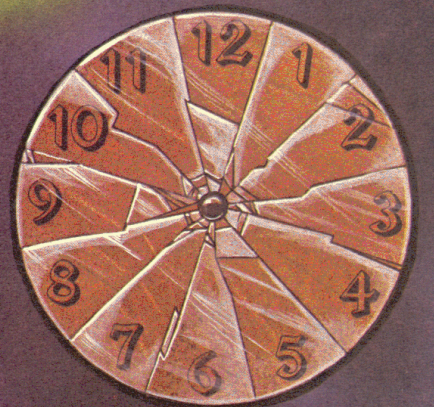

SOUL TRACK

Lemuel 12	Jason Chase 11	Doran Opal 10	Addams Evans 9	Roarke Holt 8	Lorenzo Potter 7
0	1	2	3	4	5
					Kate 6

