

# ADVENTURE GAMING

\$3.00

\$3.60 in CANADA

november, 1981



vol. 1, no. 5  
five

*Hamptier* ©1981

# GALACTIC GRENADIERS®

This is the distant future. The galaxy has been colonized, and is under the control of the Terran Interplanetary Confederation. To maintain order throughout the vast galactic spaces, the Terrans' elite strike force, the Galactic Grenadiers, are equipped with the most awesome arsenal of weapons ever devised, all controlled with built-in microtactical assault computers. A single Galactic Grenadier, in an unopposed attack, has the power to annihilate a city in a microsecond. As a team, the Galactic Grenadiers can wipe out all traces of life on an entire planet in one operation.

GALACTIC GRENADIERS®, for beginners of adventure gaming, contains everything you need to blast off on the most incredible space adventure ever: • 12-member GALACTIC GRENADIER® strike team, armed with rifles, rockets, grenades and microtactical assault computers. • 28-member defense force. • Two six-sided dice. • Complete playing aids and accessories. • Game guidelines with suggestions for game variations.

All game characters—40 in all—are 15mm detailed replicas of future space warriors. All you need to begin play is imagination, tactical skill, and enough space to let your spirit of adventure soar.



TRIAL PARTHA

5938 CARTHAGE CT. • CINCINNATI, OHIO 45212

# ADVENTURE GAMING

vol. 1, no. 5

november

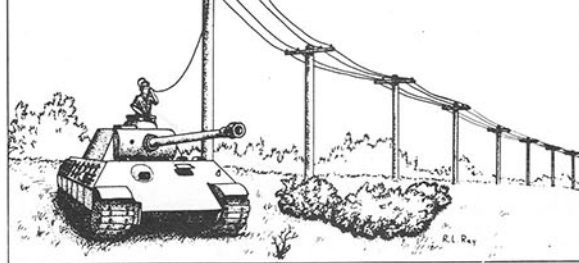

PLAY-BY-PHONE  
page 48



TITAN EVOLUTION  
page 8

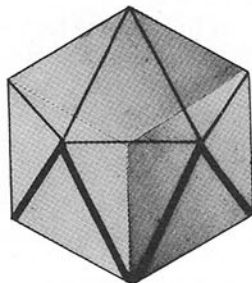

Editor and Publisher  
— Timothy J. Kask  
Ass't Editor  
and  
Distribution Mgr.  
— Kathleen Pettigrew  
Graphic Design Staff  
— Penni Rubin  
Jane Flitner  
Staff Artist  
William Neff

Cover Art by Dave Trampier

ADVENTURE GAMING is published by Manzakk Publishing, Inc., P.O. Box 12291, Norwood, OH 45212, monthly.

It is available at better hobby shops and bookstores, or by subscription. Subscription rate is \$29 for 13 months. Single copy price is \$3 (U.S.), and \$3.60 (Canadian). For back issue availability and prices, contact publisher. Canadian and overseas subscription rates available upon request.

All material published herein becomes the exclusive property of the publisher unless special arrangements to the contrary are made in advance.

Issues are numbered consecutively; subscription expiration is coded on the mailing label. The number with "AG" prefix is last issue that subscriber will receive.

Change of address must be furnished at least thirty days prior to mailing.

Unsolicited material, while welcome, can not be returned unless accompanied by a SASE, and no responsibility for such material can be assumed by the publisher in any event.

All rights on the entire contents of this magazine are reserved and nothing may be reprinted in whole or part without the written permission of the publisher. ©Copyright 1981 by Manzakk Publishing, Inc.

## SPECIAL FEATURES

- 8 **Evolving Forces in TITAN™**  
by Dave Trampier
- 48 **PANZER®, 88®, ARMOR® and Ma Bell**  
play-by-phone gaming  
by Tony Adams

## FEATURES

- 9 **The History of TITAN™**  
by Jason McAllister
- 11 **Waging TITAN™—Tactics**  
by Jason McAllister
- 26 **The Chaos of Battle: Partnership Boardgames**  
by Lewis Pulsipher
- 30 **Coming of Age on Cidri**  
pre-adventuring experience in THE FANTASY TRIP®  
by Harry White
- 32 **The First Romulan War—Pt. II**  
STAR FLEET BATTLES® scenarios  
by Rick D. Stuart
- 37 **Everything . . . To Know About Atari SPACE INVADERS®**  
by Mark Cummings
- 53 **What Our Hobby Needs Is A Yearbook**  
Guest Opinion  
by Lewish Pulsipher

## INTERVIEW

- 5 **Al Leonard!**  
co-designer of ACE OF ACES® . . . Pt. II

## REVIEWS

- 13 **Periscope**  
gaming accessories
- 18 **IRONBOTTOM SOUND®**
- 20 **FIEND FOLIO®**
- 24 **COMPUTER AMBUSH®**

## THE FUNNY PAGES

- 44 **The Adventures of Space Trader Vic**
- 45 **The Adventures of Finleous Fingers**
- 46 **Brom & Arylla**

## DEPARTMENTS

- 4 **Off The Wall**
- 21 **BOOKS**
- 23 **LETTERS**
- 28 **PHIGURE PHOTOS**
- 40 **Fox-2**
- 51 **Boardgame Talk**

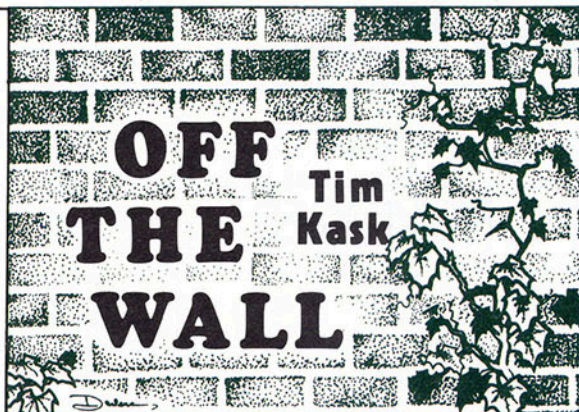
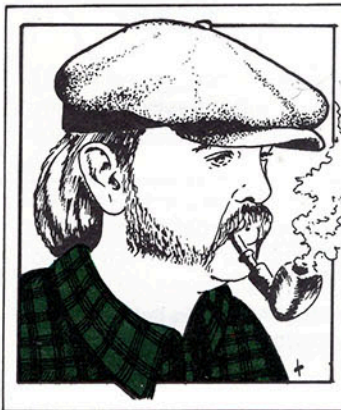

## Is Imagination Dying?

Of all the criteria necessary for the making of a fantasy gamer, none is as important as imagination. Intelligence, inquisitiveness, flexibility and the willing suspension of disbelief — all are necessary to one degree or another. Without imagination, it all comes unraveled.

In fantasy roleplaying, imagination is what binds the players together, and bonds them to the gamemaster. In particular, it is their ability to share a common image/imagery/imagination that enables the whole thing to function.

Six years ago, when FRP was brand new, it was primarily those persons endowed with vivid, sometimes lurid, imaginations that first picked up on the whole thing.

There were no pre-prepared adventures until the Temple of the Frog appeared in *Blackmoor*®. Prior to that, any adventure that anyone played in was homemade. They had much more of a hodgepodge ambience to them as we each added whatever bits and pieces suited us. This meant throwing in a dash of mythology, bits and pieces gleaned from favorite stories and novels, heavily seasoned by our sense of "rightness".

During the last couple of months I have begun to notice something that I find vaguely disturbing. If my observations are representative of the hobby as a whole, FRP is losing something. More and more FRP'ers have never played in any adventure other than a commercially produced one.

Granted, not every person that plays FRP has the time and/or inclination to sit down and design their own dungeons. (In this case, I use the term "dungeon" generically to refer to all adventure settings, whether or not they are actually set underground.) There has always

been a dichotomy between players and GM's. Some players, back in the earliest days of FRP when nothing was pre-prepared, never evinced either the desire or the inclination to be a GM. There were those who simply wanted to play, and there were those who wanted to create and/or control the action. Of the former group, there was always a matriculation upwards of new creators/controllers, thus providing the new blood and insights necessary for FRP to both spread and evolve.

Seemingly, fewer and fewer players (percentage-wise) are interested in becoming creators. Similarly, it seems that fewer and fewer of the players show any signs of wishing to become controllers or leaders, but remain content to be followers.

I do not dispute that pre-prepared modules have done a great service to the hobby. When I was still an active GM, I used a couple, and bits and pieces of others, after they started coming out. In many cases they were invaluable in providing grist for the gaming mill while I hammered out the final details of my own creations. Particularly for younger players, who did not yet have an extensive reading background, they were a great boon. They also served as both models and the incentive to do one's own.

Today, though, I worry that they might be stifling creativity and imagination. The incentive, or even the need, to stretch one's imagination has diminished. Every game store that deals in FRP games is overrun by commercially produced modules. All too many of them are prepared to too great a degree. Too many of them have already set out the goals and determined the rewards before a single adventurer sets foot in them.

Not all pre-prepared modules suffer from this. Some of them are simply

"settings", and what you make of them or how you integrate them is still left to the GM. Perhaps the best example to date is the excellent *Thieves' World* produced by Chaosium and reviewed in last month's issue. In it, they have prepared the town of Sanctuary and left it up to each GM what he does with it.

I myself am guilty to a degree for the proliferation of the more rigidly structured type, having published some of them at my first magazine and having published one last month. But they were never meant to supplant imagination. They were originally meant to supplement the creative process, not to cause imagination to atrophy.

Instead of serving as instruction on design and continuity, they have become the staple of more and more players.

What happens if for some reason the flood of modules is cut off? No company can produce at a terrific pace for long and still maintain a high level of quality. For games that are rigidly licensed and controlled, what happens when they slow down? This past season we may have already seen our first indicator of the slowing process when TSR only came out with four *AD&D*® modules. If we have become a group of *consumers* where will the *creators* come from?

FRP has always been an exercise of imagination, creativity, and extemporaneous thought, but I feel that the first two are diminishing. Granted, many who play today might not if there had been no pre-prepared adventures in which to get their feet wet. But how many of them now realize that there is another way to go?

It is difficult to briefly describe the pleasure one gets from weaving his own tapestry of events, controlling the loom of the Norns. The fact that so many other hands are on the shuttle, influencing the weave, in no way diminishes the pleasure, as it invariably results in a finer finished product with a tighter weave and fewer flaws.

I urge every GM to try his hand. Don't be intimidated if you don't feel that your effort will compare to a professional one. It doesn't have to, you're not a pro. The only thing that matters is that the players enjoy it. Designing your own adventures will provide you with a level of insight into the game that you will never truly experience by merely moderating somebody else's operation.

# INTERVIEW

## Ace of Aces<sup>©</sup>

### Introduction

*Al Leonardi is one of the co-designers of the innovative new game Ace of Aces, with Douglas Kaufman.*

*In the first half of the interview, published last month, we ascertained that Al teaches in a middle school, and that games have a role of prominence in his classroom.*

*We discussed the new system used by AoA and its heavy reliance on visual stimulation, as well as its debt to its predecessors in the WWI game field. We learned in passing that Al had to make 138,000 calculations by hand to derive the system.*

*We discussed Al's philosophy of gaming ("The play is paramount, not winning . . .") and how AoA came about.*

*In this, the conclusion, we discuss some of the legal ramifications of producing a totally new system, and delve into some of the coming crop of Nova designs.*

### Part Two

*A.L. When we were making the book and making sure the angles were right in the playtest form — I remember Douglas and I doing a lot of this, and it was because I had errors in the book — we'd come to one and I'd say "That isn't right. How the devil did you get on my tail?" Douglas would say, "Look, I went "x" and you went "y", now there it is." He had a real good head for that kind of thing. But I'll tell you, this also can be used in another way.*

*A.G. You've got plans for this basic format system that you feel you can plug it into almost anything?*

*A.L. Because it's visual, it has as much range as hex games have. It might even have more.*

*A.G. I mentioned earlier that when you pick up this game and you play it a while you have to learn to fly. You do learn the rudiments of flying.*

*A.L. That's right.*

*A.G. At Origins, you came out with Powerhouse Series. I was glad to see those. The Rotary, most people will find out, much to their dismay, is not anything like the Powerhouses.*

*A.L. But if you buy a brand new Powerhouse, and you try to fly that against your buddies in the Rotaries, you're going to get shot down for a while.*

*A.G. I know. You learn that those Powerhouses steer like barges and turn like boats, comparatively speaking. Because the Rotaries, when they want to do a right, turn on the right wheel, relatively speaking in terms of right hand turns.*

*A.L. That's right. 80° turns.*

*A.G. This guy just kind of barged across the skies like a supertanker with a PT boat turning in a big bay . . .*

*A.L. I've got early planes that will show you that these things turn beautifully; probably be a DH2 against an Eidekker, flying against each other. Flying junk.*

*A.G. Really. "Oops, I got a bullet in you-you lose." Will you have provisions for armed pilots? That's one thing that none of the other games really got into; . . . they carried out metal darts that they tried to drop on each other, bricks, rocks, handguns, rifles.*

*A.L. I'm not sure. I wrote up a list.*

*A.G. Perhaps you can write a series of very bizarre rules on that; we'll publish them for you. (Chuckles)*

*A.L. I might put it in because I included the stats for the Taube. And I was thinking if I give the German's a Taube . . .*

*A.G. That's kind of like giving them the stats for a target, isn't it? . . .*

*A.L. The wing warper—you know what the stats for a Taube are? You can't do anything but three maneuvers; straight, right & left. I'll have to do some copy work on that.*

*A.L. What most people don't realize and I didn't myself until today, is that all the books are completely interchangeable. Even in the case of the Rotaries having a maneuver that Powerhouses don't do, the maneuvers are shaped differently because of the handling technique and the characteristics. It's all built to coordinate. If you make the mistake of flying real easy against someone who knows anything at all about the Rotary, he's going to be shooting your tail off all afternoon. I learned, the hard way.*

*A.L. I did, too.*

*A.G. Five moves and I'm shot down. He got on my tail the last three and hosed me.*

*A.L. I couldn't wait to play the game; I used the Ace of Aces book and we had the printout sheets for the numbers. There is one way you can get a computer to give us a number. You have to do a lot of work to get it to go.*

*A.G. Oh, you have a program.*

*A.L. Well, sort of. It's sort of a program. The system is really quite patentable; to get the numbers to generate the program has to all still be done by hand. At least I don't make the mistakes. There was no other way to do it; 138,000 calculations — it takes a long time not to make a mistake. I made mistakes in the program, setting this thing up for the program. The program is very simple. What you have to give it is what is hard; all the statistics I have to give it. I have to give it a portion of the statistics for it to generate; the program is what it amounts to.*

---

*" . . . Because it's visual, it has as much range as hex games have. It might even have more . . . "*

---

From the people who brought you

**ACE OF ACES** 

Now comes . . .

# BOUNTY HUNTER

TM

Man-to-Man Western Gunfight Game

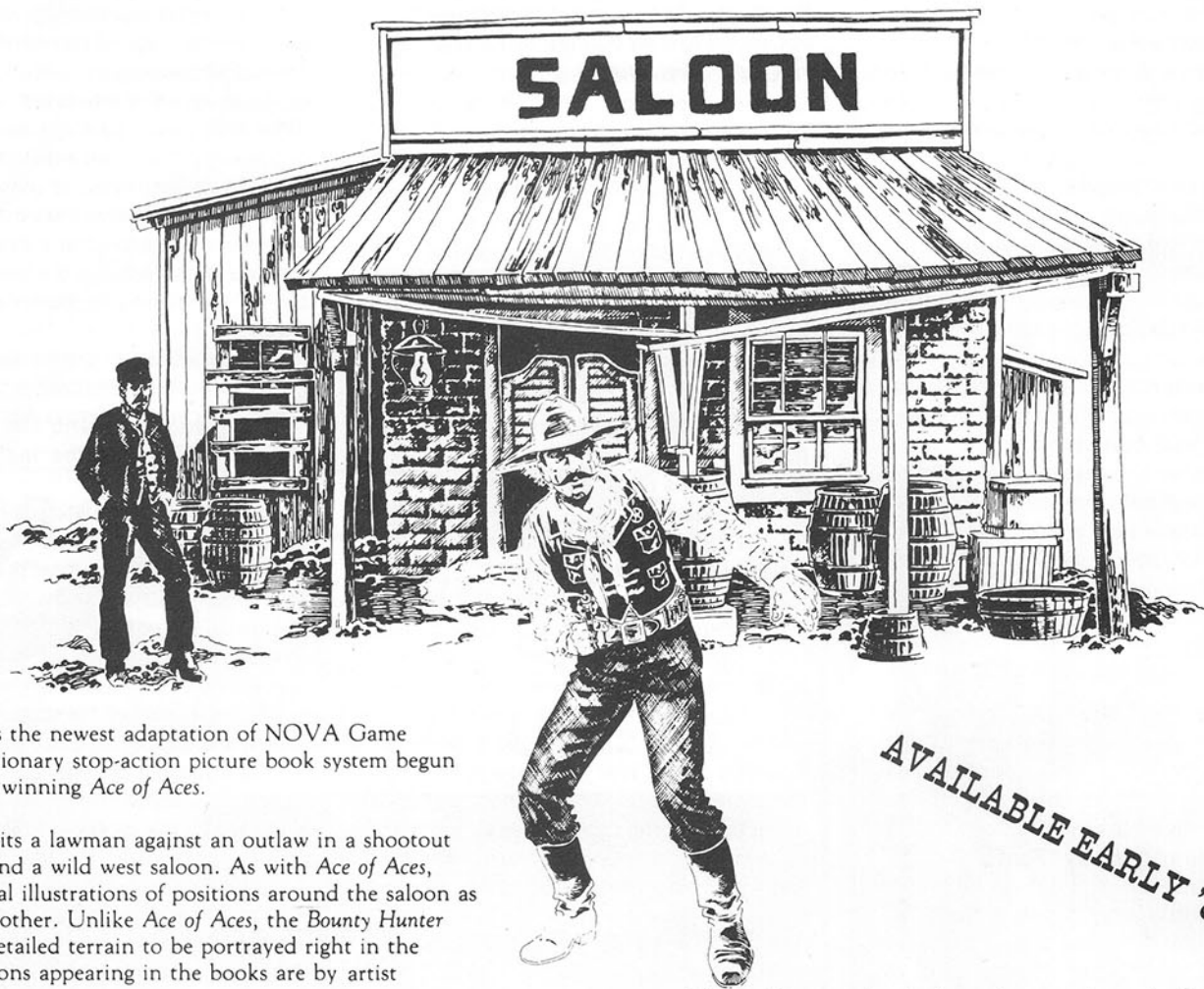

*Bounty Hunter* is the newest adaptation of NOVA Game Design's revolutionary stop-action picture book system begun with the award winning *Ace of Aces*.

*Bounty Hunter* pits a lawman against an outlaw in a shootout inside and around a wild west saloon. As with *Ace of Aces*, players see actual illustrations of positions around the saloon as they stalk each other. Unlike *Ace of Aces*, the *Bounty Hunter* system allows detailed terrain to be portrayed right in the books! Illustrations appearing in the books are by artist John Garcia.

*Bounty Hunter* is the first game to preserve true hidden movement without painstaking bookkeeping or a referee. A player can see—and shoot at—his opponent without his opponent seeing him!

AVAILABLE EARLY '82

The basic game plays in just minutes using only the two books. The advanced game introduces the role-playing aspects of the game including rules covering skill, innocent bystanders, loot and rewards, purchasing different or extra weapons, etc.—even the cost of a doctor!

2 5 x 7 softcover books, c.352 pp. ea. boxed in a 4-color slip-case and shrinkwrapped

Please write for our current brochure.

**NOVA** 

GAME DESIGNS, INC.

Nova Game Designs, Inc., 46 Dougherty Street, Manchester, Connecticut 06040



A.G. *What did you use to sit down and figure out where your relative positions would be when it came time to draw the pictures?*

A.L. That is what the invention is. That is what it is and at this point I would not want to say.

I did it with geometric relationships. It was the only way that I knew how to do it and I'm still questioning whether you would get the same subjective game that I have with the typical computer write-up. I question whether they can at this point. I think you have to generate a lot of information to the computer before it will do it, and I literally have to generate parts of the numbers to make it come out. I kept making mistakes even in that part of the format and we had to double and triple check it to make sure.

I actually have a device to tell that I didn't make a mistake on this stuff.

A.G. *And so the big secret of 'how he did it,' will remain a secret at this time.*

A.L. Well, let me get a patent first. It is pending.

We have to make sure that we get good protection. So we went and got the best legal help that we could get on it. At this point we need to establish ourselves.

A.G. *I can see a number of other applications. If you people ever do a game based on hand-to-hand combat within the fantasy milieu . . . the market is absolutely ripe. It will become another game like so many other games; people might not ever play them but they will buy them to see what ideas they can get out of it. In this case, if it works like the gunfighter or works like Ace of Aces, it is going to re-educate a number of fantasy players that have no concept what it is like to walk three abreast down an eight foot corridor, swing swords. That may make it difficult; you may have to have a whole lower set of numbers on either side for what happens when you stab the guy next to you.*

A.L. Joe is working on it. The trick is it is kind of a three dimensional *Ace of Aces*. That is what is needed. You are going to deal with things up and down. You are going to deal with things not linear, not like an airplane, banking, always pointing at each other because no matter what else they are they are combating each other. You do not have to worry about that. Now you are going to hit the guy in the shins, attack his head. It is falling into place; it is a lot of work, but it is going to look really good.

---

“. . . I am not giving up kids. I am teaching people to fly. . . .”

---

I think it is on our flow chart for the early part of next year. I think we might start going full time shortly. I am not giving up kids. I am teaching people to fly. I am teaching people . . .

A.G. *Anybody that buys this and plays it more than three times is going to know more about flying a small craft than they ever thought they wanted to know.*

A.L. The other thing is that I want to create stories. That is what I'm all about. I want to create stories for the person that plays the game. I have always wanted to do this. In the aircraft I have always had pilots. I always made up the pilots right away, because I am a "real guy" and I want to become an ace and that is hard in that game. It was not easy for them either.

A.G. *To show you how objective I am about this game; I've flown around two dozen missions total. I have shot down two opponents; I have escaped, badly mauled, perhaps five or six times and gone down in flames the remainder, and I still love the game. That game is something else.*

A.L. What we are after is a story. I feel the same way; I do not do so well against some of the better pilots. I play for fun. I

caught myself being a bad sport once in Monopoly. I got so upset with myself, that I would actually lose my temper playing the game. I know a lot of fellows are competitive and that is great. I do not mind making games that can be highly competitive. For myself, it is the *play* that I am after. That's my whole philosophy in creating these games. Take Mike's version of my game: take and make that community, plug in the cowboy, plug in the sheep herder. Make a story, make a movie, we've got the pictures. This is a story; *this* is what is new about this. It is new and it is subjective. New media, yes. What is *really* new is the fantasy, the joy that you get out of the game. You are creating a story.

There are kids that would come up to me at the booth start telling me about a pilot that they have been flying. They know the pilot as well as they know their best friend.

A.G. *It is exactly the same phenomenon that we see in fantasy all the time. A guy comes up and he wants to talk about the last adventure. That I find exceedingly surprising. I have noticed it. When I was at the Chicago CWA con I heard it. When I was at Origins I heard it. People talking about pilots, (other than the really hard core Fight in the Skies Society people, who have been playing for years). I have never heard anybody twitch about anything other than a fantasy character. That is what I think is one*

*Cont. on pg. 54*

---

Al Leonardi — co-designer of ACE of ACES



# Evolving Forces in TITAN™

by Dave Trampier

The integration of growth and attrition is a feature not unique to *TITAN*. In many war-games the scenario is partly determined by the actuation or mobilization of latent forces. Yet *TITAN* may stand alone in its orientation towards a current of evolution, whereby players' forces grow not just in quantity but also in quality continually throughout the game.

The companying diagram may be thought of as a genealogical progression, although it is ascending rather than descending. Creatures from both *TITAN* and the *BATTLELANDS* supplement

are arranged in their hierarchy with lines depicting the optional pathways along which one's forces may evolve.

Attrition plays a part in shaping the evolutionary trends of a game. Moreover, attrition follows like a shadow at the heels of the game's development. As more powerful Creatures are introduced the weakest tend to be weeded out; those that aren't introduced the weakest tend to be weeded out; those that aren't eventually become obsolete. (Obsolescence does not refer to the exhaustion of a Character type. Obsolescence refers to the point after a Character's prime whereat he is virtually out-classed by the Characters that dominate the board: that vague point when a Character turns from asset to liability.)





There are three factors which contribute to the effect of obsolescence:

(1) Character graduation runs up a steeper slope than it might appear upon a simple comparison of numerical values. During Battle a Character strikes with his full Power-factor so long as he is alive; damage he takes does not diminish his ability to strike. Therefore the relative offensive capacity of a Character is a function of his endurance as well as his force. Hypothetically the difference of one strength point between Characters of equal skill is actually the difference of an entire strike by the stronger of the two. Take the example of a Ranger (4\*4) in combat with a Griffon (5\*4). Skill-factors are identical, so each die thrown has a 50% chance of connecting (4, 5 or 6). The Ranger, making two strikes before the Griffon slays him, will have thrown eight dice, averaging four points damage. The Griffon's survival to the third Strike Phase will give him a real offensive capacity of fifteen dice as opposed to the Ranger's eight. *That's quite a difference from the five to four advantage indicated by their Power-factors.*

When opposing Legions are equal in force, the advantage lies with the Legion whose force is concentrated in fewer Characters, as their endurance will be greater. Consider a 6-4 Unicorn double-teamed by two 3-4 Centaurs. The Centaurs together match the Unicorn's strength but not his endurance. In the first Strike Phase the Centaurs throw six dice, wounding the Unicorn thrice. The Unicorn returns an identical strike but these three points of damage will slay a Centaur. In the second Strike Phase only one Centaur will be striking, bringing the Unicorn's damage to four or five — not enough to kill him. But the Unicorn, still striking with six dice, will slay the second Centaur and survive the fray. This advantage becomes more distinct when three Unicorns are set against six Centaurs. The odds tell us only one Unicorn will be slain in the confrontation. [Ed. Note: *The foregoing subsumes completely average die rolls; luck can and will make fools of us all.*]

Naturally the regeneration of the Battle's survivors plays a part in the advantage that greater endurance affords.

This isn't to assert that two Centaurs can't be more effective than one Unicorn. In specific situations the very presence of more counters may be tactically more important than their individual fighting abilities.

(2) Often an advanced Legion will be

overwhelmed by a Legion of less-potent Characters in greater number. But it is the size of a Legion that is limited, not the potency. A player may yield no more than eight Characters in a given Battle, including his reinforcement or summoned Lord. A Legion cannot contain enough Rangers to have any significant effect upon a Legion of Giants or Hydrae. It follows that by the time Hydrae, Giants and their peers abound, Rangers are becoming obsolete. You can be certain a Character type is over the hill when a Legion full of them cannot pull down the equivalent of the Angel they provide to their victor.

(3) The most significant factor ensuring the obsolescence of Characters is the fact that Titans grow in power. A Titan usually comes into his prime by the middle-game, when his role-turns from protectively passive to aggressively active. The graduation of the Titan's power is geared to a faster pace than the evolution of Character types. Titans can become virtually untouchable by lesser Creatures. With the acquisition of Teleportation the bottom begins to fall out as obsolescence increases geometrically towards the end-game. A type of entropy sets in as players become more and more selective upon the basis of vulnerability to big, hungry Titans. You might say when the Titans get going the going gets tight.

Recognition of the obsolescence on the bottom-end can be as important to a strategy as devising one's advancement at the top-end. While successful mustering is fundamental to winning, a player should muster selectively because proliferation of Characters that are either obsolete or becoming obsolete can be a boon to other Titans' scores.

It is vital to phase out your lesser Characters before obsolescence phases them out for you. The most commonly made mistake is to split off the lowliest Characters in a Legion and leave them to fare for themselves. Some may contend that these make great scouts for locating enemy Titans. Others will argue that it is best to wait until they are attacked and flee for half points. The best thing you can do is to lose them in Battles that you win. Leave them in a Legion they spawned and seek out an advantageous Engagement. Force your opponent to fight them first, then clean up with the Characters you want to preserve. Easier said than done; such opportunities don't often present themselves. The time to be looking for them is before you are forced

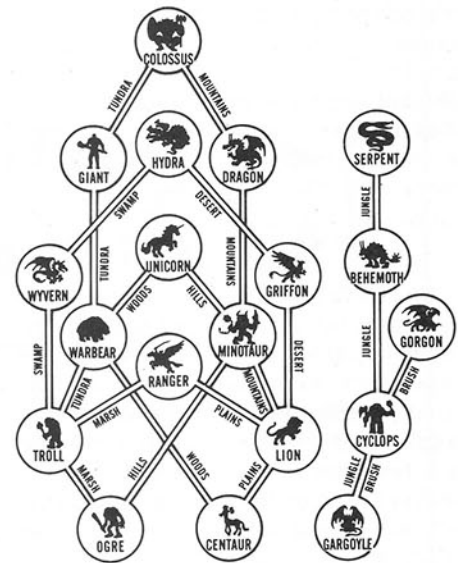

to split to make room for development.

The corollary tactic is to not help another player clean out his own garbage. Go for the Characters he'll want to preserve. When garbage is all you can take down it is better to flee; definitely not the time to attack. Let him keep it until he is forced to split it off, at which time it may be a boon to *your* score.

Every Legion can potentially serve two functions: production and destruction. If you can recognize when to use a Legion for each function, you will consistently beat players who can't.

## The History of TITAN™



TITAN was born on the outskirts of St. Louis in early 1975. Its labor pains were the fierce battles of a forty-five hour slugfest. Hundreds of demons and creatures rose and fell and rose again. We drank the last of the Blatz and called it a draw. The infant had no name as yet, but the game had been given its basic shape.

The game was woven from many strands, and the systems and components that composed that first game still remain in its published form despite the changes made across years of playtesting. The gameboard, the battlefields, the army markers and character counters were all present in that first game, but

the components did not take their final shape until mere months before their publication. The systems of movement, combat and recruitment retain similarities to their original forms, but they evolved as they grew together into the more tightly woven fabric of the final form.

The gameboard began as a fat figure of infinity twined about two cores of the most valuable terrains. The signs and movement system were nearly identical to the published version save for the addition of single arrows; the roll of a single die has always governed strategic movement, but for the first few years, players moved only a single army (Legion) per turn. Several of the terrains were different; rather than Hills and Mountains, there were High, Low and Middle Mountains; High Woods and High Plains were other favorable terrains; Brush and Towers were added later. The number of spaces was different; the original board had 160 lands. In the years since, the board has shrunk, coalescing about a single core of the top terrains; at its nadir the gameboard had but 36 lands of a mere 7 terrains. We decided on the final design because it provided enough room for the maneuvering of multiplayer yet still condensed the action enough to force conflicts.

The battlefields were at first much larger, having seven hexes per side. They retained their hexsymmetric arrangement for several years, even though their size declined to a low of four per side. We altered the number of hexes on every other side so that they could be made smaller still, further condensing the action while also favoring the advance of the attacker, thus making battles quicker and encouraging more assaults on the masterboard. Other than these changes in shape and size, the major alteration has been the individuation of the effects of the terrain features. On the original battlefields all features had the similar effect of completely blocking entry. In assigning the features a variety of effects, we realized that we needed other than a standard chart of movement point costs and doubled or halved strengths, so we made each feature specifically favor the creatures native to the terrains that contained such features. The battlefields grew from wide labyrinths of forbidden spaces into spe-

cial scenarios for close combat. Just months prior to publication we added the five-space Battleboards to further simplify and speed battles, but the response that we have received regarding our *Battlelands of TITAN* supplement indicates that most people prefer the lengthier engagements.

The original game contained an unknown number of types of Creatures, for we have lost that chart. They ranged from goblins and elves up through war-dogs and bugbears to giants and dragons. Dragons and giants have remained among the top-notch creatures of the game, but the goblins and such have long since gone. Other Creatures that the game once included were wolves, spiders, were-tigers and golliwogs. The lists of Creatures within their terrains were once charts for random rolls to determine what was recruited, but we determined that the game required more direction than that, so we instituted the progression of Creatures. [Ed. Note: See accompanying article on that.] Yet years of play leave their ruts, and my brothers still speak of rolling for creatures as "getting back to their Titan roots."

The number of Creatures allowed in a Legion has also varied. In that first game thirty was the maximum, and a Legion needed twenty to split. Later games allowed as many as you wanted, limited only by the number that could be moved onto a battlefield on the first move (a fact that occasionally cost large armies serious casualties if attacked in a constrictive terrain). We limited the size of Legions to emphasize the progression's emphasis on quality rather than mere quantity and to further condense the game and make it playable; early battles of fifty Creatures each could last hours in themselves, and the players not involved in such engagements had little to do but nap.

The characteristics of the Creatures are described in published *TITAN* by a pair of battle factors, power and skill. In proto-Titan there were four factors: strength, stamina, skill and movement. Midway through the game's development it fostered a version called M316 which condensed the strength and stamina into a common factor (M316 had other differences as well, including the introduction of certain of the specific battlefield features). The combination of

skill and movement into a single factor followed. The fewer factors made Creatures' relative worth easier to assess, an important consideration when splitting armies. The systems of tactical movement and combat that these factors were used in have remained fairly constant, the major change being the published Battleboards' elimination of the movement value in battle, although that value regains its worth on the Battlelands.

The first games had only Creatures; there were no Lords. We had what we could recruit from the board and no more; there were no points, only victories. That first game might never have ended, for we recruited faster than we fought. There was never even a reason why any of those early, massive battles had to end, because there was no turn limit on tactical play and because most of the terrains favored sitting back and waiting. Each battle was a test of nerves with the diplomacy of "come-and-get-me."

Just as we limited the size and time of battles to more speedily direct them to a conclusion, we added Lords to the game to give each player a focus of might and vulnerability. We added Demigods, and Demigod became the first name of proto-Titan. Titans first entered the game as the Demigod's equivalent of Angels; a specific Legion had to win five battles to earn a Titan. We decided that Titans seemed mightier than Demigods, so we elevated them to supremacy and changed the name accordingly; Demigods went the way of golliwogs. Demigods had been the mightiest Characters of the game; we decided to lower Titans' initial strength below that of the mightiest Creatures and allow Titans to increase in power during the game, further intensifying the focus of the game on the players' master pieces, their Titans.

The design of the actual components of the game was finalized long after the systems which they used were polished, although in most instances the finished forms were very close to their prototypes. The boards had only to be made camera ready for the printer, but when it came time to produce the pieces we encountered uncertainties. The Legion markers had begun as cardboard chits which were moved about by themselves, for their respective Creatures were recorded on their players' lists. Only in battles did

the Character chits come out, and the game required a sufficient supply of each type of Creature to provide for any likely composition of Characters. The first game was simple; we made them as we needed them from blank chits, but later games with their larger Legions required a boxful of pieces. Rather than provide paper and utensils or expect people to provide their own, we decided to stack the Legions' component Characters right on the board, eliminating the hassle of record-keeping and the possibility of record-tampering. This alteration did bring about the limitation of the total number of Characters in the game, but that aspect of the change fit well with our other condensations.

The systems of the game began much as they remain; they now work better, which results in better play. The components have improved, and their improvement has certainly enhanced the play. People have complained that dice play too large a part in the game, but it seems to me better to have a hundred rolls decide your fate than to have the game ride on only a few. All possibilities exist, and I have heard it said that game systems are like uncharted islands, existant and awaiting discovery; I think a game is more like a painting, for portions must be whited out and painted over. The game evolved, not because it did not work, but because we wanted it to play better. — Jason McAllister

Tired of playing some lowly half-dwarf who runs from wounded orc children?

Be a Titan Instead. Lead beasts and mighty beings into a war of monsters.



**TITAN™**

A fantasy boardgame for 2 to 6 players.

\$20



And introducing **The Battlelands of TITAN™**  
a supplement to the slugathon.  
Larger tactical displays and 126 new Lords, Demilords and Creatures for only \$6.

Gorgonstar Publications Dealer  
500 Oneida Inquires  
Joliet, Illinois 60435 welcome.

## Waging TITAN™: Tactics

by Jason McAllister

The system of combat used in *TITAN* remains the same whether the Battleboards or the Battlelands are being used. The difference between them comes from the movement upon the Battlelands that replaces the mere placement of characters onto the Battleboards. The decisions of placement and movement differ primarily in that Legions are committed piecemeal to the Battleboards but in their entirety upon the Battlelands. The system of striking and the effects of the hazards upon combat are nearly identical, except that on the Battlelands certain characters can employ range-strikes, hitting from other than adjacent hexes. The outcome of battles may differ depending upon which type of field is employed, for the Battleboards generally favor the attacker and also give even very slight Legions a better opportunity to somewhat damage their foes. Which-ever field is fought upon, tactical play is an important aspect of the game, for it is the gauge of Legions and their commanders, the arbiter of the conflicts of strategic play.

Strategic considerations are the first considerations of tactical play, for deciding whether or not to fight the battle at all is a strategic decision based upon the specific tactical situation. A Legion of two Tower creatures should probably *not* fight a much larger force on either type of field of any of the terrains. Consider the number of Characters in the enemy Legion and match their type with the terrain of the engagement; if they can muster there or are able to add an Angel, the Legion may emerge from the battle even stronger despite your best efforts. If such is the case, flight might be advisable, for it will at least deny the summoning of an Angel. If the lesser Legion is the attacker, an immediate concession will prevent the victorious defender from mustering. If you expect to lose, decide whether or not you can hurt the opposition enough to warrant fighting the engagement out; if not, end it quickly and get on with the game.

The placement of Characters on the Battleboards commits them directly to the front line from which they cannot withdraw until battle ends unless they

are slain, so hold back such Characters as you wish to save. Let your first line be the lesser Characters that you have already recruited beyond; their loss will provide vacancies for larger Creatures. The presence of hazards may affect the course of the battle, so put Creatures where they are advantaged or even less disadvantaged. If your Titan is involved, keep him back, although it may be necessary to commit him to assure the safety of some creature; always try to avoid isolating your Titan, although isolation is preferable to doom. If the battle will last long enough to require the placement of your Titan (or some other character that you wish to keep), time your placement carefully, gauging when your characters will perish so as to avoid being forced to place your Titan (or whatever) in an unfavorable position *vis-a-vis* the hazards; games have been lost because Titans have had to face Tower Creatures upslope. The sequence of placement tends to favor the attacker, for he can see how his opponent is arrayed, but placing first allows the defender more chances to shift side to side, and shifting an already wounded character over to finish off a badly wounded enemy is often a wise idea. The attacker may wish to hold a flying Character back so that it can be committed unwounded to the vacant hex that may open up on the defender's side at the end of the battle to help dispatch the defender's last piece with little risk to itself; if an already damaged Character is advanced, it will usually have a greater chance of dying. Don't commit Characters that you don't want to lose until you need to, but if you would rather not lose anything, shove your largest Creatures to the fore and start stomping.

The maneuvering of the Battlelands presents complications that placement lacks. The first concern of such movement is to get your Legion onto the field during your first move (Characters not moved on immediately are eliminated); not moving unwanted creatures onto a Battleland is an excellent way to dispose of them, provided that you won't need them in the ongoing engagement. Legions which contain many slow Creatures may not be able to fit on some of

the more restrictive terrains, or you may have to expose better, faster Characters to make room for such slowpokes. I would certainly not send my Titan up front just to make room for an ogre or troll. If your expendable Creatures are to take part in the fighting, then expend them by advancing them to the fore. The prime concern of maneuver is to arrange the contact of the lines so that your Characters will strike at an advantage. To do so, it is generally best to advance as many of your Characters into contact with as few of the enemy as possible. Rangestriking is another consideration; move your rangestrikers to where they can shoot, for even the single die of a ranger's rangestrike can be crucial in delivering the last blow to a foe and denying it the opportunity to survive to strike again. Flying Characters are important for surrounding part or all of the enemy line, and it is important that they be close enough to do so if such is your intention; a 3-skill flyer must begin its move within two hexes of a Character foe to be able to move beyond it, so advance such flyers to the fore. Move in as solid a line as the presence of hazards allows and make use of whatever cover they provide; position your force to diminish the enemy's ability to make contact at odds unfavorable to you. In more open terrains, arrange your Legion symmetrically to balance your strength, and when possible intersperse Characters of different skills to minimize the enemy's chances of carry-overs.

The choices to be made regarding striking are simpler than those of motion or even placement. Characters often have only a single target available; strike with these Characters first. If a Character can strike at more than one foe, strike at the one which it has the best chance of slaying, or wounding enough for another Character to slay. Plan the sequence of your strikes to maximize your potential carry-overs, even if you risk not slaying your target, it is sometimes preferable to strike at a Creature as if it were a higher skill for the chance of putting wounds on another Character as well. If you have little or no chance of slaying on the current round, strike those that you will have the best shot at the next phase. If you are fighting a losing battle for the sake of what you will kill, avoid striking at Characters that your opponent will be able to pull out of the line, for you may not see such Characters for the rest of the battle and you will have wasted those wounds. It is occasionally to your advan-

tage not to slay a particular foe on a given move (e.g., when it would block the advance of other foes) but it is required that every Character in contact with the enemy must strike, so plan your hits carefully.

Rangestriking allows the player who just moved to take free shots, for the other player cannot immediately fire back. Rangestrikes can be important in forcing a foe from a good defensive position, since such a position serves no purpose if its pieces are slain without having a chance to hit back. When possible, concentrate your range fire and attempt to kill enemy Characters without contacting them; the less that your Creatures are struck at, the better. If you lack rangestrikers, move into contact as quickly as possible. The warlocks' unique ability to fire at lords presents the specific tactic of using them to assault enemy Titans from a safe distance; three or four warlocks may be able to eliminate a Titan foe before their own Legion suffers so much as a scratch.

Other than the actual systems of movement and combat, the effects of summoned Angels or reinforcement Creatures should be considered. Often the addition of such to one side or the other may tip the entire battle, and players should be aware of the methods of attempting to prevent their enemy from getting such aid. Preventing the reinforcement is obvious enough; eliminate the defender (or at least such Creatures of the defender's Legion as might muster) before the defender's fourth turn. This is best accomplished by a vigorous assault, but the use of range fire to force the defender out into early contact can also do the job. Preventing the summoning of an Angel is more difficult, requiring precise timing regarding the initial contact which must be decisive quickly. Summoning cannot occur until after one or more of the defender's Characters have been slain, so your first move must attempt to protect your line; expose no one. Contact the enemy on your second move with Characters that will not be killed on the strike phase which follows your move; such contacts should provoke your foe to advance, and some of your Characters will likely die, but the Angel will not be summoned until your enemy's next move, so you have a turn remaining to finish him off. This strategy may not work in restrictive terrains where it is difficult to make contact with all of the attacker's force immediately, but if you want to avoid fighting that extra

Angel, you might try it. Ensuring the receipt of a reinforcement or an Angel calls for antithetical methods; hold back for your fourth turn or rush forward to swiftly slay some of the foe, but don't let your method cost more than the return it gains you.

Victory points are the product of battles, and how the score of the battle will affect the victor's score may affect choices made in the play of the battle. The half-points awarded for a Legion that flees is the most obvious consideration, but that choice is made ere tactical play begins. If attacked by a Legion with a full complement of seven Characters, a defender might choose to concede rather than flee if the extra points awarded would cheat the attacker of an Angel he might have acquired. Similarly, a player may make a suicide attack on a Legion of seven belonging to a player who has nearly earned an Angel (if you use this method to deprive someone of an Archangel, expect them to hold it against you for at least the rest of the game, if not forever). If taking a reinforcement or summoning an Angel would provide your opponent with sufficient points for an Angel, you may not wish to unless such a Character would alter the outcome in your favor. If allied with the player with whom you are engaged against some strategically superior foe, the lesser Legion may merely concede to confer full points and permit the other to remain strong. The victory point value of a battle (depending on who wins) can be closely estimated before tactical play begins; do so, so that its effects can be considered.

Tactical play pits one Legion against another upon a specific field of battle, serving as the measure of those Legions' relative worth. The difficulty in describing specific tactics arises from the variety of the terrains' effects upon the movement and combat of different Characters; a general familiarity with the tactical systems and the hazards is necessary for competent battle play. To suppose that battles are entirely decided by the compositions of the engaged Legions or the vagaries of the dice used in striking overlooks the many choices that players make throughout engagements that affect the outcome of the battle and that outcome's effect on the overall game.



# PERISCOPE

gaming accessories reviewed

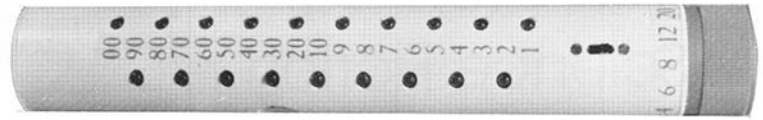

The DRAGONBONE — electronic multi-die

## MAPSTAMPS™

For those of us not blessed with artistic ability, one of the most difficult and painful parts of gaming is making maps. Sometimes, there is nothing more discouraging than a blank hex-sheet map, waiting to be filled.

*Mapstamps* may be the answer for many of us. This ingenious product consists of seven small rubber stamps and a stamp pad. The stamps are of common terrain features or symbols usable by most gamers, particularly fantasy game players. They are designed to fit inside the standard 5/8" hex.

The set comes with a black pad, and is available for \$15.50 from LETTERS, 834-W. Chalmers, Chicago, IL 60614. Additional colored pads (brown, blue, red, green and purple) are also available for \$2.50. All orders, regardless of size, must include \$1.50 for postage and handling.

Be sure to ask about their other fantasy stamps. They have a whole line of stamps of interest to gamers.—Timothy Kask

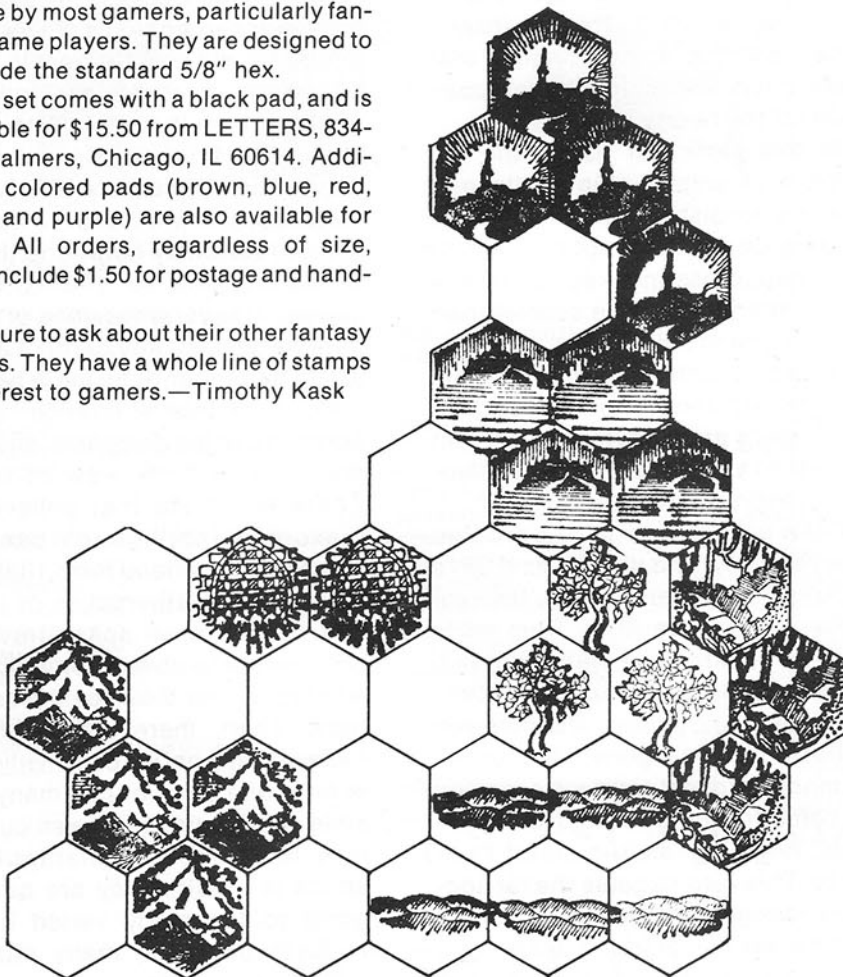

Samples of MAPSTAMPS, shown here actual size

## — THE DRAGONBONE™

During the past four or five years, there have been countless attempts to replace with electronics those poly-sided bits of plastic that we find so integral to our gaming. Rumors would pop up with unquenchable regularity that yet another company was going to do it tomorrow. Some few gamers could afford complex calculators that had function buttons or operations that could generate random numbers from 0-9, but most of us preferred not to invest. There was the occasional novelty item, most of them overpriced, and all of them limited to a single function, usually two six-siders.

At this year's *GenCon*® that situation changed dramatically with the appearance of the *DRAGONBONE*. The *Dragonbone* is an electronic random number generator, capable of simulating d4, d6, d8, d10, d12, d20 and d%.

This electronic gizmo-marvel is 10" long, 1½" in diameter, and studded with 19 red LED's. The die-range — 1-4, 1-6, etc. — is selected by turning the bottom, and activated by holding down, then releasing a button to give you the random number within the range selected.

Every one of us that has ever cursed a bit of plastic for a "bad" roll will be just as likely to curse the *Dragonbone*. It works as advertised. I really like it, and use it often, but not always. It will go against the grain for many traditional gamers, or those who feel that they possess telekinetic control over their dice. But for the rest of us, I recommend it fully.

*Dragonbone* comes complete with battery and a full warranty for one year. It is priced at \$21.95, which may be the principal obstacle for most gamers. Considering how many dice so many of us own, the price comes into perspective. It is available from D.B. Enterprises, 14030-S. Laramie, Crestwood, IL 60445. Add \$1.50 for postage and handling.

—Timothy Kask

# Approaches to Science Fiction Gaming

by Jeff P. Swycaffer

Some people, when enjoying Science Fiction role playing, feel that it's all in the aliens. Others demand accuracy, both scientific and sociological. In Fantasy role playing, the two schools of thought are best exemplified by Flying Buffalo's *Tunnels and Trolls* and SPI's *Dragonquest*. In Science Fiction gaming the difference is more evident, leading to the two theories of game design that I'll call *Alien-thought* games and *Mechanics-intensive* games.

Consider the example of one gamer, Chet, who has a ship crewed with an entire cantina-full of critters, scuttlers, and things that go bump at all hours. The chief engineer has twelve personalities in four bodies, the navigator is a psionic-sensitive with blue fur and an intense dislike of bright light, and the captain is a small green crystal that can take on the form of a humanoid for brief periods of time.

Chet and his group have adventures all over the western spiral arm of one galaxy or other (it doesn't matter to them), hijacking cargoes and forging papers. The galactic police force is a joke, and serves only as a complication to be defeated or defused at times. The real dangers are unknown aliens (never say the



world salad in the presence of a T'telli, or he will fly into an insane rage), and the many enemies that have been left in the hyperspace wake of the hearty band.

In this particular game, the full system of ship-to-ship battle mechanics consists of each ship-owner picking one of four options, which are then cross-indexed to find a result, modified by the acceleration rating of each ship.

In direct contrast to these people are the gamers who believe that mechanics are everything, and that truly alien aliens should have a scientific reason for existing.

GDW's *Travellers* falls more into this category, and it looks as if SPI's *Universe* might also. Here, tremendous effects can arise from quite subtle differences between two ships, combat systems differentiate between rifles, pistols, and between calibers of ship's guns. Most of the humanoid adventurers are assumed to come from the same overall culture, negating multi-cultural conflicts. This also negates the far-too-easy dodge of "We're not killing people; we're just frying 'bugs.'"

In mechanics-intensive games, people can die, swiftly, much as in any real-life combat. Morale effects

become vital because of this. It is always accepted that a player's own character will never retreat in panic, but when he is hit, his followers might not be that steadfast. There are times in this type of game when a player and his team are simply over-matched, and will die to the last man without seriously bothering the foe. Compare this to alien-thought games; in several sessions of play, I have never seen any party of adventurers in danger of losing a battle.

Much of this difference can be attributed to the designers' and players' philosophical view of reality. There are those that believe that reasoning intelligence can only come in one general form, that there is only one Mathematics or Logic, and therefore all space-travelling cultures will be able to communicate, whether or not they see the need to fight. Then, there are those that believe that what we call intelligence is only one form out of many possible, and for us to force all cultures into language-and-manipulation ethics is unfair. They are quick to point to the many varied human cultures on earth, many mutually incomprehensible.

The use of Psionics in Science Fiction role playing is another illus-

trative point. Most of these games have ordinary humans with titanic, if suppressed, mental capabilities, verging on the miraculous. The fact that no such capabilities have ever been found experimentally is not considered conclusive; in the future, they may be. Far too many good science fiction books and short stories have dealt with Psionics as a literary device, to the degree that now, no game could be designed without the feature.

The treatment of Psionics differs from game to game. Alien thought games use Psionics much like magic in Fantasy role playing games; it is a talent that will give the player huge advantages over normal reality. Psionics supplements exist running to many pages of new and bizarre talents, until finally those few, pitiable, blind people that don't have the skill are hopelessly outclassed.

Mechanics-intensive games usually include Psionics, for much the same reason that *Traveller* originally included swords and swordplay: people expect it. After Star Wars came out, no one wanted to play in a universe where something like the force didn't exist. On the other hand, mechanics-intensive games usually limit Psionics sharply, keeping their balance-bending talents within control. One game even went so far as to keep everyone guessing as to whether Psionics existed or not, with the referee rolling any questionable dice so that players could never know for certain. (The facts are still unrevealed; I don't know for certain). This was the closest approach to the real world I've yet seen, for the effort of proving that something doesn't exist can be titanic, and hopeful suspicion is hard to kill.

### Political and Economic Considerations

A Soviet writer, commenting in the 1950's, said that according to the "Historical Imperative" all cultures capable of achieving space flight will be necessarily Socialist, and so interstellar wars are impossible. Redmond Simonsen, editor of SPI's

*Moves* magazine, suggested in one column that a space fleet might involve far more effort of investment than could possibly be returned. He postulated nearly unlimited energy reserves and wealth, both necessary for the undertaking of building a war fleet. Given those, though, why go to war?

Since all wars have economic reasons behind them, usually less apparent than the obvious religious/political causes, Simonsen's argument is telling. (What the Soviet writer says is unimportant, and we do not hear his words . . . although they *parallel* the truth, in a way I'll deal with later).

The setting of most Science Fiction games does not include Simonsen's postulates — precisely to allow interstellar wars because of their gaming value. Energy is limited, and wealth is directly tied in with interstellar trade, which can be vulnerable and must be protected by fleets-in-being. Once this is granted, the idea of great, imperialistic battles for territory can be derived without too much effort. Mechanics-intensive games usually follow this logic through to one of its most necessary conclusions: bigger is better, an axiom that applies to states as well as ships. Thus we have empires, often in collision with each other: strong, centralized empires.

Alien-thought games seem to take a more Libertarian view, in which the concept of wealth through trade engenders small, loosely-bound trading companies, some owned by petty tyrants, and others more of a ma-and-pa operation, with the kids, pets, androids, and some lovable, if weird, aliens along for laughs. They're not rich, but they're happy, and if a tax collector should, by ill luck, appear, that's what the mining laser in the bow is for.

This concept of smallness and variability is perhaps the alien-thought game's strongest asset, especially when the gamers are after raw adventure. Anything can happen. For the roustabout player who depends upon his wits and quick

tongue, the alien-thought game gives him all the space opera flavor he desires. These games, for instance, sometimes feature a chart known as the "love table" under the provisions of which are such results as "Highly ranked person of the opposite sex falls in love with you." (Naturally, these tables also feature results of "Off with his head," which can be annoying). Even the ordinary run-of-the mill type adventure in these games can be adventurous. There are pirates to run from, port authorities to avoid and infuriate, and the strange league of nasties to defeat, who recently hired the adventurers to carry a cargo that was actually booby-trapped.

The mechanics-intensive game, on the other hand, strives for realism as much as possible. Where the alien-thought game takes the concept of the inherited nobility for granted, the more thoughtful mechanics game will either have abolished the class structure, or will have re-instituted it from necessity. *Traveller* has inherited titles, for instance, simply because the Imperium is postulated to be too large for any reasonable election procedure. If the bureaucracy is going to be appointing its own chiefs in one way or another, why not simply let heredity choose them in an orderly way?

But beyond these trappings of archaic systems, the mechanics game deals with realistic systems. The military will be structured in ranks, based as much upon seniority as skill; the notion of the dashing young hero taking command and leading the battalion to fame is a dismissable hilarity. Far more likely would be the dashing young hero being pulped by incoming heavy artillery fire and spending half a year in a military hospital. Even the aliens in these games understand human standards of protocol and diplomacy. If you say "Salad" in the presence of a T'telli, he may feel resentment at your misuse of the concept, but he won't pull his saber and attack. He might reasonably request, with a full explanation, that the word be removed from any fur-

ther conversation. With only scattered exceptions, even the greatest religious fervor will, in a modern diplomatic community, make allowances for honest ignorance.

Mechanics-intensive games believe in restraint, and in law. You don't equip your freighter with lasers and start raiding traffic, for the same reason you (most of you) don't try robbing banks; it's more dangerous than the rewards justify. Dealing with people rationally becomes more important than throwing grenades into law offices; negotiation is better rewarded than attack.

So, ask the many aficionados of alien-thought games, where's the fun? There's no action in this galaxy, so let's go find a good fast-and-loose shoot-em-up and gain a couple of experience levels.

But the strongest point of the mechanics-intensive game is that there are problems to be solved, using logic and thought. Running in shooting will not help here, and knowing when to run away is a better talent than the blind "Kill them before they kill you" strategy that is always rewarded in alien-thought games. If, for instance, a character is confronted with a computer interlock, and that character has no computer expertise, there is simply no further he can go in that direction. Although a good referee will include other options, it will be in gaming as it is in life, useless to butt one's head against a locked door. (One alien-thought game I've seen has percentage chances listed for particularly strong characters to force open even the best blast doors, locked or unlocked. This is the kind of freewheeling action that the alien-thought game is looking for; for people who react poorly to frustration, this is probably exactly what is desired).

This sometimes heartbreaking aspect of mechanics games is among their strongest points. The right answer is rewarded, while mistakes and wrong guesses are punished, placing a premium on clear thinking. This does not, however, throw out simple, everyday good luck; many a player has taken a chance or follow-

ed a hunch, to find new avenues opening before him unexpectedly. Mechanics games are usually good about rewarding judicious gambles, just as is real life.

In *Moves* magazine, a year or two ago, there was a small debate over rules-writing styles. The management of SPI put it to their readers whether the "legal case" system of writing was preferred to a less formal, "dialogue" style of writing. Although many changes have been seen since then in SPI's rules, most of them for the better, they still rely upon a very legalistic rules style, especially when compared to other companies. It is doubtless no coincidence that SPI adventure role playing games are mechanics-intensive games, with considerations of "realism" absolutely foremost. These games are still balanced, very much so. Because of this, however, the rules loopholes that can be found by the dozen in some other systems simply do not exist with SPI.

To sum up, each of the two approaches to role-playing games has both advantages and disadvantages. When role-playing games are set in a science fiction milieu, the differences become sharp and divisive.

"Alien-thought" games (those with a space opera flavor) provide faster play, far less frustration, more opportunities for role playing *per se*, and some of the most imaginative monsters ever seen in any setting. You will meet cruel tyrants, beautiful princesses, and strong gladiator-heroes doomed to die in the arena. You will have a fast spaceship, a trusty robot sidekick, and a blaster you can bet your life on.

"Mechanics-intensive" games (*Traveller* certainly, and quite probably *Universe*) provide as much realism as will go well with speculation and adventure. The adventure is no less, although the dangers are more recognizable, and mature, imaginative players will be more successful than the rush-in-and-slay type. You will meet cruel people, who may nevertheless be negotiated with, beautiful women and men in just about any walk of life (there is almost

no sex discrimination to be found in these games), and quiet people who can be moved unexpectedly to true heroism. You will have a fast spaceship (for which fuel and reloads will be a consideration), a trusty robot sidekick (that can beat anyone at chess, twenty out of twenty), and a blaster that you'll use when you have to . . . realizing that shooting at people usually means they can shoot right back. If, however, you feel that realism is to be striven for, these are the ones to buy.

### Technical Postscript

If, as Einstein postulated, the laws of physics are everywhere the same, then it follows that only one Science can exist. Electrons everywhere being electrons implies that electronics will everywhere be electronics. Only one Mathematics seems to exist, and only one Geometry. Chemistry will be a universal constant, and Mechanics. Since our culture is so intensely tied up with our science, becoming more closely integrated daily, I feel that no matter how alien real aliens are, if they can reach the stars, we will be able to talk to them. The notion that they would hop into brightly colored and glowing hot-rods and buzz the Earth repeatedly, taking unprepared citizens of small towns for short jaunts to Jupiter and back is not going to be acceptable.





# Fear No Opponent YOU Can Master Anyone Over the Game Table (and Even Under it)!

*Learn Tried & True Game  
Playing Secrets to Fame,  
Fortune, and GIRLS!*

**Revealed AT LAST! Secret  
SECRETS of POWER IN GAMING!**



## WHO IS THIS MAN?

Who WAS this man is more like it! Once a sane, capable human being reduced to an incoherent, babbling, glassy-eyed shell of a man, by a superior 112-lb. master at "Squad Leader"!

## Why Reveal This Secret?

Because of consumer DEMAND! Game Players come up to US at every GAME CONVENTION to ask, "How come all Avalon Hill GAME Tournaments ARE WON BY Avalon Hill Game players ONLY? Rather than risk PHYSICAL injury and continued MENTAL harassment, we have no choice but to DIVULGE this secret SECRET that, incidentally, VERY FEW people know about.

## Why all the CAPITALS?

Because people who are reading this ad are LOSERS, and they're the type that will have less trouble UNDERSTANDING it if it is written in BIG letters.

## Why BOTHER with LOSERS?

Because even the Mets go on a HOT STREAK occasionally! And the WINNER of an AH Classic 500 was once a POSTER CHILD for birth Control! ANYONE can turn it around. All it takes is KNOWING the secret SECRETS to building confidence, which leads to fame, fortune, and GIRLS!

## Why Do We Emphasize GIRLS?

Because at GAME conventions there aren't hardly ANY AT ALL . . . except standing at the side of those in the lead at the Avalon Hill GAME Tournaments. Girls ADMIRE those who can render an opponent impotent in "Stalingrad" at the Nemunas . . . after 14 turns yet! Holding your ground at Quatra Bras in "Waterloo" against seemingly unsurmountable odds, creates high ESTEEM in the eyes of idolatrous women. To watch YOU successfully snatch the Boston & Maine in "Rail Baron," or have the guts in "Football Strategy" to call Play #17 on your own 20-yard line, is just the type of DECISIVENESS everyone respects. GIRLS will especially admire your MASTERY and LACK of inadequacy and will almost certainly let you put your hand on their thighs out of utter ADMIRATION. And while we can't

ABSOLUTELY guarantee this, it's extremely likely and would make LEARNING OUR SECRET certainly worthwhile.

## HOW Do I Learn?

It's "How Do YOU Learn." WE already know, and this is what we're trying to convince YOU to send us a paltry buck to find out.

## HOW do YOU Learn?

We will send you ABSOLUTELY free, one of three, two of three, or three of three full-color GAME Catalogs we think are best suited to your MENTALITY and CHARISMA. All we ask is a good will donation of \$1.00 to cover the cost of postage & HANDLING by our already OVERWORKED mail-order department.

## If They're OVERWORKED, Why Do We Bother SPENDING Money for this AD?

They're overworked shipping out ACTUAL GAMES by mail-order—this year has been Avalon Hill's BEST YEAR EVER, with shipments of BATTLE GAMES up 44% over last year; which includes shipments all over the world and Mississippi. All we want YOU TO DO is to get ahead of our GAME CATALOGS which show the games THEMSELVES in glorious full-color with ample descriptive copy of 500 words (or more) written by the DESIGNERS themselves who know a lot about the games.

## APPLY this Secret in Your SPARE Time

That's right! Up to 10 HOURS a day is all you need to MASTER the tactics and strategy of Avalon Hill Games. Play "Black Spy" in a half-hour; or "Longest Day" in 36 hours. It's up to you. Lose up to 24-lbs. a week (some gamers do a 3-day convention without eating

at all); INCREASE your I.Q. within the FIRST DAY (just figuring out the rules).

## Great GIFTS

Since MOST of you reading this ad already know about us, and you think we're pretty dumb to waste money doing this bit, CONSIDER the fact that 50% of Avalon Hill games are given as XMAS GIFTS. That percentage is lower in the summer. Regardless of the time of year, to play an Avalon Hill Game is a challenge, to GIVE one a subtle COMPLIMENT. We compliment YOU for reading this far, and seriously urge you to send the coupon to read up on the very LATEST in the way of quality Avalon Hill products.

## FREE COUPON OFFER!

This coupon is FREE. To get the Full-color Game Catalogs FREE, please check off the catalogs of your choice and send us \$1.00.

- Strategy Game Catalog, battle and historical games
- Sports Game Catalog; Sports Illustrated & Statis-Pro Games
- Leisure Time Catalog, family, social, and adult strategy games

I enclose just \$1.00, regardless of how many Catalogs I order. I understand that if I am not completely satisfied I have been had.

NAME \_\_\_\_\_

ADDRESS \_\_\_\_\_

CITY \_\_\_\_\_ STATE \_\_\_\_\_ ZIP \_\_\_\_\_

Mail to:  
The Avalon Hill Game Company, Dept. A  
4517 Harford Road,  
Baltimore, MD 21214-3192

## Ironbottom Sound: Action Stations

by John Prados

**DESIGN/DEVELOPMENT:** Jack Greene

**COMPONENTS:** 160-1/2 x 1" ship counters, 136-1/2 x 1/2" markers, one 22 x 24" mapsheet, one 8-1/2 x 12" Savo Island "cut-out," ship damage record sheets, scenario sheets, separate charts and tables, 24-page rules booklet, boxed. \$17.95.

**PUBLISHER:** Quarterdeck Games, P. O. Box 929, Oceana, CA 93445

Of late there seems to have been a strong resurgence of naval games within the historical games field. Recent entries have included Yaquinto's *Ironclads* and Joe Balkowski's *Fighting Sail*, and *Task Force*. Now there is also Jack Greene's

*Ironbottom Sound*, published by the newly-formed Quarterdeck Games. *Ironbottom Sound* is a naval tactical combat game of naval battles around Guadalcanal in the Pacific during World War II. The name is taken from that given to the body of water lying between Guadalcanal and Savo Island, which came to be the resting place for so many warships in 1942-1943. It is a classic naval subject — half a dozen battles involving every type of ship in essentially the same waters, plus virtually a hundred to choose from if you do the entire Solomons campaign rather than just the Guadalcanal fighting. There is even excellent primary source material, ranging from the memoirs of a Japanese destroyer captain to the diary of a seaman on one of the US Navy cruisers.

Jack Greene has paid considerable attention to the sources and designed *Ironbottom Sound* to provide one game modeling all the Guadalcanal battles. There are ten scenarios in this game, which is tastefully done with real ship silhouettes, all essential information on the ship log sheets, and very simple and straightforward rules. Indeed the entire body of the rules is in typescript and is equivalent to only eight 8-1/2 x 11" sheets of paper. Except for somewhat garish cover art and the confusing need to match scenario sheets with log sheets, *Ironbottom Sound* would be an ideal initial release for any game company.

Designer Jack Greene is the man who put it all together. Jack goes back a long way in the hobby, to the early-1970s Simulations Design Corporation (SDC). Subsequently he worked for Avalon Hill and there devoted much attention to naval games as a result of his work on a redesign of the old AH game *Bismarck*. After leaving AH Jack returned to California where he collaborated in the formation of Paper Wars Games, whose

games I believe are marketed by Jack's new company Quarterdeck Games. For *Ironbottom Sound* Jack put together the talent of a number of people from these and other sources. Dana Lombardy who did the nice counter graphics in the game came originally from SDC. Jim Bumpas of Paper Wars did the typesetting for *Ironbottom Sound*. One of those men with playtesting credit is Craig Taylor, naval game designer for Yaquinto Games. Bill Haggart of *F&M* contributed to the artwork and executed the cover art. Nathan Okun contributed historical research. *Ironbottom Sound* has excellent pedigrees.

The game system allows for gunfire and torpedo combat as ships of both sides enter the board. A "cut-out" Savo Island allows the position of this crucial landmass to be changed with the scenario, and indeed for the players to maneuver on the single mapsheet as if it were geomorphic — by periodically displacing all pieces in play to keep them on the board. The combat resolution system uses three types of die rolls: single "die" rolls, double-"dice" rolls (called "dice sum" rolls), and the base-6 number system dice roll which will be familiar to players of the AH *Bismarck* game. Ships are given gunnery ratings for each caliber and these are apportioned by turret. There is also a central gunnery control for each ship which, if hit, critically reduces gunfire accuracy. Another feature of the game is a three-turn steaming cycle used to fix the maximum speed of each ship on the board at any given time. Facing and heading are important for gun laying and torpedo vectors. Ships expend movement points to move ahead or to change heading. All action is assumed to occur at night and there are nice touches in the design, like rules for searchlight illumination, starshell, and radar.

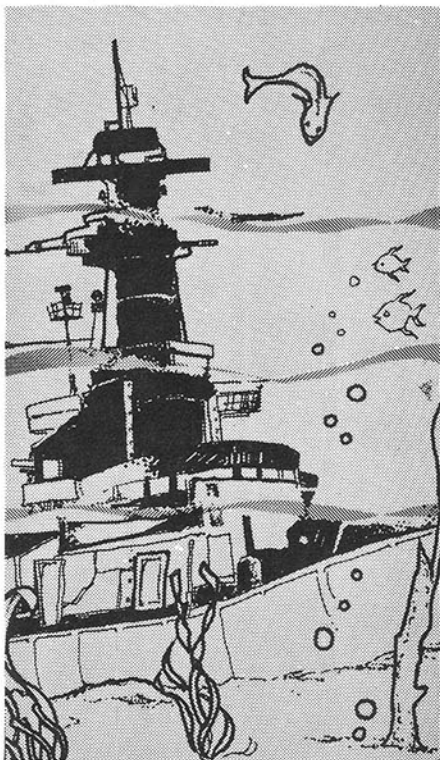

None of this is too unfamiliar nor is it stated in a complicated way by the rules. Thus one of the best things about *Ironbottom Sound* is that a new player can get into the game very quickly. Within the limits imposed by the boardgame format *Ironbottom Sound* simulates naval warfare in reasonable detail and with great playability. Designer Greene does not go to the length of SPI staffer Joe Bolkowski and eliminate the use of CRTs and other tables entirely, yet Jack still succeeds in bringing out a game as highly playable. *Ironbottom Sound* is an action game. It would be suitable as a first naval game for a gamer interested in getting into this branch of the hobby.

With the high playability of *Ironbottom Sound* game length is very suitable. Scenarios range from four to ten turns in length and games can take from half an hour to perhaps three hours. A short game length is actually a problem in engagements involving battleships since it is difficult to inflict sufficient gunfire and torpedo hits within the space of a game to sink anything of this size.

One major weakness of *Ironbottom Sound* is the inherent limitation of the single mapboard. Although the game

provides the floating Savo Island and instructions for ship displacement to keep all craft on the board, this is awkward to achieve in practice. At crucial moments the entire plot on the board has to be changed. The player is forced into artificial maneuvers with his ships to keep them on the board. Moreover, when, as a result of warship maneuvers, Savo Island disappears from the map it is impossible to bring the island back in its correct position. This has the result that subsequent maneuvers are entirely possible that would in fact have driven the ships hard into the sand, not to mention the reefs, of Savo. The device of geomorphic maps to provide a theoretically endless map has long been known to designers and it is disappointing that geomorphs were not used in *Ironbottom Sound*.

My other complaint about *Ironbottom Sound* has to do with the narrow choice of scenarios. Five, or half, the scenarios model the major Guadalcanal battles, but the other half are artificially constructed hypotheticals. These include some that are really wild! One scenario teams Japanese battleship YAMATO with the German ADMIRAL SCHEER

and pits these against the British PRINCE OF WALES and REPULSE. Another scenario assumes that Japanese battleships OWARI and AKAGI, which were cancelled in 1922, and AMAGI, destroyed in the Tokyo earthquake of September 1923, were completed and managed to find themselves in a fleet action off Guadalcanal against a US force with ships like the ("battlecruisers") CONSTITUTION and UNITED STATES. Considering the wealth of real surface actions available in the Solomons campaign there was no need to resort to such artificialities to provide sufficient scenarios for *Ironbottom Sound*, or as it was formerly called, *Japanese Destroyer Captain*.

Despite its shortcomings, which are (at least on geomorphs) probably related to the small size of a new company, *Ironbottom Sound* is an exciting naval tactical game. The game should be interesting to fans of AH's *Bismarck*, to gamers looking for an introductory naval boardgame, and to hobbyists who enjoy naval games that are playable, fairly historical, and moderately complex. Get *Ironbottom Sound* at your local retail outlet or direct from Quarterdeck Games.



From the realm of magic comes the DRAGONBONE™. The new way to decide your fate in fantasy gaming. No more lost dice, fallen figures or searching for rolling space. DRAGONBONE™ is a totally random, electronic 4, 6, 8, 12, 20 and ∞ sided die. It speeds up play because every roll is in one hand. Use some magic. Use a DRAGONBONE™.

Comes with battery & 1 year guarantee. Visa & Mastercard accepted. Illinois res. add 6% sales tax.

Send 21.95 in check or m.o. for each to:  
DB Enterprises  
14030 S Laramie  
Crestwood, Ill. 60445

## THE FIEND FOLIO<sup>©</sup>

by Lewis Pulsipher

From the standpoint of many referees, the biggest problem of any fantasy role-playing game is familiarity. The players become familiar with all the monsters, knowing exactly how to deal with each one. One antidote is a monster list which players cannot read, but this only delays the day of familiarity and normally isn't possible anyway. Another solution is GM-designed monsters—lots of them. But most GMs don't seem to have the time or imagination to make up more than a few good monsters. Thus we come to the most popular solution: published compilations of new monsters, which the GM can use at least once or twice before the players become familiar with them. It does not solve the problem, but it keeps the GM one step ahead of the players.

Unfortunately, most such monster compilations have been pretty poor quality. This is partly a reflection on the weaknesses of presentation of the first monster compilation. Book 2 of TSR's original *Dungeons and Dragons*<sup>®</sup>. Most monsters were a bunch of statistics and a few lines of text. That was sufficient when the monsters were well-known mythological creatures, since many players already knew a lot about the monster's background, but as the mythological creatures were used up and completely new ones were created, the lack of background became crippling.

The *Adventure Dungeons and Dragons Monster Manual*<sup>®</sup>(*MM*) went a long way toward changing this style, by describing monsters at considerable length (though with some redundancy), complete with a drawing. But the monsters published in other compilations, especially in many magazines and fanzines, continued to be pretty poor stuff, despite the improvements in presentation. One of the better sources was (and still is) the "Fiend Factory" feature in *White Dwarf* magazine. In 1978 Games Workshop, publishers of *White Dwarf* and at the time sole distributors of TSR products in Britain, convinced TSR that another monster manual, of monsters contributed by British players and including some from the Fiend Factory, would be worth doing. This was the genesis of the *Fiend Folio* (*FF*).

*FF* took two years from completion to

publication, because TSR decided to set up a subsidiary in Britain and Games Workshop lost its contract. I don't know what negotiations or legal problems ensued, but *FF* does include monsters reprinted (possibly with changes) from *White Dwarf*. (It seems typical of TSR's attitude that *White Dwarf* is nowhere mentioned by name.)

I suspect that the delay might have helped improve the material. *FF* now includes 20 monsters by TSR, including the monsters from the early modules such as kuo-toa and drow. And wonder of wonders, the mysterious mezzodaemon and nycadaemon, listed in the *AD&D* monster tables but not described in the *Monster Manual*, are in the *Fiend Folio*.

This must be one of the most-edited role-playing publications yet. Don Turnbull edited it, then Albie Fiore of Games Workshop went far toward re-editing, and presumably then Turnbull and later people at TSR also went over it. Not surprisingly, it closely resembles the *MM* in appearance and physical quality. The interior artwork is definitely better, but the cover is just as bad, reminding one of a poor comic book rather than art. Adults will be embarrassed to be seen with this lurid crud, particularly when so many of the uninitiated have such odd ideas about what *D&D* is.

It's hard to summarize a collection of 187 monsters. Thanks to the editing, the *FF* doesn't feel like a compilation of monsters: there are no clashes of styles or monsters inconsistent with one another. Compared with the *MM*, there seem to be quite a few creatures from the planes other than the prime material, a lot which lay their eggs in human bodies, and many small creatures which roam two foot tunnels that occasionally intersect with the larger tunnels of dungeons. There is also a collection of creatures to fill in the details of the underground war hinted at in other TSR publications: deep gnomes, githyanki, githzerai, kuo-toans, and drow to go with mind flayers, all of them tough customers.

The magic resistance inflation is notable. Unfortunately, magic resistance was not invented until many of the original *D&D* monsters had been defined, nor were they changed for *AD&D*. It's ludi-

crous for many weak creatures to have magic resistance while dragons do not, but that's the result.

Another notable trend is the monster which is intelligent, but which has no manipulative members. If these creatures (such as the hook horror) cannot handle tools, could they develop intelligence? There is also a problem with a few monsters which seem to have no reason for existence or niche in the ecology of the universe. Although there are many words of description, they still feel like collections of numbers. I suspect most GMs won't worry about it, however.

About half the monsters are first through third level, with third most prominent (47); there are only 16 monsters of eight to tenth level, along with a few of variable level which can reach those heights. In other words, the *FF* should be really useful to GMs who need reasonable new monsters to substitute for the over-familiar orcs, gnolls, and such. Unlike many independent compilations, *Fiend Folio* doesn't seem to be aimed at fifteenth level campaigns.

The level and experience points for each monster are given with other statistics. There is also a new version of the underworld and outdoor monster tables, including numbers appearing, armor class, movement rate, hit dice, and damage inflicted by attacks. It includes monsters from *MM* as well as *FF*.

Many players of fantasy role-playing games other than *D&D* will dismiss the *Fiend Folio* out of hand, and this is unfortunate. Although it is a TSR *AD&D* publication, the monsters are described in such detail, with drawings, that it should not be difficult to adapt many of them to other games. Unlike the *Monster Manual*, which is dominated by mythological monsters that are already defined in other games, the *Fiend Folio* contains monsters made up from whole cloth, with unique backgrounds attached in most cases. Consequently there is more here worth converting than in the *MM*. *Fiend Folio* is a major fantasy role-playing publication, not merely a major *D&D* book. And at \$12 for 125 pages in 8½" by 11" hardcover, it is a bargain. If you GM fantasy role-playing games, you can hardly afford to pass it by.



# BOOKS

*THE GAMES AND PUZZLES BOOK OF MODERN BOARD GAMES*, edited by David Prichard. Published 1975 by William Luscombe, Great Britain, distributed in USA by Hippocrene Books, 171 Madison Ave., New York, NY 10016. Pasteboard covers, 144 7" by 8 1/2" pages, 84 diagrams, c. 70,000 words. Contributors: Allan B. Calhamer, Terry Donnelly, Darryl Francis, John Humphries, Josie Mathews, David Parlett, Davis Wells.

Americans tend to forget that other countries really exist, except as abstractions in the news. Boardgames are as popular in Britain, in proportion to population, as they are in America, and there are several large British game publishers. More books about games are published in Britain than in America, including the one under review.

This book, compiled by the editor of

the excellent British magazine *Games and Puzzles*, describes how to play 13 twentieth century boardgames, and how to play them reasonably well. The games are *Scrabble*, *Diplomacy*, *Decline and Fall*, *The Sigma File*, *Mastermind*, *Monopoly*, *Twixt*, *Cluedo (Clue)*, *Ploy*, *Speculate*, *Tri-tactics*, *Confrontation*, and *Escape from Colditz*. The last four, plus *Decline and Fall* and possibly *Sigma File*, are British games unfortunately unknown to most American gamers.

These six British games are quite comparable to American productions, and through this book you may be able to decide whether you want to spend a lot of money to obtain a copy via a British mail order games dealer. Anyone whose favorite game is *Stratego*, for example, will want *Tri-tactics* and possibly its companion games, *Dover Patrol* and *Aviation*. These games are all more sophisticated, and require more strategy, than *Stratego*, though based on the same hidden strength idea. *Decline and Fall* (of the Roman Empire) should attract those who like *Diplomacy* or other multi-player diplomatic games. *Speculate* sounds more sane and realistic than most-stock market games, *Escape from Colditz* (a German POW camp) is a beer-and-pretzels game, while *Sigma File* is a game of bluff by the designer of *Black Box*.

The book bears some comparison with Jon Freeman's *Playboy Winners Guide to Board Games* (reviewed in *ADVENTURE GAMING* #3). Freeman's book is much longer and discusses more games, but the space devoted to the seven games covered by both books is about the same. Freeman emphasizes how experts play rather than spending a lot of time describing the basic rules. Those who play "for blood" will find more stimulating commentary there than in *Modern Board Games*, but on the other hand, the British book may be more suitable for younger players.

The *Diplomacy* and *Monopoly* chapters in the book stand out, for different reasons. The *Diplomacy* discussion, by the inventor, is the clearest and most concise introduction to the game and its strategy that I have seen. Like several other chapters, it describes at considerable length how the game is played, including a diagram of the board. Although the discussion of *Monopoly* uses the British property names, it is not hard to follow (a "station" is a railroad). But the advice is no more than any serious gamer could tell you, as opposed to the

statistical analysis in Freeman's *Monopoly* chapter. In general, Freeman gives more insight into winning play than the contributors to *Modern Board Games* do, *Diplomacy* excepted.

The British book is well-produced, but some of the diagrams are either wrong or unexplained in the text. [For example, Serbia should be shaded as landlocked in figure 19, and row 2 of figure 31 does not correspond with the text.]

Despite the added costs of importation, the book is not badly priced for a hardcover. It is rather short. There's no doubt that the *Playboy Winners Guide* is the better source of information, especially when price is taken into account, and you should buy Freeman first if you want this kind of "how to play and win" book. But *Modern Board Games* could be valuable for a game collector, or a player who is bored with American games. —Lewis Pulsipher

Sommers, Richard, J., *RICHMOND RE-DEEMED, The Siege at Petersburg*, Doubleday & Company, Inc., Garden City, N.Y., 1981, 670 pgs.

If you are a Civil War Buff this book is a must for your collection. It is the sort of book that every wargamer and amateur historian who specializes in the Civil War has been dreaming of finding on the Peninsular Campaign but has been unable to find.

This book deals with the September, 1864, attack on the fortified lines that separated the Union Army from Richmond, Virginia. It is the most detailed discussion of any Civil War battle I have ever seen.

It contains 22 detailed maps that display every phase of the battle and give the locations of every brigade on both sides. This is supported by 20 pages of orders of battle that go down to the names of the specific regiments in each brigade and identifies every artillery company. It does not provide the types or weights of guns in the field batteries, but in its discussions of the Confederate works it does provide the numbers, sizes, and makes of many of the guns emplaced. I should also add that specific comment is made as to when those guns were unserviceable or out of ammunition.

The detailed discussion of various battles is mind boggling. The actions of individual companies and batteries are often covered and the totality of the battle is supported by complete casualty returns.

There are 88 pages of notes in the back of the book that further elaborate on the text and provide source detail. It is this source detail and the bibliographical listing that are the most astonishing part of this book. The bibliography is 38 pages long and provides any one who is interested in pursuing research on this battle an invaluable list of documents, etc., that should be consulted. However, I cannot imagine why anyone would want to repeat what Mr. Sommers has done unless it is to provide unit strengths and the types of artillery pieces in use by the various batteries, the only detail that, lamentably, is not included.

If you are a miniatures gamer or a board gamer this book will provide you with sufficient detail to permit you to recreate any aspect of this battle you might wish to refight simply by turning a page. That, being my particular bent, is what causes me to believe that no one who invests in this book will be dissatisfied with it.—George Nafziger

von Müllenheim-Rechberg, Baron Burkard, *BATTLESHIP BISMARCK, A Survivor's Story*, Naval Institute Press, Annapolis, M.D., 1980, 271 pgs.

The most interesting perspectives of historical events are often those of the eyewitness. It is a true statement to say that the understanding of an eyewitness to any event is often biased or handicapped by that individual's level of personal involvement in that event, but they can also provide a level of insight into the event that makes the reading of their book well worthwhile.

Baron von Müllenheim-Rechberg was a junior gunnery officer aboard the Bismarck, serving as a director officer during her famous sortie into the Atlantic. He was often thrust into a front row seat of the various battles because it was his job to observe the fall of shot directed at the enemy ships and provide data to correct the gun laying solution. He was, however, as often on the other side of the ship and had no view of the battle other than the shells that passed overhead and struck on his side of the ship. Though an important post, he was not involved with the staff or high level decision makers and as a result has only a limited understanding of the reasons why various actions took place.

After a short autobiographical sketch, Baron von Müllenheim-Rechberg provides a detailed history and personal description of the commanding officer

of the Bismarck. He goes on to speak of the crew and its morale. Baron von Müllenheim-Rechberg joined the Bismarck as part of its commissioning crew and, as a result, is able to provide tremendous insight into the evolution and problems that occurred as the Bismarck was fitted out for sea, for sea trials, and the minor details of everyday life that are so often over-looked when those grey behemoths are viewed by history.

He describes the shakedown problems, the efforts to escape, the observation by the Swedes of the first attempt, the reasons why the British knew she had escaped, and carries the detail of his story on through to the end of the work.

His perspective of the pursuit and penetration into the Atlantic is somewhat limited, but none-the-less a most satisfactory relation of those events. The major shortcoming is that it lacks a two-sided accounting of the activities, which is not particularly surprising and does not detract from the quality of the work.

He provides great detail of the action with *Hood* and *Prince of Wales* and continues in this manner up until the final combat and his rescue from the icy waters of the Atlantic.

Of the various accounts of this vessel and its Atlantic battles, this is, without a doubt, one of the most interesting pieces that has yet to be written on it and is, to my knowledge, the only German eyewitness account ever written. The Naval Institute Press is to be congratulated on having selected it for publication and I can only say that it is highly recommended to any individual who might be interested in this ship.—G. Nafziger

*THE COMPLETE WARGAMES HANDBOOK: HOW TO PLAY, DESIGN AND FIND THEM*, by James F. Dunnigan. \$7.95 paperback, published 1980 by William Morrow and Company, 105 Madison Ave., New York, NY 10016. 272 9" by 5 3/4" pages including front matter, at least 50 illustrations including some photos. c. 100,000 words.

Ask several people from different places to define the word "wargame" and you're likely to get conflicting replies. Some miniatures players talk as though all wargames are miniatures games. Others would include all kinds of conflict games such as *Diplomacy*, role-playing games, fantasy boardgames, even computer games—all of which are now called "adventure games". Others use the word in a more restrictive sense,

to mean historical conflict simulation boardgames. *The Complete Wargames Handbook* uses the latter definition, though other types of wargames are occasionally mentioned. (The definition is not surprising, since the author is former president of SPI and the most prolific designer of conflict simulations in the world.) The book is intended to introduce the reader to wargames, as defined in this way. It is evidently aimed directly at people who know very little about wargames; I cannot say how well it does the job, since my novice days are 18 years away, but there's quite a bit of information to chew on.

The chapters are: What is a Wargame?, How to Play, Computers and Wargames, Why Play Wargames? (and How to Get More Out of It), History of Wargames, Who Plays Wargames? (and Why), Wargames in Print, and Designing Games (including a complete game, *THE DRIVE ON METZ*).

The first chapter explains what a (hex) wargame is, using examples from *Drive On Metz*. "How to Play" includes a glossary which might help novices, but it isn't much use to anyone else. The author tries to give advice about how to play well, but his own lack of interest in playing "for blood" shows. The advice is pretty nebulous, though not quite useless, compared to the "Games Theory" section in Jon Freeman's *Winners Guide To Board Games* (reviewed in *ADVENTURE GAMING* #3). Dunnigan stresses "analysis" without ever making clear what that vague word is supposed to mean in this context. It boils down to exhortations to players to think about what they're doing when they make a move—hardly inspiring but perhaps useful to novices. I wish he'd said it more concisely. The best part of this chapter is the emphasis given to what he calls "shaping". A player should decide how he wants the game to progress, and then work to fulfill this conception. In other words, control events, don't let them (or the other player) control your moves. Make the other player react. A great many mediocre games players could benefit from this section, though it will be obvious to good players.

"Computers and Wargames" is already outdated, and seems superficial in any case. The bulk of "Why Play" is a discussion of key elements in different periods of warfare, quite informative but not having much to do with wargames.

The "History" is of commercial games

# LETTERS

only, interesting but already somewhat outdated by the great growth of fantasy games in general and TSR (publishers of *DUNGEONS & DRAGONS*®) in particular. (TSR is now the largest wargame company, and SPI has fallen back from Avalon Hill to join Yaquinto, Game Designers Workshop, and perhaps Meta-gaming. *Dragon* magazine has a much larger circulation than *Strategy and Tactics*, and the days when it was \$9 a year are long gone.)

"Who Plays Wargames" is a profile of *Strategy and Tactics* subscribers, not of wargamers. Perhaps this was the only information available to the author, but he might have emphasized the probability of difference between S&T readers and wargamers in general.

"Wargames in Print" is too brief (and too old) to be useful. (Although the book was issued in summer 1980, it appears to have been written at least a year before.) The chapter also seems much like an advertisement for SPI, because only games getting fairly high scores on S&T's (naturally biased) feedback are described. At least one classic game, *Stalingrad*, does not seem to be mentioned in this section even in the listing of average games.

The last chapter describes the process of game design, using the complete game as an example. The game has a 5" by 7" map and 20 pieces which must be xeroxed or cut out, glued on cardboard, and cut apart. Naturally it is a simple, quick game which might pall after several plays, but it is good for illustrative purposes.

The style of the book is very relaxed — too much so, sounding like it was dictated rather than written, with the fuzzi-ness usually associated with that sort of thing. (I doubt that Dunnigan actually dictated it; that's just his style.) A tough copy editor might have helped. It is not a bad book by any means, but it could have been considerably better if the author had avoided self-indulgence.

As an introduction to wargames for a complete novice, *The Complete Wargames Handbook* is probably better than Jon Freeman's *Consumers Guide to Wargames* or Nick Palmer's books. (As a game buyers guide it is quite inferior to the others.) But I'd have preferred smaller print and consequently fewer pages and a lower price. You can probably find it in the local public library (I did), or persuade the library to buy a copy.

—Lewis Pulsipher

Dear Editor:

Thanks for the great magazine!

I just read *Adventure Gaming* and found the articles interesting and most enjoyable to read.

I hope in the future that you have more articles on "Starting Over" and on game reviews.

I found *Joys of Napoleonic Wargaming* very interesting and have asked some of my friends to try it, even though we are strictly FRP.

Could you print some material on *Chivalry & Sorcery*? Keep up the good work!

Steve Foster,  
Jacksonville, IL

*You're most welcome!*

*We are constantly seeking philosophical, generic articles to print, but they are few and far between.*

*We plan to have at least a couple of reviews (in-depth) in each issue. Further, if everything works out next issue, we will be initiating another type of review column, written by yours truly. Entitled "Short Takes & First Impressions", it will be just that: thumbnail sketches, and impressions, of new products. The column will be strictly my own personal*

*opinions, therefore fallible. I may "do" a game one month and amend my impression at a later date.*

*I'm sure Mr. Nafziger will be delighted when he reads this—there are never too many Napoleonic buffs.*

*I'd certainly publish something about C&S if it was interesting, well-written and I had it. —Editor.*

Dear Mr. Kask:

I see where the first editions of your new *Adventure Gaming* magazine have hit the newsstands. Congratulations! I know how satisfying it must be to finally bring such an idea to fruition.

The comments I have heard so far on AG have, unfortunately, been to the tune that it's "just another D&D periodical".

Samual T. Gill  
Kansas City, MO

*I find that statement to be hardly credible. (I don't hold it against you, as you are merely repeating it.)*

*In the first three issues, there is only one article that is D&D/AD&D specific, and it is in the third issue, which post-dates your letter.*

*Granted, there have been a few articles dealing with FRP, but always in a generic sense. I recognize that D&D/AD&D are certainly not the only FRPG's on the market, but they are the biggest selling ones at this time, closely followed by GDW's TRAVELLER.*

*Were we not to print articles of this type, we would be failing in our avowed purpose: to reflect, and disseminate information within, the adventure gaming hobby.*

*One AD&D-specific article, and four generic FRP articles out of 34 hardly make us "another D&D periodical".*

*Just as an aside, while I like to play fantasy games a lot, I am, first and foremost, and always have been and probably always will be, a historical gamer, by choice. I suppose all those years with a fantasy company, publishing a fantasy magazine, could be misleading. —Editor*

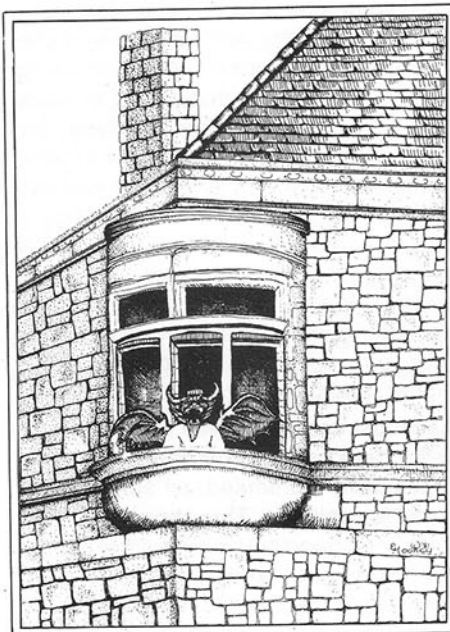

## COMPUTER AMBUSH©

by Art Wilson  
& Gregory Van Anderson

*Computer Ambush* is a computer based simulation game of squad level infantry combat in France during the Second World War. It is produced by Strategic Simulations, Inc., and lives up to their usual high standards. This game successfully uses the information processing capabilities of the home computer to make a very complex game simple to play. Although easy to play, it can be very challenging, and is not necessarily easy to win.

There are several qualities that may be considered when evaluating a computer game. In this review, the game will be treated exactly as that — a game. We will not be concerned with the programming behind the game, but rather the quality as a simulation, the physical quality of the game components, and finally we'll consider the ultimate question in the mind of every consumer — is the product worth the price?

As mentioned before, *Computer Ambush* is an easy game to play. This is not because it is simple, but is due to the fact that the drudgery of record keeping is handled by the computer, allowing the players to focus their full concentration on the action. When the disk is first booted, a very nice representation of the box cover is displayed on the screen. A number of options are offered before actual play begins, including sound or no sound, and blind or unlimited sight. Blind play is more realistic, showing enemy units only when they can be seen, but also is more time consuming than unlimited sight play, in which all units are visible, regardless of line of sight. The scenario to be played must be selected from the seven available, and if appropriate, soldiers must be chosen and positioned. In the two-player scenarios, passwords chosen by the players must be entered. The sequence of play consists of five distinct steps. First is American order entry, followed by Ger-

man order entry, computer execution phase, American report phase, and German report phase. At the end of each sequence, players are given the option of saving the game on disk for continued play at a later time.

The order entrance phase is the heart of the game for the players, and there are a number of options that may be taken. One may check the status of each of the soldiers under his command, including wounds, position, posture, facing, endurance, command control, weapons status, and current orders, all displayed in an easy to read format. Another option is to see a portion of the map. The map is very nicely displayed on the video screen, although it may not be seen in its entirety. Orders are entered for each soldier individually. A wide variety of movement, preparation, and firing orders is available. Each order has an energy- and a time-cost. The length of the turn is determined by the players at the beginning of the sequence by specifying a number of time points, with ten time points representing one second of game time. A sequence of orders may be given until all available time points have been used.

After all the soldiers have been ordered, the computer considers all the orders, and displays an approximate time it will take to complete the calculations. During this process, the number of time points remaining is displayed, giving the player a more realistic idea of how much longer they must wait. This is one of the serious drawbacks of this game. One must search for a balance between reality and playability. Although a computer is capable of handling an amazing amount of complex material, it all takes time. The more soldiers involved, the longer it will take. When in the heat of battle, so to speak, a ten minute wait can be quite frustrating. One consolation is that the computer does *all* the work. If the players wish to do something else during this wait, there is no problem with neglecting the game. For instance, a very long turn may be entered before dinner, and be ready after.

In most cases, the wait is worthwhile, as the report phase comes next. In place of the order command, an action command is available. This shows, through use of very good graphics and animation, the results of the previous order phase. Status may be checked for each soldier to determine the effects of the action.

The sequence of play is repeated until one side has completed their victory conditions, at which point a surprise animation indicates the loser, and final action may be seen by both sides.

Physically, *Computer Ambush* is a very impressive package. It comes in a bookcase type box, with an attention grabbing cover. Inside there is a rule book, one 5¼" floppy disk, a game selection card, two mapboard cards, two squad cards, and two grease pencils. The rule book is fourteen pages long, but the last seven pages are taken up by soldier's dossiers, giving good character sketches of each of the ten American and ten German soldiers. The dossiers are not necessary for the play of the game, but do add a touch of reality. The rules are very clearly specified, and as the computer does most of the work, consist primarily of explaining how to communicate with the computer. There is also some explanation of the mechanics behind the game, but it is mentioned that most of the mathematics are left out of the documentation to allow for some uncertainty in the player's minds, thus leaving us with "a game that truly creates the 'fog of war.' "

The game selection card contains details of the seven options available — there are three solitaire scenarios, and four two-player games. All the solitaire scenarios have the computer controlling the German troops, leaving the Americans for the player. There is an introductory scenario, intended for new players, with possible first turn moves included. The remaining two solitaire scenarios include a raid on the German communications center, and an ambush of a German patrol. The two-player games include a German ambush on an American patrol, a German assault on a factory the Americans are defending, and a chance meeting of two patrols. The fourth option is totally open-ended. Both the players choose any number of their soldiers, and may set them up wherever they wish. This option allows for design-your-own scenarios.

The mapboard cards are laminated, for use with the grease pencils, and depict the full map of the town, with a two-coordinate square grid system superimposed for purposes of movement. Each square represents three meters of game distance, making the total playing area 111m by 156m. On the back of the map sheet, there is a map key, defining the symbols used on the



map, a terrain chart, and a listing of what the buildings actually represent. Much like the dossiers, this listing is not essential to the play of the game, but does add a nice touch of realism.

The squad cards have a soldier characteristics chart on one side, and an order summary chart on the other. The characteristics given to each soldier are rank, name, weight, strength, intelligence, dexterity, power of observation, marksmanship (throwing and firing), and hand-to-hand combat ability. The abilities are represented by numbers from one to ten, with one being ten per cent, and ten one hundred per cent.

There are also variable characteristics for each soldier, such as wounds, endurance, and command control. Wounds indicate the amount of damage a soldier has taken: 50-98 wound points causes the soldier to go into shock, and 99 wound points means the soldier is dead. Either state effectively removes the soldier from the game. Endurance is a measure of how tired the soldier is. Each man starts with 99 points, and expends endurance by executing orders. At the beginning of each turn, endurance points are gained back, with due consideration given to strength and wounds. Command control is a measure of how well a soldier can understand and complete orders given him. This number varies with distance from the squad leader, and can have quite a profound effect on the play of the game, as the time an order takes to execute is directly dependent on this value.

The order summary chart has very useful tables on movement and weapons orders. The weapons available are rifle, auto-rifle, machine gun, knife, bayonet, garotte, fragmentation grenade, and plastic explosive. Each soldier is assigned a particular set of weapons, and this array may not be altered. Weapons also may not be exchanged among soldiers during the game. For example, if the soldier carrying the only machine gun is eliminated, the gun is lost as well. The movement orders contain a wide variety of movement possibilities, and a special command called sneaking, which allows a soldier to move cautiously, but more slowly and at a greater energy cost. The order summary chart is very convenient, giving a concise listing of command syntax as well as time and energy costs for the average soldier. After reading the rules, these charts alone contain enough information to play the game.

Now to consider the most important

Third Annual  
ADVENTURE ROLE PLAY WORKSHOP  
For Designers and Judges

## GAMESMASTERS WORKSHOP '82

JUNE 26 – JULY 9, 1982

Presented by The Companions  
with Lenard Lakofka, Peter Rice, John Wheeler and others

Held on the campus of the  
OAK GROVE-COBURN SCHOOL EAST VASSALBORO, MAINE

Choose from FOUR COMPLETE PROGRAMS

- SWORDS AND SORCERY
- CLOAKS AND DAGGERS
- WILD AND WOOLY WEST
- STAR TRAVELLERS

WRITE FOR FREE BROCHURE

**THE COMPANIONS, INC.**

245 WATER STREET  
BATH, MAINE 04530  
207-443-4909



question — is the game worth the price? The answer is not an easy one to give. If you are interested in the historical aspect of gaming, then *Computer Ambush* is not for you. It is intended solely as a simulation, and documentation is very scarce. For instance, the weapon array is sufficient for game purposes, but no statistics or even particular weapons names are given. Also, the game does not simulate a particular battle, but rather the very general premise of American infantry vs. German infantry in a French town, during World War Two.

If you are interested in the game as a simulation, it is a different story. It is a fun game, because the dull work of record keeping is taken care of by the computer, freeing the players from the actual game mechanics. The major problem is the waiting during the computer execution phase. Particularly frustrating are the times when it seems as if nothing has happened after a ten or fifteen minute wait. However, there is the save game feature which can alleviate this problem to some extent. The true merit of the game is in the Free Form scenario. There is no end to the possibilities that

can be explored with this scenario, the only limitations being weapons assignments and time. If choosing by weapon type, one is limited in the choice of soldiers. Also, the more soldiers involved, the longer each computer execution phase will take. However, the game need not be restricted to two players. Conceivably, up to twenty people can play, one soldier to each.

Although very entertaining and apparently endless in possibilities, the list price of \$59.95 will introduce a serious question of value into the buyer's mind. There are many computer games available, and most are much less expensive. The final decision rests in the hands of the buyer. If you feel you can afford a \$60 game, then *Computer Ambush* is a good one. However, considering the quality of lower priced competition, it should not be on the top of your shopping list.

*Computer Ambush* \$59.95  
Strategic Simulations, Inc.  
450 San Antonio Road, Suite 62  
Palo Alto, CA 84306

# Genuine



# Chaos



# of Battle

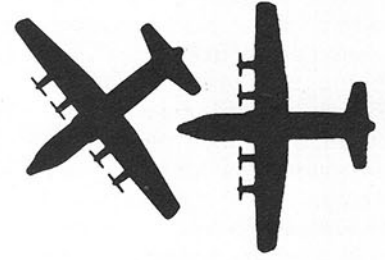

by Lewis Pulsipher

The two most unrealistic aspects of typical historical board wargames are related to the chaos of battle. One is that too much information is available to the commanders about the enemy's strength and location, and about less tangible factors. But in this article I want to discuss an interesting means of reducing the effect of second problem, sometimes called "command control."

There are few instances in warfare in which a single person could entirely control the movement of any large group of humans or machines. Napoleon, Garibaldi, Alexander the Great, the local Godfather all had to rely on subordinates to understand and carry out orders, and a certain amount of chaos resulted when communication failed or when someone decided that he knew better than the boss. On the other hand, sometimes a subordinate, by taking his own initiative, could save a less-than-infallible commander. In a typical wargame, the player completely controls all actions of his side.

There are two ways to reflect this real-life chaos while playing a game without changing the rules. The first is a multiple commander system, whereby several players in a hierarchical organization control the forces of one side on the game board. Each subordinate controls part of the force, while the superior officer(s) control reserves and give orders to subordinates. Players can communicate only by sending messages via a referee, who determines how long it takes for the message to get through. The supreme commander might never see the battlefield, relying solely on reports from his subordinates. But even if he can see it, his written orders will be garbled, misunderstood, or even ignored by subordinates who think they know better. The result can be a lesson in *real* military history. This method works particularly well in postal games. Unfortunately, it requires a lot of time, a lot of work, and a lot of players.

A method more economical of all three commodities is a game played by partners, two or three per side. Each partner plays a turn and then gives way to the next one, with communication between partners restricted in some way. Unless the partners think very much alike, they will find that their different ideas about strategies and tactics will lead to a kind of chaos reminiscent of the muddle resulting when subordinates fail to carry out their superior's intentions.

Partners not presently playing should go to another room. They might even start a second game, so that two are going at once. This is best with three players per team, so that there are fewer delays waiting for a player to finish his move in the other game. When the players' attentions are divided between two games there are even more chances of chaos.

There are a number of ways to limit communication between partners, and all offer different flavors for the game. The first is to allow no communication of any kind, except what partners might communicate with looks as they pass by one another. This is the biggest test for the team, since they have only their initial plan to guide their efforts. A second method allows the partners to talk to one another, but only in the presence of the enemy team — and no whispering. Thus the team members must decide what information is so important to a partner that the enemy can hear it, and what they should keep quiet about, hoping that their partner will notice the situation on his own. A third method allows partners to communicate only in writing. The length should probably be limited to a few hundred words per turn, or else the team with the more persevering writing hands will gain an advantage. Perhaps only a pre-determined set of symbols (a code) could be used. For example, N, S, W, E, and C might indicate

five areas of the board (C for center), an oval or X would mean armor or infantry, R could mean retreat, and so on. Players would have to somehow convey information using only the symbols provided, each player leaving a message for his successor but not otherwise communicating. The written-message method can be varied by allowing the opponents as well as partners to read messages.

There is some potential here for team competitions at conventions. A good team will make a plan before the game starts, and stick to it, while a poor team will follow individual ideas according to whichever person is playing at the time — a case of too many cooks. In this sense, the team format replicates the problems of a command hierarchy: a plan must be made and followed, because the more well-organized side following a good plan will win. I think a partnership tournament would be much more interesting to watch than man vs. man.

Partnership play need not be confined to historical games, of course. Imagine a *Diplomacy* or chess game played by partnerships. What chaos! (*Diplomacy* and similar large-scale games can also be played as competitive partnerships, with each player representing some part of the government, all maneuvering to control the moves of the pieces. Several existing variants use this idea.) Parlor games and those which do not emphasize conflict between players are probably less affected by partnership play than wargames, on the average. There are fewer opportunities to foul things up, and less happens in each individual move than in most wargames.

Whether you use partner play to represent the chaos of battle, or just to make the game more interesting while accommodating more players, it's worth trying sometime.



# The Compleat Gamer

303 S. Rohlwing Road  
Palatine, IL 60067

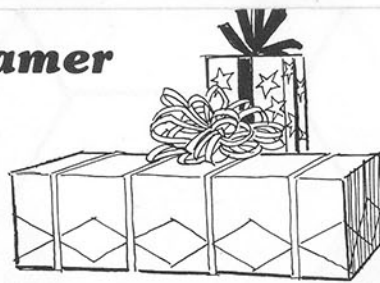

# 24 GREAT WAYS TO GET INTO THE GIFT GIVING SPIRIT!!

CALL RIGHT NOW 800-323-3849 Toll Free

or  
USE OUR AD AS YOUR ORDER FORM



- a. Jackson/Corinth . . . \$25.00
- b. Spies . . . \$15.00
- c. The Guns of August . . \$17.00
- d. Squad Leader . . . \$17.00
- e. Axis and Allies . . . \$18.95
- f. \*TaskForce . . . \$18.00
- g. \*Conflict 2500 . . . \$15.00
- h. \*B-1 Nuclear Bomber . \$15.00
- i. Planet Miners . . . \$15.00
- j. Tacforce . . . \$19.98
- k. Ace of Aces -  
Rotary Series . . . \$13.95
- l. Ace of Aces -  
Powerhouse Series . . \$13.95
- m. Knights of King Arthur  
Miniature Set . . . \$19.95
- n. Famous Monsters  
Miniature Set . . . \$19.95
- o. Dragonslayer . . . \$15.00
- p. Dungeons & Dragons  
Expert Set\*\* . . . \$12.00
- q. Dragonquest . . . \$ 9.95
- r. Thieves' World . . . \$15.95
- s. The Fiend Folio . . . \$12.00  
Vol. II of Monster Manual
- t. Universe . . . \$20.00
- u. Traveller Deluxe  
Edition . . . \$19.98
- v. Aftermath . . . \$20.00
- w. The Sword and  
The Stars . . . \$12.00
- x. Star Fleet Battles . . . \$16.95

The Compleat Gamer is as close as your mailbox!  
We ship quick, and will

SHIP TO —

NAME \_\_\_\_\_

ADDRESS \_\_\_\_\_

CITY \_\_\_\_\_ STATE \_\_\_\_\_ ZIP \_\_\_\_\_

Sorry, No C.O.D.'s

### SCHEDULE FOR SHIPPING AND HANDLING CHARGES

Order	Shipping & Handling	WE PAY SHIPPING ON ANY ORDER OVER \$25.00 PLEASE ADD \$2.00 FOR 85 PAGE ILLUSTRATED CATALOG
\$1-\$9	\$1.85	
\$9-\$14	\$2.65	
\$14-\$20	\$3.45	
\$20-\$25	\$4.00	

- CHECK ENCLOSED
- VISA/BANK AMERICARD
- MASTERCARD

	<b>SUB TOTAL</b>
	<b>SHIPPING</b>
	Illinois residents please add 6% sales tax
	<b>TOTAL</b>

	Exp. Date
CREDIT CARD ACCOUNT NO.	

SIGNATURE \_\_\_\_\_

\* For Apple, Commodore & TRS80 Computers only. MIM.16K  
\*\* Must have D&D Basic Set.

Visa-Mastercard-Money Orders shipped same day • Personal checks allow 10 days for delivery  
Alaska and Hawaii add 10% for shipping—Canadian residents add 15%—on all orders • APO/FPO shipped PAL rates

# Phigure Photos



1



2



3

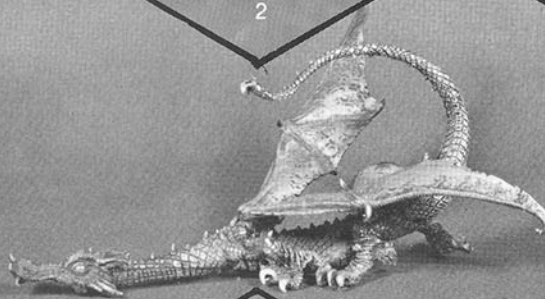

4

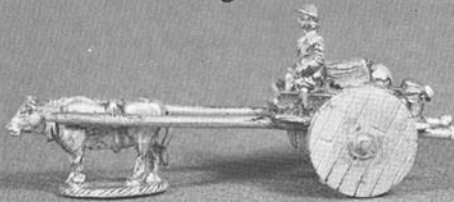

5



6



7

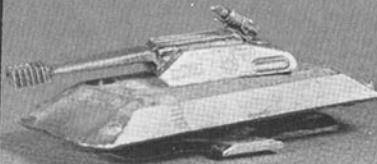

8



9



10

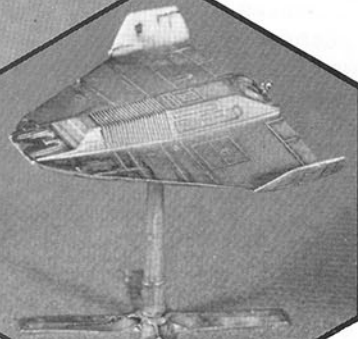

11

Each month *Adventure Gaming* will be featuring photographs of miniature figures and accessories in our Phigure Photos column. We look forward to keeping you well informed about the newest miniatures on the market. This column will not be a review column. *Adventure Gaming* photographs each figure under identical, controlled conditions. We thereby allow the figures to speak for themselves — *you* be the judge.

Ral Partha  
5938 Carthage Ct.  
Cincinnati, OH 45212

25mm  
09-091 Elf hero  
mounted & dismounted

1

GHQ  
2634 Bryant Ave. So.  
Minneapolis, Minn. 55408

1:2400  
IJN-1 Tone CA

2

Ral Partha  
5938 Carthage Ct.  
Cincinnati, OH 45212

25mm  
01-093 Anti-paladin  
mounted & dismounted

3

Ral Partha  
5938 Carthage Ct.  
Cincinnati, OH 45212

25mm  
01-094 Golden Dragon

4

Navwar Productions Ltd.  
48 East View  
Barnet, Herts.  
England

15mm  
S14 Wagon, peasant driver

5

Citadel Miniatures U.S.  
P.O. Box 12352  
Cincinnati, OH 45212

25mm  
FA6 Bard with sword & lute  
FA7 Monk with Staff

6

Citadel Miniatures U.S.  
P.O. Box 12352  
Cincinnati, OH 45212

25mm  
FA3 Cleric with cross & mace  
FA18 Female Cleric with mace

7

T-Rex  
3618 Dexter  
Fort Worth, TX 76107

1:285  
A-5 Starlord Fighter

8

T-Rex  
3618 Dexter  
Fort Worth, TX 76107

1:285  
A-3 Leopard III  
Combat Recon Unit

9

T-Rex  
3618 Dexter  
Fort Worth, TX 76107

1:285  
A-4 Leopard III  
Tactical Missile Unit

10

T-Rex  
3618 Dexter  
Fort Worth, TX 76107

1:285  
A-1 Azuriach Tiger IV  
Main Battle Unit

11

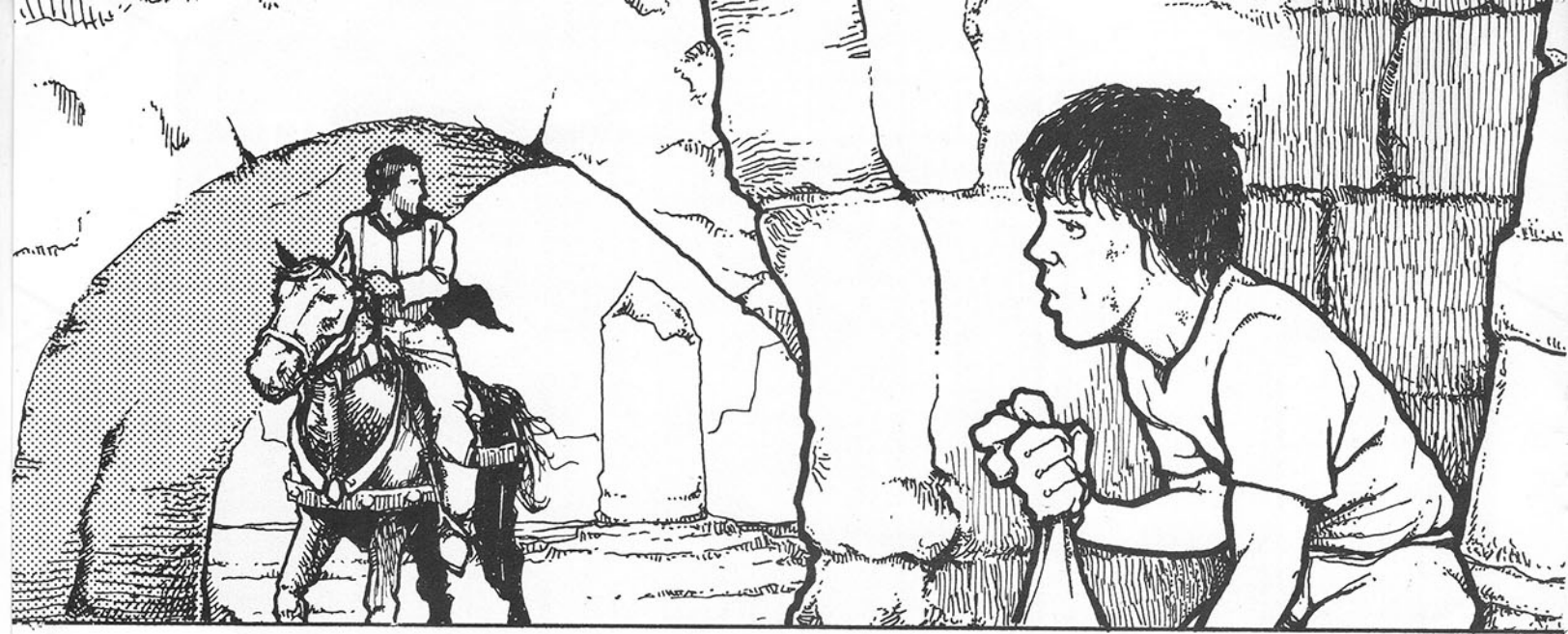

## Coming Of Age On Cidri

### Pre-adventuring Experience In THE FANTASY TRIP®

by Harry White

In most of the more popular role playing games the characters, player and non-player, are created at age eighteen or so. There is little concern about parentage, where or how they grew up, or what they experienced until their magic immaculate conception and birth at a relatively advanced age.

*THE FANTASY TRIP* (TM, Metagaming, 1980), set on the megaplanet, CIDRI, provides a system for gaining experience points by working at various jobs. This suggests a way to create a character at birth and follow his/her growth through childhood and adolescence to adulthood.

*The Fantasy Trip* system assigns two parameters for each type of employment. The lowest possible parameter is three, the highest, eighteen. Each job has a certain risk to it, and each has certain opportunities for advancement, wealth, and experience. For each week on the job roll three six-sided dice. If the roll equals or exceeds the high parameter, then something bad has happened and there is a chance for personal damage. No pay is received that week. If the low parameter or less is rolled, then a bonus in both wealth and experience is received.

For example, the parameters for a petty thief are 5/15. It's a dangerous profession, but there is a chance of stumbling onto a wealthy victim. If you roll fifteen or more, there is a chance of

jail . . . or worse! However, if the roll is five or less, then the lucky fellow rises in experience and makes an outstanding haul.

This same concept can be applied to life prior to the scenario. Risk and bonus parameters can be assigned to stress points in childhood such as birth and puberty. Just as employment has its rewards and dangers, so does growing up. Ask any kid.

It would be excessive to expect a player to roll for each week in each year of the character's development, but one roll per year through the fifteenth seems reasonable. The following table offers the base for such a system:

Period	Parameters	Bonus	Penalty
Birth	7/14	3	Death
First year	7/14	3	-3
Second year	6/15	2	-2
Third year	5/16	1	-1
Fourth year	5/16	1	-1
Fifth year	6/15	2	-2
Sixth year	5/16	1	-1
Seventh year	5/16	1	-1
Eighth year	5/16	1	-1
Ninth year	5/16	1	-1
Tenth year	5/16	1	-1
Eleventh year	5/16	1	-1
Twelfth year	7/14	3	-3
Thirteenth year	6/15	2	-2
Fourteenth year	5/16	1	-1
Fifteenth year	5/16	1	-1

To use the growth table roll 3D6 and compare the roll to the line, "Birth." If your roll was seven or less, record three bonus points. If your roll was fourteen or more, your character died at birth, an all too common experience on Cidri. If your roll was between these extremes, then your creation survived and receives nothing (but at least he/she made it!). Repeat the process for the first year of life and record a plus, a zero, or a minus according to your score. When you have completed the rolls for all sixteen periods, add up the scores. The total score represents a quantity which you distribute among strength, dexterity, and intelligence - points on top of the normal eight provided by the rules. Note, however, that you may well end up with a negative quantity to add. Do what you wish with those individuals; they might make good grooms or servants.

Compare the above table with the job table in *The Fantasy Trip*. You will discover that Cidri is a very dangerous place on which to grow up. The mortality rate for children is very high, but no higher than in some places on Earth today. In our medieval times, which some FRP games simulate, the rate was probably much higher. However, the table's opportunities for becoming exceptional are almost as great; survival of the fittest in operation.

The variety of the parameters at various ages accommodates particularly

is an obvious one, but ages five and six are also problems for humans. Pubescence is another stressful time.

You can add your own enhancements: make the parameters less dangerous by raising the high limit; increase the chance for a bonus by raising the lower; use die roll modifiers if the child is of exceptional parentage or is born in a geographic location advantageous to survival. (E.G., If born in the wilderness of poor parents, the youngster's chances of survival might be worse. On the other hand, there might be more opportunities for bonus experiences.)

Use enhancements carefully. An overage of higher bonus limits will create too many powerful beginning sixteen-year-olds. Making the penalties tougher produces a batch of weaklings. As a general rule, you should provide an equal chance for experience or catastrophe. Think in terms of narrowing or widening the parameters rather than just shifting up or down. If you are into such things, you will find it useful to run several children through the process, keep track of the results, plot them on a

graph, and see what kinds of bell-shaped curves you produce with a variety of parameters.

There is no reason the system should not be used with other RPG's (except, of course, the GAME MASTER's fiat). You need only rear the child, compute the bonus or penalty points, and then add them to the results of whatever system the game uses to create characters.

At age sixteen, after all the points have been distributed, your prodigy is on its own. Give it talents and send it off on an adventure or give it a job. And be thankful. He or she has probably passed through the worst part of life already.

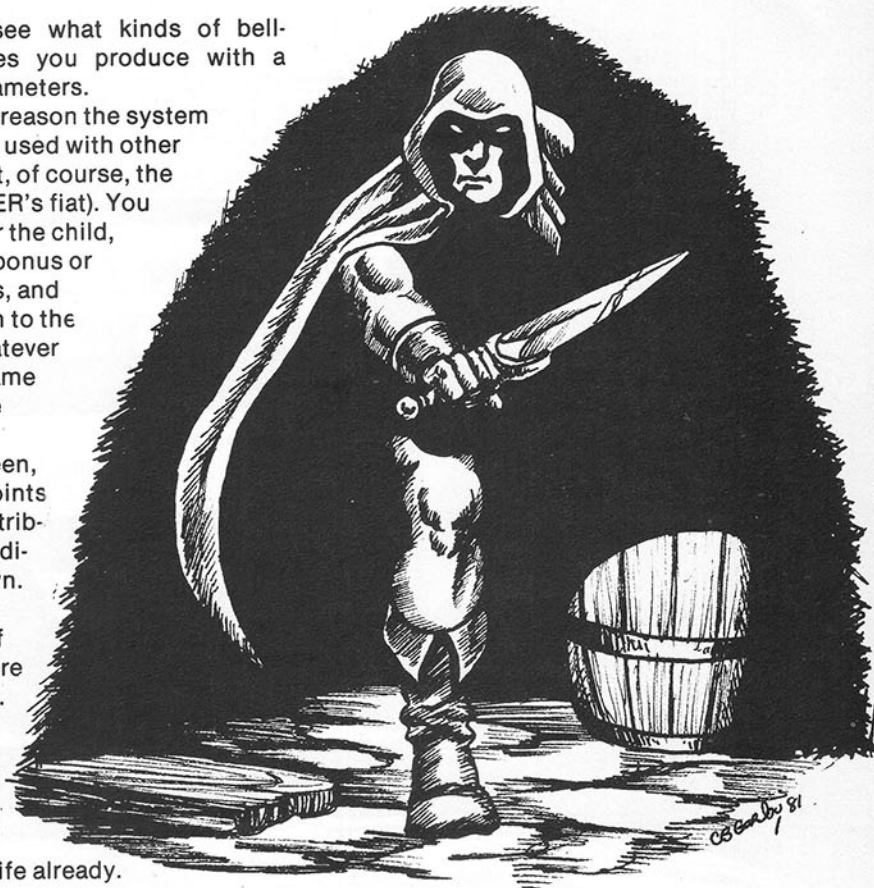

**Citadel Miniatures U.S. has expanded its ranges to include THE FANTASY ADVENTURERS. With assorted dungeon personalities, this range is designed for the most imaginative fantasy gamer.**

**CITADEL MINIATURES U.S.**

P.O.Box 12352 • Cincinnati, Ohio 45212 • 513-631-0499

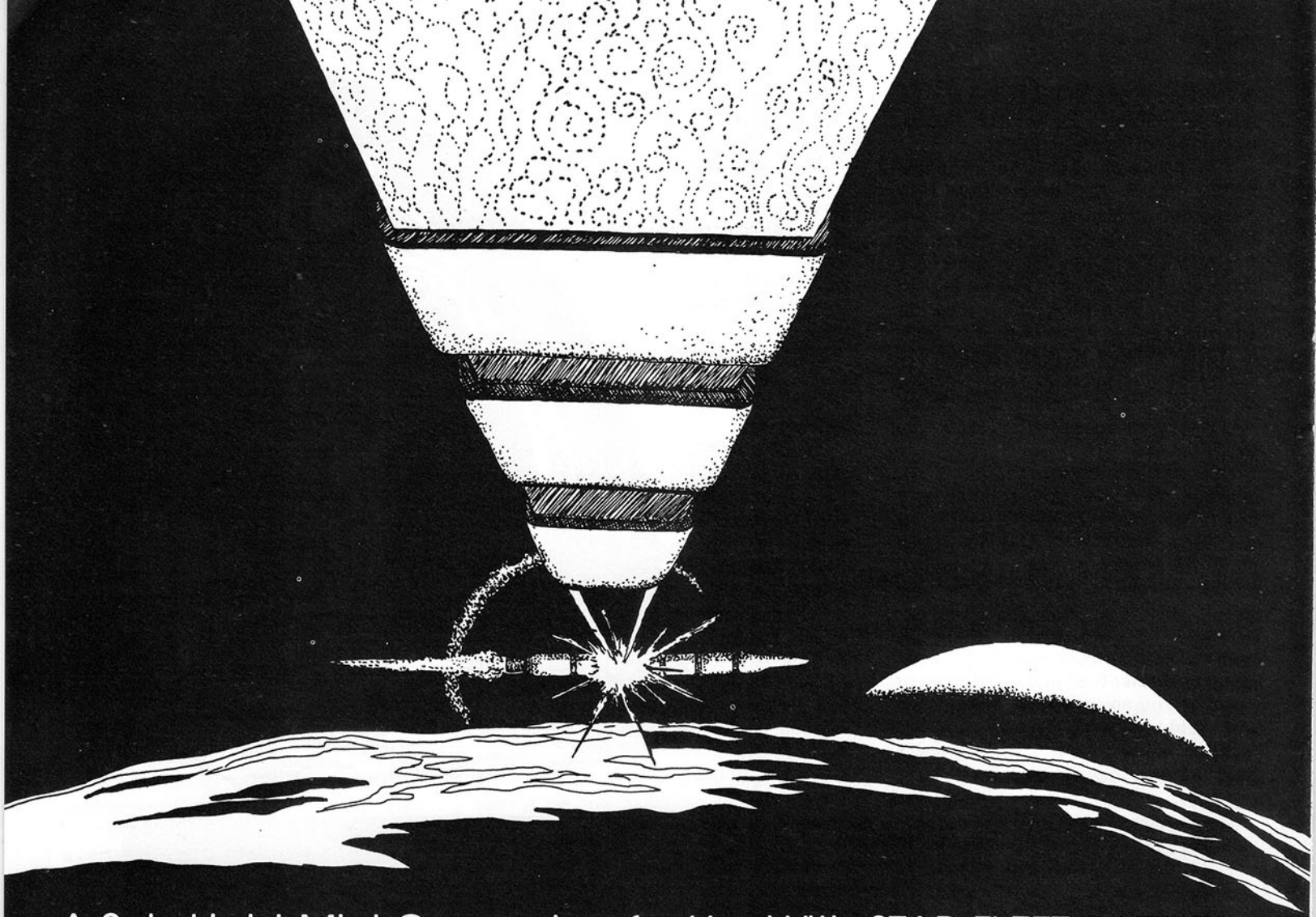

## A Sub-Light Mini Campaign for Use With STAR FLEET BATTLES®

Part Two

### **"Allies In Spite of Themselves" . . . The Response From Rigel**

*Chronology:* 2166 (43)

*Background:* Telar was not the only ally Earth had in the Romulan War. The Rigel Colonies were already developing into one of the most populous cultural centers in the galaxy. This Vulcanoid race, despite some initial hesitation, quickly responded to the call to arms although their distance from the main theatre of fighting prevented them from making an early contribution to the war effort.

Likewise, the green-skinned Orions maintained the second largest warfleet in Federation space. Although often at odds with other Federation members over their lucrative slave trade, the Orions had little desire to see their markets absorbed by the mysterious Romulans.

Despite the fact that Rigel was, and would continue to be after the war, the principle opponent of the Orion traffic in flesh, both parties displayed an amazing ability to work successfully together against a common enemy. Although not present at the defense of Daren V, two years later a combined Rigel-Orion task group proved their daring and abilities by surprising a large

Romulan convoy resupplying enemy lead elements near Argo.

#### *Order of Battle:*

Rigel-Orion: 2 Orion Heavy Cruisers, 2 Rigel Battle-Corvettes

Romulan Star Empire: 1 Warbird, 2 Warhawks, 2 Large Freighters, 1 Small Freighter

*Deployment:* Place small gas giant planet (atmosphere radius four hexes, treat as impassable) in hex 3929. Place one small gas giant (atmosphere radius two hexes, treat as impassable) in hex 2104.

Place asteroid markers in hexes: 0123, 0124, 0222, 0223, 0322, 0323, 0421, 0422, 0521, 0522, 0620, 0621, 0720, 0721, 0819, 0820, 0919, 0920.

*For purpose of this scenario all asteroid hexes (and those adjacent) are considered impassable.*

*Special Rules: Orion/Rigel Ships:* Both the Orion cruiser and the Rigel corvette are derived from the standard Orion-class ship designs that are still in use today. As there is little actual difference between ship standards at this time both Rigel and Orion make use of Orion SSDs.



*Orion Heavy Cruisers* use the Expansion Kit CA SSD with the following modifications: Eliminate Optional Weapons boxes, Add (4) APR, Replace all phasers with laser Boxes with a maximum range of eight hexes. Add two emergency impulse engines, one per wing nacelle. (These are not activated until all other impulse boxes are already destroyed in which case they operate as standard impulse power systems). Replace Photon TORPS with four boxes of armor. Drone racks are atomic missile launchers with four missiles each.

*Rigellian Battle-Corvettes*: Use Orion Pirate Raider SSD modifier as follows: Phaser boxes forward (only) are replaced with lasers. All other phaser boxes eliminated; range six hexes. Replace Photon TORP with two boxes armor. Add (1) APR. Drone racks (launchers) have two missiles each.

All other standard restrictions for sub-light game applies.

*Romulans*: For purposes of this scenario in addition to the freighters below all Romulan warships have "Hull" boxes replaced with "Cargo".

Standard freighter SSDs are utilized with following modifications:

Large freighter — Replace ten cargo boxes with (5) armor boxes. Phaser boxes are replaced with (2) 360° lasers. Add (3) APR.

Small freighter — Eliminate five cargo boxes and replace with (3) armor boxes. Small freighter has no lasers. Instead add (1) missile launcher with two missiles. Add (2) APR.

*Victory Conditions*: Romulan player receives victory points *only for exiting cargo-bearing ships off the map-edge in Map Area C*. Each remaining cargo box so exited yields 1 point.

No points are gained for destruction or damaging of enemy ships.

Orion-Rigels receive BVP's scored as per prior scenarios. In addition two points are scored for every cargo box destroyed aboard Romulan ships.

*Scenario Length*: The scenario runs until all Romulan vessels are destroyed or until all have exited the board off Map Area C.

*Player Strategy Note*: The Romulan convoy depicted here is crucial to the efforts of the Romulan High Command to maintain the steady pace of their advance despite the check at Daren V. Loss of the supplies and armaments contained in these ships would greatly upset the Romulan time table, give the Earth Federation Alliance much needed time to regroup and reorganize, and possibly, in the long run, allow for a shift in momentum that could culminate in a Romulan defeat. Thus *safe delivery of the cargo off the map is the primary concern for the Romulan commander in this situation*. Despite any personal feelings to the contrary (!) if necessary he will even sacrifice one or more of his ships to see the rest safely home.

## "A Victory Long Sought" . . .

### The Battle of Cheron

*Chronology*: 2168 (45)

Background: The battle of Cheron, depicted in part here, in many ways was *the* decisive fleet action of the First Romulan War. Cheron marks the furthest extent of Romulan penetration following the loss of Starbase One. Moreover, Cheron quickly became the ultimate test of will that in time proved to be the key to final victory over the

# HALT!

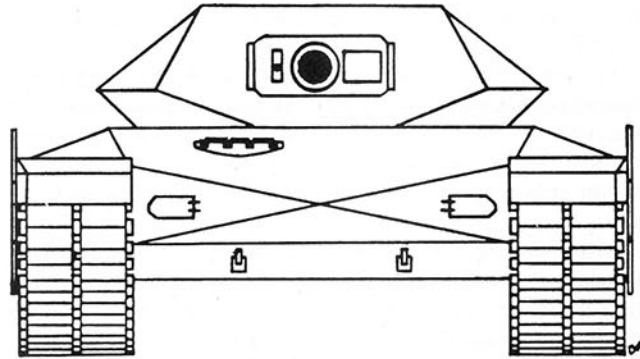

## YOUR COMMAND AWAITS YOU IN: OPERATION: SKYBOLT

OPERATION: SKYBOLT, Computer War Game Corporation's NEW Play-Py-Mail (PBM) wargame, portrays one of the major battle zones of a great Civil War occurring on the homeworld of an alien solar system. The invading lunar Colonists and defending Worlders, using conventional weapons and forces remarkably similar to those of modern day earth, attempt to wrest or maintain control of one of the few habitable regions left untouched by the nuclear devastation caused by a recent Worlder war.

### FEATURING:

- A Chain of Command: The Army/Corps Commander directing the movements, support, and supply for the powerful Divisions under his command. The 9 Division Commanders control the actual cutting edge of this awesome force; the deadly armor and infantry battalions.
- New Computer generated maps each turn showing current locations of all known units, the roads, rivers, railroads, cities, airfields, and terrain.
- Complete casualty and status reports each turn for all your units.
- No codes and few abbreviations to decipher.
- We handle all the math and record keeping so that you can concentrate on strategy and tactics as you fight your way to victory.

Games will start in December and for the months of October and November ONLY we are offering FREE setup to new players. Turns are \$4.00 for Division Commanders and \$5.00 for Army/Corps Commanders. Turns are every 21 days. Rules are \$1.00. We guarantee your money back if you don't like the game after the first turn. To join a game just send a check or money order for \$10.00 to: Computer War Games Corp., Dept. V1, 93 Hill Street, San Francisco, CA 94110

Romulan foe. *Before Cheron it could be said with certainty that the Romulans had never lost a major fleet action. After Cheron, with equal certainty, it could be said that they never won one . . .*

In its entirety Cheron covered three full solar days of intense, bitter fighting and saw some thirteen Federation and seventeen Romulan warships comprising seven separate space fleets and one "Battle-Flotilla" engaged over an area that to scale would extend over four separate mapboards.

Portrayed here is the key tactical maneuver on the second day of the engagement when Rear-Admiral Catherine Sil-Sarna attempts to drive the fatal wedge between the combined Romulan Fleets . . .

### Order of Battle:

Romulan Star Empire: 3 Warbirds, 2 Warhawks, 2 Monitor-Assault ships.

Earth Federation: 1 CA (Early Design), 3 Light Cruisers, 2 Missile Frigates

**Deployment:** Romulan forces are freely deployed on any hex in Map Areas C and F, within five hexes of each other, facing at owning player's discretion, speed not greater than 2.

Federation forces enter the map from any map-edge hex in Map Areas A or D, all vessels within four hexes of each other, movement rate initially no greater than (4). (These restrictions apply until initial damage is taken by either side after which all ships are free to maneuver at will).

**Special Rules: Early Federation Heavy Cruiser:** An early version of the more familiar *Constitution* class starships of a hundred years later were initially developed during the Romulan conflict. These vessels are represented here by using the Federation CA SSD with the following modifications in addition to all standard restrictions as per sub-light game rules:

The Early version CA may use shield rules as per normal starships, but all shields can only be set on a minimum setting. Moreover, the Alternate Shields Rule (29.0) is mandatory, as are the Damage Control rules, sections 30.0 - 30.2).

As the secondary hull is missing in this early design the "CA" counter is not used here. Instead substitute the "Tug" counter with any pods to better illustrate an accurate ship profile.

**Victory Conditions:** Both sides receive basic victory points in accordance with points awarded for destruction/damage to enemy vessels as given in Scenarios I and II.

**For purposes of over-all campaign point totals** double the points gained in this scenario for both sides, reflecting the perceived nature of this given engagement as a "must win" situation.

**Scenario Length:** This scenario runs for eighteen turns or until one side or the other completely disengages.

## **"Quarter, Neither Asked Nor Given" . . . The Assault On Romli**

**Chronology:** 2168 (45)

**Background:** Following their defeat at Cheron four months earlier the Romulans found themselves unable to halt the advance of the combined Earth Federation/Alliance until finally the last straggler was pushed back over the pre-war borders established six years before.

But if the Romulans hoped for an end to the unexpected reverses in fortune that had befallen them of late they were to be mistaken. Six years of bitter fighting had produced within the Federation a burning desire for revenge.

Thus it was decided, despite a last minute appeal by several "moderate" members of the Federation led by the Vulcans, that the homeworld system of the Romulan Empire itself must be invaded and "put to the torch" thus making any repetition of the horrors of the preceding years virtually impossible.

In this, the final fleet action of the war that saw the final dregs of the Romulan fleet — lead by the Praetor's personal flagship — matched against the combined power of twenty star systems, the enemy was capable of narrowly avoiding disaster, but only at a high cost. On the "Victor's" side the cost was almost equally as high.

In the end there were indeed *no* winners in this, the First Romulan War . . . only losers . . .

## **Order of Battle:**

Romulan Star Empire: Praetor's Flagship (see below), 3 Warbirds, 1 Warhawk, 2 Monitor-Assault Ships.

Federation/Alliance: *Earth:* 2 Early CA (Early Design), 3 Light Cruisers, 2 Missile Frigates; *Orion:* 2 CA; *Rigel:* 1 Battle-Corvette; *Telar:* 2 Armed Merchantmen; *Cygnus:* 3 Cygnian Strikeships.

**Deployment:** Romulans deploy one Class M planet counter in hex 2131. Space mine counters (blank markers) are placed in hexes: 1932, 1931, 1930, 2029, 2129, 2229, 2330, 2331, 2332.

All Romulan ships must be deployed within a ten hex radius of Romii in hex 2131. Romulan suicide shuttles are placed under the planet marker, all Fighter counters are kept off the map initially for convenience but will likewise originate from 2131. (See below).

All Federation/Alliance forces enter from off the "north" edge of the mapboard in areas A, B, and C.

**Special Rules: Romulan Planetary Defense:** Consists of ten laser boxes which do one point in damage per hit but are limited to a range of ten hexes, and are subject to "To Hit" restrictions for atmospheric conditions as exist in Scenario II. The first hits against Romii itself will be directed against these laser batteries. Each take one hit before being destroyed.

**Romulan "Pilum" Fighters:** Limited exclusively to home planetary defense, these early fighter designs would later be replaced by the more advanced "Gladiator" design. These "spear" fighter groups use counters from *SFB Exp. Kit 1*. Each counter represents ten actual fighters grouped into one "phalanx". Each counter possesses 1 laser box which will do two points of damage per hit. Fighter counters will be destroyed after four hits and a separate tally of each counter on the board should be maintained.

**Romulan Suicide Shuttles:** In lieu of standard armed shuttles, the Romulan player, for the defense of the home system, has at his disposal two manned, suicide shuttles. These specially constructed craft need not plot movement and may freely move through mine hexes (the only ships capable of doing so in this scenario). Each shuttle may absorb up to four hits before being destroyed. Impacting with an enemy vessel will cause 15 points in damage due to nuclear detonations.

**Praetor's Flagship:** In the latter part of the war in response to the Federation's development of their early CA design, the Romulans secretly developed their own "improved warbird" for use as a principle flag-command control ship, and to serve as the Praetor's personal vessel. The conversion project was never completed before the ship was pressed into service in defense of the home system. Used here it is represented by the WE counter and uses a standard WARBIRD SSD with the following modifications:

*Treat the ship as having two additional impulse engine nacelles, each producing six units of impulse power.* Although these are destroyed on "Right/Left Warp Engine" Hits they are IMPULSE engines, not warp engines. Add to the SSD *four* additional laser boxes, each doing one point damage/hit, *three* additional Armor boxes, and remove *two* Hull boxes.

**Cygnian Strikeships:** Use Orion shuttle markers. No SSD is available here; however, each strikeship has the following capabilities: (4) Impulse, (2) Missile Racks with *two Long-Range Missiles* Each (Treat as Mk. I Missiles but

# STAR FLEET BATTLES

## EXPANSION # 2

The waiting is almost over! This all new expansion module for **STARFLEET BATTLES** will be available soon in fine hobby and game stores near you. The module includes:

**COMPLETE ERRATA AND EXPANSION OF EXISTING RULES:** Phaser III Capacitors. Probe bombs. Complete rules for spotting cloaked ships. Non-violent boarding parties. New web rules. All ships explode when destroyed. Damage procedure for starbases. How power absorbers work. Corrected BPV values. The Gorn Battleship's turn mode. How many tugs the Klingons really have. And more!

**NEW SHIPS:** The long-awaited Gorn Dreadnought. The Kzinti Space Control Ship. The Hydran Dreadnought, with its devastating Hellbore cannon. The Federation Carrier and its new escorts. The fierce Federation "Tomcat" shuttle with five drones and a Gatling Phaser. Plus several all-new surprises!

**NEW RACE:** The Lyrans, complete with a full fleet of ships and new weapons—the Lyrans are the desperately longed-for Klingon ally!

**NEW RULES AND WEAPONS:** Sideslip maneuvers. Wild-Weasel probes. Sensor interlock. MIRV drones. Leech Torpedoes. Crew Quality. Legendary Captain, Science Officer, Engineer, Doctor, Weapons Officer and Navigator. Dilithium strain.

**NEW PSUEDO FIGHTERS:** Giant fighters, or tiny starships? One thing's for sure: they're deadly trouble for everyone!

**OVER A DOZEN EXCITING SCENARIOS AND NEW MINI-CAMPAIGNS:** Historical scenarios include Tomcat Terror, the Pleiades Turkey Shoot, the Cutlass Episode, Gunboat Diplomacy, and more! **SPECIAL STRATEGIC MAP** included for mini-campaigns, including Smuggling and Border Clashes.

## STARFLEET BATTLES EXPANSION # 2

It's been a long time coming.

But it was worth the wait.

Available soon. Only from

# TASK FORCE GAMES

The NEW FORCE in gaming.

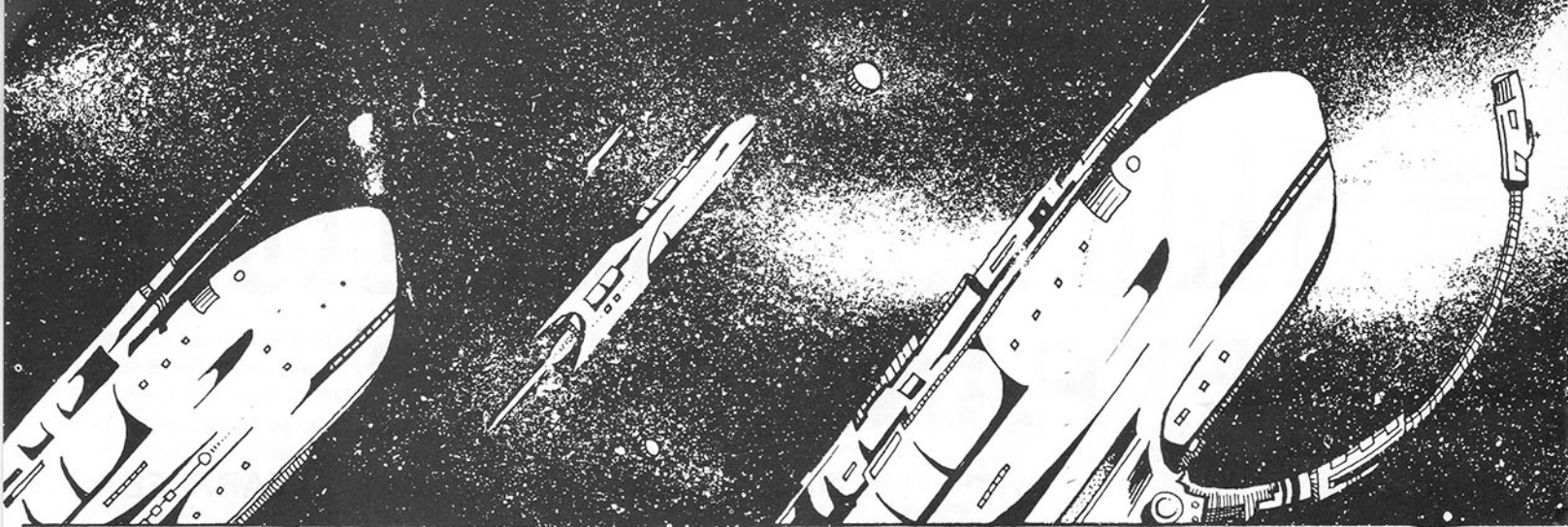

having a speed of 10 and an endurance of six turns), (1) BTTY, (1) Excess Damage Box.

**Victory Conditions:** Standard points awarded for enemy vessel destruction or damage. Additionally, the Federation player receives 40 BVP's for the destruction of the Praetor's flagship, and 1 point for each hit recorded against Romii. The Federation player, moreover, receives an automatic victory if 100+ points are registered vs. Romii (and 200

*Campaign points*).

The Romulan player receives standard points for enemy vessel destruction and damage. Each Cygnian strikeship is worth 15 BVP's.

**Scenario Length:** The scenario runs for twenty-five turns or until the Federation player gains an automatic victory, whichever comes first.

## OPTIONAL RULES

### I: Fleet Command Control:

The ability to coordinate and maintain the proper disposition of one's forces during a sub-light battle involving a large number of vessels, given the lack of sub-space radio and other modern techniques, posed a serious problem for both sides during this period. Very often a numerically superior force was made to give ground simply because it could not effectively control the flow of the battle, giving the opponent a major advantage in the tactical sense!

To reflect this players may choose to optionally designate a *flagship* for each side by secretly noting one ship (generally from among the largest and most powerful class available in a given scenario) as that fleet's command flag. In the event that this vessel is destroyed or immobilized (all power systems destroyed), all remaining fleet units *must* operate no further than six hexes from each other in order to maintain proper command control. Any vessel not operating within this restriction *must* either exit the map edge (disengage) or immediately move to place itself within the six hex radius from a fellow warship, whichever course of action is the more direct. (Taking the least amount of time in terms of game-turns and distance involved.)

### II: Campaign Victory Points:

Players may desire to play out the entire campaign simulated, in which case

certain scenarios will be of greater importance than others given the "Historical" aspects of that scenario being simulated. In such cases "Campaign Victory Points" are added to over-all point totals for certain conditions achieved. These must likewise be taken into account when determining the over-all "Winner" of the war.

Any player/team achieving a 2:1 ratio in over-all BVPs achieves a *Strategic Victory* in the game.

Any player/team achieving a 3:2 ratio in over-all BVPs achieves a *Marginal Victory* in the game.

Anything less than a Marginal Victory is considered a drawn game.

### III: Auxiliary Missile Racks

In the scenarios presented players utilize any already existing "drone" boxes to represent missile racks, adding such additional "Standard Complement" racks as are required according to ship class. Players may, however, wish to experiment with use of auxiliary racks in hopes of improving a given ship's chances of survival, or when designing their own situations based on the above material. To reflect this players should simply note on the SSD's the inclusion of up to two additional racks (each of two missiles each) and adjust the BVP's of each ship accordingly: BVP for each Federation ship increases by 2 points/per additional rack, BVP's for each Romulan ship increases by one point/per

additional rack. These are the only increases and modifications permitted to standard designs as given in this game. IV: Romulan Self-Destruction

All other conditions notwithstanding, the Romulans were (and remain) superb fighters, excellent examples of warriors who effectively live and die by the strongest of military codes ever encountered. As such, defeat is, for the Romulan, almost literally unthinkable. Death is always preferable. As the tide of the war turned against them, on several occasions where Romulan ships found themselves hopelessly outnumbered, individual commanders unhesitatingly chose to self-destruct their vessels as a last supreme act of defiance, taking as many of the enemy with them as possible. To simulate this feel for Romulan discipline and doctrine standard rules for ship self-destruct are permitted here in *the last three scenarios*. In such cases when determining victory points for that scenario, points awarded for loss of Romulan ships that self-destruct are *halved*, although exercise of this option, even once, nets the Federation player 50 *Campaign Victory Points* determination of a campaign winner.

---

Next Month — Rules for optional "Andor-class" battle-station for use with SFB and in the final scenario.

---

# Everything You Always Want To Know About Atari SPACE INVADERS\*

\*But Were Too Busy Avoiding Nasty Little Bombs To Ask

By Mark Cummings

We'll begin with some facts and figures.

A full set of thirty aliens drops about 100 bombs a minute.

Some of the bombs are dropped at "random," but a higher percentage of the bombs drop in the vicinity of your laser cannon (*i.e.*, the computer *knows* where you are and drops more bombs in the areas you are in than it does elsewhere).

On the "fast bombs" option, the bombs drop about three times as often traveling three times as fast.

In the First Round the shields disappear at the end of the second trip across the screen if even one alien from the bottom horizontal row remains on the screen (*Note: A trip is one movement of the aliens in one direction across the screen; a round begins when the last alien from a group is destroyed and a new group of thirty appear*). At the end of five trips the bottom horizontal row aliens will reach the bottom of the screen, ending the game for you (it will take many more trips to destroy the shields or reach the laser cannon if you have destroyed the bottom row aliens).

In the Second Round the bottom row aliens will destroy the shields at the end of their second trip, and will destroy the laser cannon at the end of the fourth trip.

In Round Three the shields go at the end of trip one and the cannons are out at the end of trip three; in Round Four you have no shields and the cannons are gone at the end of trip two; in Round Five you have no shields and you must destroy the bottom horizontal row of aliens before it completes its first trip or the game is over.

There are 630 total points worth of aliens each round. In the Atari program the command ship is worth 200 points each time you hit it, unless you are playing with two players, in which case it is worth only 100 points.

When you move the difficulty switch to "expert" on your control console it makes your laser cannon twice as wide, and therefore twice as easy to hit.

There are 112 game variations on the Atari program. The variations are as follows: regular speed bombs, moving shields, zigzagging bombs, fast bombs, and invisible invaders. It is possible to combine any or all of the above in any possible combination except for fast bombs and regular speed bombs; they can't be on the program at the same time. You could have invisible invaders with regular speed bombs that zigzag, or you could have all of the above operating at once with either fast or slow bombs. Furthermore, all of these variations will work with each of the one or two-player options.

There is a wide variety of two-player options. First, there is your basic, alternating turns system, where one player plays until he gets hit, and then the other player plays. This is basically two alternating games running in segments. The scoring is completely separate.

My favorite two-player option involves

two players competing at the same time, with two laser cannons. One starts at the left of the screen and the other at the right. There are two score totals, and there are some interesting things you can do with this.

For instance, each time your cannon gets blown up your opponent gets 200 points. The game ends after three hits have been scored by the aliens on the laser cannons in any combination totaling three. If you are more than 200 points ahead of your opponent, and two hits have already been scored by the aliens, just let the aliens hit you. Your opponent gets 200 points but you win the game. Another nice touch is moving over on top of and past your opponent. This will drive him crazy, particularly on a black and white T.V. where it can become hard to tell who is moving what.

The third two-player option is where there is one laser cannon to control, but you alternate shots. As soon as you fire, movement and fire control switches to your opponent's controller. When he fires, it switches back to you. You can play this one with two competing scoring

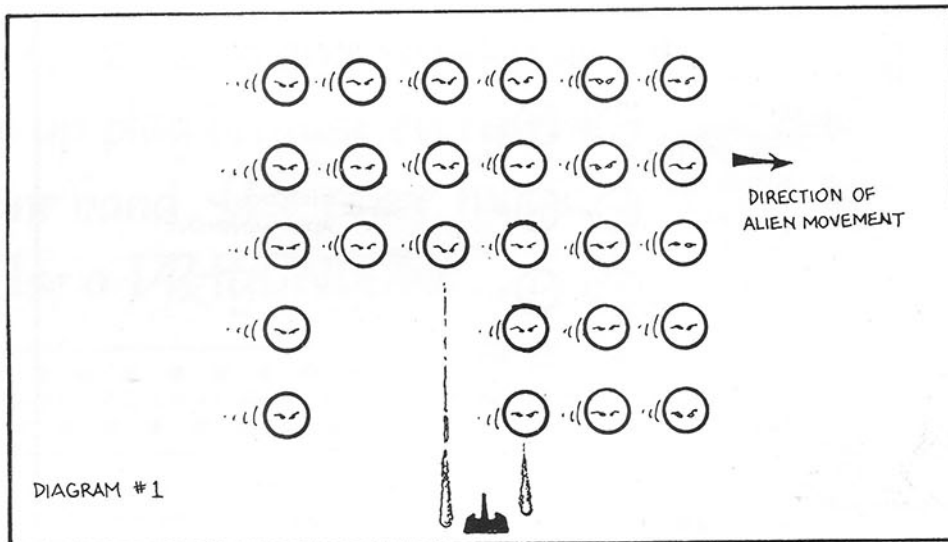

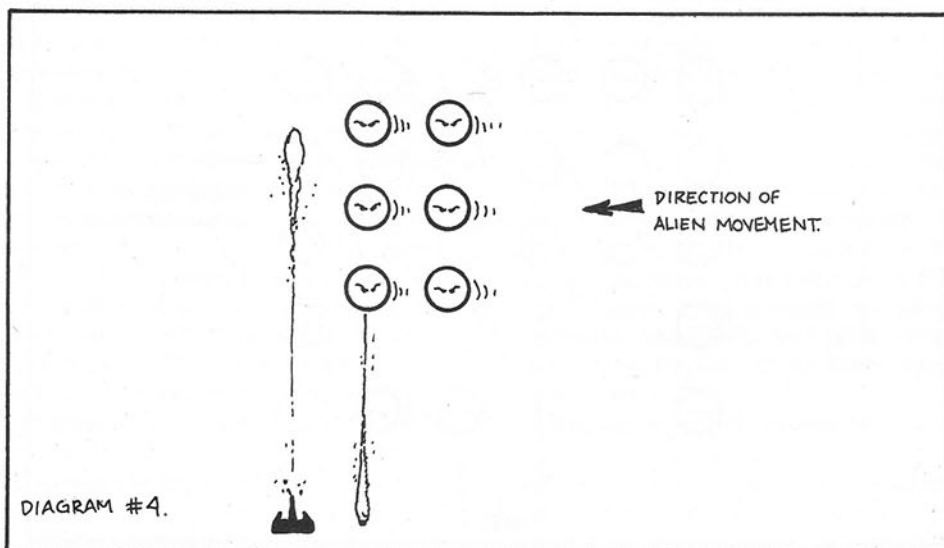
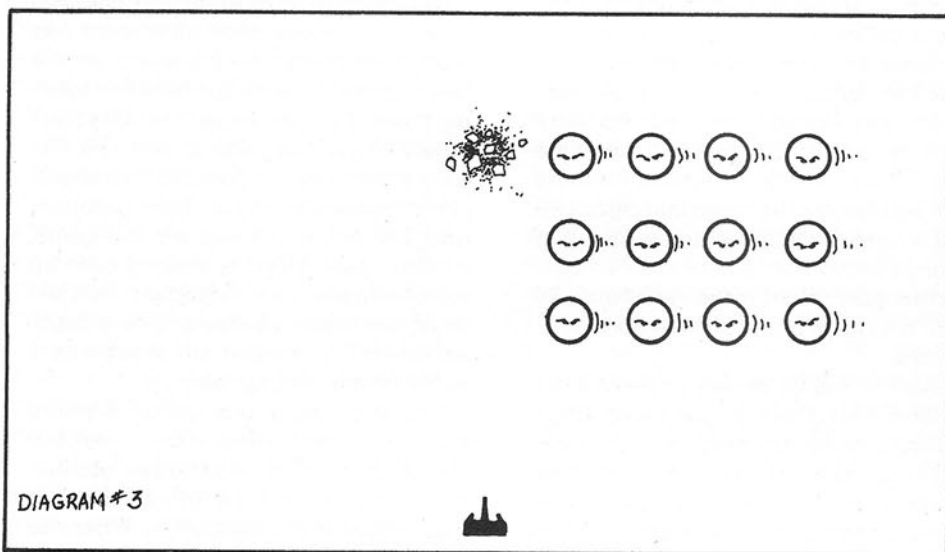
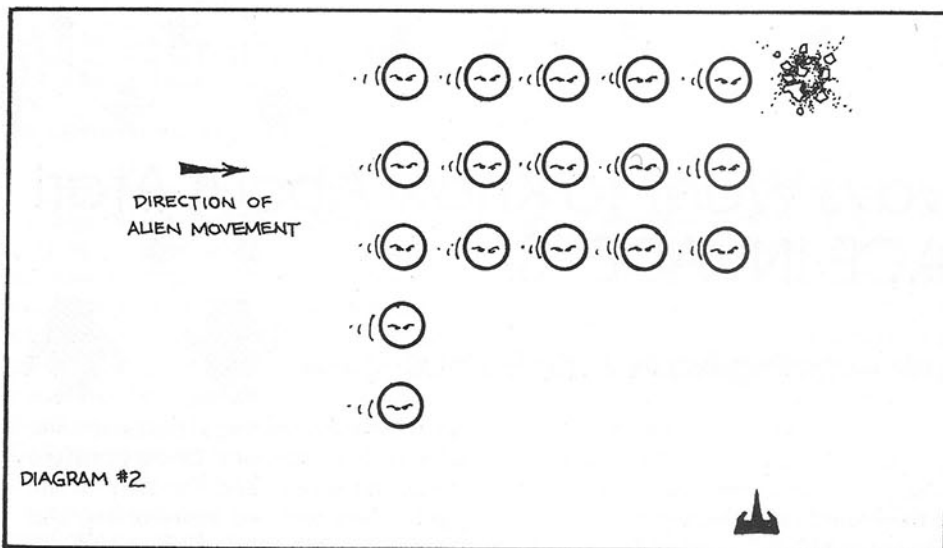

totals or with one total as a team effort.

There are two other two-player options, both of which are sure to put a strain on any marriage or friendship. In the first option, one player can move right and the other can move left. Either can fire. There is only one laser cannon, and when you both try to move at the same time you stand still and the aliens bomb the snot out of you (it is always the other person's fault). The other option is almost as bad. One player controls movement and the other player controls the firing. In both of these there is one scoring total.

Any of the above options can be played with any combination of invisible invaders, fast bombs, etc.

How do you win? First you have to define "winning." (The rest of this article will deal only with regular *Space Invaders*.) You can "win" at regular *Space Invaders* if you can blow up every alien that ever appears on the screen without ever getting blown up yourself. In other words, you can win by becoming so good at the regular game that it bores you to tears. (This doesn't stop your enjoyment of *Space Invaders* — don't forget those fast bombs; there will always be a challenge — but it does give you a feeling of satisfaction and it's a great way to show off at parties!)

Mostly, winning is just a matter of practice. But there is a nifty technique to use once your hands and eyes get used to manipulating the controls. This technique is most important from Round Four on, when you have only two or three seconds to blow up all of the aliens in the bottom horizontal row.

Before the round begins, pull your directional control to the right and keep the firing button pressed down. As soon as the round starts you will automatically destroy the two aliens above you while avoiding the bomb that they usually drop on you as soon as the action begins. Move from left to right blowing up the bottom two aliens in each row (see diagram #1).

If you miss the aliens, you can't fire again until your missile goes off the top of the screen. While you are waiting for the missile to disappear, the aliens will often hit you. The way to avoid this (and this is good for whenever you miss) is to stay between the alien rows. In this way the bombs may hit on either side of you, but you won't be hit. (see diagram #1). Of course, by the time you are able to "win," you will almost never miss any shot you ever take.

When you get to the far right vertical row, blow every single one of them up. (See diagram #2) (This won't be possible if you missed a shot on your way across and had to wait for the missile to go off the top of the screen. In this case just hit the bottom two and go on to the next paragraph.)

Move to the far left column and eliminate it (diagram #3). Then destroy all the other vertical columns as they move toward you, all except for the last column of three (see diagram #4).

When there are only three aliens left, don't chase them. Let them come to you (you can't catch them anyway). Your only movement should be to avoid bombs. When there is only one alien left, fire well ahead of him to hit him. If you miss him, wait until he comes back at you traveling in the same direction he was traveling when you missed him (*ie.* a round trip) before you fire again. This will insure that you can fire a missile when you press the button (remember, your last miss has to clear the top of the screen).

If you practice a little, and follow the above advice carefully, you too can "win" at *Space Invaders*. As soon as you "win" at the regular, you will probably want to go on to the fast bombs. If you can ever master that, there will be even more difficult programs to tackle (fast, zigzagging bombs, *etc.*).

Why? That's a very good question. Why bother? Why is a significant percentage of the population "hooked" on blowing up nasty little aliens?

My guess is that the fascination of the game is that it is so easy.

"Easy?!!!" you say. "I've never even made it through three complete rounds."

That's true, of course. People who have to play on machines that eat quarters either get very poor or else they never become very good. But the game is easy, even if you never get good enough to "win."

The game is easy because your laser cannon is outnumbered 30-1, and yet you can still destroy all thirty of your opponents. Even a rank beginner can blow up half the aliens in round one

before they hit him three times. And that is the fascination of the game.

The aliens are all idiots, and you can't let an idiot beat you. Every time you lose you know that you can do better the very next time. All you need to do is practice. The only reason they win is because they have you so badly outnumbered. It's just not fair. But you know that you can do it if you just keep at it.

So you just keep at it. Instant success. Easy gratification. I got all thirty of them! Hey, look at that! Thirty more popped onto the screen. And they're starting out even lower! Well, if I got those guys, I can get these guys too. . .

There's even a song about *Space Invaders*. I've only heard it once, and I only remember one line from it.

"He's hooked, he's hooked, his brain is cooked!"

Naturally enough, that was the line the aliens got to sing.



# Grimtooth's TRAPS



*One hundred and one catastrophic traps, sinister snares, engines of evil, and deadly devices . . .*

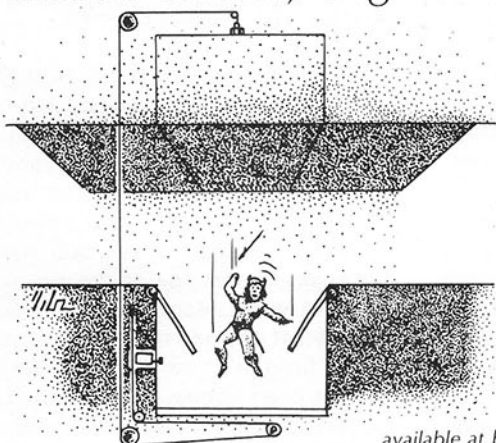

**Grimtooth's TRAPS** have been presented without game mechanics of any kind; the nature, cause, and effect of each trap has been thoroughly described so that any GM may introduce these devices of delver destruction into his or her games with ease. For example:

**Between A Rock and A Hard Place** is a clever variation on the common pit-in-the-corridor trap, and will ensure that characters keep on their toes at all times — or they will lose their toes! A standard pit in the floor is activated by whatever method you choose. When a character falls to the bottom of the pit, he will find that he is in too deep to climb out on his own.

When the trap door slams down against the side of the pit, it hits a button on the wall which causes a vial of acid to shatter. The acid rapidly dissolves a wire that runs up through the dungeon wall to secure in place the section of roof above the pit. As long as weight remains on the floor of the pit the pressure plate therein will insure that the block of ceiling remains in place. If all the weight is removed, then the ceiling (*continued on page 18 of Grimtooth's TRAPS*)

**only \$9.95 (less than a dime a death!)**

available at better game and hobby stores, or order direct from:

Flying Buffalo Inc. • P.O. Box 1467 • Dept. AG-23 • Scottsdale, AZ 85252 (please include \$1 for shipping & handling)  
(UK & European customers please order from Chris Harvey/FB, P.O. Box 100, Bath St., Walsall, W. Midlands, UK.)

# HEY DIRK! THERE'S AN X-WING ON MY TAIL!

## or, Jane's Fighters for Your Imperium

by J. D. Webster

As a longstanding fan of *TRAVELLER*® and as an avid fan of all the new sci-fi movies like *Star Wars* and *Battlestar Galactica*, I have always been inspired by all the scenes where the little snub fighters run out and do battle with giant space-stations or hordes of robot piloted saucers, etc. Because of this fighters are very prevalent in my campaign. I have noticed that in the Marc Miller universe of things fighters, though mentioned quite a bit, are not really given enough attention in the rules. With the second edition of *High Guard*, GDW has given us the formula for designing small craft and incorporating them into the game but they really don't tell us what good fighters are. I will address this shortly in the second half of this article titled "Fighter Pilot of the Empire". What I want to do right now is: present to you a compilation of all the fighters mentioned and described in various *Traveller* books and supplements; add to this list several of the movie and TV fighters which are quite popular; and give a logical reason for their existence in the GDW universe. (I've thrown in a few of my own, too.) All the USP shown are *High Guard* (second Edition) stats.

### FIGHTERS OF THE IMPERIUM

**TL-9 Hughes Defender** — One of the Empire's first fighters, the Hughes Defender can still be found on security patrols in the Spinward Marches. The Defender is a small 10-ton fighter with a one man crew and carries a single laser or a battery of missiles. Though upgraded models exist which are more capable, the basic Defender is no longer found in the military forces of the Empire but has been available to planetary security forces and commercial corporations and in some cases private citizens. (*Book 2*)

DF-0606C11-000000-10000 10 Tons  
1 Pilot Agility = 2  
M-drive (6) = 1.7 Computer m/1 = 1.0  
Weapons = 1.0 Crew Positions = 0.5  
P-drive (12) = 3.6 P-fuel = 1.2  
Cargo = 1.0 Armor = 0.0

**TL-10 Defender II** — Using the same basic frame, the Hughes company proposed an upgraded two-man version of the Defender. Unfortunately, it didn't meet the Imperial Navy's



requirements as the Navy was looking for a fighter with a heavier punch and higher agility. Hughes did make a production run on this model and sold it to a large shipping company which later handed several hundred of the craft over to pirate organizations in return for immunity from those same pirates. This act severely hurt Hughes and since then, the Hughes company has never been able to gain a major Imperial contract. (*Author*)

DF2-0606B11-230000-10001 10 tons  
2 crew Agility = 1  
M-drive (6) = 1.7 Computer m/1 = 1.0  
Weapons = 1.0 Crew Positions = 1.0  
P-drive (B) = 3.3 P-fuel = 1.1  
Cargo = 0.0 Armor (2) = 0.9

**TL-11 Rebel Y-Wing** — During one of the many rebellions which have occurred in the Empire this craft appeared. Though called a fighter, this craft was in reality a cut-down cutter used as an emergency measure. Though agile, the craft was used poorly and suffered many losses against the newer Imperial fighters. One interesting feature of the craft is that it mounts 2 pulse-lasers in an actual turret giving it a greater field of fire which surprised many Imperial pilots who were shot down when making stern attacks.

(*Star Wars*)

YF-0104D31-100000-20001 35 tons  
2 Crew Agility = 4  
M-drive (4) = 3.85 Computer m/3 = 3.0  
Weapons = 1.0 Bridge & Stateroom = 6.0  
P-drive (D) = 13.65 P-fuel = 4.55  
Cargo = 0.85 Armor (1) = 2.1

**TL-11 Cylon Raider** — Cylons are a race of robot warriors out to exterminate all humans within their galactic sector. Their basic fighter is the Raider which is a large capable craft carrying a crew of three "centurian" robots. One is the pilot, one is the missile gunner, and the third is the supervisor who also acts as a replacement for either of the others should they blow a fuse. An interesting feature of the Cylons is that they are democratic and vote on what to do while in combat. In urgent situations the supervisor has been known to make a ruling whereupon the others state "by your command" and proceed to carry out the order. The few seconds it takes to carry out this democratic process has given human pilots the edge in many a battle. The ship itself contains a repair room, has no life support, and can stay on station as long as it has fuel. (*Battlestar Galactica*)

CR-0604C41-300000-10001 40 Tons  
3 Crew Agility = 4  
(1 during democratic process)  
M-drive (4) = 4.4 Computer m/3 = 3.0  
Weapons = 1.0 Bridge, Repair  
Room & Couch = 6.5  
P-drive (C) = 14.4 P-fuel = 4.8  
Cargo = 1.1 Armor (3) = 4.8

**TL-12 X-Wing** — The X-Wing fighter was the Imperial Navy's first hard-hitting fighter to enter combat. It began replacing the Hughes Defender during the Third Frontier War and was well liked by its crews. It is powered by four hydrogen drives and has four beam-lasers, one at the tip of each split wing. Normally, only two are fired at any one time, but all four can be fired in an emergency. The strain has been known to cause the failure of the power drives. The fighter has a spot built into the fuselage to allow the emplacement of a service robot (R2D2) which allows the pilot to use



the single missile launcher on the ship. The X-Wings have been replaced by newer craft but one exploit deserves mention. That is the destruction of an Imperial Monitor accomplished by a brave suicidal attack carried out by rebel pilots using the X-Wing. The monitor was at the time the largest space vessel ever built by the Empire and contained a secret weapon whose technology was lost with the destruction of the monitor. (Star Wars)

XF-0105G31-000000-30002 25 Tons  
1 Pilot, 1 Robot Agility = 4  
M-drive (5) = 3.5 Computer m/3 = 3.0  
Weapons = 1.0 crew stations = 1.0  
P-drive (G) = 12.0 P-fuel = 4.0  
Cargo = 0.5 Armor = 0.0

**TL-12 Mercenary Fighters** — These tiny fighters were built by a private corporation primarily for use with the Broadsword class mercenary cruiser. These could be termed the first of the light fighters. Two general designs are provided for and both are armed with only missiles but come with the appropriate attachments for use with the fighter-frame module of the modular cutter. One should note that the use of a cutter for the launching of fighters is a rather clumsy affair and not at all useful in space combat. The fighters themselves are jewels with very high maneuverability and are liked by their pilots. On the other hand, the problems of launching and recovering the

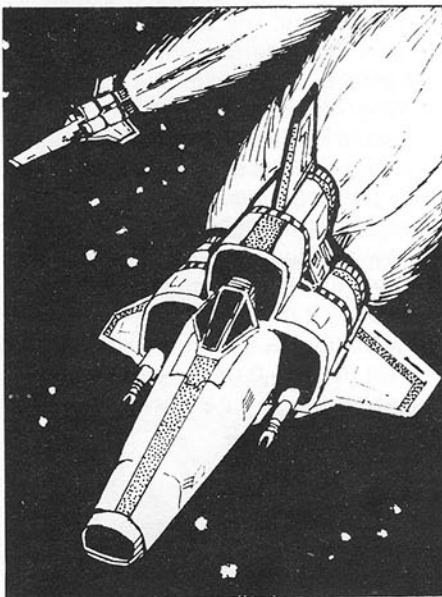

fighters has caused most of the mercenary units to discard them. They are seldom seen aboard the mercenary cruisers now. (Journal #8 TAS)

Type #1 FF-0106611-000000-00001  
6 Tons 1 Pilot Agility = 6  
M-drive (6) = 1.02 Computer m/1 = 1.0  
Weapons = 1.0 Crew Stations = 0.5  
P-drive (6) = 1.08 P-fuel = 0.5  
Cargo = 0.0 Armor = 0.0  
Type #2 FF-0105521-030000-00001  
6 Tons 1 Pilot Agility = 5  
M-drive (5) = 1.0  
Computer m/2 = 2.0  
Weapons = 1.0 Crew Station = 0.5  
P-drive (5) = 1.0 P-fuel = 0.5  
Cargo = 0.0 Armor = 0.0

**TL-12 The Tick** — One of the unhappier aspects of being a space-fighter pilot is the high casualty rates that go with the job. One small shipbuilding firm proposed a small, heavily armored, missile-equipped fighter designed to provide survivability in combat. The Empire however, was committed to buying the X-wings and didn't consider the proposal. The firm quietly built about two thousand Ticks over a ten year period and sold them to various factions. Imperial pilots who have fought the Tick are amazed at it's ability to shrug off hit after hit, even at close range. The president of this firm was eventually executed by the Empire. (Author)

AF-0206721-C00000-00002 15 Tons  
1 Pilot Agility 6  
P-drive (7) = 3.75 Computer m/2 = 2.0  
Weapons = 1.0 Crew Station = 0.5  
M-drive (6) = 2.55 P-fuel = 1.05  
Cargo = 0.25 Armor (C) = 3.9

**TL-13 Zhodani Shivva Fighters** — After constant skirmishing with mercenary fighters, the Zhodani took to the idea of a light fighter themselves. As with all missile armed fighters, the Shivva-class fighters do not have to stabilize to aim lasers and can continuously evade during their attack runs. These small agile craft of the Zhodane have caused many Imperial casualties. (Leviathan)

FM-0106D21-000000-00003 8 Tons  
1 Pilot Agility 6  
M-drive (6) = 1.36 Computer m/2 = 2.0  
Weapons = 1.0 Crew Station = 0.5  
P-drive (d) = 2.08 P-fuel = 1.04  
Cargo = .02 No Armor

**TL-13 Imperial T.I.E. Fighter** — These were the next generation of Imperial fighter and an improvement over the

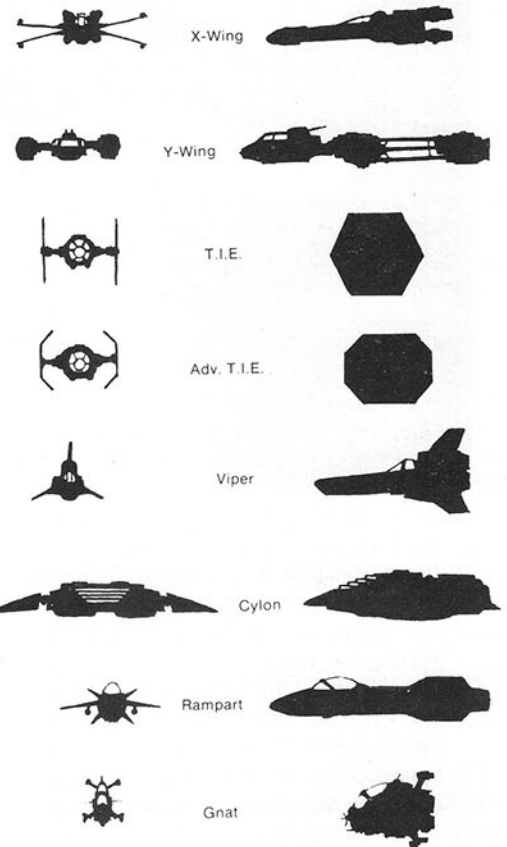

X-Wing in that they were compact and used the more efficient ion drives. They are recognizable by the large solar panel wings on each side of the fuselage. These panels were designed as a survivability feature in that they can provide power for a one-g emergency drive if the main drive is lost in combat. This survivability feature has probably contributed to the death of more pilots than it has saved as it severely restricts the pilots lateral vision. It is also why you may witness TIE fighters making regular rolling maneuvers as they clear their blind spots. The fighter has a limited atmospheric capability but it is primarily a space weapon. (Star Wars)

TF-0105L31-030000-20000 20 Tons  
1 Pilot Agility 5 (0 if in atmosphere 6+)  
M-drive (5) = 2.8 Computer m/3 = 3.0  
Weapons = 1.0 Crew Stations = 0.5  
P-drive (L) = 8.0 P-fuel = 4.0  
Cargo 0.7 No Armor

**TL-14 The Gnat** — This fighter came about as a response to the Shivva-class fighter and also because the cost of producing the bigger sophisticated fighters was straining the Imperial budget. The Imperium was looking for a pure space system with

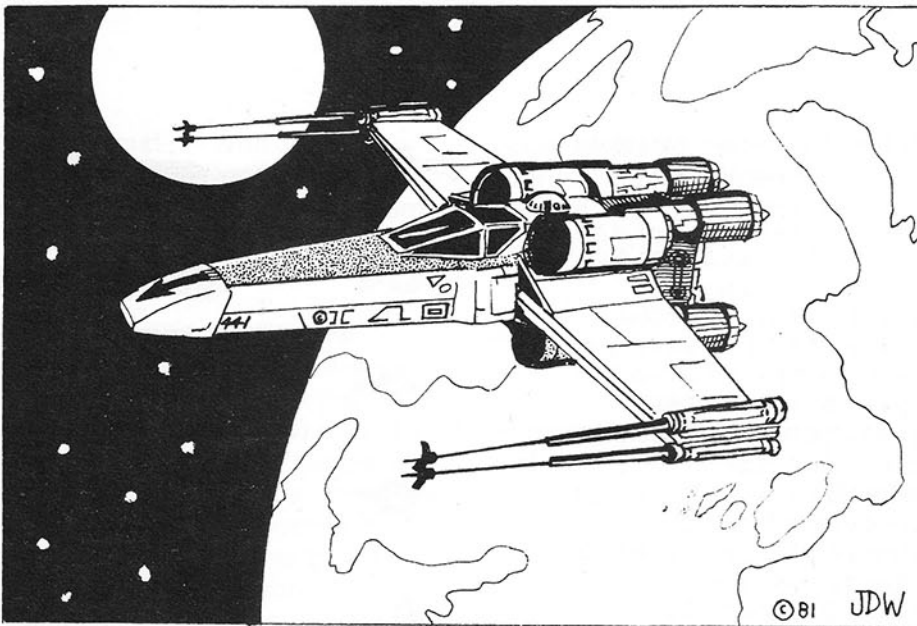

a mixed armament package in the smallest possible frame. Unfortunately, the project was mismanaged and the resulting fighter, though good for taxpayers, was a definite step backwards for naval fighter pilots. The cheapness of the fighter was offset by the expense of training replacement crews as the Gnats were shot out of space in droves. The Gnat is now only used in backwater areas. (*Trillion Credit Squadron.*)

FP-0406C21-030000-20002 8.5 Tons  
2 Crew Agility 0  
M-drive (4) = 1.44 Computer m/2 = 2.0  
Weapons = 1.0 Crew Stations = 1.0  
P-drive (C) = 2.04 P-fuel = 1.02  
No Cargo No Armor

**TL-14 Advanced T.I.E. Fighter** — A logical development of the earlier TIE fighter, it is a little larger but carries two of the deadliest fusion weapons in the place of lasers. Its solar wings, however, are canted in and braced as experience showed that the early TIE fighters had a tendency to lose their wings when diving into an atmosphere too fast while in pursuit of an enemy. The atmospheric ability of this fighter is improved over the other one. (*Star Wars*)

TF-0105Q31-000000-05000 25Tons  
1 Pilot (Villain) Agility 4 (2 in atm.)  
M-drive (5) = 3.5 Computer m/3 = 3.0  
Weapons = 2.0 Crew Stations = 0.5  
P-drive (Q) = 12.0 P-fuel = 4.0  
No Cargo No Armor

**TL-14 Zhodani Vlezhdest**—At about the same time the Empire deployed its Gnats to counter the Shivva class fighters, the Zhodane withdrew their light fighters and deployed this heavily armored and armed fighter. These

craft wrought havoc among the Gnats causing over a third of the total Gnat casualties. Only the timely arrival of Imperial reserves including large numbers of heavier fighters saved the day. (*FASA*)

FF-0106J31-900000-05000 30 Tons  
1 Pilot Agility = 6  
M-drive (6) = 5.1 Computer m/3 = 3.0  
Weapons = 2.0 Crew Stations = 0.5  
P-drive (J) = 10.8 P-fuel = 5.6  
Cargo = 0.0 Armor = (9) = 3.0

**TL-15 Rampart Fighters 1 and 2** — Realizing that the Gnats were not up to the task of defending the Marches, the Empire applied improved technology to develop another small fighter with improved maneuverability and streamlined for atmospheric work. The result was the Rampart single- and dual-seat models that are the standard complement of Lightning-class cruisers. Its cheapness is due to the fact that only the minimum sized computer and flight controls are used. Again, political mismanagement resulted in a fighter that carries a lot of dead-space which isn't necessary. Although the Ramparts are better than Gnats and faster than TIE fighters, they are not the best the Empire could've had. (*AZHANTI High Lightning*)

Single seater  
FF-0106T11-000000-40000 15 Tons  
1 Pilot Agility = 6  
M-drive (6) = 2.55 Computer m/1 = 1.0  
Weapons = 1.0 Crew Station = 0.5  
P-drive (T) = 4.05 P-fuel = 4.0  
Cargo = 1.9 No Armor  
Two seat trainer  
FL-0106611-000000-0003 15 Tons  
2 Crew Agility 6  
M-drive (6) = 2.55 Computer m/1 = 1.0  
Weapons = 1.0 Crew Stations = 1.0  
P-drive (6) = 1.0 Fuel = 1.0

Cargo = 7.45 No Armor  
**TL-15 Colonial Viper** — A fast, powerful, hard-hitting fighter just begins to describe this craft. Produced in the galactic sector under assault by the Cylon race, the Viper is a true fighter which has no wasted space. The colonial pilots that man this craft are highly motivated experts involved in a life and death struggle for humanity and are dangerous and aggressive, prone to shoot first and ask later. The fighters are deployed aboard Battlestar class carriers. (*Battlestar Galactica*).

VF-0106T41-500000-40000 24 Tons  
1 Pilot Agility = 6  
M-drive (6) = 4.08 Computer m/4 = 4.0  
Weapons = 1.0 Crew Stations = 0.5  
P-drive (S) = 6.48 P-fuel = 6.48  
Cargo = 0.02 Armor (5) = 1.44

**TL-15 Imperial Heavy Fighter** — The biggest fighter currently in the Imperial Navy, the Heavy Fighter presents a concept totally opposite of what has been presented before. The Heavy Fighter is produced within the Imperial core where budget constraints are not the obstacle they are out toward the Spinward sectors. This fighter contains staterooms making it capable of standing long patrols and also carries a superlative computer enabling it to out-fight any other ship in its class. There are smaller fighters with better weapons and armor but no other fighter carries such a large computer. With the advent of the Fifth Frontier War, one can expect to see the Heavy Fighter arriving with the Imperial Battle Squadrons that are filtering into the Spinward Marches from the Imperial core. These heavy fighters, along with the medley of other models mentioned earlier, should add another glorious chapter to the exploits of small craft in naval warfare. (*Supplement 9*).

FH-0106N71-830000-20002 50 Tons  
2 Crew Agility = 6  
M-drive (6) = 8.5 Computer m/7 = 9.0  
Weapons = 1.0  
Crew Stations & Stateroom = 3.0  
P-drive (N) = 11.0 P-fuel = 11.0  
Magazine/Cargo = 2.0 Armor (8) = 4.5



# DRAGON SLAYERS<sup>TM</sup>

## 25's

### Fantasy Miniatures

DRAGONSLAYERS<sup>®</sup> 25's is a new line designed for those gamers who wish to fill their worlds of fantasy with the specific characters required for the adventures of their realm. Most packs contain two different figures at the low price of \$1.70. All figures come in a full color blister card with a MARTIAN METALS DOSH on the back for special offers and contests. The LARGE CREATURES are priced accordingly to their special size category.



#### THE AUGUST ORDER OF DRAGONSLAYERS<sup>®</sup>

- 1500 THE HEROES (NIKLOS & DELLOS)
- 1501 THE HEROINES (GRETCHEN & FELICITY)
- 1502 THE WIZARDS (DRUADAN & KOROS)
- 1503 THE FIGHTERS (PIERCE & GURNEY)

#### MAGICAL PERSONALITIES

- 1510 WIZARDS
- 1511 ILLUSIONISTS
- 1512 SORCERERS
- 1513 MAGIC USERS
- 1514 MAGES
- 1515 UNDEAD WIZARDS
- 1516 SORCERERS #2
- 1517 SORCESS W/PANTHER
- 1518 CLERICS

#### ADVENTURERS

- 1530 ARTHOL & BERCAN
- 1531 JABAR & ANDROS
- 1532 FERGUS & THORKILD
- 1533 WILDHAIR & RANNULF

#### FIGHTERS

- 1550 THE SWORDMASTER & COMPANION
- 1551 THE HUNTRESS'S OF KOBAN
- 1552 BARBARIAN WOMEN
- 1553 MERCENARIES OF PRIDOUX BOW & SWORD
- 1554 MERCENARIES OF PRIDOUX AXE & MACE
- 1555 HALFINGS W/BOW & AXE
- 1556 COMPANION OF ZYPHER

#### SPECIALIST

- 1580 ASSASSINS (ELF & HALFLING)

#### KNIGHTS

- 1590 KNIGHTS-CHAINMAIL 1 W/SWORD 1 W/2HAND SWORD
- 1591 KNIGHTS-CHAINMAIL WAR HAMMERS
- 1592 KNIGHTS-CHAINMAIL AXE
- 1593 KNIGHTS-CHAINMAIL W/ SWORD PLATE W/SWORD (L.H.)
- 1594 KNIGHTS-CHAINMAIL 1 W/AXE 1 W/2HAND AXE
- 1595 KNIGHTS-CHAINMAIL SWORD
- 1596 KNIGHTS-CHAINMAIL 1 W/MACE 1 W/FLAIL
- 1597 KNIGHTS-PLATE MACE (L.H.)
- 1598 KNIGHTS-PLATE 2 HAND SWORD
- 1599 KNIGHTS-PLATE AXE & FLAIL

#### CREATURES, NON-PLAYER CHARACTERS AND OTHER PERSONALITIES

- 1600 SKELETON WARRIORS POLE WEAPONS
- 1601 SKELETON WARRIORS SWORD & CLUB
- 1604 LIZARD WIZARD & HENCHWIZARD
- 1605 LIZARD WARRIORS
- 1606 MINOTAUR
- 1607 MOLD & SLIME
- 1608 KAPPA & GHOST
- 1610 UNICORN (REARING)
- 1611 UNICORN (PRANCING)
- 1612 PEGASUS
- 1613 GIANT SPIDER
- 1614 ORC SUPERHERO & COMPANION
- 1615 ORCS W/BOW & AXE
- 1616 TROLLS W/HAMMER & FLAIL
- 1617 TROLLS W/SWORD & AXE

#### LARGE CREATURES

- 1700 GARGANTUA (GIANT) \$5.95
- 1701 TITAN (GIANT) \$5.95
- 1702 DRAGON (SITTING) \$7.95
- 1703 DRAGON (CHARGING) \$7.95

They're Only Metal...

# Martian Metals

BOKS 778

CEDAR PARK, TX. 78613

(512) 267-3056

# THE ADVENTURES OF SPACE TRADER VIC

STORY BY BRUCE WHITEFIELD & RON TALBOT.

ART. BY BRUCE WHITEFIELD.

AFTER FIGHTING OFF A MARAUDING BAND OF PIRATES, TRADER VIC PROCEEDS TO A BACKWATER PLANET CALLED EARTH IN SEARCH OF PROFITABLE BARTER WITH THE SIMPLE NATIVES.

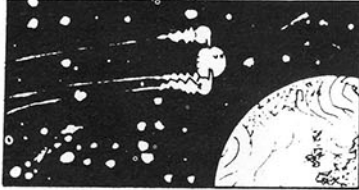

-WIRRR CLICK!- TELEVISION SURVEY COMPLETE!

-WIRRR CLICK!- RADIO SURVEY COMPLETE!

-WIRRR CLICK!- THEATER SURVEY COMPLETE!

-WIRRR CLICK!- NEWSPAPER SURVEY COMPLETE!

WHEN APPROACHING A NEW PLANET, BILL, IT'S WISE TO RUN A COMPUTER SURVEY OF ALL THE AVAILABLE COMMUNICATIONS MEDIA. IT PROVIDES VALUABLE BACKGROUND ON THE NATIVES, WHAT THEY EAT AND WEAR, THINGS THAT THEY CONSIDER VALUABLE, ETCETERA.

GOSH THAT'S SMART, CAPTAIN VIC! WHAT HAVE YOU FOUND OUT SO FAR?

IT'S AN EXTRAORDINARILY MOBILE SOCIETY WITH MOST PEOPLE LIVING IN GROUND VEHICLES KNOWN AS GASSOGS. THEY TRAVEL ABOUT THE CONTINENT WORSHIPPING THE DEITY KO-KO-KOLA. SOME HERETICS FOLLOW THE ANTI-GOD UNK-D-LA BUT THE PENALTY FOR THIS IS IMPALEMENT ON THE DREADED SWEEP STAKES! THE FAVORITE SPORT IS A GAMBLING GAME PLAYED ON WALLS AND STREETS. MOST FANS ARE ROOTING FOR A PLAYER CALLED DOW JONES, ALTHOUGH HE'S ALWAYS LOSING POINTS...



BASED ON THIS SURVEY INFORMATION, THE COMPUTER CAN PROGRAM THE DISGUISE CHAMBER TO OUTFIT US WITH INCONSPICUOUS COSTUMES AND LOCATE A SUITABLY DISCRETE LANDING SPOT FOR US TO MAKE FIRST CONTACT WITH THE NATIVES.

UTILIZING SPACE AGE TECHNOLOGY, TRADER VIC AND BILL ARE SOON READY FOR ACTION!

WOW! LIGHT SABERS, SPACE ARMOR AND RAYGUNS! THIS PLANET MAY NOT BE AS PASTORAL AS I FIRST THOUGHT!

DISGUISE CHAMBER



WELL, DOWN WE GO. THIS COULD BE A TRICKY LANDING.

ZAB!

POP!

© BRUCE WHITEFIELD 1991

THIS SEEMS LIKE A NICE DESERTED SPOT, THOUGH IT MIGHT HAVE BEEN EASIER TO LAND AT THE BASE OF THE MOUNTAIN...

XLICZAL, YOU FOOL! THIS IS THE WRONG MOUNTAIN!

GEE, SORRY BOSS.

WIRRR!

SPRING!

SPRING!

STOMP!

# The Adventures of Finieous Fingers

## Revenge of the Liche

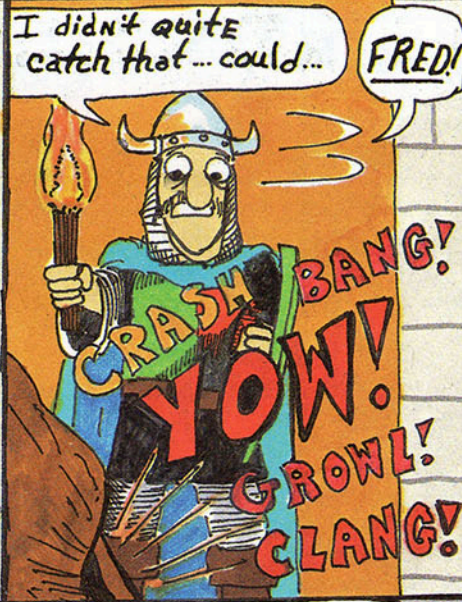
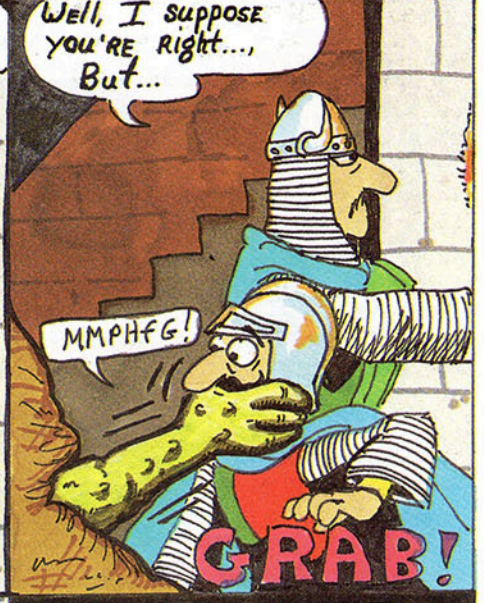
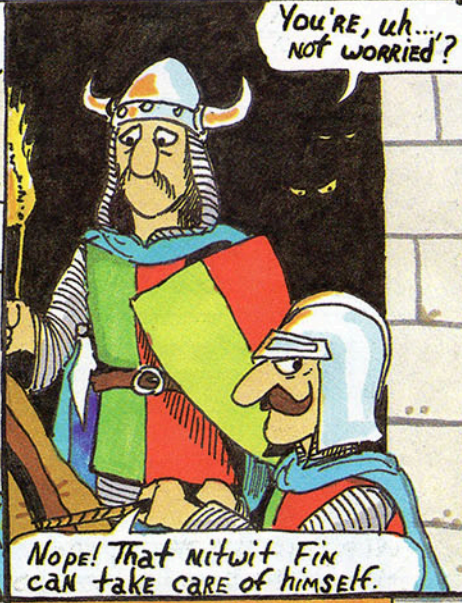
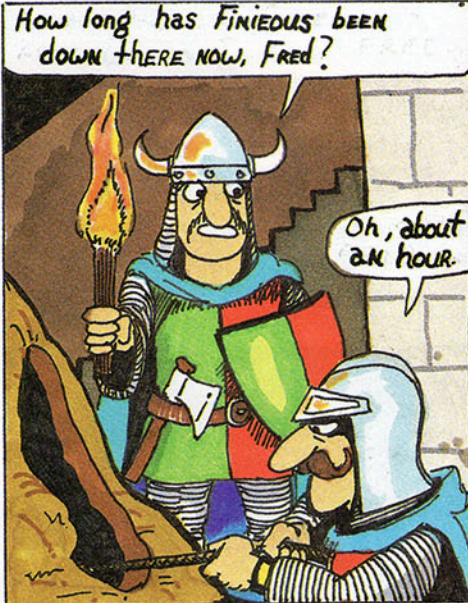

STORY BY  
BRIAN CRIST  
© 1981

# BROM & ARYLLA

ART BY  
STEVE SWENSTON  
© 1981  
LETTERING BY  
DAVE SMEDS

LAST EPISODE: ARYLLA'S CONVERSATION WITH THE GOD-BEING BROM IS INTERRUPTED!

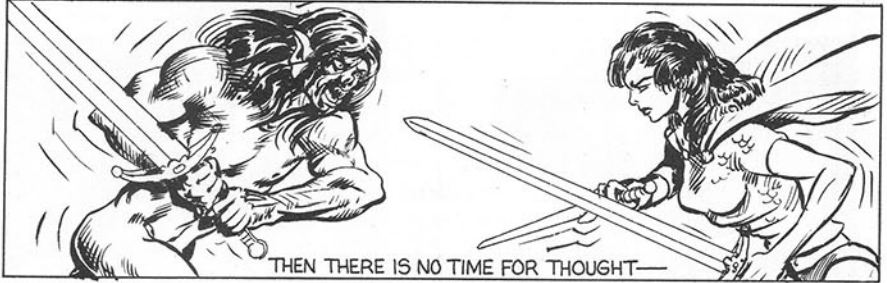
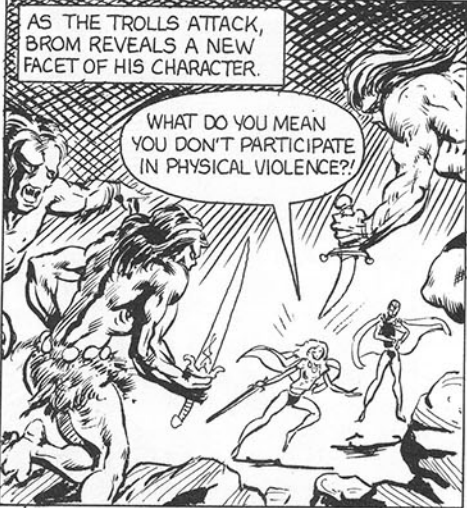

NEXT:  
BALLYMOTE!

In Ages of Chaos, Men of Courage and Ambition Lived and Died. . .

# BY THE SWORD!

A NEW APPROACH TO FANTASY MINIATURES BATTLES



Now you can fight medieval and fantastic miniature battles without the time and expense of metal figures. Using multi-colored counters on a tabletop playing area, it is possible to fight encounters between hundreds or even thousands of combatants with a minimum of preparation or cash outlay.

Over sixty units are provided in the first set, including men, orcs, elves, beasts, amazons, lizard men, chariots, heroes, wizards and more. Future sets will include giants, dragons, winged men, dwarves, siege equipment and still more! The rules incorporate an innovative **Flow Chart System** that greatly simplifies learning the game and speeds play. The rules are designed to be played on their own, or can be integrated into an existing fantasy campaign.

**BY THE SWORD!** includes:

- 20-page 8½x11 rules book with unique **FLOW CHART SYSTEM**, that covers movement, archery, melee, leadership, morale and more.
- Optional rules for terrain generation, magic and heroic campaigns.
- 2, 8½x11 full-color counter sheets, with over 60 units or 360+ counters.
- Pull-out sheets on orders of battle, unit histories, tables and flow charts.

All for only \$7.98 plus \$1.00 postage. Hawaii residents add 4% State Tax.

**SPECIAL OFFER!** No postage charges on 2 or more games plus \$1.00 off on each. (Offer expires Jan. 1, 1982).

Dealer inquiries welcome.

## The LEGIONNAIRE

1415 Dillingham Blvd. Honolulu, HI 96817 808/845-2527

# PANZER©, 88©, ARMOR© and Ma Bell

by Tony Adams

So you think that all your phone is good for is that occasional late night caller who turns out to be an old friend in need of cash? Or those people who keep calling you from Florida trying to sell you diamonds? Not to mention those obscene calls every once in a while, mostly outgoing? Well, don't despair. There actually is a good use for your phone and it's perfectly legal. That's right, I'm talking about wargaming by phone.

Now I know exactly what you are going to say, "It's too expensive to wargame by phone!"

"It's too expensive to wargame by phone!"

Wrong-O! It's too expensive to wargame by Express Mail or Eastern Onion, but thousands of people have been working very hard ever since Alex invented the thing to make it easier and cheaper to wargame by phone than ever before. I'll try to explain.

First of all, you must understand that not every game will make a good candi-

date for playing by phone. I am not advocating playing *THE LONGEST DAY* or *WAR IN EUROPE* by phone. Not that it isn't possible, but it just isn't worth it. We want a game to play by phone that will benefit by being played with hidden movement. It also has to have a clean game system and not be overly complex. It would also be good if we didn't have to worry about too many pieces. If you are one of those people who actually reads titles to articles you already know where I am heading. The *PANZER, 88* and *ARMOR* system by Yaquinto makes a perfect system to game by phone, especially if you are getting started. Let's look at what it has to recommend it for this type of gaming.

For those of you not familiar with *PANZER, 88* or *ARMOR*, they are three games that differ only in the tanks and some terrain contained in each. They all share a common game system for tactical armor and infantry combat in World War II. Each counter represents a single tank, AT gun or infantry squad and each

hex is about 50 meters across. Movement is simultaneous and the sequence of play is clear enough to make each turn easy to follow step-by-step. A simple game can be played with a small number of units as well as a bigger game with all optional rules in effect for the greatest amount of realism. The combat results charts all work on straightforward percentages which will be easy to handle for a phone game.

Let's see what this excellent game system has to gain by being played over the phone. The primary advantage in doing a game by phone is the use of complete hidden movement. In a tactical game such as *PANZER, 88* or *ARMOR* (hereafter referred to simply as *PANZER*) this adds quite a bit of realism that is hard to come by any other way. In a face-to-face game this same objective could be achieved with either a judge present or two honest players via duplicate board set-ups with much the same results. The amount of time and space this would take is often hard to come by

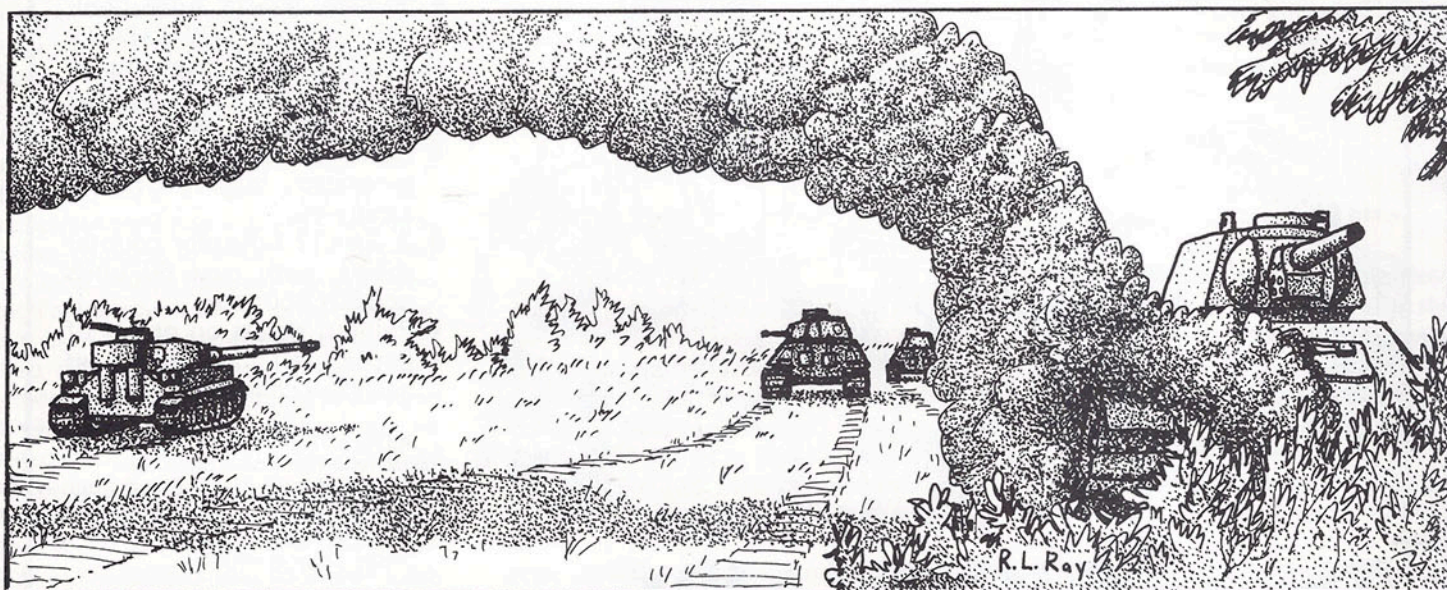



in a single afternoon and getting two or three gamers together for a project like that may just not be worth the trouble. The advantages of gaming by phone, in addition to doing hidden movement, is the fact that you can play out each turn at your convenience with time to plan and think in between, and the game is played over several short sessions which may be easier to arrange than a long afternoon of gaming. More of what I am saying will become more clear to you as we go on. Right now we should talk about just what you are going to need to play.

To start with, it does take three people to run a game by phone. One person is the moderator and the other two are players. The moderator is the judge who will make any rules decisions necessary and keep track of both players' moves on his own board. It is not as dreary as it may sound being the moderator as you will get to have complete intelligence of what is going on and oftentimes see some very interesting situations as they are developing. The two players only know what the moderator tells them as far as combat results or enemy units sighted are concerned. They must make their decisions and attempt to accomplish their objectives based on scanty information, or possibly none at all, as to the intentions and whereabouts of the enemy. All three people involved must own the same game and be familiar with the rules. They also must have a phone. Now the ideal situation would be to have a place where the game can be set up and left undisturbed for however long it is going to last and have that place also close by the phone. If each of the three players involved has this, you are all set. Realistically, the game may have to be taken down from time to time and units marked down to replace later, or orders may have to be written out if the board is not visible from the phone. At any rate, we now have three people with the same game set-up at their respective houses with a phone nearby, ready to play *PANZER, et al.*

Before beginning, everyone has to have the same terrain set-up. The moderator is usually responsible for sending out a copy of the board with terrain drawn in so that each player knows the map. A reduced copy of the maps is included in each rulebook that can be copied to do the job. In case of any disputes later the

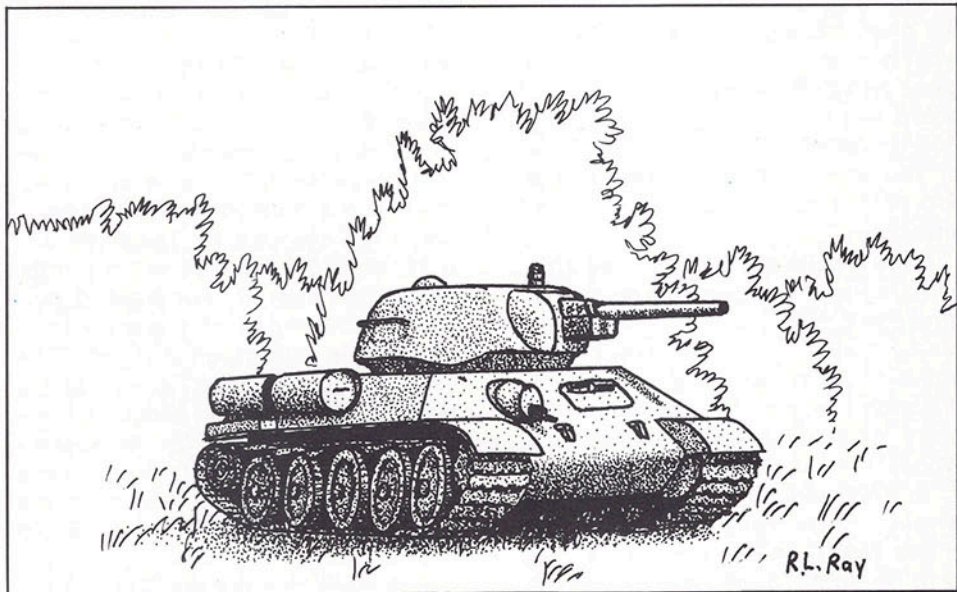

judge will prevail with the terrain as shown on his board. (An interesting twist here is for the judge to give out terrain maps to one or both players that may not accurately reflect the terrain, with good scouting being necessary to fill in gaps not shown on the map.) Once each player has a copy of the terrain (or what they think is the terrain), some criteria has to be established for determining forces on each side. Once again the moderator should decide how this will be done. The *PANZER* system of points can be used for choosing units based on a certain point total, or the judge may arbitrarily set-up a scenario of his own design. Here again, it is a good idea if the players are not given much information about their opponent's forces. In many cases we have played where the player knew nothing about what they may encounter.

Once forces have been allocated the judge should make clear to each player exactly what his objectives are, if any, and/or determine any special conditions which may exist and what items are worth points if using a point scoring system of victory. The judge should also let the players know what optional rules are in effect in addition to standard or advanced rules being used. Now we are finally ready to begin. All of the above may seem like an awful lot of work to some of you, but it really isn't. Even an inexperienced judge should be able to sit down and figure out some simple terrain and give each player a couple of units to get started with. If you are still

stumped, simply start with the simplest scenario in the booklet and don't use any optional rules or advanced game rules until you get used to playing. There is a virtually endless amount of scenarios and situations that can be done. For ideas you can either read accounts of small level unit actions or even get some ideas from the movies and see how they can be gamed. But all of this will become second nature before long anyway.

Players and judge should now agree on days and times that the game will be played. You may want to play out a game all in one day with calls going back and forth each turn until you finish. Or, and here's the real beauty of this system, you may only have one night a week or a particular time slot every so often that all three of you are available to play. While this time may not be enough to get together for a regular game, it might be enough time to simply make a couple of moves in the ongoing game of *PANZER*. In between times when you are playing, you will have a chance to plan and think out your next move based on what you think the enemy will do. The ability to have the time to explore all of the possibilities open to you makes an excellent game; you can really play your best and devote time to each move or series of moves. But be careful, because you are up against an enemy who has the same ability to plan and the unexpected will almost always occur to spoil even the best laid plans.

So now everyone agrees on when to call for the first moves and the set ups

have already been taken care of and given to the judge. Now the sequence of play starts. The best way to explain this is to actually take you through a move on the phone so that you can see exactly what is involved. Those of you with the game *PANZER* may want to set up your board and follow along. We are using Board A with the following terrain, (those of you without the game please bear with us for a moment while we set up the situation):

*There is a Stone Building in hex 3705. Hill counter 'C' is in hex 2904 pointing at direction 2. Hill counter 'B' in hex 2904, facing 2 also. Hill 'D' is in hex 4007, direction 2. Woods 'U' is in hex 3202, direction 3. Woods 'R' in hex 2908, direction 2. Woods 'N' in hex 3306, direction 2. Woods 'T' in hex 3311, direction 3. Woods 'L' in 3709, direction 3. That is all the terrain. The Germans have a Panther G in hex 2902 facing 3, and a Pz IV H in 3110 facing 2. The Russians have 3 T-34/76's; numbers 802, 803 & 804 in hexes 3812 facing 1, 4004 facing 4 and 3701 direction 5 respectively. The stage is now set for the first move. It is 7:00 p.m. on a Monday night, the time set for the first move. We now go to the judges house.*

*brrring . . . . . brrring . . . . . (or whatever a telephone sounds like coming from a typewriter.)*

*"Hello."*

*"Allo. This is de German High Command. Ve have been ordered to destroy the inferior Russian masses."*

*"Go ahead with your first move then."*

*"Very well. My PzIV stays put with opportunity fire on hex 4105. My Panther goes left, one, right (that's left 60 degrees facing, one hex forward and right 60 degrees) ending up in the woods at 3002 facing direction 3."*

*"OK. I'll call you back as soon as I get results from the Russian move. Good-bye."*

*"Good-bye."*

*A few minutes later the Russian calls.*

*"Hello."*

*"Allo Komrade! This first move will throw those German swine out of the Motherland with our massive assault!"*

*"I take it you have your move ready?"*

*"Da. T-34, #802 will go one, left, one, right, one, left to end up in the woods at 3709 facing 6. #803 will go two, right, one, right, one, right, one, left and end up in 3805, direction 6. #804 will go two, right, two, left ending up in the scrub at 3301 facing direction 5. That's it for this turn."*

*"OK. I will do results and let you know in a few minutes so that you can do your next move. Good-bye."*

*"Good-bye."*

Our phone answering judge now goes to work to do the results. Besides checking distances and lines of sight for spotting reports he also has a shot to do from the German PzIV whose opportunity fire may pay off as T-34 #803 crosses his sights in hex 4006. Range is 9 hexes. T-34 is a -1 size. It is moving 5 hexes for a -4 modifier. Opportunity fire is a -8. At that range the PzIV is a 16 on the AP chart with a -13 modifier. This gives us only a 22% chance to hit. The judge rolls a 31, miss. So the T-34 will reach its' destination after all. For sighting purposes (assuming all vehicles are buttoned up) it is determined that only T-34 #803 is visible from the Panther, so the German will not be told about the presence of the other two. On the Russian side, the PzIV is the only tank visible and then only as a muzzle flash from the woods when it fired. The judge would not have to reveal what was actually in those woods, only that the T-34 took fire from them. He can now call both players back to relay results and wait for their next moves.

The examples shown above should give you a fairly good idea of what goes on in a typical phone game of *PANZER*. As you can see, the players only had a couple of units apiece and the phone calls themselves were very brief. Even in a full-fledged game where each player has a dozen units or so the calls seldom exceed five minutes each. Given the fact that the phone calls are divided between three people (with the judge making an extra call each move) the cost is not at all prohibitive if players live at all close to each other. In some urban areas with larger phone systems closer together there may often be a 'call-pak' type plan available where there is no limit of calls during a month as the bill is paid as a flat fee. Do some checking in your area if you are not familiar with your phone rates, but it will not be as expensive as you might think at first. If you are planning a game long-distance, try to call when the rates are down. The main thing to remember is that the time actually spent on the phone is short. Whereas the time you can spend planning strategy is great. And the judge can take as much time as needed to look up specific rules questions, if any, and resolve combat and determine sighting results. All in all, a phone game has a lot to offer as a different form of wargaming. If I have aroused your curiosity and interest enough that you will give it a try I am glad. It's not that I work for the phone company, because I don't, but I really hope that you will give it a try and see what I mean. It is a dimension of wargame that is hard to achieve any other way. So good luck

with your phone gaming, if you'll excuse me though, I have to plan my next move before the phone rings again.

Other games that would be good for play-by-phone are *CV*, *RAIDER!*, *MARINE:2002* and *BATTLE* (with some sighting rules), *FLATTOP*, *PANZER-BLITZ* and *PANZERLEADER*. *SQUAD LEADER* would be very difficult.

Wait a minute. You mean you still don't believe how much fun a play-by-phone game of *PANZER* can be? OK, I'll prove it to you then. If you don't own a copy of *PANZER* then go out and buy it, if you already have it then you are all set. Get out your game and set up the situation that I described earlier using all of the proper counters for terrain and units as I listed them. Now you are set up and ready for play. Here is how we will work the game. You will take the Germans and a local friend of mine will play the Russians. At the beginning no one can sight anyone on the other side. Your objective as the German player is to destroy all three Russian tanks before they get you. Since everyone knows the set up already and we are at such close quarters the moves will be tricky and crucial. What I am proposing is that we actually play the game by phone with me as the judge. We will only play out two complete turns just to give you the idea of how it works. Now let's set up the ground rules for the game.

All rules from *PANZER*, the armor game, will be in use. The first ten players that call will get to play (as I have a limited capability to duplicate the game situation, and am only one person after all). The date and time to call are as follows: the last Monday of the month this magazine appears at 7:00 pm Central time (I live in the Chicago area). The number to call is (312) 870-8002. I will answer. This is the only time this number will be available for the game as it is normally a business phone. If the phone is busy please try again. After I have my ten players all others will be refused and I will begin call-backs with results to all players, at which time they can make their second moves and then get results. With a little cooperation from the kindly editor we will have the exact dates printed at the end of this article. There are no prizes involved, just a chance for you to play by this system. All it will cost is a couple of phone calls, one for each move. If you are interested, then I'll be talking to you soon. Good Luck.

*Ed. Note:*

*The date for the test is Nov. 30. Good luck . . .*

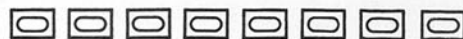

## Third World Publishers: Simulations Canada

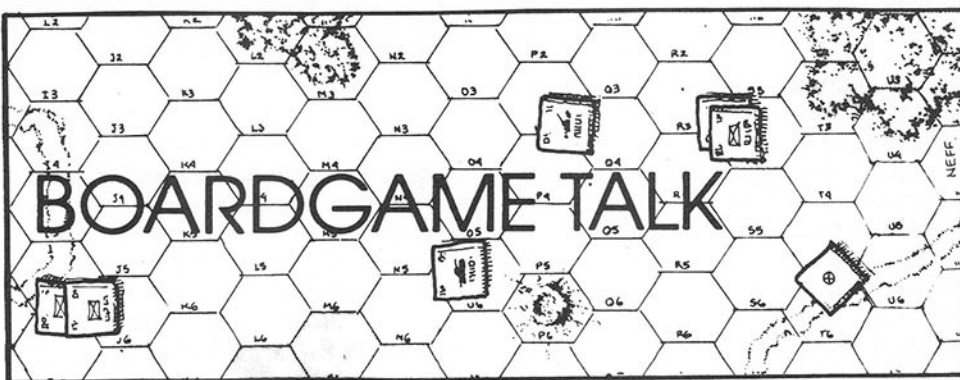

by John Prados

As part of a continuing effort to provide helpful background information for gamers, BOARDGAME TALK will present occasional profiles of game publishers. This issue the focus is on Simulations Canada, the major Canadian games publisher and one of the so-called "Third World" within the hobby overall. Simulations Canada is of interest not only for its location but because it has proved to be surprisingly resilient in a field where (witness Operational Studies Group) Third World publishers financed on a shoestring come and go with great rapidity.

Actually, in much the same way that home board wargames are an American innovation, Simulations Canada is an American import. Stephen Newberg, founder and publisher of Simulations Canada, moved north after leaving the US Navy, where he had served aboard a nuclear submarine. While in the Navy, Newberg stumbled across the Avalon Hill game *Panzerblitz* and got high on gaming. Stephen then got the urge to design a game and did so — as a training aid for the Navy which did nothing with the design. Newberg then asked for and received permission to do an unclassified version of the game for submission to outside publishers and sent off the revised design, a tactical naval anti-submarine warfare game, to both Avalon Hill and Game Designers Workshop. Avalon Hill thought the game too complex but GDW bought it and published it as *SSN* in May of 1975.

This success led Newberg to the notion that he could forge ahead as a freelance game designer and he promptly sold GDW a second game, *Missile Patrol Boat*, which has never appeared. There was also a project to do a World War II submarine game for Avalon Hill but that fell through when AH acquired

the equivalent game *Submarine* from Battleline Games in 1977. The result soured Stephen on the possibilities of freelancing and left him with a choice between seeking a job in his field of training (engineering) or going whole hog to start his own game company. He chose the latter option and formed Simulations Canada.

For the first games done on its own hook Simulations Canada chose *Peloponnesian War*, a subject that had fascinated Newberg while in graduate school, and *Dieppe*, a subject with the twin virtues of being both a World War II game and a situation in which Canadians had had a major share of the operation. Newberg's third idea was for a modern naval tactical game, a subject he had discussed with Game Designers Workshop but which he considered they would take too long to produce. So with three designs covering a broad range of historical topics Simulations Canada went into production.

Once into production Stephen began to discover just how difficult game production can be. The only Canadian printer east of Montreal capable of doing game work was Lawson Graphics in Halifax. The customs structure for shipments into the US, which constituted 90% of the market, added a lot to the US price. The Canadian tax structure did the same — a Simulations Canada game could be bought more cheaply on the Canadian Pacific Coast than it could if bought in Simulations Canada's home base of Nova Scotia. Nor were the problems only financial ones. Newberg discovered that his printers could not handle standard thickness game counters and he had difficulties with die cutting as well. The early Simulations Canada games were criticized for precisely this — substandard counters. In 1979 Stephen finally managed to solve the production problems by using American die

cutters, specifically Freedman Die-Cutting, the same company that services Simulations Publications and, until recently, Operational Studies Group. Since then Simulations Canada products have been gaining steadily in quality. Newberg began to use one inch deep boxes suited for the retail trade last year. The most recent crop of Simulations Canada games, including *Jihad* and *Divine Wind* also sport box cover art from the ubiquitous Rodger MacGowan.

Currently, Simulations Canada carries sixteen games in its line with two more releases scheduled for the fall of 1981. The "Canadian Connection" is the focus of two games, the already mentioned *Dieppe*, a battle game, and *Quebec Libre*, a political game dealing with Canadian separatism. Newberg's strong interest in naval warfare is reflected in the fact that a quarter of his line consists of this type game. The modern naval tactical game is called *Raketny Kreyser* (rocket cruiser). There is also a game trilogy on World War II naval: *IJN*, which deals with the Pacific; *Torpedo*, which focuses on antisubmarine warfare; and *Kriegsmarine*, which covers Atlantic and Mediterranean encounters. In addition one of the company's latest releases is a Pacific War strategic game called *Divine Wind*. For science fiction fans there is *Dark Stars*, a game of exploration and conflict in space. Ancient and early period fans may be interested in *Peloponnesian War*, in *Warring States*, a game on Chinese potentates from 231 to 221 BC, or in *Jihad*, on the rise of Islam from 632 to 732 AD. Gamers interested in the 19th Century may play *Le Grand Empire*, a strategic Napoleonic design, or *Lee At the Crossroads*, a brigade-level game of the Battle of Gettysburg. The US Calvary meet the Indians on the northwestern plains in Simulations Canada's game *I Will Fight No More Forever* which covers the Nez Perce "contested retreat"

through the northwest to Canada. North Africa fans may be interested in the game *Assault on Tobruk* which covers Rommel's attack on that fortress in June of 1942. The planned fall releases consist of *Inchon*, a game on the turning point of the Korean War, and *Rocket's Red Glare*, which will be the first game available on the War of 1812 in North America.

This is a fair selection of topics. It even shows some daring to choose topics that many other publishers would not touch. *Warring States*, the Nez Perce game and the Islamic one are cases in point. Where do the ideas come from? Stephen Newberg does the designing himself and says the ideas come from his general reading. Designer Newberg makes notes "when something sounds interesting" in the non-fiction he reads. Periodically he reviews the notes to extract game subjects, which he can then research further. At a given time Stephen's list of potential game topics may number two dozen. He may also accept an outside design if it falls close to potential subjects of interest.

What of Simulations Canada's design philosophy? Newberg in an *F&M* interview observed a tendency toward opposite ends of the spectrum — very big

games and very small ones. He thinks many gamers would like to see games of reasonable scope and moderate complexity. When queried on this point Stephen replied, "It comes down to: the design must teach the players what you have discovered from your research. It must do so in an interesting, and hopefully enjoyable manner. For me personally this tends to rule out very large games and very small games since the former are too much work and time (to play, that is) and the latter do not have enough scope to showcase the design research and viewpoint." Clearly Newberg has a consistent and conscious design philosophy and is articulate in explaining his viewpoint.

There are the inevitable delays and disruptions in game production, of course. Not the least of these for Simulations Canada was the Canadian postal strike and the fact that Stephen moved to a different part of Nova Scotia. No doubt playtesting was temporarily affected by the move in early 1981. In any case Newberg has already begun production work on fall 1981 releases and is busily planning his games for the spring of 1982. He reports that it is most likely that one 1982 game will be a freelance design

— an innovative game on the Napoleonic battle of Wagram. Stephen's own topic for the 1982 line will be a modern strategic naval game he has titled after the latest book from Admiral Gorshvok, *Sea-power of the State*. Both these titles sound very interesting. We will have to wait and see how the games come out.

Part of the success of Simulations Canada is no doubt attributable to the small size of the company — essentially only Stephen himself. The company began with print runs of no more than 500 units. Today the size of runs is many times greater. The small size helped keep down overhead costs on the game company. By contrast, Operational Studies Group, which was relatively much better financed than Simulations Canada and began later than it did, has since been forced to go out of business. OSG employed a much larger staff and maintained offices with consequent costs for these. Simulations Canada for its part has grown slowly but steadily. Today it is a solid company with innovative games although limited production capabilities. Let us hope they continue to progress and someday furnish us with four-color process maps too!

## FOR CITADEL MINIATURES IN CANADA, LOOK TO RAFM Co. WE HAVE THE FANTASY ADVENTURERS



# Rafm Co.

19 Concession St.,  
Cambridge, Ont., Canada  
N1R 2G6  
1-519-623-4832



FA7

FA8

FA11

FA21

A range of intrepid heroes available for fearsome adventures.

- |                                      |  |   |
|--------------------------------------|--|---|
| FA1 Fighter in Plate Mail with Sword | FA11 Illusionist                         | FA19 Female Fighter with Breast-plate and Sword |
| FA2 Wizard with Staff                | FA12 Ninja (Assassin) with Sword         | FA20 Hourai with Dagger                         |
| FA3 Cleric with Cross and Mace       | FA13 Man Beast                           | FA21 Evil Wizard                                |
| FA4 Sneak Thief with Dagger          | FA14 Elven Hero with Sword               | FA23 Evil Priestess                             |
| FA5 Druid with Sickle                | FA15 Dwarf with Two Handed Hammer        | FA24 Anti-Hero                                  |
| FA6 Bard with Sword and Lute         | FA16 Female Wizard with Dagger and Staff | FA25 Necromancer                                |
| FA7 Monk with Staff                  | FA17 Female Thief with Dagger and Sack   | FA26 Fighter in Chainmail                       |
| FA8 Ranger with Sword and Bow        | FA18 Female Cleric with Mace             | FA27 Amazon with Sword                          |
| FA9 Barbarian with Two Handed Sword  |  | FA28 Amazon Priestess                           |
| FA10 Paladin with Sword              |  |   |

Write for complete list

# What Our Hobby Needs Is A Yearbook

by Lewis Pulsipher

In 1979 a British firm published the first *International Science Fiction Yearbook*, a 400 page paperback filled with interesting articles, reference material, and listings covering the vast field of SF, from films and books to games and other fringe interests. As someone barely familiar with the fringes of SF fandom I learned a great deal from the book. I think a somewhat similar yearbook about adventure gaming would be a great service to the average gamer, in particular those who play games but don't subscribe to many games publications.

Consequently, I'd like to make some suggestions about a format for such a publication in the hope that someone will decide to compile or publish one. I haven't the requisite broad gaming interests nor the connections to edit a yearbook, but I for one would certainly buy a copy. After all, the time and money saved through the listings and reviews in the book would be worth more than the cost.

A yearbook for adventure gaming, still a small hobby compared with SF fandom, would be closer to 80 than to 400 pages. A magazine size (8½ x 11") would be more suitable than book size. A February or March issue date would hit the least active part of the gaming year with little competition for the gamer's dollars.

The yearbook should serve several functions: 1) Explain and describe all facets of adventure gaming, from conflict simulations to miniatures to role-playing, from games to computers to history, from conventions to clubs to "cult" games. 2) Be a reference source — names, addresses, prices. If I want to know where to get the game *Mig Alley* or the magazine *Sorcerers Scroll*, or who Gary Gygax is or who won the Charlie Awards, I should be able to find it here. 3) "Review" all newly-published games, at least in the sense of describing them physically and indicating relative complexity, subject matter, designer, publisher, price, and other more or less unsubjective characteristics. As time passes it should be possible to find a "review" of almost every game in print in one issue or another of the yearbook.

To accomplish these tasks is more

than one man could attempt. The editor will have to ask many prominent gamers for help, especially with reviews but also with sections on sub-hobbies and gaming overseas. He might solicit opinions and information from the game manufacturers. In the long run the yearbook might carry advertising. I doubt that any publisher could pay the editor sufficiently for his efforts — the yearbook would be, in part, a labor of love.

Extensive cross-referencing to avoid duplication should be used, and the book might be divided into chapters as follows:

1. *Introduction*. To give an overview of what has happened in adventure gaming in the past year. Any surprises, big breakthroughs, trends in sales? Where is adventure gaming going?

The next ten chapters would include reviews of new games and rules, source listings for the more popular "old" games (if not for all games in print), and an introduction to help the uninitiated understand what this is all about. The SF boardgamer, for example, may know little about computer or naval games.

2. *Conflict simulations*—land—World War II, contemporary, and near future.

3. *Consim*—land—pre WW II

4. *Consim*—sea

5. *Consim*—air

6. *Science fiction boardgames*

7. *Fantasy boardgames*

8. *Role-playing games*

9. *Computer wargames*

10. *Miniatures*. (This could be a long chapter, depending on the aims of the editor and publishers.)

11. *Miscellaneous games*. (For example, *Diplomacy* and *Risk*-type)

12. *Companies*. Give sales figures and other objective comparisons. List names and addresses. State major changes in personnel, ownership, avowed aims or specializations. Concentrate on new companies and their offerings.

13. *Magazines*. As for companies, but divided into professional and amateur.

14. *Organizations*. Describe non-local clubs such as AWA, the designers' and manufacturers' organizations, game-of-the-month or other subscription game arrangements.

15. *Conventions*. Reports from the bigger cons such as Origins, Gencon,

Michicon. List all conventions held in the past year, and all those scheduled for the next year, giving approximate date along with address to write to, where exact date is unknown.

16. *Awards*. Describe the various awards schemes and list winners.

17. *Who's Who*. Identify (and, where permission is given, give addresses for) designers, publishers, editors, writers; obituaries.

18. *Wargaming in other countries*. Foreign games, magazines, etc. should be listed in other chapters, but a long summary of the activities in countries outside North America would be desirable.

19. *Special interest groups*. Describe single games with special fandoms—*Dungeons and Dragons* and *Diplomacy* are the only ones I can think of, not surprisingly since they seem to be the best-selling adventure games worldwide.

20. *Related non-game hobbies*. Computers, SF/F, history—how to get involved, prominent magazines, etc.

21. *Miscellaneous*. Surely I've left out something. Each year there might be a special chapter, interviews, or guest articles about some aspects of wargaming. Possibly outstanding magazine articles could be reprinted.

A work like this would be invaluable to the "big names" as well as to the average player.

Ed. Note:

OK, reader, what do you think? Any publishers interested? How about GAMA? Let us know your thoughts on this.



**Interview** Cont. from pg. 7

of the main things that Ace of Aces has done. You show them how to make a story personify something other than fantasy.

A.L. We are going to do it with some other things, too. We are going to put you on the bridge of your own ship.

A.G. Oh, I know a guy back at the plant that would buy a gross of those. Give him torpedoes, and he's ready to go now.

---

"... Right now we need the grass green for us, the other people can come and mow it two years down the road ..."

---

A.L. The first one is going to be Taffrail. It is going to be on the taffrail of a frigate and you are going to see all those guns laying out there. It is the picture of just being there, you are *on* the taffrail of that ship. The basic game, even though there will not be wind in the basic game, is going to be a lot of fun and in the advanced rules of course you will have wind, and all that good stuff. We have a lot of work to do and it is all in progress. I think we will do a real good job for ourselves and for other people. Right now we need the grass green for us, the other people can come and mow it two years down the road, and they will probably want to wait that long anyway to prove to themselves that it is a safe bet.

A.G. *The key to success is to be the first. I think a number of people will be interested in an article on how to play solitaire.*

A.L. Let me keep going full time, then I can sit down and just give you the numbers and you can have the people put them in the book. At that time I will probably be able to print them into the book myself.

What I'd like to add is that these ideas were great ideas. By themselves they wouldn't have even come to the market place, if I hadn't met up with the right people: Jim Rosinus, Joe Angellilo and Mike Vitale, it would not have happened. These three men wanted to form a company. We created a company and we work very well together. It's amazing how well we work together and I think we've accomplished a lot in our one and a half year company ...

A.G. *I know you certainly set the industry on its ear with the first stage. This is a brilliant, simple game in my estimation because you will have a ton of fun.*

*Strategy Tip from Al Leonardi:  
If you wish to get an idea of what the*

*other plane has done, disregard the admonition to ignore the interim page. If you look at it, you will see the other plane's maneuver before your plane has started your own. Watch for your enemy to set a pattern of maneuver, discern it and shoot him down.*



"A SIMPLE DINNER BELL WOULD BE SUFFICIENT."

## GAME BOARDS

We feature a complete line of components that can be modified to your needs. Manufacturing hundreds of different titles in quantities of 1,000 and up.

- Rule Books
- Dice
- Pawns
- Spinners
- Maps
- Setup Boxes & Folding Cartons
- Multi Color on All Components
- Die Cut Counters
- Case Bound Books
- Play Cards
- Plastic Wrapping
- Game Boards on Plastic
- Deliveries by Patch Press Semis

Call any time for a game technician  
to review your needs.

**608/365-1273**

**Specialists In Game Manufacturing**



1929 Royce Avenue  
Beloit, Wisconsin 53511

# ICE PRESENTS MANASSAS

SUNDAY JULY 21<sup>ST</sup> 1861

**A WARGAME OF THE FIRST BATTLE OF BULL RUN**  
**GIGANTIC FULL COLOR MAP** measuring 36" x 48" illustrated in period style.

**320 LARGE DIE-CUT COUNTERS** representing every regiment, battalion, battery and Hdqtrs. that participated in this heroic conflict. Many of these pieces are in 5 colors!

**EXTENSIVE RESEARCH** has developed this fast-paced regimental-level simulation, designed with great historical accuracy and incredible playability.

**MANASSAS SUNDAY JULY 21<sup>ST</sup> 1861** comes to you beautifully boxed, \$20<sup>00</sup> (postpaid).



**IRON CROWN ENTERPRISES** brings you this unique wargame that captures the flavor of the first major action of the Civil War. Refight this historic engagement by maneuvering your units across the rolling Virginia countryside, beautifully rendered in period style on the huge 5-color map. Feel the drama in leading these brave volunteers. Experience the frustration of command as units degenerate into armed mobs in the heat of battle. Jackson stood like a stone wall... *can you?*

**MANASSAS** includes 320 large die-cut counters, 36" x 48" five-color map, rulebook, charts and tables. Boxed to you for only \$20<sup>00</sup> (postpaid).

AND COMING SOON FROM  
IRON CROWN ENTERPRISES:

**NEW MARKET: The Field of Honor** simulates the action of May 15, 1864, made so famous by the stirring charge of the VMI cadets. Will you meet the challenge?

IRON CROWN ENTERPRISES / P.O. BOX 6910 / CHARLOTTESVILLE, VA 22906

NAME \_\_\_\_\_

ADDRESS \_\_\_\_\_

CITY \_\_\_\_\_ STATE \_\_\_\_\_ ZIP \_\_\_\_\_

PLEASE RUSH ME  COPY(IES) OF **MANASSAS** @ \$20<sup>00</sup>

Yes—keep me posted on future historical releases.

# ICE PRESENTS SPELL LAW

**OVER 2000 SPELL DESCRIPTIONS** for 15 different character classes in three separate realms of power.

**DETAILED ALCHEMY RULES** covering the skills involved in making items of greater or lesser power.

**SPELL ATTACK TABLES** for the variation in spell effects. A unique expertise system allows for increased effectiveness with practice, training and further experience.

Spell Law is a magic supplement designed to improve any fantasy role-playing game. It includes hundreds of spells from all areas of mythology and literature to increase the variety of magic in your game system. Suggested for use with Spell Law is a workable spell point system (including inherent spell power and the use of wands, orbs, staves, etc.) and a unique learning system that groups spells of similar nature (to be learned in sequence as the character gains experience and power).

**SPELL LAW:** 4 color-coded parchment books, 8 parchment tables, \$17.50 postpaid (boxed).



**PUT SOME MAGIC IN YOUR GAME**

**ALSO AVAILABLE FROM ICE —**

## THE IRON WIND

A beautiful campaign module for use with any fantasy game system. The Iron Wind includes 5 dungeon layouts, 3 city plans, weather and herb charts, descriptions of the various cultures in the region and a beautiful 4-color map. \$8.00

## ARMS LAW

A fast, realistic combat system emphasizing skill over luck. 30 parchment weapons tables combine all the vital characteristics of a variety of arms so that a single die roll resolves both hit and damage. Also included are innovative rules for critical hits, parry, and extraordinary maneuvers. \$10.00

**IRON CROWN ENTERPRISES/PO BOX 6910/CHARLOTTESVILLE, VA 22906**

NAME \_\_\_\_\_

ADDRESS \_\_\_\_\_

CITY \_\_\_\_\_ STATE \_\_\_\_\_ ZIP \_\_\_\_\_

PLEASE SEND ME  SPELL LAW  ARMS LAW  IRON WIND

Please enclose check or money order for the proper amount, or send your name and address for more information.