

a **CAR WARS** supplement

The AADA Vehicle Guide

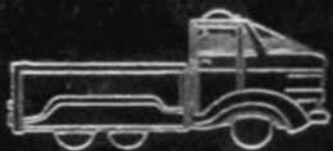
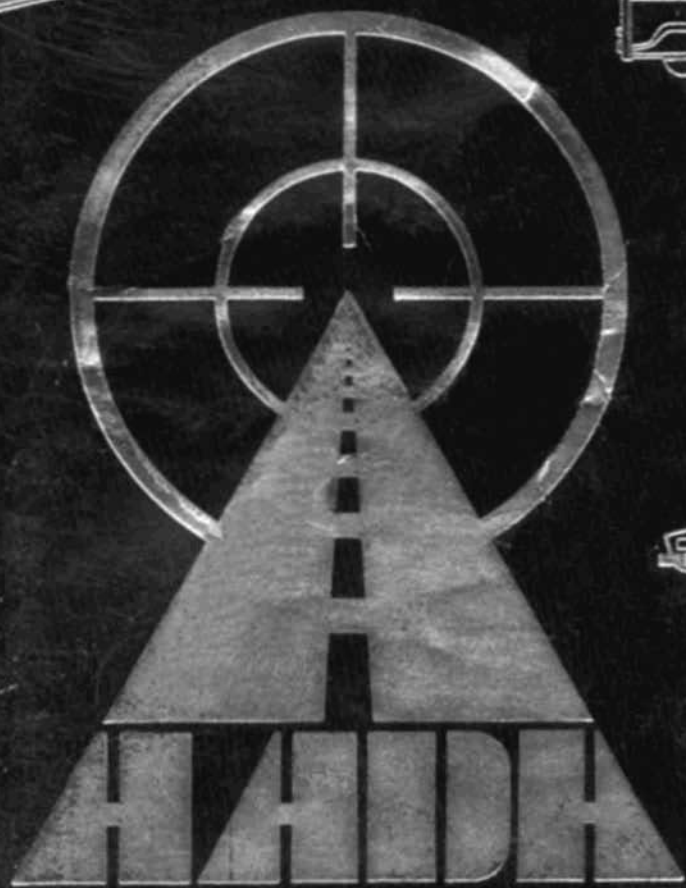

STEVE JACKSON GAMES

The AADA Vehicle Guide

2034 Edition

by **Scott Haring and Jim Gould**
edited by **Steve Jackson**

**Artists: Kim Strombo,
Jeff George, David Welling,
C. Mara Lee, Graham Chaffee, Jeff Hayes**

Special thanks to Robert Vivrette

Introduction	2
Motorcycles	4
Tricycles	9
Compacts & Subcompacts	12
Mid-sized	17
Luxury	21
Station Wagons	28
Pickups	30
Vans	34
Buses	37
Tractors	43
Trailers	46
Helicopters	50
Trike Design & Combat	54
Off-Road Duelling	58
Customizing Vehicles	61
Late Arrivals	64

Copyright © 1984 by Steve Jackson Games

Car Wars is a trademark of Texas Instruments Incorporated. *Autoduel*, *AADA* and the AADA logo are trademarks of Steve Jackson Games. All rights reserved.

Introduction

With the fast-growing popularity of autoduelling, both on the road and in the arena, has come a corresponding growth in the variety of duel-equipped vehicles available to the buyer. Gone are the days when every armed car on the road was either a custom job or one of a half-dozen standard makes. Today, well over 200 models of passenger cars and trucks come factory-equipped for autoduelling . . . to say nothing of the well-armed commercial carriers and helicopters we now see daily.

But with this popularity has come a problem of identification. Just like the WWII soldier a century ago, today's driver is faced with a bewildering variety of potential friends and foes. The soldier had the famous "Jane's" volumes to guide him. The duellist had nothing . . . until now. With a tip of our hat to the pioneers at Jane's — long may they publish — we are proud to present the first edition of the *AADA Vehicle Guide*.

It is a sad fact of life that no reference book can ever be as complete as the compilers might like. Obviously, this Guide could not cover one-of-a-kind vehicles, or even short production runs, or it would become so unwieldy as to be useless. In choosing which vehicles to include, we tried to cover every make, American or foreign, having at least 5,000 examples in use in North America today. For helicopters and commercial vehicles, the cutoff was 1,000. Vehicles suitable only for arena combat, and models so rare that the average driver is unlikely to encounter one, were regretfully omitted.

Of course, new information is always appearing. Even with tight deadlines, two vehicles made their debut after the pages had been set up; they are listed in "Late Arrivals," page 64. Revisions of this guide will be published as needed; in the meantime, check *Autoduel Quarterly* for supplementary listings and updates.

Motorcycles

Popper

Because of its heavy armor and low price, the Popper remains one of Crane Industries' best-selling cycles. Its only weaponry is a front-mounted RL, handicapping it when faced with a larger or more nimble vehicle.

Popper — Medium cycle, hvy. suspension, small power plant, driver, 2 std. tires, RL front. Armor: F30, B24. Acceleration 5, HC 2; 1,100 lbs., \$3,444.

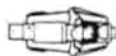

Santa Cruz

A no-frills combat vehicle from Crane Industries, the Santa Cruz packs a front-and-back punch that makes it a more versatile opponent than most cycles. Radial tires are a standard option, making this vehicle hard to topple as well.

Santa Cruz — Heavy cycle, hvy. suspension, large power plant, driver, 2 PR tires, MG front, MD rear. Armor: F15, B14. Acceleration 10, HC 2; 1,299 lbs., \$5,948.

Radial option — replace tires with PR radials. Armor: F14, B13. HC 3. 1,297 lbs., \$6,524.



Spider

A popular model from Cycle Concepts, the Spider is particularly dangerous because its recoilless rifle has less of an ammo restriction than most. Its armor is adequate for highway use. Deal with the Spider by closing to short range and getting things over quickly, or your opponent may hang back and pick you to pieces.

Spider — Heavy cycle, hvy. suspension, large power plant, driver, 2 HD tires, RR front, extra RR magazine. Armor: F16, B12. Acceleration 10, HC 2; 1,298 lbs., \$5,486.

SmokeSpider — replace extra magazine with SS. Armor: F14, B12. 1,296 lbs.; \$5,412.



RoadMiser

This inexpensive cycle is a favorite of short-haul couriers with small packages. It was the first truly practical combat design for a light cycle, and to this day has no serious competition in the category. Many cyclists fondly remember the RoadMiser, now in its seventh year as the best-selling model in the Cycle Concepts line, as the first two-wheeler they ever owned. The "Rocket RoadMiser," introduced in 2032, has only one punch but is far better armored, making it more likely to live through a sustained fight.



RoadMiser — Light cycle, hvy. suspension, small power plant, driver, 2 standard tires, MG front. Armor: F10, B7. Acceleration 10, HC 2; 798 lbs., \$2,870.

RoadMiser II — As above, but replace standard tires with PR tires. Armor: F7, B5. Costs \$3,120.

Rocket RoadMiser — As RoadMiser, but replace MG with HR. Armor: F25, B17. \$1,820.

Hawk

Fairly well armored, the Crane Industries Hawk is undergunned as combat cycles go. Its primary threat lies in the opponent's uncertainty over what weapons it is carrying; the two Hawk models are absolutely indistinguishable (thanks to dummy weapon ports) and are very differently equipped. Handle with care until the first shot is fired.

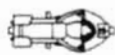

Hawk — Medium cycle, hvy. suspension, med. power plant, driver, 2 PR tires, MG front, SD back. Armor: F20, B15. Acceleration 10, HC 2; 1,100 lbs., \$4,485.

Hawk Firebrand — As above, but replace MG and SD with FOJ. Armor: F40, B34. \$4,289.

Taurus

Another in the "Zodiac" line, the Taurus isn't named after the bull for nothing. An RL-equipped sidecar is a standard option, and can be mounted to either side of the cycle — making for some interesting tactics, as two Taurus will pull up on opposite sides of a target vehicle and give it a double dose of firepower. Without the sidecar, the Taurus is a good but not spectacular combat vehicle.



Taurus — Medium cycle, hvy. suspension, super power plant, driver, 2 PR tires, MG front. Armor: F20, B20. Acceleration 10, HC 2 (with sidecar, acceleration 5, HC 3); 1,100 lbs., \$5,240.

Taurus sidecar — Hvy. sidecar, 1 PR tire, RL side, SD rear. Armor: F2, B2, S4. HC 1; 748 lbs., \$2,790.

MD sidecar option — replace RL with rear-mounted MD, link MD and SD. Armor: F6, R6, S4. 746 lbs.; \$2,530.

Scrapper

The jury is still out on the newly-introduced Cycle Turret Sidecar, and the long-term success of Wheeler Motors' Scrapper is still in question — but thousands are already on the road, giving the CTS its acid test. So far, it seems to be doing well; stock Scrapper cycle-sidecar combinations have taken on and defeated four-wheelers more than once. For conservatives, Wheeler offers a "Scrambler" sidecar with the same armament, unturreted, and less weight.

Scrapper — Heavy cycle, hvy. suspension, super power plant, driver, 2 PR tires, RL front, extra magazine. Armor: F13, B10. Acceleration 10, HC 2 (with either sidecar, acceleration 10, HC 3); 1,203 lbs., \$5,626.

Scrapper sidecar — heavy CTS, impr. suspension, RL in turret, PR tire. Armor: F2, S1, B1, U2, T6. HC 1; 797 lbs., \$6,610.

Scrambler sidecar — heavy sidecar, impr. suspension, RL front, PR tire. Armor: F5, S4, B2. HC 1; 745 lbs., \$2,550.



Tomcat

This Courier Services model will practically never be found in the arena — or on the open highway, for that matter — but it is the standard vehicle for inner-city and short-haul delivery services, and can take care of itself in a brief fight. The Tomcat is only available with its lightly armored, cargo-carrying sidecar.

Tomcat — Medium cycle, hvy. suspension, large power plant, driver, 2 PR tires, MG front. Armor: F20, B20. Acceleration 10, HC 3 (with sidecar); 1,375 lbs., \$5,615 (including sidecar).

Tomcat sidecar — Lt. sidecar, impr. suspension, 1 PR tire. Cargo capacity: 100 lbs., 2 spaces. Armor: F5, B5, S5. HC 1; 300 lbs., \$875. Included as part of Tomcat package, but available separately.



Gazelle

The Gazelle design is most popular as a Division 5 duelling cycle. It is not often encountered on the road, except in relatively quiet areas, because of the relatively skimpy armor. The original Gazelle has now been replaced by an improved (and less costly) model. Pre-2033 models have twin machine-guns; newer models have better suspension, a single RR, and heavier armor, and are more of a threat. The illustration shows the newer model; a pre-2033 is distinguishable from the front by the single RR port, but from the rear looks identical.

Gazelle (pre-2033) — Medium cycle, impr. suspension, med. power plant, driver, 2 HD tires, 2 linked MGs front. Armor: F6, B6. Acceleration 10, HC 1; 1,100 lbs., \$4,982.

Gazelle (2033 and after) — As above, but with heavy suspension; replace MGs with one RR; armor F11, B11. HC 2; \$4,192.



Slasher

Amex Combat Autoworks' Slasher is not much of a threat when encountered alone, but it can be very effective as part of a combat group. The heavy rear-mounted defensive weaponry on the standard Slasher sidecar makes it a bad foe to follow.

Slasher — Medium cycle, hvy. suspension, med. power plant, driver, 2 HD tires, 2 linked HRs front. Armor F26, B26. Acceleration 10, HC 2, 1,100 lbs., \$3,122.

Machine-gun option — Replace HRs with MG. \$4,172.

Slasher sidecar — Light sidecar, light suspension, HD tire, linked SS and SD mounted to rear. Armor: F2, B2, S2. HC 0; 400 lbs, \$1,130.

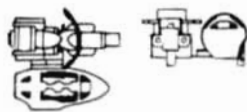

Tornado

This Cycle Concepts model is designed for those with a taste for performance — it has excellent handling and acceleration and a top speed as good as any non-gasburner on the market. However, its light armor and armament make it less than formidable in combat.

Tornado — Medium cycle, hvy. suspension, super power plant, driver, 2 PR radial tires, MG front. Armor: F10, B8. Acceleration 15, HC 3; 1,100 lbs., \$5,598.

Div. 5 duel model — As above, but change tires to regular PR. HC 3; 990 lbs; \$4,998.



Mantis

Another basic combat workhorse from Crane, the Mantis is a basic, no-frills heavy combat cycle. Its armor (especially to the rear) is lighter than that of most cycles this size, and its only offensive weapon is front-mounted, but the smokescreen gives the Mantis a chance to escape when the fight turns against it. This is definitely not an arena vehicle, though.

Mantis — Heavy cycle, hvy. suspension, large power plant, driver, 2 PR tires, 2 linked MGs front, SS rear. Armor: F10, B6. Acceleration 10, HC 2; 1,296 lbs., \$6,692.



Aquarius

The first of Mystic Motors' "Zodiac" series, the Aquarius is one of the most dangerous cycles available in its price range. Most duellists feel it carries an excellent balance of armor and weaponry. On the road, it remains handicapped by the lack of rear-firing weapons.

Aquarius — Medium cycle, hvy. suspension, small power plant, driver, 2 PR tires, RR front. Armor: F15, B15. Acceleration 5, HC 2; 1,100 lbs., \$3,980.

Rocket launcher option — Replace RR with RL. Armor: F25, B25. \$3,700.



Samson

Critics laughed when Howard Samson named his new heavy cycle after himself. But the Samson proved to be equally effective on the road or in Division 10 duelling, and the Samson sidecar, in either passenger or armored version, proved a good seller separately.

Samson — Heavy cycle, impr. suspension, large power plant, driver, 2 PR radials, RR front. Armor: F20, B14. Acceleration 10, HC 2 (acceleration 5, HC 3 with side-car); 1,289 lbs., \$5,558.

Samson passenger sidecar — Heavy sidecar, impr. suspension, 1 PR radial tire, FOJ rear. Armor: F6, B6, S6, U5. Cargo (passenger) space: 152 lbs., 1 space. HC 1; 598 lbs.; \$2,690.

Samson armored sidecar — As above, but add SD rear, linked to FOJ. Armor: F10, B10, S10, U5. No cargo space. 745 lbs., \$3,100.



Maxi

One of the most heavily armed cycles on the road, the formidable Maxi is Cycle Concepts' top-of-the-line model. The sidecar is an integral part of the design, and, being comparatively unprotected, is the Maxi's weak point. Even without the sidecar weaponry, the Maxi retains heavy offensive capability to the rear — often a fatal surprise to the uninformed opponent. Handle with care.

Maxi — Heavy cycle, heavy suspension, large power plant, driver, 2 PR tires, RL and SD to rear. Armor: F14, B15. Acceleration 5, HC 3 (with sidecar); 1,999 lbs., \$8,498 (including sidecar).

Maxi sidecar — Heavy sidecar, impr. suspension, 1 PR tire, RL front, extra RL magazine. Armor: F5, B3, S2. Available only as part of Maxi package.



Flash

This Division 15 model won instant fame when Howard Samson rode it to the AADA California Cycle Championship, demolishing three more costly two-wheelers in the process. Careful investment of the prize and endorsement money let Samson start his own company — and, naturally, his first project was to turn the custom Flash into a production model. Unlike most makes, the "standard" Flash is the top of its line; both options involve reduced price and performance. Any type of Flash is dangerous from the front, much less so from the rear.

Flash — Heavy cycle, hvy. suspension, med. power plant, driver, 2 PR tires, laser front, hi-res computer. Armor: F10, B6. Acceleration 5, HC 2; 1,296 lbs. \$14,792.

Flash II — As above, but without computer. \$10,792.

Flash X — As basic Flash, but with light suspension. HC 0; \$9,992.



Tricycles

Until recently, tricycles of any type were rarely seen on the highways. In the last year, though, the sport of off-road duelling has grown from an occasional country pastime to a significant part of the sport, and AADA groups in several areas have sanctioned off-road meets. And it is in off-road combat that the tricycle comes into its own — even without special equipment, trikes are good OR vehicles. Several manufacturers now offer combat-equipped tricycles, and report steadily increasing sales, both of off-road and “standard” models. Though tricycles may be a novelty to many duellists, they can be serious combat vehicles. A well-equipped trike is often more than a match for a small four-wheeler. Don’t laugh at a trike unless you’ve got the firepower to back it up.

So, with thanks for expanding the scope of our favorite sport, this section is dedicated to the off-road duellists.

Imp

The Imp, by Budget Autoworks, is a light one-man, one-weapon trike that can compete in Division 5. Its armor — especially top and underbody — is very light, but its acceleration is good. To achieve that good acceleration, armor was shaved; as a result, the Imp can handle 400 lbs. of cargo, and is sometimes used as a delivery vehicle in safe areas. The off-road version mounts better weaponry and twice the armor, but sacrifices acceleration and cargo capacity.

Imp — Light tricycle, med. power plant, impr. suspension, 3 PR radial tires, driver, RL front. Cargo capacity: 400 lbs., 3 spaces. Armor: F12, R8, L8, B10, T8, U6. Acceleration 10 without cargo, 5 otherwise; HC 2; 1,200 lbs., \$4,922.

Off-road version — As above, but with OR tires and OR suspension. Replace RL with RR. No cargo capacity. Armor: F20, R16, L16, B24, T14, U16. Acceleration 5, HC 2; 1,600 lbs., \$6,816.



Sportster

Trinity Motors is the oldest American maker of three-wheelers, and the Sportster is their most popular bottom-end model. Used primarily for joy-riding, it is no threat to any large vehicle — but it carries better armor weight than some small cars.

Sportster — Light tricycle, med. power plant, hvy. suspension, 3 solid tires, driver, gunner, MG front, 2 linked HRs R and L. Armor: F13, R9, L9, B16, T8, U12. Acceleration 5, HC 2; 1,598 lbs., \$5,937.

Off-road model — As above, but change tires to OR solid. Replace weaponry with RL front and MG back. Armor: F12, R8, L8, B12, T8, U8. 1,600 lbs., \$7,016.



Sandcrab

Originally designed as a beachmobile, the Sandcrab is now available in a highway model which qualifies for Division 10 arena combat. The Vulcan MG/rocket launcher combination makes either Sandcrab far more formidable from the front than from the rear . . . and, with no gunner, the Sandcrab driver must concentrate on one foe at a time. Armor is adequate. The Sandcrab's combat-worthiness is about that of the average compact 4-wheeler.

Sandcrab — Medium tricycle, large power plant, OR suspension, 3 OR solid tires, driver, VMG front, RL back. Armor: F12, R12, L12, B15, T9, U15. Acceleration 5, HC 2; 2,095 lbs., \$9,450.

Highway model — As above, but with heavy suspension and regular solid tires. Add computer. Armor: F13, R12, L12, B15, T10, U15. 2,100 lbs., \$9,874.



Leo

Mystic Motor's Leo features a good combination of weapons. It is easy to recognize because of the "lion's mane" of body blades. Its side armor is light, but the side-mounted HRs make a rear approach the safest bet. The "Pride" model trades armor weight for a turret, giving it more flexibility.

Leo — Medium tricycle, large power plant, OR suspension, 3 OR solid tires, driver, MG front, linked HRs R and L, body blades, fire extinguisher. Armor: F18, R12, L12, B25, T15, U15. Acceleration 5, HC 2; 2,097 lbs., \$7,964.

Leo Pride — As above, but mount MG in turret. Armor: F10, R8, L8, B18, T18, U10. \$8,664.



Asmodeus

The combination of a laser with a hi-res computer gives Trinity's Asmodeus withering firepower — from the front. The rear facing is defensively oriented, with surprisingly heavy armor. The standard Asmodeus is a credible Division 20 entry; the Asmodeus Deluxe is a prestige long-range off-road model for vacationers or serious backwoods duellists.

Asmodeus — Heavy tricycle, super power plant, hvy. suspension, 3 solid tires, driver, gunner, laser F, SS back, MG back, fire extinguisher, hi-res computer (at gunner position). Armor: F15, R15, L15, B22, T4, U9. Acceleration 5, HC 2; 2,798 lbs., \$19,970.

Asmodeus Deluxe — as above, but with OR suspension, OR solid tires, and brushcutter. Remove smokescreen; add LD radio and laser battery. FP armor: F12, R11, L11, B20, T9, U9. 2,974 lbs., \$22,416.



Cratermaker

This Amex model is the only production trike to mount an AT gun. That, plus solid armor on all sides, make it a dangerous vehicle, with no real weakness except its lack of rear-firing offensive weapons (which is remedied in the off-road versions) and its vulnerability to flame weapons (which is not).

Cratermaker — Heavy tricycle, super power plant, hvy. suspension, 3 solid tires, driver, AT gun front, MD back. Armor F20, R18, L18, B24, T15, U10. Acceleration 5, HC 2; 2,798 lbs., \$9,670.

Cratermaker II — As above, but with OR suspension and OR solid tires. Replace MD with an MFR to the rear. Armor: F25, R18, L18, B24, T15, U11. 2,797 lbs., \$9,904.

Cratermaker III — As Cratermaker II, but add a second MFR mounted R, and replace front AT with RL. Armor: F30, R27, L27, B35, T15, U20. 2,798 lbs., \$9,806.



Lumberjack

The basic version of this Trinity model is a working vehicle, used by northwestern loggers. It's still a combat vehicle to be treated with respect. The "Lucky Pierre" trades passenger capability for armor and electronics, and is one of the toughest three-wheelers around. It's still a working vehicle, though; police forces and lumber companies use this model for woods patrol.

Lumberjack — X-hvy. tricycle, super trike power plant, OR suspension, 3 OR solid tires, driver, gunner, 2 passengers, turreted RR, linked MGs R and L, brushcutter, fire extinguisher. Armor: F14, R10, L10, B10, T8, U5. Acceleration 5, HC 2; 3,496 lbs., \$14,712.

Lumberjack "Lucky Pierre" — As above, but without passenger capacity. Add 2 computers. Armor: F20, R15, L15, B20, T15, U10. 3,500 lbs., \$17,320.



Compacts & Subcompacts

Coaster Series

These models, by Courier Services, represent a change of pace for that formerly service-oriented firm. The basic Coaster is a light taxi/delivery vehicle. The Rearguard, with heavier armor and no armament except for linked minedropers, is an inexpensive but effective specialty car — a "Tail-End Charlie" for convoy work. But the Deluxe, which combines Coaster weapon layout with Rearguard armor weight, checks in as a solid Division 10 duelling entry, and already has a loyal following.



Coaster — Compact, x-hvy. chassis, med. power plant, hvy. suspension, 4 solid tires, driver, MG front, MD rear. Armor: F40, R35, L35, B40, T25, U20. Cargo capacity: 180 lbs., 1 space. Acceleration 5, HC 3; 4,020 lbs. w/o cargo, \$9,435.

Rearguard — As above, but with no MG, and two linked MDs (one B, one R). No cargo capacity. Armor: F30, R30, L30, B80, T30, U25. 4,200 lbs.; \$9,375.

Deluxe — As the standard Coaster, but with armor F45, R40, L40, B45, T30, U25. No cargo capacity. 4,200 lbs.; \$9,825.

Flamenco

A Mexican import from Conquistador, the Flamenco is moderately popular as a Division 10 duel vehicle, and is the only production model in its class to feature the flaming oil jet. To an extent, its good acceleration and handling compensate for the light weaponry. The only difference between the Division 10 and highway models is the slightly heavier armor on the road version. Seen from the rear, the distinctive silhouette should be a warning to watch for fire on the road!

Flamenco (highway model) — Compact, hvy. chassis, large power plant, hvy. suspension, 4 solid tires, driver, MG front, FOJ back. Armor: F35, R30, L30, B35, T28, U23. Acceleration 10, HC 3; 3,998 lbs., \$10,189.

Flamenco (Division 10 model) — As above, but with armor F35, R25, L25, B35, T20, U23. 3,908 lbs., \$9,994.



Capricorn

Mystic Motor's Capricorn is a tough nut defensively, though its weaponry is adequate at best. It has no particular strong or weak points. The "Capricorn Plus" has heavier weaponry but is still a clearly defensive vehicle.

Capricorn — Compact, x-hvy. chassis, lg. power plant, hvy. suspension, 4 PR radials, driver, RL front, SS back, targeting computer. Armor: F45, R35, L35, B40, T37, U35, 4 10-point wheelguards. Acceleration 5, HC 3; 4,437 lbs., \$11,451.

Capricorn Plus — Replace RL with RR, replace radials with solids, remove wheelguards. \$11,551.



Haymaker

Amex Combat Autoworks named this model well . . . its game is ramming, and it plays very well. Avoid a direct frontal assault at all costs. If the Haymaker has a weak point, it's the tires.

Haymaker — Compact, x-hvy. chassis, large power plant, hvy. suspension, 4 PR tires, driver, turreted RL with extra magazine, targeting computer. Armor: F50 (ram plate), R30, L30, B35, T35, U20. Acceleration 5, HC 3; 4,415 lbs., \$12,025.



Sargasso

Kane Motors' Sargasso is also a popular first car, and is frequently seen on city streets and in Division 5 duels. Its 10-mph acceleration is one of its better features. The "XH" version, with its heavier armor, is too costly for Division 5 duelling but makes a more practical city car. Even the XH remains a risky choice for highway travel.

Sargasso — Subcompact, hvy. chassis, med. power plant, hvy. suspension, 4 PR tires, driver, MG front. Armor: F15, R8, L8, B10, T8, U7. Acceleration 10, HC 3; 2,530 lbs., \$4,816.

XH option — Upgrade to x-hvy chassis. Armor: F25, R18, L18, B16, T13, U12. 2,760 lbs., \$5,472.



Iguana

The Iguana is Amex Combat Autoworks' entry in the subcompact field. Though lightly armored, the Iguana, in either of two standard models, is a very popular Division 5 duelling vehicle. Like most combat subs, its offense is better than its defense; the Iguana is too lightly armored for street use in any but the quietest locale. Its weakest points are the roof and underbody, both of which are almost unarmored.

Iguana I — Subcompact, std. chassis, small power plant, impr. suspension, 4 HD tires, driver, 2 linked MGs front. Armor: F5, R3, L3, B5, T1, U1. Acceleration 5, HC 2; 2,300 lbs., \$4,748.

Iguana II — As above, but replace the MGs with an RR; add a targeting computer. Armor: F7, R5, L5, B7, T2, U2. \$4,658.

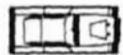

Scorcher & Slammer

In 2032, Mitsui's designers gambled that American drivers would buy a FT-armed vehicle without a fire-extinguisher system. They were right; thousands of Scorchers are on the road today, and their safety record is fairly good. The fireproof armor and heavy rear protection helps considerably. In the true kamikaze spirit, the Scorcher also features a ram plate in lieu of any front-mounted weaponry. When dealing with this model, stay to the sides if possible, in front if you must — but don't hang behind, and *don't* let it hit you.



Almost identical in body style is the newer Mitsui Slammer, distinguishable by the heavier ram plate in front and the multiple rocket-ports to the rear. One of the more formidable compacts on the road today, the Slammer is best fought from the sides or rear — or else left alone.

Scorcher — Compact, x-hvy. chassis, med. power plant, hvy. suspension, 4 solid tires, driver, 2 linked FTs back (often moved to other positions by customizers). Fireproof armor: F30 (with ram plate), R15, L15, B30, T10, U10. Acceleration 5, HC 3; 4,200 lbs., \$9,980.

Slammer — as above, but replace FTs with a front-mounted MG and 9 MNRs to rear. Fireproof armor: F50 (with ram plate), R30, L30, B45, T25, U23. 4,198 lbs., \$13,578.

Slugger

Considering its tremendous armor weight, the Excalibur Slugger is surprisingly inexpensive. A Slugger duellist must pick his combat spots wisely . . . but when the time comes, he can throw everything but the kitchen sink at a foe. When dealing with the Slugger, remember that once the rockets are fired, there's nothing left (except on a custom model).



Slugger — Compact, x-hvy. chassis, med. power plant, hvy. suspension, 4 PR tires, driver, 2 linked HRs front, 2 linked HRs back, targeting computer. Armor: F50, R40, L40, B40, T40, U30. Acceleration 5, HC 3; 4,190 lbs., \$8,220.

Mini-rocket option — Replace HRs with MNRs (6 front, 6 back). Add 28 points of armor as desired. 4,198 lbs., \$8,284.

Rocket pod option — Replace one pair of HRs with a MFR pod; add 10 points of armor as desired. 4,200 lbs., \$8,350.

Swordfish

Atlantic Industries' Swordfish is one of the most formidable compacts available today. On the road or in the arena, it has repeatedly proven itself able to take on bigger opponents and win. In combat, use smoke or paint to baffle its laser, and treat with great caution.



Swordfish — Compact, x-hvy. chassis, large power plant, heavy suspension, 4 solid tires, turreted laser, targeting computer, fire extinguisher. Armor: F30, R25, L25, B25, T30, U21. Acceleration 5, HC 3; 4,436 lbs., \$18,228. Many buyers choose to upgrade to a universal turret, adding \$1,000 to the price.

Yellowjacket



When the Laser Factory announced that it would produce a Division 10 duelling vehicle — and a subcompact at that! — incorporating an \$8,000 laser, the duelling community was skeptical. As finally released in 2033, the Yellowjacket is a triumph of design; not a dollar or an ounce is wasted. Its light armor (with *none* top or bottom) mean the "YJ" driver must win quickly or die. But the potent zapgun and the YJ's good handling command respect — enough so, in fact, that this model is often seen outside the arena. A single good shot anywhere will take it out of action, but a foe who fails to get that shot in *quickly* may not live to rectify the error.



Early this year, the Laser Factory licensed the Yellowjacket body design to Ital Works, who used it for the Division 5 "Bee." The two models are indistinguishable from a distance . . . protective coloration at work! When in doubt, play safe and assume it's a Yellowjacket.

Yellowjacket — Subcompact, hvy. chassis, small power plant, hvy. suspension, 4 HD tires, laser front. Armor: F5, R4, L4, B5, T0, U0. Acceleration 5, HC 3; 2,400 lbs., \$9,998.

Bee — As above, but replace laser with MG and add roll cage. \$4,498.

Thresher



The Atlantic Industries Thresher is one of the most common vehicles on the road today, and certainly the cheapest stock combat model. If its armor or weaponry were any lighter, it would never be seen outside the arena. Its handling is poor, and its top speed only 80 mph. The Thresher's life expectancy is short, and most Thresher drivers die young or graduate to a heavier vehicle. The ones that survive do so by beating cars they shouldn't — so be warned! The Six-Shooter option can give an opponent a nasty surprise, but once expended, it leaves the car defenseless. The standard version is probably the better buy.



Thresher — Subcompact, std. chassis, small power plant, lt. suspension, 4 std. tires, driver, RL front. Armor: F12, R10, L10, B8, T8, U8. Acceleration 5, HC 1; 2,300 lbs., \$2,966.

Six-Shooter option — Replace RL with MFR. 2,200 lbs., \$2,066.

X-10



The original X-10 model by Jontue Motors won quick notoriety among Division 10 duellists, due to its incorporation of the Vulcan MG. But, like most other subs, it is simply too lightly armored for highway safety. The X-10A abandoned the Vulcan in favor of heavier armor and a rear-mounted paint spray, achieving a more popular (and more survivable) balance at the cost of some offensive capability.



X-10 — Subcompact, hvy. chassis, small power plant, hvy. suspension, 4 PR tires, driver, VMG front, hi-res computer. Armor: F8, R3, L3, B6, T0, U0. Acceleration 5, HC 3; 2,400 lbs., \$9,120.

X-10A — Replace VMG with MG front and PS rear. Armor: F15, R10, L10, B12, T4, U4. Costs \$8,955.

Rattler

As subcompacts go, the Rattler is very dangerous, combining accurate weaponry and good acceleration with a respectable amount of armor. It's still not often found on the open road, but is not to be taken lightly.

Rattler — Subcompact, x-hvy. chassis, med. power plant, hvy. suspension, 4 solid tires, driver, MG front, hi-res computer. Armor: F20, R15, L15, B15, T10, U7. Acceleration 10, HC 3; 2,760 lbs., \$10,452.



Max II

A solid, though small, vehicle. Nearly 20% of all compacts on the road in North America are Max IIs, or a licensed variant of this winning Kane Motors design. The front armor is surprisingly light, and many buyers choose to beef it up, but the standard Max tactic remains "get in front, and chew them up."

Max II — Compact, std. chassis, med. power plant, hvy. suspension, 4 PR tires, driver, 2 linked MGs in turret, MD rear. Armor: F15, R15, L15, B18, T18, U10. Acceleration 5, HC 3; 3,696 lbs., \$9,533.

Max III — As above, but replace MGs with RR and add 9 points of armor. 3700 lbs., \$8,450.



Mako

Less expensive and less formidable, but still packing a nasty punch, is the Atlantic Mako. Available with either RR or VMG, it is one of the few two-seater compacts available. However, there is no second weapon in the Mako.

Mako RR — Compact, hvy. chassis, med. power plant, hvy. suspension, 4 solid tires, driver, gunner, turreted RR, hi-res computer. Armor: F25, R25, L25, B25, T30, U23. Acceleration 5, HC 3; 4,068 lbs., \$13,539.

Mako V — As above, but with VMG instead of RR. Armor F25, R20, L20, B25, T25, U21. 4,066 lbs., \$14,168.



DT/DT Extra

That old standby, linked MGs, makes Indra's compact entry dangerous from the front: a MFR rocket pack provides a lethal one-shot punch to the rear. The sides are unarmed but heavily armored. The "Extra" option lets duellists trade the rocket pack and some armor for the offensive staying power of another pair of MGs. Body style on the two models is identical.

DT — Compact, x-hvy. chassis, med. power plant, hvy. suspension, 4 PR tires, driver, 2 linked MGs front, MFR back, targeting computer. Armor: F40, R35, L35, B40, T20, U13. Acceleration 5, HC 3; 4,198 lbs., \$11,579.

DT Extra — As above, but with 2 linked rear-firing MGs in place of the MFR. Armor: F28, R23, L23, B28, T22, U17. 4,196 lbs., \$13,633.



Mid-sized

Q-Mid

"Q-ship" vehicles are not uncommon among trucks and vans — but the Amex Q-Mid packs a big surprise attack in a mid-sized body. It's a favorite of undercover police forces, highway sucker-punch looters, and drivers who just don't like to show all their cards. Handle with care. The fireproof version is absolutely indistinguishable from the standard model until you are close enough to read the nameplate.

Q-Mid — Mid-size, x-hvy. chassis, large power plant, hvy. suspension, 4 solid tires, driver, MG front, laser in universal pop-up turret, hi-res computer, fire extinguisher. Armor: F45, R30, L30, B40, T30, U25. Acceleration 5, HC 3; 5,750 lbs., \$26,600.

Fireproof version — upgrade to FP armor, add LD radio. \$30,400. With the radio removed, the fireproof Q-Mid qualifies for Division 30 duels.



Courier

The flagship of the Courier Services line, this is one of the most popular vehicles for transporting passengers or cargo through dangerous areas. Armor has been sacrificed for good acceleration. The three standard versions all look similar, but if the car in question is a one-seater, it's the Courier II, with very light bottom armor and an additional front-mounted RL. The Courier III has no cargo area, but can carry a passenger in the gunner's seat.

Courier — Mid-size, hvy. chassis, super power plant, hvy. suspension, 4 PR tires, driver, gunner, turreted laser, hi-res computer (usually in gunner position). Cargo capacity: 300 lbs. w/o losing acceleration; 1 space. Armor: F20, R20, L20, B20, T25, U20. Acceleration 10, HC 3; 4,900 lbs., \$21,100.

Courier II — As above, but with no gunner position. Add front-mounted RL. Armor: F20, R18, L18, B18, T25, U13. 4,896 lbs.; \$22,242.

Courier III — As the basic Courier, but with cyberlink instead of hi-res computer, and two ejection seats. No cargo capacity. 5,200 lbs., \$34,100.



Pisces

Another entry in the Mystic Motors "Zodiac" line, the Pisces is a solid Division 10 duelling vehicle with fair firepower. Over the last two years it has fallen into disfavor for road use because of its relatively light armor. Thus, Pisces introduced two modifications. The Pisces "V" is a Division 10 car mounting a Vulcan — easily identified from the front, but not from any other angle — and more armor than the standard model's. The Pisces "H," visually indistinguishable from the original model, is simply a Pisces with as much armor as the chassis will carry, for drivers unconcerned with cost limitations.

Pisces — Mid-size, std. chassis, large power plant, hvy. suspension, 4 PR tires, driver, 2 linked MGs front, 2 linked HRs back, HR right, HR left. Armor: F20, R18, L18, B20, T18, U18. Acceleration 5, HC 3; 4,546 lbs., \$9,992.

Pisces "V" — as for standard model, but replace front MGs with VMG. Armor F25, R22, L22, B25, T20, U20. 4,772 lbs. \$9,994.

Pisces "H" — as for standard model, but armored F30, R23, L23, B30, T18, U19. 4,794 lbs., \$10,488.



Sizzler

When Bill Hickman showed up at the Division 5 National Championships in 2033 in a garishly-painted mid-size, a lot of people laughed. But "Wild Bill's Wallet Beater" swept the field. The design, renamed the Sizzler, is now in production by Amex. It's becoming a popular first car. Its size and weaponry make it look more formidable than it is; the Sizzler's light armor, poor handling, and low top speed make it little more than an overblown compact, and it's not a car for sustained combat. Still, the Sizzler's weapons, in either model, can't be shrugged off in a quick close-up match.

Sizzler — Mid-size, lt. chassis, med. power plant, lt. suspension, 4 HD tires, FT right, FT left, SD rear. Armor: F15, R12, L12, B14, T6, U5. Acceleration 5, HC 1; 4,197 lbs., \$4,704.

Sizzler HR — As above, but replace SD with HR front, and upgrade tires to PR. Armor: F14, R8, L8, B14, T6, U6. 4,198 lbs.; \$4,876.



Iron Horse

One of the most common Division 15 mid-sized cars on the AADA circuit, the Iron Horse is aptly named. Crane Industries has put lots of armor on this model, as well as good firepower. This is another model with no real weak spot, aside from the rear quarter on the MFR option after the rockets are fired.

Iron Horse — Mid-size, x-hvy. chassis, large power plant, hvy. suspension, 4 PR tires, driver, RR front, MG left, MG right, MD rear. Armor: F45, R40, L40, B40, T40, U40. Acceleration 5, HC 3; 5,760 lbs., \$14,670.

MFR option — Replace MD with MFR, add 6 pts. armor to back. 5,758 lbs., \$14,216.



Banzai series

One of the most expensive mid-sizes on the road today, the Mitsui Motors Banzai is also one of the most dangerous. The Banzai is capable of taking out many opponents with a single shot, but its Achilles' heel is the lightly-armed rear quarter. The better-equipped Special shares the same weakness. Even the Deluxe has only a MG to cover the rear. The Banzai must turn to face its foe, or die.

Banzai — Mid-size, x-hvy. chassis, large power plant, hvy. suspension, 4 solid tires, driver, 2 linked lasers front, HR rear, fire extinguisher. Armor: F45, R30, L30, B40, T30, U20. Acceleration 5, HC 3; 5,760 lbs., \$25,770.

Banzai Special — As above, but with fireproof armor and cyberlink. Remove fire extinguisher. 5,710 lbs., \$44,590.

Banzai Deluxe — As Special, but replace HR with MG. Armor: F45, R29, L29, B40, T25, U20. 5,754 lbs., \$45,666.



Defender

The Lymestwold Defender may be the ultimate in small defense-oriented vehicles. But the best defense is a good offense, and a challenger trying to wear down the Defender may find himself worn down first, especially if he attacks from behind, where the mines can take their toll.

Defender — Mid-size, x-hvy. chassis, lg. power plant, hvy. suspension, 4 solid tires, driver, fire extinguisher, turreted RR with extra magazine, MD rear, targeting computer. Armor: F40, R35, L35, B40, T35, U25, 4 10-point wheelguards. Acceleration 5, HC 2; 5,755 lbs., \$15,910.

Defender Supreme — As above, but with PR radials instead of solids; roll cage; ejection seat; no fire extinguisher. HC 3. Fireproof armor: F35, R30, L30, B31, T35, U25. 5,753 lbs.; \$19,702.



Joseph Special

One of the earliest factory-ready duelling vehicles, the Joseph Special was first introduced in 2029, to great fanfare, and remains a solid seller. Many original models are on the road today, with plenty of victories to their credit. However, the Joseph's sides are a weak point; they are underarmored by current standards.

Joseph Special — Mid-size, std. chassis, large power plant, impr. suspension, 4 PR tires, AT front, RL rear, PS right. Armor: F30, R15, L15, B25, T15, U15. Acceleration 5, HC 2; 4,795 lbs., \$10,340.

Joseph Special "T" — Replace AT, RL, and PS with 2 linked MGs in turret. Add 3 HRs (usually 1 front, 2 back). Armor: F30, R15, L15, B25, T30, U16. 4,798 lbs., \$11,246.



Flamberge

Rothschild's Flamberge is one of the most successful mid-sized vehicles on the road today. Good armor weight and a classic weapon combination make it a common choice. The "luxury" turreted version has proven to be a better seller than the basic model for highway use. However, the basic version is seen more often in the arena; it's a strong Division 15 competitor, while the turreted model is overmatched in Division 20. The Flamberge has no weak spots worth the mention; in a combat situation, you'll have to outgun it or outrun it.

Flamberge — Mid-size, x-hvy. chassis, large power plant, hvy. suspension, 4 solid tires, driver, gunner, 2 linked MGs to rear, RR front. Armor: F50, R36, L36, B40, T45, U30. Acceleration 5, HC 3; 5,746 lbs., \$14,792.

Turreted model — Move the two MGs to a turret. Armor: F40, R35, L35, B35, T40, U28. 5,754 lbs., \$15,908.



Hammer

The Hudson Hammer is one of the best-armed mid-sized vehicles ever to come out of Detroit — or anywhere else. When dealing with the standard Hammer, combatants should avoid the front field of fire; the turreted Vulcan is dangerous enough by itself. For the 2034 model year, a minedropper version is available; the body style is the same, but the distinctive weapon ports make the two types easily distinguished from front or back.

Hammer — Mid-size, x-hvy. chassis, lg. power plant, hvy. suspension, 4 solid tires, turreted VMG, 2 linked RRs in front. Armor: F35, R30, L30, B30, T30, U27. Acceleration 5, HC 3; 5,756 lbs., \$16,962.

Minedropper version — replace RRs with linked MDs to rear. Armor: F45, R35, L35, B40, T35, U30. 5,760 lbs., \$15,870.



Scrambler

Indra Motors' Scrambler depends exclusively on that old standby, the machine-gun; it has six of them. The only "dead spot" in its field of fire is straight overhead. The minedropper version sacrifices rear firepower for extra armor and deterrent capability.

Scrambler — Mid-size, x-hvy. chassis, lg. power plant, hvy. suspension, 4 solid tires, driver, 2 linked MGs front, 2 linked MGs rear, MG right, MG left. Armor: F40, R30, L30, B40, T30, U30. Acceleration 5, HC 3; 5,750 lbs., \$18,400.

Minedropper option — Replace two rear MGs with an MD. Armor F46, R35, L35, B50, T30, U30. 5,758 lbs., \$16,766.



Luxury

Hotshot

One of the earliest duelling designs in mass production, the Hotshot remains a standard combat vehicle. Stock Hotshots won the Division 15 World Championships the first two years that competition was held. Armor — especially side armor — is very light on the basic Hotshot; the MD option has better armor.

Hotshot — Luxury, x-hvy. chassis, super power plant, hvy. suspension, 4 PR tires, driver, 2 linked MGs front, 2 linked FTs back, one FT right, one FT left, fire extinguisher. Armor: F20, R10, L10, B20, T10, U10. Acceleration 5, HC 3; 6,600 lbs., \$14,600.

Minedropper option — Replace one rear FT with MD. Armor: F25, R20, L20, B25, T10, U10. \$15,400.

Machine-gun custom job (not a factory option, but extremely common on Hotshots intended for highway use) — replace one or more FTs with MGs. Add 30 pts. armor and \$1,350 for each changeout.



Bombardier

Tate Manufacturing's first release, the "Bomb" combined a powerful frontal attack with high acceleration and maneuverability. Modern disenchantment with the AT gun as a weapon system, combined with the basic Bombardier's lack of dropped or rear weapons, led to the release of several variant models.

Bombardier — Luxury, std. chassis, super power plant, hvy. suspension, 4 PR tires, driver, gunner, AT front, fire extinguisher. Armor F20, R15, L15, B20, T10, U15. Acceleration 10, HC 3; 5,200 lbs., \$10,500.

Bombardier II — Replace AT with two linked MFRs front and turreted MG. 5,150 lbs., \$11,450.

Bombardier III — As basic Bombardier, but replace AT with turreted laser. \$17,500.

Bombardier IV — As basic Bombardier, but replace AT with 2 MGS (one front, one back) and add roll cage. \$12,000.



Superflash

Another heavily-gunned but lightly-armored entry. "Madman" Pirelli used a stock Kane FP Superflash in his bloody but unsuccessful bid for the North American Unlimited Class Championship in 2032. Pirelli counted on his firepower to take out opponents before they could get to him, but this failed in the finals. The Callahan brothers, in a lighter-armed but more heavily-armored vehicle, eliminated Pirelli using tactics that can be applied against a Superflash, Dragon, or other overgunned car: give the big guns no more than one shot at each side of your car, try to concentrate your own fire on a single point, and hope your armor outlasts his!

Superflash — *Luxury, x-hvy. chassis, super power plant, hvy. suspension, 4 solid tires, driver, gunner, turreted laser, 2 linked lasers front, fire ext., 2 hi-res computers.* Armor: F25, R20, L20, B25, T20, U15. Acceleration 5, HC 3; 6,600 lbs., \$44,150.

FP Superflash — *Add FP armor, 2 cyberlinks; remove hi-res computers.* Armor: F20, R15, L15, B20, T20, U15. \$69,850.



Applause

Often seen on eastern roads, the Ital Works Applause is a low-budget vehicle for the family that duels together. It suffers from very light armor (even the wheelguards, where provided, are only good against small-arms fire) and the lack of a gunner position, but can put up a fight in a road duel — especially if the passengers have plenty of grenades to drop.

Applause — *Luxury, std. chassis, large power plant, impr. suspension, 4 PR tires, driver, 4 passengers, 2 MGs (front and back), SD back, HR front, fire extinguisher.* Cargo: 525 lbs., 3 spaces. Armor: 10 in all positions. Acceleration 5, HC 2; 4,975 lbs., \$9,400.

Wheelguard option — *Add 4 1-point wheelguards and roll cage.* HC 1. Cargo capacity: 209 lbs., 2 spaces. 5,291 lbs., \$10,440.

RL option — *As basic Applause, but replace HR and MG with front-mounted RL.* Cargo capacity: 575 lbs., 3 spaces. \$9,050.



Hussar

The Lymestwold Hussar is an inexpensive passenger/courier vehicle for fairly hazardous roads. It combines versatile firepower with fairly strong armor. Vulnerable spots are the tires and turret.

Hussar — *Luxury, hvy. chassis, large power plant, lt. suspension, 4 PR tires, driver, gunner, 2 passengers, 2 linked MGs in turret, 6 HRs (2 linked F, 2 linked B, one R, one L).* Armor: F30, R20, L20, B25, U15, T20. Acceleration 5, HC 1; 6,000 lbs., \$12,450.

Hussar MFR — *Replace front and back HRs with MFRs.* 5,900 lbs.

Hussar RL — *As basic Hussar, but replace the 6 HRs with 2 linked RLs (F) and a single HR (rear).* \$14,100.

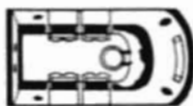

Spring Surprise

The Galleria Spring Surprise is a luxury Q-car — arguably the most dangerous surprise package on four wheels. Galleria has gone to great lengths to promote this vehicle, even to the extent of producing "custom kits" specifically designed to disguise the car. The basic version can be recognized from the rear by the vertical fin incorporating the paint spray and oil jet nozzles. The laser and MFR options lack even the fin, and disguised ones may only be recognized by general attention to body lines. The Spring Surprise has fair fire-power but poor acceleration; if you can't outfight it, you can try to outrun it.

Spring Surprise — Luxury, x-hvy. chassis, super power plant, hvy. suspension, 4 solid tires, RR in pop-up turret, PS and OJ back. Armor: F40, R35, L35, B35, T30, U25, 4 10-pt. retractable wheelguards. Acceleration 5, HC 2; 6,560 lbs., \$18,700.

Laser option — Replace PS, OJ, and RR with laser and fire extinguisher. Convert to FP armor: F35, R30, L30, B35, T30, U25. \$27,400.

MFR option — Replace OJ and PS with MFR. 6,560 lbs., \$18,000.



Tonto

One of the most effective escort vehicles on the market, the Nevada Systems Tonto has a very balanced weapons distribution for road combat. The ram plate version, for crashing roadblocks, is often encountered as a lead vehicle for small convoys. The Tonto's front armor is so heavy that, from the front, a tire shot is often the best choice.

Tonto — Luxury, x-hvy. chassis, super power plant, hvy. suspension, 4 solid tires, driver, gunner, RR front, MG back, 2 MDs linked (1 R, 1 L), fire extinguisher, 2 targeting computers, spare tire. Armor: F60, R25, L25, B35, T20, U25. Acceleration 5, HC 3; 6,575 lbs., \$19,800.

Ram Tonto — Reduce front armor to 40, add ram plate and LD radio. \$21,200.



Katana 2035

A little light on weaponry as large cars go, this new Mitsui offering features a ram plate and the mass to make collisions truly deadly. Its turreted RL and multiple flaming oil jets make a rear approach highly unwise; in a road duel, get well in front and stay there.

Katana 2035 — Luxury, x-hvy. chassis, large power plant, heavy suspension, 4 PR radials, driver, turreted RL, FOJ back, 2 HFOJ (R and L), fire ext., link for all three oil jets, LD radio, hi-res computer. Armor: F30 (ram plate), R25, L25, B30, T30, U20, four 10-pt. wheelguards. Acceleration 5; HC 3; 5,960 lbs., \$24,175.

Katana 2035-G — Replace 2 HFOJs with gunner and 2 linked MGs (rear). Armor: F30 (ram plate), R20, L20, B25, T25, U17. 6,000 lbs., \$22,815.

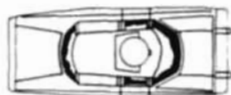

Moose

Adrienne Horowitz' oft-copied Division 25 design (in which she won the Canadian championship in 2031) can be seen today as a workhorse duelling and escort vehicle from Kane. The recently-introduced Vulcan version is especially tough. A weakness of Horowitz' original design, never corrected, is the light underbody armor.

Moose — *Luxury, x-hvy. chassis, super power plant, hvy. suspension, 4 solid tires, driver, 2 linked ATs front, 2 linked RLs back, fire ext., hi-res computer. Armor: F30, R20, L20, B25, U15, T10. Acceleration 5, HC 3; 6,600 lbs., \$22,300.*

Fireproof model — *Convert to FP armor. \$24,700.*

Vulcan model — *As standard Moose, but replace ATs with 2 linked VMGs. Armor: F40, R30, L30, B35, U20, T15. \$23,700.*



Doublecharge

This innovative vehicle is a 2034 introduction. Built by Freeway, the Doublecharge solves the limited-range problem by incorporating two full-sized power plants. What it gains in range, though, it loses in firepower. The laser option (distinguishable by the very flat turret style) is dangerous because of its effectively unlimited firepower, but the other versions are not for heavy combat.

Doublecharge — *Luxury, x-hvy. chassis, 2 super power plants, hvy. suspension, 4 solid tires, driver, 1 passenger, RR in turret, PS back, fire extinguisher. Armor: F30, R20, L20, B25, T15, U10. Acceleration 5, HC 3; 6,575 lbs., \$17,500.*

Fireproof option — *add FP armor, LD radio. \$20,500.*

Laser option — *As basic Doublecharge, but replace RR and passenger space with laser. \$23,650.*



Dragon

The Indra Motors Dragon is one of the most heavily armed four-wheelers on the road today. It is also one of the most expensive, and is rather rare. The lasers' huge drain on the power plant reduces range, and a hotheaded Dragon driver can find himself stranded after a prolonged duel. Dragon armor is also surprisingly light — *very* light on the King Dragon. In fact, the King Dragon's side armor cannot stand up to a single hit from its own weaponry . . .

Dragon — *Luxury, x-hvy chassis, super power plant, hvy. suspension, 4 solid tires, driver, gunner, 2 linked lasers front, laser back, fire extinguisher. Armor: F35, R25, L25, B30, T15, U15. Acceleration 5, HC 3; 6,600 lbs., \$35,050.*

King Dragon — *Replace all lasers with 2 linked HLs front. Add targeting computer. Armor: F25, R15, L15, B20, T10, U10.*

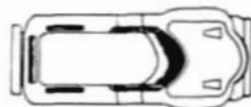

Naginata

As an escort vehicle or a duelling car, the Mitsui Naginata has become one of the more popular imports. Its weapons and armor are both well above average. The Naginata has no real weak points, but the rear quarter is less dangerous than the others. The "Flare" model, with heavy FOJ, has a rear-mounted spoiler/splashguard, but this is often removed; the "Spike" variant has a very visible ram plate. Oregon's Johanssen Transport Company, flying gold and green, uses the "Flare" almost exclusively, with an excellent success record.

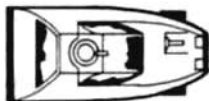

Naginata — Luxury, x-hvy. chassis, super power plant, hvy. suspension, 4 solid tires, driver, gunner, turreted RR, RR front, OJ back, SS back, fire extinguisher, 2 hires computers. Armor: F45, R30, L30, B30, T30, U25. Acceleration 5, HC 3; 6,600 lbs., \$25,950.

Naginata "Flare" — Replace OJ and SS with HFOJ. 6,590 lbs., \$27,050.

Naginata "Spike" — As basic Naginata, but replace front RR with space for two passengers. Armor: F34 (ram plate), R30, L30, B30, T30, U24. 6,600 lbs., \$24,880.

Piranha

This tried-and-true model from Atlantic Industries has the advantages of good weapon coverage and a nearly inexhaustible ammo supply. The only way to deal with the Piranha is to close the range and get the show over with . . . before you're nibbled to pieces.



Piranha — Luxury, hvy. chassis, large power plant, hvy. suspension, 4 PR tires, driver, gunner, RL front, 3 MGs, each with extra magazine (R, L, B), HR front, fire ext. Armor: F30, R25, L25, B30, T20, U20. Acceleration 5, HC 3; 5,995 lbs., \$16,200.

Commercial option — Remove one MG and magazine, HR, fire extinguisher; upgrade power plant to super. Armor: F25, R15, L15, B25, T10, U10. Cargo: 870 lbs., 3 spaces. Acceleration 10 w/less than 20 lbs. cargo, 5 otherwise. 5,180 lbs., \$13,650.

Bodyguard

Mitsui's Bodyguard is an extreme example of the "convoy rearguard" specialty vehicle. If caught without support, it is easily defeated. On the other hand, in its intended role, it is effective and almost unassailable.



Bodyguard — Luxury, hvy. chassis, large power plant, hvy. suspension, 4 solid tires, driver, 2 linked MDs (L and R), 3 linked OJs (L, R, and B), 2 linked PSs (L and R), "panic button" link for all weapons. Armor: F20, R45, L45, B50, T20, U20. Acceleration 5, HC 3; 5,925 lbs., \$15,400.

Bodyguard Shadrach — Convert to FP armor, replace OJs with FOJs. 5,440 lbs., \$21,425.

Bastogne

This Lymestwold model was nicknamed the "Bastion" as soon as it appeared, and for good reason; it's practically a four-wheeled pillbox. Heavy armor and a thorough assortment of defensive systems make the Bastogne one of the safest vehicles going. Naturally, offensive capability was sacrificed, but the Bastogne's light weaponry is accurate, and can often knock off a pursuer's front tire before the fleeing "Bastion" suffers serious damage. The heavy smoke feature makes this model nearly impregnable to laser assault.

Bastogne — *Luxury, x-hvy. chassis, super power plant, hvy. suspension, 4 PR radials, driver, gunner, MG front, MG back, HDSS back, 2 hi-res computers, fire extinguisher, anti-theft system. Fireproof armor: F50, R40, L40, B50, U25, T15, 4 10-pt. wheelguards. Acceleration 5, HC 3; 6,600 lbs., \$30,200 plus cost of AP grenades.*

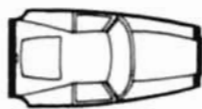

Darter

The Acme Darter is definitely a defensive vehicle. Despite the name, it features fairly heavy armor and has low acceleration. This car has no one weak point, but no really strong ones either. The XT model is distinguishable by its wheelguards; it is fireproof, but with much thinner armor.

Darter — *Luxury, x-hvy. chassis, super power plant, hvy. suspension, 4 solid tires, driver, gunner, 2 passengers, turreted RR, 3 linked SSs (L, R, and B), fire extinguisher. Armor: F38, R27, L27, B35, T35, U25. Acceleration 5, HC 3; 6,595 lbs., \$16,290.*

Darter XT — *As above, but add 2 ejection seats, anti-theft system, and 4 AP grenades. Fireproof armor: F30, R25, L25, B25, T25, U21, 4 10-pt. wheelguards. HC 2; \$20,990.*



Timeshifter

The Excalibur Timeshifter is a favorite escort vehicle because of its good handling and virtually limitless ammo supply. It is also popular as a taxi or courier vehicle for less settled areas. It is at its best in a running fight, but handicapped in a slugging match.

Timeshifter — *Luxury, x-hvy. chassis, super power plant, hvy. suspension, 4 solid tires, driver, gunner, 3 passengers, turreted VMG with extra magazine, 2 linked SDs (one L, one R), fire extinguisher. Armor: F30, R20, L20, B30, T30, U20. Acceleration 5, HC 3; 6,515 lbs., \$16,700.*

Timeshifter Photon — *Replace VMG with laser. 6,565 lbs., \$22,000.*

Timeshifter Photon Plus — *Add FP armor to the Photon. \$25,000.*



Shuriken

The least expensive luxury-sized vehicle ever to be mass produced, the Mitsui Shuriken was dumped in American markets from 2029 to 2032. As a combat vehicle, the Shuriken was a total failure; as a cargo or taxi vehicle for safe (i.e., non-combat) areas, many survive. The Shuriken is easily modified, and some upgunned examples are combat-worthy, but the poor handling and light armor are inescapable problems.

Shuriken — Luxury, light chassis, large power plant, light suspension, 4 HD tires, driver, MG front, fire ext. Armor: 10 pts. in all locations. Cargo: 10 spaces, 990 lbs. Acceleration 10 with up to 40 lbs. cargo, 5 with more. HC 1; 3,960 lbs., \$6,040.



Morningstar

Rothschild Auto Works immortalized the slogan "Combat in Comfort" with this model. Heavy armor, a turreted laser, and a heavy ram plate make the Morningstar a solid combat vehicle; two passenger spaces make it a good working car; the "Velvet Glove" luxury trimmings (at \$10,000) make it a prestige entry. Flashy though it may be, the Morningstar is not an easy target.

Morningstar — luxury, x-hvy. chassis, super power plant, hvy. suspension, 4 solid tires, driver, 2 passengers, turreted laser, MD rear, fire ext. hi-res computer. Armor: F40 (ram plate), R25, L25, B20, T30, U20. Acceleration 5, HC 3; 6,500 lbs., \$37,000.



Chameleon

The Linden Motors Chameleon is a popular Division 15 duel vehicle, and a practical highway car as well. Its weakest point is the lightly-armored turret; its strong point is the good overall performance at a very low price.

Chameleon — Luxury, hvy. chassis, large power plant, hvy. suspension, 4 solid tires, driver, gunner, RR front, turreted MG, 2 linked HRs front. Armor: F40, R35, L35, B40, U20, T10. Acceleration 5, HC 3; 6,000 lbs., \$14,800.

"Big Bang" option — Replace RR with AT. Armor: F35, R30, L30, B30, U15, T5. \$14,750.



Station Wagons

Conestoga

One of the most common vehicles on the road, the Conestoga is a choice for motorists who prefer deterrence to combat. It's no pushover — in 2032, a Magnum Long Hauler came off second-best to a stock Conestoga in a lane-changing dispute outside Dallas — but it lacks either long range or sustained fire capacity.

Conestoga — Station wagon, hvy. chassis, large power plant, impr. suspension, driver, gunner, 4 PR tires, 2 linked HRs front, 2 linked HRs back, MG front. Cargo capacity: 1,000 lbs., 7 spaces. Armor: F30, R25, L25, B20, U10, T10. Acceleration 5, HC 2; 5,000 lbs., \$9,600.

Conestoga Deluxe — Replace HRs with 1 MFR back, roll cage, fire ext. Cargo capacity: 800 lbs., 7 spaces. 5,200 lbs., \$10,450.

Conestoga GL — As basic Conestoga, but replace HRs with 2 GLs — one each front and back. Cargo capacity: 840 lbs., 7 spaces. 5,160 lbs., \$10,700 w/o grenades.

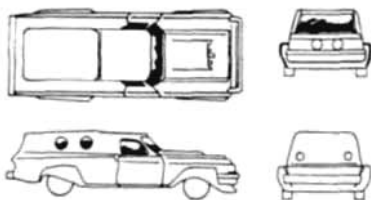

Decade

This well-protected working vehicle comes in two versions — one designed to carry passengers and one for cargo. Its weaponry is defensive/deterrent in nature. Not a choice for the driver looking for combat, but well able to take care of itself.

Decade — station wagon, x-hvy. chassis, large power plant, hvy. suspension, 4 PR radials, driver, 3 passengers, turreted recoilless rifle, smokescreen B, hi-res computer, sleeping area, fire ext. Cargo capacity: 125 lbs., 4 spaces. Armor: F30, B35, R20, L20, T20, U15, 4 10-pt. wheelguards. Acceleration 5, HC 3; 5,875 lbs., \$18,000.

Decade Delivery — As above, but upgrade power plant to super. No passengers or sleeping area. Cargo capacity: 975 lbs., 9 spaces. 5,625 lbs., \$19,000.

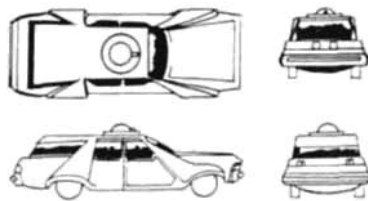

Rockwell

Kane's Rockwell is an inexpensive cargo-carrier with nominal armor and armament. Not found in hazardous areas, and usually escorted by more powerful vehicles even in safe zones.

Rockwell — Station wagon, x-hvy chassis, super power plant, impr. suspension, 4 PR tires, driver, gunner, MG front, PS back, fire ext. Armor: F15, R10, L10, B15, U15, T10. Cargo capacity: 2,025 lbs., 8 spaces. Acceleration 10 w/625 lbs. or less cargo, 5 w/more. HC 2; 4,575 lbs., \$10,150.

Spikedropper option — replace MG with 2 linked SDs (R and L). Cargo capacity 2,075 lbs., 7 spaces. \$9,300.



Vigilant

The Lymestwold Vigilant is a 2033 model, configured for convoy escort duty. It features good weaponry, excellent armor, and two rear sleeping areas. The expensive but effective "Nightfighter" option has the best electronics system currently available in a stock combat vehicle of any class. The "Vig" is already popular with convoy crews with a schedule to meet. The best defense against the Vigilant is not to start trouble; in a fight, the tires are more vulnerable than any quarter of the body.

Vigilant — Station wagon, x-hvy. chassis, super power plant, hvy. suspension, 4 solid tires, driver, 2 passengers (riding in sleeping areas), turreted laser, hi-res computer, 2 sleeping areas. Armor: F40, R30, L30, B40, U25, T60. Acceleration 5; HC 3; 6,600 lbs., \$25,800.

Vigilant Nightfighter — Remove laser and hi-res computer. Add turreted RGM system with extra magazine, cyberlink for turret, radar, infrared, LD radio, and MG front. Fireproof armor: F30, R20, L20, B30, U20, T53. 6,595 lbs., \$49,870.



Enduro & Eagle

In the quest for greater range on Western highways, Indra Motors created the Enduro station wagon. It combines significant cargo capacity with laser firepower. It is very vulnerable, however, to laser and FT attacks, having no fire extinguisher system. The Indra Eagle uses the same body but is more conventionally equipped and has greater cargo capacity.

Enduro — Station wagon, hvy. chassis, large power plant, hvy. suspension, 4 solid tires, driver, extra small plant in cargo space, turreted laser. Armor: F20, R20, L20, B20, T10, U10. Cargo capacity: 450 lbs., 5 spaces. Acceleration 5, HC 3; 5,550 lbs., \$18,900.

Eagle — As basic Enduro, but replace laser and extra power plant with turreted VMG w/extra magazine, MD with extra magazine. Cargo capacity: 820 lbs., 8 spaces. 5,180 lbs., \$14,900.



Pickups

King Crab

A diehard defender's battletruck, the King Crab looks inoffensive but is almost impossible to kill. Furthermore, the turreted MG with extra magazine gives light, but reliable, return firepower. The King Crab driver isn't likely to provoke an encounter — but records show he'll probably survive anything that develops. The less expensive "Hermit Crab" version has fewer gadgets but heavier armor, and is just as hard to take out.

King Crab — Pickup, x-hvy. chassis, super power plant, hvy. suspension, 6 PR radials, driver, turreted MG with extra magazine, ejection seat, fire extinguisher, roll cage, infrared, hi-res computer. Fireproof armor: F60, R50, L50, B50, U24, T40, 4 10-pt. wheelguards. Acceleration 5, HC 2; 7,799 lbs., \$33,556.

Hermit Crab — Remove wheelguards, ejection seat, roll cage, infrared; replace PR radials with solids; downgrade armor to regular. Armor: F65, R60, L60, B60, U33, T50. 7,790 lbs., \$22,750.

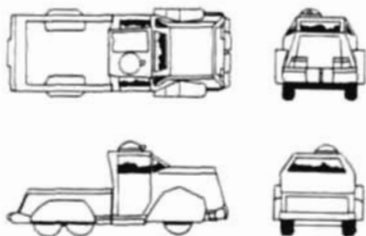

Micro

The Magnum Micro is almost the "generic" armed pickup, with its emphasis on deterrence and durability and its ability to haul better than half its own weight in cargo. The underbody and turret are both rather lightly armored, but the duellist model — driven by Danielle Adair, among others — uses that extra weight capacity for very heavy armor and has done consistently well in Division 30 competition. On the road, look for the wheelguards that distinguish the deadly Micro Duellist from its workhorse brother.

Micro — Pickup, x-hvy. chassis, super power plant, impr. suspension, 6 PR tires, driver, turreted RL, 3 HRs front. Cargo capacity: 2,300 lbs., 11 spaces. Armor: F20, R20, L20, B20, U10, T10. Acceleration 5, HC 2, 5,500 lbs., \$12,650.

Micro Duellist — Upgrade suspension to heavy and tires to PR radial. Add fire extinguisher and hi-res computer; remove one HR. No cargo capacity. Fireproof armor: F60, B60, R42, L42, T40, U40, 4 10-pt. wheelguards. 7,794 lbs., \$29,696.

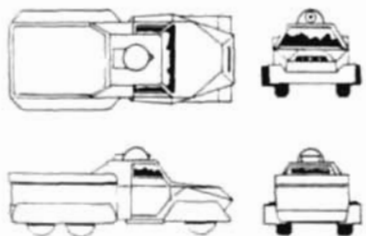

Galahad

This Acme entry is a straight duelling model, without cargo capacity; the pickup chassis' endurance is taken to the limit with heavy armor. The Galahad is a tough opponent; a possible tactic is to close the range, to minimize the laser's superiority, and go for the wheels.

Galahad — Pickup, x-hvy. chassis, super power plant, hvy. suspension, 6 solid tires, driver, turreted laser, fire ext., hi-res computer. Armor: F55, R50, L50, B50, U30, T50. Acceleration 5, HC 2; 7,785 lbs., \$29,320.

Galahad Grail — replace hi-res with cyberlink, make turret universal, change tires to PR radial, make armor fireproof. HC 3; 7,795 lbs., \$48,590.

Galahad Squire — As basic Galahad, but replace laser with RL, remove computer. Armor: F60, R55, L55, B60, U29, T50. 7,799 lbs., \$19,198.

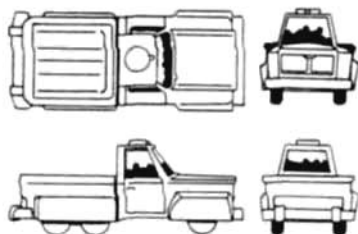

Texan

Almost as common as the Hauler is the Fnord Texan. The Texan avoids a turret, mounting the weapons within the body and armoring the sides better than those of most cargo-haulers. The underbody is especially well armored, but the rear quarter is fairly vulnerable unless the minedropper option has been chosen — look for the MD port to the right of center, just above the rear bumper.

Texan — pickup, hvy. chassis, super power plant, hvy. suspension, 4 solid tires, driver, gunner, 3 MGs (2 linked F, one B). Cargo capacity: 1,100 lbs., 11 spaces. Armor: F35, R25, L25, B30, T10, U25. Acceleration 5, HC 2, 6,050 lbs., \$15,550.

Minedropper option — As basic Texan, but replace one front and one back MG with a MD to the rear. Cargo capacity: 1,300 lbs., 11 spaces. 5,850 lbs., \$13,500.

Six-Shooter option — As basic Texan, but replace the two front MGs with MFR front. Cargo capacity: 1,350 lbs., 11 spaces. 5,800 lbs., \$12,950.

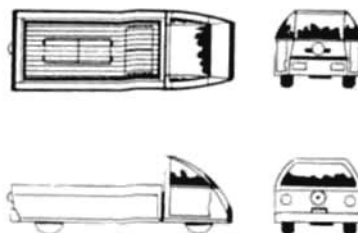

Vigilante

One of the first armed pickups to be commercially produced, the Vigilante — and its beefed-up Urban Cowboy option — are still popular in areas where cargo-hauling muscle and good firepower are both important. The Urban Cowboy version drew comment by adding a second weapon and taking away the gunner — but, with the front RR on automatic and the turret manually controlled, it can lay down withering fire.

Vigilante — Pickup, x-hvy. chassis, super power plant, hvy. suspension, 6 solid tires, driver, gunner, 2 linked MGs in turret, SS back. Cargo capacity: 2,075 lbs., 11 spaces. Armor: F15, R15, L15, B20, T20, U15. Acceleration 5, HC 2; 5,725 lbs., \$16,350.

Urban Cowboy option — Remove gunner and MGs; add 2 RRs (one F, one turreted) and SD back. Armor: F50, B50, R40, L40, T50, U45. 7,800 lbs., \$20,850.

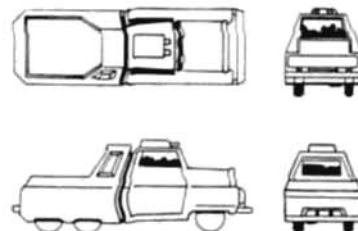

EconoBox

The Crane Industries EconoBox is the most lightly-equipped armed pickup available. It is a reliable cargo workhorse, rarely seen where combat is frequent. Its strong point is its surprisingly good acceleration.

EconoBox — Pickup, hvy. chassis, super power plant, hvy. suspension, 4 PR tires, driver, RL front, SD back. Cargo capacity: 2,395 lbs., 13 spaces. Armor: F20, R15, L15, B10, T10, U10. Acceleration 10 with up to 445 lbs. cargo, otherwise acceleration 5; HC 3; 4,755 lbs., \$9,910.

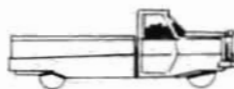

Fireball

The Conquistador Fireball is a favorite unlimited-class duel vehicle, but it is hampered in road duels by a lack of rear armament. An unusual design feature — the sides are the best-armored part of the vehicle. The only good way to handle an encounter with the Fireball is to stay on its tail and try for the tires.

Fireball — Pickup, x-hvy. chassis, super power plant, hvy. suspension, 6 solid tires, driver, 2 linked lasers front, fire ext. Armor: F40, R45, L45, B40, T40, U40. Acceleration 5, HC 2; 7,700 lbs., \$31,100.

Fireball Plus — Replace lasers with one HL front plus cyberlink. Convert armor to fireproof. 7,800 lbs., \$48,550.

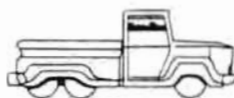

Virtuoso & Maestro

The Amex Virtuoso is a fairly well-balanced cargo mover for the part-time duellist or the rancher who lives in a rougher area. Its real weakness is its poor handling. Recent (2034) Virtuoso's are better protected and have a better suspension, but less armament (check for the MD ports to the rear). Sharing the same body style is the Maestro, a Division 20 duelling pickup. One sure way to tell the two apart is to check for cargo; the Maestro is so heavily armored that it can't carry any.

Virtuoso (pre-2034) — Pickup, hvy. chassis, super power plant, impr. suspension, 4 PR tires, driver, passenger, 2 linked MGs in turret, MD back, targeting computer. Cargo capacity: 1,330 lbs., 11 spaces. Armor: F30, R20, L20, B20, T20, U10. Acceleration 5, HC 1; 5,820 lbs., \$15,240.

Virtuoso (2034) — As above, but with heavy suspension. Replace MD with roll cage and fire ext. Cargo capacity: 1,080 lbs., 11 spaces. HC 2; 6,070 lbs., \$15,990.

Maestro — As pre-2034 Virtuoso, but upgrade to hvy. suspension and solid tires; add fire ext.; remove passenger capacity. Armor: F50, R35, L35, B40, T40, U31. Acceleration 5, HC 2; 7,141 lbs., \$19,632.



Combatant

This Excalibur model was designed as a Division 15 duelling vehicle. A Division 20 model, distinguishable by its ram plate, was released in mid-2033 and is now common both in Eastern arenas and on Eastern roads. The turreted RR on both versions, with its extra magazine, provides accurate, sustained firepower.

Combatant — Pickup, std. chassis, large power plant, hvy. suspension, 4 solid tires, driver, linked SDs (R and L), turreted RR with extra magazine, fire ext. Cargo capacity: 205 lbs., 11 spaces. Armor: F35, R20, L20, B20, T25, U10. Acceleration 5, HC 2; 5,795 lbs., \$13,810.

Combatant 20 — As above, but upgrade tires to PR radials and add targeting computer. Fireproof armor: F30 (ram plate), R18, L18, B25, T30, U15. HC 3; 5,977 lbs., \$19,958.

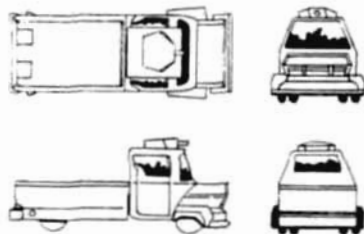

Cowboy Stretch

The Cowboy Stretch, a new introduction for 2034, is Acme's attempt at a long-range pickup. Along any really hazardous road, though, this lightly armed and armored vehicle might not last long enough to need the extra power plant. The turret is especially underarmored.

Cowboy Stretch — Pickup, std. chassis, 2 large power plants, hvy. suspension, 6 PR tires, driver, MG in turret. Cargo capacity: 640 lbs., 11 spaces. Armor: 10 in each position. Acceleration 5, HC 3; 5,360 lbs., \$11,370.

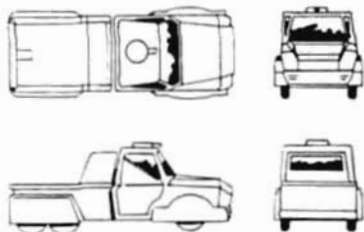

Hauler

Indra's standard Hauler pickup, with a body design little different from the pickup trucks of sixty years ago, can be encountered nearly everywhere on the continent. Woefully underarmed as a combat vehicle, it is an efficient load-mover for low-combat areas.

Hauler — Pickup, x-hvy. chassis, super power plant, hvy. suspension, 6 solid tires, driver, gunner, turreted MG, SD back, fire ext. Cargo capacity: 2,395 lbs., 11 spaces. Armor: F15, R15, L15, B15, U10, T10. Acceleration 5, HC 3 (drops to 2 with more than 95 lbs. cargo); 5,405 lbs., \$14,110.

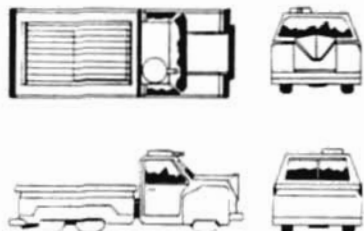

Vans

Because of their ample space and box-style construction, vans are the easiest vehicles to customize. There are a number of standard makes on the road — but, even more so than with other vehicles, don't be quick to judge capabilities by the exterior.

Vacationer

The Lymestwold Vacationer is a very common family vehicle. Underarmed and grossly underarmed by duellist standards, it can still be effective in combat. More than once, predatory cycle gangs have broken against convoys of Vacationers.

Vacationer — Van, std. chassis, large power plant, impr. suspension, 4 PR tires, driver, gunner, 2 linked MGs in turret, 2 linked HRs front, HR back. Cargo capacity: 720 lbs., 16 spaces. Armor: F20, R10, L10, B10, U10, T10. Acceleration 5, HC 1; 5,280 lbs., \$12,100.

Vacationer Supreme — Add fire extinguisher; upgrade armor to fireproof. Cargo capacity: 570 lbs., 15 spaces. 5,430 lbs., \$14,500.

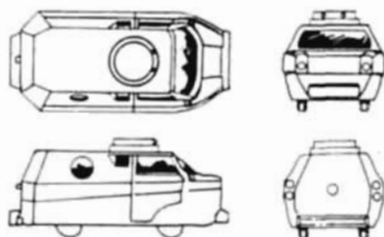

Firestarter

The AutoLigne Firestarter is the most costly stock van commonly seen on the roads. It carries little cargo, and is primarily useful as an escort for other vehicles. With all its firepower, its armor is still rather weak, especially on the sides and underbody. The long-range option, with no cargo capacity, is sometimes seen as an Unlimited Class duelling vehicle.

Firestarter — Van, x-hvy. chassis, super power plant, hvy. suspension, 6 solid tires, driver, MD back, HL in 3-space turret, hi-res computer, fire ext., sleeping area. Cargo capacity: 310 lbs., 14 spaces. Armor: F20, R15, L15, B20, T25, U15. Acceleration 5, HC 2; 6,890 lbs., \$32,700.

Long-range option — Add laser battery. No cargo capacity. Fireproof armor: F25, R15, L15, B25, T25, U20. 7,200 lbs., \$37,400.

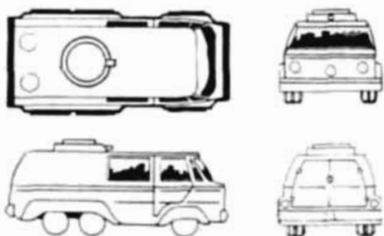

Hideaway

This Fnord Motors specialty is often chosen by the low-profile duellist or traveller, or by the professional traveller (i.e., Field Engineers) who won't look for a fight, but can't afford to run away. Weak points are the RR (when the turret is up) and the underbody.

Hideaway — Van, x-hvy. chassis, super power plant, hvy. suspension, 6 solid tires, driver, gunner, RR in pop-up turret, MG front, 2 linked SDs (one R, one L), fire ext. Cargo capacity: 390 lbs., 8 spaces. Armor: F20, R20, L20, B15, U10, T15, 4 10-pt. retractable wheelguards. Acceleration 5, HC 2 (1 with WG down); 6,810 lbs., \$20,800.

Hideaway Magnum — replace solids with PR radials, add 2 passenger seats and 2 targeting computers. HC 3; cargo capacity 180 lbs., 6 spaces. 7,020 lbs., \$22,800.

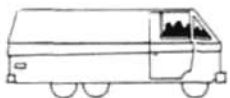
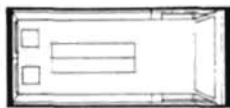

Raketen

The Excalibur Raketen has a reputation for toughness on the road, though it is rarely seen in the arena. It is better-armed than most vans; its primary weakness is its lack of an accurate long-range weapon. Those engaged with this vehicle will do best to keep their distance and look out for mines on the road.

Raketen — Van, x-hvy. chassis, super power plant, hvy. suspension, 6 solid tires, driver, gunner, 2 linked RLs front, one RL right, one RL left, one RL back, 2 linked MDs (one R, one L). Armor: F30, R20, L20, B20, T15, U15. Acceleration 5, HC 2; 7,180 lbs., \$22,050.

Raketen Nachtmacher — Replace one MD with HDSS; HDSS and MD are linked. Armor: F30, R20, L20, B20, T12, U15. 7,188 lbs., \$21,860.

Raketen Schon — Replace rear-firing RL with MFR. Armor: F30, R20, L20, B25, T18, U15. 7,192 lbs., \$21,390.

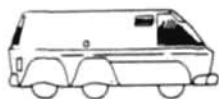

Vanguard

The Delta Automotive Vanguard is a common and well-equipped "Tail-End Charlie" convoy guard. Like most specialized rearguard models, it is vulnerable on its own — especially to frontal attacks and to mines. The turret is also lightly armored.

Vanguard — Van, x-hvy. chassis, super power plant, impr. suspension, 6 solid tires, driver, gunner, 2 passengers, 2 linked MDs (one R, one L), 2 linked OJs (one each R, L, and B), 2 linked PSs (one R, one L), and turreted RL. Armor: F15, R26, L26, B40, U12, T16. Acceleration 5, HC 1; 7,190 lbs., \$20,450.

Vanguard Hi-Tek — Remove OJs, MDs, one PS, and passenger spaces; add 2 linked HFOJs (one R, one L), 2 linked Spear 1000 MDs (one L, one R), and fire ext. Move PS to back. 7,193 lbs., \$23,660.



Slingshot

This rocket-tossing van from Kane is a common low-capacity cargo carrier, but is occasionally seen in Division 15 duels as well, where its fire-power sometimes makes up for the fact that it's a big target. Due to the low accuracy of the Slingshot's weapons, it is best engaged at medium to long range.

Slingshot — Van, x-hvy. chassis, super power plant, hvy. suspension, 6 PR tires, driver, gunner, RL front, 3 pairs linked HRs (R, L, and B), fire extinguisher. Cargo capacity 1,002 lbs., 11 spaces. Armor: F20, R20, L20, B20, T10, U17. Acceleration 5, HC 2; 6,198 lbs., \$14,010.

Slingshot II — Replace the 6 HRs with 10 MRs linked in pairs (2 right, 2 left, 1 back); replace PR tires with PR radials. Cargo capacity: 1,042 lbs., 7 spaces. HC 3; 6,158 lbs., \$16,110.

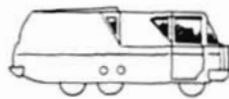

Torch

Fnrord's success with the Hotshot inspired the design for the Torch, a van mounting similar weaponry. It's more costly than the Hotshot and a bigger target, with slightly less weaponry and armor and little cargo capacity — but it does have a gunner position, which can make it a tough customer. However, side and underbody armor are very light.

Torch — Van, x-hvy. chassis, super power plant, hvy. suspension, 6 PR radial tires, driver, gunner, RL front, FT right, FT left, HDFT back, fire ext. Cargo capacity: 254 lbs., 10 spaces. Armor: F15, R15, L15, B15, T4, U10. Acceleration 5, HC 3; 6,946 lbs., \$16,720.

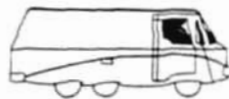
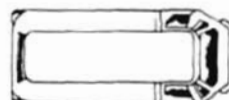

Security Six & Seven

Courier Services' van entries have remained popular — and effective — for years. The Six is a cargo carrier; the upgunned but more lightly armored Seven is usually used to carry a single paying "passenger" in the secondary gunner position. The Seven has a weak rear quarter, but getting close enough to take advantage is not easy.

Security Six — Van, x-hvy. chassis, super power plant, hvy. suspension, 6 solid tires, driver, gunner, turreted laser, SS and OJ back, fire ext., 2 hi-res computers. Cargo capacity: 600 lbs., 14 spaces. Armor: F20, R20, L20, B20, T25, U20. Acceleration 5, HC 2; 6,600 lbs., \$32,000.

Security Seven — As above, but add 2 linked RLs front, HR back, and a second gunner with hi-res computer. Cargo capacity: 7 spaces, 130 lbs. Armor: F18, R18, L18, B18, T20, U13. 7,070 lbs., \$38,350.



Buses

Although dozens of makes of buses and RVs are available, most of those on the road fall into a few popular types. Any bus — whether it's a public conveyance or a privately owned RV — has space and chassis to mount firepower heavier than that of any smaller vehicle. The first rule of engaging a bus is — don't. Should combat be unavoidable, keep in mind that no bus has good acceleration or maneuverability. They can't be out-shot, but they can be out-driven.

Aero Defender

HMF's only bus model, the Aero Defender is a special-purpose model designed to deal with bandit helicopters. Its phenomenally accurate weaponry has led to its use in a number of unorthodox situations. If engaged with this vehicle, the only feasible tactic is to close to short range to avoid the turret weapons, and aim for the wheels.

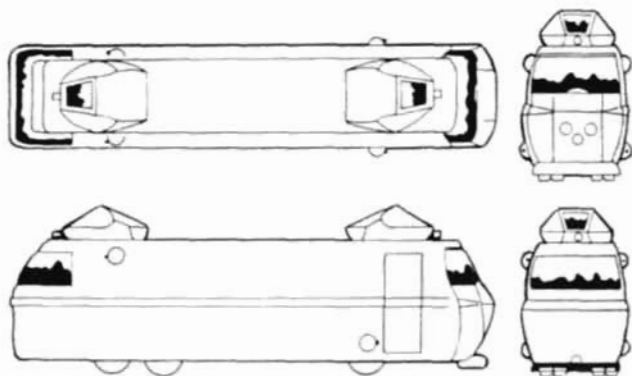

Aero Defender — 30' bus, x-hvy. chassis, regular truck power plant, 10 solid tires, driver, 3 gunners (2 in cupolas), 2 RRs (front and back), 4 MGs (RF, RB, LF, LB), 2 4-space universal cupolas, each with a laser, fire ext., 2 sleeping areas, 8-space crew lounge area. Cargo capacity: 500 lbs., 4 spaces. Armor: F40, RF30, RB30, LF30, LB30, B40, TF45, BF45, UF30, UB30. 18,700 lbs., \$91,250.

Aero Defender II — Replace one laser with RGM and extra magazine, add cyberlink. Cargo capacity: 285 lbs., 2 spaces. 18,915 lbs., \$108,300.

Aero Defender III — Replace lasers with VMGs, add cyberlinks for both cupolas, convert armor to FP. Cargo capacity: 400 lbs., 2 spaces. 18,800 lbs., \$124,900.

Loadmaster

Courier Services' one bus entry is a practical, no-frills model designed to get a load of cargo and a few passengers from one city to the next. Good electronics make up for the inherent inaccuracy of the twin rocket-launchers, and heavy rear defensive weapons discourages tailgaters.

Loadmaster — 30' bus, x-hvy. chassis, regular truck power plant, 10 solid tires, gunner, 4 passengers, MG front, 2 linked RLs TF, 2 linked MDs back, HDOJ (linked to MDs) back, 2 hires computers, fire extinguisher. Cargo capacity: 2,325 lbs., 12 spaces. Armor: F30, RF30, RB30, LF30, LB30, B30, TF40, TB20, UF30, UB30, 6 10-pt. wheelguards. 16,875 lbs., \$71,150.

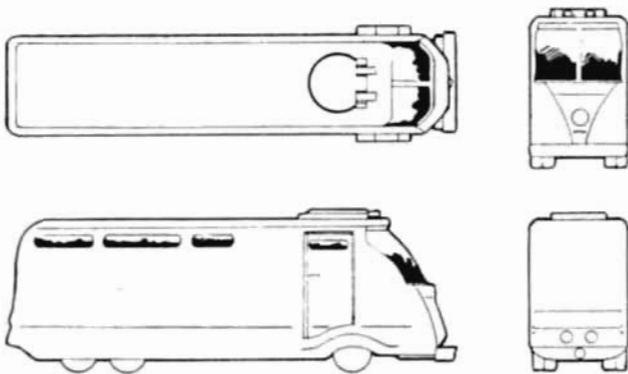

Scarab

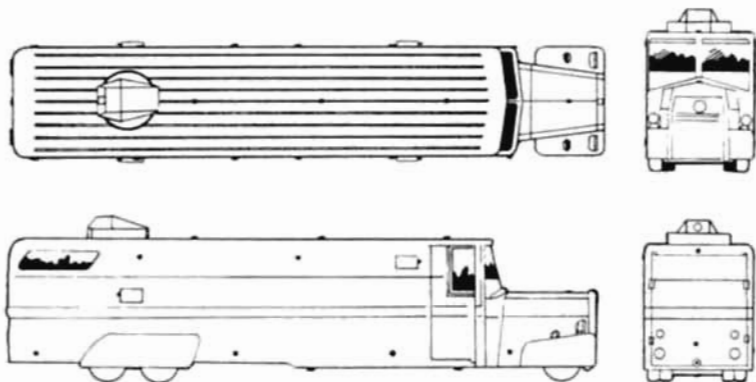

Few motorists have not seen one of these specialized units salvaging wreckage by the roadside. The Scarab is lightly armed for a bus — that is, it has only a little more firepower than the average luxury car. Many garages and salvage operations find the Scarab a practical way to bring wrecks in, since it can carry a complete portable shop plus a wreck up to luxury-car sized. Scarabs have also been used as "Trojan Horse" vehicles, carrying well-equipped non-wrecked cars or cycles.

Scarab — 40' bus, x-hvy. chassis, regular truck power plant, 10 solid tires, driver, 2 gunners, 5 MGs (RF, RB, LF, LB, B), turreted VMG top back, RL front, fire extinguisher, assault ramp, 22 AP flechette grenades. Cargo capacity: 8,820 lbs., 33 spaces. Armor: F30, 20 all other positions. 16,380 lbs., \$67,850.

Scarab FP — Add anti-theft system; upgrade armor to fireproof. \$77,260.

Slugfest

This new Foster model is already common, especially in areas with high cycle-gang activity. The design is intended to eliminate threats from pedestrian "flies" and following vehicles, and works very well.

Slugfest — 30' bus, x-hvy. chassis, regular truck power plant, 10 solid tires, driver, gunner, 10 passengers, turreted RRs front and back, HD smokescreen back, MD back, OJ back, link for all back weapons, fire ext., 2 hi-res computers, 18 AP flechette grenades. Armor: TF 45, TB 45, B40, all other positions 35, 6 10-pt. wheelguards. 19,190 lbs., \$72,075.

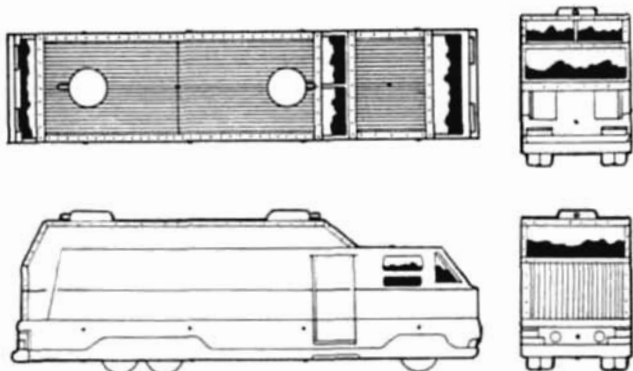

Boomer

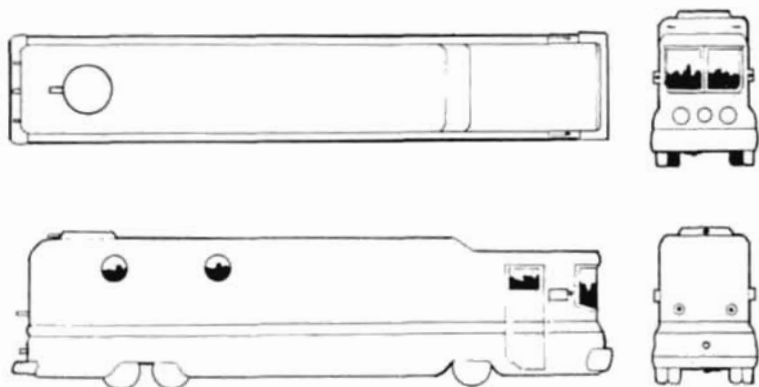

Production of the Boomer passenger bus dropped off rapidly last year when Fnord's supply of military surplus tank guns ran out . . . but this popular roadblock-buster is still one of the more common buses for dangerous areas, and the hastily-introduced Boomer B makes good use of linked antitank guns in place of the bigger weapon. The only possible weak point of either Boomer model is the exposed wheels. Under no circumstances should this vehicle ever be attacked from the front!

Boomer — 40' bus, std. chassis, regular truck power plant, 10 solid tires, driver, gunner, 13 passengers, TG w/extra magazine front, 5 MGs (RF, LF, 2 linked B, one turreted TB), HDOJ B, fire ext., spare tire, 2 computers. Armor: 40 in all positions. 23,100 lbs., \$80,300.

Boomer B — As above, but replace TG with twin AT guns, linked F, each with an extra magazine. 12 passengers. 22,915 lbs., \$74,400.

Pusher

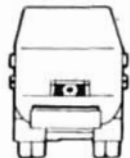
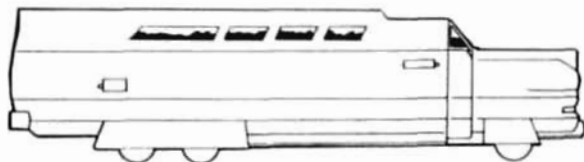

Another standard long-haul passenger bus, the Magnum Pusher has especially heavy front and side armor. The Pusher Hardshell, with ram plate, can plow through almost any obstacle.

Pusher — 40' bus, x-hvy. suspension, regular truck power plant, 10 solid tires, driver, gunner, 16 passengers, AT front, 2 linked HRs front, 4 MGs (RF, RB, LF, LB), RL back, fire ext. Armor: F90, RF60, RB60, LF60, LB60, B70, TF30, TB30, UF30, UB30, 6 10-pt. wheelguards. 25,200 lbs., \$76,000.

Pusher Hardshell — As above, but convert armor to fireproof; add ram plate and reduce front armor to 60. \$101,600.

Commando

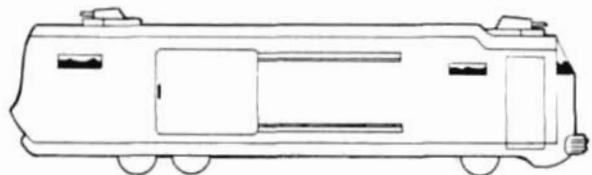

This Amex model follows a design pioneered by the Louisiana People's Militia; they are now in service across North America, with police forces and civilian defense groups. The Commando can carry up to 38 ground fighters into combat, albeit under very cramped conditions, and allow them virtually instant access to the outside. Its armor is very light.

Commando — 40' bus, hvy. chassis, regular truck power plant, 10 PR tires, driver, gunner, 38 passengers (with only 1 space each), RL front, 2 linked turreted RRs TF, 2 linked turreted RRs TB, fire ext., assault ramp, 2 side doors (LB, RB). Armor: F27, TF 25, TB 20, 15 in all other positions. 23,086 lbs., \$57,730.

Baron

The Rothschild Baron is the company's first foray into large-sized vehicles . . . a recreational vehicle for those who can afford both safety and comfort. It could be argued that the weapons systems reflect a desire to hold declass  opponents at arm's length; at any rate, the Baron's guns are both heavy and accurate. The "Velvet Glove" interior adds \$15,000 to the price.

Baron — 30' bus, x-hvy. chassis, regular truck power plant, 10 solid tires, driver, 2 gunners, 4 passengers, 2 WGMs linked in front turret, AT with extra magazine in back turret, 6 MGs (F, RF, RB, LF, LB, B), fire ext., 3 hi-res computers, 7-space lounge area. Cargo capacity: 175 lbs., 2 spaces. Armor: 35 in all positions. 19,025 lbs., \$104,250.

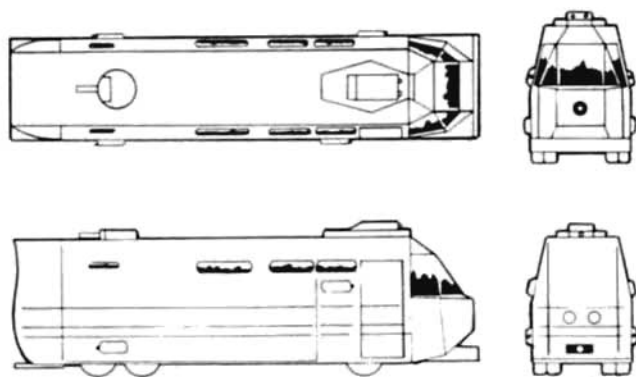

Busnought, Model E and F

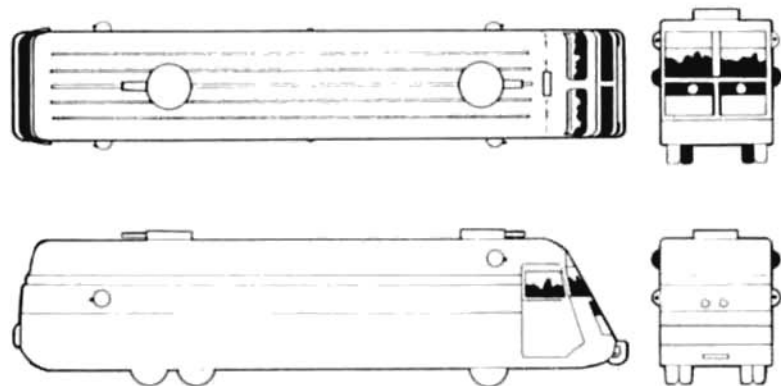

The Foster Model E Busnought was designed as a luxury vehicle, designed to carry a few high-paying passengers in comfort and safety. Its track record has been good, but in 2033 Foster discontinued it in favor of the Model F, incorporating fireproofing and point-defense features.

Model E Busnought — 40' bus, x-hvy. chassis, regular truck power plant, 10 solid tires, driver, 2 gunners, 7 passengers, 8 MGs (2 linked front, 2 linked back, one each RF, RB, LF, LB), MD back, AT in front turret, HL in back turret, 3 hi-res computers. Armor: 50 in each position, 6 10-pt. wheelguards. 25,190 lbs., \$112,700.

Model F Busnought — As above, but add fire extinguisher and 22 AP flechette grenades. Fireproof armor: UF46, UB 46, 50 in all other positions. 25,196 lbs., \$133,460.

Camel

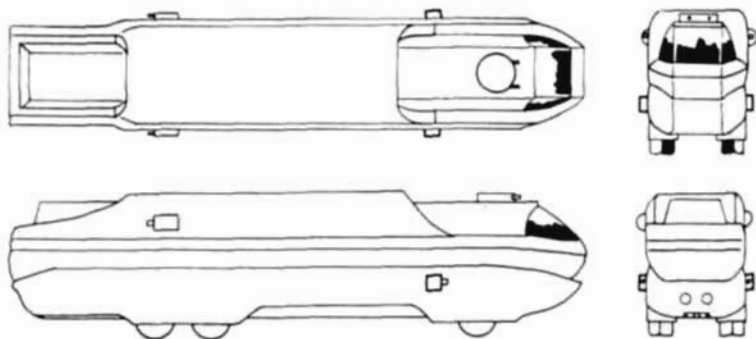

The Magnum Camel is especially popular with Western bus companies for its ability to travel 400 miles between charges. Like its namesake, it is almost self-sufficient.

Camel — 40' bus, x-hvy. chassis, 2 regular truck power plants, 10 solid tires, driver, gunner, 14 passengers, 2 linked RRs in front turret, 4 MGs (RF, RB, LF, LB), SD back, fire ext. Armor: F40, RF40, RB30, LF40, LB30, B50, TF50, TB30, UF30, UB30, 6 10-pt. wheelguards. 25,125 lbs., \$88,250.

Camel "Two-Humper" — As above, but mounting two turrets with one RR each. Add 2 computers. Carries 11 passengers. 24,925 lbs., \$89,700.

Molotov

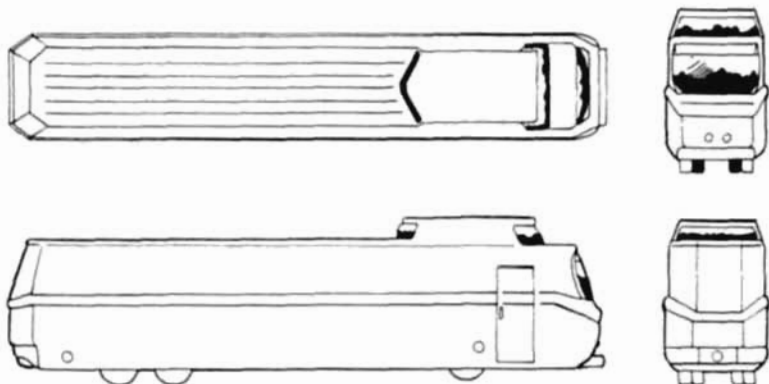

The Conquistador Molotov is a standard intercity bus — lightly armed, as such vehicles go, but still formidable. As originally manufactured, it used linked FTs, but a factory upgrade program has replaced most extant Molotovs' weaponry with the modern heavy-duty FT, saving weight and money.

Molotov — 40' bus, hvy. chassis, regular truck power plant, 10 PR tires, driver, gunner, 11 passengers, 5 linked HDFTs (RF, RB, LF, LB, B), 2 linked MGs front, fire ext. Cargo capacity: 1,090 lbs., 2 spaces. Armor: F40, RF30, RB30, LF30, LB30, B35, TF20, TB20, UF30, UB30. 22,010 lbs., \$55,400.

Tractors

Wolverine

Crane Technologies' Wolverine was one of the first true "battletrucks," and the design stands up well today. Although it mounts no heavy weapons except the one-shot rockets, the armor is solid and the electronics are good. Back armor is disproportionately heavy. The new Laser variant, using higher technology and bigger guns, is relatively untested but seems deadly.

Wolverine — Sleeper longnose, x-hvy. chassis, super truck power plant, 10 solid tires, driver, gunner, 3 MGs (F, R, L), rocket platform with 3 HRs, 2 computers, fire ext. Armor: F70, R50, L50, B40, T45, U45, 6 10-pt. wheelguards. 16,190 lbs., \$98,350.

Laser Wolverine — As above, but remove front MG, rockets, and rocket platform; add turreted HL. Upgrade computers to hi-res. Fireproof armor: F60, R45, L45, B30, T48, U35, 6 10-pt. wheelguards. 16,198 lbs., \$124,284.

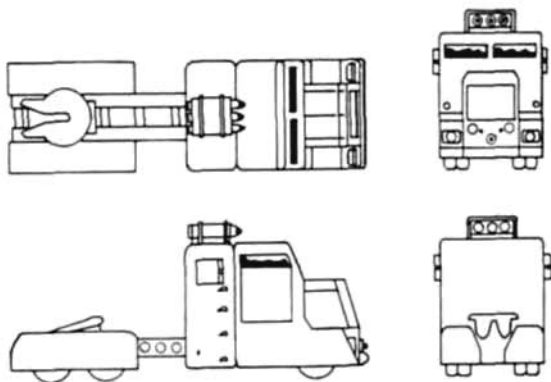

Economy

This is the bottom of Magnum's tractor line. If engaging an Economy, attack the very light rear armor if possible.

Economy — Standard cab-over, std. chassis, regular truck power plant, 10 PR tires, driver, gunner, RL front, rocket platform with 2 linked HRs, fire ext. Armor: F25, R20, L20, B5, T15, U15. 10,000 lbs., \$38,250.

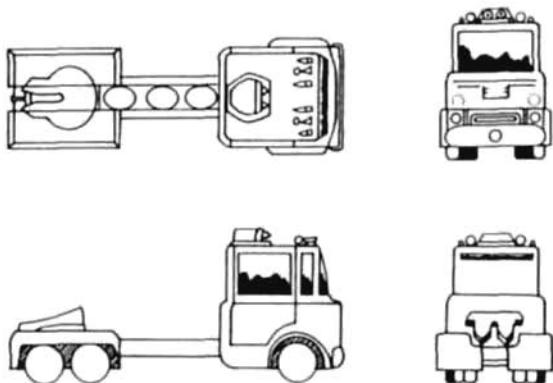

Colossus

Designed more to deal with pedestrian problems than with vehicle attacks, the Crane Colossus has no long-range heavy weapons but packs a nasty punch up close. Since its wheelguards are light, the tires are a possible weak point.

Colossus — Sleeper cab-over, x-hvy. chassis, large truck power plant, 10 solid tires, driver, gunner, turreted GL, 3

MGs (F, R, L), 10 AP flechette grenades, fire ext. Armor: F50, R50, L50, B40, U40, T33, 6 1-pt. wheelguards. 14,399 lbs., \$85,276.

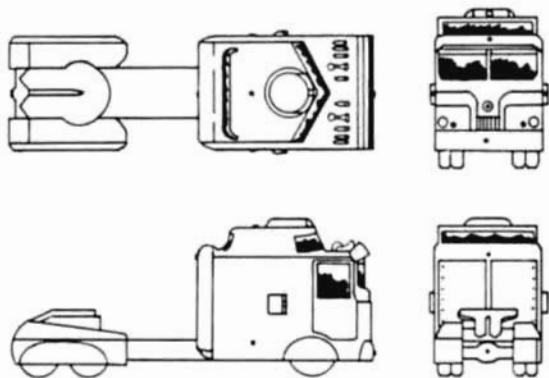

Bruiser

The heaviest tractor on Magnum's regular production line, the Bruiser has relatively light side firepower but a deadly punch to the front. There are no weak spots in the armor, and the electronics are excellent. A deadly vehicle.

Bruiser — Sleeper longnose, x-hvy. chassis, super truck power plant, 10 solid tires, driver, gunner, HL front, tur-

retted MG, LD radio, radar, 2 hi-res computers, sleeping compartment. Fireproof armor: F64, R50, L50, B40, T40, U50, 6 10-pt. wheelguards. 16,194 lbs., \$126,192.

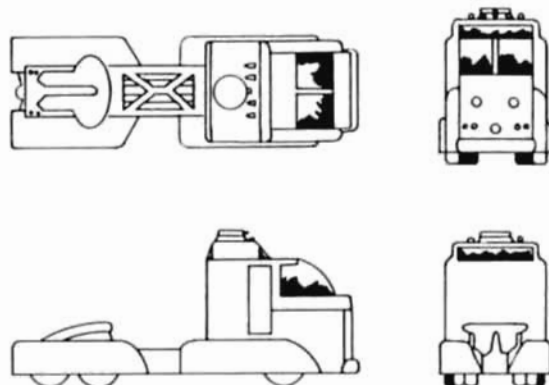

Long Hauler

An extra power plant gives the Long Hauler increased range, making it common on western roads. Driver fatigue and relatively light armor, especially underneath, are distinct drawbacks. Note the lack of side armament and the unusual design of the turret.

Long Hauler — Sleeper long-nose, hvy. chassis, 2 regular truck power plants, 10 solid

tires, driver, turreted RL, 2 linked MGs front, fire ext., computer. Armor: F30, R25, L25, B11, U20, T20. 14,846 lbs., \$86,654.

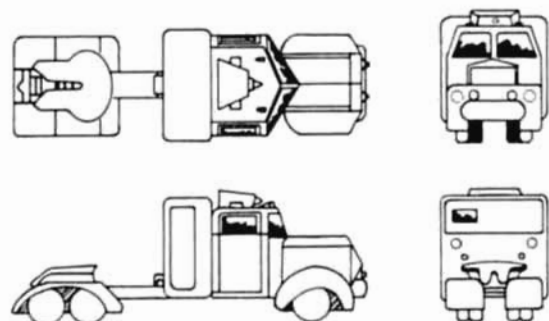

Barcelona

This Amex model features an extraordinarily heavy ram plate, and has sometimes been used, with or without a trailer, as a barricade crusher. Depending as it does on rockets, the Barcelona packs an incredible first punch but has little endurance . . . except for collisions. It can ram an opponent repeatedly if given the chance.

Barcelona — Standard longnose, x-hvy. chassis, large truck power plant, 10 solid tires, driver, gunner, 2 pairs linked HRs front, 3 HRs on rocket platform, fire ext. Armor: F90, R25, L25, B15, T10, U15. 13,200 lbs., \$74,400.

Bail-out option — Replace front HRs with 2 linked MFRs; replace platform HRs with 6 LR; add 2 ejection seats. 13,150 lbs., \$75,300.

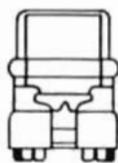
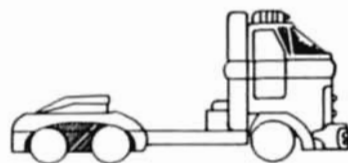
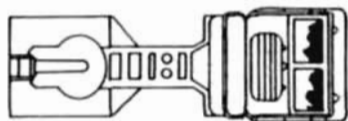

Maul

This heavy-duty design, from a company better known for its luxury vehicles, features devastating front firepower and solid armor; the "Spiked Maul" upgunned version is even deadlier. This is one to avoid confronting.

Maul — Sleeper longnose, x-hvy. chassis, large truck power plant, 10 solid tires, driver, gunner, 2 linked RRs front, turreted MG, RL right, RL left, fire ext., 2 hi-res computers. Armor: F70, R60, L60, B30, U30, T50, 6 10-pt. wheelguards. 16,140 lbs., \$103,050.

Spiked Maul — Remove RLs, and MG; add laser in universal turret, 2 laser batteries, and LD radio. 16,190 lbs., \$109,950.

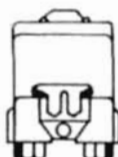
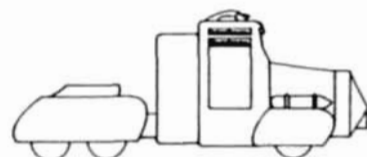

Trailers

Of the dozens of trailer types in use today, only a few are seen often enough to warrant inclusion in this Guide. The seven makes listed below are the only ones for which at least 1,000 examples are in use today. With van and reefer trailers, be very wary of possible customized weaponry.

Econoforce

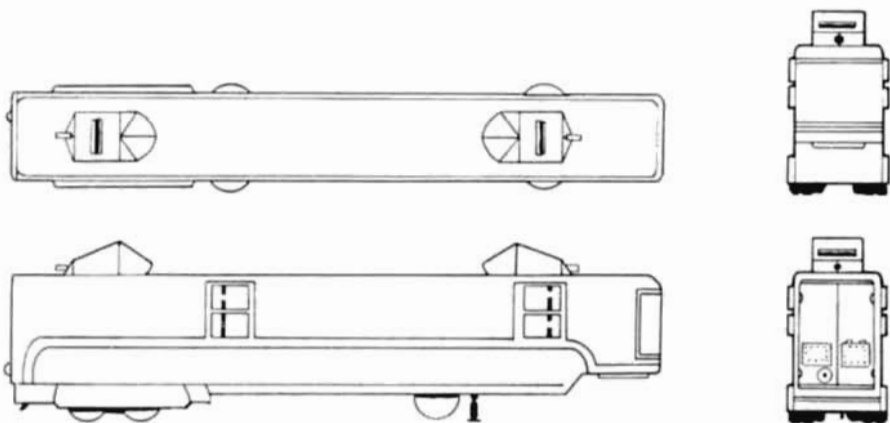

The only Q-trailer in full-scale production, Autoline's Econoforce is usually disguised to resemble the other trucks in the convoy it accompanies. The outer structures are designed to make the AT guns look like MGs, while the heavy tank gun is usually covered by a fire-through cap that looks like an armor patch — a dead giveaway if spotted in time. The "Extraforce" variant is almost overkill.

Econoforce — Van trailer, explosive kingpin, 12 solid tires, 5 gunners (2 in cupolas), 8 ATs (linked pairs RF, RB, LF, LB), TG back, HL back, 5 MDs (2 RB, 2 LB, 1 B, all linked), 2 lasers in pop-up cupolas, 5 hi-res computers, 22 AP flechette grenades, 2 sleeping areas, fire ext., 8-space crew lounge. Armor: 100 in each location, 6 10-pt. wheelguards. 35,440 lbs., \$163,750.

Extraforce — As above, but replace cupola HR computers with cyberlinks, add LD radio, radar, infrared, 2 laser batteries. 3 sleeping areas, but no crew lounge. 35,950 lbs., \$195,850.

Budget Box

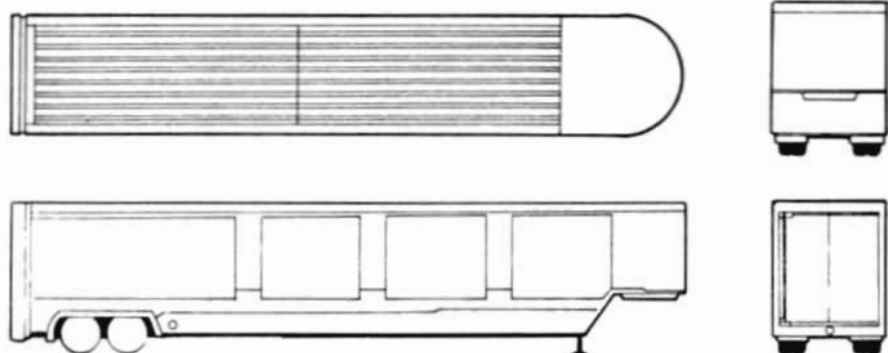

Underarmored and only usable in safe areas, the HMF Type One, or "Budget Box," has few strong points except its price. However, the rear-mounted RL can surprise an attacker who expects nothing but dropped weapons from a trailer.

Budget Box — Van semi-trailer, standard kingpin, 8 HD tires, 2 linked SDs (RB and LB), RL back. Cargo capacity: 76 spaces. Armor: 10 in all locations. 5,840 lbs., \$14,500.

Crew Cut

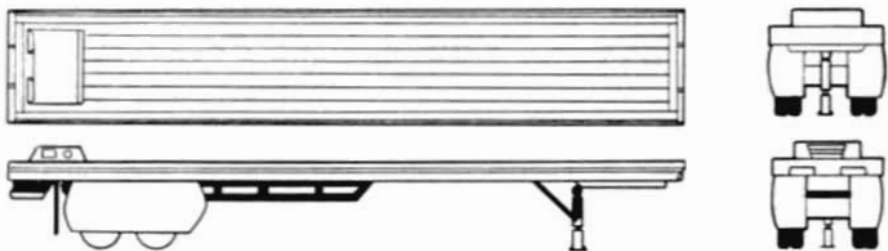

This Autoligne model is by far the most popular flatbed trailer, due to its wheelguards and solid weapon box. Almost anything may be installed in that box; the most common variants are shown below.

Crew Cut (MD/PS) — Flatbed semi-trailer, standard kingpin, 8 solid tires, 50-pt. weapon box with 2 linked MDs (RB, LB) and 2 linked PSs (RB, LB); all weapons linked. Cargo capacity: 44 spaces safely, more if cargo is stacked. Armor: 50 UF, 50 UB, 4 10-pt. wheelguards. 6,960 lbs., \$25,600.

Crew Cut (HDFOJ) — Replace weaponry with 2 HDFOJs (RB, LB), linked. 6,690 lbs., \$26,200.

Tailgunner

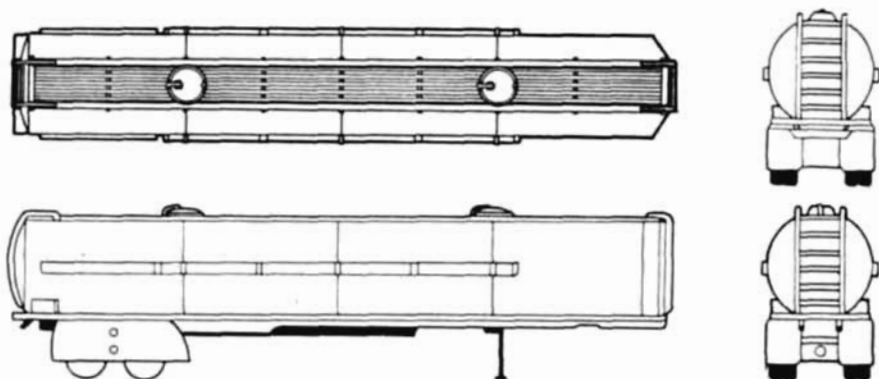

The difficulty of mounting offensive weapons on a tanker has forced bulk liquid haulers to rely extensively on dropped weaponry. Crane's Tailgunner can escape (or eliminate) almost any foe behind it, but needs a well-armed cab to survive a confrontation from the front or side.

Tailgunner — Tanker semi-trailer, std. kingpin, 8 solid tires, 3 linked MDs with extra magazines (RB, LB, B), 3 linked PSs (RB, LB, B), HDOJ back, link for all weapons. Cargo capacity: 45 spaces. Armor: 60 in all locations, 4 10-pt. wheelguards. 18,265 lbs., \$60,150.

Tailgunner Plus — Replace all MDs with Spear 1000 MDs, replace HDOJ with HDFOJ, convert all armor to FP. 18,320 lbs., \$85,950.

Basher

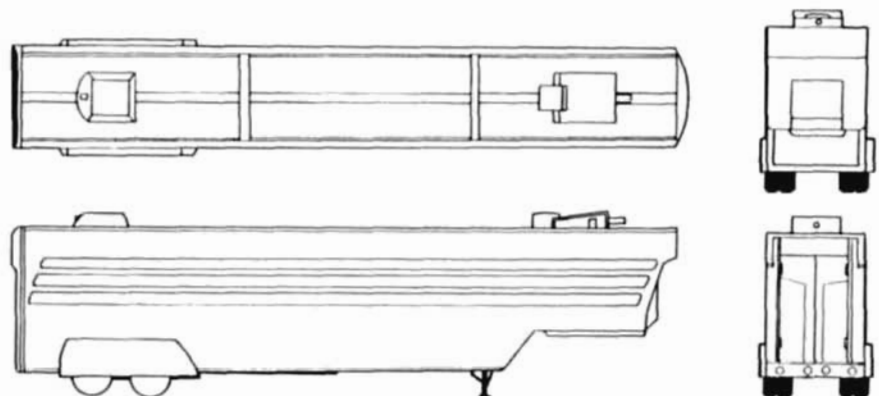

This tough Magnum model makes no attempt to hide its firepower; it advertises it as a deterrent. Not a desirable opponent.

Basher — Van semi-trailer, std. kingpin, 8 solid tires, SD, MD, OJ, SS rear (all linked), laser in front turret, RR in rear turret, fire ext. Cargo capacity: 69 spaces. Fire-proof armor: F40, B60, 50 elsewhere, 4 10-pt. wheelguards. 15,185 lbs., \$73,850.

Collector

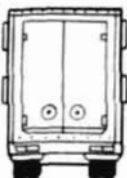
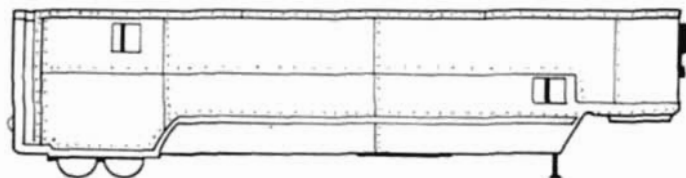
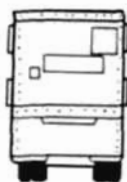

The Acme Collector has little competition in its specialized role — salvage. Its cargo area will hold two vehicles of up to pickup size.

Collector — Van semi-trailer, std. kingpin, 8 solid tires, 2 gunners, 6 MGs (2 linked B, one each RF, RB, LF, LB), wheel ramps, LD radio, winch, fire ext. Cargo capacity: 68 spaces. Armor: 100 in all positions, 4 10-pt. wheelguards. 24,310 lbs., \$69,250.

Behemoth*

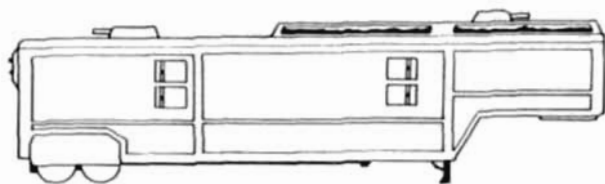
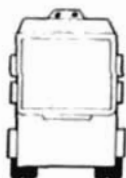
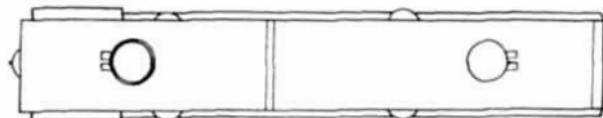

The Magnum Behemoth is currently the ultimate in stock cargo carriers. Since this trailer's introduction in 2032, five have been looted after barricade ambushes, two hijacked by inside jobs, and only one taken out in road combat.

Behemoth — Van trailer, quick-release kingpin, 8 solid tires, 5 gunners, 2 turreted lasers linked TF, 2 turreted lasers linked TB, 2 HLs linked B, 6 MDs (2 linked RB, 2 linked LB, 2 linked B), link for all 6 MDs, 8 RRs (4 linked pairs, one each RF, RB, LF, LB), 22 AP flechettes, small car power plant, CargoSafe. Cargo capacity: 23 spaces, including 10 within CargoSafe. Armor: 100 in all locations, 50 in each position on interior CargoSafe, 4 10-pt. wheelguards. 41,960 lbs., \$188,150.

**Originally announced as the "Courier," this model underwent a name change after an objection by Courier Services Limited.*

Helicopters

Robobee

Designed as an expendable scout unit, the unmanned Cybertech Robobee has become popular with fortress towns, search-and-rescue units, and even convoys. Its cost — less than that of a well-equipped luxury car — has also made it attractive as a decoy for raiders. Armor is heavy overall; the Robobee's big handicap is the inaccurate handling and fire that comes with remote control.

Robobee — One-man helicopter, mini copter power plant, no pilot, 2 RRs linked front, fire ext., remote control unit. Armor: T50, 60 in all other locations. Acceleration 5, HC 0; 6,650 lbs., \$31,650.

Rocket Robobee — As above, but replace RRs with MFR front and 2 linked bombs under. \$28,600.

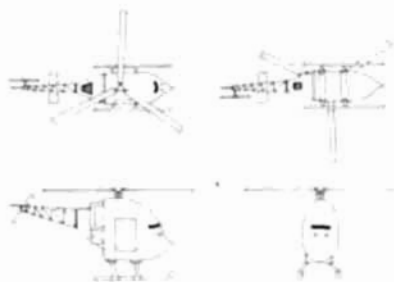

MicroMedic

The most common helicopter in America's skies is the MicroAir MicroMedic, a staple of medical services and disaster-control units everywhere. Gold Cross units are armed with a single MG; most other MicroMedics are unarmed. The armed version is a nimble combat chopper when need arises, and even the unarmed version has been known to fight its way out of trouble by blinding attackers with the searchlight.

MicroMedic — One-man helicopter, mini copter power plant, pilot, one passenger inside, two passengers on skid stretchers, winch right, side door right, searchlight under. Armor: F35, R40, L40, U40, B30, T15. Acceleration 5, HC 3; 6,400 lbs., \$25,500.

Armed MicroMedic — As above, but replace winch with MG front. 6,200 lbs., \$26,500.

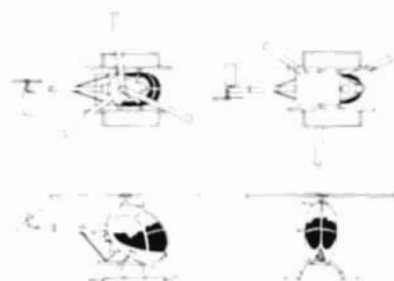

Gnat

The MicroAir Gnat is a sport vehicle with practical applications; it is often used as a truck-carried scout for important convoys. It is the helicopter equivalent of a speedy compact, with good acceleration, moderate weaponry, and light armor. The SuperGnat, on the other hand, is a formidable combat copter with heavy weapons and armor.

Gnat — One-man stowaway helicopter, mini copter power plant, pilot, MG front, 2 linked HRs front. Armor: F20, R20, L20, U20, B15, T5. Acceleration 10, HC 3; 4,350 lbs., \$24,550.

Rocket option — As above, but replace weaponry with MFR front and one bomb underneath. 4,200 lbs., \$23,150.

SuperGnat — As basic Gnat, but replace weaponry with laser and cyberlink, add LD radio. Fireproof armor: 50 in all positions. Acceleration 5, HC 3; 6,150 lbs., \$50,400.



Husky

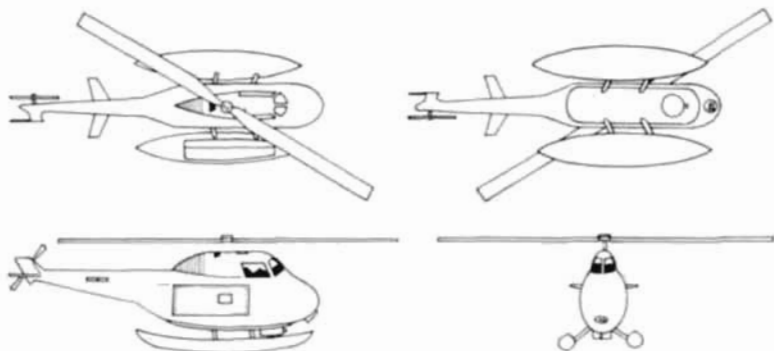

The CanAir Husky is a superior all-weather search and rescue vehicle, fast-moving and heavily armored; it has also been used to insert commando teams in hostage rescue operations. The "Watchdog" version is an effective combat chopper. Husky armor is good, but the front is relatively light.

Husky — Standard helicopter, std. copter power plant, pilot, gunner, passengers (see below), RR in universal turret under, winch right, pontoons w/2 stretchers, infra-red, radar, searchlight under. Armor: F60, R80, L80, B60, U80, T40. Passenger configuration I: 2 paramedics, 2 patients in pontoon stretchers, 2 patients prone inside. Passenger configuration II: 8 passengers seated inside, 2 patients on pontoon stretchers. Acceleration 10, HC 1; 13,000 lbs., \$84,650.

Husky Watchdog — As above, but add second gunner, RR front, 2 MGs (L and R), 2 bombs under. Convert armor to fireproof. No passenger capacity except for pontoon stretchers. 12,900 lbs., \$101,700.

Plunge

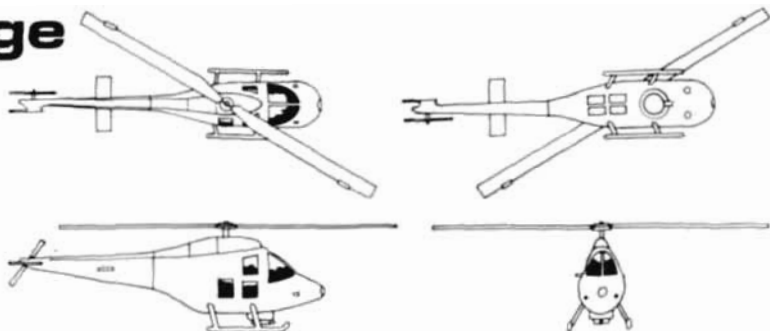

By far the most common attack chopper is the stock Airtech Plunge. Acceleration is superior to that of most helicopters. Three VMGs with excellent electronics give it an effective offense. The weakest points are the vulnerable rotors and the rear; other armor (especially on the underbody) is heavy.

Plunge — Standard helicopter, std. copter power plant, pilot, gunner, 2 VMGs linked front (cyberlink/gunner), VMG in universal turret under, 2 pairs linked bombs under, fire ext., infrared, 2 hi-res computers. Armor: F70, R80, L80, B70, U90, T40. Acceleration 10, HC 1; 13,320 lbs., \$112,350.

Smokescreen option — Replace 2 bombs with HDSS. 13,370 lbs., \$113,000.

Flaming oil option — Replace 2 bombs with HDFOJ. 13,160 lbs., \$113,900.

Suppressor

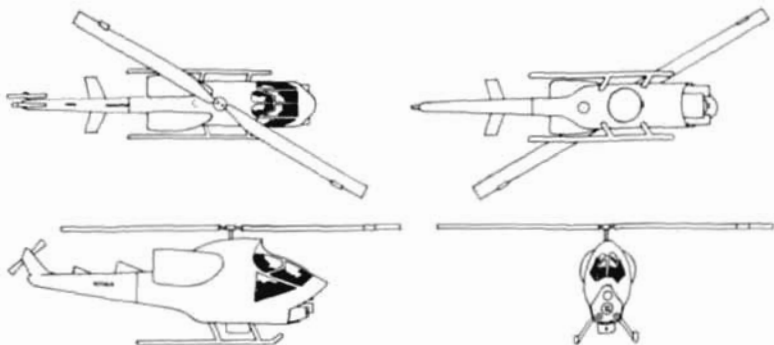

The Lorne Suppressor first appeared in 2032 as a riot-suppression copter. It is now used by many police forces and government agencies in a variety of surveillance and apprehension duties. Although Lorne's policy is to sell only to government bodies, a number of Suppressors have fallen into "unofficial" hands. Its electronics and weaponry make the Suppressor extremely formidable; if a combat situation is unavoidable, the rotors are the only attractive target.

Suppressor — Standard helicopter, small copter power plant, pilot, gunner, VMG in universal turret under, 2 linked MGs front, 2 GLs (F and U), 2 cyberlinks (pilot/MGs, gunner/VMG), stealth, infrared, sound system, sound enhancement, searchlight front. Armor: T40, 60 in all other positions. Acceleration 5, HC 1; 11,670 lbs., \$134,650 plus cost of grenades.

RR option — As above but replace MGs and VMG with RRs (one front, one in universal turret under). 11,520 lbs., \$132,600.

Aerohauler

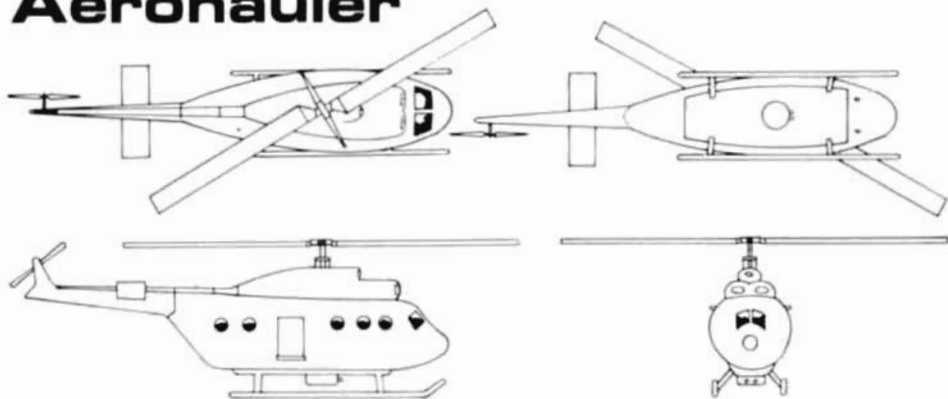

The Aerohauler is the most popular long-range transport copter. CanAir offers two combat options, but the standard version is commoner by far; the bomb version has limited utility, and the laser-equipped Aerohauler Supreme, while it has a formidable punch, is too lightly armored for sustained combat.

Aerohauler — Transport helicopter, 2 small copter power plants, pilot, gunner, 2 linked MGs in universal turret under. Armor: 20 in all locations. Cargo capacity: 2,460 lbs., 15 spaces. Acceleration 5, HC 0; 10,940 lbs., \$119,750.

Aerohauler Bomber — As above, but add 6 bombs under (linked in pairs) and 6 HRs back (linked in pairs). Cargo capacity 1,260 lbs., 3 spaces. 12,140 lbs., \$121,850.

Aerohauler Supreme — As basic Aerohauler, but remove MGs, turret, and gunner. Add 2 lasers linked in universal turret under, 2 linked lasers back, 2 laser batteries. Cargo capacity: 610 lbs., 13 spaces. 12,790 lbs., \$151,800.

Leviathan



By far the heaviest combat chopper in regular production, the standard Airtech Leviathan is well enough equipped to fight a war by itself. Under no circumstances should the average driver consider a dispute with this helicopter!

Leviathan — Transport helicopter, super copter power plant, pilot, gunner, 2 linked lasers front, TG back, 2 VMGs linked in universal turret under, 3 bombs under, 2 hi-res computers, fire ext. Armor: T100, 160 in all other positions. Acceleration 5, HC 0; 25,550 lbs., \$182,100.

Trike Design & Combat

Tricycles are designed like other *Car Wars* vehicles. A tricycle counter is 1" long, like that for a car. A tricycle's fields of fire are different from those of other vehicles (see *Tricycle Combat*, below); this should be taken into account when placing weapons and armor.

Trike Bodies

<i>Body</i>	<i>Cost</i>	<i>Weight</i>	<i>Max. Load</i>	<i>Spaces</i>	<i>Armor cost/wt.</i>
Light	250	300	1,600	6	11/5
Medium	300	500	2,100	8	12/6
Heavy	400	700	2,800	10	14/7
Extra-Heavy	550	950	3,500	12	16/8

Trikes carry armor like cars — that is, they have six armor positions: front, back, left, right, top, and underbody. A trike chassis is designed for heavy work to start with, so it is not possible to modify its maximum load.

Trikes use the same suspension costs that motorcycles do. Light suspension gives HC 0; improved suspension doubles body cost and gives HC 1; heavy suspension triples body cost and gives HC 2. Thus, trikes, like cycles, always have a lower HC than standard vehicles — but they suffer only a very small handling class penalty when driving off the road. (Special off-road suspension is also available for trikes — see the Off-Road section, page 58.)

Trikes use the same tires and power plants that standard cycles do. Trikes can also use the Super Trike power plant, which is a cycle-type power plant that is even larger than the Super Cycle plant. The Super Trike plant costs \$3,000 and weighs 250 lbs. It takes up 3 spaces, has DP 6, and has 1,200 power factors. Its top speed is 100 mph.

Regular cycles can also use the Super Trike plant. Vehicles larger than tricycles may *not* use this power plant.

Trikes can use any weapon or accessory that a car or cycle can, with a few exceptions. Trikes cannot have ram plates, and they cannot pull sidecars. Light trikes cannot carry turrets; medium trikes can only use one-space turrets. Larger trikes can carry up to two-space turrets.

Trikes *may* use wheelguards: auto wheelguards on the back two wheels, and a cycle wheelguard on the front wheel. Wheelguards *do not* reduce HC on a trike, but *do* reduce HC by 1 on a reverse trike. Retractable wheelguards make little sense on a trike, and are not available.

Reversed Trikes

First seen in Europe, and now being experimented with in North America, the "reversed" trike design puts two wheels in front and one in the center of the back. This configuration provides greater stability than the traditional trike, but is not readily available and is not as efficient from a space standpoint. Reversed trikes come in the same body styles as regular trikes, but have one less space, and cost an extra 50% for the chassis. HC for a reversed trike is one higher than for a regular trike (maximum HC is still 3). Reversed trikes can carry a ram plate, but in all other respects are the same as regular trikes.

Feel free to photocopy this Tricycle Record Sheet for your own use. Tape it over the top part of a standard Vehicle or Cycle Record Sheet and you're ready for three-wheeled action!

TRICYCLE RECORD SHEET

Back armor _____

Left armor _____

Top armor _____

Front armor _____

Right armor _____

Underbody armor _____

Tricycle _____ **Driver** _____

Tricycle Combat

A tricycle is *not* just a small three-wheeled car. The successful tricycle duellist (or designer) must keep the differences in mind if he intends to survive. Trikes have some significant advantages, but they have disadvantages as well.

Fields Of Fire

Trike weapons may be located front, back, or to either side; they may also be turreted. Front and back weapons have the same field of fire that a car's weapons do (see Figure 1); turreted weapons, of course, have a 360-degree field of fire.

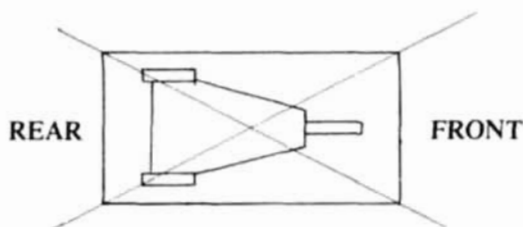

Side-mounted weapons, though, have a greater field of fire than a car's side weapons do, because of the wedge shape of the trike body. A trike's side weapon can fire into the "normal" side field of fire, *plus* the *front* field of fire of a standard vehicle. Figure 2 shows this field of fire.

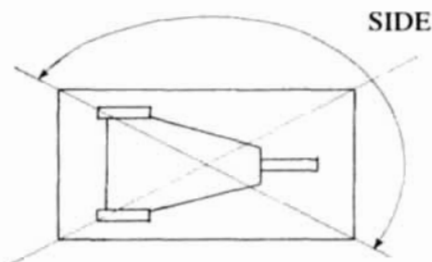

Furthermore, any target in the front field of fire can be hit by weapons mounted on *both sides* (as well as the front!). Right-side and left-side weapons may be linked together, or linked with front weapons, and *aimed together* for fire at targets within this field. As for other vehicles, the linked weapons must be of the same type unless they are going to be fired on automatic, aimed straight ahead.

Weapon Location

A tricycle may mount any weapon to the front or in a turret. However, recoil problems occur when heavy weapons are side-mounted. The only offensive weapons a trike can mount to the side are MGs, FTs, lasers, and rockets of all kinds.

A tricycle may not mount dropped weapons anywhere but to the rear; side-mounted dropped weapons would endanger the vehicle. Side-mounted paint sprays and smoke-screens are legal but impractical. Exception: A reversed trike may mount dropped weapons to the sides.

Trike Targeting

Because of their size and low profile, trikes are harder to hit, as shown below:

	<i>From Front/Back</i>	<i>From Side</i>
Light Trike	-3	-2
Med. Trike	-2	-1
Hvy. Trike	-1	-1
X-Hvy. Trike	-1	0

Because trikes are low to the ground, their *tops* can be fired upon. Any attacker may choose to fire at the top of a trike if he has a shot at the front or side. (You can't hit a trike's top from behind.) Because the top is steeply sloped, any attack on the top is at a *further* -2 to hit. Thus, for example, to shoot at the top of a light trike, from in front, would be at a -5! If the trike has a turret, attacks on the top automatically hit the turret at no further penalty.

The wedge shape of tricycles means that an attacker will often be able to draw a line of fire to the front *or* to *either* side. However, when this happens, the attacker is deemed to be *directly in front* of the trike. He *must* target the front, accepting the penalties that go with it. (Reason: from his position, the angle of the sides is so steep that any attack — even a laser beam — would be very likely to bounce off.)

When a tricycle is struck in the front by weapon fire, roll two dice. On an 11 or 12, the front wheel is hit. Any remaining damage is lost. On a 2 through 10, the front armor is hit. Any remaining damage after the armor is destroyed will affect internal components in the same way cars are affected. Use the damage allocation for cars for any attack from the sides or rear, too.

For reversed trikes, all the above holds true — just reverse "front" and "back." Exception: You still cannot hit the top of a reversed trike from behind, because the back is still the highest part of the tricycle.



Off-Road Duelling

In real life, many of the most demanding combat situations take place away from roads and arenas. A beach battle, with cycles and buggies flying over the dunes . . . a cat-and-mouse hunt in a Louisiana swamp . . . a Badlands raid, with pickups *literally* sweeping down from the hills to intercept a convoy . . . all these, and more, have been front-page news in the past year. And off-road recreational duelling is now becoming popular.

But converting a regular combat car to off-road use is no easy task. A simple hillside can be murder on a car or cycle designed for the open road or the smooth asphalt of an arena. For the duellist interested in off-road action, the following section will describe some of the problems to be faced, and the equipment available to deal with them.

Off-Road Penalties

Any vehicle *can* go off-road without modifications — but the handling class of an unmodified vehicle is reduced greatly, as follows:

Motorcycle (with or without sidecar): Subtract 2 from HC

Tricycle: Subtract 1 from HC

4- or 6-wheel vehicle: Subtract 3 from HC

Oversized vehicle: Subtract 2 from HC

The handling bonus for PR radials does *not* apply to off-road travel. However, special off-road tires are available (see below).

In addition, most vehicles are subject to damage when going off-road. Every turn a standard 4-wheeled or larger vehicle is off-road and traveling faster than 10 mph, roll *two* dice. On a 2 or 3, the underbody takes 1 point of damage. On a 4 or 5, one tire (roll randomly to see which) takes 1 point of damage. If the vehicle is going over 50 mph, roll twice per turn. Once the underbody armor is gone, the internal components do *not* take further damage.

Exceptions to the above: Vehicles with solid tires (regular or off-road) do not take tire damage. Cycles and trikes (and, of course, vehicles with OR suspension) are built higher off the ground, and don't take underbody damage.

Off-Road Advantages

The only significant advantage to driving off-road is that the ground is softer than cement. Thus, in a "bail-out" situation or a roll, cars and drivers are more likely to survive.

Jumping out of vehicles. Anyone jumping out of a vehicle, or off a cycle, when off-road will take less damage. Figure damage as though he/she had been hit by a car going 30 mph slower than the speed at which he actually hit the ground.

Rolling. When a vehicle rolls in an off-road situation, each side that hits the ground take (1 die-2) damage, instead of 1 die damage. Tires likewise take (1 die-2) damage in an off-road roll. Thus, the most damage you can take is 4 points per phase. It is quite possible to roll a vehicle on soft ground and drive it away afterwards — if you can get it upright.

Off-Road Equipment

Although a well-built car can tough it out for a brief trip away from the concrete, the serious off-road combatant will have a specially equipped "boondock battleship" that can handle any terrain it meets. The following equipment is available:

Off-road solid tires. OR solids improve off-road handling by one; they have no effect on HC on the road. They cost \$600, weigh 80 lbs. each, and have 12 DP. Cycle tires weigh half as much but have the same cost and DP. Off-road solids are not available for oversized vehicles.

Off-road suspension. This heavily-sprung, high-off-the-ground look is the hallmark of the true off-road vehicle. It is only available as original equipment; once built, a car's suspension cannot be changed. OR suspension for a cycle or trike costs 300% of the body cost; OR suspension for a 4- or 6-wheel vehicle costs 500% of the body cost. Off-road suspension is not available for oversized vehicles.

Off-road suspension gives a vehicle a HC of 2, either on or off the road. A vehicle with OR suspension does not take automatic underbody damage when off the road.

Brushcutter. A front-mounted blade; may be mounted on regular armor or a ram plate. \$100, 20 lbs., no spaces. Lost if the front armor is lost, but must be replaced after every off-road run anyway. Adds 2 hits to damage done to any pedestrian hit by the front of the car. Allows the vehicle to mow down small trees (normally a D2 or D3 hazard) with no ill effects. Has no effect on rocks, other vehicles, etc.

Off-Road Terrain

Off-road should *not* be construed to mean the dirt on the edge of the highway; the shoulder of the road is (usually, at least) no great hazard. "Off-road" means open country . . . whether it's country fields, Arizona desert, or just your local city park. All maneuvers performed off-road are made at an additional D1 difficulty. This applies to *all* vehicles.

For any off-road scenario, the referee should prepare a map in advance, showing location of hazards and the general "lay of the land" — especially sloped locations that would allow a vehicle to jump. Off-road duellists may encounter almost any terrain. Some possibilities include:

Grass and open fields. This is the basic off-road terrain. No extra penalties apply — just the standard +D1 difficulty for off-road travel.

Trees. Small ones might be D2 or D3 hazards; larger ones would be fixed barriers of

20 DP or more. They can also block line of sight (see *Sunday Drivers*). Brushcutters (see above) will cut down small trees with no hazard to the vehicle.

Boulders. Small ones (a foot across or so) should be treated as obstacles. Those 1 to 2 feet in diameter are fixed barriers of 25 DP, which are knocked out of the way (rather than destroyed) if they take more than their DP value in a collision. Larger boulders have greater DP values — a 4-foot boulder would be worth at least 50 DP.

Ditches and gullies. Small ditches (less than 2 feet across) are a D3 hazard at 20 mph or less, but only a D1 hazard at greater speeds — vehicles fly right over them. Ditches between 2 and 4 feet across are impassable at less than 20 mph — if a vehicle tries to cross one, it will fall in, and effectively collide with the far wall at full speed. Very dangerous. At 25–40 mph, such a ditch is a D3 hazard. At 45 mph or greater, it is a D1 hazard — again, you can fly right over. Wider ditches should not be jumped without a ramp — see Flying, below. Very wide gullies, unless they are full of water, can be crossed by driving down one side and up the other!

Flying

What's the use of going off-road if you can't get off the ground once in a while? With the right terrain, you can gun your vehicle to the top of a hill and take off, or even jump right over a surprised foe!

With a good takeoff angle (20 to 40 degrees), a vehicle will fly 15 feet for every 10 mph of takeoff speed over 20 (30 mph yields 15' of flight, 40 mph yields 30' of flight, and so on). A flatter or steeper angle (15 or 45 degrees) will *halve* the distance traveled. Inclines flatter than 15 degrees, or steeper than 45 degrees, cannot be used to launch a jump.

Landing is a D1 hazard, +D1 for every full 30 feet flown. Thus, a 15-foot jump is a D1 hazard, a 30- or 45-foot jump is a D2 hazard, a 60- or 75-foot jump is a D3 hazard, and so on. Subtract 1 from the hazard if you land on an upward slope (because all your wheels will hit at about the same time). Add 1 to the hazard if you land on a *downward* slope (which you usually will, if you are jumping from the top of a hill). On landing from a jump, roll one die for each tire *except* solids or off-road solids. On a 1, 2, or 3, that tire takes 1 point of damage.



Customizing Vehicles

With enough time and calculation, a vehicle can be modified in any fashion the owner wishes. Certain custom jobs, though, are especially easy to calculate because they do not change the weight or spaces of a car. Some of these are:

Armor rearrangement. Armor can be moved about a vehicle design freely, without affecting weight, spaces, or cost, unless the vehicle is equipped with a ram plate. A ram plate's weight and cost depend on the thickness of the front armor.

Weapon rearrangement. Weapons can be pointed in different directions from those specified. Remember, though, that linked weapons (except for dropped-type weapons) should usually be of the same type and point in the same direction; if not, they cannot be aimed when fired in linked mode, and must fire straight out, as though they were on automatic. If a weapon link is removed, cut \$50 from the price.

Weapon exchanges. The following pairs of weapons have the same weight/space requirement and can be exchanged, one for the other. Costs differ, of course! But, for example, you can remove the FT from your car and put in a laser, paying an extra \$7,250, but making no other change.

Flamethrower to laser: +\$7,250.

Two HRs to minedropper: +\$600.

Spikedropper to smokescreen: +\$50.

Spikedropper to paint spray: +\$350.

Smokescreen to paint spray: +\$300.

Likewise, to save money, an expensive weapon may be removed from a design and replaced with a cheaper one.

Computers. Regular or hi-res targeting computers can be added, at a cost of \$1,000 and \$4,000 respectively, without changing vehicle configuration. Or computers can be removed to cut costs. The cyberlink is another matter, since it requires extra weight and space.

Fireproof armor. To make a vehicle's armor fireproof, simply double its cost. Remember that the cost of a ram plate also doubles.

Turrets. Any turret can be upgraded to "universal" (capable of firing at any angle, including straight up) for \$1,000.

Special Equipment

The following weapons and accessories do not appear in the basic *Car Wars* rulebook. This listing will tell you where the item can be found (the number following *ADQ* items refer to the volume and issue number of *Autoduel Quarterly*) and some basic construction information:

Anti-Theft System (*ADQ* 1-3): \$1,000, no weight or space, plus the cost of AP grenades.

AP Grenades (*Truck Stop*): Anti-Personnel Grenades, \$50, no weight or space.

Assault Ramp (*Truck Stop*): \$1,000, 100 lbs., 1 space.

Bomb (*Autoduel Champions*): \$100, 100 lbs., 1 space.

CargoSafe (*ADQ* 1-2): \$22,000, 12,000 lbs., 15 spaces.

Cyberlink (*Autoduel Champions*): \$16,000, 100 lbs., 1 space.

Cycle Blades (*Sunday Drivers*): \$50, 20 lbs., no space.

Ejection Seat (*ADQ* 2-1): \$500, 100 lbs., no space.

Fake Blades (*Sunday Drivers*): \$20, no weight or space.

FOJ (*ADQ* 1-1): Flaming Oil Jet, \$1,175, 80 lbs., 2 spaces (loaded).

4-space Cupola (*Truck Stop*): \$5,500, 500 lbs., 2 spaces; Pop-up: \$6,500, 750 lbs., 6 spaces.

4-space Turret (*Truck Stop*): \$3,500, 400 lbs., 2 spaces; Pop-up: \$4,500, 600 lbs., 6 spaces.

FP Armor (*ADQ* 1-3): Fireproof armor, doubles normal armor cost, no effect on weight.

GL (*ADQ* 1-2): Grenade Launcher, \$1,000, 200 lbs., 2 spaces (unloaded), WPS 4, 20 shots, CPS depends on grenade type.

HDFOJ (*ADQ* 1-4): Heavy Duty Flaming Oil Jet, \$1,950, 140 lbs., 3 spaces (loaded).

HDFT (*ADQ* 2-2): Heavy Duty Flamethrower, \$1,750, 750 lbs., 3 spaces (loaded).

HDOJ (*Autoduel Champions*): Heavy Duty Oil Jet, \$900, 130 lbs., 3 spaces (loaded).

HDPS (*Autoduel Champions*): Heavy Duty Paint Spray, \$1,200, 130 lbs., 2 spaces (loaded).

HDSS (*Autoduel Champions*): Heavy Duty Smokescreen, \$900, 250 lbs., 2 spaces (loaded).

Heavy CTS (*ADQ* 1-4): Heavy Cycle Turret Sidecar, \$2,500, 450 lbs., armor 5/6, 2-space weapon in turret and one non-passenger space in body. Max. load 800 lbs.

HL (*Truck Stop*): Heavy laser, \$12,000, 1,000 lbs., 3 spaces.

Infrared (*Autoduel Champions*): \$4,000, 100 lbs., 1 space.

Kingpin (*Truck Stop*): Standard — \$100, no weight or space; Explosive — \$500, no weight or space; Quick-release — \$1,000, no weight or space.

Laser Battery (*ADQ* 1-4): \$500, 100 lbs., 1 space.

LDR (*ADQ* 1-1): Long-Distance Radio, \$600, no weight or space.

Light CTS (*ADQ* 1-4): Light Cycle Turret Sidecar, \$1,500, 250 lbs., armor 5/5, one-space weapon in turret and one non-passenger space in body. Max. load 550 lbs.

LR (*ADQ* 2-1): Light Rocket, \$75, 25 lbs., 1/2 space.

MFR (*ADQ* 1-4): Multiple-Fire Rocket pod, \$450, 150 lbs., 2 spaces.

MNR (*ADQ* 2-1): Mini Rocket, \$50, 20 lbs., 1/3 space.

MR (*ADQ* 2-1): Medium Rocket, \$140, 50 lbs., 1 space.

Pontoons (*Autoduel Champions*): \$500, 50 lbs., no space.

Portable Shop (*Truck Stop*): \$1,000, 75 lbs., 1 space.

- PR Radials (*ADQ 1-3*): Puncture-Resistant Radial Tires, \$500 and 60 lbs. each, 30 lbs. each for cycles.
- Radar (*Autoduel Champions*): \$2,500, no weight or space.
- Ram Plate (*ADQ 1-1*): +50% weight and +150% cost of front armor.
- Reflective Armor (*ADQ 2-2*): Adds 10% to armor cost and weight.
- Reflective FP armor (*ADQ 2-2*): Adds 10% to armor weight, multiplies cost by 250%.
- Remote Control (*Autoduel Champions*): \$2,000, no weight or space.
- RGM (*ADQ 2-1*): Radar-Guided Missile, \$7,000, 400 lbs., 2 spaces (loaded).
- Rocket Platform (*Truck Stop*): \$150, 200 lbs., no space.
- Roll Cage (*ADQ 1-3*): \$1,000, 300 lbs., 1 space.
- Searchlight (*Autoduel Champions*): \$200, 50 lbs., 1 space.
- Side Doors (*Autoduel Champions*): \$1,000, 1,000 lbs., no space.
- Skid Stretchers (*Autoduel Champions*): \$300, 25 lbs., no space.
- Sleeping Area (*Truck Stop*): 3 spaces, no cost or weight.
- Sound Enhancement (*Autoduel Champions*): \$6,000, 150 lbs., 1 space.
- Sound System (*Autoduel Champions*): \$1,000, 100 lbs., 1 space.
- Spear 1000 MD (*ADQ 2-1*): \$1,250, 200 lbs., 2 spaces (loaded).
- Stealth Mode (*Autoduel Champions*): \$16,000, 200 lbs., 2 spaces.
- Tank Gun (*Truck Stop*): \$11,000, 1,400 lbs., 10 spaces.
- Tear Gas (*ADQ 1-2*): Loaded in smokescreen, CPS 50, WPS 1.
- 3-space Cupola (*Truck Stop*): \$3,500, 400 lbs., 2 spaces; Pop-up: \$4,500, 600 lbs., 5 spaces.
- 3-space Turret (*Truck Stop*): \$2,500, 300 lbs., 2 spaces; Pop-up: \$3,500, 450 lbs., 5 spaces.
- Tinted Windshield (*ADQ 2-2*): \$500, no space or weight.
- Tool Kit (*Truck Stop*): \$600, 40 lbs., 1 space.
- Universal Turret (*Autoduel Champions*): Any turret or cupola can be made universal (capable of firing upwards) for an additional \$1,000, no addition weight or space.
- VMG (*Autoduel Champions*): Vulcan Machine Gun, \$2,700, 450 lbs., 2 spaces (loaded).
- WGM (*ADQ 2-1*): Wire-Guided Missile, \$3,300, 230 lbs., 2 spaces (loaded).
- Wheel Ramps (*Truck Stop*): \$300, 200 lbs., no space.
- Wheelguards (*Truck Stop*): \$10 and 4 lbs. per point of armor, \$10 and 2 lbs. per point for cycles.
- Winch (*Autoduel Champions*): \$500, 100 lbs., 1 space.



Late Arrivals

Hammerhead

This brand-new British import is the first reversed trike to reach North America in any quantity. Macmillan Motors has configured it for sustained combat, with a turreted RR and extra magazine. The ram plate will come as a surprise to those unfamiliar with reversed trike design, but the Hammerhead is heavy enough — and handles well enough — to make it work.

Hammerhead — X-hvy. reversed tricycle, super trike power plant, hvy. suspension, 3 solid tires, driver, turreted RR with extra magazine, MD rear. Armor: F35 (ram plate), R18, L18, B14, T27, U12. Acceleration 5, HC 3; 3495 lbs., \$14,149.

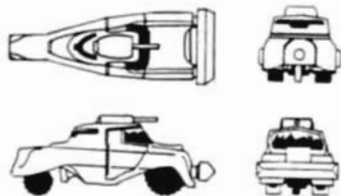

Dragonfly

MicroAir's new Dragonfly is an inexpensive combat-support helicopter. Its excellent electronics make up for otherwise inaccurate weaponry. The Dragonfly has already become a popular choice for those arenas offering copter-vs.-car combat displays.

Dragonfly — Small helicopter, mini copter power plant, pilot, gunner, 2 linked RLs front, 3 bombs underneath, hi-res computer (gunner). Armor: T30, 40 in all other positions. Acceleration 5, HC 2; 6,700 lbs., \$41,650.

Rocket Dragonfly — As above, but replace bombs with one MFR under, one HR front. 6,650 lbs., \$42,000.

Laser Dragonfly — As basic Dragonfly, but replace weaponry with laser front, MFR under, and MFR rear. 6,700 lbs., \$47,500.

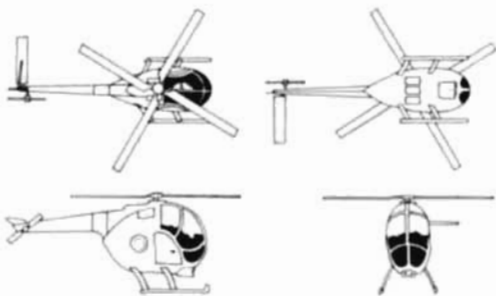

The AADA Vehicle Guide includes:

- 129 *Car Wars* vehicle designs — each fully described and illustrated
- 133 options — for a total of 262 complete vehicles
- An index of *Car Wars* weapons and gadgets
- Hints on customizing your vehicles
- New rules for *Off-Road* combat
- Complete design and combat rules for a new *Car Wars* vehicle type . . . the killer *three-wheelers*!