

WARCRAFT

THE ROLEPLAYING GAME

MAGIC & MAYHEM™



A Magic and Technology Sourcebook for v.3.5 Roleplaying

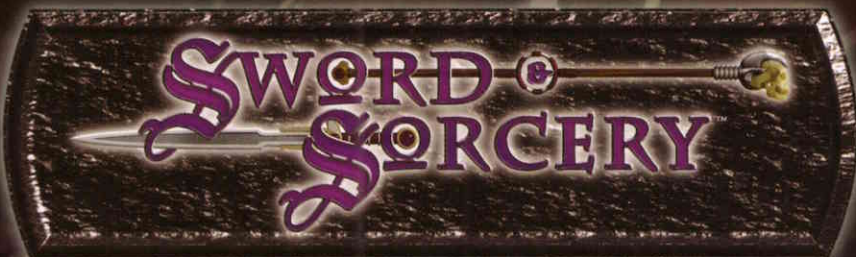

James E.
2004 #19





WARCRAFT

THE ROLEPLAYING GAME

MAGIC & MAYHEM™



WARCRAFT

THE ROLEPLAYING GAME

MAGIC & MAYHEM™



Credits

Authors:

Rob Baxter (prestige classes, magic items, tech devices, constructs), Scott Bennie (magic), Bob Fitch (rune magic, runemaster, rune families, spells), Bruce Craw (magic items), Luke Johnson (fiction, feats, spells), Seth Johnson (fiction, engineer, tech creation, tech devices)

Creative and Rules Design Assistance and Additional Material:

Chris Metzen and Bob Fitch

Developer:

Mike Johnstone

Editor:

Ellen P. Kiley

Managing Editor:

Andrew Bates

Art Director:

Matt Milberger

Book Design:

Matt Milberger

Cover Artist:

Samwise Didier

Interior Artists:

Ted Beargdon, Samwise Didier, Michel & René Koiter, Chris Metzen

Playtesters:

Tom Cadwell, Tim Campbell, Sebastien Couture, Phillip Dunn, Sean Gardiner, Mike Heiberg, Robert Lennon, Scott Mercer, The Monkeyfans, Chris Pagel, Lorne Peterson, Steve Sloane

Special Thanks—Mike Johnstone

Three cheers to Bob Fitch and Chris Metzen, who know how to keep things up during the down times, and for pouring as much heart and soul as anyone into the RPG. We owe you more than words can say.

To the other great folks at Blizzard: Paul Sams, Elaine Di Iorio, Neal Hubbard and Lisa Bucek.

Finally, to the regulars, newcomers, and occasional visitors to the official **Warcraft RPG** discussion forum: thanks for keeping us on our toes, but most of all thanks for your interest in and support of the game. You're the best!

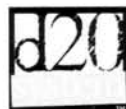

Check out upcoming Sword and Sorcery Studio products online at: <http://www.swordsorcery.com>
Distributed for Sword and Sorcery Studio by White Wolf Publishing, Inc. This printing of *Magic & Mayhem* is published in accordance with the Open Game License. See the Open Game License Appendix of this book for more information. Arthaus and its logo are trademarks of Arthaus Publishing, Inc. All rights reserved. Sword and Sorcery and its logo, Manual of Monsters, Alliance & Horde Compendium, Magic & Mayhem, Lands of Conflict, and Shadows & Light are trademarks of White Wolf Publishing, Inc. All rights reserved. © 2004 Blizzard Entertainment. Warcraft and Blizzard Entertainment are trademarks or registered trademarks of Blizzard Entertainment in the U.S. and/or other countries, used with permission. All rights reserved. Dungeons & Dragons and D&D are registered trademarks of Wizards of the Coast, Inc., and are used with permission. "d20 System" and the "d20 System" logo are registered trademarks owned by Wizards of the Coast and are used according to the terms of the d20 System License version 5.0. A copy of this License can be found at <www.wizards.com/d20>. The mention of or reference to any company or product in these pages is not a challenge to the trademark or copyright concerned.

PRINTED IN CANADA.

WARCRAFT

THE ROLEPLAYING GAME

MAGIC & MAYHEM

Contents

Credits	2
Introduction	9
Chapter One: Flame and Faith	13
Arcane Magic	14
Spellcasters	15
Variant Rule: Arcane Corruption	16
Divine Magic	22
Ordeals	22
Tests of Faith	23
Fel Energy	24
Fel Offerings	24
Fel Poison	24
Rune Magic	24
Creating Rune Families	25
Chapter Two: Prepare Yourself!	29
Feats	30
New Core Class and Prestige Classes	33
Runemaster	34
Bombardier	38
Engineer	40
Graven One	42
Shadow Hunter	45
Spiritwalker	48
Steamwarrior	50
Warden	53
Witch Doctor	55
Chapter Three: Fountains of Mana	60
Rune Families	61
Runes	62
New Spells	79

Chapter Four: Destiny and Reward	113
Armor and Shields	114
Weapons	116
Potions	129
Rings	133
Rods, Staffs and Wands	134
Scrolls	135
Wondrous Items	137
Minor Artifacts	155
Chapter Five: Temple of Boom	162
Creating and Using Technological Devices	163
Vehicles: Movement and Maneuverability	164
Malfunction Effects	164
Collaborative Construction	167
Masterwork Devices	167
Special and Favored Materials	168
Technological Devices	169
Adventuring Gear	169
Special Substances and Items	182
Vehicles	186
Weapons	190
Zecker Devices	196
Appendix One: Constructs	198
Appendix Two: Legal Information	207

Tables

Table 1-1: Arcane Corruption Check Circumstances	17
Table 2-1: The Runemaster (Rnm)	35
Table 2-2: Flurry of Blows and Runes per Day	36
Table 2-3: The Bombardier (Bmb)	39
Table 2-4: The Engineer (Eng)	41
Table 2-5: The Graven One (Gvn)	43
Table 2-6: The Shadow Hunter (Swh)	46
Table 2-7: The Spiritwalker (Spw)	49
Table 2-8: The Steamwarrior (Stm)	51
Table 2-9: The Warden (Wdn)	54
Table 2-10: Warden Spells per Day	54
Table 2-11: The Witch Doctor (Wtd)	56
Table 3-1: Summon Undead	103
Table 4-1: Armor and Shields	115
Table 4-2: Weapon Special Abilities	117
Table 4-3: Specific Weapons	125
Table 4-4: Potions and Scrolls	130
Table 4-5: Rings, Rods, Staffs and Wands	134
Table 4-6: Wondrous Items	139
Table 5-1: Malfunction Effects	165
Table 5-2: Technology	169
Table 6-1: Junk Golem Chaotic Construction	203



Flames danced wildly in Zul'ajik's black eyes. The witch doctor rolled his head from side to side, uttering sounds reminiscent of the crackling campfire before him. He shifted, and the light gleamed suddenly off the bronzed goblin skull atop the spear that lay across his knees. The skull grinned at Gimbolt Surehammer, who gritted his teeth and stared right back.

Gimbolt soon looked away, meeting the eyes of Maer-thiss. The blood elf's lip twitched in a smile as he observed Gimbolt's discomfort.

"This is foolishness," hissed the dwarf. "What is this charlatan doing? He must've had too many of those mushrooms." Gimbolt indicated the stand of blue toadstools that grew outside the witch doctor's tent. "Never trusted trolls. Never will."

"Quiet," Maer-thiss replied. "If he can tell us what we need to know, I do not care how drugged he is... or how vengeful." The elf eyed the bronze goblin skull and his lip twitched again in irritation.

The dwarf gave a great sigh in a vain attempt to annoy Maer-thiss, then took his eyes away from the blue-skinned troll. He glanced around the empty camp, just for something else to look at. Tall wooden stakes marked the camp's circular boundary, each bearing a goblin skull. Some skulls still had bits of flesh remaining. Gimbolt did not know why the troll despised goblins with such vehemence. He found goblins rather amusing. In fact, he would say he liked goblins best of all the... *questionable* races he was now forced to abide. Including blood elves.

Well, at least they learned of the witch doctor's odd hatred before they entered the camp. If Zul'ajik had seen Ziggler, the situation might have become messy. Yet for once the goblin erred on the side of caution and had agreed to stay out of sight. The last Gimbolt had seen of Ziggler, the goblin was tinkering with his latest creation: a humanoid construct of gearwork and steam, with a brown beard pasted on and silver hands painted all over. Gimbolt found it oddly flattering.

"Ooh, I contacta the spirits, mon." The troll's sudden exclamation snapped Gimbolt's head around. The dwarf's eyes narrowed, noting that the fool elf was leaning closer to





absorb every word. The troll spoke on: "Theya show you the way. Theya tell me, and then I-ah guide you."

"To the Demonwell?" Asked Maer-thiss, his eagerness palpable. Not for the first time, Gimbolt questioned his choice of traveling companions.

"Yeah, mon. To de Demonwell." Zul'ajik was still in a trance as he stood and looked to the south. "If you—"

"Aaaaaa!" The troll's speech was halted by a familiar, high-pitched scream. Ziggler's latest creation, chugging noisily and blasting steam, came careening down the slope and smashed aside two of the gruesome stakes. Atop the clockwork mechanism's head sat Ziggler himself, a maniacal grin stretching his face. Blue mushrooms protruded from his belt pouch.

Zul'ajik screeched. "Why-ah you bring da goblin here?" Maer-thiss leapt to his feet. The troll's eyes were clear now, and he was shaking with rage. He pointed his quivering spear at Maer-thiss. "I kill you!"

"No, Zul'ajik, I—" Maer-thiss was cut off as Ziggler's creation slammed into him from behind. The blood elf hit the dirt, and the clockwork dwarf continued marching, piston-driven legs pounding against Maer-thiss's ribs, spine and head.

Ziggler cackled as the troll's spear caromed off his creation. Pulling a lever, he piloted the gadget toward Zul'ajik's tent, where the creation tore down the entire structure. A vicious scream tore from the witch doctor's throat as he watched the gnome ride the clockwork dwarf into the night, the tent's remains dragging behind.

Gimbolt, who had stood open-mouthed during this entire scene, came to his senses. He sprinted after Ziggler after a quick examination of his options, making a rude gesture at the troll as he passed.

Maer-thiss lifted his bruised face from the dirt. Zul'ajik scowled, drawing a bone knife from his belt. "I'm with you," said the blood elf. "Let's kill them both."





INTRODUCTION

In your hands lies a tome of great and dangerous knowledge. The lore contained within its pages offers paths to untold power. Between its covers you will find the secrets of the trolls' voodoo magic and the gnomes' machines of sky and sea. You will learn of the mysterious runemaster and of the indomitable steam golem. You will discover the terrible uses of the rod of necromancy and the ingenious functions of the automatic alchemist. You will know precisely how arcane magic can twist your soul, how steam and phlogiston can cause irreparable disasters.

Thus, proceed carefully, dear reader, lest you fall prey to the tome's sweet whispers and believe the world yours to conquer. Such delusions lead only to ruin.

— Han'al, Mage of the Kirin Tor, Master Lorekeeper

Welcome to **Magic & Mayhem**, a core sourcebook for **Dungeons & Dragons® Warcraft® the Roleplaying Game**. This volume presents players and Game Masters (GMs) with an in-depth exploration of the setting's two defining elements: magic and technology.

This book focuses primarily on rules and game mechanics for the **Warcraft RPG** — variants, new feats and spells and technological devices, and so forth. Previous supplements provided a taste of such things, but **Magic & Mayhem** offers up the full six-course meal. Yet despite this menu dedicated to what some call the “crunchier” aspects of roleplaying games, we do not leave story and setting behind. If anything, the magical and technological morsels served in **Magic & Mayhem** strengthen and clarify the unique atmosphere of the world of Azeroth.

How so? Well, to change metaphors, we put specific, practical tools in the hands of players and GMs that you can apply to characters and shape the feel of your campaigns. From well-known items such as *claws of attack* to newer items such as goblin army boots, from spells such as *storm, earth and fire* to prestige classes such as the bombardier, a **Warcraft** game separates itself from other d20 fantasy games through the rules and mechanics it establishes to communicate its distinct character. The races, nations and history of Azeroth are also vitally important, but it's the feats, magic items, technological devices and variant rules geared for **Warcraft** that help them come alive at the gaming table.

Magic & Mayhem dives into game mechanics and practical rules application, but it's far from a dry

rulebook — indeed, it's a lot of fun! You'll recognize many of your favorite items, spells and units from the **Warcraft** real-time strategy games, plus a wealth of fresh material created specifically for this book. In fact, along with the **Warcraft RPG** and **Manual of Monsters**, we think this weighty tome is an essential resource for any **Warcraft** game.

Full speed ahead!

Spell Slots vs. Mana Points

Ever since the **Warcraft RPG** first launched, some players wondered why it uses the d20 spell slot and spell preparation system (as opposed to, say, a mana point system). It was a design decision we made after a lot of thought and discussion.

The most significant consideration involves the portability of the **Warcraft RPG** to other d20 games. In using the d20 System's standard spell slot method, the **Warcraft** spellcasting classes and spells can be incorporated easily into nearly any d20 fantasy campaign. This encourages people to take what they want of the **Warcraft** setting without feeling that they have to play only in that setting. The same works in reverse, too. Having the spells for **Warcraft** based on the existing v.3.5 rules makes it that much easier for players and GMs to use magic from the *Player's Handbook* and other d20 sources in their **Warcraft** campaign.

Also, if you think in terms of mechanics, a mana point system does not function much differently from, say, the sorcerer's spell slot system. In the **Warcraft** RTS, for instance, a hero or unit might lose access temporarily to high-level spells after expending mana — the same situation a sorcerer faces if she has only a few low-level spells left after using up all her high-level spell slots.

Due to these considerations and others, we decided that it was best to maintain direct compatibility with the magic system for the majority of standard d20 games.

That's not to say you can't make changes of your own, of course. We encourage you to play **Warcraft** however you like. Owing to the portability of rules among d20 games, you can seek out a spellcasting system — or design one yourself! — that uses mana or some other method to reflect RTS gameplay in an RPG. The important thing, in our opinion, is to have fun and to make the **Warcraft RPG** accessible to as many players as possible.

What's the Flight Plan?

Chapter One: Flame and Faith delves into the role of magic in *Warcraft*, both arcane and divine. It discusses variant rules for arcane corruption as well as tests and ordeals for divine spellcasters, and it introduces rune magic to the *Warcraft RPG*.

Chapter Two: Prepare Yourselves! details several new feats related to magic and technology, a new core class called the runemaster and eight new prestige classes.

Chapter Three: Fountains of Mana offers a plethora of new spells for spellcasters of all types, including the new rune families and runes used by the runemaster.

Chapter Four: Destiny and Reward describes new magic items of all kinds, from weapons such as the *warden's moon sword* to wondrous items such as *Alleria's flute of accuracy*.

Chapter Five: Temple of Boom is a tinker's dream, expanding upon the rules for creating technological devices and presenting the most thorough collection of technological devices this side of Ratchet.

Appendix One: Constructs focuses upon the creatures of *Warcraft* that exemplify the coming together of magic and technology, such as the junk golem and the stone watcher.

Cross-References

Unless indicated otherwise, we use the following notations throughout to identify material from other *Warcraft* sources and to distinguish new material in *Magic & Mayhem* when necessary:

- One asterisk (*) refers to the *Warcraft RPG*.
- Two asterisks (**) refers to the *Manual of Monsters*.
- A dagger (†) refers to *Magic & Mayhem*.

Warcraft and d20

Magic & Mayhem's new rules, feats, prestige classes, spells, magic items, technological devices and constructs all advance and deepen the development of the world of *Warcraft* by bringing more of the *Warcraft* computer games into the medium of the roleplaying game. Even though the content in this book was designed for the *Warcraft RPG* setting, its compatibility with and reliance upon revised 3rd Edition rules make it work just as well in any d20 game.

So, even if you don't want a campaign set in the world of Azeroth, you can still get a lot of utility from *Magic & Mayhem* — as a player seeking new options for your character or as a GM looking for ways to inject something new into your campaign... and perhaps surprise your players!



"Welcome, my son. Come in. Bask in the glory of the Light." The priest smiled at the penitent and moved aside to let the younger man enter.

Verius returned the smile, ducked his head and moved into the chapel. A massive stained glass window depicting a Knight of the Silver Hand battling a demon dominated the small shrine. The paladin depicted looked pious and fierce, but Verius would put his gold on the demon.

"I am Father Rammal," said the priest, still smiling through his short, gray beard. His clear blue eyes glittered with kindness. "Is there anything in particular I can do for you, my son? Or have you come simply to pay your respects?"

Verius removed his heavy leather gloves and slapped them against his hand. He glanced around the empty pews. "Attendance looks rather slim today, Father."

"Yes. There have been fewer and fewer faithful of late. One would think that our triumph over the foul demons would bring more to our doorstep. But in fact it seems to be doing just the opposite. I cannot understand it."

Verius could. He quickly turned his face away so that the priest would not see the red that suddenly flashed from his eyes. As cunning as his spells were, his true nature sometimes bled through.

"Actually, Father," he said, pretending to examine the window, "there is something I would like. They tell me that you are in charge of recommending new warriors for inclusion in the Order of the Knights of the Silver Hand. I would like such a recommendation."

The smile faded from Father Rammal's face for the briefest of moments. "But, my son, I do not even know your name. I have never seen you before. How am I to know if you are a man who truly walks in the Light? Though I do not doubt your sincerity, I need at least several months before..."

The old man's words trailed off as Verius turned, his eyes burning now with their true nature revealed — a pair of orange-red orbs, with fire surrounding slit pupils.





The eyes caught Father Rammal. The eyes held the priest fast and subsumed him. The eyes, the demonic eyes, blasted all thought from the old man's mind.

"No, *human*." Verius spat the word. "I think you have known me for long enough to make your judgment, haven't you?" The priest nodded mechanically. "Now, you will go to your superiors and tell them—"

The door to the inner sanctum opened and a young elven woman backed into the chapel, leading a cleaning cart. "Father, I have finished with—" She gasped when she saw Verius. He blinked, his eyes returning to their human guise. Father Rammal groaned and wavered.

Verius turned and smiled at the newcomer. "Greetings, I was speaking with Father Rammal about joining the paladin order."

"Liar!" The woman shouted. Her voice thundered throughout the room. She drew an amulet from her robes and thrust it skyward. It pulsed with a red-gold glow. "I know you for what you are, demon!"

Even as she spoke, Verius felt his disguise melting away — his form lengthening, magnifying, until he filled half the small chapel. His massive, slug-like body pressed against the door, but Verius laughed, undaunted. "And what of it, mortal? Surely you did not seek to save *this*." Gargantuan muscles rippled as the pit lord flicked Father Rammal against a wall — or would have, if his arm had not been blasted back. Verius turned in shock to see the priest enveloped by a blue glow.

"You have made a mistake, creature!" shouted Rammal. His beard shortened until it sank into his face, his skin smoothed and changed, his ears lengthened and pointed. Golden hair tumbled to his shoulders. His priestly garments fell away, revealing a robe of red and black.

"But we are glad of it," smirked the woman, reaching for her belt. "For it has been too long since we feasted on your kind."

Verius roared as the blood elves fell upon him.



CHAPTER ONE: FLAME AND FAITH



The world of **Warcraft** is a place of ever-present magic: where sorcerers cast perilous spells that risk shattering the world, and where the steadfast servants of the gods stand in eternal vigil against threats from beyond — against the Burning Legion and the corruption that can taint even the most heroic souls. Many believe that the primary conflict on Azeroth is between human and orc; but far deeper and more constant is the struggle between arcane magic, the magic of pride and personal power, and divine magic, the magic of humility, nature and compassion.

The consequences of this conflict between the arcane and the divine have been devastating. Continents have been sundered, worlds shattered, great heroes corrupted and fallen into darkness. This conflict knows neither armistice nor treaty, for it is fought without cessation within the hearts of every creature on Azeroth.

Arcane Magic

Magic is the gift of titans to the world, a gift that comes with the highest price. Thousands of years ago, the titans placed the Well of Eternity in the center of Kalimdor to serve as a source of restoring, life-giving energy. They intended that the Well's energies would empower life of all forms to emerge on Kalimdor — plants, animals, monsters, races. After a time, the titans left Azeroth, leaving Kalimdor in the hands of the five dragon Aspects. Yet the Well of Eternity proved too great a lure to remain hidden for very long, particularly from Sargeras and the Burning Legion.

The Well was discovered by the Kaldorei, who were later known as night elves. Ever eager to uncover secrets hidden in dark places, the Kaldorei listened to the Well as it promised to give them great power. At the Well's behest, the Kaldorei learned spellspeech and used it to weave the first arcane spells. Within decades, Kaldorei mages had attained sufficient mastery over arcane magic that they built a great civilization. They founded the imperious city of Zin-Azshari, from which they extended their domination over most of Kalimdor.

Ultimately, the magic corrupted them. The Kaldorei had been a simple folk who gazed blissfully at the stars, enjoying the immortality given to them by the Well, but their haughtiness robbed them of that gift forever. Each succeeding generation be-

came prouder and more decadent, and the lust for power only made the Kaldorei more of a beacon to the Lords of the Twisting Nether. Finally, their greatest mage, Queen Azshara, cast a spell in the heart of the Well of Eternity itself — and a way was opened for Evil to invade the world. Through Azshara's breach came the Burning Legion, the most terrifying warriors in existence. This fiendish horde ravaged Azeroth, pillaging entire kingdoms, destroying all that stood in its path, mocking anyone who begged it for mercy.

When the Burning Legion ravaged the land, great heroes recognized that arcane magic posed a continuing threat to all living creatures, so they elected to destroy the Well of Eternity and put an end to arcane magic forever. Unfortunately, among their number was one Illidan Stormrage, an arcane spellcaster who dreaded the thought of losing his powers. Secretly he stole some of the Well's water and used it to create a new Well of Eternity at Mount Hyjal, thus preserving the power of the arcane. This theft allowed future elven generations to follow in the footsteps of Illidan and Queen Azshara. These elves called themselves the *Quel'dorei*, "the high elves" (for they believed that their mastery of the arcane elevated them to higher status). They also taught the arcane arts to the newly discovered race of humans, who showed a natural aptitude.

These human mages, however, were even more reckless than the night elves had been. The high elf mages warned their human pupils that magic was addictive, but the acolytes dismissed any suggestion that the tragedies that had befallen the elves would also afflict them. The humans were no better at resisting corruption than the elves had been, and eventually the arrogance of wizards brought the Burning Legion to Azeroth once more. Once again, great acts of heroism were needed to spare Azeroth from destruction.

Elsewhere, on the orcish home world of Draenor, arcane sorceries corrupted the once-noble race of orcs, transforming them into the Horde, a nigh invincible army. After ravaging their home world, the orcs came to Azeroth; and with their warlocks, they waged two great wars against the races of human, elf and dwarf. The orcs failed to seize control of Azeroth; during these wars, Draenor itself was utterly destroyed, and the orcs were forced to relocate to Azeroth.

In the wake of the Third War against the lich Ner'zhul and the Burning Legion, the orc Warchief Thrall has rejected arcane magic and embraced his race's traditional shamanistic ways. Yet orc warlocks still walk the world, and demons whisper in their ears each time they cast a spell. Neither humans nor high elves have abandoned the pursuit of the arcane; if anything, the defeat of the Burning Legion at the Battle of Mount Hyjal has fed the arrogance of many spellcasters, who believe that the world is now protected from demonic influences and that arcane spellcasters may practice their art in relative safety.

Nothing sows the seeds of the fields of tragedy quite like arrogance.

Spellcasters

Arcane spellcasters come in many different flavors, most of them unpleasant. Sorcerers and wizards are the most common; wizards control magic through careful study, while sorcerers command magic through instinctual mastery. There are other arcane spellcasters, less common but more dangerous: warlocks, a class dedicated to summoning demons and interacting with the worlds beyond Azeroth; the graven ones, whose necromantic abilities make them natural allies of the Scourge; and the runemasters, whose approach to arcane magic may be the safest yet discovered.

The Four Laws

There are four important rules to remember about the use of arcane magic in Azeroth.

- *Magic is Powerful.* Magic in the **Warcraft RPG** is the difference between a slave and a master, a foot soldier and a king. Few races and nations can operate without powerful mages and warlocks. The use of arcane magic is growing; historically, each time this has happened before, a great disaster shortly follows. However, even though the history of the arcane is well known, mages and their patrons invariably come to the same self-serving conclusion: *It won't happen to them.*

- *Magic is Corrupting.* Magic corrupts the soul; if the humblest person on Azeroth became a practitioner of the arcane, by the time that prac-



tioner reached the higher levels in her art, all traces of her humble roots would be lost. Magic breeds pride and arrogance. Magic corrupts the body; it ages the caster before her time and hastens the blight that the world inflicts on things fair and beautiful.

- *Magic is an Addiction.* When one feels the power of an arcane spell coursing through one's body as it's being cast, resisting the urge to cast it again is difficult.

- *Magic Attracts the Twisting Nether Like Flies to Honey.* The Burning Legion has invaded Azeroth three times, drawn by the power of the Well of Eternity and those who employ it. Magic is a literal gateway drug that allows dark titans such as Sargeras to bring evil influences to the world. Those who employ arcane magic must deal with demons and other servants of the Twisting Nether.

Variant Rule:

Arcane Corruption

The *Warcraft* RPG does not include explicit rules that govern arcane magic's corrupting influence on characters, as imposing evil and madness on PCs does not necessarily make for a fun gaming experience, and players should be able to play arcane spellcasters who (with a few sensible precautions) need not worry about corruption effects. However, arcane corruption is a part of the world of *Warcraft*, and those GMs who think that it might add an interesting twist to their games may wish to employ the following optional system.

Arcane spellcasters may, under certain circumstances, be forced to make a Corruption check. A Corruption check is a Will save made against a target number; if the character fails this save, he suffers Arcane Corruption damage.

A character has an Arcane Corruption allowance equal to his Wisdom plus his total character levels. In essence, this number represents the "the hit points of the soul" — when a character takes Arcane Corruption damage, this number drops. When a character's Arcane Corruption allowance reaches zero, the character drops one Corruption category and receives a Corruption Effect. Corruption Effects might include delusions, infirmities, madness and addiction depending on the spellcaster's preferred school of magic. Corruption categories are (from best to worst) normal, tainted, marked, defiled and complete.

If a situation triggers more than one Corruption circumstance (such as casting a spell at the caster's highest spell level in the presence of a demon), the caster only needs to make a single Corruption check. Use whichever circumstance has the highest potential Corruption total.

Because sorcerers directly channel arcane energy, they're more prone to Corruption than wizards. Sorcerers receive a -2 penalty on their Corruption checks. On the other hand, runecasting slightly mitigates the corrupting effects of arcane magic; runemasters receive a +1 bonus on their saves.

Maximum Spell Level: When an arcane spellcaster casts a spell at the highest spell level he possesses (such as a 1st- or 2nd-level wizard casting a 1st-level arcane spell, a 3rd- or 4th-level wizard casting a 2nd-level arcane spell, a 5th- or 6th-level wizard casting a 3rd-level arcane spell, and so forth), he needs to make a Corruption check against the listed DC.

If the character casts more than one spell at his maximum spell level, the DC of the check is increased by +1 (e.g., a 5th-level wizard who wishes to cast a 3rd-level arcane spell must make a DC 8 Corruption check the first time he casts that spell, a DC 9 check the second time he casts a spell of that level, and so forth). This penalty is removed after the caster rests for 8 hours.

Unlike other effects, corruption triggered by Maximum Spell Level does not accumulate; once a character has reached a tainted Corruption category, this circumstance no longer causes the spellcaster to lose additional points from his Corruption allowance.

Spell Prepared for the First Time: When an arcane spellcaster casts a spell she has never cast before (such as a new spell she's learned for advancing in levels, researched or copied into her spellbook), she needs to make a Corruption check to acclimate herself to the spell.

Spell Cast Near a Fel Weapon: Because of the demonic origins of fel weapons, a spellcaster is vulnerable to low levels of Arcane Corruption when he casts an arcane spell within 30 feet of them. A person can only be affected once in a combat by this circumstance.

Spell Above Caster Level Cast From a Scroll: If a caster attempts to cast an arcane spell that's above the level she can normally cast (such as a 5th-level wizard attempting to cast a 4th-level spell from a scroll), or any arcane spell (if she is a non-spellcaster employing

Table 1–1: Arcane Corruption Check Circumstances

Circumstance	Save	Corruption
Casts a spell at his maximum spell level	Will (DC 5 + spell level) Additional circumstance/day	1 +1 DC (cumulative)
Casts a spell that he's prepared for the first time	Will (DC 10)	1d3
Casts a spell near a fel weapon	Will (DC 10)	1d3
Uses an arcane spell above his caster level from a scroll	Will (DC 10 + spell level) Additional circumstance/day	1d4 +2 DC (cumulative)
Casts a spell on unholy ground or in the presence of minor demons	Will (DC 13) Additional circumstance/day	1d6 +2 DC (cumulative)
Casts a 1st–3rd level spell that contacts the Twisting Nether	Will (DC 13) Additional circumstance/day	1d6 +1 DC (cumulative)
Casts a bonus spell per day as a result of a Nether Whisper	Will (DC 15 + spell level)	1d6
Casts a pushed spell	Will (DC 15 + spell level) Additional circumstance/day	1d6 +5 DC (cumulative)
Casts an enhanced spell	Will (DC 15 + spell level)	2d4
Casts a 4th–6th level spell that contacts the Twisting Nether	Will (DC 18) Additional circumstance/day	2d6 +3 DC (cumulative)
Casts a spell in the presence of major demons	Will (DC 18) Additional circumstance/day	2d6 +3 DC (cumulative)
Casts a spell in the presence of a Lord of the Twisting Nether	Will (DC 20) Additional circumstance/day	3d6 +3 DC (cumulative)
Casts a 7th–9th level spell that contacts the Twisting Nether	Will (DC 20) Additional circumstance/day	3d6 +3 DC (cumulative)
Casts a spell that taps a major source of arcane power	Will (DC 25)	5d6

a class ability to use magic devices), she needs to make a Corruption check.

Each additional circumstance imposes an additional +2 DC penalty, which is cumulative with further attempts. This penalty is removed after the caster rests for 8 hours.

Casting a Spell on Unholy Ground or Near Demonic Presences: It's especially dangerous to cast spells on ground that's been *desecrated* or within 90 feet of minor servants of the Twisting Nether (CR 8 or lower). This condition includes casting spells in the vicinity of a familiar who originates from the Twisting Nether; wizards who employ such creatures are almost always corrupt.

A more difficult Corruption check is required if someone casts a spell within 150 feet of a major servant of the Twisting Nether (CR 9 to CR 16), and a very difficult one is required if someone casts a spell within 300 feet of a pit lord or a being of similar stature (CR 17 and above).

Repeated castings under these conditions require additional Corruption checks, with penalties applied cumulatively.

Contacting the Twisting Nether: Any spell that contacts the Twisting Nether (such as a warlock's summoning spells, or a *gate*) holds the possibility of causing great corruption.

This condition also applies to casting spells with the fel descriptor.

Nether Whisper: Because of the ambient arcane energies unleashed during the breaking of the world long ago, Azeroth is never silent for anyone who practices arcane magic, for the incantations of every spell ever cast remain as echoes on the wind. These voices, discernable by any arcane spellcaster who strains to hear them, are the nether whisper. As with other forms of arcane magic, it is used by the marshals of the Twisting Nether as a tool of corruption.

If a spellcaster has a spell slot that has not been expended, he can listen to the nether whisper and

replace that slot with any spell of the same spell level that is normally available to him (in his spellbook or repertoire). Thus, a wizard who has both *sleep* and *mage armor* in his spell book but who only has prepared *sleep* may listen to the nether whisper and change the spell from *sleep* to *mage armor*.

Anyone trying to listen to a nether whisper must make a Concentration check (DC 20 + spell level) to hear the voice of the arcane. A successful check indicates he's heard (and recognizes) a new incantation that allows him to switch spells. Failing this check causes the spellcaster to lose the original spell. Listening to the nether whisper is a free action, but the new spell must be cast in the same round, or it is lost. Listening to the nether whisper also requires the caster to make a Corruption check to avoid negative effects.

A nether whisper spell uses the material components (if any) of the spell that was originally prepared in that slot. A spellcaster may only listen to a nether whisper once per day.

Pushed Spells: A spellcaster may “push” a spell, recklessly tapping into the ambient forces of the arcane in the world without any caution; doing so increases the DC of its saving throw by +3, and incurs a Corruption check.

The number of times a spellcaster can push a spell each day is equal to her Intelligence modifier.

Enhanced Spell: Similar to pushing a spell (but even more perilous) is the practice of tapping into the ambient arcane energies of Azeroth to enhance a spell. This is a more dangerous variation on the high elves' empowered magic ability (see *Warcraft RPG*, Chapter Two, “Elf, High”) that allows a caster to add *any* single metamagic feat to a spell, once per day, without incurring the normal spell slot penalty.

Casting a Spell near a Major Source of Arcane Power: As Queen Azshara discovered, tampering with primal sources of arcane energy can be perilous. If any spell is cast within 30 feet of a small quantity of water that is tainted by the Well of Eternity, or within 120 feet of a larger source, the caster becomes susceptible to massive amounts of arcane corruption.

Oddly enough, thanks to the World Tree, the Well of Eternity itself no longer provides the Twisting Nether with such a potent source of corruption.

Corruption Effects

If a character's Arcane Corruption allowance is higher than zero, he does not suffer any ill effects.

However, when a character has been exposed to sufficient Arcane Corruption to become *tainted*, he gains a minor Corruption Effect. This is a physical or psychological blemish that remains on the character until removed by divine healing. A character may only have one minor Corruption Effect at a time. Once a character is tainted, his Arcane Corruption allowance is reset to its maximum value.

When a tainted character's Corruption total equals zero again, he is *marked* by the arcane. He receives a moderate Corruption Effect, which is a more serious blemish. Moderate Corruption Effects stack with minor ones; they also require divine healing to remove. A character may have no more than one moderate effect at a time. Again, once a character is marked, his Arcane Corruption allowance is reset to its maximum value.

When a marked character's Corruption drops to zero or below his arcane corruption allowance, he is *defiled* by the arcane. He receives a major Corruption Effect, which is an extremely serious blemish — by this point, the character will find living a normal life extremely difficult. Major Corruption Effects require very powerful divine healing to remove, and they stack with both moderate and minor ones.

When a defiled character's Arcane Corruption allowance drops to zero or below, he's beyond redemption. He becomes totally dedicated to bringing the Burning Legion to Azeroth (or, in the case of necromancers, serving the Scourge), and is no longer available as a player character (PC).

When a character receives a minor Corruption Effect, his personality becomes noticeably colder and more callous. By the time he receives a major Corruption Effect, his desire to do good has been thoroughly eroded; even when he's in control of his actions, he's arrogant and self-centered, and often willful and malicious (especially if he perceives that someone is hostile toward arcane magic).

The Corruption Effect that a character receives depends on the type of magic he most commonly employs. Select the appropriate school based on the PC's favorite spells (or just choose one that looks interesting).

Abjuration

Minor: The character becomes a magic addict. He must spend a 10 minute period each morning resisting the effects of addiction or suffer a –1

penalty to caster level for all spells and a -2 penalty on all saving throws against spells and magical effects. The character will become noticeably more distrustful of strangers, often ascribing the worst possible motives to their words and deeds.

Moderate: The character becomes notably defensive. He shuns intimate contact with others, and he will not willingly make physical contact with anyone in *any* circumstances, even to save a close friend's life or to cast a touch spell against an enemy, though he may override this effect by making a DC 15 Will save. He becomes notably suspicious of food and drink, and will not share his fare nor eat food offered by others.

Major: The character becomes extremely defensive, if not paranoid. He becomes reluctant to travel or to perform any action that might be considered dangerous (Will DC 20 to resist). He will be extremely suspicious of others, and must struggle to make any social contact with others whatsoever.

Conjuration (all)

Minor: The character becomes a magic addict. She must spend at least an hour each day meditating in a room surrounded by conjuration symbols, or she will suffer a -1 penalty to caster level for all spells and a -2 penalty on all saving throws against spells and magical effects. Whenever possible, such characters will wear robes inscribed with magical symbols, and their fashion tastes may become noticeably gaudy.

Conjuration (Calling/Summoning)

Moderate: The character becomes unnaturally attached to creatures that she summons. She will treat them like extremely pampered pets, doing anything they tell her to do (she may resist this effect with a Will save against DC 15). Her summoned creatures mean everything to her; and if it looks like they are in danger, she'll gladly risk her life to protect them, even pitting herself against close friends. If her summoned creatures are killed, she may experience a mental breakdown.

Major: The character becomes an unintentional focus for summoned creatures. Once per day, at a random time, a *summon monster* spell of the highest level available to the caster will be spontaneously cast within 2d12 miles of her. This effect does not use any of the spellcaster's spell slots and is inde-

pendent of her control. The summoned creature originates from the Twisting Nether and will wreak havoc in whatever manner is appropriate to it. The caster may command this creature as she can normally command creatures brought forth by her *summon monster* spell, though she's normally unaware when this sort of summoning occurs.

The caster will be very tempted to ally herself with demon-worshipping cults, and the creatures she's summoned will encourage associations with the Burning Legion every chance they get.

Note: Characters who are responsible for summoning creatures from the Twisting Nether are usually not very popular with local rulers or the general populace.

Conjuration (Creation)

Moderate: The character becomes obsessed with magically created objects, viewing them as superior to objects of natural origin. Whenever feasible, the character will live in places created by magical spells and eat food created by magic. Any attempt to harm a construct or refuse a magically created gift (even if it's magically created food from someone who's likely to poison him) requires a DC 15 Will save.

The character takes on an artificial appearance, as if his face had been carved out of highly polished wood.

Major: Works created by the caster take on sinister overtones: statues whose eyes track your movements, intelligent weapons that continuously bombard their wielders with bloody thoughts, and the like. The spellcaster becomes insanely possessive over anything he creates (either magically or through a Craft skill); sharing the fruits of his labors requires a DC 20 Will save, and he will always begrudge any such generosity.

High-level wizards who reach this point of Corruption often attempt to create magical vessels in which to place their souls.

Conjuration (Healing)

Moderate: The character fails to heal by natural means, but must use magic (either arcane or divine) to effect any healing. The character's skin is always cold to the touch; and except when she has recently bathed, there is always a slightly rotten odor about her.

Major: The character's flesh becomes rotten and decaying; if she does not receive healing magic, the

disfigurement becomes obvious within one day and difficult to stomach within a week. Whenever she sees healing magic being used on anyone but herself, she flies into a violent rage unless she makes a DC 20 Will save.

Conjuration (Teleportation)

Moderate: Whenever the character teleports, he briefly passes through the Twisting Nether. She must make a DC 15 Reflex save or a random creature from the Twisting Nether will attach itself to the caster as he teleports and materialize at his destination. This creature does not count as part of the caster's weight allowance for the spell, and the caster has no control over the creature.

Furthermore, any failure result for a teleport spell will result in the caster and anyone accompanying him being trapped in the Twisting Nether.

Major: Whenever the character sleeps, he must make a DC 20 Will save or teleport 2d6 miles in a random direction from his current location. This effect does not require a spell slot or any material components, and the character has no control over this spell.

Divination

Minor: The character becomes highly superstitious. She is terrified of performing an action that is proscribed by her culture's customs. These superstitions can be ignored by making a DC 13 Will save but they will occasionally inconvenience the character in play. Come up with a list of five or so appropriate superstitions for the PC's culture, such as:

- Never speak for a full minute after hearing a dog or wolf's howl.
- Never touch a black cat or let it cross your path.
- Never speak the orc Warchief's name aloud without taking a drink.
- Never accept a spell from a stranger without knowing his name.
- Always pay in silver and gold, never in copper.
- Never eat food that has been cooked in a metal pot on the last day of the week.

Moderate: The character becomes obsessed with fortunes and auguries. Performing any significant act that has not first been approved with an augury requires a DC 15 Will save, and a DC 20 Will save is needed to perform any action that goes against an augury.

Major: The character is completely ruled by auguries, portents and other superstitions. She will not

deal with anyone unless she's first consulted an augury, not even someone who was a close friend. The character will indulge in bizarre, extreme and even violent behavior if an augury tells her such behavior is required (Will DC 20 to resist, yet even then she'll remain suspicious).

Enchantment

Minor: The character becomes a magic addict. He must spend at least an hour each day meditating or suffer a -1 penalty to caster level for all spells and a -2 penalty on all saving throws against spells and magical effects.

Moderate: Whenever feasible, the character will live in places enhanced by magical spells and eat food created by magic; he will not use a weapon unless it is enchanted. He is so enamored of enchantments that he cannot bring himself to cast *dispel magic* or a counterspell, even to save himself, unless he makes a successful DC 15 Will save first.

Major: The character finds coexisting with creatures that have free wills very difficult. Wherever possible, the character will use *charm* and *dominate* spells to bring the people around him under his control. A simple difference of opinion is likely to throw the character into a rage. If the character has a serious disagreement with someone, she must make a DC 20 Will save or attack the subject; likewise, anyone who resists (or breaks) his spells will probably become the target of a vendetta.

Evocation

Minor: The character's body is warm to the touch, and maintaining intimate contact with her for more than a full round is difficult (any spell that protects against heat and fire will allow someone to ignore this effect, as will a successful DC 13 Fortitude save; creatures grappling this character may also ignore this effect). Metal objects, cats and furs within 60 feet of the character accumulate minor static electricity charges (which will do no damage but may surprise people).

Moderate: Weather in a 1-mile radius around the character is seldom sunny or cheerful. If there's a windstorm, it will intensify around the character's location; if there's a thunderstorm, lightning will repeatedly strike buildings or trees near the character. The character will enjoy stormy weather and become depressed when things are calm and peaceful. People who are incapable of casting evocation spells are viewed as inferior and treated derisively.

Major: The character becomes prone toward committing violent acts in stormy weather. When she sees fire, even a candle, her instinct will be to spread it around; when she's caught in a storm, she'll venture out into the middle of it (Will DC 20 to resist). The character will view the peril of those endangered by natural forces, even if magically evoked, as part of the natural order and will not attempt to save them. If her evocation spells cause collateral damage, she will feel no remorse and make no effort to rectify or atone for her actions.

Illusion

Minor: The character hears voices at odd times. They occasionally lead him into dangerous places or try to trick him. The character may use a free action to make a DC 13 Will save; if successful, he will realize the voice was an illusion.

Moderate: When the caster casts illusion spells, he also becomes convinced the effects are real. Reminding himself of the magical nature of his illusions requires a standard action and a DC 15 Will save.

If the character has murdered someone, he will be tormented by a "ghost companion" who appears to him (and only him), mocks him, and engages in long, philosophical conversations that encourage him to perform more violent and evil actions. If the character is in a moral crisis, the "ghost" will help find as many rationalizations for evil behavior as possible. A concerted effort of will (a standard action and a successful DC 15 Will save) dismisses the ghost until the character goes to sleep.

Major: The character finds distinguishing between fantasy and reality difficult, and is constantly bedeviled by visions of friends betraying him, conspiring against him, and committing other acts that are prone to provoke a violent (or evil) response. If a PC suspects that she perceives a vision, she must take a full-round action and make a DC 20 Will save to break through the vision and behold reality. Spells such as *true seeing* will also penetrate this type of delusion.

Necromancy

Minor: The character's flesh is cold to the touch. Wounds and blemishes, unless immediately treated, take on a rotted, infected appearance.

Moderate: The character fails to heal by natural means, but must use magic (either arcane or divine)

to effect any healing. In a 60-foot radius around the character, the air feels like the proverbial grave. Animals will shun this area unless directed by a rider (no Ride check is necessary) or a master, and any Will saves against fear are made with a -1 penalty. A *detect undead* spell will detect a faint aura around the character.

Major: The character now prefers death to life. He sleeps in coffins or surrounded by the undead. He has trouble tolerating living creatures. If he sees anyone attacking an undead creature, even if that person is attempting to defend him, he must make a DC 20 Will save to suppress the urge to defend the undead. The character will look sympathetically upon death cults and seek the secrets that will allow him to transform himself into a lich. Such characters are almost certain to look upon the Scourge with favor.

Transmutation

Minor: The character's looks are badly blemished. Warts form on the character's face, while boils and abscesses appear on other parts of the character's body.

Moderate: The character grows an extra finger on each hand and an extra toe on each foot. Other abnormalities include an extra nipple or a birthmark that looks like an infernal rune.

Major: Bizarre growths appear over the character's body, including eyestalks, vestigial hands growing out of the elbows and knees, mouths appearing in the center of the character's stomach, and so forth. Other people see the character as hideous and deformed, but the caster views these changes as vast improvements and is prone to get angry when "insulted" unless she succeeds at a DC 20 Will save.

Healing Corruption

Getting rid of Arcane Corruption is a very difficult process.

Going for a week without casting an arcane spell restores a single point to the character's Arcane Corruption allowance. If the character spends that time in natural surroundings, undisturbed by any exposure to arcane magic, the number of points restored increases to 2d3.

An *atonement* spell, accompanied by an appropriate sacrifice or quest, will remove 1d6 points of Arcane Corruption, plus 1 point per two caster levels (rounding fractions up). A *wish* or *miracle*

spell will restore an Arcane Corruption allowance to its maximum value.

The Corruption Effects are more difficult to eliminate. A minor effect is only removed with a *restoration* spell, a moderate effect is removed with a *greater restoration* spell, while a major effect is removed with a *touch of life** spell. Removing the worst Corruption Effect will also bring the character down one Corruption category (from defiled to marked, marked to tainted, or tainted to normal).

A Cautionary Note

For an arcane spellcaster to reach high levels without falling victim to corruption may seem impossible. While the feat is indeed difficult, many mages have, by taking a few precautions, lived long, healthy and untainted lives. Those who boldly (and stupidly) ignore the inherent corruptions of arcane magic are most prone to fall. The GM should be careful not to penalize a cautious character with excessive amounts of Arcane Corruption.

Divine Magic

Most of the divine beings of Azeroth (known as Eternals) are distant entities. They exist to assist those caught in the conflicts of a cruel, violent world. Never directly intervening in the affairs of the world, they use divine magic as a proxy. With their many healing and protective spells, practitioners of divine magic are at the vanguard of the gods' efforts to ensure their peoples' survival.

Divine magic is not wholly the province of the gods; it draws on a wide variety of sources depending on the faith of the practitioner. Priests whisper prayers to evoke power from beings such as Elune the Moon Goddess. Healers bask in the good will provided by the religion of the Holy Light. Under the awesome sky, shamans call upon the natural order to empower their spells and heighten their understanding of the world. Witch doctors summon ancestral spirits and tribal protectors. Shadow hunters invoke the names of dark gods, ancient powers whose legends are stained in cruelty and bloodshed, but who are also capable of benevolence when appeased. Druids of the wild bond with plants and animals and draw on the magic power inherent in the natural world.

Though the sources of divine power are varied, its use has one constant: faith. Effectively wielding

divine power requires tremendous conviction; the dedication required to achieve such perfect faith is a lifelong pursuit. Unlike arcane spellcasters, who believe that power exists to be *taken*, divine spellcasters must constantly affirm that they are *worthy* of their gifts. They must be certain that they are properly honoring their gods, philosophies, ancestors or convictions. Perfect faith requires intense training and constant testing, which continues throughout the practitioner's lifetime. Of the many tests that a practitioner must face, two of the most common are ordeals and trials of faith.

Ordeals

When a divine spellcaster needs to test his convictions, he arranges to face a special personal challenge in which he affirms his faith by enduring torment.

The specific challenge depends on the practitioner's background. A druid of the wild or a shaman might journey into the wilderness and survive storms of preternatural intensity without magical aid. A healer might lock himself in an enclosed area with plague victims and share their meat and water. A shadow hunter might venture onto grounds consecrated to the Old Gods and spill his own blood to entice the forces of primeval cruelty to come and visit their worst afflictions upon him.

A member of the priest prestige class has particularly bizarre ordeals. Submission to public stoning or burning is common, but the most noteworthy — and sadistic — ordeal is the ritual of shaming. In this rite, which is held in the priest's home community among family and friends, the priest is locked in shackles and stocks and subjected to a full day of mockery and physical torture. By enduring the cruelest human impulses, the priest demonstrates the unwavering power of his faith, and (by continuing to serve the community after enduring its torture) the virtue of forgiveness. Thereafter, the priest symbolically bears the burden of the people's transgressions. Wounds inflicted during this ordeal — and it's almost certain there will be wounds — must heal naturally. The scars inflicted during this trial will be left untouched as a reminder of the sustaining power of faith.

A practitioner doesn't endure an ordeal for rewards, but to affirm his faith. However, the renewed confidence in his ability to serve as his faith's

champion does impart one tangible benefit, known as the benefit of grace: after surviving an ordeal, the priest may choose to substitute a Will save for any other type of saving throw. This substitution must be declared before the roll is made. This benefit may only be used once per ordeal; although this may seem like an insultingly small reward for enduring such great pain, the benefit of grace has been known to save practitioners' lives.

Ordeals are initiated by a PC when he feels a need to demonstrate his faith. They should be rare events in a PC's life — most reasonable people think that an adventurer's career holds more than enough ordeals to demonstrate faith — and those who submit to them more than a few times in a decade (and more than once per year) are considered showy and gauche (at the GM's option, they may no longer receive the benefit of grace).

Tests of Faith

The people of Azeroth believe that faith is one of the noblest qualities that a person can possess, but anyone who puts her faith into practice is required to prove it. Periodically, a situation may occur in which a practitioner of divine magic must choose between her own personal safety (and her friends' and comrades') and the principles of her religion. A healer might be forced to choose between healing someone who's threatened to kill her or leaving the villain to die. A druid of the wild may be asked to protect a seemingly insignificant grove of trees — and take up arms against her friends who have been driven from their homes and are trying to fell the grove to build a new town. A human priest may be compelled to offer hospitality to the first visitor who asks, only to discover that her visitors are wild orcs, whose revels tear her home apart even as she's obliged to serve their every whim.

The practitioner will not be aware that she is being tested until after the test is completed. The test can be illusory (an illusion sent by the divine) or real, although the more dangerous tests are likely to be illusory.

If the divine spellcaster fails the test, she receives a -1 penalty to her caster level for the next month and will be forced to acknowledge publicly her failure and make penance before others of the faith. The GM may add additional consequences (such as a stigma scar to mark the test's failure, the need to perform an atone-



ment quest, or exclusion from the faith's most sacred rituals and benefits). A test of faith is a major event in a character's life, and the player should understand this and roleplay the consequences of the character's failure; anyone who takes such a failure in stride invites more severe penalties (such as higher penalties to caster level or a -2 luck penalty on all skill checks) from whatever empowers her faith.

If the test succeeds, then once each day the practitioner may cast a spell as if it were augmented with the Empower Spell feat without incurring the normal spell slot penalty. This benefit lasts for 1 month after the test.

The GM must devise tests of faith and determine what conditions are needed to pass. A test may occur at any time in a divine spellcaster's career, but most often when her dedication to her cause appears to be flagging. When a practitioner spends more time socializing with friends than pursuing the goals of her faith; when her response to the desecration of a church, sacred grove or ancestral tomb is half-hearted or ineffectual; when she shows reluctance in standing up for her beliefs: the powers may choose that time to test her mettle.

A test of faith doesn't occur more than once each year; usually a divine practitioner will be tested once every 5 to 10 years. However, a GM who has a special destiny in mind for a divine practitioner may present the PC with a steady stream of challenges. Though at the time it may seem like the world has turned against her, in the end the reward is usually well worth the suffering. The ability to endure the worst trials of the gods without flinching is a hallmark of the greatest heroes of legend.

Fel Energy

The ultimate manifestation of the demonic arcane on Azeroth is fel energy. This energy, which most commonly manifests itself as ghastly, green-yellow flame, is arcane magic at its most corrupt, for it employs the blood of demons. Spells with the fel descriptor are very difficult to resist. Casters gain a +10 fel bonus on caster level checks made to penetrate spell resistance, and the DC of saving throws increases by +2. Casters who cast fel spells also risk massive amounts of Arcane Corruption.

Casting a fel spell is described by many spellcasters as a euphoric experience. If arcane magic is an addiction, fel magic is the embodiment of the drug in its purest form.

Since the Burning Legion returned to Azeroth, the world's heroes have encountered fel weapons and fel magic with increasing frequency. As demon cults continue to fester and grow in Desolace, the Ashenvale Forest and other remote corners, gruesome sacrifices are held to entice demons into giving their blood in trade. The cultists use this blood to enchant the weapons that they hope will bring about their masters' ultimate victory.

Fel Offerings

Demons sometimes tempt spellcasters by offering small amounts of their blood in exchange for services. If the recipient drinks the demon's blood within 24 hours of the offering, then the next arcane spell he casts will be a fel spell.

Fel blood is highly addictive as well as corruptive. Anyone who drinks it must make a DC 13 Will save or become dependent on fel blood. Unless the person consumes fel blood daily, he will suffer a -1 penalty to caster level for all spells and a -2 penalty on all saving throws against spells and magical effects; after 7 days, he may attempt to make a DC 15 Will save to break the addiction.

Fel Poison

Fel-poisoned creatures are another threat from the Twisting Nether. They are starting to appear in places where the Burning Legion is strongest. When a creature with a natural poison attack is imbued with fel energy, its venom becomes more difficult to resist. Take the normal DC of the venom and add the bonus appropriate to the creature's Hit Dice, as indicated in the chart below.

Hit Dice	DC
Up to 1	+2
2-3	+4
4-7	+6
8-15	+8
16-31	+10
32-63	+12
64-127	+14

Rune Magic

A rune is an arcane symbol inscribed on a creature, surface or object. Runes inscribed on creatures are called marks; those on surfaces are sigils; and

those on objects are glyphs. Runes exist in groups called families, which are composed of ten runes from 0-level to 9th level in power and include a rune family power. When a rune inscriber knows a rune family, she also gains that rune family's power.

Rune inscribers have rune slots, but do not need to prepare runes in advance. An inscriber knows a certain number of rune families and thereby knows one rune per level from that family. The inscriber creates any rune she knows using a proper rune slot each time a rune is inscribed. All runes take a full-round action to inscribe unless the rune description says otherwise, and they all require a somatic component (the rune must be drawn) and material components (magical inks applied with masterwork brushes). No runes ever require a verbal component. As well, some runes have additional material or experience requirements; see the specific runes in Chapter Three for more information.

Inscribing a rune requires physical contact with the target and provokes an attack of opportunity. If something interrupts the inscriber's concentration, she must make a Concentration check or lose the rune. The rules are the same as for casting a spell, so if the check fails then the rune is lost just as if it had been created to no effect.

The effects generated by runes are like arcane spell effects and as such are subject to spell resistance unless stated otherwise in the rune's description. A rune's effect can be dispelled or counterspelled, although rune slots cannot be used for counterspells. The caster level of a rune effect is equal to the level of the inscriber who created the rune.

Types of Runes

Marks are runes inscribed on a creature. The subject must be still, so marks cannot be inscribed on unwilling creatures; however, a mark can be inscribed on any helpless creature. Marks generate their effects immediately upon completion. Some inscribers have the ability to delay mark activation or even to make a mark permanent.

Glyphs are runes inscribed on an object. As with marks, a glyph cannot be inscribed on an object in the possession of an unwilling creature. Glyphs activate immediately upon completion. Again, some inscribers are able to extend the life of a glyph or even to make one permanent.

Sigils are inscribed on a surface that subsequently acts as the rune's trigger. The affected surface is always a 5-foot by 5-foot area, and the first creature

to enter the space with a sigil activates it, even if the creature is unaware of the sigil. (Leaving a space that contains a sigil does not activate it.) Sigils last until triggered, dispelled or erased. The inscriber can choose to activate a sigil upon its completion as part of the final inscription process. An activated sigil always generates a 30-foot-radius burst centered on the rune, affecting all creatures in its area unless stated otherwise in the rune's description.

Detecting Runes

Some creatures can see runes. The trapfinding ability of rogues can be used to locate hidden runes (Search DC 25 + the rune's level). *Detect magic* will sense a rune, but not reveal it visually. Creatures with ranks in the Knowledge (runes) skill can make a skill check to identify by name and function a rune they can see. Moreover, creatures with the erase runes (see the runemaster in Chapter Two) or trapfinding abilities can use the Disable Device skill to erase a rune without activating it; as with magic traps, the DC is 25 + the rune's level. If the Disable Device check beats the DC by 10 or more, the creature may bypass the rune (with his group) without erasing it. Normal runes require 2d4 rounds to erase; permanent runes require 1 day.

Extended or Permanent Runes

Extended or permanent marks on a creature are obvious: they appear as tattoos. Extended or permanent sigils and glyphs are difficult to see. An inscriber must intentionally make such runes visible, otherwise they become almost invisible (to most people) the moment they are completed.

If a character is capable of inscribing permanent runes, follow the same pricing rules as for crafting wands. The base price of a permanent rune is 375 gp x the rune's level x the inscriber's level. The inscriber pays half the price in raw materials and 1/25 of the price in XP. The inscriber pays 50 times the normal rune's additional material and XP costs, if any. Inscribing a permanent rune requires 1 day per 1,000 gp of the base price.

Creating Rune Families

Creating new rune families is quite easy. Rune families are collections of ten runes that share a similar focus. First, decide what the focus of your rune family will be. Second, choose ten spells ranging in power from 0-level to 9th level. Third, choose a rune family power; it

should be something in the flavor of the rune family spells you have chosen.

For each spell in your new rune family, check to see if it targets a single creature, multiple creatures, or something else. Spells that target a single creature get turned into marks, spells affecting multiple creatures become sigils, and spells affecting objects become glyphs.

The school of magic remains the same. Generally, it's a good idea to use the spell's level as the rune's level, though in rare cases a rune becomes more or less powerful than the same spell just by turning it into a rune. Adjust the rune's level if you feel it necessary.

Regardless of the spell's components, a rune never has a verbal component, though runes always include somatic and material components. If a spell includes a costly material component or XP cost, impose the same cost on inscribing the rune.

A spell that requires a standard action or full-round action to cast becomes a full-round action to inscribe. Spells that take longer than a full round to cast should also take longer to inscribe as a rune.

As stated above, a sigil targets a surface. When a sigil activates, it affects a 30-foot-radius area. Com-

pare the level of the spell, its effect, and its normal area to see if this is too weak or too powerful. Adjust the sigil's area of effect as necessary to keep its power in check.

The saving throw and spell resistance of a rune should be the same as the spell. This often means there will be a "Will negates (harmless)" or "Fortitude negates (harmless)" saving throw, and spell resistance of "Yes (harmless)."

The magic within a rune comes from the arcane symbol itself and not from the inscriber. Rune effects never include level-dependent effects, such as variable duration or dice rolled per level, and they very rarely include variable effects of any kind. The duration of a rune's effect is always a static value. Generally, as long as the effect remains balanced, design 1st- through 3rd-level rune effects as though generated by a 5th-level caster, 4th- through 6th-level rune effects as though generated by a 10th-level caster, and 7th- through 9th-level rune effects as though generated by a 20th-level caster. For example, a 4th-level spell with a normal duration of 1 round/level would instead last 10 rounds as a rune.



"I can't believe we managed to get out of Ratchet without an inspection!" Jocas Irongear reached into his tool-laden pack and drew out a bottle wrapped in thick layers of cotton. "I've been saving this bottle of Shady Rest Ale since we left Theramore. Time to celebrate!"

"Silence, goblin!" hissed Blackhawk. The warden's eyes pulsed with a green fire as she scanned the shadows of the zeppelin's cargo hold. Her hand snapped from beneath the folds of her cloak and a trio of knives flashed through the air. A chittering hiss erupted from a wooden crate, Blackhawk's blades buried hilt-deep in its side. "We've been misled about the nature of our cargo," said the warden. "Tauren, open the crate."

Ashar stepped forward and raised his axe in a mighty stroke. Blood and ichor mixed with splinters on the deck as the crate dashed apart, revealing the corpse of a carrion beetle. The spiritwalker turned back to his companions. "That is not spices," he growled.

"Another piece of Ghosthoop wisdom," said Jocas. "Hey, I wonder if this means—" "That your passenger is not who he claimed?" came a voice from the doorway. "Yes, I believe it would." The merchant pointed a carved totem toward Blackhawk. "I wouldn't advise any rash actions, Kaldorei. My minions above have your crew quite under control, which leaves you for me." The totem vanished and the merchant threw back his hood. A greasy mane of green hair spilled over sharp features and beady yellow eyes.

"A troll!" said Jocas. "A smart, skinny troll with glowing hands!"

"A witch doctor," said Ashar. Touching the kodo claw hanging around his neck, the spiritwalker shoved Jocas behind a crate and stepped in the path of the bolts of eldritch energy that lanced from the troll's fingertips. "You have no respect for the spirits you draw upon!" roared the tauren. As Ashar rushed forward, the totem flashed back into existence behind the witch doctor and exploded in a shower of sparks. The spiritwalker stumbled, the sparks dancing across his horns; he fell to one knee, dazed.





"Your mulish dedication to the spirits of your ancestors has blunted your skills, warrior." Tossing another magical bolt down the length of the cargo hold, the troll shouted, "Come out, little goblin!" The witch doctor dragged a claw down the tauren's muzzle. "The thing I like best about goblins is the greasy stain they leave behind when I roast them. But you should provide ample entertainment during the journey. Perhaps I'll see what it takes to make your heart burst."

Shadows gathered behind the witch doctor and shaped themselves into Blackhawk. She stepped forward and skewered the troll with her moonsword in one smooth motion. "Perhaps not," she said as the troll collapsed at her feet.

"Your condition, tauren?" Blackhawk asked as she returned Ashar's fallen axe to the spiritwalker.

"I am shamed, but I will live," the tauren said as he struggled to his feet.

"Don't make vows you can't keep," Jocas shouted from the back of the hold. Ashar and Blackhawk found him kneeling in front of a panel, a wrench in one hand and a hammer in the other. A fog of steam poured out from a severed rubber hose. "Looks like one of those magic bolts found the compressor sub-assembly."

"Enough engineer tongue," said Ashar. "First we dump this cargo into the sea. There will be time to fix the machine while we look for new passengers."

"I think I'll fix this now," said Jocas, tugging at a bolt. "Or else the gasbag will deflate and we're all going swimming." The goblin gestured over his shoulder with his wrench. "You two might want to grab whatever water's on board and head up top. We need to keep the phlogiston tanks cooled or they'll melt the bladders for good."

As he followed Blackhawk toward the upper decks, Ashar shook his head. "It is like my father always said — the air belongs to birds, tinkers and the foolish."





CHAPTER TWO: PREPARE YOURSELVES!

The runes inscribed upon your fists glow as you rush into combat, a deadly force of enhanced martial power. Your well-placed bomb decimates a troop of skeletons in a glorious riot of boom! and fire and bone shards. Calling upon the ancient spirits of the kodo beasts, your skin thickens and your body grows larger and stronger. One button activates the saw, one lever ignites the flamethrower, and one switch releases gleaming steel spikes all over the breastplate: now you're ready for those fool forest trolls....

This chapter explores the ways of magic and technology in **Warcraft** through new feats, a new core class and new prestige classes.

Feats

The new feats presented in this section focus on magic and technology. Prerequisite feats found in other **Warcraft** books are noted as described in the Introduction.

Additional Familiar [Special]

You gain an additional familiar.

Prerequisite: Sorcerer or wizard level 6th.

Benefit: You gain an additional familiar in the same way you attained a familiar the first time. Choose another type of animal to serve as your familiar. This familiar follows all the normal rules for familiars, except that your level in the appropriate class is treated as 5 levels lower for the purposes of determining the additional familiar's traits and abilities.

Avoid Technological Mishap [Technology]

You are particularly adept at avoiding problems when using technological devices.

Prerequisite: Skill Focus (Use Technological Device*).

Benefit: When using a technological device, you treat its Malfunction Rating as 1 less than it actually is (to a minimum of 1).

Special: A tinker may select Avoid Technological Mishap as one of her tinker bonus feats.

Capture Spell [Metamagic]

You can capture spells instead of countering them, storing them in your own mind.

Prerequisite: Arcane Energy Control*, Block Spell*.

Benefit: When you successfully counter a spell, instead of dismissing it entirely you may instead try to capture that spell. The spell must be on your spell list.

To make the attempt, after successfully countering the spell you must expend another spell of a level at least equal to the spell you are trying to capture (in addition to the spell used to counter the spell). Make a caster level check (DC = 11 + the spell's caster level). If you succeed, you capture the spell in your own mind and can cast it yourself—even if it is a spell you normally do not know. Alternately, you can scribe the spell into your spellbook. The spell remains in your mind until 24 hours have passed or you next prepare spells, whichever comes first. If you fail in the attempt to capture the spell, the spell is still countered and the spell you expended to attempt the capture is still lost.

For example, Leanine Starborn, a high elf wizard, is dueling her old nemesis Alastair Bentstaff, a human sorcerer. Leanine readies an action to counter a spell. Alastair indeed begins casting a spell, and Leanine identifies it as *chain lightning*—a spell she does not even have in her spellbooks. She attempts to counter it with *dispel magic* and succeeds. She then decides she would like to capture the spell and so expends her 6th-level spell *spirit touch*. She makes a caster level check at 1d20 + her caster level against a DC of 11 + Alastair's caster level. She rolls a total of 19, which is not nearly enough (Alastair is a 15th-level sorcerer, so the DC was 26). She does not capture *chain lightning*, though the spell is still countered. Leanine expended both *dispel magic* and *spirit touch*. If she had succeeded in her caster level check, she would have captured *chain lightning* in her mind and could, for instance, have cast it at Alastair on her next turn. In all likelihood, however, she would have saved it to scribe later into her spellbook.

Consummate Machinist [Technology]

Your mastery of various disciplines boosts your skills in all technological endeavors.

Prerequisites: Build Firearms*, Build Siege Weapons*, Build Small Devices*, Build Vehicles*.

Benefit: Your technological limit for building technological devices is increased by +2. This increase stacks with the bonuses provided by the prerequisite feats.

Special: A tinker may select Consummate Machinist as one of her tinker bonus feats.

Dismissible Spell [Metamagic]

You can dismiss any spell you cast.

Benefit: A spell cast with this metamagic feat can be dismissed, as per any other dismissible spell (see *Player's Handbook*, Chapter 10: Magic, "Spell Descriptions,"

Duration). Any spell with a duration longer than instantaneous and which is not normally dismissible may be augmented with this feat. A dismissible spell uses up a slot one level higher than normal.

Fel Infusion [Metamagic]

You can inundate your spells with fel energy, drawing strength from the dark powers.

Prerequisites: Any one other metamagic feat, ability to cast at least three spells with the fel descriptor.

Benefit: A spell modified by this feat gains the fel descriptor in addition to its normal descriptors. (Spells with the fel descriptor grant the caster increased saving throw DCs [by +2] and a +10 fel bonus on caster level checks to overcome spell resistance.) In addition, any damage that the spell inflicts is fel damage instead of normal damage. For example, a *magic missile* altered by Fel Infusion inflicts 1d4+1 points of fel damage. Note that the spell is still a force effect, as it retains its old descriptors.

A spell modified by Fel Infusion uses up a spell slot three levels higher than the spell's actual level.

Fork Spell [Metamagic]

You can split a spell's effects into two equal parts.

Benefit: When you cast a forked spell, two copies of the spell come into being. You may direct

each copy as if it were a separate spell. For example, a forked *frost nova** can affect two different areas.

Each copy is at half potency. If the spell inflicts damage, the damage is halved (round down). If the spell does not deal damage and has a duration longer than instantaneous and shorter than permanent, the duration is halved (round down). If the spell does not deal damage and does not have a duration longer than instantaneous and shorter than permanent, and if it affects an area, the area is halved (round down). If none of these factors applies to the spell, the spell cannot be forked.

For example, *frost nova** deals damage. A forked *frost nova* affects two 10-foot-radius spreads, inflicting half normal damage to creatures within each spread. *Summon monster I* does not deal damage (directly), but has a duration longer than instantaneous and shorter than permanent. A forked *summon monster I* conjures two creatures, each of which persists for half as long as normal.

A forked spell takes up a spell slot one level higher than normal.

Greater Link Spell [Metamagic]

You can cast any number of spells at the same time.

Prerequisite: Link Spell†.

Benefit: As Link Spell, except that you may link any number of spells together.

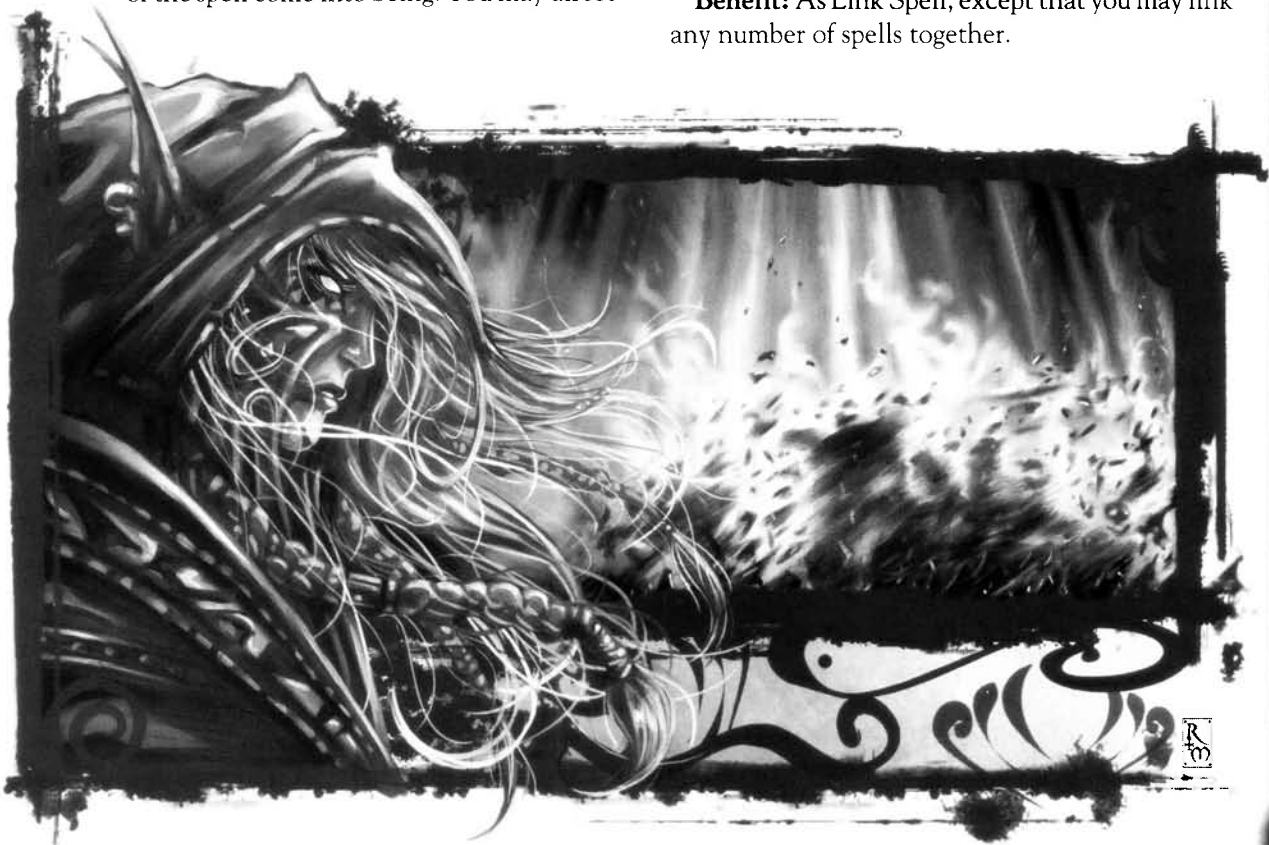

Greater Spell Specialization [General]

Your mastery with a single spell is unmatched.

Prerequisites: Greater Spell Focus, Spell Focus, Spell Specialization†, caster level 12th.

Benefit: Choose a spell with which you have Spell Specialization† and that belongs to a school in which you have Spell Focus and Greater Spell Focus. Your caster level is considered to be 4 levels higher when casting that spell. This change affects all variables associated with caster level, including level-dependent variables (such as range or damage), and dispel and spell penetration checks. In addition, when you prepare that spell with a metamagic feat, it takes up a spell slot two levels lower than normal, to a minimum of its normal level. For example, if Leanine Starborn takes Greater Spell Specialization and chooses *blizzard** (a 3rd-level spell), she can prepare a maximized *blizzard* as a 4th-level spell, an empowered *blizzard* as a 3rd-level spell and so on.

The benefits of this feat do not stack with the benefits of Spell Specialization†.

Special: You may take this feat multiple times. Its effects do not stack. Each time it applies to a different spell.

Hasten Spell [Metamagic]

You can cast spells much faster than normal.

Benefit: You can cast a hastened spell as a move action. Casting the spell provokes attacks of opportunity, as normal. Only spells that have a casting time of 1 standard action can benefit from this feat.

A Hastened spell uses up a slot two levels higher than normal.

Link Spell [Metamagic]

You can cast two spells at the same time.

Benefit: When preparing spells, you can link two spells together. These spells must then be cast at the same time; when you cast one, you automatically cast the other. The casting time is equal to the longest casting time listed between the two spells. (For example, if one spell has a casting time of “1 standard action” and the other has a casting time of “1 round,” you need a full-round action to cast them both.) You choose all targets normally for the spells; they can have different targets or the same targets.

Each linked spell takes up a spell slot one level higher than normal.

Spell Specialization [General]

You are especially adept with a single spell.

Prerequisites: Spell Focus, caster level 4th.

Benefit: Choose one spell that falls into your Spell Focus school. Your caster level is considered to be 2 levels higher when casting that spell. This affects all variables associated with caster level, including level-dependent variables (such as range or damage), and dispel and spell penetration checks. In addition, when you prepare that spell with a metamagic feat, it takes up a spell slot one level less than normal, to a minimum of its normal level. For example, if Leanine Starborn takes Spell Specialization and chooses *blizzard** (a 3rd-level spell), she can prepare a maximized *blizzard* as a 5th-level spell, a silent *blizzard* as a 3rd-level spell and so on.

Special: You may take this feat multiple times. Its effects do not stack. Each time it applies to a different spell.

Technological Weaponry [Technology]

You can use any technological device as a weapon.

Prerequisite: Use Technological Device* 6 ranks.

Benefit: You can use any technological device with which you are familiar as a weapon, even those that were not designed as such. You rake gears across opponents' faces, crack their knees with extending iron spikes, vent boiling steam at them and otherwise use the device to your fiendish advantage. You are considered proficient with all devices used as weapons in this way. The damage type is piercing, slashing or fire, depending on the device. Specific damage amounts are up to the GM, but are generally based on the device's size, as shown on the following table.

Size	Damage
Fine	1d2
Diminutive	1d3
Tiny	1d4
Small	1d6
Medium	1d8
Large	2d6
Huge	2d8
Gargantuan	3d6
Colossal	3d8

You can only use a device in this way if it is one size category larger than you or smaller (for example, a Medium creature could use a Large device as a

weapon). However, you can use a piece of a larger device (for example, blasting your opponents with steam from a pipe on a siege engine) as a weapon. You can use any given device as a weapon of the same size category it actually is or any size category smaller (you can use a Medium device as a Medium, Small, Tiny, Diminutive or Fine weapon, for example).

Using a device as a weapon requires a Use Technological Device check against a DC +2 higher than normal. The malfunction rating applies to your attack roll.

With this feat, you can even inflict damage with a goblin army knife!

Special: A tinker may select Technological Weaponry as one of her tinker bonus feats.

Transcendent Spell [Metamagic]

Your spells can go beyond normal limits.

Benefit: A transcendent spell is has no maximum value based on caster level. A transcendent *magic missile* can create more than five missiles, a transcendent *frost nova** can inflict more than 10d6 points of damage and a transcendent *healing light*† can heal more than 2d8+10 points of damage.

A transcendent spell takes up a spell slot seven levels higher than normal.

Undead Supremacy [General]

Undead under your control are tougher and faster than normal.

Prerequisite: Spell Focus (necromancy).

Benefit: All undead under your control gain a +4 enhancement bonus to Dexterity and gain a number of bonus hit points. These bonus hit points are based on the creature's size, as shown on the table below.

Undead Creature's Size	Bonus Hit Points
Fine	None
Diminutive	None
Tiny	None
Small	10
Medium	20
Large	30
Huge	40
Gargantuan	60
Colossal	80

New Core Class and Prestige Classes

This section details new class options for the *Warcraft RPG*. First is a new core class, the runemaster. This monk-like arcane spellcaster also uses the new rules for rune magic found in Chapter One and Chapter Three.

Following this new core class are eight prestige classes which fill roles in the *Warcraft* universe related to magic (such as the spiritwalker and the witch doctor) and technology (such as the engineer and steamwarrior).

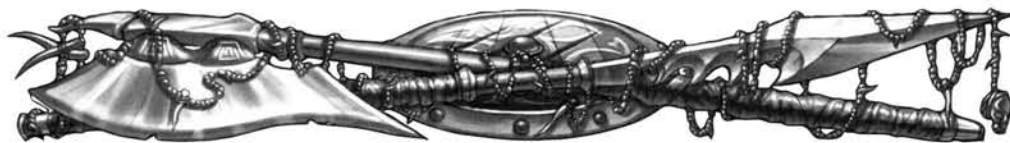

Runemaster

Description: The traditions of the runemasters date back to the ancient time of the titans, creators of runic magic. Dwarves quickly mastered the mysteries of the runes taught to them. However, as generations passed, dwarves forgot their heritage and lost all knowledge of runes and their hereditary powers.

Tauren in Kalimdor rediscovered the power of runes. An ancient race as well, tauren remembered the myths of runecasting and revived interest in this nearly lost art. The dwarves that came to Kalimdor with Jaina's Alliance Expedition learned tauren runecasting techniques. Tauren and dwarves do not share good relations, but they were eager to share knowledge of runes and titan myths.

The runemaster is a free spirit, more at home in the wild than in the city. He merges brute strength with arcane magic, covering his body with mystic tattoos and often imbuing them with magical energies to increase his skill in hand-to-hand combat. While a runemaster shuns armor, this is more to prevent hindrances to inscribing his runes than to demonstrate his subtlety and finesse with unarmed strikes. Quite to the contrary, a runemaster prefers to get in the face of his enemies. Using little trickery or subterfuge, the runemaster takes down foes with toe-to-toe, all-out assaults, hammering them with tattooed fists and feet brimming with arcane power.

Runic magic is considered primitive yet complex by most other races. The dwarves have taken to it with deft skill, while the tauren study it more slowly.



Table 2–1: The Runemaster (Rnm)

Class Level	Base Attack Bonus	Fort Save	Ref Save	Will Save	Special
1st	+0	+2	+0	+2	Create runes, flurry of blows, unarmed strike
2nd	+1	+3	+0	+3	See runes
3rd	+2	+3	+1	+3	Erase runes
4th	+3	+4	+1	+4	Rune sense +1
5th	+3	+4	+1	+4	Improved flurry
6th	+4	+5	+2	+5	Extended glyph
7th	+5	+5	+2	+5	Rune sense +2
8th	+6/+1	+6	+2	+6	—
9th	+6/+1	+6	+3	+6	Extended mark
10th	+7/+2	+7	+3	+7	Rune mastery, rune sense +3
11th	+8/+3	+7	+3	+7	Greater flurry
12th	+9/+4	+8	+4	+8	Lasting glyph
13th	+9/+4	+8	+4	+8	Rune sense +4
14th	+10/+5	+9	+4	+9	Fixed sigil
15th	+11/+6/+1	+9	+5	+9	Lasting mark
16th	+12/+7/+2	+10	+5	+10	Rune sense +5
17th	+12/+7/+2	+10	+5	+10	Fixed glyph
18th	+13/+8/+3	+11	+6	+11	Tattoo
19th	+14/+9/+4	+11	+6	+11	Rune sense +6
20th	+15/+10/+5	+12	+6	+12	Rune mastery

Affiliation: Any.

Abilities: Intelligence determines a runemaster's bonus runes per day and saving throw DCs. Dexterity helps make up for a runemaster's lack of armor, and Strength improves his unarmed attack and damage rolls.

Hit Die: d8.

Class Skills

The runemaster's class skills (and the key ability for each skill) are Climb (Str), Concentration (Con), Craft (Int), Decipher Script (Int), Disable Device (Int), Heal (Wis), Jump (Str), Knowledge (arcana) (Int), Knowledge (nature) (Int), Knowledge (runes) (Int), Listen (Wis), Profession (Wis), Search (Int), Sense Motive (Wis), Spellcraft (Int), Spot (Wis), Survival (Wis), Swim (Str), and Use Magic Device (Cha). See Chapter 4: Skills in the *Player's Handbook* for skill descriptions.

Skill Points at 1st Level: (4 + Int modifier) x 4.

Skill Points at Each Additional Level: 4 + Int modifier.

Class Features

Starting Wealth: The runemaster has wealth equivalent to a wizard.

Weapon and Armor Proficiency: Runemasters are not proficient with any weapons, armor or shields.

When wearing armor, using a shield, or carrying a medium or heavy load, a runemaster loses his flurry of blows ability and is subject to arcane spell failure on his inscribed runes.

Create Runes (Ex): A runemaster can create any rune he knows at any time, assuming he has not yet used up his runes per day for that rune level. He does not have to decide ahead of time which runes he will create, nor does he need to prepare anything in advance.

To inscribe a rune, a runemaster must have an Intelligence score equal to at least 10 + the rune's level. The Difficulty Class for a saving throw against a runemaster's rune effect is 10 + the rune's level + the runemaster's Intelligence modifier.

Table 2–2: Flurry of Blows and Runes per Day

Class Level	Flurry of Blows	— Runes per day —										
		0	1st	2nd	3rd	4th	5th	6th	7th	8th	9th	
1st	–2/–2	2	0	—	—	—	—	—	—	—	—	—
2nd	–1/–1	3	1	—	—	—	—	—	—	—	—	—
3rd	+0/+0	3	2	0	—	—	—	—	—	—	—	—
4th	+1/+1	3	3	1	—	—	—	—	—	—	—	—
5th	+2/+2	3	3	2	0	—	—	—	—	—	—	—
6th	+3/+3	3	3	3	1	—	—	—	—	—	—	—
7th	+4/+4	3	3	3	2	0	—	—	—	—	—	—
8th	+5/+5/+0	3	3	3	3	1	—	—	—	—	—	—
9th	+6/+6/+1	3	3	3	3	2	0	—	—	—	—	—
10th	+7/+7/+2	3	3	3	3	3	1	—	—	—	—	—
11th	+8/+8/+8/+3	3	3	3	3	3	2	0	—	—	—	—
12th	+9/+9/+9/+4	4	3	3	3	3	3	1	—	—	—	—
13th	+9/+9/+9/+4	4	4	3	3	3	3	2	0	—	—	—
14th	+10/+10/+10/+5	4	4	4	3	3	3	3	1	—	—	—
15th	+11/+11/+11/+6/+1	4	4	4	4	3	3	3	2	0	—	—
16th	+12/+12/+12/+7/+2	4	4	4	4	4	3	3	3	1	—	—
17th	+12/+12/+12/+7/+2	4	4	4	4	4	4	3	3	2	0	—
18th	+13/+13/+13/+8/+3	4	4	4	4	4	4	4	3	3	1	—
19th	+14/+14/+14/+9/+4	4	4	4	4	4	4	4	4	3	2	—
20th	+15/+15/+15/+10/+5	4	4	4	4	4	4	4	4	4	3	—

A runemaster can only create a certain number of runes of each rune level per day. His base daily rune allotment is given on Table 2–1: The Runemaster. In addition, he receives bonus runes per day if he has a high Intelligence score, just as spellcasters receive bonus spells per day.

A runemaster's selection of runes is extremely limited. He begins play with mastery of two rune families of your choice. Each rune family gives the runemaster access to a rune at each rune level he can create, from 0-level on up, as well as a granted power. The runemaster gets the granted powers of both rune families selected.

Flurry of Blows (Ex): This ability functions like that of the monk from the *Player's Handbook*, except the runemaster can only make unarmed strikes. The runemaster does not use weapons of any kind. See Table 2–2: Flurry of Blows and Runes per Day for the runemaster's Flurry of Blows Attack Bonus.

Unarmed Strike (Ex): This ability functions like that of the monk from the *Player's Handbook*, except the runemaster's damage from unarmed strikes does not improve with his level. A Small runemaster deals 1d4 points of damage, a Medium runemaster deals 1d6 points of damage, and a Large runemaster deals 1d8 points of damage.

See Runes (Ex): At 2nd level, a runemaster can see all arcane runes of lower level than the highest level he can inscribe without needing to make a Search check. For example, a runemaster capable of inscribing 3rd-level runes is able to see all runes of 2nd level and lower without making a Search check. In addition, a runemaster who merely passes within 5 feet of an arcane rune more powerful than he can normally see is entitled to a Search check to notice it as if he were actively looking for it.

Erase Runes (Ex): At 3rd level, a runemaster can make a Disable Device check to erase an arcane rune without activating it. See the Rune Magic section of Chapter One for details.

Rune Sense (Ex): At 4th level, a runemaster gains an intuitive sense that alerts him to danger from runes and steels him against rune effects. He receives a +1 bonus on saves against rune effects, as well as a +1 bonus on Search checks to locate hidden runes and Disable Device checks made to erase them. These bonuses rise to +2 when the runemaster reaches 7th level, to +3 at 10th level, to +4 at 13th level, to +5 at 16th level, and to +6 at 19th level.

Extended Glyph (Ex): At 6th level, a runemaster's glyphs need not activate immediately upon completion. Instead, the glyph remains quiescent for 1 minute per runemaster level. The glyph fades to no effect at the end of this time if it has not already been activated, dispelled or erased. Anyone can activate the glyph as a move action. An enemy who is aware of the glyph can try to activate it by making a touch attack against the rune (use the size of the rune, which has +8 to its AC for Fine size, instead of the surface's normal size AC modifier).

At 12th level, the runemaster gains lasting glyphs. They have no time limit, remaining until activated, dispelled or erased.

An object can only have one extended or lasting glyph at a time. If a second is inscribed, the first fades to no effect.

Extended Mark (Ex): At 9th level, a runemaster's marks need not activate immediately upon completion. An extended mark functions like an extended glyph. It remains quiescent for 1 minute per

runemaster level and fades to no effect at the end of this time.

At 15th level, the runemaster gains lasting marks. They have no time limit, remaining until activated, dispelled or erased.

A creature can only have one extended or lasting mark at a time. If a second is inscribed, the first fades to no effect.

Rune Mastery (Ex): At 10th level, the runemaster chooses a third arcane rune family. The runemaster gains the family's granted power and access to all its arcane runes that he is of sufficient level to create. At 20th level, the runemaster gains a fourth arcane rune family and its granted power.

Fixed Sigil (Ex): At 14th level, a runemaster's sigils can be made permanent. A fixed sigil does not fade after activation, though it can only be activated once per day. See the Rune Magic section for details.

Fixed Glyph (Ex): At 17th level, a runemaster's glyphs can be made permanent. A fixed glyph does not fade after activation, though it can only be activated once per day. See the Rune Magic section for details.

Tattoo (Ex): At 18th level, a runemaster's marks can be made permanent. A tattoo can be activated once per day as a standard action that provokes an attack of opportunity. The tattoo does not fade after activation.

A creature can have only one magic tattoo per 5 Hit Dice. To replace a magic tattoo, the creature must first have an old one erased.

Bombardier

Description: The bombardier is the highest practitioner of the art of things that go boom. Meticulous planners with a frenzied need to blow things up, most bombardiers are a haphazard mixture of forward-thinker and absent-minded tinker.

Hit Die: d6.

Requirements

Affiliation: Any.

Special: To become a bombardier, the character must destroy a single structure or group of creatures (3 or more) with an explosion of some sort.

Skills: Craft (alchemy) 5, Craft (technological device*) 5, Knowledge (architecture and engineering) 5.

Feats: Build Small Devices*, Scavenge Materials*.

Class Skills

The bombardier's class skills (and the key ability for each) are Bluff (Cha), Concentration (Con), Craft (Int), Disable Device (Int), Intimidate (Cha), Knowledge (architecture and engineering) (Int), Open Lock (Dex), Profession (Wis), Use Magical Device (Cha), Use Technological Device* (Int). See Chapter 4: Skills in the *Player's Handbook* and Chapter Two: Heroes in the *Warcraft RPG* for skill descriptions.

Skill Points at Each

Level: 4 + Int modifier.

Class Features

Weapon and Armor Proficiency: A bombardier is proficient with all simple weapons, and may take the Weapon Focus feat and use ranged weapon feats with explosive weapons.

Goblin Sapping (Ex): Beginning at 1st level, the bombardier learns the fine art of sapping a structure with explosives. He can reduce the hardness of wooden structures by the value of his Intelligence bonus for purposes of blowing them up.

Bomb-Bouncing (Ex): At 1st level, the bombardier masters the art of making a bomb travel further. See the tinker base class for an explanation of this special ability (*Warcraft RPG*, Chapter Two: Heroes, "New Base Classes"). The ability to bounce bombs stacks with the tinker special ability, and triples the range increment of explosives the bombardier throws.

Excellent Timing (Ex): Bombardiers are experts at assessing critical timing, especially when setting up explosive devices. At 2nd level, when prepping a bomb for explosion, the bombardier ignores the DC penalty for setting a delay.

Trick Toss (Ex): Grenade throwing and bomb chucking are the bombardier's favorite sports. While the more clumsy bombardiers discover quickly that throwing well is crucial, talented grenade throwers usually find a way to put a spin on a toss for interesting effects.

At 3rd level, the bombardier can lob bombs ignoring low cover and targeting beyond it without any penalty.

The bombardier perfects a spiraling seeker toss at 6th level. Using the bomb's own spin as a way to direct the explosive device, the bombardier can ignore any type of cover except for total cover.

Boom! (Ex): At 4th level, the bombardier can double the explosive force of bombs or grenades without increasing the

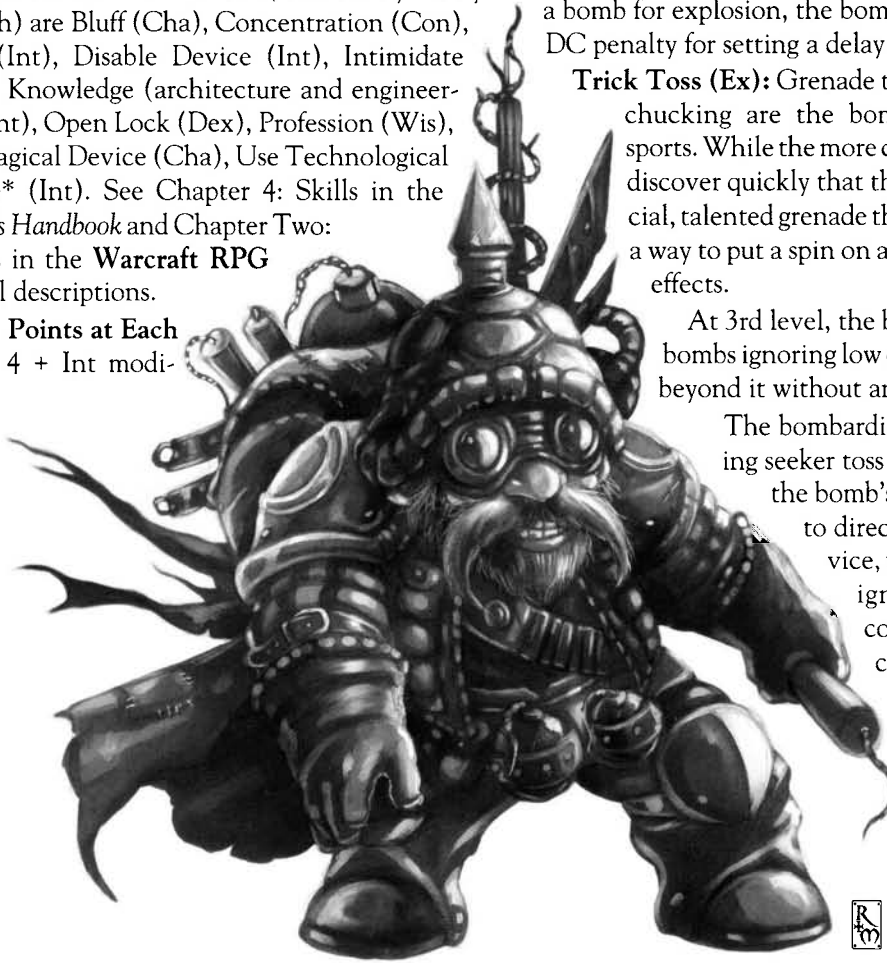

Table 2–3: The Bombardier (Bmb)

Class Level	Base Attack Bonus	Fort Save	Ref Save	Will Save	Special
1st	+0	+0	+2	+0	Goblin sapping, bomb-bouncing
2nd	+1	+0	+3	+0	Excellent timing
3rd	+2	+1	+3	+1	Trick toss (lob)
4th	+2	+1	+4	+1	Boom!
5th	+3	+1	+4	+1	Dwarven sapping
6th	+4	+2	+5	+2	Big boom!
7th	+5	+2	+5	+2	Trick toss (seeker)
8th	+6	+2	+6	+2	Improved excellent timing
9th	+6	+3	+6	+3	Master sapper
10th	+7	+3	+7	+3	Ground zero

size or weight of the device. This requires that the bombardier upgrade the explosive device (see *Warcraft RPG*, Chapter Three, “Creating Technological Devices,” *Upgrades and Adding Functions*).

Dwarven Sapping (Ex): Using tips from dwarven demolitionists and mortar teams, the bombardier learns to sap stone or metal. At 5th level, the bombardier reduces the hardness of stone and metal structures by the value of his Intelligence bonus for purposes of blowing them up.

Big Boom! (Ex): At 6th level, the bombardier can maximize the construction of a bomb so that it always does the maximum amount of damage possible. The bombardier must spend time to upgrade the explosive device (see *Warcraft RPG*, Chapter Three, “Creating Technological Devices,” *Upgrades and Adding Functions*).

Improved Excellent Timing (Ex): Upon reaching 8th level, the bombardier can precisely time grenades and other thrown or fired explosive devices without penalty, down to a specific initiative number in the initiative sequence.

Master Sapper (Ex): At 9th level, the bombardier can apply his ranks in Knowledge (architecture and engineering) as bonus damage for a placed and planned explosion. The bombardier must spend a full-round action positioning or aiming the explosives. The damage bonus only applies to engineered structures or Large and larger technological devices.

Ground Zero (Ex): At 10th level, the bombardier can add double his current hit point total to the amount of damage an explosion does. He must remain close enough to the explosives to supervise a precise detonation (a full-round action). This explosion typically kills the bombardier, but he may make one DC 25 Reflex save against the blast. If successful, the bombardier escapes unscathed; otherwise he takes normal (unmodified by his hit points) damage. Improved evasion and evasion don’t apply to the circumstances of this ability, since he has to watch the explosives very closely before they go off.

Engineer

With the rise of technology in the world of **Warcraft**, tinkers are becoming common among almost all factions and races. A rarer breed, however, are the geniuses among the tinkers who focus their intelligence on a particular type of technology and can lead impossibly ambitious projects that turn fantasy into reality. The earliest of these prodigies developed the phlogiston-powered boilers that allowed the goblins to replace their scout balloons with enormous zeppelins, and the Horde to take its iron-clad juggernauts to sea. They named themselves after their work, and those who have followed in their footsteps honor them by taking that title for their own.

They are the engineers.

Hit Die: d6.

Requirements

Affiliation: Any.

Feats: Leadership.

Skills: Craft (technological device*) 10 ranks.

Special: A character aspiring to be an engineer must complete construction of a device with a Technology Score of at least 10 without assistance.

Class Skills

The engineer's class skills (and the key ability for each skill) are Appraise (Int), Concentration (Con), Craft (Int), Decipher Script (Int), Diplomacy (Cha), Disable Device (Int), Gather Information (Cha), Knowledge (any but arcana or religion) (Int), Open Lock (Dex), Profession (Wis), Use Magic Device (Cha), Use Rope (Dex), and Use Technological Device* (Int).

Skill Points at Each Level: 8 + Int modifier.

Class Features

All of the following are class features of the engineer prestige class.

Weapon and Armor Proficiency: Engineers are proficient with all simple weapons and all types of armor and shields.

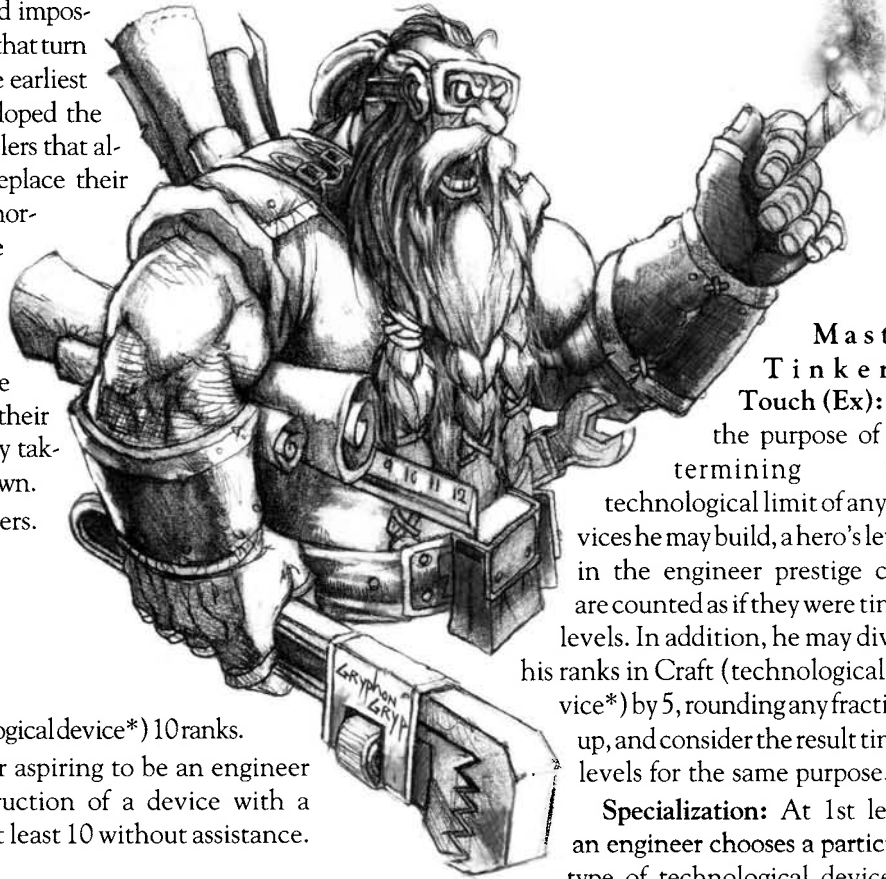

Master Tinker's Touch (Ex):

For the purpose of determining the technological limit of any devices he may build, a hero's levels in the engineer prestige class are counted as if they were tinker levels. In addition, he may divide his ranks in Craft (technological device*) by 5, rounding any fractions up, and consider the result tinker levels for the same purpose.

Specialization: At 1st level, an engineer chooses a particular type of technological device in which to specialize (e.g., steam armor, zeppelins, siege weapons, traps). All Craft (technological device*) checks an engineer makes when working in his area of specialization receive a +1 competence bonus. This bonus increases by +1 at every other level thereafter (+2 at 3rd level, +3 at 5th level, and so forth). At 5th level, an engineer selects a second field of specialization to which all specialization bonuses apply; and at 8th level he selects a third. However, as an engineer focuses his tinkering genius, his more general mechanical abilities suffer. Any Craft (technological device) checks made by an engineer outside his areas of specialization suffer a -3 penalty.

Lead Collaboration (Ex): Engineers understand the process of mechanical creation so well that they

Table 2–4: The Engineer (Eng)

Class Level	Base Attack Bonus	Fort Save	Ref Save	Will Save	Special
1st	+0	+0	+2	+2	Master tinker's touch, specialization (+1), first specialization
2nd	+1	+0	+3	+3	Lead collaboration (x9)
3rd	+1	+1	+3	+3	Specialization (+2)
4th	+2	+1	+4	+4	Bonus feat, draft schematic
5th	+2	+1	+4	+4	Specialization (+3), second specialization
6th	+3	+2	+5	+5	Hold together
7th	+3	+2	+5	+5	Specialization (+4), lead collaboration (x8)
8th	+4	+2	+6	+6	Bonus feat
9th	+4	+3	+6	+6	Specialization (+5)
10th	+5	+3	+7	+7	Third specialization, lead collaboration (x7)

can organize the efforts of tinkers in order to create larger or more complex devices together than they could individually. After reaching 2nd level, an engineer gains the ability to lead group projects with efficiency. Applicable modifiers from any feats possessed by the engineer (such as Build Siege Weapons) may be included when determining the technological limit of any device construction project he leads. In addition, as long as he supervises and participates in the construction of the device, it is completed when progress is greater than the item's market value x 9. Once the engineer is 6th level or higher, projects he leads are completed when progress is greater than the item's market value x 8, and a project led by a 10th-level Engineer is completed at market value x 7. The engineer must supervise and make weekly progress on the project, or he is no longer considered to be leading the project and completion reverts to the normal standard of market value x 10.

Bonus Feat: At 4th and 8th levels, engineers receive a bonus feat that must be selected from the list of tinker bonus feats (see Chapter Two of the

Warcraft RPG). An engineer must still meet all prerequisites for any bonus feat.

Draft Schematic (Ex): Upon reaching 4th level, engineers learn how to draw plans that allow devices they've built to be recreated more easily. If an engineer has been personally involved in the creation of a device, at any time after the device's completion the engineer may make a Craft (technological device*) check with a DC equal to 10 + the device's Technology Score. Success on this check allows the creation of schematics that may be passed along to other tinkers. Use of these schematics grants a bonus equal to the engineer's class level divided by 2 on all Craft (technological device) checks involved in constructing a copy of the original device. Engineers may not make use of their own schematics.

Hold Together (Ex): After achieving 6th level, an engineer has such rapport with technology that his devices are less likely to malfunction under his watchful eye. A technological device being operated by an engineer of 6th level or higher behaves as if its Malfunction Rating were lowered by -1 (to a minimum of zero).

Graven One

Description: The graven one seeks power from the deep well of death instead of from supplicating dark powers or acting as a sycophant for demonic entities. Unwholesome rites, sigils, and the shedding of one's mortal shell are all a small part of what graven ones seek. Eventually, they become masters over undeath.

Hit Die: d4.

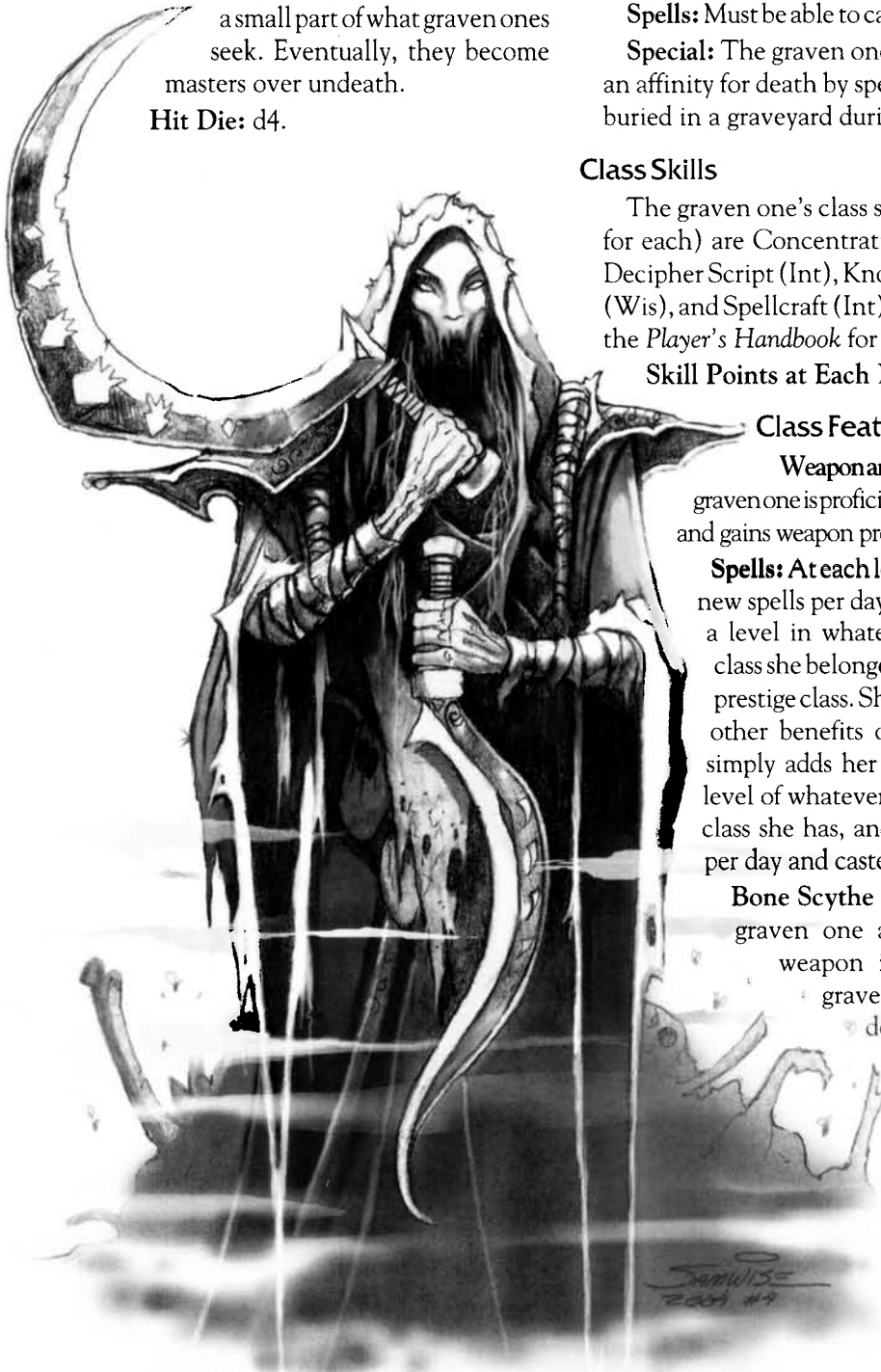

Requirements

Alignment: Any non-good.

Affiliation: Independent.

Skills: Knowledge (arcana) 8 ranks, Knowledge (religion) 8 ranks.

Feats: Spell Focus (necromancy).

Spells: Must be able to cast 3rd-level arcane spells.

Special: The graven one must show that she has an affinity for death by spending at least one night buried in a graveyard during a new moon.

Class Skills

The graven one's class skills (and the key ability for each) are Concentration (Con), Craft (Wis), Decipher Script (Int), Knowledge (Int), Profession (Wis), and Spellcraft (Int). See Chapter 4: Skills in the *Player's Handbook* for skill descriptions.

Skill Points at Each Level: 2 + Int modifier.

Class Features

Weapon and Armor Proficiency: The graven one is proficient with all simple weapons and gains weapon proficiency with the scythe.

Spells: At each level, the graven one gains new spells per day as if she had also gained a level in whatever arcane spell casting class she belonged to before she added the prestige class. She does not gain any of the other benefits of her former class. She simply adds her graven one level to the level of whatever other arcane spellcaster class she has, and then determines spells per day and caster level accordingly.

Bone Scythe (Su): Created when the graven one achieves 1st level, this weapon is an extension of the graven one's connection with death. As the graven one gains levels, her power manifests through the weapon as well.

At 3rd level, the bone scythe becomes a +2 weapon and gains the keen property. At 6th level, it becomes a +3 weapon and gains the ghost touch property.

Table 2–5: The Graven One (Gvn)

Class Level	Base Attack Bonus	Fort Save	Ref Save	Will Save	Special	Spell
1st	+0	+0	+0	+2	Bone scythe	+1 level of arcane spellcasting class
2nd	+1	+0	+0	+3	Awaken minion (2nd level)	+1 level of arcane spellcasting class
3rd	+1	+1	+1	+3	Bolstered bones	+1 level of arcane spellcasting class
4th	+2	+1	+1	+4	Awaken minion (4th level)	+1 level of arcane spellcasting class
5th	+2	+1	+1	+4	<i>Imbue ability</i>	+1 level of arcane spellcasting class
6th	+3	+2	+2	+5	Awaken minion (6th level)	+1 level of arcane spellcasting class
7th	+3	+2	+2	+5	<i>Seize ability</i>	+1 level of arcane spellcasting class
8th	+4	+2	+2	+6	Awaken minion (8th level)	+1 level of arcane spellcasting class
9th	+4	+3	+3	+6	Armor of bones and steel	+1 level of arcane spellcasting class
10th	+5	+3	+3	+7	Undying	+1 level of arcane spellcasting class

At 9th level, it becomes a +4 weapon and gains the unholy property.

The graven one can summon the bone scythe into her hand as a standard action. Only the graven one or her awakened minion (see below) can wield the weapon.

Awaken Minion (Su): At 2nd level, the graven one gains the ability to awaken a minion from the bones of a dead warrior or mage. She must steal the bones from the actual grave of a buried wizard, sorcerer or fighter. The creation is a loyal skeletal warrior or skeletal mage that follows the graven one's verbal commands.

The minion is the equivalent of a 2nd-level fighter, sorcerer or wizard with the skeletal warrior or skeletal mage template (see **Manual of Monsters**, Chapter 3: The Scourge, Skeletal Warrior or Skeletal Mage). This undead creation shares in the power of its master and becomes more powerful as the graven one advances in ability. At 4th, 6th and 8th level, the minion gains 2 more effective character levels. The levels gained must be in the minion's original class (wizard or fighter).

The graven one can have one minion at any time. If the minion is destroyed, the graven one can build another of the same or lower level of power. Creating a new minion takes 1 month's time per level of the minion, and requires the stolen skeletal remains of a warrior or mage.

Bolstered Bones (Su): At 3rd level, any skeletal undead (skeletal mages or warriors) summoned by the graven one gain +4 turn resistance and +2 hit points per Hit Die. Her awakened minion gains +4 turn resistance.

Imbue Ability (Sp): Once per day, the 5th-level graven one may transfer a special undead ability from one of her creations to another. She can transfer any supernatural (Su) undead ability to another undead creature. The creation retains the ability until destroyed. This process consumes the creature that possessed the original power.

The graven one spends a number of XP equal to 10 times the originating creature's hit points to transfer the ability. She must be touching both undead when using this ability.

Seize Ability (Sp): Upon attaining 7th level, the graven one can transfer a special undead ability

from one of her creations (summoned or created undead) to herself by touch. She can do this once per day for every point of her Intelligence bonus. This process consumes the creature that possessed the original power and requires a full-round action. The stolen abilities remain with the graven one for 24 hours.

Armor of Bones and Shadow (Su): At 9th level, the graven one can summon a full set of +4 *full plate* made from interlocking bone and shadow with a full-round action. This suit provides her with all the benefits of a suit of full plate without any of the disadvantages. While wearing the armor she may cast spells without penalty.

The armor can be shattered with a command word, and the shards travel to interlock with up to 10 of her minions within 100 feet. This interlocking plate grants the affected creatures a +4 armor bonus and a +4 bonus on saving throws. The suit reassembles with the utterance of the same command word.

Undying (Ex): At 10th level, the graven one becomes one of the undead. She no longer ages or needs to sleep (though she must spend time meditat-

ing to regain spells). For full details of undead traits, see Chapter 7: Glossary in the MM.

Graven One Spell List

The graven one concentrates on the creation, control and conjuration of undead creatures. Unlike a necromancer, who preys upon the living for life energy, the graven one seeks to create undead in a perfect state to serve her as faithful and undying servants.

The graven one gains the following spells in addition to her regular arcane spell list.

1st Level — *call of the spirits* †, *command undead*, *summon undead I* †.

2nd Level — *cannibalize* *, *dark sacrifice* †, *lesser death coil* *, *summon undead II* †.

3rd Level — *animate dead*, *death coil* *, *summon undead III* †.

4th Level — *death pact* *, *greater death coil* *, *summon undead IV* †.

5th Level — *create undead*, *summon undead V* †.

6th Level — *control undead*, *summon undead VI* †.

7th Level — *create greater undead*, *summon undead VII* †.

8th Level — *summon undead VIII* †.

9th Level — *summon undead IX* †.

Shadow Hunter

Description: Shadow hunters deal with the darkest aspects of the spirit world. Their connections to powerful voodoo spirits give them the ability to curse and heal at a whim. Brave practitioners of rituals and dark rites, shadow hunters tread a cautious line between darkness and light.

The shadow hunter's craft originated with the jungle trolls. Since joining the Horde, this breed of civilized troll has taught voodoo to others deemed worthy of the craft. Orcs, tauren and even some night elves have become skilled shadow hunters.

Hit Die: d8.

Requirements

Affiliation: Horde.

Base Attack Bonus: +4.

Skills: Knowledge (religion) 5 ranks, Survival 5 ranks.

Spells: The ability to cast 1st-level divine spells.

Class Skills

The shadow hunter's class skills (and the key ability for each) are Climb (Str), Concentration (Con), Craft (Int), Heal (Wis), Intimidate (Cha), Jump (Str), Knowledge (nature) (Int), Knowledge (religion) (Int), Survival (Wis), Swim (Str). See Chapter 4: Skills in the *Player's Handbook* for skill descriptions.

Skill Points at Each Level:
2 + Int modifier.

Class Features

Weapon and Armor Proficiency: Shadow hunters are proficient with all simple weapons as well as with light armor.

Spells: When a character gains a new shadow hunter level, he also gains new spells per day as if he had also gained a level in whatever divine spellcasting class he formerly belonged to before he added the shadow hunter prestige class. He does not gain any of the other benefits of his former class. He simply adds his shadow hunter level to the level of whatever other divine spellcaster class he has, and then determines spells per day and caster level accordingly.

Spirit of the Loa: The voodoo faith of the shadow hunter deals with communing with beings called the Loa. These spirits are mightier than elementals, yet not quite as powerful as gods. The shadow hunter uses the Loa's granted abilities to combat darkness or heal those in need. Unless otherwise specified all Loa abilities are standard actions.

The shadow hunter can choose to learn one of the following abilities from the Loa at 1st, 3rd, 5th, 7th, 9th and 10th level:

Battle Stride (Sp): The Loa Legba is a master of swift motion. Through him, the shadow hunter learns to move with great speed. Once per day he can imbue a number of allies equal to his shadow

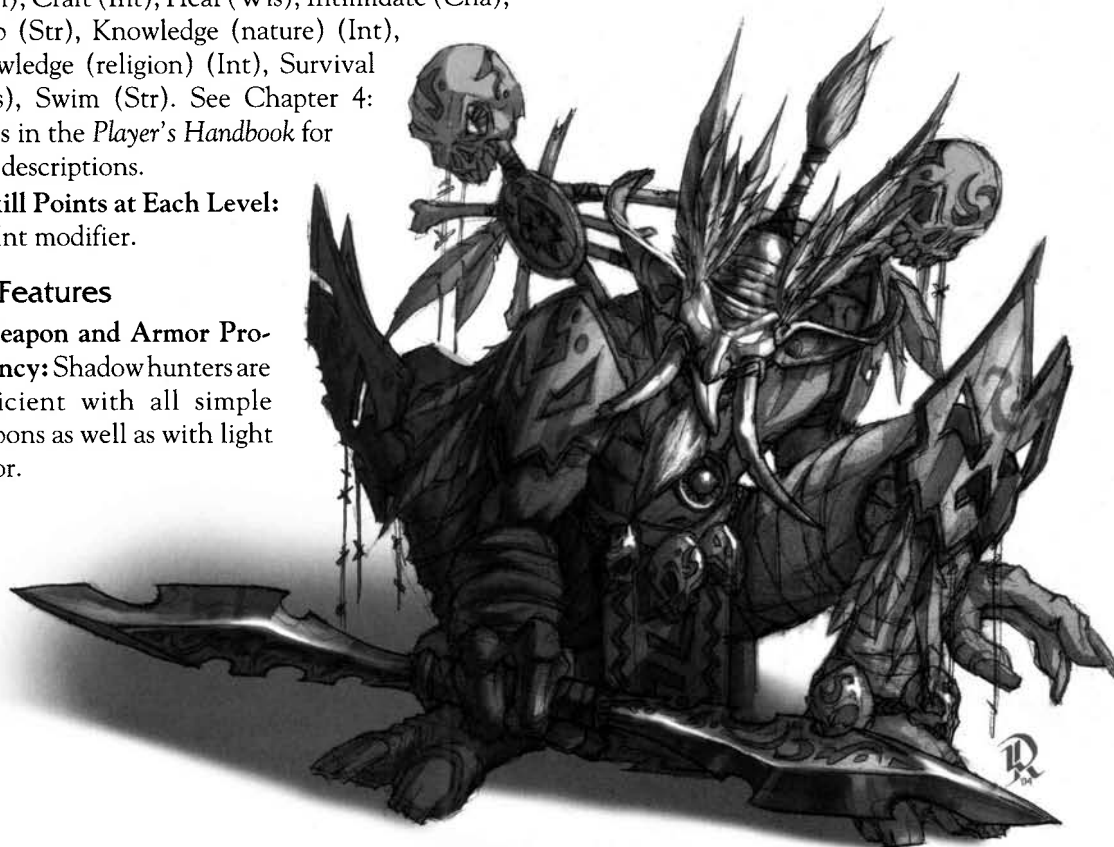

Table 2–6: The Shadow Hunter (Swh)

Class Level	Base Attack Bonus	Fort Save	Ref Save	Will Save	Special	Spell
1st	+0	+0	+0	+2	Spirit of the loa	+1 level of divine spellcasting class
2nd	+1	+0	+0	+3	—	+1 level of divine spellcasting class
3rd	+2	+1	+1	+3	Spirit of the loa	+1 level of divine spellcasting class
4th	+3	+1	+1	+4	—	+1 level of divine spellcasting class
5th	+3	+1	+1	+4	Spirit of the loa (Hex)	+1 level of divine spellcasting class
6th	+4	+2	+2	+5	—	+1 level of divine spellcasting class
7th	+5	+2	+2	+5	Spirit of the loa	+1 level of divine spellcasting class
8th	+6	+2	+2	+6	—	+1 level of divine spellcasting class
9th	+6	+3	+3	+6	Spirit of the loa	+1 level of divine spellcasting class
10th	+7	+3	+3	+7	Spirit of the loa	+1 level of divine spellcasting class

hunter level with a +4 bonus on initiative checks and an additional 10 feet to their speed. These allies must be within 30 feet of him when he uses this ability. The effects of this ability last for a number of rounds equal to his shadow hunter level. This ability cannot affect the shadow hunter.

Healing Wave (Sp): Lukou is the Loa of healing and respite, and she grants the ability to heal allies. With a word, the shadow hunter invokes healing with a wave of soothing light.

The shadow hunter can target any ally within 30 feet with the healing wave. It heals the target and then bounces to the next ally within 10 feet. The wave travels from ally to ally (on a path designated by the shadow hunter) as long as each one is within 10 feet of one other. If the healing wave is unable to reach other allies, it travels back to heal the previous target, following its path back to the shadow hunter. The wave's healing effects are instantaneous.

The ability initially cures 1d8 points of damage + 1 point per shadow hunter level; the die type diminishes as the wave travels between allies (1d8, then 1d6, then 1d4), stopping at 1d4 points of

damage + 1 point per shadow hunter level. The die type increases to 1d10 when he reaches 5th level, then to 1d12 at 10th level.

The shadow hunter may sacrifice a 1st, 2nd or 3rd level healing spell to use this ability a number of times per day equal to his Wisdom bonus. This ability may not be used to harm undead; the spirits will only aid the shadow hunter's allies.

Hex (Sp): Ogon, the Loa of war, teaches the shadow hunter to place dire curses upon his enemies. This Loa ability is so potent that the shadow hunter may learn it only after he gains 5th level.

Once per day, the shadow hunter may change a single targeted individual into a frog. This ability functions exactly like the spell *baleful polymorph* except as noted here. A Fortitude saving throw (DC 10 + the shadow hunter's level + the shadow hunter's Wisdom bonus) negates the hex. The effect lasts for 1 round for every two shadow hunter levels. The affected target takes on the form of a frog (use the toad statistics from Chapter 2: Animals in the MM), but retains its hit points, Hit Dice and saving throws. When changed to or from the frog shape, the target does not provoke an attack of

opportunity. Summoned creatures are immune to this ability.

Serpentine Form (Su): The Loa of serpents and treachery, Dambala teaches the shadow hunter to move swiftly and quietly by changing his shape into a serpent or snake. This ability functions like the *polymorph* spell, except as noted here. The effect lasts for 1 hour for every shadow hunter level, or until the shadow hunter chooses to change back. Changing form (to serpent or back) is a standard action and does not provoke an attack of opportunity.

Smite Undead (Su): Samedi is the Loa of cemeteries and the restful sleep of the dead. The undead are an abomination in his eyes. The shadow hunter can add his class level to a single attack and damage roll against an undead creature. This ability may be used a number of times per day equal to his Wisdom bonus.

Stormspear (Su): The realm of storms is controlled by Shango, and he guards the secrets of lightning and mayhem. By channeling the Loa's fury, the shadow hunter throws a lightning bolt that does 1d4 points of electricity damage + 1 point of damage per shadow hunter level. This attack requires a ranged touch attack; there is no saving

throw. The ability can be used a number of times per day equal to the shadow hunter's Wisdom bonus.

Shadow Hunter Spell List

Shadow hunters learn magic that hinders enemies and aids allies, gaining a unique mix of spells that delve into the more occult aspects of the Loa.

1st Level — *detect undead*, *roar**, *sentry ward†*, *shadow meld**, *sleep*, *stasis trap**.

2nd Level — *call of the spirits†*, *cause fear*, *command*, *cripple**, *remove fear*.

3rd Level — *clairaudience/clairvoyance*, *deep slumber*, *healing ward**, *serpent ward**, *speak with dead*, *stitch†*, *voodoo spirits†*.

4th Level — *arcane eye*, *confusion*, *crushing despair*, *detect scrying*, *scrying*.

5th Level — *disrupting weapon*, *mark of justice*, *symbol of pain*, *symbol of sleep*.

6th Level — *lightning monsoon†*, *mass cripple†*, *symbol of fear*, *undeath to death*.

7th Level — *control weather*, *greater scrying*, *insanity*, *symbol of stunning*.

8th Level — *symbol of death*, *symbol of insanity*.

9th Level — *big bad voodoo†*, *storm of vengeance*.

Spiritwalker

Description: Spiritwalkers have a powerful connection with tauren ancestral heritage. Capable of channeling ancient heroes, these champions of the spirit are valued in tauren society for the wisdom and history they carry within them. Tauren also fear the spiritwalker as a potent sign of the coming age; while many of this powerful race look upon the spiritwalker with some apprehension, the spiritwalkers still receive respect from their brethren.

Tauren ancestors dwell deep within the Emerald Dream (see *Warcraft RPG*, Chapter Five: The

World of Warcraft). The energies of that plane change the spiritwalker's pelt to pure white over time (though some are born with white pelts, destined to walk the path of spirit).

Hit Die: d8.

Requirements

Race: Tauren only.

Affiliation: Any.

Feats: Follower of the Totem*.

Spellcasting: Able to cast 2nd-level divine spells.



Table 2–7: The Spiritwalker (Spw)

Class Level	Base Attack Bonus	Fort Save	Ref Save	Will Save	Special	Spell
1st	+0	+2	+0	+2	<i>Ghost dance</i> , <i>spirit companion</i>	+1 level of divine spellcasting class
2nd	+1	+3	+0	+3	Hero's spirit	—
3rd	+2	+3	+1	+3	Spirit of the kodo	+1 level of divine spellcasting class
4th	+3	+4	+1	+4	Ethereal form	—
5th	+3	+4	+1	+4	Chant of ages	+1 level of divine spellcasting class
6th	+4	+5	+2	+5	<i>War dance</i>	—
7th	+5	+5	+2	+5	—	+1 level of divine spellcasting class
8th	+6	+6	+2	+6	Mass ethereal form	—
9th	+6	+6	+3	+6	<i>Dreamwalk</i>	+1 level of divine spellcasting class
10th	+7	+7	+3	+7	<i>Avatar of the ancients</i>	—

Class Skills

The spiritwalker's class skills (and the key ability for each) are Climb (Str), Craft (Int), Handle Animal (Cha), Intimidate (Cha), Jump (Str), Knowledge (arcana) (Int), Knowledge (nature) (Int), Knowledge (religion) (Int), Listen (Wis), Survival (Wis), and Swim (Str). See Chapter 4: Skills in the *Player's Handbook* for skill descriptions.

Skill Points at Each Level: 2 + Int modifier.

Class Features

Weapon and Armor Proficiency: The spiritwalker is proficient with all simple weapons, with tauren halberds and tauren totems, with light and medium armor, and with shields.

Spells: Every alternating spiritwalker level (beginning at 1st), the character gains new spells per day as if he had also gained a level in whatever divine spellcasting class he formerly belonged to before he added the spiritwalker prestige class. He does not gain any of the other benefits of his former class. He simply adds his additional spellcasting level to the level of whatever other divine spellcaster class he has, and then determines spells per day and caster level accordingly.

Ghost Dance (Sp): The defense of the tauren people is one of the spiritwalker's tasks. The

spiritwalker learns the ghost dance at 1st level. By performing the ghost dance (a standard action), the spiritwalker gains his Wisdom bonus on attack and damage rolls against undead, demons and other known foes of the tauren's tribe. He can perform the ghost dance once per day for every 2 class levels.

Spirit Companion (Sp): The spiritwalker's soul shares a deep bond with the Emerald Dream. At 1st level, he can summon forth an animal spirit companion from the Emerald Dream. Summoning or dismissing the creature is a full-round action; the companion remains unless killed or dismissed.

This ability functions the same as the druid's animal companion class ability, except that the character's spiritwalker level is used where a druid level is required. Killing the spirit companion on the mortal plane sends it back to the Emerald Dream for 1d6 days. Treat the spirit companion as a normal animal with the extraplanar subtype.

Hero's Spirit (Su): The spiritwalker channels the collective warrior soul of the tauren people. Upon reaching 2nd level, he can call upon this spirit for martial guidance. Once per day, he can gain a morale bonus equal to his class level on attack and damage rolls and on saving throws. The effects last for a number of rounds equal to his Wisdom bonus.

Spirit of the Kodo (Su): The kodo is a powerful and symbolic animal; in tauren society, it is a sign of strength and endurance. At 3rd level, the spiritwalker can channel the spirit of the kodo to gain a +4 enhancement bonus to natural armor and a +2 enhancement bonus to Strength and Constitution. He can summon the spirit of the kodo once per day as a free action, and the spirit remains within him for a number of rounds equal to his new Constitution bonus.

Ethereal Form (Su): At 4th level, as a free action, the spiritwalker can step partially into the Dream, becoming immaterial for a short time. While the spiritwalker still occupies his place on the Material Plane, he is incorporeal. Only spells and magical weapons can harm him while he is incorporeal (see the Glossary in the *Player's Handbook* for the complete effects of incorporeality).

He can take on the ethereal form once per day for a number of rounds equal to his spiritwalker level. He can only affect the physical world with spellcasting while in ethereal form.

Chant of Ages (Su): Knowledge isn't lost, only hidden. At 5th level, by performing the chant of ages, the spiritwalker can call upon the knowledge of all the tauren who have passed on to the Emerald Dream. He can add his Wisdom bonus to any skill check he makes, as long as he is able to take 10 or 20.

War Dance (Sp): At 6th level, the spiritwalker's dance can incite others as well. The war dance invigorates any allies within 30 feet of him. His allies receive a +4 morale bonus on attack and damage rolls, and on saving throws. He must concentrate in order to perform the dance, and he may continue for as long as he wishes. Interrupting the dance does not dispel the effects, and the dance's energy lingers for a number of rounds equal to half the spiritwalker's level. This ritual does not affect the spiritwalker.

Mass Ethereal Form (Su): The spiritwalker can ethereally shift others at 8th level. He may make a number of allies equal to his spiritwalker level incorporeal along with himself. Affected allies are subject to the benefits and restrictions noted in the spiritwalker's ethereal form ability above.

Dreamwalk (Sp): At 9th level, the spiritwalker learns how to walk into the Emerald Dream, as the 10th-level druid of the wild special ability (see *Warcraft RPG*, Chapter Two: Heroes, "Prestige Classes").

Avatar of the Ancients (Sp): Once per year, the 10th-level spiritwalker may reach out to the Emerald Dream for aid from his tauren ancestors. The resulting aid comes as an ancient (see *Manual of Monsters*, Chapter One) with the aspect of War or Lore. This ancient has the extraplanar subtype and remains for 1 day. It will aid the spiritwalker to the best of its ability.

Steamwarrior

Steamwarriors are mechanics who take their skills to the battlefield by building walking suits of phlogiston-powered armor. Though the armor of most steamwarriors takes on a generally humanoid form, a suit's functions are as individualized as its pilot. The only activity most steamwarriors enjoy more than using their armor in combat is tinkering with it between battles, improving old functions and adding new ones.

Hit Die: d4.

Requirements

Affiliation: Any.

Skills: Craft (technological device*) 8 ranks, Profession (blacksmithing) 6 ranks, Use Technological Device* 8 ranks.

Feats: Build Vehicles*, Vehicle Proficiency (combat armor)*.

Special: Before she can enter the steamwarrior prestige class, a hero must complete a basic set of steamwarrior armor. This is a device of at least TS 8 that must move under

the direction of the wearer, provide the wearer with a degree of protection and operate on a Time Factor measured in rounds.

Class Skills

The steamwarrior's class skills (and the key ability for each) are Craft (Int), Decipher Script (Int), Disable Device (Int), Gather Information (Cha), Knowledge (any but arcana or religion) (Int), Open Lock (Dex), Profession (Wis), Use Rope (Dex), and Use Technological Device* (Int). See Chapter 4: Skills in the *Player's Handbook* and Chapter Two: Heroes in the *Warcraft RPG* for skill descriptions.

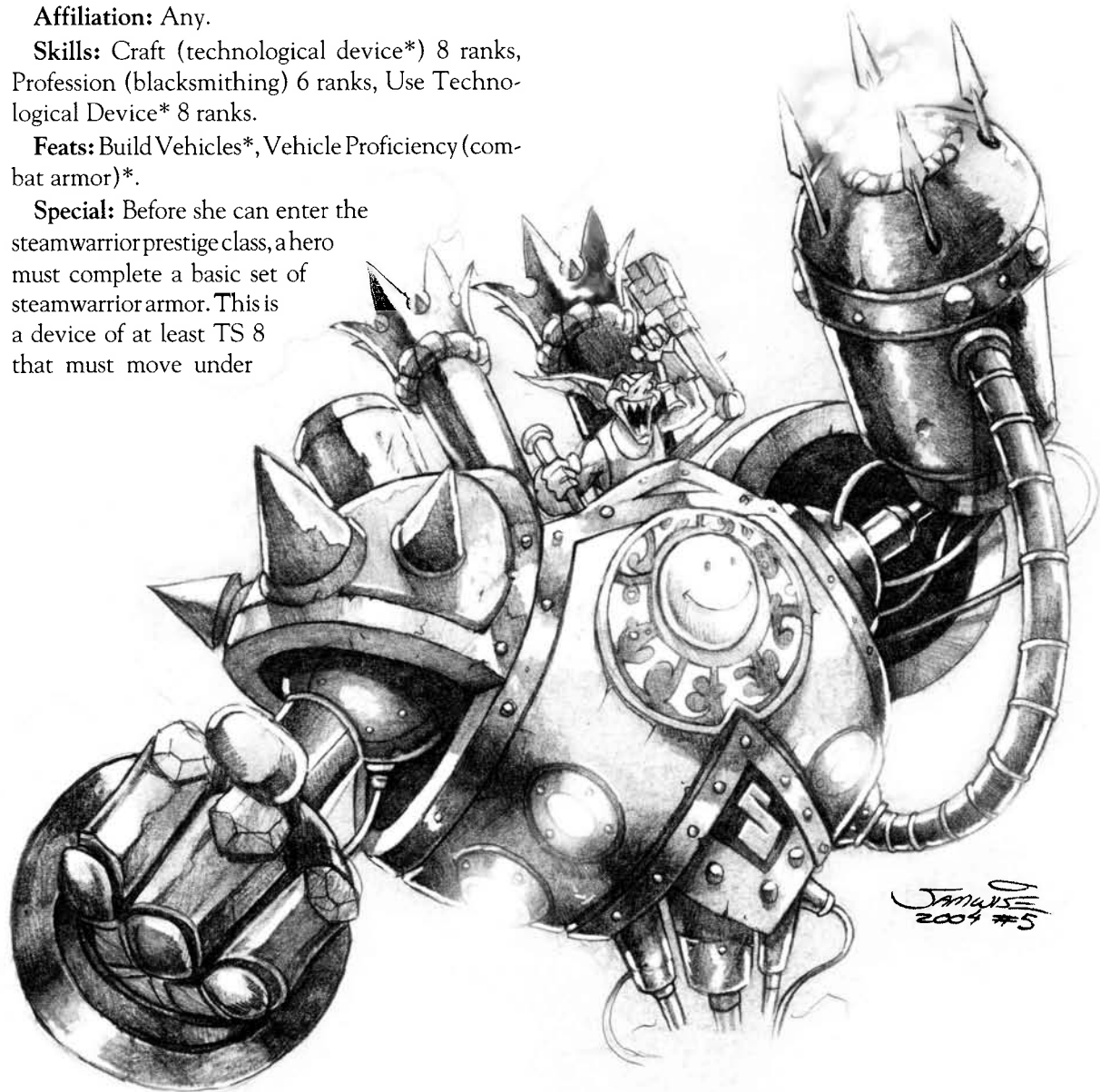

Table 2–8: The Steamwarrior (Stm)

Class Level	Base Attack Bonus	Fort Save	Ref Save	Will Save	Special
1st	+0	+0	+2	+2	Tinker's touch, spark of genius
2nd	+1	+0	+3	+3	Modular upgrade
3rd	+1	+1	+3	+3	Bonus feat
4th	+2	+1	+4	+4	Modular upgrade
5th	+2	+1	+4	+4	Cobble together (–1 MR)
6th	+3	+2	+5	+5	Modular upgrade, bonus feat
7th	+3	+2	+5	+5	Cobble together (–2 MR)
8th	+4	+2	+6	+6	Modular upgrade
9th	+4	+3	+6	+6	Bonus feat
10th	+5	+3	+7	+7	Modular upgrade

Skill Points at Each Level: 4 + Int modifier.

Class Features

All of the following are class features of the steamwarrior prestige class.

Weapon and Armor Proficiency: Building on their basic familiarity with tools, steamwarriors are proficient with all simple weapons and all types of armor.

Tinker's Touch (Ex): A hero's levels in steamwarrior are counted as if they were tinker levels for the purpose of determining the technological limit of any devices she may build.

Spark of Genius (Ex): The primary functions of a steamwarrior's armor must remain protection and mobility. However, a steamwarrior may make upgrades that raise the TS of her armor by up to 5 per upgrade.

Modular Upgrade (Ex): At 2nd level, and upon achieving every other level thereafter, a

steamwarrior may add a single secondary function to her armor by building the secondary function as if it were a separate device. Once the secondary function is completed, it becomes a part of the armor as if it had been added in a full upgrade.

Bonus Feat: At 3rd, 6th and 9th level, the steamwarrior may select a bonus feat that is either a technology feat or a proficiency feat related to one of her armor's functions.

Cobble Together (Ex): The creations of a steamwarrior are a tangle of technology — yet somehow, they work better than they should. Upon reaching 5th level, all devices created by the steamwarrior operate as if their Malfunction Ratings were –1 lower (to a minimum of 1); at 7th level, the MR is 2 lower (to a minimum of 1). This modifier adjusts the MR after the device is completed.

Warden

Description: The wardens are the most feared arm of the night elves' wrath. These mystical assassins mete out justice, capture fugitives and carry out covert executions. Trained in martial and magical arts, wardens command a fearsome and formidable range of abilities. Using a combination of cunning, stealth and tactical planning, a warden can shake even a large fighting force to its core.

Hit Die: d6.



Requirements

Race: Night elf only.

Alignment: Any non-chaotic.

Affiliation: Alliance only.

Base Attack Bonus: +5.

Skills: Gather Information 8 ranks, Move Silently 6 ranks.

Feats: Dodge, Mobility.

Class Skills

The warden's class skills (and the key ability for each) are Balance (Dex), Bluff (Cha), Climb (Con), Concentration (Con), Craft (Int), Gather Information (Cha), Hide (Dex), Intimidate (Cha), Jump (Str), Listen (Wis), Move Silently (Dex), Search (Int), Sense Motive (Wis), Spot (Wis), Swim (Str), and Tumble (Dex). See Chapter 4: Skills in the *Player's Handbook* for skill descriptions.

Skill Points at Each Level: 4 + Int modifier.

Class Features

Weapon and Armor Proficiency: Wardens are proficient with all simple and martial weapons, and light and medium armor.

Slicing Torrent (Sp): A warden can unleash an arsenal of blades and knives upon the unsuspecting. At 1st level, the warden can magically split a thrown knife to let loose a cascade of cutting terror upon her quarry.

The warden can target any group of creatures within a 40-foot-long cone-shaped burst. This fan of knives harms the 5 closest targets within that area (friend or foe). These magically summoned blades do much more damage than mundane knives. Each target takes 1d4 points of damage for each of the warden's class levels (maximum of 5d4). A successful Reflex save (DC 10 + the warden's level + the warden's Dexterity bonus) means that the target takes half damage.

Table 2–9: The Warden (Wdn)

Class Level	Base Attack Bonus	Fort Save	Ref Save	Will Save	Special
1st	+1	+0	+2	+0	<i>Slicing torrent</i> 3/day (40-ft. cone)
2nd	+2	+0	+3	+0	Blink 1/day
3rd	+3	+1	+3	+1	<i>Lesser shadow strike</i> (1/day)
4th	+4	+1	+4	+1	<i>Slicing torrent</i> 5/day (50-ft. cone)
5th	+5	+1	+4	+1	Blink 2/day
6th	+6	+2	+5	+2	<i>Lesser shadow strike</i> (2/day)
7th	+7	+2	+5	+2	<i>Slicing torrent</i> 7/day (60-ft. cone)
8th	+8	+2	+6	+2	Blink 3/day
9th	+9	+3	+6	+3	<i>Lesser shadow strike</i> (3/day)
10th	+10	+3	+7	+3	<i>Avatar of vengeance</i>

The warden may use this ability 3 times per day at 1st level, 5 times per day at 4th level, and 7 times per day at 7th level. She threatens a longer cone at 4th level (50 feet) and 7th level (60 feet). The focus necessary for this ability is a single throwing dagger.

Blink (Su): As a free action at 2nd level, the warden may teleport over short distances. This ability functions exactly like the *dimension blink*† spell, and she uses her warden level to determine the distance she can cover. The warden can blink twice per day at 5th level and three times per day at 8th level.

Lesser Shadow Strike (Sp): One of the deadliest abilities of the warden is her power to imbue a weapon with the wrath and justice of the night elves. Once per day at 3rd level, she can cast *lesser shadow strike*† upon

a slashing or throwing weapon that she holds. She can use this ability twice per day at 6th level and three times per day at 9th level.

Avatar of Vengeance (Sp): The ultimate expression of the warden's spirit of justice and wrath is the summoning of a night elf spirit of vengeance. Summoning this spirit works exactly like the spell *vengeance*†, with the following exceptions. The greater spirit of vengeance has maximum hit points, and the lesser spirits of vengeance summoned immediately begin attacking whomever the warden commands them to. She does not need the spell focus for *vengeance*† in order to use this ability.

Warden Spell List

The warden's magic is drawn from conviction and belief in justice for the night elves. Thus, a warden's spells are much like the spells a paladin warrior or shaman receives. Treat the spells in the warden spell list as divine spells.

A warden uses her Wisdom score when determining bonus spells.

1st Level — *alarm, command, detect poison, detect snares and pits, expeditious retreat, feather fall, jump, moonblade*, obscuring mist, pass without trace, sleep, trueshield*.

2nd Level — *cat's grace, delay poison, detect thoughts, fox's cunning, invisibility, owl's wisdom, resist energy, see invisibility, spider climb, zone of truth*.

3rd Level — *darkvision, deep slumber, discern lies, displacement, hold person, nondetection, snare*.

4th Level — *dimension door, freedom of movement, greater invisibility, locate creature, neutralize poison, poison*.

Table 2–10:

Warden Spells per Day

Class Level	1st	2nd	3rd	4th
1st	0	—	—	—
2nd	1	—	—	—
3rd	1	0	—	—
4th	1	1	—	—
5th	1	1	0	—
6th	1	1	1	—
7th	2	1	1	0
8th	2	1	1	1
9th	2	2	1	1
10th	2	2	2	1

Witch Doctor

Description: The witch doctor's arcane magical art is formed from the ability to twist and turn nature through a crude yet effective science called juju. Often the more cunning and savvy members of the savage troll tribes, witch doctors are uncommon among other, more civilized races that instead rely on shamanistic or priestly aid in times of need. During war, the witch doctor's juju can give a troll tribe a needed edge.

Hit Die: d4.



Requirements

Race: Any troll.

Alignment: Any non-good.

Affiliation: Any.

Skills: Craft (alchemy) 7 ranks.

Feats: Brew Potion.

Spells: The ability to cast 2nd-level arcane spells.

Class Skills

The witch doctor's class skills (and the key ability for each) are Bluff (Cha), Concentration (Con), Craft (alchemy) (Int), Heal (Wis), Intimidate (Cha), Knowledge (arcane) (Int), Knowledge (nature) (Int), Profession (Wis), Spellcraft (Int). See Chapter 4: Skills in the *Player's Handbook* for skill descriptions.

Skill Points at Each Level: 2 + Int modifier.

Class

Features

Weapon and Armor Proficiency: The witch doctor is proficient with all simple weapons.

Spells: Every second witch doctor level, the character gains new spells per day as if he had also gained a level in whatever arcane spellcasting class he formerly belonged to before he added the witch doctor prestige class. He does not gain any of the other benefits of his former class. He simply adds his witch doctor level to the level of whatever other arcane spellcaster class he has, and then determines spells per day and caster level accordingly.

Table 2–11: The Witch Doctor (Wtd)

Class Level	Base Attack Bonus	Fort Save	Ref Save	Will Save	Special	Spell
1st	+0	+2	+0	+2	Ward craft	—
2nd	+1	+3	+0	+3	Shaka brew	+1 level of arcane spellcasting class
3rd	+1	+3	+1	+3	Bad juju	—
4th	+2	+4	+1	+4	Voodoo weapon	+1 level of arcane spellcasting class
5th	+2	+4	+1	+4	<i>Doom rattle</i>	—
6th	+3	+5	+2	+5	Bambe brew	+1 level of arcane spellcasting class
7th	+3	+5	+2	+5	Heap bad juju	—
8th	+4	+6	+2	+6	—	+1 level of arcane spellcasting class
9th	+4	+6	+3	+6	Zuveni brew	—
10th	+5	+7	+3	+7	<i>Death rattle</i>	+1 level of arcane spellcasting class

Ward Craft (Ex): At 1st level, *ward* spells (such as *sentry ward*) cast by the witch doctor that create totems of any sort gain a bonus to Armor Class, hardness and hit points equal to his Intelligence bonus.

Shaka Brew (Ex): The witch doctor's seething cauldron contains a hallucinogenic mixture of herbs, poisons, crushed insects and other noxious materials. At 2nd level, he may add drops of this Shaka brew to improve the efficiency of any potion or alchemical item he creates. The Shaka brew maximizes all variable, numeric effects of the witch doctor's potions or alchemical creations. Saving throws and opposed rolls are not affected, nor are potions without random variables. Drinking a potion treated with the Shaka brew leaves the imbiber with a euphoric buzz.

Using the Shaka brew as an additive increases the cost of brewing potions by 5 XP per level of the spell. Creating an alchemical item invigorated by Shaka increases the DC of creation by +5.

Bad Juju (Su): Creating curses is a specialty of the witch doctor. At 3rd level, the witch doctor can make a deadly doll of wax or tallow containing a specific person's hair, skin or blood (1 hit point worth). He can affect the target with a harmful touch attack spell or any single spell with the enchantment (compulsion) descriptor of up to 3rd level as long as

the person is on the same plane. The doll disintegrates after a touch attack or once the duration of the enchantment spell has passed.

The target may make any allowable saving throws with a penalty equal to the witch doctor's level. The target is flat-footed for any Reflex saves. The witch doctor can have a number of dolls equal to his Intelligence bonus at one time.

Voodoo Weapon (Ex): At 4th level, the witch doctor chooses a simple wooden weapon (e.g., staff, club, spear or javelin) that he prefers. He can infuse the weapon with alchemical reagents and various toxins and clays. Once per day as a full-round action, he may imbue the weapon with the frost, flaming or thundering special weapon properties. This ability lasts for a number of rounds equal to his class level. Anyone other than the witch doctor who attempts to use the weapon while it is active suffers the ill effects of the weapon's special properties.

Preparing a new voodoo weapon takes 1 month and 1,000 gp worth of alchemical reagents.

Doom Rattle (Sp): Upon reaching 5th level, the witch doctor can shake and rattle the gourds and necklaces that he carries to create a frightening rhythmic effect. Any foe within a 60-foot-radius who hears the doom rattle must make a Will save (DC 10 + the witch doctor's level + the witch doctor's Intelligence

bonus) or become shaken. Using this ability is a full-round action, requires concentration, and provokes attacks of opportunity. It lasts for as long as the witch doctor can concentrate.

Bambe Brew (Ex): The Bambe brew is a secret recipe that extends the effectiveness of magical potions. Upon attaining 6th level, whenever the witch doctor uses the Brew Potion feat he can pay an additional 1/2 the normal XP cost to make two potions instead of one. Making a potion with both Shaka and Bambe brews is possible. Apply the XP cost of the Shaka brew before calculating the cost of using the Bambe brew.

Drinking Bambe brew potions leaves the imbiber with a faint crawling sensation over her skin.

Heap Bad Juju (Su): At 7th level, the witch doctor learns to heap bad juju upon his foes. This ability functions exactly like the bad juju ability, but harmful touch or enchantment (compulsion) spells of any level can affect the doll. The proper components are still required to make the doll.

Zuvembi Brew (Ex): At 9th level, the witch doctor can add drops of this brew to any potion. The brew creates a powerful suggestive state in the imbiber that he can trigger and control.

For 1d4 days after drinking a Zuvembi brew potion, the imbiber can be dominated by the witch doctor as if under the effects of the *dominate monster* spell, with the following differences. The witch doctor may trigger this domination as a free action as long as he is within a line of sight of the target. If successful, the domination lasts a number of days equal to the witch doctor's level. The witch doctor can dominate a number of beings equal to his Intelligence bonus at the same time.

A potion treated with the Zuvembi brew costs 100 times its normal cost in ingredients (XP costs are normal). Drinking a Zuvembi brew potion leaves the imbiber feeling as if she were walking about in a dream.

Death Rattle (Sp): At 10th level, the juju of the witch doctor becomes potent enough to kill.

The arcane focus required to use this ability is a death gourd, which must be cured and carved by the witch doctor himself using bizarre and disgusting components worth 2,500 gp (the focus is not consumed when this ability is used, but the gourd is fragile and merits special care). Once per day, the witch doctor can rattle his death gourd, targeting a number of living creatures equal to 1 + his Intelligence bonus in a 20-foot radius. The closest creatures are affected first. Each listener must make a Fortitude save (DC 10 + half the witch doctor's level + his Intelligence bonus). Creatures with fewer than 3 Hit Dice die immediately on a failed save; success means they suffer 6d10 points of damage. Creatures with 3–9 Hit Dice take 6d10 points of damage on a failed save, and half damage if successful. Creatures with 10 Hit Dice or more suffer 6d10 points of damage on a failed save, and no damage if successful. Creatures who are deaf are immune to this effect.

Witch Doctor Spell List

Much like a wizard, the witch doctor relies on his ability to bend nature to his will. Juju secrets can only go so far, though.

The witch doctor gains access to these spells in addition to the arcane spells he may normally cast.

1st Level — *cure light wounds, inflict light wounds, lesser confusion, roar**, *sentry ward†*, *stasis trap**, *lesser trueshot aura†*, *war drums†*.

2nd Level — *cure moderate wounds, heroism, inflict moderate wounds, troll flesh†*.

3rd Level — *bloodlust**, *confusion, cure serious wounds, delay poison, healing ward**, *inflict serious wounds, serpent ward**, *trueshot aura†*.

4th Level — *cure critical wounds, inflict critical wounds, modify memory, neutralize poison, poison*.

5th Level — *greater heroism, greater trueshot aura†, heal, mass troll flesh†*.



Rain began to fall. Excellent.

Zaj'tal paused long enough to stretch, allowing the moisture to trickle between his scales. Just because he could survive outside the ocean did not mean that he liked to do so. He savored the sensation for a moment before continuing on, his snakelike tail writhing along the ground as he slithered up the hill.

As Zaj'tal neared the crest of the hill, he slowed and clutched his massive trident. He lowered his torso to the ground, inched forward, and peered over the edge.

Yes. There was the Alliance encampment. The fires were nothing but faint orange embers, even now being extinguished by the rain. The pines around the small cluster of tents shook with the drops and shed water. Nothing stirred. Yet there must be a sentry — surely Zaj'tal was not lucky enough to come upon a sleeping lookout.

There he was.

Cloaked, but obviously a Kaldorei. The naga could not make out the elf's features through the rain and dark, but he could imagine them well enough. The face a delicate indigo, with smooth features and elegant, pointed ears. Handsome. The sort of face that naga women found attractive. Zaj'tal would enjoy disfiguring that beautiful face.

The sentry stood against a tree, huddled in the rain. The fool Kaldorei had grown weak. This one could not even face the elements without shivering and drawing his dark cloak about himself.

Zaj'tal would prove that the naga had grown strong.

He lifted his left hand and its fingers danced in a complex pattern. Words of magic poured from his mouth.

Nothing happened. Zaj'tal was momentarily taken aback — the sentry had resisted his spell. Perhaps the Kaldorei had not fallen as far as he thought.

"*Allamnak!*" The sentry made a powerful gesture and bright light flashed, illuminating Zaj'tal's hunkeing form. The Kaldorei threw back his hood and stared at the intruder.





Zaj'tal was surprised to see that it was a female. He suppressed the momentary sensation of fear he felt upon seeing that feminine face, so akin to those of his own cruel mistresses. He was *naga*. He would not face this threat crouched on the ground like some grass snake. Rearing himself up, he hissed at the woman.

"Naga," she said with a smile, the words carrying across the distance despite her quiet tone. "You are far from your home."

"Assss are you, wench. *Gellin'Dallah!*" Nothing visible happened, but the camp was shrouded in an aura of silence. Now he could best this silly woman without alerting her allies.

She laughed, continuing forward. Zaj'tal again felt a surge of fear, which angered him more than anything else. He growled.

"Snake, you made a mistake coming to my camp. I do not allow *animals* in on my watch. *Keermissar!*" She flung out a hand, and three whirling yellow stars flashed forth and slammed into Zaj'tal, slicing deep into his flesh before vanishing. A simple spell, but it stung.

"Thank you, woman," was his guttural, hissing reply. "I wasss itchy there. *Gall'mak!*" He thrust his trident forward and a massive wave, ten feet high, blasted forward. It slammed into the sentry and continued on, smashing apart several trees before sinking into the ground.

There was silence, save for the falling rain. A trail of broken branches and gouged earth marked the wave's path. There was no sign of the Kaldorei.

Zaj'tal grinned. He slithered forward to where the woman's body had fallen. Indeed, there she lay, broken and bloody on the ground. The *naga* was pleased to see that she still breathed.

"I..." she began, but then coughed up a gout of blood.

"Do you know," rumbled Zaj'tal, "I thought you were a man. When I firssst sssaw you. I thought I would enjoy tearing your face from your ssskull." She made no reply. Her eyes were closed, and rainwater ran in rivulets down her face. "Now," he said, reaching forward, "I think I ssshall enjoy it far more."



CHAPTER THREE: FOUNTAINS OF MANA



From healers to witch doctors, wizards to necromancers, spellcasters stand as some of the most powerful and influential figures in the world of **Warcraft**. The tools of their power and influence — spells — access and shape the energies of nature, other planes of existence, death, spirits, ancestors, ideals and more. With their hands, minds and souls, spellcasters both arcane and divine can change the course of history... for better or worse.

This chapter constitutes the most comprehensive collection of spells in the **Warcraft RPG**, emulating nearly all the special abilities and powers of the units and heroes in the computer games and offering some fresh material. It first covers the rune families and runes cast by the runemaster core class (see Chapter One, "Rune Magic," and Chapter Two, "New Core Class"). Then it presents a large selection of new spells that increases the options available to all **Warcraft** spellcasting classes.

Rune Families

The rune families available to runemaster characters are detailed in this section. See the "Runes" section, below, for full descriptions of each rune.

Awareness Family

Granted Power: A rune from this family has a duration 10 times longer than normal when you inscribe it on yourself.

Awareness Family Runes

- 0 **Mark of Lesser Vision:** Subject gains low-light vision.
- 1 **Mark of Lesser Awareness:** Subject gains a +10 insight bonus on next attack roll.
- 2 **Mark of Awareness:** Subject gains a +4 insight bonus to AC.
- 3 **Mark of Vision:** Subject gains darkvision and can see invisible objects.
- 4 **Mark of Greater Awareness:** Subject is alerted to magical eavesdropping.
- 5 **Mark of Evasion:** Subject gains improved evasion.
- 6 **Mark of True Vision:** Subject sees all things as they really are.
- 7 **Mark of Sensing:** Subject gains blindsight and scent.
- 8 **Mark of Greater Sensing:** Subject gains tremorsense.
- 9 **Mark of Ultimate Awareness:** Subject gains "sixth sense" warnings of impending danger.

Beast Family

Granted Power: You can make a full attack when you charge a foe.

Beast Family Runes

- 0 **Mark of the Cat:** Subject gains a bonus on next Dexterity-based skill check.
- 1 **Mark of the Tiger:** Natural weapon does more damage.
- 2 **Mark of the Beast:** Subject gains +4 to Constitution, Dexterity or Strength for 2 minutes.
- 3 **Mark of the Badger:** Subject flies into a rage, like a barbarian.
- 4 **Mark of the Imp:** Subject gains fast healing 2.
- 5 **Mark of the Werewolf:** Subject gains damage reduction of 10/silver.
- 6 **Mark of the Golem:** Subject gains natural armor and damage reduction.
- 7 **Mark of the Snake:** One natural weapon is endowed with venom sacs.
- 8 **Mark of the Basilisk:** Subject can make gaze attacks.
- 9 **Mark of the Dragon:** Subject gains a breath attack.

Healing Family

Granted Power: You gain a +4 bonus on Heal checks.

Healing Family Runes

- 0 **Mark of Minor Healing:** Cures 1 point of damage.
- 1 **Mark of Lesser Healing:** Cures 2d6 points of damage.
- 2 **Mark of Healing:** Cures 4d6 points of damage.
- 3 **Mark of Greater Healing:** Cures 6d6 points of damage.
- 4 **Mark of Superior Healing:** Cures 8d6 points of damage.
- 5 **Mark of Ultimate Healing:** Cures 10d6 points of damage.
- 6 **Sigil of Healing:** Cures 4d6 points of damage.
- 7 **Sigil of Greater Healing:** Cures 6d6 points of damage.
- 8 **Sigil of Superior Healing:** Cures 8d6 points of damage.
- 9 **Sigil of Ultimate Healing:** Cures 10d6 points of damage.

Motion Family

Granted Power: You gain fast movement (as the barbarian) if you do not already possess it.

Motion Family Runes

- 0 **Mark of Lesser Speed:** Subject's speed improves by 10 feet for 1 minute.
- 1 **Glyph of Safe Fall:** Object falls slowly.
- 2 **Mark of Speed:** Creature gains speed increase and bonuses to Climb and Jump checks.
- 3 **Mark of Flying:** Subject flies at speed of 60 feet.
- 4 **Sigil of Lesser Transportation:** Teleports creatures a short distance.
- 5 **Sigil of Transportation:** Teleports creatures anywhere.
- 6 **Mark of Motion:** Subject can climb, burrow, fly and swim.

- 7 **Sigil of Greater Transportation:** Teleports creatures to any plane.
- 8 **Glyph of Opening:** Open a passage through wood or stone, door or wall.
- 9 **Sigil of Ultimate Transportation:** Permanent sigil teleports creatures to designated spot.

- 5 **Mark of Greater Shielding:** Subject gains spell resistance 21.
- 6 **Mark of Superior Shielding:** Subject gains immunity to necromancy and transmutation effects.
- 7 **Mark of Ultimate Shielding:** Turns spells back on the original caster.
- 8 **Mark of Mind Shielding:** Subject is immune to magical effects on mind or emotions and scrying.
- 9 **Sigil of Ultimate Shielding:** Spells are absorbed.

Restoration Family

Granted Power: You gain a +4 resistance bonus on saving throws against poison and disease. You heal temporary ability point damage at twice the normal rate (2 points per night of rest and 4 points per day of complete bed rest).

Restoration Family Runes

- 0 **Mark of Lesser Restoration:** Ends dazed and dazzled adverse conditions.
- 1 **Mark of Vigor:** Removes fatigue or alleviates exhaustion.
- 2 **Glyph of Mending:** Repairs an object.
- 3 **Sigil of Purification:** Restores the land and improves crops.
- 4 **Mark of Purification:** Immunizes subject against poison, detoxifies venom in or on subject.
- 5 **Mark of Freedom:** Subject moves normally despite impediments.
- 6 **Mark of Restoration:** Subject is restored to normal mental function.
- 7 **Mark of Greater Restoration:** Restores all levels and ability scores.
- 8 **Glyph of Resurrection:** Fully restores dead subject.
- 9 **Mark of Regeneration:** Subject gains regeneration 20.

Shielding Family

Granted Power: You can generate a protective ward around yourself as a supernatural ability. You gain a resistance bonus equal to your runemaster level on your next saving throw. Activating this power is a standard action. The protective ward is an abjuration effect with a duration of 1 hour that is usable once per day.

Shielding Family Runes

- 0 **Mark of Minor Shielding:** Subject gains +1 resistance bonus on saving throws.
- 1 **Mark of Lesser Shielding:** Spell attacks miss subject 50% of the time.
- 2 **Mark of Energy Shielding:** Subject ignores 10 points of damage per attack from specified energy type.
- 3 **Sigil of Dispelling:** Cancels spells and magical effects.
- 4 **Sigil of Shielding:** Stops 1st- through 3rd-level spell effects.

Striking Family

Granted Power: You gain the Weapon Focus (unarmed) feat for free.

Striking Family Runes

- 0 **Mark of Kind Striking:** Natural weapon deals an extra 1d4 points of nonlethal damage on next attack.
- 1 **Mark of Sure Striking:** Natural weapon ignores partial cover and concealment.
- 2 **Mark of Magic Striking:** Natural weapon gains +1 enhancement bonus.
- 3 **Mark of Aligned Striking:** Natural weapon becomes good, evil, lawful or chaotic.
- 4 **Mark of Hardened Striking:** Natural weapon gains improved base damage and critical multiplier.
- 5 **Mark of Vampiric Striking:** Natural weapon's attacks heal the attacker.
- 6 **Mark of Energy Striking:** Natural weapon deals an extra 1d6 points of energy damage.
- 7 **Mark of Sonic Striking:** Natural weapon deals an extra 1d6 points of sonic damage.
- 8 **Mark of Greater Hardened Striking:** Natural weapon becomes adamantite and gains improved base damage.
- 9 **Mark of Ultimate Striking:** Natural attacks gain reach and improved base damage, and allow ranged attacks.

Runes

The description of each rune is presented in a standard format, similar to that of a spell. Runes follow the same conventions as schools of magic, and they rank from 0-level to 9th level. Rune descriptions are presented with missing entries when those entries follow the "standard rules" for those qualities. For example, runes with somatic and material components are missing their Components entry since this is the default for all runes. The standard Inscribing Time is 1 round; Range is touch; Target for a mark is always "Creature

touched,” Target for a sigil is “All creatures in a 30-foot-radius burst,” and glyphs always include a Target entry. All runes include Duration, Saving Throw and Spell Resistance statistics. Some runes include an additional Material Components entry for costly components or an XP Cost entry.

Glyph of Mending

Repair a broken object.

Transmutation

Level: Restoration 2

Target: One object of up to 100 cu. ft.

Duration: Instantaneous

Saving Throw: Will negates (harmless, object)

Spell Resistance: Yes (harmless, object)

Description

Breaks and tears in a broken object are completely repaired, making the object strong as new.

Rune Effect

This rune functions like the spell *make whole* except as already noted.

Glyph of Opening

Creates a passage through wood or stone.

Conjuration (Creation)

Level: Motion 8

Target: See text

Duration: 1 minute

Saving Throw: None

Spell Resistance: No

Description

A portion of the Material Plane is shunted into the Twisting Nether, creating a tunnel through a door or wall.

Rune Effect

This glyph is usually inscribed on a door, but can be inscribed on a wall no thicker than 40 feet. In either case, activating the glyph creates a visible hole in the affected door or wall. The material of the door or wall is not destroyed and does not disappear; it temporarily shifts into the Twisting Nether, leaving behind a hole. Only wood, plaster or stone walls are affected.

The hole begins to waiver 8 rounds after activation and fades completely after 10 rounds. The tunnel is subject to *dispel magic*. Anyone within the

passage when it is dispelled or fades on its own is harmlessly ejected.

Glyph of Resurrection

Restores life to a corpse.

Conjuration (Healing)

Level: Restoration 8

Inscribing Time: 10 minutes

Target: One corpse

Duration: Instantaneous

Saving Throw: None (see text)

Spell Resistance: Yes (harmless)

Description

Restores life and complete strength to any deceased creature.

Rune Effect

This rune functions like the spell *resurrection* except as noted here. The creature can have been dead no longer than 200 years.

Material Component: A special rune ink prepared with crushed diamonds totaling 10,000 gp.

Glyph of Safefall

An object falls more slowly.

Transmutation

Level: Motion 1

Inscribing Time: 1 free action

Target: One Large or smaller freefalling object

Duration: Until landing or 2 minutes

Saving Throw: Will negates (object)

Spell Resistance: Yes (object)

Description

One object fights the effects of gravity. If the object is being worn or carried by a creature, that creature falls more slowly as well.

Rune Effect

This glyph can be inscribed with a quick flick of the wrist, allowing it to be inscribed as a free action. This rune functions like the spell *feather fall* except as noted here. The target object and all creatures clinging to it cannot weigh more than 500 pounds combined.

Mark of Awareness

The subject gains a +4 insight bonus to AC.

Transmutation

Level: Awareness 2
Duration: 1 hour
Saving Throw: Will negates (harmless)
Spell Resistance: Yes (harmless)

Description

The subject is granted increased awareness, a fraction of a second into the future. This allows the subject to sense from which direction attacks will come.

Rune Effect

The subject gains a +4 insight bonus to AC. This insight bonus is lost whenever the subject loses her Dexterity bonus to AC unless she is only flat-footed, in which case *mark of awareness* still grants a +2 insight bonus to AC.

Mark of Awareness, Greater

The subject is alerted to magical eavesdropping.

Divination
Level: Awareness 4
Duration: 2 hours
Saving Throw: Will negates (harmless)
Spell Resistance: Yes (harmless)

Description

A field of awareness surrounds the subject and alerts him to any attempt to observe him by means of a divination (scrying) spell or effect.

Rune Effect

For the duration of the effect, the subject knows the location of every magical scrying sensor within a 40-foot radius. If a scrying attempt originates within the area, the subject instantly knows the location from which the attempt was made; otherwise, the creature attempting to scry immediately makes a caster level check (DC 21) to hide her identity. If she fails the check, the subject of *mark of greater awareness* gets a visual image of the creature attempting to scry and an accurate sense of her direction and distance.

Mark of Awareness, Lesser

The subject gains a +10 insight bonus on his next attack roll.

Transmutation
Level: Awareness 1
Duration: See text
Saving Throw: Will negates (harmless)
Spell Resistance: Yes (harmless)

Description

The subject gains an intuitive awareness of the future, allowing a bonus on his next attack roll.

Rune Effect

The subject gains a +10 insight bonus on his next single attack roll. Additionally, the subject is not affected by the miss chance that applies to attackers trying to strike a concealed target.

Mark of Awareness, Ultimate

The subject gains a powerful sixth sense.

Divination
Level: Awareness 9
Duration: 10 minutes
Saving Throw: Will negates (harmless)
Spell Resistance: Yes (harmless)

Description

The subject gains a powerful sixth sense, receiving instantaneous warnings of impending danger or harm.

Rune Effect

The subject is never surprised or flat-footed. The subject gains a +8 insight bonus to AC and on Reflex saves. This insight bonus is lost whenever the subject loses her Dexterity bonus to AC.

Mark of Evasion

The subject avoids magical and unusual attacks with great agility.

Divination
Level: Awareness 5
Duration: 1 hour
Saving Throw: Will negates (harmless)
Spell Resistance: Yes (harmless)

Description

The subject gains an intuitive awareness of how to defend himself against magical attacks.

Rune Effect

The subject gains improved evasion, as the rogue class special ability.

Mark of Flying

The subject flies at a speed of 60 feet, with good maneuverability.

Transmutation

Level: Motion 3

Duration: 10 minutes

Saving Throw: Will negates (harmless)

Spell Resistance: Yes (harmless)

Description

The subject becomes as light as air, soaring into the air to fly like a bird.

Rune Effect

The subject gains the fly movement mode with a speed of 60 feet and a maneuverability of good (or 40 feet and average if it carries a medium or heavy load or wears medium or heavy armor). He can ascend at half speed and descend at double speed. He can attack or cast spells normally, charge but not run, and cannot carry aloft more weight than his maximum load plus any armor he wears.

Should the rune's duration expire while the subject is still aloft, he floats downward 60 feet per round for 1d6 rounds, covering any remaining distance by falling (and taking damage as normal). The subject descends in this way if the rune is dispelled, but not if it is negated by an *antimagic field*.

Mark of Freedom

Subject moves normally despite impediments.

Abjuration

Level: Restoration 5

Duration: 2 hours

Saving Throw: Will negates (harmless)

Spell Resistance: Yes (harmless)

Description

The subject's mind and body are freed from physical and magical constraints.

Rune Effect

This rune functions like the *freedom of movement* spell, except as already noted.

Mark of Healing

Cures 4d6 damage.

Conjuration (Healing)

Level: Healing 2

Duration: Instantaneous

Saving Throw: Will half (harmless; see text)

Spell Resistance: Yes (harmless; see text)

Description

This mark is imbued with positive energy. It cures damage when activated.

Rune Effect

The subject is cured of 4d6 points of damage.

Since undead are powered by negative energy, this effect deals damage to them instead of curing their wounds. An undead creature can apply spell resistance and can attempt a Will save to take half damage. Note that inscribing a rune on an undead creature can be quite difficult since few will voluntarily sit completely still for a full round.

Mark of Healing, Greater

Conjuration (Healing)

Level: Healing 3

As mark of healing, except that it cures 5d8 points of damage.

Mark of Healing, Lesser

Conjuration (Healing)

Level: Healing 1

As mark of healing, except that it cures 3d4 points of damage.

Mark of Healing, Minor

Conjuration (Healing)

Level: Healing 0

As mark of healing, except that it cures 1 point of damage.

Mark of Healing, Superior

Conjuration (Healing)

Level: Healing 4

As mark of healing, except that it cures 6d10 points of damage.

Mark of Healing, Ultimate

Conjuration (Healing)

Level: Healing 5

As mark of healing, except that it cures 7d12 points of damage.

Mark of Motion

The subject gains burrow, climb, fly and swim movement modes.

Transmutation

Level: Motion 6
Duration: 1 hour
Saving Throw: Will negates (harmless)
Spell Resistance: Yes (harmless)

Description

The subject is imbued with the burrowing ability of a carrion beetle, the climbing ability of a spider, the flying ability of a bird and the swimming ability of a shark.

Rune Effect

This rune functions like the *mark of flying* except as noted here. The subject gains a fly movement mode at a speed of 80 feet (good). Furthermore, the subject also gains a burrow mode at 20 feet, a climb mode at 30 feet, and a swim mode at 40 feet.

Wearing medium or heavy armor, or carrying a medium or heavy load, reduces these speeds to burrow 15 feet, climb 20 feet, fly 60 feet, and swim 25 feet. The subject retains her Dexterity bonus to AC in all movement modes.

The subject gains a +8 racial bonus on Climb checks. She can always choose to take 10 on Climb checks, even if rushed or threatened.

The subject also gains a +8 racial bonus on any Swim check to perform some special action or avoid a hazard. She can always choose to take 10 on a Swim check, even if distracted or endangered. She can use the run action while swimming, providing she swims in a straight line.

Mark of Purification

Removes many physical afflictions.
 Conjuration (Healing)
Level: Restoration 4
Duration: Instantaneous
Saving Throw: Will negates (harmless)
Spell Resistance: Yes (harmless)

Description

Positive energy washes over the subject to wipe away physical afflictions.

Rune Effect

The following adverse conditions affecting the target are immediately ended: blinded, deafened, diseased, nauseated, sickened and poisoned.

A poisoned creature suffers no additional effects from the poison, and any temporary effects are

ended, but instantaneous effects are not reversed (such as hit point damage, temporary ability damage or effects that don't go away on their own).

Mark of Regeneration

The subject gains regeneration 20.

Transmutation

Level: Restoration 9
Duration: 1 minute
Saving Throw: Fortitude negates (harmless)
Spell Resistance: Yes (harmless)

Description

The subject gains the regeneration of a troll as lost body parts are regained, broken bones are mended and physical vitality is increased.

Rune Effect

The subject gains regeneration 20. All damage inflicted on the subject from all sources is treated as nonlethal damage, which heals at a rate of 20 points per round, although acid and fire deal lethal damage to the subject. Also, the subject's severed body members (fingers, toes, hands, feet, arms, legs, tails, or even heads of multi-headed creatures), broken bones, and ruined organs grow back. After the mark is activated, the physical regeneration is complete in 1 round if the severed members are present and touching the creature. It takes 1 minute otherwise. *Mark of regeneration* also rids the subject of exhaustion or fatigue. Damage that the subject suffered before activating the rune is converted to nonlethal damage and regenerated; when the rune's duration expires, all remaining damage becomes lethal (unless it was caused by a nonlethal effect). The mark has no effect on nonliving creatures (including undead).

Mark of Restoration

Removes several mental afflictions.
 Conjuration (Healing)
Level: Restoration 6
Duration: Instantaneous
Saving Throw: Will negates (harmless)
Spell Resistance: Yes (harmless)

Description

Positive energy washes over the subject to wipe away mental afflictions.

Rune Effect

The following adverse conditions affecting the target are immediately ended: *confused*, the effects of a *feblemind* spell and insanity.

Mark of Restoration, Greater

Restores level and ability score drains.

Conjuration (Healing)

Level: Restoration 7

Components: S, M, XP

Duration: Instantaneous

Saving Throw: Will negates (harmless)

Spell Resistance: Yes (harmless)

Description

Spirits of past runemasters bless the subject, restoring drained levels and ability scores.

Rune Effect

Activating this mark dispels all magical effects penalizing the creature's abilities, cures all temporary ability damage and restores all points permanently drained from all ability scores. It dispels all negative levels afflicting the target. This effect also reverses level drains by a force or creature, restoring the creature to the highest level it had previously attained. The drained levels are restored only if the time since the creature lost the level is no more than 3 months.

Mark of greater restoration does not restore Constitution points lost due to death.

XP Cost: 500 XP.

Mark of Restoration, Lesser

Alleviates dazed and dazzled conditions.

Conjuration (Healing)

Level: Restoration 0

Duration: Instantaneous

Saving Throw: Will negates (harmless)

Spell Resistance: Yes (harmless)

Description

Positive energy washes over the subject wiping away minor afflictions.

Rune Effect

Activating this mark immediately ends any and all of the following adverse conditions affecting the target: dazed and dazzled.

Mark of Sensing

The subject gains the blindsight and scent qualities.

Abjuration

Level: Awareness 7

Duration: 2 minutes

Saving Throw: Fortitude negates (harmless)

Spell Resistance: Yes (harmless)

Description

The subject's non-visual senses are heightened, granting him the ability to notice things he cannot see.

Rune Effect

Activating this mark grants the subject blindsight and scent, each with a range of 30 feet.

Mark of Sensing, Greater

The subject gains the tremorsense quality.

Abjuration

Level: Awareness 8

Duration: 2 minutes

Saving Throw: Fortitude negates (harmless)

Spell Resistance: Yes (harmless)

Description

The subject becomes one with the spirits of the earth, allowing the subject to sense the location of anything that is in contact with the ground and within range.

Rune Effect

Activating this mark grants the subject tremorsense with a range of 30 feet.

Mark of Shielding, Energy

The subject ignores damage from specified energy type.

Abjuration

Level: Shielding 2

Duration: 1 hour

Saving Throw: Fortitude negates (harmless)

Spell Resistance: Yes (harmless)

Description

An aura surrounds the subject and protects her from harm caused by a specific form of energy damage. The color of the aura varies with the damage prevented: yellow for acid, red for cold, brown for electricity, blue for fire or white for sonic.

Rune Effect

When making the final stroke of this mark, the inscriber must choose one of the following elements: acid, cold, electricity, fire or sonic. When the mark is activated, the subject is granted energy resistance 10 against damage of whichever one of the five energy types was selected. This rune functions like the spell *resist energy*, except as already noted.

Mark of Shielding, Greater

The subject gains spell resistance 21.

Abjuration

Level: Shielding 5

Duration: 10 minutes

Saving Throw: Will negates (harmless)

Spell Resistance: Yes (harmless)

Description

A magical aura shields and protects the subject from spell effects.

Rune Effect

Activating this mark grants the subject spell resistance 21.

Mark of Shielding, Lesser

Spell attacks miss subject 50% of the time.

Abjuration

Level: Shielding 1

Duration: 1 minute

Saving Throw: Will negates (harmless)

Spell Resistance: Yes (harmless)

Description

The subject becomes effectively invisible to the world of magic. Enemy casters can still see the protected creature, but it is difficult to direct targeted magical energy at her.



Rune Effect

The subject has complete concealment (50% miss chance) against spell attack rolls (melee touch and ranged touch attacks).

A *see invisibility* or *true seeing* spell does not counteract this effect because the subject is only invisible with regard to targeted magical energy. The subject is not physically invisible.

Mark of Shielding, Mind

The subject is immune to magical effects on his mind and emotions, and to scrying.

Abjuration

Level: Shielding 8

Duration: 24 hours

Saving Throw: Will negates (harmless)

Spell Resistance: Yes (harmless)

Description

The subject's mind is shielded against magic that tries to read his thoughts or scry on his location.

Rune Effect

This rune functions like the spell *mind blank*, except as already noted.

Mark of Shielding, Minor

The subject gains a +1 resistance bonus on saving throws.

Abjuration

Level: Shielding 0

Duration: 1 minute

Saving Throw: Will negates (harmless)

Spell Resistance: Yes (harmless)

Description

A faint magical aura shields the subject and protects her from spells.

Rune Effect

This rune functions like the spell *resistance*, except as already noted.

Mark of Shielding, Superior

The subject gains immunity to necromancy and transmutation effects.

Abjuration

Level: Shielding 6

Duration: 1 minute

Saving Throw: Will negates (harmless)

Spell Resistance: Yes (harmless)

Description

The subject's vitality is girded and protected against magical effects that would sap his life energy or force his shape to change, among many other effects.

Rune Effect

When this mark is activated, the subject gains immunity to all necromancy and transmutation effects of 6th level and lower. Any such effects already active on the creature are immediately dispelled. Treat this effect as unbeatable spell resistance. The supernatural energy drain attacks of undead creatures are not affected by this rune; the necromantic spell *energy drain* is.

Mark of Shielding, Ultimate

Reflects spells back at caster.

Abjuration

Level: Shielding 7

Duration: Until expended or 2 hours

Saving Throw: Will negates (harmless)

Spell Resistance: Yes (harmless)

Description

A shimmering aura of protection forms around the subject that turns spells and spell-like effects targeted on the subject back upon the original caster.

Rune Effect

The abjuration turns only spells that have the subject as a target. Effect and area spells are not affected. It also fails to stop touch-range spells.

When the subject is targeted by a spell, there is a chance the spell is turned. After turning a spell successfully, there is a chance *mark of ultimate shielding* dissipates. Chances for turning and dissipation are listed below.

Spell Level	Chance Turned	Chance of Dissipation
0	99%	1%
1	99%	5%
2	99%	15%
3	99%	30%
4	99%	50%
5	99%	75%
6	97%	90%
7	95%	95%
8	85%	97%
9	75%	99%

Mark of Speed

The subject's speed and maneuverability increase.

Transmutation

Level: Motion 2

Duration: 10 minutes

Saving Throw: Will negates (harmless)

Spell Resistance: Yes (harmless)

Description

The subject gains the speed, climbing and jumping ability of a tiger.

Rune Effect

The subject gains several benefits when this mark is activated.

The subject's base land speed increases by 30 feet. There is no effect on other modes of movement such as burrow, climb, fly or swim. As with any effect that increases speed, this spell affects jumping distance (see "Jump" in Chapter 4: Skills of the *Player's Handbook*).

The subject gets a +10 racial bonus on Climb checks and retains her Dexterity bonus to Armor Class (if any) while climbing, and opponents get no special bonus to their attacks against her; however, the subject cannot use the run action while climbing.

The subject gets a +10 racial bonus on Jump checks.

Mark of Speed, Lesser

The subject's speed increases by 10 feet.

Transmutation

Level: Motion 0

Duration: 1 minute

Saving Throw: Will negates (harmless)

Spell Resistance: Yes (harmless)

Description

The subject is invigorated with energy and gains a quick burst of speed.

Rune Effect

The target's base land speed increases by 10 feet when this mark is activated. There is no effect on other modes of movement such as burrow, climb, fly, or swim. As with any effect that increases your speed, this spell affects your jumping distance (see "Jump" in Chapter 4: Skills of the *Player's Handbook*).

Mark of Striking, Aligned

A natural weapon becomes chaotic, evil, good or lawful.

Transmutation [see text]

Level: Striking 3

Target: One natural weapon

Duration: 1 hour

Saving Throw: Will negates (harmless)

Spell Resistance: Yes (harmless)

Description

One of the subject's natural weapons is imbued with highly focused and energetic spirits.

Rune Effect

Choose an alignment from chaotic, evil, good or lawful when placing the finishing stroke of the mark. Activate this mark to align the natural weapon as chosen when the mark was inscribed. This rune functions like the spell *align weapon*, except as already noted.

Mark of Striking, Energy

A natural weapon deals bonus energy damage.

Transmutation [see text]

Level: Striking 6

Target: One natural weapon

Duration: 1 hour

Saving Throw: Will negates (harmless)

Spell Resistance: Yes (harmless)

Description

One of the subject's natural weapons erupts with acid, cold, fire or electricity energy. The subject's attacks deal additional energy-based damage, but the subject suffers no ill effects.

Rune Effect

Choose one energy type from acid, cold, fire or electricity when making the final stroke to complete this mark. Activate this mark to cause the natural weapon it imbues to erupt with the chosen energy. This mark dispels any existing energy effect already on the natural weapon. For example, if the natural weapon is already flaming when a *mark of energy striking* is activated for cold damage, the flaming effect is dispelled.

The energy does not harm the subject. The natural weapon deals an extra 1d6 points of the chosen energy damage on a successful hit. Upon striking a successful

critical hit, the natural weapon deals an additional 1d10 points of the chosen energy damage.

This mark is treated as an acid, cold, fire or electricity effect based upon the finishing stroke.

Mark of Striking, Greater Hardened

Natural weapon becomes adamantine.

Transmutation

Level: Striking 8

Target: One natural weapon

Duration: 1 hour

Saving Throw: Will negates (harmless)

Spell Resistance: Yes (harmless)

Description

The subject's natural weapon becomes effectively living adamantine, dealing bonus damage and penetrating hardened defenses.

Rune Effect

The base damage of the natural weapon improves by one step as though its size were increased. For example, a weapon that did 2d6 points of damage would improve to 3d6 with this effect (see Table 7-4 in the *Player's Handbook*). Attacks made with this natural weapon are treated as adamantine for the purposes of dealing damage to creatures with damage reduction and bypassing hardness.

Mark of Striking, Hardened

Natural weapon hardens like steel.

Transmutation

Level: Striking 4

Target: One natural weapon

Duration: 1 hour

Saving Throw: Will negates (harmless)

Spell Resistance: Yes (harmless)

Description

The subject's natural weapon hardens like steel, and well-placed strikes are particularly damaging.

Rune Effect

The base damage of the natural weapon improves by one step as though its size were increased. For example, a weapon that did 1d6 points of damage would improve to 1d8 with this effect (see Table 7-4 in the *Player's Handbook*). In addition, the critical

multiplier of the weapon increases by 1. A critical multiplier of x2 becomes x3, while a critical multiplier of x3 becomes x4. Multiple effects that increase a weapon's critical multiplier don't stack.

Mark of Striking, Kind

Natural weapon inflicts bonus nonlethal damage.

Evocation

Level: Striking 0

Target: One natural weapon

Duration: See text

Saving Throw: Will negates (harmless)

Spell Resistance: Yes (harmless)

Description

The subject deals bonus damage, yet sharp claws are temporarily dulled and hard knuckles are momentarily softened.

Rune Effect

Activate this mark to make your next successful attack with the inscribed natural weapon deal an extra 1d4 points of nonlethal damage. The effect ends after 1 minute or if discharged.

Mark of Striking, Magic

Natural weapon gains a +1 enhancement bonus.

Transmutation

Level: Striking 2

Target: One natural weapon

Duration: 1 hour

Saving Throw: Will negates (harmless)

Spell Resistance: Yes (harmless)

Description

The subject's natural weapon becomes magical.

Rune Effect

Activate this mark to give the natural weapon a +1 enhancement bonus on attack and damage rolls.

Mark of Striking, Sonic

Natural weapon deals bonus sonic damage.

Transmutation [Sonic]

Level: Striking 7

Target: One natural weapon

Duration: 1 hour

Saving Throw: Will negates (harmless)

Spell Resistance: Yes (harmless)

Description

Successful attacks made with the natural weapon are so strong that they cause thunderclaps.

Rune Effect

The base damage of the natural weapon improves by one step as though its size were increased. For example, a weapon that did 1d8 points of damage would improve to 2d6 with this effect (see Table 7-4 in the *Player's Handbook*). Further, the natural weapon deals an extra 1d6 points of sonic damage on a successful hit, and it acquires the *thundering* weapon special ability (see the DMG, Chapter 7, "Weapons").

Mark of Striking, Sure

Negates concealment and cover penalties.

Transmutation

Level: Striking 1

Target: One natural weapon

Duration: 1 hour

Saving Throw: Will negates (harmless)

Spell Resistance: Yes (harmless)

Description

This mark has the appearance of an eye, and the natural weapon almost seems to see on its own.

Rune Effect

The natural weapon ignores the AC bonus granted to targets by anything less than total cover and the miss chance granted to targets by anything less than total concealment. Total cover and total concealment provide their normal benefits against the natural weapon.

Mark of Striking, Ultimate

Gain deadly reach and ranged attacks.

Transmutation

Level: Striking 9

Duration: 4 hours

Saving Throw: Will negates (harmless)

Spell Resistance: Yes (harmless)

Description

The subject's natural weapons become so powerful that shockwaves precede them. He no longer needs to make actual physical contact with a victim to deal melee damage.

Rune Effect

The bearer's unarmed attacks gain multiple effects. First, the base damage of all natural weapons improves by one step as though each weapon's size were increased. For example, a weapon that did 3d6 points of damage would improve to 4d6 with this effect (see Table 7-4 in the *Player's Handbook*).

Second, the subject's reach increases by 5 feet.

Finally, a visible shockwave emanates from the subject's fists whenever he throws punches. The subject can use his natural weapons to make ranged touch attacks with a range of 30 feet. The shockwaves produced from these strikes deal 1d8 + Strength modifier points of bludgeoning damage plus 1d6 points of sonic damage.

Mark of Striking, Vampiric

Natural weapon drains the victim's life force.

Transmutation

Level: Striking 5

Target: One natural weapon

Duration: 1 hour

Saving Throw: Will negates (harmless)

Spell Resistance: Yes (harmless)

Description

The subject's natural weapon is imbued with the essence of a vampire. Her natural attacks give life back to her.

Rune Effect

The subject heals as many points of damage as it inflicts with the base damage of its natural weapon. The creature does not heal extra damage dealt by Strength, enhancements, energy and so on. If the creature's base attack is 1d8, then only this roll provides healing, even if the full amount dealt with each attack is, for example, 1d8+10 points of damage plus 1d6 points of fire damage. Critical hits heal all base attack damage dealt. For example, the natural attack from the previous example would heal 2d8 hit points per critical hit.

Mark of the Badger

The subject flies into a rage.

Transmutation

Level: Beast 3

Duration: See text

Saving Throw: Will negates (harmless)

Spell Resistance: Yes (harmless)

Description

The subject is imbued with the essence of a badger and flies into a powerful rage.

Rune Effect

The subject enters into a barbarian rage, but is not fatigued when the effect ends (see the description of rage in Chapter 3: Classes of the *Player's Handbook*).

Mark of the Basilisk

The subject gains a gaze attack.

Transmutation

Level: Beast 8

Duration: 1 minute

Saving Throw: Will negates (harmless)

Spell Resistance: Yes (harmless)

Description

The subject is imbued with the essence of a basilisk, granting him a gaze attack that turns victims to stone.

Rune Effect

Unlike a normal gaze attack, creatures within range do not need to make a Fortitude save each round. Instead, the subject can make one gaze attack each round as a free action. The target of the gaze attack must be within 30 feet, and the target gets a Fortitude save (DC 10 + 1/2 subject's Hit Dice + subject's Charisma modifier) to negate the effect. The power of *mark of the basilisk* is discharged after 1 minute or if one victim is turned to stone.

Mark of the Beast

Increases Constitution, Dexterity or Strength.

Transmutation

Level: Beast 2

Duration: 2 minutes

Saving Throw: Will negates (harmless)

Spell Resistance: Yes (harmless)

Description

The subject is imbued with the essence of a cat, bear or bull, granting her increased agility, vitality or strength.

Rune Effect

When this mark is inscribed, the runemaster finishes the mark with a stroke to indicate whether the

mark affects Constitution, Dexterity or Strength. Activating this mark grants the target a +4 enhancement bonus to the selected ability score.

This rune functions like the spells *cat's grace*, *bear's endurance* or *bull's strength* as appropriate, except as already noted.

Mark of the Cat

Dexterity-based skills improve.

Transmutation

Level: Beast 0

Duration: See text

Saving Throw: Will negates (harmless)

Spell Resistance: Yes (harmless)

Description

The subject is imbued with the agility of a cat.

Rune Effect

When this mark is activated, the subject gains a +5 circumstance bonus on his next skill check from the following list: Balance, Escape Artist, Hide, Move Silently or Tumble.

Mark of the Dragon

The subject gains a breath weapon.

Transmutation

Level: Beast 9

Duration: 1 minute (see text)

Saving Throw: Will negates (harmless)

Spell Resistance: Yes (harmless)

Description

The subject is imbued with the essence of a dragon, granting her a breath attack.

Rune Effect

The finishing stroke of this mark sets its energy type and attack method. The inscriber must choose from acid, cold, fire or electricity, and either a line or cone area of effect. Once the choice has been made, the mark cannot be altered. Once activated, the subject has 1 minute to make one breath attack. If the mark was inscribed as a line, the breath weapon is 5 feet wide, 5 feet high, and 140 feet long. If the mark was inscribed as a cone, the breath weapon is 70 feet long. The breath weapon deals 20d6 points of damage of the energy type chosen when the mark was inscribed. Victims in the area of

effect may make a Reflex save (DC 10 + 1/2 subject's Hit Dice + subject's Constitution modifier) for half damage.

Mark of the Golem

The subject gains natural armor and damage reduction.

Transmutation

Level: Beast 6

Duration: 2 minutes or until discharged

Saving Throw: Will negates (harmless)

Spell Resistance: Yes (harmless)

Description

The subject's skin hardens like stone, warding him against blows, cuts, stabs and slashes.

Rune Effect

Activating this mark grants the subject a +5 enhancement bonus to natural armor and damage reduction 10/adamantine. Once the effect has prevented a total of 100 points of damage, it is discharged.

When both this rune and *mark of the werewolf* are in effect, the DR 10/adamantine reduces damage by silver weapons by 10 points, which is taken off the 100 points of protection provided by *mark of the golem*.

Mark of the Imp

The subject gains fast healing 3.

Transmutation

Level: Beast 4

Duration: 10 rounds

Saving Throw: Fortitude negates (harmless)

Spell Resistance: Yes (harmless)

Description

The subject is imbued with the essence of an imp, granting her superior healing powers.

Rune Effect

The subject gains fast healing 3.

Mark of the Snake

Natural attacks become poisonous.

Transmutation

Level: Beast 7

Target: One piercing natural weapon

Duration: 2 minutes

Saving Throw: Fortitude negates (see text)

Spell Resistance: Yes

Description

The subject is imbued with the essence of a snake. Poison sacs develop, and the subject becomes capable of injecting poison into wounds he creates.

Rune Effect

Whenever the subject strikes with the affected natural weapon, victims struck must succeed at a Fortitude saving throw (DC 10 + 1/2 subject's Hit Dice + subject's Constitution modifier) or suffer 1d4 points of temporary Constitution damage, and another 1d4 points of temporary Constitution damage 1 minute later. The subject's claws or teeth will grow long enough to act as piercing weapons for the mark's duration; the subject gains a claw or bite attack if he did not have one already.

Mark of the Tiger

Increases natural weapon's damage.

Transmutation

Level: Beast 1

Target: One piercing natural weapon

Duration: 2 minutes

Saving Throw: Will negates (harmless)

Spell Resistance: Yes (harmless)

Description

The subject is imbued with the essence of a tiger. The natural weapon sharpens and deals additional damage.

Rune Effect

The subject's claw and or bite attack becomes more potent, the natural weapon's base damage improving by one step as though its were size increased. For example, a weapon that did 1d6 base points of damage would improve to 1d8 with this effect (see Table 7-4 in the *Player's Handbook*). If the subject does not have a claw or bite attack, he acquires one of his choice for the rune's duration.

Mark of the Werewolf

The subject gains damage reduction 10/silver.

Transmutation

Level: Beast 5

Duration: 2 minutes or until discharged

Saving Throw: Will negates (harmless)

Spell Resistance: Yes (harmless)

Description

The subject is imbued with the essence of a werewolf, protecting her from damage but leaving her vulnerable to silver.

Rune Effect

Activating this mark wards the subject against blows, cuts, stabs and slashes. The subject gains damage reduction 10/silver. (She ignores the first 10 points of damage each time she takes damage from a weapon, though a silver weapon bypasses the reduction.) Once the effect has prevented a total of 100 points of damage, it is discharged.

Mark of Vigor

Eliminates fatigue.

Conjuration (Healing)

Level: Restoration 1

Duration: Instantaneous

Saving Throw: Will negates (harmless)

Spell Resistance: Yes (harmless)

Description

Positive energy invigorates the subject, wiping away fatigue.

Rune Effect

The subject is no longer fatigued. If the creature was exhausted, that condition is reduced to fatigued.

Mark of Vision

The subject gains darkvision, and can see invisible creatures and objects.

Transmutation

Level: Awareness 3

Duration: 1 hour

Saving Throw: Will negates (harmless)

Spell Resistance: Yes (harmless)

Description

The subject's eyes glow a deep violet, granting the ability to see in pitch black and to see invisible objects.

Rune Effect

This rune functions like the spells *darkvision* and *see invisibility*, except as already noted.



Mark of Vision, Lesser

The subject gains low-light vision.

Transmutation

Level: Awareness 0

Duration: 1 minute

Saving Throw: Will negates (harmless)

Spell Resistance: Yes (harmless)

Description

The subject's eyes glow a faint yellow as he gains the ability to see better in dimly lit areas.

Rune Effect

Activate this mark to gain low-light vision for the rune's duration.

Mark of Vision, True

The subject sees all things as they really are.

Divination

Level: Awareness 6

Duration: 2 minutes

Saving Throw: Will negates (harmless)

Spell Resistance: Yes (harmless)

Description

The subject gains the ability to see through darkness; notice magically hidden doors; pinpoint creatures through magical concealment; and see invisible objects, illusions, and the true forms of transmuted things.

Rune Effect

This rune functions as the spell *true seeing*, except as already noted.

Material Component: The ink for this rune is made from 250 gp worth of mushroom powder, saffron and fat.

Sigil of Dispelling

Cancels magical spells and effects.

Abjuration

Level: Shielding 3

Duration: Instantaneous

Saving Throw: None

Spell Resistance: No

Description

A blast of counter-magic dispels magical spells and effects in the area.

Rune Effect

This rune functions as the spell *dispel magic*, except as noted here. It acts as an area dispel only, affecting everything within a 30-foot radius. The caster level of the rune is 10th, so the caster level check is 1d20+10.

Sigil of Healing

Cures 4d8 points of damage for many creatures.

Conjuration (Healing)

Level: Healing 6

Duration: Instantaneous

Saving Throw: Will half (harmless) or Will half (see text)

Spell Resistance: Yes (harmless) or Yes (see text)

Description

A blast of positive energy heals all nearby creatures.

Rune Effect

All creatures in the area (allies and enemies alike) are cured of 4d8 points of damage.

Like other cure effects, *sigil of healing* deals damage to undead in its area rather than cures them. Each affected undead may attempt a Will save for half damage.

Sigil of Healing, Greater

Conjuration (Healing)

Level: Healing 7

This sigil functions like *sigil of healing*, except that it cures 5d10 points of damage.

Sigil of Healing, Superior

Conjuration (Healing)

Level: Healing 8

This sigil functions like *sigil of healing*, except that it cures 6d12 points of damage.

Sigil of Healing, Ultimate

Conjuration (Healing)

Level: Healing 9

This sigil functions like *sigil of healing*, except that it cures 200 points of damage.

Sigil of Purification

Removes blight and increases crop yields.

Transmutation

Level: Restoration 3

Area: 1-mile-radius burst
Duration: See text
Saving Throw: Will negates (harmless)
Spell Resistance: Yes (harmless)

Description

A wave of positive energy bursts outward to restore the land and improve crop productivity.

Rune Effect

The wave moves 100 feet per round, extending out to a 1-mile radius. (This process takes 5 minutes to affect the entire area.) All plants within the area have their potential productivity raised over the course of the next year to one-third above normal. Blighted land, such as that affected by the *withering blight*** spell, is restored to normal. This sigil has no effect on plant creatures.

Sigil of Shielding

Stops 1st- through 3rd-level spell effects.

Abjuration
Level: Shielding 4
Area: 5-ft.-radius burst
Duration: 1 minute
Saving Throw: None
Spell Resistance: No

Description

Activating this mark creates a burst of shimmering energy that coats all creatures in the area with a protective aura.

Rune Effect

Affected creatures are immune to spell effects of 3rd level or lower. Excluded effects include spell-like abilities and spells or spell-like effects from items. The warded creature can still cast spells. Spells of 4th level and higher are not affected, nor are spells already in effect when *sigil of shielding* activates. Creatures who leave the area of effect lose this protection; creatures who enter the area gain it for the remaining duration.

This effect can be brought down by a targeted *dispel magic* spell, but not by an area *dispel magic*.

If a given spell has more than one level depending on which character class is casting it, use the level appropriate to the caster to determine whether *sigil of shielding* stops it.

Sigil of Shielding, Ultimate

Blocks all spells and effects.

Abjuration
Level: Shielding 9
Area: 5-ft.-radius burst
Duration: See text
Saving Throw: None
Spell Resistance: No

Description

When this sigil is activated, a burst of magic coats creatures in the area with a shimmering aura of protection that blocks spells.

Rune Effect

Affected creatures are immune to all spells and effects of 9th level or lower for 3 hours or until the aura is expended. Creatures who leave the area of effect lose this protection; creatures who enter the area gain it for the remaining duration. Each time the aura blocks a spell, there is a chance the aura dissipates for that creature. The chance of dissipation is listed below.

Spell Level Absorbed	Chance of Dissipation
0	0%
1	1%
2	3%
3	5%
4	10%
5	15%
6	30%
7	50%
8	80%
9	95%

Sigil of Transportation

Transports creatures instantly.

Conjuration (Teleportation)
Level: Motion 5
Area: 10-foot-radius burst
Duration: Instantaneous
Saving Throw: Will negates
Spell Resistance: Yes

Description

Creatures in the area disappear, reappearing somewhere else on the same plane.

Rune Effect

As *sigil of lesser transportation*, except you can designate any location on the plane as long as you have seen the physical destination at least once (possibly using magic) and the destination has not significantly changed. (The GM makes this determination. If she decides the locale has changed too much since you last saw it then you may end up someplace else that looks very similar.)

Sigil of Transportation, Greater

Transports creatures anywhere instantly.

Conjuration (Teleportation)

Level: Motion 7

Area: 10-foot-radius burst

Duration: Instantaneous

Saving Throw: Will negates

Spell Resistance: Yes

Description

Creatures in the area disappear, reappearing somewhere else in the universe.

Rune Effect

As *sigil of lesser transportation*, except you can designate any location on any plane. If you have never been to the designated plane, then you can inscribe general marks that effectively pick a random location on that plane. If the indicated destination has changed significantly since you last saw it, the effect is the same as designating a random location on the plane.

Sigil of Transportation, Lesser

Instantly transports creatures a short distance.

Conjuration (Teleportation)

Level: Motion 4

Area: 5-foot-radius burst

Duration: Instantaneous

Saving Throw: Will negates

Spell Resistance: Yes

Description

Creatures in the area disappear, reappearing somewhere else nearby.

Rune Effect

When you inscribe this sigil, you must designate a spot within 500 feet as the destination by encoding intricate marks within the sigil. Activating this mark causes all affected creatures to teleport instantly to the destination.

The subjects can't take any other actions after teleporting until their next turns.

Subjects carrying more weight than their maximum loads do not teleport.

If the subjects arrive in a place that is already occupied by a solid body, each teleported creature takes 1d6 points of damage and is shunted to a random open space on a suitable surface within 100 feet of the intended location. If there is no free space within 100 feet, each teleported subject takes an additional 2d6 points of damage and is shunted to a free space within 1,000 feet. If there is no free space within 1,000 feet, each teleported creature takes an additional 4d6 points of damage and the effect simply fails.

Sigil of Transportation, Ultimate

Instantly transports creatures anywhere.

Conjuration (Teleportation)

Level: Motion 9

Area: 5-foot-radius burst

Duration: See text

Saving Throw: Will negates

Spell Resistance: Yes

Description

Creatures in the area disappear, reappearing somewhere else on the same plane.

Rune Effect

As *sigil of lesser transportation*, except you can designate any location on the plane as long as you have seen the destination at least once and the destination has not significantly changed (see *sigil of transportation*). Also, this sigil is permanent and can be activated any number of times.

A *sigil of ultimate transportation* that is disabled becomes inactive for 10 minutes; it can then be triggered again as normal.

Material Component: Rune paint laced with powdered amber worth 1,000 gp.

New Spells

Presented in this section is an extensive selection of new spells for spellcasters of all types in the *Warcraft* RPG.

Absorb Mana

Transfers all spell levels from the target to the caster.

Transmutation

Level: Sor/Wiz 4

Components: V, S

Casting Time: 1 minute

Range: Touch

Target: Willing creature touched

Duration: Instantaneous

Saving Throw: None

Spell Resistance: Yes

Description

The caster kisses the target's mouth, and both jerk violently as the target's magical power is instantly transferred to the caster.

Spell Effect

This spell may only be cast on willing creatures. Thus, the spell allows no saving throw. This spell also affects only creatures capable of casting spells.

Upon completion of the spell, all the target's unused spell levels are transferred to the caster, who recalls his own spells on a 1-to-2 ratio (0-level spells are unaffected by *absorb mana*). That is, for every two spell levels that the target loses, the caster recalls up to one spell level of spells or spell slots that he has previously expended. He can divide these spell levels up however he wishes to recall levels of various spells. Recalled spells must be spells that the caster had previously prepared and expended (either by casting them or losing them in some other way). The respective classes (e.g., a wizard absorbing spell levels from a healer) and spell lists do not matter for the purposes of this spell. Any excess portions (e.g., half a spell level left over) are wasted; the target loses all her spell levels whether or not the caster can use them.

For example, Leanine Starborn, an 11th-level high elf wizard, has cast all her spells for the day except for one 5th-level spell — *absorb mana*. Her friend Maruff Grandhorn — an 11th-level tauren healer who has one 5th-level spell, one 4th-level spell, and six 1st-level spells prepared — agrees to let

her use *absorb mana* on him to recover some of her spells. When Leanine finishes casting the spell, she absorbs all of Maruff's unused spells: the tauren loses the rest of his spells (just as if he had cast them), and Leanine gains a total of seven spell levels (2 1/2 for the 5th-level spell, 2 for the 4th-level spell, and 3 for six 1st-level spells; the excess half is wasted). She can divide these spell levels up however she wishes in order to recover her own spells. She could recall one 4th-level spell and one 3rd-level spell; two 2nd-level spells and three 1st-level spells; seven 1st-level spells; and so on. She must decide how to divide up the spell levels and which spells she recalls as soon as she casts *absorb mana*. Unused spell levels are wasted.

Aerial Shackles

Immobilizes and damages flying creature.

Conjuration (Creation) [Force]

Level: Sor/Wiz 2

Components: V, S

Casting Time: 1 standard action

Range: Close (25 ft. + 5 ft./2 levels)

Target: One flying creature

Duration: Concentration, up to 1 round/level (D)

Saving Throw: Will negates

Spell Resistance: Yes

Description

With this spell, the caster creates a brilliant, golden energy web that captures and damages one flying creature. A bright beam of light seemingly links the target to the caster's outstretched hand.

Spell Effect

The *aerial shackles* envelop one target flying creature that fails its Will saving throw. The target cannot leave the space (or spaces) it occupied when the spell was cast. Though unable to move or fly freely, the target nonetheless does not fall. The *aerial shackles* keep the subject hovering in place. The target may attack, use a breath weapon or cast spells (though a Concentration check may be required).

The caster must maintain concentration to keep the target encased in the energy web. Starting on the round after the spell takes effect, the target suffers 1d6 points of damage each round that it remains trapped within the *aerial shackles*.

The *aerial shackles* are composed of force energy. Neither the strands around the subject nor the link

to the caster can be cut or damaged, though the effect can be dispelled normally with *dispel magic*.

Avatar

Caster becomes a mean, gray-sheened fighting machine.

Transmutation

Level: Pre 7, Sor/Wiz 7

Components: V, S, M

Casting Time: 1 standard action

Range: Personal

Target: You

Duration: 1 round/level

Description

The caster screams a war cry as she grows in size and strength. Her flesh hardens. Her skin, clothing and all her possessions become a dimly luminous silver-gray.

Spell Effect

Upon casting this spell, the caster becomes a fighting avatar of her ideals. Her mindset changes so that she relishes combat. She loses her spellcasting ability, including her ability to use spell activation or spell completion magic items, just as if the spells were no longer on her class list.

The caster gains a +4 enhancement bonus to Strength, a +6 enhancement bonus to Constitution and a +2 enhancement bonus to Dexterity. She gains a +8 enhancement bonus to natural armor (this stacks with any inherent natural armor but not with any other enhancements to natural armor) and spell resistance equal to 10 + her caster level. She is considered proficient with all simple and martial weapons.

The caster doubles in height and increases in weight by a factor of 10. This increase changes the caster's size category to the next larger one. The caster gains an additional +4 size bonus to Strength, a -2 size penalty to Dexterity (negating the enhancement bonus noted above), and a -1 size penalty on attack rolls and AC due to her increased size. (In total, the caster will benefit from +8 to Strength, +6 to Constitution, +7 to AC, +3 on attack rolls and +4 on damage rolls.)

A humanoid creature whose size increases to Large has a fighting space of 10 feet and a natural reach of 10 feet. This spell does not change the caster's speed.

If insufficient room is available for the growth, the caster attains the maximum possible size and may make a Strength check (using her increased Strength) to burst any enclosures in the process. If she fails, she is constrained without harm by the materials enclosing her — the spell cannot crush the caster by increasing her size.

All equipment worn or carried by the caster is similarly enlarged by the spell. Melee and projectile weapons affected by this spell deal more damage. Other magical properties are not affected by this spell. Any enlarged item that leaves the caster's possession (including a projectile or thrown weapon) instantly returns to its normal size. This means that thrown weapons deal their normal damage, and projectiles deal damage based on the size of the weapon that fired them. Magical properties of enlarged items are not increased by this spell.

Multiple magical effects that increase size do not stack.

Avatar dispels but does not counter *reduce person*.

Material Component: A chunk of adamantite worth at least 500 gp.

Berserker Strength

Subject gains a +4 bonus to Strength and Constitution.

Transmutation

Level: Hlr 3, Hnt 3, Sor/Wiz 3

Components: V, S, M/DF

Casting Time: 1 standard action

Range: Touch

Target: Creature touched

Duration: 1 min./level

Saving Throw: Will negates (harmless)

Spell Resistance: Yes (harmless)

Description

The subject becomes as strong and hardy as the toughest orc warriors.

Spell Effect

The subject gains a +4 enhancement bonus to Strength and Constitution.

Arcane Material Component: A few hairs, or a pinch of dung, from an orc.

Berserker Strength, Mass

Transmutation

Level: Hlr 7, Sor/Wiz 7

Range: Close (25 ft. + 5 ft./2 levels)

Targets: One creature/level, no two of which can be more than 30 ft. apart

This spell functions like *berserker strength*, except that it affects multiple creatures.

Big Bad Voodoo

Caster's allies gain powerful protections and rapid healing.

Abjuration

Level: Hlr 9, Swh 9

Components: V, S

Casting Time: 1 standard action

Range: Personal

Area: 30-ft.-radius emanation

Duration: Concentration, up to 1 round/level

Saving Throw: Will negates (harmless)

Spell Resistance: Yes (harmless)

Description

Dark spirits swarm to protect the caster's allies, mon.

Spell Effect

The caster summons invisible dark spirits to protect his allies. All allies (except the caster) within the spell's radius gain a +8 deflection bonus to AC, damage reduction 10/—, spell resistance 15 + caster level and fast healing 5.

An ally gains these benefits only when in the radius of the spell. An ally within the radius when the spell is cast retains the benefits only while he remains within the spell's radius. An ally who enters the radius after the spell is cast gains the benefits for as long as he remains within the radius.

Black Arrow

Altered arrow deals continuous damage, raising the victim as a skeleton.

Conjuration (Creation) [Fel]

Level: Sor/Wiz 6

Components: V, S, M

Casting Time: 1 standard action

Range: Medium (100 ft. + 10 ft./level)

Target: One living creature

Effect: One black arrow

Duration: Special (see text)

Saving Throw: Fortitude negates

Spell Resistance: Yes

Description

A vile black arrow composed of dark, demonic energy consumes one normal arrow as it springs from the caster's hand and speeds to its target. The victim writhes in pain until it dies from the agony. Its flesh then falls away as its skeleton rises from the corpse.

Spell Effect

The caster must succeed at a ranged touch attack to hit the target. The arrow deals 1d8 points of damage upon impact. For the next 1 round per caster level, the subject automatically takes another 1d8 points of damage. At the end of this period, the subject makes a Fortitude saving throw. If the subject succeeds, the effect ends. If the subject fails, the effect lingers. The subject continues taking 1d8 points of damage per round until dead or the effect is dispelled.

If the subject is humanoid and dies while under the effect of this spell, an appropriately-sized skeleton rises from the victim's corpse on the following round. This spell gives the caster no special control over the skeleton.

Material Component: One normal arrow.

Blazing Column

Fiery pillar damages creatures over time.

Evocation [Fire]

Level: Sor/Wiz 4

Components: V, S, M

Casting Time: 1 standard action

Range: Medium (100 ft. + 10 ft./level)

Area: Cylinder (20-ft.-radius, 60 ft. high)

Duration: 6 rounds

Saving Throw: None

Spell Resistance: Yes

Description

The caster calls down a column of roaring fire. The column burns for a time before slowly fading away.

Spell Effect

The column deals 1d6 points of fire damage for every two caster levels (maximum 5d6) each round for the first 3 rounds, and deals 1d6 points of fire damage each round for the following 3 rounds. The column is stationary.

Material Component: A bit of brimstone and a drop of the caster's own blood (or whatever passes for blood).

Breath of Fire

Caster breathes fire after consuming liquid.

Transmutation [Fire]

Level: Sor/Wiz 2

Components: V, S, M

Casting Time: 1 standard action

Range: Close (25 ft. + 5 ft./2 levels)

Area: Cone

Duration: Instantaneous

Saving Throw: Reflex half

Spell Resistance: Yes

Description

The caster takes a drink and then spews forth flames to engulf his enemies.

Spell Effect

Breath of fire creates a cone of flames originating at the caster's mouth. All creatures

caught in the cone take 2d4 points of damage +1 point per caster level (maximum of +10). Unattended objects also take this damage. Combustibles in the area catch fire.

Material Component: A beverage containing the equivalent of at least one shot of alcohol, which is consumed prior to casting the spell.

Brilliance Aura

Caster and nearby allies make Spellcraft checks to cast spells for free.

Transmutation

Level: Sor/Wiz 7

Components: V, S

Casting Time: 1 standard action

Range: Personal

Area: 20-ft.-radius emanation

Duration: 1 round/level (D)

Saving Throw: Will negates (harmless)

Spell Resistance: No



Description

The caster surrounds herself with a pulsing aura of cerulean energy. This aura grants crystalline thought to all friendly spellcasters around her and empowers them to cast their spells without actually losing them.

Spell Effect

Whenever an ally (including the caster) casts a spell while within the aura, she may make a Spellcraft check (DC 30 + the spell's level). If successful, she casts the spell but it is not expended. The spell remains prepared or the spell slot remains unused. A natural roll of 4 or less always fails.

Burrow

Subject gains a burrow speed.

Transmutation

Level: Sor/Wiz 3

Components: V, S, F

Casting Time: 1 standard action

Range: Touch

Target: Creature touched

Duration: 10 minutes/level

Saving Throw: None

Spell Resistance: Yes (harmless)

Description

The nails on the hands and feet of the subject become perfect for digging as they harden and elongate.

Spell Effect

The spell's subject can burrow with a speed of 10 feet. The subject can tunnel through dirt, but not rock. Using the *burrow* spell requires as much concentration as walking, so the subject can attack or cast spells normally. The subject of a burrow spell cannot run while burrowing. The subject can choose to leave a tunnel in the dirt behind himself or close the tunnel, leaving no passage for others to follow. The elongated nails are suitable for digging, not combat. This spell provides no special benefit to making unarmed attacks, but neither does it hinder the subject's ability to attack or wield weapons normally.

Arcane Focus: The tip of a clawed leg from a crypt fiend.

Call of the Spirits

Caster gains a +5 bonus on one die roll.

Necromancy

Level: Drw 2, Gvn 1, Sha 2, Swh 2

Components: V, DF

Casting Time: 1 standard action

Range: Personal

Target: You

Duration: 1 hour/level or until discharged

Description

The caster beseeches the surrounding spirits to help him on a specific task.

Spell Effect

Upon casting this spell, the caster declares one specific die roll that he expects to make within the duration of the spell (for example, "My first attempt to strike Baelzor the Defiler with my mace" or "My first attempt to save against the red dragon's breath weapon"). If the caster makes that die roll before the spell's duration expires, the spirits grant him a +5 bonus on the roll. Note that this is an unnamed bonus, and therefore stacks with all others.

The caster may only have one *call of the spirits* spell active at any one time. Subsequent castings replace earlier ones.

Counterspell

Automatically counters a spell.

Abjuration

Level: Hlr 6, Sor/Wiz 6

Components: V, S

Casting Time: 1 standard action

Range: Long (400 ft. + 40 ft./level)

Target: One creature casting a spell

Duration: Instantaneous

Saving Throw: None

Spell Resistance: No

Description

The caster easily counters her opponent's spell.

Spell Effect

This spell does nothing at all by itself, but it may be used to counter any spell of 6th level or lower. All the normal rules for countering spells apply; *counterspell* counts as a copy of the spell being countered and therefore works automatically. Note that while the range of this spell is considerable, the caster still needs to identify the opposing spell as it is being cast, and thus *counterspell* is usually useful only at distances that enable the caster to hear and see the target (see the *Player's Handbook*, Chapter 4: Skills, "Skill Descriptions," *Spellcraft*).

Counterspell, Greater

Abjuration

Level: Hlr 9, Sor/Wiz 9

This spell functions exactly as *counterspell*†, except that it counters spells of up to 9th level.

Counterspell, Lesser

Abjuration

Level: Hlr 3, Sor/Wiz 3

This spell functions exactly as *counterspell*†, save that it counters spells of up to 3rd level.

Cripple, Mass

Transmutation

Level: Sor/Wiz 6, Swh 6

Range: Close (25 ft. + 5 ft./2 levels)

Targets: One living creature/level, no two of which can be more than 30 ft. apart

This spell functions like *cripple**, except that it affects multiple creatures.

Crushing Wave

Giant wave pounds opponents and knocks them prone.

Evocation [Water]

Level: Sha 4, Sor/Wiz 3

Components: V, S, M

Casting Time: 1 standard action

Range: Close (25 ft. + 5 ft./2 levels)

Area: Line to maximum range

Duration: Instantaneous

Saving Throw: Reflex half

Spell Resistance: No

Description

The caster evokes a 10-foot-high wave, which blasts forward at unstoppable speed.

Spell Effect

The wave travels along the ground or other semi-solid surface (water, for example). Creatures within the wave's path take 1d8 points of bludgeoning damage per caster level (maximum 10d8), with a Fortitude save allowed for half. Those who fail this save are also knocked prone (standing up is a move action).

Crushing wave cannot be cast into the air. This spell can be cast normally underwater.

Material Component: A drop of ocean water.

Cyclone

Windstorm lifts opponent into the air.

Evocation [Air]

Level: Drw 3, Sha 3

Components: V, S

Casting Time: 1 standard action

Range: Medium (100 ft. + 10 ft./level)

Target: One Medium or smaller creature

Duration: 1 round/2 levels

Saving Throw: Reflex negates (see text)

Spell Resistance: Yes

Description

The caster summons a small cyclone that lifts the target into the air, spinning him rapidly and buffet-ing him with powerful winds.

Spell Effect

A 10-foot-high cyclone appears in the square you designate. A Medium or smaller creature within that square risks being battered by the cyclone and lifted into the air (Large and larger creatures are unaffected). The target is allowed an initial Reflex save to avoid taking 2d6 points of damage. If the target succeeds, he immediately moves to a square adjacent to the cyclone (if these squares are all occupied, he falls prone in one of them). If this save is failed, in addition to taking damage the subject must attempt another Reflex save or be lifted into the air and whirled viciously by the cyclone, taking 2d6 points of damage each round. A creature that can fly is allowed a Reflex save each round to escape the cyclone; the creature still takes damage but can leave if the save is successful.

A creature trapped in the cyclone cannot move but can otherwise act normally, though to cast a spell it must succeed at a Concentration check (DC 15 + the level of the spell the creature is attempting to cast). A creature caught in the cyclone takes a -4 penalty to Dexterity and a -2 penalty on attack rolls.

The cyclone is stationary and persists for the spell's duration. A creature moving into the square the cyclone occupies risks damage and entrapment, as described above. The cyclone can carry only as many creatures as can fit into its square (i.e. one Medium or Small creature), so if it is "full" other creatures passing through the square do not risk

capture — though they must make Reflex saves to avoid damage as normal.

Dark Conversion

Puts a weak target to sleep and turns her into a zombie.

Necromancy [Death, Fel]

Level: Ncr 5

Components: V, S, M

Casting Time: 1 standard action

Range: Close (25 ft. + 5 ft./2 levels)

Target: One living creature with 1 Hit Die or fewer

Duration: Permanent

Saving Throw: None

Spell Resistance: Yes

Description

The target falls into a restless sleep for a few moments, emerging from her slumber as a zombie.

Spell Effect

This spell affects only creatures with 1 Hit Die or fewer. If the target fails her saving throw, she falls asleep (as the *sleep* spell) for 1d4+1 rounds. She can be awoken during this time, though doing so does not stop the horrible transformation that is to occur. After the allotted time asleep (whether or not she actually sleeps), the target's soul flies from her body, her heart stops and she becomes a zombie under the caster's control. A *death ward*, *limited wish*, *restoration*, *miracle* or *wish* spell prevents this transformation if cast on the target before she becomes a zombie.

Zombies created by this spell count toward the caster's limit of the number of undead he can control at one time (4 Hit Dice/caster level).

Material Component: An hourglass containing a measure of gold dust worth at least 50 gp.

Dark Conversion, Mass

Necromancy [Death, Fel]

Level: Ncr 9

Range: Close (25 ft. + 5 ft./2 levels)

Targets: One creature/level, no two of which can be more than 30 ft. apart

This spell functions like *dark conversion* †, except that it affects multiple creatures.

Material Component: An hourglass containing a measure of gold dust worth at least 100 gp per target.

Dark Metamorphosis

Caster takes on a demonic form and power.

Transmutation [Fel]

Level: Sor/Wiz 7

Components: V, S, M

Casting Time: 1 standard action

Range: Personal

Target: You

Duration: 1 round/level

Description

The caster transforms into a fearsome, black, demon-like creature. Long horns sprout from his head and wings grow from his back. His skin and all his belongings become void-black, and his only facial features are two glowing, slit-like red eyes.

Spell Effect

The caster transforms into a demon-like creature for the spell's duration. This grants him fast healing 3, damage reduction 10/good and silver, a +4 enhancement bonus to Strength and Constitution, and a +4 enhancement bonus to natural armor. In addition, he may cast *orb of annihilation** each round as a standard action.

Material Component: A vial of demon blood, which the caster drinks.

Dark Sacrifice

Undead creature's destruction allows caster to recall expended spells.

Necromancy

Level: Gvn 2, Ncr 3

Components: V, S

Casting Time: 1 standard action

Range: Close (25 ft. + 5 ft./2 levels)

Target: One undead creature under your control

Duration: Instantaneous

Saving Throw: Will negates

Spell Resistance: Yes

Description

The caster destroys an undead creature under her command, drawing its dark animating energy to empower her own spellcasting.

Spell Effect

This spell may only be cast on an undead creature under the caster's control. That creature is immediately

destroyed. The caster then recalls one or more spells that she has already prepared and expended (either by casting them or losing them through some other means). For every 2 Hit Dice of the undead creature destroyed, the caster can recall one spell level. These spell levels may be divided however the caster wishes.

For example, if Gul'zakar the necromancer casts *dark sacrifice* upon an undead creature with 6 Hit Dice, he gains three spell levels. He can recall one 3rd-level spell; a 2nd-level spell and a 1st-level spell; or three 1st-level spells. 0-level spells count as half a level for these purposes.

If the target succeeds at its Will save, the caster loses control of the creature.

Death and Decay

Withers and destroys all within range.

Necromancy

Level: Ncr 9

Components: V, S, M

Casting Time: 1 standard action

Range: Medium (100 ft. + 10 ft./level)

Area: 60-ft.-radius emanation

Duration: Concentration, up to 1 round/level

Saving Throw: Fortitude half

Spell Resistance: Yes

Description

Negative energy infuses the area in visible puffs. Living creatures age rapidly, as skin sags and flesh sloughs off bones. Structures wither and collapse, suffering the effects of decades within a few seconds.

Spell Effect

All living creatures and non-natural structures in the area take 3d3 points of damage per caster level (maximum 20d8) per round from negative energy. Creatures are allowed Fortitude saving throws to halve the damage.

Since undead are powered by negative energy, this spell cures them a like amount of damage.

Material Component: A dead rose.

Devotion Aura

Surrounding allies gain bonuses to AC.

Conjuration

Level: Hlr 2, Plw 2

Components: V, S, DF

Casting Time: 1 standard action

Range: Personal

Area: 20-ft.-radius emanation

Duration: 1 round/level

Saving Throw: Will negates (harmless)

Spell Resistance: Yes (harmless)

Description

A glowing aura of blue light surrounds the caster, extending to swirl around his allies. This light seems intangible, but serves as a barrier against enemy attacks.

Spell Effect

All allies within the spells' area, including the caster, gain a +1 deflection bonus to AC for every 6 caster levels, to a maximum of +4 at caster level 20.

An ally gains these benefits only when in the radius of the spell. An ally within the radius when the spell is cast retains the benefits only while he remains within the spell's radius. An ally who enters the radius after the spell is cast gains the benefits for as long as he remains within the radius.

Dimension Blink

Caster teleports a short distance.

Conjuration (Teleportation)

Level: Sor/Wiz 5

Components: V, S

Casting Time: 1 free action

Range: Close (25 ft. + 5 ft./2 levels)

Target: You

Duration: Instantaneous

Description

With a quick word and hard gesture, the caster vanishes and reappears a short distance away.

Spell Effect

The caster can teleport to any location within range that she can see. Casting this spell is a free action; a character can cast only one spell as a free action each round.

Divine Grace

Subject gains spell resistance and +1 to AC.

Transmutation [Good]

Level: Hlr 2, Plw 2

Components: V, S, DF

Casting Time: 1 standard action

Range: Close (25 ft. + 5 ft./2 levels)

Target: One creature

Duration: 1 min./level
Saving Throw: Will negates (harmless)
Spell Resistance: Yes (harmless)

Description

Holy energy protects the subject from harm. Casters usually refer to this spell by the name of their deity or philosophy: for example, "Elune's grace" or "grace of the Holy Light."

Spell Effect

The subject gains a +1 sacred bonus to AC and spell resistance equal to 5 + caster level.

Divine Grace, Mass

Transmutation [Good]

Level: Hlr 6

Range: Close (25 ft. + 5 ft./2 levels)

Targets: One creature/level, no two of which can be more than 30 ft. apart

This spell functions like *divine grace*†, except that it affects multiple creatures.

Drunken Haze

Target becomes flammable and his vision grows blurry.

Enchantment [Mind-Affecting]

Level: Sor/Wiz 2

Components: V, S, M

Casting Time: 1 standard action

Range: Close (25 ft. + 5 ft./2 levels)

Target: One creature

Duration: 1 round/level

Saving Throw: Will negates

Spell Resistance: Yes

Description

The target is doused in flammable alcohol. In addition, the inebriating effects of strong spirits are imposed upon the target's mind.

Spell Effect

The target receives a -2 penalty to Dexterity and, because his vision is blurred, all opponents have concealment against him. In addition, he automatically catches on fire if he suffers at least 1 point of fire damage. (See the DMG v 3.5, Chapter 8: Glossary, "The Environment," *Heat Dangers*, for details on catching on fire.)

Material Component: A flask of ale or like amount of alcohol.

Forked Lightning

Bolts of electricity can hit multiple targets.

Evocation [Electricity]

Level: Sor/Wiz 2

Components: V, S

Casting Time: 1 action

Range: Close (25 ft. + 5 ft./2 levels)

Target: Up to five creatures, no two of which can be more than 30 ft. apart

Duration: Instantaneous

Saving Throw: None

Spell Resistance: Yes

Description

Electricity arcs from the fingertips of the caster's outstretched hand, striking up to five targets.

Spell Effect

Two arcs of electricity spring from the caster's fingers to strike two separate targets. The caster must make a ranged touch attack to hit his chosen targets. Inanimate objects cannot be damaged by the spell. Each bolt deals 1d6 points of electrical damage plus 1 point of damage per caster level (maximum +10).

For every two levels past 3rd, the caster gains an additional bolt of forked lightning. The character has three at 5th level, four at 7th level, and the maximum of five bolts at 9th level. If there are fewer than the maximum allowed targets then the extra bolts do not appear and are wasted; a single bolt can strike only one creature. The caster must designate targets before rolling for spell resistance or damage.

Frost Arrow

Arrow deals cold damage to and slows target.

Conjuration (Creation) [Cold]

Level: Sor/Wiz 2

Components: V, S, M

Casting Time: 1 standard action

Range: Medium (100 ft. + 10 ft./level)

Effect: One frost arrow

Duration: Special (see text)

Saving Throw: Will negates (see text)

Spell Resistance: Yes

Description

An arrow in the caster's grasp freezes and magically springs from her hand as it speeds to its target. The victim is momentarily encased in a shell of ice that quickly breaks away in thin shards, but leaves the victim aching and slowed.

Spell Effect

The caster must succeed at a ranged touch attack to hit the target. The arrow deals 1d8 points of cold damage upon impact. The target is forced to make a Will saving throw or suffer an additional effect. Those who fail their saving throw are affected as though by a *slow* spell for 1 round/level.

A *slowed* creature can take only a single move action or standard action each round, but not both (nor may it take full-round actions). It takes a -1 penalty on attack rolls and Reflex saves, and to AC. It moves at half its normal speed (round down), which affects the creature's jumping distance as normal.

Frost arrow dispels but does not counter *haste* and does not otherwise affect magically speeded or slowed creatures.

Material Component: One normal arrow.

Frost Bolt

Blast of cold damages and stuns the target.

Evocation [Cold]

Level: Sha 3, Sor/Wiz 3

Components: V, S

Casting Time: 1 standard action

Range: Close (25 ft. + 5 ft./2 levels)

Target: One creature

Duration: Instantaneous

Saving Throw: Fortitude negates (see text)

Spell Resistance: Yes

Description

The caster flings forth a blast of super-frozen ice and dancing blue energy. The frost bolt slams into the target, sending numbing waves of cold pulsing through his marrow.

Spell Effect

The caster must succeed at a ranged touch attack to hit with the frost bolt. The bolt deals 5d6 points of cold damage. Creatures who take damage from the frost bolt must succeed at a Fortitude save or be stunned for 1d4 rounds, as the chill numbs their limbs.

Healing Light

Cures an ally or damages undead.

Conjuration (Healing)

Level: Hlr 3, Plw 3

Components: V, S

Casting Time: 1 standard action

Range: Close (25 ft. + 5 ft./2 levels)

Target: One creature

Duration: Instantaneous

Saving Throw: Will half (see text)

Spell Resistance: Yes

Description

A column of argent light, coruscating with positive energy, beams down on the target and heals his wounds.

Spell Effect

The light heals 2d8 points of damage + 1 point per caster level (up to +10) to living creatures.

Since undead are damaged by positive energy, this spell deals a like amount of damage to them, rather than healing them. Undead are allowed Will saves to halve the damage.

Healing Light, Greater

Conjuration (Healing)

Level: Hlr 4, Plw 4

As healing light†, except that it heals 3d8 points of damage + 1 point per caster level (up to +15).

Healing Light, Lesser

Conjuration (Healing)

Level: Hlr 2, Plw 2

As healing light†, except that it heals 1d8 points of damage + 1 point per caster level (up to +5).

Hooks of Binding

Entangles and anchors a demon or undead creature.

Conjuration (Creation) [Force]

Level: Hlr 3, Plw 3, Sor/Wiz 3

Components: V, S, M/DF

Casting Time: 1 standard action

Range: Medium (100 ft. + 10 ft./level)

Target: One demon or undead creature with up to 12 Hit Dice

Duration: 1 round/level

Saving Throw: Fortitude negates

Spell Resistance: Yes

Description

The caster summons hooked chains of burning red and yellow force. The chains snake up from the target's feet and entwine its legs and torso, holding it in place.

Spell Effect

The spell affects only demons and undead creatures. The target is captured by the chains and cannot move. The creature also suffers a -4 penalty to Dexterity and a -2 penalty on attack rolls. To cast a spell, it must succeed at a Concentration check (DC 15 + the level of the spell it is attempting to cast) or lose the spell. The chains hold the target in place, no matter if it was standing, flying, swimming or using any other mode of movement. Because the chains are composed of force, this spell can affect incorporeal creatures. This spell also disallows teleportation and planar travel effects.

Each round that the spell remains active, the target may attempt a Strength or Escape Artist check against a DC equal to the spell's save DC as a full-round action. If successful, the creature bursts or slips the bonds and ends the spell.

Arcane Material Component: A brass chain link.

Hooks of Binding, Greater

Conjuration (Creation) [Force]

Level: Hlr 5, Sor/Wiz 5

Target: One demon or undead creature

This spell functions like *hooks of binding*, except that it can affect creatures with more than 12 Hit Dice.

Impale

Spikes rise from the ground and impale victims.

Evocation [Force]

Level: Sor/Wiz 3

Components: V, S, M

Casting Time: 1 standard action

Range: Close (25 ft. + 5 ft./2 levels)

Area: 10 ft. wide by 25 ft. + 5 ft./2 levels

Duration: Instantaneous

Saving Throw: Reflex half

Spell Resistance: Yes

Description

Vicious spikes jut up through the ground, striking everything in the spell's path. Creatures impaled on the spike cannot move.



Spell Effect

The caster releases a powerful wave of spikes that erupt from the ground and shoot up through everything in their path. The spikes are 6 inches in diameter and each ranges in height from 3 to 6 feet tall. Only creatures and objects within 5 feet of the ground at the time the spell is cast are at risk. Each 5-foot by 5-foot area of the effect occupied by a creature subjects that creature to 1d4 spikes. (A Medium creature is affected by 1d4 spikes; a Large creature is affected by up to 4d4 spikes, and so on. Small creatures are affected by 1d2 spikes, Tiny creatures by 1 spike, and smaller creatures are not affected by the spell at all.) Each spike deals 1d6 points of damage. Targets who succeed at Reflex saving throws take half damage. Targets who fail their saving throws take full damage and are lifted off the ground as they are impaled on the spikes. An impaled creature suffers a -2 penalty on attack rolls, a -4 penalty to effective Dexterity, and can't move. An impaled character who attempts to cast a spell must make a Concentration check (DC 15) or lose the spell. Spikes that do not impale a creature immediately retract back into the earth. An impaled creature can make an Escape Artist check (DC 23) to get loose. The spikes impaling a creature immediately retract if the subject escapes. All spikes automatically retract after 1 round per level whether affected subjects escape or not.

Implant Carrion Beetle

Carrion beetle devours victim from inside.

Necromancy

Level: Sor/Wiz 1

Components: V, S, M

Casting Time: 1 standard action

Range: Touch

Target: One living creature

Duration: 1 round/level (see text)

Saving Throw: Fortitude negates

Spell Resistance: Yes

Description

The caster's corrupting touch implants a carrion beetle larva in a creature. The larva eats the victim from the inside out. It bursts from its victim when it hatches into a carrion beetle, and attacks the character's opponents.

Spell Effect

The caster must succeed at a touch attack to implant the carrion beetle larva. One round later, the

target must succeed at a Fortitude saving throw or the carrion beetle hatches and bursts from the victim's body, causing 1d6 points of damage. In addition, the newly hatched carrion beetle attacks the same victim on the following round if it survived the initial damage (information on the carrion beetle can be found in the **Manual of Monsters**). The carrion beetle begins to attack the caster's other opponents to the best of its ability once the initial target is dead. The carrion beetle is mindless and the caster cannot direct its attacks. After 1 round per caster level, the carrion beetle disappears at the end of its turn.

Material Component: Piece of a carrion beetle shell.

Inner Fire

Subject gains +2 to damage and AC.

Transmutation

Level: Hlr 2, Plw 2

Components: V, S

Casting Time: 1 standard action

Range: Close (25 ft. + 5 ft./2 levels)

Target: One creature

Duration: 1 min./level

Saving Throw: Will negates (harmless)

Spell Resistance: Yes (harmless)

Description

The caster draws forth the potential of an ally's fighting spirit and wreathes him in his own spiritual energies.

Spell Effect

The target gains a +2 competence bonus on damage rolls and a +2 deflection bonus to AC.

Inner Fire, Mass

Transmutation

Level: Hlr 6

Range: Close (25 ft. + 5 ft./2 levels)

Targets: One creature/level, no two of which can be more than 30 ft. apart

This spell functions like *inner fire*, except that it affects multiple creatures.

Kaboom!

Caster sacrifices himself to damage all nearby.

Evocation [Fire]

Level: Sor/Wiz 4

Components: V, S

Casting Time: 1 standard action
Range: Personal
Area: Burst with a radius of 25 ft. + 5 ft./2 levels
Duration: Instantaneous
Saving Throw: Reflex half (see text)
Spell Resistance: Yes (see text)

Description

Why not go out with a bang?

Spell Effect

The caster explodes, dealing 2d6 points of fire damage per caster level to everything within the spell's radius. Creatures are allowed Reflex saves to halve this damage, and spell resistance also applies. Casting this spell slays the caster and destroys his body.

Lightning Monsoon

Storm creates repeated lightning bolts.

Evocation [Electricity]

Level: Drw 6, Sha 6, Sor/Wiz 5, Swh 6

Components: V, S, M

Casting Time: 1 standard action

Range: Medium (100 ft. + 10 ft./level)

Area: 20-ft.-radius cylinder (40 ft. high)

Duration: 1 round/2 levels

Saving Throw: Reflex half

Spell Resistance: Yes

Description

The caster evokes a roiling black thundercloud that flickers ominously. Sparking yellow bolts crack down repeatedly from the cloud, blasting all standing beneath it.

Spell Effect

Each round, beginning on the round in which the spell is cast, each creature and object within the area is subject to a lightning bolt. The bolts deal 1d6 points of electricity damage per caster level (maximum 15d6), with a Reflex save allowed for half.

This spell can only be cast outdoors.

Material Component: A copper rod.

Magic Defense

Subject gains spell resistance but is slowed.

Abjuration

Level: Hlr 4

Components: V, S, DF

Casting Time: 1 standard action

Range: Close (25 ft. + 5 ft./2 levels)

Target: One creature

Duration: 1 min./level

Saving Throw: Will negates (harmless)

Spell Resistance: Yes (harmless)

Description

A portion of the target's own vigor and energy manifests as a thin red shell encapsulating her, warding her from spells.

Spell Effect

The subject gains spell resistance 15 + the caster's level, but is also *slowed* (as the *slow* spell). The subject may, as a free action, suspend this spell, so that she moves normally and does not gain the spell resistance. She may spend a full-round action concentrating to regain the effects of the spell.

Multiple *slow* effects do not stack.

Mana Shield

Expend spell slots to absorb damage.

Abjuration

Level: Sor/Wiz 1

Components: V, S, M

Casting Time: 1 standard action

Range: Personal

Target: The character

Duration: 1 hour/level

Saving Throw: None

Spell Resistance: No

Description

The caster is cloaked in a faint blue aura that protects her from damage.

Spell Effect

The caster can choose to shrug off damage by expending spell slots while under the effects of *mana shield*. A 1st-level spell slot can absorb 1 point of damage. Each additional spell level increases the amount of damage a spell slot can absorb by 2 points. (A 2nd-level spell slot can absorb 3 points of damage, a 3rd-level spell slot 5 points of damage, and so on.) Only hit point damage can be absorbed by *mana shield*. The character can choose to absorb as much or as little damage as desired using any available spell slots. Once expended, the spells from those slots are unavailable as though they had been cast. If damage

is not absorbed at the time it is dealt then it cannot be absorbed retroactively. In other words, spell slots cannot be used to heal the character.

For example, the caster is taking 13 points of damage and would die if she did not use *mana shield* to prevent some of the damage. She has three spell slots remaining: one 1st-level slot, one 3rd-level slot, and one 5th-level slot. She could expend her 5th-level slot to prevent 9 points of damage; she could also expend her 3rd-level slot to stop a total of 14 points of damage. However, she believes she'll need her 3rd-level spell for something else to help finish the fight, so instead she decides to use just her 5th-level and 1st-level slots to absorb a total of 10 points of damage. She takes 3 points of damage herself.

Damage cannot be absorbed by expending 0-level spell slots.

Material Component: A sapphire worth at least 10 gp.

Mass Revival

Returns brief life to many allies.

Conjuration (Healing)

Level: Hlr 9

Components: V, S, M, DF

Casting Time: 1 round

Range: Close (25 ft. + 5 ft./2 levels)

Target: Up to six dead creatures, no two of which can be more than 30 ft. apart

Duration: 1 round/4 levels

Saving Throw: None

Spell Resistance: No

Description

An angelic form appears in the air as the caster's fallen allies rise again.

Spell Effect

This spell functions like *touch of life**, except that it can affect multiple creatures and the duration is shorter.

Material Component: Diamonds worth a total of at least 1,000 gp/creature.

Mind Rot

Target loses his highest-level spell.

Necromancy

Level: Sor/Wiz 3

Components: V, S, M

Casting Time: 1 standard action

Range: Close (25 ft. + 5 ft./2 levels)

Target: One creature capable of spellcasting

Duration: Instantaneous

Saving Throw: Will negates

Spell Resistance: Yes

Description

The target staggers as a spell deteriorates from his mind.

Spell Effect

The target loses his highest-level prepared spell or highest available spell slot of 6th level or lower. If he has more than one spell available of equally high level, he may choose which spell is lost.

Material Component: A bit of mold.

Mysterious Purple Blast

Damages the target with mystic energy.

Evocation

Level: Sor/Wiz 1

Components: V, S, M

Casting Time: 1 standard action

Range: Medium (100 ft. + 10 ft./level)

Target: One creature

Duration: Instantaneous

Saving Throw: None

Spell Resistance: Yes

Description

The caster slashes with her weapon (or punches with her fist), sending forth a bright, sparking sphere of purple energy. It is not electricity, it is not negative energy; no one knows quite what it is — but damn it, it hurts.

Spell Effect

The caster must succeed at a ranged touch attack to hit with this spell. The blast deals 1d8 points of damage per two caster levels (maximum 5d8). This is raw magical damage, so all forms of energy resistance are ineffective against it.

Material Component: Anything.

Orb of Annihilation

Caster flings an exploding sphere of fel energy.

Evocation [Fel]

Level: Sor/Wiz 2

Components: V, S

Casting Time: 1 standard action

Range: Close (25 ft. + 5 ft./2 levels)
Target: One creature or intersection
Duration: Instantaneous
Saving Throw: Reflex half (see text)
Spell Resistance: Yes

Description

The caster summons a crackling sphere of black and purple energy and hurls it at his target.

Spell Effect

The caster must make a successful ranged touch attack to hit with the orb. The orb deals 4d8 points of fel damage to the target and explodes on impact. All creatures within 5 feet of the target take 1d8 points of fel damage (half on a successful Reflex save). Alternately, the caster can throw the *orb of annihilation* at an intersection of squares, just like any other splash weapon. Also like other splash weapons, if the caster misses his target he must roll randomly to see where the orb lands. (See the *Player's Handbook*, Chapter 8: Combat, "Special Attacks," *Throw Splash Weapon*.)

Owl Scout

Caster sees through a magic owl's eyes and hears through its ears.

Conjuration (Summoning)
Level: Drw 4, Elr 4, Sha 4
Components: V, S, DF
Casting Time: 1 round
Range: Close (25 ft. + 5 ft./2 levels)
Effect: One summoned owl scout
Duration: 1 min./level (D)
Saving Throw: None
Spell Resistance: No

Description

The caster creates an invisible, green owl. The owl moves where the caster wills, and the caster sees through its eyes.

Spell Effect

This spell creates an owl scout anywhere within range. The owl scout has the statistics of a giant owl (see the MM, Chapter 1: Monsters A to Z, "Owl, Giant"), though it cannot attack, has spell resistance equal to 10 + caster level, and is invisible. The caster can mentally control the owl as a free action. If the caster concen-

trates (a standard action), she can utilize the owl's senses as her own—seeing through its eyes and hearing through its ears for as long as she wishes, up to the spell's duration. The caster takes leave of her own senses while concentrating. When using the owl's senses, the caster can see *invisibility*, as the spell of the same name.

Parasite

Parasite infects victim and allows caster to see with victim's eyes.

Necromancy
Level: Sor/Wiz 5
Components: V, S
Casting Time: 1 standard action
Range: Close (25 ft. + 5 ft./2 levels)
Target: One living creature
Duration: Permanent
Saving Throw: Fortitude negates
Spell Resistance: Yes

Description

The caster introduces a tiny, diseased, ocular parasite in the target's ear that proceeds to burrow into its victim's brain. It links itself with the target's optic nerves and allows the caster to see through the victim's eyes. Unfortunately for the subject, the parasite also passes on a debilitating contagion.

Spell Effect

The target feels a sting in an ear of the caster's choice as the parasite takes hold. If the target fails the Fortitude saving throw, the parasite quickly burrows to the target's optic nerve and passes on its disease. The initial pain can be considerable. (Creatures without ears or eyes cannot be targets.)

The caster can use a free action once per round to link his vision with that of any known victim of his spell. The caster sees, through the eyes of a linked victim, exactly what the victim sees. For example, if the victim's eyes are closed, then the caster sees nothing; if the victim has low-light vision or darkvision, then the caster sees as though he had the same.

The target also suffers a debilitating disease from the parasite. The target must make a Fortitude saving throw each day or take 1d4 points of Wisdom damage (this damage cannot be healed by normal or magical means until the parasite has been removed). The target takes no damage the day after a successful saving throw. Only *remove disease*, *dispel magic*, or similar effects can remove

the parasite. The caster can no longer form a link with a victim once it has been cured, killed, or if the subject is on another plane. The caster does not get any information as to why a link cannot be established.

Duration: 1 round/level

Saving Throw: None

Spell Resistance: No

Pass Unknown

The subject is invisible and inaudible.

Illusion (Glamer)

Level: Sor/Wiz 5

Components: V, S, M

Casting Time: 1 standard action

Range: Personal or touch

Target: You or a creature weighing no more than 100 pounds/level

Duration: 1 min./level

Saving Throw: Will negates (harmless)

Spell Resistance: Yes (harmless)

Description

The subject becomes invisible and inaudible. This illusion falls away when the subject attacks, but he can regain it with a moment of concentration.

Spell Effect

This spell functions like *invisibility*, except that it also makes the subject perfectly silent. The subject makes no noise when he moves or manipulates objects, though objects can make noise through indirect activities. (For example, if the subject knocks over a vase, it still smashes loudly on the ground. If he picks a lock, however, it makes no sound.) This effect adds a +20 circumstance bonus to the subject's Move Silently checks. The subject can make noise if he wishes—for example, to cast a spell with a verbal component.

If the subject attacks, he becomes visible and makes noise normally (much like *invisibility*). However, the subject can spend one full round concentrating to regain his invisibility and soundlessness.

Material Component: An eyelash encased in a piece of gum arabic.

Phase Shift

Caster becomes incorporeal after suffering damage.

Abjuration

Level: Hlr 3, Sor/Wiz 4

Components: V, S, M

Casting Time: 1 standard action

Range: Personal

Target: You

Description

When an enemy successfully hits the caster in combat, the caster becomes incorporeal for a short time, avoiding further attacks.

Spell Effect

If the caster takes damage while this spell is in effect, she immediately becomes incorporeal (though she remains visible as a ghostly outline). The caster becomes corporeal again in the next round, immediately before the initiative count of the effect that damaged her.

While incorporeal, the caster can be harmed only by spells and magic weapons and has a 50% chance to avoid all damage from a corporeal source. She takes damage normally from other incorporeal creatures, force effects, positive or negative energy spells, and weapons with the *ghost touch* quality; she does not have a 50% chance to avoid damage from these sources. While incorporeal the caster loses all armor and natural armor bonuses to AC, but gains a deflection bonus to her AC equal to her armor bonus + natural armor bonus + her Charisma modifier. Essentially, all armor and natural armor bonuses become deflection bonuses while the caster is incorporeal.

The caster cannot affect corporeal creatures while incorporeal, save by force effects and *ghost touch* weapons. She can affect other incorporeal creatures normally.

Material Component: A faerie dragon wing.

Profane Aura

Surrounding allies move and heal faster.

Transmutation [Evil]

Level: Hlr 4, Ncr 4

Components: V, S, M

Casting Time: 1 standard action

Range: Personal

Effect: 20-ft.-radius emanation

Duration: 1 round/level

Saving Throw: Fortitude negates (harmless)

Spell Resistance: Yes (harmless)

Description

The powers of unlife grant terrible energy and rapid healing to the caster's allies.

Spell Effect

Allies (including the caster) within the area of the spell gain +10 feet to all movement modes and gain fast healing 1.

An ally gains these benefits only when in the radius of the spell. An ally loses the spell's benefits when leaving its radius, while an ally who enters the radius after the spell is cast gains the benefits for as long as he remains within the radius.

Material Component: A bone of any size.

Recall Undead

Brings back undead sequestered in the Twisting Nether.

Necromancy [Fel]

Level: Ncr 2

Components: V, S

Casting Time: 1 round

Range: Close (25 ft. + 5 ft./2 levels)

Effect: One or more summoned undead creatures, the total Hit Dice of which cannot exceed your caster level

Duration: Instantaneous

Saving Throw: None

Spell Resistance: No

Description

The caster recalls a number of undead creatures that he had previously secluded away in the netherworld.

Spell Effect

The caster summons one or more undead creatures from the Twisting Nether that he had previously secluded there with the spell *soul preservation*†. The undead creatures are under his control.

Rejuvenation, Mass

Conjuration (Healing)

Level: Hlr 9

Range: Close (25 ft. + 5 ft./2 levels)

Targets: One living creature/level, no two of which can be more than 30 ft. apart

This spell functions like *rejuvenation**, except that it affects multiple creatures.

Restore Critical Damage

Transmutation

Level: Sor/Wiz 4

This spell functions like *restore light damage*†, except that it restores 4d8 points of damage +1 per caster level (maximum +20).

Restore Critical Damage, Mass

Transmutation

Level: Sor/Wiz 8

This spell functions like *mass restore light damage*†, except that it restores 4d8 points of damage +1 per caster level (maximum +40).

Restore Light Damage

Repairs damage to a golem, technological device or structure.

Transmutation

Level: Sor/Wiz 1

Components: V, S

Casting Time: 1 standard action

Range: Touch

Target: Object or construct touched

Duration: Instantaneous

Saving Throw: Will negates (object, harmless)

Spell Resistance: Yes (object, harmless)

Description

The caster magically repairs damage dealt to a single building, golem, war engine or similar construction.

Spell Effect

This spell has no effect on living creatures or undead; it affects only artificial constructs such as buildings, catapults, golems and so on. Magical energies restore 1d8 points of damage +1 per caster level (maximum +5) to the target.

Restore Light Damage, Mass

Repairs damage to many golems, mechanical objects and/or structures.

Transmutation

Level: Sor/Wiz 5

Range: Close (25 ft. + 5 ft./2 levels)

Targets: One object or construct/level, no two of which can be more than 30 ft. apart

This spell functions like *restore light damage*, except that it can affect multiple targets and restores 1d8 points of damage +1 per caster level (maximum +25) to each selected target.

Restore Minor Damage

Transmutation

Level: Sor/Wiz 0

This spell functions like *restore light damage*†, except that it restores only 1 point of damage.

Restore Moderate Damage

Transmutation

Level: Sor/Wiz 2

This spell functions like *restore light damage*†, except that it restores 2d8 points of damage +1 per caster level (maximum +10).

Restore Moderate Damage, Mass

Transmutation

Level: Sor/Wiz 6

This spell functions like *mass restore light damage*†, except that it restores 2d8 points of damage +1 per caster level (maximum +30).

Restore Serious Damage

Transmutation

Level: Sor/Wiz 3

This spell functions like *restore light damage*†, except that it restores 3d8 points of damage +1 per caster level (maximum +15).

Restore Serious Damage, Mass

Transmutation

Level: Sor/Wiz 7

This spell functions like *mass restore light damage*†, except that it restores 3d8 points of damage +1 per caster level (maximum +35).

Searing Arrows

The caster's arrows burst into flame.

Transmutation

Level: Elr 2, Hnt 2, Pre 2, Sha 2, Sor/Wiz 2

Components: V, S, M/DF



Casting Time: 1 standard action

Range: Personal

Target: You

Duration: 1 round/level (D)

Description

The caster's hands sparkle with orange energy. As she draws and looses an arrow, it bursts into flame.

Spell Effect

While this spell is in effect, all missile weapons loosed (fired, thrown and so forth) by the caster deal an additional 1d6 points of fire damage. In addition, the blazing energy grants the missiles extra range, allowing the caster to function as if she had the Far Shot feat. (If she already possesses the Far Shot feat, this spell provides no additional benefit.)

Arcane Material Component: A pinch of sulfur, which the caster snorts upon casting the spell.

Sentry Ward

Magic totem provides clairaudience and clairvoyance.

Conjuration

Level: Sha 1, Sw 1, Wtd 1

Components: V, S

Casting Time: 1 standard action

Range: 5 ft.

Effect: One conjured totem

Duration: 1 hour/level

Saving Throw: None

Spell Resistance: No

Description

The caster conjures a totem and plants it in the ground. The totem depicts a face with jagged fangs and scary eyes.

Spell Effect

By concentrating (a standard action), the caster can see and hear through the totem. This effect functions as simultaneous *clairaudience* and *clairvoyance* spells (see the *Player's Handbook*, Chapter 11: Spells) centered on the totem. The caster takes leave of his senses while concentrating.

The totem can be attacked. It has an AC of 7, hardness of 5 and 5 hit points. If the totem is destroyed, the spell ends.

Shadow Strike

Successful attack with slashing weapon deals continuous damage.

Transmutation

Level: Sor/Wiz 6

Components: V, S, F

Casting Time: 1 standard action

Range: Touch

Target: One creature touched

Duration: Permanent until discharged (see text)

Saving Throw: None

Spell Resistance: Yes

Description

The caster charges a slashing weapon with shadow energy to deliver a particularly devastating blow. A lingering effect continues to sap the target's vitality.

Spell Effect

The caster must charge a slashing weapon he is already wielding. If the caster's weapon deals any damage on its next successful melee attack, then *shadow strike* deals an additional 10d8 points of damage. *Shadow strike* leaves a lingering effect that continues for another 6 rounds: each round the subject takes another 5d8 points of damage. The additional damage granted by this spell is not multiplied on a critical hit.

If the caster's next successful melee attack does not deal damage (such as when the target prevents all damage through damage reduction or a damage shield), the spell discharges to no effect and is lost. If the caster casts another spell or stops wielding the slashing weapon for any reason before discharging the effect, then the spell is lost.

Focus: A slashing weapon.

Shadow Strike, Greater

Transmutation

Level: Sor/Wiz 8

As shadow strike†, except the initial attack deals an extra 20d8 points of damage and the lingering effect deals 10d8 points of damage each round.

Shadow Strike, Lesser

Transmutation

Level: Hda 4, Sor/Wiz 4

As shadow strike†, except the initial attack deals an extra 6d8 points of damage and the lingering effect deals 3d8 points of damage each round.

Siphon Life

Caster drains Constitution from victim and gains hit points.

Necromancy

Level: Sor/Wiz 5

Components: V, S

Casting Time: 1 standard action

Range: Close (25 ft. + 5 ft./2 levels)

Target: One living creature

Duration: Concentration, up to 1 round/level (D)

Saving Throw: None

Spell Resistance: Yes

Description

Gouts of blood erupt from a victim's eyes, nose and mouth. The streams spin and twist into a single, larger, rope-like stream as they bridge the gap between the target and the caster. The caster opens her mouth and draws in the stream, gaining vitality as the victim weakens.

Spell Effect

The target takes 1 point of temporary Constitution damage per round, beginning on the round the spell is cast. The caster regains 5 hit points per point of Constitution bled from the target. A direct line of sight is required for the stream. If the target or caster moves out of range, the spell ends. If line of sight becomes blocked by an object at least 5 feet by 5 feet, the spell ends. The spell can be cast through squares occupied by other creatures of Medium size and smaller. Large creatures can of course be targets, but such a creature in the path of the stream will usually block line of sight and end the spell.

Siphon Mana

Transfers spell slots from target to caster.

Transmutation

Level: Sor/Wiz 5

Components: V, S, M, F

Casting Time: 1 standard action

Range: Close (25 ft. + 5 ft./2 levels)

Target: One creature

Duration: Concentration (see text)

Saving Throw: Will negates

Spell Resistance: Yes

Description

The target's mouth and eyes open wide as streams of incandescent magical energy pour from his body.

The caster catches these cerulean strands and absorbs the magic into her body, using it to recall spells that she has already cast.

Spell Effect

This spell affects only creatures capable of casting spells. The target is allowed a new Will save each round to break free of the spell. The target can end the spell in several other ways as well, such as by moving out of range or blocking the line of effect.

Siphon mana drains spell levels from the target. The total number of spell levels that can be drained is equal to the caster's level. In the round the spell is cast, the target loses a single 1st-level prepared spell or unused spell slot; the spell or spell slot is expended just as if the target had cast the spell. The target may choose which 1st-level spell he loses. Simultaneously, the caster regains any one 1st-level (or lower) spell or spell slot that she had previously expended (either by casting it or by some other means). She may choose which spell she recalls, though it must be one that she had previously prepared and expended. The spell or spell slot is immediately regained, just as if she had never cast or used it. If the target did not have a 1st-level spell or spell slot available, then he does not lose any spells or spell slots and the caster does not regain any. If the caster had not expended a 1st-level (or lower) spell, she does not regain any spells or spell slots but the target still loses one.

In the second round, the caster similarly drains one 2nd-level spell or spell slot from the target, regaining one 2nd-level (or lower) spell or spell slot of her own. If the target has no 2nd-level spells or spell slots available, the caster instead drains one 1st-level spell or spell slot (if able) and recalls one 1st-level spell (if able).

In the third round, the caster drains one 3rd-level spell or spell slot from the target. *Siphon mana* continues to absorb spells in this fashion until the caster ceases concentration, the target succeeds at a Will save (or otherwise ends the spell), or the caster absorbs the maximum number of spell levels (equal to her caster level).

Material Component: A piece of string dipped in ink and black dragon blood.

Focus: An ivory-backed glove or gauntlet worth at least 50 gp, which the caster must wear and use to capture the magical energy flowing from the target.

Soul Preservation

Sends undead into stasis in the Twisting Nether.

Necromancy [Fel]

Level: Ncr 2

Components: V, S, M

Casting Time: 1 minute

Range: Close (25 ft. + 5 ft./2 levels)

Target: One undead creature under your control

Duration: Permanent

Saving Throw: None

Spell Resistance: No

Description

The caster sends one of his undead minions to the Twisting Nether, where it floats idly until recalled.

Spell Effect

The target creature, which must be an undead creature under the caster's control, is sent to the Twisting Nether. While the target is under the effect of this spell, the caster cannot control the creature and it does not count against his limit of controlled undead. The caster can bring the creature back to his side by casting *recall undead*†.

Material Component: A crystal hourglass worth at least 10 gp that the caster crushes when casting the spell.

Spirit Link

Damage is divided among linked subjects.

Abjuration

Level: Hlr 2

Components: V, S, DF

Casting Time: 1 standard action

Range: Touch

Target: One willing creature touched/2 levels

Duration: 1 round/level (D)

Saving Throw: Will negates (harmless)

Spell Resistance: Yes (harmless)

Description

Spiritual energies intertwine all things. Some can tap these energies to create a link between two or more spirits. This spell wards the subjects and creates a mystic connection between them so that wounds received by any of them are shared by all in the link.

Spell Effect

The caster creates a spirit link if one does not already exist when this spell is cast. A character can

have only one spirit link active at a time, so multiple castings with new targets simply add them to the caster's existing spirit link.

The subjects of a spirit link take only half damage from all wounds and attacks (including those inflicted by special abilities) that deal hit point damage. The amount of damage not taken by a warded creature is taken by others in the same spirit link, divided evenly among all subjects in the link. The subject of the attack takes all remaining damage that is not applied to the others in the link.

For example, three creatures are in a spirit link. One of them is hit for 10 points of damage. It takes only 5 points of damage, and the other 5 points are divided evenly among the other two creatures in the spirit link. However, this means the others take 2 points of damage each and there is 1 point left over. The subject therefore takes 6 points of damage and the others each take 2 points of damage.

Forms of harm that do not involve hit points are not affected. If a subject suffers a reduction of hit points from a lowered Constitution score, the reduction is not split with the others in the spirit link. When the spell ends, subsequent damage is no longer distributed, but damage already split is not reassigned to the subject.

A subject can be in only one link at a time. A second casting of this spell on the same subject links the subject into the newest link. Note it is possible for the effect to wear off on a subject while a spirit link still exists for its caster. The subject is simply removed from that link. A member of a spirit link can dismiss the effect on itself at any time as a free action, thereby immediately removing itself from the link. Only one subject might remain in a link after others in the link are removed. A spirit link with one subject provides no benefit, though new members can be added with another casting of the spell.

Spirit Touch

The subject recalls one spell.

Transmutation

Level: Hlr 5, Sor/Wiz 6

Components: V, S, F/DF

Casting Time: 1 standard action

Range: Touch

Target: Creature touched

Duration: Instantaneous

Saving Throw: Will negates (harmless)

Spell Resistance: Yes (harmless)

Description

You infuse the target with magical energy, allowing her to recall one spell she already cast.

Spell Effect

This spell only functions on a creature capable of spellcasting. Upon casting this spell, the target immediately recalls one 4th-level or lower spell or spell slot she has already expended. The spell regained must be a spell that the target had previously prepared and expended (either by casting it or by some other means). The spell or spell slot is immediately regained, as if the target had not cast that spell at all.

Arcane Focus: An etched ivory charm worth at least 15 gp, worn on a chain around the neck.

Stitch

Target becomes blind and dumb.

Conjuration (Creation)

Level: Sor/Wiz 3, Swh 3

Components: V, S, M

Casting Time: 1 standard action

Range: Close (25 ft. + 5 ft./2 levels)

Target: One creature

Duration: 1 minute/level

Saving Throw: Will negates

Spell Resistance: Yes

Description

Threads of pale orange energy weave through the target's mouth and eyelids, rendering him blind and mute.

Spell Effect

The target is blinded and muted by this spell. He cannot speak or cast spells with verbal components, though he may make noise in other ways (by clapping his hands, kicking a stone, sounding a gong and the like).

Material Component: A needle and a length of thin bronze wire.

Storm, Earth and Fire

Caster splits into three elemental forms, each with different powers.

Illusion (Shadow)

Level: Sor/Wiz 8

Components: V, S, M

Casting Time: 1 round

Range: Personal

Effect: Three shadow duplicates

Duration: 1 round/level (D)

Saving Throw: None

Spell Resistance: No

Description

The caster disappears in a shower of multicolored sparks. Appearing from three large concentrations of red-, orange- and yellow-colored sparks are three new copies of the caster. From the shower of red sparks emerges the Essence of Fire, from the orange sparks comes the Essence of Earth, and from the yellow sparks rises the Essence of Storm. Each copy of the caster has special powers.

Spell Effect

This spell cannot be cast unless the caster is on at least a 10-foot by 10-foot area or 5-foot by 15-foot area of open terrain. The caster disappears and three shadow duplicates appear in her place. They each look, sound and smell like the caster, though there are small differences based on the particular form. They are composed of a quasi-real shadow material and are tangible. Each copy appears within 5 feet of the point where the spell was cast. Each copy regains lost hit points as if having rested for a day (though this healing does not restore ability damage or provide other benefits of resting for a day; changing back does not heal the caster further).

After 1 round per level, the effect ends and the caster's spirit merges with any surviving shadow copy. That copy returns to the character's normal form while the other copies (if they survived) simply fade away. The caster has the adjusted remaining hit points of the selected form. If all copies are slain, then the last copy killed reverts to her original form, though she remains dead.

The caster cannot use feats unless they are usable as free actions. Class features that require actions (including any normal spellcasting) are not available while under the effects of this spell. The copies use the character's normal ability scores, saving throws and Armor Class, along with various modifications based on the particular form. Shadowy versions of all gear and magic items appear on all forms, but triggered and consumable magic items are not usable. Persistent effects continue normally.

The caster controls the actions of all three copies as though they were separate characters, though

they all start at the same initiative as the caster when the spell is cast. Each form may speak as though it were the caster herself. The character sees through the eyes and hears through the ears of all three forms at the same time.

All Forms: The three forms of Earth, Fire and Storm each gain a +5 shadow bonus on all saving throws (see Chapter Four: Destiny and Reward, "Minor Artifacts," *Shadow Orb* for more information on shadow bonuses). All forms gain a +1 base attack bonus per two caster levels (which may give the caster's forms extra attacks).

Essence of Earth: The skin of this form hardens and appears like rock. The form gains a +4 shadow bonus to Strength and Constitution and a -4 penalty to Dexterity. It gains spell resistance of 10 + 1/2 the character's level + the character's Charisma modifier. The form gains a +10 enhancement bonus to natural armor and damage reduction of 5/—. The form may use the Power Attack feat. Creatures struck by this form must succeed at a Fortitude saving throw (DC 10 + 1/2 the character's level + the character's Strength modifier) or be stunned for 1 round.

Essence of Fire: This form appears cloaked in flames. The form gains a +4 shadow bonus to Dexterity and a -4 penalty to Strength. The form's attacks deal an additional 1d8 points of fire damage. It gains the Weapon Finesse feat if it can be applied to the weapon the character is wielding. The form is surrounded by an immolation aura: all creatures (except the other copies created by this spell) within 5 feet take 1d6 points of fire damage per round. The form has fire immunity.

Essence of Storm: This form seems to move in an aura of light mist that provides concealment. The form's attacks deal an additional 1d8 points of electricity damage and gain +2d6 sneak attack damage (when applicable). The form can make ranged touch attacks within a range of 30 feet that deal 2d8 points of electricity damage. It gains the Point Blank Shot and Precise Shot feats, as well as the ability to cast self-only *invisibility* at will as a caster of the character's level. The form is immune to electricity.

Material Component: A bit of earth, a flame, and a wisp of smoke or steam.

Strike as the Wind

Caster becomes invisible and moves faster.
Illusion (Glamer)

Level: Elr 3, Sor/Wiz 2

Components: V, S, M

Casting Time: 1 standard action

Range: Personal

Target: You

Duration: 1 min./level (D)

Description

The caster fades from sight and moves with unnatural quickness.

Spell Effect

This spell functions exactly as *invisibility* (see the *Player's Handbook*, Chapter 11: Spells), except that the caster may only cast it upon himself and gains +20 feet to all his movement modes. This bonus does not stack with any other effects that increase movement, such as *expeditious retreat* or *longstrider*.

Material Component: A wisp of smoke.

Summon Undead I

Corpse becomes undead creature that fights for the caster.

Necromancy [Evil]

Level: Gvn 1, Ncr 1

Components: V, S, M

Casting Time: 1 round

Range: Close (25 ft. + 5 ft./2 levels)

Target: One corpse

Duration: 1 round/level (D)

Saving Throw: None

Spell Resistance: No

Description

The caster causes an undead creature to arise from a corpse. The newly risen creature, controlled by the caster, may possess many of the abilities it had in life.

Spell Effect

This spell can only be cast upon the corpse of a once-living creature. The corpse rises as an undead creature. The newly created creature acts immediately, on the caster's turn. It attacks the caster's opponents to the best of its ability. If the caster can communicate with the creature, he can direct it not to attack, to attack particular enemies or to perform other actions.

The corpse rises as one of the undead creatures from the 1st-level list on Table 3-1: Summon Undead. The caster chooses which kind of creature to summon, and the caster can change that choice each time he casts the

spell. The type and Challenge Rating of the creature that provided the corpse limit the caster's options, as shown on Table 3-1. The summoned creature does not count against the caster's normal undead control limit. Because undead summoned with this spell are temporary, the caster cannot target them with *dark sacrifice*†, *soul preservation*† or similar effects.

A summoned undead cannot summon or otherwise conjure another creature, nor can it use any teleportation or planar travel abilities. Creatures cannot be summoned into an environment that cannot support them. At the end of the duration, the undead creature collapses and falls apart in a scattering of bones (or simply vanishes, if the creature was incorporeal). These remains cannot be used to summon additional undead, nor can they be used as a component for *animate dead*, *create undead* or similar spells.

Casting this spell despoils the corpse used in the summoning, just as any other effect that transforms dead creatures into undead.

Material Component: The corpse.

Summon Undead II

Necromancy [Evil]

Level: Gvn 2, Ncr 2

Target: One or more corpses, no two of which can be more than 30 ft. apart

This spell functions like *summon undead I*†, except that the caster can summon one creature from the 2nd-level list or 1d3 creatures of the same kind from the 1st-level list. One corpse is required for each summoned creature.

Summon Undead III

Necromancy [Evil]

Level: Gvn 3, Ncr 3

Target: One or more corpses, no two of which can be more than 30 ft. apart

This spell functions like *summon undead I*†, except that the caster can summon one creature from the 3rd-level list, 1d3 creatures of the same kind from the 2nd-level list or 1d4+1 creatures of the same kind from the 1st-level list. One corpse is required for each summoned creature.

Summon Undead IV

Necromancy [Evil]

Level: Gvn 4, Ncr 4

Target: One or more corpses, no two of which can be more than 30 ft. apart



Table 3-1: Summon Undead

All creatures on this table appear in the Manual of Monsters.

Undead	Base Creature	Minimum Hit Dice or Challenge Rating
1st Level		
Zombie	Humanoid or monstrous humanoid	1 HD fewer ¹
2nd Level		
Zombie	Humanoid or monstrous humanoid	2 HD ¹
3rd Level		
Forsaken	Humanoid	CR 2 or less
Ghoul	Humanoid or monstrous humanoid	CR 2 or less
Skeletal Mage	Humanoid	CR 1 or less
Skeletal Warrior	Humanoid or monstrous humanoid	CR 2 or less
Withered	Aberration, animal, dragon, fey, magical beast, plant or other monstrous creature	CR 2 or less
Wraith	Humanoid or monstrous humanoid	CR 2 or less
Zombie	Humanoid or monstrous humanoid	4–5 HD ¹
4th Level		
Banshee	Humanoid	CR 1 or less
Forsaken	Humanoid	CR 3
Ghoul	Humanoid or monstrous humanoid	CR 3
Shade	Humanoid	CR 1 or less
Skeletal Mage	Humanoid	CR 2
Skeletal Warrior	Humanoid or monstrous humanoid	CR 3
Withered	Aberration, animal, dragon, fey, magical beast, plant or other monstrous creature	CR 3
Wraith	Humanoid or monstrous humanoid	CR 3
Zombie	Humanoid or monstrous humanoid	6–7 HD ¹
5th Level		
Banshee	Humanoid	CR 2
Crypt Fiend	Nerubian	CR 4 or less
Forsaken	Humanoid	CR 4
Ghost	Aberration, animal, dragon, giant, humanoid, magical beast, monstrous humanoid or plant of Cha 6+	CR 1 or less ²
Ghoul	Humanoid or monstrous humanoid	CR 4
Shade	Humanoid	CR 2
Skeletal Mage	Humanoid	CR 3
Skeletal Warrior	Humanoid or monstrous humanoid	CR 4
Withered	Aberration, animal, dragon, fey, magical beast, plant or other monstrous creature	CR 4
Wraith	Humanoid or monstrous humanoid	CR 4
Zombie	Humanoid or monstrous humanoid	8 HD ¹
6th Level		
Banshee	Humanoid	CR 3–4
Crypt Fiend	Nerubian	CR 5–6
Forsaken	Humanoid	CR 5–6

Table 3-1: Summon Undead (continued)

All creatures on this table appear in the *Manual of Monsters*.

Undead	Base Creature	Minimum Hit Dice or Challenge Rating
6th Level (continued)		
Ghost	Aberration, animal, dragon, giant, humanoid, magical beast, monstrous humanoid or plant of Cha 6+	CR 2–3 ²
Ghoul	Humanoid or monstrous humanoid	CR 5–6
Shade	Humanoid	CR 3–4
Skeletal Mage	Humanoid	CR 4–5
Skeletal Warrior	Humanoid or monstrous humanoid	CR 5–6
Withered	Aberration, animal, dragon, fey, magical beast, plant or other monstrous creature	CR 5–6
Wraith	Humanoid or monstrous humanoid	CR 5–6
Zombie	Humanoid or monstrous humanoid	9–10 HD ¹
7th Level		
Banshee	Humanoid	CR 5
Crypt Fiend	Nerubian	CR 7–8
Forsaken	Humanoid	CR 7–8
Ghost	Aberration, animal, dragon, giant, humanoid, magical beast, monstrous humanoid or plant of Cha 6+	CR 4 ²
Ghoul	Humanoid or monstrous humanoid	CR 7
Shade	Humanoid	CR 5
Skeletal Mage	Humanoid	CR 6–7
Skeletal Warrior	Humanoid or monstrous humanoid	CR 7–8
Withered	Aberration, animal, dragon, fey, magical beast, plant or other monstrous creature	CR 7
Wraith	Humanoid or monstrous humanoid	CR 7
8th Level		
Banshee	Humanoid	CR 6–7
Crypt Fiend	Nerubian	CR 9–10
Forsaken	Humanoid	CR 9–10
Ghost	Aberration, animal, dragon, giant, humanoid, magical beast, monstrous humanoid or plant of Cha 6+	CR 5–6 ²
Ghoul	Humanoid or monstrous humanoid	CR 8–9
Shade	Humanoid	CR 6–7
Skeletal Mage	Humanoid	CR 8–9
Skeletal Warrior	Humanoid or monstrous humanoid	CR 9–10
Withered	Aberration, animal, dragon, fey, magical beast, plant or other monstrous creature	CR 8–9
Wraith	Humanoid or monstrous humanoid	CR 8–9
9th Level		
Banshee	Humanoid	CR 8
Crypt Fiend	Nerubian	CR 12
Forsaken	Humanoid	CR 11

Table 3–1: Summon Undead (continued)

All creatures on this table appear in the *Manual of Monsters*.

Undead	Base Creature	Minimum Hit Dice or Challenge Rating
9th Level (continued)		
Ghost	Aberration, animal, dragon, giant, humanoid, magical beast, monstrous humanoid or plant of Cha 6+	CR 7 ²
Ghoul	Humanoid or monstrous humanoid	CR 10
Shade	Humanoid	CR 8
Skeletal Mage	Humanoid	CR 10
Skeletal Warrior	Humanoid or monstrous humanoid	CR 11
Withered	Aberration, animal, dragon, fey, magical beast, plant or other monstrous creature	CR 10
Wraith	Humanoid or monstrous humanoid	CR 10

¹Does not include any Hit Dice from class levels.

²Ghosts summoned with this spell possess the malevolence, horrific appearance and corrupting gaze abilities.

This spell functions like *summon undead I*[†], except that the caster can summon one creature from the 4th-level list, 1d3 creatures of the same kind from the 3rd-level list or 1d4+1 creatures of the same kind from any combination of lower-level lists (for example, zombies with varying Hit Dice). One corpse is required for each summoned creature.

Summon Undead V

Necromancy [Evil]

Level: Gvn 5, Ncr 5

Target: One or more corpses, no two of which can be more than 30 ft. apart

This spell functions like *summon undead I*[†], except that the caster can summon one creature from the 5th-level list, 1d3 creatures of the same kind from the 4th-level list or 1d4+1 creatures of the same kind from any combination of lower-level lists (for example, zombies with varying Hit Dice). One corpse is required for each summoned creature.

Summon Undead VI

Necromancy [Evil]

Level: Gvn 6, Ncr 6

Target: One or more corpses, no two of which can be more than 30 ft. apart

This spell functions like *summon undead I*[†], except that the caster can summon one creature from the 6th-level list, 1d3 creatures of the same kind from the

Summon Nature's Ally Additional Creature Selections

Below is a list of additional creatures that may be summoned with the various *summon nature's ally* spells (see Chapter 11 in the *Player's Handbook*). All creatures listed below appear in the *Manual of Monsters*.

2nd Level

Elk (animal)
Wisp [NG]
Wolf, Timber (animal)

3rd Level

Storm crow (animal)
Tallstrider (animal)

4th Level

Bog beast [CE]
Kodo beast

5th Level

Dryad [CG]
[CG]

6th Level

Phoenix egg¹
Wolf, Giant (animal)
Revenant (any) [NE]

7th Level

Ancient [NG]

8th Level

Ancient, Corrupted

Phoenix

9th Level

Keeper of the grove

¹The egg hatches in 1d4+1 rounds.

5th-level list or 1d4+1 creatures of the same kind from any combination of lower-level lists (for example, zombies with varying Hit Dice). One corpse is required for each summoned creature.

Summon Undead VII

Necromancy [Evil]

Level: Gvn 7, Ncr 7

Target: One or more corpses, no two of which can be more than 30 ft. apart

This spell functions like *summon undead I†*, except that the caster can summon one creature from the 7th-level list, 1d3 creatures of the same kind from the 6th-level list or 1d4+1 creatures of the same kind from any combination of lower-level lists (for example, zombies with varying Hit Dice). One corpse is required for each summoned creature.

Summon Undead VIII

Necromancy [Evil]

Level: Gvn 8, Ncr 8

Target: One or more corpses, no two of which can be more than 30 ft. apart

This spell functions like *summon undead I†*, except that the caster can summon one creature from the 8th-level list, 1d3 creatures of the same kind from the 7th-level list or 1d4+1 creatures of the same kind from any combination of lower-level lists (for example, zombies with varying Hit Dice). One corpse is required for each summoned creature.

Summon Undead IX

Necromancy [Evil]

Level: Gvn 9, Ncr 9

Target: One or more corpses, no two of which can be more than 30 feet apart

This spell functions like *summon undead I†*, except that the caster can summon one creature from the 9th-level list, 1d3 creatures of the same kind from the 8th-level list or 1d4+1 creatures of the same kind from any combination of lower-level lists (for example, zombies with varying Hit Dice). One corpse is required for each summoned creature.

Tentacle Lash

The caster gains a constricting weapon with long reach.

Transmutation

Level: Drw 2, Sor/Wiz 2

Components: V, S, M

Casting Time: 1 standard action

Range: Personal

Effect: 15-ft.-long (or longer) tentacle

Duration: 1 round/level (D)

Description

One of the caster's arms transforms into an enormous purple tentacle, studded with powerful suckers. The tentacle uncoils to lash at the caster's enemies.

Spell Effect

The caster can attack with the tentacle as if it were a weapon with which she is proficient. She can attack with it (once) in the same round in which she casts the spell. The tentacle has a Strength of 25 (or the caster's Strength, whichever is higher) and deals 1d8 points of damage (1d8+7 with Strength 25). It has a reach of 10 feet greater than the caster's normal reach (i.e., 15 feet for Medium casters). The tentacle can also wrap around targets and crush them. It counts as a Large creature for the purposes of grappling (+4 grapple bonus) and has the Improved Grab ability (can attempt to start a grapple as a free action without provoking attacks of opportunity if it makes a successful melee attack). If the tentacle gets a hold, it can constrict, dealing 2d8+7 points of damage with a successful grapple check.

While the caster's arm is a tentacle, she cannot use it to wield weapons or perform other tasks of fine manipulation. She suffers a -4 penalty on all skill checks involving deft manipulation (Disable Device, Open Lock and so on). She cannot cast spells with somatic components.

The caster may cast this spell multiple times (though subsequent castings must avoid the somatic component), gaining multiple tentacles (up to one per arm). Fighting with more than one tentacle incurs all the normal penalties of fighting with multiple weapons.

Material Component: A bit of squid flesh.

Thorn Shield, Greater

Transmutation

Level: Drw 4, Sor/Wiz 4

Greater thorn shield works like *thorn shield**, except that it grants the creature touched a +4 natural armor bonus to AC; this bonus increases to +5 at 12th level and up. Attackers suffer 2d6 points of damage +2 points per caster level.

Thorn Shield, Lesser

Transmutation

Level: Drw 1, Sor/Wiz 1

This spell functions like *thorn shield**, except that attackers suffer 1d4 points of damage.

Thunderclap

Nearby creatures take damage and are slowed.

Evocation [Sonic]

Level: Drw 2, Sor/Wiz 2

Components: V, S, M

Casting Time: 1 standard action

Range: Personal

Area: 20-ft.-radius burst

Duration: 1 round (see text)

Saving Throw: Fortitude negates

Spell Resistance: Yes

Description

The caster slams the ground, causing an enormous, thunder-like clap that ruptures enemies' ear drums. The magic also inundates the targets with jittering sonic energy, slowing them to a fraction of their normal speed.

Spell Effect

All creatures within the area (except the caster) take 1d8 points of sonic damage per 3 caster levels (maximum 5d8). Creatures who take damage from this effect are also slowed (as the *slow* spell) for 1 full round.

Multiple *slow* effects do not stack. *Thunderclap* dispels but does not counter *haste*.

Material Component: A small silver hammer.

Thunder Lizard Rush

Caster summons thunder lizards to trample his foes.

Conjuration (Summoning)

Level: Drw 9

Components: V, S

Casting Time: 1 round

Range: 5 feet

Effect: One thunder lizard/round

Duration: Concentration, up to 1 round/level

Saving Throw: None

Spell Resistance: No

Description

The caster summons hordes of thunder lizards to charge his enemies!

Spell Effect

Each round, this spell summons two thunder lizards that appears in any square adjacent to the caster and immediately charges (if able) one enemy the caster selects. Both thunder lizards cannot target the same creature in the same round. After this attack, each thunder lizard vanishes — but another appears in the next round. This spell does not function in environments where thunder lizards cannot charge (for example, in the air or underwater).

Troll Flesh

The subject gains fast healing.

Transmutation

Level: Hlr 2, Sor/Wiz 4, Wtd 2

Components: V, S, M

Casting Time: 1 standard action

Range: Touch

Target: Living creature touched

Duration: 1 min./level

Saving Throw: Will negates (harmless)

Spell Resistance: Yes (harmless)

Description

The subject's skin becomes a dark, troll-like shade of gray (or purple, or green or white, depending on the variety of troll used to provide the material component). She begins to heal, much like a troll.

Spell Effect

The subject gains 1 minute of fast healing 1, plus 1 round per 2 caster levels. If the subject already has fast healing, the rate improves by 1 hit point per round.

Material Component: A small, preserved piece of troll flesh (often an ear, nose, eye or finger).

Troll Flesh, Mass

Transmutation

Level: Hlr 6, Sor/Wiz 8, Wtd 5

Range: Close (25 ft. + 5 ft./2 levels)

Targets: One creature/level, no two of which can be more than 30 ft. apart

This spell functions like *troll flesh†*, except that it affects multiple creatures.

Trueshot Aura

Allies gain attack and damage bonuses with missile weapons.

Transmutation
Level: Hlr 3, Wtd 3
Components: V, S, DF
Casting Time: 1 action
Range: Personal
Area: 20-ft.-radius emanation
Duration: 1 round/level (D)
Saving Throw: None
Spell Resistance: Yes (harmless)

Description

The caster is surrounded by a glowing, blue-white aura. This aura grants keen insight to archers, crossbow wielders and similar warriors.

Spell Effect

Allies within the radius, including the caster, gain a +2 insight bonus on attack rolls and a +4 insight bonus on damage rolls with ranged weapons. These bonuses only apply if the target of the attack is within 30 feet of the character.

An ally gains these benefits only when in the radius of the spell. An ally within the radius when the spell is cast retains the benefits only while he remains within the spell's radius. An ally who enters the radius after the spell is cast gains the benefits for as long as he remains within the radius.

Trueshot Aura, Greater

Transmutation
Level: Hlr 4, Wtd 5

This spell functions as *trueshot aura*, but grants recipients a +3 insight bonus on attack rolls and a +6 insight bonus on damage rolls with ranged weapons.

Trueshot Aura, Lesser

Transmutation
Level: Hlr 2, Wtd 1

This spell functions as *trueshot aura*, but grants recipients a +1 insight bonus on attack rolls and a +2 insight bonus on damage rolls with ranged weapons.

Vampiric Aura

Allies drain life with every attack.
 Necromancy
Level: Sor/Wiz 8
Components: V, S, M
Casting Time: 1 standard action

Range: Personal
Effect: 20-ft.-radius emanation
Duration: 1 round/2 levels
Saving Throw: Will negates (harmless)
Spell Resistance: Yes (harmless)

Description

The caster's and his allies' attacks are empowered to drain life from their opponents, granting unholy vigor and health to the spell's subjects.

Spell Effect

Allies (including the caster) within the spell's radius can drain life with successful melee attacks. For each point of damage they deal to a living opponent with a melee attack, they gain 1 temporary hit point. An affected creature cannot gain more hit points from a single opponent than that opponent has (i.e., his current hit points + 10). These temporary hit points disappear 1 hour later.

An ally gains these benefits only when in the radius of the spell. An ally within the radius when the spell is cast retains the benefits only while she remains within the spell's radius. An ally who enters the radius after the spell is cast gains the benefits for as long as she remains within the radius.

Material Component: Powdered dreadlord horn.

Vampiric Swarm

Vermin damage targets and restore hit points to caster.
 Conjunction (Summoning)
Level: Ncr 3, Sor/Wiz 4
Components: V, S, M
Casting Time: 1 round
Range: Personal
Effect: 20-ft.-radius spread
Duration: Concentration
Saving Throw: None
Spell Resistance: No

Description

This spell creates a swarm of angry, flying vermin that bite and tear at nearby enemies. As they chew the enemy flesh, they convert it into a substance that restores hit points to the caster when they return to him.

Spell Effect

An enemy creature in the swarm that takes no actions other than fighting off the vermin suffers 1



point of damage on its turn. A creature in the swarm that takes any other action, including leaving the effect's area, suffers 1d4 points of damage. Two rounds later, as the vermin return, the caster regains a number of lost hit points equal to the total damage dealt, up to the caster's normal maximum.

For example, if the swarm deals a total of 7 points of damage on the first round, then the caster regains 7 hit points on the third round. If the swarm subsequently deals 10 points of damage on the second round, the character regains 10 hit points on the fourth round, and so on.

The vermin cease their attacks once concentration has been broken, but it still takes two more rounds for the remaining vermin to return and restore life to the character.

Spellcasting or concentrating on spells within the swarm is impossible. The vermin's attacks are nonmagical. Damage reduction, being incorporeal, and other special abilities also make a creature immune to damage from the swarm. The swarm

cannot be fought effectively with weapons or spells of any kind. Any vermin killed are quickly replaced the following round as the effect continues to generate new vermin. The swarm stays centered on the caster and moves as the caster moves.

Material Component: The caster must consume a live locust.

Vengeance

Summons spirits of vengeance that fight for the caster.

Conjuration (Summoning)

Level: Hlr 9, Sor/Wiz 9

Components: V, S, F/DF

Casting Time: 1 round

Range: Close (25 ft. + 5 ft./2 levels)

Effect: One summoned greater spirit of vengeance and a number of lesser spirits of vengeance up to 1d4+1 for every 3 caster levels

Duration: 1 round/2 levels (D)

Saving Throw: None

Spell Resistance: No

Description

The caster moans in anguish and hatred, slashing herself with a barbed dagger. As her blood strikes the ground, a greater spirit of vengeance rises, with lesser spirits of vengeance arising from the caster's fallen comrades, moving to strike down her enemies.

Spell Effect

The caster deals 1d4 points of damage to herself when she casts this spell. This spell summons a greater spirit of vengeance (see the **Manual of Monsters**, Chapter One: Creatures of Azeroth). The spirit appears where the caster designates and acts immediately on the caster's turn. It attacks the caster's opponents to the best of its ability, and the caster can direct it not to attack, to attack particular enemies or to perform other actions.

In addition, this spell summons a number of lesser spirits of vengeance from the corpses of the caster's fallen allies. For each such corpse within range, a lesser spirit of vengeance appears in that location (up to 1d4, +1 for every 3 caster levels). These lesser spirits attack the caster's enemies and obey her commands just as the greater spirit does.

Note that the greater spirit of vengeance summoned by this spell can use its create spawn ability freely, but any spawn it creates vanish when the spell's duration expires.

Arcane Focus: A jagged knife crafted of flint and obsidian with a ruby worth at least 1,500 gp in the pommel. The caster slashes herself with the knife while casting the spell. A shadowy, indistinct copy of the knife appears in the left hand of the greater spirit summoned by the spell.

Voodoo Spirits

Target takes damage, caster heals a like amount.

Conjuration (Summoning)

Level: Sha 3, SwH 3

Components: V, S

Casting Time: 1 standard action

Range: Close (25 ft. + 5 ft./2 levels)

Target: One living creature

Duration: 2 rounds

Saving Throw: Fortitude half

Spell Resistance: Yes

Description

The caster summons of cackling group of semi-tangible, dark spirits. The spirits rip the target's life from his body and bring it back to the caster.

Spell Effect

The spirits inflict 1d8 points of negative energy damage per two caster levels (maximum 10d8) to the target. The next round, the spirits return to the caster and bequeath the stolen life unto him, healing him a like amount of damage. Damage healed above the caster's maximum becomes temporary hit points, which disappear after 1 hour.

This spell has no effect on undead.

War Drums

Allies gain +2 bonus on damage rolls.

Enchantment (Compulsion) [Mind-Affecting]

Level: Hlr 1, Plw 1, Wtd 1

Components: V, S, DF

Casting Time: 1 standard action

Range: Personal

Area: 50-ft.-radius emanation

Duration: 1 min./level

Saving Throw: None

Spell Resistance: Yes (harmless)

Description

The invigorating sound of war drums echoes in the ears of the caster's allies, spurring them to make short work of their opponents.

Spell Effect

The caster and all allies within range gain a +2 morale bonus on damage rolls.

An ally gains these benefits only when in the radius of the spell. An ally within the radius when the spell is cast retains the benefits only while she remains within the spell's radius. An ally who enters the radius after the spell is cast gains the benefits for as long as she remains within the radius.



“...Then you have one minute to open that door. If you fail, I want time to enjoy killing you myself.”

Isak drew thieves' tools from his pockets and tugged his gloves on tighter. “Magic gloves,” he muttered nervously. “Magic gloves of celeb... celery—”

“Celery,” said Bohein, opening the pouch around his neck. The ring inside dropped into his calloused palm. The tauren watched the cold moonlight glint off its silver strands for a moment, then he slipped it over the chipped tip of one horn. From his pack he brought out a glass vial filled with a glowing blue-green liquid. Bohein had won the potion in Bluefen on his first elderquest, and he had carried it unused — unneeded — for many years. Yet if he didn't use it tonight, there would be no tomorrow. Thumbing open the stopper, he tipped the vial to his muzzle and drank.

The tauren felt the warmth of magical strength flowing into his limbs as Isak shouted, “I've got the lock open, but there are traps! Magic traps!” The goblin dug frantically in his pack. “I just need to find that amulet...”

Bohein stepped to the edge of the cliff and looked over. Roiling masses of the undead swarmed at the base of the mesa. An abomination halfway up the rock face reached for a new grip but found instead one of the wards Bohein had cast earlier. The explosion ripped open the abomination's undead flesh and sent it tumbling back into the darkness. Skeletons to either side continued their climb, undeterred. Bohein turned back to the goblin. “When I return, that door will be open.”

Isak clutched the bronze disc around his neck and sneezed as he waved away a smoky cloud jetting up from the door. “Poison gas! She really didn't want anyone opening this door. Just a few more seconds!”

Unknotting the leather thongs binding weapon to baldric, Bohein muttered the whistling elven word that released the spells bound into his horn ring. Trusting to the magic, he took a step over the edge and toppled forward — only to plant his hoof firmly against the vertical face of the cliff. Another step forward and he stood sideways on the side of the mesa, a hundred feet above the ground. The hordes of undead far below





were a swarm on the distant ground that had become a "wall" to Bohein, and the skeletons skittering forward pressed themselves tightly to the cliff that was now his "floor." Reaching over his shoulder, Bohein shook the wrappings from his weapon. They fell away, pulled at an odd angle by gravity he could not feel.

Freed of its rough scabbard, the tauren's ancient axe roared with rage as the undead approached. Bohein joined his weapon's cry as he moved from one enemy to the next, chopping off bony limbs and knocking ghouls from the rocks. As he pushed back wave after wave of the enemy, the war chants of his ancestors sang in his mind. For seconds that felt like hours, he let himself swim in the glorious tides of battle. Then, as he felt his ring's magic wane, he rushed up the face of the cliff and leapt back onto the top.

"The vault's open!" cried Isak. "I've got it!"

Bohein ripped the bundle from the goblin's hands and tore away the leather wrappings. The smell of decay and death bloomed from the book inside. The tauren felt the powerful magics bound into the tome reach out to shroud the moon in dark clouds. This was it. This was what they had been looking for.

Turning to the skeletons and ghouls clambering over the edge, Bohein held the book high and cried, "In the name of Queen Azshara and with the power of this book, I command death itself! **BACK!**"





CHAPTER FOUR: DESTINY AND REWARD

The world of **Warcraft** teems with magic bound inside many types of weapons and objects. Some are so common that they can be found for sale from even the most isolated goblin merchants, while others can only be attained after perilous quests. The magic items won and wielded by adventurers are some of their most precious possessions and can mark the difference between becoming a legend and falling in battle.

The material in this chapter is based upon Chapter 7: Magic Items in the revised *DMG*; please refer to the *DMG* on creating and pricing magic items.

The tables for random magic item generation incorporate the items found in this book as well as the **Warcraft RPG** core book and the **Manual of Monsters**. Items from other sources are noted as described in the Introduction.

Racial Body Slots

Most of Azeroth's humanoid creatures can use items in the standard body slots (see "Magic Items on the Body" in Chapter 7: Magic Items of the *DMG*). Some races, however, have additional slots based on their particular physiology, as indicated below:

Dwarf: A dwarf can wear any item designed for a neck slot by weaving it into his beard. This still takes up the neck position.

Elf, Gnome, Half-Elf, Half-Orc, Human, Troll: No additional slots.

Furbolg, Orc, Pandaren: Orcs, furbolgs and pandaren can attach certain small magic items to their long, sharp canine teeth, which are generally referred to as "jaws." Jaw slot items usually grant the creature bonuses to any natural bite attack or permit the character to do something special by means of a bite. Items without such affinities are not allowed in the jaw slot.

Goblin: A goblin can wear a single magical ring in either his left or right ear. This ring may not exceed any other rings he has in power (determined by comparing caster levels), nor may it be one that requires greater than a 7th-level caster to create. Rings attached as ear piercings require 1 full round to remove or attach.

Naga: Naga can wear one ring on each hand they possess, and can wear one set of gloves for each pair of hands (but not on tentacles). They may not wear boots, nor may they use helms if they have snakes

for hair (though they could employ a circlet or similar item). Naga with a natural bite attack can employ the same jaw slot used by orcs and furbolgs.

Tauren: Tauren have 2 additional slots. A tauren may attach a magical ring to her nose, following the same rules as goblin earrings. Tauren also possess a slot for their horns. Horn items (which may include rings) normally increase the creature's gore attack, provide protection for the head, allow the horns to be used as special melee weapons, or similar abilities. Items without such affinities are not allowed in the horn slot. (There is only one slot that covers both horns, not one slot per horn.) Because they have hooves instead of feet, tauren may not wear boots, shoes or similar items, although certain magic items that take up those slots (such as greaves) may still be used.

Armor and Shields

Azeroth's races seek out magical defenses as much as they do weapons. Those who do not fight for a living are equally interested in armor and shields, for these items can keep the wearer alive in the more dangerous areas of the world.

When generating armor and shields, employ Table 7-2 from the *DMG* to determine the type of item generated. If a specific item or shield is generated, use Table 4-1: Armor and Shields, below. If a special ability is called for, roll again on Table 7-2 to determine other benefits.

New Armor and Shield Special Abilities

Magic armor and shields can have one or more of the special abilities detailed here, in addition to an enhancement bonus. Armor or a shield with a special ability must have at least a +1 enhancement bonus.

Command: This enhancement can be added only to suits of armor and shields designed for military commanders. The benefits provided by all commander feats are increased by +1 for as long as the item is worn and visible to all allies within the appropriate range. If the commander puts something on over the armor or shield, is immersed in *darkness*, turns *invisible*, or otherwise removes the item from view, its benefits are lost.

Moderate enchantment; CL 12th; Craft Magic Arms and Armor, *prayer*; Price +2 bonus.

Table 4–1: Armor and Shields

Minor	Medium	Major	Item	Market Price
01–25	01–20	01–15	Devotion	+1 bonus
26–50	21–40	16–30	Enlarging	+1 bonus
51–75	41–60	31–45	Generalship	+1 bonus
—	61–70	46–55	Command	+2 bonus
—	71–80	56–65	Ranged defense	+2 bonus
76–90	81–90	66–75	<i>Enchanted shield of Veth'talia</i>	13,153 gp
91–99	91–95	76–85	<i>Bladebane armor</i>	23,070 gp
100	96–99	86–95	<i>Arcanite shield of Karrus</i>	25,180 gp
—	100	96–99	<i>Shield of honor</i>	64,170 gp
—	—	100	<i>Frost wyrm skull shield</i>	77,150 gp

Devotion: Armor and shields with this feature are designed for leaders. Anyone who recognizes the character wearing this armor or carrying this shield as their leader (i.e., anyone who would benefit from that character's commander feats, if any) receives a +1 morale bonus on attack rolls and saving throws, and to Armor Class. This bonus does not apply to the character wearing the armor or holding the shield.

Moderate enchantment; CL 10th; Craft Magic Arms and Armor, *prayer*; Price +1 bonus.

Enlarging: Armor crafted with this property can *enlarge* itself and its wearer upon command up to 3 times per day. Because of the enchantment's special nature, there is no Dexterity loss while the armor's owner is *enlarged*. The effects last for 10 rounds, although the *enlargement* can be voluntarily ended early with a single command word.

Moderate enchantment; CL 8th; Craft Magic Arms and Armor, *enlarge person*; Price +1 bonus.

Generalship: Armor of this type is intended for use in mass combat situations (see Chapter Three: The Art of War in the *Alliance & Horde Compendium*), but can also be useful in other situations. The armor gleams and shines, and has colorful borders that mark it as special. Some versions include epaulets or other indicators of rank depending on the original creator. When worn, this armor gives its owner a +5 competence bonus on Knowledge (military tactics*) and Profession (military commander) checks (see *Alliance & Horde Compendium* Chapter One: The New Blood, "New Skill").

Moderate transmutation; CL 10th; Craft Magic Arms and Armor, caster must have 5 ranks in Knowledge (military tactics) and Profession (military commander); Price +1 bonus.

Ranged Defense: This enhancement can be added only to shields. A shield with this power has an uncanny ability to interpose itself between the wielder and any ranged attack, providing the owner with damage resistance 5/—against any ranged weapon, even exceptional ones. This condition does not stack with any other damage resistance provided by other magical items or inherent powers the wearer may possess.

Moderate abjuration; CL 10th; Craft Magic Arms and Armor, *stoneskin*; Price +2 bonus.

Specific Magical Armor and Shields

Azeroth's legends speak of many special armors and shields that have become well known to scholars and sages. Some of these items are listed here.

Arcanite Shield of Karrus

Description: This shield was once wielded by the legendary human warrior Karrus during the first campaign against the orcs in Lordaeron. Although he fell in battle, his shield was preserved, and since that time several other examples of its type have been created. All bear his name and a bas relief image of his face in reverence to this great hero.

Powers: This +2 *tower shield*, made entirely of arcanite save for an ornately cast steel border, bears the *ranged defense* enhancement. (It was often said that no arrow made could fell Karrus, and indeed, he was finally brought low by a swarming attack of orcish foot soldiers.) The shield deflects critical hits 50% of the time.

Moderate abjuration; CL 12th; Craft Magic Arms and Armor; Price 25,180 gp; Cost 12,590 + 1,007 XP.



Bladebane Armor

Description: Suits of this form of half-plate armor were originally seen among the orcs, where they were used by leaders of great renown. The humans eventually copied the design. The surface of all exposed plate sections is decorated with raised images of warriors involved in glorious battle. Orcish *bladebane armors*, naturally, show orcs at war, while those suits produced by humans depict powerful knights striking down their foes. No self-respecting human or orcish warrior would consider wearing armor created by the opposing race.

Powers: This armor is considered +3 *half-plate of devotion*, except that the morale benefits apply to all allies within the prescribed range, regardless of whether or not they recognize the character as their leader. In addition, once per day, the wearer of this armor can invoke a *shield other* effect upon any ally within 60 feet.

Moderate enchantment; CL 12th; Craft Magic Arms and Armor, *shield other*; Price 23,070 gp; Cost 11,535 gp + 1,283 XP.

Enchanted Shield of Veth'talia

Description: The fighting sorceress Veth'talia was known as much for her combat abilities as her mastery of the arcane arts. Among her most prized possessions was this small shield carved from a single block of wood drawn from the heart of an ancient tree felled by lightning. The shield is unnaturally light and easy to handle.

Powers: This +2 *light wooden shield* confers no arcane spell failure penalties upon its owner. Any character can use it with proficiency, even if he does not have the appropriate feat. In addition to its

armor protection, the shield also provides a +2 enhancement bonus to Constitution when used.

Moderate transmutation; CL 10th; Craft Magic Arms and Armor, *bear's endurance*; Price 13,153 gp; Cost 6,577 gp + 526 XP.

Frost Wurm Skull Shield

Description: This unique shield was carved from the flattened crown of a white dragon's skull. The bone has been hardened and enhanced with an intricate steel framework interlaced with unidentifiable runes from an unknown maker.

Powers: This +2 *light steel shield* provides spell resistance 19 while carried. The unique material has hardness 10 and 40 hit points, and any repairs to it require double the normal fee. If this shield is visible, all reactions by white dragons or any related creatures are at a -4 penalty.

Strong abjuration; CL 16th; Craft Magic Arms and Armor, *spell resistance*, white dragon skull; Price 77,150 gp; Cost 38,575 gp + 3,086 XP.

Shield of Honor

Description: These powerful shields were once employed by the greatest generals of Lordaeron. The shields are pentagonal in shape, with a dragon carved into the steel surface. When a commander takes up the shield, the creature seems to move and twist on the facing, and low growls and hisses issue forth. In combat, the dragon periodically roars, bolstering the confidence of the bearer's allies.

Powers: This +5 *heavy steel shield of command* provides the bearer and all allies within 20 feet complete immunity to fear as long as it is visible; and the character carrying it does not fall unconscious or die and is recognized by his allies as their leader.

Strong enchantment; CL 15th; Craft Magic Arms and Armor, *calm emotions*, caster must have at least 2 commander feats; Price 64,170 gp; Cost 32,085 gp + 2,567 XP.

Weapons

Magical weapons are some of the most sought-after items in all of Azeroth. A powerful weapon can often be the difference between glorious victory and cold steel in the gut.

Any of the following enhancements can be added to firearms. However, the addition of magic to a technological item gives it an element of instability.

WARCRAFT

THE ROLEPLAYING GAME

Table 4-2: Weapon Special Abilities

Minor	Medium	Major	Item	Market Price
01-07	01-03	01-02	Devotion	+1 bonus
08-13	04-06	03-04	Dispelling	+1 bonus
14-19	07-09	05-07	Fast reloading	+1 bonus
20-25	10-12	08-09	Fear	+1 bonus
26-32	13-15	10-12	Friendly	+1 bonus
33-38	16-18	13-14	Frugal	+1 bonus
39-44	19-21	15-16	Functionality	+1 bonus
45-50	22-24	17-18	Howling	+1 bonus
51-56	25-27	19-21	Piercing	+1 bonus
57-62	28-30	22-24	Reloading	+1 bonus
63-69	31-33	25-26	Roaring	+1 bonus
70-75	34-36	27-29	Self-loading	+1 bonus
76-81	37-39	30-31	Shockwave	+1 bonus
82-87	40-42	32-34	Shrinking	+1 bonus
88-93	43-45	35-36	Vermin	+1 bonus
94-100	46-48	37-38	Warding	+1 bonus
—	49-51	39-41	Blowthrough	+2 bonus
—	52-54	42-44	Capability	+2 bonus
—	55-57	45-47	Crippling	+2 bonus
—	58-60	48-50	Crushing	+2 bonus
—	61-63	51-53	Enfeeblement	+2 bonus
—	64-66	54-56	Entangling	+2 bonus
—	67-69	57-59	Frost nova	+2 bonus
—	70-72	60-62	Healing	+2 bonus
—	73-75	63-65	Knockback	+2 bonus
—	76-78	66-68	Lifestealing	+2 bonus
—	79-81	69-71	Maximized	+2 bonus
—	82-84	72-74	Multiple targeting	+2 bonus
—	85-87	75-77	Severity	+2 bonus
—	88-90	78-80	Spike stone	+2 bonus
—	91-93	81-83	Transmutation	+2 bonus
—	94-96	84-86	Unholy frenzy	+2 bonus
—	97-99	87-90	Death	+3 bonus
—	100	91-93	Destruction	+3 bonus
—	—	94-95	Heroic	+3 bonus
—	—	96-97	Mana burn	+3 bonus
—	—	98-99	Prescience	+3 bonus
—	—	100	Bloodlust	+4 bonus

Except as noted in the ability descriptions below, adding any enhancement increases a technological device's MR by 1. This penalty does not apply in the case of siege weapons and their special ammunition, unless applied directly to the ammunition itself.

Siege weapons may also be enhanced with many different weapon capabilities — typically those that apply to ranged weapons only. Enhancements that apply a bonus to the wielder (e.g., statistics boosts, extra feats, and so forth) won't work with siege

weapons. Special effects that affect individual targets, such as fear or wounding, work only with standard ammunition and only against the first target struck (not any targets affected by splash damage, if applicable). Note that many other effects, such as vorpal, simply aren't applicable to siege devices. A siege weapon need not be masterwork to be enchanted with any special abilities, but the creator must have the Build Siege Weapons feat, in addition to any other prerequisites listed hereafter.

When generating weapons, employ Table 7-9: Weapons from the *DMG* to determine the type of item generated, then use Tables 4-2: Weapon Special Abilities and 4-3: Specific Weapons, below, for weapon special abilities and specific weapons unique to *Warcraft*.

New Magic Weapon Special Abilities

Weapons can have one or more of the following special abilities in addition to an enhancement bonus. A weapon with a special ability must have at least a +1 enhancement bonus.

Bloodlust: This enhancement causes anyone who takes up the weapon to become seized with a lust for battle. The wielder receives a +4 enhancement bonus to Strength and may make 1 extra attack in each round of combat, exactly as if affected by the *bloodlust** spell. This benefit does not stack with other spells, such as *haste* or *bull's strength*, or a weapon of *speed*. If a *slow* spell is used upon the wielder, the *bloodlust* benefits are suppressed until the *slow* spell wears off.

Moderate transmutation; CL 10th; Craft Magic Arms and Armor, *bloodlust**; Price +4 bonus.

Blowthrough: A ranged (but not siege) weapon equipped with this enhancement provides a special blowthrough ability to its ammunition. When the shot hits a target, the ammunition pierces the creature's body, comes out the other side, and continues on in a direct line away from the weapon owner's square. Any targets whose squares touch that line are subject to attack by that same shot at no penalty. Each time a hit is scored, the ammunition blows through to the next target, if any, out to the shot's range limit. Note that range penalties apply normally with each successive attack. Upon any miss, the shot stops advancing down the line at that point. This is a favorite enhancement in war-

time situations where enemies often advance in ranks and columns, but is of lesser use in smaller engagements.

Moderate conjuration; CL 10th; Craft Magic Arms and Armor, *Mel's acid arrow*; Price +2 bonus.

Capability: A *weapon of capability* provides no special benefits to non-spellcasters; but in the hands of an arcane spellcaster, it turns the character into a capable warrior. When this weapon is employed, a character's arcane caster levels are treated as fighter levels for purposes of attack bonus only. The weapon does not confer any fighter feats or other abilities beyond the bonus to attack rolls, but it does provide the character proficiency with its weapon type when held.

Strong transmutation; CL 14th; Craft Magic Arms and Armor, *Tensor's transformation*; Price +2 bonus.

Crippling: When this weapon hits a living target, the victim must make a DC 14 Fortitude save or become crippled (as per the spell *cripple**). A crippled opponent suffers a -2 penalty to Armor Class; a -2 penalty on melee attack rolls, melee damage rolls, and Reflex saves; and jumps only half as far as normal. The creature's Strength is also reduced by 1d6 points, but not below 1. The crippling effect lasts for 5 rounds, but a *haste* spell will dispel it before that period ends. If the target is already enhanced by *haste*, that ability is dispelled upon any hit by the crippling weapon (no saving throw is allowed).

Moderate transmutation; CL 10th; Craft Magic Arms and Armor, *cripple**; Price +2 bonus.

Crushing: Only bludgeoning weapons may have this attribute. In addition to any extra damage from enhancement bonuses, crushing weapons inflict an additional +5 points of impact damage on their targets. This excess damage is multiplied normally with any critical hit.

Moderate transmutation; CL 12th; Craft Magic Arms and Armor, *telekinesis*; Price +2 bonus.

Death: A *weapon of death* may be used only by evil creatures. Any non-evil creature attempting to wield the weapon suffers a -1 level adjustment for as long as the weapon is held. When it hits a living target, the weapon deals an additional 2d6 points of negative energy damage. Should the weapon hit or touch an undead target, the target is healed instead; however, a *weapon of death* can heal no more than 100 hit points per day. If desired, a *weapon of death* can

attempt to destroy any undead target under the wielder's control. Upon a successful attack, the undead must make a DC 18 Will save. If this save succeeds, the undead is released from service, but if it fails, the creature is destroyed and crumbles to dust. All its hit points are conferred to the wielder as if he had just been healed (this effect cannot result in his having more hit points than his usual maximum). *Weapons of death* can only be melee weapons.

Strong necromancy; CL 14th; Craft Magic Arms and Armor, *death coil**, *death pact**; Price +3 bonus.

Destruction:

Only bludgeoning weapons may have this attribute. When employed against constructs, vehicles or other solid objects such as doors, walls or similar barriers, such a weapon deals 3d6 points of bonus damage on a successful hit. A *weapon of destruction* automatically destroys any 5-foot section of a magically created wall (e.g., a *wall of ice*, *wall of iron*, or any other physical wall — it would not function against a *wall of fire*, for example) and is treated as a *disintegrate* spell when used against a *wall of force* or similar defenses. In addition, once per day on command, a *weapon of destruction* can invoke a *passwall* upon any solid surface it strikes.

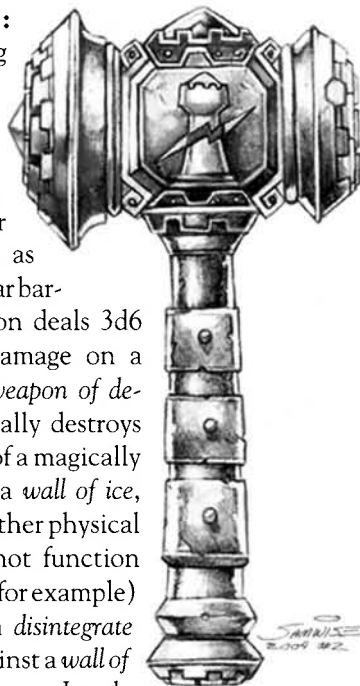

Strong transmutation; CL 14th; Craft Magic Arms and Armor, *disintegrate*, *passwall*; Price +3 bonus.

Devotion: Weapons with this feature are designed for leaders. Anyone who recognizes the character wielding this weapon as her leader (i.e., anyone who would benefit from that character's commander feats, if any) receives a +1 morale bonus on attack rolls and saving throws, and to Armor Class. This bonus does not apply to the character holding the weapon, but it does stack with any other morale bonuses provided with commander feats (an exception to the normal stacking rules).

Moderate enchantment; CL 10th; Craft Magic Arms and Armor, *prayer*; Price +1 bonus.

Dispelling: When a weapon with this enchantment strikes a target, 1 spell or spell-like effect on that target, chosen at random, is dispelled. The attacker makes a dispel check (see *dispel magic* in Chapter 11: Spells of the *Player's Handbook*) equal to 1d20 + the amount by which the attack roll succeeded. If this check exceeds 11 + the spellcaster's level, the effect is dispelled. The wielder may attempt to dispel negative effects on allies, but only if he makes a normal attack on them (he may not do this by simply touching the weapon to a friendly target). Under no circumstances may the wielder select which effect is dispelled — the choice is always random. The weapon may not dispel other magic items or area effects, nor may it use counterspells. (When the targeted creature has many active spells and magic items with continuous effects, players and GMs may find it easiest to determine which effect the dispelling weapon acts against before making the dispel check.)

Moderate abjuration; CL 10th; Craft Magic Arms and Armor, *dispel magic*; Price +1 bonus.

Enfeeblement: When this weapon hits a target, it inflicts 1 point of temporary Strength damage in addition to normal hit point damage. Critical hits do not multiply this damage. Creatures immune to critical hits are not subject to Strength loss.

Moderate necromancy; CL 10th; Craft Magic Arms and Armor, *ray of enfeeblement*; Price +2 bonus.

Entangling: When a target is struck with this weapon, roots and vines extend out of the ground and attempt to hold it fast (as per the spell *entangling roots**). The creature must be standing on a natural surface (dirt, swamp and similar terrains), although actual plants are not required in the vicinity. A flying creature would not be affected unless it was on the ground when struck. If the target fails a Reflex save (DC 10 + the amount by which the attack roll succeeded), it cannot move thereafter, although it can still fight or turn in place. Each round, the roots constrict to inflict 1d4 points of damage. The affected creature can escape by making a DC 15 Strength or Escape Artist check, or by hacking away the vines and roots (AC 10, 22 hp); but if not, the effects end after 5 rounds.

Moderate transmutation; CL 10th; Craft Magic Arms and Armor, *entangling roots**; Price +2 bonus.

Fast Reloading: This quality can only be added to siege weapons. A siege device with this enhancement

imparts a boost of speed to its crew, allowing them to reload it 20% faster, rounding all fractions up. In other words, a siege weapon with a reload speed of 5 or less reloads 1 round faster, a weapon with a speed of 6–10 reloads 2 rounds faster, and so on.

Moderate transmutation; CL 10th; Craft Magic Arms and Armor, Build Siege Weapons, *haste*; Price +1 bonus.

Fear: Any creature struck by this weapon must make a Will save (DC 10 + the amount by which the attack succeeded). If this save fails, the creature is frightened for 1d4 rounds. If the save succeeds by less than 5, the creature is shaken for 1 round. Creatures immune to fear are not affected.

Moderate necromancy; CL 10th; Craft Magic Arms and Armor, *cause fear*; Price +1 bonus.

Friendly: Ranged weapons with this enchantment are designed for use in close-combat situations. When a *friendly weapon* fires into melee, all penalties for shooting into combat or for allies in the weapon's path are halved. In addition, the shot can never accidentally hit an ally — any such result is simply a miss. This power does not help with weapons that cause damage over a wide area, such as a blunderbuss or bomb, or special enhancements such as frost nova (see below).

Moderate abjuration; CL 8th; Craft Magic Arms and Armor, *protection from arrows*; Price +1 bonus.

Frost Nova: This enhancement can only be applied to ranged or siege weapons. All ammunition fired from this weapon explodes in a burst of frost that produces almost no concussion. The target and all other creatures (including the wielder's allies, or the wielder himself) within 10 feet take 1d6 points of cold damage. A successful DC 14 Reflex save halves this damage, but the weapon's target receives no save. If the shot misses, there is no nova burst.

Moderate evocation; CL 10th; Craft Magic Arms and Armor, *frost nova**; Price +2 bonus.

Frugal: This enhancement can only be added to ranged weapons (not siege weapons). Whenever a shot misses, the ammunition lost is immediately returned to its container (quiver, bullet pouch or other holder). Special magical ammunition specifically described as being destroyed on a miss does not return, nor do items that explode upon impact even on a miss (e.g., mortar shells). Note that while bullets might return to their pouches, the gunpowder expended in firing them does not.

Moderate transmutation; CL 10th; Craft Magic Arms and Armor, *telekinesis*; Price +1 bonus.

Functionality: This enhancement can be added only to enchanted technological devices. The magic acts to stabilize the weapon and keep it from malfunctioning, reducing the Malfunction Rating by 1 (this also eliminates the normal +1 MR penalty for techno-magical items). A weapon reduced to an MR of zero has no chance of malfunctioning, thus allowing nearly anyone to employ it with no risk to their health.

Faint transmutation; CL 5th; Craft Magic Arms and Armor, *mending*; Price +1 bonus.

Healing: At first glance, giving a weapon the healing property may seem strange, but there is a method to the madness. The weapon inflicts damage normally unless ordered to switch into healing mode, which can be done as a free action. In healing mode, all damage the weapon would inflict actually heals the target instead of harming it. If the weapon hits an undead creature, it wounds the target instead of healing it, and all damage scored is doubled. A *healing weapon* can cause at most 100 points of healing "damage" per day, after which it reverts to inflicting normal damage.

Strong conjuration; CL 12th; Craft Magic Arms and Armor, *heal*, creator must be good; Price +2 bonus.

Heroic: A heroic weapon turns its wielder into a fighting machine. The weapon's wielder receives a +4 morale bonus on attack rolls, damage rolls and saving throws. However, at the conclusion of each battle, or after 10 rounds of combat have elapsed, she becomes fatigued for 10 rounds (and if already fatigued, she becomes exhausted). The weapon does not provide its morale bonuses if employed again during the fatigue period.

Strong enchantment; CL 12th; Craft Magic Arms and Armor, *greater heroism*; Price +3 bonus.

Howling: *Howling weapons* make a sound like a distant wolf baying when used in combat. Upon striking an opponent, such weapons issue a screeching howl that deals an additional 1d4 points of sonic damage to the target. In addition, the opponent must make a Fortitude save (DC 10 + the amount by which the attack roll succeeded) or be deafened for 1d4 rounds. Ranged weapons enchanted with this ability confer this bonus to their ammunition, which makes a sound like wolves on the prowl when fired.

Moderate evocation; CL 10th; Craft Magic Arms and Armor, *shout*; Price +1 bonus.

Knockback: This enhancement can only be added to ranged weapons. Whenever a round of ammunition from a *knockback weapon* strikes a target, that creature is forcibly moved 5 feet away from the wielder. Creatures 2 or more size categories or larger than the weapon's size category are not affected. The target must move directly away from the wielder if possible, so that its range is now exactly 5 feet farther. Since more than one square will likely meet this criteria, the target is permitted to choose which square it will actually occupy. The target must move no more than one square; if no squares are eligible that meet this criteria (the creature is up against a wall, for example), there is no movement. This motion does not provoke attacks of opportunity — wielders of *knockback weapons* have been known to shoot their own allies to move them out of hostile targeting zones!

Moderate evocation; CL 10th; Craft Magic Arms and Armor, *gust of wind*; Price +2 bonus.

Lifestealing: These vampiric weapons may seem evil in nature, but as with many such things, their alignment is defined by the wielder's actions. When such a weapon strikes a living creature, any damage scored by its enhancement bonus alone is returned to the wielder, healing him of a like amount of hit points. For example, a +3 *lifestealing sword* would cure its wielder of 3 points of damage on each successful hit. If used to strike an undead creature, this bonus damage is inflicted on the wielder as damage instead of healing.

Moderate necromancy; CL 9th; Craft Magic Arms and Armor, *vampiric touch*; Price +2 bonus.

Mana Burn: These weapons are the bane of spellcasters. Any target hit by one of these weapons loses 1d4+1 spell levels of her choosing. For example, if 4 spell levels were called for, the target could choose to lose one 4th-level spell; two 2nd-level spells; four 1st-level spells; one 1st-level and one 3rd-level spell; or any other combination (a 0-level spell is treated as half of a 1st-level spell for this purpose). Any spellcaster picking up such a



weapon loses one spell level each round she holds it, as her spells are literally drained out of her.

Strong transmutation; CL 12th; Craft Magic Arms and Armor, *mana burn**; Price +3 bonus.

Maximized: A maximized weapon bears a powerful enchantment that causes it to deal damage at its highest level of effectiveness. Once per round, when a *maximized weapon* scores a hit by 5 or more over the required roll (e.g., if the character's attack roll result were a 25 or better against AC 20), it automatically inflicts full damage without any roll required. If a qualifying hit is also a threat, the critical damage will be maximized only if the critical roll also succeeds by 5 or more (continuing the example above, if the first attack were a threat, the critical roll would also have to be a 25 or more). If the critical is confirmed but not by 5 or more, bonus dice are rolled normally; if it is confirmed by 5 or more, all bonus dice are maximized. Bonus critical dice may be maximized no more than 3 times per day.

Strong transmutation; CL 14th; Craft Magic Arms and Armor, Maximize Spell, *keen edge*; Price +2 bonus.

Multiple Targeting: Any ranged (but not siege) weapon can receive this enchantment. Once per combat round, the wielder can fire 1 round of ammunition as a multiple targeting shot. In doing so, he designates 3 targets and the order they are to be attacked. All targets must be within 30 feet of each other. The wielder must be able to see the first target, but need not see the next targets in line, although he must be aware of their presence. The attack against the first target is treated normally, the attack against the second is at -2, and the attack against the third is at -4. The segment that attacks the second target is treated as having come from the direction of the first target for purposes of cover bonuses, and the attack against the third target is treated as coming in the direction of the second. If any attack misses or is intercepted (e.g., with the Snatch Arrows feat), the ensuing attacks in line automatically miss. If an attack is reflected somewhere down the line, it heads back toward the previous target, but it may never make more than 3 attacks.

Moderate conjuration; CL 10th; Craft Magic Arms and Armor, *moonglaive**; Price +2 bonus.

Piercing: This enhancement can only be added to piercing weapons or ranged weapons that use piercing ammunition. A *weapon of piercing* ignores the first 5 points of damage resistance it encounters,

regardless of what type of weapon is normally required to penetrate this damage resistance (silver, good and so on). The only resistances not ignored are those that affect the weapon type itself (bludgeoning or slashing), which provide damage resistance as usual. Thus, the 5/bludgeoning damage resistance of a skeleton would not be ignored, but the 10/silver of a lycanthrope would be treated as 5/silver. For ranged weapons, this ability is conferred to their ammunition when fired.

Moderate evocation; CL 9th; Craft Magic Arms and Armor, *magic missile*; Price +1 bonus.

Prescience: One of the few divination enchantments used on weapons, this ability allows the wielder to look briefly ahead into the future and make changes based on what she sees. Once per battle (and no more than once in any 10-minute period), she may redo the results of any round after she has finished her actions and seen the results of her die rolls. This ability must be declared and used before the next creature acts. If the prescient power is invoked, the character is returned to her starting point as if her actions never happened, and she replays the round making any changes as she wills. All die rolls she or anyone else made during her actions are discarded and re-rolled as necessary. For example, a fighter who moved across a room and was hit by 3 attacks of opportunity might re-think that decision and decide to stay put — if this is the case, those attacks never took place, and all damage she took is erased. Note that this power does not require that the entire combat round be replayed, only the weapon wielder's actions for that round. This ability only functions in combat.

Strong divination; CL 16th; Craft Magic Arms and Armor, *moment of prescience*; Price +3 bonus.

Reloading: This ability can be conferred to crossbows or firearms. Any character wielding such a weapon is treated as having the Rapid Reload or Lightning Reload feats, as appropriate. If the character already has those feats, his reload speed is increased still further. If a move action is required, the item can be reloaded as a free action; if a full-round action is required, the item can be reloaded as a move action. For longer periods, the delay time is halved. Any item reduced to a free-action reload can be fired as often as if the character were using a bow.

Moderate transmutation; CL 10th; Craft Magic Arms and Armor, *haste*; Price +1 bonus.

Roaring: When its wielder enters a fight, this weapon lets off a resounding roar, imbuing the owner and his allies with extraordinary courage. The wielder and all allied creatures within 50 feet at the time the roar sounds receive a +1 morale bonus on attack and damage rolls, so long as they are capable of hearing it (e.g., not deafened or under the effects of a *silence* spell). This benefit lasts for 10 rounds. A weapon may roar only once per battle.

Moderate enchantment; CL 7th; Craft Magic Arms and Armor, *roar*; Price +1 bonus.

Self-Loading: This property can only be added to siege weapons. When a siege device is enchanted in this manner, it automatically draws its own ammunition out of whatever stack or nearby container is provided, reducing the number of crew members required to operate the mechanism by 2. There is no increase in reload speed, however.

Moderate conjuration; CL 9th; Craft Magic Arms and Armor, Build Siege Weapons, *telekinesis*; Price +1 bonus.

Severity: A *weapon of severity* scores extra damage on critical hits. The critical multiplier is increased by 1 for its weapon type. For example, a *longsword of severity's* critical statistics become 19–20/x3, while a heavy pick would increase from x4 to x5. If the severity ability is combined with the keen ability on any specific weapon, increase the market price by an additional +1 shift (a combined +4 bonus).

Strong transmutation; CL 12th; Craft Magic Arms and Armor, *keen edge*, caster must have Improved Critical feat; Price +2 bonus.

Shockwave: This enchantment must be placed upon a two-handed melee weapon for a Medium creature, or a one- or two-handed melee weapon for a Large or larger creature. Once every 3 rounds, the wielder may use one of his normal attacks to slam the weapon into the ground, producing a shockwave that deals 3d6 points of damage to all creatures within 25 feet (this is a force effect). The wielder is not affected by this wave, but his allies can be. All creatures may make a Reflex save (DC 10 + the attack bonus of the attack expended to slam the weapon into the ground) to avoid the damage (do not include any bonuses from Strength or feats when calculating the save DC). The shockwave will not cross barriers in the ground, nor will it leap across cracks or other gaps. Creatures not touching the ground at the time the special ability is invoked are not affected.

WARCRAFT

THE ROLEPLAYING GAME

Moderate evocation; CL 10th; Craft Magic Arms and Armor, *shockwave**; Price +1 bonus.

Shrinking: This odd enchantment is generally seen only on large, heavy weapons, particularly siege weapons. At will, the wielder can speak a single command word that shrinks the weapon by 2 size categories. Thus, a greatsword would become the size of a dagger (and would fit inside a dagger's scabbard), while a catapult would become human-sized. Object weights are reduced to about 1/10th normal, allowing even massive siege weapons to be easily carried by 1 or 2 individuals. A weapon may not be used while in its reduced state and remains as such only while on the person of its owner (or while being carried or moved by her, in the case of siege devices). If released, or if the reversal command word is spoken, the item returns to normal size. If it is inside some other object or creature at the time, it is ejected without harm to itself or whatever is carrying it. Note that ranged weapons and siege devices do not also shrink their ammunition.

Moderate transmutation; CL 10th; Craft Magic Arms and Armor, *shrink item*; Price +1 bonus.

Spike Stone: This enhancement can be applied only to siege weapons. Any stone or iron projectiles fired by the device in question sprout nasty spikes immediately after launch, dealing an additional 1d10 points of piercing damage against any target hit. If a critical hit is scored, this extra damage has a multiplier of x3 regardless of the actual critical rating of the original ammunition. Thus, a spike stone projectile scoring 2d10 points of bludgeoning damage (x2 critical) and 1d10 points of piercing damage (x3 critical) would inflict a total of 4d10 points of bludgeoning damage and 3d10 points of piercing damage on a confirmed critical hit.

Moderate conjuration; CL 9th; Craft Magic Arms and Armor, Build Siege Weapons, *stone shape*; Price +2 bonus.

Transmutation: A weapon of this type can shift its composition to any type of metal or other substance as needed. Once per round, as a free action, the wielder can change the weapon as he wills. This change must be made at the start of the character's actions, before he makes any attacks (he cannot change in between attacks or at the conclusion of his attacks.) The weapon could be made of silver one round, cold iron the next, and normal wood the

third. A weapon may not be a combination of types, such as silver/arcanite. Special powers such as holy, unholy, anarchic and the like are not available. If a weapon is changed to thorium, the character must have the Exotic Weapons (thorium weapons)* feat to employ it with proficiency. A weapon shifted to a new composition suffers all the disadvantages of that metal or substance (e.g., silver scores 1 point less damage on a hit) as well as the hit points and hardness of a weapon of that type. A ranged weapon with this ability does not alter its own composition, but changes the ammunition it fires. A weapon may not be shifted to a composition inappropriate for its nature — slashing weapons will not function if turned to wood, for example. A siege weapon equipped with this enhancement cannot change its armament into a special technological item, such as an acid bomb, although it could transform a stone projectile into an iron one (but not an iron bolt, since only the composition — not the shape — is altered).

third. A weapon may not be a combination of types, such as silver/arcanite. Special powers such as holy, unholy, anarchic and the like are not available. If a weapon is changed to thorium, the character must have the Exotic Weapons (thorium weapons)* feat to employ it with proficiency. A weapon shifted to a new composition suffers all the disadvantages of that metal or substance (e.g., silver scores 1 point less damage on a hit) as well as the hit points and hardness of a weapon of that type. A ranged weapon with this ability does not alter its own composition, but changes the ammunition it fires. A weapon may not be shifted to a composition inappropriate for its nature — slashing weapons will not function if turned to wood, for example. A siege weapon equipped with this enhancement cannot change its armament into a special technological item, such as an acid bomb, although it could transform a stone projectile into an iron one (but not an iron bolt, since only the composition — not the shape — is altered).

Strong transmutation; CL 12th; Craft Magic Arms and Armor, *polymorph, fabricate*; Price +2 bonus.

Unholy Frenzy: The wielder of one of these weapons receives all the benefits of a *weapon of speed*. However, he also suffers 1d4 points of negative energy damage per round. Spells cannot protect the wielder from this damage. Undead creatures wielding such a weapon are healed of 1d4 damage each round instead, although the weapon can heal no more than 100 points of damage per day in this manner.

Moderate necromancy; CL 10th; Craft Magic Arms and Armor, *unholy frenzy**; Price +2 bonus.

Vermin: When drawn, this weapon becomes surrounded by a horde of stinging and buzzing insects,



such as bees, wasps, hornets and the like. When the wielder makes a successful hit in combat, these creatures deal an additional 1d6+1 points of acid damage to the target. The vermin cannot function in any environment that disrupts their ability to fly and swarm about the weapon, such as strong winds, underwater, or if the wielder moves faster than they can fly (60 feet per round).

Moderate conjuration; CL 10th; Craft Magic Arms and Armor, *carion swarm**; Price +1 bonus.

Warding: This enchantment requires the intricate carving of special symbols and images on the weapon's surface. When desired, the wielder can activate the weapon's special power as a free action, turning it into a *healing ward** in addition to its other combat abilities. All the wielder's allies are cured of 1 point of damage per round so long as they are within 20 feet of the weapon. Undead creatures within this range suffer 1 point of damage every round. The ward's effects last for 1 minute, and it can be used 3 times per day.

Moderate conjuration; CL 8th; Craft Magic Arms and Armor, *healing ward**; Price +1 bonus.

Specific Weapons

This section details some of the more well-known weapons found across the lands of Azeroth. These specific weapons are usually pre-constructed with exactly the qualities described here.

Assassin's Blade

Description: Intended for use by Horde assassins, these charcoal-black daggers are designed for striking directly into the hearts of foes. Even when held up to the light, they do not glint or produce any sort of reflection that will give their wielder away.

Powers: This blade is a +1 weapon in the hands of most wielders, but it gains special powers when carried by a Horde assassin. In such a case, the weapon acts as a *dagger of venom*, and also deals +2 bonus damage upon a successful hit (doubled on a critical). This bonus damage is then scored again on each of the next 3 ensuing rounds (the continuing damage is not doubled on a critical). Any *cure* spell cast on the target will end this cascading damage effect. Should the *blade* hit the target multiple times, all bonus damage is cumulative (so an *assassin's blade* that hits 3 times in 1 round would deal 6 points of damage on each of the next 3

rounds). Bonus damage does not affect creatures normally immune to critical hits, such as undead.

Strong necromancy; CL 12th; Craft Magic Arms and Armor, *poison*, *vampiric touch*; Price 32,000 gp; Cost 16,000 gp + 1,280 XP.

Blackgore Totem

Description: Originally owned by a tauren warrior-shaman of great renown whose birth name has been lost to history, this immense totem is carved with intricate symbols and runes celebrating the Earth Mother. Only the most powerful warriors can wield this incredibly heavy weapon in battle, but it can also be used for the surprisingly gentle healing arts.

Powers: This is a +3 *healing totem of warding*. Anyone wielding it in combat suffers a -1 penalty on attack and damage rolls for every point of Strength less than 20 (i.e., -1 at Strength 19, -2 at Strength 18, and so on). If wielded by a tauren healer, its *warding* ability can be used 5 times per day instead of only 3 times.

Moderate conjuration; CL 12th; Craft Magic Arms and Armor, creator must be a tauren proficient in the use of a totem; Price 72,420 gp; Cost 36,210 gp + 2,897 XP.

Claws of Attack, Ferocious

Description: *Ferocious claws of attack* are strapped to the back of the hand and allow for savage assaults in hand-to-hand combat. The *claws* are a favored weapon of many tauren, with small fortunes traded to their allies in the Horde to gain possession of a set.

Powers: Use of this item requires the wielder to have the Exotic Weapon Proficiency (claws) feat. When used in combat, the claws are a +2 *wounding weapon of severity* that deals 1d6 points of damage with a x3 critical modifier. Matched pairs may be worn with one set of claws strapped to the back of each hand, though the wielder suffers all penalties and limitations of wielding two weapons when doing so.

Moderate evocation; CL 12th; Craft Magic Arms and Armor, *magic fang*; Price 72,325 gp (single), 144,650 gp (pair); Cost 36,163 gp + 2,893 XP (single), 72,325 gp + 5,786 XP (pair).

Claws of Attack, Mauling

Description: These weapons have wickedly serrated blades that occasionally drip blood when worn.

Powers: These claws are +4 *wounding and severity* weapons.

Table 4-3: Specific Weapons†

Minor	Medium	Major	Item	Market Price
01-12	01-07	—	<i>Storm hammer*</i>	8,500 gp
13-24	08-14	—	<i>Demon hunter war blades</i>	18,640 gp
25-36	15-21	01-05	<i>Assassin's blade</i>	32,000 gp
37-48	22-28	06-10	<i>Eyegouger horns</i>	26,540 gp
49-60	29-35	11-15	<i>Fangs of rending</i>	18,150 gp
61-72	36-42	17-21	<i>Goreblood horns</i>	32,320 gp
73-84	43-49	22-26	<i>Ironwood branch</i>	14,390 gp
85-91	50-55	27-31	<i>Ferocious claws of attack (single)</i>	72,325 gp
92-95	50-56	32-36	<i>Slavering jaws</i>	32,210 gp
96-97	57-63	37-41	<i>Claws of the frost wolf</i>	56,625 gp
98-99	64-70	42-47	<i>Kelen's dagger of escape</i>	34,142 gp
100	71-76	48-52	<i>Maul of strength</i>	36,312 gp
—	77-80	53-57	<i>Killmaim</i>	50,350 gp
—	81-84	58-62	<i>Frostguard</i>	50,375 gp
—	85-88	63-67	<i>Searing blade</i>	55,320 gp
—	89-92	68-71	<i>Ferocious claws of attack (pair)</i>	144,650 gp
—	93-96	72-75	<i>Razorteeth</i>	72,060 gp
—	97-98	76-79	<i>Blackgore totem</i>	72,420 gp
—	99	80-82	<i>Toy catapult</i>	74,200 gp
—	100	83-85	<i>Spellbreaker blades</i>	251,400 gp
—	—	86-88	<i>Savage claws of attack (single)</i>	98,325 gp
—	—	89-91	<i>Warden's moon sword</i>	100,350 gp
—	—	92-94	<i>Mauling claws of attack (single)</i>	128,325 gp
—	—	95	<i>Savage claws of attack (pair)</i>	196,650 gp
—	—	96	<i>Vampiric runeblade*</i>	200,000 gp
—	—	97	<i>Frostfathom**</i>	201,000 gp
—	—	98	<i>Mauling claws of attack (pair)</i>	256,650 gp
—	—	99	<i>Blades of Azzinoth**</i>	275,000 gp
—	—	100	<i>Flamestrike**</i>	416,000 gp

Strong evocation; CL 14th; Craft Magic Arms and Armor, *magic fang*; Price 128,325 gp (single), 256,650 gp (pair); Cost 64,163 gp + 5133 XP (single), 128,325 gp (pair) + 10,266 XP (pair).

Claws of Attack, Savage

Description: These weapons appear identical to standard *claws of attack* except for a slight reddish tint to the blades.

Powers: These claws are +3 *wounding and enfeeblement* weapons.

Strong evocation; CL 14th; Craft Magic Arms and Armor, *magic fang*; Price 98,325 gp (single), 196,650 gp (pair); Cost 49,163 gp + 3,933 XP (single), 98,325 gp + 7,866XP (pair).

Claws of the Frost Wolf

Description: These orcish claws of attack bear white and silver enamel decorations that honor the spirits of winter and the prowess and grace of the wolf. Each blade appears frosted over in a layer of fine ice crystals. Frost wolf pelt lines the bracer ensuring insulation from the freezing powers of the claws.

Powers: These +2 *keen frost orcish claws of attack* are powerful weapons in the hands of a shaman. Once per day at sunset, a shaman wielding these claws can call forth a dire frost wolf (see Chapter One in **Manual of Monsters**) who will serve the shaman as a mount and guardian until the next sunrise.

WARCRAFT

THE ROLEPLAYING GAME



Moderate conjuration; CL 9th; Craft Magic Arms & Armor, *summon nature's ally V*, *chill metal*; Price 56,625 gp (single); Cost 28,313 gp + 2,265 XP (single).

Demon Hunter War Blades

Description: These blades appear as a strange cross between a small buckler and a sharp-looking, curved, two-bladed short sword. The demon hunters of the night elves wear these blades while they hunt the minions of the Scourge, the Burning Legion or other dark adversaries worthy of such weaponry. While many of the demon hunters rely on non-magic weapons, eventually most have either one of these double blades or a matching pair.

Powers: This *two-bladed +1 cold iron short sword* glows with a bluish-green light when within 100 feet of demons or undead. In addition, the buckler shaft of the blade provides a +1 armor bonus and gives the wielder the benefits of a *protection from evil* spell. Consider these blades to be an exotic weapon.

Moderate abjuration; CL 4th; Craft Magic Arms and Armor, *detect evil*, *protection from evil*, creator must be a night elf; Price 18,640 gp; Cost 9,320 gp + 746 XP.

Eyegouger Horns

Description: This long sheath fits over both a tauren's horns and extends across the head. The sheath is flexible until attached, at which point it gains the color and consistency of cold iron.

Powers: While in place, these items act as *+1 keen cold iron horns* that can be used as a natural weapon at any time, not just when charging. A gore attack made alongside another melee attack (i.e., with weapons) suffers a -5 penalty on the attack roll (or a -2 penalty with the Multiattack feat; see Chapter 8: Glossary of the MM). Upon command, the *horns* can extend to 3 times their natural length, permitting the wearer to make an attack with a 10-foot reach. However, the character's speed is reduced by 10 feet per round while the horns are extended.

Moderate transmutation; CL 12th; Craft Magic Arms and Armor, *enlarge person*; caster must be tauren; Price 26,540 gp; Cost 13,270 gp + 1,062 XP.

Fangs of Rending

Description: These white fangs appear to be a decorative item carved out of ivory or bone. They can, however, be pressed to the underside of existing canine teeth, where they seamlessly merge until removed with a command word.

Powers: These *+2 fangs* function only in the jaw slot of a sentient creature capable of making a bite attack, such as a furbolg or pandaren. They provide the Improved Natural Attack feat (see Chapter 6 of the MM). If the creature already has that feat, this bonus stacks.

Moderate transmutation; CL 8th; Craft Magic Arms and Armor, caster must be capable of making a natural bite attack; Price 18,150 gp; Cost 9,075 + 726 XP.

Frostguard

Description: This wickedly curved and unnaturally sharp bladed weapon has an odd, bluish tint when held up to the light. Its surface is oddly cold to the touch, and in warm or humid climates a thin white sheen of frost builds up on its surface.

Powers: This weapon is a *+2 defending frost falchion* that has the special ability of chilling its target. On any successful critical hit, the target must make a Fortitude save (DC 10 + the amount by which the critical hit was confirmed) or become chilled, exactly as described under the *frost nova** spell description.

Strong evocation; CL 10th; Craft Magic Arms and Armor, *frost nova**; Price 50,375 gp; Cost 25,188 gp + 2,015 XP.

Goreblood Horns

Description: This pair of end caps is designed to fit neatly over the end of a tauren's horns, or to replace a missing tip lost in battle. The *goreblood horns* are made of steel and coated with a thin layer

of what appears to be blood, though it cannot be washed off.

Powers: The horns are +2 *crippling weapons* when used for a natural gore attack. This bonus applies equally when used as part of a charge or when set against a charging enemy.

Moderate transmutation; CL 11th; Craft Magic Arms and Armor, caster must be tauren; Price 32,320 gp; Cost 16,160 gp + 1,293 XP.

Ironwood Branch

Description: This unadorned staff appears to be a simple gnarled branch ending at a well-worn knob on one end and a silver-coated shaft on the other. A single knothole mars the surface approximately halfway up the haft. Upon examination, anyone proficient with the staff recognizes that this particular weapon is surprisingly well-balanced, and despite its unnatural weight is quite easy to wield.

Powers: This is a +2 *quarterstaff*, one end of which is wooden, the other silver. The staff provides a +2 enhancement bonus to Strength when held in either hand.

Moderate transmutation; CL 9th; Craft Magic Arms and Armor, *bull's strength*; Price 14,390 gp; Cost 7,195 gp + 756 XP.

Kelen's Dagger of Escape

Description: The stealthy rogue Kelen was well known for his ability to slip away from any pursuit and find his way out of even the most escape-proof traps. Only upon his death did the world learn that his secret was really in the glass-sheathed dagger he carried. The pommel appears to be fitted with an immense ruby, but this stone is also made of glass, a fact even a poorly trained merchant can recognize upon a successful Appraise check (DC 10).

Powers: This dagger has a +3 enchantment and glows with an inner light upon command, illuminating an area 20 feet in diameter. Once per day, when the dagger is slipped into its special glass scabbard, the owner can *dimension door* to any known location within a half-mile range. The character need not be able to see this position to transport himself there, but he must have visited it within the last day. The *dimension door* effect can carry the dagger's wielder and up to 100 pounds of gear, but nothing more.

Moderate conjuration; CL 11th; Craft Magic Arms and Armor, *dimension door*; Price 34,142 gp; Cost 17,071 + 1,366 XP.

Killmaim

Description: This immense greatsword has a series of fang-like points extending from both sides of the blade. Although these "teeth" look fragile, they do not snap off on a hit, but instead cause painful bite-like wounds that drain life away, returning it to the weapon's wielder. The teeth seem to drain any blood from the blade, so that it effectively cleans itself after each fight.

Powers: This +2 *lifestealing greatsword* deals +2 bonus piercing damage against living creatures that possess blood. In such a case, this damage is added to the weapon's normal bonuses for the *lifestealing* effect, so any appropriate hit returns 4 points of healing to the wielder.

Moderate necromancy; CL 12th; Craft Magic Arms and Armor, *keen edge*; Price 50,350 gp; Cost 25,175 gp + 2,014 XP.

Maul of Strength

Description: This unusually large mace appears at first glance to be virtually unusable, but is actually quite well balanced. The added weight inside the headpiece produces devastatingly effective blows in combat.

Powers: The *maul* is actually a +1 *crushing heavy mace* that adds a +2 enhancement bonus to the Strength of any character who wields it. If the weapon is used two-handed, the wielder adds double her Strength bonus instead of one-and-a-half times the bonus.

Moderate transmutation; CL 14th; Craft Magic Arms and Armor, *bull's strength*; Price 36,312 gp; Cost 18,156 gp + 1,452 XP.

Razorteeth

Description: This item appears to be a set of false teeth filed to razor-sharp points. When placed in the mouth of a creature with a natural bite attack, the teeth settle into place until released with a special command word.

Powers: These +2 *keen piercing weapons of severity* deal piercing damage on a hit. The creature employing them is treated as having the Multiattack feat (see Chapter 6 of the MM). Unfortunately, the teeth are so sharp that the owner risks hurting himself by accidentally biting his own mouth or tongue. If he does not remove the *razorteeth* after each battle, he must make a DC 15 Fortitude save every minute or suffer 1d6 points of damage. Damage resistance does not mitigate this effect.

Moderate transmutation; CL 12th; Craft Wondrous Item, caster must have a natural bite attack; Price 72,060 gp; Cost 36,030 + 2,882 XP.

Searing Blade

Description: When drawn, this sword becomes unnaturally hot to the touch — not enough to start fires, but sufficient to burn and blister unprotected skin. In moist environments, the warm metal sizzles, and in the rain or underwater, it bubbles and pops.

Powers: Any flesh that touches this weapon suffers 1 point of heat damage for every round it stays in contact with the hot metal. The weapon is a +2 *keen flaming and piercing rapier*, except that it does not actually burst into flame like a normal *flaming sword*. It scores double damage against any sort of water elemental it strikes.

Moderate evocation and transmutation; CL 13th; Craft Magic Arms and Armor, *wall of fire*; Price 55,320 gp; Cost 27,660 gp + 2,213 XP.

Slavering Jaws

Description: This item looks very much like the bleached jaw section of a tauren skeleton. Although they appear too large to fit, the jaws can be easily slipped into the mouth of any creature, where they snap into place like a set of dentures. The wearer's jaw now protrudes downward, with saliva-coated teeth extending out in several directions, giving the wearer a truly horrifying appearance.



Powers: If placed in the mouth of a creature that already has a natural bite attack, the *jaws* act as a +3 *weapon of fear*.

Moderate necromancy; CL 10th; Craft Wondrous Item, caster must have a natural bite attack; Price 32,210 gp; Cost 16,105 gp + 1,288 XP.

Spellbreaker Blades

Description: The deadly, two-bladed swords of the spellbreakers strike fear in the hearts of wizards and sorcerers. The blood elves' elite warriors employ these frighteningly effective weapons to execute outlawed spellcasters, necromancers and other evil practitioners of magic.

Powers: This blood-elven +2 *two-bladed sword* is the bane of any evil spellcaster. When spun as a full-round action, the blade can cast a *globe of invulnerability* centered on the wielder for 10 rounds. The wielder may move at her normal speed while the spell emanates from her; since the sword maintains the globe and carries it along with the wielder, attacking with the blades ends the *globe of invulnerability*.

A wizard who takes damage from this weapon must make a DC 15 Fortitude save or lose a single memorized spell of 3rd level or lower of his choice. Sorcerers taking damage lose one spell slot of 3rd level or lower for one day.

Moderate Abjuration; CL 12th; Craft Magic Arms and Armor, *globe of invulnerability*, *feeblemind*, creator must be a blood elf; Price 251,400 gp; Cost 125,700 gp + 10,056 XP.

Toy Catapult

Description: Originally intended as a mass-produced siege weapon that could be carried in a soldier's backpack, these catapults can be reduced to the size of a child's toy upon command. Unfortunately, they proved too fragile and expensive to truly catch on. One orcish army drained its entire treasury to create a kind of "catapult cavalry" unit equipped with these tiny weapons, only to lose the whole unit (and their weapons) in a single ambush. Unaware of their true powers, the victorious opponents took the "toys" home to their children. No one is sure how many of these items are now scattered around the world, gathering dust on a child's bedroom shelf.

Powers: This is a +2 *shrinking spike stone siege catapult* that effectively has the *shrinking* property twice. The siege weapon can be made to shrink to

approximately a foot in size, enabling it to be easily packed away with its commander's gear. In this state, the weapon has only hardness 2 and 5 hit points, however, making it highly vulnerable to damage.

Strong transmutation; CL 12th; Craft Magic Arms and Armor, Build Siege Weapons, *shrink item*; Price 74,200 gp; Cost 37,100 gp + 2,968 XP.

Warden's Moon Sword

Description: Specially chosen wardens wield these circular slashing blades. The serrated, hoop-shaped moon sword is a deadly weapon for both subduing and executing the warden's quarry.

Powers: This +2 *keen* moon blade does damage as a falchion, but requires the Exotic Weapon Proficiency to be effective. Once per day, the warden can throw the blade at a single target (range increment of 10 feet). The weapon returns to her hands immediately after it has done damage.

The warden can stamp the name of a given person on the blade's handle. This target must be a person the warden's quarry. The weapon gives the general direction of the individual, and grants the warden the ability to recognize the target regardless of disguise or attempts to conceal his identity with magic. The warden is aware immediately if the target dies while his name rests on the blade's handle.

Moderate divination; CL 9th; Craft Magic Arms and Armor, *keen edge*, *locate object*, *true seeing*, creator must be a night elf; Price 20,350 gp; Cost 10,175 gp + 814 XP; Weight 7 lb.

Potions

Not all potions on Azeroth are simple spells in liquid form. Some have been enchanted with greater powers. Even so, they are still just potions, with a single use and all the other limitations of their item category. Some of the more unusual types of potions are listed below.

When a potion or scroll is called for by random treasure distribution, roll 50% of the time on Table 4-4: Potions and Scrolls.

Antimagic Potion

Description: This powerful item looks like a vial filled with a clear liquid that appears at first glance to be merely water. If viewed carefully, however, small

flecks of gold can be seen swirling about within. When unstoppered, the potion begins to bubble and seethe like a cauldron set to boiling.

Powers: When imbibed, this potion confers absolute immunity to all forms of magic, both harmful and helpful, for 10 rounds. Any magical spells or effects currently in place upon the character at the time he drinks the potion are instantly and automatically dispelled. This protection applies to area effects, healing, and anything else that comes into contact with or would affect the character in any way. The antimagic effects do not apply to items worn or used by the imbiber, and do not prevent him from casting spells or employing magic against other targets. The potion does not permit the character to pass magical barriers or destroy or damage magical creatures simply by touching them. The effects of this draught can be removed or bypassed only by powers capable of destroying or bypassing an *antimagic field*.

Moderate abjuration; CL 12th; Brew Potion, *antimagic field*; Price 3,600 gp.

Clarity Potion

Description: These potions appear milky in nature, but when unstoppered, they rapidly turn perfectly clear, without any sign of impurities.

Powers: This potion is of great help to arcane spellcasters, and some divine casters also appreciate its benefits. When imbibed before resting, there are two effects. First, the drinker receives 1 additional 1st-level and 1 additional 2nd-level spell slots when she prepares spells (if the consumer cannot cast 2nd-level spells, she does not receive any bonus spells of that level). A character capable of casting either divine or arcane spells may select which type is received as bonus spells (she does not receive 1 of each per level). In addition, the amount of time an arcane caster must sleep or meditate is cut in half (for most characters, this lowers the normal 8-hour requirement to 4 hours). Furthermore, the amount of time required to study or pray for spells following this rest period (if any) is also cut in half. Note that other requirements, such as the 8-hour delay period after casting before a spell can be replaced, are not halved. The potion must be imbibed immediately before resting or preparing spells, but if those activities are summarily delayed, the potion remains in effect for any additional time, not to exceed 4 additional hours. The above effects do not stack with any other potions that provide similar abilities.

Table 4-4: Potions and Scrolls

Minor	Medium	Major	Item	Market Price
01-10	—	—	<i>Hong's fighting lager</i>	375 gp
11-20	—	—	<i>Bravery brew</i>	500 gp
21-30	01-07	—	<i>Scroll of speed</i>	700 gp
31-40	08-13	—	<i>Fiery belly ale</i>	750 gp
41-50	14-20	—	<i>Mana potion*</i>	900 gp
51-60	21-27	—	<i>Chou's steadying cider</i>	1,250 gp
61-70	28-34	01-07	<i>Drunken Master's secret tonic</i>	1,250 gp
71-75	35-41	08-13	<i>Lesser clarity potion</i>	1,400 gp
76-80	42-48	14-19	<i>Scroll of protection</i>	1,400 gp
81-85	49-55	20-26	<i>Lesser replenishment potion</i>	1,450 gp
86-90	56-62	27-32	<i>Wounded warrior's whiskey</i>	1,750 gp
91-95	63-69	33-40	<i>Clarity potion</i>	1,800 gp
96-99	70-76	41-48	<i>Greater clarity potion</i>	2,200 gp
100	77-83	49-56	<i>Replenishment potion</i>	2,700 gp
—	84-90	57-64	<i>Divinity potion</i>	3,315 gp
—	91-95	65-72	<i>Anti-magic potion</i>	3,600 gp
—	96-97	73-80	<i>Greater replenishment potion</i>	3,850 gp
—	98-99	81-85	<i>Replenishment scroll</i>	4,050 gp
—	100	86-90	<i>Scroll of regeneration</i>	5,250 gp
—	—	91-95	<i>Greater replenishment scroll</i>	5,500 gp
—	—	96-99	<i>Arcane scroll of the High Guardian</i>	8,000 gp
—	—	100	<i>Potion of greater mana</i>	9,000 gp

Note: Scrolls are detailed later in this chapter.

Moderate transmutation; CL 9th; Brew Potion, *Rarey's mnemonic enhancer*; Price 1,800 gp.

Clarity Potion, Lesser

Description: This concoction resembles a *clarity potion*, but is translucent rather than opaque. It functions like that potion, but for conferring a reduced benefit.

Powers: The potion provides only one bonus 1st-level spell slot and reduces resting time by 25%, not 50%.

Faint transmutation; CL 7th; Brew Potion, *Rarey's mnemonic enhancer*; Price 1,400 gp.

Clarity Potion, Greater

Description: This concoction resembles a *clarity potion*, but contains streaks of purple that seem to swirl and shift, even when the container is kept still. It functions like that potion, but confers an increased benefit.

Powers: The potion provides one bonus 1st-level spell slot, one bonus 2nd-level slot, and one bonus 3rd-level slot (assuming the imbiber is ca-

pable of casting spells of those levels). Resting time is also reduced by 75%, not 50%.

Moderate transmutation; CL 11th; Brew Potion, *Rarey's mnemonic enhancer*; Price 2,200 gp.

Divinity Potion

Description: These draughts seem clear, but when exposed to sunlight they begin to shift quickly through all the colors of the rainbow. If carried in a clear container, they glow with a faint white light.

Powers: Whoever drinks this potion comes under the protection of several powerful spirits. For 20 rounds, the character has a +4 deflection bonus to Armor Class as well as spell resistance 19.

Moderate abjuration; CL 13th; Brew Potion, *shield of faith*, *spell resistance*; Price 3,315 gp.

Replenishment Potion

Description: This light green, syrupy liquid is cast through with dark black specks that seem to crawl and swirl in the mixture.



Powers: This potion combines the effects of healing and spell recovery. The unusual combination of divine and arcane magic requires a creator skilled in both types of spellcasting. When the potion is consumed, the imbiber heals $2d8+9$ hit points of damage and recovers 3 levels of spells cast previously. These can be any combination of 3 levels, e.g., one 3rd-level spell, one 1st- and one 2nd-level spell, and so on. Each 0-level spell counts as one 1st-level spell. If the imbiber does not have 3 levels of spells available, the excess recovery is lost (it cannot be saved and used later).

Moderate transmutation and conjuration; CL 9th; Brew Potion, *cure moderate wounds*, *Rarey's mnemonic enhancer*; Price 2,700 gp.

Replenishment Potion, Lesser

Description: This concoction resembles a *replenishment potion*, but lacks the swirling black flecks. It functions as that potion, but for conferring a reduced effect.

Powers: The potion heals $1d8+7$ hit points and recovers 2 levels of spells.

Faint transmutation and conjuration; CL 7th; Brew Potion, *cure light wounds*, *Rarey's mnemonic enhancer*; Price 1,450 gp.

Replenishment Potion, Greater

Description: This concoction resembles a *replenishment potion*, but has both white and black flecks swirling within the mixture. It functions as that potion, although it confers an increased effect.

Powers: The potion heals $3d8+11$ hit points and recovers 5 levels of spells.

Strong transmutation and conjuration; CL 11th; Brew Potion, *cure serious wounds*, *Rarey's mnemonic enhancer*; Price 3,850 gp.

Pandaren Brews

The pandaren are an old and refined culture with many traditions and arts important to their way of life, none of which have influenced the pandaren so thoroughly as the art of brewing. Drink is in every aspect of pandaren life; and because of the craft involved, a tradition of brewing potent fluids has become a cultural institution for the gentle people of Pandaria.

The pandaren brewmasters travel the world for new and exotic ingredients and recipes. These affable yet deadly warriors practice a unique combination of healing arts and martial skill. With their knowledge of alchemy, potion-making and brewery, the pandaren have created superb ales and liquors that have become a welcome drink at any adventurers table either before or after a battle.

The brews hold magical properties, as plants, berries and fungi that harbor powerful spirits are often included as ingredients in whiskeys, ales and other alcoholic beverages. Distilling these ingredients focuses potent magic. Drinking a pandaren brew follows the same rules as drinking a potion. Pandaren brews tend to be so potent that they take immediate effect and require only one drink to take effect unless otherwise noted.

Bravery Brew

Description: This stout and powerful ale has remarkable qualities when it comes to establishing feelings of camaraderie and kinship, especially before a battle. With a thick, nearly molasses-like taste and bittersweet foam, this ale has become the favorite of many dwarven riflemen companies. A keg of this brew holds 20 mugs' worth of ale.

Powers: The brew grants a +1 morale bonus on saving throws and attacks to a group that shares a keg of this ale together. This morale bonus lasts 3d4 hours.

Faint transmutation; CL 5th; Brew Potion, *bless*; Price 500 gp; Weight 10 lb.

Chou's Steadying Cider

Description: Many have felt the chill of fear creep up when facing the minions of the Scourge.

To watch ghouls and abominations rush across the fields of war to savage foes with hooked chains, claws and teeth can shake a warrior to his core. Chou the brewmaster despises the Scourge for the terror and ugliness they spread. He brews this strong drink to aid those who fight against the tides of undead that threaten the world.

Powers: This drink is a strong plum cider that grants the drinker the ability to detect undead within a 60-foot radius for one day. In addition, the drink grants a +2 morale bonus on saving throws against fear and energy drain attacks for 1d4 hours. A keg of this cider holds 20 mugs' worth.

Faint transmutation; CL 5th; Brew Potion, *detect undead, bless*; Price 1250 gp; Weight 10 lb.

Drunken Master's Secret Tonic

Description: The pandaren brewmaster Chou Ling Sing introduced this magnificent brew to the acrobats of Slink Strong's Goblin Circus as a gift for teaching him the tricks of goblin tumbling. Since then, many have copied the brew's recipe and it is enjoyed by many a stealthy, acrobatically inclined performer.

Powers: The tonic is potent, and a single swig from a bottle can make the drinker appear as if she were inebriated. This deceptive state of clumsy motion allows a +10 bonus on Bluff checks when attempting to feint an attack. An unopened bottle of this tonic holds 10 swigs.

Faint transmutation; CL 5th; Brew Potion, *cat's grace*; Price 1,250 gp; Weight 1 lb.

Fiery Belly Ale

Description: This powerful, pepper-flavored ale often leaves the surprised drinker gasping for cool water to sooth the burning in his throat. Fiery belly ale is a harsh, unforgiving drink that leaves a steady flame in the imbiber's gut. Many trolls and orcs have found this a pleasant sensation, and seeing a precious keg of this drink in their possession is almost becoming common.

Powers: This ale is an inebriating, pepper-flavored beer that gives the drinker the ability to belch flames after drinking 1d6 mugs (roll to determine how many drinks are needed). A tell-tale churning and burning in the gut indicates that the special properties are active.

Highly intoxicating, this brew causes the drinker to suffer a -4 penalty on initiative checks for 1 hour for every mug he drank. The drinker may belch a

single short burst of flame as a free action, dealing 1d4 points of fire damage for each mug that he drank (to a maximum of 5d4) to a single target within 5 feet of him; a DC 12 Reflex save halves the damage.

Drinking more than 3 mugs is dangerous and may cause the drinker to vomit flame at an inappropriate moment. While still inebriated by the brew, a DC 19 Fortitude save is required during each round. The character makes the saving throws for a number of rounds equal to the number of mugs he drank. If the saving throw fails, the drinker vomits up a 15-foot cone of flame that deals 3d4 points of fire damage (Reflex DC 15 half). Use the scattering rules (see *Player's Handbook*, Chapter 8: Combat, "Special Attacks," *Throw Splash Weapon*) to determine the direction and distance of the regurgitation. On a result of 1 on the scatter roll, the imbiber vomits upon himself (and gets no saving throw to avoid damage).

A vomiting drinker takes 2d4 points of fire damage and loses the use of his voice for 1d4 days in addition to any other ill effects he may incur upon himself.

A keg of this brew holds 20 mugs of ale.

Faint transmutation; CL 5th; Brew Potion, *burning hands*; Price 1,250 gp; Weight 20 lb.

Hong's Fighting Lager

Description: Combat is a state of grace amongst the shodo-pan of the pandaren empire; and as much as it is an art form, it is thirsty work. *Hong's fighting lager* revivifies fatigued and frightened soldiers and warriors after fighting a long and difficult battle. It is also highly valued for its crisp wheat taste and subtle honey and citron-like accents.

Powers: A single mug of this mighty beer removes a fatigued condition in 2 hours of rest as opposed to 8, as long as the drinker imbibes the fluid slowly. Drinking the lager as a full-round action while sickened or shaken removes the effects for 1d6 hours or the duration of the effect, whichever is shorter. Swigging back the ale in a thirsty frenzy does not grant any special properties. A keg of this beer holds 20 mugs' worth.

Faint transmutation; CL 5th; Brew Potion, *bless*; Price 375 gp; Weight 10 lb.

Wounded Warrior's Whiskey

Description: To the pandaren, whiskey is a drink of fortitude. A good whiskey can make a warrior strong enough to face 10,000, so the pandaren proverb goes. This brewmaster's whiskey has incredibly potent heal-

ing properties, and a wounded warrior can become as strong as a lion after drinking this powerful liquid.

Powers: The smooth taste of this whiskey is only one of its benefits. Each swig of this pandaren brew actually heals 1d4 hit points of damage. Drinking 4 swigs of this whiskey grants a +2 bonus to Strength and Constitution for 1d4 hours, in addition to the healing properties. Drinking 10 swigs of this whiskey grants a +6 bonus to Strength and Constitution (in addition to healing) for 1d6 hours, and the drinker becomes immune to any fear or charm effect for the duration. For each swig imbibed, the drinker suffers a -1 penalty on initiative checks and Reflex saves until the duration of the effects expire. An unopened bottle of this whiskey holds 10 swigs.

Faint transmutation; CL 5th; Brew Potion, *bear's endurance*, *bull's strength*, *cure moderate wounds*; Price 1,750 gp; Weight 1 lb.

Rings

Magical rings are not as common in Kalimdor as they are on the rest of Azeroth, perhaps because the indigenous people simply did not see rings as a particularly useful method of employing magic. Those rings that were created on Kalimdor frequently carry greater powers than those forged on Lordaeron.

When a ring is generated randomly, roll 15% of the time on Table 4-5.

Earring of Technological Prowess

Description: Designed by goblins for goblins, these items consist of tiny clockwork gears fashioned in the shape of a ring. Although intended to pierce the ear of a goblin, they can be twisted and stretched easily enough to fit around the little finger of a taller individual.

Powers: The *earring* enhances technological understanding, providing a +5 competence bonus on Use Technological Device* checks. In addition, once per day, the wearer can choose to automatically succeed at any one skill or attack roll to use a technological device (effectively lowering the MR of that item to zero for that purpose only).

Faint transmutation; CL 7th; Forge Ring, at least 5 ranks in Use Technological Device*; Price 3,500 gp.

Jade Ring of Veth'talia

Description: One of the items created by the high elf Veth'talia during her career as a fighting

spellcaster was this ring made of purest jade. The item appears to have been carved directly from a single chunk of this precious stone and is a circle as perfect as any seen on Azeroth. When worn, the owner's eyes change color to a deep, rich, almost glittering green.

Powers: The ring provides a constant +2 enhancement bonus to Dexterity. In addition, once per day, the wearer can choose to re-roll any failed Dexterity-based skill check. The owner must live (or die) by the second roll. This power may not be employed for Reflex saves.

Moderate transmutation; CL 7th; Forge Ring, *cat's grace*, creator must be a high elf; Price 9,040 gp.

Lion's Ring of the Acolyte

Description: The original *lion's ring* was crafted by Urtis, a low-ranking sorcerer known for his indecisiveness. Urtis never rose highly in the ranks like most of his fellows, but some of the items he created live on today, and several more that he did *not* create bear his name if only because they seem, like him, unable to decide what their true function is. The ring's golden band bears an intricately carved lion's head that holds a half-inch jewel in its mouth. Regardless of the success of any Appraise checks, the type of gem cannot be determined, and in fact seems to shift and change in color and consistency from moment to moment.

Powers: The ring provides a +4 enhancement bonus to Strength, Constitution, Dexterity, Intelligence, Wisdom or Charisma as its wearer wishes. When first found, the ring will generally be found at a random setting, which operates continuously unless altered. The ring can change from one specific bonus to another only once per day. If it switches to another statistic, there is a delay period of one hour while it shifts to its new role, during which it provides no bonuses whatsoever.

Moderate transmutation; CL 9th; Forge Ring, *bear's endurance*, *bull's strength*, *cat's grace*, *fox's cunning*, *eagle's splendor*, *owl's wisdom*, one 1,000 gp gem of any type; Price 21,050 gp.

Ring of the Mind

Description: This gold band contains a platinum device that resembles the top of a skull with the cranium cut open. A large chrysoberyl occupies the cup-shaped cavity, cut with a number of bumps and ridges instead of the usual facets found in most jewels.

Table 4–5: Rings, Rods, Staffs and Wands

Minor	Medium	Major	Item	Market Price
01–35	01–25	01–10	<i>Earring of technological prowess</i>	3,500 gp
36–60	26–40	11–25	<i>Jade ring of Veth'talia</i>	9,040 gp
61–80	41–55	26–40	<i>Ring of the mind</i>	18,100 gp
81–95	56–70	41–50	<i>Spider ring</i>	19,120 gp
96–99	71–80	51–60	<i>Lion's ring of the acolyte</i>	21,050 gp
100	81–85	61–70	<i>Staff of negation</i>	28,875 gp
—	86–90	71–80	<i>Wand of the wind</i>	30,000 gp
—	91–95	81–88	<i>Scepter of healing</i>	53,679 gp
—	96–99	89–94	<i>Nature's ring**</i>	54,720 gp
—	100	95–98	<i>Rod of necromancy</i>	85,800 gp
—	—	99	<i>Mindstaff</i>	160,697 gp
—	—	100	<i>Rod of undead mastery**</i>	212,000 gp

Powers: The ring allows a spellcaster to shift his prepared spells to other types, within certain limits. Before it can work, the ring must be worn for at least 2 consecutive days, after which it attunes itself to the thoughts of its owner. In addition, if owned by a wizard, the character must memorize a spell at least once during this period if the ring will be able to employ that spell. Once these conditions are met, the wearer can choose to drop up to one level of spells per caster level per day, replacing them with any other spells he knows or can access. For example, a 6th-level wizard who prepared 2 *fireball* spells, but now needs *identify* for 6 recently discovered items, could drop the no-longer-needed *fireballs* in exchange for the *identify* spells (so long as he has previously memorized *identify* while wearing the ring). Replacing spells in this manner is a full-round action, and once the change has been made, the replaced spells may be cast normally.

Moderate transmutation; CL 11th; Forge Ring, *Rarey's mnemonic enhancer*, one 500 gp chrysoberyl; Price 18,100 gp.

Spider Ring

Description: This platinum ring appears to have been made of thin strands of spider silk woven in a concentric pattern. Eleven garnets arranged like a spider's eyes stare out from a web-shaped faceplate.

Powers: The ring provides a +2 enhancement bonus to Dexterity and allows the wearer to *spider climb* 3 times per day for up to 10 rounds per use.

Faint transmutation; CL 7th; Forge Ring, *cat's grace*, *spider climb*; Price 19,120 gp.

Rods, Staffs and Wands

Many of the rods, staffs and wands described in the *DMG* are known to exist on Azeroth. Several additional such items are found only in the world of *Warcraft*. Some of them are described below.

When any rod, staff or wand is called for via random treasure selection, roll 15% of the time on Table 4–5.

Mindstaff

Description: This gnarled length of wood features unusual wrinkles, like those found in a sentient brain. The tip is a chunk of onyx carved with concentric circles that seem to ripple slowly across the surface in an oddly entrancing optical illusion.

Powers: This staff allows for use of the following mind-affecting spells:

- *Charm person* (1 charge)
- *Hypnotism* (1 charge)
- *Daze monster* (1 charge)
- *Charm monster* (2 charges)
- *Suggestion* (2 charges)
- *Mass suggestion* (3 charges)
- *Mass charm monster* (4 charges)

In addition to these powers, the staff allows its owner and all allied characters to memorize one additional 1st-, 2nd-, and 3rd-level arcane spell per day. These must be spells from the enchantment school and do not stack with any other bonus spells provided from magic items (e.g., a *ring of wizardry*),

although they do stack with bonuses from specialization. To earn this bonus, the caster and his allies must spend their required daily rest time within 60 feet of the staff and must put one hand on upon it while they study spells for the day.

Strong enchantment; CL 15th; Craft Staff, *charm monster, charm person, daze monster, hypnotism, mass charm monster, mass suggestion, Rarey's mnemonic enhancer*; Price 160,697 gp.

Rod of Necromancy

Description: A rod of necromancy carries a sharp-toothed skull with ruby eyes atop a heavy metal shaft the color of dried blood.

Powers: The rod has 3 spell-like abilities, each activated by a command word:

- *Animate dead* (50 charges) as if cast by an 8th-level caster.
- *Control undead* (50 charges) as if cast by a 10th-level caster.
- *Create undead* (50 charges, usable once per day) as if cast by a 15th-level caster.

Strong necromancy; CL 15th; Craft Rod, *animate dead, control undead, create undead*; Price 85,800 gp.

Scepter of Healing

Description: This short, razor-straight haft of polished iron is often thought at first to be a rod, but is actually a staff. The *scepter* bears a crystalline ball on one end that glows with a faint white light. Any divine caster who touches the orb feels a contented warmth flow through her body.

Powers: The scepter allows the use of all the following spells:

- *Mass cure light wounds* (1 charge)
- *Mass cure medium wounds* (2 charges)
- *Mass cure serious wounds* (3 charges)
- *Mass cure critical wounds* (4 charges)
- *Mass heal* (7 charges)

Whenever any spell is invoked, the character doing so glows with a pure white light.

Strong conjuration; CL 18th; Craft Staff, *mass cure critical wounds, mass cure light wounds, mass cure medium wounds, mass cure serious wounds, mass heal*; Price 53,679 gp.

Staff of Negation

Description: This staff of polished gray wood is cold to the touch and inlaid with black runes. Bands of silver bind a star-shaped crystal to its tip.

Powers: The staff allows for use of the following spells:

- *Dispel magic* (1 charge)
- *Erase* (1 charge)
- *Dismissal* (2 charges)
- *Greater dispel magic* (2 charges)

Moderate abjuration; CL 10th; Craft Staff, *dispel magic, erase, dismissal, greater dispel magic*; Price 28,875 gp.

Wand of the Wind

Description: A wooden baton rimmed with ivory and decorated in runes in the language of the night elves.

Powers: A new wand has 50 charges of the spell *whirlwind* as if cast by a 10th-level caster.

Moderate evocation; CL 10th; Craft Wand, *whirlwind*, a night elf must craft the physical components of the wand, though it may be enchanted by any spellcaster; Price 30,000 gp.

Scrolls

In the world of Azeroth, not all scrolls contain spells waiting to be cast. Some are more like wondrous items, with special runes that release potent magical abilities. Unless noted otherwise in the descriptions below, any character may employ one of these scrolls.

For generating scrolls randomly, see Table 4-4: Potions and Scrolls, above.

Arcane Scroll of the High Guardian

Description: This scroll has been scribed upon the carefully stretched and dried skin of an orc slain in battle. Scrolls of this type are found within containers carved of bone that must be snapped in half while the scroll's magic is invoked.

Powers: Only characters capable of casting arcane spells may use this scroll. Reading the runes and smashing the bone case require a full-round action. Once this is done, all friendly creatures within 30 feet of that spot heal 3 hit points per round, recover one spell level per round, and receive a +4 deflection bonus to their AC. Spell levels restored can be used to restore immediately a spell previously cast, or saved up to recover a higher-level spell in a future round (e.g., it would take 4 rounds to restore a 4th-level spell). The scroll cannot restore spells of a level higher than the creator could cast. Benefits accrue only while friendly creatures remain within the effect's radius.

—if they move outside, they gain none of the above advantages until they return to the affected zone. The scroll's effects last for 12 rounds.

Moderate to strong abjuration and conjuration; CL 10th or higher; Scribe Scroll, *cure light wounds*, *shield*; Price 8,000 gp.

Replenishment Scroll

Description: These sheets of parchment appear at first to be ordinary magical scrolls, but upon examination, their language shifts to something that can be understood easily by the reader.

Powers: This scroll combines the effects of healing and spell recovery. The unusual combination of divine and arcane magic requires a creator skilled in both types of spellcasting. When read, the user and all allies within a 20-foot radius are healed of 1d8+9 hit points of damage and recover 2 levels of spells previously cast. These spell levels can be any combination of 2 levels, such as one 2nd-level spell or two 1st-level spells. Each 0-level spell counts as one 1st-level spell. If a beneficiary of this magic does not have 2 levels of spells available, the excess recovery is lost (it cannot be saved and used later).

Moderate transmutation and conjuration; CL 9th; Scribe Scroll, *mass cure light wounds*, *Rarey's mnemonic enhancer*; Price 4,050 gp.

Replenishment Scroll, Greater

Description: This scroll resembles a *replenishment scroll*, but is about twice the length of that item and confers an increased effect.

Powers: This scroll heals 2d8+11 points of damage and recovers 3 levels of spells. The 20-foot range is not increased, however.

Moderate transmutation and conjuration; CL 11th; Scribe Scroll, *mass cure moderate wounds*, *Rarey's mnemonic enhancer*; Price 5,500 gp.

Replenishment Scroll, Lesser

Description: This scroll resembles a *replenishment scroll*, but is only about half the length of that item and confers a reduced effect.

Powers: This scroll heals only 1 point of damage and recovers only 1 level of spells. The 20-foot range is not decreased, however.

Faint transmutation and conjuration; CL 7th; Scribe Scroll, *cure light wounds*, *Rarey's mnemonic enhancer*; Price 1,750 gp.

Scroll of Protection

Description: This scroll appears to be little more than a rolled-up strip of parchment with a few magical words inscribed across its surface. With a few moments of studying, however, any character can read the runes without difficulty.

Powers: When read, this scroll provides a +3 deflection bonus to the AC of all allied creatures within 30 feet. The effects last for 12 rounds.

Faint abjuration; CL 7th; Scribe Scroll, *shield of faith* cast with the Widen Spell feat (even though that feat normally does not affect that spell); Price 1,400 gp.

Scroll of Regeneration

Description: This scroll is inscribed on crisp, clean parchment that stays a brilliant white even if exposed to dirt, grime, or mud. The words inscribed thereon are magical, but easily understood, and are written in a circle that rotates when read, allowing the inscription to be easily repeated.

Powers: This scroll must be read aloud and continuously as a full-round action. The character doing the reading must concentrate fully upon the scroll and may not move while invoking its powers. If he is attacked, he must make a Concentration check as usual to avoid being interrupted. For as long as he reads the scroll, he and all his allies within 30 feet heal 3 hit points per round, but only if they can hear the magical words as they are spoken (possibly requiring Listen checks in some circumstances). The character may continue reading for as long as he is able, although after 10 rounds of continuous chanting he must make a Will save (DC 10 + 1 for each round after the 10th) each round to avoid slipping up and interrupting the magic. Once the reading is disrupted by any means, the scroll crumbles to dust.

Moderate conjuration; CL 15th; Scribe Scroll, *cure serious wounds* cast with the Widen Spell feat, even though that feat does not normally work with this spell; Price 5,250 gp.

Scroll of Speed

Description: A faint whistling sounds from this scroll when it is removed from its container. As the page is unrolled, it seems to flap about as if caught in a breeze.

Powers: When this scroll is read, all creatures within 30 feet gain 10 feet to their movement

speeds for 1 minute. This bonus does not stack with other magical speed enhancements such as *haste*, *expeditious retreat* and similar powers.

Faint transmutation; CL 7th; Scribe Scroll, *expeditious retreat* combined with the Widen Spell feat (even though that spell does not normally benefit from it); Price 700 gp.

Wondrous Items

In addition to the wondrous items described in the *DMG*, a wide variety of similar objects are native to the world of *Warcraft*. These items come in many shapes and sizes, and of all levels of power. A few of the better-known types are detailed below.

Whenever a wondrous item is called for through random selection, roll 50% of the time on Table 4–6: Wondrous Items.

Alleria's Flute of Accuracy

Description: These instruments are wooden flutes bound and trimmed in gold. It is unclear if the *flutes of accuracy* were named to honor the elven ranger Alleria or if she played a part in their invention. Anyone can blow into the *flute of accuracy* and call upon its powers, but skilled musicians can sustain its effect for longer periods of time.

Powers: Once per day, this flute can be played to grant all ammunition for ranged weapons within a 30-foot radius a +2 enhancement bonus on damage rolls. This bonus lasts for a number of rounds equal to 1 + the user's ranks in Perform (instrument).

Moderate transmutation; CL 6th; Create Wondrous Item, *magic weapon*; Price 6,500 gp; Weight 1/2 lb.

Amulet of Recall

Description: This ordinary-looking piece of jewelry is made of polished silver surrounded by a ring of platinum. A series of spheres of various sizes are inscribed on the flat sides, some overlapping the others like a cluster of moons in the sky. The pattern of spheres rearranges itself periodically, so anyone familiar with the amulet sees a different arrangement each time he studies it.

Powers: This *amulet* is attuned mystically to its creator and can return to him from any location upon command, even if held in an extradimensional space. If someone else is wearing or carrying the amulet at the time the command word is spoken, that person, all his gear, and up to 7 other individuals

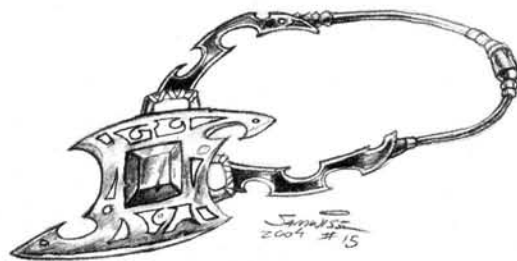

and their supplies not to exceed a total of 1,200 pounds are all brought before the *amulet's* creator through a *dimension door* effect. This ability can be used once per day and will not function if the amulet is presently in any location that blocks *teleportation* or similar travel, such as the radius of a *dimensional lock* spell. The *amulet* can be attuned to a new individual only if the original owner dies or voluntarily chooses to give up his control over the item.

Strong conjuration; CL 12th; Create Wondrous Item, *dimension door*; Price 17,750 gp; Weight 1/2 lb.

Amulet of Spell Shield

Description: This hemispherical disk is made of an unknown material that is not quite metal, but seems just as sturdy and solid. The translucent surface appears to swirl and dance with vibrant colors hiding deep within its body.

Powers: The *amulet* defends against all spells cast upon the wearer, conferring him spell resistance 25. Each time the *amulet* deflects a spell (i.e., any time the spell resistance check indicates that the *amulet's* protection blocked a spell, and any other spell resistances the wearer possesses would not have done so), its protection level drops by 1 point. These points return at the rate of 1 point for every 24 hours that pass without a spell being deflected.

Strong abjuration; CL 11th; Craft Wondrous Item, *spell resistance*; Price 130,000 gp; Weight 1/2 lb.

Amulet of the Wind

Description: This golden amulet is decorated with a scene portraying the night sky, with the constellation of the Bear clearly marked. At twilight, the shape of a bear-like creature can be clearly seen in place of the constellation.

Powers: Once per day, this *amulet* can call forth a friendly furbolg as a fighting ally. The furbolg is always the same each time, the actual creature having been entrapped within the amulet and

forced to serve. When the command word is spoken, the furbolg appears 1 round later in an open square adjacent to the amulet owner's location and immediately attacks the wearer's nearest enemy. The wearer can also give the furbolg other instructions, which the creature will obey to the best of its ability. The furbolg returns to the amulet if it is slain or after 10 minutes have passed, whichever comes first. The next time the creature appears, it is healed of all wounds and ready for battle. The owner can free the beast by destroying the amulet, in which case it immediately bounds off toward its former home, eager to be reunited with its fellows.

Moderate conjuration; CL 9th; Craft Wondrous Item, *summon nature's ally IV*; Price 13,150 gp; Weight 1/2 lb.

Ancient Figurine of Insight

Description: This small statuette depicts a scholarly figure seated on a stool studying a large book stretched across his lap. The race and gender of the delicately carved individual is indeterminate, as it wears a hooded cape that drapes down over its darkened face. The entire *figurine* appears to have been carved of a black crystalline substance that defies identification.

Powers: While the *figurine* is carried, it whispers supportive thoughts and ideas into its owner's mind. One full day after the item is first picked up, the owner receives a +2 insight bonus to Intelligence. This bonus persists for as long as the *figurine* is carried on the owner's person, regardless of its actual location, but it may not be in an extradimensional space. If the item is set down or given to another person, it does not provide its bonus until grasped again. If someone else carries it for a full day, she begins to earn the Intelligence bonus, and the former owner must wait a full day after recovering it before he can enjoy its advantages once again. Once the *figurine* has acclimated itself to its owner, it can give a flash of inspiration once per day upon command. When this is done, the owner receives a +10 insight bonus on any one Intelligence-based skill check he attempts in that round.

Moderate transmutation; CL 10th; Craft Wondrous Item, *fox's cunning*; Price 12,000 gp; Weight 1/2 lb.

Ankh of Resurrection

Description: An *ankh of resurrection* is a palm-sized metal sigil worn like an amulet and imbued with magic powerful enough to raise the dead. The

dwarves believe that titans created the first ankhs to honor their reverence of life.

Powers: When the wearer of an *ankh* is reduced to -10 hit points or less, the magic of the *ankh* restores him to full hit points, vigor and health immediately, with no loss of prepared spells. However, the wearer does lose 1 level (or 1 point of Constitution if he was 1st level). The *ankh* can revive someone killed by a death effect, but it cannot revive someone who has died of old age.

Strong conjuration; CL 14th; Create Wondrous Item, *resurrection*; Price 24,600 gp; Weight 1/4 lb.

Banner of the Angry Boar

Description: Orcish shamans design these broad silken banners to fly from the backs of orcish swordmasters. The banner depicts a rampant boar amidst a spray of bloody letters that spell out words of fury in Orcish.

Powers: The rancor and tenacity of the boar possess the banner's wearer and any of her allies within 30 feet. The wearer and her allies can continue to fight without penalty even while disabled or dying. Once per day, the bearer can cast *bloodlust** on himself and five other allies within 30 feet.

If the banner wearer is 6th level or higher, once per day she can summon a dire boar to protect her. Treat the boar as if summoned by the spell *summon nature's ally IV*, with the exception that the boar remains for 1 day or until slain.

Moderate Conjuration; CL 9th; Craft Wondrous Item, *bloodlust**, *summon nature's ally IV*, creator must be an orc; Price 22,550 gp; Weight 2 lb.

Banner of the Black Wolf

Description: This red silk sashimono banner is in the same style as those worn by orcish bladesters. The banner depicts a stylized black wolf running across a field of blood.

Powers: This banner grants a +10 bonus to the speed of the wearer and any of his allies within 30 feet. Once per day, the banner's bearer can cast *pass without trace* on himself and up to 5 allies within 30 feet.

If the banner's wearer is 6th level or higher, once per day he can summon a black dire wolf to act as a companion. The wolf will protect the wearer as if summoned by the spell *summon nature's ally IV*, with the exception that the dire wolf remains for 1 day or until slain.

WARCRAFT

THE ROLEPLAYING GAME

Table 4–6: Wondrous Items

Minor	Medium	Major	Item	Market Price
01–05	01–03	—	<i>Neevil's spectacular voice-activated bomb</i>	320 gp
06–10	04–06	—	<i>Gloves of celerity*</i>	2,000 gp
11–15	07–09	—	<i>Horn of the clouds</i>	3,240 gp
16–20	10–12	—	<i>Shimmerglaze roast</i>	3,300 gp
21–25	13–15	—	<i>Boots of Quel'Thalas</i>	4,000 gp
26–30	16–18	—	<i>Neevil's amazing multi-use grenade</i>	4,040 gp
31–35	19–21	—	<i>Boots of speed</i>	4,500 gp
36–40	22–24	—	<i>Cloak of shadows</i>	4,500 gp
41–45	25–27	—	<i>Runed bracers (SR 13)</i>	5,000 gp
46–50	28–30	—	<i>Mask of the Loa</i>	5,200 gp
51–55	31–33	—	<i>Alleria's flute of accuracy</i>	6,500 gp
56–60	34–36	—	<i>Tome of retraining</i>	8,100 gp
61–66	37–40	—	<i>Spidersilk brooch</i>	9,000 gp
67–73	41–44	—	<i>Warsong battle drums</i>	9,720 gp
74–80	45–48	—	<i>Runed bracers (SR 15)</i>	10,000 gp
81–83	49–51	—	<i>Ancient figurine of insight</i>	12,000 gp
84–86	52–54	—	<i>Khadgar's pipe of insight</i>	12,000 gp
87–89	55–56	—	<i>Banner of the deadly blades</i>	12,450 gp
90–91	57–58	—	<i>Enchanted vial of Veth'talia</i>	12,600 gp
92–93	59–60	—	<i>Amulet of the wind</i>	13,150 gp
94	61–62	—	<i>Book of the dead</i>	13,360 gp
95	63–64	—	<i>Gloves of haste</i>	15,000 gp
96	65–66	01–02	<i>Spiked fel collar</i>	16,200 gp
97	67–68	03–04	<i>Neevil's incredible flying gyroparasol</i>	16,350 gp
98	69–70	05–06	<i>Runed bracers (SR 17)</i>	17,000 gp
99	71–72	07–08	<i>Circlet of nobility</i>	17,250 gp
100	73–74	09–10	<i>Amulet of recall</i>	17,750 gp
—	75–76	11–12	<i>Health stone</i>	18,000 gp
—	77–78	13–14	<i>Periapt of vitality</i>	18,000 gp
—	79–80	15–16	<i>Mana stone</i>	18,000 gp
—	81–82	17–18	<i>Gauntlets of ogre strength</i>	18,125 gp
—	83–84	19–20	<i>Bloodfeather's heart</i>	19,800 gp
—	85–86	21–22	<i>Figurine of wondrous power, frost shard</i>	20,000 gp
—	87–88	23–24	<i>Figurine of wondrous power, inferno stone</i>	20,000 gp
—	89–90	25–26	<i>Helm of valor</i>	22,000 gp
—	87–88	27–28	<i>Talisman of evasion</i>	22,250 gp
—	89–90	29–30	<i>Banner of the black wolf</i>	22,450 gp
—	91–92	31–32	<i>Banner of the angry boar</i>	22,550 gp

Table 4–6: Wondrous Items (continued)

Minor	Medium	Major	Item	Market Price
—	93	33–34	<i>Figurine of wondrous power, demonic</i>	24,000 gp
—	94	35–36	<i>Figurine of wondrous power, stone token</i>	24,000 gp
—	95	37–38	<i>Ankh of resurrection</i>	24,600 gp
—	96	39–40	<i>Runed bracers (SR 19)</i>	26,000 gp
—	97	41–42	<i>Cloak of writhing shadows**</i>	26,000 gp
—	98	43–44	<i>Figurine of wondrous power, drake egg</i>	27,000 gp
—	99	45–46	<i>Grimoire of souls</i>	27,500 gp
—	100	47–48	<i>Legion doom-horn</i>	27,720 gp
—	—	49–50	<i>Ivory tower</i>	28,800 gp
—	—	51–52	<i>Druid pouch</i>	28,960 gp
—	—	53	<i>Warden's cloak</i>	29,500 gp
—	—	54–55	<i>Scourge bone chimes</i>	30,000 gp
—	—	56–57	<i>Hood of cunning</i>	34,000 gp
—	—	58–59	<i>Medallion of courage</i>	34,500 gp
—	—	60	<i>Khadgar's gem of health</i>	42,480 gp
—	—	61–62	<i>Helm of battlethirst</i>	42,800 gp
—	—	63–64	<i>Healing wards</i>	43,000 gp
—	—	65–66	<i>Greater talisman of evasion</i>	44,750 gp
—	—	67–68	<i>Cloak of flames</i>	45,000 gp
—	—	69–70	<i>Witch's circlet**</i>	45,000 gp
—	—	71–72	<i>Brooch of the crypt lord</i>	46,500 gp
—	—	73–74	<i>Firehand gauntlets</i>	49,150 gp
—	—	75–76	<i>Cap of Raiden</i>	51,000 gp
—	—	77–78	<i>Lightning cloak</i>	54,000 gp
—	—	79–80	<i>Gloves of spell mastery</i>	54,200 gp
—	—	81–82	<i>Janggo of endurance</i>	60,000 gp
—	—	83–84	<i>Gargoyle robe</i>	68,500 gp
—	—	85–86	<i>Diamond of summoning</i>	72,060 gp
—	—	87–88	<i>Crown of kings</i>	84,000 gp
—	—	89–90	<i>Cloak of flames*</i>	90,000 gp
—	—	91	<i>Mask of death</i>	93,600 gp
—	—	92	<i>Belt of might**</i>	108,000 gp
—	—	93	<i>Gauntlets of might**</i>	108,000 gp
—	—	94	<i>Superior boots of elvenkind**</i>	112,000 gp
—	—	95	<i>Amulet of spell shield</i>	130,000 gp
—	—	96	<i>Crown of the dreadlord</i>	133,920 gp
—	—	97	<i>Drek'thar's spellbook</i>	237,400 gp
—	—	98	<i>Robes of elven kings**</i>	309,200 gp
—	—	99	<i>Girdle of the betrayer**</i>	322,000 gp
—	—	100	<i>Celestial orb of souls</i>	352,800 gp

Moderate conjuration; CL 9th; Craft Wondrous Item, *longstrider*, *pass without trace*, *summon nature's ally IV*, creator must be an orc; Price 22,450 gp; Weight 2 lb.

Banner of the Deadly Blades

Description: This slashed and battered silken banner depicts hundreds of blades in an ornate spiraling pattern. Within the center of the spiral is an orcish blademaster's symbol for balance and fury. Blademasters wear these banners on their backs.

Powers: Once per day, the wearer of this banner may make a Whirlwind Attack (as the feat) as a free action. This deadly whirlwind of steel also bears the benefits of the Improved Critical and Great Cleave feats (this is an exception to the rule that bonus attacks may not be taken during a Whirlwind Attack).

If the banner's bearer is 6th level or higher his weapon gains the keen special weapon ability while being used for the Whirlwind Attack if it does not already have it.

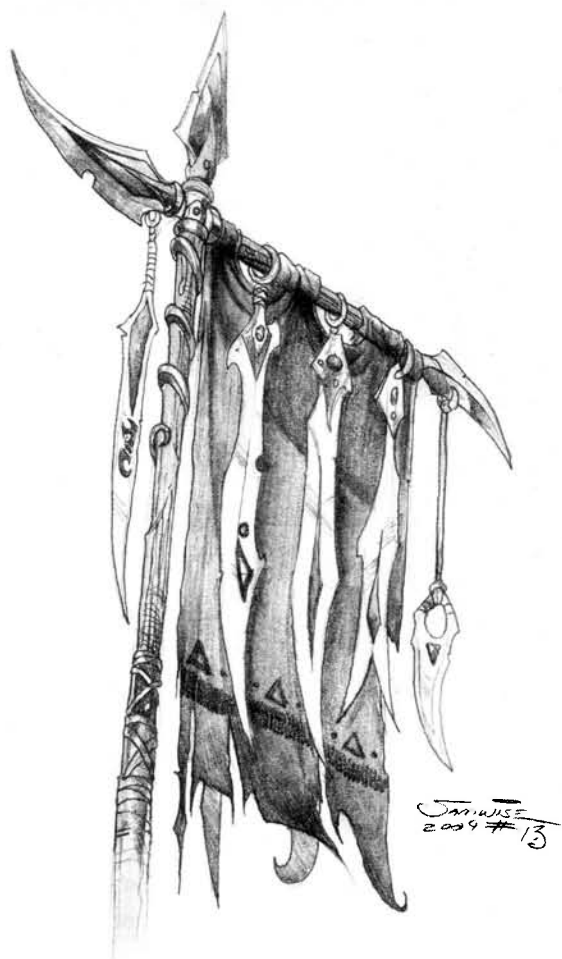

Moderate transmutation; CL 9th; Craft Wondrous Item, *greater heroism*, *keen edge*, creator must be an orc; Price 12,450 gp; Weight 2 lb.

Bloodfeather's Heart

Description: This multifaceted, blood-red ruby seems to shine with an inner glow. Anyone grasping it firmly feels a kind of suffusing warmth, as if everything will be all right with the world. In darkness, the glow produces a reddish light that illuminates a 5-foot area around the gem, but only so long as it is held by a living creature. According to stories, the first of these jewels was created using the heart of a powerful griffon that once served a dwarf-king, but this is likely just a rumor.

Powers: So long as the owner keeps the *heart* in his possession, he earns a +4 enhancement bonus to his Dexterity. In addition, once per day, the gem can be held in one hand and commanded to *fly* as the spell. The jewel takes its owner along for the ride, but he may not use anything in that hand while flying, including weapons or shields.

Moderate transmutation; CL 10th; Create Wondrous Item, *cat's grace*, *fly*, 1,000 gp ruby; Price 19,800 gp; Weight negligible.

Book of the Dead

Description: This ancient, musty tome is decorated with inlaid bones from various creatures. The cover and spine are made from dried skin stretched and treated to remain flexible. The ink used to write the magical words and runes inside is blood drawn from the veins of living creatures killed as sacrifices when the book was completed.

Powers: This book may be used only by evil creatures. Non-evil creatures even so much as touching this tome gain one negative level for as long as they handle it, and suffer 2d6 points of negative energy damage if they attempt to read even a single line of the verses within. The owner earns a +2 unholy bonus on all attempts to rebuke or command undead while she holds the book in her hands and presents it before the target creatures. In addition, the owner may, once per day, summon 3d6 skeletons by reading the incantations within. This effect requires a full-round action that can be interrupted; but if the owner is interrupted, this attempt does not count as the summoning for the day. Half of any skeletons that appear are fighters, while the remainder are archers, and each appears with its

own weapons. No corpse focus is required. Undead summoned in this manner serve and obey their creator without question and last for 8 hours or until destroyed.

Moderate necromancy; CL 9th; Create Wondrous Item, *animate dead*; Price 13,360 gp; Weight 2 lb.

Boots of Quel'Thalas

Description: *Boots of Quel'Thalas* are created of soft leather tooled by the high elves' most skilled artisans, then trimmed in silver enchanted by elven wizards to grant the wearer magical agility. They are often passed from one generation to the next in elven families.

Powers: The wearer of these boots gains a +2 enhancement bonus to his Dexterity, adding the usual benefits to AC, Reflex saves and other uses of the Dexterity modifier.

Moderate transmutation; CL 8th; Create Wondrous Item, *cat's grace*, creator must be a high elf; Price 4,000 gp; Weight negligible.

Boots of Speed

Description: These boots are a favorite among orcish light infantry, where they provide a speed boost to leaders consigned to ground movement. The *boots of speed* are created using the tanned hides of kodo beasts treated to remain soft and comfortable on the inside while protecting the feet from rocks and other obstacles.

Powers: These boots grant an additional 30 feet to the wearer's movement speed on land. This is considered an enhancement bonus. If the owner is carrying a medium load, the bonus is decreased to 20 feet, and if carrying a heavy load, it drops to 10 feet.

Moderate transmutation; CL 8th; Create Wondrous Item, *expeditious retreat*, creator must be an orc; Price 4,500 gp; Weight 1 lb.

Brooch of the Crypt Lord

Description: The spider kings of Azjol-Nerub created a number of these powerful elder items. More than a few of these brooches have made their way into the hands of servants of the Scourge. Stylized to resemble the spider-like legs, outer shell and scything arms of a crypt lord, this gold and blue enamel brooch is a powerful protective item. Inscribed on the back of each brooch is the ancient tongue of the spider kings of Azjol-Nerub, denoting which crypt lord the wearer supposedly serves.

Powers: The brooch wearer may speak to spiders and other arachnoids as if the wearer understood their native tongue. As well, all arachnoids and insect vermin (including summoned vermin) immediately recognize the wearer as an emissary of the crypt lords and they will not attack the wearer unless attacked first.

Upon command, the brooch covers the wearer's body and face with a sturdy layer of segmented blue and gold chitin plates that grant a +4 natural armor bonus. Scythe-like claws extend to cover the wearer's hands. These blades are considered scimitars for determining damage and critical threats, and the wielder uses them as if fully proficient. The wearer also gains the benefits of the Two Weapon Fighting feat when using the claws.

Strong transmutation; CL 12th; Craft Wondrous Item, *magic armor*, *magic weapon*, *tongues*; Price 46,500 gp; Weight 1 lb.

Cap of Raiden

Description: Created by the pandaren geomancer Raiden, these caps are wide and slightly conical, woven from specially treated bambus reed. Iron wire threads through the cap in a lightning-like pattern. Inside of the conical cap is a series of painted sigils. These sigils combined with the iron thread give the cap its power. Once charged, the threads glimmer with a soft blue light.

Powers: The cap offers resistance to electricity 10. It can also store electricity touch attack spells as charges (to a maximum of 10 charges). The user can expend 1 charge to deliver a *shocking grasp* to a target as if the wearer were a 2nd-level wizard. Expending 5 charges casts a *lightning bolt* as if the wearer were a 5th level wizard. Casting electricity touch attack spells on the cap will charge it, but it does not absorb electricity spells that target the wearer.

Moderate evocation; CL 5th; Craft Wondrous Item, *lightning bolt*, *resist energy*, *shocking grasp*; Price 30,000 gp; Weight 1 lb.

Celestial Orb of Souls

Description: This crystalline ball, about 6 inches in diameter, glows and swirls with ghostly shapes. Although it appears to be made of ordinary glass, the *celestial orb* is virtually indestructible, with hardness 20 and 50 hit points. The device's unassuming appearance hides a tremendous power.

Powers: The orb captures the fleeing soul of any creature slain within 60 feet of its owner. These souls remain within the murky demesne of the *orb* for 1 minute before escaping and moving on to their rewards. During that period, the *orb's* owner may, with a single word, bring that creature back to life through any of the following means: *reincarnation* (1 charge), *raise dead* (2 charges), *resurrection* (3 charges), or *true resurrection* (4 charges). The *orb* has 10 charges; and when they are all expended, the colors within become drained and lifeless. The orb regenerates 1 charge every day at sunrise as long as it is exposed to light as the sun comes up (this effect works even if the skies are cloudy).

Strong conjuration; CL 14th; Create Wondrous Item, *true resurrection*, creator must be good; Price 352,800 gp; Weight 1 lb.

Circlet of Nobility

Description: This ornamental piece of headgear is made of gold inlaid with platinum filigree. A single large emerald hangs down over the wearer's forehead, glowing slightly for as long as the *circlet* is worn. Legend has it these items were created for human nobles, but they have proven so popular that many adventurers now employ them.

Powers: The wearer earns a +2 enhancement bonus to his Strength, Wisdom and Charisma, the traditional traits of leadership. The *circlet* occupies a helmet slot and may not be worn underneath a helm, hood or other covering without voiding its Charisma bonus.

Moderate transmutation; CL 10th; Create Wondrous Item, *bull's strength*, *eagle's splendor*, *owl's wisdom*, 1,000 gp emerald; Price 17,250 gp; Weight 1/2 lb.

Cloak of Flames

Description: This is a heavy but normal rust-colored cloak until the wearer draws the hood over her head and speaks the command word; its outer surface erupts in flames that damage any creatures who attack her in melee.

Powers: Any creature using its body or handheld weapons to attack the wearer of this cloak while it is aflame suffers 1d6+5 points of fire damage on a successful strike (the attacker still inflicts damage as normal). The cloak appears consumed with realistic-looking fire while it is flaming, but the flames shed no heat and give off light equal to only

half the illumination of a normal torch (10 feet). At all times, whether flaming or not, the cloak provides the wearer with protection against fire-based attacks; the wearer takes only half damage from such attacks, and upon a successful save takes no damage from attacks that allow a Reflex save for half damage.

Moderate evocation; CL 7th; Create Wondrous Item, *fire shield*; Price 45,000 gp; Weight 5 lb.

Cloak of Shadows

Description: This black cloak, spun from silk gathered by the nerubian spider lords, allows the wearer to vanish into the darkness.

Powers: In any area that isn't directly illuminated, the wearer of this cloak gains a +15 circumstance bonus on Hide checks.

Faint illusion; CL 3rd; Craft Wondrous Item, *invisibility*, cloak must be woven of spider silk. Price 4,500 gp; Weight 1 lb.

Crown of Kings

Description: This impressive crown is made of gold decorated by lacy platinum strands woven delicately through the surface and around the borders. Gems and jewels of various types adorn the *crown's* 12 points; and in the center over the forehead, four huge emeralds surround a glowing black opal. Only a few of these impressive items are known to exist, all of them created for human kings in days long past.

Powers: The wearer of this crown earns a +4 enhancement bonus to his Strength, Wisdom and Charisma, and a +2 enhancement bonus to Dexterity, Constitution and Intelligence. The *crown* occupies a helmet slot and may not be worn underneath a helm, hood or other covering without voiding its Charisma bonus.

Strong transmutation; CL 12th; Create Wondrous Item, *bear's endurance*, *bull's strength*, *cat's grace*, *eagle's splendor*, *fox's cunning*, *owl's wisdom*, four 1,000 gp emeralds, one 2,500 gp black opal; Price 84,000 gp; Weight 1 lb.

Crown of the Dreadlord

Description: This dark crown is made of blackened ebony decorated by spikes of sharpened bones. Reddish, blood-like splotches adorn the surface, which seems to pulse against the wearer's head. These crowns were created to serve the Scourge's

purpose and were given to those ranking high in its service.

Powers: If a non-evil creature attempts to put one of these crowns, the sharp tips bend and pierce the skin, causing 1d6 points of damage for each round the *crown* is left on the creature's head. This damage ignores all damage resistance. If worn by an evil creature, the *crown* provides a +2 enhancement bonus to Constitution and allows the creature to memorize one additional spell of each spell level; however, such bonus spells must be from the school of necromancy. This benefit does not stack with similar abilities provided by other magical items such as a *ring of wizardry*. In addition, the *crown's* wearer can cast *finger of death* once per day as a spell-like ability. Any damage dealt is returned to the *crown's* wearer as immediate healing; should the target be slain, assume that the damage dealt was equal to the exact number of hit points required to kill the creature (e.g., a target with 50 hit points would return 60 points of healing to the *crown's* wearer).

Strong necromancy; CL 16th; Create Wondrous Item, *bear's endurance*, *finger of death*, *limited wish*; Price 133,920 gp; Weight 2 lb.

Diamond of Summoning

Description: This item appears to be an ordinary (if extremely valuable) diamond in all ways, except that a faint flickering light emanates forth from within. The gem may be, but is not always, mounted in some other piece of jewelry, such as a ring or amulet, but if so, it does not take up that particular body slot. Items of this sort are often given to a knight or similar character sent upon a quest, with instructions not to invoke the gem's power until her mission is complete.

Powers: The *diamond* can be given to any ally along with a command word to be used to activate it. The *diamond* thereafter activates as the focus for a *refuge* spell, except that the item need not be destroyed to activate the *teleportation* effect. The *diamond* may not transport the original owner to the user (normally available as an option for the *refuge* spell). The *diamond* may be used only once per day and is linked to the original owner until the *refuge* power is invoked. Once the holder has used the recall power, the *diamond* may then be transferred to a new owner.

Strong conjuration; CL 14th; Craft Wondrous Item, *refuge*, 1,500 gp diamond; Price: 72,060 gp; Weight negligible.

Drek'thar's Spellbook

Description: This ragged tome is covered by a sheath of carved wood kept sealed by interlocking teeth. Originally the property of the orcish sorcerer Drek'thar, it reeks of powerful magic.

Powers: When found, this book contains a selection of ordinary spells just like any spellbook would. These spells can be determined randomly or chosen by the GM. If selected randomly, there are 1d20+50 spell levels inscribed in the book. In addition, several of the pages contain long-forgotten orcish runes that can be invoked daily for special powers. Also, when its owner carries the book, it provides protection against hostile magic.

Bonus Spells: If the owner of this book studies spells from its pages, he may memorize 1 extra spell per level per day. Each spell selected must be from the book itself, present when it was found. These spells are in addition to any other bonus spells from other items, such as a *ring of wizardry*.

Dimensional Portal: One of the book's pages is blank, but has an ornately designed border, like the frame for an unfinished painting. If the owner holds the book open to this page and speaks a certain orcish command word, a picture of his present location appears within the frame as if drawn by a pen dipped in blood. At any time thereafter, the owner can speak another command word, and a shimmering circular portal 6 feet in diameter will appear before him. The book must be held open to this same page when this word is spoken. The portal remains in place for 1 round before closing once again, allowing the book's owner and anyone else close enough to pass through, arriving at the original spot drawn in the book. The image of that location then disappears, leaving the page blank once more, although of course it could be set again at that point. The page retains its magic for 1 month before fading. Although the image on the page can be changed at will, using the *dimensional portal* can be accomplished only once per day.

Spell Resistance: For as long as the book is carried on the owner's person (not within an extradimensional space), the owner has spell resistance 19.

Spell Turning: Once per day, the owner can read a special page near the back of the book as a full-round action. Doing so activates a *spell turning* effect that is treated as having been cast at the

reader's caster level (even if he is not of a level normally high enough to invoke that spell). When this is done, the page turns blank, but the words return after 24 hours.

Strong abjuration, transmutation and conjuration; CL 15th; Craft Wondrous Item, *dimension door*, *Rarey's mnemonic enhancer*, *spell resistance*, creator must be an orc; Price 237,400 gp; Weight 3 lb.

Druid's Pouch

Description: This small container is made of leather with a top flap that clasps to the bag with a single tooth. When touched to the owner's belt or any other article of clothing, it fastens itself there until released with a command word, thereby making it impossible to steal through sleight of hand.

Powers: Any character wearing this bag receives a +1 enhancement bonus to Intelligence. When carried by a druid of the wild, however, the bonus increases to +4. In addition, once per day, the druid of the wild can reach into the bag and draw forth a cluster of herbs that, when consumed by himself or any of his allies, heal 2d8+9 points of damage and carry all the benefits of a *lesser restoration* spell. The herbs must be eaten within 5 rounds before they spoil.

Moderate conjuration; CL 9th; Craft Wondrous Item, *cure moderate wounds*, *fox's cunning*, *lesser restoration*, creator must be a druid of the wild; Price 28,960 gp; Weight negligible.

Enchanted Vial of Veth'talia

Description: The high elf Veth'talia created several special items to aid her career as a fighting spellcaster. One of these items was a special vial made of virtually unbreakable glass, filled with a clear liquid. A stopper of specially treated bark is clamped over the lip with a band of soft leather. The container has hardness 10 and 30 hit points.

Powers: When first examined, the container appears to be filled with ordinary water. Upon command, it can be made to fill with either a blue-tinted or reddish liquid. The blue elixir allows the owner to recall instantly up to 5 levels of arcane spells previously cast that day (in any combination of levels, e.g., one 5th-level spell; two 2nd-level and one 1st-level; or some other sampling). The red material causes the imbiber to be instantly healed of 2d8+7 hit points of damage. The *vial* can be made to create 1 dose of each type of liquid per day.

Moderate conjuration; CL 7th; Craft Wondrous Item, *cure moderate wounds*, *Rarey's mnemonic enhancer*, creator must be a high elf; Price 12,600 gp; Weight 1/2 lb.

Figurine of Wondrous Power, Demonic

Description:

This intricately carved black onyx statuette depicts a baleful demon with claws outstretched and a single hoof raised to as if to stomp upon the ground.

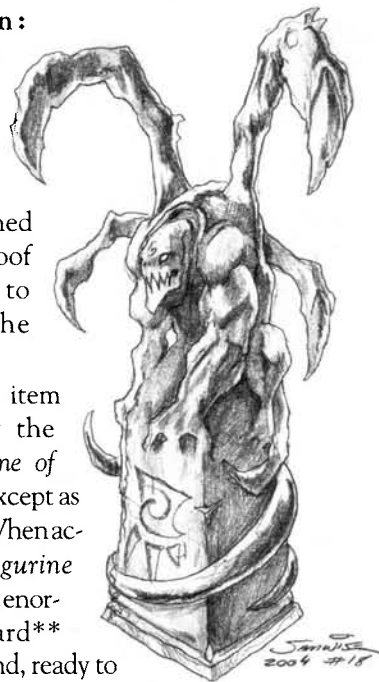

Powers: This item functions using the rules for a *figurine of wondrous power* except as noted hereafter. When activated, the *figurine* transforms into an enormous doomguard** with sword in hand, ready to attack. If the user is evil, the doomguard will obey his instructions as commanded without question. If the owner is good, the doomguard instead attacks him, fighting until he kills the one who summoned him or is slain in the process. If activated by a neutral creature, the doomguard will attack him 50% of the time; otherwise, it obeys normally. The *figurine* can be activated once per week and remains in doomguard form for up to 1 hour.

Strong transmutation; CL 13th; Craft Wondrous Item, *animate objects*; Price 24,000 gp; Weight 1/4 lb.

Figurine of Wondrous Power, Drake Egg

Description: This 3-inch oblate spheroid is colored a deep, fiery red. Upon close examination, tiny cracks can be seen all across the *egg's* surface. These are not flaws, however, but intentional details added by whoever created this high-quality piece of art.

Powers: This item functions using the rules for a *figurine of wondrous power* except as noted hereafter. When activated, the *egg* transforms into a red drake** and awaits its owner's commands. The *egg* can be activated once per week and remains in dragon form for up to 4 hours. If desired, the owner

can command a mature red dragon to appear instead of a drake, but if this is done, the figurine shatters when the creature reverts to statuette form.

Strong transmutation; CL 15th; Craft Wondrous Item, *animate objects*; Price 27,000 gp; Weight 1/4 lb.

Figurine of Wondrous Power, Frost Shard

Description: This item looks like a chunk of ice carved from the purest crystal. When held, it seems to draw body heat from its owner, chilling his flesh in a notable, but harmless, manner.

Powers: This item functions using the rules for a *figurine of wondrous power* except as noted hereafter. When activated, the *shard* transforms into a frost revenant** with its weapon at the ready. The creature obeys as long as it is not given orders contrary to its nature, such as to work alongside a fire revenant, attack other frost-based creatures, and the like. Should these conditions not be met, or if the summoner is slain, the frost revenant goes rogue immediately and acts as it sees fit, either fighting if it feels victory is assured or fleeing to make its own way in the world. If the frost revenant is slain, or a full hour passes, it reverts to statuette form. The item can be used twice per week, but not within 1 day of a previous use.

Should this figurine ever come into contact with an *inferno stone*, both objects explode, causing 6d6 impact damage to all within a 5-foot radius.

Strong transmutation; CL 12th; Craft Wondrous Item, *animate objects*; Price 20,000 gp; Weight 1/2 lb.

Figurine of Wondrous Power, Inferno Stone

Description: This item appears to be a black rock shot through with red and orange streaks. When held, flickering but harmless flames dance across the object's surface, producing slight warmth against the skin. This fire is not actually hot enough to ignite even the driest parchment.

Powers: This item functions using the rules for a *figurine of wondrous power* except as noted hereafter. When activated, the *stone* transforms into a fire revenant** with its weapon at the ready. The creature obeys as long as it is not given orders contrary to its nature, such as to work alongside a frost revenant, attack other fire-based creatures, and the like. Should these conditions not be met, or if the summoner is slain, the fire revenant goes rogue immediately and acts as it sees fit, either fighting if it feels victory is assured, or fleeing to

make its own way in the world. If the fire revenant is slain, or a full hour passes, it reverts to statuette form. The item can be used twice per week, but not within 1 day of a previous use.

Should this figurine ever come into contact with a *frost shard*, both objects explode, causing 6d6 impact damage to all within a 5-foot radius.

Strong transmutation; CL 12th; Craft Wondrous Item, *animate objects*; Price 20,000 gp; Weight 1/2 lb.

Figurine of Wondrous Power, Stone Token

Description: This chunk of igneous rock has an oval-shaped smooth section hollowed out and carved with unintelligible runes.

Powers: This item functions using the rules for a *figurine of wondrous power* except as noted hereafter. When activated, the *token* transforms into a stone golem and awaits its master's command. The golem obeys all orders to the letter, interpreting them with stubborn precision. If its master dies or leaves its sight, however, it forgets everything and goes berserk, attacking the nearest creature with uncontrollable abandon. The item can be used once per week and lasts for 4 hours.

Strong transmutation; CL 12th; Craft Wondrous Item, *animate objects*; Price 24,000 gp; Weight 1 lb.

Firehand Gauntlets

Description: These high-quality gauntlets appear at first glance to be made of a reddish-tinged leather, but upon careful examination their true nature becomes obvious — they are crafted from dragon's hide. While worn, they give off a softly flickering red glow as if made of crackling embers.

Powers: These gloves provide a +5 armor bonus to AC as well as fire resistance 5. Upon command, they can be made to burst into flame, scoring an additional 1d6 points of fire damage upon a successful grapple or unarmed strike. The gloves may not be removed while flaming, and if the wearer attempts to grasp anything, he could conceivably set it on fire (running one's hands through one's hair while wearing these gloves is not a good idea, for example).

Moderate transmutation; CL 10th; Craft Magic Arms and Armor, Craft Wondrous Item, dragon hide, *flame blade* or *fireball*; Price 49,150 gp; Weight negligible.

Gargoyle Robe

Description: This robe at first appears stitched from a single sheet of thick grey leather. Once

activated, the wearer goes through a remarkable transformation. Used amongst the dwarven guardians of the Ironforge clans, the *gargoyle robe* is a formidable protective item.

Powers: The robe gives the wearer the power to assume the form of a stone statue resembling a gargoyle. The wearer must remain stationary and make a successful DC 20 Hide check in order for the statue guise to become active. The stony cloak offers damage resistance 10/adamantine when in the gargoyle form, as well as resistance to acid 20, cold 20 and fire 20. These benefits cease once the wearer moves.

Creatures with fewer than 6 Hit Dice who approach within 10 feet of the wearer of the gargoyle robe (while it is active) must make a Will save (DC 12) or be frightened for 1d4+1 rounds; those who make the save are shaken for 1 round.

Strong transmutation; CL 9th; Craft Wondrous Items, *polymorph*, *stoneskin*, *scare*; Price 68,500 gp; Weight 3 lb.

Gauntlets of Ogre Strength

Description: These thick leather gloves appear at first glance to be far too big to wear, and yet they fit any creature of size Small, Medium or Large normally. The gloves make their owner's hands and forearms appear unnaturally oversized, although the owner suffers no penalty to Dexterity or fine manipulation. The cured surface appears gnarled and skin-like, even sprouting bristly hairs on the back of the hands and forearm sections.

Powers: The wearer of these gauntlets has a +4 enhancement bonus to Strength for any action that requires his hands or arms (e.g., this bonus would not apply to most uses of the Jump skill, but would count for Climb or Swim checks). In addition, once per day, the owner can attempt one phenomenal feat of strength using his hands with a +10 circumstance bonus on any related skill check. This benefit may not be used in combat.

Moderate transmutation; CL 11th; Craft Wondrous Item, *bull's strength*; Price 18,125 gp; Weight 2 lb.

Gloves of Haste

Description: *Gloves of haste* are elbow-length studded leather gloves that can be buckled securely into place.

Powers: Upon expending a charge, the wearer of these gloves may take an extra attack action during each round, as though under the effects of a *haste*

spell. The duration of this effect is determined by the caster level of the gloves' creator. These gloves are created with 50 charges.

Faint transmutation; CL 5th; Craft Wondrous Item, *haste*; Price 15,000 gp; Weight negligible.

Gloves of Spell Mastery

Description: These thin leather gloves look like any other set of leather gauntlets until worn by an arcane spellcaster. In such a case, they begin to shimmer and glow with a striking array of colors that constantly shift and change through all hues of the rainbow.

Powers: If a non-arcane caster wears these gloves, they provide a +2 enhancement bonus to Dexterity. In the hands of an arcane spellcaster, this bonus increases to +6, and the wearer also gains a greater control over her spells with a somatic component. When casting such a spell, the wearer can select to cast it as a still spell, enlarged spell, extended spell, or heightened spell (1 level maximum enhancement) exactly as if she had the appropriate feat and had prepared the spell with that special ability in place. The choice of which special ability, if any, to use is made at the moment of casting. These gloves may provide no more than one spell enhancement per use and may improve spells no more than 6 times per day. Each time a spell is improved, the bonus to Dexterity drops by 1 until 24 hours have passed.

Moderate transmutation; CL 13th; Craft Wondrous Item, *cat's grace*, creator must have the Enlarge Spell, Extended Spell, Heightened Spell and Still Spell feats; Price 54,200 gp; Weight negligible.

Grimoire of Souls

Description: This black-coated, dusty tome is protected by a thick buckle sealed with wax mixed with blood. A barely noticeable humming emanates from the spine.

Powers: Despite the name, no souls are actually entrapped within the book. Instead, the pages are inscribed with mystical images and words that strengthen and toughen the reader's soul — which of course extends to the body as well. Anyone studying the arcane diagrams and runes for a full day finds himself suffused with the book's power, raising his hit point total by 10 points permanently. Afterward, the material inside the book vanishes, leaving the pages empty. A given individual may benefit from no more than one of these *grimoires* in his lifetime.

Strong indeterminate; CL 17th; Craft Wondrous Item, *wish*; Price 27,500 gp; Weight 4 lb.

Healing Wards

Description: Healing wards are Horde totems decorated with fearsome faces to scare away evil spirits. They are also charged with magical power by Horde shamans to mend the wounds of warriors who rally to the healing wards on the battlefield.

Powers: When the creature carrying the *ward* speaks the command word, all allies in a 40-foot radius are cured of 1d8+10 points of damage. This expends one of the item's charges. Wards are created with 50 charges.

Moderate conjuration; CL 10th; Craft Wondrous Item, *Enlarge Spell*, *healing circle*; Price 43,000 gp; Weight 15 lb.

Health Stone

Description: This polished, crystalline white stone is translucent, so that anyone holding it up to the light can see it has a reddish liquid at the center. The bauble has hardness 10 and 20 hit points, but its owner can break it open at will with little effort.

Powers: The *stone* allows its bearer to recover 1 hit point of damage every uninterrupted hour she carries it on her person. The crystal may not be in an extradimensional space during this period. If desired, the holder can break the *stone* open, releasing the reddish oil within. Any creature upon whom this liquid is spread is cured as if affected by a *heal* spell. If used on an undead creature, this effect is treated as *harm* instead. Employing the oil in this manner destroys the *stone*.

Moderate conjuration; CL 9th; Craft Wondrous Item, *cure critical wounds*; Price 18,000 gp; Weight 1/4 lb.

Helm of Battlethirst

Description: These helmets are generally crafted by orcish sorcerers and bear large horns, eyes and a toothy mouth screwed up in a horrific grimace. In more civilized areas, they are sure to draw attention to the wearer!

Powers: The wearer of this helm finds his muscles bulging and his heart pounding at the thought of combat. He receives a +4 enhancement bonus to his Strength and Constitution, and has the ability to fly into a greater rage (as the barbarian ability) once per day, in addition to any similar abilities he may already possess. However, if he has not yet used the



helm's rage power, he must make a DC 14 Will save during his first action in any battle upon initially taking sight of an enemy. Should he fail, the greater rage activates on its own, without waiting for the character's conscious decision to use it. This rule applies only to the helm's greater rage power, not any other rage abilities the character may possess.

Moderate transmutation; CL 10th; Craft Wondrous Item, *bull's strength*, *bear's endurance*, *rage*; Price 42,800 gp; Weight 2 lb.

Helm of Valor

Description: Though they can be decorated at the whim of those who craft them, most *helms of valor* are as designed by their original creators — winged blue helms marked with a white star.

Powers: In addition to providing a +2 armor bonus, this helm has 50 charges each of *bull's strength* and *cat's grace* as if cast by a 5th-level caster. These charges are activated by use of a command word.

Moderate transmutation; CL 6th; Craft Magic Arms and Armor, *bull's strength*, *cat's grace*; Price 22,000 gp; Weight 3 lb.

Hood of Cunning

Description: This item is a blood-red hood that fastens about the wearer's neck with a simple silver clasp. The fabric's edges are decorated with a shimmering gilded weave. The hood may not be worn without draping it over the head — if the owner attempts to do so, it always flops back into place on its own, as if pushed upwards by a firm but gentle breeze.

Powers: The wearer of this hood receives a +4 enhancement bonus to her Intelligence and Wisdom. In addition, once per day she can add a +10 circumstance bonus on any single Intelligence- or Wisdom-based skill check. When this is done, the hood fills out and billows as if blown by a steady wind.

Moderate transmutation; CL 9th; Craft Wondrous Item, *fox's cunning*, *owl's wisdom*; Price 34,000 gp; Weight Negligible.

Horn of the Clouds

Description: This intricately carved tauren horn is twisted unnaturally into an almost corkscrew-like shape, as if wrenched about by a creature of phenomenal strength. Small puffs of smoke regularly emanate from the wider end.

Powers: When blown, the horn spews forth a dense fog similar to that provided by an *obscuring mist* spell. This fog quickly fills a 20-foot radius around the individual blowing the horn, affecting all within like an *obscuring mist* except that the owner and his allies can see through it without difficulty. The horn may be blown but once per day.

Moderate conjuration; CL 9th; Craft Wondrous Item, *obscuring mist*; Price 3,240 gp; Weight 1 lb.

Ivory Tower

Description: In its portable form, an *ivory tower* is a 6-inch-tall model of a guard tower carved from the tusks of a kodo beast.

Powers: When this item is placed on a surface and the command word spoken, the model grows to become a white stone tower 30 feet tall and 15 feet in diameter. Inside the tower's sturdy door is a clean and dry room with 4 bunks, a circular table, and 4 chairs. A ladder in the room's center leads upward; 12 feet up is a 5-foot-wide circular catwalk where archers can fire out 4 equidistant arrow slits. Continuing up to the 25-foot level, the ladder emerges through a trap door onto a platform surrounded by a 5-foot-tall crenellated wall.

The tower has no heating or cooling source (other than the natural insulation qualities of its walls). Therefore, extreme heat adversely affects it and its occupants. The dwelling does, however, provide considerable security otherwise — it is as strong as a normal stone building and resists flames and fire as if it were natural stone. It is impervious to normal missiles (but not the sort cast by siege machinery or giants). The lower door, the trap door

at the tower's top, and the shutters that can be closed over the arrow slits can all be arcane locked with the use of a second command word.

The tower remains for 12 hours or until another use of the main command word, when it instantly reverts to model form. Anyone inside the tower when it reverts falls from a similar height.

The main command word may be used to enlarge the tower 50 times, after which the ivory tower crumbles to dust.

Moderate conjuration; CL 8th; Craft Wondrous Item, *Leomand's secure shelter*; Price 28,800 gp; Weight .5 lb.

Janggo of Endurance

Description: The thundering drums of war played from high atop lumbering kodo beasts not only intimidate enemies, but are often enchanted by orcish shamans to become *janggo of endurance* that can imbue the warriors of the Horde with magical speed and endurance.

Powers: When these drums are played, all allies in a 50-foot radius may act as if under the effects of a *haste* spell. In addition, allies also gain a +1 resistance bonus on all Fortitude saves.

Moderate transmutation; CL 10th; Create Wondrous Item, *haste*, *resistance*; Price 60,000 gp; Weight 40 lb.

Khadgar's Gem of Health

Description: This flawless diamond, set in a platinum fitting surrounded by tiny amethysts, seems to flash with an inner light. When held by a character or dangled around the neck on a chain, the flickering from within gradually shifts to match its owner's heartbeat. The first of these special jewels was created by the arch-wizard Khadgar to help keep him alive during his trials. Since then, others have duplicated its special magic.

Powers: Although the gem is often found fitted on a chain or bracelet, it need not be employed in any specific body slot. One hour after it is first held, its flashing light matches the owner's heartbeat and provides him with a +6 enhancement bonus to Constitution. (This ability does not function for creatures that do not have hearts.) In addition, once per day, the bearer can grasp the jewel and call upon its protection, earning a +10 circumstance bonus on a single Fortitude save. This can be done the moment the save is called for as a free action, so long as the jewel is touching the owner's skin or within easy

reach. Upon using this power, the gem goes dark for 24 hours and does not provide its Constitution bonus until that period has elapsed.

Moderate conjuration; CL 9th; Craft Wondrous Item, any *protection* spell, *bear's endurance*, 2,000 gp diamond; Price 42,480 gp; Weight 1/2 lb.

Khadgar's Pipe of Insight

Description: The first of these pipes was carved by the arch-wizard Khadgar while he studied with the acolytes of Dalaran. Though the look of subsequent *pipes of insight* has varied slightly, most appear similar, with a stem of gnarled wood and a deep bowl made of yellowed bone.

Powers: When the pipe is used, it emits a cloud of fluorescent smoke that spreads around the user in a 25-foot radius. Everyone in this area for an hour gains the effects of a full night's rest (including healing and regained hit points). Spellcasters may prepare spells and meditate during this hour.

Faint conjuration; CL 5th; Craft Wondrous Item, *cure moderate wounds*; Price 12,000 gp; Weight negligible.

Legion Doom-Horn

Description: These large horns are carved from the tusks of the mightiest kodo beasts and ringed with hairs cut from the heads of fallen orcish heroes. The interior of a *doom-horn* is blackened as if gutted with flame, but is smooth and cool to the touch.

Powers: Once per day, the owner can blow this horn as a full-round action, producing a tremendous, resounding bass note that reverberates across the battlefield. The individual blowing the horn and all his allies within 60 feet of her position are instantly cured of 2d8+9 points of damage. In addition, all subjects increase their base land movement by 30 feet for 10 rounds. This bonus does not stack with any other speed-enhancing spells or items, such as *haste* or *boots of speed*.

Moderate conjuration and transmutation; CL 11th; Craft Wondrous Item, *expeditious retreat*, *mass cure moderate wounds*; Price 27,720 gp; Weight 5 lb.

Lightning Cloak

Description: The cloth of this blue cloak is threaded with hair-thin strands of copper, giving it a metallic sheen in the sunshine. When the command word is spoken, sparks of electrical energy dance across the cloak's surface.



Powers: Any creature using its body or handheld weapons to attack the wearer of this cloak while it is activated suffers 1d6+5 points of electricity damage on a successful strike (the attacker still inflicts damage as normal). Those using metallic weapons (such as a sword or an armored gauntlet) suffer an additional 1d4 points of electricity damage. At all times, the cloak provides the wearer with resistance to electricity 10.

Moderate evocation; CL 7th; Craft Wondrous Item, *fire shield*, *lightning bolt*; Price 54,000 gp; Weight 1 lb.

Mana Stone

Description: This crystalline sphere is a translucent, smoky black color. Inside, a turquoise liquid seems to swirl about, as if waiting to be released. The *mana stone* has hardness 10 and 20 hit points, but its owner can break it open easily with only the slightest pressure from his fingers.

Powers: A stone captures some of the essence of any magic spells its owner casts. For each hour that passes, the owner may recall one level of spells he cast so long as he was holding the stone throughout that time and has not been without it in the intervening period. For spells higher than 1st level, the owner must wait a number of hours equal to the spell's level, e.g., 5 hours recalls one 5th-level spell. The owner is not required to expend all available levels at once; so if, for example, he is waiting for a 6th-level spell but

decides after 4 hours that he needs a 3rd-level spell, he can use it and still have one level available. In times of dire need, the owner of one of these stones can break it open, producing a bluish liquid which, when rubbed across the forehead, restores all spells cast since the owner last prepared spells. Using this power destroys the stone.

Moderate transmutation; CL 9th; Craft Wondrous Item, *Rarey's mnemonic enhancer*; Price 18,000 gp; Weight 1/4 lb.

Mask of Death

Description: This horrific ebony mask is carved in the likeness of a demon's face. Tremendous curved horns sweep up and back out of the forehead and around behind the ears, while the fangs seem to glisten as if ready to bite into living flesh. When worn, the eye sockets become covered with a glassy shield that seems to glow red to any observers. When the wearer speaks, her voice utters forth like a guttural growl.

Powers: The wearer of this evil item is protected by a vampiric aura similar to that produced by a dreadlord**. Whenever the wearer hits an enemy in combat, she immediately gains hit points equal to the lesser of her character level or the base damage scored (including any magical bonuses, but not those provided by special enhancements such as extra cold damage from a *frost brand*). These hit points heal any wounds the mask's wearer has sustained, or, if she is uninjured, produce temporary hit points up to a maximum of double her character level. These extra hit points last for up to 1 hour or until the mask is removed. If a non-evil creature wears the mask, the character receives 1 negative level until he removes the item. While worn, the mask takes up both the eye and helmet body slots.

Strong transmutation; CL 13th; Craft Wondrous Item, *greater death coil**, creator must be evil; Price 93,600 gp; Weight 3 lb.

Mask of the Loa

Description: This wooden, carved mask, typically the size of a small shield, is a focus that many shadow hunters use. These masks provide protection from evil spirits and those seeking to harm the wearer.

Powers: When a shadow hunter puts on this mask, he gains the ability to see invisible and incorporeal creatures. The mask automatically reveals any invisible creature or spirit within 60 feet

of the shadow hunter. In addition, the mask protects the shadow hunter from evil spirits, undead and outsiders as if he were under the effects of a *protection from evil* spell.

Faint abjuration; CL 3rd; Craft Wondrous Item, *detect undead*, *protection from evil*, the mask must be made by a troll shadow hunter; Price 5,200 gp; Weight 2 lb.

Medallion of Courage

Description: Very few of these medals still exist; they were once given as awards to the most celebrated heroes of Lordaeron. They take the form of a 4-pointed star on a field of blue and hang around the neck on a red-and-yellow ribbon. Since these items are considered to be military decorations in the human army, anyone wearing one of these medals without authorization will be frowned upon at best, and may find herself arrested and the item impounded at worst.

Powers: This medallion occupies the wearer's amulet body slot and may not be worn without the gaudy ribbon that accompanies it. In addition to a +4 enhancement bonus to both Strength and Charisma, this item provides the wearer with a +4 morale bonus against all fear effects.

Moderate transmutation and light abjuration; CL 10th; Craft Wondrous Item, *bull's strength*, *eagle's splendor*; Price 34,500 gp; Weight 1/2 lb.

Neevil's Amazing Multi-Use Grenade

Description: This small, hand-held bomb is made of a number of interlocking pieces, like a three-dimensional jigsaw puzzle. When assembled completely, the specially treated surface makes for a perfect grip. This item was purportedly first created by the legendary goblin inventor Neevil, although he denies any interest in techno-magical combinations.

Powers: This item is one of several new technological devices that have cropped up in recent years, melding goblin mechanical know-how with gnomish magical enhancements. As with many technological items that add magic, the malfunction rating is increased by 1 over the basic item type. This particular device acts as a +1 *grenade*, but applies its bonus only to hit, not to damage. In addition, after it explodes, its pieces pull themselves out of whatever they're embedded in, crawl across the floor, and reassemble into the original

grenade. This process takes 3 rounds to complete, after which the device can be recovered and used by whoever was able to pick it up. If any of its parts cannot reach the main body within 10 rounds (say, they flew off the side of a cliff during the explosion or sank into a lake), the grenade's magic is lost.

Faint transmutation; CL 7th; Craft Wondrous Item, *mending*, caster must create the grenade himself; Price 4,040 gp; Weight 1 lb.

Neevil's Incredible Flying Gyroparasol

Description: Another item supposedly invented by Neevil, this device is more likely a knockoff of the original design enhanced by magic. The item resembles a standard gyroparasol, but is made of higher quality materials and has a special, malleable handgrip that adjusts to fit its owner's fingers.

Powers: Like most techno-magical items, this item's malfunction rating is increased by 1 over a standard gyroparasol. It does, however, possess 5 additional hit points due to its quality construction. If properly used, it eliminates up to 4d6 points of falling damage. In addition, it can both *levitate* and *fly* once per day. To use the former power, the gyroparasol must be used in an area with light or no winds, or it will automatically fail. For full flight, the winds must be moderate or less, and the user must spend his entire action every round controlling the gyroparasol's flight (even if it hovers in place). Both powers operate for only 10 rounds per day and are activated by throwing a special switch on the handle's tip.

Moderate transmutation; CL 9th; Craft Wondrous Item, *fly*, *levitate*, caster must create the gyroparasol himself; Price 16,350 gp; Weight 2 lb.

Neevil's Spectacular Voice-Activated Bomb

Description: These bombs have no fuse or other apparent triggering mechanism. They look like spheres made of iron, with only a single flat surface to keep them from rolling away if placed on even ground. Although these are usually referred to as "Neevil bombs," Neevil himself denies ever inventing such a weapon.

Powers: This bomb conforms to all the rules of an emplaced bomb except that it requires no fuse or trigger, and has an MR of 1–2. Instead of a fuse, the device detonates when it hears a pre-arranged detonation word. To prevent accidents, the word is not "programmed" into the bomb, but set by the owner

just prior to use. The owner places the device where he wants it to be, puts his hand atop the smooth surface, and says "Activate Explosives" followed by the word he wants to invoke detonation. The bomb then arms itself and waits to hear that word. It will wait up to a week before its magic runs out. Once activated, the bomb may not be disarmed; and every time it is moved, a DC 15 Use Technological Device* check must be made to avoid setting it off. The trigger word must be spoken in the original language used to arm the bomb. The device has an effective +20 bonus on Listen checks in situations where its ability to "hear" a command word is in question.

Faint transmutation; CL 7th; Craft Wondrous Item, caster must have 5 ranks in the Listen skill and must create the bomb himself; Price 320 gp; Weight 10 lb.

Periapt of Vitality

Description: This golden amulet bears a large, raised rune over a deep-red ruby that is warm to the touch.

Powers: Once per day, the periapt can grant its wearer 2d8 temporary hit points. If these hit points are not lost in combat, they go away in 8 hours.

Moderate enchantment; CL 9th; Create Wondrous Item, *aid*; Price 18,000 gp; Weight 1/2 lb.

Runed Bracers

Description: Only in recent years have sorcerers learned to recreate the magic in these powerful artifacts, golden bracers inscribed with ancient and unintelligible runes.

Powers: These bracers come in several types that grant the wearer varying degrees of spell resistance when worn. The spell resistance can be SR 13, SR 15, SR 17, or SR 19 depending on the specific bracers.

Moderate to strong abjuration; CL 15th; Craft Wondrous Item, *spell resistance*; Price 5,000 gp (SR 13); 10,000 gp (SR 15); 17,000 gp (SR 17); 26,000 gp (SR 19); Weight 5 lbs (set).

Scourge Bone Chimes

Description: A set of chimes made of human and animal bones connected by cords that glow with an eerie luminescence.

Powers: These chimes may be struck once per day, causing a deep resonance that grants the user the ability to make a vampiric melee touch attack (as *vampiric touch* cast by a 10th-level caster).

Moderate necromancy; CL 10th; Craft Wondrous Item, *vampiric touch*; Price 30,000 gp; Weight 8 lb.

Shimmerglaze Roast

Description: This small chunk of unidentifiable raw meat appears at first to be covered with some kind of yellowish slime. The coating, however, is not moist, but solid, encasing and protecting the steak within from spoilage. The complete item has the feel and weight of a chunk of rock.

Powers: If the meat is cooked over a fire, it gradually expands into a huge roast coated with a honey-sweet glaze, capable of sating the hunger of up to 12 Medium creatures (2 Small creatures take the place of 1 Medium, and 2 Medium creatures equal 1 Large for this purpose). Any who partake of this magical meal gain the benefits of a *heroes' feast* for 12 hours and will not become hungry or thirsty again during that time. The roast may only be used once.

Moderate conjuration; CL 11th; Craft Wondrous Item, *heroes' feast*; Price 3,300 gp; Weight 2 lb.

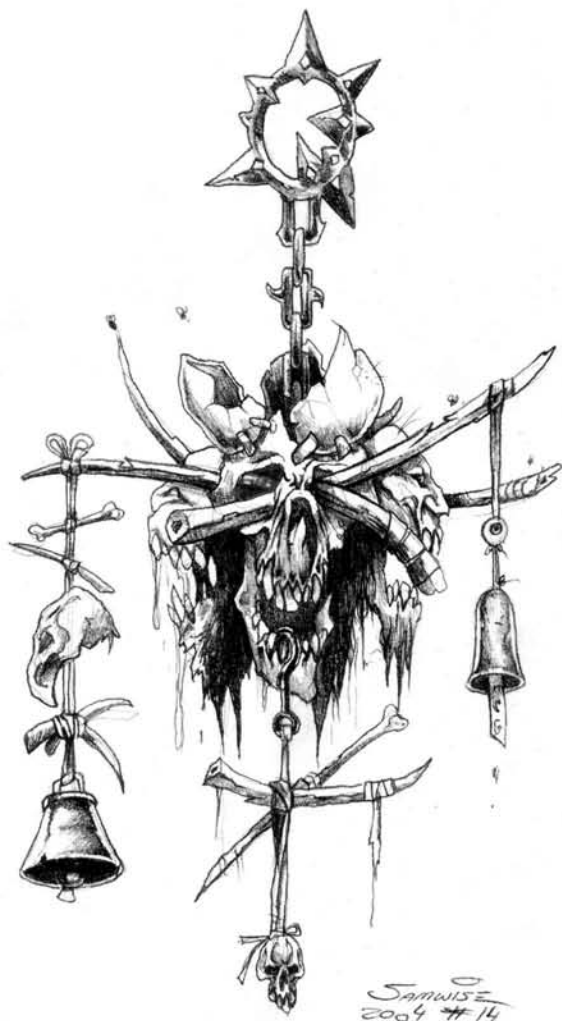

Spider Silk Brooch

Description: This large silver brooch looks as though it has been woven completely from spider silk, except for eight sharply jointed arms that extend outward like those of an arachnid. No pin or chain is required to wear this item — it attaches itself to any clothing and clings there until the owner wills it to let go.

Powers: The wearer of this brooch is immune to the effects of a *web* spell and cannot be stuck, slowed or entrapped by spider webs. He can also climb the webs of giant spiders with the same ease as he would climb a rope ladder. Once per day, the owner can throw a *web* spell as a standard action with a single command word.

Moderate conjuration; CL 9th; Craft Wondrous Item, *freedom of movement*, *web*; Price 9,000 gp; Weight 1/2 lb.

Spiked Fel Collar

Description: This black dog collar is ringed with wicked-looking barbed spikes and comes with its own leash. The collar remains fully open at all times, as if it were truly wrapped around a hound's neck, even though nothing is inside.

Powers: If the leash is held and the collar released, it falls to a position exactly where a large dog would be expected to stand and follows at the owner's heels in the manner of a trained beast. While the leash is held this way, the owner can speak a single command word to summon a *fel stalker***, which appears within the collar. The creature may then be released to attack its master's enemies or given any other simple commands (*heel*, *guard*, *fetch* and so on). The *fel stalker* remains for up to 1 hour before disappearing. The leash and collar can be used once per day.

Moderate conjuration; CL 10th; Craft Wondrous Item, *summon monster III*; Price 16,200 gp; Weight 1 lb.

Talisman of Evasion

Description: This gold amulet is bejeweled with sapphires and a large blue diamond that pulses with light when its powers are employed.

Powers: The wearer of this talisman gains the *rogue* ability of the same name. If exposed to any effect that normally allows a character to attempt a Reflex saving throw for half damage, the talisman's wearer takes no damage with a successful saving throw. The talisman's powers can only be used if the owner is wearing light

armor or no armor. If the character already has evasion as a special ability, this talisman provides no further benefit.

Moderate transmutation; CL 9th; Create Wondrous Item, *cat's grace*; Price 22,250 gp; Weight 1/2 lb.

Talisman of Evasion, Greater

Description: This amulet looks almost identical to a standard *talisman of evasion*, except that the diamond at the center is of the purest white. As the higher quality of its diamond suggests, this item is a much more adaptive version of the basic *talisman of evasion*.

Powers: If the wearer of this amulet does not possess evasion as a special ability, the *greater talisman* provides it. If the wearer already has evasion, this ability is upgraded to improved evasion, so that the owner takes half damage even if his Reflex save fails. If the wearer already has improved evasion, it is upgraded to supernatural evasion, which quarters all damage even on a failed save. In all cases, the wearer also receives a +1 luck bonus to Reflex saves.

Strong transmutation; CL 15th; Create Wondrous Item, *cat's grace*, *divine favor*; Price 44,750 gp; Weight 1/2 lb.

Tome of Retraining

Description: This small book looks more like a notebook than a full-fledged arcane tome. Clearly written instructions inside the front page explain the item's purpose to any interested reader. Anyone reading these instructions must decide immediately whether or not to employ the *tome's* power; if they choose not to do so, it closes itself to that individual forever.

Powers: Any character of 10th level or lower can read this book. Characters of a higher level see only blank pages. Once the book's magic is invoked, the reader loses all feats he has learned over the course of his career, including those gained at 1st level, with the sole exception of feats that can only be chosen at character creation. The reader must then spend 3 full days studying the arcane writings and instructions that appear in the book's pages in response to his own desires. After that period has elapsed, he may select an entirely new arrangement of feats, essentially replacing the ones he lost with new ones. Each new feat takes the place of ones earned at specific points in his career and must follow all the applicable restrictions — i.e., a new feat replacing one taken at 1st level is treated as having been selected at 1st level for purposes of prerequisites. A character may not select a feat that

may only be taken at character creation and must meet all prerequisites per the normal rules. Should the 3-day study period be interrupted for any reason, other than eating, sleeping, and at most 1 hour of other activities, the tome's magic is broken and the character's old feats return at the end of the delay period. Regardless of the result, the tome only works once, crumbling to dust when its magic is expended.

Strong transmutation; CL 18th; Craft Wondrous Item, *shapechange*; Price 8,100 gp; Weight 1 lb.

Warden's Cloak

Description: Specially constructed for the night elves' wardens, these green velvet cloaks bear a fringe of deadly, razor-sharp blades along the hem, resembling the wings of an owl. Wardens learn to shift and swing the cloak dramatically, presenting the blade fringes to anyone who might get too close. The cloak is both a defensive measure against sneak attacks and a potent weapon for the warden when surrounded by enemies. It also provides numerous knife blades for the warden to use with her *slicing torrent* ability.

Powers: This bladed *cloak of elvenkind* provides a number of special magical abilities to a warden in addition to its martial and defensive measures.

Spinning in the cloak grants a special attack that targets everyone within 10 feet of the warden with its brutal, slashing fringes. This action requires a full attack. When used as a melee weapon, the cloak inflicts 1d8 points of damage (the wearer's Strength bonus damage applies) with a threat range of 20 and a critical multiplier of x2.

The deadly blades also grant one additional attack of opportunity with the cloak. This stacks with any other attacks of opportunity granted by feats or spells.

Anyone attempting to sneak attack the warden in combat while she is wearing the cloak must make a successful DC 25 Tumble or Bluff check as the cloak swings and swipes. Failure means the attacker immediately takes 1d8 points of damage and is forced back 5 feet.

The warden is impossible to flank while wearing this cloak since the blades present a significant threat.

The cloak provides a focus for her *slicing torrent* class ability while she wears it.

In addition to the cloak's bladed properties, the warden can also use the following magical abilities:

- *Feather fall* 3/day
- *Jump* 3/day

- *Levitate* 1/day
- *Spider climb* 1/day

Untrained individuals attempting to wear the cloak must make a DC 15 Reflex save each round while running, tumbling or performing any action that requires intense physical motion. Failure means that the cloak cuts the wearer and does 1d4 points of damage. A 1st-level wizard can use the cloak effectively.

Faint illusion; CL 5th; Craft Wondrous Item, *feather fall*, *invisibility*, *jump*, *levitate*, *spider climb*, creator must be a night elf; Price 29,500 gp; Weight 5 lb.

Warsong Battle Drums

Description: This pair of moderately sized percussion instruments is made of dried skin stretched over the skulls of defeated Horde enemies. A long strap allows their owner to wear them across his chest like a bandolier.

Powers: When the drums are played as a full-round action, the owner makes a DC 15 Perform (percussion instruments) check. If he succeeds, all allies hearing the inspirational rhythms feel their hearts beat faster and their hands tighten more firmly about their weapons. For the next 10 rounds, everyone affected receives a +1 morale bonus on melee damage rolls. For every 5 points by which the Perform check succeeded, a further +1 is added to the bonus (i.e., +2 if the check succeeded by 5, +3 at 10, and so on). If these drums are played for the Drums of Courage feat, the bonuses from that feat stack with these benefits (an exception to the normal rule against like benefits stacking). These drums may be played once per day.

Moderate transmutation; CL 9th; Craft Wondrous Item, *rage*, caster must have the Drums of Courage feat; Price 9,720 gp; Weight 2 lb.

Minor Artifacts

Although several of the more powerful artifacts on Azeroth have been described in other *Warcraft* books, many more await discovery by adventurers. Not all are supremely powerful, campaign-altering items. This section lists several of these minor artifacts.

Horn of Cenarius

When Cenarius perished, the location of his magical horn was lost from the ken of the mortal races. According to legend, this powerful item had the power to call upon the spirits of all night elves. Although many have

searched for it, none have discovered its location. Rumors suggest that the forest itself claimed this lost artifact for all time, and yet one day it may again appear when the need for it is great enough.

Although Cenarius normally kept his *horn* for himself, he loaned it to others on occasion. According to tales, the *horn* has the following known powers, in addition to any others as yet undiscovered:

Body and Mind: The bearer gains a +2 inherent bonus to all 6 primary attributes.

Call of the Spirits: Once per day, the bearer may blow upon the *horn* to summon the righteous might of the night elves. This summoning may not be done to aid in the destruction of nature or its environs, only to attack those who are abusing the land or its indigenous creatures. For 5 rounds after the *horn* is blown, immense silvery stars rain down upon a site designated by the bearer. All creatures and structures within a 100-foot radius, except those friendly to the *horn's* owner or native to the land, suffer 20d6 points of divine damage (no saving throw) per round. This damage does not affect the landscape, natural plants, indigenous creatures, the bearer of the *horn* or his allies.

Cloak of the Night: When outdoors at night, the bearer is protected by cold resistance 10, fire resistance 10 and spell resistance 21. If the character is a night elf, his shadowmeld ability bonus is doubled.

Heart of the Scout: The bearer gains 2 effective levels of the scout class, in addition to those he already possesses. If he has no levels of scout, this ability provides no benefit.

Lore of the Wild: The bearer can always take 20 on all Survival or Knowledge (nature) checks as a standard action.

Speed of the Wind: The bearer's base land speed is increased by 30 feet and he is treated as having the effects of *haste*, although this power cannot be dispelled or countered.

Strength of Soul: The bearer has a bonus of +50 hit points and regenerates 1 lost hit point every 10 minutes.

A rumor hints that the *horn's* bearer will gradually be turned into a night elf if he carries it for long, but as only night elves have possessed this item for any length of time, this legend cannot be substantiated.

Strong transmutation; CL 23rd; Weight 5 lb.

The Orbs

The Orbs are powerful minor artifacts of unknown origin. Though each is a fist-sized gem that grants the

wielder a similar set of magical enhancements, the various types have their own particular appearances and unique powers associated with them:

Orb of Corruption: A diamond crudely carved into the form of a skull, the *orb of corruption* grants the bearer a +10 competence bonus on all damage rolls. All damage dealt by the bearer is considered chaotic damage. All attacks made by the bearer also ignore all armor bonuses to AC.

Strong transmutation; CL 18th; Weight 3 lb.

Orb of Darkness: A sphere of polished obsidian, the *orb of darkness* grants the bearer a +10 competence bonus on all damage rolls. All damage dealt by the bearer is considered unholy damage. When the character carrying the *orb* deals a killing blow, he has the option to immediately raise the creature as though with *animate dead* cast by a 20th-level caster.

Strong transmutation; CL 20th; Weight 3 lb.

Orb of Fire: A sapphire sphere glowing with an inner fire, the *orb of fire* grants the bearer a +10 competence bonus on all damage rolls. All damage dealt by the bearer is considered fire damage. The bearer of an *orb of fire* may make attacks as though she possessed the Whirlwind Attack feat.

Strong transmutation; CL 17th; Weight 3 lb.

Orb of Frost: A sphere of smooth, ice-cold topaz, the *orb of frost* grants the bearer a +10 competence bonus on all damage rolls. All damage dealt by the bearer is considered cold damage. When a character bearing the *orb* makes a successful hit on a target, the target suffers a -4 penalty on initiative checks and his movement rate is halved for 1d4 hours.

Strong transmutation; CL 16th; Weight 3 lb.

Orb of Lightning: An enormous pearl with sparks dancing across its surface, the *orb of lightning* grants the bearer a +10 competence bonus on all damage rolls. All damage dealt by the bearer is considered electrical damage. The bearer of an *orb of lightning* may cast *dispel magic* at will, and *lightning bolt* once every 10 minutes, both as if cast by a 15th-level caster.

Strong transmutation; CL 17th; Weight 3 lb.

Orb of Venom: A jade sphere inscribed with a maze of grooves, the *orb of venom* grants the bearer a +10 competence bonus on all damage rolls. All successful attacks made by the bearer are considered to be made by a *wounding* weapon. The bearer of an *orb* may cast *contagion* at will.

Strong transmutation; CL 15th; Weight 3 lb.

Shadow Orb

Description: The *shadow orb* was constructed by the Shadow Council and given to Gul'dan. Shortly before his death, the *shadow orb* was shattered into ten different pieces that became scattered throughout the underground tomb of Sargeras.

Years later, the night elf warden Maiev recovered the *shadow orb* and used it in her bid to recapture the renegade Illidan. Unfortunately, the *shadow orb* was lost during a battle and was once again shattered into ten different pieces. This time, they were scattered all across Azeroth. Some believe there may even be a piece or two hidden somewhere out in the Twisting Nether.

When assembled, the *shadow orb* is a smooth, solid black globe about 5 inches in diameter. It glows with a faint violet light and is surprisingly heavy for its size. The individual *shadow orb* fragments are jagged and non-luminous.

Powers: When two fragments of the *shadow orb* are touched to each other, they immediately fuse into a single piece. The seam disappears as though the fragments had never been separate.

Each of the ten separate fragments of the *shadow orb* has the same ability. When two or more fragments are brought together and fused, the resulting fragment loses its previous powers but gains new, more powerful abilities.

See the Campaign Seed sidebar for ideas on how to use the *shadow orb* as the basis of an entire campaign story arc.

1 Fragment

This is the smallest fragment of the *shadow orb*. To activate its power, you must touch it to a weapon. The fragment fuses itself with the weapon, which takes on the physical appearance of a masterwork weapon and gains a +1 enhancement bonus.

The fragment can be removed as a full-round action. Touching another fragment to this one increases the fragment's size and power (see 2 Fragments, below).

Faint evocation; CL 3rd; Weight 1 lb.

2 Fragments

This fragment is activated as the 1-fragment *shadow orb* and grants the same bonus, plus the following:

The eyes of the weapon's wielder glow faintly, and the wielder gains low-light vision.

Faint evocation and transmutation; CL 3rd; Weight 2 lb.

Campaign Seed

An epic quest to reconstruct the *shadow orb* makes a great basis for an entire campaign. Another piece of the *shadow orb* can be recovered at various key levels throughout the campaign. While a single fragment is individually a “weak” treasure, granting only a +1 enhancement bonus to a single weapon, it should be assumed that a newly discovered fragment will be recombined by the adventuring group with another fragment to generate a much more powerful piece. In a campaign where single fragment pieces are handed out as encounter rewards over time, the following levels are appropriate points for such rewards.

The first fragment should be a reward for 5th-level characters. The second fragment should be given to 7th-level characters, the third to 9th-level characters, the fourth to 12th-level characters, the fifth to 15th-level characters, the sixth to 18th-level characters, the seventh to 21st-level characters, the eighth to 24th-level characters, the ninth to 28th-level characters, and the final fragment should be given as a reward to 32nd-level characters.

Combined fragments can be given as rewards as well, but this doesn't change the level at which a fragment should be awarded; only the number of times a fragment can be a quest reward is decreased. Use the combined total of fragments to determine the appropriate level for obtaining a new fragment.

For example, if the group already has three combined fragments, the GM doesn't need to give a single fragment as a reward at 12th level. Instead, the GM could give a larger fragment (say, with two pieces already fused) at 15th level. Because the resulting piece will have five fused fragments, that is the size that determines the appropriate level (regardless of whether players actually combine the fragments or not).

3 Fragments

This fragment is activated as the 2-fragment *shadow orb* and grants the same abilities, plus the following:

The wielder's form darkens with shadows, granting her a +5 circumstance bonus on Hide checks.

The fragment can be removed from the weapon as a full-round action. Touching another fragment

to this one increases the fragment's power, but also causes the fragment to drop off the attached weapon (see 4 Fragments, below).

Faint evocation, illusion and transmutation; CL 3rd; Weight 3 lb.

4 Fragments

Smaller fragments are too weak to grant their powers without being directly attached to a weapon. Once four or more fragments are fused, the resulting fragment is powerful enough to operate free of restrictions.

To activate this fragment, simply hold it out and release it. The fragment starts to orbit the owner's torso like a massive ioun stone.

The owner gains a +1 shadow bonus on all attack rolls and a +1 deflection bonus to AC.

The owner's eyes glow faintly, and she gains low-light vision.

The owner's form darkens with shadows, granting her a +5 circumstance bonus on Hide checks.

Faint abjuration, evocation, illusion and transmutation; CL 5th; Weight 4 lb.

5 Fragments

This fragment is activated as the 4-fragment *shadow orb* and grants the same bonuses, plus the following:

On command, the owner may cast *levitate* on herself.

Faint abjuration, evocation, illusion and transmutation; CL 5th; Weight 5 lb.

6 Fragments

This fragment is activated as the 5-fragment *shadow orb* and grants the same bonuses, except as follows:

The owner's shadow bonus on all attack rolls improves to +2, and circumstance bonus on Hide checks improves to +10.

Once per day, the owner may summon one shadow. This power otherwise functions as the spell *summon monster I*.

Faint abjuration, evocation, illusion and transmutation, strong conjuration; CL 7th; Weight 6 lb.

7 Fragments

This fragment is activated as the 6-fragment *shadow orb* and grants the same bonuses, except as follows:

The owner's deflection bonus to AC increases to +2. She acquires darkvision out to 60 feet. She may use the shadow summoning ability twice per day for 1d3 shadows each.

Faint abjuration, evocation, illusion and transmutation, strong conjuration; CL 9th; Weight 7 lb.

8 Fragments

This fragment is activated as the 7-fragment *shadow orb* and grants the same bonuses, except as follows:

The owner's shadow bonus on all attack rolls and deflection bonus to AC both improve to +3, and circumstance bonus on Hide checks improves to +15. She gains a fly speed of 40 feet, with good maneuverability. Twice per day she may summon 1d4+1 shadows. Once per day, the owner may cast *shadow walk*.

Faint abjuration and transmutation, strong conjuration, evocation and illusion; CL 11th; Weight 8 lb.

9 Fragments

This fragment is activated as the 8-fragment *shadow orb* and grants the same bonuses, except as follows:

The owner's shadow bonus on all attack rolls and deflection bonus to AC both improve to +4, and circumstance bonus on Hide checks improves to +20. She may summon shadows three times per day.

The owner heals 1 point of damage per level every hour rather than every day. (This ability cannot be aided by the Heal skill.) Nonlethal damage heals at a rate of 1 point of damage per level every 5 minutes. Lost limbs, organs and other missing body parts grow back after 1 minute.

Faint abjuration and transmutation, strong conjuration, evocation and illusion; CL 15th; Weight 9 lb.

10 Fragments

When the final fragment of the *shadow orb* is reconnected with its cousins, there is a burst of darkness (manifesting as a *deeper darkness* spell from a 20th-level caster centered permanently on the point where the *shadow orb* becomes whole).

The completed *shadow orb* is activated as the 9-fragment *shadow orb* and grants the same bonuses, except as follows:

The owner's shadow bonus on all attack rolls and deflection bonus to AC both improve to +5. She may summon 2d6 shadows three times per day. She gains regeneration 5. Lost limbs, organs and other missing body parts grow back after 1 minute.

On command, the owner can become incorporeal. The effect is dismissible.

The owner can make melee touch attacks that deal 1d6 points of Strength damage to a living foe. A creature

Shadow Bonuses

Shadow themes are strong throughout the **Warcraft** universe. "Shadow" is a new bonus type common to many items and spells created by the Shadow Council and other such nefarious organizations. Shadow bonuses to the same roll do not stack with each other, just as enhancement bonuses do not stack with each other. Shadow bonuses do stack with other non-shadow bonuses, such as enhancement, insight, luck and so on.

reduced to Strength 0 dies and becomes a shadow 1d4 rounds later. This is a negative energy effect.

The dark power of the completed *shadow orb* can be overwhelming. The owner's most notable obsession grows stronger over time. In the case of Gul'dan, he died trying to acquire the *eye of Sargeras*. Maiev became obsessed with recapturing Illidan to the point where all other considerations were secondary.

Faint abjuration and necromancy, strong conjuration, evocation, illusion and transmutation; CL 20th; Weight 10 lb.

Shield of the Deathlord

Exactly who created this shield is unknown. Some believe the Lich King himself designed it for his most powerful death knights, while others feel it is a demonic artifact brought to Azeroth during one of the great wars and lost by its original owner. It might also be from a different world entirely, flung into the Twisting Nether eventually to find its way to Kalimdor.

When first found, the *Shield of the Deathlord* looks fairly unassuming — a slightly curved sheet of darkened steel rimmed with a jagged border and covered with what appear to be scratches and dents across its surface. If picked up by a creature that is not lawful evil in alignment, it acts as a +3 *light steel shield* (and identifies as such), but its power slowly attempts to convert the bearer to the cause of evil. Each time he slays an enemy in battle, the shield's owner must make a Will save (DC 10 + 1 for each week he has owned the shield) or shift alignment one step toward lawful evil — for example, lawful good to lawful neutral, or chaotic neutral to either chaotic evil or true neutral. The change is so subtle that the owner might not even be aware that anything unusual is happening.

Should the owner be lawful evil or convert at last to that alignment, the shield's true nature becomes known.

To the owner, it now appears to be covered with skulls that bear demonic horns and sharp canine teeth. It is now a +5 *light steel shield* with the following additional powers:

- The holder gains a +1 inherent bonus per character level to his Constitution.
- All 1st-, 2nd-, and 3rd-level spells are doubled in the manner of a *ring of wizardry*, but this bonus does not stack with that item or any similar magic.
- Upon command, the bearer is enveloped in blood-red flames that duplicate the effect of the *immolation** spell.

This shield can always be used without any combat penalties, even if the owner cannot normally use shields. The shield has an arcane spell failure and armor check penalty of zero.

Strong transmutation and evocation; CL 22nd; Weight 10 lb.

Soul Gem

The *Soul Gem* is a minor artifact with a single, potentially devastating power. The jewel appears to be any of a number of other common baubles found in treasure hordes across the land. Only when the quarter-inch blue jewel is exposed to

detect magic does its strong power reveal itself, although the type of magic is indeterminate.

The gem's true nature cannot be discovered until it is dipped in blood from an intelligent living creature sacrificed for this purpose. When this ceremony is completed, the jewel swells to 10 times its normal size and begins to glow with a pulsing violet light. The gem can now be used to entrap any one living creature up to Colossal size with but a single command word. The target must be within 60 feet for this power to work, and it receives no saving throw. Treat this entrapment as an *imprisonment* spell, except the target creature is reduced in size and held within the *Soul Gem* itself.

The creature within can be released by a second command word from the creature that entrapped it, or held forever in that state. No other known magic can release a trapped individual — not even a *freedom*, *miracle* or *wish* spell. The soul within can also be used for a variety of vile demonic purposes known only to a few tortured sages and elders of the Burning Legion. When the jewel is emptied, by whatever means, it returns to its original form. The *Soul Gem* cannot hold more than one creature at a time and may not trap another while one remains within.

Strong indeterminate; CL 21st; Weight negligible when empty, 1 lb. when it holds a creature.



Sunstorm lay on the ridge, looking down at the Horde encampment in the valley below. In the dim, pre-dawn light he counted at least sixty orcs and a trio of raider wolves sleeping near the dying embers of a campfire. The orcs had apparently assigned only two grunts to the duty — and one of them was asleep. He would have guarded the camp with at least two shifts of three men; the place was easy pickings. With 200 battle-hardened Alliance soldiers less than a mile away, Sunstorm knew the fight could be over within minutes.

Instead, he would follow his orders.

The Alliance Assembly wanted intelligence, and the tinkers had promised that they could get it. To Sunstorm's left, Nuji Kodosbreath looked at him expectantly. "We're ready to go," he whispered.

Sunstorm nodded. The dwarf pulled a strange crossbow from his belt. Pointing it toward the slate-colored sky, Nuji pulled the trigger. The bolt burst into flame as it left the weapon and carved a blazing slash across the sky.

"First, they'll take out the guard," Nuji said. A man arose from behind a bush and rolled a grenade between the guard's feet. A quiet *chuff* tossed powder at the guard, who twitched and froze in mid-cry. "Total paralysis," said the dwarf. "The dust is related to the same toxin Zecker used for his wand. Believe it or not, you have to milk a spider to—"

"The wolves," said Sunstorm. "They're awake." One was on its feet already, looking toward the fallen guard.

"Wait for it," Nuji replied, as all three wolves padded across the camp. "Closer..." Sunstorm gritted his teeth as the lead wolf sniffed at the guard. "Now!" hissed Nuji, just as a pair of elves stepped onto the road. When the wolves bayed and charged, the first elf launched a net that wrapped around the beasts. The second pulled a rope that activated a steam engine hidden in the woods, dragging both net and howling wolves across the road and up into a tree.





"That woke 'em up," said Nuji. "Time to bring out everyone." As orcs leapt to their feet and snatched up weapons, the dwarf pulled at a ring hanging by his ear and the steam whistle mounted on his helmet let out a piercing shrill.

"Much better," grumbled Sunstorm. Horde archers loosed arrows in their direction as their commander circled his troops in a defensive formation. When a half-dozen steamwarriors stepped out of the woods, the archers switched targets, following the lead of the headhunters hurling spears at the tinker warriors. With the spears and arrows bouncing off their thick armor, the saws mounted on the arms of the steamwarriors roared into life. Tossing clouds of woodchips behind them, the steamwarriors toppled trees and pushed the orcs toward the center of the camp.

"Six against sixty," said Sunstorm. "You really think those are good odds? They can't win this fight on their own. Let me send in the rest of the unit before your men are slaughtered."

"The steamwarriors aren't fighting the orcs," said Nuji. "They're driving them. Here come the dirtworm crews with the big finish."

A low rumbling shook the valley as the ground beneath the Horde troops shuddered and collapsed. Cursing, the orcs and trolls tumbled into the 15-foot-deep hole now beneath them. A moment later, a pair of gnomish helicopters crested the far rise, dragging a cable-mesh net that they dropped over the mouth of the hole. From the surrounding bushes, tinkers leapt forward and began spiking the net in place.

Nuji let out a pair of blasts on his steam whistle and the tinkers in the valley below joined him in a victory cheer. "I heard the Assembly wasn't too happy when your men killed all the orcs in the last raid. I wonder how much information they'll be able to get out of sixty prisoners," he said, grinning.



CHAPTER FIVE: TEMPLE OF BOOM



Magic? That's commonplace stuff, really. Well, it's also the stuff that keeps bringing the demons back and that swells the ranks of the Scourge... but, truly, wizards and warlocks and necromancers are everywhere. What's the big mystery? Everyone knows magic will corrupt your soul eventually.

Technology? Now *there's* an art worth talking about! Historians may not always acknowledge the fact, but those who fought on the battlefield understand that the Third War could not have turned out as it did in the absence of technology. How were troops moved quickly across great distances? What blasted gargoyles and dragons alike from the skies? How were enemy buildings demolished? Sure, magic seethes within Azeroth's very veins. Yet technology relies upon ingenuity, know-how, craft, physical materials — and perhaps not a little disregard for one's safety. (Sudden explosions, unfortunately, are a hazard of the trade.) Magic messed up the world; technology will take it to grand, new heights.

Fantasy and Technology

One might think that a fantasy setting would run into problematic contradictions with the inclusion of technology as a key aspect of its essential character. In the *Warcraft* computer games, such potential contradictions become less significant, perhaps, in the context of creating and improving various units so that magic and technology work together in achieving specific mission goals. With a fantasy roleplaying setting, however, expectations of internal consistency must be met. Why doesn't magic simply pervade every aspect of life on Azeroth? Why should goblins *need* zeppelins or dwarves their blunderbusses? If magic already lets one fly and bombard enemies, the presence and development of technological devices can seem a bit, well, not so fantasy-like.

Such is not the case in **Warcraft**.

A great strength of the **Warcraft** setting lies in the fantastical nature of technology. Sure, it has firearms and siege weapons, which we know well from Earth's history. Yet dwarves fashion those blunderbusses... and goblins build zeppelins, gnomes develop submarines, and the undead employ meat wagons. Technology in **Warcraft**, one might say, gives purpose and distinction to traditional fantasy elements such as dwarves, goblins, gnomes and undead. It does not supplant or undermine magic; rather, it works seamlessly alongside magic, actually reinforcing and heightening the sense of fantasy in the setting.

Not unlike the wonder of spells that can call forth lightning storms or put someone to sleep, the scope of and possibilities for technological devices in **Warcraft** are limited only by the imagination. Magic and technology can, of course, work together — spells and rituals and mysterious components, for instance, creating a *+1 flintlock pistol of manaburn*. More intriguingly, though, technology offers its own kind of "magic." From skate boots to valuators, portable kitchens to rainmakers, gnomish helicopters to lightning nets, technological devices use phlogiston, steam, oil, gears and pistons to do fantastical things.

On Azeroth, the magic of technology carries the sense of the still-freshly discovered: the world stands at the edge of a great renaissance of innovation. How its peoples embrace or reject this innovation will decide much about their place in Azeroth's history. Mages had their chance. Tinkers own the future.

Light the fuse....

What's in this Chapter?

Chapter Five is devoted to expanding upon the rules for creating and using technological devices and to presenting a veritable horde of technological devices both new and derived from the *Warcraft* computer games.

Below, you will find maneuverability rules for vehicles, an extensive look at malfunction effects, details on collaborative projects and masterwork devices, and further discussion of the favored materials for tinkers of different races. The bulk of the chapter then consists of descriptions of technological devices, including adventuring gear, special substances and items, vehicles and weapons — as well as the unusual and infamous Zecker devices.

For the core rules on creating technological devices, see Chapter Three in the **Warcraft RPG**. You can also find a small selection of technological devices in Chapter Three of that book. Finally, siege weapons and ammunition are detailed in Appendix One of the **Alliance & Horde Compendium**.

Creating and Using Technological Devices

This section expands upon the rules for creating technological devices originally detailed in Chapter Three of the **Warcraft RPG** and offers additional discussion on the use and function of technological devices in your game.

Vehicles: Movement and Maneuverability

Tinker-built vehicles can travel at speeds that match and even exceed the fastest mounts. Only skilled pilots keep dwarven siege engines or gnome helicopters from becoming crumpled wrecks of metal, and even they sometimes have trouble with the fickle and unwieldy controls of some vehicles.

Piloting a vehicle requires the character at the controls to make regular maneuverability checks to maintain control of the vehicle. Maneuverability checks are based on a vehicle's Maneuverability rating. While vehicles may travel up to their top speed, Maneuverability ratings assign a speed increment that indicates how quickly a vehicle becomes difficult to control. For each speed increment beyond the first, the vehicle's pilot suffers a -4 penalty on any Maneuverability checks.

To maintain control of a vehicle traveling in a straight line and at a constant speed, pilots must make regular standard Maneuverability checks with their Use Technological Device* skill. In travel under normal conditions, a standard Maneuverability check requires a pilot to make a DC 10 Use Technological Device* check once per hour. In combat, a vehicle is considered to move on its pilot's initiative count, and a standard Maneuverability check requires a DC 20 Use Technological Device* check once per round.

If the pilot succeeds at a Maneuverability check, he is considered to be in control of the vehicle and may perform a standard action after the move action. If he fails, the check becomes a full-round action and the pilot cannot perform any actions until the following round, at which point he must attempt to make the check once again.

Attempting to do more than maintain control of a vehicle and move in a straight line can also require Maneuverability checks:

Rating	Speed Increment
Clumsy	5 mph (45 ft./round)
Poor	10 mph (90 ft./round)
Average	15 mph (135 ft./round)
Good	20 mph (165 ft./round)
Perfect	25 mph (220 ft./round)

Changing Speed: A pilot may accelerate or decelerate a vehicle up to one speed increment and require only a standard Maneuverability check to maintain control of the vehicle. For each additional speed increment the pilot accelerates or decelerates the vehicle, he must make a Maneuverability check with a -4 penalty per increment.

Turning: A vehicle can be turned up to 45 degrees and require only a standard Maneuverability check by the pilot to maintain control. Turning more than 45 degrees requires a full-round Maneuverability check with a -4 penalty per additional 45 degrees.

Drifting: The pilot may drift a vehicle while it's moving, sliding the vehicle laterally to the left or right while continuing to travel forward. For each vehicle width a vehicle drifts, a Maneuverability check must be made with a -4 penalty.

Example: Maneuverability in Combat

In search of thunder lizards, Ryon Quarvel is riding into the Barrens on a steam horse with a top speed of 60 mph (530 ft./round) and Average maneuverability. Traveling for several hours at 45 mph, he is required each hour to make standard Maneuverability checks — a DC 10 Use Technological Device* check with a -8 penalty for each of the two speed increments (15 + 15 + 15 = 45 mph) beyond the first.

Suddenly encountering a pair of thunder lizards, Ryon enters combat at 45 mph (390 feet/round). As he rides past the lizards in the first round, he makes a DC 20 Use Technological Device* check with a -8 penalty due to speed. In the second round, he slows two speed increments to 15 mph (130 feet/round) and turns 180 degrees. This action requires a DC 20 Use Technological Device* check with a -4 penalty for the second speed increment decelerated and a -12 penalty for each 45 degrees turned beyond the first, for a total penalty of -16.

In the third round, as he lowers his lance to attack, Ryon is traveling 15 mph. As this is within the first speed increment for a vehicle with Average maneuverability and he is traveling in a straight line, Ryon makes his standard Maneuverability check (a DC 20 Use Technological Device* check) with no penalties. He succeeds on the check. The check is thus considered only a move action, allowing Ryon to attack the lizards in the same round.

Malfunction Effects

Stories of the amazing devices created by tinkers are matched in number by stories of their malfunc-

tions. At best, vehicles don't move and weapons don't fire. In the worst situations, those using the devices get injured — sometimes by enormous explosions that occur when the phlogiston-fueled boilers powering the devices are ruptured.

A tinker maxim says: "Two devices may be constructed from the same plans, but each will malfunction in its own manner." All devices created by tinkers in the world of **Warcraft** have a Malfunction Rating (MR), set between 0 and 5 during the device's creation. When a skill check or attack roll is made while using the device and the result is equal to or under the device's Malfunction Rating, a malfunction occurs.

The immediate effect of a malfunction is that the device will stop operating until repaired (as explained in Chapter Three of the **Warcraft RPG**) But sometimes malfunctions have longer lasting — and to tinkers, much more frustrating — effects.

Table 5-1: Malfunction Effects lists a number of possible malfunction effects. While constructing a device, players and the GM may choose a particular effect from the table or agree upon a different one. Alternately, devices constructed by the player can have their Malfunction Ratings decreased by -1 (to a minimum of 1, with the adjustment made after device construction is complete) by allowing the GM to roll a random malfunction effect from the table each time a malfunction occurs. Note that whether a malfunction effect is chosen or occurs randomly, in cases where it would not have a negative effect an alternate malfunction effect should be selected or rolled.

Function Lock: For 2d6 rounds, the device continues to repeat the actions taken in the round in which it malfunctioned. Weapons continue to fire and their direction cannot be altered; vehicles continue to move uncontrollably in the same direction at the same speed. All ammunition or fuel loaded into the device is consumed or destroyed in the malfunction.

Mangled: The device can be repaired, but it will never look the same again. For all purposes related to sale or valuation of the device, the market value is halved. If a device suffers this malfunction effect twice, it is considered permanently broken.

Leaky: After suffering this malfunction, the device will always require regular applications of some substance in order to continue operating. This may be a lubricant to keep gears turning smoothly, or

Table 5-1: Malfunction Effects

d20	Malfunction
1	Function lock
2	Mangled
3	Leaky
4	Total failure
5	Inhibited function
6	Degradation
7	Balky
8	Complex device
9	Awkward operation
10	Backfire
11	Frangible
12	Control complications
13	Bulky
14	Critical component
15	Ablative
16	Noisemaker
17	Fused function
18	Fragile
19	Pain machine
20	Phlogiston explosion

phlogiston to replace what is seeping out of a leaky boiler. If the substance is not applied daily, the device ceases to function.

Total Failure: Not only does the malfunctioning function fail, so do all other functions of the device. All functions must be repaired individually before they will work again.

Inhibited Function: Once the device is repaired, the time factor on which it operates (whether startup time, the time that passes between initiation of the device's function and its completion, or some other factor) is doubled. A weapon that could fire each combat round may now only fire every 2 rounds; a vehicle that required 3 minutes to start now requires 6, and so forth. Though the device may be repaired to regular (albeit slower) operation with a Craft (technological device*) check, the inhibited function may only be returned to its previous speed by treating its repair as an upgrade (see Chapter Three of the **Warcraft RPG**).

Degradation: The device was damaged in the malfunction. As appropriate to the device's pre-malfunction capabilities, even after being repaired one ability of the device (of the GM's choice) is

decreased by 1 point of TS (as indicated on Table 3–6 in Chapter Three of the **Warcraft RPG**): maximum AC bonus is lowered by 1; maximum damage inflicted or prevented is lowered by 1d6; maximum movement speed is decreased by 20 miles per hour, and so on.

Balky: Vehicles and other devices with a Maneuverability rating (see above) that suffer this malfunction effect have their Maneuverability rating decreased by one category. This effect can only be repaired by a DC 25 Craft (technological device*) check with a duration equal to the device's TS in days.

Complex Device: The device is more difficult to repair than others, falling apart into a multitude of tiny components when a malfunction occurs. The Craft (technological device*) skill check required to repair the device has a minimum DC of 25.

Awkward Operation: A device that suffers this malfunction effect is always more difficult to operate after being repaired. All weapons become two-handed, and all actions involving the device become full-round actions.

Backfire: All weapons on the device backfire, doing damage to the operator equal to what they would normally do to their targets. If the device is not strapped or attached to the operator in any way, the operator is allowed a Reflex save with a DC equal to (10 + the number of dice of damage the weapon inflicts) for half damage.

Fragible: Though it can be repaired normally, the device is more likely to malfunction in the future. Its Malfunction Rating is increased by +1. This effect is cumulative if it occurs multiple times to the same device, and can be repaired only by giving the function an upgrade that lowers its MR.

Control Complications: Its controls damaged by the malfunction or complicated by the repairs, a device repaired after this malfunction effect will forevermore be more difficult to operate. Operators of the device suffer a –3 penalty on all related rolls. This penalty is cumulative for devices that suffer this malfunction effect multiple times.

Bulky: A device that suffers this malfunction effect may only be repaired and rebuilt in a new, larger form. After repair, the device is one size class larger — Tiny devices become Small, Small devices become Medium, and so on. The weight of the device is similarly affected, and the vehicle's top speed is lowered by 20 miles per hour.

Critical Component: A critical component of the device is completely destroyed by the malfunction. The device cannot be repaired until a rare or delicate component worth at least 5% of the device's market value can be replaced. (This requirement might be an adventure seed for components that may not be commonly available on the open market.)

Ablative: Even after they are repaired, devices that suffer this malfunction effect continue to damage themselves each time they are used, losing 1 hit point each time they operate. This damage can be repaired with normal Craft (technological device*) rolls, but the malfunction effect can only be removed with an effort equal to an upgrade that would provide the device with its maximum number of hit points (and a Technology Score equal its current TS).

Noisemaker: At the time of the malfunction, the device emits a loud and annoying noise that can be heard by any creature within 60 feet. After repair, the device makes the noise continuously during its operation and for a period afterward equal to its startup or operation time (but not less than 1 minute). This effect can be repaired by a second Craft (technological device*) with a DC equal to that required to repair the Device check.

Fused Function: After being knocked into a malfunctioning state, the device becomes difficult to repair and impossible to alter. After suffering this malfunction effect, the device may never be upgraded, and all skill checks made to repair the device have their DC increased by +5. The penalty to skill checks is cumulative for devices that suffer this malfunction effect multiple times.

Fragile: After malfunctioning, the device becomes more easily damaged. Even after repair, the maximum hit points that the device can possess is equal to its Technology Score x 1. This malfunction effect can only be repaired via an upgrade to raise the device's hit points to their previous level.

Pain Machine: The device can be repaired normally, but after suffering this malfunction effect the device will cause 1d6 points of damage to its operator each time it is used. Repair of this effect requires effort and cost equal to adding an upgrade with the ability to inflict 1d6 points of damage.

Phlogiston Explosion: The small phlogiston boiler at the heart of a steam-powered device explodes, doing damage equal to (the device's Technology Score x 1d6) to all characters and creatures within 15 feet. The Craft (technological

device*) check required to repair the device will have a minimum DC of at least 15 and will involve procuring a new supply of phlogiston.

Collaborative Construction

Some devices, such as goblin zeppelins and the Horde's oceangoing juggernauts, are so large or so difficult to construct that few tinkers could complete the task on their own. While untrained workers can assist by moving raw materials and handling simple tasks, multiple, skilled tinkers must combine their efforts to guide the project to timely completion. The creation of a technological device by collaboration is as described in Chapter Three of the *Warcraft RPG*, but with the following differences:

Technological Limit: The technological limit of a group project is figured as follows:

Collaboration Technological Limit =

number of tinkers + project's average tinker level

Feat modifiers are not included in this calculation unless the project is led by an engineer with the lead collaboration ability (see the engineer prestige class in Chapter Two).

The project's average tinker level is determined by adding the total tinker class levels of all tinkers involved and dividing by the total number of tinkers. All fractions are rounded to the nearest whole number.

Device Construction: In a collaborative construction project, the DC of the Craft (technological device*) check required to make progress is still equal to 15 + the Technology Score of the device. After the market value of the device is determined, each tinker involved in the project may make rolls on either a daily basis (where progress is marked in silver pieces) or a weekly basis (where progress is marked in gold pieces). However, when a tinker makes a successful Craft check, the result is multiplied by (the check's DC + the average project tinker level).

Masterwork Devices

In their most desperate moments, tinkers can use their skills to cobble together makeshift devices from rusty parts found in a dungeon's depths. These rough gadgets serve their purpose, but no tinker would dare call them a masterwork.

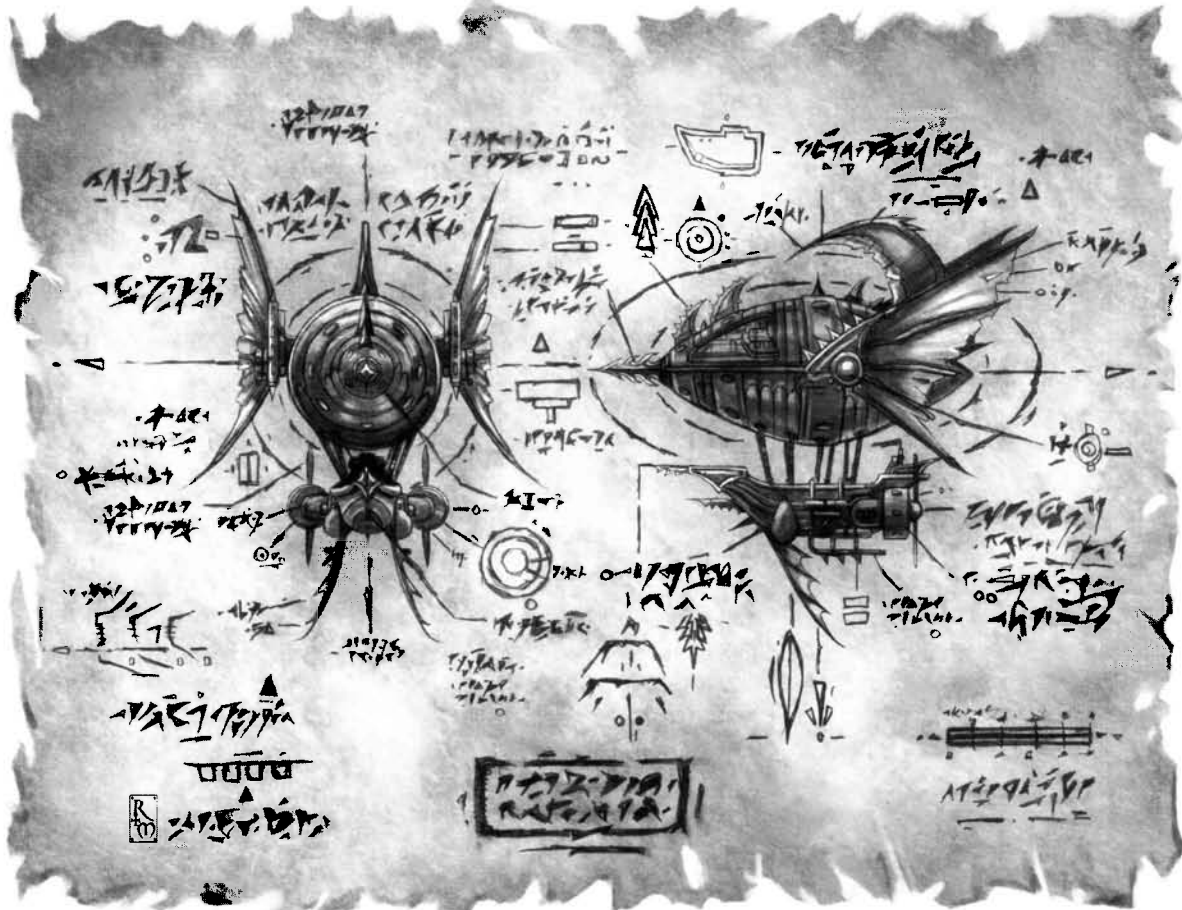

Masterwork devices are similar to masterwork items created by other artisans in that their superior construction makes them more effective than normal devices. To create a masterwork technological device, a tinker first designs the device as described in Chapter Three of the **Warcraft RPG**, and pays one-third of the item's market value to begin construction. However, when creating a masterwork device, the tinker must pay an additional 10% of the item's cost to reflect the higher quality of the device's components, and make a Craft (technological device)* check with a DC equal to 15 + the device's Technology Score. Though the cost of building a masterwork device must only be paid once, each attempt to begin takes 1 week. Once the tinker has succeeded at this check, she may begin making normal progress on construction of the Device check.

Masterwork devices grant their operators a +3 bonus on any skill checks required to operate them. The masterwork quality is not automatically conferred upon upgrades that provide a masterwork device with a new secondary function or replace its primary function. These upgrades must be constructed as masterwork devices in order to grant their operators the bonus.

Special and Favored Materials

Like other artisans of their races, tinkers like to work with their favored materials. Occasionally, when they manage to procure supplies, tinkers of other races also like to work with these special materials due to their superior qualities.

The favored special material of each race is described in Chapter Three of the **Warcraft RPG**. A tinker receives a +1 bonus on all Craft (technological device*) checks while working with his race's favored material. All devices created with special materials must be of masterwork quality, created as described in Masterwork Devices, above.

The bonuses granted by special materials are as described below. The costs of using special materials are as described only where these materials are available. Typically, a tinker will only be able to easily procure the favored material of her own race at the cost listed. Obtaining other special materials may involve exploring to gather them in the wild or stealing them from other races.

Adamantine: A device fashioned with adamantite has a maximum hardness equal to twice its

Technology Score and maximum hit points equal to its Technology Score x 8. Use of adamantine adds an additional 50% to the cost of raw materials required to begin construction of a device.

Arcanite: A device crafted using arcanite can inflict or prevent a maximum of 1d6+2 points of damage per round for each point in its Technology Score. It also has a maximum hardness equal to its Technology Score + 10. Raw arcanite costs 1,000 gp per point of TS, which must be paid when purchasing raw materials before construction of the device begins.

Darkwood: A device made of darkwood is sturdy but unexpectedly light; it has a maximum cargo load of its Technology Score x 400 pounds. In addition, its maximum movement speed is equal to its Technology Score x 25 miles per hour. Use of darkwood in building a device adds 1,000 gp per point of TS to the cost of raw materials required to begin construction.

Dragonhide: A device covered in dragonhide is rare but exceptionally resistant to damage. It has a maximum AC bonus equal to twice its Technology Score and a hardness equal to its Technology Score + 5. Adding dragonhide covering to a device costs one-quarter the market value of a device, which must be paid when purchasing raw materials before construction begins.

Mithral: A device made with this light but rigid material has maximum hit points equal to its Technology Score x 9 and a maximum AC bonus equal to its Technology Score + 4. In addition, lightweight vehicles built with mithral are so easy to pilot that they grant their operators a +5 bonus on Maneuverability checks. Use of mithral doubles the cost of raw materials required to start construction of a Device check.

Thorium: Thorium grants a device into which it is incorporated not only strength but unusual density. Able to withstand higher steam pressure, it can inflict up to its Technology Score x 1d8 points of damage per round and has a maximum range increment equal to its Technology Score x 75 feet. It also has a maximum AC bonus equal to its Technology Score +3 and maximum hit points equal to its Technology Score x 10. However, as thorium is also heavier than other metals, devices made with it have a maximum cargo capacity equal to their Technology Score x 150 pounds and add a -5 penalty on all Maneuverability checks made by the operator. The use of thorium in constructing a device doubles the cost of raw materials required to start construction.

Technological Devices

From goblin army boots to the truth detector, from the meat wagon to gnomish rockets, from the phlogiston collector to the wizard's desk — this section presents a wondrous menagerie of mayhem. In Chapter Three of the *Warcraft RPG*, we offered but a sampling of the technological devices used by the races of Azeroth. Here, we provide the definitive collection of technological devices available to heroes and villains alike.

Technological Device Listings

Each device is listed by name and has a complete description, much like a magic item. A statistics block follows the description. Statistics include Armor Class (AC); hardness (HR); hit points (hp); size (SZ); weight (WT) in pounds; top speed (Spd) in miles per hour, with maneuverability rating noted in parentheses; cargo capacity (Cargo); number of crew members needed (Crew); market value (MV) in gold pieces; item creation DC (Create DC); startup time (ST); and Malfunction Rating (MR).

For weapons, the statistics include rate of fire (RoF); range increment (Range); amount of damage; and Malfunction Rating (MR).

Not all devices will list every statistic; in case of an omission, the statistic either is not applicable or is the same as for a standard piece of equipment, weapon or similar object.

See the *Warcraft RPG*, Chapter Three: Adventuring and the *PHB*, Chapter 9: Adventuring, "Exploration," for more information on objects.

Adventuring Gear

This section details items that adventurers may find useful during their quests to save the world... or to cook a decent meal while on the road.

Adaptive Shackles

Description: A warden traveling with a master tinker in search of an escaped fugitive invented adaptive shackles during their journey. Once the chainmail sheath of adaptive shackles is placed over a prisoner's hands and the cuffs around his wrists inflated and tightened, it is unusually difficult to escape. The DC of Escape Artist checks to get free from adaptive shackles begins at 30. Each time an attempt to escape is made and fails, the DC

Table 5–2: Technology

Adventuring Gear

Item	MR	Cost	Weight
Adaptive shackles	2	125 gp	20 lb.
Automatic alchemist	0	750 gp	125 lb.
Automatic thief	3	375 gp	15 lb.
Autostilts	2	165 gp	20 lb.
Blade barrel	3	50 gp	20 lb.
Bow stabilizer	2	100 gp	3 lb.
Brighteye helm	0	50 gp.	10 lb.
Cargo pack, standard	1	100 gp	20 lb.
Cargo pack, large	1	150 gp	25 lb.
Clockwork oxen	4	200 gp	1,100 lb.
Collapsible bridge	1	100 gp	20 lb.
Dragon gun	5	150 gp	45 lb.
Earhelm	0	100 gp	7 lb.
Goblin army boots	3	50 gp	20 lb.
Goblin's lock pick	3	150 gp	3 lb.
Gryphon's eyes	0	300 gp	3 lb.
Holdout sheath	2	30 gp	1 lb.
Inflatable soldier, standard	1	40 gp	40 lb.
Inflatable soldier, improved	2	60 gp	40 lb.
Inflatable soldier, superior	3	80 gp	40 lb.
Mechanical sentry	1	50 gp	1/2 lb.
Mellodium	5	various	30 lb.
Pocket noisemaker	1	50 gp	1/4 lb.
Portable kitchen	1	225 gp	100 lb.
Potion injector	2	250 gp	4 lb.
Queuing quiver	4	50 gp	7 lb.
Rope, ironrope (50 ft.)	0	30 gp	20 lb.
Rope, wirecore (50 ft.)	0	20 gp	15 lb.
Sapper's shield	0	30 gp	15 lb.
Sawtooth ring	0	300 gp	1/8 lb.
Seahelm	2	650 gp	20 lb.
Sharpening sheath	1	450 gp	5 lb.
Shield pack	1	325 gp	17 lb.
Skate boots	1	150 gp	5 lb.
Steam gauntlets	2	500 gp	40 lb.
Steam winch, standard	0	170 gp	50 lb.
Steam winch, improved	0	260 gp	75 lb.
Stearmsaw	3	120 gp	25 lb.
Summer tunic	1	100 gp	15 lb.

Table 5-2: Technology (continued)

Adventuring Gear (continued)

Item	MR	Cost	Weight
Sunbuckle	0	50 gp	1/2 lb.
Tinker's arms	2	2,500 gp	20 lb.
Tinker's belt	1	25 gp	10 lb.
Tracking boots, dire bear	0	40 gp	12 lb.
Tracking boots, dire wolf	0	40 gp	12 lb.
Tracking boots, quilloar	0	50 gp	12 lb.
Tracking boots, frost wolf	0	60 gp	12 lb.
Tracking boots, frostsaber cat	0	75 gp	12 lb.
Tracking boots, kodo beast	0	120 gp	12 lb.
Traphands	4	625 gp	25 lb.
Trap thumper	5	500 gp	100 lb.
Valuator	1	250 gp	3 lb.
Wand harness	0	30 gp	4 lb.
Wizard's desk	0	200 gp	15 lb.

Special Substances and Items

Item	MR	Cost	Weight
Dirtworm	1	415 gp	1,500 lb.
Memory scrubber	2	33,000 gp	225 lb.
Miser's forge	3	9,375 gp	200 lb.
Neutralizer grenade	1	500 gp	1 lb.
Noble's swordsmen	1	2,250 gp	7,000 lb.
Phlogiston collector	2	37,500 gp	12,000 lb.
Phlogiston, liquid (vial)	—	20 gp.	1/4 lb.
Portable head (language)	2	110 gp	15 lb.
Portable head (Knowledge, 3 ranks)	2	120 gp	15 lb.
Portable head (Knowledge, 6 ranks)	2	215 gp	15 lb.
Substitution engine	1	6,000 gp	200 lb.
Truth detector	2	1,750 gp	300 lb.

Vehicles

Item	MR	Cost	Weight
Destroyer	1	1,660 gp	22,000 lb.
Flying machine	1	2,170 gp	1,100 lb.
Footcarts	1	125 gp	6 lb.

Vehicles (continued)

Item	MR	Cost	Weight
Gnomish helicopter	2	750 gp	600 lb.
Gnomish submarine	1	2,225 gp	5,500 lb.
Goblin shredder	3	1,350 gp	900 lb.
Goblin zeppelin	0	6,000 gp	3,000 lb.
Iron fish	2	1,500 gp	600 lb.
Meat wagon	1	1,000 gp	5,000 lb.
Phlogistic unicycle	0	300 gp	60 lb.
Rainmaker	3	87,500 gp	42,000 lb.
Scout balloon	1	45 gp	40 lb.
Siege engine	3	1,500 gp	4,500 lb.
Siege wagon	1	2,750 gp	4,000 lb.
Steam horse	1	782 gp	600 lb.
Steam launch	1	660 gp	300 lb.
Steamwarrior armor	1	2,550 gp	1,300 lb.

Weapons

Item	MR	Cost	Weight
Alchemical grenades	1	80 gp	1 lb.
Blast arrow	3	75 gp	1/16 lb.
Demon dirk	1	17 gp	2 lb.
Dwarven reciprocator	3	1500 gp	15 lb.
Firestarter	1	5,000 gp	3,500 lb.
Fire arrow	2	100 gp	1/16 lb.
Flash pod	1	50 gp	1 lb.
Glue mines (6)	1	175	1/2 lb.
Glue rifle	1	400 gp	20 lb.
Gnomish rockets	2	125 gp	5 lb.
Grease mines (12)	0	300 gp	1/3 lb.
Ironjaw	1	200 gp	4 lb.
Lightning net	2	165 gp	10 lb.
Musk bomb	0	300 gp	1 lb.
Net launcher	1	250 gp	8 lb.
Oscillating hilt	2	65 gp	1 lb.
Splinter gun	1	330 gp	15 lb.
Swordbelt	1	150 gp	4 lb.
Tinker's tosser	2	375 gp	15 lb.

Zecker Devices

Item	MR	Cost	Weight
Zecker's cloak	0	12,500 gp	25 lb.
Zecker's firestaff	2	330 gp	12 lb.
Zecker's wand	1	100 gp	1 lb.

increases by +3 as the phlogiston boiler and machinery cinching the shackles at their center react by inflating the cuffs more tightly and drawing in more of the sheath. When the DC reaches the maximum of 45, the shackles will be tight enough to inflict 1d6 points of damage each time the prisoner tries to escape. If the prisoner stops trying to escape and remains still, the cuffs will slowly slacken at the rate of -3 to the DC per minute until they have returned to their base level (DC 30). A ring welded to the center of adaptive shackles allows them to be chained to a wall or vehicle.

Malfunction: A malfunction occurs only when the shackles are being placed onto a prisoner, though the malfunction may not be immediately apparent to anyone but the prisoner.

Operation: DC 15 Use Technological Device* check to put shackles on a subject.

AC 15; HR 5; hp 25; SZ Small (1.5 ft. long x 1 ft. diameter sheath); WT 5 lb.; MV 125 gp; Create DC 20; ST 2 rounds; MR 2.

Automatic Alchemist

Description: Alchemy, while an interesting science, has its fair share of tedium. Gnomes, goblins and other races have discovered that making shortcuts in alchemy can often lead to disastrous results, especially when trying to balance a delicate formula or mix a special combination of ingredients. An inventor designed the automatic alchemist to eliminate the need for alchemical practitioners to perform boring or repetitive tasks.

This dwarf-sized metal dome contains advanced apparatus for running alchemical tests, mixing reagents and performing formulaic balancing. The device can perform any task that the Craft (alchemy) skill can do, but with 5 ranks in the skill. The automatic alchemist can only take 10 or 20. Manufacture of acid, alchemist's fire and other alchemical items is possible as long as the vat in the device has the necessary raw materials. A special series of bins in the automatic alchemist holds containers for necessary ingredients that allow it to make up to six of any alchemical item before requiring more supplies.

Specific cogs contain alchemical recipes that are available from gnomish alchemists. These cogs provide the recipes for making a specific alchemical item, cost 10 times the amount the item itself would normally cost, and wear out over time (20 uses).

Using one of these cogs boosts the automatic alchemist's Craft (alchemy) skill by 10 ranks for the purpose of making that single alchemical item.

Refilling: Refilling the automatic alchemist requires a DC 15 Use Technological Device* check. Failing the check to refill the automatic alchemist spills the contents of the refill bin and renders the materials useless. Each refill costs 250 gp in alchemical supplies.

Operation: DC 20 Use Technological Device* check to trigger; see text for refilling.

AC 10; HR 5; hp 10; SZ Medium; WT 125 lb.; MV 750 gp; Create DC 20; ST 5 rounds; MR 0.

Automatic Thief

Description: The name of the automatic thief is perhaps a bit more melodramatic than its actual function. Upon encountering a lock, the operator of an automatic thief selects appropriately sized probes from compartments atop its brass-bound case. The device is then connected to the probes; the intricate system of gears, springs, and counterweights inside is activated; and the automatic thief begins to attempt to open the lock. This is a noisy and usually lengthy process, but the device manages to open most doors and standard locks.

To connect an automatic thief to a lock, the operator must make a Use Technological Device* check with a DC equal to one-half the DC required to disable the lock. Five rounds after it is activated and every 5 rounds thereafter, the automatic thief makes a Disable Device check as if it had 20 ranks in the skill. While in operation, the automatic thief makes as much noise as a loud conversation held in the same area.

Operation: Use Technological Device* check (see above).

HR 5; hp 10; SZ Tiny (18 in. wide x 1 ft. tall x 8 in. deep); WT 10 lb.; MV 375 gp; Create DC 19; ST 5 rounds; MR 3.

Autostilts

Description: Autostilts are mechanical devices that strap to each of the feet and lower legs of the wearer, with cables snaking to a control unit that hangs from his belt. Use of the buttons on the control unit has the following effects:

Buttons 1 and 2: Pressing the first button on the control unit raises the wearer atop the stilts to a maximum height of 60 feet at a rate of 10 feet per round, while allowing him to stop rising at any time. Pressing the second button will

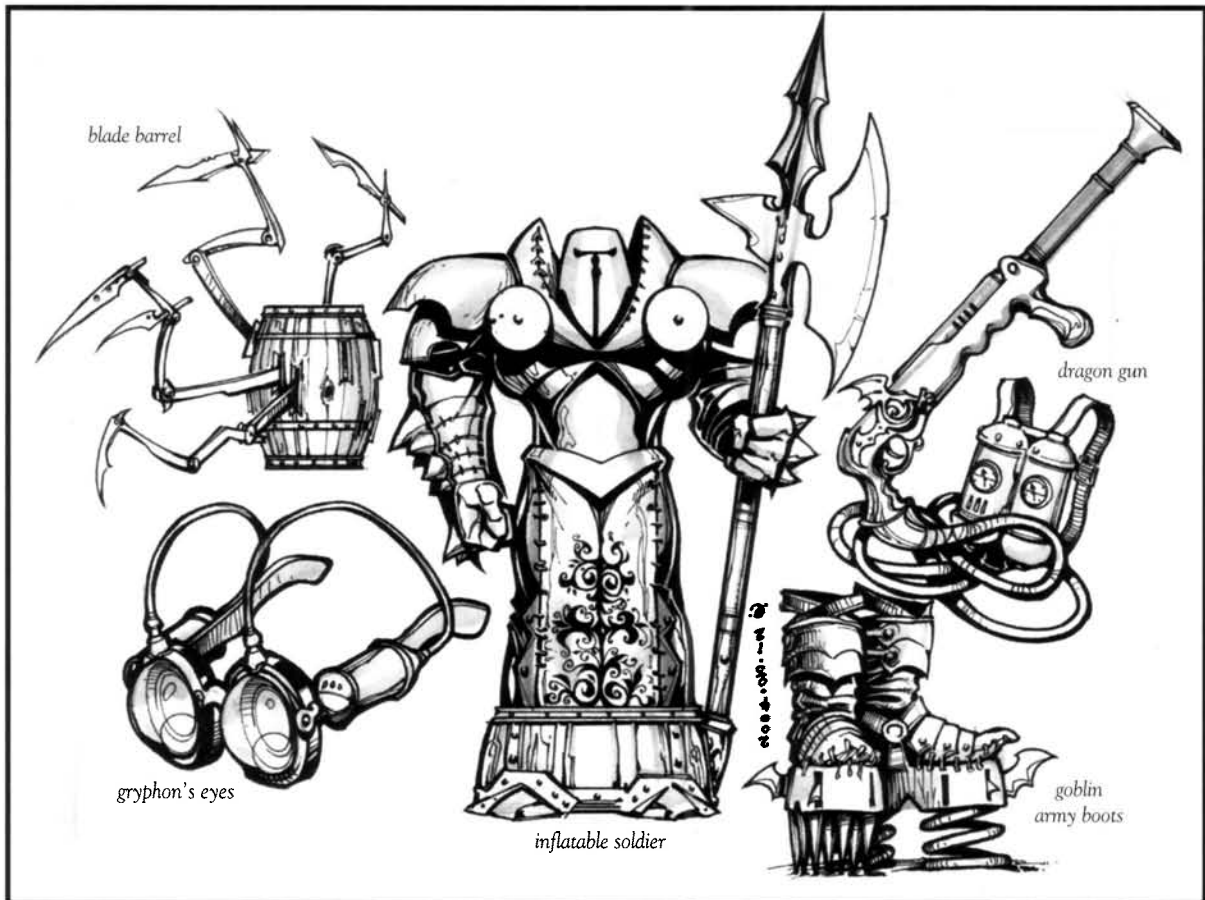

lower him at the same rate. Moving while the stilts are extended requires a Balance check against a DC equal to (5 + 3 for each 10 feet of stilt extension).

Button 3: Pressing the third button extends the stilts to a 20-foot length nearly instantaneously, and then retracts them just as quickly. This function allows for prodigious leaps — the character may make a Jump check with a +15 circumstance bonus, and a maximum distance that is capped by the character's height + 20 feet. When this function is used, the autostilts may not be used again for 10 minutes while steam pressure rebuilds inside the pistons.

A character's movement speed is halved while wearing autostilts.

Operation: DC10 Use Technological Device* check.

HR 5; hp 25; SZ Small; WT 20 lb.; MV 165 gp; Create DC 20; ST 1 round; MR 2.

Blade Barrel

Description: The goblins of Ratchet have developed hundreds of ways to secure precious shipments sitting in the warehouses and storage rooms of their famous city. The blade barrel seems to be the most

popular measure of the moment, a stunningly intimidating contraption. Goblin dock wardens place blade barrels among shipments of precious goods.

The device is a deterrent to theft. Triggered by proximity or movement, the blade barrel unfolds, and up to 10 articulated arms slide out of hidden panels. Each of these arms terminates in a scalpel-sharp dagger blade capable of slicing bone. These arms hover like serpents waiting for any sign of movement. Clockwork sensors and phlogiston-directed vanes detect motion near the blade barrel, and anything larger than a rat is subject to a lethal series of attacks.

Blade barrels appear to be normal barrels of goods or warehouse crates. A tell tale ticking can be heard with a DC 20 Listen check by those cautious enough to stand still and listen. Cruel or malicious goblins often tip the dagger arms with venom to mark anyone that the blade barrels daggers slash.

The blade barrel lashes out at anything that stumbles within its 10-foot reach. It makes 1d10 attacks per round on its own initiative, each at +5 to attack. Each blade inflicts 1d4 points of damage (this may also carry poison, depending on how the device was armed).

Disarming the trap requires a special whistle, which deactivates it when blown. A smart goblin will blow the whistle from about 30 feet away and then have the barrel removed by a junk golem.

Operation: DC 14 Use Technological Device* to set and to deactivate. Failing the deactivation check by more than 5 means that the trap will appear inactive while remaining fully primed to attack.

AC 8; HR 10; hp 15; SZ Medium; WT 20 lb.; MV 50 gp; Create DC 20; ST 1 round; MR 3.

Bow Stabilizer

Description: The bow stabilizer was invented by a tinker supporting a company of Alliance archers as they rode into battle against the Horde in siege wagons. When the archers complained about the jostling of the vehicle affecting the accuracy of their shots, Always Cogspin constructed a set of gears and counterweights that compensated for the shocks and jolts of firing while in motion. When the “Rolling Thunder” was honored as one of the most effective units in the Second War against the Horde, the commander was quick to acknowledge how much of their success came from Cogspin’s devices. Widely copied, the bow stabilizer is now a popular accessory for archers who don’t mind the device’s occasional malfunctions.

A bow stabilizer can be installed on any longbow or shortbow with a DC 25 Craft (technological device) check. It takes one hour to attach the stabilizer. Once attached, the bow stabilizer grants a +3 circumstance bonus on any shot made from a moving vantage (such as a vehicle, or horseback). However, when a bow stabilizer malfunctions, the bow becomes unbalanced and difficult to use, causing a –2 penalty on all attack rolls until it is repaired.

Operation: DC 25 Craft (technological device) to attach stabilizer to bow.

HR 5; hp 5; SZ Diminutive; WT 3 lb.; MV 100 gp; Create DC 18; ST 1 hour (attach to bow); MR 2.

Brighteye Helm

Description: Created for miners and adventurers exploring underground caverns, this helmet projects a powerful beam of light from a hemispherical lens mounted on its brow. This beam provides clear illumination in a 50-foot cone and shadowy illumination in a 100-foot cone. It operates for 12 hours on one phlogiston battery.

The brighteye helm was named not only for its light but also because of the lid-like cover that can be

dropped down over the lens to cover the light. The beam must be turned off separately, or when the lid is closed the helm will heat up and inflict 1 point of fire damage per minute on the wearer. Enterprising adventurers have turned this problem to their advantage and use the helmet as a cooking pot — it can bring water to a boil in less than 10 minutes.

Operation: Standard action to turn the light beam on or off, or to raise or lower the lid.

HR 5; hp 15; SZ Tiny (1 ft. x 1 ft. x 1 ft.); WT 10 lb.; MV 50 gp; Create DC 16; ST 1 round; MR 0.

Cargo Pack

Description: This cargo pack has a sturdy and intricate series of supports making up its frame, allowing the wearer of the enormous yet well-balanced backpack to comfortably carry enormous loads. The straps on a standard cargo pack can be adjusted to fit any Small or Medium humanoid creature. A larger pack, able to carry even more astounding loads, is available for tauren and other Large humanoids. Any load up to the full capacity may be carried inside a cargo pack; only a quarter of the total weight is considered for the purpose of determining carrying capacity.

Malfunction: One of the cargo pack’s complex support straps snaps. The cargo pack acts as a standard backpack (with all weight treated normally) until it is repaired.

Operation: DC 10 Dexterity check to don or remove.

HR 2; hp 10; SZ Medium (standard) (5 ft. tall x 3 ft. wide x 3 ft. deep), cargo capacity 400 lb.; Large (large) (8 ft. tall x 4 ft. wide x 4 ft. deep), cargo capacity 600 lb.; WT 20 lb. (standard), 25 lb. (large); MV 100 gp (standard), 150 gp (large); Create DC 17 (standard), 18 (large); ST 1 round; MR 1.

Clockwork Oxen

Description: This cheaper, cruder version of the steam horse is designed to carry heavy loads of cargo in the interior of its barrel-shaped body. Though its shell is extremely durable, the steam engine powering the clockwork oxen is so prone to malfunction that most merchant caravans using the machines include tinkers to repair the inevitable breakdowns.

Operation: DC 15 Use Technological Device* check.

AC 12; HR 10; hp 50; SZ Large (15 ft. long x 7 ft. tall x 6 ft. wide), cargo capacity 2,000 lb.; WT 1,100 lb.; Spd 10 mp (90 ft./round); MV 200 gp; Create DC 25; ST 10 min.; MR 4.

Collapsible Bridge

Description: A collapsible bridge is a system of canvas, pipes and cables that folds into a small trunk. When opened, the bridge has a canvas surface 5 feet wide and anywhere between 10 and 30 feet in length. In its shortest form (10 feet long), the bridge can support up to 600 pounds. For each additional 10 feet the bridge is extended, its maximum load decreases by 200 pounds, to a minimum of 200 pounds at 30 feet in length. Rings on the far ends of the bridge poles and on the trunk allow the bridge to be spiked in place at both ends.

Operation: DC 10 Use Technological Device* check.

HR 2, hp 10; SZ Small (2 ft. wide x 1 ft. tall x 1 ft. deep), stored; WT 20 lb.; MV 100 gp; Create DC 17; ST 1 min. per 10 ft. of extension to unfold or repack; MR 1.

Dragon Gun

Description: Dragon guns are tinker-created weapons inspired by the deadly breath weapons of dragons. Alchemist's fire is projected by steam pressure from the tip of a blunderbuss-like rifle to cast sheets of flame across a battlefield. Though dragon guns are terrifying and destructive weapons, the backpack tanks that store the liquid ammunition are notoriously fragile.

The weapon has a 20-foot range increment and inflicts 2d6 fire damage on a successful hit. On the round following a hit, the target takes an additional 1d6 points of damage as the sticky alchemist's fire continues to burn. The target can take a full-round action to attempt to extinguish the flames before taking this additional damage. A successful DC 15 Reflex save is needed to extinguish the flames. Going prone and rolling on the ground gives the target a +2 bonus on this saving throw. Leaping into a lake or magically extinguishing the flames automatically extinguishes the flames.

Ammunition: A fully-loaded dragon gun carries 15 charges of alchemist's fire. Each charge allows one shot.

Operation: Exotic Weapon Proficiency (dragon gun) and ranged attack roll.

HR 5; hp 5; SZ Small; WT 45 lb.; MV 150 gp; Create DC 18; ST 1 round; MR 5.

Earhelm

Description: Earhelms have large, goblin-ear-shaped dishes mounted on their sides. These dishes focus the sounds ahead of the wearer and give him the ability to hear a whisper at incredible distances.

Earhelms allow the wearer to make Listen checks with a -1 modifier to the DC per 50 feet of distance. The dishes may be rotated to face forward or backward. They grant the wearer a +5 bonus on Listen checks to detect the sound of any creature attempting to sneak in the direction the dishes are pointed (typically forward), but a -3 penalty on attempts to detect creatures sneaking up from the opposite direction. If the wearer is willing to look silly by having one dish rotated forward and the other back, he gains a +2 bonus to detect creatures sneaking from either direction, and no penalty. Creatures sneaking to the wearer's flanks are treated normally.

Operation: Listen check; DC as appropriate to the situation.

AC +1 armor bonus to wearer's AC (stacks as a shield); HR 2; hp 10; SZ available for Small or Medium creatures; WT 7 lb.; MV 100 gp; Create DC 16; MR 0.

Goblin Army Boots

Description: The first thing a person thinks of when goblins come to mind is most likely not footwear. Yet the innovations that goblins have brought to the design of shoes for adventuring are undeniable. Goblin army boots take the design ethos of the goblin army knife and apply it to military footwear.

Goblin army boots are sturdy leather boots that strap up to the knee. The heels are very thick, lending another 6 inches to the height of anyone wearing a pair. Contained within the heels of the boots are a number of devices that aid in jumping and traversing difficult terrain. The wearer can direct the boots to perform several tasks by manipulating a series of toe triggers with a successful Use Technological Device* check; failure means the desired function is not triggered. It takes three rounds to switch the boots from one mode to the next.

The soles of the boots contain several options for negotiating obstacles and terrain. Tightly coiled springs released from the soles grant the wearer a +5 bonus on Jump checks as well as increasing his base land speed by 10 feet when running with the springs extended. Accordion-like stilts extend from the heels, allowing for an additional 2 feet of height, although a DC 10 Balance check is required to stay upright on the stilts. Using a bellows in the heel, air bladders in each boot inflate to allow a wearer of Small or Medium size to cross a body of water without getting wet, with a DC 15 Balance check required to stabilize and stay upright when walking across water.

For combat situations, a dagger blade extends from the toe of each boot to provide stopgap weapons in a combat. Using these blades, the wearer's kick attacks inflict 1d4 points of lethal damage.

The boots themselves are quite heavy, each weighing approximately 10 pounds. However, this multipurpose footwear is watertight, and custom-fitted to the wearer's feet with a series of adjustable straps and laces (which in dire situations connect to provide 50 feet of strong spider silk line). Sadly, these versatile boots are so heavy that they reduce the speed of the wearer by 10 feet.

Operation: DC 10 Use Technological Device* check.

AC 11; HR 2; hp 5; SZ Tiny; WT 20 lb.; MV 50 gp; Create DC 15; ST 3 rounds; MR 3.

Goblin's Lock Pick

Description: Seldom seen outside of Ratchet, goblin's lock picks are a thief's dream come true. The goblin's lock pick is a small, pistol-gripped device with a series of triggers and levers designed to give a trained thief the edge needed to pick a lock quickly. Not only does the rapid selection of picks and probes grant a thief a +4 bonus on Open Lock checks, but the attempt only requires a standard action. The goblin's lock pick also functions as a standard set of masterwork thieves' tools. The noise they make is only a slight clicking, but hearing them with a DC 20 Listen check is possible.

HR 5; hp 5; SZ Tiny; WT 3 lb.; MV 350 gp; Create DC 15; MR 3.

Gryphon's Eyes

Description: Tinkers working among the windriders have long sought to recreate the gryphon's ability to see in the dark. Thus far, the best result they have achieved is these bulky goggles that grant the wearer low-light vision. The wearer can see normally in starlight, moonlight, torchlight and similar conditions of poor illumination. However, due to the goggles' thick lenses, the wearer suffers a -4 penalty on any Spot checks or checks related to observing visual detail. Further, the small batteries that power the goggles work for only 1 hour before they must be recharged with a fresh supply of phlogiston.

Battery Recharge: Recharging the goggles' dead batteries with phlogiston requires a DC 15 Use Technological Device* check and a charge of liquid phlogiston.

Operation: Full-round action to turn low-light vision on or off; see text for recharging.

HR 2; hp 15; SZ Diminutive (10 in. wide x 6 in. tall x 4 in. deep); WT 3 lb.; Create DC 18; ST 1 round; MR 0.

Holdout Sheath

Description: This sheath straps to the forearms and is usually worn beneath the sleeves of a loose tunic. A controlled twitch of the muscles releases a catch, and springs inside the sheath push a dagger out into the wearer's hand. This draw is considered a move action and requires a DC 10 Reflex save to catch the hilt of the dagger properly. When the holdout sheath is activated, the wearer has the option to forego the Reflex save and use the knife as a ranged weapon. This attack has a range increment of 5 feet and requires a ranged attack roll with a -4 penalty.

Malfunction: A malfunction on either the Reflex save or the attack roll means that the dagger has jammed in the sheath.

Operation: Reflex save or ranged attack roll (see text).

HR 2; hp 5; SZ Diminutive (8 in. long x 2 in. wide x 1 in. deep); WT 1 lb.; MV 30 gp; Create DC 16; ST move action to use, 1 min. to reload dagger into sheath; MR 2.

Inflatable Soldier

Description: An enterprising merchant making regular runs along the dangerous trade routes between Nighthaven and Theramore commissioned the creation of the inflatable soldier. Made of sheep's bladders with an outer covering of mercenary garb, inflatable soldiers make overnight camps appear better guarded than they truly are. As they gain popularity among merchants too poor or too cheap to hire full escorts, inflatable soldiers of increasing realism (with facial features, chain shirts, and tin helms) are becoming available, as are models appearing to be members of varying humanoid races. Unfortunately, due to their more complex stitching, the more realistic models are more likely to spring a leak when being repacked into the small kegs that make up their bases.

A standard inflatable soldier can be recognized as an artificial construct with a DC 15 Spot check (all modifiers due to distance and darkness apply to this check). An improved inflatable soldier requires a DC 18 Spot check, and a superior inflatable soldier requires a DC 21 Spot check.

Operation: DC 5 Use Technological Device* check to set up.

AC 11 (standard), 10 (improved), 15 (superior); HR 0; hp 5 (standard), 10 (improved), 15 (superior); SZ Medium (inflated: 7 ft. tall x 3 ft. wide x 2 ft. deep), Small (stored: 2 ft. tall x 1 ft. diameter keg); WT 40 lb.; MV 40 gp (standard), 60 gp (improved), 80 gp (superior); Create DC 17; ST 10 min.; MR 1 (standard), 2 (improved), 3 (superior).

Mechanical Sentry

Description: These 5-inch wooden spheres can be used to set a perimeter around a campsite, or to secure a hallway. A ring mounted on one side can be pulled to extend up to 30 feet of wire, which can be attached to either a spike or another mechanical sentry. When an intruder brushes against the taut wire, a shrill steam whistle inside the mechanical sentry triggers to alert those nearby.

Operation: DC 5 Use Technological Device* check to set up.

AC 14; HR 5; hp 20; SZ Tiny (5-in. wooden sphere); WT 1/2 lb.; MV 50 gp; Create DC 16; ST 1 min.; MR 1.

Mellodium

Description: A mellodium can capture a performance on a musical instrument and later use the instrument to replay the performance automatically. Each type of instrument requires its own type of mellodium. The device is connected to the instrument, and a musician makes a Perform skill check with a -5 circumstance penalty to play despite the attachments. The result of that skill check is captured to a hard wax tablet inside the mellodium, and can be replayed at any time using a mellodium attached to the same instrument; though other mellodiums use the same tablets, music recorded on other instruments will be played as noise.

Operation: DC 30 Use Technological Device* check to attach a mellodium to an instrument; move action to replay.

HR 2; hp 10; SZ Small; WT 30 lb.; MV 625 gp (drum), 650 gp (fife), 780 gp (lute), 800 gp (pan flute), 950 gp (mandolin/lyre); Create DC 27; ST 1 hour; MR 5.

Pocket Noisemaker

Description: The pocket noisemaker is a hand-sized device with four legs; when wound up and

released, it scuttles across the floor in a straight line at the rate of 50 feet per round. Starting in the second round it rings a small bell on its back, continuing to ring and crawl for the following three rounds until it runs down. Pocket noisemakers are popular among rogues, who use them to distract guards while they slip past in the shadows.

Operation: DC 5 Use Technological Device* check.

HR 2; hp 5; SZ Fine (5 in. x 4 in.); WT 1/4 lb.; MV 50 gp; Create DC 16; ST 1 round; MR 1.

Portable Kitchen

Description: These heavy and expensive items are still used mainly by military officers and wealthy merchants, though there are many tinkers laboring to create a version for mass production. A portable kitchen is the size and shape of a barrel. A phlogiston-amplified steam engine built into the base heats a small oven in its midsection and the kettle underneath the cover atop it.

Cooking bread or stew with the portable kitchen is as simple as adding the mixed ingredients to the appropriate compartment, using a lever to set the heat to the proper level, and watching the clock count down the minutes until the food is prepared.

Use of the portable kitchen provides a +9 bonus on Profession (cook) checks. Those untrained in the skill can still use the portable kitchen to make simple and bland (but filling) food, provided they follow the instructions included with the kitchen when it is sold.

Operation: See text.

HR 5; hp 35; SZ Medium; WT 100 lb.; MV 225 gp; Create DC 18; ST 1 min.; MR 1.

Potion Injector

Description: A potion injector is a device that straps around the upper arm of the wearer, with a cable running down to a control box worn around the wrist. Vials of potion can be mounted on clamps around its exterior, their stoppers replaced with corks and tubes running into the device. When a stud is pressed on the control box, the potion held in the indicated slot is immediately injected into the wearer of the device. In all but a few rare cases, this injection has the same effect as swallowing the potion, and its effects take place normally. If the wearer of a potion injector is unconscious, using the device to administer a potion is a standard action (as opposed to the normal full-round action required).

Activating the potion injector is a standard action, but does not provoke the attack of opportunity associated with drinking a potion. Attacks may be directed against the potion injector, but the device takes damage first before any potions it contains — inside a protective chainmail covering — can be harmed. The wearer of a potion injector cannot wear any armor covering the area where the device is worn. The potion injector can hold up to six potions. If the potion injector is activated when it is not worn, the potion is expended with no effect.

Operation: DC 10 Use Technological Device* check to use; DC 17 Use Technological Device* check to load a potion into the injector.

HR 3; hp 15; SZ adjustable for Small, Medium, or Large creatures; WT 4 lb.; MV 250 gp; Create DC 18; ST standard action to use (see text), 1 min. to load; MR 2.

Queuing Quiver

Description: This quiver has a clockwork mechanism inside, wound with a crank built into its bottom end. Up to 30 crossbow bolts can be loaded into the quiver, one per slot. In combat, the bolts will feed out in the exact order they were loaded, rotating around and extending into an easy-draw position. This makes reloading a hand or light crossbow a free action, and reloading a heavy crossbow a move action. While many archers appreciate the higher rate of fire this allows, they are also wary of the quiver's penchant for jamming and locking all the bolts irretrievably into their slots.

Loading and using the queuing quiver in combat requires no special checks. Checks for malfunctions are made during the ranged attack roll using the weapon loaded from the quiver. If an attack roll is less than or equal to the quiver's MR, the quiver jams and no further bolts can be removed until it is repaired.

Operation: See text.

HR 5; hp 5; SZ Tiny; WT 7 lb.; MV 50 gp; Create DC 19; ST 5 min. to fill with 30 bolts and wind the mechanism; MR 4.

Rope, Ironrope

Description: Without the fiber core inside ironrope's wire-wrapped exterior, it would be nearly inflexible. Even with the hemp at its center, ironrope still remains awkward enough to employ that Use Rope checks suffer a -1 circumstance penalty. Each 50-foot length of ironrope has 10 hit points and requires a DC 28 Strength check to burst.

Operation: Use Rope; see text.

HR 2; hp 10 per 50 ft.; SZ Small; WT 20 lb. per 50 ft.; MV 30 gp; Create DC 13; ST as necessary for the task; MR 0.

Rope, Wirecore

Description: A hempen rope wound around a core of braided wrought-iron wire, wirecore rope is more durable and can carry heavier loads than traditional rope. Sold in 50-foot lengths, it has 6 hit points and requires a DC 26 Strength check to burst.

Operation: Use Rope; see text.

HR 2; hp 6 per 50 ft.; SZ Small; WT 15 lb. per 50 ft.; MV 20 gp; Create DC 13; ST as necessary for the task; MR 0.

Sapper's Shield

Description: A sapper's life is nasty, brutal and short. A sapper who manages to get to her objective and blow it up is lucky if she can hobble home and sew her fingers and toes back on. Gnomes realized the need for those who work with things that go boom to have some sort of protection from explosive forces. This created a brief burst of technological innovation in clumsy armor suits and weird extended arms. The result was the sapper's shield.

The sapper's shield is a specially reinforced tower shield with an alchemically treated glass window. This window has the same strength as steel and is of the variety used in gnomish submersibles. The shield has two armored gauntlets on the front; from behind the shield, the sapper can set explosives without having to worry about premature detonation. The shield provides damage reduction 15/— and full cover from explosions to the person directly behind it. A special set of extendable legs hold up the shield; these require a standard action to set up.

A variation of this shield called the sniper's shield exists. Instead of armored gauntlets, it has a port for a rifle barrel and a lower window that allows the user to fire a rifle while aiming from a kneeling position behind the shield.

Operation: See text.

AC 15; HR 4; hp 20; SZ Small; WT 15 lb.; MV 30 gp; Create DC 10; ST —; MR 0.

Sawtooth Ring

Description: Invented for questionable purposes and usually sold behind closed doors to questionable people, the sawtooth ring is nonetheless a remark-

able device. Though it appears to be a normal ring, the two halves of a sawtooth ring can be pulled apart to reveal a band of sharpened teeth wound tightly inside. The band spins furiously for 10 rounds, doing 3d6 points of damage per round to anything the teeth touch. Captured rogues often use a sawtooth ring to cut their way free of bonds, but the rings also have the potential for use as a melee weapon.

A DC 20 Reflex save is required to pull the ring open. A character failing this check takes 1 round of damage from the ring before he can get his own fingers out of the way. Once a sawtooth ring has been opened, it cannot be stopped until 10 continuous rounds have passed. Rewinding and closing the ring takes 10 minutes and requires a DC 10 Use Technological Device* check.

Using the sawtooth ring to damage an opponent in combat requires a melee attack and inflicts 3d6 points of damage.

Operation: See text.

HR 5; hp 10; SZ Fine; WT 1/8 lb.; MV 300 gp; Create DC 18; ST 1 round; MR 0.

Seahelm

Description: The collar of this heavy helmet seals tightly around the wearer's neck, after which

all air he breathes comes through rubber hoses from four bladders hanging on a shoulder strap. This has allowed underwater explorations to continue for up to an hour. Seahelms are sold with a hand-cranked pump to refill their air bladders, a laborious process that takes more than an hour per bladder.

Operation: DC 20 Use Technological Device* check.

HR 5; hp 25; SZ Small; WT 20 lb.; MV 650 gp; Create DC 23; ST 4 rounds; MR 2.

Sharpening Sheath

Description: Sharpening sheathes come in varying sizes constructed for short swords, longswords, bastard swords and greatswords. When a sword is drawn from a sharpening sheath, miniature grindstones built into its housing sharpen the edge of the blade and grant it a temporary enhancement bonus to damage. The first hit made by a blade after it is drawn from a sharpening sheath gets a +3 bonus on the damage roll, the second a +2 bonus, and the third a +1 bonus. All following hits deal normal damage. The Quick Draw feat may not be used in conjunction with a sharpening sheath. As sharpening sheathes are thick and bulky, they are usually worn over the shoulder on a baldric rather than hanging from the belt.

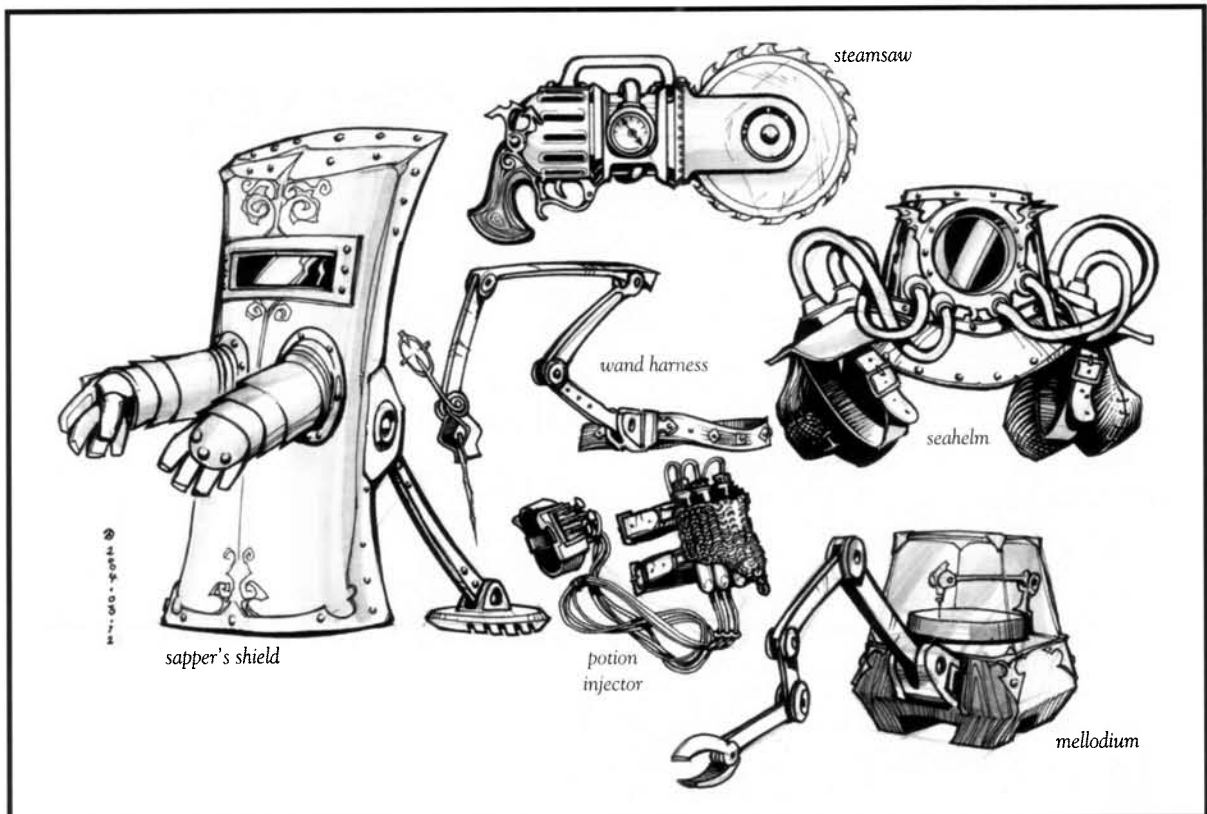

Operation: DC 5 Use Technological Device* check.
HR 2; hp 5; SZ Tiny; WT 5 lb.; MV 450 gp;
Create DC 18; ST free action; MR 1.

Shield Pack

Description: A shield pack is a backpack with a limited carrying capacity due to the phlogiston boiler and mechanisms concealed in its interior. These mechanisms connect to a large mechanical arm that reaches around the wearer and ends in a heavy wooden shield. When devices concealed behind the shield detect an incoming attack, the shield swings to block it. The protection provided by the shield pack grants the wearer a +2 shield bonus to her AC yet still allows her to wield a two-handed weapon (or a weapon in each hand). However, as the movement of the shield is automatic, it often gets in the way of the wearer's attacks as it protects her. When turned off, the shield arm folds away over the back of the pack. Yet when the shield pack is active and providing protection, the wearer has a -1 penalty on all melee attacks as she fights around the shield.

Operation: DC 10 Use Technological Device* check to activate or deactivate.

HR 2; hp 10; SZ available for Small, Medium, and Large creatures; WT 17 lb.; MV 325 gp; Create DC 17; ST 3 rounds; MR 1.

Skate Boots

Description: The small steam engines that power these wheeled boots allow the wearer to move at high speeds over clear terrain. The user must make a successful DC 15 Balance check each round to stay upright (falling inflicts damage as if falling 10 feet for every 10 mph of the boots' current speed).

Operation: DC 10 Use Technological Device* check to activate and deactivate.

HR 2; hp 10; SZ Tiny; WT 5 lb.; Spd 40 mph (355 ft./round) (good); MV 150 gp; Create DC 17; ST 3 rounds; MR 1.

Steam Gauntlets

Description: Gnomish inventors have always excelled at making up for physical shortcomings through technology. While the more fringe elements of the gnomish technological community advocate the use of permanent steam powered prosthetics, more civilized and sane gnomes have opted for a solution that requires less surgery. Steam

gauntlets are one of the many innovations that gnomes have invented to help them open jars, mine and crush things.

Two pneumatically enhanced, steam-powered gauntlets attach to a bulky portable steam engine. This engine straps to the back of the wearer. The gauntlets themselves are more like gigantic armored mitts, and are usually adjustable to fit the hands of races of differing sizes.

Wearing the gauntlets and activating the steam plant grants the wearer enhanced Strength. Special stabilizers in the gauntlets allow even the smallest user the ability to pick up objects as if he had Strength 18. The wearer gains all the benefits of this enhanced Strength while the gauntlets operate, except that the wearer's carrying capacity and encumbrance do not change. In fact, the steam-powered pack is often so heavy that it can hinder use for weaker beings.

Kicking the gauntlets into overdrive is possible. Doing so grants the wearer the benefits of having a 26 Strength score for 1d6 rounds before consuming all the fuel in the steam plant. The steam plant burns unusually hot while in overdrive, and the wearer takes 1d4 points of fire damage per round while the gauntlets are stuck in this mode. Overdrive does 1d6 points of damage to the device when it finally runs out of fuel.

The gauntlets do 1d8 + Strength bonus in damage when being used to punch. These gloves are difficult to be dexterous in, and performing tasks requiring fine manipulation while wearing them is impossible. Putting on the gauntlets and steam pack takes 5 minutes.

Operation: DC 15 Use Technological Device* check.

HR 2; hp 5; SZ Small; WT 40 lb.; MV 500 gp; Create DC 18; ST 5 min.; MR 2.

Steam Winch

Description: The steam winch is rapidly becoming a standard piece of traveling equipment for military units, merchant caravans and even small parties of adventurers. Its compact casing holds a small but powerful phlogiston engine that turns a drum wrapped with 300 feet of wirecore rope (see above). Once bolted or spiked to a surface, the winch can be run in either direction to raise or lower up to 600 pounds, 15 feet per round. When

the rope is attached to a fixed object, the winch can exert a force equal to Strength 30.

Upgraded steam winches are also available, featuring a drum of ironrope (see above). This sturdier cable allows for a load of up to 1,200 pounds, although it can only be moved at a rate of 10 feet per round.

Operation: DC 10 Use Technological Device* check to use; Use Rope at appropriate DC to attach the winch's rope to an object.

AC 13; HR 3; hp 15; SZ Small (2 ft. wide x 18 in. deep x 18 in. tall); WT 50 lb. (standard), 75 lb. (upgraded); MV 170 gp (standard), 260 gp (upgraded); Create DC 18; ST 5 rounds; MR 1.

Steamsaw

Description: Steamsaws are smaller, portable versions of the saws attached to the arms of goblin shredders. The spinning blade of a steamsaw is usually used to cut down trees, but some have learned to use the unwieldy device in combat.

Use of a steamsaw in melee combat requires Exotic Weapon Proficiency (steamsaw). The steamsaw is a two-handed weapon that inflicts (2d6 + Strength modifier) points of slashing damage.

Operation: DC 15 Use Technological Device* check for basic use; see text for combat use.

HR 5; hp 25; SZ Small; WT 25 lb.; MV 120 gp; Create DC 17; ST 2 rounds; MR 3.

Summer Tunic

Description: These long-sleeved, woolen tunics are threaded with tubes leading to a small phlogiston boiler that hangs from the belt of the wearer. The boiler runs heated water through the tubes to keep the wearer "as warm as a summer day" even in the coldest weather. The flow of water may be adjusted such that the wearer feels anywhere between 1 and 60 degrees warmer than the outside environment. In cold weather, this feature may save characters from required Fortitude saves, but in warmer climates it may accidentally raise a careless character's temperature into the range where she must *make* Fortitude saves (see DMG, Chapter 8: Glossary, "Cold Dangers" and "Heat Dangers").

Operation: DC 10 Use Technological Device* check to start the boiler; DC 15 Use Technological Device* check to make temperature adjustments.

HR 1; hp 10; SZ Tiny; WT 15 lb.; MV 100 gp; Create DC 17; ST 1 min.; MR 1.

Sunbuckle

Description: This buckle can be attached to any belt and operates like a normal belt buckle. When a secret catch is pressed, however, the face of the buckle flips open and flash powder inside the buckle is ignited. All creatures within 50 feet of the wearer's front arc must make a DC 15 Reflex save or be blinded for 2d6 rounds. The buckle will operate 10 times before the flash powder inside it is expended.

Operation: Standard action to trigger; DC 10 Use Technological Device* check to reset.

HR 1; hp 5; SZ Fine (3 in. tall x 4 in. wide x 1 in. deep); WT 1/2 lb.; MV 50 gp; Create DC 16; ST 1 round; MR 0.

Tinker's Arms

Description: The first tinker's arm was created by the Tinker's Guild in Ratchet for Samuel Wrenchwright, a popular member who lost a limb in an accident. When others saw that Wrenchwright had not only gained a useful limb but also increased strength, they asked the tinkers to develop a version that might be used without the loss of a living arm. The resulting apparatus straps to the wearer's arms, and when activated grants a +2 enhancement bonus to her Strength score. Tinker's arms designed for a creature of one size category may not be used by creatures of another size category.

Operation: DC 20 Use Technological Device* check.

HR 2; hp 15; SZ Small; WT 20 lb.; MV 2,500 gp; Create DC 35; ST 2 rounds; MR 2.

Tinker's Belt

Description: Many tinkers may leave their workshops to go adventuring, but some bring their workshops with them in the form of a tinker's belt. This heavy leather belt features a small phlogiston boiler to power devices, large pouches to carry parts and inventions-in-progress, hooks and straps to carry tools, and two articulated arms with hand-like clamps that can hold devices while the tinker works on them. While these "hands" must be manually positioned in place, tinkers have been known to use them as aids in climbing and other non-mechanical pursuits.

A tinker's belt includes and carries all the standard tools required so that Craft (technological device) checks can be made without circumstance penalties.

Positioning the arms is a standard action, and for purposes of gripping once closed, the clamps have

Strength 16. Attaching the boiler to another device requires a DC 15 Use Technological Device* check.

Operation: See text.

HR 2; hp 10; SZ Small; WT 10 lb.; MV 25 gp; Create DC 16; ST 3 rounds; MR 1.

Tracking Boots

Description: Built from old discarded pairs of goblin mine shoes, tracking boots distribute the weight of the wearer so that the carved soles of the boots leave the tracks of various large, wild animals. Goblin merchants traveling the Barrens are known to use tracking boots to disguise their tracks as those of dire wolves in order to fool tauren patrols into searching for nonexistent Horde scouts.

Donning tracking boots requires a Use Technological Device* check, the result of which becomes the DC for a tracker's Survival check to realize the false nature of the tracks. Characters wearing tracking boots may not move at any speed faster than a walk.

Operation: Use Technological Device* check (see text).

AC 12; HR 2; hp 10; SZ Small (2 ft. x 1 ft. x 6 in.); WT 12 lb.; MV 40 gp (dire bear or dire wolf), 50 gp (quillboar), 60 gp (frost wolf), 75 gp (frostsaber cat), 120 gp (kodo beast); Create DC 17; ST 5 min.; MR 0.

Traphands

Description: Traphands were invented by an orc tinker after his brother lost both hands to a trunk trapped with a gunpowder charge. The operator of a pair of traphands sticks his hands into gauntlet-like holes in the side of the device. By moving her hands, the operator controls the movement of hands mounted on long arms that can be extended up to 15 feet from the device. Traphands are deft enough to allow the use of lockpicks and thieves' tools, but also just awkward enough that the operator suffers a -4 penalty to any checks made through the device. Though they have a mailed exterior in an attempt to resist damage inflicted by acid, needles and other traps, the delicate machinery in the hands is prone to malfunction.

As is implied by the name, traphands are used primarily to disable dangerous devices ranging from trapped doors and chests to land mines. Yet in recent years, betting on sword fighting competitions using traphands has become popular among gamblers in Ratchet and taverns across eastern Kalimdor.

Operation: Requires appropriate skill checks.

AC 15; HR 5; hp 25; SZ available for Medium and Large creatures; WT 25 lb.; MV 625 gp; Create DC 20; ST 2 rounds; MR 4.

Trap Thumper

Description: Pressure plates, razor traps and needles in locks are all rapid routes to a quick demise or at least substantial personal injury. When stealth isn't an issue and time is abundant, the trap thumper is the best way to check a hallway, door or lock to trigger any countermeasures left for the unwary.

The trap thumper resembles a spring-loaded, 3-foot-tall, heavy leather bag with two short feet. The device also has an armature probe for checking locks. Winding the trap thumper sets it into one of three modes.

Thumping: When set in this mode, the clumsy leather creation hops up and down, traveling forward at a speed of 10 feet to a preset distance (up to 100 feet, decided on by the activator). This pattern sets off any pressure plates, triggers or pit traps that may be in the thumper's path.

Probing: In this mode, the device extends the armature and pokes the end of it into a lock or hole to see if there are any traps within. A leather pad indicates pinpricks or bites, and a small, soft, felt tip on the end of the probe becomes damp when exposed to poison. The "finger" of the trap thumper will probe up to 10 times before requiring a replacement pad.

Baiting: This is the most innovative mode. The thumper crawls forward at a speed of 30 feet to a preset distance (up to 100 feet, decided by the activator). Once at its destination, the leather-clad trap thumper moves back toward its point of origin while making noise to draw attention to its motion.

Operation: See text.

AC 13; HR 1; hp 15; SZ Small; WT 100 lb.; MV 500 gp; Create DC 25; ST 5 min.; MR 5.

Valuator

Description: A valuator is a small device used to assess the value of gemstones. The gemstone is fixed into a cradle and a crank atop the valuator turned, setting into motion a number of devices inside that automatically weigh the gemstone, check its color, and more. A counter on the side displays the device's final evaluation. The valuator allows checks to be made as if it possessed 5 ranks in the Appraise skill.

Operation: DC 10 Use Technological Device* check.

HR 1; hp 5; SZ Tiny (8 in. tall x 6 in. wide x 4 in. deep); WT 3 lb.; MV 250 gp; Create DC 17; ST 5 rounds to value a gem; MR 1.

Wand Harness

Description: Inspired by the tinker's belt, this device is an articulated arm that hangs from a wizard's belt and can unfold to hold a wand at the ready. A small set of crosshairs mounted on the arm allows for preparatory aiming while casting a spell. A wand held in the harness can be readied with a free action, and the wearer of a wand harness gets a +2 bonus on attempts to make ranged attacks with the wand during the round in which it is readied.

Operation: DC 10 Use Technological Device* check to place a wand in the harness.

HR 1; hp 5; SZ Tiny; WT 4 lb.; MV 30 gp; Create DC 16; ST 3 rounds to place a wand in the harness; MR 0.

Wizard's Desk

Description: A wizard's desk travels folded up to the size of a small trunk. When the legs are extended, the side can fold down to become a writing surface. Inside are compartments for material components, spellbooks, parchment, inks... and the tinker-created device that makes wizard's desks so sought after. From one side of the interior, an articulated arm can be unfolded. At its tip is a stylus with a tube that runs back down the arm and is connected to a vial of ink. Stabilized by springs and providing an uninterrupted flow of ink, this design allows spellcasters to work quickly and precisely when scribing scrolls. The time required to scribe a scroll is halved when using a wizard's desk, but the cost of raw materials rises to two-thirds of the base price (cheaper parchments tear under the clean strokes of the silver nib, and inferior inks clog the rubber tubing).

Operation: Requires the Scribe Scroll feat.

HR 5; hp 10; SZ Small (3 ft. wide x 2 ft. tall x 1 ft. deep); WT 15 lb.; MV 200 gp; Create DC 17; ST 1 min. (set-up time); MR 0.

Special Substances and Items

The following technological devices are unusual works of engineering with rather specific applications.

Dirtworm

Description: A dirtworm is a large mechanical device designed by goblin sappers during the First War to aid them in tunneling beneath Alliance

defenses. Enormous teeth on the front of the device chew up earth and pull it inside, where steam hammers push it outward and compact it to create a tunnel with hard-packed walls.

The dirtworm can chew through any material with 7 or fewer points of hardness at the rate of 10 feet per minute. Harder materials take 10d6 points of damage per round. The tunnel it carves is 8 feet in diameter with walls of hardness 4; a 5-foot length of the tunnel will collapse after taking 50 points of damage.

On open ground when not tunneling, the dirtworm can be moved at a maximum speed of 20 feet per round.

Operation: DC 15 Use Technological Device* to start, and an additional check once per minute for continued operation. Operating the dirtworm is a full-round action.

HR 5; hp 25; SZ Large (10 ft. long x 8 ft. diameter); WT 1,500 lb.; MV 415 gp; Create DC 20; ST 5 min.; MR 1.

Memory Scrubber

Description: Tinkers have long sought methods to help those soldiers haunted by their war experiences. The most methods attempt to erase the memories of those events altogether. Unfortunately, none have yet managed to achieve the desired degree of precision that would allow the removal of only selected memories. However, tinkers have managed to develop a machine that can erase the most recent memories of those it is used upon: the memory scrubber.

The memory scrubber is a chair attached to a large trunk full of machinery. The target of the device sits on the chair and places the device's helmet onto her head. The operator then has the choice of several settings; the device can attempt to scrub the target's memories of the last 1d20 hours, 1d10 days, 1d6 weeks, 1d4 months or 1d2 years. Upon activation, targets report seeing flashes of light and hearing a buzzing sound, followed by a calming void. After 1 minute, the process is complete. If the process was successful, the target will be unable to remember any part or aspect of the period erased.

Use of memory scrubbers has occasionally caused some trouble when it has resulted in the loss of crucial information. Yet thus far, no tinker has created a machine to recover erased memories.

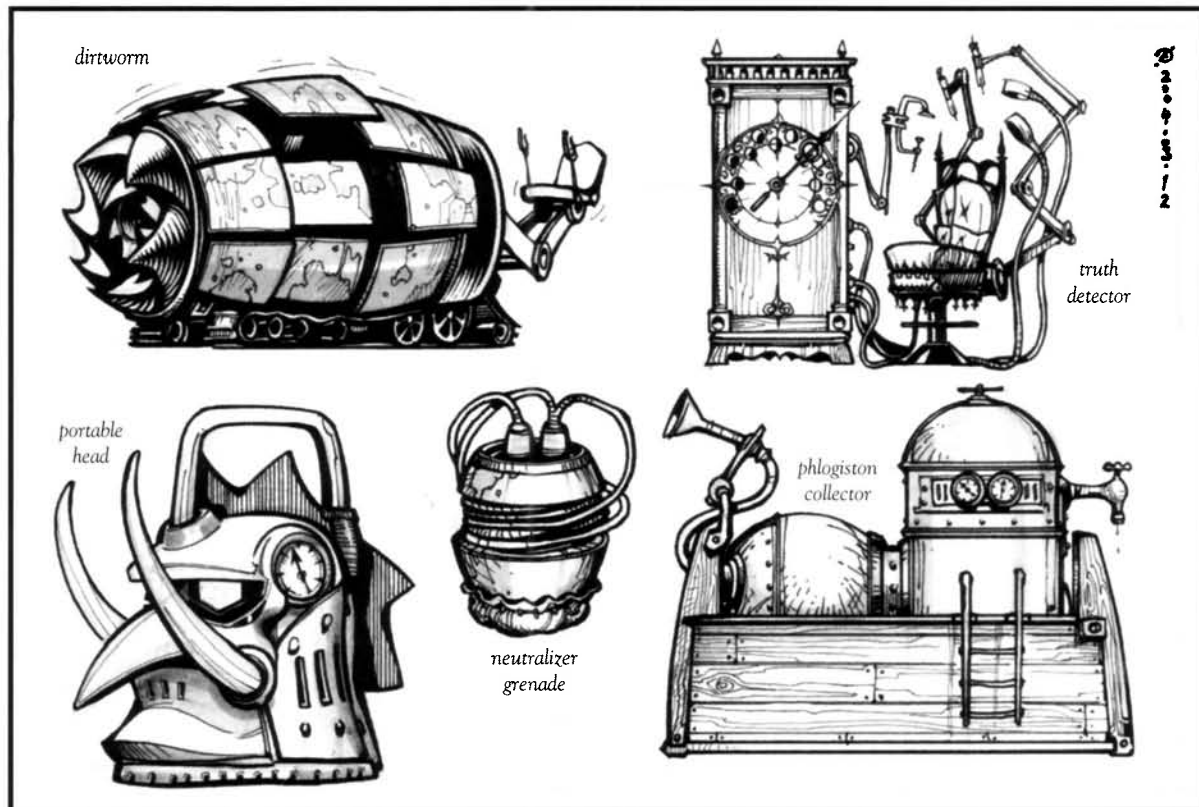

Operation: DC 15 Use Technological Device* check to hook up a subject; DC 25 Use Technological Device* check to operate the device.

HR 1; hp 5; SZ Medium (4 ft. wide x 4 ft. deep x 3 ft. tall); WT 225 lb.; MV 33,000 gp; Create DC 25; ST 5 min. to hook up subject, 1 hour for machine to become operational; MR 2.

Miser's Forge

Description: A miser's forge is a device spoken of in tavern tales, always owned by "a friend of a friend." Few can claim to have seen one with their own eyes, although its handiwork does appear in marketplaces from time to time.

The device described in the stories is a small, phlogiston-powered forge that melts down a coin of a high denomination and then uses the resulting metal to gild lower-value coins — creating surprisingly effective forgeries. A single gold piece melted in a miser's forge can cover up to five coins. The coins covered are typically of lower denomination, used to defraud merchants. However, on occasion coins are discovered with gilding that makes them appear cheaper (such as gold coins coated in silver) in order to avoid paying taxes.

When a miser's forge is used, it "converts" one type of coin into another as though it had 15 ranks of Forgery. A check is made for each batch of five coins produced by the machine.

A user with 5 or more ranks in Forgery gains a +2 synergy bonus to Use Technological Device* checks made with the miser's forge.

Malfunction: In general, a device malfunction ruins all coins involved in the batch.

Operation: DC 25 Use Technological Device* check for each batch.

HR 5; hp 10; SZ Medium (3 ft. tall x 2 ft. wide x 2 ft. deep); WT 200 lb.; MV 9,375 gp; Create DC 20; ST 1 hour; MR 3.

Neutralizer Grenade

Description: The neutralizer grenade is an experimental attempt to create a device that will interfere with the workings of other devices. Thrown into an area, it explodes to release a jolt of electricity to melt wiring, dust and oil to clog delicate gearwork, and a cloud of inert phlogiston gas to interfere with phlogiston boilers. The end result is that all devices in a 10-foot radius from a neutralizer grenade explosion have their Malfunction Ratings

raised by +3 for 2d6 rounds. A full-round DC 30 Use Technological Device* check by the operator of a targeted device can reverse these effects before they've run their course.

Operation: The grenade can be used as a thrown weapon with a range increment of 30 feet.

HR 1; hp 5; SZ Tiny (4-in. diameter sphere); WT 1 lb.; MV 500 gp; Create DC 20; ST attack action to activate, grenade detonates 2 rounds later; MR 1.

Noble's Swordsmen

Description: The noble's swordsmen is a room-sized apparatus commissioned from a group of tinkers by advisors to the Alliance Assembly; they wished to settle disputes with traditional swordfights, yet didn't want to risk any true physical harm.

The noble's swordsmen requires two operators; each straps himself into a skeleton-like framework that wraps around him and telegraphs his movements using marionette-like cables to one of two life-sized mechanical soldiers. Armed with wooden swords, these soldiers' movements mimic those of their operators. Their wooden bodies have compartments that can be packed with bladders full of red dye in order to simulate injury in particular body parts. Though severing the control cables with the wooden sword is possible, such tactics are frowned upon by devotees of the Device check.

Strapping into the control framework requires a DC 10 Use Technological Device* check. Combat between two creatures operating the swordsmen is run as if it were a combat between the two operators, with the following exception: the movement of the swordsmen is limited to an area 30 feet in diameter. Once loaded with "blood" packs, each swordsman is considered to have 25 hit points, and the swords do 1d4 points of damage (with a bonus to damage of only half the operator's Strength bonus.) The mechanism's statistics (see above) represent its inherent physical attributes, were someone to attempt to destroy it specifically.

Operation: See text.

HR 5; hp 30; SZ Gargantuan (50 ft. long x 20 ft. high x 50 ft. wide); WT 7,000 lb.; MV 2,250 gp; Create DC 23; ST 10 min.; MR 1.

Phlogiston Collector

Description: The first samples of phlogiston were collected in the labs of dwarven tinkers in Khaz Modan when a vacuum pump was used to collect the

superheated air over a kettle of molten iron. In the years since, the process has been much refined, leading to the development of the phlogiston collector. This wagon-sized piece of machinery has a large intake valve to pull air into a reserve over a glowing crucible. Once the phlogiston gas has been separated and purified, the device bubbles it into a mixture of oil and water to capture it. The liquid is then siphoned into glass vials and sold as "liquid phlogiston," the fuel for many devices.

A phlogiston collector running at full speed can collect 40 vials of liquid phlogiston per hour, though collectors running atop mountaintops (such as the collectors at the high altitudes of Khaz Modan) collect a bit more and collectors at seaside (such as those at Thermaore) collect a bit less.

Phlogiston collectors are temperamental pieces of machinery and require constant supervision. If they collect too little phlogiston gas, the water content of the liquid phlogiston will be too high and devices won't operate properly. If too much phlogiston gas is collected, the crucible inside may start to react with the gas, burning white-hot until the entire collector melts into slag and the collected gas ignites in a titanic explosion.

The collector requires a Use Technological Device* check each hour; failure means that no phlogiston is collected that hour. If the collector is shut down, even for a moment, a full day is required for it to heat up and collect enough air to begin processing again.

Operation: DC 20 Use Technological Device* check.

Liquid Phlogiston

Description: Produced by phlogiston collectors, vials of liquid phlogiston contain a precise mixture of oil, water and phlogiston gas. Liquid phlogiston allows smaller boilers to burn at the tremendous temperatures and pressures that enable portable tinker technology and gigantic vehicles to operate. Unless otherwise specified, most portable phlogiston-powered devices require 1 vial of liquid phlogiston per week. Vehicles may require anywhere between 1 and 20 vials per week based on their size and weight.

A vial of phlogiston weighs 1/4 lb. and has a market value of 20 gp.

AC 25; HR 10; hp 75; SZ Huge (18 ft. long x 12 ft. wide x 9 ft. tall); WT 12,000 lb.; MV 37,500 gp; Create DC 30; ST 1 day; MR 2.

Portable Head

Description: Portable heads are compact repositories of knowledge. Though they could likely take on any outward appearance, tinkers with capricious senses of humor usually build them in the form of the heads of various creatures (and often in the form of their own heads).

All portable heads know at least one language, in order to understand spoken commands. The most common portable heads are those with a second language installed in order to act as translators. After being activated, the translator listens to what is being said during one round and speaks it in the next. Listening to languages it does not understand confuses the head; it will return no results and light its gemstone eyes in confusion.

More complex portable heads possess a body of knowledge on a particular subject. When activated, the head can be asked a question. If it doesn't know the answer, its eyes will light. When it does possess the knowledge, it will speak the answer via a small, vibrating membrane hidden in its "mouth."

When a portable head is created, it can possess a single Speak Language skill or a Knowledge skill at 3 or 6 ranks (with prices as listed below). Multiple languages and Knowledge skills must be added as secondary functions. Additional languages or ranks in Knowledge skills may be added to a head later as upgrades. (See Chapter Three of the **Warcraft RPG** for details.)

Spoken languages are translated automatically when a portable head is active, but multiple nearby speakers easily confuse it. When posed a question that requires a Knowledge skill check, the GM makes the roll on behalf of the portable head. If the check fails, the head does not have or cannot access the information desired. A portable head can operate for 6 hours before its internal boiler requires a fresh dose of liquid phlogiston.

Operation: DC 15 Use Technological Device* check to activate.

HR 2; hp 15; SZ Small (1 ft. cube); WT 15 lb.; MV 110 gp (1 language), 120 gp (3 ranks Knowledge skill), 215 gp (6 ranks Knowledge skill); Create DC 16 (1 language or 3 ranks Knowledge skill), 17 (6 ranks Knowledge skill); ST 5 rounds; MR 2.

Substitution Engine

Description: A brilliant Alliance engineer invented these devices recently; they remain one of the Alliance Assembly's greatest secrets. Intricate gearwork inside the bronze-sided trunk allows the user to transform a message into a series of random letters. The holes in a wooden "key," which is custom-carved for each message, record the internal settings of the substitution engine; differently carved keys will result in messages that are scrambled differently. Only with the key, the scrambled message, and another substitution engine can the original message be reconstructed.

Substitution engines were designed by a high elf tinker. Thus, using one of the few devices currently in operation requires the operator to understand Tharlassian. It also requires the operator to make a DC 15 Use Technological Device* check to successfully create the wooden key that records the engine's internal settings. Though it is plain that a scrambled message is written in the Tharlassian alphabet, the message is considered to be written in a language spoken only by the substitution engine with the key that created it; the *tongues* spell and other, similar spell effects are not effective against the substitution engine's encryption.

Operation: DC 15 Use Technological Device* check and knowledge of Tharlassian.

AC 8; HR 5; hp 15; SZ Medium (4 ft. wide x 3 ft. deep x 3 ft. tall); WT 200 lb.; MV 6,000 gp; Create DC 23; ST 10 min.; MR 1.

Truth Detector

Description: This complex device is employed in the City of Ratchet when the Venture Company is making an important deal with a new supplier and wants to ascertain whether or not the supplier is trustworthy. The creature being tested sits in a comfortable chair surrounded by an array of machinery, and is slowly and painstakingly connected to each and every one of them. Clamps on the ends of caliper arms help measure the movement between brow and jaw, tight elastic bands measure the contraction of muscles in the forearm, glass tubes filled with mercury track changes in temperature and pressure near the ears, and membranes pressed up against the chest help record the sound of liquids moving in the stomach. These measurements all feed back into a wardrobe-sized cabinet, and the result is shown by the movement of an arm mounted

on a pivot on its exterior. If the arm points toward the painting of a full moon, the device is certain that the words spoken are the truth. As it swings along a line of waning moons toward the black disc of a new moon, it is increasingly likely that the subject speaks a falsehood. The device is surprisingly accurate; the results have led some wizards and priests to reconsider the abilities of technology.

Once a subject is attached to the truth detector (a complicated process that requires 30 minutes), the machine can make a Sense Motive check once per minute as if it possessed 9 ranks in the skill. A DC 20 Use Technological Device* check is required each time a Sense Motive check is desired. When the measuring instruments are not in use, they can be stored inside the cabinet.

Operation: DC 25 Use Technological Device* check to hook up a subject; see text for use.

HR 5; hp 15; SZ Large (7 ft. tall x 4 ft. wide x 3 ft. deep); WT 300 lb.; MV 1,750 gp; Create DC 18; ST 1 hour; MR 2.

Vehicles

Soar through the skies! Rumble over the land! Rule the seas! Just don't forget those regularly scheduled tune-ups.

Destroyer

Description: Destroyers are heavy, iron-clad warships that can quickly carry a half-dozen heavy cannon to any point on a coastline and bombard a target into submission.

Operation (Destroyer): Vehicle Proficiency (water vehicles)* to pilot and DC 30 Use Technological Device* checks to operate.

Operation (Cannon): Exotic Weapons Proficiency (firearms) and ranged attack roll.

AC 25; HR 15; hp 110; SZ Colossal (180 ft. long x 45 ft. wide); WT 22,000 lb.; Spd 20 mph (175 ft./round) (poor); Cargo 4,400 lb.; Crew 7 (1 pilot, 6 gunners); MV 1,660 gp; Create DC 37; ST 10 min.; MR 1.

Cannon: RoF 1/3 rounds; Range 100 ft.; 4d6; MR 2.

Flying Machine

Description: A dwarven improvement on the helicopters built by their gnomish cousins, the flying machine is a heavily armed, flying gun platform. Thick armor protects the daredevil pilots

who pilot the flying machines, but the armor also slows the vehicle considerably.

Operation (Flying Machine): Vehicle Proficiency (air vehicles)* to use and DC 20 Use Technological Device* checks to operate.

Operation (Flak Cannon): Exotic Weapon Proficiency (firearms)* to use and ranged attack roll.

Operation (Bomb): Ranged attack roll.

AC 18; HR 10; hp 50; SZ Large (20 ft. long x 15 ft. wide); WT 1,100 lb.; Spd 60 mph (530 ft./round) (good); Cargo 200 lb.; Crew 1; MV 2,170 gp; Create DC 25; ST 3 min.; MR 1.

Flak Cannon: RoF 1/round; Range 50 ft.; 3d6; MR 1.

Bomb: RoF once; Range 10 ft.; 6d6; MR 3.

Footcarts

Description: The inventor of footcarts was once a poor tinker who employed her talents at toymaking in the coastal town of Tidus. The most popular of the products she sold in the marketplace were miniature, phlogiston-powered, dwarven steam tanks. When a tauren scoffed at the "foolish toys" and attempted to leap upon and smash them... he suddenly found himself pulled across the marketplace with the wreckage of tiny steam tanks bent around the bottoms of his hooves. That night, the toymaker realized that her inventions might be put to more useful ends and crafted two simple carts *designed* to be strapped to the bottoms of her feet. The next morning she arrived at the marketplace, put on her "footcarts," and zoomed into tinker history. Today they are one of the first useful devices tinkers teach apprentices to construct.

Though footcarts have become a simple and popular mode of transportation even among adults in many Kalimdorian cities, they are rarely seen outside city walls. The reasons are primarily pragmatic: off smooth cities streets and packed earth, footcarts turn every loose pebble into the possibility of a painful spill.

Footcarts are such simple devices that they use the character's Dexterity as the basis for Maneuverability checks (rather than Use Technological Device*). A character with 5 or more ranks in Balance gets a +2 synergy bonus on these checks. Normal DCs for standard Maneuverability checks are halved when wearing footcarts.

Operation: See text.

HR 2; hp 5; SZ available for Small, Medium, and Large creatures; WT 6 lb.; Spd 20 mph (165 ft./



round) (clumsy); Cargo 200 lb.; Crew 1; MV 125 gp (set of 2); Create DC 16; ST 3 min.; MR 1.

Gnomish Helicopter

Description: The first tiny flying machines were built by the gnomes of Khaz Modan, who proved their worth to the Alliance by using their helicopters to scout far behind enemy lines. Though unarmed, fragile and temperamental, gnomish helicopters remain some of the fastest and most maneuverable machines in the skies.

Operation: Vehicle Proficiency (air vehicles)* to use and DC 20 Use Technological Device* checks to operate.

AC 13; HR 5; hp 25; SZ Large (15 ft. long x 13 ft. wide); WT 600 lb.; Spd 80 mph (705 ft./round) (excellent); Cargo 200 lb.; Crew 1; MV 750 gp; Create DC 20; ST 3 min.; MR 2.

Gnomish Submarine

Description: Gnome inventors took their resourcefulness to the seas and created these amazing watertight vessels that can travel under the waves. The submarines have proved themselves to be a powerful threat to not only ships, but also coastal targets within range of the submarine's battery of rockets.

Special: A successful opposed Hide check allows the pilot of the submarine to use the periscope to view the surface while submerged without being spotted.

Operation (Gnomish Submarine): Vehicle Proficiency (water vehicles)* to use and DC 30 Use Technological Device* checks to operate.

Operation (Rocket-Propelled Torpedo): Ranged attack roll.

AC 15; HR 5; hp 25; SZ Huge (30 ft. long x 12 ft. wide); WT 5,500 lb.; Spd 20 mph (175 ft./round) on the surface, 10 mph (90 ft./round) underwater (good); Cargo 600 lb.; Crew 2 (1 pilot, 1 gunner); MV 2,225 gp; Create DC 21; ST 5 min.; MR 1.

Torpedo: RoF 1/round; Range 100 ft. (airborne), 50 ft. (underwater); 4d6; MR 1.

Goblin Shredder

Description: The first machine designed to mimic the humanoid form, goblin shredders use the steamsaws attached to their arms to cut down lumber at an incredible rate, unmatched by peasant work crews.

Operation (Goblin Shredder): DC 15 Use Technological Device* check.

Operation (Steamsaw): DC 10 Use Technological Device* check to start; Exotic Weapon Proficiency (steamsaw) and melee attack rolls for combat.

AC 2; HR 5; hp 50; SZ Large (15 ft. tall x 9 ft. wide); WT 900 lb.; Spd 10 mph (90 ft./round) (poor); Cargo 1,000 lb.; Crew 1 (usually designed for goblin-sized Small creatures, though larger versions have been built); MV 1,350 gp; Create DC 25; ST 2 min.; MR 3.

Steamsaw (mounted on right arm): 4d6; ST 2 rounds; MR 3.

Goblin Zeppelin

Description: The goblins built their first balloons in the days of the Alliance's early battles with the Horde. Refining and enlarging their craft over the years led to the construction of the first goblin zeppelin, a massive air vehicle capable of transporting vast numbers of troops.

Operation: Vehicle Proficiency (air vehicles)* to use and DC 25 Use Technological Device* check to operate.

AC 12; HR 0; hp 120; SZ Colossal (90 ft. long x 30 ft. wide x 50 ft. tall); WT 3,000 lb.; Spd 40 mph (350 ft./round) (poor); Cargo 8,000 lb.; Crew 2 (1 pilot, 1 engine tender); MV 6,000 gp; Create DC 40; ST 5 min.; MR 0.

Iron Fish

Description: This single-person vehicle holds enough air to allow for 1 hour of underwater travel. On several occasions, pilots have taken advantage of its powerful engine and thick metal hull to ram — and even sink — other vessels.

Operation: Vehicle Proficiency (water vehicles)* to use and DC 30 Use Technological Device* checks to operate.

AC 18; HR 8; hp 40; SZ Large (3 ft. wide x 12 ft. long); WT 600 lb.; Spd 60 mph (530 ft./round) (excellent); Cargo 200 lb.; Crew 1; MV 1,500 gp; Create DC 23; ST 2 min.; MR 2.

Meat Wagon

Description: A weapon of both destruction and terror, the meat wagon is a vehicle constructed by the Scourge to collect corpses from the field of battle. These corpses can then be flung at the enemy with the meat wagon's catapult or, if the meat wagon carries a necromancer, raised to swell the Scourge's undead ranks.

Special: The meat wagon can automatically gather up to six corpses that it drives over. If these corpses are used for ammunition, full damage is still done at the point of impact; any living characters within a 15-foot radius can become diseased with filth fever (injury, Fort DC 12, incubation 1d3 days, 1d3 Dex/1d3 Con; see Table 8–2 in the DMG).

Operation (Meat Wagon): Vehicle Proficiency (land vehicles)* to use and DC 20 Use Technological Device* check to operate.

Operation (Catapult): Exotic Weapon Proficiency (catapult)* and ranged attack roll.

AC 17; HR 7; hp 35; SZ Gargantuan (20 ft. wide x 35 ft. long); WT 5,000 lb.; Spd 20 mph (165 ft./round) (good); Cargo 1,400 lb.; Crew 3 (1 pilot, 1 gunner, 1 passenger); MV 1,000 gp; Create DC 22; ST 5 min.; MR 1.

Catapult: RoF 1/round; Range 50 ft.; 3d6 bludgeoning (standard catapult ammo); MR 1.

Phlogistic Unicycle

Description: The unicycle is a favorite of both goblins and gnomes for rapid transportation on city streets. While uncommon in the cities of humans except during performance expositions, unicycles are common in Ratchet as an eccentric form of transportation. The infamous Slink Strong, goblin performer extraordinaire, bases his “line of death” stunt on a reliable, Ratchet–designed phlogistic unicycle and 10 pulley guns firing spider silk line. These one-wheeled devices can move with startling speed and perform maneuvers of such finesse they almost seem like a natural extension of the driver.

Running on a small steam engine heated with combusting phlogiston, the unicycle can travel up to 1 hour without needing refueling. Unicycles are for Small riders, but they can carry a Medium rider of up to 150 pounds without difficulty. At least 5 ranks in the Balance skill are required to ride one of these contraptions. A pedal mode allows them to travel at slower speeds without consuming fuel.

Operation: Vehicle Proficiency (land vehicles)* to use and DC 10 Use Technological Device* check to operate.

AC 10; HR 2; hp 5; SZ Tiny (2 1/2 ft.); WT 20 lb.; Spd 40 mph, or 60 feet (12 squares) per round in pedal mode (good); Crew 1; MV 300 gp; Create DC 18; ST 3 min.; MR 0.

Rainmaker

Description: Villages in the sun-baked Barrens helped fund the construction of this incredible device, able to summon storm clouds from a clear sky. The rainmaker is so large that it has an engine and wheeled tracks that allow it to be driven from town to town like a vehicle, with a small cabin on the front that acts as a control room for the machine and living quarters for the two-person crew.

Driving the rainmaker from one place to another requires the Vehicle Proficiency (land vehicles)* feat and DC 15 Use Technological Device* checks to operate. Operating the weather control machinery of the rainmaker requires a DC 25 Use Technological Device* check.

When the rainmaker is activated, clouds immediately begin to form and gather in the sky. Within an hour the clouds become thick and heavy with moisture. Heavy rain begins to fall shortly thereafter, and it will continue to rain steadily in a 2-mile radius centered on the device for 2d6 hours thereafter. In particularly cold weather, the rain will manifest as heavy snow, dropping 1d4 inches per hour.

Side effects of operating the rainmaker include heavy winds and the incredible noise generated by the rainmaker when it is in operation.

Operation: See text.

AC 17; HR 5; hp 35; SZ Gargantuan (60 ft. long x 30 ft. wide x 20 ft. tall); WT 42,000 lb.; Spd 20 mph (165 ft./round) (average); Cargo 1,200 lb.; Crew 2; MV 87,500 gp; Create DC 22; ST 1 hour; MR 3.

Scout Balloon

Description: Invented by the Alliance as they explored Kalimdor, the scout balloon is a backpack containing a balloon inflated with hot air produced by a tiny phlogiston engine. A small propeller on the pack allows the “pilot” limited maneuverability, but scout balloons are usually tethered to a tree and used simply for an elevated view of the surrounding territory. Cheap and simple to operate, scout balloons are becoming increasingly common.

Operation: No proficiency to use, but DC 10 Use Technological Device* check to operate.

AC 11; HR 4; hp 25; SZ Large (10 ft. x 10 ft.); WT 40 lb.; Spd 10 mph (90 ft./round) (poor); Cargo 200 lb.; Crew 1; MV 45 gp; Create DC 20; ST 10 min.; MR 1.

Siege Engine

Description: The dwarven siege engine was a new addition to the Alliance forces during their battle with the Scourge. Though many believe the siege engine is an unwieldy vehicle slowed by its thick layer of armor, dwarven tank pilots can coax them up to surprisingly high speeds to ram enemy fortifications.

Operation (Siege Engine): Vehicle Proficiency (land vehicles)* to use and DC 25 Use Technological Device* check to operate.

Operation (Cannon): Exotic Weapon Proficiency (cannon*).

AC 20; HR 10; hp 50; SZ Huge (14 ft. wide x 25 ft. long x 12 ft. tall); WT 4,500 lb.; Spd 40 mph (350 ft./round) (poor); Cargo 1,200 lb.; Crew 3 (1 pilot, 1 gunner, 1 passenger); MV 1,500 gp; Create DC 25; MR 3.

Cannon: RoF 1/round; Range 200 ft.; 5d6 bludgeoning; MR 1.

Siege Wagon

Description: After the advent of phlogiston-powered boilers, the first vehicles to be built in Lordaeron and Azeroth were weapons of war — dwarven steam tanks, goblin zeppelins, Horde demolishers. Quick on their heels were vehicles to support weapons and troops at war, and the most versatile of these vehicles has proved to be the siege wagon.

The siege wagon is a boxy vehicle with iron-bound wooden wheels, an armored skin and an expansive interior. The inside compartment of the siege wagon carries materiel and troops to the front lines. Then, upon arriving at an encampment, some wagons become field hospitals or kitchens, while others are used as tinkers’ workshops or officers’ headquarters.

However, the truly remarkable use of siege wagons requires multiple wagons used in combination. Using troops and a block and tackle, siege wagons can be stacked atop one another and bolted together to form mobile siege towers that can slowly roll up to the outer fortifications of large cities and bring troops within striking distance. Arrow slits in the sides of a siege wagon allow archers to attack in all directions, and ladders leading through hatches in the top and bottom of the vehicle allow for easy transit between stacked siege wagons. Each siege wagon can extend a 20-foot-long and 4-foot-wide plank to allow troops to cross to fortifications.

When siege wagons are stacked to form a siege tower, they remain mobile. Only the operator of the bottom siege wagon is required to make checks to maneuver the tower. For each tower stacked atop the first, the top speed of the operator's siege wagon drops by 10 miles per hour and its Maneuverability rating drops by one class to a minimum of Clumsy. When six or more siege wagons are stacked, the resulting tower is immobile. As the boilers of all siege wagons in a stack help power the tower, the weight of stacked wagons does not count toward a siege wagon's cargo capacity.

Operation: Requires the Vehicle Proficiency (land vehicles)* feat and DC 15 Use Technological Device* checks to operate. Stacking siege wagons atop one another requires the use of the appropriate block and tackle and labor to raise its weight, as well as a DC 20 Use Technological Device* check.

AC 21; HR 11; hp 55; SZ Huge (15 ft. long x 15 ft. wide x 10 ft. tall); WT 4,000 lb.; Spd 60 mph (495 ft./round) (average); Cargo 2,200 lb.; Crew 1; MV 2,750 gp; Create DC 26; ST 1 min.; MR 1.

Steam Horse

Description: The first steam horses were built by the Alliance for patrols traveling the arid savannah of the Barrens in eastern Kalimdor, where grazing was sparse. The rider sits in the saddle atop the four-legged machine and guides it just as she would a living mount. The rear of the steam horse includes a spacious compartment for cargo and gear.

Operation: Vehicle Proficiency (land vehicles)* to use, DC 10 Use Technological Device* check to start, and Ride checks to operate.

AC 12; HR 13; hp 15; SZ Large (7 ft. tall x 10 ft. long); WT 600 lb.; Spd 60 mph (530 ft./round) (good); Crew 1; MV 782 gp; Create DC 18; ST 1 min.; MR 1.

Steam Launch

Description: These small boats are enormously popular among fishermen. Several steam launches are often kept aboard larger ships for ferrying troops and supplies to and from shore.

Operation: Vehicle Proficiency (water vehicles)* to use and DC 20 Use Technological Device* checks to operate.

AC 12; HR 5; hp 20; SZ Large (12 ft. long x 8 ft. wide); WT 300 lb.; Spd 20 mph (175 ft./round)

(good); Cargo 800 lb.; Crew 1; MV 660 gp; Create DC 19; ST 2 min.; MR 1.

Steamwarrior Armor

Description: Steamwarriors are tinkers who take to the battlefield in walking suits of armor. Though a steamwarrior's personal set of armor is endlessly improved and modified, steamwarriors in need of money have been known to construct and sell basic sets of armor. These have no projectile weapons, but do possess axe blades that fold out from the wrists to allow melee combat.

Operation (Steamwarrior Armor): Vehicle Proficiency (combat armor) to use and DC 25 Use Technological Device* check to operate.

Operation (Wrist Axe): Martial Weapon Proficiency (axe) and melee attack roll.

AC 12; HR 8; hp 40; SZ Large (11 ft. tall x 7 ft. wide); WT 1,300 lb.; Spd 40 mph (350 ft./round) (good); Cargo 400 lb.; Crew 1; MV 2,550 gp; Create DC 25; ST 1 round; MR 1.

Wrist Axe (one on each arm): ST attack action; 1d6; MR 1.

Weapons

This section describes technological devices designed for incapacitating — if not blowing to smithereens — your enemies. As always, proceed with caution....

Alchemical Grenade

Description: The dwarves have taken to technology with exceptional efficiency. The stout race is more focused than gnomes, and less manic than the goblins when it comes to implementing technology. Most dwarven technology, while efficient and well designed, appeals to their more martial nature. In other words, the dwarves enjoy making better weapons.

These alchemically enhanced grenades deliver elemental effects with a blast. The dwarves have made a grenade for electricity, fire and ice. Other variations include a grenade that unleashes a low baleful howl to terrify targets, and a grenade that unleashes choking gas.

An electricity, fire or ice grenade deals an additional 1d6 points of damage of its energy type in addition to the grenade's blast damage. Each type of grenade has a distinct special effect.

Electricity: Electrical energy can stun even the sturdiest opponent; anyone caught in the blast of an electrical grenade must make a DC 15 Fortitude save or stand dazed for 1 round.

Fire: Those stuck in the blast of a fire grenade must make a DC 15 Reflex save for half damage. The burst area of a fire grenade is filled with flames for an additional round, inflicting another 1d6 points of fire damage to anyone still in the burst zone (no save).

Ice: Anyone inside the blast radius of an ice grenade slows temporarily due to the chill, and receives a -2 penalty on initiative checks for a number of rounds equal to the damage dealt by the cold effect of the grenade.

Gas: Alchemical gas grenades create a cloud that fills a volume of 30 feet. All living creatures within the cloud must make a DC 15 Fortitude saving throw or be nauseated until the cloud disperses, or for 1d4 rounds after leaving the area of effect. The cloud disperses in 1d4+6 combat rounds.

Howl: Howl grenades do not deal damage. Instead, the devices release a hellish, demonic howl that affects anyone within 20 feet of the grenade.

Anyone who fails a DC 15 Will save is frightened for 1d6 rounds, while those who succeed are shaken for 1 round.

Operation: Thrown or launched as appropriate.

SZ Tiny; WT 1 lb.; MV 80 gp; Create DC 20; Range 10 ft.; 2d6 + 1d6 energy damage, or other (see text); ST move action to arm, detonates on impact; MR 1.

Blast Arrow

Description: Early accidents during the development of the fire arrow (see below) led to the blast arrow. Blast arrows appear similar to fire arrows, but their gunpowder charges don't ignite until they strike a target. A ranged attack roll with a blast arrow suffers the same -4 circumstance penalty as a fire arrow due to the arrow's unwieldiness; but as they are not propelled by the charge, these shots have a normal range increment.

Operation: Firing an arrow with a previously attached blast arrow is a normal ranged attack.

SZ Fine (3 in. long by 1/2-in. diameter cylinder); WT 1/16 lb.; MV 75 gp; Create DC 18; Range as the weapon; 3d6; ST 1 min. to attach blast component to arrow, detonates on impact; MR 3.

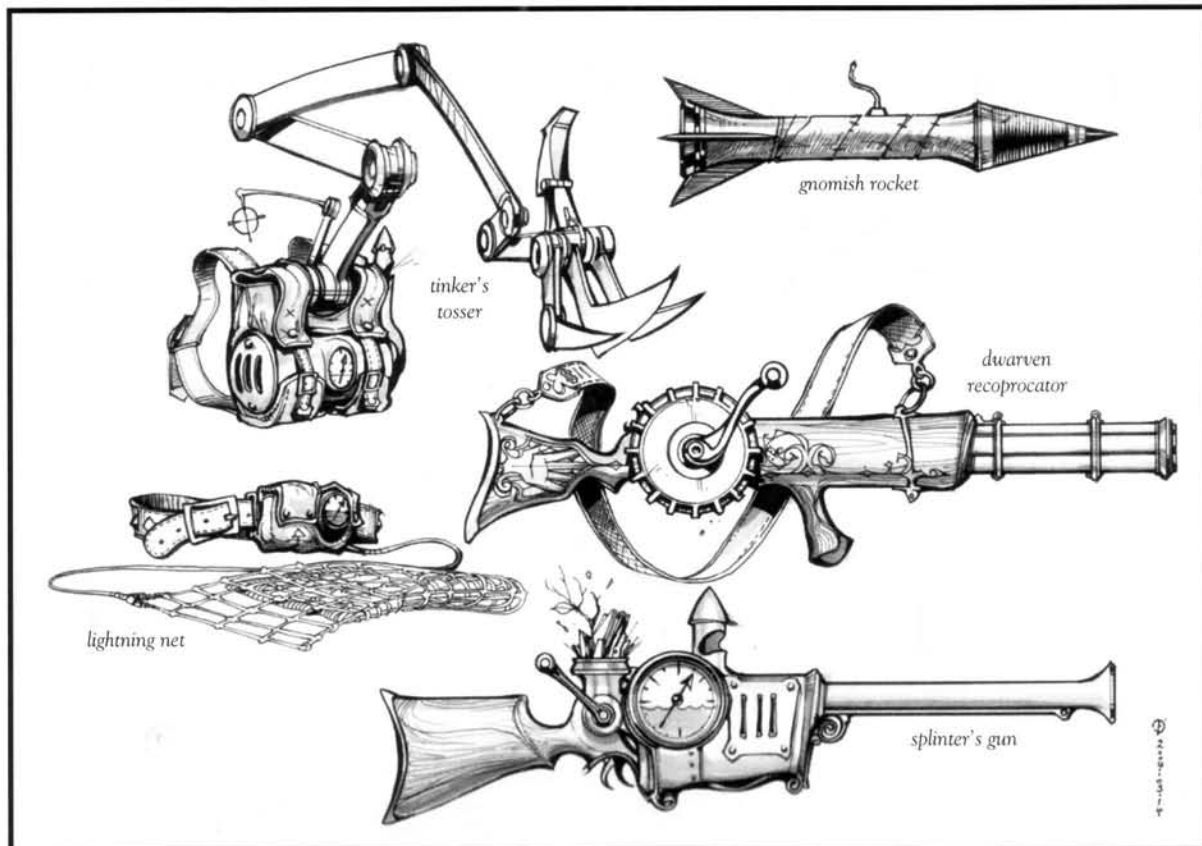

Demon Dirk

Description: The demon dirk was originally invented by a lazy tinker as a self-oiling dagger that couldn't rust. Upon carrying it, he quickly discovered that he had invented a weapon with more possibilities than he imagined: not only was the dagger protected from rusting, it could more readily cut through fibers (even those of a giant spider's web, thus saving the tinker's life on one important occasion). Most importantly, the tinker discovered (when he let dagger and its oily coating stray too close to a campfire) that the weapon's blade would burst into flame. Reminded of weapons he had seen carried by the Burning Legion, the tinker christened the weapon a "demon dirk" and began selling them.

A demon dirk is immune to the rust ability, as well as any spells or abilities that corrode or damage metal. The weapon also grants a +15 bonus on Escape Artist checks when the wielder is entangled by a spell or object. Igniting the dagger's blade using the sparker built into its hilt is a move action. When the blade is aflame, it can inflict 1d6 additional points of fire damage per attack for 6 rounds until the oil stored in the hilt is expended and must be replaced. The dagger's immunities are lost while the oil reserve is empty.

Operation: DC 10 Use Technological Device* check and a half pint of oil to load.

Simple Light Melee Weapon; WT 2 lb.; MV 17 gp; Create DC 16; 1d3 (Sm) or 1d4 (Med), crit 19–20/x2; ST 5 min. to reload; MR 1.

Dwarven Reciprocator

Description: At first, this short-barreled rifle appears to be a very long blunderbuss or flintlock. Only on closer inspection does one realize it has five barrels instead of one large barrel. A clockwork crank and rotating clockwork action act as the trigger for this reciprocating long-arm. The dwarven reciprocator is a brutal and intimidating weapon designed for use against charging opponents at close range. This weapon has proven ideal for dwarven tunnel delvers as well, since it can fill a hallway with enough lead to poison any pursuer permanently.

Turning the action once fires a single shot as a normal attack action. As a full attack, winding the clockwork crank around several times fires all five barrels in rapid succession. Each barrel shot receives a cumulative –2

penalty (–2 for the first shot, –4 for the second, and so forth), but the shooter can aim each shot at multiple targets as long as they are within 5 feet of each other. The barrels each hold a single shot, and cranking will only fire the number of shots that remain in the weapon.

The weapon needs to be braced for reciprocating fire. Bracing the reciprocator requires a single standard action. Firing the reciprocator without properly bracing it doubles the penalties incurred.

Operation: Exotic Weapon Proficiency (firearms); Ironforge dwarves and goblins treat dwarven reciprocators as martial weapons.

WT 15 lb.; MV 1,500 gp; Create DC 20; Range 20 ft.; 3d6; MR 3.

Firestarter

Description: A device first employed by elven tinkers, a firestarter is a system of lenses and mirrors that collects the light and heat of the sun and focuses it upon a distant target. Few targets can withstand the incredible heat, and most immediately burst into flame.

Firestarters are large, heavy devices mounted on carts drawn by teams of horses. Their creation requires an incredible amount of precision craftsmanship, and usually involves a partnership between tinkers and artisans familiar with glasswork in order to make the large, highly polished mirrors and finely ground lenses required. Efforts to make firestarters small enough to be carried by individuals have thus far proven unsuccessful.

Operation: The firestarter requires Exotic Weapon Proficiency (siege weapons) to operate (see **Alliance & Horde Compendium**, Chapter One: The New Blood). The mechanism requires the sun's rays to function. Setting it up to collect and focus the sunlight properly requires 1 hour and a DC 25 Use Technological Device* check.

Each round that the firestarter is employed in combat, one member of the crew must make a ranged attack roll in order to maintain the weapon's aim on the target, while the other must make a DC 15 Use Technological Device* check to keep the mirrors and lenses in alignment. Focusing a firestarter inside its first range increment is difficult, and any attempts to do so have a –6 penalty.

The firestarter deals 1d6 points of fire damage to a target in the first round it successfully hits. Each following round that it successfully remains on the

same target (requiring a successful ranged attack roll by the crew each round), the damage increases by +1d6 (2d6 in the second round, 6d6 in the sixth round, and so on), to a maximum of 20d6.

Siege Weapon; HR 1; hp 20; SZ Large (12 ft. long x 8 ft. wide x 6 ft. tall); WT 3,500 lb.; Crew 2; MV 5,000 gp; Create DC 35; 1d6 fire plus 1d6 per successive round (see text); Range 70 ft.; ST 1 hour to collect and focus sunlight; MR 1.

Fire Arrow

Description: In developing the fire arrow, dwarven tinkers took the expertise with gunpowder they gained developing rifles and rockets and turned it toward the bow and arrow. The fire arrow isn't itself an arrow. Instead, it's a small brass cylinder that attaches just below the arrow's head, with a short cord attaching the cylinder to a ring on the archer's quiver. When the arrow is fired, the cord ignites the charge inside the cylinder and propels the arrow incredible distances.

Attaching a fire arrow to an arrow increases the range increment of that shot to 200 feet but also makes the arrow slightly unwieldy, imposing a -4 circumstance penalty on the attack roll.

Operation: Firing an arrow with a previously attached fire arrow is a normal ranged attack.

SZ Fine (3 in. long by 1/2-in. diameter cylinder); WT 1/16 lb.; MV 100 gp; Create DC 19; Range 200 ft.; ST 1 min. to attach fire component to arrow; MR 2.

Flash Pod

Description: Flash pods are a tinker invention inspired by lights used in the night elf village of Nighthaven. Inside a flash pod's wooden shell is a small charge of gunpowder and two compartments containing the secretions of phosphorescent insects from Ashenvale Forest.

Two rounds after the quick-burning fuse of a flash pod has been lit, the gunpowder charge detonates. The explosion deals 1d6 points of damage to any creature within 5 feet. It also allows the secretions inside to combine, and ignites them in a blinding flash. All creatures within 30 feet of the detonation must make a DC 20 Reflex save to avoid being blinded for 2d6 rounds.

Operation: Standard action to light the fuse.

SZ Tiny (5-in. diameter sphere); WT 1 lb.; MV 50 gp; Create DC 17; Range 10 ft. (thrown); 1d6 + special (see text); ST 1 round; MR 1.

Glue Mine

Description: Glue mines are bladders of sticky adhesive. When thrown or stepped upon, they burst and spread glue over a 10-foot square area. Anyone in the area when the bladder explodes must make a DC 15 Reflex save. If this save succeeds, the creature is entangled, but not prevented from moving, though moving is more difficult than normal while entangled (see below). If the save fails, the creature is entangled and can't move from its space, but an entangled creature can break loose by taking a full-round action to make a DC 15 Strength check or a DC 20 Escape Artist check. Once loose (either by making the initial Reflex save or a later Strength check or Escape Artist check), the creature remains entangled, but may move across the glue very slowly. Each round devoted to moving allows the creature to make a new Strength check or Escape Artist check. The creature moves 5 feet for each full 5 points by which the check result exceeds 10. Glue mines are typically sold in units of 6, packed in boxes filled with straw to prevent them from exploding prematurely.

Operation: Standard action to drop the mine; ranged attack roll throw the mine.

SZ Fine (4-in. diameter); WT 1/2 lb.; MV 175 gp (6 mines); Create DC 17; Range 10 ft. (thrown); ST burst on contact; MR 1.

Glue Rifle

Description: This wide-barreled firearm uses glue mines as ammunition (and is famously used by some wardens to stick their quarry to walls and trees). The rifle fires the adhesive-filled bladders at such a high velocity that they inflict 2d4 points of damage to any target they strike before they burst and spread their sticky payload.

Operation: Exotic Weapon Proficiency (firearms)* and a ranged attack roll.

WT 20 lb.; MV 400 gp; Create DC 17; Range 100 ft.; 2d4 plus adhesive (see text); ST full-round action to reload; MR 1.

Gnomish Rocket

Description: During Gnomeregan's fall to invading trogg mobs, gnomish inventors discovered that their fireworks made effective weapons. Gnomish alchemists took to employing these explosive devices against the incoming hordes of troggs that threatened their city. Sadly, the gnomes were too late, but they had sufficient fireworks to make a last ditch escape to

freedom despite the superior forces arrayed against them. Since settling with the dwarves of Ironforge, the two races have worked together to turn the gnomish firework into a deadly weapon. Some of these weapons have made their way to Kalimdor, as gnomes traveling with dwarven compatriots have returned to manufacturing explosives to combat the Horde.

Gnomish rockets pack the punch of a bomb combined with the range of a bow. Lighting a rocket and aiming it is a full-round action, and aiming it at a target still leaves it vulnerable to scatter (see *Player's Handbook*, Chapter 8: Combat, "Special Attacks," *Throw Splash Weapon*) should it miss. Delaying a rocket's fuse is impossible. A rocket explodes upon impact unless it malfunctions. Rockets can hit indirect targets, but these munitions can't safely be aimed at targets closer than 10 feet.

Operation: Exotic Weapon Proficiency (gnomish rocket) to employ normally; gnomes treat them as martial weapons.

WT 5 lb.; MV 125 gp; Create DC 13; Range 150 ft.; 4d6 (20-ft. burst); ST full-round action to light and aim, detonates on impact; MR 2.

Grease Mine

Description: These palm-sized clay discs are sold by the dozen. They can either be laid as traps for the unwary, or thrown to crack open in a desired area. When a grease mine is shattered, the grease inside the disc spreads to cover an area 5 feet square. Any creature on or crossing this area must make a DC 20 Reflex save or fall prone. A grease mine can also be broken on a character; the grease will grant the character a +5 circumstance bonus on attempts to escape a grapple.

Operation: Standard action to drop the mine; ranged attack roll throw the mine.

SZ Fine (4-in. diameter disc); WT 1/3 lb.; MV 300 gp per dozen; Create DC 18; Range 10 ft. (thrown); ST bursts on contact; MR 0.

Ironjaw

Description: An ironjaw is an awkward-snouted apparatus that wraps around the wearer's head, with a pair of rubber-covered bits that go into the mouth. When the wearer of an ironjaw opens and closes her mouth, the movement is amplified by gears and pistons and imparted to the sharp sets of teeth mounted on the end of the snout. When the wearer has successfully grappled an opponent, the ironjaw allows her to make a bite attack.

Ironjaws are unusual devices, but they are cherished by many of those who wear them. Often they are painted to resemble the snout of an animal, from a dire wolf to the mandibles of a spitting spider.

Operation: Exotic Weapon Proficiency (ironjaws) feat and a melee attack roll.

Exotic Light Melee Weapon; HR 4; hp 20; WT 4 lb.; MV 200 gp; Create DC 19; 3d6 (do not apply wearer's Strength modifier); ST 1 round; MR 1.

Lightning Net

Description: A lightning net is a normal net woven with copper strands that stretch back along the control rope to an electrical battery pack worn around the wielder's waist. When a target becomes entangled in the net, the wielder can press a stud on the rubber-coated control rope to release the batteries' charge into the net. A creature in contact with the net yet not ensnared in it may make a DC 15 Reflex save to leap clear and avoid damage. Before the charge builds enough to be released again, 4 rounds must pass; and the battery packs hold only enough energy for six charges before they have to be recharged by connecting them to a standard phlogiston generator.

Malfunction: On a malfunction, the lightning net loses its remaining charges for the rest of the encounter. It may continue to be used as a normal net.

Operation: Exotic Weapon Proficiency (net) and a ranged touch attack to use (see *Player's Handbook*, Chapter 7, "Weapon Descriptions," *Net* for more information on nets and how to employ them). Releasing the electrical charge into the net is a free action.

Exotic Ranged Weapon; hp 10; WT 10 lb.; MV 165 gp; Create DC 20; 5d6 electricity; ST 1 round; MR 2.

Musk Bomb

Description: A musk bomb is a foot-long copper cylinder perforated with holes. When the ring on one end is tugged, a bladed rod at the center of the cylinder rips through the small bladders inside to release the concentrated scents of a dozen creatures. Three rounds after being activated, the mixed odors spread to cover an area with a 60-foot radius, hiding anyone in the area from being detected or tracked using the scent ability. If the musk bomb is dropped in place and the scents allowed to concentrate, the effect will last for 1 hour. If the musk bomb is carried, the effect lasts 2d6 minutes.

Operation: Standard action.

Hp 15; SZ Diminutive (1 ft. long x 2-in. diameter cylinder); WT 1 lb.; MV 300 gp; Create DC 18; ST 1 round; MR 0.

Net Launcher

Description: A net launcher looks like a large blunderbuss with a small keg mounted at the end of its barrel. When the weapon is fired, the net carefully packed inside the keg shoots out. A successful hit means that the target is entangled. An entangled creature takes a -2 penalty on attack rolls, a -4 penalty to Dexterity, can move at only half speed, and cannot run or charge. If the entangled creature attempts to cast a spell, it must make a DC 15 Concentration check to cast the spell successfully. An entangled creature can escape with a DC 20 Escape Artist check, a full-round action. The net has 10 hit points and can be burst with a DC 25 Strength check (also a full-round action.)

The nets for a net launcher are carefully designed for use with the weapon. Any creature attempting to use a net launcher net as a standard net suffers a -4 penalty to all attack rolls. Reloading a net launcher requires a DC 20 Use Technological Device* check and 10 minutes.

Operation: Exotic Weapon Proficiency (net launcher) feat and a ranged attack roll.

Hp 5; WT 8 lb.; MV 250 gp; Create DC 17; Range 40 ft.; ST 1 round; MR 1.

Oscillating Hilt

Description: The oscillating hilt is a modification for any straight-blade weapon from a dagger to a greatsword. The blade is removed from its original hilt and placed into a new hilt crafted by tinkers. When a catch in the grip is depressed, a small phlogiston engine built into the hilt's pommel spins the sword's blade at a high velocity, granting the wielder a +4 bonus on attempts to disarm his opponent. However, as the mechanisms weaken the overall structure of the sword, it loses 3 points of hardness.

If a blade equipped with an oscillating hilt is used as a drill, it can inflict 2d6 points of damage per round. This ability cannot be used in combat without the Weapon Focus (oscillating blade) feat.

Operation: Craft (weaponsmithing) check to install; free action to spinning the blade during a disarm attempt.

WT 1 lb. (added to weight of blade); MV 65 gp; Create DC 17; ST 1 round; MR 2.

Splinter Gun

Description: This weapon uses steam pressure to fire hundreds of thorn-sized wooden darts in a single shot. To fire the splinter gun, the wielder makes a ranged attack roll. Success means that the target has been struck for full damage. Even if the attack fails, the splinter gun shoots out darts in a 30-foot cone, and all creatures in the affected area who fail a DC 15 Reflex save take 2d6 points of damage.

Ammunition for the splinter gun can be created by feeding small pieces of wood into a grinder built into its stock. One round of ammunition requires 1 minute to create and weighs 1 pound. Ammunition must be stored separately from the weapon, and many of those who wield splinter guns can be recognized by the "tinder pouches" hanging from their belts.

Operation: Exotic Weapon Proficiency (firearms)* feat and ranged attack roll.

HR 5; hp 10; SZ Small (2 ft. long x 5 in. wide x 8 in. tall); WT 15 lb.; MV 330 gp; Create DC 20; Range 20 ft.; 4d6; ST 5 rounds to reload; MR 1.

Swordbelt

Description: A swordbelt can appear to be a perfectly normal longsword. However, when the pommel is unscrewed, it releases the tension of a cable running through its core and allows the weapon to collapse into a series of connected segments that can be fastened around the waist. The half-basket hilt of the weapon is even designed to appear like a belt buckle. The clever craftsmanship of the weapon grants the wielder a +15 bonus on Sleight of Hand checks attempting to conceal the device's true nature by wearing it like a belt (it also allows an untrained individual to use Sleight of Hand for this purpose only). However, as it lacks the solid construction of a traditional longsword, a swordbelt is an unbalanced weapon that gives the wielder a -2 penalty on all attack rolls.

Operation: Breaking down the longsword into a belt requires a DC 10 Use Technological Device* check, as does reversing the process. Using the swordbelt as a weapon requires the wielder to have Weapon Proficiency (longsword) and to make appropriate melee attack checks.

One-Handed Martial Melee Weapon; HR 5; hp 10; WT 4 lb.; MV 150 gp; Create DC 18; 1d6 (Sm) or 1d8 (Med), crit 19-20/x2; ST 1 min. to change from one form to another; MR 1.

Tinker's Tossler

Description: The tinker's tosser is yet another in a long line of mechanical arms, this one a sizeable model attached to a backpack containing its phlogiston power source. A hand mounted on the end of the arm can hold anything from a rock to a dagger, while crosshairs hanging in front of the wearer's eye allow him to select a target. Properly loaded and aimed, the tosser throws its payload at the target.

The tinker's tosser can be used to throw any weapon or object, with its range increment doubled. Due to the tremendous force with which it throws improvised weapons, the normal -4 penalty is halved to -2. When determining damage, the tinker's tosser has a Strength modifier of +5.

Operation: Ranged attack roll.

HR 5; hp 10; SZ adjusts to fit any Small or Medium creature; WT 15 lb.; MV 375 gp; Create DC 18; ST 2 rounds to build up initial head of steam; MR 2.

Zecker Devices

For years, balladeers sang of the ongoing adventures of the great and powerful wizard Brymidaine Zecker. Only when Zecker vanished from his room at the Shady Rest Inn, allowing the innkeeper to sort through his belongings in search of clues to his whereabouts, was it discovered that Zecker was not a wizard at all. He was, in fact, a brilliant tinker who for his entire adventuring career had duped the world into believing his inventions were magical artifacts.

Zecker's Cloak

Description: Brymidaine Zecker was never seen without his glistening bronze "cloak of the titans," which stories said he had recovered on the expedition that discovered Bael Modan. Weaved entirely of metallic threads, the cloak was marked with runes similar to those from the Disks of Uldaman. Despite repeated requests from the high councils of Khaz Modan and Bael Modan, Zecker never presented himself or the cloak for inspection.

When the cloak was closely examined after his disappearance, it was discovered that its properties were the result of ingenious construction rather than the blessings of the titans. The dwarves who once treated the cloak and Zecker with reverence immediately condemned both. Still, the cloak remains widely admired by tinkers for its amazing

array of protective properties, especially the weave of metallic threads that tighten and stiffen to absorb the force of blows. A collective of tinkers in Ratchet has begun to craft replicas of Zecker's cloak, but they remain difficult to construct and expensive to purchase.

A character who wears a replica of Zecker's cloak is granted a +5 armor bonus to AC. In addition, the wearer gains damage reduction 2d6/— per round. Finally, when the wearer is grappled, the cloak releases an electrical charge that does 4d6 points of electricity damage to the attacker per round for 6 rounds unless the wearer of the cloak is released. The cloak has an armor check penalty of -1, an arcane spell failure chance of 15%, and can run for 1 hour on a charge of liquid phlogiston.

Operation: DC 25 Use Technological Device* check to activate the complex protective mechanisms hidden in the cloak.

SZ replicas are made for Medium creatures; WT 25 lb.; MV 12,500 gp; Create DC 21; ST 1 round; MR 1.

Zecker's Firestaff

Description: The signature item of the "wizard" Zecker was his staff — Zecker's Staff of the Elements. Six feet of polished wood bound in silver and gems, the staff could shoot a jet of flame on command and just as quickly snuff a roaring campfire. It could release a bolt of lightning or a peal of thunder. It allowed Zecker to walk through the air as though clouds were stone. The iron globe clutched next to the blade mounted at the staff's tip could glow as brightly as a star, shedding warmth and light, or it could absorb heat until the surrounding area was sheathed in ice.

After Zecker's disappearance, his staff — now revealed as technological trickery — was purchased by a wealthy elven tinker. In a process that lasted two years, the elf slowly took apart the staff to learn its secrets. Shortly thereafter, he realized that he couldn't put it back together. While the elf continues his quest to reassemble the work of the master tinker, he has trained his apprentices to recreate some of the effects. These lesser staves, known as "Zecker's Firestaves," still have a variety of functions (see below).

Operation: Using the staff requires Use Technological Device* and the expenditure of liquid phlogiston, as noted for each different function. One of the most innovative aspects of Zecker's "staff of the elements" is a system that holds charges of liquid phlogiston and feeds them to the stave's

functions as needed. Zecker's firestaves hold a maximum of six charges of liquid phlogiston.

- *Light*: When a gem in the shaft is depressed, the globe at the tip of the staff glows brightly and lights an area with a 30-foot radius. This ability requires a DC 10 Use Technological Device* check and uses up one charge of liquid phlogiston for each 6 hours of use.

- *Cone of Flame*: Another gem causes the tip of the staff to spray a phlogiston mist that is ignited by a flint to create a 20-foot cone of flame that deals 3d6 points of fire damage per round. This ability requires a DC 20 Use Technological Device* check and consumes one charge of liquid phlogiston for each use.

- *Leaping*: In a crude attempt by the elven tinker to match his abilities to the stories of Zecker's ability to walk on air, a small footrest folds out of the lower end of the staff. When the wielder steps onto this rod, it activates a jet of flame that allows the wielder to leap up to 50 feet into the air. This ability requires a DC 15 Use Technological Device* check and consumes one charge of liquid phlogiston for each use.

HR 5; hp 25; SZ Large (6 ft. tall x 2-in. diameter); WT 12 lb.; MV 330 gp; Create DC 20; ST 1 round; MR 2 (functions can malfunction individually).

Zecker's Wand

Description: The most popular of the recreations of Zecker's devices that have started to appear in recent years are those of his "wand of stunning." Though slightly thicker than normal, it is to all other outward appearances a finely crafted magical wand with a sizeable quartz crystal affixed to its tip. Hidden among the brasswork that wraps around the wand's shaft is a small catch. When the catch is triggered, a small piston inside the wand sprays a 10-foot cone of poisonous vapor. Any creature in the cone must make a DC 15 Fortitude save or be paralyzed for 1d8 rounds. The wand holds enough poison for three uses, after which a new charge must be obtained from an alchemist.

Operation: DC 12 Use Technological Device* check.

HR 2; hp 10; SZ Diminutive (1/2-in. diameter x 1 ft. long); WT 1 lb.; MV 100 gp; Create DC 17; ST 1 round to charge up after each use; MR 1.

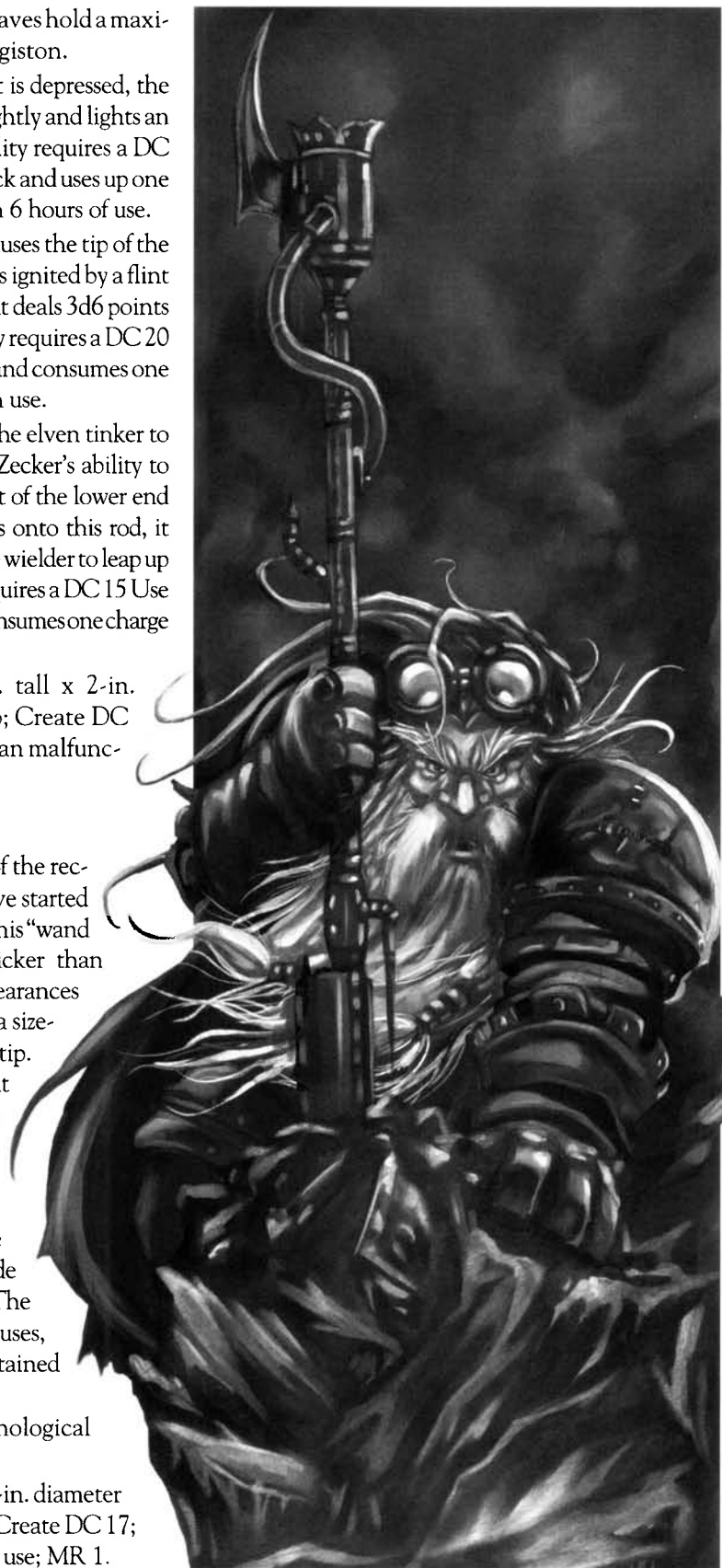

APPENDIX ONE: CONSTRUCTS



Giants made of metal or flesh stride across the battlefields of Kalimdor. The Scourge molds the flesh of captives into abominations capable of rending an orc in half without a thought. The constructs of war in the world of **Warcraft** are violent and deadly things; even the mildly dangerous junk golems of the goblins can prove lethal to the inexperienced and ill-prepared adventurer. While the foot soldiers and heroes of the Alliance might rail against the damned abominations of the Scourge, it can be certain that the gnomes' new constructs and weaponry will take their toll in bones and rotten flesh.

To the armies of the Alliance, constructs are just an extension of a new way of thinking. Humans view technology as best left to the tinkers. Dwarves and gnomes are the true masters of steam and brass, while humans are content to rely on spell, spear and sword to deliver them in combat. The night elves view technology as another creation of artifice, another affront to nature, a necessary violation. They treat almost all technology with disdain. Yet it is clear to all of the Alliances' various members that the battlefields are changing. When two riflemen with blunderbusses can lay a group of soldiers low, a sword is not as much of a threat as it used to be. A golem becomes far more valuable since it can resist damage and even the fear-spreading magic of the Horde and the undead Scourge.

Even the servants of the Lich King are capable of bringing powerful constructs to the field. Contraptions such as the meat wagon and grotesqueries such as the abomination become commonplace the longer the bodies pile up to supply the Scourge with clay for their craft. To the Scourge, an animate creature, construct or not, is just another tool to further the glory of the Lich King and bring more under the yoke of his control.

The Horde is really the only faction that eschews the use of constructs. Relying on powerful shamanistic magic, the powers of the Horde may not be capable of destroying many of these creations outright; but with help from the Independent factions, they have been able to resist the advances of technology, relying instead on goblin innovation to aid them in times of need. Yet even some orcs and trolls see the advantage of the tinker's craft. While their minds have yet to form concepts that will bring new creations into the world, it is only a matter of time before even the Horde begins to employ mighty forces created from brass, wood and iron.

Black Iron Golem

Huge Construct (Forsaken)

Hit Dice:	16d10+40 (128 hp)
Initiative:	+2
Speed:	40 ft. (8 squares) (can't run)
Armor Class:	32 (−2 size, +2 Dex, +22 natural), touch 10, flat-footed 30
Base Atk/Grapple:	+12/+32
Attack:	Slam +22 melee (2d12+12)
Full Attack:	Slam +22 melee (2d12+12)
Space/Reach:	15 ft./15 ft.
Special Attacks:	Ability drain, energy drain, frightful presence, trample
Special Qualities:	Darkvision, low-light vision, black iron body, damage reduction 15/mithril, immunity to acid, cold, electricity and fire, spell immunity, spell resistance 26, construct traits
Saves:	Fort +5, Ref +7, Will +5
Abilities:	Str 35, Dex 15, Con —, Int —, Wis 10, Cha 10
Skills:	—
Feats:	Awesome Blow, Improved Bull Rush, Great Cleave, Improved Overrun, Improved Sunder, Power Attack
Environment:	Any underground (The Undercity)
Organization:	Solitary, brace (2)
Challenge Rating:	15
Treasure:	None
Alignment:	Always neutral
Advancement:	17–32 HD (Huge); 33–48 HD (Gargantuan)
Level Adjustment:	—

This bulky creature is a huge, black iron statue covered in lambent green runes. Its curled, massive fists seem to be in a violent state of readiness. The creature's head is a death mask forged from iron in the darkest pits.

Description

Resting beneath the ruins of Lordaeron's capitol lies the Undercity, populated by the undead Forsaken. At the gates to the realm deep below are black iron creations under the control of the Banshee Queen Sylvanas. Since their discovery, the 13 iron juggernauts have become the guardians of a realm that opposes the undead tyranny of the Scourge.

These black iron sentinels prevent incursion from the Scourge above. While the denizens of the Undercity plot to move against the Lich King and his undead armies, these creations of some elder race defend the gates of the Forsaken realm. The Banshee Queen is clearly not the creator of these relics, since they were in the Undercity long before men discovered it. How Sylvanas managed to tame them is a closely guarded secret.

Standing 30 feet tall and weighing at least 10,000 pounds, these solid black iron statues at first appear to blend in with the rest of Undercity's décor. The formidable, black iron statues bear the rich runes of an ancient undecipherable tongue. Leering masks hang on the faces of these iron golems. These vast death heads grin at those who might seek to trespass through the thresholds under their guard. A black iron golem's surface almost seems to absorb the light cast upon it.

While they don't seem to respond to the commands of Undercity's denizens, they do not move to block those not under the Lich King's yoke. Even independent undead serving the Lich King are blocked by these creatures; many spies have been destroyed trying to sneak past them. Yet for some mysterious reason, the Forsaken can pass through the gates without fear.

In total, 13 golems block the entrances to Undercity, each one responsible for a different entrance, with the largest entrance to the tunnels and caves guarded by two of the massive statues. When the forces of the Scourge attempt to rush the gates, the golems easily rebuke them, especially when aided by the magic and martial skill of the Forsaken warlocks and warriors who dwell within.

Combat

To see a black iron golem in motion is to witness violent death embodied. Swift and indomitable, these creations are relentless in moving to block the gates of the Undercity from trespass.

Ability Drain (Su): Upon a successful melee attack, the black iron golem drains 1d6 points of strength. A DC 23 Fortitude save negates this effect.

Energy Drain (Su): A successful melee attack from the black iron golem bestows 1 negative level upon the target and invigorates the golem. A DC 23 Fortitude save negates this effect. The golem gains 5 hit points for every negative level it inflicts; it cannot accumulate hit points over its maximum.

Frightful Presence (Ex): A black iron golem causes terror in the enemies of the Forsaken when it moves to defend the city. Creatures with fewer than 16 Hit Dice who are not immune to fear effects must succeed at a Will save (DC 18) or be frightened for 5d6 rounds.

Trample (Ex): A black iron golem's trample inflicts 2d12+18 points of damage; Reflex DC 29 for half.

Black Iron Body (Ex): The iron construction of the golem allows it to sap energy with greater efficiency. The DC of all saves to resist the golem's attribute and level draining abilities are increased by +5 (this bonus is already factored in).

Spell Immunity (Ex): Summoned creatures cannot attack the iron golem. Negative energy spell attacks actually heal the golem (1d8 points per spell level). Positive energy attacks do not harm the golem, but *slow* it for 1 round per spell level. Healing spells count as positive energy attacks.

Construction

Whoever built these imposing black constructs has not left a record of how to create them. The Black Iron Golems of the Undercity defy analysis. The runes and magic shift and change with each inspection. Although their true purpose remains a mystery, it is obvious that these hulking guardians will remain unique for now. Anyone attempting to create a black iron golem creates a normal iron golem instead. Use the construction rules and statistics for an iron golem for attempts to create a black iron golem.

Harvest Golem

Large Construct

Hit Dice:	5d10+30 (57 hp)
Initiative:	+3
Speed:	30 ft. (6 squares)
Armor Class:	22 (-1 size, +3 Dex, +10 natural armor), touch 12, flat-footed 19
Base Atk/Grapple:	+3/+12
Attack:	Claw +7 melee (1d10+5)
Full Attack:	2 claws +7 melee (1d10+5)
Space/Reach:	10 ft./10 ft.
Special Attacks:	Pounce
Special Qualities:	Darkvision 60 ft., low-light vision, damage resistance 5/—, endoskeleton, harvest guise, construct traits

Saves:	Fort +1, Ref +4, Will +1
Abilities:	Str 20, Dex 17, Con —, Int —, Wis 11, Cha 1
Skills:	—
Feats:	Cleave, Power Attack
Environment:	Any temperate land (around crop fields and roads)
Organization:	Solitary, gang (2–4)
Challenge Rating:	7
Treasure:	None
Alignment:	Always neutral
Advancement:	6–10 HD (Large); 11–20 HD (Huge)
Level Adjustment:	—

The creature appears to be a massive, stocky, animated scarecrow with three razor-sharp blades extending lengthwise from the ends of its arms. Baleful red eyes glow from underneath its broad-brimmed hat.

Description

The region of Westfall has gathered its fair share of sorrow in the last few years. Alongside abandoned towns, the desolate crops and the fear of undead in the night, more strife only adds to the already substantial worries of the local folk. The chilling whir and clank of the harvest golems' approach is one of the most feared sounds a Westfall farmer might hear while out gathering crops.

The harvest golem is a machine, and has no concept of the difference between night and day. Its glowing red eyes can fall upon the unsuspecting at any time. These ogre-sized constructs amble across the fields of Westfall, where they tear apart livestock, beasts of burden, and farmers and folk without mercy. These aimlessly wandering creations serve their purpose well: to spread fear and mayhem.

Rumor has it the Defias Brotherhood originally created these golems as a means to scare off innocent farm folk. Now, many harvest golems guard the fields and roads around the abandoned town of Moonbrook. For some reason, this center of Defias activity is very well guarded.

Parodies of the farmers' own harvest totems and scarecrows, the harvest golem stands roughly 9 feet in height. Dressed in stitched-together burlap bags stuffed with straw and sporting broad-brimmed hats, most harvest golems at first appear to be stocky scarecrows ambling across the fields. Long, straight-

razor-sharp claws protruding from their arms betray their sinister purpose as they charge to destroy any man or beast within their sight.

Beneath the burlap and hay is a skeleton of steel filled with gears and cogs that churn and clank as the golem moves. All too often, an overconfident group will attack one of these creatures only to discover it is made out of more than simply straw and sack cloth. With the ability to charge into combat and tear a man apart with swipes from its vicious, razor-sharp blades, the harvest golem is a true creation of terror.

Combat

The prime purpose of the harvest golem is to destroy any living thing it should encounter. The golem's design gives it terrible swiftness in combat, allowing it to charge at its targets and deliver a series of blows that are capable of tearing a grown man in half. The golem tends to use this speed to its advantage, making as many charges and full attacks as possible.

Pounce (Ex): The harvest golem may make a full attack after making a charge.

Endoskeleton (Ex): The core of the harvest golem is a sturdy steel and iron skeletal construction. This metal cage protects the creature's sensitive inner workings. Once reduced to 25% of its original hit points (14 hp), the harvest golem gains damage reduction 10/bludgeoning and loses the harvest guise special quality.

Harvest Guise (Ex): The harvest golem wears a thick layer of burlap, straw, and cloth to pad its endoskeleton and give it a fearsome appearance. This visage can be unsettling to folk not used to fighting such monstrosities.

Those witnessing the harvest golem during an attack must make a DC 15 Will save or be shaken for 1d4 rounds. At the GM's discretion, characters with enough exposure to the creatures (perhaps having killed 3 or more) may ignore the effect.

Construction

A person can buy the blueprints for constructing a harvest golem, especially if one knows the right people. Those who have secured the plans to one of these creations may construct it. Assembling the steel skeleton requires an expert eye and some magical ability. The entire golem weighs at least 800 pounds. The golem must be fitted with an engine powered by specially engineered cogs and magical crystals worth

1,500 gp. The scarecrow components are included in the cost of the body. Creating the body requires a DC 25 Craft (weaponsmithing) check or a DC 25 Craft (technological device) check.

CL 10th; Craft Construct, *arcane eye*, *unseen servant*, creator must have 5 levels in tinker; Price 21,500 gp; Cost 11,500 gp + 770 XP.

Junk Golem

Medium Construct

Hit Dice:	1d10+20 (25 hp)
Initiative:	+1
Speed:	30 ft. (6 squares) (can't run)
Armor Class:	16 (+1 Dex, +5 natural), touch 11, flat-footed 15
Base Atk/Grapple:	0/+1
Attack:	Slam +1 melee (1d6 +1)
Full Attack:	Slam +1 melee (1d6 +1)
Space/Reach:	5 ft./5 ft.
Special Attacks:	—
Special Qualities:	Darkvision 60 ft., low-light vision, chaotic construction, breakdown, damage reduction 4/bludgeoning, construct traits
Saves:	Fort +0, Ref +1, Will +0
Abilities:	Str 12, Dex 12, Con —, Int —, Wis 10, Cha 1
Skills:	—
Feats:	—
Environment:	Any
Organization:	Solitary, pair, company (2–5), or swarm (5–20)
Challenge Rating:	2
Treasure:	None
Alignment:	Always neutral
Advancement:	2 HD (Medium); 3 HD (Large)
Level Adjustment:	—

This lumbering mechanical contraption stands no higher than a dwarf. Covered in a variety of lenses and armatures, it appears built from wire, lengths of wood and broken barrels. Steam belches from a furnace somewhere in its body as it moves. Clumsy arms with various attachments seem to grope mindlessly at the air.

Description

It is a common sight to see a junk golem bumbling down the city streets of Ratchet. Almost considered disposable by many goblins, these constructs

vary so widely in construction that really categorizing them is impossible. In a city where tinkering is a respected science and where phlogiston and coal are relatively cheap, this golem has become an almost common minion of not only Ratchet's junk guilds but also traveling goblins in general.

Identifying a junk golem by the quality of its components is very easy. These constructs always appear ready to fall apart. Tied together with string, glue and luck, the junk golem tends to have a haphazard appearance. Most have a variety of different appendages for digging, burning, cutting, smashing and picking things up.

Most tinkers customize junk golems to suit their needs. Not overly reliable, the constructs have a tendency to break down under stress. Cheap wooden barrels, recycled tracks, bellows, junk wire, broken clock gears and other unreliable mechanical components are responsible for the frequent breakdowns of a junk golem.

The junk guilds of Ratchet build a dizzying array of types of this golem. Some are even capable of clumsy flight to perch on top of junkyard heaps.

Combat

Junk golems in combat can be a barrel of surprises. Each golem can be different, having a variety of attacks and tactics that it could employ. However, these constructs aren't subtle and generally go for the most direct route. In numbers, junk golems tend to overwhelm opponents by sheer force.

Chaotic Construction (Ex): Junk golems tend to have all kinds of functions and apparent uses. From picking up bottles to grinding wood chips, junk golems can perform a number of special attacks based on their design. To determine that design, roll on Table 6–1 1d4 times to determine the special properties of the junk golem. Re-roll contradictory results (like getting the Tracked result twice). Every two additional features increases the CR of the junk golem by 1.

Breakdown (Ex): Hitting a junk golem for 10 hit points of damage or more makes it lose the use of one of its special functions. When hit, it spews cogs and pieces out of its shell as it malfunctions. Use an appropriate die to select the broken ability. The construct also begins to slow down, falling one place down the initiative count every time it takes a significant hit.

Construction

A junk golem's body is assembled from various piles of junk, and ends up weighing about 200

Table 6-1: Junk Golem Chaotic Construction

Roll	Special Feature	Effect
1	Digging Claws	The junk golem gains a slam attack that deals 1d10 damage, and a burrow speed of 5 feet.
2	Steam Hammer	Once every 10 rounds, the junk golem may make a full attack resulting in a slam attack that does 5d6 points of damage. For other special properties, see details on the steam hammer (<i>Warcraft RPG</i> , Chapter Two: Adventuring, "Equipment," Steam Hammer).
3	Sweeper	Sweeping brushes on the golem can trip opponents; the construct may use the Improved Trip feat.
4	Multi-Armed	The junk golem has an array of mechanical arms (1d4+2), each which can deliver a slam attack as a full attack.
5	Tracked	Caterpillar treads comprise the junk golem's main source of motion. The golem has a speed of 40 feet (8 spaces) and can negotiate difficult terrain and obstacles without penalty.
6	Saw Blades	Replace the slam attack of the golem with a 1d10 slashing attack. The saw blade ignores the hardness of wooden targets when determining damage.
7	Forge Shielding	Heavy plates shield the golem from fire. The junk golem gains resistance to fire 5.
8	Incinerator	The golem can belch a gout of flame from a spout once every 10 rounds. Treat this attack like <i>burning hands</i> cast by a 3rd-level wizard.
9	Broken Boiler	The boiler of the golem threatens to explode when the golem is under extreme stress. A 1d12 roll is required every time the golem takes more than 10 points of damage. On a result of 1, the boiler explodes, doing 3d6 points of fire damage in a 10-foot burst, with a DC 10 Reflex save for half. The explosion destroys the golem.
10	Blunderbuss	Some insane tinker was crazy enough to arm this construct with a blunderbuss. It may make a single ranged attack with the blunderbuss with a -4 penalty on the attack roll.
11	Drill	A wide-tipped, high-speed drill for making holes in various different materials is on the end of one of the junk golem's arms. This piercing weapon deals 1d8 points of damage, has a critical threat range of 17-20, and does x4 damage on a critical hit.
12	Gyro Blades	The junk golem relies on rotors to fly and move around. The junk golem loses its land-based movement and gains a flying speed of 30 feet (6 spaces), the Hover feat and a maneuverability rating of poor. The rotors can deliver a melee attack (2d10/20/x2) as a full-round action, but the golem crashes on a natural 1.

pounds. Oiled up and filled with some phlogiston and coal, the steam plant itself is worth 150 gp. Each added special ability increases the price of the golem by 100 gp (4 maximum). Creating the body requires a DC 15 Craft (technological device) check or a DC 15 Craft (weaponsmithing) check.

CL 1st; Craft Construct, *unseen servant*, creator must be at least a 5th-level tinker; Price 1,150 gp; Cost 650 gp + 46 XP.

Steam Golem

Medium Construct

Hit Dice: 3d10+20 (36 hp)
Initiative: +4
Speed: 30 ft. (6 squares)
Armor Class: 19 (+4 Dex, +5 natural), touch 14, flat-footed 15

Base Attack/Grapple: +2/+6
Attack: Slam +6 melee (1d8+4)
Full Attack: Slam +6 melee (1d8+4)
Space/Reach: 5 ft./5 ft.
Special Attacks: Powerful charge (+1d6 damage)
Special Qualities: Darkvision 60 ft., low-light vision, fortify, interlock, damage reduction 5/—, construct traits
Saves: Fort +1, Ref +5, Will +1
Abilities: Str 19, Dex 19, Con —, Int —, Wis 10, Cha 10
Skills: —
Feats: Cleave, Power Attack
Environment: Any land
Organization: Solitary, squadron (2-5), or patrol (5-20)
Challenge Rating: 3

Treasure:	None
Alignment:	Always neutral
Advancement:	4–6 HD (Medium); 7–9 HD (Large)
Level Adjustment:	—

This metallic mechanism resembles a hunched-over dwarf. It seems ready to move at a moment's notice. Its body coils with power as steam vents from its nostrils.

Description

The gnomes built the steam golems to serve them as powerful foot warriors to help defend their warrens and caverns from future assault. Gnomes have always built steam-powered contraptions with the intent to use them in a peaceful manner. With the destruction of Gnomeregan, the gnomes have begun to make machines with more martial purposes. On occasion, one of these powerful, stocky constructs trundles along with a gnomish tinker or emissary working with the dwarves in Kalimdor. Undying, loyal to its charge, and powerful enough to deter even the boldest assailant, the steam golem has proven worth its weight in gold to the diminutive gnomes.

The construction of the first steam golem brought in a renaissance of tactical design for the gnomes working with dwarven engineers. Ignoring their more whimsical designs, the gnomes focused on function. The gnomish steam golem is efficient and full of purpose, able to serve as a powerful porter and bodyguard in times of peace and as a deadly combatant and soldier in times of war.

The unique feature of the steam golem is its ability to combine with other steam golems. Four steam golems can combine to create a portable fortress on the battlefield. Five steam golems can interlock to create a larger steam golem construct capable of dealing more damage and of wreaking havoc on unsuspecting foes.

Combat

In combat, the steam golem can serve a number of different roles. Typically, steam golems act as bodyguards in times of peace, but in times of war squadrons of them will deploy to hold strategic positions.

Powerful Charge (Ex): When charging, the powerful piston-driven fists of the steam golem deal an additional 1d6 points of damage.

Fortify (Ex): As a full-round action, 4 steam golems within 5 feet of each other can combine to form a

formidable structure capable of moving slowly across the battlefield. This 15-foot by 15-foot square structure has an Armor Class of 19, a speed of 5 feet (1 square), and can provide full cover for 4 Small inhabitants or 2 hunched-over Medium inhabitants. There are slits on each side for firing weapons, and a hatch on the roof allows egress for one creature of Small size. The shelter has a hardness of 5 and 100 hit points.

Interlock (Ex): As a full-round action, 5 steam golems adjacent to each other can combine to form a Large version of the steam golem with 9 Hit Dice. Clumsier and sturdier than its lesser components, this mega-steam golem is often a terrifying surprise to cocky orcs or necromancers. This form gains the following changes:

- The combined golem has 120 hit points.
- Initiative –3.
- The interlocked steam golem's powerful charge now deals +1d10 points of damage.
- The base damage of the steam golem's attack increases to 1d12+4.
- Trample: 1d8 +6 points of damage, Reflex DC 18 for half.
- Great Cleave.
- Armor Class 14.

Disengaging from the interlocked state requires 2 full-round actions.

Construction

Gnomes assemble a steam golem's body from brass and steel plating, the whole of which ends up weighing 600 pounds. The phlogiston-injected steam plant that operates as its heart is worth 500 gp. Creating the body requires a DC 20 Craft (technological device) check or a DC 20 Craft (weaponsmithing) check.

CL 10th; Craft Construct, *unseen servant*, *Leomand's tiny hut*, creator must be at least a 5th-level tinker; Price 10,000 gp; Cost 5,500 gp +400 XP.

Stone Keeper

Medium Construct

Hit Dice:	3d10+20 (36 hp)
Initiative:	–1
Speed:	30 ft. (6 squares)
Armor Class:	21 (–1 Dex, +12 natural), touch 9, flat-footed 21
Base Attack/Grapple:	+2/+5

Attack:	Slam +5 melee (2d6+3)
Full Attack:	Slam +5 melee (2d6+3)
Space/Reach:	5 ft./5 ft.
Special Attacks:	Spell-like abilities
Special Qualities:	Darkvision 60 ft., low-light vision, programmed intelligence, damage reduction 5/adamantine, immunity to magic, construct traits
Saves:	Fort +1, Ref +0, Will +1
Abilities:	Str 16, Dex 9, Con —, Int 17, Wis 11, Cha 1
Skills:	Appraise +9, Decipher Script +9, Search +9, Sense Motive +6, Spellcraft +9
Feats:	—
Environment:	Any
Organization:	Solitary or gang (2–4)
Challenge Rating:	4
Treasure:	None
Alignment:	Always neutral
Advancement:	4–9 (Medium)
Level Adjustment:	—

The creature appears to be an animated stone statue. It is humanoid, although otherwise nearly featureless. Only a few colored crystals embedded in its left forearm are particularly distinguished.

Description

A stone keeper has a humanoid body made from a smooth, grey marble alien to Azeroth. It stands 7 feet tall and weighs 1,300 pounds. Stone keepers have relatively plain features, as though their creators could not be bothered with the details of appearance. They are functional, and nothing more.

The titans created stone keepers to be servants and assistants. These constructs were granted an almost sentient intelligence, though little of the brute strength of the stone watcher. While stone watchers served as guardians of the titans' property, stone keepers often served as companions; one might even think as pets.

Stone keepers possess a programmed intelligence so sophisticated that observers have a difficult time distinguishing one from a sentient being. A stone keeper is able to communicate in the ancient language of the titans. However, few creatures (if any) are alive who understand this language. Not all is lost. The constructs can use powerful magic to

analyze languages, and are able to communicate with any intelligent being capable of speech.

Combat

A stone keeper is generally not programmed to fight, but is usually programmed to defend itself. Stone keepers tactics often include simple frontal assaults, but some employ tactics when necessary.

Spell-Like Abilities: At will — *analyze dweomer, detect magic, discern lies, legend lore, read magic, tongues, true seeing*. Caster level 12th.

Programmed Intelligence (Ex): A stone keeper can manipulate the crystals on its forearm to generate any number of spell-like abilities, such as *tongues*, each as a standard action that provokes an attack of opportunity (see above).

Further, a stone keeper can activate its crystals to retrieve archived information. The stone keeper receives a +10 circumstance bonus on its next Knowledge check after using this ability. Most of the stone keeper's knowledge tends to be millennia out of date.

Immunity to Magic (Ex): A stone watcher is immune to any spell or spell-like ability that allows spell resistance. In addition, certain spells and effects function differently against the creature, as noted below.

A *transmute rock to mud* spell slows a stone watcher (as the *slow* spell) for 2d6 rounds with no saving throw, while *transmute mud to rock* heals all of its lost hit points.

A *stone to flesh* spell does not actually change the keeper's structure, but negates its damage reduction and immunity to magic for 1 full round.

Construction

The secrets of constructing a stone keeper were lost long ago with the titans. Today, those who have located and studied stone keepers may try to replicate these masterpieces; but they succeed only in replicating basic traits, not its programmed intelligence.

Stone Watcher

Large Construct

Hit Dice:	15d10+30 (112 hp)
Initiative:	–1
Speed:	40 ft. (8 squares)
Armor Class:	31 (–1 size, –1 Dex, +1 dodge, +22 natural), touch 9, flat-footed 31
Base Attack/Grapple:	+11/+25

Attack:	Slam +21 melee (3d8+10)
Full Attack:	3 slams +21 melee (3d8+10)
Space/Reach:	10 ft./10 ft.
Special Attacks:	Time distortion
Special Qualities:	Darkvision 60 ft., low-light vision, damage reduction 15/adamantine, immunity to magic, construct traits
Saves:	Fort +5, Ref +4, Will +5
Abilities:	Str 30, Dex 9, Con —, Int —, Wis 11, Cha 1
Skills:	—
Feats:	—
Environment:	Any
Organization:	Solitary or gang (2–4)
Challenge Rating:	16
Treasure:	None
Alignment:	Always neutral
Advancement:	16–22 HD (Large); 23–45 (Huge)
Level Adjustment:	—

A massive humanoid statue pounds its way toward you. Its nondescript, featureless face is emotionless as it raises its arms to strike with stony fists.

Description

A stone watcher is 15 feet tall and weighs 6,000 pounds. The stone that makes up the watcher's body is unnatural, and no stone like it exists on Azeroth except in the construction of these constructs and the related stone keepers. This creation is incredibly swift; it relies on time magic to move with a devastating purpose. Much like the enigmatic black iron golems, there is a similarity in the apparent design of these constructs.

Most stone watchers lurk over ancient ruins, guarding entrances to long-lost halls and crumbled stone constructions of immense size. The constructs are obviously guardians of some sort, left to watch over long-abandoned sites that once probably held great significance. These creatures sometimes guard ancient roads or remote wilderness areas waiting for intruders to attempt to pass. These relics of an ancient race can still prove a deadly and final menace to the unwary.

Time Distortion (Su): A stone watcher exists in a bubble of time that is slightly out of phase with the normal world. The effect is similar to a *haste* spell,

but the effect cannot be dispelled. The following bonuses are already factored into the statistics above. The stone watcher loses the following bonuses in an *antimagic field*.

When making a full attack, a stone watcher may make one extra slam attack. It gains a +1 bonus on attack rolls and Reflex saves, and a +1 dodge bonus to AC. Any condition that would cause the stone watcher to lose its Dexterity bonus to Armor Class also makes it lose its dodge bonus.

The stone watcher's normal movement speed is 10 feet, but with its time distortion it seems to move 40 feet.

Finally, a stone watcher is able to make even larger shifts through time, and seemingly move from one place to another almost instantly. The stone watcher may use this ability to gain 5 complete rounds of movement while time seems to cease for everyone but the stone watcher. The stone watcher cannot interact with the material world while it is in this special state, shifting through time. After making a large shift, a stone watcher's energy reserves must recharge; and it cannot make another shift for 1d4 rounds.

Immunity to Magic (Ex): A stone watcher is immune to any spell or spell-like ability that allows spell resistance. In addition, certain spells and effects function differently against the creature, as noted below.

A *transmute rock to mud* spell strips a stone watcher of its time distortion ability for 2d4 rounds with no saving throw, while *transmute mud to rock* heals all of its lost hit points.

A *stone to flesh* spell does not actually change the watcher's structure, but negates its damage reduction and immunity to magic for 1 full round.

Construction

The secrets of constructing a stone watcher were lost long ago with the titans. Today, those who have located and studied stone watchers attempt to duplicate the stone watcher's superior techniques, but invariably fall short. Anyone wishing to construct a stone watcher only succeeds in creating a stone golem instead. Use the construction rules and statistics for a stone golem for attempts to create a stone watcher.

Appendix Two: Legal Information

This printing of *Magic & Mayhem* is done under version 1.0a of the Open Game License; version 5.0/4.0 of the d20 System Trademark License and d20 System Trademark Logo Guide; and the Revised (v.3.5) System Reference Document, by permission from Wizards of the Coast. Subsequent printings of this book will incorporate final versions of the license, guide, and document.

Designation of Product Identity: The following items are hereby designated as Product Identity in accordance with Section 1(e) of the Open Game License, version 1.0a: Any and all Sword and Sorcery Studio and Arthaus logos and identifying marks and trade dress, including all Sword and Sorcery Studio and Arthaus Product and Product Line names including but not limited to Manual of Monsters, Alliance & Horde Compendium, Magic & Mayhem, Lands of Conflict, Shadows & Light, Lands of Mystery, Creature Collection Revised, Creature Collection 2: Dark Menagerie, Creature Collection 3: Savage Bestiary, Relics and Rituals, Relics and Rituals 2: Lost Lore, the Scarred Lands and the Scarred Lands logo; all text under the "Description" header of any creature, spell, true ritual, magic item, artifact, or NPC's listing; any elements of the Warcraft setting, including but not limited to capitalized names, names of artifacts, devices, characters, countries, creatures, geographic locations, gods, historic events, magic items, organizations, or spells; any and all stories, storylines, plots, thematic elements, and dialogue; all artwork, symbols, designs, depictions, illustrations, maps and cartography, likenesses, poses, logos, symbols, or graphic designs, except such elements that already appear in the d20 System Reference Document and are already OGC by virtue of appearing there. The above Product Identity is not Open Game Content.

Designation of Open Game Content: Subject to the Product Identity designation above, the following portions of *Magic & Mayhem* are designated as Open Game Content: all creature and NPC static templates (i.e. from Size Type [e.g., Small Undead] down to the italicized text immediately before the "Description" header); all skills, feats, special attacks (SA), and special qualities (SQ); prestige classes; all text under the "Powers" section of individual magic items; all text under the "Spell Effect" section of spells, and all text under the "Rune Effect" section of runes; all text under the "Combat" section of a creature's listing; all text for Variant Rule: Arcane Corruption in Chapter One; the description of rune magic in Chapter One and the rune families in Chapter Three; vehicle maneuverability, malfunction effects, collaborative construction and masterwork items rules in Chapter Five; statistics for technological devices in Chapter Five; and anything else contained herein that is already Open Game Content by virtue of appearing in the System Reference Document or some other OGC source.

Some portions of this book that are delineated OGC originate from the System Reference Document and are ©1999, 2000, 2001, 2002, 2003, 2004 Wizards of the Coast, Inc. The remainder of these OGC portions of this book is hereby added to Open Game Content, and if so used, should bear the COPYRIGHT NOTICE "Magic & Mayhem Copyright 2004, Blizzard Entertainment."

All contents of this book, regardless of designation, are copyrighted year 2004 by Blizzard Entertainment. All rights reserved. Reproduction or use without the written permission of the publisher is expressly forbidden, except for the purpose of review or use of OGC consistent with the OGL.

OPEN GAME LICENSE Version 1.0a

The following text is the property of Wizards of the Coast, Inc. and is Copyright 2000 Wizards of the Coast, Inc ("Wizards"). All Rights Reserved.

1. Definitions: (a) "Contributors" means the copyright and/or trademark owners who have contributed Open Game Content; (b) "Derivative Material" means copyrighted material

including derivative works and translations (including into other computer languages), potation, modification, correction, addition, extension, upgrade, improvement, compilation, abridgment or other form in which an existing work may be recast, transformed or adapted; (c) "Distribute" means to reproduce, license, rent, lease, sell, broadcast, publicly display, transmit or otherwise distribute; (d) "Open Game Content" means the game mechanic and includes the methods, procedures, processes and routines to the extent such content does not embody the Product Identity and is an enhancement over the prior art and any additional content clearly identified as Open Game Content by the Contributor, and means any work covered by this License, including translations and derivative works under copyright law, but specifically excludes Product Identity. (e) "Product Identity" means product and product line names, logos and identifying marks including trade dress; artifacts; creatures characters; stories, storylines, plots, thematic elements, dialogue, incidents, language, artwork, symbols, designs, depictions, likenesses, formats, poses, concepts, themes and graphic, photographic and other visual or audio representations; names and descriptions of characters, spells, enchantments, personalities, teams, personas, likenesses and special abilities; places, locations, environments, creatures, equipment, magical or supernatural abilities or effects, logos, symbols, or graphic designs; and any other trademark or registered trademark clearly identified as Product Identity by the owner of the Product Identity, and which specifically excludes the Open Game Content; (f) "Trademark" means the logos, names, mark, sign, motto, designs that are used by a Contributor to identify itself or its products or the associated products contributed to the Open Game License by the Contributor (g) "Use", "Used" or "Using" means to use, Distribute, copy, edit, format, modify, translate and otherwise create Derivative Material of Open Game Content. (h) "You" or "Your" means the licensee in terms of this agreement.

2. The License: This License applies to any Open Game Content that contains a notice indicating that the Open Game Content may only be Used under and in terms of this License. You must affix such a notice to any Open Game Content that you use. No terms may be added to or subtracted from this License except as described by the License itself. No other terms or conditions may be applied to any Open Game Content distributed using this License.

3. Offer and Acceptance: By using the Open Game Content you indicate your acceptance of the terms of this License.

4. Grant and Consideration: In consideration for agreeing to use this License, the Contributors grant You a perpetual, worldwide, royalty-free, non-exclusive license with the exact terms of this License to Use, the Open Game Content.

5. Representation of Authority to Contribute: If You are contributing original material as Open Game Content, You represent that Your Contributions are Your original creation and/or You have sufficient rights to grant the rights conveyed by this License.

6. Notice of License Copyright: You must update the COPYRIGHT NOTICE portion of this License to include the exact text of the COPYRIGHT NOTICE of any Open Game Content You are copying, modifying or distributing, and You must add the title, the copyright date, and the copyright holder's name to the COPYRIGHT NOTICE of any original Open Game Content you Distribute.

7. Use of Product Identity: You agree not to Use any Product Identity, including as an indication as to compatibility, except as expressly licensed in another, independent Agreement with the owner of each element of that Product Identity. You agree not to indicate compatibility or co-adaptability with any Trademark in conjunction with a work containing Open Game Content except as expressly licensed in another, independent Agreement with the owner of such Trademark. The use of any Product Identity in Open Game Content does not constitute a challenge to the ownership of that Product Identity. The owner of any Product Identity used in Open Game Content shall retain all rights, title and interest in and to that Product Identity.

8. Identification: If you distribute Open Game Content you must clearly indicate which portions of the work that you are distributing are Open Game Content.

9. Updating the License: Wizards or its designated Agents may publish updated versions of this License. You may use any authorized version of this License to copy, modify and distribute any Open Game Content originally distributed under any version of this License.

10. Copy of this License: You MUST include a copy of this License with every copy of the Open Game Content You Distribute.

11. Use of Contributor Credits: You may not market or advertise the Open Game Content using the name of any Contributor unless you have written permission from the Contributor to do so.

12. Inability to Comply: If it is impossible for You to comply with any of the terms of this License with respect to some or all of the Open Game Content due to statute, judicial order, or governmental regulation then You may not Use any Open Game Material so affected.

13. Termination: This License will terminate automatically if You fail to comply with all terms herein and fail to cure such breach within 30 days of becoming aware of the breach. All sublicenses shall survive the termination of this License.

14. Reformation: If any provision of this License is held to be unenforceable, such provision shall be reformed only to the extent necessary to make it enforceable.

15. COPYRIGHT NOTICE

Open Game License v 1.0a Copyright 2000, Wizards of the Coast, Inc.

System Reference Document Copyright 2000–2004, Wizards of the Coast, Inc.; Authors Jonathan Tweet, Monte Cook, Skip Williams, Bruce R. Cordell, based on original material by E. Gary Gygax and Dave Arneson.

Original Spell Name Compendium Copyright 2002 Necromancer Games, Inc.; based on spells from the *Player's Handbook* that were renamed in the System Reference Document, found on the legal page of www.necromancergames.com.

Manual of Monsters Copyright 2003, Blizzard Entertainment

Alliance & Horde Compendium Copyright 2003, Blizzard Entertainment

Magic & Mayhem Copyright 2004, Blizzard Entertainment.

Magic and Mechanics Clash!

Sorcerers and wizards truck with demons while tinkers and engineers build mighty engines of battle in this sourcebook for Dungeons & Dragons® Warcraft® the Roleplaying Game, which translates the hugely successful Warcraft computer game series into an exciting pen-and-paper roleplaying game world based on the popular d20 System rules!

Requires the use of the
Dungeons & Dragons® Player's Handbook,
published by Wizards of the Coast®.
This product utilizes updated material
from the v.3.5 revision

Designed with extensive input from the creative minds behind the Warcraft computer games, Magic & Mayhem includes:

- In depth discussion of magic in the Warcraft setting, including rules for arcane corruption and a new type of magic called rune magic.
- The new runemaster core class; 8 new prestige classes, including the warden and the steamwarrior; and several new feats.
- New spells, as well as full descriptions of the new rune families and runes used by the runemaster.
- A horde of new magic items and technological devices, as well as expanded details on creating technological devices.
- Statistics for Warcraft constructs — the ultimate in the merging of magic and technology!



ISBN 1-58846-954-9
WW17203 \$29.99 U.S.



www.swordsorcery.com

