

VILLAINS
AND
VIGILANTES™

FANTASY GAMES UNLIMITED

2033a

VILLAINS UNLEASHED



WRITTEN BY
DAN JONES

FOSTER COKER AND STEVE EFFLER

Joe Singleton
2016

VILLAINS UNLEASHED IS BOTH A SOURCEBOOK AND AN ADVENTURE BOOK FOR V&V. THE INITIAL PAGES PRESENT TWO COMPLETE THEMED VILLAIN GROUPS (WITH 12 CHARACTERS) AND 14 INDEPENDENT VILLAINS. THE SECOND PART OF THE BOOK ARE THE INTRODUCTORY ENCOUNTERS THAT LEAD IN TO A MULTI-BOOK ADVENTURE CAMPAIGN. WHAT IS THE INTERNATIONAL SYNDICATE KNOWN AS TRISKELION? WHAT ARE THEIR GOALS? AND HOW DO THE SEEMINGLY UNRELATED CRIMES IN THE ADVENTURE "THE TRISKELION GAMBIT" RELATE TO THOSE GOALS? READ ON AND DISCOVER NEW VILLAINS FOR USE IN ANY CAMPAIGN AND THE BEGINNING OF A COMPLETE CAMPAIGN FOR ANY GAMING GROUP.

UNDISCLOSED BLACK SITE IN THE NEVADA DESERT.

TWENTY-SIX MONTHS AGO.

HOW MUCH LONGER DO YOU THINK WE'LL LET THIS GO ON, ALIEN?

OH, WE ARE QUITE DONE, MY STUDIES ARE COMPLETE.

TRUE WORK? STUDIES? WHAT DOES THAT MEAN? WHAT STUDIES?

WHAT HAVE YOU BEEN STUDY-ING?

I FINALLY HAVE WHAT I NEED TO BEGIN MY TRUE WORK.

YOU, MOSTLY, AGENT WINSLOW, I NEEDED TO -HOW DO YOU SAY-

MY NAME. HOW DID YOU?

"GET INSIDE YOUR SKULL", YES THAT'S THE PHRASE! SO MANY INTERESTING PATHWAYS, LIKE A LABYRINTH...

MY SKULL?

AND SO MUCH FEAR. YOU ARE STEEPED IN FEAR, NATHANIEL WINSLOW, IT HAS BEEN A DELIGHT TO EXPERIENCE...

BUT, NOW, YOU ARE NO LONGER NECESSARY TO MY WORK, BUT I WILL NOT LEAVE YOU ALONE...

YES, HERE, I HAVE FOUND THE SUBJECTS FOR MY RESEARCH. I WAS A DOCTOR, YOU KNOW.

SKULL?

IN MY SKULL...

NO... >URK< PLEASE, NO...

AND, I WILL BE, AGAIN. A DOCTOR OF AGONY! OF FEAR!

I WILL BE DOCTOR SKULL!



WRITERS
 DAN JONES FOSTER COKER STEVE EFFLER

ARTIST
 JOE SINGLETON

EDITOR
 SCOTT BIZAR



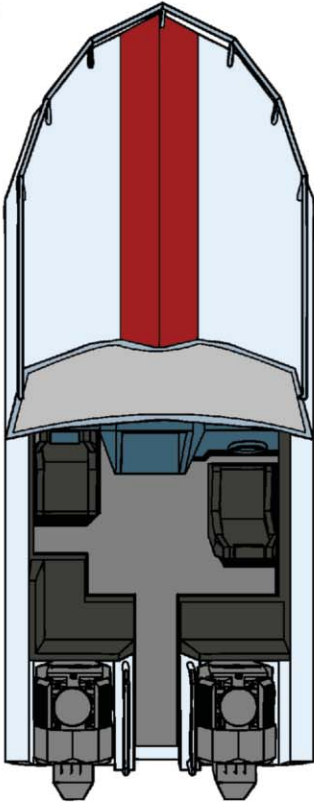

SPEED BOAT

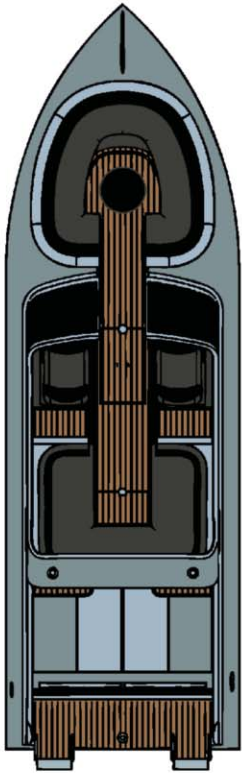

SPEED BOAT

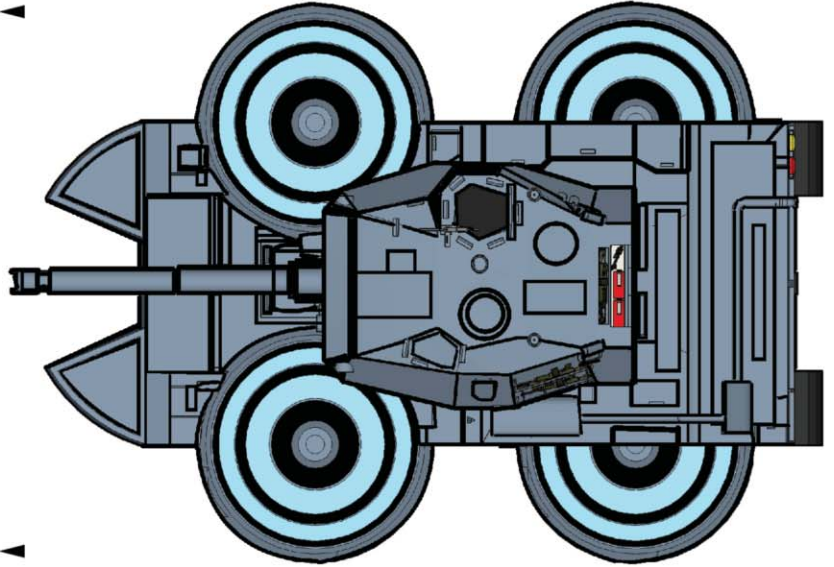

HOVER TANK

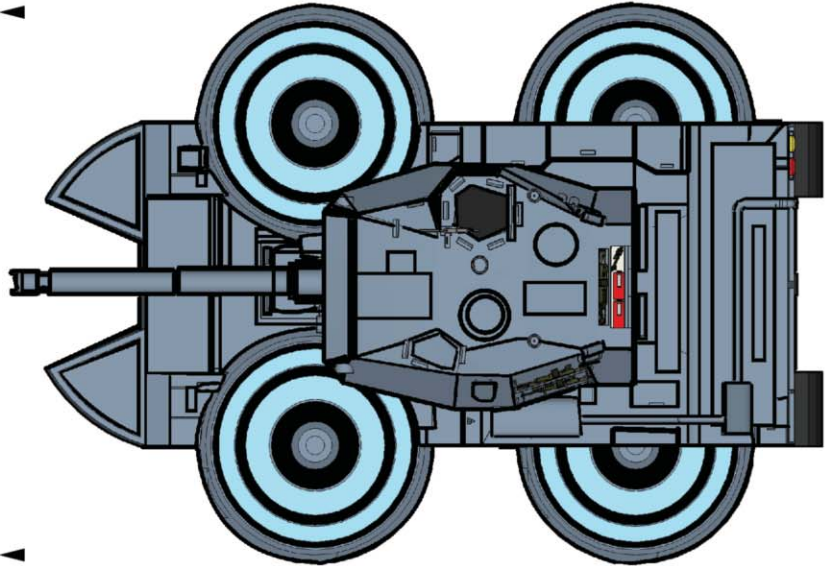

HOVER TANK

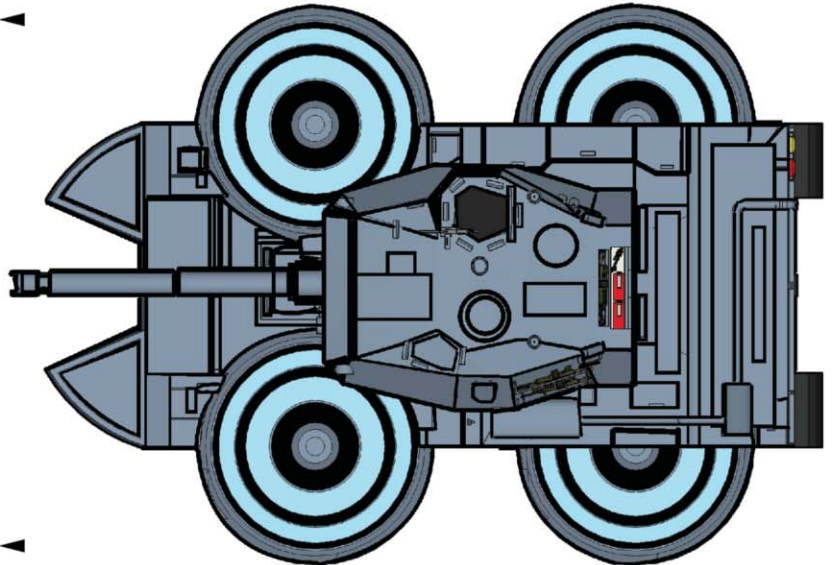

HOVER TANK

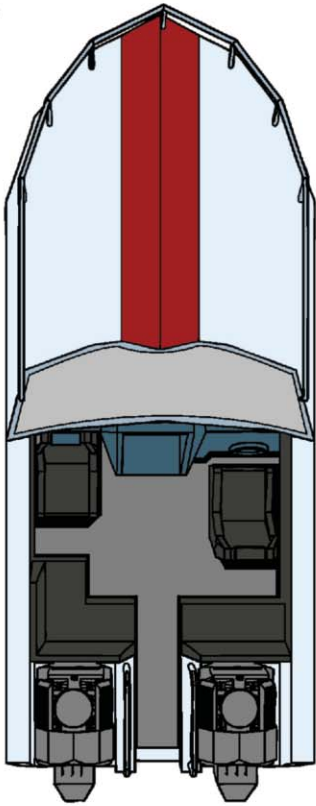

SPEED BOAT

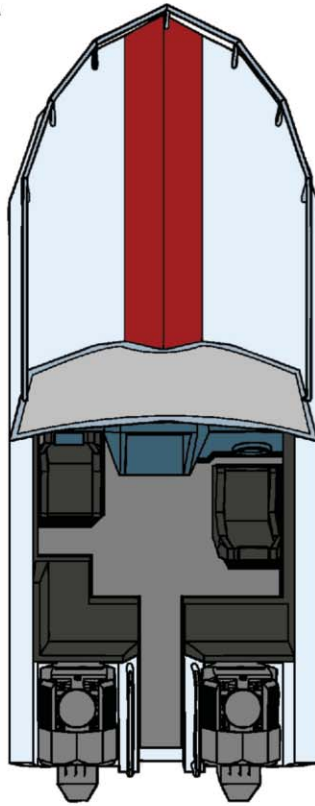

SPEED BOAT

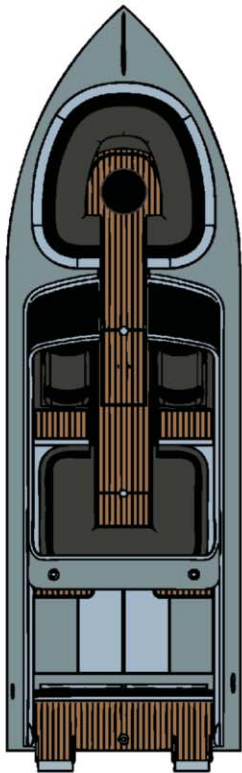

SPEED BOAT

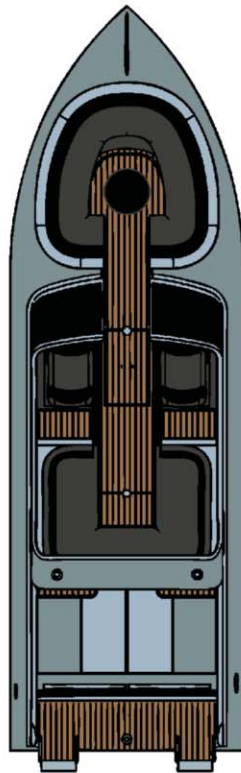

SPEED BOAT



BIG BLUE



SLAB

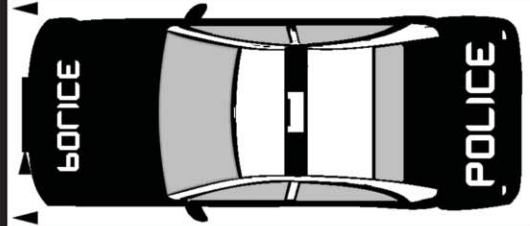

POLICE CAR

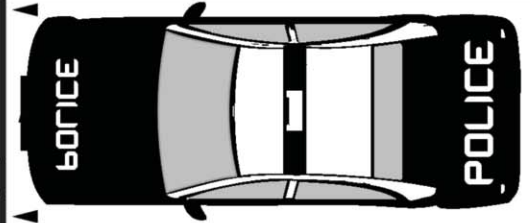

POLICE CAR

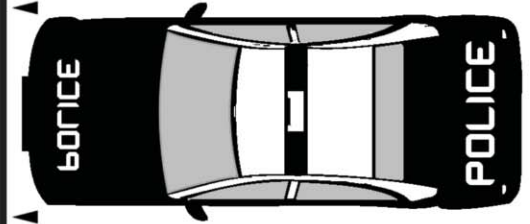

POLICE CAR



FORK LIFT



FORK LIFT

VILLAINS UNLEASHED

A



SOURCEBOOK

**Including the Adventure
The Triskelion Gambit**

Written by

Dan Jones, Foster Coker, and Steve Effler

Illustrated by Joe Singleton



P.O. Box 1082 Gilbert, AZ 85299
www.fantasygamesunlimited.net

CONTENTS

INTRODUCTION.....	3
DEDICATION.....	3
VILLAIN TEAMS.....	4
SPECTRUM.....	4
The Red Tide.....	4
Agent Orange.....	5
Yellow Lotus.....	6
Viridian.....	7
Big Blue.....	8
Indiglow.....	9
Ultraviolet.....	10
THE MALEVOLENTS.....	11
Greyhawk.....	11
Cerberus.....	12
Pulsator.....	13
Slab.....	14
Miss Fortune.....	15
INDIVIDUAL VILLAINS.....	16
Dr. Skull.....	16
Killshot.....	16
Quarry.....	17
Electric Skull.....	18
LaserBlast.....	18
Ripcurl.....	19
Bloodsport.....	20
Hypersonic.....	21
Glamazon.....	22
Doctor Degaton.....	22
Freeze-R-Burn.....	23
Power Pirate.....	24
Evil Jim.....	25
Zeitgeist.....	25
RULES VARIANTS.....	26
Experience Point Variant.....	26
NEW/VARIANT POWERS.....	26

1. Invulnerability.....	26
2. Probability Field.....	26
3. Force Field.....	27
THE TRISKELION GAMBIT.....	27
INTRODUCTION.....	27
1. HEADQUARTERS.....	27
1.1 The Blood Bank.....	27
River District Map Key.....	27
Map 1: The River District.....	28
1.2 Structural Damage Chart in the River District.....	29
1.3 Experience Points.....	29
2. THE DIAMOND EXCHANGE.....	29
2.1 The Cold Trail.....	29
2.2 Heroes on Patrol.....	29
2.3 Arriving at the Diamond Exchange.....	29
Diamond Exchange Map Key.....	29
Map 2: The Diamond Exchange.....	30
2.4. Events at the Diamond Exchange.....	31
2.5 Experience Points.....	31
2.6 Structural Damage Chart for the Diamond Exchange.....	32
3. TRISKELION.....	32
3.1 The Long-Retired Hero.....	32
3.2 The Briefcase.....	33
3.3 Triskelion.....	33
3.4 Experience Points.....	33
4. THE WAREHOUSE/HIDEOUT.....	33
4.1 Going Inside.....	34
4.2 A Quick View Inside the Abandoned Warehouse.....	34
Abandoned Warehouse Map Key.....	34
Map 3: The Abandoned Warehouse.....	35
4.3 Structural Damage Chart for the Abandoned Warehouse.....	36
4.4 Time for Action.....	36
4.5 An Unexpected Escape.....	36
4.6 The Aftermath.....	37
4.7 Experience Points.....	37
5. HENCHMEN CHART.....	38

EDITORIAL INTRODUCTION

Villains Unleashed is both a sourcebook and an adventure book for V&V. The adventure, *The Triskelion Gambit*, introduces an international organization (whose role is only hinted at) and makes use of many of the villains presented in the first part of this book. Other villains (and groups) are presented for Gamemasters to use within their own campaigns and will appear in later installments to this multi-adventure book campaign.

This is the first of three inter-connected adventures that will make up their own V&V GIANT (print book containing three traditional adventure or sourcebooks). For this reason, players may be a bit surprised and frustrated at the engineered escape of many of the villains at the end of the adventure. But, don't despair, they will be encountered again (and hopefully defeated) in the later installments.

The art for this book was originally assigned to a new artist we hoped to develop, but that artist totally bailed out on the project. Joe Singleton stepped in and saved the day (in true super-hero fashion). And, though he said nothing in his previous work for FGU, it appears that he prefers to do his character illustrations in color. This has led to an interesting decision and change in our usual packaging. We've decided to use the color illustrations in the PDF version of this book and only convert them to black-and-white for the print version in the GIANT. For those readers who don't understand this policy, allow me to explain that all FGU PDFs and books are designed first and foremost as print products. The cost of printing a book in color is so much greater than in black and white that the cost of any book we

printed in color would be two to three times that of the same book in black and white (interior, as we do always use color covers). As it is our goal to provide Gamemasters and players with the most material possible at the lowest price we can, we have chosen to continue to print our books as we always have, with black and white interiors. We've also resisted the temptation of offering color in the PDF versions of the same books so as to have a consistent product.

But, since Joe Singleton provided such excellent full-color art, we've decided to break with our usual policy and offer that color in the PDF version of this book, while the print version will have that converted to the usual black and white art.

Well, enough of explanations. On to the villains and the adventuring.

Scott B. Bizar, Editor-in-Chief

US COPYRIGHT NOTICE

Copyright 2016 Dan Jones, Foster Coker and Steve Effler.

All rights to this book are reserved. No part of this book may be used or reproduced in any manner whatsoever without permission, except in the case of brief quotations embodied in critical articles or reviews.

Cover art and interior illustrations are copyright 2016 by Joe Singleton.

Villains and Vigilantes is a trademark of Fantasy Games Unlimited.

For information, contact Fantasy Games Unlimited, PO Box 1082, Gilbert, AZ 85299 or at fantasygamesunlimited.net.

VILLAINS UNLEASHED

INTRODUCTION

First, I suppose an introduction is in order. My name is Lance Cannon. If the name sounds the least bit familiar to you, it's because I've spent the better part of the last ten years working as a freelance investigative reporter for a variety of news media outlets, crisscrossing the globe in pursuit of the Truth: the truth about metahumans, their powers, their origins, their organizations, and their goals.

In my travels, I've seen and heard a lot of things that may seem unbelievable, but I assure every word in the document you now hold is one-hundred percent truth. No folklore, no tall tales, no crazy, publicity-seeking lies. I have spoken to over two-thousand eyewitnesses, victims, government agents, and so-called experts, as well as over a hundred metahumans themselves.

I am releasing these findings to the public now in order to combat the wall of lies erected by various agencies around the world. These agencies, hiding behind such concepts as national security and the "need to know," have for years now concealed the facts behind a never-ending series of misdirections, blaming certain events on such bizarre causes as meteor strikes, freak thunderstorms, and other "Acts of God." I strongly believe the time has come for the Truth to be aired, no matter the personal risk or consequences.

Thus, I present Villains Unleashed, an exhaustive manual of several of the utmost extraordinary individuals on the planet, concealed from the general public, but acknowledged by authorities, and by some manipulated by influential, wealthy individuals all over the world to acquire specific goods, execute specialized tasks or exterminate competitors, all for a fee of course. You will be made privy to the beginnings of a plot that I uncovered concerning the organization calling itself Triskelion. The first stage I have labeled the Triskelion Gambit, and the rest of the scheme will be revealed in the next volume

of my expose, as soon as all the facts are correlated.

The entries in this manual represent just a fraction of the data I have assembled over the years; more adventures will be forthcoming. Until then, go collect a reward or two.

GM NOTES:

You will notice that the Origins/Backgrounds in this adventure are based on the notes collected by the author and only the information that was gathered is provided; this is different than most V&V adventures. This provides you, the Game Master, the ability to make any adjustments or modifications you see fit, with little explanation needed beyond a simple it looks like "this or that" was left out of the original notes. You will also notice that no Personality/Character Traits are included, simply because we, as fellow GameMasters and players, did not want to take these characters totally out of your hands.

This will allow you to add your "game style touch" so that the characters in question flow within the routine of your game night sessions.

Please also note that you will find monetary rewards, along with experience point values for Captured and Thwarted listed with each villain and henchman; please reference the Rules Variant included in this book for further explanation. Have fun and, of course, send in any questions or concerns you may have.

You will also notice that when a character has an increase in any of the five basic characteristics the original number is provided in brackets, ex: Strength 30 (17).

We'd like to offer a special thanks to fellow gamer and longtime friend Shane Handke who provided invaluable proofreading and editing assistance with this project. Any mistakes contained herein are entirely the fault of the authors, (so don't blame Shane).

Sincerely; Dan Jones, Foster Coker and Steve Effler

DEDICATION

Over the years, a few of our dear friends and fellow heroes have passed away and it is to their memory that we dedicate this volume.

Jim Sheets – The Black Knight, Les Green – The Mean Marine, Louis Nettles – Defender, Deanna Gray – Mind Dancer
They started as heroes. Now, they are legends.



VILLAIN TEAMS

SPECTRUM

The super-villain team called Spectrum first appeared nearly three years ago when they staged a series of color-themed crimes across the southwestern United States. I followed in their considerable wake, gleaning from witnesses and victims what information I could about the group's amazing powers and abilities. In Denver, I got a tip that Spectrum might next target Green Glen, the famous estate of eccentric billionaire Augustus Greenway. Thus, I was on hand that fateful night when the seven gaudily-clad criminals made their move. They easily overpowered the estate's high tech security team and made off not only with millions in jewels and art but also a hostage. That's right; yours truly was captured during the raid and taken back to a secret base of some kind somewhere in the Rockies.

I spent the next two weeks as Spectrum's "guest," and during that time was surprised to discover that they were more than willing to share with me virtually every detail of their personal lives and histories, including their origins, the extent of their powers, and so forth. Near the end of the two weeks, I learned the reason behind their apparent largesse...I was informed by The Red Tide that I would be held captive until I completed a book on Spectrum, in effect becoming their unwilling biographer under threat of grievous bodily harm.

Thankfully, that didn't transpire as they hoped. The day after The Red Tide's announcement, the base was attacked by a makeshift coalition of heroes including Stalwart, Apogee, and Screaming Eagle. The villains managed to escape by the skin of their teeth, but they were forced to leave behind a good deal of their loot and, thankfully, their would-be biographer.

What follows are profiles of the seven members of Spectrum, including many details I got straight from the villains themselves. Understandably, of course, I had little reason to take my captors' word on much of their information, so I naturally followed up my period of captivity with several months of leg work, verifying as many details as possible through outside sources such as employment records, newspaper reports, eyewitness accounts, and the like.

THE RED TIDE

Identity: Dr. Roy Grant Biven
Sex: Male
Level: 8

Side: Evil/Spectrum
Age: 30
Training: Strength +2,
Endurance +1, Agility +2,
Combat Accuracy +2

Powers:

1. Animal/Plant Powers (one celled organism): -4 Strength, +2 Endurance, +2 Agility.
2. Special: Body of Water: The Red Tide can change from his normal solid state to a liquid state along with ½ his carrying capacity at the speed of thought. This allows him to gain access to any area not air tight. Treat as Non-Corporeality defense on the combat chart.
3. Heightened Endurance B: +17
4. Mutant Power (Water Blast): The Red Tide is able to project a powerful blast of water from his hands. Range is Strength + Endurance/2.5 inches. Damage is 2d6. Use the Ice Power table for attacks. PR = 3 per attack.
5. Venom/Poison (Phytoplankton): This can be used one of two ways. It can be used as a carrier attack with the water blast which acts as a Devitalization attack doing 3d10 damage to the target's Power score in addition to the same done by the water blast, PR = 2 per use. If the Red Tide touches the target, it acts as Death Touch (see rule book for full description of Death Touch).
6. Heightened Agility B: +17
7. Heightened Intelligence B: +17
8. Heightened Attack: +1 damage per level, currently +8 damage.
9. Heightened Defense: -4 to be hit.
10. Weakness Detection: Must be within 1" of target and spend one



turn studying the target to detect a weakness and gain Intelligence/3, currently +11 combat attack bonus.

11. Willpower A: The Red Tide is able to prepare his mind for incoming attacks against him, willing himself to ignore pain and distractions. PR = 1 per turn.

12. Weakness (Obsession): Visible Light Spectrum: The Red Tide is obsessed with the colors of the visible light spectrum. He must make an Intelligence saving throw on 1d100 to resist going after valuable objects of those colors.

This makes it somewhat easier to lure him and Spectrum into a trap.

Weight: 185 lbs.

Basic Hits: 4

Endurance: 33 (15)

Intelligence: 33 (16)

Hit Mod: 30.8448

Reactions from Good: -3

Damage Mod: +8 (+16)

Accuracy: +7

Carrying Cap: 465 lbs.

Movement Rate: Ground 78" or 390'

Detect Hidden: 24%

Inventing Points: 26.4

Height: 6'0"

Reward \$16,000

Captured Experience Value 3760

Thwarted Experience Value 1880

Agility Mod: —

Strength: 12

Agility: 33 (14)

Charisma: 20

Hit Points: 123

Evil: +3

Healing Rate: 4 per day

Power: 111

Basic HTH: 1d6

Detect Danger: 28%

Inventing: 99%

Origin & Background: Research Technology, Crime, Education, Sports, Physics-Optics. Legal Status: Citizen of the United States, known criminal wanted for questioning.

Roy Biven has been fascinated by the colors of the rainbow since childhood. This led him to choose the University of Hawaii over other colleges. Roy, a gifted athlete, student, and natural leader, played

quarterback for the Rainbow Warriors and majored in physics. After receiving his doctorate, Biven stayed on to teach at the University. There he met and became romantically involved with Alaula Kailani, a grad student who became his top lab assistant.

While performing an experiment to determine if the effects of different wave lengths of radiant energy on algal bloom could cause it to disperse without causing ecological harm to the phytoplankton, and still prevent "Red Tide" from occurring, Dr. Biven implemented the use of a specially-modified laser light prototype. Due to an unforeseen design flaw, the device malfunctioned and exploded. Miss Kailani was bathed in radiant energies and Biven was knocked into the pool containing the radiated phytoplankton. The University blamed Biven for the accident and terminated him on the basis of reckless endangerment. He soon discovered the accident had mutated both him and Alaula. With his reputation ruined, unjustifiably (in his opinion), Biven turned to crime to fund his experiments and to allow him to afford the lifestyle he believes he deserves.

Combat Tactics/M.O.: The Red Tide will target flyers with his Water Blast – Phytoplankton carrier attack. If a foe has good defensive skills, he will close on them and use his Weakness Detection to increase his chance of successfully hitting. He will only use his Death Touch power as a last resort. He hates to kill, but will do so if he feels he has no other option.

Equipment: The Red Tide, like all members of Spectrum, wears special contacts that shield him from the effects of Ultraviolet's Light Burst.

AGENT ORANGE

Identity: Dr. Michael Rising Sun
Sex: Male
Level: 6

Side: Evil/Spectrum
Age: 40
Training: Endurance +1,
Combat Accuracy +2,
Combat Damage +2

Powers:

1. Armor B: The GAPS Mark II has an Armor Defense Rating (ADR) of 128. It also has the following special abilities built into it;

A. Flight: The GAPS is capable of flight, at speeds up to 238 mph, 1,047.2 inches per turn. It can operate in the atmosphere, underwater or in space. It can operate in flight mode for twenty-one hours before requiring recharging.

B. Adaptation: The GAPS was designed to "Go Anywhere." It will protect the user from any and all environmental hazardous conditions; anything from the vacuum of space to the high pressure on the bottom of the ocean, from the fire and heat inside an active volcano to the frigid cold of Antarctica. It is also able to protect against certain types of attacks, withstanding up to twenty four attacks against the system before giving out. (see rule book for full description of Adaptation).

C. Weakness Detection: Dr. Rising Sun modified the GAPS environmental scanners and sensors to analyze enemy combatants, revealing any weakness, showing the best attack type and location. It takes one action for the analysis to complete. After that, a weakness, if any, will be displayed and the user will receive a +7 accuracy bonus on the target analyzed.

2. Regeneration Device: Agent Orange has bio-repair nanites inside his body. They will converge on any damaged area and immediately begin repairs. They are able to heal two hit points worth of damage per turn (see rule book for full description of Regeneration).

3. Special Weapon: The GAPS weapon system is a sub-system of the armor. It works through it but it is not a part of it. So, if the armor gets damaged, the weapon system will not suffer any ill effects. The weapon system produces a jet of liquid which has been altered to quickly evaporate and turn into a gas. It can affect a target by contact or inhalation, so most force fields do not protect against it, unless the force field is airtight. It has the following uses:

A. Poison (paralyzing): A chemical compound that immediately reduces the oxygen levels in the blood stream rendering the target unconscious but otherwise unharmed (as per Paralysis Ray). It has a



range of 26" and is usable five times a day. Use Paralysis Ray on the combat chart when attacking.

B. Poison (fatigue): A chemical compound that accelerates the lactic acid build up in the muscles causing extreme fatigue in the target. The Poison does 3d10 points of power damage (as per Devitalization Ray). Usable twelve times a day. Use Paralysis Ray on the combat chart when attacking.

C. Acid: A highly corrosive mixture that will burn and dissolve most matter. The Acid does 1d20 damage to people or objects. (per Disintegration Ray). Usable fourteen times a day. Use Disintegration Ray on the combat chart.

4. Heightened Intelligence B: +12

5. Heightened Expertise: +4 to hit with the GAPS weapon system.

Weight: 230 lbs.

Agility Mod: —

Endurance: 15

Intelligence: 28 (16)

Hit Mod: 5.2416

Reactions from Good: -2

Damage Mod: +6

Accuracy: +3

Carrying Cap: 644 lbs.

Movement Rate: Ground 44" or 220'; Flight: 1,047" or 5,235'

Detect Hidden: 20%

Inventing Points: 16.8

Height: 5' 10"

Reward \$9,000

Captured Experience Value 1188

Thwarted Experience Value 594

Basic Hits: 5

Strength: 16

Agility: 13

Charisma: 15

Hit Points: 27

Evil: +2

Healing Rate: 2 per day

Power: 72

Basic HTH: 1d8

Detect Danger: 24%

Inventing: 84%

Origin & Background: Engineer: Weapon Systems, Engineer-

Armory, Scientist: Chemistry, Scientist: Environmental. Legal Status: Citizen of the United States, no criminal record but wanted under various charges in multiple nations

Dr. Michael Rising Sun was born and raised in the Big Cypress Indian Reservation, the largest of the six Seminole Tribe reservations in Florida. From an early age, Michael disliked the U.S. government for what they had done to his people and the U.S. military for what they had done to his father, Billy. Sgt. Billy Rising Sun served in the U.S. Army with two tours in Vietnam. He came home in 1972, but died in 1977 from Hodgkin's Lymphoma, caused by his extensive exposure to dioxin-contaminated Agent Orange. Michael was only four years old.

As Michael grew older, his love and respect for the environment also grew. A brilliant student, he enrolled at Florida State University where he quickly earned his first doctorate in Chemistry. He transferred to MIT where he developed skills as an engineer. After earning two more doctorates, he began work on his dream project. He called it GAPS (Go Anywhere Protective Suit). This suit could protect an individual from extreme environmental conditions, allowing a scientist access to areas he could never safely enter otherwise. It was equipped with environmental sensors and scanners to assist the user in all types of environmental experiments.

The Aeon Corporation agreed to purchase Michael's design, ostensibly to assist them in making environmentally safe products and to ensure their facilities had little to no harmful effect on the local environment. However, once Aeon had the plans, they started modifying the design to make it an extreme combat suit for the U.S. military.

Michael was devastated. His greatest achievement had been bastardized and given to the organization that killed his father. Modifying the prototype suit he kept, Michael broke into the Aeon research facility where the GAPS was being redesigned and destroyed all of the files. Knowing Aeon would realize he was responsible, he decided to use the GAPS against big corporations, like Aeon, and the U.S. Government. Both were the same in his mind.

Dr. Biven had worked with Dr. Rising Sun for a time when the latter visited the University of Hawaii after graduating from MIT. Biven called upon Rising Sun to join Spectrum, promising him the chance of greater revenge on those who had wronged him.

Combat Tactics/M.O.: Agent Orange will take to the air in combat, if possible. All of his attacks are ranged and he knows he is vulnerable on foot. He will spend his first action picking a target and scanning him using Weakness Detection. If the targets aren't military or government agents (FBI, local government agents like police, or government sponsored heroes) he will use the paralyzing poison first, until he runs out, then switch to the fatigue causing poison. Against government agents, he will use his acid spray first.

Equipment: In addition to the equipment listed, Agent Orange wears special goggles that shield him from the effects of UltraViolet's Light Burst.

YELLOW LOTUS

Identity: Sera Li
Sex: Female
Level: 6

Side: Evil/Spectrum
Age: 24
Training, Combat Accuracy
+3, Combat Damage +2

Powers:

1. Natural Weaponry: +3 to hit, +6 damage, Yellow Lotus has been trained in multiple styles of martial arts since she was old enough to walk. She is an expert in everything from Thai Kickboxing to Krav Maga. Bonus Ability: Ki Strike: six times a day Yellow Lotus is able to deliver a blow that does +12 damage instead of the normal +6. This is in addition to other damage modifiers.
2. Heightened Defense: -4 to be hit.
3. Heightened Expertise: Yellow Lotus is an expert using all martial art weaponry. She has a +4 attack bonus, in addition to the weapon's normal attack bonus.
4. Heightened Agility A: +21

5. Heightened Strength B: +11
6. Heightened Endurance B: +13
7. Prejudice: Being the daughter of a superhero and taking on his name doesn't generate a lot of good will with either side. Heroes think she is bringing disgrace to the name and memory of a much-loved champion. Villains don't trust her. They believe she could be working undercover against them. Her teammates trust her, for the most part, except for Viridian, who trusts her completely.

Weight: 120 lbs.
Agility Mod: +2
Endurance: 27 (14)
Intelligence: 10
Hit Mod: 27.2
Reactions from Good: -1
Damage Mod: +7
Accuracy: +10
Carrying Cap: 1,100 lbs.
Movement Rate: Ground 91" or 455'
Detect Hidden: 8%
Inventing Points: 6
Height: 5'3"
Reward \$7,200
Captured Experience Value 2196
Thwarted Experience Value 1098

Basic Hits: 3
Strength: 25 (14)
Agility: 39 (18)
Charisma: 12
Hit Points: 82
Evil: -1
Healing Rate: 2.4 per day
Power: 91
Basic HTH: 1d10
Detect Danger: 12%
Inventing: 30%



Origin & Background: Martial Arts. Legal Status: Dual Citizen of the United States and China, no criminal record but wanted under various charges in multiple nations.

Sera Li is the daughter of Sam "Yellow Lotus" Li, a Chinese-American superhero based out of Jacksonville, Florida; and Jujie "Snap Dragon" Hua, a Chinese national super-villain operating out of Beijing. They say opposites attract; this was surely the case with Sam and Jujie. Sadly, the love affair was brief. Jujie died giving birth to Sera.

Sera was raised by her father, Sam, with the assistance of Mrs. Livingston, Sam's housekeeper. Sam's busy lifestyle, police lieutenant by day and superhero by night, didn't leave much time for Sera. What time they did share together was spent training Sera in all areas of the martial arts. She excelled in the physical aspects partially due to the superhuman agility she inherited from her mother, but didn't seem interested in the mental and spiritual side.

Sera didn't do well in school, either; it just didn't interest her. She constantly got into trouble, something the counselors attributed to her need for attention from her father. In spite of this, or maybe because of it, Sera and Sam were constantly at odds with each other. As punishment, Sam would increase Sera's training and exercise routines.

Sera's relationship with her father continued to deteriorate. She ran away from home multiple times and did a small amount of time in the juvenile shelter. She rebelled against all authority. When she turned seventeen, she got a full back tattoo of a dragon, just to spite her father.

Just before Sera's eighteenth birthday, while she was doing time in the juvenile shelter for petty theft, she was told that her father had been killed. It wasn't in the line of duty or while fighting some super-villain. He was killed by a drunk driver while on his way to see her.

After being released from the shelter, Sera settled down somewhat. She opened a Goth boutique called "Death Warmed Over" with the insurance money she got from her father's policy. Still, when there was trouble in the area, the police would harass her. The harassment got so bad, she ended up losing her business.

She decided if she was going to be blamed for crimes, she might as well reap the benefits. She made a female version of her father's costume and began her full-time life of crime as Yellow Lotus.

While vacationing in New Orleans for Mardi Gras, Sera met a beautiful Creole woman, Hattie "Viridian" Barre'. Hattie moved to Jacksonville to be with Sera and to join in on the "fun" Sera was having wreaking havoc on the local police.

The two of them came to the attention of the Red Tide, who had begun putting his team together. While leery about taking in someone using the name of a well-known hero, Red Tide's compulsion for color overcame his reluctance. He gave Sera the male approval she always wanted and became a surrogate father figure to her.

Combat Tactics/M.O.: Yellow Lotus is somewhat reckless in combat. She will attack whom she perceives to be the fastest or toughest non-flyer. She will use her Ki attack until it's depleted then switch to one of her weapons if she thinks the additional damage is needed.

Equipment: Yellow Lotus, like all members of Spectrum, wears special contacts that shield her from the effects of UltraViolet's Light Burst. She also carries several martial arts weapons such as a Katana, Eskrima Sticks, Nunchaku, and Kama.

VIRIDIAN

Identity: Harriet "Hattie" Barre'
Sex: Female
Level: 6

Side: Evil/Spectrum
Age: 26
Training: Intelligence +1,
Agility +2, Strength +1,
Combat Accuracy +1

Powers:

1. Telepathy: Viridian has the ability to communicate directly with all minds within a 330" (550 yard) radius. She can automatically detect all thoughts within this range by performing a "Thought Scan" at a cost of 1 PR. This takes an action. She can read surface thoughts (what the subject is thinking of at the time of the Thought Scan), broadcast her thoughts, or act as a mental switchboard connecting the minds of up to thirty-three individuals. This takes 1 PR per turn to maintain. She can track a person by their thoughts as long as they stay in the range of the Thought Scan at a cost of 1 power per hour. To get more than surface thoughts, a Mind Probe can be attempted by touching the target. (see rule book for full description of Telepathy).

2. Psionic Power (Precognition): Viridian is able to get glimpses of the

possible/probable future by concentrating for 1D6 turns. Success depends on the amount of time she is looking ahead to. For one hour into the future she has a success rate of (Intelligence x2) 66%. A day is (Intelligence) 33%, a week (Intelligence / 2) 17%. More than a week is (Intelligence / 4) 8%. The GM rolls to determine success. A failed roll can be misinformation or simply no reading at all, PR = 7 per use.

3. Willpower A: Viridian's training allows her to ignore pain and distractions while in combat, PR = 1 per turn.

4. Heightened Intelligence B: +18

5. Magic Spells: These are spells taught to Viridian by her grandmother or learned from intense research (see rule book for full description of Magic Spells).

Only one spell can be active at any given time.

A. Poltergeist: as Non-Corporeality but she doesn't have the ability to make any part of her solid, PR = 6 per hour.

B. Arcane Bolt: attacks using Power Blast column. Range is (Intelligence + Endurance/2 23" or 115') Damage = 1D20+6. PR = 2 per shot.

C. Glamor (as Emotion Control Love): Range is 33" or 165'. PR = 8 per attempt. Target is allowed a saving throw (Roll Charisma or less on d100). A save is allowed each in-between turn. Spell doesn't affect an area as the power does.

D. Sleep (as Paralysis Ray): A successful hit renders the target unconscious without loss of hit points. Normal wake up rules apply (see rule book) Range is 33" or 165', PR = 8 per shot.

E. Recall (Special Teleportation): A limited form of Teleportation which returns Viridian and anyone or anything up to her Carrying Capacity to a predetermined location. This location can be changed as often as she likes but she must meditate in the location for at least one hour to set it as the destination spot. PR = 6 per use and the distance is her current power x105 inches (maximum range of 947 miles).

F. Heal: Viridian is able to restore hit points or power to an individual. The amount of hit points that can be restored is 1D10 with a power cost of double the amount of HP restored. The amount of power that can be restored is 2D10, PR = 6 per use. Success is automatic. Range is touch.

Weight: 115 lbs.

Agility Mod: +2

Endurance: 13

Intelligence: 33 (14)

Hit Mod: 5.7456

Reactions from Good: -2

Damage Mod: +6

Accuracy: +4

Carrying Cap: 175 lbs.

Movement Rate: Ground 43" or 215'

Detect Hidden: 24%

Inventing Points: 19.8

Height: 5'6"

Reward \$ 9,000

Captured Experience Value 1128

Thwarted Experience Value 564

Basic Hits: 3

Strength: 12

Agility: 18

Charisma: 15

Hit Points: 18

Evil: +2

Healing Rate: 0.9 per day

Power: 76

Basic HTH: 1d4

Detect Danger: 28%

Inventing: 99%

Origin & Background: Arcane Arts, Craft (Cooking), Research, Performing Art (Dancing), Psychology. Legal Status: Citizen of the United States, with a criminal record, currently wanted for questioning.

Harriet Barre', called Hattie by her friends and family, is the granddaughter of a Creole Voodoo priestess, as was her grandmother's grandmother. The gift seems to skip every other generation. Hattie was born outside of Monroe, Louisiana near the Black Bayou.

Hattie's childhood was uneventful, and that was the problem. Her gift was much stronger than her grandmother's, and by the time she was twenty-one, Hattie had mastered all her grandmother could teach her. Anxious for new challenges, she moved to New Orleans against her



family's wishes. It was there she met and fell in love with a vacationing Sera Li (aka Yellow Lotus). She moved back to Jacksonville, Florida with Sera and joined in Sera's criminal endeavors. Hattie isn't evil, just deeply in love and craving adventure. Sera provides both.

Combat Tactics/M.O.: Viridian is usually used by Spectrum to scout a potential job using her magical and psionic abilities. With the assistance of UltraViolet's heightened senses, Spectrum usually knows as much as can be learned about a target. In combat, Viridian usually casts Poltergeist and uses her Telepathy, in effect becoming a mental switchboard for Spectrum, allowing them to be in contact with each other without talking. If more offense is needed, she will use her Willpower to get into combat mode and attack with either Sleep or Glamor. She doesn't like using Arcane Bolts, but will if the need is dire. If things start going badly she will begin healing her teammates as needed. If it looks like capture is imminent, she will use Recall to escape, taking Yellow Lotus with her if at all possible.

Equipment: like all members of Spectrum, wears special contacts that shield her from the effects of UltraViolet's Light Burst.

BIG BLUE

Identity: Do'Ron "Bluey" Jackson
Sex: Male
Level: 4

Side: Evil/Spectrum
Age: 23
Training, Agility +1,
Endurance +1, Accuracy +1

Powers:

1. Natural Weaponry: +4 to hit, +8 damage: Big Blue had to learn how to fight to be able to survive in his neighborhood. Anything goes when you play for blood.

Bonus Ability: Due to Big Blue's increased size, both his accuracy and damage bonus from Natural Weaponry have doubled to match his size. This is reflected above.

2. Heightened Attack: +1 damage per level, currently +4 damage.
3. Heightened Strength B: +9

4. Heightened Endurance B: +12

5. Size Change (Larger): Big Blue stands thirteen feet tall, twice his normal height before taking the experimental HGH. His weight has increased by a factor of eight. This change is permanent. This makes him much stronger, and has doubled his movement rate. It also makes it easier to hit him from far away because he's a big target (The distance is half when figuring range modifiers).

6. Inconvenient Size: Being thirteen feet tall and weighing over a ton presents multiple problems for Big Blue. He lives in a world where most items were designed to be used by someone half his size.

Weight: 2,480 lbs.

Agility Mod: -8

Endurance: 30 (18)

Intelligence: 11

Hit Mod: 7.6

Reactions from Good: —

Damage Mod: +12

Accuracy: +3

Carrying Cap: 23,095 lbs.

Movement: Ground Rate: 128" or 640'

Detect Hidden: 8%

Inventing Points: 4.4

Height: 13'

Reward \$4,000

Captured Experience Value 3640

Thwarted Experience Value 1820

Basic Hits: 50

Strength: 25 (16)

Agility: 9

Charisma: 10

Hit Points: 380

Evil: —

Healing Rate: 45 per day

Power: 75

Basic HTH: 3d10

Detect Danger: 12%

Inventing: 33%



Origin & Background: Streetwise, Athletics. Legal Status: Citizen of the United States, no criminal record but wanted under various charges in multiple nations.

Do'Ron Jackson, called "Bluey" by his friends and family (because he was so dark, his skin had a bluish tint to it) grew up in Grantham Park, the toughest neighborhood in Chicago. Cops wouldn't even go

there at night and hardly went there during the day unless they had to, and then they went en masse.

Family life at the Jackson household was just as tough as the neighborhood. Bluey's mom worked three jobs trying to keep food on the table for Bluey and his younger siblings, so she was seldom home and when she was, she was dead tired. Bluey's dad was killed by the cops before Bluey was born. So with little adult supervision, Bluey ran the streets.

He was smart enough not to get caught if he did anything illegal. He wanted out of the neighborhood and he knew a shortcut; football.

Bluey was a high school all-star at left tackle. Heck, football was the only reason he went to school. He received multiple college scholarships offers and decided to play for Michigan. It was fairly close to home and when the fans cheered for the team "Go Blue!" it would be like they were cheering for him.

College was more difficult than Bluey had imagined. He had to intently study just to maintain a passing grade so he could stay on the team. It wasn't that he was stupid; education just didn't interest him. He was going to play professional football, make millions and never work a day in his life.

Life on the football field wasn't as easy as it was in high school, either. There, he was a man among boys, here, he was a man among other men his size and strength. In high school he was able to get by on his physical abilities. That wasn't going to be the case at Michigan. Luckily, Bluey knew a shortcut!

Bluey began taking steroids and human growth hormone therapy in his sophomore year. These helped a lot. He got bigger and faster so he didn't have to devote the time to work on technique. He made All-Conference his junior year and declared he would go professional. He knew the pros had a strict drug policy and he wouldn't be able to keep taking the same stuff. Luckily he knew another shortcut.

A booster had approached Bluey during his junior season. He told Bluey he knew he was taking stuff that would keep him out of the NFL. Bluey tried to deny it, but the booster told him not to worry. He was friends with a doctor who could give Bluey an experimental human growth hormone that could not be detected by the NFL. This new drug would make him even bigger and faster than he already was. Bluey decide to visit Dr. Curtis Kline to get this miracle treatment.

That's when Bluey's luck ran out. Something went horribly wrong during the treatment. Dr. Kline had used Bluey as the guinea pig for a new drug of his own design, one based on Superhuman Growth Hormone. It increased Bluey's size and strength to monstrous proportions. Bluey's football career was over, but a new career field opened up for him; that of a superhero. Things didn't work out for him on that front, either. He caused a lot of property damage and civilian casualties when attempting to stop the simplest of crimes and he ended up being a wanted man. That's when Dr. Biven stepped in and took Bluey under his wing to work for Spectrum.

Combat Tactics/M.O.: Because of his size, there are many places Big Blue can't go. If he can't fit in a building, he will wait outside to engage the police or any heroes. Big Blue is a brawler. He doesn't use any weapons except his over-sized fists and feet. If he spots anyone or is engaged in combat, the rest of the team will know it, thanks, to Viridian's psionic abilities.

Equipment: Big Blue, like all members of Spectrum, wears special contacts that shield him from the effects of UltraViolet's Light Burst.

INDIGLOW

Identity: Renato Braga
Sex: Male
Level: 4

Side: Evil/Spectrum
Age: 18
Training: Intelligence +2,
Strength +1

Powers:

1. Illusions (Solid Light Energy): Indiglow is able to create and shape objects of solid light. His creation points are twice his current power score. He can use this in two different ways.

A. Inanimate object: Indiglow can create solid inanimate objects of light. Each creation point gives the object 1 structural point and 50 lbs. of weight. The range on this is 30" or 150', PR = 2 per object created.

B. Animate objects: Indiglow can form and control mobile masses of solid light. Each creation point used gives the object 1 hit point and 2 inches of movement. If used to attack it does damage per the Brawling Weapons (see the rule book). Multiply the object's HP by 50 lbs. to determine bonuses to hit and damage caused. Use the Light column on the combat chart when making an attack. It takes one action, PR = 8 per object created (see rule book for full description of Illusions).

2. Force Field: Indiglow is able to construct a field of solid light around him for protection. The field's FFR score of 34, PR = 3 and an action to erect it. No action is needed to maintain it, PR = 1 each turn it is active. If the field takes damage, Indiglow can spend an action to reinforce it, PR = 3. Magnetic energy can bypass the field. (see the new alternate Force Field rules for full description).

3. Flight: Indiglow is able to ride light waves and fly at a speed of up to 82" per turn, 360 mph. PR = 1 per hour.

4. Indigo (Power) Blast: Indiglow can project electromagnetic energy from his eyes at a range up to 20 inches. The blast does 1d20 in damage, PR = 1 per use.

5. Heightened Endurance B: +12

6. Power Limitation: Indiglow can only fly with his Force Field active. The Force Field is also sound proof, so, while it is active, Indiglow is effectively deaf and mute.



Weight: 160 lbs.
Agility Mod: —
Endurance: 24 (12)
Intelligence: 15
Hit Mod: 8.064
Reactions from Good: -1
Damage Mod: +2
Accuracy: +1
Carrying Cap: 462 lbs.

Basic Hits: 4
Strength: 15
Agility: 15
Charisma: 13
Hit Points: 33
Evil: +1
Healing Rate: 2.8 per day
Power: 69
Basic HTH: 1d6

Movement Rate: Ground 54" or 270'

Detect Hidden: 12%

Inventing Points: 6

Height: 5'10"

Reward \$5,200

Captured Experience Value 816

Thwarted Experience Value 408

Origin & Background: Streetwise, Urban Survival. Legal Status: Citizen of Brazil, no criminal record but wanted under various charges in multiple nations.

Renato Braga was one of the seven million "Lost Children" of Rio de Janeiro, an orphan of mixed European and Amerind descent, growing up in a violent, desperate slum with little or no hope for a future. He learned at an early age to beg and steal, watching in horror as dozens like him were callously ignored, abused, and even murdered by so-called death squads charged with "cleaning up the streets." Strong and lucky enough to survive, Renato eventually fell into one of the innumerable gangs that roam that great city's back alleys and byways. By the age of thirteen, he was leader of the gang, then, just before his fourteenth birthday, a bizarre event took place that would change Renato's life forever.

An armed death squad was sweeping through the squalid tenements which Renato's gang often used for shelter. When cornered by one of the gunmen, Renato attempted to dodge away from a hail of submachine gun fire by diving out a second floor window. To his astonishment, he did not fall but rather found himself flying through the air, his body encased in a deep blue field of glowing energy. As the gunman ran to the window to fire again, his bullets bounced ineffectually off the energy field. Enraged, Renato felt a surge of power well up within him, and a beam of force lanced out from his eyes to blast the shooter into unconsciousness.

Though poorly educated, Renato had enough natural intellect to realize that he now possessed superhuman powers like the costumed characters he had seen in the scraps of newspaper that had often served as his blankets and bedding. He vowed never to go hungry or be victimized again, and for the next few year, the radiant figure the press dubbed Indiglow was seen all over Rio, stealing food, clothing, money and whatever else he wanted. The police were unable to stop him, and in time new reports of the glowing menace came to the attention of Dr. Roy G. Biven. He left immediately for Rio, used his own powers to attract Indiglow's attention, and successfully recruited him into Spectrum.

Combat Tactics/M.O.: If not actively engaged, the first thing Indiglow will do in combat is activate his Force Field and take to the sky, providing there is enough clearance to do so. He has a strong sense of survival and will spend the time needed to keep his Force Field close to full strength. This takes away from his effectiveness in dishing out damage. He usually relies on his Indigo Blast for offensive fire power. Another favorite tactic is to form light cages around hand-to-hand or melee opponents on the ground. This keeps them busy trying to break down the light cage, freeing up his teammates to attack other opponents or escape. He relies on Viridian's ability to act as a mental switchboard to communicate during combat.

Equipment: Indiglow's mask has been treated with a special chemical that shields him from the effects of UltraViolet's Light Burst

ULTRAVIOLET

Identity: Alaula Kailani

Sex: Female

Level: 7

Side: Evil/Spectrum

Age: 24

Training: Endurance +1,
Agility +1, Combat Accuracy
+2, Combat Damage +2

Powers:

1. Heightened Senses (Radiant Energy Vision): Ultraviolet can see using different frequencies of the radiant energy spectrum. In addition

to normal visual light, she can see infrared (detecting temperature differences and allowing her to see invisible objects due to their heat signature), ultraviolet (allowing her night vision) and x-ray (allowing her to see through objects). Her detect abilities are increased by a factor of three due to her vision.

2. Light Control (Ultra Violet Beam): Range is 56" or 280'. Ultra Violet Beam (invisible to normal vision) doing 2d8 damage, PR = 1 per shot. Special attack to the target's eyes to temporarily blind (Endurance save on D100 to recover). Ultraviolet can also do a blinding flash of visible light targeting all within a 56" or 280' radius. (Note: All members of Spectrum wear specially-coated contact lenses that protect them from this attack). Chance for recovery is Endurance save on D100 – roll each between-turns. Those affected behave as if they are encircled in Darkness (see rule book for a full description of Darkness Control), PR = 1 per use.

3. Invisibility: If Ultraviolet starts combat invisible (and she usually does) she starts off with a +4 to hit and a -4 to be hit. Each round she remains undetected, she accumulates +1 to hit and -1 to be hit until she is detected. Once detected, she starts over with a +1/-1 (see rule book for full description of Invisibility), PR = 1 per hour.

3. Flight: 726" 165 mph PR=1 per hour

4. Heightened Agility A: - +14



Weight: 110 lbs.

Agility Mod: +2

Endurance: 15 (14)

Intelligence: 16

Hit Mod: 6.048

Reactions from Good: -3

Damage Mod: +6

Accuracy: +7

Carrying Cap: 156 lbs.

Movement Rate: Ground 53" or 265'; Flight 726" or 165 mph

Detect Hidden: 36%

Inventing Points: 11.2

Captured Experience Value 1232

Thwarted Experience Value 616

Basic Hits: 3

Strength: 11

Agility: 27 (12)

Charisma: 18

Hit Points: 19

Evil: +3

Healing Rate: 1.2 per day

Power: 69

Basic HTH: 1d4

Detect Danger: 48%

Inventing: 48%

Height: 5'5"

Reward \$12,600

Origin & Background: Physics, Fine Art (Painting). Legal Status: Citizen of the United States wanted for murder.

Alaula Kailani was born and raised in the Wailuku district on Maui, Hawaii. Alaula's parents were killed in an auto accident when she was five-years old, and she was placed in the custody of her only living relative, her father's sister Aineki.

Alaula was a girl beautiful in face, body and spirit, and her aunt was extremely jealous of her. Alaula was also nearly as intelligent as she was beautiful, and her Aunt Aineki was none of these. Plain- looking, cruel and stupid, the woman did all she could to make her niece's life a living hell. She constantly abused Alaula, both physically and mentally. As Alaula grew into a teenager, Aineki dressed her in drab clothing much too large for Alaula, in order to hide her figure. Aineki made Alaula wear thick glasses which practically ruined the poor girl's eyesight, and haphazardly cut her hair to make Alaula as unattractive as possible.

She wouldn't allow Alaula to wear "whore's paint" (makeup) to cover up the acne she developed as a teenager. Whenever Alaula made good grades in school, her aunt berated her, made fun of her and called her names. Due to the way she looked, other children also made fun of her. She was friendless and unloved.

All of this changed when Alaula won a full academic scholarship to the University of Hawaii. Away from her aunt's influence, Alaula slowly started to regain her confidence. This greatly accelerated when she met Dr. Roy Biven, her physics professor. Biven saw the potential Alaula had and worked with her to achieve it. The two fell in love, although they kept the romance quiet so Biven wouldn't lose his job.

While Biven was still in the hospital recovering from the accident that gave both of them their powers, Alaula met her aunt by happenstance. Aineki didn't recognize her niece until Alaula called out to her. Alaula was hoping time had somehow softened her aunt, but it hadn't. Aineki didn't waste any time resuming her old familiar verbal abuse, calling Alaula a slut. When Aineki drew back her hand to strike her niece, Alaula raised her hands to ward off the blow. As she did, she emitted a burst of invisible ultraviolet light, striking Aineki in the face and blinding her. Her aunt didn't have long to worry about her eyesight, though. Years of anger and pain came flooding out of Alaula, along with wave after powerful wave of UV light. She cooked her aunt there on the spot then turned and slowly walked away.

Combat Tactics/M.O.: If Ultraviolet knows a fight could be coming she will become invisible and take to the air if possible. If surprised, this will be her first action. Ultraviolet is smart and wanted for murder. She will go after those who have the best chance to bring her in. She will use her Heightened Vision powers to check for hidden or invisible opponents and go after them, if they exist. If any of her opponents also have Heightened Senses and it's known to her, she will target them. Otherwise, she will attack using her Light Control, first against anyone attacking the Red Tide, and then against any other opponent she thinks she can affect. If things start to go badly, she doesn't have a problem abandoning her teammates, with the exception of the Red Tide. She won't leave without him or without knowing he has already escaped.

THE MALEVOLENTS

The ambitions of the wicked have forever been hampered by their tendency to end-up behind bars. The very notion of this challenge led to the foundation of the Malevolents. Following numerous setbacks at the hands of various vigilantes, Greyhawk, the self-appointed leader, put together a plan to establish the group. He attempted to recruit Zeitgeist & Spell Jammer but both declined membership, so he set his eyes on Cerberus, Pulsator, Slab, and Miss Fortune, who all eagerly accepted. Banding together under Greyhawk's leadership, the villains have been terrorizing the innocent for several years now, never forgetting the team motto – "No Bad Deed goes Unrewarded."

GREYHAWK

Identity: Kyle Nipper
Sex: Male
Level: 5

Side: Evil/The Malevolents
Age: 26
Training: Combat
Damage +4

Powers:

1. Wings (Flight Device): 51" per turn (255mph), High Capacity Micro Lithium Battery Pack holds 14 charges. 1 charge per hour.
2. Heightened Agility: Special +4
3. Heightened Expertise: +4 with sword.
4. Heightened Senses: Vision x2 detection.
5. Sword: +2 to hit / +1d6 damage.

Weight: 180 lbs.
Agility Mod: —
Endurance: 15
Intelligence: 13
Hit Mod: 6.0984
Reaction from Good: -1
Damage Mod: +6
Accuracy: +4 (+10 with sword)
Carrying Cap: 577 lbs.
Movement Rate: Flight 51" or 255'
Detect Hidden: 10% (20%)
Inventing Points: 6.5
Height: 6'1"
Reward \$6,000
Captured Experience Value 910
Thwarted Experience Value 455

Basic Hits: 4
Strength: 17
Agility: 17 (20 flying)
Charisma: 12
Hit Points: 25
Evil: +1
Healing Rate: 1.6 per day
Power: 66
Basic HTH: 1d8
Detect Danger: 14% (28%)
Inventing: 39%



Origin & Background: Gaming, Martial Arts. Legal Status: Citizen of the United States, convicted murderer wanted in several states. My research on Greyhawk is as accurate as it can be; there may be

hidden details that I did not uncover during my investigations.

As a youth, Kyle Nipper discovered that he had better than average eyesight. As a matter of fact, according to documents on file, his vision was so superior it even bewildered the best optometrists and ophthalmologists. Realizing that he could use his vision as an advantage, at age twelve he began studying laijutsu, mainly because he felt this Japanese sword fighting style was technically more complex than others and would allow him to master spotting his opponents' movements and launch an attack at them before they had time to counter.

At age fifteen, Kyle joined a high school club called The Society for Historical Adventures, which was your basic fantasy role-playing group, focusing on dragons, wizards, and dungeons. He fell in love with this lifestyle and, according to research, he even told the group that he would become his first character, Greyhawk, if ever given the chance. Graduating from high school, Kyle enrolled in Le Moyne College in Syracuse, New York, looking to acquire a Bachelor's Degree in Japanese History. He wasted no time in locating the campus RPG'ers and joined the school club. It was on one of these gaming nights that he introduced his fantasy character Greyhawk and stated that he would one day become his character in the real world. As a lark, one of his gaming friends, (who wanted to remain anonymous for this interview) boasted that he had been working on the design for a pair of special, functional wings that he claimed would give Kyle the power of flight he so desired. True to his word, Kyle's friend, a post-graduate mechanical engineer, dedicated himself to working alongside Kyle, perfecting and building the aerodynamic lightweight titanium and mylar wings. After two grueling years of flawed designs and painfully unsuccessful testing, the wings were completed.

These two years of hard work and expenditures left Kyle substantially in debt. He always had a penchant for playing rogue characters that operated beyond the law, so at long last he adopted his Greyhawk identity and started pulling small time petty robberies to test his abilities. Before long, he moved on to bigger crimes like bank robberies, jewelry heists, and even the occasional hit-for-hire. Naturally, he drew the attention of some of the area's costumed vigilantes such as Screaming Eagle and Apogee, whom he managed to defeat, thanks to a combination of skill and luck. He developed an ego and came to believe himself invincible, but he was eventually disabused of this notion after a chance encounter with Manhattan-based hero Stalwart. By painstakingly accessing police data bases, I discovered that Greyhawk spent the next several months behind bars, but took advantage of that opportunity to network connections in the underworld so that when he was later released, he quickly was able to ally himself with the like-minded villains that now comprise The Malevolents.

Combat Tactics/M.O.: Greyhawk knows it is to his advantage to take flight and will do so for his first action. He will make use of his sword for all attacks whenever possible.

Equipment: Greyhawk always has his sword on him. He also carries an extra fully charged High Capacity Micro Lithium Battery Pack, clipped to the rear of his belt.

CERBERUS

Identity: Jack Johnson
Sex: Male
Level: 5

Side: Evil/The Malevolents
Age: 24
Training: Combat Accuracy +3, Endurance +1

Powers:

- Flame Power (surrounds entire body): PR = 3 to activate.
 - Flight: 59" per turn (295mph), PR = 1 per hour.
 - Automatic Flame Defense
 - Flame Blast: range 44" (220'), 1d12 damage, PR = 3 per attack.
- Heightened Strength A: +16
- Natural Weaponry (Claws): +2 to hit/+5 damage with unarmed combat.

4. Body Power: When hit points are reduced to 20 points or less the following occurs.

- Two identical spirit heads appear, giving the look of three-heads.
- Gains x3 to Detect Hidden objects & Detect Danger.
- Reduced flame breath from the two heads only, range 22" (110'), 1d6 damage, PR = 2 per attack.

Weight: 225 lbs.
Agility Mod: —
Endurance: 18 (17)
Intelligence: 12
Hit Mod: 7.744
Reaction from Good: -2
Damage Mod: +1
Accuracy: +4
Carrying Cap: 2,180 lbs.
Movement Rate: Ground 59" or 295'
Detect Hidden: 10% (30%)
Inventing Points: 6
Height: 6'4"
Reward \$8,500
Captured Experience Value 1100
Thwarted Experience Value 550

Basic Hits: 5
Strength: 26 (10)
Agility: 15
Charisma: 17
Hit Points: 39
Evil: +2
Healing Rate: 2.5 per day
Power: 71
Basic HTH: 1d12

Detect Danger: 14% (42%)
Inventing: 36%



Origin & Background: General Equipment Maintenance, Mining. Legal Status: Citizen of the United States, wanted by police for various crimes and by the government for a "special project" study.

The majority of the information I obtained about Cerberus came from his last employer, hospital records, and a couple of family members.

Jack Johnson grew up in southeastern Arizona and, like many young men from that region, took up a profession that would allow him to go to work in the numerous copper mines of the area. His community college records indicate that Jack studied general equipment maintenance and mine engineering. Jack was working his way through college at the Esha Copper Mine, on White Wolf Mountain, which had been rumored to be haunted going back to the late 19th Century. His former supervisor,

PULSATOR

Identity: Pramana (Paul) Santor
 Sex: Male
 Level: 7

Side: Evil/The Malevolents
 Age: 29
 Training: Combat Accuracy
 +2, Agility +2, Combat
 Damage +1, Intelligence +1

Area of Knowledge:

Powers:

1. Devitalization Ray: Range 26" (130'), 3d10 Damage, PR = 3 per attack.
2. Flight: 800.8" per turn (182 mph), PR = 1 per hour.
3. Heightened Agility A: +10
4. Heightened Intelligence A: +16
5. Vibratory Blast: Range 46" (230'), 2d8 damage, PR = 5 per attack.
 - A. Chance to destroy a device is 28%.
 - B. Vibratory Defense – no PR cost.
 - C. Pass through solid objects, PR = 2 per use.

Weight: 178 lbs.

Agility Mod: —

Endurance: 13

Intelligence: 27 (10)

Hit Mod: 5.9136

Reaction from Good: -2

Damage Mod: +6

Accuracy: +6

Carrying Cap: 324 lbs.

Movement Rate: Ground 50" (250'), Flight: 800.8" per turn (182 mph)

Detect Hidden: 20%

Inventing Points: 18.9

Height: 5'10"

Reward \$11,900

Captured Experience Value 1414

Thwarted Experience Value 707

Basic Hits: 4

Strength: 14

Agility: 23 (11)

Charisma: 17

Hit Points: 24

Evil: +2

Healing Rate: 1.2 per day

Power: 77

Basic HTH: 1d6

Detect Danger: 24%

Inventing: 81%



Origin & Background: Vibration Analysis, Vibration Control, Structural Foundation Analysis, Tactical Air Borne Combat Studies.
 Legal Status: Citizen of the Indonesia, with criminal record, in the USA

Mr. Caine, described Jack as extremely proficient at a variety of on-site duties including working on drilling equipment, shuttle cars, long wall shearers, crushers, and pumps.

Incident records from the Esha Copper indicate that one night, while working on a piece of blasting equipment in the lower tunnels, approximately three-hundred feet underground, Jack and the other crew members were startled by the appearance of a vaporous apparition in the form of an enormous wolf. One of the frightened crewmen dropped a piece of the blasting equipment, causing a spark to ignite some undetected gas in this tunnel cavity. Jack and the crewmen were engulfed in a huge fireball; all that Jack could recall before passing out was that the wolf-like image had lunged between him and the explosion, as if in an effort to shield him in some way.

Local hospital records revealed that Jack was in a medically-induced coma for nearly three months, having suffered major burns requiring multiple skin grafts all over his body. When Jack was told that the mine explosion had killed all seven other members of the work crew, he was overwhelmed with grief and let out an eerie, inhuman howl. Doctors were unable to account for this strange sound, nor for the tremendous amount of coarse hair that began to rapidly grow from out of the grafted patches of skin. Alarmed about their patient's "symptoms", the hospital administration felt that for the protection of the employees and other patients, Jack should be under twenty-four hour quarantine and surveillance until a diagnosis was made.

Within a few hours of coming to, Jack was feeling somewhat better and asked his doctors for their best guess regarding his new hair growth and ear-shattering howl. The doctors admitted their lack of a hypothesis, and revealed to Jack that they had been consulting with a special government department, which was sending in a team of specialists from California.

The following statement was taken from a police file. It should be noted that the statement is incomplete, as some pages were missing. "Mr. Johnson confessed to his nurse that the more he thought of being examined by government specialists, the more apprehensive he became. He indicated he did not want to be one more missing person under the masquerade of a government 'special project'. He also confided to the nurse that he had uncovered a very small vein of diamonds that he had been discreetly removing over the preceding couple of months, concealing them within assorted pieces of mining equipment he worked with every day. The more he dwelt on these subjects, the faster his heart would race, and the louder his monitoring equipment would protest.

Hospital records indicate that staff came running to his room, finding Jack in a state of confusion, yelling, howling, and sweating profusely. Witnesses stated that the patient's body was by then covered with hair, and seemed to be morphing somehow into a new, only partially-human form. A quick decision was made to sedate him, but once the nurse got close enough, Jack snapped the restraints that had held him to the bed rails. Striking the nurse and knocking her down, Jack jumped from the bed and fought off an attempted tackle by an orderly. Jack grabbed the chair in his room, threw it through the window and jumped two stories to the sidewalk below. By the time he dashed off into the night, the transformation was complete...he now had the form of a bipedal wolf-man hybrid.

Over time, Jack figured out that the explosion had somehow merged his body with that of the wolf spirit, and he now had the ability to encase his body in fire without harming himself. With his newfound power, strength and claws, he quickly turned to a life of theft and intimidation to survive. It was during one of his bolder attempts at robbery that he was overcome by a pair of costumed vigilantes, Firethorn and Thistle, and turned over to the authorities. While incarcerated, Jack met and befriended Greyhawk, who eagerly invited Jack to join his new team of villains, The Malevolents.

Combat Tactics/M.O.: Cerberus will call forth his Flame Power as a defense at the first sign of trouble. He will attack with his claws, but if things start to get out of hand, he will shoot a Flame Blast or two and try to fly away.

illegally. Wanted in Kotang, Indonesia for political assassination and murder.

This is a collection of loose notes supplied to me by the Government of Padang, though many of the notes were missing or redacted; it's all I had to go on.

Pramana Santor was born in Kotang, Indonesia the fourth-largest city on the west coast of Sumatra. His father was a minor government official, and instilled in young Pramana a sense of patriotism and loyalty. He unexpectedly discovered his powers at the age of nine while playing soccer with a group of friends. In just a few weeks he was taken into government custody after the mysterious deaths of his family members. He was placed into a privately-funded government program where he could be monitored, and there he studied vibration and air-combat related subjects.

According to government records, by the age of seventeen Pramana had mastered his powers and was working as an agent on "special projects" on the government's behalf.

At the age of twenty-four, while still loyally serving his country under the code name Pulsator, Pramana discovered that the deaths of his parents were not accidental, as he had originally been led to believe. Rather, Pramana's father had been assassinated (and his mother killed during the assassination) as part of a scheme to allow a political rival to come to power in the city. That rival, Kanjit Kartagawa, had since risen to become Governor of the region and it was he, in fact, who gave Pulsator the direct orders for the "special projects." Pulsator instantly realized that the so-called projects had all along been criminal actions designed to strengthen Kartagawa's political power.

This revelation drove Pulsator mad with grief and rage. He channeled his energies to never before reached levels and attacked the Governor's mansion, killing the Governor and three of his personal guards before escaping. Branded a murderer in his home country, Pulsator fled to the United States where he continued using his powers to steal, only now for his own benefit rather than that of his corrupt government. He was eventually caught and imprisoned, and it was while spending time in jail that he befriended Greyhawk, who promptly invited him to join a new team of villains, called The Malevolents.

Combat Tactics/M.O.: Pulsator will take flight and use his Devitalization Ray to weaken opponents, and then target weakened opponents with his Vibratory Blast.

SLAB

Identity: Raymond Shelton
Sex: Male
Level: 5

Side: Evil/The Malevolents
Age: 19
Training: Combat Accuracy +1, Endurance +2, Combat Damage +1

Powers:

1. Heightened Strength B: +17
2. Natural Weaponry (Slab Fist): +2 to hit / +5 damage with unarmed combat.
3. Heightened Attack: +1 damage per level, currently +5 Damage.
4. Heightened Expertise: Strength/Slab Fist - +4 to hit.
5. Invulnerability B: 8 points, blocks 2d10 damage per attack, all cold based attacks bypass his Invulnerability, (see the new alternate Invulnerability for full description).

Weight: 640 lbs.
Agility Mod: -4
Endurance: 18
Intelligence: 10
Hit Mod: 3.696
Reaction from Good: —
Damage Mod: +11
Accuracy: -2 (+5)
Carrying Cap: 10,109 lbs.
Movement Rate: Ground 56" or 280'

Basic Hits: 13
Strength: 31 (14)
Agility: 7 (11)
Charisma: 10
Hit Points: 49
Evil: —
Healing Rate: .5 per day
Power: 66
Basic HTH: 2d10



Detect Hidden: 8%
Inventing Points: 5
Height: 7'9"
Reward \$5,000
Captured Experience Value 1150
Thwarted Experience Value 575

Detect Danger: 12%
Inventing: 30%

Origin & Background: Short Order Cook. Legal Status: Citizen of the United States, with criminal record.

The attached information was gleaned from Slab's own confession, freely given to authorities as part of plea bargain which included an agreement to help him better understand his condition and, theoretically, find a cure for it.

Raymond Shelton was just your everyday short order cook working for a diner inside an office building in the metro Detroit downtown area. It was just another Friday, just another paycheck; as he walked past all the downtown construction on his way to the bank to cash his check.

As he turned the corner, a bolt of lightning struck the fence that surrounded the construction area, knocking him off his feet. It was not going to be another same old Friday, for he was trapped in the middle of a fight between two unknown masked individuals. He jumped to his feet and ran through the hole in the fence twisted by the blast. He didn't notice the wet cement foundation until it was too late; he was now held fast up to his shoulders in the cement and powerless to move.

The two combatants paid little attention to Shelton, and both launched many attacks toward each other, with many missing their target and hitting the wet cement that had Shelton trapped. A Lightning Bolt here, a Sonic Blast there, it didn't take long before he passed out from the agony.

Once he came to, he was alone and it was now dark. Part of the wooden construction area had collapsed on top of him, and he guessed this was why no one had found him. He suddenly realized

that he should be dead, and had somehow survived the barrage of powers. These attacks somehow reacted to the still wet chemical compounds within the cement foundation and transformed him into a hulking disfigured brute possessing augmented strength and a high degree of resistance to bodily harm.

Vowing to never flip another hamburger, he turned to a life of crime. He was eventually caught and while spending time in jail he was befriended by Greyhawk and invited to join a new team of villains called The Malevolents.

Combat Tactics/M.O.: Slab is the brute force of the group, and will attack with his fists most of the time. He has also been known to lift and throw heavy objects when confronted by a flying opponent.

Equipment: Keeps a chain that he grabbed from the construction site as a belt (he regards it more as a memento than a weapon).

MISS FORTUNE

Identity: Monika Gamble
Sex: Female
Level: 5

Side: Evil/The Malevolents
Age: 22
Training: Agility +2, Combat Damage +2

Powers:

1. Mutant Power (special Probability Field): Radius range is equal to Charisma/3, currently 6" (30') in all directions. (see the new alternate Probability Field rule for full description).

A. This field enables her allies to re-roll every roll once, i.e. an attack roll, a damage roll, a consciousness check, etc. PR = 0.

B. It also causes all her opponents' successful rolls to be re-rolled once, PR = 2 per turn.

2. Heightened Defense: -4 to be hit.

Weight: 127 lbs.
Agility Mod: —
Endurance: 12
Intelligence: 16
Hit Mod: 2.688
Reaction from Good: -3
Damage Mod: +4
Accuracy: +2
Carrying Cap: 121 lbs.
Movement Rate: Ground 39" (195")
Detect Hidden: 12%
Inventing Points: 8
Height: 5'4"
Reward \$9,000
Captured Experience Value 640
Thwarted Experience Value 320

Basic Hits: 3
Strength: 10
Agility: 17
Charisma: 18
Hit Points: 9
Evil: +3
Healing Rate: .9 per day
Power: 55
Basic HTH: 1d4

Detect Danger: 16%
Inventing: 48%

Origin & Background: Dance, Games of Chance. Legal Status: Citizen of the United States, wanted for questioning.

It was not hard getting detailed information on Miss Fortune; from the very outset of her criminal career, she has made little or no effort to cover her tracks or hide her identity. The information below was gleaned in interviews with childhood acquaintances, friends, and former co-workers.

Science tells us that most mutants' powers manifest in adolescence, but in this particularly strange case, Monika Gamble's powers seemed to activate when she was still in her mother's womb. Michael Gamble and his pregnant wife Serena were the only survivors of Pan-Atlantic Flight 1202 when it crashed upon take-off at Chicago's O'Hare Airport about twenty years back. Miraculously, Serena's pregnancy was unaffected and Monika was born three months later. For the next several years, the Gambles continued to enjoy good fortune in the form of promotions, good health, and even a modest lottery win when Monika was nine. The happy household came crashing down three



years later, though, when Monika's mother learned her husband had been having an affair with a woman at work. They decided to divorce and twelve-year-old Monika blamed her father for the break up. A week later, Michael Gamble died in an automobile accident while driving Monika to school. Monika was badly injured but survived.

Over the next six years, Monika came to realize that she was different...her friends seemed to experience an inordinate amount of good luck, and those she considered her enemies always seemed to fall victim to an equally unusual amount of bad luck. Through careful concentration, and a great deal of trial and error, Monika learned to recognize that her power only affected others, never herself. She also came to realize that the power was constant; she could not will it to deactivate no matter how hard she tried.

Seeking a way to make money through the good fortune of others, Monika headed out west to Las Vegas where her natural good looks and charisma got her a job with a reputable escort service. She would accompany wealthy customers at the gambling tables, and as part of the escort service's contract, she would pocket a percentage of each client's winnings. She made a good living doing this for the next nine months, and then a coalition of casino security teams realized that her clients virtually always won big when she was around. Monika was banned from all Nevada casinos, and retreated to her lavish penthouse apartment to figure out her next step.

That's when she was contacted by Kyle Nipper, AKA the super-villain Greyhawk. Nipper, using an alias, had happened to be one of Monika's clients a few weeks prior, and had kept tabs on her out of a nagging suspicion that Monika was something special. Realizing what an asset Monika's ability would be to his newly-formed team, the Malevolents, Nipper recruited her on the spot. Thus, Monika became Miss Fortune, and has been wanted by the law ever since.

Combat Tactics/M.O.: Monika will not engage in combat unless it's a matter of life and death. However, she will maintain close proximity to her allies, so that her Probability Field will aid them in battle.

INDIVIDUAL VILLAINS

DR. SKULL

Identity: Unknown

Side: Evil
estimated

Level: 5

+1, Agility +1, Strength +2

Area of Knowledge:

Sex: Male Age: 27

Training: Combat Accuracy

Powers:

1. Teleportation: Range 77" (385') - (current power score in inches), PR = 1 per use.

2. Will Power A: PR = 1 per turn.

3. Heightened Endurance B: +19

4. Disintegration Ray: Range 15" (75'), damage 1d20, PR = 2 per shot.

5. Transformation (special, shape shifter, head only): can change his head into a horrific looking skull which triggers an emotional aura of horror. Range 1" (5'). Save vs Charisma + level on percentile dice, PR = 8 per use, Failed save results in individual fleeing at full speed until save is made.

Weight: 248 lbs.

Agility Mod: -2

Endurance: 31 (12)

Intelligence: 15

Hit Mod: 10.2144

Reaction from Good: —

Damage Mod: +2

Accuracy: +3

Carrying Cap: 803 lbs.

Movement Rate: Ground 62" (310')

Detect Hidden: 12%

Inventing Points: 9

Basic Hits: 5

Strength: 15

Agility: 16

Charisma: 10

Hit Points: 52

Evil: —

Healing Rate: 4.5 per day

Power: 77

Basic HTH: 1d8

Detect Danger: 16%

Inventing: 45%



Height: 5'8"

Reward \$6,000

Captured Experience Value 1548

Thwarted Experience Value 774

Origin & Background: Psychology, Medicine. Legal Status: Illegal alien status in the US. No criminal record, but he is wanted by the government for questioning.

Most of the information I have on Dr. Skull comes from a very dependable contact within a certain government agency which I am forced to leave unnamed. It seems that the not-so-good Doctor is from the planet Phobion (whose existence has been kept secret from the general public). Dr. Skull was apparently contacted by the unnamed government agency shortly after his arrival on Earth and taken into custody, though whether he was actually a guest or a prisoner is not clear.

It was determined he had been banished from his home world for reasons he did not care to discuss. He did, however, agree to undergo certain tests which confirmed that Dr. Skull, like others on his home world, communicates using methods of emotional manipulation. His preferred emotion was quite obviously fear; as he was observed to revel in the apprehension his eerie transformation often wrought in his hosts/captors. Future tests were planned, but Dr. Skull had other ideas and took his leave at his first available opportunity. For the last two years, he has been seen in various locales around the globe, sowing fear and distrust.

Combat Tactics/M.O.: Dr. Skull will not hesitate to use his Emotional Transformation powers to make his head look like a horrific skull. He can also generate and project a blast of alien radiant energy that breaks down the molecular bond of inanimate objects. This same energy can be used for Teleportation as he disassembles and reassembles the molecules within his alien body.

KILLSHOT

Identity: Unknown

Sex: Male

Level: 10

Side: Evil

Age: 28

Training: Agility +2, Combat
Damage +2, Strength +4,
Endurance +1

Powers:

1. Heightened Agility A: +14

2. Heightened Expertise (Special Weapon): +4 to hit.

3. Heightened Attack: +1 damage per level, currently +10 damage.

4. Armor (ADR 44): can repair 14 point of armor damage per day with sufficient funds.

5. Special Weapon: Killshot carries two .50 Magnum Pistols with High Explosive Armor Piercing Bullets. 10 shots per clip – 1d12 damage.

A. H.E.A.P. Bullets: ignore the first 10 points of any armor or invulnerability.

B. H.E.A.P. Bullets: grant a +2 to hit target.

Weight: 185 lbs.

Agility Mod: —

Endurance: 14 (13)

Intelligence: 14

Hit Mod: 5.39

Reaction from Good: -1

Damage Mod: +13

Accuracy: +10

Carrying Cap: 537 lbs.

Movement Rate: Ground 55" (275')

Detect Hidden: 10%

Inventing Points: 14

Height: 5'11"

Reward \$12,000

Captured Experience Value 1820

Thwarted Experience Value 910

Basic Hits: 4

Strength: 17 (13)

Agility: 24 (10)

Charisma: 12

Hit Points: 22

Evil: +1

Healing Rate: 1.2 per day

Power: 69

Basic HTH: 1d8

Detect Danger: 14%

Inventing: 42%



Origin & Background: Marksmanship, Espionage. Legal Status: No criminal record, but wanted on suspicion for various crimes, suspected involvement with an organized criminal organization.

It's has been extremely difficult finding out much detail on Killshot. I included what I know and it has been rumored that those who knew too much are no longer alive.

Simply put, Killshot is a killer for hire. No one knows his true name or has ever seen him without his mask. He is extremely successful at his profession, having committed countless murders on six continents over the last five years without ever being caught by the authorities. The skill set demonstrated on his documented cases would seem to indicate that he has had extensive training, not only in the use of firearms but also in espionage.

Combat Tactics/M.O.: Killshot prefers to work alone, unless the money is right. He will take care of himself during any fight and won't hesitate to escape if the odds turn against him. He will almost always try to get the jump on anyone, firing off a couple of lethal head shots before the target even knows he's there. Much of this is sheer speculation; I actually could not find anyone who had fought Killshot and lived to tell the tale.

Equipment: Carries four extra .50 Magnum clips, each holds ten H.E.A.P. Bullets

QUARRY

Identity: Quarry
Sex: unknown
Level: 6

Side: Evil
Age: unknown
Training: Combat Accuracy +2, Combat Damage +1, Strength +1, Intelligence +1

Powers:

1. Heightened Strength B: +23
2. Heightened Strength A: +9
3. Heightened Endurance B: +15
4. Invulnerability B: 16 pts., Blocks 2d10 damage per attack;

5. Heightened Expertise (Fist): Hand to Hand Combat: +4 to hit.
6. Natural Weaponry (Fist): +3 to hit / +6 damage with unarmed combat.
7. Mute: incapable of speech and can't verbally communicate, uses grunts, snorts and hand signals.

Weight: 1400 lbs.
Agility Mod: -6
Endurance: 26 (11)
Intelligence: 9
Hit Mod: 7.56
Reaction from Good: —
Damage Mod: +7
Accuracy: +7
Carrying Cap: 79,234 lbs.
Movement Rate: Ground 91" (455')
Detect Hidden: 8%
Inventing Points: 5.4
Height: 5'8"
Reward \$6,000
Captured Experience Value 3624
Thwarted Experience Value 1812

Basic Hits: 28
Strength: 48 (16)
Agility: 7 (13)
Charisma: 10
Hit Points: 212
Evil: —
Healing Rate: 19.6 per day
Power: 90
Basic HTH: 5d10
Detect Danger: 12%
Inventing: 27%

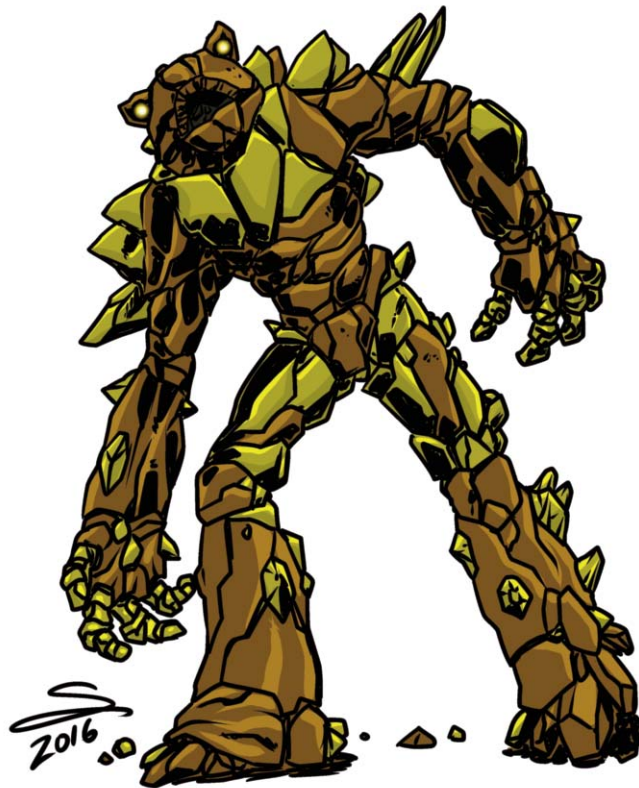

Origin & Background: Legal Status: Non-citizen from the underworld, No criminal record, but wanted by authorities for the murder of a scientist.

Remember (in the beginning) how I mentioned that the world's governments often try to blame certain extraordinary events on ordinary occurrences like natural disasters? Well, for once, they were close to being right as far as the creature called Quarry is concerned.

According to an interview with Professor Akam, Quarry (name given by one of the scientists that said "it looks like some of the quarry is moving in our direction") appeared out of a yawning chasm caused by an earthquake. While a research team was investigating this larger than normal opening in a remote southern California area, they noticed movement on the sonar that was being used to measure the depth. Soon a monstrous, misshapen creature who would be dubbed Quarry surfaced and the scientists ran for their lives.

One scientist had the presence of mind to take a phone video of the creature; Quarry appeared to be confused, and seemed to react instinctively to the sounds and movements of the scientist. Moving faster than expected, he picked up a large boulder and hurled it at the scientist who was pointing his phone at him, killing his victim instantly.

A report was filed, a second team was sent to the scene and, this time, two super-powered heroes, Midnight Angel and Black Arrow, went with them. Quarry was nowhere to be found, but the phone was, and, after some time, the video was retrieved. Quarry was put on the list of wanted unknowns. It was also noted that some tests were run on his body residue from the boulder he threw, and it was discovered that his molecular structure is susceptible to certain forms of chemical manipulation and heat-based attacks. This information has been shared with the local authorities.

Not much else is known about this strange creature, as Quarry has not been seen in a very long time.

Combat Tactics/M.O.: Quarry will attack if provoked and his hardened hands do considerable damage. He lacks any recognizable form of communication, but does appear capable of producing grunts and snorts. He may still be in some mountainous areas in the western United States.

ELECTRIC SKULL

Identity: Mike Potts
Sex: Male
Level: 12

Side: Evil
Age: 34
Training: Combat Accuracy
+5, Combat Damage +6

Powers:

1. Electricity Control (attacks as Lightning Control): Range 34" (170'), 2d8 damage, PR = 4 per attack, can short-out electrical devices and electronic circuitry with a roll of 34% or less PR=4 per attempt.
2. Body Power (Electric Field): Has the ability to surround himself with an Electric Field which provides an ADR 35 (heals 10 ADR overnight), PR = 1 to activate. Does additional 1d6 damage against all hand-to-hand attacks against him.
3. Absorption (Electricity) :
 - A. Any electrical attack against him does zero damage. Damage is rolled normally and 2d8 is absorbed. This absorbed amount will count as bonus damage on his next Electric Blast attack.
 - B. In addition to the above, 1d4 is also absorbed and added back to his Power Score each time. He cannot exceed his original Power Score.
4. Flight: 306mph or 1346" per turn, PR = 1 per hour.

Weight: 232 lbs.
Agility Mod: —
Endurance: 17
Intelligence: 17
Hit Mod: 6.566
Reaction from Good: -2
Damage Mod: +9
Accuracy: +8
Carrying Cap: 874 lbs.
Movement Rate: Ground 53" (265"),
Detect Hidden: 12%
Inventing Points: 20.4
Captured Experience Value 2472
Thwarted Experience Value 1236

Basic Hits: 5
Strength: 18
Agility: 18
Charisma: 15
Hit Points: 33
Evil: +2
Healing Rate: 2.0 per day
Power: 70
Basic HTH: 1d8
Flight 306mph (1346")
Detect Danger: 16%
Inventing: 51%
Height: 6'4"
Reward \$18,000



Origin & Background: Basic Electricity, Advanced Math. Legal Status: Citizen of the United States, suspect wanted for questioning, wanted for various crimes. Suspected of involvement with an organized criminal organization. My investigative work led me to Columbus, Mississippi in search of an Electrical Killer (as the local papers called him) who appeared soon after a severe electrical storm.

A spokesperson for the Columbus Light & Water Department informed the media that an employee named Mike Potts, a linesman, was working on a transformer that powered Baptist Memorial Hospital when the boom truck and lift box that he was in was struck by lightning. Curiously, no body was discovered by investigators; he was assumed to have been completely incinerated by the lightning.

A few weeks later, according to reports, an electrical being was seen flying over the city at night. These overnight flights turned into more aggressive encounters and developed into bank robberies and other crimes. A bank surveillance camera did manage to get a good picture of this person; he had a skull face and was surrounded in a continuous field of electrical energy. He demonstrated the ability to manipulate electricity and project it from his fingertips. It is assumed that this is Mike Potts, but it has never been verified.

I did not encounter the Electric Skull, as he is now being called, during my stay, but I was able to verify the information listed here as true. I also believe that the Electric Skull and Mike Potts are one in the same.

Combat Tactics/M.O.: Records indicate that he will activate his Electrical Field, take Flight, and shoot blasts from afar.

LASERBLAST

Identity: Nelson Bostwick
Sex: Male
Level: 7

Side: Evil
Age: 24
Training: Combat Accuracy
+2, Combat Damage +1,
Strength +2, Agility +1

Powers:

1. Power Blast: Range 13.5" (67.5'), 1d20 Damage, PR = 1 per shot. Power Blast can be used as a defense only if another action is available 1 (see rule book for full description of Power Blast).
2. Flight: 180mph (792") per turn, PR = 1 per hour.

Weight: 185 lbs.	Basic Hits: 4
Agility Mod: —	Strength: 12
Endurance: 15	Agility: 30
Intelligence: 17	Charisma: 14
Hit Mod: 8.03	Hit Points: 33
Reaction from Good: -1	Evil: +1
Damage Mod: +6	Healing Rate: 1.6 per day
Accuracy: +7	Power: 74
Carrying Cap: 299 lbs.	Basic HTH: 1d6
Movement Rate: Ground 57" (285'), Flight 180mph (792")	Detect Danger: 16%
Detect Hidden: 12%	Inventing: 51%
Inventing Points: 11.9	
Height: 5'9"	
Reward \$9,800	
Captured Experience Value 1498	
Thwarted Experience Value 749	



Origin & Background: Arctic Survival, Laser Technology. Legal Status: Dual citizenship in Canada & the United States, suspect wanted for questioning. Self-confessed environmental terrorist wanted by authorities for sabotage, destroying private and government property.

I was sent to cover the illegal waste dumping and oil spills not far from the community of Deadhorse, in Alaska's North Slope Borough. I came across much more than expected.

This community is very small and it did not take long for the rumor to spread that an investigator from a national newspaper was in town.

The townsfolk there were very upset over what they perceived as the government's attempt to cover up the illegal dumping and oil spills.

At a small community meeting in a local café, I was approached by Nelson Bostwick, a self-styled spokesman for the town. The rest of this report is my account of his words and actions, and he didn't have much to hide, either.

Nelson confided to me that he and others in the community had long-ago grown tired of watching the natural environment and family-owned lands get destroyed by the big oil companies. In desperation, they formed a small group to disrupt shipments in and out of the oil refineries. They operated under the protective aegis of a masked man going by the name of Laserblast. No one knew who he was; they only cared that he shared their pain.

While venting his frustrations to me, Nelson seemed to be overcome with emotion. To the surprise of myself and the others in the café, Nelson peeled off his snow suit to reveal a red and gold costume underneath. Pulling on the mask, he announced to everyone that he was, in fact, Laserblast, and that he would never stop using his powers to cause the big oil companies more pain and suffering than anyone in Deadhorse had ever experienced.

The community was shocked, and made no attempts to stop Laserblast as he walked out the door. Since then, he has been true to his word, often appearing in the sky to disrupt oil drilling and exploration all over the state.

Combat Tactics/M.O.: Simply put, no oil drilling expedition should feel safe while Laserblast is on the loose. He attacks from the air and rains destruction on his enemies with concentrated beams of coherent light.

RIPCURL

Identity: Jeff Conn	Side: Evil
Sex: Male	Age: 21
Level: 6	Training: Combat Damage +4, Agility +1

Powers:

1. Hydrokinesis (same formulae as Gravity): weight moved = Intelligence x 2 x Level x 50 lbs. currently 7200lbs. (approximately 862.27 gallons).
2. Heightened Attack: +1 per combat attack, currently +6.
3. Heightened Expertise: +4 with all water powers
4. Body Power (Water): can walk or run on water
 - A. Breathe Underwater (Water Breathing A): Has no difficulty breathing either water or air, PR = 1 per hour while breathing underwater.
 - B. Heightened Detection: Increases by a multiple of x3 while in water.
 - C. Heightened Speed (in/on water only): +14 initiation, bonus movement, +43" (+ 215") (total = 91" or 455" in/on water).
 - D. Hydro Wall: ADR 50, PR = 1 per turn to maintain, ADR does not heal, once reaching zero another wall must be formed.
 - E. Wave Blast: Range: Agility x Level = (currently) 108" (540"), 2d10 damage, PR = 3 per turn.

Weight: 170	Basic Hits: 4
Agility Mod: —	Strength: 14
Endurance: 16	Agility: 18 (+14 initiative)
Intelligence: 12	Charisma: 12
Hit Mod: 4.51	Hit Points: 19
Reaction from Good: -1	Evil: +1
Damage Mod: +6	Healing Rate: 1.6 per day
Accuracy: +7	Power: 60
Carrying Cap: 369 lbs.	Basic HTH: 1d6
Movement Rate: Ground 48" (240')	
Detect Hidden: 10% (30%)	Detect Danger: 14% (42%)
Inventing Points: 7.2	Inventing: 36%
Captured Experience Value 948	Height: 5'10"
Thwarted Experience Value 474	Reward \$7,200



Origin & Background: Surfing, Maritime Transportation. Legal Status: Citizen of Australia, with a criminal record, wanted for multiple maritime crimes, property damage, suspected of involvement with an organized criminal organization.

While working on my notes concerning the Triskelion organization, I came across an interesting article about a villain called Ripcurl, who had been seen off the coast of Australia. Naturally, I packed my bags and went to investigate.

This iconic destination offers sun-drenched beaches, glitz, glamour, and hours of fun at the bars and nightclubs. The perfect spot, it occurred to me, for a crime organization to place an agent. My inquiries led me to a woman named Becky Henderson and, as luck would have it, I caught her at home on the first try. No sooner had I introduced myself than she said "You are here about Jeff, aren't you?" My curiosity piqued, I told her that I was, and once she told me she was a struggling student/waitress, I knew \$200 would get me all the information I needed. Two hours later, I had gotten the lowdown on Ripcurl from one of the few people of Earth who knew the whole truth.

It turned out that Miss Henderson's "Jeff" was her former boyfriend, Jeff Conn, a highly-talented professional surfer who had succumbed to the lures of fame and drugs and all but ruined his career. According to Becky, a down-on-his-luck Jeff was approached by an American scientist named Dr. Curtis Kline, who made promises to restore Jeff's fading skills and even give him greater ability than ever before, all via an experimental serum he had developed back in the States. Jeff was all too eager and soon Dr. Kline was injecting him with this new experimental drug. In a matter of minutes, Jeff had been transformed, but not in the manner Dr. Kline had claimed. Jeff found himself possessing super-powers, including the ability to walk on, breathe, and even mentally manipulate water. Dr. Kline christened Jeff "Ripcurl" and introduced him to some associates who would help him learn how to control his new powers.

Becky confided to me that she only saw Jeff once more, when he came by her place late one night to tell her what he had become. He made it clear he was leaving for good, and left her with the advice to

"find someone new, someone still human."

Soon after that, reports began to surface of a blue-clad figure committing piracy in the maritime shipping lanes off the coast, robbing freighters, merchant ships, yachts, and cruise ships with impunity. Because of the international nature of the vessels he has preyed upon, Ripcurl is now wanted by the authorities of fourteen countries all across the world.

Combat Tactics/M.O.: Ripcurl is at home in water, and uses multiple water-based attacks to reach his intended objectives.

Equipment: Has been seen using a surf board on occasions.

BLOODSPORT

Identity: Bruce Harger
Sex: Male
Level: 8

Side: Evil
Age: 23
Training: Combat Damage
+2, Strength +2, Endurance
+2, Agility +1

Powers:

1. Heightened Strength B: +15
2. Heightened Endurance A: +8
3. Heightened Expertise: Hand to Hand Combat +4 to hit. Wears spiked Cesti on both hands, +2 to hit 1d6 damage.
4. Absorption (hit points): Carrier attack only, absorbs 1 hit point per point of damage inflicted, Absorption can't exceed maximum hit points (currently 73), PR = 2 per touch.

Weight: 280 lbs.
Agility Mod: -2
Endurance: 24 (14)
Intelligence: 11
Hit Mod: 9.36
Reaction from Good: -2
Damage Mod: +3
Accuracy: +7
Carrying Cap: 4,506 lbs.
Movement Rate: Ground 68" (340')
Detect Hidden: 8%
Inventing Points: 8.8
Height: 6'7"
Reward \$12,800
Captured Experience Value 2176
Thwarted Experience Value 1088

asic Hits: 6
Strength: 31 (14)
Agility: 13 (15)
Charisma: 16
Hit Points: 73
Evil: +2
Healing Rate: 4.2 per day
Power: 79
Basic HTH: 2d8
Detect Danger: 12%
Inventing: 33%

Origin & Background: Street Survival, Mafia. Legal Status: Citizen of the United States, with criminal record. Wanted for Murder, Money Laundering, and various other criminal activities. Suspected of involvement with an organized criminal organization.

While in Chicago, Illinois covering a massive winter storm, an airport shutdown left me with some time on my hands. I decided to follow up on a recent tip about some underground boxing.

Of course my investigative trails all dried up quickly, but I did manage to acquire a pass to one of the boxing events. It was held in the proverbial abandoned warehouse in the South Shore district on 72nd street. This placed reeked of the Mafia, and I noticed that the boxing ring skirts had the same logo as the Triskelion organization that I had been gathering notes on.

Wasting no time, I took out my small voice recorder and went to work, easing my way through the crowd, making notes of anything interesting I heard. It wasn't long before I had the misfortune of bumping into a fellow who was obviously part of the event's security contingent. He instinctively pegged me for a reporter, and called for someone named Bloodsport to see me out. A huge character appeared almost immediately, clad in a red mask and spiked metallic shoulder plates. I remember a spiked fist slamming into my face, leaving me stunned and bleeding, then I was only vaguely aware of the masked man carrying me out to the street and leaving me in the

Detect Hidden: 10%
 Inventing Points: 9.8
 Height: 5'6" Reward \$11,200
 Captured Experience Value 1218
 Thwarted Experience Value 609

Detect Danger: 14%
 Inventing: 42%



Origin & Background: Organized Crime, Religion. Legal Status: Citizen of the United States, no criminal record, but being watched by authorities for possible involvement with the Cajun Underground.

While investigating the supposedly haunted Alameda Insane Asylum in Louisiana, I stumbled across some backwoods moonshine bootleggers who were running their business out of the asylum. I wasn't able to enter the building, and wasn't even sure that I wanted to considering all the reports that I had gathered of it being haunted. As if the rumors and whispered stories weren't enough to discourage interlopers, the moonshiners had also set up a regular guard patrol about the place. As I observed the place from the cover of some nearby woods, I took notice of a green and yellow-clad female flying to and from the Asylum every couple of hours, carrying packages. I apologize for not being able to provide more accurate information on this, but the people that live deep in the Bayou country keep to themselves and money just doesn't make most of them talk to strangers.

I showed the local police captain the video I had taken while investigating the Asylum, and asked him if he had any information on this person to share with the press. He said that he could possibly somehow arrange a meeting with this person, whom he referred to as Hypersonic. After some negotiations that concluded with me forking over three grand, a meeting was set for a few days later at one the area's older cemeteries.

gutter with a warning that if he ever saw me again, I'd be a dead man.

After doing some research in police records, I found out that Bloodsport is a former boxer named Bruce Harger and has been linked to various crimes, a villain called Red Dragon and the Triskelion organization.

Combat Tactics/M.O.: His tactics are really straight forward; he just beats the crap out of people.

Equipment: Wears spiked Cesti gloves on each hand.

HYPERSONIC

Identity: Nina Wagner
 Sex: Female
 Level: 7

Side: Evil
 Age: 26
 Training: Combat Accuracy +3, Combat Damage +1, Endurance +1, Intelligence +1

Powers:

1. Sonic Ability: Range 22" (110'), 1d12 damage, PR = 1 per shot. Sonics have an 11% chance to destroy non-living objects.
2. Flight: 187mph (822.8") per turn, PR = 1 per hour.
3. Heightened Speed (70): +700" movement rate (3,500'), +21 initiative.

Weight: 135 lbs.
 Agility Mod: —
 Endurance: 17
 Intelligence: 14
 Hit Mod: 5.54
 Reaction from Good: -2
 Damage Mod: +4
 Accuracy: +8
 Carrying Cap: 205 lbs.
 Movement Rate: Flight 756" (3,780')

Basic Hits: 3
 Strength: 11
 Agility: 28 (+21initiative)
 Charisma: 15
 Hit Points: 17
 Evil: +2
 Healing Rate: 1.2 per day
 Power: 70
 Basic HTH: 1d4



After keeping me waiting for about an hour, Hypersonic finally showed, swooping in from the sky to land right beside me. I told her who I was and explained that I wanted to shoot a video interview with her for a national newspaper. She didn't seem to mind; in fact, she was more than willing to answer my questions right from the start. The name she gave me was Nina Wagner. She explained the extent of her powers, but not how she obtained them. When I got around to asking about the packages I had seen her carrying, she stepped back, raised her hands towards me, and gave me a firsthand demonstration of her abilities. A powerful wave of sonic energy emanated from her hands and swept over me, destroying every piece of electronic equipment I had. Then she flew away laughing.

Local police reports suggest that Hypersonic is running drugs and moonshine for a branch of the Cajun Underground. With very little actual evidence against her and a good lawyer in her corner, Hypersonic has come in for questioning several times without any charges being filed.

Combat Tactics/M.O.: She will take advantage of her speed to get the jump on an opponent, and then fly up and unleash her Sonic attack from above.

GLAMAZON

Identity: Japhet Kamena
Sex: Female
Level: 6

Side: Evil
Age: 22
Training: Combat Damage
+3, Strength +2

Powers:

1. Heightened Strength B: +27
2. Heightened Endurance B: +22
3. Heightened Expertise (tribal spear and sword): +4 to hit.
4. Spear: +3 to hit 1d4 damage, if Spear is thrown, range 14" (70'), +1 to hit, 1d4 damage.
5. Sword: +2 to hit, 1d6 damage

Weight: 190 lbs.
Agility Mod: —
Endurance: 34 (12)
Intelligence: 10
Hit Mod: 17.47
Reaction from Good: -2
Damage Mod: +4
Accuracy: +5
Carrying Cap: 7,877 lbs.
Movement Rate: Ground 91" (455")
Detect Hidden: 8%
Inventing Points: 6.0
Height: 6'6"
Reward \$9, 6000
Captured Experience Value 2052
Thwarted Experience Value 1026

Basic Hits: 4
Strength: 43 (14)
Agility: 14
Charisma: 16
Hit Points: 70
Evil: +2
Healing Rate: 4.0 per day
Power: 101
Basic HTH: 2d10
Detect Danger: 12%
Inventing: 30%

Origin & Background: African culture / history. Legal Status: Citizen of Zambia, in the U.S. illegally, no criminal record, but wanted by authorities for questioning. Glamazon is also on the government of Zambia's watch list. Suspected of being involved with a criminal organization.

While on a visit to the remote Luangwa Valley, in Zambia, I heard amazing stories of a lady the local tribesmen called "ChinyanJa" or Black Rhino.

The stories depicted her as being stronger, faster, and larger than any man around. Of course with all stories come a "but," so I began asking more questions and learned that her real name was Japhet Kamena, and in the past she had worked with a company called African Safari Tours, run by members of the Mutombo Tribe. From what I could piece together, this Black Rhino was bringing in lots of cash by using her powers in a variety of activities both legal and illegal. The



money she earned was apparently not being shared with the tribe for the benefit of all the members, contrary to Mutombo custom. Having run afoul of local authorities and her own tribal elders, the Black Rhino disappeared. There were rumors that she had left Africa for Europe, or possibly the United States.

Upon hearing several witnesses describe the Black Rhino's striking physique, I could not help but notice the uncanny similarity to a villainess called Glamazon, who had been spotted in several East Coast cities, often in the company of the well-known villain, Shadowcaster. Once I returned to the U.S. I began looking into this Glamazon. From what I was able to gather, she is a mercenary-for-hire and has been linked to the Triskelion organization.

I stopped my investigation after meeting an informant at a smoke-filled bar outside of Baltimore. I had been interrogating a potential informant when a large cloaked figure appeared behind me. A spear point pressed against my spine and I was advised to drop the matter right away. Though a good six and a half feet tall, the person who threatened me had a decidedly feminine voice and an unmistakable East African accent.

Combat Tactics/M.O.: Glamazon is a natural athlete with enhanced physical abilities including incredible strength. She is highly adept with either spear or sword and will not hesitate to use either.

Equipment: Spear, Sword, & Belt with Scabbard.

DOCTOR DEGATON

Identity: Alexia Monahan
Sex: Female
Level: 6

Side: Evil
Age: 27
Training: Agility +3,
Strength +2

Powers:

1. Heightened Defense: -4 to be hit.
2. Heightened Strength B: +24
3. Non-Corporeality: PR = 4 per hour.
4. Power Blast II (must be solid to use): Range 29" (145'), damage 2d20, PR = 2 per shot.

Weight: 158 lbs.
 Agility Mod: —
 Endurance: 16
 Intelligence: 14
 Hit Mod: 8.2368
 Reaction from Good:-1
 Damage Mod: +1
 Accuracy: +1
 Carrying Cap: 7,494 lbs.
 Movement Rate: Ground 72" (360°)
 Detect Hidden: 10%
 Inventing Points: 8.4
 Height: 5'11"
 Reward \$7,800
 Captured Experience Value 1428
 Thwarted Experience Value 714

Basic Hits: 4
 Strength: 42 (18)
 Agility: 14
 Charisma: 13
 Hit Points: 33
 Evil: +1
 Healing Rate: 1.6 per day
 Power: 86
 Basic HTH: 2d8

Detect Danger: 14%
 Inventing: 42%



Origin & Background: Basic Science, Mutant Law. Legal Status: Citizen of the United States, with a criminal record.

Doctor Degaton is another one of the villains I had a hard time finding any information on. Local authorities' records indicate that she may be a mutant with the ability to control her molecular density and become intangible at will. It is also noted that she possesses the ability to discharge a powerful blast of energy. She has pulled off robberies in several western states and has come out on top in battles with

several costumed heroes.

Combat Tactics/M.O.: Doctor Degaton will use her Power Blast at the first sign of danger; she will use her Non-Corporeality ability to escape if all else fails. She has been known to employ a few henchmen.

FREEZE-R-BURN

Identity: Andy Pendleton
 Sex: Male
 Level: 4

Side: Evil
 Age: 23
 Training: Endurance +2,
 Strength +1

Powers:

1. Heightened Expertise (Body Power): +4 to hit.
2. Heightened Intelligence A: +13
3. Body Power (Mutagenic Energy Manipulating): Can produce a Plasma Blast from one side of his body or an Arctic Spray from the other side.
 - A. Plasma Blast (Flame Power): Range 31" (155'), damage 1d12, PR = 2 per attack.
 - B. Plasma Defense: cost's an action, PR = 0.
 - C. Arctic Spray (Ice Power): Range 6" (30'), damage 1d12, PR = 5 per attack.
 - D. Arctic Armor (Ice Armor): Can sacrifice one inch of movement to gain one point of Ice Armor defense rating (+30) as per armor rules, 1 (see rules for full description of Armor).

Weight: 195 lbs.
 Agility Mod: —
 Endurance: 16
 Intelligence: 27 (14)
 Hit Mod: 6.4512
 Reaction from Good:-1
 Damage Mod: +4
 Accuracy: +6
 Carrying Cap: 486 lbs.
 Movement Rate: Ground 47" (235')
 Detect Hidden: 20%
 Inventing Points: 10.8
 Height: 6'1"
 Reward \$5,200
 Captured Experience Value 800
 Thwarted Experience Value 400

Basic Hits: 4
 Strength: 15
 Agility: 16
 Charisma: 13
 Hit Points: 26
 Evil: +1
 Healing Rate: 1.6 per day
 Power: 74
 Basic HTH: 1d8
 Detect Danger: 24%
 Inventing: 81%

Origin & Background: Chemistry, Survival, Medicine, Crime. Legal Status: Citizen of the United States, no criminal record but wanted by authorities for sabotage, destroying private and government property.

Once again I resorted to one of my reliable yet costly government contacts to acquire what information was available on Freeze-R-Burn. He is a mutant who was placed into a government protection program by his grandparents after his parents died in a car crash. Around the age of sixteen, he became very friendly with and trusted by the medical staff overseeing the program. One day he overheard some of the staff talking about a way to remove his abilities and he decided to suppress his Mutagenic Energy Manipulating abilities to try to trick the medical staff into believing his abilities had mysteriously, suddenly left him. He spent the next two years concealing his abilities from those he once trusted and thought of as family.

His ploy worked and he was eventually deemed perfectly normal and was placed into a guardianship home until he was ready to live on his own.

From there on, he embarked on a career of crime, beginning with a series of hold-up attempts. One of these thefts was of a chemically-enhanced body suit comprised of unstable metabolic molecules which maintain a stable body temperature, protecting him from the effects of using his own abilities.

Combat Tactics/M.O.: During testing he demonstrated the ability



to stimulate the chemicals in his brain, using Mutagenic Energy Manipulation to create either a Plasma Blast of super-heated subatomic particles or an Arctic Spray of super-cooled metabolic particles. He will use either to defend himself.

Equipment: Body suit

POWER PIRATE

Identity: Kurt Maher
Sex: Male
Level: 3

Side: Evil
Age: 27
Training: Agility +1,
Strength +1

Powers:

1. Power Copy: This is a special version (see description below) of the power, activated by touch, i.e., a successful hit in hand-to-hand combat.

Weight: 204 lbs.
Agility Mod: —
Endurance: 16
Intelligence: 12
Hit Mod: 4.4352
Reaction from Good: -1
Damage Mod: +1
Accuracy: +2
Carrying Cap: 581 lbs.
Movement Rate: Ground 49" (245")
Detect Hidden: 10%
Inventing Points: 3.6
Height: 5'11"
Reward \$3,900
Captured Experience Value 504
Thwarted Experience Value 252

Basic Hits: 5
Strength: 16
Agility: 17
Charisma: 13
Hit Points: 23
Evil: +1
Healing Rate: 2.0 per day
Power: 61
Basic HTH: 1d8

Detect Danger: 14%
Inventing: 36%

Origin & Background: Super hero and villain enthusiast concerning powers and abilities. Legal Status: Citizen of the United States, wanted by authorities for various crimes.

Obtaining information on Power Pirate was not that hard based on his past life of crime and all the paperwork available from the court case mentioned below.

As a child, Kurt Maher was always fascinated with super-heroes. He read about their exploits in comic books, followed their adventures on television, and swapped stories and memorabilia with like-minded fans all over the world via the internet. Kurt's personal favorite was Tampa's hometown champion, Sundial. When a fifteen-year old Kurt finally got the chance to meet his idol at a comic book store autograph signing, a strange exchange of energy took place as the boy shook the hero's hand. Kurt suddenly began discharging beams of coherent light, injuring several bystanders. He was rushed to a hospital when the emissions subsided, but tests revealed no discernible cause for the incident. Sundial was blamed in the media and, as he was on the cusp of a lucrative movie deal, he moved swiftly to redirect the blame at Kurt, describing the boy as a thrill-seeking mutant who engineered the whole thing to call attention to himself.

Families of the injured bystanders came after Kurt and his family in court, and, based on Sundial's testimony, the Maher family was found liable for damages that quickly soared into the hundreds of thousands of dollars. Financially ruined, Kurt's blue collar father committed suicide and Kurt's grief-stricken mother abandoned him to fend for himself.

Curious about the cause of the sudden power discharge, and disillusioned by his betrayal by the man he admired most in the world, Kurt set out to learn if the incident was a fluke. Over the next few years, he surreptitiously met other super- humans, and over time, learned that he somehow possessed the ability to steal and utilize their super-powers. With a grudge against the legal system that shattered his family, and against super-heroes because of Sundial, Kurt embarked upon a career as a costumed criminal, calling himself the Power Pirate.

Power Copy: When he hits, Power Pirate needs to make a successful Agility roll on a d20 in order to steal one of the target's



powers. He must be aware that the target possesses the power; he could not, for example, meet the Electric Skull's secret identity and copy one of the Skull's powers. On a successful Agility roll, the Power Pirate steals the chosen power for Endurance in turns. (Exception: On a critical hit, the theft lasts Endurance in hours.) The stolen power must be a superhuman power inherent to the target. As long as the Power Pirate possesses a stolen power, that power cannot be used by the original owner of the power. Powers that are mechanical or supernatural in nature cannot be stolen. Also, Armor B has its ADR percentage chance to block the theft; the target rolls its ADR once per successful hit to determine if the armor thwarts the theft. The Power Pirate can steal more than one super-power, but may only attempt to steal one power per combat hit. Every successive power theft after the first is made at a -4 penalty to the Agility roll (i.e. -4 for a second power, -8 for a third, and so on).

Combat Tactics/M.O.: The Power Pirate often hires out his services to non-powered criminals who are expecting to run into super-powered opposition. He usually conceals his costume beneath an overcoat and wide-brimmed hat so that he can get close to his target, then strikes when his foe is otherwise distracted. He will then discard the disguise and use his stolen powers to render his foe unconscious and help his allies with the remainder of their heist. The Power Pirate is not a killer; he will never actively use a power that seems likely to slay an opponent.

Equipment: Carries a journal of all known heroes and villains with their powers, so that he can keep an upper hand and strategize to his benefit.

EVIL JIM

Identity: James Dombrowski
Sex: Male
Level: 3

Side: Evil
Age: 39
Training: Combat damage
+1, Combat accuracy +1

Powers:

1. Heightened Expertise (all weapons): + 4 to hit, PR = 0.
2. Heightened Defense: -4 to be hit, PR = 0.
3. Natural Weaponry: +2/+4 with unarmed combat
4. Armor Device (Series-5 Ballistic Combat Armor, ADR 64): can repair 16 point of armor damage per day with sufficient funds.

Weight: 235 lbs.
Agility Mod: —
Endurance: 15
Intelligence: 16
Hit Mod: 4.1472
Reaction from Good: -2
Damage Mod: +3
Accuracy: +3
Carrying Cap: 499 lbs.
Movement Rate: Ground 44" (220")
Detect Hidden: 12%
Inventing Points: 4.8
Height: 6'2"
Reward \$4,800
Captured Experience Value 486
Thwarted Experience Value 243

Basic Hits: 5
Strength: 14
Agility: 15
Charisma: 16
Hit Points: 21
Evil: +2
Healing Rate: 2.0 per day
Power: 60
Basic HTH: 1d8

Detect Danger: 16%
Inventing: 48%

Origin & Background: Street Wise, Strategy. Legal Status: Citizen of the United States, with an extensive criminal record.

Evil Jim (as he likes to be called) is a modern day "tough guy" modeling himself after some of the more famous gangland figures from the early 20th Century. His criminal record is as long as your arm, so gathering information on him was as simple as walking into the local public records department.

James Dombrowski was a career criminal from an early age. He started out committing petty crimes in his hometown of Gary, Indiana, but by the age of nineteen had relocated to Chicago, where he soon



made a name for himself as a henchman for a variety of costumed criminals, including the Lensman, War Pig, and the Electric Skull. His resourcefulness and daring often led to Jim acting as a villain's second-in-command, and his career took him to such bizarre locations as Moonbase Six and the Dread Dimension.

Finally, Jim became fed up with his employers' constant willingness to sacrifice their so-called underlings in order to draw a hero's fire or cover the villain's escape. Donning a yellow and purple costume of his own design, and christening himself "Evil Jim," Jim embarked on a career as a super-villain in his own right. He quickly became a popular employer with the loose-knit professional henchmen network in the Midwestern U.S., offering better benefits and bigger loot shares than almost every other villain in the business. Although he has been defeated by various heroes from time to time, and imprisoned on a number of occasions, Evil Jim has always been sprung from captivity by his loyal aides to return to his larcenous career.

Combat Tactics/M.O.: Evil Jim is a skilled planner and tactician, typically choosing his heists to provide the maximum return for the smallest risk. His tutelage under the various villain employers of the past has left him adept with most conventional and high-tech weaponry, and he fights in a highly effective hand-to-hand style incorporating several different martial arts techniques. He leads his men from the front, and is loathe to use his henchmen for cover unless he has no other choice. He wears series-5 Ballistic Combat Armor and often employs a combat truncheon.

Equipment: Known to carry any number or type of weapons.

ZEITGEIST

Identity: unknown
Sex: Male
Level: 7

Side: Evil
Age: 27
Training: Agility +1, Strength
+1, Combat damage +2,
Combat accuracy +2

**Powers:**

1. Non-Corporealness: PR = 4 per hour.
2. Flight: 238mph max speed, PR = 1 per hour.
3. Stuck in Time (variant Paralysis Ray): range = 34", PR = 7 per shot.
4. Power Limitation: Can only use flight while Non-Corporeal, cannot use Paralysis Ray while Non-Corporeal.
5. Heightened Intelligence A: + 14

Weight: 183 lbs.
 Agility Mod: —
 Endurance: 17
 Intelligence: 26 (12)

Basic Hits: 4
 Strength: 14
 Agility: 15
 Charisma: 13

Hit Mod: 5.184
 Reaction from Good:-1
 Damage Mod: +5
 Accuracy: +4
 Carrying Cap: 407 lbs.
 Movement Rate: Ground 46" (230')
 Detect Hidden: 18%
 Inventing Points: 18.2
 Height: 5'8"
 Reward \$9,100
 Captured Experience Value 1302
 Thwarted Experience Value 651

Hit Points: 21
 Evil: +1
 Healing Rate: 1.6 per day
 Power: 72
 Basic HTH: 1d6
 Detect Danger: 22%
 Inventing: 78%

Origin & Background: Espionage, Crime, Quantum Physics, Fine Art. Legal Status: Believed to be a citizen of Germany, suspected of being involved with a criminal group/organization, no criminal record.

To say getting information on Zeitgeist was difficult is an understatement. The information provided here includes authorities' speculation on the nature of his powers and knowledge skill set.

Almost nothing is known about the super-villain who calls himself Zeitgeist. His name and accent suggest a German, Swiss, or Austrian background, but these may be an affectation on his part to throw suspicion away from his true origins.

He first appeared only two years ago at the site of the Masters of Mayhem's epic clash against The Nine Intrepids in Hong Kong. Taking advantage of the chaos surrounding the battle, Zeitgeist slipped inside the Bank of China to make off with over \$8,000,000 in bearer bonds and stock certificates. In the aftermath of the incident, the Nine Intrepids' spokesperson Glorious Atomic Widow speculated that Zeitgeist had been working alongside the Masters of Mayhem all along, perpetrating the heist on the Masters' behalf while the heroes and villains were otherwise occupied.

Zeitgeist has reappeared twice since, each time in a different part of the world and each time to steal cash or goods worth over \$5,000,000. He has proven to be virtually impossible to stop, let alone apprehend, thanks to powers that appear to allow him to manipulate time itself.

Combat Tactics/M.O.: Zeitgeist usually enters a target structure by passing straight through the floor or walls. He does so by making himself slightly out of synch with the flow of time. He will then "solidify" long enough to gather his loot, then exit the same way he came in. If confronted and forced to fight, he possesses the ability to cause a victim to become "Stuck in Time", in effect creating a field around the target wherein time stands still.

RULES VARIANT: EXPERIENCE POINTS

The rule book states that opponents (villains) captured and turned over to the authorities are worth a certain number of experience points to the characters who defeated them. Fighting other heroes earns a character no experience points, nor do they receive any for villains they fail to capture. Opponents killed are worth no experience points in most cases.

This rule goes on to say that the experience points should be divided equally among all players involved.

As for this adventure, a variant is in place to add (thwarted) into the mix. At the GM's discretion, if the villains were prevented from achieving their objective, the GM may award one-half of the full captured experience points that would have been awarded.

NEW/VARIANT POWERS INVULNERABILITY

Roll percentile dice to determine which type of Invulnerability the character has.

0 – 75% Invulnerability Type A
 76 – 100% Invulnerability Type B

Invulnerability A: is exactly as the rules book reads.

Invulnerability B: This alternate form of Invulnerability provides 2d10 protection against all attacks; it is not ablative like Invulnerability A. Roll the 2d10 once at character creation and record the number on the character sheet. However, for every five full points there will be one power of the player's choosing that will bypass Invulnerability B. PR = 0.

PROBABILITY FIELD

A Probability Field has a radius of Charisma/3" in all directions. This field enables allies to re-roll every roll once, i.e. an attack roll, a damage roll, a consciousness check, etc., PR = 0. It also causes all opponents' successful rolls to be re-rolled once, PR = 2 per turn.

FORCE FIELD:

A Force Field forms a protective screen around the character. The Force Field Rating, or FFR, is equal to $\frac{1}{2}$ the character's maximum power rounded down. The cost to erect the protective field is the FFR/10 rounded down. The cost per turn to maintain is half the cost to erect it. It does not take an action to maintain it. Every attack that deals damage reduces the FFR value by the amount of damage dealt. If a character wishes to reinforce or bolster his Force Field, he can expend an action and power equal to the initial cost to erect adding power spent plus 1d12 to the FFR. The FFR may at no time exceed the character's maximum Power/2.

An activated Force Field always provides Force Field as a defense on the combat table.

To determine the FFR for a Force Field Device, roll 1d100+30 and

divide by 2. It takes an action to activate the device. A Force Field Device cannot be reinforced. Once it has taken enough damage to exceed its FFR, it ceases to function and must be repaired. The cost of repair is \$100 in parts and equipment per point of FFR restored. It is assumed adequate facilities for repair are available. The amount of FFR that can be restored per day is equal to the character's Intelligence score. The original FFR rating of the Force Field Device cannot be exceeded without going through the inventing procedure (see rulebook).

Note: Every Force Field has one damage dealing power against which it is ineffective. This can be chosen by the player with the GM's approval. (During character creation, a character can take the Power Limitation to have an additional power against which his Force Field is ineffective.)

THE TRISKELION GAMBIT

INTRODUCTION

This adventure is intended for use with the Villains & Vigilantes game system. If you are a Gamemaster, then read on. If you plan to participate in this adventure as a player-character, then please stop. While it may seem tempting to read ahead so that you will be prepared for the trials that your character will face, two things should be kept in mind: first, your Gamemaster has gone to a lot of trouble to run this adventure for you, and "peeking" is no way to reward him for his efforts. Pre-reading an adventure in order to affect its outcome is tantamount to cheating, and will rob you, the Gamemaster, and the other players of most of the fun of the adventure you are all about to share. Secondly, even if you were to read ahead, you might not be able to influence the game as much as you'd wish to; with dice rolling being an integral part of this and most other role-playing games, a certain element of random chance is always going to be at work in the resolution of any conflict.

This adventure is best played with 4-6 players, levels 2-6. Since this is designed to fit within your ongoing or brand-new game campaign, the city and adventure location are all yours to set up.

The Triskelion Gambit is a series of encounters staged in a particular order to allow player progression, introduce new villains, and lead up to the big finish, if all goes well. The player-character heroes should all be members of an existing team, as this is a team-based adventure and not suited to solo crime-fighters. The action can be set in any relatively large city, real or fictional, but the city needs to be one with a waterfront and a downtown with at least a few skyscrapers.

Gamemasters, it is very important that you remember not to use the following NPC's from this book until the final encounter – Killshot, Quarry, Veridian, Yellow Lotus and Electric Skull. Feel free to adjust all other encounters to best fit your players' styles and abilities, but keep it a challenge. Winning easy victory after easy victory is no fun for either you or the players.

1. HEADQUARTERS

This adventure begins with the player-character heroes on hand at their headquarters, perhaps for a regularly-scheduled Saturday meeting or training session. Their activities are interrupted by a police call. It seems that a water-powered, costumed villain and a gang of accomplices have broken into the Blood Bank located close by your city's waterfront. The super-villain database identifies the perpetrator as Ripcurl, a relatively low-level Australian criminal whose rap sheet

includes maritime thefts and robberies, as well as occasional strong arm work as a super-villain for hire.

1.1 THE BLOOD BANK

Note: You will need to determine the number of henchmen needed for this encounter and those that follow based on your number of players and player levels. Refer to Section. 5.0: Henchmen Chart.

Rushing to the scene, the heroes will discover that the would-be thieves broke into the Blood Bank through the back door. If any of the heroes makes a successful Detect Hidden roll, they might also discover that two high-powered speedboats are waiting underneath a pier around the corner. As the heroes arrive, the criminals will be leaving the building carrying several large coolers full of blood. Their clash will take place outdoors.

Use the provided map #1 – River District to play out the encounter and remember, it is imperative that Ripcurl escape this initial encounter with the heroes. If necessary, have the henchmen create a distraction by endangering civilians; a park and basketball court are close by if you need help creating a diversion; or optionally you can have the henchmen do something like setting a building afire or crashing a passing car so that the heroes will be forced to pause to save lives while the villain makes his escape. That way, the heroes will be unable to learn why Ripcurl was attempting to steal the blood, as he did not share his motivation or plan with his underlings. If, despite your best efforts, the heroes still manage to capture Ripcurl, adjust the story so that he was hired by an anonymous source to steal the blood without being told why. He was to be contacted after the theft and given a site to drop off the goods, so has no useful information to give the heroes.



RIVER DISTRICT MAP KEY:

Note: The provided map key will focus on the main points of interest as they apply to the Triskelion Gambit adventure. However, most of this map can be role-played out, so feel free to add any additional encounters or distractions as you see fit.

Area #1 Parking Lot: Typical public parking area with several spaces for cars and a delivery truck loading/unloading area, some light poles, bike rack, and trash cans; there will normally be eight cars here at any given time and 2-3 bicycles in the rack.

Area #2 River Park: Small well-kept Public Park with trees, bushes,

MAP 1: RIVER DISTRICT

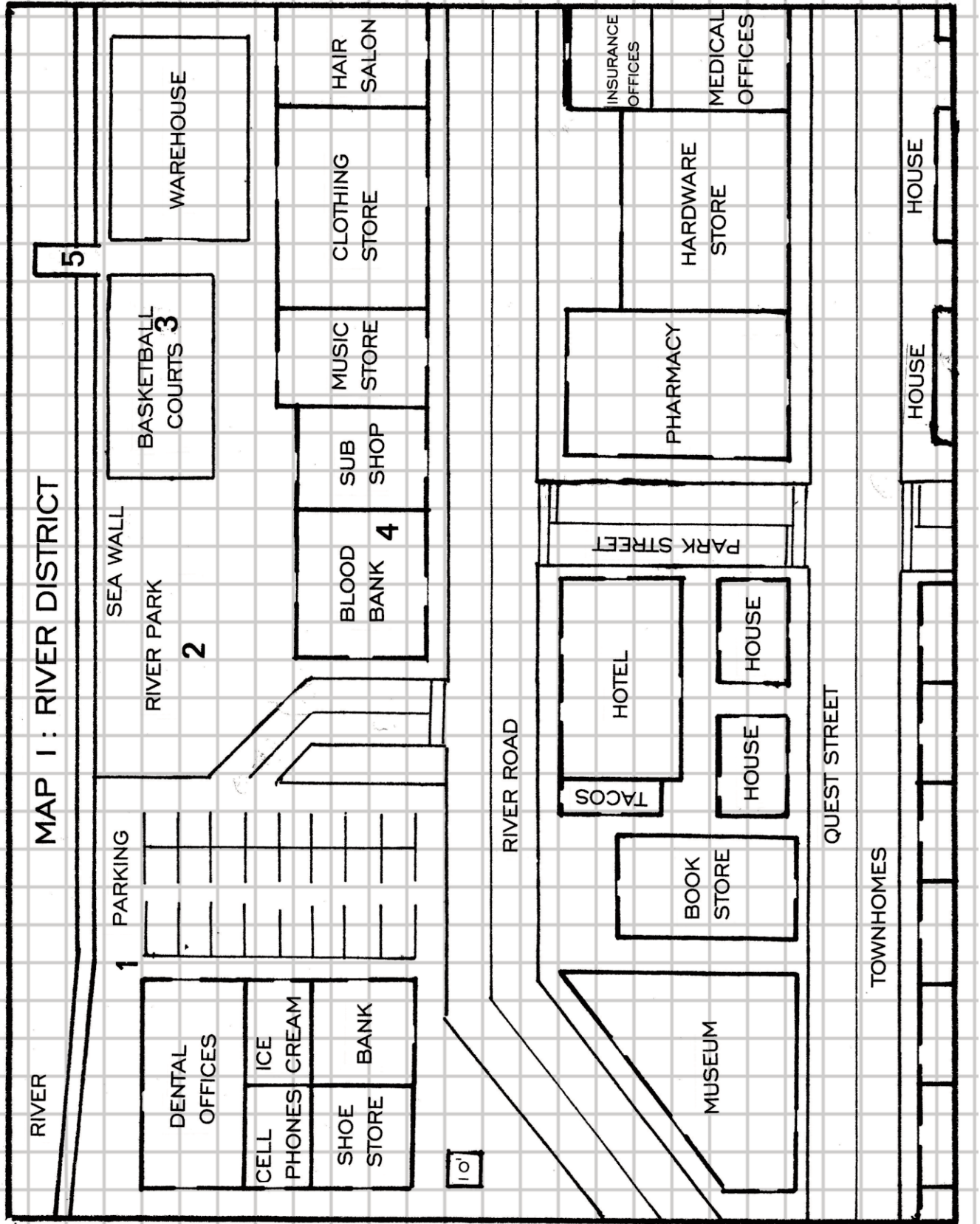

10'

flowers, swing set, slides, a jogging path, park benches, a covered outdoor grill area, water fountains, trash cans and public restrooms. Normally fifteen to twenty people will be at this park during the daylight hours.

Area #3 Basketball Court: This fenced in area has two goals, one at each end, with three tiered benches on each side, court light poles and a water fountain. A friendly street game is in progress and about

thirty spectators are watching.

Area #4 Blood Bank: Square-shaped concrete building with two large front glass windows and a set of double glass doors. The rear of the building has a single solid metal door.

Area #5 Public Boat Slips: This area is where the player-characters have a chance of noticing the two covered high-powered speedboats. At this time there are four additional boats moored in the slips.

1.2 STRUCTUAL DAMAGE CHART: RIVER DISTRICT AREA

Item	Location	Material	Weight	HP	Height	Length	Width
Light pole	Park/parking lot/ basketball court	Aluminum	250	15	15	4	4
Delivery truck	Parking lot	Steel	12,000	240	10	24	12
Bike rack	Park / parking lot	Steel	25	3	3	6	2
Trash can	Park / parking lot/ basketball court	Plastic	2	1	2	2	2
Standard car	Parking lot / street	Plastic / steel	4000	80	5	16	8
Swing set	Park	Steel	100	8	7	10	15
Slide	Park	Plastic	60	5	6	5	3
Park bench	Park	Wood	20	2	2	4	2
Grill	Park	Steel	25	10	3	3	4
Water cooler	Park / basketball court	Plastic	20	3	2	2	2
Basketball goal	Basketball court	Steel	60	10	10	2	2
Speed boat	Boat slip	Fiberglass	4500	90	3	10	4
Bleachers	Basketball court	Aluminum	2500	25	8	15	20

1.3 EXPERIENCE POINTS

Note: Please remember to issue experience at the end of this segment, as this adventure is designed to allow player-characters to advance as they progress through each encounter. For your ease of use, reward value and experience points are included on each character's description and on the henchman chart.

2. THE DIAMOND EXCHANGE

GM NOTES

The next phase of this adventure will require you to place a sixty story building somewhere within your game world's city. The next encounter originates from the 50th floor of this building; only a map of the 50th floor is provided, the rest can be estimated if needed. For this encounter, you will need to use the following three villains from this book – Glamazon, Bloodsport and Hypersonic (average level is 7). You will need to decide the number of henchmen needed for this encounter based on your number of players and player-character levels Refer to section. 5.0 Henchmen Chart.



2.1 THE COLD TRAIL

Three days after the Blood Bank incident, the heroes have learned nothing about the motive behind the crime. If any of the henchmen were captured, they are either not talking or, if they do, they do not possess any information other than they were paid by Ripcurl to help break into the Blood Bank.

2.2 HEROES ON PATROL

To begin this encounter, have two player-heroes on patrol in the downtown area. They discover that the Diamond Exchange is being robbed by masked thieves. Please make your encounter force of the two player-characters to act at least one turn before their teammates arrive. The security guards in the Diamond Exchange should not come into play, except as a possible source of information, so no stats are provided.

2.3 ARRIVING AT THE DIAMOND EXCHANGE

Have the two heroes on patrol make an Intelligence roll on 1d20 and, if they succeed, they remember hearing about a rare African diamond from Zambia, the "Blood Diamond", being displayed today at the Diamond Exchange for potential buyers.

DIAMOND EXCHANGE MAP KEY:

Player-characters wishing to enter through a window will learn that each has a structural rating score of 18.

Desk: Each desk (S1 – S8) has a desktop computer with a 34" flat top monitor, a jeweler's light with magnifier lens, a desk phone, three deluxe padded steel chairs, a floor-mounted triangle-shaped safe and

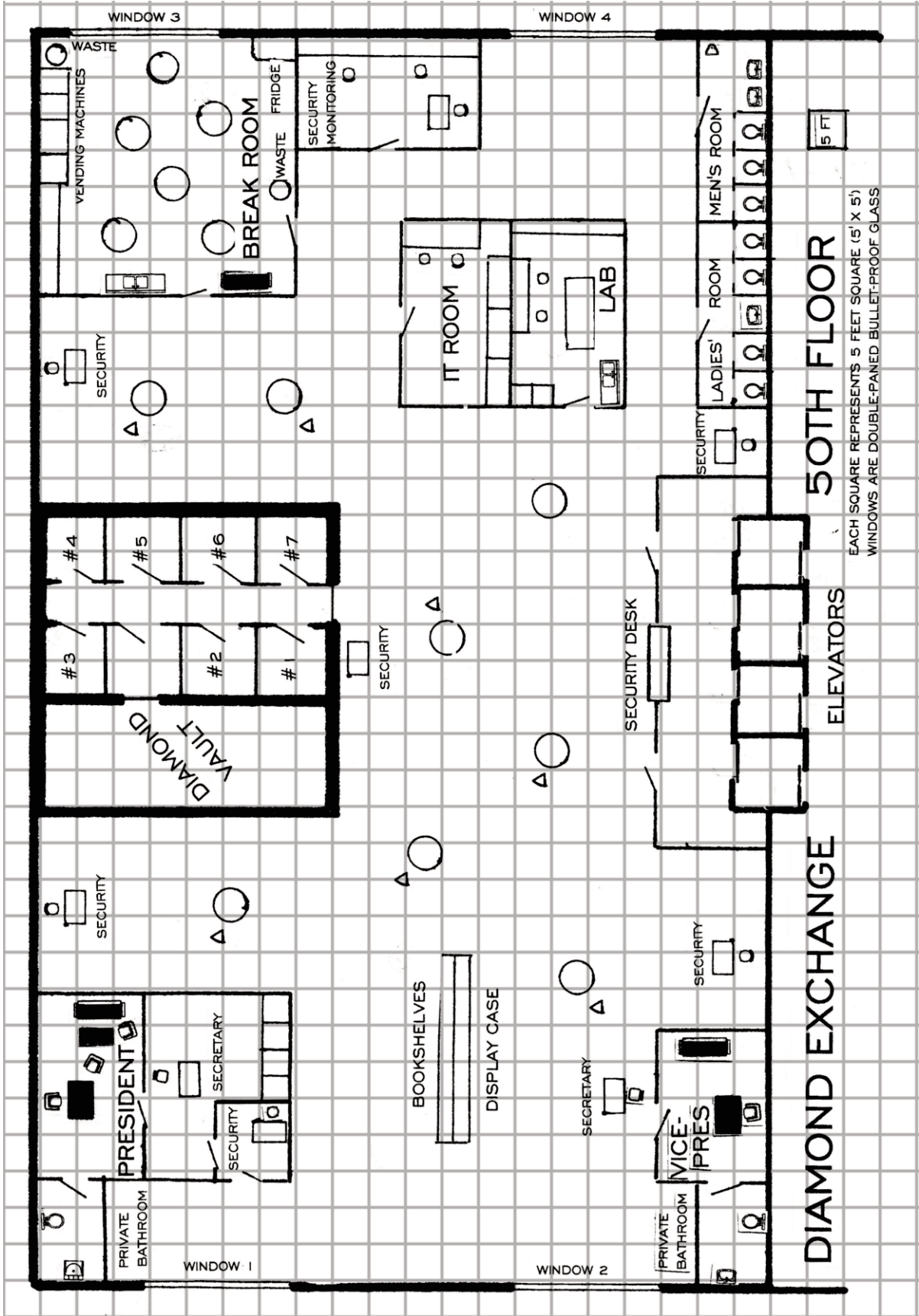

EACH SQUARE REPRESENTS 5 FEET SQUARE (5' X 5')
 WINDOWS ARE DOUBLE-PANED BULLET-PROOF GLASS

an alarm button mounted under each desk.

Security Stations: A desk, chairs, phone, alarm button. The security guards have been captured, killed, or knocked-out (your choice).

I.T. Room: Three seven foot cabinets house the server and assorted electrical hardware, desk, chairs, phone and a desktop computer with a 34" monitor, (The two I.T. techs are being held captive in the break room).

Lab: Scales, a jeweler's light with magnifier lens, testing chemicals, miscellaneous testing equipment, lockers, a wash sink, desk and chair, a lab table, phone and an alarm button. (The two lab techs are being held captive in the break room).

Security Monitoring Room: Panel of security camera monitoring screens, a desk, chair, phone, alarm button, security guards have been captured, killed, or knocked-out (your choice).

Main Vault: Comprised of an advanced form of Omnium Steel with a structural rating score of 45. Inside will be wall-mounted safe deposit boxes and a security system, plus a large round table. There are also private side rooms (see below).

Vault Side Rooms: A wall with one door inside the vault leads to the seven private side rooms, each room has a jeweler's light with magnifier lens, a wall-mounted shelf, alarm button, and each has a standard door that can be locked from the inside only.

Break Room: Opulent modern furnishings, reference the items within the diamond exchange chart for the entire item and the structural rating score for each. The door that is facing the vault has two steel desk legs bent and wrapped through the door handles to prevent entering or exiting.

2.4 EVENTS AT THE DIAMOND EXCHANGE:

1. Players can make a Detect Hidden roll and, if they succeed, they will notice a bulky flying vehicle hovering just outside the Diamond Exchange. If there are any fliers in the group, they have the option to fly up for a look.

2. Another option is to go inside and take the secured private elevators up to the 50th floor. Both options can happen simultaneously if the heroes have fliers and want to stage a two-pronged attack.

3. The airborne vehicle is an older version of the current "flying tank" recently put into use by several of the world's military forces (see stats below). There will be two henchmen operating the vehicle, one in the driver's seat (completely concealed inside the tank) and the other henchman manning the .50 caliber machine gun that sits on top of the tank. Player-heroes should easily notice that one of the large building windows has been shattered. Players will need to make a successful

Detect Hidden role in order to spot the costumed female (Hypersonic) who is overseeing the action from a nearby, higher rooftop.

4. Once the players reach the 50th floor, they encounter a scene of near-total destruction - the security desk is smashed to pieces, and the security doors have also been broken down. Player-heroes will automatically notice the four defeated security guards.

5. Upon entering the main part of the Diamond Exchange, the heroes will notice a few overturned desks, a few more defeated security guards, and a large vault in the back of the room. They will hear cries for help coming from the back right corner area of the exchange. Note: position the remaining henchmen throughout the area so that they can trap anyone who enters the room in a crossfire. The goal here is to keep the heroes away from the huge vault in the back of the room.

6. Once the shooting starts, two figures will emerge from the vault; a large man (Bloodsport) & a large woman (Glamazon); please look over their character sheets and describe them in further detail if you so desire. They will immediately head toward the upper left of the map (in the direction of the first broken window) and try to escape; since neither can fly, they are depending upon the flying craft to be there waiting for them. Have the player-heroes make a Detect Hidden roll and, if successful, they will notice that Glamazon has a leather bag (containing the Blood Diamond) halfway tucked under her belt. Once the villains reach the window, the plan is to get the leather sack to Hypersonic so that she can get away with the Blood Diamond.

Note: You may need to use a henchman here to ensure Hypersonic gets away with the Blood Diamond. Also, remember those cries for help mentioned earlier? Those are coming from the break/lunch room where the remaining live hostages are still trapped inside by a bomb rigged to the outside of the barricaded door. The bomb is magnetically attached to the door and has an LED display counting down from two minutes to zero.

Bomb Stats: See the rule book and choose a bomb that best fits your player-characters' abilities.

If the heroes defeat the villains at the Diamond Exchange, but have not noticed Hypersonic's presence, she will attempt to zoom in at super-speed and escape with the gem.

2.5 EXPERIENCE POINTS:

Note: Please remember to issue experience at the end of this segment, as this adventure is designed to allow player-heroes to advance in the course of the adventure. Experience point values for capturing, defeating, or thwarting the villains are included on each character's description and on the henchman chart.

VTT-VECTOR THRUST TANK

Weight: 20,000 lbs.,

Crew: 2, 1 driver, 1 gunner, and 2 passengers

Flight Speed: 1,320' per turn, 300 mph

Ground Speed: 352' per turn, 80 mph

ADR: 75

Hit Points To Disable: 50

Hit Points To Destroy: 200

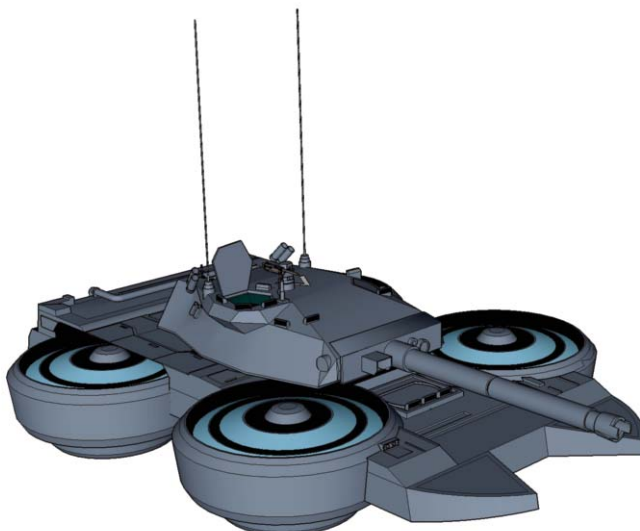

2.6 STRUCTURAL DAMAGE CHART: THE DIAMOND EXCHANGE

Item	Location	Material	Weight	HP	Height	Length	Width
Standard chair	Break room	Wood	10	1	3	2	2
Deluxe padded chair	Office / work stations	Steel	20	2	3	2	2
Drink machine	Break room	Steel	300	8	6	3	3
Snack machine	Break room	Steel	250	7	6	3	3
Micro wave oven	Break room	Stainless steel	25	2	2	2	2
Sink	Break room / lab	Stainless steel	20	3	4	2	2
Refrigerator	Break room	Stainless steel	300	7	6	3	3
Mini-frig	President & V.P. office	Stainless steel	50	4	3	2	2
60" wall mounted							
H.D. Smart TV.	Break room	Plastic / glass	85	5	5	5	1
Tables	Break room	Wood	50	2	3	4	4
Espresso machine	Break room	Stainless steel	20	3	2	3	2
Coffee machine	Break room	Stainless steel	15	2	2	2	3
Deluxe desk	President & V.P. office	Wood	250	5	3	6	3
Standard desk	Sales floor	Steel	125	3	3	4	3
Desk top computer	All desk	Plastic	15	2	2	2	1
34" flat screen							
monitor	All desk	Plastic / glass	12	2	3	3	1
Jewelers light	All desk &						
w/ magnifier lens	vault privacy rooms	Plastic / glass	2	1	1	1	1
Desk phone	All desk	Plastic	1	1	1	1	1
Mounted triangle-							
shaped floor safe	Sales floor	Steel	50	10	2	2	1
Water cooler	Sales floor / break room	Plastic	35	3	2	2	2
Book shelf	Sales floor	Wood	75	4	6	4	1
Lab table	Lab	Stainless steel	150	7	8	4	4

3 TRISKELION

By now the players should be intrigued as to why chests of blood and the Blood Diamond have been the target of the thieves. Please feed off of this; have the player-characters start researching the Flying Tank and the logo on the side of it. Of course, for the logo, the internet will not supply much information; it's as if the whole World Wide Web has been wiped clean on this topic. You can have a website show up on a search, but just have an error prompt appear saying that the web site is no longer available. The craft itself is a Vector Thrust Tank, or VTT, more commonly referenced as a Flying Tank. The heroes' research will reveal that several costumed heroes battled against criminals operating these exact same vehicles some twenty to twenty-five years in the past.

3.1 THE LONG-RETIRED HERO

Once you have the player-heroes running out of clue options, set the stage for the following scenario to occur:

1. The video surveillance system at their headquarters detects an image of a man in the conference room and sets off the intruder alarm.
2. Once the heroes arrive in the conference room, they will notice what looks to be an astral image of a very old and wrinkled African man carrying a staff and clad in a tribal-style costume and a web-like cloak.
3. He introduces himself as Spiderwalker, a retired hero from Central Africa. Have the player-heroes make an Intelligence roll on 1d20 and, if successful, they do indeed recognize the name. Spiderwalker has a

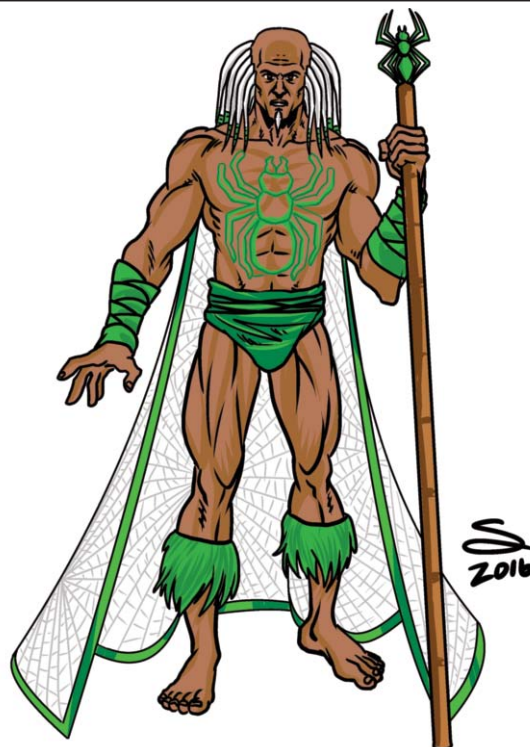

good reputation, with a career dating back forty years, but little has been heard of him in the last several years and he is generally thought of as retired. He goes on to say, *“A grave danger has risen in your city, an evil out of the past, long thought of as destroyed. It is imperative that you do everything in your power to stand up to this evil and put an end to it. I appear to you in my astral form, as my power leaves me physically bound to my African homeland. I have information that may be of use concerning the origins of this evil force.”*

3.2 THE BRIEFCASE

After his announcement, Spiderwalker will gesticulate and recite an ancient African chant, causing a rather old-looking briefcase to suddenly appear on the conference table before the heroes. Spiderwalker says: *“I was hoping that apportionment spell would work while I was still in astral form. At my age, my powers are not what they once were. Inside that briefcase, you will find the information that eluded your internet searches. The attempted thefts of the blood supply and the Blood Diamond appear to be the work of an organization known as Triskelion. Alongside other African heroes, I battled their evil early in my career, and thought them destroyed. But now they appear to be resurfacing... to what end, I cannot say. This briefcase contains the notes my allies and I compiled years ago during our conflict with Triskelion. I hope it will be of some use to you. I wish that I could assist you, but I am long past my prime and, as I have said, my powers have always left me bound to the African continent. Please understand no matter the objectives, Triskelion is extremely dangerous. Their long arms of evil reach completely around the world. Please stop them for good, before it's too late!”*

3.3 TRISKELION

The organization known as Triskelion traces its origins back to the closing days of World War II. With an Allied victory all but assured by April 1945, many Axis leaders scrambled to escape the justice they knew was waiting for them. Three such war criminals were Germany's Otto Schreck, Japan's Masahito Matsuda, and the Italian Count of Taliaferro, Salvatore Silvio.

Otto Schreck was a General in the German army, a decorated veteran of World War I and, at first, a trusted confidante of Adolph Hitler. He was a master strategist and tactician and, as the war progressed, he became increasingly dumbfounded by his Fuehrer's obsession with the occult and Hitler's refusal to take his advice on even the most basic military maneuvers. In truth, Hitler resented and feared Schreck because of his successes in the field and the loyalty he commanded from his troops. By the end of the war, Hitler was determined to rid himself of someone he perceived as a rival for the affections of the German people, so he ordered Schreck and his entire division sent to the Eastern Front to be slaughtered by the invading Soviet forces. Not wishing to lose his entire command at the whim of the drug-addled Fuehrer, Schreck instead led his men out of Germany to a secret base he had established during his days as a battlefield commander in North Africa.

Masahito Matsuda was a Japanese industrialist and a genius inventor in his own right. Many of his startlingly advanced machines were offered freely to the Japanese war effort, including the world's first field-portable phased plasma weapon and the “shark suits” that made Japanese frogmen nearly invincible in underwater combat. When he realized that the defeat of the empire was imminent, Matsuda blanched at the idea of his inventions falling into “gaijin” hands, and fled the country along with his family and many of his key personnel. They took up refuge on an isolated Pacific island called Gosutoshima, where Matsuda had the foresight to establish a secret base and factory before the war.

Salvatore Silvio, for all his airs and titles, was essentially an organized crime lord based out of Nettuno in central Italy. Capable of tracing his lineage back to the ancient Romans, Silvio was involved in smuggling, gunrunning, vice and protection rackets all under the

veneer of a wealthy nobleman living in a lavish hilltop villa. Very few suspected the Count of Taliaferro of being a criminal, and the few who did learn the truth were either bought off, eliminated, or brought into the fold as one of Count's operatives. Realizing the end of the war would probably expose his various enterprises to the world, Silvio relocated to the United States where he continued operations of his criminal empire from an estate in upstate New York.

Over the course of the late 1940s and early 1950s, the organizations under the command of these three leaders grew in size and in power. Schreck's division grew into a veritable army, a heavily-armed, well-trained mercenary force available to the highest bidder. They saw action in brush and border wars in Asia, Africa, and South and Central America. Matsuda's island factory became the birthplace of a large volume of high-tech weaponry and equipment, again available to whoever could meet his prices. And Silvio rapidly became the preeminent crime lord in North America, branching out into drugs, hijacking, murder for hire and all manner of other criminal enterprises.

Then came the fateful events of May 6, 1954, when the three organizations were all hired simultaneously by the infamous science villain, Dr. Alpha. Dr. Alpha intended to use Schreck's troops armed with Matsuda's advanced weaponry to pull off a series of crimes choreographed by Silvio's lieutenants in fifteen cities across the U.S. over the course of single twenty-four hour day. Only the combined efforts of a number of that era's costumed crime fighters thwarted Dr. Alpha's scheme.

Shortly thereafter, the three leaders met in a secret conference in Marseilles to discuss a more permanent working arrangement. Out of that meeting was born Triskelion, the three-headed consortium dedicated to wealth and power through war, technology and crime. The logistics quickly fell into place. The organization would have three leaders and three bases of operations, and would hire its services to individuals, companies and governments all over the globe.

Over the last six decades, Triskelion has been smashed many times, only to rise phoenix-like from its own ashes to menace the world anew. They were last encountered in the Congo about twenty-eight years ago, when they attempted to access the supposedly unlimited treasure of the ancient city of Jahartin. An epic battle was fought between Triskelion and a coalition of super-heroes from that part of the world. In the end, the ruined city and all its wealth was destroyed in a volcanic upheaval and Triskelion was once again presumed dead as well.

3.4 EXPERIENCE POINTS

Please remember to issue experience at the end of this segment, as this adventure is designed to allow player-characters to advance as they progress through each encounter. Since this part of the adventure didn't require any planned combat you will need to issue the experience based on the role-playing of the player-characters.

4. THE WAREHOUSE/HIDEOUT

To ensure the safe transportation of the chest of blood and/or the Blood Diamond, Triskelion has reached out and hired Viridian and Yellow Lotus, two members of the super-villain group Spectrum. Viridian and Yellow Lotus accepted this job independently from the group, as it is not in the normal realm of the groups' specialized color-themed based activities.

Please note that, depending upon the prior outcome of this adventure, you, the GM, must place the chest of blood and/or the Blood Diamond in the warehouse.

This is where all those crazy ideas the players have been throwing at you can come into play. Once again, the idea here is for this adventure to be your adventure, not a step-by-step adventure cookbook. We want your fingerprints all over it; we are only providing the required groundwork for you to expand upon. This should make the



adventure extremely flexible.

1. Have the player-heroes find out that the bail on the detained henchmen was recently paid and that they are in the process of being released, even though it's nine o'clock at night. This is a great time to have two heroes follow them. If any of the super-villains were captured, their bail has not been paid yet.

2. Doing the best they can to cover their tracks, the henchmen make their way back to an old boarded-up and abandoned vacuum parts and repair warehouse. As they round the back corner, the player-characters will lose sight of them. Have the heroes make a Detect Hidden roll and, if successful, they will notice that the rather old rusty dumpster that's behind the building looks to have been recently moved based on the marks in the ground.



Note: Either way, just make sure that the heroes discover the movement of the dumpster. This would also be a good time to encourage them to call for back-up if they have not already done so.

4.1 GOING INSIDE:

Once the player-heroes are ready and you have them convinced that this is the only way in, they will notice once the dumpster is moved away that a large handle has been welded onto the back of it, allowing for the dumpster to be moved in and out of place.

4.2 A QUICK VIEW INSIDE THE ABANDONED WAREHOUSE

Here is a quick overview of what the player-characters will see at first, feel free to modify this as you see fit.

The player-heroes will immediately notice that there is indeed power being supplied to the building, as the lights are on and they can hear various humming sounds and other sounds of machinery being used. Before the player-characters is an area that seems to be designated as bulk storage, as many types of industrial grade goods are being stored on pallets within. There is also a chain hoist/winch system mounted to a set of large metal beams overhead. The heroes will also recognize two VTT-Vector Thrust Tanks like the one they encountered at the Diamond Exchange.

To the left (east side) there is a lot of noise coming from beyond this wall. Instead of normal doors, there are two sets of thick walkway strip curtain doors

To the right (west side) are a couple of rows of eight-foot-tall metal storage shelves, which have various items stored upon them. Player-heroes can't see much past these shelves, but the wall does appear to go beyond the shelves. There is a floor-to-ceiling support wall in place that is also limiting the heroes' view.

Along the North wall are four sets of normal-looking office doors. There are some roll-up loading dock doors and a warehouse office in the far South section. The heroes cannot see much of this section due to all of the storage items obscuring their view.

ABANDONED WAREHOUSE MAP KEY

The GM should familiarize himself/herself with this map because once the entire group of player-characters are inside, it's going to be one big fast-paced battle.

1. Break Room: Very simple furnishings: a sink, a four person table, chairs, a water cooler and a microwave oven.

2. Showers: Six working shower stalls, a towel rack and a large, wall-mounted mirror.

3. Locker Room: Has thirty metal personal storage lockers, floor-mounted sitting benches, a large, wall-mounted mirror, sink, and hand dryer.

4. Flashlight Station: Ten industrial quality flashlights with chargers.

5. Pallet Storage Area: Bulk pallets of various industrial goods such as steel pipe, chain, copper wire, brass and copper shells, fabric, kegs of gunpowder, etc.

6. Front Entrance: Boarded-up area has an old, unused reception desk on one side and the remains of a parts counter/drop off area.

7. Liquid Propane (or LP for short) Gas Storage Cage: This cage is locked at all times and has twenty 80lb LP gas cylinders inside.

8. LP Gas-Powered Generators: There are four of these located throughout the warehouse, each is connected to the electrical power for the individual section of the warehouse it provides power for. There are also two-inch pipes that provide ventilation for each generator.

9. Parts Shelves: All types of espionage gear are located on these shelves, feel free to modify these items any way you see fit – gas masks, infrared night vision goggles, various grenades, body armor, cases of assorted handgun and rifle ammunition, handheld radios, matte finish holsters, tactical navigation watches, commando Kevlar gloves, combat backpacks, tactical trauma first aid kits, tactical knives, high-capacity magazines, web belts with pouches and military-grade handcuffs.

10. Fork Lift Charging Station: Two standard electrical forklifts are connected to the chargers.

11. West Wall Storage Area: The storage racks here are deep and currently have four speedboats stored on the upper racks, while the lower racks hold locked arms storage cases containing a wide variety of modern weaponry: AK47, AK84, Uzi MP-2, Beretta AR-70, Colt AR-15, HK-94, Sterling MK-6, Bushmaster Assault Rifle, Sterling MK-7, Calico M-950, Striker12 and Street Sweeper SS/12, et al.

12. Southwest Dock Area: An electric forklift is in this area along with a few pallets of bulk goods and an LP gas generator.

13. Southeast Dock Area: Same as area #12, only with two loading dock doors and a support wall.

14. Men's Restroom: Typical restroom furnishings: a sink, four urinals, four toilets, a hand-dryer, trash can and a wall-mounted mirror.

15. Women's Restroom: Typical restroom furnishings: two sinks, four toilets, a hand-dryer, trash can and a wall-mounted mirror.

16. Main Office: Two standard office desks, a water cooler, portable A/C unit, a wall-mounted dry erase board, a desktop computer and monitor, trash cans, a filing cabinet and a wall-mounted 52" TV.

17. Shipping Office: Converted into a living area for the henchmen. Bunk beds line the walls and there is a small area with two couches and four recliners, a wall-mounted 52" TV, a water cooler, a portable A/C unit and a card table with six chairs.

18. Converted Repair Area: This area has been converted to an up-to-date and fully-operational machine shop with the following (among other) machinery: a metal saw, drill press, dust collector, lathe, grinder, belt sander, sand blaster, parts cleaner, work benches, plasma torch, a welding torch with a protective screen, a portable A/C unit and an LP gas generator. Some of the henchmen work in this area using skills learned in prison.

19. VTT-Vector Thrust Tank: Weight: 20,000 lbs., crew: 2, 1 driver, 1 gunner, 2 passengers, Speed: Flight 1,320' per turn (300 mph); Ground 352' per turn (80 mph), ADR: 75, Hit Points to Disable 50, Hit Points to Destroy 200.

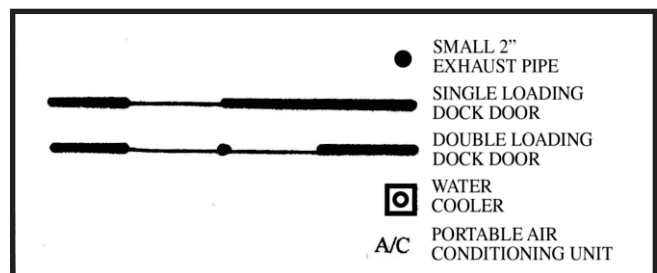

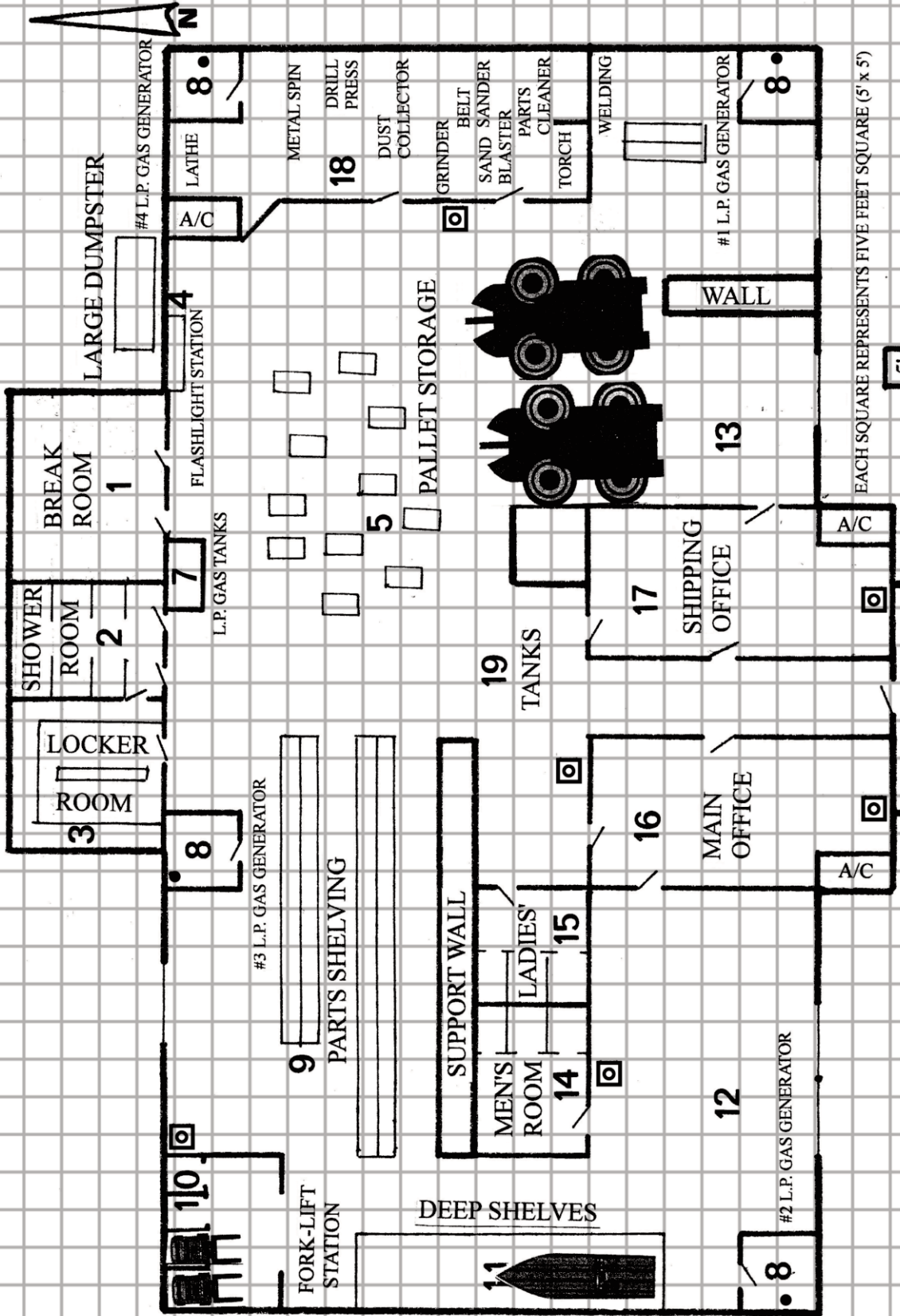

EACH SQUARE REPRESENTS FIVE FEET SQUARE (5' x 5')

5'

VACUUM PARTS & REPAIR WAREHOUSE - ABANDONED

4.3 STRUCTURAL DAMAGE CHART: THE ABANDONED WAREHOUSE

Item	Location	Material	Weight	HP	Height	Length	Width
Empty pallet	Area 5	Wood	45	2	1	4	4
Chain hoist	Area 5	Metal	60	4	1	2	1
Storage shelves	Area 9	Metal	25	4	8	55	3
Standard door	Various	Wood	15	1	7	3	2
4-person table	Shipping office area 16	Wood	50	2	3	4	4
Standard chair	Main office/shipping office/ break room	Wood	10	1	3	2	2
Water cooler	Various	Plastic	35	3	2	2	2
Micro wave oven	Break room area 1	Steel	20	2	2	2	2
Stainless steel sink	Break room area 1	Stainless steel	20	3	4	2	2
Work bench	Area 18	Wood / steel	150	7	8	4	4
Hand dryer	Bathrooms area 14 & 15	Steel	3	1	1	2	1
Receptions desk	Area 6	Wood	50	2	3	6	3
L.P. gas cylinder	Area 7	Steel	80	15	3	2	2
Gas generator	Area 8	Steel	125	8	3	2	
Storage rack	Area 11	Steel	250	10	15	45	15
Forklift	Various	Steel	3000	60	6	8	3
Forklift chargers	Area 10	Steel	250	12	3	3	4
Speed boat	Area 11	Fiberglass	4500	90	3	10	4
Bathroom sink	Area 14 & 15	Porcelain	10	1	1	2	1
Toilet / urinals	Area 14 & 15	Porcelain	40	2	3	2	2
Portable a/c unit	Area 16,17,18	Plastic	55	4	3	3	1
Computer	Area 16 & 17	Plastic	15	2	2	2	1
34" monitor	Area 16 & 17	Plastic / glass	12	2	3	3	1
Filing cabinet	Area 16 & 17	Steel	40	4	5	2	1
52' wall mounted t.v.	Area 17	Plastic / steel	70	4	4	3	1
Dumpster	Outside north wall	Steel	1500	30	5	5	10
Bunk beds	Area 17	Wood	75	4	6	6	3
Couch	Area 17	Wood / cloth	50	2	3	5	3
Recliner	Area 17	Wood / cloth	25	2	4	2	3
Card table	Area 17	Wood	20	1	3	4	4
Asst. machine shop equipment (avg.)	Area # 18	Metal	40	3	4	2	3

4.4 TIME FOR ACTION

At some point (GM choice), a henchman will emerge from area #18 (converted repair area) and spot the player-characters and yell out: "INTRUDERS!!!"

A number of henchmen (reference section: 5.0 Henchmen Chart) will then emerge from various locations chosen by the GM. At least one of the henchmen will climb upon a VTT-Vector Thrust Tank to turn the .50 caliber machine-gun turret on the player-characters.

Note: Here are the suggested locations for the super-villains Quarry, Killshot, Electric Skull, Viridian, and Yellow Lotus: You are not limited to just these five villains, so feel free to add or subtract any that will provide the necessary challenge to the player-characters.

* Quarry has been hiding behind some of the taller bulk pallets in area #5 (pallet storage).

* Killshot will fire upon the player-characters from the parts shelves in area #9 (parts shelves).



QUARRY



KILLSHOT

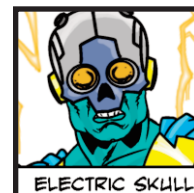

ELECTRIC SKULL

* Electric Skull will be standing between area #16 (main office) and area #17 (shipping office).

* Viridian is eating some dinner in area #1 (break room).

* Yellow Lotus is in area #16 (main office).

4.5 AN UNEXPECTED ESCAPE:

Lord Sinister and the three remaining members of the Sinister Seven (Broadsword, La Espada and Magneticus) will appear near the end of the

battle in Area #13 (Southeast loading dock) in front of the support wall.

That's right, just like in the comic books, there's a cliffhanger! No matter the outcome of the previous sequence of events, once the player-heroes are either A) relaxing after having defeated the villains or B) on the verge of certain defeat, a group of four costumed characters will suddenly appear out of thin air, and the player-characters will notice that one of the new arrivals is pressing a series of numbered buttons on a small hand-held device. The first buttons pressed will trigger the revelation of a previously unnoticed 10' x 10' hidden room simply marked "wall" on the map (section # 5 pallet storage area, support wall slides over), which contains eight hostages chained to a very large bomb. The second series of buttons pressed will teleport the four new arrivals away along with Killshot, Quarry, and Electric Skull.

Left behind are Yellow Lotus and Viridian.

Bomb Stats – see the rule book and choose a bomb that best fits your player-characters' abilities.

4.6 THE AFTERMATH:

After a hard fought battle, which hopefully the good guys won, the heroes are left puzzling over the identities of the four costumed characters who teleported in and escaped with the three villains from the warehouse. A search of the warehouse will turn up one vital clue... the tattered remnants of a floor plan which appears to be for some kind of museum or art gallery.

4.7 EXPERIENCE POINTS:

Please remember to issue experience at the end of this segment, as this adventure is designed to allow player-characters to advance as they progress through each encounter. For your ease of use, reward value and experience points are included on each character's description and on the henchman chart.

5.0 HENCHMEN CHART

To determine the number of henchmen present during any given encounter, simply roll a 1d6 and add that number plus one for every hero at the scene.

Henchman Number	Gender/ Name	Level	Agility	Power	Hit Points	Move	Dmg Acc		Basic HTH	Weapon + Hit Mod	Weapon Damage	Reward \$	XP Value	
							Mod	Mod					Captured	Thwarted
1	F / Pam	1	14	51	8	39	1	1	1d4	Pistol +3	1d8	1,000	118	59
2	M/ Greg	2	14	58	11	44	1	1	1d6	Pistol +3	1d8	2,000	276	138
3	M/ Mike	2	13	52	8	40	1	1	1d6	Rifle +4	1d10	2,000	240	120
4	M/ Spike	3	15	57	14	44	1	2	1d6	Energy Pistol +2	1d10	3,000	426	213
5	M/ Rod	1	16	53	14	42	1	2	1d6	Big Club +3	1d6	1,000	134	67
6	F/ Helen	2	17	60	23	48	1	2	1d8	Hand Grenade +2	1d10	2,000	332	166
7	M/ Bulldog	1	12	51	13	39	1	1	1d6	Shotgun +2	2d6	1,000	128	64
8	M/ Sarge	3	15	58	19	44	1	2	1d6	Energy Rifle +3	1d12	3,000	462	231
9	M/ Leon	2	15	53	15	41	1	2	1d6	Pistol +3	1d8	2,000	272	136
10	F/ Wendy	1	14	52	9	42	1	1	1d6	Rifle +4	1d8	1,000	122	61
11	F/ Luna	1	16	50	11	40	1	2	1d6	Knife +1	1d4	1,000	122	61
12	M/ Taz	2	13	57	16	43	1	1	1d6	Pistol +3	1d8	2,000	292	146
13	M/ Big Bob	3	14	61	22	47	1	1	1d8	Big Club +3	1d6	3,000	498	249
14	M/ Andre	2	12	50	10	36	1	1	1d6	Energy Pistol +2	1d10	2,000	240	120
15	M/ Frank	1	12	56	13	42	1	1	1d6	Shotgun +2	2d6	1,000	138	69
16	M/ Walt	1	12	52	8	38	2	1	1d4	Bolas +3	1d3	1,000	120	60
17	M/ Ace	3	16	60	19	46	1	2	1d8	Hand Grenade +2	1d10	3,000	474	237
18	M/ Doc	4	16	64	31	48	1	2	1d8	Energy Rifle +3	1d12	4,000	760	380
19	F/ Queen	3	14	54	10	42	1	1	1d6	Energy Rifle +3	1d12	3,000	384	192
20	M/ Victor	2	15	55	16	43	1	2	1d6	Energy Pistol +2	1d10	2,000	284	142