

**VILLAINS
AND
VIGILANTES**

FANTASY GAMES UNLIMITED

2005

ONE MAN
KNEW THE
SECRET OF...

FORCE



H-HE'S
DEAD!

AN ACTION-
PACKED
ADVENTURE
BY
THOMAS
DOWD!!

F.O.R.C.E.

A
VILLAINS
AND
VIGILANTES™
ADVENTURE

WRITER: THOMAS DOWD
ILLUSTRATOR: JEFF DEE



P.O. BOX 182
ROSLYN, N.Y. 11576

EDITORIAL INTRODUCTION

I'll keep this short, 'cause I know that you're all dying to find out who these FORCE guys are and what makes them think they're so tough. Tom Dowd wrote this one up and submitted it quite a while back, and now that the new rules are out we are happy to finally be able to present it in all its glory (and then some). It's going to have been worth the wait . . . but the waiting is over! Read on!

-JEFF
DEE

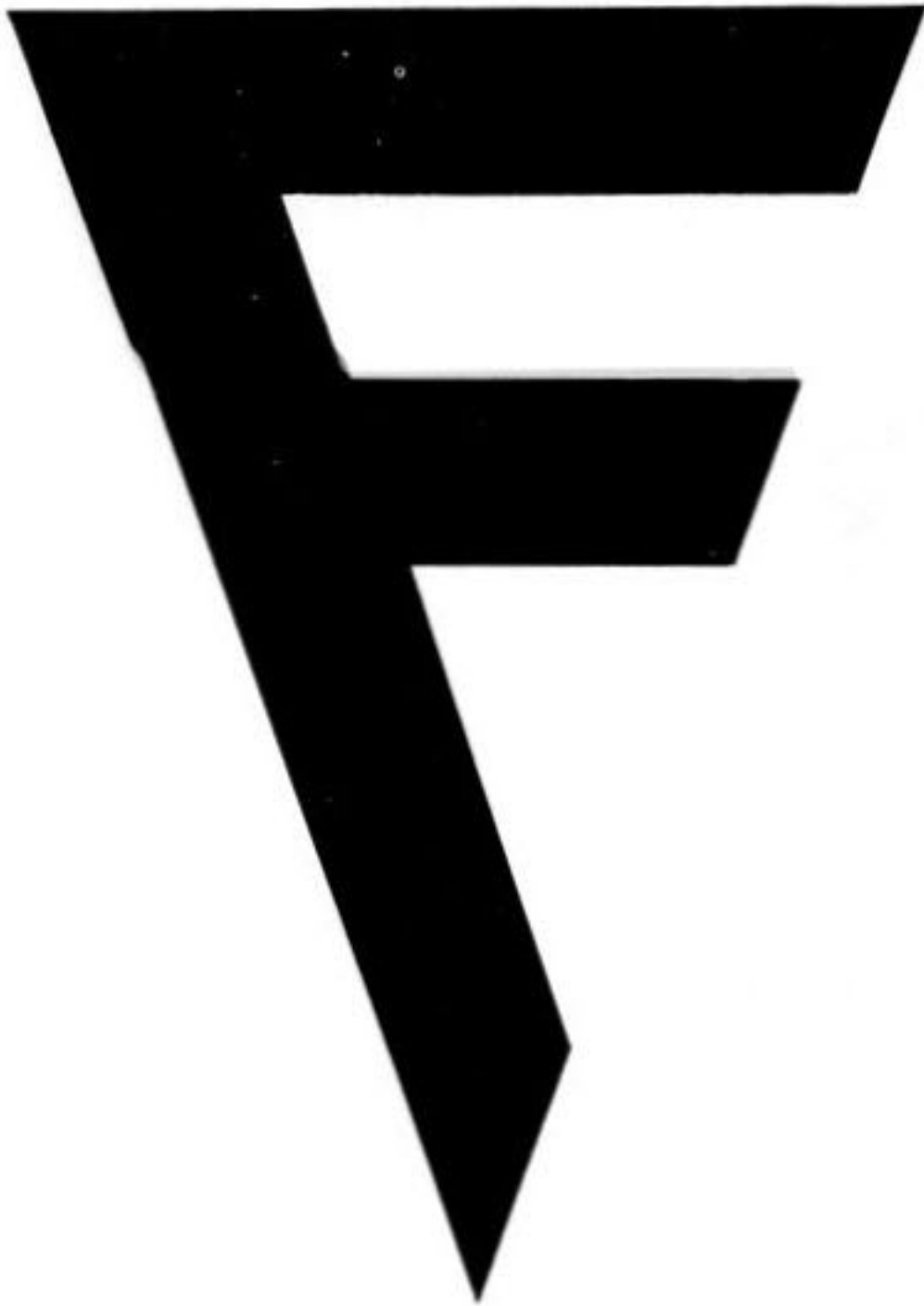

U.S. COPYRIGHT NOTICE

Copyright 1982 Thomas Dowd

Captain Cold (back cover and page 11): Copyright 1982 Jeff Jarka
Empress (back cover and page 11): Copyright 1982 Caroline Maher
Archangel (back cover and page 11): Copyright 1982 Dan Fitzgerald

All rights to this book are reserved. No part of this book may be used or reproduced in any manner whatsoever without permission, except in the case of brief quotations embodied in critical articles or reviews. Cover art and interior illustrations are copyright 1982 by Jeff Dee.

Any resemblance to persons living or dead is purely coincidental. This is a fictional work. All rights reserved.

For information contact: Fantasy Games Unlimited Inc., P.O. Box 182, Roslyn, N.Y. 11576.

CONTENTS

1. THE EAST COAST FOR RANSOM	3
1.1 The Situation	3
1.2 The Ransom Demand.	3
1.3 The Ransom Pick-Up.	3
1.4 The Beginning of the End?.	3
2. SHADOWING THE SHADOWHAWK	3
2.1 Events on Long Island Sound	3
2.2 Tailing the ShadowHawk.	3
3. ST. SEBASTIAN ISLAND	5
3.1 Common Knowledge of the Island	5
3.2 Details of the Island	5
3.3 The Underground Complex	6
3.4 The Tram Stations	7
The Rocket-Plane	9
3.5 Security Mobilization.	9
The Nuclear Weapon	10
S-97.	10
4. THE KANSAS COMMUNE	12
4.1 General Information	12
4.2 The Commune.	12
4.3 The Town	13
4.4 The Guards Barracks	14
4.5 The Main House.	14
4.6 The Underground Training Complex	15
4.7 Defense of the Complex	17
5. CAST OF CHARACTERS	17
Goon Weapons Charts	22
Goon Table	23
Post Mortem.	24

INTRODUCTION

This adventure has been designed for use with the revised edition of **Villains and Vigilantes**, although with a bit of work on the part of the GameMaster it can be converted for use with the original edition of **V&V**. This product is intended for use by the Gamemaster only; any players reading this should stop reading at this point.

The Gamemaster should note that the information presented within this adventure pack is intended to create a framework around which the complete adventure is to take place. You, the Gamemaster, should feel free to make whatever changes you believe should be made for play balance or the enjoyment of your players. Perhaps you will decide that you do not like a part of it or have come up with a better idea to fit into your campaign, feel comfortable in making such necessary changes. For convenience and to avoid later confusion, we recommend that any such changes be made before play begins.

Obviously the unexpected will occur. Make the best of it and go with the flow. You will be surprised at how well things can turn out. Just remember that the Heroes will usually win, but this does not mean that they will not have a difficult time in the process.

Above and beyond everything else, always remember that **Villains and Vigilantes** is just a game. It has no bearing on reality. Now on with the adventure. Good Luck!

Thomas Dowd

THOMAS DOWD

1. THE EAST COAST FOR RANSOM

1.1 THE SITUATION

The heroes to be involved in this adventure are either contacted by the government or learn through their own contacts (as heroes or in their secret identities if they are important enough) the following information:

a. The East Coast of the United States is currently being blackmailed by a previously unknown group known as The Force. This group has stolen a deadly bacteriological agent (S-97) from the U.S. Army and has planted it and a medium sized nuclear weapon somewhere on the East Coast.

b. The weapon will be detonated in such a way as to spread the bacteriological agent over an area with a 100 mile radius. The effect on those infected is too horrible to allow the public to learn what is happening as it would cause widespread panic. The player characters can contact the Army to determine measures needed to destroy or neutralize the S-97 virus.

1.2 THE RANSOM DEMAND

The Force demands \$500 million in diamonds as ransom for not detonating the weapon. The ransom must be paid by the end of ten days or else.

The following information is disclosed on the fifth day:

The diamonds are to be taken to the largest airport near where the heroes are located and brought to the middle of the runway area. If any attempts are made to stop or hinder the ransom pick-up, the weapon will be set off. The diamonds are to be placed inside one or two carrying cases of some sort, with handles so they may be carried. Any attempt to place a tracking device (or anything other than the diamonds) inside the case(s) will be instantly detected. Once the diamonds have been safely picked up and delivered to their destination, the authorities will be notified as to where the weapon is and how to disarm it.

1.3 THE RANSOM PICK-UP

The ransom is to be picked up in a rather ingenious method. Once the ransom is brought to the center of the runway area, a helicopter will land a short distance away. After a few moments, a man dressed in simple street clothes (Teleporter, in disguise) will get out of the helicopter, leaving the engines running. He will go to the case(s), pick them up, and teleport out. He will teleport a large distance away and have the cases searched. If any bugs are found, they will be given to

another agent to dispose of. This agent will probably place such a device on a truck making an interstate delivery. Teleporter will then teleport to St. Sebastian Island.

If the origin of the helicopter is checked, it will be found to have been rented by a person named William Williams (a false name); the trail ends there.

If the ransom is paid in full, the information on how to disarm the weapon will be disclosed, as well as its location.

1.4 THE BEGINNING (OF THE END?)

Several days before the final ransom deadline, after days of fruitless investigation, the following should occur:

One of the superheroes will be approached by a seemingly desperate man claiming to have information about Force (not The Force) but he does not have much time. Suddenly he will scream in pain and fall to the ground clutching at his head. Before he dies (of a massive brain hemorrhage) he will be able to spit out '... Fo... ShadowHawk...'. (The name ShadowHawk may, and should be, changed if it is similar to a name currently in use in the campaign). Note that if Revivification is used, the man will be a mindless vegetable due to an extremely powerful hypnotic suggestion. The man turns out to be Nathan Jonas, ace reporter for the major local newspaper. If the heroes check (and they should do so), they will find that Jonas was assigned to write an expose on the Church of Divine Harmony, specifically its leader, Father Heronomos Kinkaid. If they continue to check, they will learn that the ShadowHawk is a yacht registered to Kinkaid. The yacht is currently anchored in Long Island Sound.

The player characters will also find out that Jonas' last known location was Kansas. He had infiltrated a Church of Harmony commune there. In order to get in, he had posed as a middle aged man, recently divorced, who was looking for spiritual aid.

At this point the player characters will decide whether to follow the ShadowHawk lead or the Commune lead. If they opt for the ShadowHawk, proceed to the next section. Should they choose to go to Kansas, proceed to the section on the Kansas Commune.

If the players decide to split up and investigate both angles, let them. They will probably end up in lots of trouble. If they do, give each group a chance of escaping. If neither group does well, . . . well, you are the GM, think of something!

2. SHADOWING THE SHADOWHAWK

2.1 EVENTS ON LONG ISLAND SOUND

The heroes should easily find the location of the ShadowHawk. On board the vessel will be Cicada and Mr. Magnum in disguise. There will also be ten Goons (numbers 1-10). The Goons will be spread out through the yacht as follows:

- 1-3 will be in the wheelhouse.
- 4-5 will be in the kitchen.
- 6-7 will be in the engine room.
- 8-10 will be sleeping in their cabins below deck.

The ShadowHawk is outfitted with full radar/sonar equipment which may be detected by the player characters. It also has a highly advanced communications system. The superheroes may decide to attack the ship, in which case Mr. Magnum and/or Cicada will alert Force of that fact. (Note: Force will not take any drastic action if informed that the ship is under attack, but he will be ready for action if anything else occurs.) After alerting Force, they will repel any intruders or die trying (they will never check morale because of Force's Psionics). The Goons also fight under these rules. If the player characters are captured, the Police will be called and Kinkaid will explain the presence of Mr. Magnum and Cicada by explaining that they are new converts to the Church who are working as his bodyguards. He will then sue the player characters for damages.

If the villains are captured, Kinkaid will explain their presence on the yacht as above. He will then sue the heroes for damages.

If the player characters check the ship's log, they will find a listing of the ports the vessel has visited. They will also learn that it is usually moored at St. Sebastian Island.

2.2 TAILING THE SHADOWHAWK

The superheroes may decide to only watch the ship, in which case they will view what appears to be two men other than the regular crew. These are Mr. Magnum and Cicada. After two days, the ship will leave Long Island Sound and sail down the East Coast towards Florida. Off the coast of South Carolina the ship will be met by a flying multi-colored figure (Phantasm). Soon after the figure lands on board the yacht will shift into Hydrofoil mode and rapidly speed up. The yacht will leave U.S. territorial waters and steer for the Caribbean. ShadowHawk will head for an island known as St. Sebastian Island (see map). The hydrofoil will steer for the far side of the island and enter a small lagoon. Once in the lagoon, it will sail past the dock and steer straight into the waterfall (allowing it to enter the secret cave).

Should the player characters decide to assault the ShadowHawk while it is enroute to St. Sebastian Island, combat is resolved as usual. The GM should be aware that the vessel has an elaborate radar/sonar detection unit. The superheroes may be able to circumnavigate this detection equipment since it will be obvious from the appearance of the ship that this equipment is on board. If the GM determines that the player characters have devised a way to get on without being detected, then, by all means, let them. The same applies to the Island itself.

If the heroes are defeated, they will be taken to the island. It is recommended that they be given a small opening for escape. It is up to them how they utilize this chance.

Should the heroes prove victorious, they will have a decision to make. What will they do with the captured villains and Goons? Will they continue the ShadowHawk on its journey?

What is done with the captured villains and Goons can be handled on the spot by the GM. He/She should take into account that the cap-

SHADOWHAWK

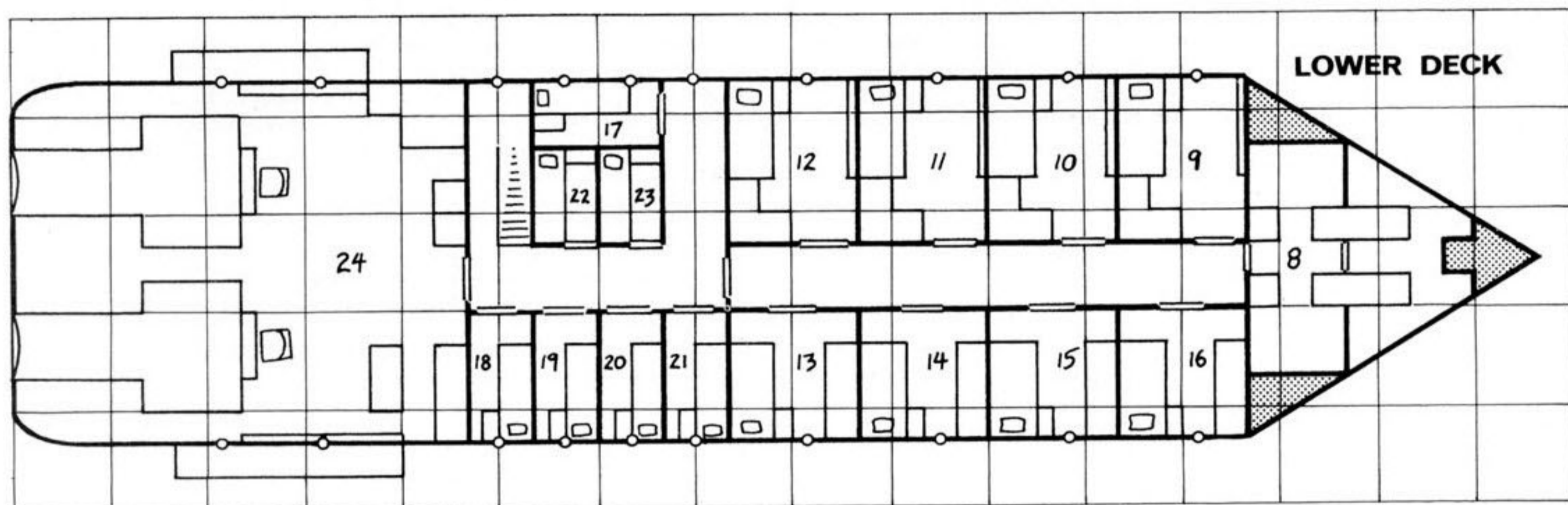
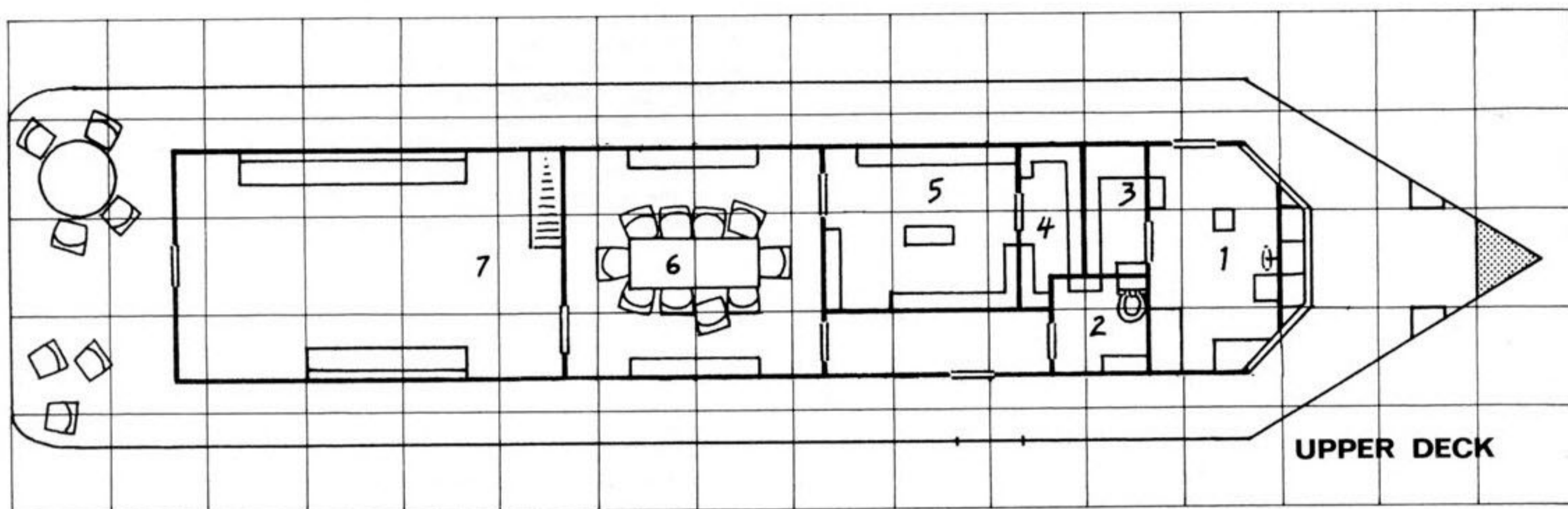

- 1: Wheelhouse
- 2: Bathroom
- 3: Radar/Sonar/Commo. Room
- 4: Storeroom
- 5: Galley
- 6: Dining Room
- 7: Lounge
- 8: Storeroom/Equipment Locker
- 9-12: Executive Cabins
- 13-16: Guest Cabins
- 17-23: Crew Cabins
- 24: Engine Room

Scale: 1 square = 5 feet

tured villains will be watching for even the smallest opportunity to escape and alert Force.

If the player characters decide to search the yacht, they will find the log book listing the ports of call, and the like. They will also discover a clipboard in the wheel house. On this clipboard is a piece of paper giving the latitude and longitude location of St. Sebastian Island. Also on this paper is a small notation which reads:

Transmit signal at ETA minus 10.

Let the player characters decide what this means among themselves. Should they search the remainder of the ship they will find in the Captain's Cabin (cabin number 9) a small code book. Inside this book will be a single entry:

transmit—
Shadow to Overlord
reply—
Overlord; Go Shadow

transmit—

The Hawk has arrived. Repeat The Hawk has arrived.

reply—

Overlord; Hear you Shadow bring it home.

transmit—

Bringing her in Overlord.

If the above conversation does not occur verbatim, the island will be alerted to the fact that something is wrong. The player characters will be unable to get the code out of any of the crew members or villains unless Telepathy or a similar power is utilized. They will be able to find out about the underground base and the hydrofoil dock behind the waterfall. They will only be able to learn the names of the villains present at the island and a brief physical description of each such supervillain.

If the superheroes do get into the base undetected, use the locations given for Goons and Villains. Once it becomes obvious that the base is being invaded, it is up to the GM to determine where the various defenders go.

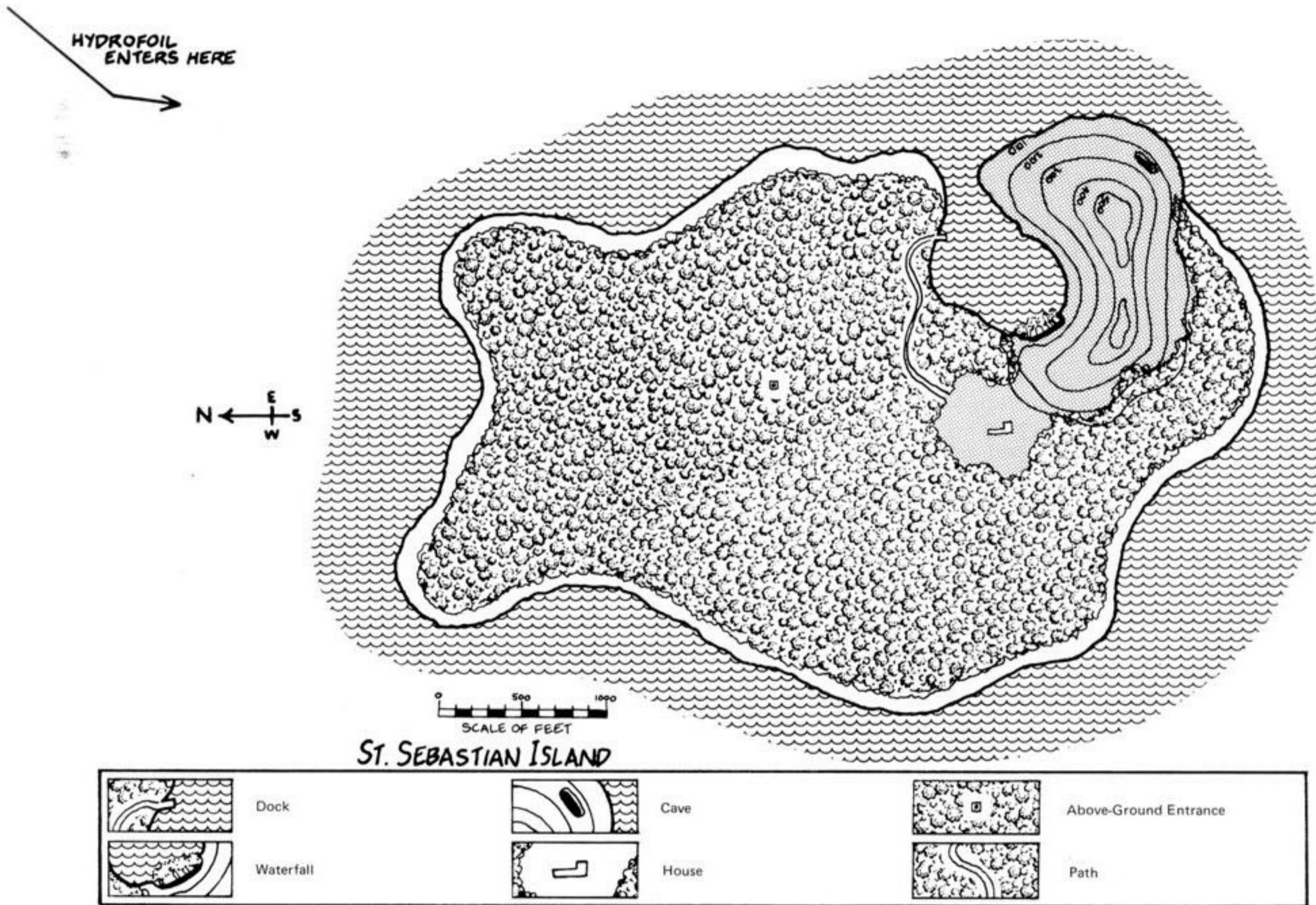

3. ST. SEBASTIAN ISLAND

3.1 COMMON KNOWLEDGE OF THE ISLAND

If the players ask for information about the island itself, the following may be read to them:

St. Sebastian Island is an island approximately one mile across, nestled amongst a smaller group of islands. The island itself is basically flat, except for a small mountain rising some 500 feet. Adjacent to the mountain is a lagoon which contains a large dock. There is also a high waterfall which flows off the mountain into the lagoon.

The main house is located in a clearing near the center of the island. Adjacent to the house is a swimming pool and a tennis court.

3.2 DETAILS OF THE ISLAND

The inner compound containing the house is actually false to confuse aerial photographs of the island. The house appears to be normal in all respects when viewed from the outside. When entered, it is obviously false since it is only a framework with no floors, only walls. The waterfall cascading into the lagoon is actually powered by powerful pumps. The waterfall conceals the hydrofoil dock inside the mountain.

The main entrance (other than the boat dock) is marked on the island map by a black dot. Above ground it appears as a concrete building with a metal door. The door is unlocked. Inside is another door made of solid Titanium, one foot thick. The door can only be opened by inserting an ID card into the receptacle on the wall next to it (the door can, of course, be bashed down, but this will set off a silent alarm). An ID card is carried by all the agents of The Force currently on the island. Behind this door is a room with an elevator leading down. There is a single button on the wall which will send the elevator down when depressed (see map). The elevator leads down to a tram car station. The tram car stations are described later.

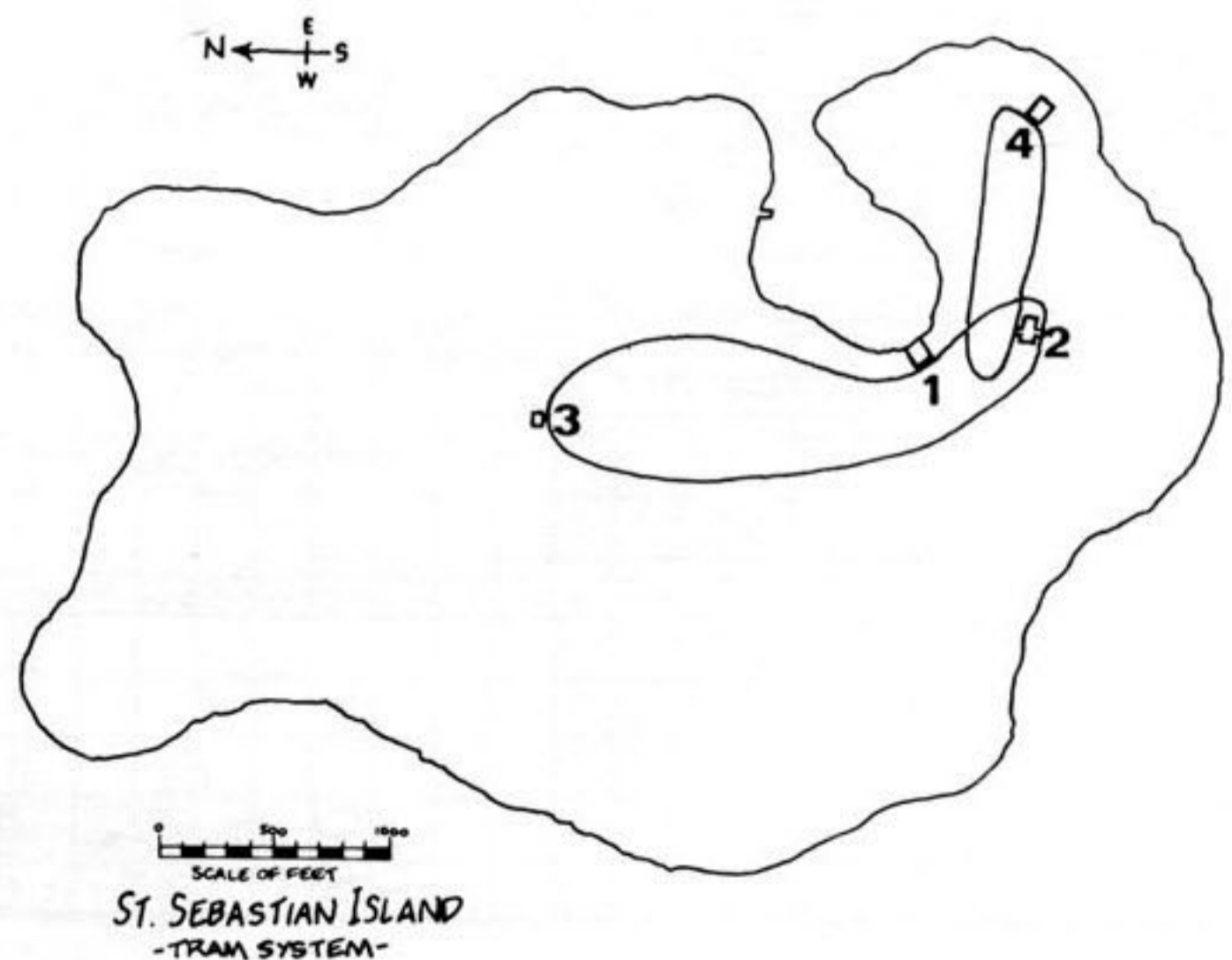

3.3 THE UNDERGROUND COMPLEX

- 1) Tram Station No. 2: See tram description later.
- 2) Bedroom: If this room is searched, the following will be found: a small, low-power, classroom type laser, a multi-colored reflective costume, and a large amount of literature concerning holograms. This is Phantasm's bedroom.
- 3) Bedroom: Upon searching this room the following will be found: an insect collection, many books concerning insects, and a set of weight lifting equipment. This is Cicada's bedroom.
- 4) Bedroom: The first thing noticed about this room is that the air conditioning seems to be turned up all the way (and then some). If the room is searched, the following will be found: a set of ski equipment, a travel brochure of Alaska, a picture book about polar bears. This is SnowBlind's bedroom.
- 5) Bedroom: If this room is searched, the following will be found: a poster of Clint Eastwood, a replica gun collection, and a framed target with the center blown away. This bedroom belongs to Mr. Magnum.
- 6) Bedroom: If this room is searched, the following will be found: a large collection of Doctor Strange comic books and a model of the human skull. This is Shardakos' bedroom.
- 7) Security Barracks: This room houses the sleeping quarters for the security force as well as the visiting agents. At any given time (except in the case of a security mobilization) Goons 11-14 will be found here.
- 8) Office: This is simply some sort of office for handling the necessary paperwork for the complex. Goon 15 will be here.
- 9) Office: See room 8 for description. There will be no Goon here.
- 10) Defense Room: The defense of the island and underground complex is controlled from here. Goons 16-19 will be monitoring the controls.
- 11) Security Room: This room is the office of the security chief, SnowBlind. It is also used for the interrogation of prisoners. There is also a coffee machine here (broken). Goons 20-22 will be here. Goon 21 will be pounding the coffee machine.
- 12) Office Supply: This room is very simply the supply room for the offices. Inside, there is a large copy machine and a paper shredder. If the base is under attack and in danger of being overrun, all important papers will be shredded.
- 13) Office: See room 8 for description. Goon 23 is present.
- 14) Office: See room 8 for description. No Goons are present.
- 15) Office: See room 8 for description. Goon 24 will be here.
- 16) Agent Coordination Room: From this room, agents of The Force are contacted and controlled. There is a large ultra-high frequency radio on one of the tables. There are also large filing cabinets containing the names, addresses, and missions for all of the agents.

- Each filing cabinet is equipped with an incineration device which will automatically destroy all files if an emergency arises. Goons 25 and 26 will be present in this room.
- 17) Debriefing Room: This room is used for the debriefing of agents who have reported in. There will be no Goons here.
 - 18) Lab: In this lab experiments are being conducted into drugs and their effects on the human body. Any drugs found in this room will be unusable because these drugs must be specifically created for a specific person (due to varying DNA structure). The information found here will modify one character's inventing chance (on a related subject) by +10%. This bonus is applicable to only one invention. Goons 27-31 are stationed here.
 - 19) Lab Supply: This room contains supplies for the various labs in the complex. No Goons are present in this supply room.
 - 20) Lab: This lab is being used for research into energy weapons. The same holds true for this lab as for the others with respect to inventions found here or information found here. Goons 32-34 are in this lab.
 - 21) Lab: This lab is currently being renovated and is, therefore, not in use at this time. There are no Goons present.
 - 22) Class Room: This room resembles a regular classroom except that there are pictures of weapons, weapon breakdowns (internal diagrams) and the like. The classroom is empty.
 - 23) Lab: This room is a cybernetics laboratory. The same rules for information pertains to this lab as to all the other labs in the complex.
 - 24) Bedroom: This bedroom belongs to Force himself. The room is very elaborately decorated with tapestries and paintings. If the room is searched the following will be found: a very expensive electronics repair kit, a black wig, a theatrical makeup kit, and two wallets. One wallet identifies the owner as Father Heronimus Kinkaid of the Church of Divine Harmony. The second wallet identifies the owner as Franklin Emerson. By comparing the descriptions on both drivers licenses, it can be discerned that Kinkaid and Emerson do not look alike.
 - 25) Main Control Room: This is the main control room for all operations. It is presently being used for the control of the blackmail operation. The room is set up similarly to NASA's mission control room. Force and Shardakos are present. Goons 35-41 are working in various parts of the room.
- On the north wall is a large map clearly showing the hidden location of the weapon (see map). In the center of the room is the master control for the weapon. Once the weapon has been activated it can not be easily disarmed from here.
- If the superheroes decide that one of them is going to expend an action to disarm the weapon, it can be done.

THE HYDROFOIL DOCK

Goons 62-65 are normally stationed here.

Scale: 1 square = 5 feet

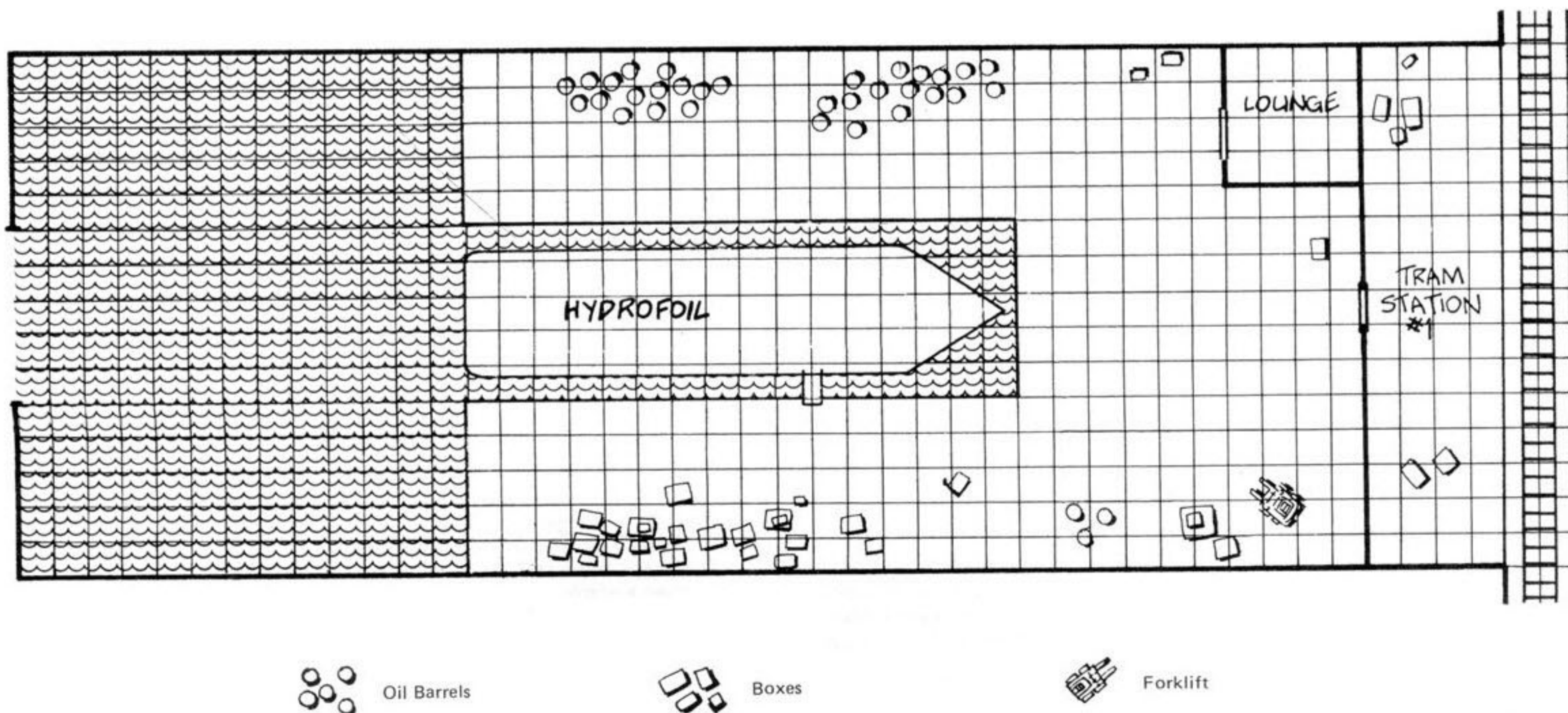

UNDERGROUND COMPLEX

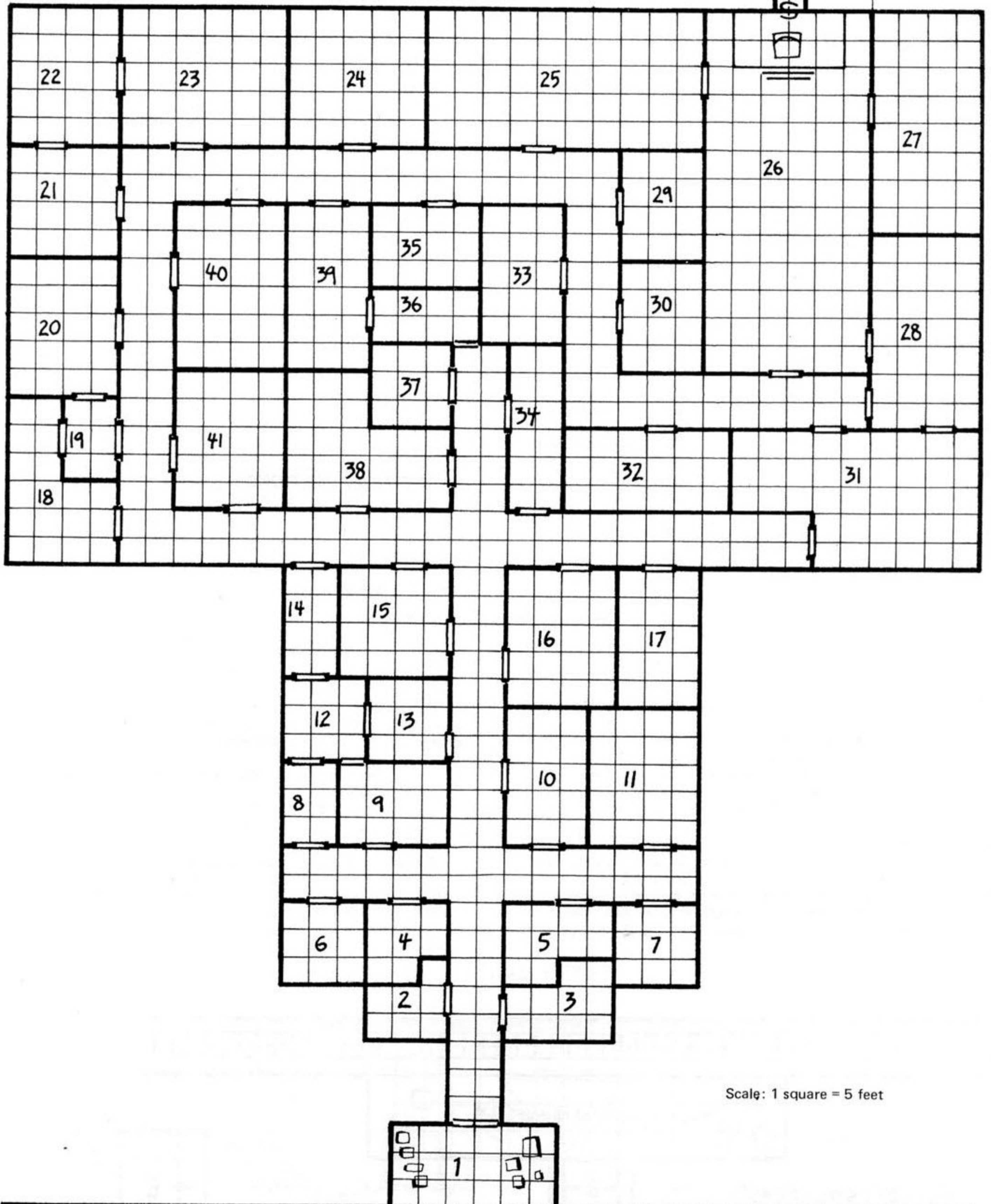

Scale: 1 square = 5 feet

There is also a weapon that will destroy the island if activated. This bomb is controlled by another button on a different panel. If the complex is in danger of being overrun, Force will activate both weapons and attempt to escape via his rocket-plane. Both weapons will detonate three minutes (12 turns) after activation. There is absolutely no way to deactivate the second bomb.

26) Reception Hall: At the top of this room is a raised platform on which rests an ornamental chair. About five feet from the wall on both sides of the room (extending three deep to a side, each five feet apart) are restraining clamps. These clamps hang from the ceiling and are connected to it by chains. Any person being restrained here has his or her hands placed inside the clamps. Their hands are held in place by forcefields. Such a prisoner is then lifted off the ground until he is three feet in the air. At that point, metal poles are plugged into the wall behind the prisoner. The poles are attached to a prisoner by means of more clamps. If the prisoner attempts to blast free of the clamps, he/she should be informed that there seems to be some sort of energy buildup inside the clamp. This is only due to the forcefield itself. In fact, if a prisoner does more than 11 points of damage to the clamps (a roll to penetrate the forcefield is also required), he will break free. If less than 11 points of damage are inflicted, or if the forcefield is not penetrated, the prisoner takes the damage himself. The same applies to the clamps on the feet.

Behind the ornamental chair, on the wall, is a large television screen that connects with the communications network. There is also an intercom located in the right arm of the chair. Any captured devices will be placed in a secret compartment in the left side of the chair. If the device is too large, it will be taken to one of the labs. Mr. Magnum and Cicada are present (this is assuming that nothing has occurred to prevent them from being here).

27) Greenhouse: The greenhouse, even though it is underground, is brightly lit by overhead ultra-violet lighting. There are plants of almost every known variety in this room. Force is very proud of his plants and may even show them off to any captured player characters.

28) Church: This room is used to carry on church services. It cannot be determined what type of services are being held here. (It is for the Church of Divine Harmony.)

29) Computer Room: This room houses the main computers for the complex.

30) Computer Room: See room 20 for description.

31) Barracks: These are the sleeping quarters for the technicians and workers in the complex. Goons 42 and 43 are here.

32) Supply Room: This is the supply room for the entire complex. There are no Goons present in the supply room.

33) Recreation: Inside this room are pool tables, ping-pong tables, and video games. Phantasm is playing pool with SnowBlind. (SnowBlind is losing badly.)

34) Barracks: This room is the sleeping quarters for the various department heads. Goons 44-46 are present.

35) Bathroom: This is the bathroom for the complex. It gets rather crowded at times. Goon 47 is present and indisposed.

36) Kitchen: This is simply the cooking area. Goon 48 is here.

37) Communications: This is the radio room for most non-high priority off-base communication. Goons 49 and 50 are here.

38) Gym/Training Room: Inside this room is the latest in exercise and weight training equipment. Goons 51-53 are working out.

39) Dining Room: The dining room is set up cafeteria style. There are two Goons eating here. (They are numbers 54 and 55.)

40) Class Room: See room 23 for description. No Goons are here.

41) Lab: This lab is set up for experiments involving lasers and holograms. The same rule for information pertains to this lab as it does to all the others.

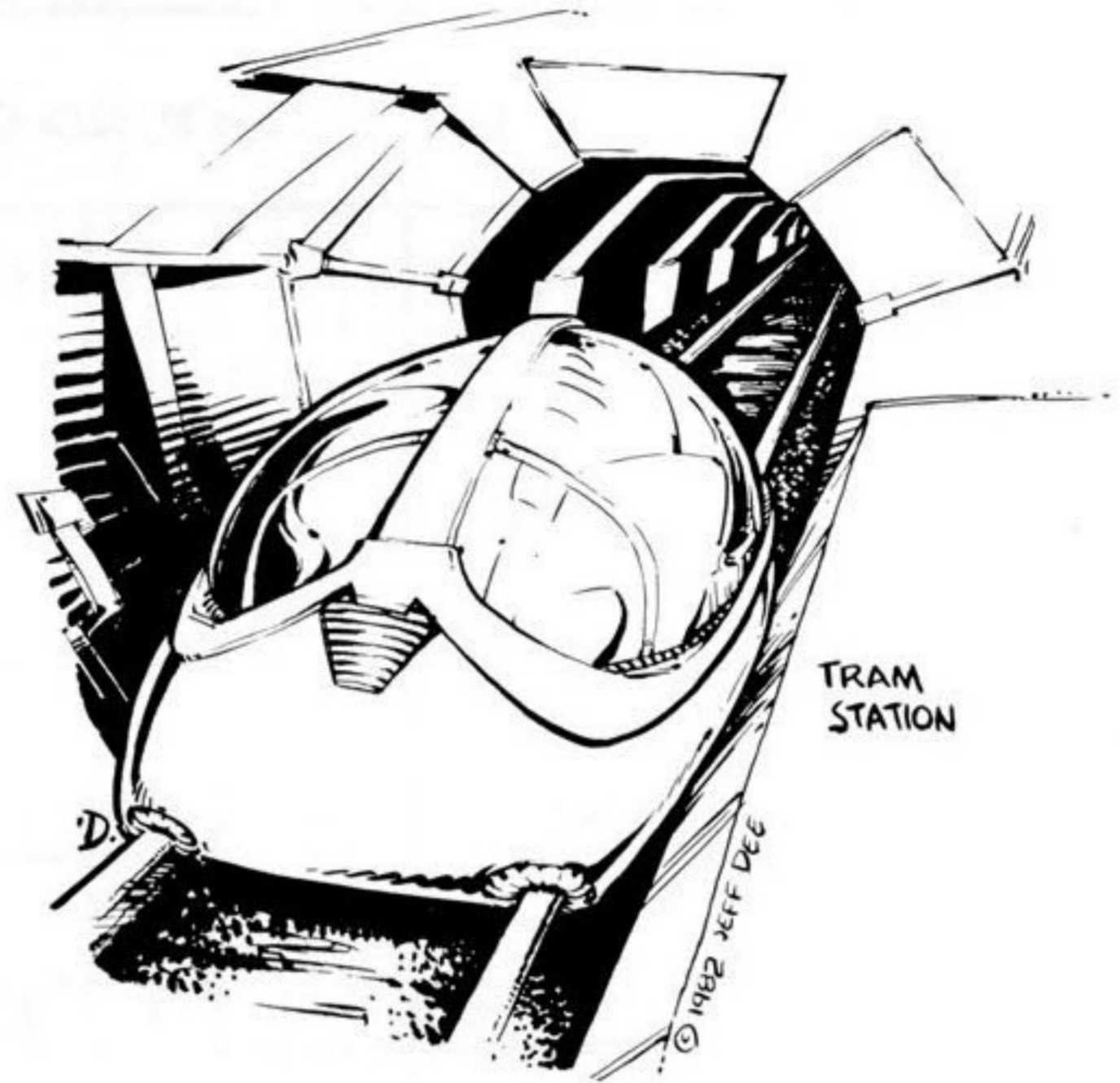

3.4 THE TRAM STATIONS

The tram stations (see diagrams) are situated at four points: 1) the Hydrofoil Dock, 2) the above-ground entrance, 3) the complex entrance, and 4) the rocket-plane pad. Goons will be stationed at the various tram stations as follows: 56 and 57 at 1, 58 and 59 at 2, 60 and 61 at 3, and none at 4 since this is a secret tram station, unknown to any but Force himself.

THE TRAM CARS

The plexiglass top opens by a simple switch on the inside and outside. Due to the coloring of the plexiglass and the lighting, the plexiglass becomes, in effect, one-way glass. Only those inside can look straight through the glass, those outside cannot see in. On the control panel of the tram car are two buttons; a red button and a green button. The button to push to get to an intended destination depends upon the point of embarkation.

Starting Point	Red Button	Green Button
Station 1	Station 2	Station 3
Station 2	Station 3	Station 1
Station 3	Station 1	Station 2

Station 4 is only accessible by means of the secret tram found behind the wall in the reception hall. This tram will only go between station 4 and the reception hall, nowhere else. The tram cars will take 20 points of damage before becoming useless, and 35 points of damage before exploding (use medium bomb for force of explosion). Each car will seat six people comfortably, or eight uncomfortably.

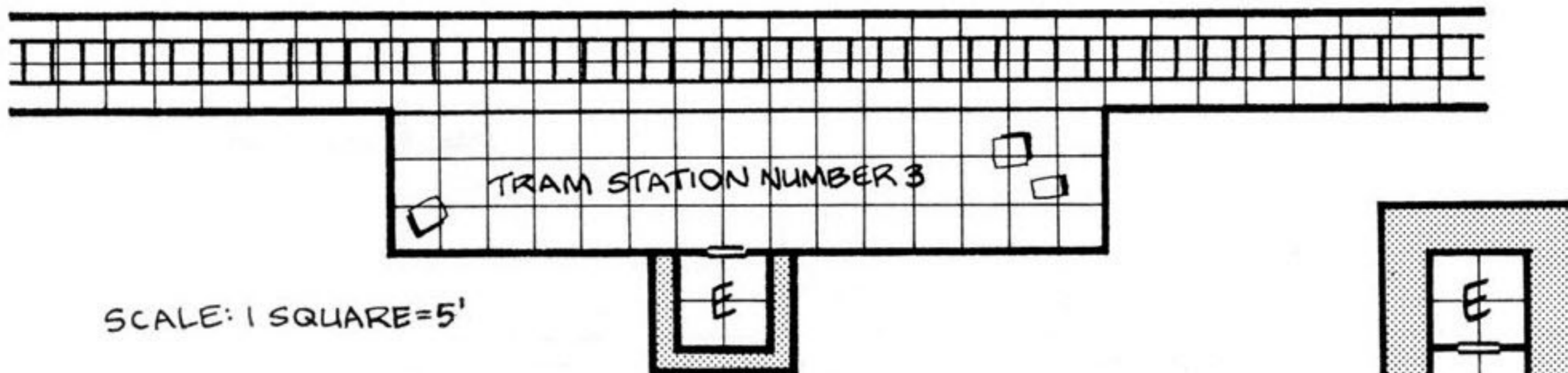

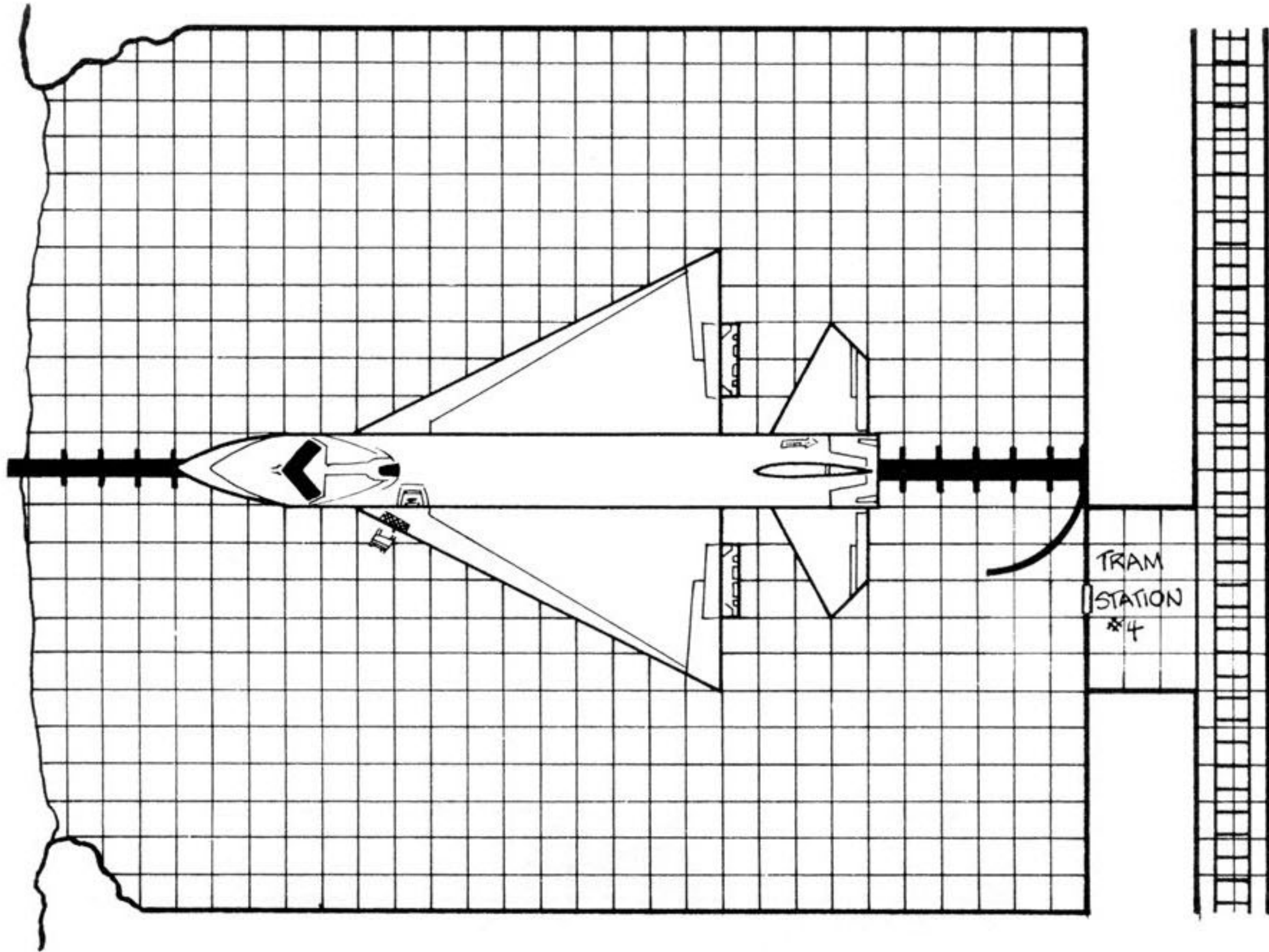

cave mouth covered by camouflage netting

Scale: 1 square = 5 feet

STATION 4: THE ROCKET-PLANE

The launching pad for the rocket-plane is only accessible by way of the tram hidden behind the reception hall. Inside the cave which overlooks the south-east side of the island is the rocket-plane itself (see diagram). When the plane is launched (it can be flown by anyone who can fly a jet aircraft), anyone inside the cave will take 6D10 points of damage.

The rocket-plane will leave the cave and accelerate to Mach-1 very quickly. Anyone in the plane who is not strapped into an acceleration couch will take their Basic Hits times two every turn for twelve turns, after which the inertial dampeners in the plane will compensate for the G-force inside the plane. At this point, the solid fuel boosters will drop away and the regular engines will take over. The plane will then gradually accelerate to Mach-3 and head towards the South Atlantic. It will then vanish from all radar screens. If any player character is on board and has survived the launch, Force and whoever else is on board will attempt to dispose of them.

Please note that when the rocket-plane takes off from the island it will create a great deal of smoke and noise. Therefore, the superheroes should be unable to communicate for a short time afterward due to temporary blindness and deafness.

3.5 SECURITY MOBILIZATION

The GM should realize that the island has a radar unit. Thus, there is a chance that any superheroes approaching the island will be detected. They will not be detected if they are approaching invisibly, non-corporeally, or astrally. If they are using some sort of a vehicle, the chance they will be detected is 100%. If they are flying in themselves, this chance is 85%. If they are small, say bird-sized, the chance is reduced to 40%. Anything of bird-size or smaller will not alarm the security personnel. The above chances also apply to underwater travel. If the player characters are detected, ambushes will be set up.

Hydrofoil Dock:

Goons 11-20 and 56-57 will station themselves around the dock. Mr. Magnum and Cicada will also be there. They will wait with the lights out until the player characters enter the dock area itself. At that point, they will turn on the lights and attack. Mr. Magnum will use infra-red goggles and attack first, just before the lights come on. Cicada will be hiding above the mouth of the cave and will swoop down, grab someone, and slam him into the nearest wall.

ROCKET-PLANE INTERIOR

Scale: 1 square = 5 feet

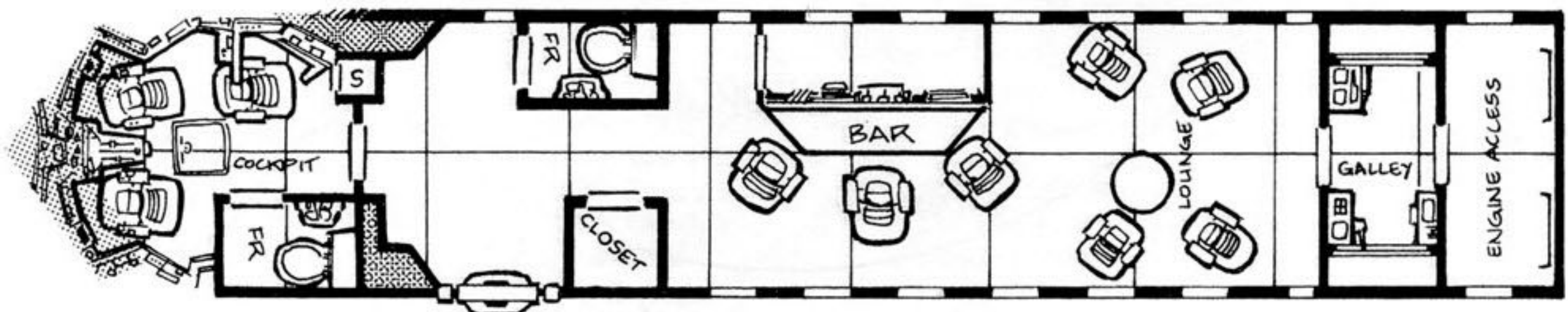

Tram Station 2:

Goons 21-30 will station themselves behind the boxes on the landing. Phantasm and Shardakos will also be waiting. They will remain hidden until they are certain that the superheroes are, indeed, inside the tram car. If they are, they will do their best to make sure the car no longer exists. If they are not inside, they will move down the tunnel in the direction from which the car arrived.

Tram Station 3:

Goons 31-40 will station themselves on the tram car tracks looking over the landing at the elevator door. Once the doors open, they will open fire on the inside. If the elevator is empty, they will throw three hand grenades inside and sent it back up. If a fire fight breaks out, do not forget that the Goons have the three grenades (assuming the heroes came straight down).

The Complex:

The remainder of the Goons will station themselves along the side corridors leading off the main corridor. They will wait there until they catch as many player characters as possible in a cross-fire. The Goons will only hit each other if the incidental rolls are made after each miss.

Force and SnowBlind will man the main control room. Once it seems that the player characters are going to win, Force will activate the self-destruct for the base and the weapon itself. Then he and SnowBlind (and any other super-villains) will be notified to get out. They will make their escape in the rocket-plane. This warning is a repeated loud beep heard throughout the base and island. The Goons are not aware of the meaning of this alarm.

Note: If Security Mobilization takes place, assume that all Goons are equipped with Automatic Rifles. Otherwise, use the weapons listed in the Goon Chart. When not in use, all Auto-Rifles are kept in the security barracks.

THE NUCLEAR WEAPON

The weapon itself is homemade, with the uranium acquired through illegal methods. (The Three-Mile Island accident was a cover for the uranium theft.) Due to the bomb's homemade nature, it has only a 75% chance of actually detonating. The bomb is a medium sized nuclear weapon.

The nuclear weapon is hidden in a cabin deep within the Chattanooga National Forest. The vial of S-97 is situated adjacent to the weapon. The explosion will shatter the flask and propel the virus high into the atmosphere.

S-97

The virus code-named S-97 was stolen from the U.S. Army while enroute to be destroyed. S-97 was originally developed in the late 1960s for use in Vietnam. After testing, it was decided that the weapon was too horrible for use. It was put into storage until its recent removal for destruction.

Once the virus is exposed to air it begins to mutate and multiply. If it is inhaled, or even absorbed through the skin, it begins to act on the body it has infected. Within one hour after initial contact, the blood vessels in the brain begin to deteriorate rapidly, causing insanity. Thirty minutes after the insanity sets in, the arteries to the heart decay to such a point that they begin to fall apart. At this time, the heart muscle itself deteriorates, causing it to explode inside the chest when it beats. Death is slow and painful. There is no way to stop it or cure this disease once it has been exposed to air. Fortunately, the virus only has a life span of 12 hours, after which it dies. If the flasks containing the virus can be found and frozen solid, the germ will die since it cannot exist at temperatures below 0°C. Adaptation defense will only work for eight hours against this virus, after which the adapted person will also be infected and begin to show all symptoms up to, and including, eventual death.

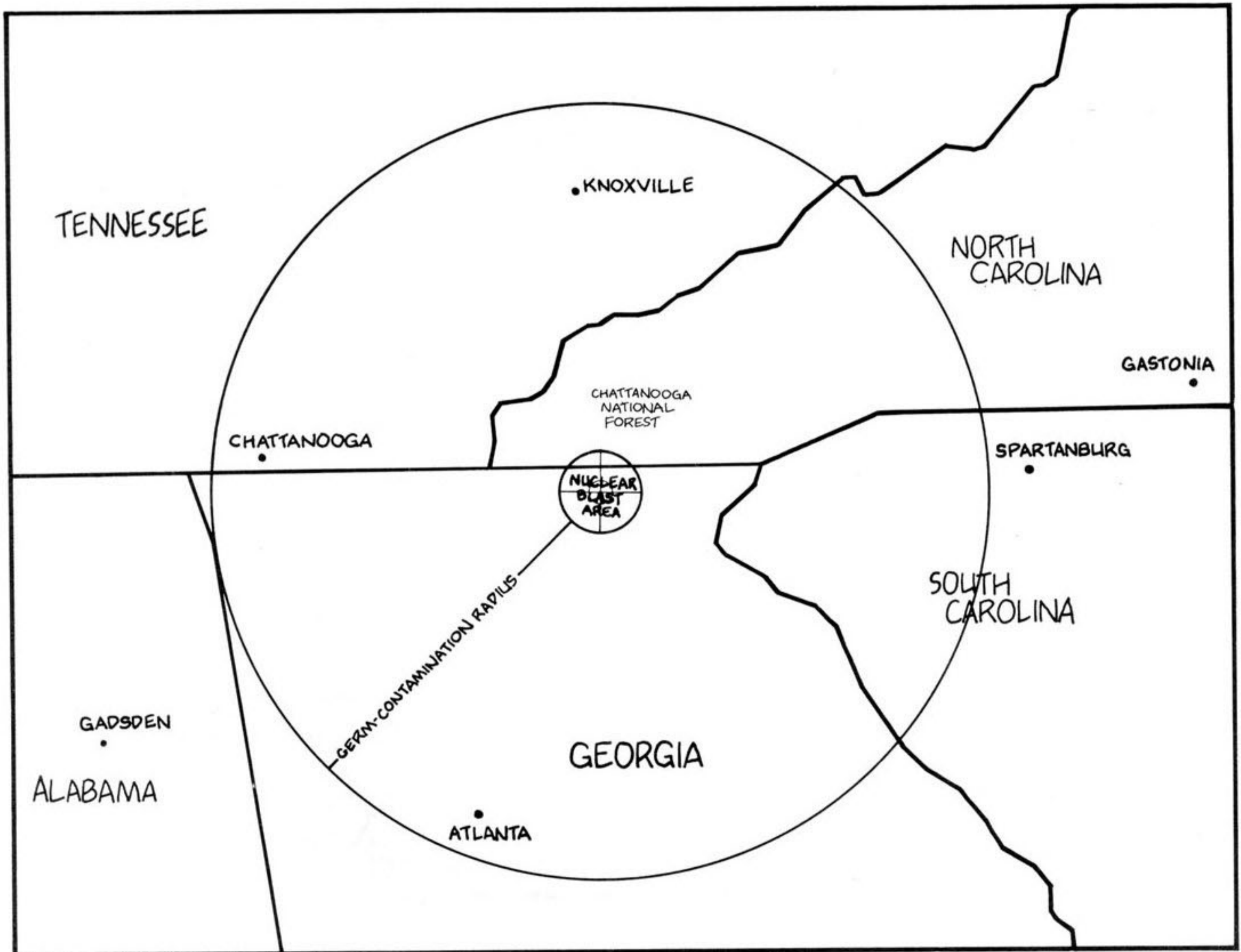



...WITH INCREDIBLE RESULTS!

EVERYBODY
OUT THE SIDE
DOOR--MOVE!



THAT WAS CLOSE!
EMPRESS, I TOLD YOU
TO WATCH OUT FOR
THOSE OIL
DRUMS!

LOOK, I'M
SORRY, OKAY?
SO SHUT UP!



CUT THE SQUABBLING,
KIDS, AND LOOK WHAT
WE'VE FOUND!

A SUBWAY!

THESE TUNNELS
MUST LINK UP
THE WHOLE BASE!



SO WHAT ARE WE
WAITING FOR?
LET'S
GO!

OH, NO. I HAVE A
BETTER IDEA...



MOMENTS LATER:

MAGNUM!
THEY COME!
SIGNAL YOUR
MEN NOW!



SHADARKOS,
REPORT!

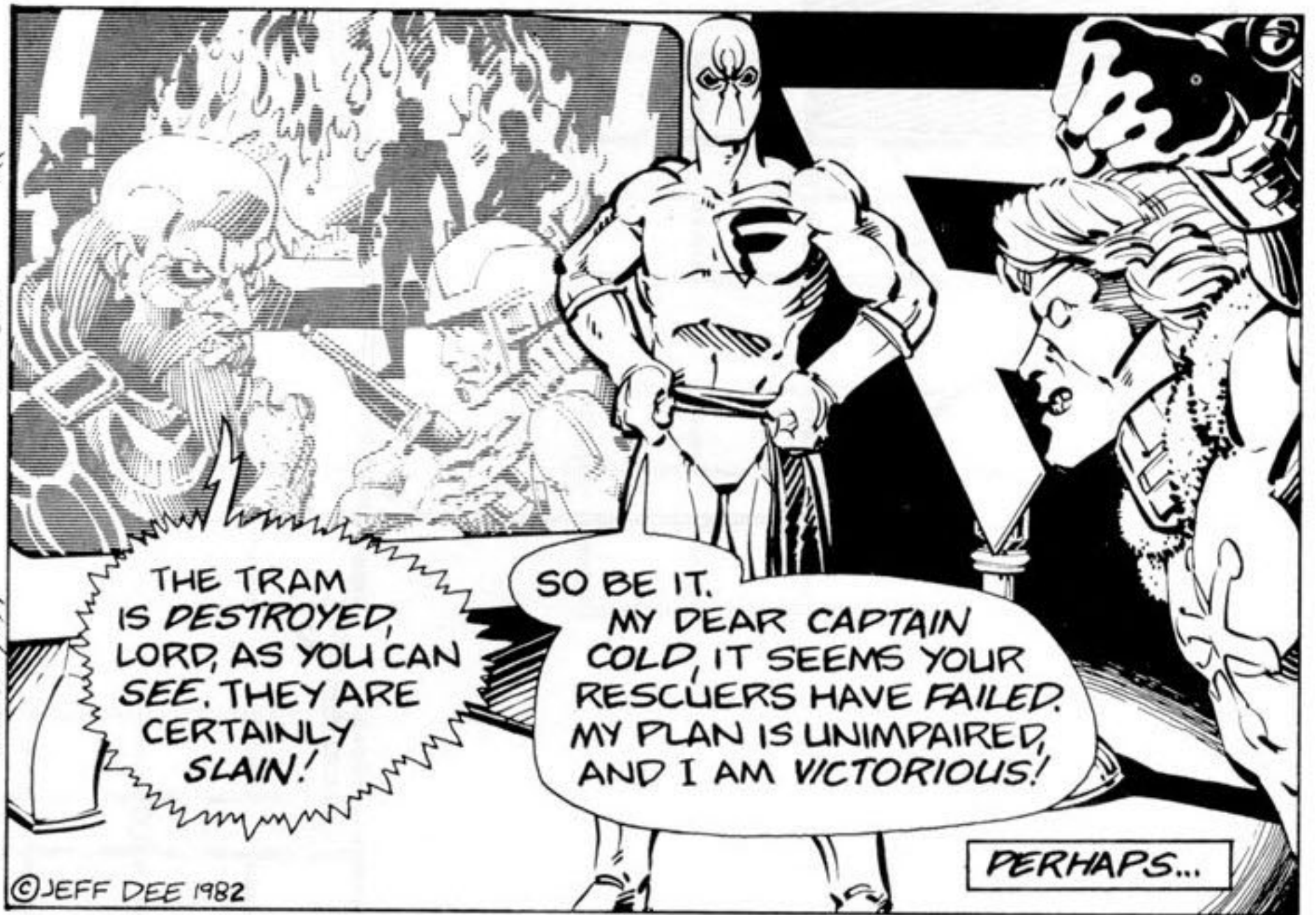

THE TRAM
IS DESTROYED,
LORD, AS YOU CAN
SEE. THEY ARE
CERTAINLY
SLAIN!

SO BE IT.
MY DEAR CAPTAIN
COLD, IT SEEMS YOUR
RESCUERS HAVE FAILED.
MY PLAN IS UNIMPAIRED,
AND I AM VICTORIOUS!

PERHAPS...

4. KANSAS COMMUNE

4.1 GENERAL INFORMATION

The player characters should have no trouble finding the location of the Church's commune in Kansas. It is located approximately forty miles North-Northwest of Dodge City, Kansas. The commune is well known to the people in the area. If asked, they will report that they have never had an ounce of trouble from anyone associated with the commune. In fact, they have a very high opinion of Father Kinkaid and his followers.

It seems that every year the Church makes a sizable donation to one of the local charities. The GM should note that there is a 10% chance that one of the commune members will be in town and will notice the player characters asking questions. If this is so, he will immediately notify the commune of such activities.

The commune itself is set back from the main road, about one half mile from the highway. It can be reached by a dirt road leading from the main road (see map).

4.2 THE COMMUNE

1. The Fence: The fence surrounding the commune is a twenty foot high metal chain-link fence. Spaced about fifty feet apart, all the way around the perimeter, are large signs reading 'CDH Retreat. No Trespassers.' These signs are mounted on the fence. The fence is also electrified and there are signs indicating this spaced between the many CDH Retreat signs. If anyone touches the fence, and has no way of dealing with the effects of electrical current, he or she will take 2D10 points of electrical damage. If the player characters wish to break down the fence, they must do damage to it in excess of the structural strength of the steel (i.e. 11 points of damage) to destroy a section of fence. Any less damage will not break the fence.

2. The Dirt Road: This is the dirt road which links the commune with the main highway. There is nothing special or notable about the road, except that it is extremely bumpy for wheeled vehicles.

3. The Main Gate: The gate itself is only operable from the inside.

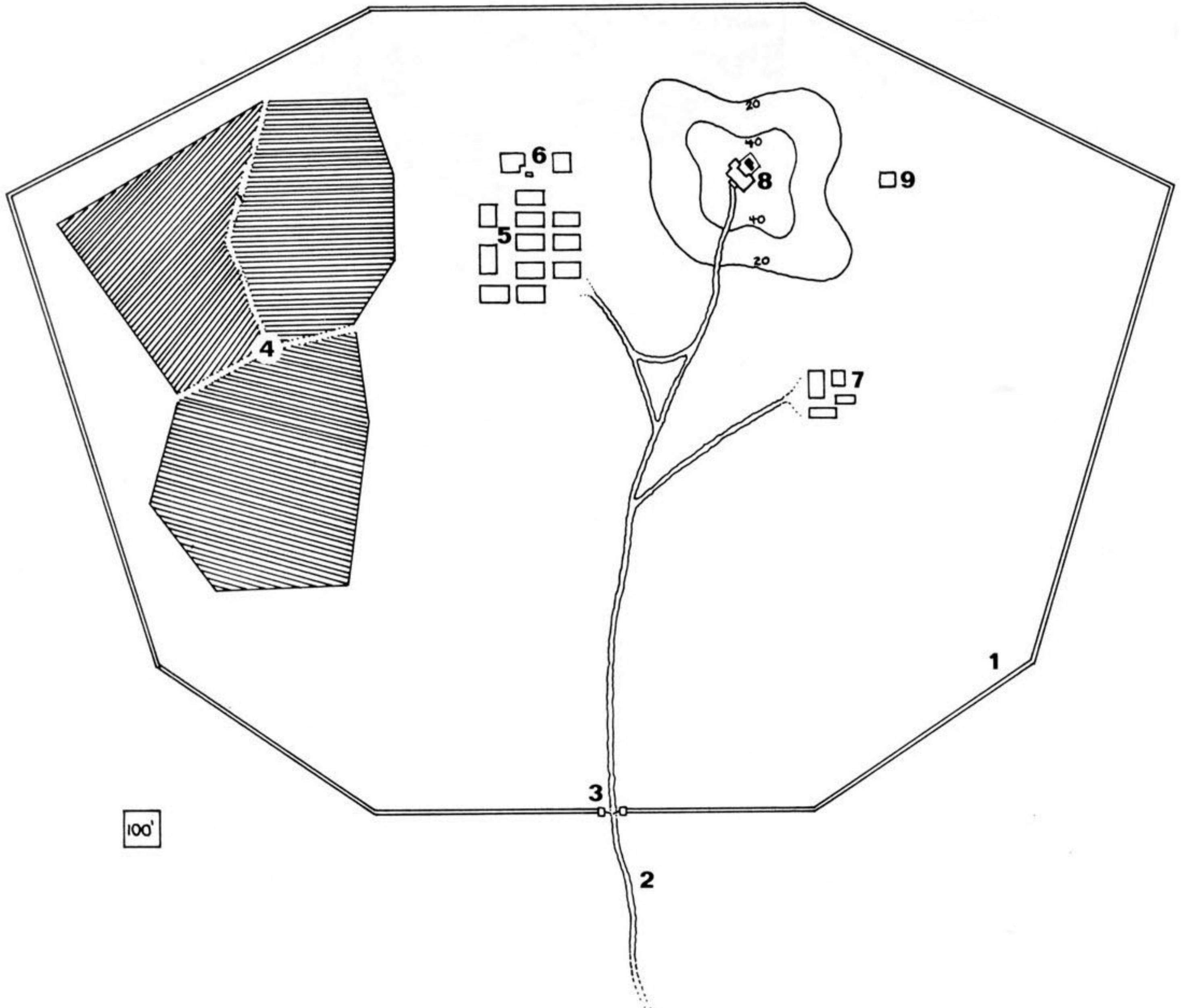

The guard stationed here (Goon 1) uses his ID card to activate the mechanism which opens the gate. If there is any trouble, he will immediately notify the main house.

4. The Fields: These fields are farmed by the commune members who live in the small town, a short distance away. The basic crops are corn, strawberries, wheat, and a selection of vegetables. Any other foodstuffs used by the commune are grown in small gardens. The meat animals and dairy herd are found in the barn area.

- 5. The Town: See section 4.3.
- 6. The Barn Area: Detailed in section 4.3.
- 7. The Guards Barracks: See section 4.5.
- 8. The Main House: See section 4.5.
- 9. The Helipad: See section 4.7.

4.3 THE TOWN

1. The Land Rovers: These two four-wheel drive vehicles are the primary means of transportation around the commune. They each weigh 6000 pounds and can absorb 30 points of damage before becoming disabled. They have a top speed of 80 miles per hour (352 inches) and can carry up to ten passengers.

2. The Maintenance Building: This building holds most of the tools needed to make repairs around the commune, excluding the main house. It also contains the necessary materials for repairs and upkeep of the Land Rovers.

3. The Garden Patch: Various types of edible plant life are grown in this patch of land. This garden is used to grow the lesser needed vegetables for the commune.

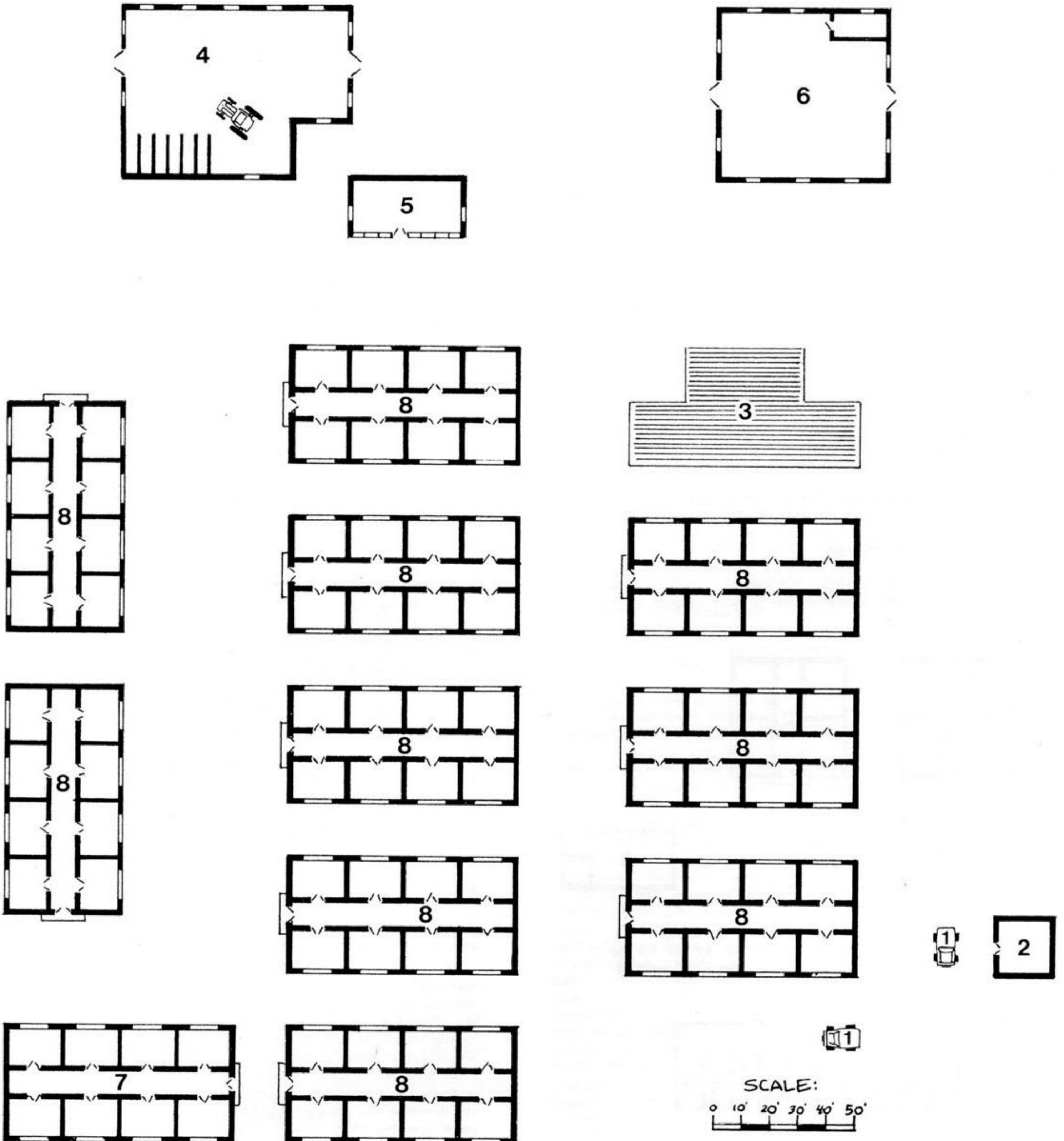

4. Barn 1: This barn is used to house lambs, goats, and cows. The animals are slaughtered in a small room at the rear of the barn. The goats and cows are also used to produce milk. From the overabundance of vegetables it is obvious that the commune lives on a primarily vegetarian diet.

5. The Hen House: This smaller building is where the chickens are kept. Inside are some baby chicks and, within special cages, some roosters.

6. Barn 2: This barn is used to house farm machinery and horses. Inside the barn is a tractor (weight: 5 tons, top speed: 40 miles per hour) and six riding horses. There are also three work horses and two mules. Mounted on the inside walls are racks of various farm implements.

7. The First Barracks: This building houses the sleeping quarters of the religious leaders of the commune. Religious services are held every Wednesday at precisely twelve o'clock noon, rain or shine. These services are held out of doors, a few hundred feet Northeast of the Town. The inside of this building is identical to the inside of the other barracks building.

8. The Other Barracks: These buildings (all the identically shaped buildings, excluding building 7) are used as the sleeping and living quarters for the residents of the Town. There are two people in each room for a total population of 88 commune members.

4.4 THE GUARDS BARRACKS

1. Barracks 1: This building is laid out in the same fashion as the barracks buildings in the Town. The guards (Goons 2-17) use this building as their sleeping quarters. It should be noted that Kinkaid explains the need for guards by claiming that he has to watch out for misguided deprogrammers attempting to kidnap some of the commune members.

2. Barracks 2: This building is laid out in the same fashion as the other barracks. It is used to house the remainder of the guards (Goons 18-25).

3. Recreation Building: The inside of this building is basically one huge room, except for a bathroom at the rear. It is full of various recreational devices; television, stereo, pool table, ping-pong table, video game set-up, and a dart set. If not out on their motorcycles, the guards will generally be found in this building when off-duty.

4. Motorcycle Garage: Inside this building the twelve motorcycles with side-cars are kept. Each cycle weighs 1500 pounds, can absorb 8 points of damage before becoming disabled, and has maximum speeds of 90 miles per hour (396 inches) on open road and 50 miles per hour (220 inches) cross-country. Each side-car has an Automatic Rifle (+4 to hit, 1D10 damage) mounted on its nose. Each rifle can be fired up to four times (four bullets) on automatic. It can only fire into its forward facing direction.

Each motorcycle will be ridden by two guards; one driving and one in the side-car. If the driver is killed or disabled the motorcycle will crash. If the gunner in the side-car is killed or disabled, the Auto-Rifle cannot be fired.

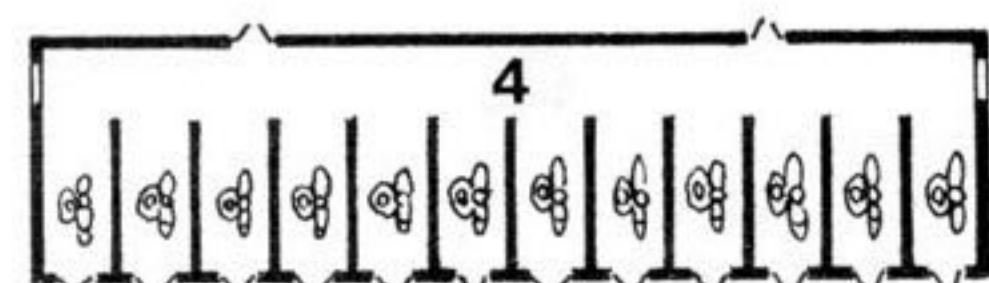
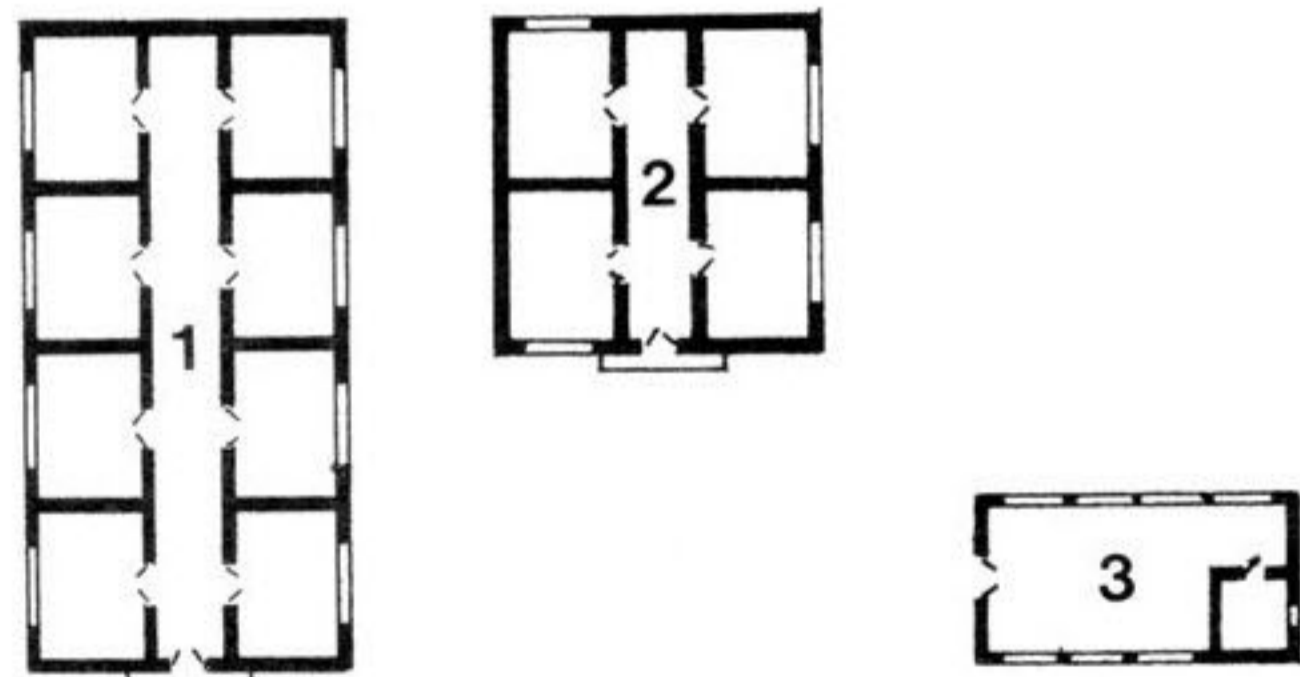

4.5 THE MAIN HOUSE

1. Servants' Quarters: The servants for the Main House (Goons 26-28) use this room as their sleeping quarters.

2. Kitchen Area: This room is used as the cooking and food storage area for the Main House. Two cooks (Goons 29 and 30) are virtually always at work here. The two cooks do not have rooms in the Main House as they sleep in the Town. At the rear of the kitchen is a refrigerated storage room.

3. Dining Room: This room is primarily occupied by a huge oaken dining table. Hanging on the walls are a multitude of stunning paintings (all originals) including a Picasso, a Michaelangelo, and a Rembrandt. Sliding glass doors lead out to the pool area.

4. Closet: This is a ten foot by ten foot room used as a huge walk-in closet when there are guests staying at the House.

5. Library/Study: This is one of Kinkaid's favorite rooms. The shelves along the walls are full of all sorts of different works of literature. There is a large desk near the far wall of the room. On the desk is a telephone unit. It consists of the typical telephone handset, attached to a console on which ten buttons are mounted. Depressing one of the buttons will link the telephone to various locations.

- 01 outside line
- 02 First Barracks (Town)
- 03 Front Gate
- 04 Security (Underground)
- 05 outside line
- 06 outside line (will alert Security underground)
- 07 kitchen
- 08 Security Barracks (Rec Building)
- 09 Communications (Underground)
- 10 Servants' Quarters

Beneath the middle desk drawer (mounted beneath it) is a high caliber, one shot, Gyro-Jet pistol. The pistol (+4 to Hit, 3D10 damage) cannot be removed from under the desk without rendering it inoperable. It swivels to cover a 90° angle in front of the desk.

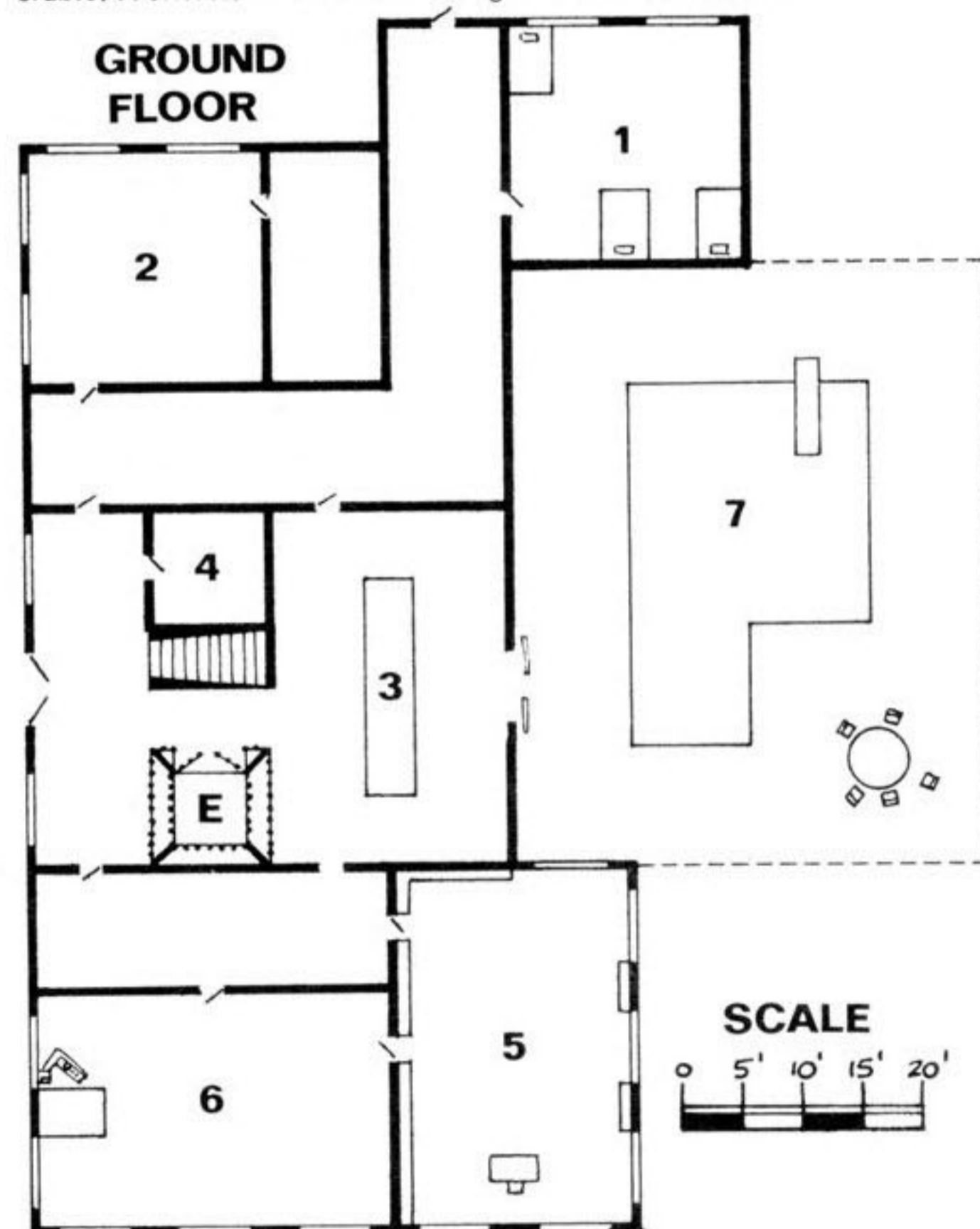

6. Bedroom: This is Kinkaid's bedroom. There is a large canopy bed along with various other forms of bedroom furniture. Alongside the bed there is a console mounted on a swivel arm. The arm enables the console to swing out over the bed itself. The console is identical to the telephone unit in the library/study except that there is a large white plastic panel mounted next to the unit. The panel is a palm print analyzer. If Kinkaid places his hand over the panel the bedroom window shutters will seal over. These shutters are on the outside of the windows and are connected to a circuit to close a thin metal (steel) panel over the doors. Once this has been completed, the bedroom will begin to descend like an elevator.

If anyone other than Kinkaid places his palm on this plastic panel, an alarm will sound in the security room (underground).

The bedroom will descend after an alarm has sounded, but there will be a welcoming committee awaiting its arrival underground.

7. Pool Area: There is nothing particularly special about the pool area. The dotted line indicates the end of the concrete deck.

8. Bedroom: This is a guest bedroom. The primary room color is dark blue. The door is made of steel reinforced hardwood, although it appears to be a heavy oaken door.

9. Bedroom: This is a guest bedroom. The primary room color is white. See room 8 for a description.

10. Bedroom: This is also a guest bedroom where the primary room color is brown. The door to this room is constructed like that for room 8.

11. Bedroom: This is another guest bedroom where the primary room color is gold. The door to this bedroom is identical to those of the other guest bedrooms.

E. The Elevator: The elevator located in the entrance lobby of the house is of the 1920s open cage variety. It can only be entered through the door area of the elevator. The controls are very simple; one button, if the elevator is on the first floor it goes up, if it is on the second floor it goes down when the button is depressed. The doors are manually operated.

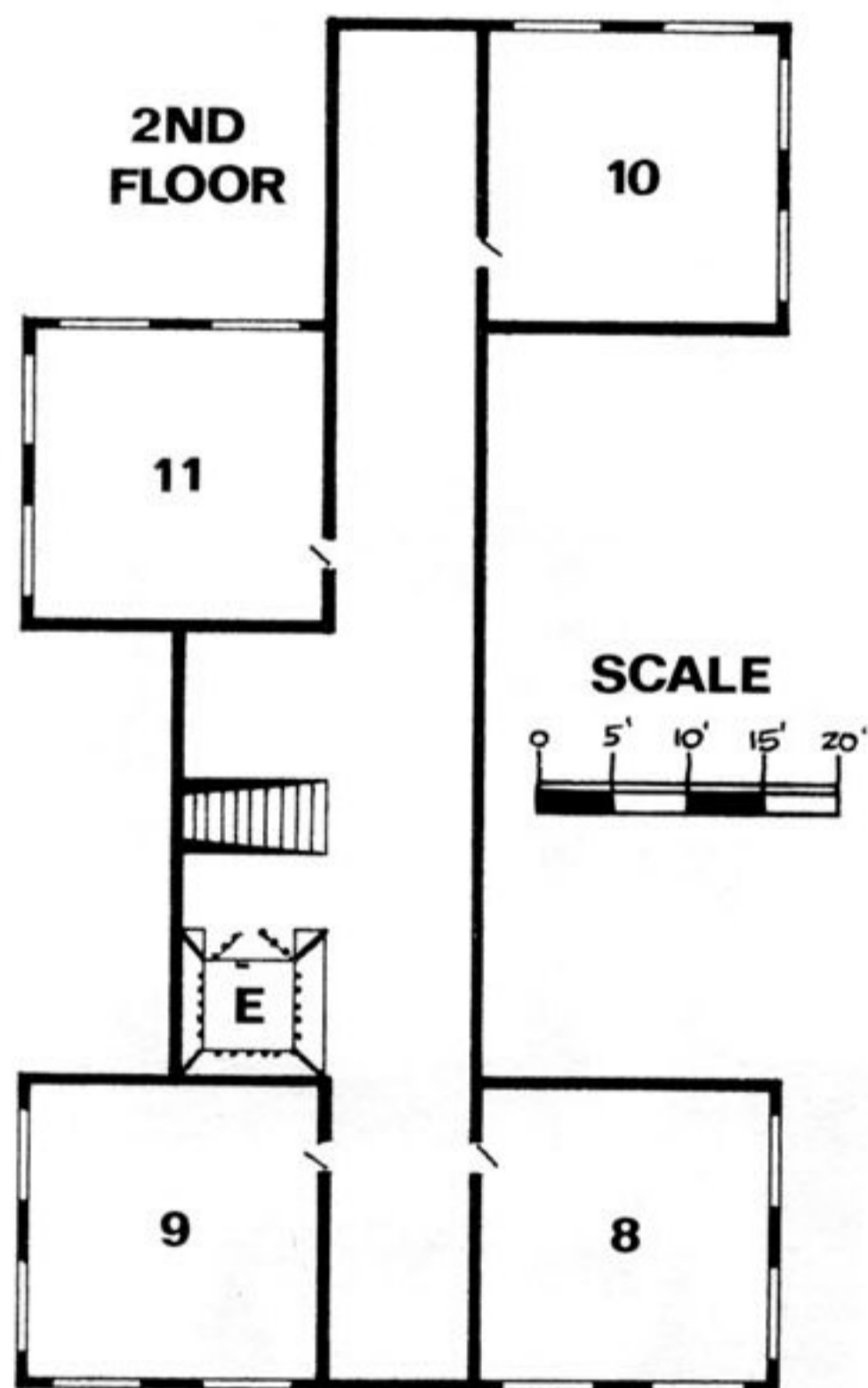

4.6 THE UNDERGROUND TRAINING COMPLEX

The underground complex is located 150 feet below the main house. It is surrounded by twenty feet of solid steel reinforced concrete (structural strength of 9). Any attempt to bash through the concrete barrier will set off seismic trigger alarms alerting security.

1. Bedroom: When the bedroom from the Main House arrives underground, the metal door guard will retract revealing an identical set of doors to those upstairs. This set of doors will not open unless the bedroom (Kinkaid's) is present. The same holds true for the doors upstairs. Kinkaid will change into Force before exiting this room.

2. Meeting/Conference Room: If there is a need for a large scale meeting, it is held here. This room is also used for Wednesday services.

3. Kitchen/Cafeteria: These rooms are the main eating area for the complex. Goons 31-37 will be in the process of eating.

4. Communications: This room is the focal point for all communications either leaving or entering the complex. From here messages can be and are relayed to virtually anywhere else. Those players with Communications oriented skill backgrounds may be able to notice that the equipment present links into an orbital satellite. If this line of investigation is pursued, the superheroes will learn that the satellite is owned and operated by Emerson Electronics Corp.

There is also a special communications unit that transmits and receives in an intricate, number-based code. This unit is used to relay all messages between the commune and St. Sebastian Island. A player character with a Technology or Computer skill background may be able to discern to where the code transmitter is transmitting. He would be able to sift through the memory portion of the unit until he discovers the transmission frequencies and to what they are assigned.

Stationed around this room are Goons 38-45, who act as technicians. Also in this room are five guards armed with Auto-Rifles (Goons 46-50).

5. Security: This room is the central control for commune security. The room is filled with television monitors which watch over virtually every place in the Commune. Every room in the Main House is monitored, the Main Gate is monitored, the Town is monitored, the Security Barracks are monitored, the Helipad is monitored, the Commune perimeter is monitored, and the underground complex is monitored. These monitoring devices are virtually undetectable.

If the player characters search for monitoring devices, roll to Detect a Hidden Thing with a -2% penalty. If the roll is successful and they are in a monitored area, they will find a hidden camera.

Inside the security room are six technicians (Goons 51-56) and two armed guards (Goons 57 and 58).

6. Bedroom: This bedroom is the sleeping quarters of Clamor. If searched, the player characters will find an extensive collection of Heavy Metal albums, a \$2000 stereo set-up, and a shelf full of rock star biographies. Clamor himself will be inside, reclining on the bed, listening to AC/DC on a set of headphones. Hence, if an alarm is sounded, he will probably not hear it.

7. Tram Station: This tram line runs only between this point and the helipad tram station. See the description of the tram car itself as it is identical to the tram cars of St. Sebastian Island, except that this tram car has only one button on the inside control panel for choice of destination.

8. Barracks: This room is used to house the technicians and/or guards who are presently in training. There is nobody present in this room.

9. Barracks: This room is used to house the technicians and/or guards in training. It is identical to room 8. Goon 59 is present but he is ill (treat as fatigued).

10. Barracks: This room is used to house the trainers and teachers for the complex. It is presently empty.

11. Lounge: This is the rec room for the trainees and trainers. It has a pool table, a ping-pong table, and a multitude of video games. There is no one inside.

12. Bedroom: This is StarGazer's bedroom. She is always in. She will be found in a lotus position on her bed. StarGazer very rarely leaves this position. She is unable to put up any physical resistance. If the room is searched, a wheelchair and a photo-album will be found. The album contains photos of some children who will not be recognized by the player characters.

13. Gym: This is the physical training area for the trainees. It is fully equipped. At present, Goons 60 and 61 are present.

14. Firing Range: This room, as the name implies, is indeed a firing range. Goon 62 is currently attempting to hit the far wall with his pistol. He is not doing too well.

15. Storage Area: This room is used to store most of the incidentals that are needed around the complex. There is no one inside.

16. Classroom: The trainees need to be taught a great many things. This is where it is done. Inside are a group of chairs, a couple of blackboards, four computer training consoles, and a shelf full of textbooks of various sorts. There are two tech trainees at the computer consoles (Goons 62 and 63).

17. Medical: This room contains a fully up to date medical facility. Included are an advanced diagnostic center, a mini-surgery, and a large glass cabinet filled with pharmaceuticals.

18. Control Room: The control room resembles a NASA launch control center with rows of consoles facing a large screen. On the screen is a map of the Caribbean with St. Sebastian Island marked with a flashing red dot. If any player characters attempt to sift through the computers present and have an appropriate background, they will also be able to verify the exact location of the island base and that there is indeed a nuclear-biological weapon hidden somewhere in the continental United States. There is nobody currently on duty since they do not have an active part in the current operation. Hence, a large number of technicians and guard instructors are on duty at the island headquarters and this complex is somewhat understaffed. Also note that no one at the underground complex is aware of where the nuclear weapon is hidden.

Though there are no personnel on duty here at this time, there are

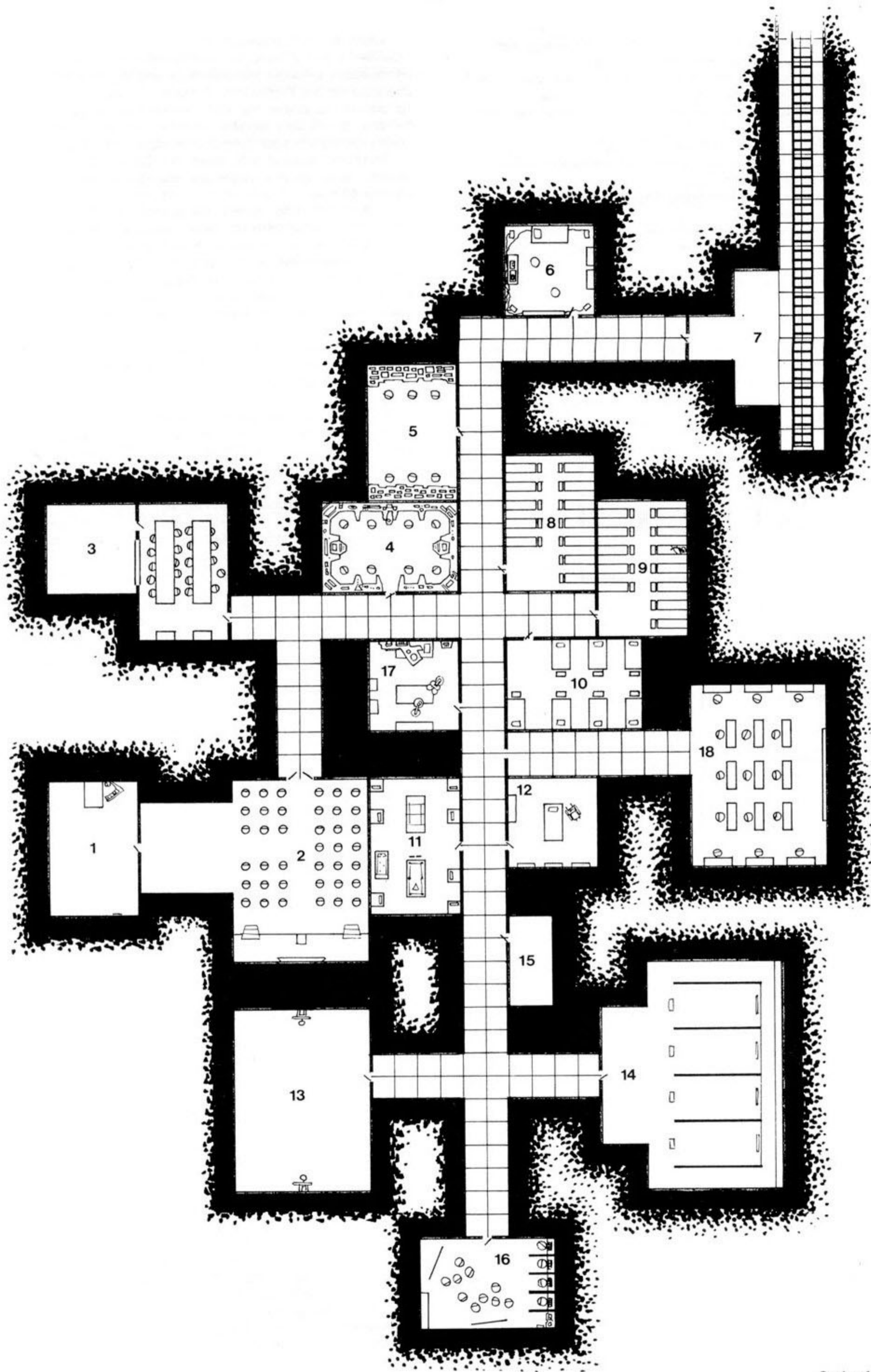

Scale: 1 square = 5 feet

two techs (Goons 64 and 65) who are presently fooling around with a homemade Star Trek program on one of the consoles.

On the right wall is a control panel marked 'Authorized Personnel Only.' Beyond this panel is the self-destruct device for the training complex. If the proper key is inserted and turned, the complex will be utterly laid waste in two minutes; after one minute and thirty seconds there is no way to deactivate this self-destruct mechanism. Only two people have access to the key. They are Clamor and the Security Chief of the training complex, Mr. Magnum, who is not currently in the complex.

THE HELIPAD

The helipad (9 on the map) is a simple concrete slab large enough for two helicopters to land without fear of collision. There is no one guarding the helipad or the helipad tram station entrance.

4.7 DEFENSE OF THE COMPLEX

The locations of the Goons and supervillains are given if the player characters should enter the underground complex undetected. If they are detected, it will be up to the GM to determine exactly what defensive action will be taken by the security forces. There is no preset and cohesive defense plan. The complex will not be destroyed unless it becomes evident that the complex will be captured intact.

If the players went to the island first, then the training center will be put on alert the moment the island base was attacked. If the island is going to be destroyed, the training center will be evacuated and then destroyed as well.

STARGAZER'S POWER

StarGazer has a range of 2500 feet (or 500 inches) where she has an 88% chance of perceiving anything specific. She coordinates the motorcycle patrols of the security forces when they are in her extended range by telepathy. Once the motorcycles are out of action, or the need for her attention becomes more pressing elsewhere, she will focus her attention on the most pressing problem.

HELIPAD

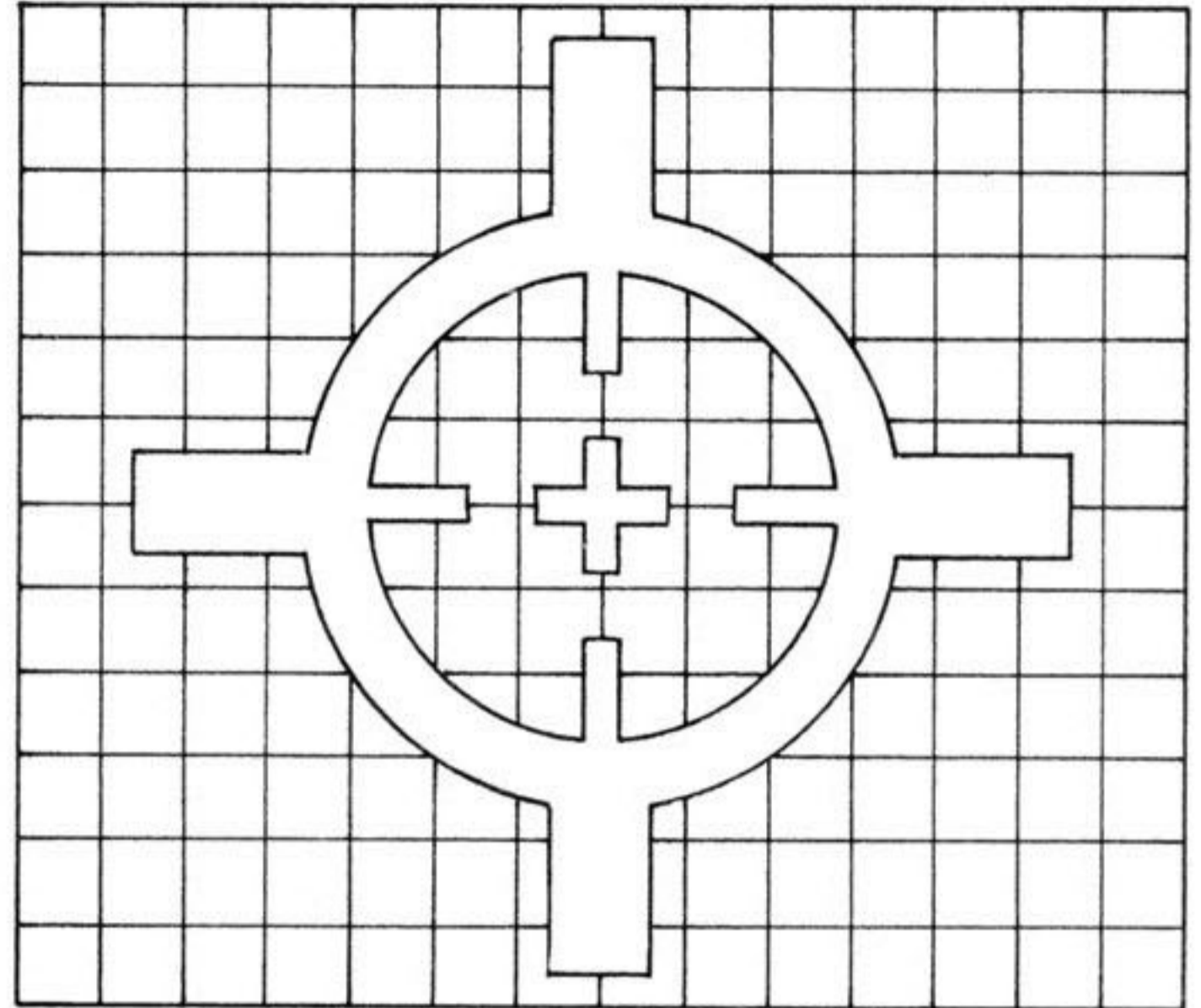

SCALE: 1 SQUARE = 5'

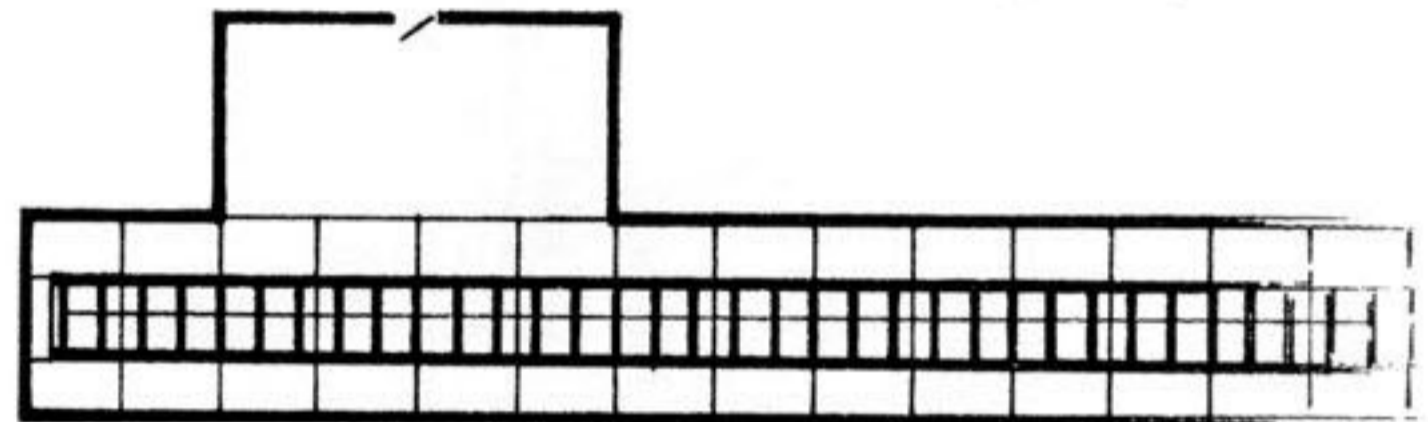

5. CAST OF CHARACTERS

FORCE

Identity: F. Emerson/H. Kinkaid

Side: The Force

Experience: 41,250

Age:

Powers:

1. Android Body: +11 Endurance, 96% human appearance, can repair up to 76% of damage internally (20 pts.)
2. Body Power: Electro-touch, PR = 1. Damage = 1D12. Range = touch.
3. Psionics: Charisma Enhancement to 25. PR = 3 per hour. Enhanced to 46 = PR of 8 per attack (as Mind Control).
4. Heightened Intelligence: +20
5. Life Support Device

Weight: 230 lbs.

Agility Mod.: -

Endurance: 24

Intelligence: 33

Reactions from Good: *

Hit Mod.: 8.424

Damage Mod.: +5

Accuracy: +1

Carrying Cap.: 529 lbs.

Movement Rate: 50 inches ground

Det. Hidden: 26%

Inventing Points: 18.4

Sex: Male

Level: 8

Training: Agility

Basic Hits: 5

Strength: 13

Agility: 13

Charisma: *

Evil: *

Hit Points: 42

Healing Rate: 3.5

Power: 83

Basic HTH: 1D8

Det. Danger: 30%

Inventing: 99% (flight device)

* Charisma is modified as described under his power of Charisma Enhancement from Psionic Powers. If used against a player character without the player character realizing that FORCE is evil, use the Good vs Good reaction modifier. If he is known to be evil, use the Evil vs Good modifier. When used against pedestrians, use the Good vs Good modifier.

Origin & Background: Force is, in reality, multi-millionaire Franklin Emerson (Franklin Oscar Randolph Charles Emerson), owner of Emerson Electronics. Force is actually a highly sophisticated android. He uses different voices when appearing as Force, Emerson, or Kinkaid. Force/Emerson is also Heronomous Kinkaid. When he addresses people and he needs to convince them of what he is saying (i.e. Kinkaid addressing a gathering, Emerson at a business meeting, or Force when acquiring new agents) he uses his unique psionic power to temporarily raise his Charisma score so as to alter people's view of him. He can either raise it to 25 (from its normal 17) to subtly affect people, or he can raise it to 46 to really affect them. Whenever he raises it to 46, he must make a successful Mind Control attack. If he does not succeed in this attack, the intended victim must make a percentage roll save against his or her Intelligence to be aware that something has occurred. If the victim is successful, he/she is aware that something happened, but does not know exactly what transpired. If this save is not made, the victim is unaware that anything happened, and views Force as having a 25 Charisma.

The Gamemaster should always remember that Force is both Randolph Emerson and Heronomous Kinkaid and may, at any time he chooses, portray any of the three. Also note that in the guise of Emerson he rarely uses his Psionic power, preferring to maintain the 25 Charisma level whenever possible.

Force appears to be a tall (6'5") well-built man. He wears a white, skin-tight costume with a green 'F' over the breast pocket area.



THE FORCE

The Force is a group dedicated to world rule under the divine (or so they believe) guidance of their leader, known as Force. The group presently specializes in mega-buck blackmail and political assassinations (for favors or fees). The members of The Force are ultra-fanatical in their crusade and will resort to anything to fulfill their missions. The Force has an almost limitless supply of advanced equipment due to the identity of Force.

Heronomous Kinkaid: It is in this guise that Force recruits personnel for his organization. He first holds massive rallies from which he chooses potential recruits. (At these rallies he only uses the Charisma of 25.) Once he has determined which recruits he would like in his organization, he approaches them individually and uses the high power charisma level on them. If he succeeds, he will recruit them into the Church. Once they are safely at the Church communes in either Kansas or California, he uses the high power Charisma on them again and inducts them into The Force.

Heronomous Kinkaid appears as a tall man (6 feet tall) with a light to medium build. He has jet black hair. He also constantly wears dark sunglasses. Under the sunglasses, he has blue eyes.

The Church of Divine Harmony: The primary teaching of the Church is that of unilateral equality. All men, no matter what their differences, are equal. The leader of the Church is Father Heronomous Kinkaid. Kinkaid is believed to be the one who will bring equality to the world. The Church of Divine Harmony is a registered, non-profit organization.

Franklin Emerson: Emerson, born in 1940, is no longer human. In 1967 he contracted an incurable degenerative muscular disease that was destined to kill him. Nine years later, in 1976, he had an android created in his likeness. When it became impossible for him to function properly as a human being, he had his thought/memory patterns transferred to the android. The monetary cost was staggering, but the transfer was successful. He explained his sudden cure as the result of an experimental drug he took in a Mexican clinic.

Emerson appears as a tall man (three inches over six feet tall) with a light to medium build. He has dark black hair that is streaked with gray. His eyes are dark brown.

Emerson Electronics Corp.: The slogan of Emerson Electronics, 'Tomorrow's Priorities Today,' is a clear example of the views of the

company. Emerson Electronics' development of the laser memory chip (twice the memory, half the size) has put the company at the top of the electronics ladder. In conjunction with a weapons manufacturer, Thorfin Enterprises, Emerson developed the Hyper-Lance missile, currently in use by both the United States and NATO. The main corporate headquarters is in Chicago, while the actual plants are in Connecticut and Missouri. The company is solely owned by Franklin Emerson.

The GM should be completely aware that Force, Franklin Emerson, and Heronomous Kinkaid are all one and the same. For the sake of simplicity it can be assumed that Emerson is the primary incarnation (since he was, indeed, the first). Emerson alters his android form to fit the description of any of his three selves. This is done through make-up, replaceable facial masks (the face plate of the android), lifts in the soles of his feet, and other similar methods. This enables Emerson to change himself to be either Emerson, Force, or Kinkaid.

CICADA

Identity: Larry Williams

Side: The Force

Experience: 2,900

Age: 23

Powers:

1. Heightened Endurance (B): +16

2. Heightened Agility (B): +11

3. Wings: +3 Agility and air movement of 199 mph (875 inches/turn)

3. Animal Power (Insect): Diminished Senses: Colorblind, lowered hearing

Reduced Charisma: -5

Natural Weaponry: +3 to Hit, +6 Damage

Heightened Senses: x3 Danger Detection

Weight: 150 lbs.

Agility Mod.: -

Endurance: 30

Intelligence: 16

Reactions from Good: +1

Hit Mod.: 15.96

Damage Mod.: +4

Accuracy: +4

Carrying Cap.: 478 lbs.

Movement Rates: 70 inches ground, 875 inches air

Det. Hidden: 12%

Inventing Points: 1.2

Sex: Male

Level: 2

Training: Strength

Basic Hits: 3

Strength: 15

Agility: 25

Charisma: 8

Evil: -1

Hit Points: 48

Healing Rate: 2.7

Power: 86

Basic HTH: 1D6

Det. Danger: 48%

Inventing: 48%



Origin & Background: Cicada is a direct result of driving while intoxicated. Larry Williams was attending the Mardi Gras in New Orleans when, in a drunken stupor, he ran down an old woman with his car. Before the old woman died, she threw a curse on Williams, turning him into Cicada.

Cicada is obviously insect shaped, but he is humanoid. He is very tall (7 feet) and thin. His eyes are black. When he talks he drools (so he rarely speaks).

CLAMOR

Identity: Billy Klang

Side: The Force

Experience: 7,285

Age: 20

Powers:

1. Sonic Abilities: (with Mutant Power) Range = 20 inches. Damage = 1D12. PR = 1. There is a 10% chance to destroy.
 - a) Ignore structural strength of invulnerable structures
 - b) +5 damage to all but invulnerable targets
2. Heightened Expertise: +4 to hit with Sonic Abilities
3. Natural Weaponry: +1 to Hit, +2 Damage
4. Heightened Defense: -4 to hit
5. Heightened Agility: +10

Weight: 150 lbs.

Agility Mod.: -

Endurance: 18

Intelligence: 14

Reactions from Good: -1

Hit Mod.: 3,146

Damage Mod.: +1

Accuracy: +1

Carrying Cap.: 210 lbs.

Movement Rate: 50 inches ground

Det. Hidden: 10%

Inventing Points: 4.2

Basic Hits: 3

Strength: 10

Agility: 22

Charisma: 12

Evil: +1

Hit Points: 9

Healing Rate: 1.5

Power: 64

Basic HTH: 1D4

Det. Danger: 14%

Inventing: 42%

MR. MAGNUM

Identity: Oliver Harris

Side: The Force

Experience: 8,790

Age: 43

Powers:

1. Heightened Expertise (x2): +4 to hit with Military weapons and HTH
2. Heightened Endurance (B): +19
3. Heightened Senses: x3 chance to detect danger, heightened sense of balance (+3 on Agility saves)
4. Special Weapon: 'Magnum' weapon which can be used on automatic. Damage = 2D8, +3 to hit, 15 bullets per clip, 5 clips carried.
5. Force Screen Device: Device worn on arm, generates a Force Screen which protects front and side facings only. PR = 1 per attack repulsed and carries 28 charges.

Weight: 200 lbs.

Agility Mod.: -

Endurance: 30

Intelligence: 12

Reactions from Good: -

Hit Mod.: 6.5208

Damage Mod.: +1

Accuracy: +1

Carrying Capacity: 574 lbs.

Movement Rate: 58 inches ground

Det. Hidden: 10%

Inventing Points: 0.6

Basic Hits: 4

Strength: 14

Agility: 14

Charisma: 9

Evil: -

Hit Points: 26

Healing Rate: 3.6

Power: 70

Basic HTH: 1D8

Det. Danger: 42%

Inventing: 36%



Origin & Background: The top brass of the United States Army were deathly afraid to promote Oliver Harris to Major, even though he was the best damn soldier the Army ever had. The problem was that Harris was too violent for the Army (soldiers in his command had a habit of dying on maneuvers). The Army, therefore, decided to retire Harris. Harris was upset. It was he who engineered the theft of the S-97 Virus from the Army.



Origin & Background: Billy Klang was rapidly on his way to becoming a major Heavy Metal rock star. Then, his voice changed. He could no longer get a booking since no promoter was willing to book a performer who literally brought the house down. Billy Klang hit the road to get away from it all and eventually encountered the Church of Divine Harmony.

Clamor is just under six feet tall. He has dark black hair and brown eyes. He wears a tight fitting blue costume with light blue gloves and boots. He also wears a dark blue half-face mask.

Mr. Magnum is tall (6 feet, 7 inches). He wears dark black pants, black shirt, black windbreaker, and dark sunglasses (of a different style than those worn by Kinkaid). He has dark brown hair and brown eyes.

Mr. Magnum carries a curious looking key at all times, which players may locate if they search. This is a key for the self-destruct mechanism at the Kansas Commune.

PHANTASM

Identity: Franz Undorf

Side: The Force

Experience: 10,310

Age: 37

Powers:

1. Illusion A/B: A) Holograms
B) Solid Energy (Creation Points = Current Power x 2). Range = 70 inches.
2. Heightened Agility (B): +21
3. Heightened Intelligence (B): +25
4. Adaptation: PR = 1 per hour or use as a defense
5. Flight: PR = 1 per hour. Speed is 255 mph (1122 inches/turn)

Weight: 240 lbs.

Agility Mod.: -

Endurance: 17

Intelligence: 36

Reactions from Good: -2

Hit Mod.: 16.2792

Damage Mod.: +8

Accuracy: +6

Carrying Cap.: 609 lbs.

Movement Rates: 67 inches ground, 1122 inches air

Det. Hidden: 28%

Inventing Points: 10.4

Basic Hits: 5

Strength: 15

Agility: 35

Charisma: 17

Evil: +2

Hit Points: 81

Healing Rate: 2

Power: 103

Basic HTH: 1D8

Det. Danger: 30%

Inventing: 108%



Origin & Background: Professor Franz Undorf was West Germany's foremost laser expert until four years ago. At that time, Undorf was experimenting with the use of a synthetic prism to refract laser light. Unfortunately for Undorf, not only did the prism refract the light, but it also amplified and altered the light. The altered light/radiation reached down into his cells and mutated his DNA structure. He quickly realized that his new DNA structure gave him incredible powers. Shortly thereafter, Undorf met Franklin Emerson and teamed up with him. Phantasm is the only one of Force's underlings not affected by his Charisma power. Phantasm follows Force until such time as he is able to break off on his own.

Phantasm is a tall man (6 feet, seven inches) who wears a multi-colored, semi-reflective costume. When he creates an illusion of type B (creation) multi-colored beams of light/energy emit from his hands. He can will this not to happen if he so wishes.

SHADARKOS

Identity: Matthew Harrison

Side: The Force

Experience: 6,221

Age: 50

Powers:

1. Disintegration Ray (2 times): Range = 14 inches. Damage = 2D20. PR = 3.
2. Darkness Control: Range = $\frac{1}{4}$ Power Score. PR = 2 to create + one action, reshaping costs only movement.
3. Transformation: Shapeshift to Black Eagle. He has only HTH attack capability in this form.
4. Willpower: Type A. He can force himself beyond normal limits.

Weight: 180 lbs.

Agility Mod.: -

Endurance: 15

Intelligence: 18

Reactions from Good: -

Hit Mod.: 4.4928

Damage Mod.: +2

Accuracy: +2

Carrying Cap.: 392 lbs.

Movement Rates: 44 inches ground, 308 inches in air as Black Eagle

Det. Hidden: 14%

Inventing Points: 2.4

Sex: Male

Level: 3

Training: Endurance

Basic Hits: 4

Strength: 14

Agility: 15

Charisma: 11

Evil: -

Hit Points: 18

Healing Rate: 1.6

Power: 62

Basic HTH: 1D6

Det. Danger: 18%

Inventing: 54%



Origin & Background: Just over twenty five years ago, archeologist Matthew Harrison was aiding in the excavation of a tomb somewhere in Egypt. He discovered a red crystal ring that did not seem to fit with the other artifacts already uncovered. The ring was Evil (with a capital E). It influenced him to steal it and bring it back with him to America (against Egyptian laws which forbid the removal of any discovered artifacts from Egyptian soil). Shortly after returning to the States, the ring began to affect him. It took many years, but he eventually evolved into Shadarkos.

Shadarkos is of average height and thin. He has gray hair and eyes. He wears dark robes that stretch down to the floor and wears a red crystal ring on his hand.

SNOWBLIND

Identity: Johnny Roget

Side: The Force

Experience: 3,650

Age: 27

Powers:

1. Heightened Agility (B): +20
2. Invulnerability: 17 points
3. Regeneration: 2 points (50% of +1), maximum of once per turn
4. Ice Power: Range = 6 inches. Damage = 1D12. PR = 5.
5. Light Control: Range = 58 inches. Damage = 2D8. PR = 1*

Weight: 210 lbs.

Agility Mod.: -

Endurance: 18

Intelligence: 11

Reactions from Good: -

Hit Mod.: 6.16

Damage Mod.: +3

Accuracy: +5

Carrying Cap.: 294 lbs.

Movement Rate: 57 inches ground

Det. Hidden: 8%

Inventing Points: 0.2

Basic Hits: 5

Strength: 10

Agility: 29

Charisma: 11

Evil: -

Hit Points: 31

Healing Rate: 2.5

Power: 68

Basic HTH: 1D6

Det. Danger: 12%

Inventing: 33%

* If a player character is encased in ice and is struck by a light beam, make a separate additional roll (special attack) to determine if the character will be temporarily blinded. The PC will remain blinded by light for turns equal to the damage caused minus the target's END. If SnowBlind uses a Glare Attack while encased in ice armor, add +2 to the chance of blinding in this fashion.



Origin & Background: Johnny Roget was not prepared for the incredible biological reaction when he accidentally inhaled pure freon gas at his job in a meat packing plant. The reaction also caused him to absorb the very light around him. Unable to handle the changes that had occurred in him, he turned to Father Heronomous Kinkaid for spiritual guidance. The rest can be easily guessed.

SnowBlind's costume is light blue with white areas resembling the facets of a crystal. He is tall (six feet three inches tall) and well built.

STARGAZER

Identity: Andrea Hanlon

Side: The Force

Experience: 6,110

Age: 89

Powers:

1. Cosmic Awareness: (Mutant Power) Range is a radius of 2500 feet. PR = 3 per turn. Brings four times normal sense of danger. 88% perception success (see text).
 2. Heightened Intelligence: +15
 3. Heightened Endurance: +6
 4. Telepathy: (Psionic) Range = 2500 feet. PR = 1.
- Physical Handicap: Crippled.

Weight: 130 lbs.

Agility Mod.: -

Endurance: 20

Intelligence: 25

Reactions from Good: -3

Hit Mod.: 5.28

Damage Mod.: +3

Accuracy: +2

Carrying Cap.: 195 lbs.

Movement Rate: 15 inches in wheelchair

Det. Hidden: 18%

Inventing Points: 7.5

Basic Hits: 3

Strength: 10

Agility: 15

Charisma: 20

Evil: +3

Hit Points: 16

Heal Rate: 1.5

Power: 70

Basic HTH: 1D4

Det. Danger: 88%

Inventing: 75%

Origin & Background: Andrea Hanlon led a completely normal life until a tragic fire took the life of her daughter and three grandchildren. She lapsed into a self-induced coma. Father Kinkaid found her in that state during a visit to a nursing home (during this self-induced coma, her mind traveled the multitude of dimensions that intersect our own.) It was during her mental travels that she gained her mental powers.

StarGazer stands about five feet tall and has white hair and gray eyes. She wears a simple gray robe with dark blue trim. She is quite old and lacks the patience to put up with Clamor, who she sees as immoral and decadent.



TELEPORTER

Identity: Stanley Forte
 Side: The Force
 Experience: 4,110
 Age: 20
 Powers:

Sex: Male
 Level: 2
 Training: Strength

1. Teleportation: Maximum Range = Current Power x 10,000 in inches.
 PR = 5.
2. Heightened Agility (A): +16
3. Heightened Endurance (B): +23

Weight: 100 lbs.	Basic Hits: 2
Agility Mod.: +2	Strength: 14
Endurance: 33	Agility: 29
Intelligence: 12	Charisma: 11
Reactions from Good: -	Evil: -
Hit Mod.: 15.5232	Hit Points: 31
Damage Mod.: +3	Heal Rate: 2
Accuracy: +5	Power: 88
Carrying Cap.: 302 lbs.	Basic HTH: 1D6
Movement Rate: 76 inches ground	
Det. Hidden: 10%	Det. Danger: 14%
Inventing Points: 0.4	Inventing: 36%

Origin & Background: Mr. and Mrs. Forte quickly recognized that their young son; Stanley, was not an ordinary baby. They constantly found Stanley in the strangest places after he had vanished from where they had left him. Unable to deal with the urchin, Stanley's parents were forced to put him up for foster care. The boy was bounced from foster home to foster home. Stanley eventually found a sense of belonging in the Church of Divine Harmony.

Teleporter is six feet tall and very thin. His costume is gold and black with some dark blue areas. Both his hair and mustache are dark black.

It should be noted that Teleporter will be present for the pick-up of the ransom but not at St. Sebastian Island.



GOON WEAPONS CHARTS

At the Island Base:

01 - P	16 - P	46 - AR
02 - P	17 - P	48 - K
03 - P	18 - K	49 - P
04 - K	22 - P	50 - P
06 - K	25 - P	53 - P
07 - AR	26 - P	54 - P
08 - P	29 - K	55 - P
09 - AR	33 - K	56 - AR
10 - AR	40 - K	57 - AR
11 - P	42 - P	58 - AR
12 - AR	43 - P	59 - AR
13 - P	44 - P	60 - AR
14 - AR	45 - P	61 - AR

At the Training Complex:

01 - AR and P	13 - P	25 - P
02 - P	14 - P	29 - K
03 - P	15 - P	30 - K
04 - P	16 - P	46 - AR
05 - P	17 - P	47 - AR
06 - P	18 - P	48 - AR
07 - P	19 - P	49 - AR
08 - P	20 - P	50 - AR
09 - P	21 - P	57 - AR
10 - P	22 - P	58 - AR
11 - P	23 - P	62 - P
12 - P	24 - P	65 - P

P = Pistol, K = Knife, AR = Automatic Rifle.
 Any Goons not listed are unarmed.

GOONS

Number	Hit Points	Power	Accuracy	Dam. Mod.	Move	HTH	Agility
01	12	55	+1	+1	37	1D6	13
02	8	54	+1	+2	41	1D4	14
03	12	60	-	-	38	1D8	10
04	9	51	-	-	35	1D8	11
05	23	72	+2	+2	57	1D8	16
06	6	48	-	+2	31	1D6	9
07	10	56	+1	+1	38	1D6	12
08	15	64	+1	+2	40	1D8	14
09	9	51	-	+2	37	1D6	11
10	6	45	+1	+2	33	1D4	12
11	10	59	+2	+3	40	1D6	15
12	10	49	+2	+3	42	1D6	16
13	16	67	+3	+3	41	1D8	18
14	13	60	+2	+4	39	1D8	16
15	11	44	+1	+1	37	1D8	12
16	12	53	+1	+1	39	1D4	13
17	13	46	+2	+3	35	1D8	16
18	12	78	+1	+2	43	1D6	13
19	13	53	+1	+2	45	1D6	14
20	9	51	+1	+1	37	1D8	12
21	12	60	-	+1	43	1D6	10
22	10	58	+1	+2	42	1D6	13
23	9	47	+2	+2	32	1D8	17
24	13	52	-	-	40	1D6	11
25	11	53	+1	+1	40	1D8	13
26	15	67	+2	+3	41	1D8	16
27	20	62	+2	+3	41	1D8	16
28	12	60	+1	+1	47	1D6	13
29	6	52	-	-	39	1D4	11
30	21	60	+2	+3	39	1D8	17
31	9	53	+1	+1	41	1D6	12
32	12	60	+1	+1	47	1D6	13
33	10	56	-	-	44	1D6	10
34	7	49	-	-	40	1D8	11
35	11	59	+2	+1	45	1D6	15
36	8	62	-	+1	46	1D6	9
37	17	58	+1	+1	44	1D8	12
38	10	53	+1	+1	41	1D4	14
39	11	52	+1	+1	40	1D6	13
40	8	54	+1	+1	41	1D6	14
41	12	59	+2	+2	40	1D6	16
42	9	57	-	-	41	1D4	10
43	5	60	-	-	46	1D6	11
44	21	56	+2	+1	42	1D8	15
45	13	51	+1	+2	35	1D8	13
46	16	58	-	+1	43	1D8	10
47	21	52	+1	+2	40	1D8	12
48	13	62	-	-	47	1D6	11
49	10	47	+1	+1	39	1D6	14
50	11	46	+2	+2	36	1D4	16
51	9	51	-	+1	41	1D6	10
52	5	59	+1	+1	45	1D6	14
53	8	56	+2	+1	42	1D6	15
54	7	55	+1	+1	46	1D8	13
55	11	59	-	-	46	1D8	10
56	9	57	-	+1	38	1D8	10
57	10	52	+2	+1	38	1D8	15
58	11	51	-	-	37	1D8	11
59	7	60	+1	+1	46	1D8	12
60	8	53	-	+1	36	1D6	10
61	5	52	-	-	41	1D4	11
62	6	58	+2	+1	44	1D4	15
63	9	59	-	+1	44	1D6	11
64	10	51	+1	+1	40	1D8	12
65	11	57	+1	+1	43	1D6	13

POST MORTEM

When the smoke has finally cleared, the Gamemaster should keep in mind the following pieces of information:

1) Emerson has created a respectable number of replacement androids. These are kept scattered across the globe in Force or Emerson run installations. The androids are kept dormant until they are needed. When the currently operative android is destroyed, the entire memory of that android is transferred to the next replacement android in line. This is accomplished by means of a powerful microwave transmission (emitted from the defunct Force android and bounced off an orbiting Emerson Electronics satellite) from the defunct android to the next in line. The time delay is approximately fifteen seconds (one turn) before the replacement android is active and in control of the entire Force/Emerson/Kinkaid persona.

2) The superheroes cannot be sure they have successfully captured or killed Phantasm as they may have encountered an animated illusion.

3) It is in the tradition of the comics that the obviously vanquished or dead are not really so and that such defeated foes may continue to reappear ad infinitum.

4) Also realize that Force has more super-powered henchmen around the world.



















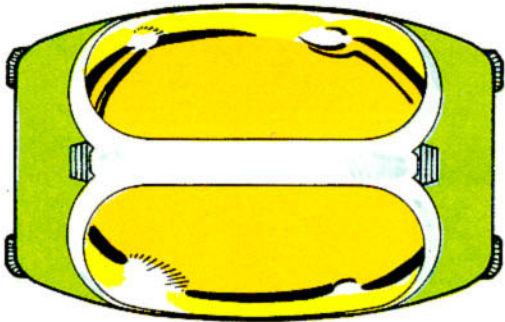
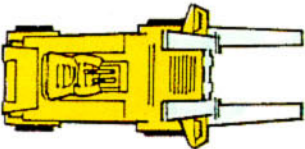

As mentioned earlier, the Gamemaster should feel free to change anything that does not fit his own campaign. It is recommended that the levels of the NPCs be dependent upon the levels of the player characters themselves. Super-Villains should be one or two levels higher than the heroes to make up for the disadvantage of the GM having to run all NPCs while the players run only their own characters. Goons should be two levels below the heroes (minimum of first level). This should help to balance the scenario. Simply adjust the character stats of the NPC villains to reflect such changes made in their levels.

Well, that about wraps this one up. Any comments and/or criticisms about this adventure would be greatly appreciated. Send them to the author in care of FGU.

In the **Villains and Vigilantes** campaign that included this adventure, nuclear destruction was averted with mere seconds to spare. Force, Mr. Magnum, Shadarkos, and Phantasm escaped in the rocket-plane. SnowBlind and Cicada were captured. Shortly thereafter, Phantasm left the Force and has struck out on his own. SnowBlind was temporarily crippled (brain damage) in an aborted prison escape. StarGazer and Clamor vanished in the midst of the commune raid.

At this point, the player characters have been unable to conclusively prove that Franklin Emerson is Force, so he remains free. The heroes have no doubts that they will encounter Phantasm again, but the question is when (and where)?

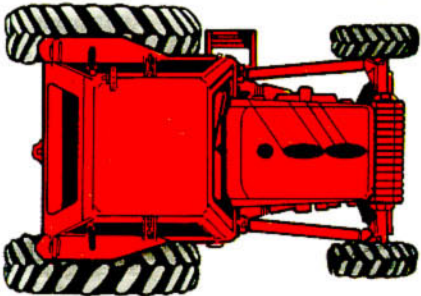
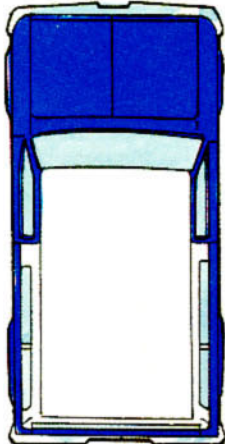
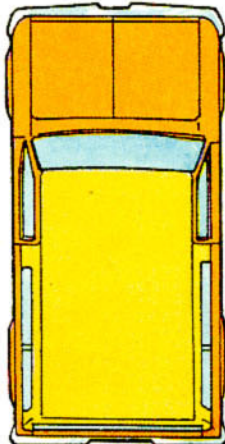

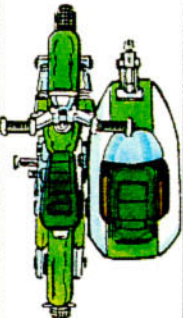
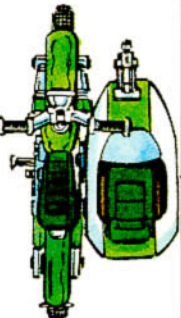
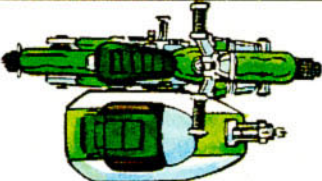
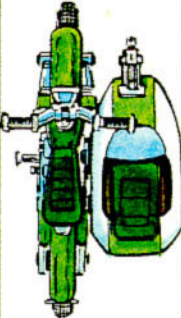
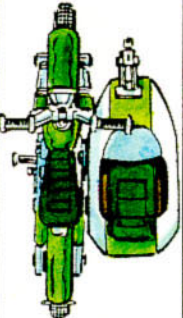
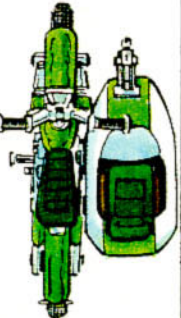
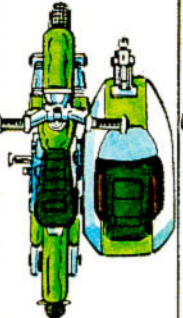
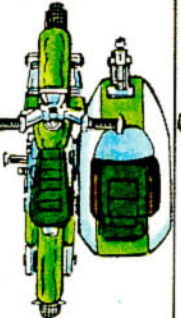
						
CICADA	CLAMOR	FATHER KINKAID	FORCE	FRANKLIN EMERSON	MR. MAGNLM	PHANTASM
						
SHADARKOS	SNOWBLIND	STARGAZER	TELEPORTER			
FORKLIFT-						
						
TRACTOR						
				LAND ROVER-1		LAND ROVER-2
MOTORCYCLE-1	MOTORCYCLE-2	MOTORCYCLE-3	MOTORCYCLE-4			MOTORCYCLE-5
						
MOTORCYCLE-6	MOTORCYCLE-7	MOTORCYCLE-8	MOTORCYCLE-9	MOTORCYCLE-10	MOTORCYCLE-11	MOTORCYCLE-12

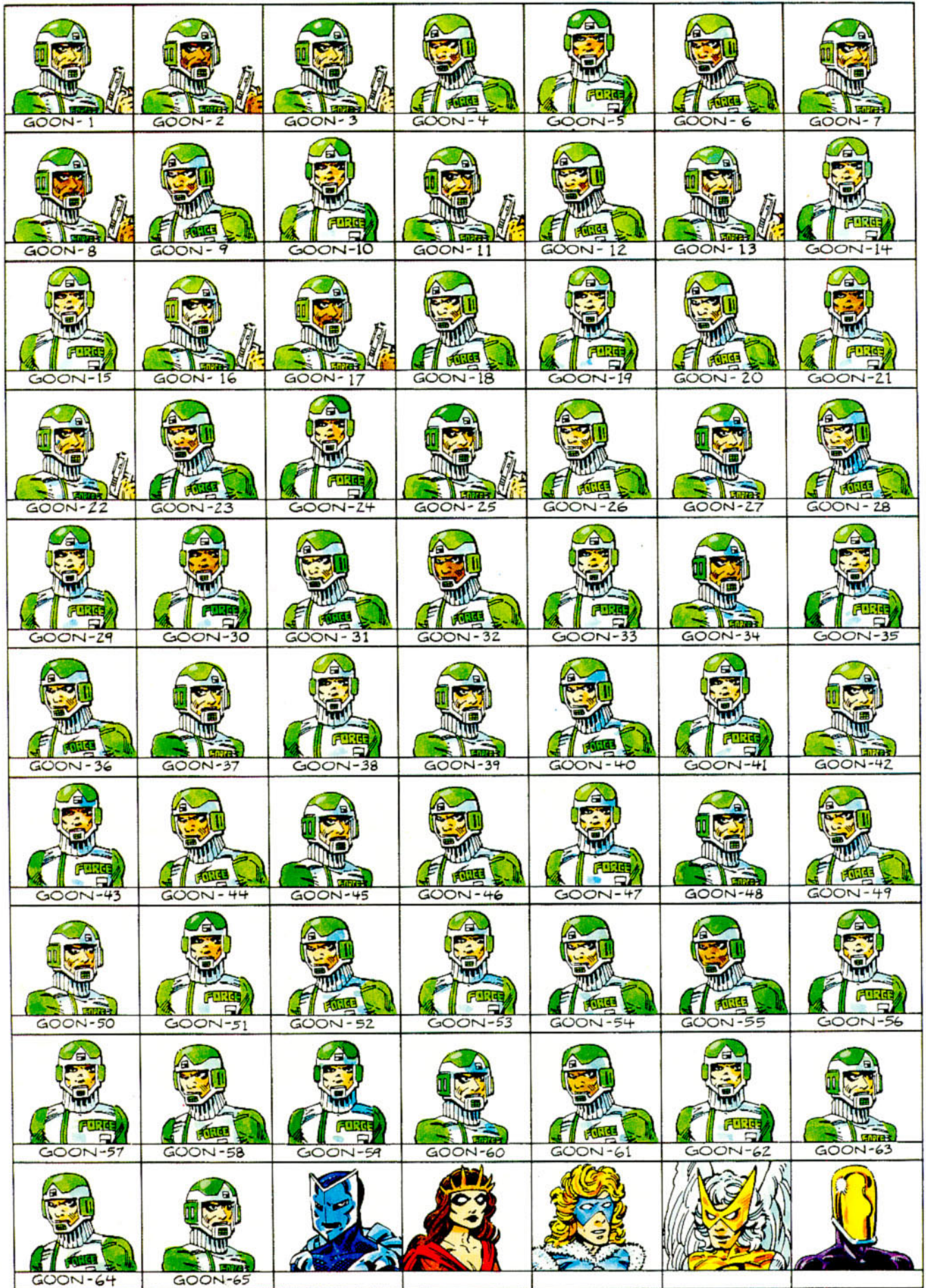

HERE'S A FANTASTIC ADVENTURE FOR THE VILLAINS AND VIGILANTES™ GAME-SYSTEM. A MYSTERIOUS ORGANIZATION CALLING ITSELF THE FORCE HOLDS AMERICA FOR RANSOM... CAN YOU TRACK THEM DOWN AND SAVE THE EASTERN SEABOARD FROM THE INSIDIOUS EFFECTS OF VIRUS S-97? THIS IS AN EXCITEMENT-FILLED ADVENTURE FOR FOUR OR MORE SUPERHERO CHARACTERS.



IN THE BEGINNING, THERE WAS THE **PLAN**...

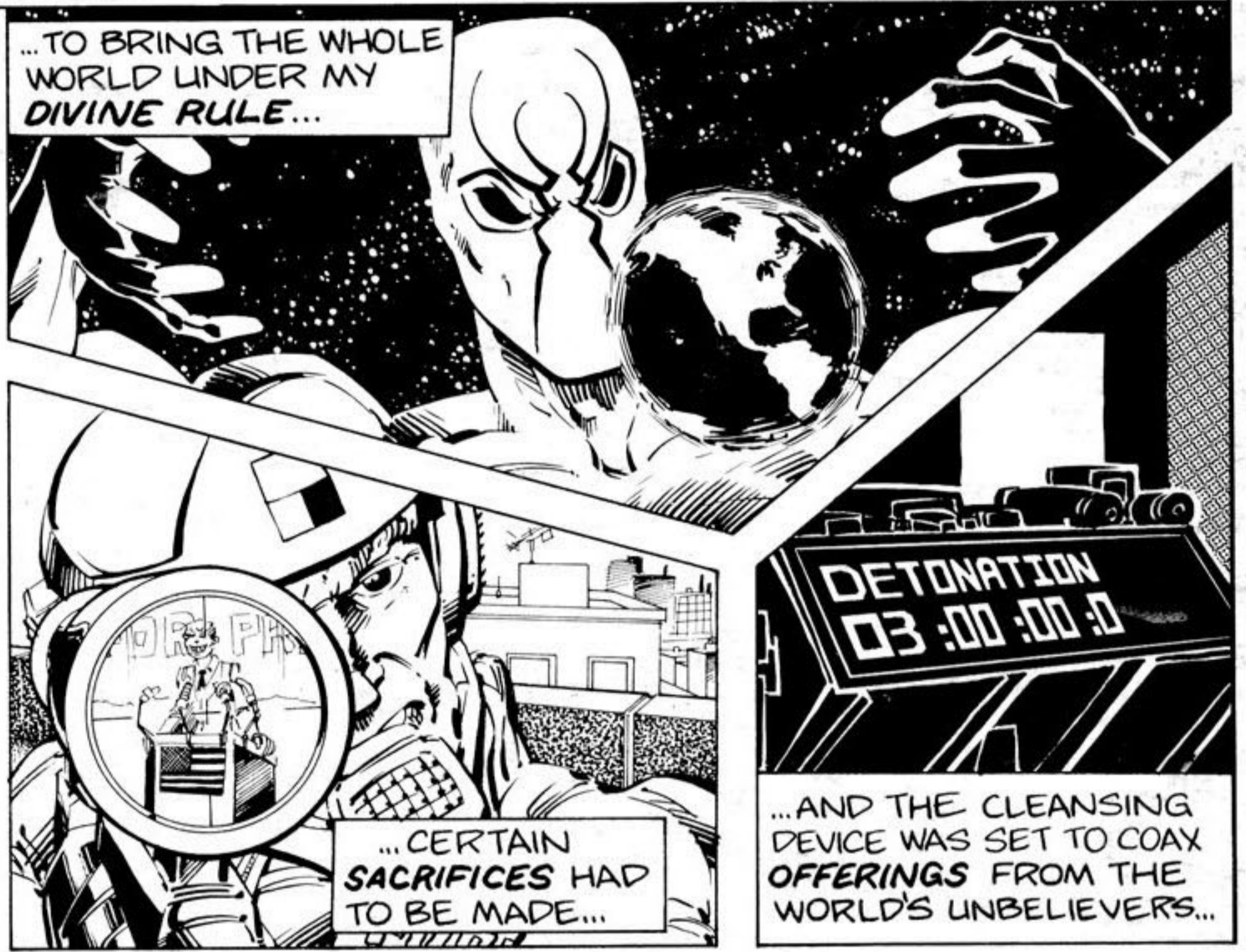

...TO BRING THE WHOLE WORLD UNDER MY **DIVINE RULE**...

...CERTAIN **SACRIFICES** HAD TO BE MADE...

DETONATION
03 :00 :00 :0

...AND THE CLEANSING DEVICE WAS SET TO COAX **OFFERINGS** FROM THE WORLD'S UNBELIEVERS...



...AND THE HEATHENS SENT **WARRIORS** TO RUIN OUR HOLY WORK...

AND THE LORD SAID... **KILL THEM ALL!**

© JEFF DEE 1982



TOM DOWD AUTHOR * **JEFF DEE** ARTIST/EDITOR * **SCOTT BIZAR** EDITOR-IN-CHIEF * **MR. SCARLET** A.S.A. CONSULTANT